



— 2020–2021 —

# Penn State Tree Fruit Production Guide



**PennState Extension**

***Production Guide Coordinator***

R. M. Crassweller

***Horticulture***

R. M. Crassweller, section coordinator

T. A. Baugher, T. G. Ford, R. P. Marini, J. R. Schupp,  
D. Weber

***Entomology***

G. Krawczyk, section coordinator

D. J. Biddinger

***Pollination and Bee Management***

D. J. Biddinger, M. López-Uribe

J. Hopwood, Xerces Society

***Plant Pathology and Nematology***

K. A. Peter, section coordinator

B. L. Lehman

***Wildlife Resources***

M. C. Brittingham

***Pesticide Safety***

J. Johnson, E. Crow, E. Weaver, Penn State Pesticide Education  
Program

***Harvest and Postharvest Handling***

R. M. Crassweller, J. R. Schupp

***Cider Production and Food Safety***

L. F. LaBorde

***Orchard Budgets***

J. K. Harper, L. F. Kime

***Farm Labor Regulations***

K. Kephart, R. H. Pifer

***Marketing***

K. M. Kelley

***Precision Agriculture***

L. He, P. Heinemann

***Disease, Insect Figures***

C. Gregory, C. Jung

***Cover Photo***

R. M. Crassweller

---

**extension.psu.edu**

Penn State College of Agricultural Sciences research and extension programs are funded in part by Pennsylvania counties, the Commonwealth of Pennsylvania, and the U.S. Department of Agriculture.

Where trade names appear, no discrimination is intended, and no endorsement by Penn State Extension is implied.

This publication is available in alternative media on request.

The University is committed to equal access to programs, facilities, admission and employment for all persons. It is the policy of the University to maintain an environment free of harassment and free of discrimination against any person because of age, race, color, ancestry, national origin, religion, creed, service in the uniformed services (as defined in state and federal law), veteran status, sex, sexual orientation, marital or family status, pregnancy, pregnancy-related conditions, physical or mental disability, gender, perceived gender, gender identity, genetic information or political ideas. Discriminatory conduct and harassment, as well as sexual misconduct and relationship violence, violates the dignity of individuals, impedes the realization of the University's educational mission, and will not be tolerated. Direct all inquiries regarding the nondiscrimination policy to the Affirmative Action Office, The Pennsylvania State University, 328 Boucke Building, University Park, PA 16802-5901, Email: [aao@psu.edu](mailto:aao@psu.edu), Tel (814) 863-0471.

Produced by Ag Communications and Marketing

© The Pennsylvania State University 2020

Code AGRS-045 Rev8M01/20printers.com

# CONVERSION OF WEIGHTS AND MEASURES

## Dry measure

16 ounces = 1 pound  
 one ton = 2,000 pounds  
 1 metric ton = 1.102 ton

## Square measure

one acre = 43,560 square feet = 4,840 yards  
 one square foot = 144 square inches  
 one square yard = 9 square feet

## Weights of liquids

1 gallon water = 8.34 pounds  
 1 cubic foot water = 62.4 pounds  
 231 cubic inches = 1 gallon

## Linear measure

one foot = 12 inches  
 one yard = 3 feet = 36 inches  
 one rod = 16.5 feet = 5.5 yards  
 one mile = 5,280 feet = 8 furlongs  
 one rod x 1 mile = 2 acres

## Cubic measure

1 cubic foot = 1,728 cubic inches  
 1 cubic yard = 27 cubic feet  
 231 cubic inches = 1 gallon

## Parts per million (ppm)

ppm = % x 10,000  
 1% = 10,000 ppm  
 1 ppm = 1 milligram per liter  
           = 1 milligram per kilogram  
 1 ppm = one part per million by weight  
           = 1 pound in 100,000 gals. of water  
 100 ppm = 1 pound in 1,000 gals. of water  
           = 1.6 ounces in 100 gals. of water

## Liquid measure

1 tablespoon = 3 teaspoons  
 1 fluid ounce = 2 tablespoons  
 1 cup = 8 fluid ounces = ½ pint  
 1 pint = 2 cups = 16 fluid ounces  
 1 quart = 2 pints = 4 cups = 32 fluid ounces  
 1 gallon = 4 quarts = 8 pints = 16 cups = 128 fluid ounces

## Miscellaneous facts

diameter = circumference x 0.318  
 area of a circle = diameter<sup>2</sup> x 0.785  
 volume of a cylinder = 3.14 x radius<sup>2</sup> x height  
 volume of a sphere = diameter<sup>3</sup> x 0.524  
 volume of a cone = area of base x height ÷ 3  
 1 ppm is approximately:  
   1 inch in 16 miles or  
   1 minute in 2 years or  
   1 ounce in 31 tons or  
   1 cent in \$10,000

## METRIC WEIGHTS AND MEASURES

Centimeters	Inches	Feet	Meters	Yards	Inches	Kilometers	Miles
1.00	0.394	0.0328	1.000	1.093	39.37	1.000	0.621
2.54	1.000	0.083	0.914	1.000	36.000	1.609	1.000
30.48	12.000	1.000					

Acres	Hectares	Grams	Ounces	Pounds	Kilograms	Ounces	Pounds
1.000	0.405	1.00	0.035	0.002	1.000	35.274	2.205
2.471	1.000	28.35	1.000	0.063	0.028	1.000	0.063
		453.59	16.000	1.000	0.454	16.000	1.000
		1000.00	35.274	2.205			

Liters	Pints	Quarts	Gallons	Milliliter	Teaspoon	Tablespoon	Fluid ounce	Cup
1.000	2.113	1.057	0.264	1.000	0.200	0.064	0.032	0.004
0.473	1.000	0.500	0.125	15.000	3.000	1.000	0.500	0.063
0.946	2.000	1.000	0.250	240.000	48.000	16.000	8.000	1.000
3.785	8.000	4.000	1.000	30.000	6.000	2.000	1.000	0.125

## COMMON METRIC EQUIVALENTS

Metric	U.S.	U.S.	Metric
Millimeter	0.039 inches	Inch	2.54 centimeters
Centimeter	0.39 inches	Foot (12 in.)	30.5 centimeters
Meter (100 cm)	39.4 inches = 3.28 feet	Mile (5,280 ft.)	1.6 kilometers
Kilometer (1,000 m)	0.62 miles	Square inch	6.5 square centimeters
Square centimeter	0.155 square inches	Square foot (144 sq. in.)	930 square centimeters
Square meter	1.2 square yards	Square yard (9 sq. ft.)	0.84 square meters
Hectare (10,000 sq m)	2.471 acres	Acre (43,560 sq. ft.)	0.405 hectares
Square kilometer (100 ha)	247 acres	Ounce	28.3 grams
Gram	0.035 ounces	Pound (16 oz.)	453.5 grams = 0.454 kilograms
Kilogram (1,000 g)	2.2 pounds	Tablespoon (3 teaspoons)	14.79 milliliters
Ton (metric) (1,000 kg)	1.1 tons (U.S.)	Fluid ounce (2 tablespoons)	29.6 milliliters
Milliliter	0.032 fluid ounce	Pint (2 cups)	0.473 liters
Liter (1,000 ml)	1.056 quarts = 2.1 pints	Quart (4 cups)	0.946 liters
Cubic meter (1,000 l)	264.17 gallons (U.S.)	Gallon (U.S.) (4 quarts)	3.8 liters

---

# PENN STATE TREE FRUIT PRODUCTION GUIDE 2020–2021

---

<b>I. Cultural Information.....</b>	<b>1</b>
<b>II. Diseases, Disorders, Pests, and Natural Enemies.....</b>	<b>99</b>
<b>III. Chemical Management .....</b>	<b>191</b>
<b>IV. Chemical Management Tables .....</b>	<b>265</b>
<b>V. Integrated Pest Management Spray Programs .....</b>	<b>289</b>
<b>VI. Harvest and Postharvest Handling .....</b>	<b>331</b>
<b>VII. Cider Production.....</b>	<b>341</b>
<b>VIII. Maintaining the Safety of Pennsylvania Apples and Apple Products.....</b>	<b>349</b>
<b>IX. Farm Management .....</b>	<b>363</b>
<b>X. Marketing .....</b>	<b>391</b>
<b>XI. Precision Agriculture .....</b>	<b>425</b>

---

# CONTENTS

---

<b>Introduction</b> .....	iii
<b>Part I</b> Cultural Information .....	1
<b>Part II</b> Diseases, Disorders, Pests, and Natural Enemies .....	99
<b>Part III</b> Chemical Management.....	191
<b>Part IV</b> Chemical Management Tables .....	265
<b>Part V</b> Integrated Pest Management Spray Programs .....	289
<b>Part VI</b> Harvest and Postharvest Handling .....	331
<b>Part VII</b> Cider Production .....	341
<b>Part VIII</b> Maintaining the Safety of Pennsylvania Apples and Apple Products .....	349
<b>Part IX</b> Farm Management .....	363
<b>Part X</b> Marketing .....	391
<b>Part XI</b> Precision Agriculture .....	425
<b>Appendix</b> .....	437
<b>Bibliography</b> .....	440



---

# INTRODUCTION

---

The 2020–2021 edition of the *Penn State Tree Fruit Production Guide* has been updated and revised to make it as accurate as possible for current recommendations and pesticide registrations. The chapters, or parts, are printed on the back cover with tab markings to make them easy to locate. Comprehensive tables of contents are provided at the beginning of each part. Chemical management tables are grouped together to make them easily accessible. New parts were added to Parts I, II, III and IV. The pesticide registration information included in this guide reflects available labels as of September 2019. Always read the current pesticide label before any pesticide application.

---

## OVERVIEW OF THE PENN STATE TREE FRUIT PRODUCTION GUIDE

More than a “spray guide,” the *Penn State Tree Fruit Production Guide* collates information on the full range of commercial tree fruit production issues. The guide is revised every two years with input by a score of Penn State faculty members and other consultants. It is meant to be a reference that growers and other fruit industry personnel can turn to often.

**Part I, Cultural Information**, contains guidelines for establishing an orchard, choosing a tree fruit nursery, caring for nonbearing trees, and maintaining bearing orchards. Included is a listing of nurseries, up-to-date information on disease-resistant cultivars and rootstock availability, cookbook directions for pruning apples to different systems, a listing of apple and peach cultivars, as well as recommendations for summer pruning. Environmental monitoring and frost protection also are discussed in detail. The bee and pollination issues are also discussed in this chapter.

**Part II, Diseases Disorders, Pests, and Natural Enemies**, stresses the use of all possible control strategies in pest and pesticide management. It contains information on the biology of tree fruit pests and provides control options other than pesticides, including biological, biorational, and cultural pest management tools. In addition, commonly encountered disorders on fruit and leaves are also included.

**Part III, Chemical Management**, describes the appropriate use of chemicals within integrated pest management (IPM) and pesticide resistant management (PRM) strategies. It also deals with safety, spraying, and the use of individual pesticides.

**Part IV, Chemical Management Tables**, includes efficacy and timing tables for pesticide use in the various tree fruit crops. It also covers reentry and preharvest intervals and pesticide storage.

**Part V, Integrated Pest Management Spray Programs**, offers specific suggestions for pesticide use on apples, pears, peaches, nectarines, apricots, cherries, and plums. Remember that the pesticide label is the document that ultimately prescribes how a chemical can be used, and that labels can change. When applying a chemical, have a copy of the label in hand.

**Part VI, Harvest and Postharvest Handling**, incorporates new information on controlled-atmosphere fruit storage. Also discussed are fruit testing to determine maturity, storage guidelines, and the control of common postharvest fruit disorders and diseases.

**Part VII, Cider Production**, describes how to make, handle, and market safe, high-quality apple cider. Good manufacturing practices for cider production are described.

**Part VIII, Maintaining the Safety of Apples and Apple Products**, describes good management practices for growing, packing, and cider production to avoid potential food safety hazards.

**Part IX, Farm Management**, presents sample budgets for land preparation, orchard planting, and mature orchards, as well as production budgets for fresh-market apples, processing apples, fresh-market peaches, and other tree fruit. Also included in Part IX are updated descriptions of state and federal laws that apply to Pennsylvania fruit producers, including those governing hiring, wages and withholding, worker and community safety, workplace discrimination, and seasonal/migrant labor.

**Part X, Marketing**, provides basic information about marketing products and is intended to help growers consider whether they are fully utilizing their retail outlet, offering the right products to the right consumers, and using the right promotional strategy.

**Part XI, Precision Agriculture**, new for this edition, discusses developing a decision support system to improve efficiency and optimize returns while reducing inputs. Water use, energy consumption, labor, and environmental impact are examples of production practices that will be reduced. Once reducing these inputs, the result should be an increase in production, crop quality, and efficiency. These goals can be accomplished through the use of sensors, cameras, improved machinery, robotics, and autonomous field operations.

**Appendix: Tree Fruit on the Web** is a list of websites with information for growers. A bibliography of important reference texts follows the web listings. Finally, a chart of useful conversions for weights and measures is included.

## The IPM Approach

Pesticide use and pest resistance can be decreased—and even eliminated in some cases—by understanding diseases and insects clearly, scouting for pests routinely, and monitoring environmental conditions daily. Effective pesticide programs require careful pesticide applications and correct timing. The combination of thorough orchard monitoring, horticultural controls, and judicious pesticide use is known as integrated pest management (IPM).

IPM is the guiding concept of the 2020–2021 *Penn State Tree Fruit Production Guide*. To make the best use of this guide, study and understand the biology of diseases and insects. Then

incorporate horticultural control measures, as well as chemical ones, into your management strategy.

Always read the label before using any chemical on your farm. Application rates in this guide's tables and spray programs are given as amounts of the commercial formulations. Consult the section on pesticide safety (in Part III) or your county extension office concerning the safe disposal of any chemical mentioned in this publication.

All pesticides discussed in this guide are registered for the indicated crops as of September 2019. Application suggestions are based on the continued registration of each pesticide. If any material listed should lose or change its registered usage, a notice to that effect will be announced. A brief update of the information in this guide may be published in early 2021 and distributed at extension educational meetings and local extension offices. Do not use this publication after the 2021 season.





# CULTURAL INFORMATION

## CONTENTS

**Orchard Establishment ..... 3**  
 Site Selection ..... 3  
 Replanting an Orchard Site ..... 4  
 Orchard Layout ..... 5  
 Tree Nursery and Grade Selection ..... 6

**Orchard Floor and Weed Management ..... 9**  
 Row Middle Management ..... 9  
 Orchard Sod Management ..... 10  
 Tree Row Management ..... 10  
 Establishing a New Orchard ..... 10

**Plant Nutrition ..... 13**  
 Determining Tree Nutritional Status through Foliar Analysis.. 13  
 Nutrient Deficiency and Toxicity Symptoms in Tree Fruit... 14  
 Foliar Application of Nutrients ..... 17  
 Fertilizer Application ..... 18

**Apples ..... 21**  
 Cultivars ..... 21  
 Pruning ..... 28  
 Pruning and Training in Young Trees ..... 30  
 Summer Pruning of Apples and Peaches ..... 30  
 Deciding on a Production System ..... 31  
 Production Systems for Apples ..... 31  
 Apple Tree Spacing ..... 37  
 Using Beds to Attain Higher-Density Orchards ..... 40  
 Determining the Number of  
 Trees per Acre in Bed Plantings ..... 41  
 Apple Rootstocks ..... 41  
 Planting Depth ..... 44  
 Pollination ..... 44  
 Cork Spot and Bitter Pit Fruit Disorders ..... 59  
 Preharvest Assessment of the  
 Potential for Bitter Pit in Honeycrisp ..... 64

**Growth Regulators in Apple and Pear Production... 66**  
 Increasing Branching ..... 66  
 Shoot Growth Suppression ..... 66  
 Management of Fire Blight Using PCa ..... 70  
 Increasing Return Bloom ..... 70

Blossom Thinning of Apples ..... 70  
 Postbloom Chemical Thinning of Apples ..... 71  
 General Comments on Thinning ..... 73  
 Apple Preharvest-Drop-Control Sprays ..... 76  
 Record Keeping for the Application  
 of Plant Growth Regulators ..... 80

**Pears ..... 80**  
 Site Selection and Soil Preparation ..... 80  
 Asian Pears ..... 80  
 Cultivars Evaluated at Penn State ..... 81  
 Rootstocks ..... 81

**Peaches ..... 82**  
 Site Selection and Soil Preparation ..... 82  
 Nursery Tree Quality ..... 82  
 Planting Depth ..... 82  
 Peach and Nectarine Cultivars ..... 82  
 Pruning and Training Peaches ..... 84  
 Rootstocks ..... 89  
 Split Pit ..... 89  
 Shattered Pit ..... 89  
 Nectarine Pox ..... 90

**Cherries ..... 90**  
 Site Selection and Soil Preparation ..... 90  
 Growth Regulators ..... 90  
 Rain Cracking of Cherry Fruit ..... 90  
 Cultivars ..... 92  
 Rootstocks ..... 96  
 Pruning Cherries and Production Systems ..... 97

## TABLES

**Table 1-1.** Number of trees  
 per acre at various tree spacings ..... 6

**Table 1-2.** Nutritional ranges used to interpret leaf analysis  
 values for apples, peaches, nectarines, pears, and cherries ..... 15

**Table 1-3.** Recommended leaf nitrogen  
 levels for apple cultivars by bearing habit ..... 16

**Table 1-4.** Foliar applications  
 for special nutritional problems ..... 17

**Table 1-5.** General indices for  
 judging nitrogen status of fruit trees ..... 17

<b>Table 1-6.</b> Apple cultivars.....	20
<b>Table 1-6B.</b> Parentage of common and new apple cultivars ....	22
<b>Table 1-7.</b> Comparisons of apple rootstock characteristics .....	39
<b>Table 1-8.</b> Increase in tree density made possible using beds. ....	40
<b>Table 1-9.</b> Toxicity of insecticides, miticides, fungicides, and blossom- and fruit-thinning agents to bees, and suggested timing of application .....	48
<b>Table 1-10.</b> Sources of nitrogen, nitrogen content, and application rates .....	59
<b>Table 1-11.</b> Poor soil conditions that may result in low-calcium fruit disorders, their modes of action, and corrective measures. ....	61
<b>Table 1-12.</b> Nutritional imbalances that may interfere with production of high-calcium apples, their modes of action, and corrective measures.....	61
<b>Table 1-13.</b> Causes of excessive vegetative growth that may compete for available calcium, their modes of action, and corrective measures .....	62
<b>Table 1-14.</b> Factors that may result in a small crop of large fruit, their modes of action, and corrective measures.....	62
<b>Table 1-15A.</b> Growth regulators for apples and pears .....	67
<b>Table 1-15B.</b> 6BA conversion chart for fluid ounces per 100 gallons of water.....	69
<b>Table 1-16.</b> Tree and weather conditions affecting fruit thinning with chemicals .....	74
<b>Table 1-17.</b> Suggested apple thinning recommendations .....	75
<b>Table 1-18.</b> A quick comparison of compounds registered as stop drops .....	76
<b>Table 1-19.</b> Fluid ounces of Fruitone L or PoMaxa or ounces of Fruitone N or Refine 3.5 WSG to apply per acre in enough water to thoroughly wet the foliage at a given ppm .....	80
<b>Table 1-20.</b> Concentration of NAA (ppm) applied based on amount of PoMaxa, Fruitone L, Fruitone N, or Refine 3.5 WSG desired per acre (from Table 1-19) and gallons of water to be applied per acre.....	80
<b>Table 1-21.</b> Parts per million (ppm) of NAA in tank based on amount of Amid-Thin W added to tank of (x) size .....	80
<b>Table 1-22.</b> Commercially grown and promising peach and nectarine cultivars for Pennsylvania .....	83
<b>Table 1-23.</b> Growth regulators for stone fruit.....	91
<b>Table 1-24.</b> Sweet cherry pollination guide.....	93
<b>Table 1-25.</b> Critical temperatures for various fruits.....	95
<b>Table 1-26.</b> Management practices for apples and stone fruits .....	97

## FIGURES

<b>Figure 1-1.</b> Considerations for orchard sites .....	3
<b>Figure 1-2.</b> Orchard layout based on a triangle .....	5
<b>Figure 1-3.</b> Orchard layout on the contour .....	5
<b>Figure 1-4.</b> Traditional arrangement and possible arrangements of two- and three-row beds.....	40
<b>Figure 1-5.</b> Pollination agreement .....	51
<b>Figure 1-6.</b> Phenology of tree fruit bloom time and wild bee flight periods.....	57
<b>Figure 1-7.</b> Example of meadow wildflowers valuable to bees .....	58
<b>Figure 1-8.</b> Example of trees and shrubs that are valuable to bees.....	58
<b>Figure 1-9.</b> How to sample peel tissue .....	65
<b>Figure 1-10.</b> Determining application timing for ReTain to increase effective harvest window, increase fruit firmness, and reduce preharvest drop.....	77
<b>Figure 1-11.</b> Determining application timing for NAA to extend harvest window and reduce preharvest drop .....	78

## ORCHARD ESTABLISHMENT

### Site Selection

The success of an orchard is only as good as the planning and site preparation that go into it. This is a simple maxim, but one that is often overlooked by novice and experienced grower alike. Shortcuts and haphazard approaches can result in less-than-ideal growth and other problems during the orchard's life. It is easier to amend a site before the trees are planted than it is once they are in the ground.

To build a good orchard, you need a good foundation. The ideal site is on rolling or elevated land so that cold air can drain during spring frosts. Figure 1-1 shows typical site arrangements. Site A is a warm location that receives more sun. This site is not affected by late spring frosts because cold air drains to lower-lying areas. Site B also misses late spring frosts, but the top may be too cold in winter because of exposure. Site C is similar to site A but colder, warming up later in the spring. Site D is the most susceptible to spring frosts because cold air drains into it from elevated areas. Site E can still be frosty, but the woods act as a windbreak, sheltering this site from prevailing winds. Site F is not desirable because of the dense woods at the base of the hill. Woods can trap cold air and prevent it from draining to lower-lying areas. Site G is similar to site B.

Slope exposure should be considered for its effect on fruit trees as they come out of dormancy. A southern-facing slope warms up faster in spring, while the opposite is true of a northern slope. Eastern-facing slopes are intermediate. In Mid-Atlantic areas, a western-facing slope tends to be windier. Wind can cause spraying problems during the growing season.

While uphill or rolling land is the most desirable, the degree of slope can also limit its suitability. The ideal site has a 4 to 8 percent slope. It may be difficult to operate machinery on slopes of more than 10 percent.

Selecting a site for an orchard involves belowground considerations as well, primarily soil depth and soil texture. An old recommendation for a desirable orchard soil is that it be deep and well drained.

Soil drainage is probably the most important factor in the longevity of an orchard. This is because of the inherent inability of certain types of fruit trees to survive when planted in imperfectly drained soils. Stone fruits (peaches, cherries, and plums) are the most susceptible to poor drainage. Apples are intermediate, and pears can survive on the more poorly drained soils.

Soils are made up of four basic ingredients: mineral elements, pore space, organic matter, and other items consisting mainly of living organisms, including fungi, bacteria, and nematodes. One classification of soils is based on the mineral part of soil and consists of four sizes of particles. Clay particles are the smallest, followed by silt, sand, and gravel. The USDA has devised another system of classifying soil particles. In this system soil is divided into seven categories: clay, silt, and five sizes of sand.

Soil texture is determined by the percentage of sand, silt, and clay in the soil. Arendtsville gravelly loam, Highfield channery silt loam, and Steinsberg sandy loam are examples of soil types having different textures. The structure of a soil is influenced by soil texture and also by the aggregation of small soil particles into

larger particles. The amount of aggregation in a soil is strongly influenced by the amount of organic matter present.

The pore spaces in a soil are normally filled with air or water. As the amount of water increases, the amount of air must therefore decrease. The pores of a well-drained soil have certain physical characteristics that, after a period of heavy rainfall, enable water to rapidly drain away and allow air to return to its original percentage.

The amount of organic matter in soil is an important factor in soil structure. Organic matter consists of dead and decomposing plant and animal parts. Living organisms break down plant debris into organic matter.

The cation exchange capacity, or the ability of soil to store cations (positively charged particles) is highly dependent on the amount of clay and organic matter in the soil. Clay and organic matter contain predominantly negatively charged sites that attract cations. Applied nutrients such as ammonium nitrogen, potassium, calcium, and magnesium attach themselves to the negatively charged soil particles. This phenomenon is called cation exchange, and it allows the soil to be a reservoir for plant nutrients.

Before selecting a site for an orchard, consult a county soil map. Soil surveys are available at most Natural Resources Conservation Service offices in Pennsylvania. These publications are valuable in determining if your particular site has the detailed requirements for a long-term viable orchard operation. If your orchard is located outside of Pennsylvania, you may be able to access soil information at the USDA NRCS Web Soil Survey at [websoilsurvey.nrcs.usda.gov](http://websoilsurvey.nrcs.usda.gov). Another source of soil data is the UC Davis California Soil Resource Lab in collaboration with the USDA Natural Resources Conservation Service located at [casoilresource.lawr.ucdavis.edu/gmap](http://casoilresource.lawr.ucdavis.edu/gmap). You can enter the geographical coordinates of your site and see the satellite image of the field with the soil types mapped. A more detailed site evaluation is probably warranted, and we recommend that a backhoe be used to dig holes 5 to 7 feet deep so that the soil profile can be examined. A test similar to a percolation test used for installing septic systems may also be advisable where internal soil drainage is questionable. Poorly drained soils often have horizontal layers of light-colored material.

Although pH and fertility are often considered important factors for orchard soils, internal soil drainage is actually the most important. Soil fertility can often be corrected by applying fertilizer or by increasing the level of organic matter in the soil. Soil pH can be corrected and is not usually a limiting factor unless a site is highly acid. In this case only the plow layer depth can be corrected with applications of lime.

The best soil is a well-drained loam a minimum of 3 to 4 feet deep. Good drainage, however, should take preference over depth. In Figure 1-1, soils at site B are most likely to be the shallowest

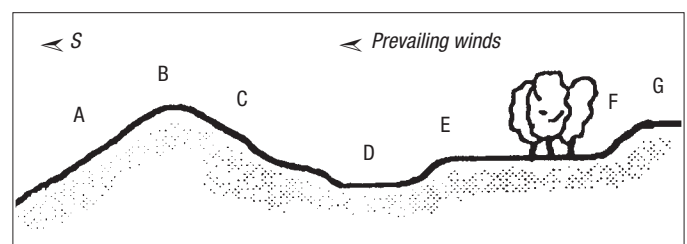

Figure 1-1. Considerations for orchard sites.

because of erosion, while those at site D tend to be the richest. Soil fertility should be medium to low. Overly fertile soils can lead to excessive tree growth at the expense of fruit production. Adding fertilizer to increase tree vigor is easier than trying to reduce vigor. Fruit trees grow well in soil with a pH of 6.0 to 6.5. Higher or lower levels can cause nutrient deficiencies.

Once you have selected a site, you must prepare it. If you are replacing an existing orchard, particularly a stone fruit orchard, it is important to rotate into biofumigant cover crops for at least two years before planting a new orchard. The cover crops are also effective in correcting soil physical problems such as compaction, which can occur from equipment driving over the previous orchard. Take a nematode test before the old trees are removed to determine the need for fumigation. Nematode tests are recommended even when the site was not formerly an orchard since nematodes can severely stunt young trees or transmit viruses. For more information on nematode management, see *Nematode Problems in Deciduous Fruit Trees* in Part II. Next, take a soil test to determine soil fertility. Penn State provides a soil testing service through the Agricultural Analytical Services Laboratory for a fee. You can contact them by going to the lab's website ([agsci.psu.edu/aasl](http://agsci.psu.edu/aasl)) or calling 814-863-0841. When establishing a new orchard or replanting an old orchard, soil samples should be taken at two depths. One should be collected from a depth of 6 to 12 inches and a second sample from deeper at 12 to 18 inches. Fertility and pH should be adjusted to optimum levels prior to planting a new orchard since lime and certain fertilizers move very slowly in soils. With some of the bitter-pit-prone cultivars, such as Honeycrisp and York Imperial, it is especially important to adjust pH to 6.5 prior to planting your trees. Private labs that can analyze your soil are also available. When starting a new orchard, you may want to consider also having the lab test the organic matter level in your soil. Organic matter is an important consideration in determining how vigorous or fertile your soil may be and also affects soil drainage. If you are replacing an existing orchard or clearing the land for a new one, take the soil sample after removing the trees and as many of the roots as possible. An initial plowing and leveling should also be done before taking the soil sample. In this way, any subsoil that comes to the surface can be thoroughly mixed.

A two-year crop rotation prior to planting will also aid in weed control. Examine the field for the presence of perennial weeds before working the ground. If multiflora rose, thistle, poison ivy, or hackberry are in the field, they should be treated in the summer or fall with glyphosate. If the problem weeds have been established for a number of years, controlling them will require two or three treatments of glyphosate. It is best to subsoil as deeply as possible. Running a deep shank in two directions across the field will break up any existing hardpans.

Chop and plow down cover crops in late summer to increase soil tilth and organic matter. Take another soil test before doing the final disking and leveling. Incorporate any needed amendments, such as lime, phosphorus, or potassium.

Orchard sod should be planted the fall before trees are planted. The grass cover traditionally used is Kentucky-31 tall fescue. It establishes itself rapidly and is a durable cover crop, although it does require frequent mowing during the growing season. The ideal time to plant seed is mid-August to late September. Seed the grass at a rate of 20 to 40 pounds per acre.

## Replanting an Orchard Site

Replanting an old orchard block requires a specialized approach for preventing replant disorders and stunted tree growth. Soils often need to be rejuvenated over several years. Over the life of an older orchard the nutrients and soil pH decline and the old tree rows may have developed herbicide residues that will suppress young tree growth. Organic matter can decline as orchards age. These problems need to be remedied. The following steps are recommended to help prepare the site beginning the fall after the last harvest.

- Remove old trees and roots. Rip the soil thoroughly to expose additional roots and large rocks for removal.
- Collect samples for soil nutrient and nematode tests. Soil tests should include soil organic matter as well. Cornell University offers a soil health test that measures available water capacity, surface hardness, subsurface hardness, aggregate stability, active carbon level, phosphorus and potassium levels, minor elements, and textural class. They provide a color-coded numeric rating value for each of these parameters plus an overall score.
- If perennial weeds were present, treat the entire site with glyphosate to kill them.
- Apply lime to adjust soil pH to 6.5 and incorporate by deep plowing. If more than 1,500 pounds of lime are required, apply half before plowing and incorporate the remaining half after plowing by disking.
- Broadcast 50 pounds of actual nitrogen per acre along with required amounts of phosphorus and potassium needed for forage crops, based on the soil test results, and incorporate them into the soil.
- In early June plant Sudex (a sorghum x sudangrass hybrid variety of *Sorghum bicolor*) at 35 to 45 pounds of seed per acre. Sudex produces a large amount of biomass quickly and the roots will penetrate 4 to 6 feet deep. The addition of the organic matter should also help reduce herbicide residues from the previous crop. Watch a video demonstrating the Sudex planting at [extension.psu.edu/planting-sorghum-sudangrass-following-orchard-removal](http://extension.psu.edu/planting-sorghum-sudangrass-following-orchard-removal).
- In mid-August, mow sudangrass using a flail mower or use another strategy to chop and macerate the grass as much as possible. Incorporate the residue immediately and follow with a cultipacker. It's best not to mow down more area than can be plowed under within two hours.
- The soil conditions during sudangrass incorporation should be similar to those for soil fumigation (i.e., some soil moisture and soil temperatures above 50°F). Mowing injures the plants and initiates a process that releases nematicidal compounds into the soil.
- Incorporate 50 to 75 pounds of ammonium sulfate per acre during the disking of the sudangrass. The sulfur may acidify the soil, but it should increase the amount of toxic materials produced following the rapeseed crop.
- At least two weeks after plowing down the Sudex residue plant 'Dwarf Essex' rapeseed at 8 to 10 pounds per acre. The ideal planting date for southeast Pennsylvania is September 15 and somewhat earlier for more northern areas. The goal is to have developed a rosette by winter so that it will overwinter well, but not too much vertical growth, which can winter kill. Rapeseed produces natural chemicals that are toxic to plant-parasitic nematodes.

- The following spring in mid- to late April mow the rapeseed with a flail mower and plow down the residue immediately. Soil conditions during rapeseed incorporation can affect the efficacy of the rapeseed. Soil temperatures should be above 50°F and moist. Never mow down more area than can be plowed under within two hours. Flail mowing injures the rapeseed and releases the nematicidal chemicals into the soil. Failure to incorporate mowed rapeseed quickly allows much of the nematicidal compounds to escape by volatilization.
- Two weeks after plowing down the first rapeseed crop, broadcast 50 to 75 pounds of ammonium sulfate and plant a second crop of 'Dwarf Essex' rapeseed or a second crop of sorghum sudangrass. The two-week interval is important to prevent phytotoxicity to the summer rotation crop.
- Collect and submit soil samples in early August for pH and basic fertility levels to obtain results by early September.
- In mid-August mow down and incorporate the cover crop as done previously. Broadcast any lime needed to adjust soil pH to 6.5 and other needed nutrients from the soil test report, along with 15 to 20 pounds of actual nitrogen per acre. Do not use ammonium sulfate. The lime and other nutrients, including the nitrogen, can be applied before mowing and incorporating the biofumigant crop, or after, depending on the height of cover crop and practicality.
- After leveling the soil, plant the chosen grass seed evenly across the acreage (see the Row Middle Management section).
- Two weeks prior to planting the new trees, apply a glyphosate herbicide product as a directed spray to kill the sod cover in 4-foot-wide strips marking the planting rows. Try to avoid using the old tree rows for the new trees, and leave the killed sod in place and plant trees through the sod with a tree planter.

### Orchard Layout

Laying out an orchard on level land is a simple matter of establishing a straight baseline, usually next to a fence or roadway. Then, lines at right angles to the baseline are established at both ends of the plot and one or two places in the middle. An easy way to establish these angles is to use three ropes whose lengths are in a 3:4:5 proportion (based on the Pythagorean theorem). For example, use ropes 30, 40, and 50 feet long. Put the 40-foot rope along the baseline, then place the 30-foot rope at approximately a right angle, and, finally, close the triangle with the 50-foot rope (Figure 1-2). Adjust the 30-foot segment in either direction so that it just touches the end of the 50-foot piece. This ensures that the 30-foot section is at a right angle to the baseline.

Next, place stakes along the baseline and the right angle line for sighting to extend these lines. From this point on, any desired row and tree spacing can be established using a tape measure or knotted rope to measure off the proper intervals. Place a handful of lime to mark the spot where each tree is to be planted.

An alternative method is to use a tree planter to cross-hatch the ground. This method requires a skillful tractor operator who can drive a straight line over a large area. A single shank is attached to the tractor. The driver then lays out all the rows and finishes cross-hatching by going from side to side at a distance based on the desired within-row spacing.

A third method is used on sloping land. Trees are planted beginning at the steepest point of the field, and rows follow the contour of the land (Figure 1-3). This method requires the use of a surveyor's level and rod. Plant the first row at the highest elevation and stake it out level (i.e., make all points on the line the same elevation, A to C). Next, find the steepest slope along this row (along the line A to B) and measure the minimum distance between rows. From that point lay out the next row on a level line as before. As one moves from the steepest slope to less steep slopes, the rows become wider apart. Wherever the distance between two adjacent rows becomes twice the minimum distance, lay out a short contour row between them from that point to the end of the plot (squares marked D).

To plant trees, you can use either an auger or a tree planter. If you use an auger, take care to prevent "glazing" the sides of the hole. Glazing can occur if you dig the holes when the soil is too wet. One remedy is to slice the edge of the hole with a shovel or pick. Another is to weld a steel tine onto the auger.

The most common mistake in using a tree planter is going too fast and failing to place the trees at the proper depth. Along with the tractor driver and the person on the planter, a third or fourth person should walk behind the planter to straighten up trees and adjust them to the proper depth. This can be done right after planting simply by pulling up or stepping down on the newly planted tree.

### Determining the number of trees per acre in single-row plantings

The traditional method of determining the number of trees per acre (TPA) has been to multiply the in-row spacing by the between-row spacing and divide that number into the number of

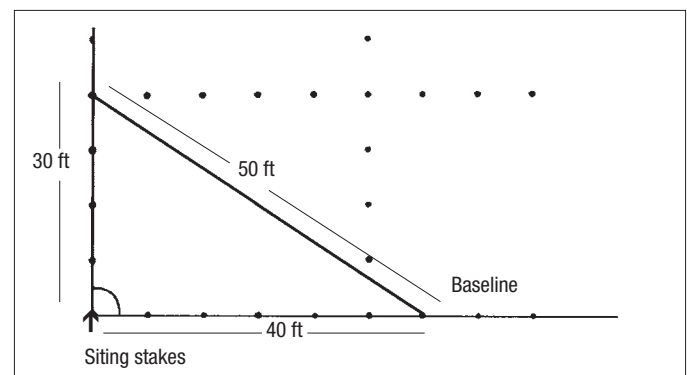

Figure 1-2. Orchard layout based on a triangle.

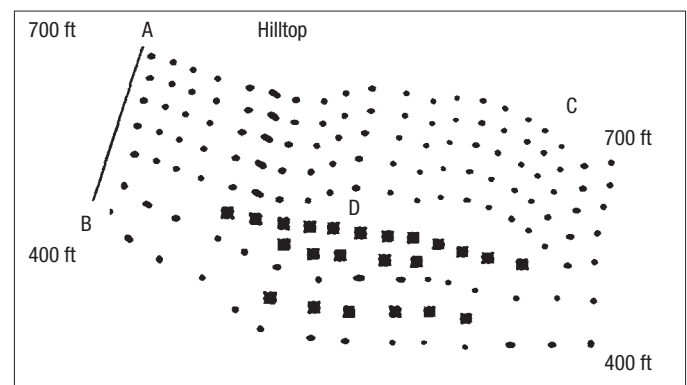

Figure 1-3. Orchard layout on the contour.

square feet in an acre (43,560 square feet). Table 1-1 gives the TPA at various spacings for single-row orchards. To determine TPA, locate the desired or planned in-row spacing of trees on either the vertical or horizontal axis. Next, locate the between-row spacing on the other axis. The number of trees per acre can be found at the intersection of the two spacings.

For example, if we want trees to be spaced 6 feet in the row with 14-foot between-row spacings, we would go down the left-hand column to 14 and follow across to where the 6-foot column intersects, and we find the TPA to be 518. (For information on bed systems, see Using Beds to Attain Higher-Density Orchards.)

### Tree Nursery and Grade Selection

An orchard can only be as good as the quality of its young trees. A planting begun with poor-quality trees may never recover. Buy the best trees that you can. Bargain or low-priced trees are often more costly in the long run. Fortunately, most nurseries are honest, but accidents can occur. Growers should be aware of a nursery's policies on replacing incorrectly labeled trees.

When ordering trees, choose a nursery carefully. Ask if the nursery has the cultivar and strain, rootstock, tree size, and quality that you want and if there are enough in stock to meet your needs. You could end up with a spacing problem in your orchard because you have planted a mixed block of cultivars, strains, and rootstocks. You're better off in delaying your planting for a year until you are able to get exactly what you want. Don't accept an undesirable cultivar-rootstock combination.

Information that comes from word of mouth and other growers' experiences can be of invaluable help when deciding on a nursery. Most nurseries realize that the best advertisement for their product is a satisfied customer.

Talk to growers who have ordered from a nursery you do not know. Ask about the condition of trees on arrival and about problems in ordering or receiving the trees. It's also a good idea to visit the nursery, if at all possible. Nurseries usually welcome anyone interested in their operation.

Another factor to consider before ordering trees is the nursery's guarantee concerning survivability, quality, and trueness to name. All Pennsylvania tree fruit nurseries that sell to commercial growers participate in the Pennsylvania Department of Agriculture Certification Program. These nurseries guarantee their trees to be true to name and free from all disease and insect problems.

Some nurseries in other states also have their own certification programs. You would be wise to ask the nursery if it participates in a certification program. If not, ask if it has its own guarantee.

### Selecting a grade of tree to order

The Pennsylvania Fruit Tree Improvement Program is a cooperative voluntary program administered by the Pennsylvania Department of Agriculture (PDA). A Program Advisory Committee is composed of PDA employees, Penn State research and extension workers, and Pennsylvania fruit tree nursery operators. The purpose of the committee is to direct the programming of the Fruit Tree Improvement Program (FTIP) to ensure that it is addressing the needs of the participating nurseries, that it is practically and scientifically sound, and that it is fulfilling its mission as outlined in the regulations. In addition, the committee is to provide an opportunity for exchange of information among industry, university, and regulatory personnel with fruit tree responsibilities. To learn more about FTIP, go to [www.agriculture.pa.gov/Plants\\_Land\\_Water/PlantIndustry/plant-health/FTIP/Pages/default.aspx](http://www.agriculture.pa.gov/Plants_Land_Water/PlantIndustry/plant-health/FTIP/Pages/default.aspx).

Regulations of the program under Section D describe two types of certified nursery blocks. The first is Penn-Premium trees. These have rootstocks that must be approved by PDA and shall originate from registered seed trees or registered stool beds. Registered scion sources are propagated onto these rootstocks.

Penn-Standard trees should use registered scion sources when available. Alternatively, PDA-approved scions also may be used. There are no specifications for rootstocks in this grade.

It is recommended that Pennsylvania stone fruit growers buy Penn-Premium trees whenever possible to ensure that the rootstocks and scions are of the highest quality. Since most apple rootstocks are produced on the West Coast by specialty nurseries, quality control in apple rootstocks normally is better than that seen in stone fruit rootstock sources.

### Ordering trees

The nursery business has changed dramatically in the past few years. The proliferation of the multitude of new rootstocks has complicated the ordering process and finished tree production. Plus the addition of many new sports and club varieties has required that nurseries grow only what they have contracts to produce. Most nurseries are no longer growing trees on specula-

**Table 1-1. Number of trees per acre at various tree spacings.**

	3	4	5	6	7	8	9	10	11	12	13	14	15	16	17	18	19	20
8	1,815	1,361	1,089	907	777	680												
9	1,613	1,210	968	806	691	605	537											
10	1,452	1,089	871	726	622	544	484	435										
11	1,320	990	792	660	565	495	440	396	360									
12	1,210	907	726	605	518	453	403	363	330	302								
13	1,116	838	670	558	478	418	372	335	304	279	257							
14	1,037	778	622	518	444	388	345	311	282	259	239	222						
15	968	726	580	484	414	363	322	290	264	242	223	207	193					
16	907	680	544	453	388	340	302	272	247	226	209	194	181	170				
17	854	641	512	427	366	320	284	256	232	213	197	183	170	160	150			
18	806	605	484	403	345	302	268	242	220	201	186	172	161	151	142	134		
19	764	573	435	382	327	286	254	229	208	191	176	163	152	143	134	127	120	
20	726	545	414	363	311	272	242	217	198	181	167	155	145	136	128	121	114	108
	3	4	5	6	7	8	9	10	11	12	13	14	15	16	17	18	19	20

To use this table, locate the desired or planned in-row spacing of trees on either the vertical or horizontal axis. Next, locate the between-row spacing on the other axis. The number of trees per acre can be found at the intersection of the two spacings. To determine trees per acre for values not listed in the table use the following formula:  $trees/A = 43,560 / (\text{in-row spacing} \times \text{cross-row spacing})$ .

tion. Order trees from a nursery as far in advance as possible. The current delay in obtaining trees is largely due to the inability to find enough rootstocks and grow the increased number of trees needed in today's high-density plantings. Ordering early will give you a better choice of cultivars and rootstocks.

Most nurseries will custom bud or graft a particular cultivar from your orchard if you give them the budwood far enough in advance. If you want a nursery to do this, contact it no later than June or July, two to three years in advance of the year you wish to plant. Therefore, if you wish to plant in 2023, contact the nursery in 2020.

Fruit trees are sold according to trunk caliper. In addition, the recent emphasis on large tree sizes has created a demand for trees that are branched. Most nurseries have a special category for this type of tree, referred to as either "feathered" or "well branched." Be specific about the type and age of trees you want. If you are establishing a high-density planting system, it may be beneficial to pay the extra expense for feathered trees because they will be larger and come into bearing earlier if handled properly. We have planted feathered trees and left a few fruit on them their second growing season, and obtained good yields in the third growing season. An economic analysis spreadsheet developed by Penn State from commercial grower data has shown planting well-feathered trees in a high-density orchard provides a quicker return on expenses and earlier profits.

Some growers prefer trees that already have branches even when they are planted at lower densities. The advantage is that you begin with larger trees that already have some scaffolds; in addition, these often have wide branch angles. The disadvantages are that the branches may not be in the right location or at the right height, and sometimes branches can be broken during handling and shipping.

The ideal size for a peach tree is one purchased as a whip with a diameter of  $\frac{1}{2}$  to  $\frac{5}{8}$  inch. Such a tree is usually 4 to 6 feet tall. If you cannot order a tree of that size, then the next size smaller, which is  $\frac{3}{8}$  to  $\frac{1}{2}$  inch in diameter, is better than the next size larger, which is  $\frac{5}{8}$  to  $\frac{3}{4}$  inch in diameter. As previously noted with apples and pears, if you will be planting a high-density peach system, it is better to opt for the larger tree as your second choice.

### Nursery tree production

The traditional tree is produced in a three-year cycle. Fall of year one daughter rootstock liners are cut from the mother stool beds and graded based on diameter, freedom from spines, and general straightness of the stem. The preferred diameter is  $\frac{3}{16}$  to  $\frac{7}{16}$  inch in diameter. They are kept in cold storage for the winter. Rootstock liners are planted the following spring in long rows spaced approximately 10 to 12 inches apart. Beginning in mid-July and stretching sometimes into late August the rootstocks are budded by either chip budding or T-budding. The following spring the rootstock liner is cut off just above where the bud was inserted. A single shoot is allowed to develop during the growing season from that bud. The shoot may be treated with plant growth regulators to induce branching to produce a feathered tree. In the fall finished trees are dug from the nursery, and graded by diameter and branching. Trees are kept in cold storage, keeping their roots moist. The following late winter or spring the trees are shipped to the grower for planting.

### Alternative types of trees

Some nurseries have returned to producing bench-grafted trees. These trees are grafted over the winter and shipped to the grower as whips. Their advantage is that you can order the combination of scion and rootstock, and not have to pay the nursery to grow the tree for another year.

Trees that are bench grafted should usually be grown for an additional year in the grower's nursery bed. Some growers have planted the newly grafted trees directly into their orchards at high densities. If you choose to do this, be prepared to visit the trees on a regular basis. Problems that can occur include deer depredation and tree death. Interstem trees, if budded, require an extra year in the nursery. Interstem trees that are bench grafted do not require the extra year because both the interstem and the scion are grafted on at the same time and grown out for one additional growing season before shipment. Since interstem trees require additional handling, they cost more to purchase.

Another type of tree is called the "sleeping eye" tree. These trees are produced by growing and budding the rootstock in the traditional manner, but cutting off the rootstock above the bud before shipping the tree to the grower. The advantage to the nursery is that it saves on growing and shipping costs, so they can offer the trees at a cheaper price. If purchasing this type of tree, it is best that the grower plant them in a "holding pen," an area that is protected by a deer fence and has an irrigation system. The trees would then be dug in the fall and stored or planted at the desired spacing in the new orchard. Alternatively, they can be dug the following late winter and planted that spring.

### Should you propagate your own trees?

Some growers do not like the expense of ordering trees for their orchard plantings and think they can propagate their own. This can be a very costly mistake. Propagating and growing trees is a very specialized business; trees require special equipment and training. Much care is required to ensure that trees are not neglected and that they do not become overgrown with weeds or suffer from water stress.

Another consideration is that many of the latest cultivars are protected by plant patents. This means you are in violation of a patent should you collect budwood from one of these trees for propagation in your orchard. Patented trees cannot be propagated without paying a royalty to the original source.

Fruit growers need to realize that they are in the business of producing either fruit or trees. Rarely can a fruit grower produce trees as good as those sold by a reputable nursery. Any savings realized by propagating your own trees are quickly eliminated by the added cost of production delays from poor-quality trees.

There are, however, certain instances when growers may wish to propagate a few trees for particular reasons. If you want to propagate a few trees, your best choice is to purchase rootstocks from a nursery and either graft or bud onto them. Set aside a small area and grow the trees out one year before planting them into the main orchard blocks. It is much easier to care for young trees if they are grouped together in one location where they can be checked daily. Scattered throughout the orchard, young trees easily can be forgotten and become overgrown with weeds. Do not try to plant the rootstocks in their final space in an orchard and then bud them. If you have poor bud take, tree size in the block will not be uniform since you will have to use replants to replace the missing trees.

Several years ago, the Cornell University Extension Fruit Team held a grower school about the feasibility of growers establishing their own on-farm nurseries to help defray some of the cost of establishing high-density tall-spindle orchards. In one paper they presented an excellent summary of the issues involved. Consider the following issues before beginning an on-farm nursery:

1. Is this the best place to invest money and time to improve the profitability of my farming business?
2. Are you willing to seek permission and pay royalties to propagate cultivars legally?
3. Do you understand and are you willing to assume the risks of growing your own trees?
4. Are you capable of managing the two businesses of an orchard and a nursery?
5. Are you willing to invest the time to take on the steep learning curve of propagation and tree growing?
6. Are you willing to hire more labor to manage your on-farm nursery?
7. Do you have the correct soil resources that can grow a quality nursery tree?
8. If the trees do not grow well, are you willing to forgo early yields when planting lower-quality trees in the new orchard?
9. Are you willing to establish a rigorous grading system and throw away smaller, poor-quality trees to achieve a uniform new orchard?
10. Are you willing and able to purchase the specialized equipment needed to manage a nursery?
11. Will you be able to install a good deer fence, irrigation system, and stakes required for supporting each tree?

### Sources of fruit trees

Listed below are some nurseries that sell fruit trees. The list is not all inclusive and does not imply endorsement of these nurseries; nor are nurseries not listed inferior. The list is merely a starting point for anyone purchasing trees. If we have omitted a particular nursery, we would appreciate receiving a catalog so that in the future we may include it in this listing. Please note that many of the nurseries have their own websites that can provide additional information.

Adams County Nursery, Inc., 26 Nursery Rd., PO Box 108, Aspers, PA 17304, [www.acnursery.com](http://www.acnursery.com)

Banning Orchards and Nursery, 400 Grant Rd., East Wenatchee, WA 98802; phone: 509-884-7041

Boyer's Nursery and Orchards, 405 Boyer Nursery Rd., Biglerville, PA 17307, [www.boyernurseries.com](http://www.boyernurseries.com)

Brandt's Fruit Trees, Inc., PO Box B, Parker, WA 98939, [provarmanagement.com/brandts/brandts-fruit-trees](http://provarmanagement.com/brandts/brandts-fruit-trees)

Burchell Nursery, Inc., 12000 State Highway 120, Oakdale, CA 95361, [www.burchellnursery.com](http://www.burchellnursery.com)

C&O Nursery Co., PO Box 116, Wenatchee, WA 98807-0116 [www.c-onursery.com](http://www.c-onursery.com)

Cameron Nursery, 1261 Ringold Rd., PO Box 300, Eltopia, WA 99330-0300, [www.cameronnursery.com](http://www.cameronnursery.com)

Copenhagen Farms Nursery, 12990 SW Copenhagen Rd., Gaston, OR 97119, [www.copenhagenfarms.com](http://www.copenhagenfarms.com)

Cummins Nursery, 1408 Trumansburg Rd., Ithaca, NY 14850, [www.cumminsnursery.com](http://www.cumminsnursery.com)

Dave Wilson Nursery, 19701 Lake Rd., Hickman, CA 95323, [www.davewilson.com](http://www.davewilson.com)

Fowler Nurseries, Inc., 525 Fowler Rd., Newcastle, CA 95658, [www.fowlernurseries.com](http://www.fowlernurseries.com)

Green Tree Nursery, 23979 Lake Rd. La Grange, CA 95329, [www.greentreenursery.com](http://www.greentreenursery.com)

Heritage Cider Supply, 10112 Canyon Rd. E, Suite 8-879, Puyallup WA 98373, [www.heritagecidersupply.com](http://www.heritagecidersupply.com)

L. E. Cooke, 26333 RD 140, Visalia, CA 93277, [www.lecooke.com](http://www.lecooke.com)

Moser Fruit Tree Sales, 5329 Defield Rd., Coloma, MI 49038, [www.forfruittrees.com](http://www.forfruittrees.com)

Proprietary Variety Management, [www.provarmanagement.com](http://www.provarmanagement.com)

ProTree Nurseries, 741 Sunset Rd., Brentwood, CA 94513, [www.protreenursery.com](http://www.protreenursery.com)

Sierra Gold Nurseries, 5320 Garden Highway, Yuba City, CA 95991-9499, [www.sierragoldtrees.com](http://www.sierragoldtrees.com)

Stark Bros. Nurseries, PO Box 368, Commercial Dept., Louisiana, MO 63353, [www.starkbros.com](http://www.starkbros.com)

Summit Tree Sales, 55826 60th Ave., Lawrence, MI 49064, [www.summittreesales.com](http://www.summittreesales.com)

TRECO Inc. Oregon Rootstock & Tree Co., 10906 Monitor-McKee Rd. NE, Woodburn, OR 97071, [www.treco.nu](http://www.treco.nu)

Tree Connection, PO Box 549, Dundee, OR 97115-0549, [www.treeconnect.com](http://www.treeconnect.com)

Van Well Nursery, Inc., 2821 Grant Rd., Wenatchee, WA 98802, [www.vanwell.net](http://www.vanwell.net)

Vaughn Nursery, 8678 Smithville, Highway, McMinnville, TN 37110, [www.vaughnnursery.com](http://www.vaughnnursery.com)

Wafler Nurseries, 10662 Slaght Rd., Wolcott, NY 14590, [www.waflernursery.com](http://www.waflernursery.com)

White Oak Nursery, 2507 White Oak Rd, Strasburg, PA 17579-9733; phone: 717-687-8884

Willow Drive Nursery, 3539 Road 5 NW, Ephrata, WA 98823, [www.willowdrive.com](http://www.willowdrive.com)

### Foreign nurseries

Carolus Nursery, Heuvelstraat 50, 3850 Nieuwerkerken, Belgium, [www.carolustrees.com/en](http://www.carolustrees.com/en)

Janssen Brothers Nurseries Limited, PO Box 2711 6030 aa Nederweert, Holland, [www.janssen-rootstocks.nl](http://www.janssen-rootstocks.nl)

McGrath Nurseries, 192/2 Gorton Rd. RD 2 Cambridge, Waikato, New Zealand, 07 827-8281, [mcgrathnurseries.co.nz](http://mcgrathnurseries.co.nz)



Rene Nicolai Nursery Lindestraat 22, 3570 Alken, renenicolai.be/index.htm

Schrama Nursery, Prof. Zuurlaan 10, 8256 PE, Biddinghuizen, Holland, www.schramaboomkwekerijen.nl/index\_eng.html

Verbeek Nurseries, Kruislandsedijk 13, 4651 RH Steenberg (NB), Holland, www.verbeek.nu/eng/index.htm

Viveros Requinoa, Victoria Subercaseaux No. 323, Santiago, Chile, viverosrequinoa.cl/english-version/index.html

#### Sources of rootstocks

Brandt's Fruit Trees, Inc., PO Box B, Parker, WA 98

Burchell Nursery, Inc., 4201 McHenry Ave., Modesto, CA 95356

Cameron Nursery, 1261 Ringold Rd., PO Box 300, Eltopia, WA 99330-0300

Copenhagen Farms Nursery, 12990 SW Copenhagen Rd., Gaston, OR 97119

Cummins Nursery, 18 Glass Factory Bay Rd., Geneva, NY 14456

Four Mile Nursery, 27027 South Hwy. 170, Canby, OR 97013, www.fourmile.com

Janssen Brothers Nurseries Limited, PO Box 2711 6030 aa Nederweert, Holland

TRECO Inc., 10906 Monitor-McKee Rd. NE, Woodburn, OR 97071

Van Well Nursery, Inc., PO Box 1339, Wenatchee, WA 98801

Willamette Nurseries, Inc., 25571 S. Barlow Rd., Canby, OR 97013, www.willamettenurseries.com

Willow Drive Nursery, 3539 Road 5 N.W., Ephrata, WA 98823

#### Sources that carry heirloom or antique cultivars

Big Horse Creek Farm, PO Box 70, Lansing, NC 28643, bighorsecreekfarm.com

Boyer's Nursery and Orchards, RD 2, Biglerville, PA 17307

Fedco Trees, PO Box 520, Waterville, ME 04903, www.fedcoseeds.com/trees

Moser Fruit Tree Sales, 5329 Defield Rd., Coloma, MI 49038

Trees of Antiquity, 20 Wellsona Rd., Paso Robles, CA 93446, www.treesofantiquity.com

Vintage Virginia Apples, PO Box 210, North Garden, VA 22959, www.albemarleciderworks.com

White Oak Nursery, 2507 White Oak Rd., Strasburg, PA 17579-9733

## ORCHARD FLOOR AND WEED MANAGEMENT

### Row Middle Management

The ground cover in an orchard must be managed just as the tree canopy is managed. The orchard floor can be divided into two distinct areas: the area between the tree rows, and the area directly underneath the trees. Row middle management in Pennsylvania orchards traditionally has fallen into three broad categories: (1) clean cultivation, (2) trashy cultivation, and (3) planting a permanent cover crop. The first two are no longer recommended because they tend to destroy soil structure by increasing soil compaction and erosion. They also create an ideal seedbed for the establishment of broadleaved perennial and annual weeds, which serve as a reservoir for viruses. The vast majority of commercial orchards in Pennsylvania are grown under a ground management system of a sod row middle with a vegetation-free zone underneath the trees. Sod between the rows prevents soil erosion, provides traction for equipment, adds organic matter to the soil, improves soil moisture and structure, and can be a site for beneficial predatory insects.

Grass covers used in row middles tend to grow rapidly and require frequent mowing. Perennial ryegrass and K-31 tall fescue are covers that have been traditionally grown in Pennsylvania orchards. A number of turfgrasses have been found to perform well as slow-growing cover crops. Because they grow more slowly, these new grasses require fewer mowings. They tolerate low-fertility soils, poor growing conditions, and heavy traffic, and they grow densely enough to crowd out weeds.

The addition of clover or other legumes is not recommended for orchard row middles. While they may provide additional nitrogen to the orchard, the release of that nitrogen is unpredictable. Legumes also can serve as reservoirs for tomato ringspot virus, which causes stem pitting in peaches and apple union necrosis in pome fruit. Clover can also attract pollinating insects into the orchard when insecticides are being applied, causing them to be harmed.

Choose a grass cultivar that is endophyte enhanced. Endophytes are fungi that live within the grass plant and deter certain turf insects from feeding. Some species and varieties have naturally high levels of endophytes. Research and other observations made around the state indicate that hard fescue, chewing fescue, creeping red fescue, and slow-growing, turf-type perennial ryegrass can be used with success in orchard row middles. Chewing fescue and creeping red fescue grow taller than hard fescues and mat down more, but they seem to establish faster. Each type may contain many acceptable cultivars. New cultivars regularly become available; check with your local supplier.

Using these grasses successfully depends on proper establishment practices. Failure to follow the steps below may result in a cover that is too sparse to be effective.

- Eliminate perennial weeds before planting. During their establishment phase, slow-growing grasses do not compete well with perennial weeds.
- Have soil tested and amended according to crop needs. Apply 20 to 40 pounds of actual nitrogen per acre when the cover is being established.

- Thoroughly work the soil before seeding. Any broadcast machine will do. Do not cover the seed with soil.
- A cyclone spreader, drop spreader, or Brillion seeder is recommended for planting seed. If a grain drill is used, disconnect the hoses at the grain box and let the seed fall to the ground. The light, fine seed of the fescues will not fall through the hoses.
- Seed the grass at a rate of 20 to 60 pounds per acre. The higher rates will produce a faster cover.
- The best time to seed is late August to late September. The next best time is mid-March to early May. If planted in spring, slow-growing grasses will not compete well with weeds the first growing season.
- Limit weed competition the year of planting by mowing weeds before they reach 10 inches tall. Timely applications of 2,4-D will prevent broadleaved weeds from becoming established.
- If desired, you may want to add a nurse crop of oats in the seeding mix at a rate of 5 pounds per acre to help establish a covering to prevent erosion.

### Orchard Sod Management

Managing the sod middles properly can prevent the invasion of unwanted weeds, provides a firm drive row for early spring orchard chores, prevents or reduces soil erosion, and increases soil organic matter. Weeds in the sod middles can serve as alternate hosts for insects, diseases, and nematodes. Weeds such as dandelion that bloom during orchard blossoming time can attract bees to them rather than to your fruit trees. At other times of the year, weed blossoms can attract native pollinating insects that might be harmed during the normal application of insecticides to the fruit trees.

Sod management practices will help suppress weeds, including white clover, which can be difficult to control. Using herbicides with good management practices will help maintain the sod middles free of weeds. Fertilizer application to the sod middle is a management tool that can be utilized to favor grass growth rather than clover. Application of nitrogen will stimulate grass growth, and phosphorus and potassium stimulate clover growth when present. Therefore, do not apply phosphorus and potassium fertilizers if clover is a problem in your sod middle. If the trees need phosphorus or potassium, band those materials in the grass-free area underneath the trees. Close mowing will favor clover growth, while higher mowing heights will favor the grass growth. Do not mow closer than 4 inches if clover control is a problem.

Weed control in the sod should be completed in early spring or delayed until fall. Weeds are most susceptible to 2,4-D when they are vigorously growing and before the flower buds appear. When using 2,4-D make sure you are using a formulation that is labeled for orchards and is an amine formulation that will not drift. Do not use ester formulations that may volatilize and drift, causing damage to surrounding vegetation. An application of Prowl H2O at 1 to 1.5 quarts per acre can help control summer annual grasses such as crabgrass species, foxtail species, and others that can weaken the desired sod grass. Certain weeds such as clover, wild onion, and garlic can be suppressed or controlled with 2,4-D, but it requires additional effort. Clover leaves are densely covered with fine hairs, wild onion leaves are waxy and

vertical, and both retain spray poorly. The addition of a nonionic surfactant can increase wetting and spray retention to improve control. Another strategy is to make a split application of 2,4-D. Applying two half-rate sprays spread one to two weeks apart may help improve suppression or control when the weeds have become established. In apples and all stone fruit, the addition of 3 to 4 ounces of Stinger 3A per acre with the 2,4-D can also improve control of susceptible weeds.

### Tree Row Management

The area underneath the trees is important in the development of an orchard. Numerous studies have shown that excessive vegetation underneath trees competes with the tree for water and nutrients and can reduce the growth and cropping of the trees. Research in New York showed that apple trees grown in a mowed sod were nearly 25 percent smaller than trees grown under an herbicide program six years after planting. Research at Penn State with peaches also showed that the width of the vegetation-free strip affected tree growth and yield, with a narrower 2-foot-wide strip producing less fruit and smaller trees. Ideally, the vegetation-free strip should extend out to the edge of the tree's canopy width. The width should be established early in the life of the orchard and should not be reduced on newly planted trees.

The timing of weed control has also been shown to be critical. A study with Gala/M.26 showed that the first crop in the life of the orchard was much larger when weeds were controlled early in the season. The weed competition also affected fruit size. Based on this work, it is believed that the critical period for weed competition in apple runs from bloom to 30 days after petal fall.

At first thought, mulching might seem to offer some attractive potential benefits for orchards. Mulching usually results in greater moisture retention, increased organic matter, and can help to suppress weed growth. However, mulch also provides an ideal habitat for meadow and pine voles, which can feed on tree trunks and roots.

Cultivation under the trees has some potential with the development of improved machinery. However, it can increase erosion, and frequent cultivation and a skillful tractor driver are required. Cultivation should be shallow to avoid injuring tree roots.

Herbicides are the primary tools used to manage vegetation under the tree row, but they also have risks. Young trees can be very sensitive to herbicides, and drift onto green bark or foliage can stunt or kill the tree. The use of inexpensive Tyvek tree wraps can reduce the effects of herbicide damage to young tender trunk tissue. Commercial rolls of Tyvek material can be purchased from supply stores such as U-Line. Rolls come in various widths and thicknesses. It is best to purchase the thicker 7.5-mil sheets. Continual usage of herbicides can also build up residues of the chemical in the soil, resulting in sterilization. Herbicides are, however, the most cost-effective means currently available to control vegetation under the tree.

### Establishing a New Orchard

#### Preplant

Establishing a weed control program for orchards begins with site preparation. Prior to planting, any persistent perennial weeds should be treated and removed. Most of the herbicides labeled for tree fruit work well against annual weeds, but only a few can control perennial weeds. Therefore, you should clean up any

problem perennial weeds before planting. Ideally, the site to be planted should be either cover or row cropped for at least two years before planting. The most common practice is to rent out the land to a local farmer to grow crops such as corn or wheat. Grains such as these cannot serve as reservoirs of tomato ringspot virus. Trials have shown sorghum sudangrass to be an excellent cover crop.

Care should be taken in selecting herbicides for rotational crops. Many common corn and wheat herbicides can persist and injure subsequent crops. Persistent herbicides can kill young trees, reduce growth, or injure root systems. Root system injury may not show up until later in the growing season, when the plants are under stress. Typical signs of root injury include sudden collapse of the tree, new foliage distortion, marginal leaf necrosis or bleaching of leaf tissue.

Generally, three major classes of herbicides used in row crops are persistent and can cause damage to new plantings: the sulfonyleureas, the imidazolinones, and the triazines. Examples of the sulfonyleureas include the brand names Accent, Escort, and Pinnacle; examples of the imidazolinones include Pursuit, Raptor, and Steel. Atrazine is the most common triazine used in field crops, but it is also closely related to simazine, which is a common herbicide used in tree fruit. Injury from these two classes of herbicides is typified by chlorosis of the growing points and new growth, along with root growth inhibition. Atrazine inhibits photosynthesis, which may cause the older leaves of plants to turn yellow.

Herbicide persistence is dependent on soil and environmental factors. Breakdown of herbicides in the soil occurs either by microbial degradation or chemical hydrolysis. Both factors require that the soil be moist and temperatures warm. Thus, cool temperatures and dry conditions slow herbicide degradation. Soil pH and organic matter are also important for herbicide degradation. For example, degradation of some herbicides is slowed considerably when the soil's pH is above 6.5. We also know that if the soil pH is 6.0 or lower, microbial breakdown of herbicides slows down. Because of these soil and environmental influences on herbicide degradation and persistence, rotation restrictions should be used as minimum guidelines.

If you are unsure whether there is a herbicide residue, conduct a bioassay. Collect small samples of soil and place in a small growing flat. Sow either grass seed or oats and watch the germination. If there is still a residue, germination and growth will be poor. If the germination test shows no residue then the field should be planted to a suitable grass sod. Research has shown that establishing an orchard-wide ground cover of grass and then killing off the rows where the trees will be planted with glyphosate, commonly called the "killed-sod" method, has resulted in better initial tree growth. The grass residue improved soil moisture and organic matter and usually persisted for about three years after planting.

### After planting

If you do not use the killed sod method described above, then herbicide applications are recommended to control weeds around young plantings. There is a critical period in crop development where weed competition hurts yields. For new orchards, this is usually the first two to three months of the planting. If weeds are controlled early in this first season, trees grow better and start cropping earlier and heavier. Best control of weeds is achieved

when herbicides are applied when emerged weeds are smaller than 2 to 5 inches, depending on the material used. For bearing trees, this period runs from prebloom until four to six weeks after bloom. Weeds will rob the most growth and fruit size from your trees during the months of May and June. If weeds are controlled during this critical time, yields will not be reduced. Weed growth later in the season primarily affects the water status of the tree and may not be a problem in most years. Weak weed growth under your trees from August onward can actually be a good thing—as long as it does not hamper harvest—because it may help the tree go dormant faster.

Herbicides labeled for use on newly planted trees are listed in Tables 4-1 and 4-2 in Part IV along with their rates and application timing. Be careful when applying herbicides to newly planted trees. Read and follow label instructions completely. No herbicides should be applied until after the ground has settled around the tree and there are no cracks in the soil. Avoid using contact or burndown herbicides on newly planted trees unless you shield the tree trunks from the spray. We have tested rolls of Tyvek sheet insulation that can be stapled in a tube around the trunk of the tree to protect green bark. Rolls of Tyvek are available from ULINE corporation ([www.uline.com](http://www.uline.com)). Search for "Uline" and "Tyvek rolls" on the Internet. The product comes in 150-foot-long rolls and is available in various widths. We recommend the 7.5-ml thickness and either 30- or 36-inch widths. Tubes usually last in the orchard for two to four years. Do not make the guards too high because winds can reduce the life of the tubes.

As trees age and become established, the range of herbicides that can be used increases. Chateau, Diuron, Kerb, Matrix, Rely, simazine, 2,4-D, and others can be applied to orchards established at least one year. Once trees have been in the ground for two years, a combination of Sinbar plus diuron can be used, as well as glyphosate. Alion can be used in orchards established at least three years. Sinbar can be used alone at higher rates once the trees have been in the orchard for three years. Starane Ultra, which is only labeled for pome fruits, cannot be applied to orchards established less than four years.

Herbicides should be rotated to prevent the buildup of resistant biotypes and a gradual shift in weed population. Weed scientists have confirmed that certain species of weeds that were once susceptible and easily controlled by herbicides no longer are controlled. Herbicide resistance most likely occurs when a particular population of weeds is continuously exposed to the same mode of action of herbicides. The most common example is the development of triazine-resistant pigweed and lambsquarters. The only triazine material used in orchards is simazine, which is one of our most commonly used materials. Rotation away from a continual usage of simazine will help reduce the chance of resistance developing.

Some scientists believe that to be effective in preventing herbicide resistance you need to not only rotate specific herbicides, but also rotate between similar modes of action. Mode of action refers to how the herbicide will kill the plant once it is absorbed. Some herbicide modes of actions are very specific and only work on one site in the plant. Others may work on several sites. As with fungicides and insecticides, the more sites a herbicide affects, the less likely resistance is to develop. In the case of simazine, it acts by inhibiting photosynthesis. The same is true of norfluzon, diuron, and terbacil.

Continual use of one particular residual herbicide can also lead to a gradual shift in the weed species present. Knowing which herbicides affect which weed species can tell you if you are causing that population shift. Plan on a two-year rotation of herbicide mode of action in any orchard block. One of the best things you can do during the supervision of your harvest crews is to notice the weed population in your various orchard blocks. You should note where the weed problems are the worst, how dense the weed growth is, and the weed species present. Follow up by making a physical map of the weeds to prepare to control the problem.

### Split applications of herbicides

A normal weed control program would include a combination of a residual material, such as simazine or diuron, plus a contact material, such as carfentrazone-ethyl, glufosinate ammonium, glyphosate, paraquat, or pyraflufen ethyl. Note that some of these burndown herbicides primarily only control broadleaf weeds. Better weed control in the tree row has been achieved when split applications of herbicides are used. Applying a half rate of a combination in the late fall after the fruit has been harvested and then applying the second half the following spring during June can provide better weed control. Split applications result in some residue being present for a longer period of time. The herbicide application in the fall helps prevent the development of annual winter weeds such as mustards. The second application helps control some of the later germinating weeds, such as foxtails.

### Controlling perennial weeds

Nearly all the herbicides labeled for weed control in tree fruit are designed to work against annuals. Many times, in established orchards the majority of the weeds in the tree row are perennial weeds. This means that they do not germinate, flower, and die in one year, but rather survive by means of underground roots, tubers, or rhizomes. We only have a few herbicides that can, with regular use, control perennial weeds, including 2,4-D amine, fluroxypyr, glyphosate, and clopyralid.

Once perennial weeds become established it is difficult to eliminate them from the orchard. In most cases, it will take several applications at different timings. The first step in eliminating perennial weeds is to make a spring “chemical mowing” application. This consists of applying some sort of burndown material, such as 2,4-D, glufosinate ammonium, Aim, glyphosate, paraquat, or Venue—or in the case of apples and stone fruits, clopyralid—during the early growth stage of the plant, usually sometime in April through June. The second step is to prevent the weed from flowering and producing seeds. This is accomplished by another burn down application or physically cutting the weed before it flowers. The final step is a fall application of glyphosate, which is preferred, or a 2,4-D product. Fall applications have the added advantage of having the material translocated downward in the plant to the roots or other storage organs resulting in death of the plant. When applying herbicides in the fall, spray on a day with a mild afternoon following cool morning temperatures to encourage translocation of the herbicide to the belowground organs. In any event, perennial broad leaf weeds should be sprayed while they are still actively growing, which is usually before a hard frost has occurred. In most instances where perennial weeds are well established it will take two to three years following the

steps outlined above to rid the orchard of the problem. Be sure to treat perennial weeds that are growing in the fence rows or in adjacent fields to prevent them from flowering, producing seeds, and being blown into the orchard by wind.

### Weed identification

The importance of knowing the weed species present and the extent of the spread can provide you with valuable insight on possible control strategies. The book *Weeds of the Northeast* by Uva, Neal, and DiTomaso is an excellent reference tool to help in identifying weeds. It has color pictures and helpful keys to identify the weeds.

Not all weed problems need to be controlled by a blanket application to the tree rows. Some weeds introduce themselves into orchards in discrete patches rather than over the entire orchard floor. Quackgrass, nutsedge, and thistle tend to enter an orchard in one area then jump in patches. Weeds that produce fruit and seeds for animals to disperse may also typically develop in patches. Site-specific herbicide applications to these “patch communities” will be more cost-effective as long as they are timed appropriately. On the other hand, weed species that depend primarily on wind dispersal of their seeds for spread may spread evenly over the orchard; a good example is dandelions and their light, airy seeds. This is also a point of attack for control. Destroy weeds before they flower and shed seeds. Pay particular attention to the edge of your orchard or along the roadsides. In the late summer and early fall scout your orchard for weeds, and map out the weed patches. Try to identify any weeds you are unsure of. Destroy weeds in flower before they shed seeds. This is very important around field edges and along roadsides. Many of our problem weeds are being blown into the orchards. Several online weed identification sites are available to help determine which weeds are a problem; see the Rutgers New Jersey Weed Gallery ([njaes.rutgers.edu/weeds/default.asp](http://njaes.rutgers.edu/weeds/default.asp)) and the Weed Science Society of America ([wssa.net/weed/weed-identification](http://wssa.net/weed/weed-identification)). The chemical management is no longer current, but the biology of the weeds is very relevant. The Penn State Center for Turfgrass Science has images of broadleaf weeds, grasses, and sedges at [plantscience.psu.edu/research/centers/turf/extension/plant-id](http://plantscience.psu.edu/research/centers/turf/extension/plant-id).

### Plant factors affecting weed control

Several characteristics of specific plants interact with the efficacy of herbicides. Contact herbicides will be ineffective if the growing point of the herbicide is either protected in a sheaf of leaves or below the soil surface. Plants that have narrow or upright leaves can result in herbicide runoff as compared to plants with broad or flat leaves. Plants with thick wax or cuticle layer, such as yellow toadflax, can prevent herbicide entry to the leaf and the waxy surfaces can cause the spray mix to form droplets, which can run off of leaves. Dense leaf hairs can hold spray droplets away from the leaf. Young, rapidly growing plants are more susceptible to herbicides. Seedlings are very susceptible to most weed control methods. Some perennial plants can be very susceptible to systemic materials just prior to their blooming.

### Site factors affecting weed control

The orchard site can influence the response of the weeds to herbicides. The primary influencing factor is soil texture. Soils that are heavier—either having higher amounts of clay or higher amounts of organic matter—may require higher rates of herbi-

cides. Control in these types of soils may also not be as long as on lighter soils. On the other hand, overdosing and causing herbicide injury may be easier on lighter soils.

### Herbicide mode of action

Herbicides must (1) adequately contact the target weeds, (2) be absorbed by the weed, (3) move within the weed to the site of action without being neutralized, and (4) be in high enough concentration to be toxic at the site of action. The mode of action refers to the chain of events from absorption to the weed's death. The specific site the herbicide affects is referred to as the site of action. Understanding herbicide mode of action (MOA) is helpful in knowing what groups of weeds are killed. It can specify the application technique that will be most effective. It can help in diagnosing herbicide injury problems and preventing the development of herbicide-resistant weeds.

A common method of grouping herbicides is by the mode of action. Many herbicides have similar chemical properties and are grouped into chemical families. In some instances there may be two or more chemical families that may have the same mode of action and can, therefore, be grouped into herbicide classes. Table 3-9 lists the herbicides used in tree fruit according to those characteristics. The grower should utilize this table to determine which herbicides are similar or have a similar mode of action. Rotating to an herbicide that has a different mode of action on an annual basis can prevent the buildup of resistant types of weeds and will help maintain a diverse weed population without the increase of any dominant species. For a more complete listing of herbicides by their class, go to [hracglobal.com](http://hracglobal.com) and under the Tools tab on the title bar click on Global Classification Lookup.

### Herbicide failure

Many growers who apply herbicides but do not obtain the desired results blame the material. However, in many cases it is not the fault of the herbicide but rather that of the applicator. Unlike insecticides and fungicides, many soil-applied herbicides need rain to work well. They need about ½ inch of rain shortly after application to activate them. Some herbicides, like Casoron, need rainfall to move them into the soil away from sunlight to prevent photodegradation. Also, if rainfall comes some time later, it will stimulate germination of weed seedlings just at the time that the concentration of the herbicide falls below its effective level due to natural breakdown in the soil. With our erratic weather patterns in the last few years, herbicides in orchards have not performed as well as we would like. Most herbicides generally do not give complete season-long control of all weeds, especially in young plantings where the canopies have not filled out completely. In older, more mature plantings, denser and fuller canopies often provide some shade that helps inhibit weed seedling growth under them.

The second most common reason for herbicide failure is applying materials that do not control the weed species present in your orchard. Read the label carefully and be sure the material you are using is labeled to control your problem weed. This means you must also be able to correctly identify the weed.

The third most common reason for poor weed control is applying the material at the wrong time. Poor timing is more of a problem with materials such as glyphosate, Fusilade, Poast, and 2,4-D. Read the label carefully to determine the appropriate time

for the best control of the weed species present. Environmental conditions can also affect timing. Most of the postemergent herbicides mentioned above should be applied when the weeds are not under stress and instead are actively growing. Plants growing under stress develop thicker wax cuticles on the leaves that can reduce the absorption of herbicides into the leaf.

The last possibility for failure is the development of herbicide-resistant weed species. Similar to the way apple scab can develop resistance, the overuse of a single mode of action herbicide can speed the development of resistance. Rotate the herbicides you use to incorporate different modes of action. To learn more about herbicide mode of action, visit the Herbicide Resistance Action Committee website at [hracglobal.com](http://hracglobal.com).

## PLANT NUTRITION

Nutritional requirements of fruit trees differ from those of agronomic crops, cover crops, and orchard sod. Growers may estimate fruit trees' nutritional needs through leaf and soil analysis, tree growth and cropping, and past experience. Since fruit trees are a perennial crop, leaf or foliar analysis is the most accurate way to determine nutritional status of an orchard. Factors such as rootstock, crop load, soil type, and weather conditions influence whether or not trees are absorbing enough nutrients to produce maximum yields of high-quality fruit.

Foliar analysis can also be of value in diagnosing the cause(s) of abnormalities in plant growth or fruit development. While only a single sample may be needed, paired samples, one from normal foliage and one from abnormal foliage, are frequently helpful. Foliar analysis, particularly if done over a period of years, can warn of an approaching deficiency or toxicity before the plant shows any visible symptoms.

Soil analyses, on the other hand, are not nearly as accurate in determining the nutritional status of an orchard. They do, however, play an important role in fertility programs when used in specific situations. In established orchards the main value of a soil test is to monitor soil pH. A soil test should also always be taken before an orchard is planted, since it is much easier to adjust nutrient levels before the trees are established. Renovating older orchards disturbs the subsoil enough to alter the soil test results. Therefore, when removing an old orchard for replanting, it is best to collect a soil sample after all the roots have been removed and any grading or soil disturbance has been completed.

Occasionally, soil and leaf analyses may offer opposing recommendations for fertilizing with phosphorus, potassium, and magnesium. If this occurs, follow the recommendations listed on the leaf analysis. However, if the soil analysis recommends lime, lime should always be applied.

### Determining Tree Nutritional Status through Foliar Analysis

#### What is foliar analysis?

Foliar analysis is the process whereby leaves from the current season's shoots are collected from the trees and then dried, ground, and chemically analyzed for their nutrient content. Nitrogen, phosphorus, potassium, calcium, magnesium, iron, copper, boron, sulfur, and manganese are among the elements tested for. A foliar analysis can help determine what fertilizer(s) a grower needs to apply. Unlike

soil tests, which only show what is in the ground, a leaf analysis shows what the trees actually absorbed. Soil tests do not typically give accurate measurements of nitrogen or the minor elements.

### When to collect samples

Specific guidelines must be followed when collecting a leaf sample for analysis. The first is timing. Leaves should be collected starting around mid-July until approximately mid-August. Samples are collected then because the nutrient levels in fruit trees are the most stable at that time. Earlier in the season, trees are actively growing and transporting nutrients up into the leaves; later in the season, senescence is beginning and nutrients are being transported out of leaves. To avoid contamination (see below), samples should be collected as long as possible after a cover spray or just before a cover spray.

### Frequency of sampling

To gain the most benefit from a foliar analysis program, we recommend sampling each block of your orchard at least once every three years. A good method is to divide your orchard into thirds and sample one third each year.

### Collecting the sample

Healthy leaves should be collected from the midsection of the current season's growth, located about midway on the tree or chest high on large trees, and at a representative height of the majority of foliage on young, small or dwarf trees. Similar to the procedure for taking a soil sample (see [agsci.psu.edu/aasl](http://agsci.psu.edu/aasl)), randomly walk through your orchard and pull leaves from trees until you have approximately 50 to 60 leaves. No more than two leaves should be taken from an individual terminal shoot. Alternatively, you can select 8 to 10 trees in a block that are uniform and typical of the entire block and collect an equal number of leaves from the chosen trees.

We strongly recommend that you collect leaves from one cultivar on one rootstock in a similar soil type. The next best sample comes from one cultivar on one rootstock and, finally, from a single cultivar. We do not recommend collecting leaves from several cultivars to be mixed into a single sample. Do not mix leaves from young and old trees of the same cultivar. Younger trees will have distinctly different nutritional requirements than older mature trees. Make sure you fill out the informational sheet accompanying the leaf sample as completely and accurately as possible. The information is used in making a recommendation.

### Contaminated leaf samples

Certain fungicides contain trace amounts of the minor elements. This becomes evident when the leaf analysis reports unusually high levels of elements such as copper, manganese, or zinc. The following fungicides contain both manganese and zinc: Dithane, Manzate, and Penncozeb. The following fungicides contain zinc only: Ziram and Polyram.

Some growers might think that washing the leaves will help; it does if you do it right. But most growers are not equipped to wash leaves properly. Washing involves using a 0.1 percent soap solution and triple rinsing in distilled water. Most attempts to wash leaves will only produce greater contamination.

### Interpreting foliar analyses

Table 1-2 lists the standard nutrient values used to interpret leaf tissue analysis results. The ranges outlined in the table cover the levels within which various kinds of fruit will grow, flower, and fruit sufficiently to produce high-quality commercial crops. The range for nitrogen, however, is purposely broad owing to factors such as tree age, fruit use, and fruit cultivar. Nitrogen should be higher for young nonbearing fruit trees. To further interpret nitrogen status in an orchard, refer to Tables 1-3 and 1-5, and the section on nitrogen that follows.

### Nutrient Deficiency and Toxicity Symptoms in Tree Fruit

Growers often look at their orchards and suspect that something is not quite correct. Listed below are general guidelines for diagnosing symptoms that result from deficiencies or toxicities of certain elements. A tree may be deficient in these elements not only because they are scarce but also because an excess of other elements has prevented a balanced uptake of essential elements.

The guidelines are not precise, and drastic changes in fertilizer practices should not be made based on a visual assessment.

If you suspect a nutrient deficiency or toxicity, a leaf analysis should be conducted to confirm the visual symptoms. Information on nutrient symptoms that follows was adapted from Childers (1966), *Mineral Nutrition of Fruit Crops*; Shear and Faust (1980), "Nutritional Ranges in Deciduous Tree Fruits and Nuts" in *Horticultural Reviews* 2:142–63; and Stiles and Reid (1991), *Orchard Nutrition Management* (Cornell Information Bulletin 219). See these sources for further reading and color photographs.

Elements required by plants are broken down into two broad categories: macronutrients and micronutrients. Plants need both to grow, flower, and fruit naturally. The distinction between the two groups is the quantities required by the plant. Macronutrients are needed in a larger amount and are usually expressed as percent dry weight. The micronutrients are required in smaller quantities and are usually expressed in parts per million.

### Macronutrients

#### Nitrogen

**Deficiency:** Symptoms appear as reduced top growth with short, spindly shoots that have pale green to yellow leaves. Generally speaking, symptoms first become evident in the older leaves at the base of shoots. In stone fruits deficient leaves appear reddish and may exhibit a "shothole" effect as the condition worsens. Fruits, especially stone fruits, tend to be smaller and to mature earlier.

**Toxicity:** Symptoms appear as an excessive amount of shoot growth accompanied by dark green foliage and delayed leaf drop in the fall. As nitrogen increases above the optimum, fruit color is reduced and maturity is delayed. Red cultivars are less red, and yellow cultivars tend to remain green. In apples and pears flavor and storage life are reduced. Besides direct toxic effects, other physiological problems, such as corking and bitter pit, can occur in apples and pears because of higher nitrogen levels that are not in balance with calcium levels.

**Table 1-2. Nutritional ranges used to interpret leaf analysis values for apples, peaches, nectarines, pears, and cherries.**

<b>APPLES</b>				
	<b>Deficient</b>	<b>Low</b>	<b>Normal</b>	<b>High</b>
<b>Dry matter (%)</b>				
Nitrogen <sup>a</sup>	<1.60	<1.80	1.80–2.80	>2.80
Phosphorus	<0.11	<0.15	0.15–0.30	>0.30
Potassium	<0.70	<1.20	1.20–2.00	>2.00
Calcium	<0.31	<1.30	1.30–3.00	>3.00
Magnesium	<0.03	<0.20	0.20–0.40	>0.40
Sulfur	<0.13	0.13–0.15	0.16–0.41	>0.41
<b>ppm</b>				
Manganese	<5	<22	22–140	>140
Iron	<25	<40	40–100	>100
Copper	<4	<6	6–25	>25
Boron	<11	<35	35–80	>80
Zinc	<6	<20	20–200	>200
<b>PEACHES AND NECTARINES</b>				
	<b>Deficient</b>	<b>Low</b>	<b>Normal</b>	<b>High</b>
<b>Dry matter (%)</b>				
Nitrogen	<2.00	<2.50	2.50–3.40	>3.40
Phosphorus	<0.10	<0.15	0.15–0.30	>0.30
Potassium	<1.70	<2.10	2.10–3.00	>3.00
Calcium	<0.50	<1.90	1.90–3.50	>3.50
Magnesium	<0.03	<0.20	0.20–0.40	>0.40
Sulfur	<0.10	0.11–0.19	0.20–0.41	>0.41
<b>ppm</b>				
Manganese	<10	<19	19–150	>150
Iron	<40	<51	51–200	>200
Copper	<4	<6	6–25	>25
Boron	<11	<25	25–50	>50
Zinc	<6	<20	20–200	>200
<b>PEARS</b>				
	<b>Deficient</b>	<b>Low</b>	<b>Normal</b>	<b>High</b>
<b>Dry matter (%)</b>				
Nitrogen	<1.35	<1.60	1.60–2.40	>2.40
Phosphorus	<0.15	<0.18	0.18–0.26	>0.26
Potassium	<0.16	<0.20	0.20–2.00	>2.00
Calcium	<0.10	<1.30	1.30–3.00	>3.00
Magnesium	<0.05	<0.30	0.30–0.60	>0.60
Sulfur	<0.09	0.10–0.16	0.17–0.26	>0.26
<b>ppm</b>				
Manganese	<5	<20	20–200	>200
Iron	<40	<50	50–400	>400
Copper	<2	<6	6–25	>25
Boron	<5	<35	35–80	>80
Zinc	<5	<20	20–200	>200
<b>CHERRIES</b>				
	<b>Deficient</b>	<b>Low</b>	<b>Normal</b>	<b>High</b>
<b>Dry matter (%)</b>				
Nitrogen	<2.00	<2.30	2.30–3.30	>3.30
Phosphorus	<0.20	<0.23	0.23–0.38	>0.38
Potassium	<0.80	<1.00	1.00–1.90	>1.90
Calcium	<0.30	<1.60	1.60–2.60	>2.60
Magnesium	<0.03	<0.49	0.49–0.65	>0.65
Sulfur	<0.10	0.11–0.14	0.15–0.49	>0.50
<b>ppm</b>				
Manganese	<5	<18	18–150	>150
Iron	<40	<50	50–250	>250
Copper	<3	<6	6–25	>25
Boron	<5	<39	39–80	>80
Zinc	<5	<20	20–200	>200

a. See also Table 1-3.

## Phosphorus

**Deficiency:** Deficiencies severe enough to produce visual symptoms are rare in fruit trees. When they do occur, symptoms may appear first as limited and slender terminal growth with young expanding leaves that are abnormally dark green. The young leaves' lower sides, especially along the margins and main veins, frequently show purplish discoloration. The leaves may have a leathery texture and form abnormally acute angles with the stem. Leaf symptoms are most often seen early in the growing season and diminish later in the season. When soil moisture is low, lower levels of phosphorus are common in leaf analysis results.

**Toxicity:** Effects of excess phosphorus are usually expressed as deficiencies of one or more of the essential heavy metals, such as zinc, copper, iron, and manganese. Since deficiency symptoms of these elements may also be induced by excesses of phosphorus, visual foliar symptoms of phosphorus toxicity are not reliable.

## Potassium

**Deficiency:** Symptoms generally develop first on older leaves at the base of the current season's shoot growth. They are characterized by a marginal scorching of the leaves. In stone fruits an upward lateral curling and chlorosis may also become evident with the development of scorching. A heavy fruit crop usually accentuates the appearance of symptoms. Research suggests there is an inverse relationship between leaf potassium and crop load. Therefore, the lighter the crop the higher the demand for potassium. As with phosphorus, under conditions of low soil moisture, lower levels of potassium are common in leaf analysis results.

**Toxicity:** No known visual symptoms are directly attributable to high levels of potassium. However, magnesium deficiencies tend to appear when there are high levels of potassium.

## Calcium

**Deficiency:** Specific foliar deficiency symptoms of a lack of calcium are rare in orchards. More common are symptoms induced by high levels of other nutrients. If deficiencies are present, they are first noticed in younger leaves as an upward cupping of leaf margins and a uniform veinal and interveinal chlorosis of the expanding leaves. Fruit often shows symptoms associated with a low level of calcium even when there may be sufficient levels in the leaves. (See section on bitter pit and corking.)

**Toxicity:** No known symptoms are associated with toxic levels of calcium.

## Magnesium

**Deficiency:** In their severest stages, symptoms may look similar to the marginal scorching associated with potassium deficiency, although this is very rarely observed in Pennsylvania. More characteristic is a fading of the green color at the terminals of older leaves, progressing interveinally (between veins) towards the base and midrib of the leaf and giving the typical "heringbone" appearance. In pears, dark purplish islands of tissue

**Table 1-3. Recommended leaf nitrogen levels for apple cultivars by bearing habit.**

Cultivar <sup>a</sup>	Nonbearing	Early bearing	Mature
Paulared, McIntosh, Empire, Golden Delicious, Gala, Jonagold, Mutsu	2.4–2.6	2.0–2.4	1.8–2.1
Delicious, Fuji, Braeburn	2.4–2.6	2.2–2.4	2.2–2.25
York Imperial, Rome Beauty, Stayman	2.4–2.6	2.2–2.6	2.2–2.4

a. Fruit destined for fresh market will have better color and firmness if N levels are reduced by 0.2 percent, but high N levels are associated with maximum tonnage. Note: N levels may be lower on light-cropping trees.

surrounded by chlorotic bands may develop in the interveinal areas. As the growing season progresses, symptoms develop on progressively younger leaves and the older leaves fall off.

**Toxicity:** Symptoms of excessive magnesium levels are not specific but usually appear as a deficiency of either potassium or calcium.

### Sulfur

**Deficiency:** For many years sulfur was of little concern to tree fruit nutrition programs due to the abundance of that element in precipitation (acid rain). Most of the sulfur falling contained in the rainfall was the result of emissions from coal-fired utility plants with the burning of coal containing sulfur. This was commonly referred to “acid rain.” However, over the years due to the reduction in the use of sulfur-containing coal and the increased use of electrostatic precipitators on the smokestacks by the utilities, sulfur emissions into the atmosphere have been drastically reduced (see <http://nadp.sih.wisc.edu/NTN/annualmapByYear.aspx>). Sulfur deficiencies have recently been seen in agronomic crops.

Plant deficiency symptoms include stunted and pale green growth due to a lack of chlorophyll formation. Sulfur is required for the formation of the chlorophyll molecule. Several amino acids essential for plant growth are also affected by a lack of sulfur. These symptoms may appear similar to nitrogen deficiency. However, since sulfur is not easily translocated from old to new growth, deficiency symptoms appear in younger leaves first. This is the opposite of nitrogen deficiency, which appears in older leaves first. Of the tree fruits, peaches, nectarines, and apricots have the highest need for sulfur.

**Toxicity:** Soil testing for sulfur has not been very successful because its behavior in soils is similar to that of nitrogen. Sulfur exists in three forms: a mineral as gypsum and pyrite, iron, and aluminum oxides (the adsorbed form); organic matter (70–90 percent); and in the soil solution. All these forms exist in a fluid equilibrium among one other. Therefore, the method to determine sulfur levels is through leaf analysis. Deficiencies in tree fruit will appear as young leaves that are light yellow or pale green. In extreme cases when sulfur is below 0.1 percent dry weight in leaves, trees turn yellow and applications of nitrogen do not alleviate the yellow leaf color.

### Micronutrients

The following elements are classified as micronutrients because they are required by plants in smaller quantities. With the exception of manganese, toxicities are very difficult to diagnose visually. Deficiency symptoms tend to be characteristic of the lack of a particular element.

#### Iron

**Deficiency:** Iron deficiencies are very common in plants.

Initial symptoms are a loss of green color in the very young leaves. While the interveinal tissue becomes pale green, yellow, or even white, the veins remain dark green. New leaves may unfold completely devoid of color, but the veins usually turn green later.

**Toxicity:** Although rare in the field, an excess of iron usually produces symptoms similar to those of manganese deficiency.

#### Manganese

**Deficiency:** Symptoms begin as chlorosis between the main veins starting near the margin of the leaf and extending toward the midrib. Symptoms can often be confused with those of iron and magnesium deficiencies. But unlike magnesium deficiency, manganese deficiency symptoms seldom develop so far as to produce interveinal chlorosis, the chlorosis normally being confined to leaf margins. The other distinguishing characteristic is that manganese deficiencies appear on the youngest leaves first, and the finest leaf veins do not remain green as they do with iron deficiencies.

**Toxicity:** “Measles” is a disorder of apples, especially Delicious and Jonathan. It is caused in part by an excess of manganese accompanied by low calcium levels. The symptoms first appear as small, red pustules on the smooth bark of young twigs. Tissue in the center of the pustules is dead and the damage extends into the cortex or phloem inside of the bark. Peeling back the bark reveals brown flecking or streaking of the internal bark tissue. Measles is most commonly brought about when soils become more acid. Applying lime to raise the soil pH and reduce the availability of manganese levels may help the tree recover.

#### Boron

**Deficiency:** In most fruit crops, boron deficiencies show up in the fruit before appearing in the leaves. Symptoms in apples and pears are similar: gnarled, misshapen fruit caused by depressions usually underlaid by hard corky tissue. This symptom is often confused with bitter pit or corking caused by calcium deficiency. Researchers disagree whether the two symptoms can be told apart visually. Boron deficiency might be distinguished from bitter pit by the presence of pitting from the peel to the core, whereas in bitter pit the pitting usually occurs only at the calyx end and only very close to the skin. In some instances of boron deficiency, the entire surface is covered with cracks that have callused over, producing a russeted appearance.



In plums, the symptoms appear as brown sunken areas in the fruit flesh, ranging in size from small spots to almost the whole fruit. The fruit usually colors earlier than normal, and falls. Gum pockets may also form in the flesh. In peaches, the flesh adjacent to the pit develops brown, dry, corky areas, and some fruits may crack along the suture. The most typical vegetative symptom is the death of the terminal growing points, resulting in a “witch’s broom” appearance.

**Toxicity:** Symptoms in apples include dieback of twigs, greatly enlarged nodes on one- and two-year-old twigs, early fruit maturity, internal breakdown, and dropping of fruit. Foliar symptoms occur first on the older leaves and include a yellowing along the midrib and the large lateral veins. In peaches vegetative symptoms include necrotic lesions on leaves, crinkling of margins and tips of leaves, reduced flower bud formation and set, and pit splitting.

### Copper

**Deficiency:** Younger leaves appear stunted or misshapen, narrow, and slightly elongated with wavy margins. There may be some terminal dieback. Copper and zinc deficiencies often occur together and are aggravated in soils that have a high pH.

**Toxicity:** Symptoms are almost nonexistent under orchard conditions, but when present they may resemble those of zinc deficiency.

### Zinc

**Deficiency:** Symptoms have often been described as a “rosetting” of leaves or “little leaf.” Newly developing leaves are smaller than normal. Reduced shoot elongation keeps them close together, resulting in the rosette appearance. In severe cases, older leaves may drop, resulting in a more pronounced rosetting. In the early spring, the observer might notice a delayed foliation of lateral leaves on last year’s shoots. This symptom has been confused with that of winter injury, but the distinguishing characteristic is that winter injury will also produce browning of the cambium.

**Toxicity:** Symptoms are rare and most likely are masked by secondary symptoms resembling those of other micronutrient toxicities.

### Foliar Application of Nutrients

The most efficient way to apply nitrogen, phosphorus, potassium, and magnesium is by ground application. Foliar applications of these elements should be viewed as temporary or emergency solutions only. Boron, zinc, copper, and manganese can be added by either foliar or ground application. The foliar method is usually preferred because very small amounts are applied per acre. Table 1-4 gives foliar application suggestions. The materials listed in the table are the most common and the cheapest, but other commercial formulations are available. Since formulations differ by manufacturer, it is essential to check compatibility of the material when mixing. Foliar application of calcium to control cork spot and bitter pit is dealt with in Cork Spot and Bitter Pit Fruit Disorders.

**Table 1-4. Foliar applications for special nutritional problems.**

Problem nutrient	Material	Rate/acre <sup>a</sup>	Timing <sup>b</sup>	Comments
Nitrogen	Urea (45% N, Low biuret)	10 lb	P or PH	Not recommended where calcium deficiency disorders are problems.
Calcium	Calcium chloride (77–80% CaCl <sub>2</sub> )	15–50 lb	1–7	Do not substitute calcium nitrate. Do not premix calcium chloride with Solubor. (See Cork Spot and Bitter Pit Fruit Disorders.)
Potassium	Potassium sulfate (27% K <sub>2</sub> O)	6–10 lb	D or PH	Apply in a dilute spray. Do not use potassium materials containing nitrogen.
Magnesium	Magnesium sulfate (11%)	10 lb	PF	May be applied in first or second cover. Compatible with pesticides.
Manganese	Manganese sulfate (24%)	5 lb	D or PH	Apply in spring before growth starts.
Copper	Copper sulfate (22% Cu)	4–6 lb	D or PH	Apply in spring before growth starts.
Boron	Solubor (20.5% B)	4 lb 8 lb	PF and 1 PH	Make two applications of equal rates, but do not exceed 8 lb/A per year.
Zinc	Zinc sulfate (89%)	5.5–11 lb	D or PH	Apply before growth starts.

The materials listed are some of the more concentrated, single nutrient sources of these nutrients. Other materials may be suitable, but always ask for independent test results on products not known to be effective.

a. Commercial formulation.

b. D = dormant, P = pink stage, FB = full bloom, PF = petal fall, 1–7 = first through seventh cover sprays, PH = postharvest.

**Table 1-5. General indices for judging nitrogen status of fruit trees.**

Index	Low N	Normal N	Excessive N
Shoot growth	Bearing: small diam. <8 inches long Nonbearing: <10 inches	Avg. 12–18 inches Avg. 18–24 inches	Avg. 18–24 inches Avg. 24–40 inches
Leaf size	Small, thin	Medium to average	Large, thick, often puckering at tip
Leaf color	Pale yellow green	Normal green	Very dark green
Fall leaf drop	Early, leaves show red in veins	Normal, leaves green to light green	Late, leaves dark green until frost
Bark color	Light brown to red brown	Gray to dark gray brown	Green gray to gray
Fruit set	Poor, heavy June drop	Normal, 1–3 fruits per cluster	Little or no effect or reduction
Fruit overcolor	Highly colored often earlier than normal	Average color	Poor color
Fruit undercolor	Yellow earlier than normal	Yellow green at maturity	Green to green yellow at harvest
Fruit maturity	Earlier than normal	Normal	5–10 days later than normal

Adapted from G. Cahoon, *Fertilizing Fruit Crops* (Ohio Cooperative Extension Service).

## Fertilizer Application

### Nitrogen

Nitrogen requirements are best determined by tree growth and performance. Soil tests for nitrogen have not proven useful in determining tree needs. Table 1-5 gives visual indices for judging nitrogen status of fruit trees. As mentioned previously, nitrogen levels in a foliar analysis should be higher for young nonbearing trees. The values should be towards the upper end listed in Table 1-2. Leaf nitrogen levels also tend to be higher in samples from trees carrying heavy crops. Biennial bearing trees in their off year or trees with a light crop generally have lower nitrogen levels. This is probably related to the inverse relationship between shoot growth and fruiting.

Nitrogen cycle and its availability is a complex situation. Nearly 80 percent of our atmosphere is composed of nitrogen. Some can be precipitated out during thunderstorms and rain events. Additionally, much nitrogen is recycled when organic matter decomposes. It has been estimated that for every 1 percent of organic matter in the soil as much as 20 to 45 pounds of nitrogen per acre per year can be made available for plants to absorb. In addition, much of the nitrogen in the leaves can be remobilized back into the tree to be stored in the structural portions of the tree. This stored nitrogen is what supplies the initial tree growth in the spring. The larger the tree, the more potential nitrogen the tree can store. Conversely, this means that the new smaller trees on a per-tree basis will store less nitrogen.

In apples, we have a better understanding of nitrogen levels based on cultivar. Cornell University researchers suggest the following nitrogen levels in mature trees based on cultivar (see Table 1-3):

- 1.8 to 2.2 percent nitrogen: Soft cultivars such as Cortland, Gala, Golden Delicious, Jersey mac, Jonagold, Jonamac, Jonathan, Macoun, McIntosh, Mutsu, Paulared, Spartan, Tydeman's Red, and other early ripening cultivars.
- 2.2 to 2.4 percent nitrogen: Braeburn, Delicious, Empire, Fuji, Idared, Liberty, Melrose, Rhode Island Greening, Rome Beauty, Stayman, York Imperial, and other varieties.

**Application rates:** As a general rule, young trees may require about 0.01 to 0.04 pound of actual nitrogen per year of age up to 0.3 pound actual nitrogen per tree at maturity. These general levels should be adjusted up or down, depending on pruning, size of crop, cultural practices, indices presented above, and leaf analyses. Young nonbearing trees should grow up to 24 inches annually. Mature and heavily bearing trees should grow less, with apple and pear trees growing 12 to 18 inches; apricot, cherry, plum, and prune trees 15 to 18 inches; and peach and nectarine trees 18 to 24 inches.

**Form of nitrogen:** Fruit trees respond to any form of nitrogen fertilizer. Avoid using ammonium sulfate, urea, or ammonium nitrate if pH is below 6.0. Fall urea sprays on apples and pears may help increase fruit set while preventing the buildup of scab inoculum. If applying urea as a foliar spray, use low-biuret-containing (less than 0.25 percent) urea. Applications of urea sprays to stone fruits are ineffective during the growing season. Research in California has shown successful uptake of foliar nitrogen applications to stone fruits in postharvest sprays during September and October. Calcium nitrate sprays should be avoided on apples during the growing season to discourage corking. (See Cork Spot and Bitter Pit Fruit Disorders.)

**Time of application:** Traditionally, we have said that nitrogen should be applied in the spring as close to bud break as possible. However, if using urea, applications should be avoided when temperatures may cause volatilization of urea. Research in the Pacific Northwest, however, indicates that application at this time results in the nitrogen chiefly accumulating in the foliage of the trees with little going into the flowers and developing fruitlets to help fruit set. Studies have shown that the majority of the nitrogen used to set fruit comes from the reserves within the tree and spring-applied nitrogen does not reach the developing fruit in time to be effective. In studies in apples and pears in Oregon, late summer to early fall nitrogen application was found to be preferentially translocated to the roots and the flower buds where it was mobilized from the roots and available in the flower buds next spring to increase flower strength and fruit set capabilities. Research in New York and small-scale trials in Pennsylvania have supported these findings. Since many growers now apply foliar urea in the fall to reduce scab inoculum, the best program may be to apply urea in the fall and supplement, based on leaf analysis and terminal shoot growth, with ground applications of nitrogen just prior to bud break.

### Phosphorus

Phosphorus is important to plant growth because it is a catalyzing agent that induces metabolic reactions. It permits the plant to use nitrogen and to develop seeds. Failure of seeds to set often results in abortion of the young fruit and in misshapen fruit. Preplant soil test recommendations are made to attempt to raise soil levels to 100 pounds available phosphorus per acre.

**Application rates:** Rates should be based on either leaf analysis or soil analysis. Soil levels of less than 100 pounds phosphorus per acre indicate that an application of phosphorus is needed. Leaf analysis levels of less than 0.18 percent in apples and pears; 0.15 percent in peaches and nectarines; 0.23 percent in cherries; and 0.09 percent in plums indicate a need for phosphorus.

**Form of phosphorus:** The effectiveness of special forms of phosphorus under Pennsylvania conditions has not been documented.

**Time of application:** Application may be made anytime during the year in established orchards. Preferably, applications should be broadcast before the trees are planted and turned under with the previous crop. This aids in getting phosphorus down into the root zone.

### Potassium

Potassium is important for maintaining water turgor in leaves and for functioning in the opening and closing of stomates. It is available in the soil as a cation; at excessive levels it competes with calcium and magnesium for uptake by the plant. Fruit contain a large amount of potassium and their removal with harvest constitutes a major loss of the element from the orchard ecosystem.

**Application rates:** If the potassium level in the foliage is over 1.5 percent, a response to potassium application is doubtful regardless of the soil test, unless leaf nitrogen or soil magnesium is too high. When soil test values exceed 4.5 percent base saturation of potassium, then no additional potassium is needed. Values lower than this call for an application.

**Form of potassium:** Any added value of one type of potassium fertilizer over another has not been determined.

**Time of application:** Same timing as for phosphorus.

## Calcium

Calcium plays a vital role in reducing the incidence of corking and bitter pit. Calcium levels in the Mid-Atlantic are generally adequate; however, deficiencies can be observed in sandy soils or acidic soils due to leaching. Low soil test values are often found in very sandy or shaley soils. Calcium in the form of limestone is important for maintaining soil pH. Improper soil pH can lead to deficiencies or toxicities of other nutrients. The need for lime is best determined by a soil test. Calcium, like potassium and magnesium, is available to the plant as a cation, and an excess of potassium or magnesium can reduce calcium uptake. In fruit trees, calcium-related disorders, such as bitter pit or cork spot, are often related to intra-tree competition with potassium and/or magnesium. Tree vigor, crop load, and excessive moisture can have an impact on calcium problems.

**Application rates:** Soil application depends on soil pH, buffer pH, and depth of pH change desired. Calcium chloride applied as a foliar spray is recommended to prevent corking and bitter pit in the fruit. Current recommendations and additional information are listed in Cork Spot and Bitter Pit Fruit Disorders.

**Form of calcium:** Growers should base their limestone-purchase decisions on the price per ton of calcium carbonate equivalent (% CCE), including spreading costs. Most limestone contains some impurities, the most common being magnesium. Continual use of dolomitic or high-magnesium lime can cause problems in a tree's uptake of calcium. Dolomitic lime should not be used unless the soil test or the leaf analysis indicates a need for magnesium.

**Time of application:** In preplant situations lime is most effective when broadcast and incorporated at least 6 to 12 months prior to planting. In established orchards any time is suitable, although postharvest or early spring applications allow rains to move lime into the soil. Regardless of how much rain accumulates, the process of raising the soil pH is slow, with the effects of lime moving downward at about 1 inch per year.

## Magnesium

Leaf analysis values below 0.2 percent in apples and plums, 0.3 percent in peaches and pears, and 0.49 percent in cherries suggest that trees may respond to applications of magnesium. In soil tests, when the ratio of the percentage base saturation of magnesium to potassium is less than 2.0, magnesium applications may be needed.

**Application rates:** Foliar applications of magnesium sulfate at 10 pounds per acre should be viewed as quick but temporary measures. A more permanent solution is to apply a magnesium containing limestone at rates recommended in the soil analysis.

**Form of magnesium:** Magnesium is normally found in all but the purest limestone. The Penn State soil test results give a separate recommendation for magnesium. Growers should examine the purity of the limestone to determine whether the percentage of magnesium contained in it will also satisfy the magnesium requirement.

**Time of application:** Magnesium sprays are effective only when applied during the growing season. Applications may be single or split (i.e., applied at petal fall or in the first two cover sprays). Foliar sprays appear to be most effective when applied separately from pesticide applications. Ground applications can be made when lime is applied.

## Boron

Boron is a nutrient often found to be low or deficient in orchards. Deficiency symptoms are observed more often in apple, plum, and pear trees than in peach and cherry trees. In apple trees, a deficiency may be expressed as internal cork in the fruit, as a dieback of shoots, and as bark necrosis. In pear trees, a deficiency may be expressed as internal cork, withering of blossoms, or poor fruit set. In peach trees, toxicity symptoms appear as necrotic lesions on leaves, crinkling of margins and tips of leaves, reduced flower bud formation and set, and pit splitting.

Tissue test values less than 35 ppm in apples indicate a shortage of boron. Values between 35 and 60 ppm indicate sufficiency. In the soil, values less than 0.5 ppm are low, while values between 0.5 and 1 ppm indicate a sufficient level. *Caution:* Excessive boron can be extremely toxic. Leaf values of over 80 ppm or soil values of over 1 ppm are excessive.

**Application rates:** In orchards where boron is low, apply 0.8 to 1.6 pounds per acre of actual boron (4–8 pounds per acre of Solubor 20.5% B) in two separate sprays at bloom, petal fall, or first cover; or apply a single postharvest foliar spray of 1.6 pounds per acre of actual boron. For trees more than three years old, especially pears, apply boron annually to the soil. Apply 0.12 pound of actual boron per acre for four-year-old trees. For each additional year of tree age up to 16 years, increase the rate by 0.02 pound per acre of actual boron. Use the lower rate as a maintenance program when no leaf analysis has been made. Eight pounds of Solubor per acre is recommended for proven cases of low boron.

**Form of boron:** Boron is most effective when applied as a foliar spray on apples and to a lesser extent on pears. Special formulations such as Boro-spray or Solubor should be used. Agricultural borax is adequate for ground applications for any tree fruit.

**Time of application:** Soil applications can be made anytime. Foliar applications can be made during bloom or postharvest while leaves are still green and active on the tree.

## Copper

Copper is a catalyzing element in plant metabolic reactions. Foliar analysis is best for determining copper deficiency. Values below 5 ppm indicate the need to apply copper.

**Application rates:** When leaf analysis indicates a deficiency, 4 to 6 pounds per acre of copper sulfate is recommended.

**Form of copper:** Copper sulfate (22 percent Cu) is the most readily available and cheapest material to use.

**Time of application:** Foliar applications should be made during the dormant season or after the fruit has been harvested and while the leaves are still active and green. Soil applications can be made anytime.

## Zinc

Deficiencies of zinc occasionally occur in Pennsylvania orchards. Small leaves clustered on the end of shoots indicate zinc deficiency but may be confused with winter injury. Zinc applications are recommended when leaf levels are below 20 ppm. Foliar applications of zinc sulfate should only be made during dormancy or postharvest. Do not apply zinc sulfate with oil or apply within 30 days of the application of oil.

**Table 1-6. Apple cultivars.**

Cultivar	Pollen viability	Bloom	Vigor <sup>b</sup>	Harvest	DAFB <sup>c</sup> range est.	S <sup>d</sup>	PM <sup>d</sup>	CAR <sup>d</sup>	FB <sup>d</sup>
Akane	Good	Early to midseason	V	Early Sept.	105–110	M <sup>e</sup>	H <sup>e</sup>	H	M
Ambrosia	Good	Midseason	MV	Late Sept.	140–150	H	O <sup>e</sup>	M	M
Arlet	Good	Early to midseason	MV	Mid-Sept.	125–130	H	H	H	M
Autumn Crisp	Good	Midseason	MV	Mid-Sept.	125–130	L <sup>e</sup>	—	—	—
Blondee	Good	Mid- to late season	MV	Late Aug.	105–115	H	M <sup>f</sup>	H	H
Braeburn	Good	Midseason	MV	Late Oct.	160–170	H	H	H	H
Cameo (Carousel)	Good	Midseason	VV	Mid-Oct.	155–165	H	M	H	M
Cortland	Good	Midseason	V	Early to mid-Oct.	125–135	H	H	H	H
Crimson Crisp <sup>a</sup>	Good	Midseason	V	Mid-Sept.	125–135	O <sup>e</sup>	M	M	M
Crimson Gold <sup>a</sup>	Good	Midseason	V	Mid-Sept.	125–135	O	—	—	—
Crispin (Mutsu)	Not good	Midseason	VV	Late Oct.	160–170	M	M	M	L
Cripps Pink (Pink Lady <sup>®</sup> )	Good	Mid- to late season	VV	Mid- to late Nov.	180–195	H	O	O	H
Delicious	Good	Midseason	MV–LV	Late Sept.	135–155	L	L	L	L
Earligold	Good	Midseason	VV	Mid-Aug.	95–105	—	—	—	H
Elstar	Good	Mid- to late season	V	Early Sept.	110–125	H	H	H	—
Empire	Good	Midseason	LV	Early Oct.	125–140	H	H	L	M
Enterprise <sup>a</sup>	Good	Mid- to late season	V	Late Sept.	135–145	O	M	O	O
EverCrisp	Good	Late season	MV	Mid- to late Oct.	150–160	M	—	—	M
Freedom <sup>a</sup>	Good	Mid- to late season	V	Late Sept.	140–150	O	O	H	L
Fortune	Good	Mid- to late season	V	Mid-Oct.	150–160	L	—	—	H
Fuji	Good	Mid- to late season	V	Late Oct to mid-Nov.	165–175	H	O	H	H
Gala	Good	Midseason	MV	Late Aug.	110–120	H	M	H	H
Galarina <sup>a</sup>	Good	Midseason	MV	Early–mid-Sept.	145–165	O	M	—	M
Gala Supreme	Good	Mid- to late season	V	Early Oct.	150–160	M	M	M	—
Ginger Gold	Good	Midseason	V	Early Aug.	95–105	H	M	H	H
Golden Delicious	Good	Midseason	V–MV	Mid-Sept. to early Oct.	135–150	L	L	L	M
Golden Supreme	Good	Mid- to late season	MV	Early to mid-Sept.	125–140	M	M	L	—
GoldRush <sup>a</sup>	Good	Late Season	MV	Late Oct.	165–175	O	R	H	M
Granny Smith	Good	Late season	MV	Early Nov.	165–180	H	H	H	M
Gravenstein	Not good	Early season	VV	Early Sept.	110–115	H	H	H	M
Grimes Golden	Good	Early season	MV	Mid-Sept.	130–145	O	L	O	M
Honeycrisp	Good	Early season	MV	Early Sept.	125–140	L	M	M	M
Idared	Good	Early season	MV	Early Oct.	145–160	H	H	H	H
Jerseymac	Good	Early season	VV	Mid-Aug.	90–110	H	H	L	M
Jonafree <sup>a</sup>	Good	Midseason	MV	Late Sept.	135–150	O	L	H	M
Jonagold	Not good	Midseason	V	Late Sept.	135–150	H	L	H	H
Jonamac	Good	Midseason	MV	Mid-Sept.	115–130	H	H	L	M
Jonathan	Good	Midseason	LV	Mid- to late Sept.	135–145	H	H	H	H
Liberty <sup>a</sup>	Good	Early season	V	Late Sept.	140–150	O	L	L	L
Lodi	Good	Early season	V	July	65–75	H	H	H	H
McIntosh	Good	Midseason	MV	Mid-Sept.	120–135	H	H	L	M
Macoun	Good	Midseason	LV	Mid-Oct.	130–140	H	H	H	M
Melrose	Good	Late season	V	Late Oct.	140–165	H	H	H	L
Mutsu (Crispin)	Not good	Midseason	VV	Late Oct.	160–170	H	H	H	M
Northern Spy	Good	Late season	VV	Mid-Oct.	140–160	H	H	H	H
Northwest Greening	Good	Midseason	V	Mid-Oct.	130–145	—	—	—	M
Novamac <sup>a</sup>	Good	Early season	MV	Mid-Sept.	115–125	O	M	L	L
Nova Spy <sup>a</sup>	Good	Midseason	V	Mid-Oct.	—	O	L	M	L
Orin	Not good	Midseason	MV	Early Oct.	145–165	H	H	M	—
Paulared	Good	Early season	MV	Early Sept.	95–100	L	H	L	H
Pristine <sup>a</sup>	Good	Early season	V	Late July	90–100	O	L	L	O
Redfree <sup>a</sup>	Good	Midseason	MV	Late Aug.	90–100	O	L	O	L
Rome Beauty	Good	Late season	V	Late Oct.	165–170	H	H	H	H
Sansa	Good	Midseason	LV	Late Aug.	100–115	L	L	L	—
Scarlet O'Hara <sup>a</sup>	Good	Midseason	M	Late Sept.	135–145	O	L	O	H

**Table 1-6. Apple cultivars (continued).**

Cultivar	Pollen viability	Bloom	Vigor <sup>b</sup>	Harvest	DAFB <sup>c</sup> range est.	S <sup>d</sup>	PM <sup>d</sup>	CAR <sup>d</sup>	FB <sup>d</sup>
Shizuka	Not good	Midseason	V	Mid-Sept.	130–140	—	—	—	—
Silken	Good	Early season	MV	Mid-Sept.	125–135	M	L	H	—
SnowSweet	Good	Early season	MV	Late Sept.	125–140	M	—	—	M
Spartan	Good	Midseason	V	Late Sept.	120–130	H	H	H	M
Spigold	Not good	Midseason	VV	Mid-Oct.	140–155	H	H	H	H
Stayman	Not good	Early season	MV	Late Oct.	165–175	H	L	M	M
Summer Rambo	Not good	Early season	VV	Late Aug.	90–100	H	H	H	M
Summerset	Good	Early season	MV	Early Sept.	110–120	M	—	—	—
Suncrisp	Good	Midseason	V	Late Sept.	140–160	M	M	M	H
Sundance <sup>a</sup>	Good	Midseason	V	Mid-Oct.	140–150	O	L	O	O
Sunrise	Good	Midseason	MV	Mid-Aug.	95–105	O	—	—	—
Tydemans Red	Good	Early season	MV	Late Aug.	90–100	H	L	H	H
Williams Pride <sup>a</sup>	Good	Early season	MV	Mid-Aug.	85–90	O	M	O	L
Winesap	Not good	Late season	V	Late Oct.	165–175	H	L	H	L
Winter Banana	Good	Midseason	MV–LV	Late Oct.	160–170	H	H	H	H
Yellow Transparent	Good	Midseason	V	Mid-Aug.	65–75	H	H	H	H
York Imperial	Good	Midseason	MV	Late Oct.	170–180	H	H	H	H
Zestar!	Good	Early season	V	Late Aug.	95–100	H	L	M	M

Appreciation is expressed to Dr. Stephen Miller, formerly of the USDA Fruit Research Lab in Kearneysville, West Virginia, for additional information on disease susceptibility.

a. Scab-resistant cultivar.

b. V = vigorous; MV = moderately vigorous; VV = very vigorous; LV = low vigor.

c. DAFB = days after full bloom.

d. S = scab; PM = powdery mildew; CAR = cedar apple rust; FB = fire blight.

e. H = high; M = moderate; L = low; O = not susceptible; — = unknown.

## APPLES

### Cultivars

The apple cultivar situation is constantly changing across the country and within Pennsylvania.

Consider thoroughly which cultivars to plant. The first consideration is to determine how you intend to sell the fruit. Roadside markets, pick your own, and, to some extent, wholesale fresh market growers all need a continual supply of products. Therefore, it is important to choose cultivars that will accommodate an extended marketing period.

Information about various cultivars and their ripening sequences can be found in nursery catalogs. Information is also published periodically in the “Register of New Fruit and Nut Cultivars” by the American Pomological Society in the *HortScience* journal (<https://journals.ashs.org/hortsci/view/journals/hortsci/hortsci-overview.xml>). Table 1-6B lists the parentage, place of origin, and synonyms for many of the traditional apple cultivars grown throughout the United States as well as some of the new cultivars. The female parent from planned crosses will indicate, in general, the outward visual appearance of the fruit. Therefore, apple cultivars having a female parent of Fuji, such as EverCrisp, will look more like a Fuji-type apple than the male parent appearance of Honeycrisp. Additional information and images of the cultivars are available on the eXtension website at [www.extension.org/pages/66370/apple-cultivars#.VeNAEX1p0-w](http://www.extension.org/pages/66370/apple-cultivars#.VeNAEX1p0-w).

The cultivar market has changed with the release of cultivars that have restrictions on the sale of the trees and/or the fruit. “Club” or “controlled supply” cultivars have been established to control oversupply in the market and enhance the dollar return

to the grower. These restrictions can take multiple forms. Some cultivars are restricted geographically by only allowing certain areas to grow the fruit. Some are restricted by marketing constraints where the fruit must meet a minimum quality standard to be labeled. Many apple cultivars are being named or given selection numbers, and then trademarked under another name. The advantage of this approach is that a trademark, unlike a patent, never expires. Finally, some cultivars may be restricted by only allowing a certain number of trees to be propagated, thereby controlling the overall supply of the fruit. Pacific Rose and Jazz are two club cultivars that require the grower to pay an “entrance fee” (i.e., purchase the trees and then pay a percentage of the gross returns to a marketing firm). Kiku Fuji is another club cultivar that has no entrance fee, but in order to label the fruit Kiku Fuji, they must be graded to specific standards and marketed through a licensed broker. Common current apple cultivars grown in the United States or Canada that are managed in some form include Pink Lady®, Tentation (Delblush), Piñata, Jazz™ (SciFresh), Sundowner, Envy™ (SciLate), SweeTango, and Cosmic Crisp™ (WA 38). For more information on the development of new cultivars and their marketing restrictions, do an Internet search for “Making Sense of New Apple Varieties, Trademarks, and Clubs” and “Update on New Apple Varieties, Managed Varieties and Clubs.” Both were prepared by Dr. Susan Brown, the apple breeder at Cornell, and appeared in the *New York Fruit Quarterly journal*.

Before setting out large plantings of a new strain or cultivar, always plant a few trees on a trial basis. Also try to visit or talk to growers who may already have bearing fruit of a particular cultivar.

Many of the new cultivars are being introduced from Europe, New Zealand, and Japan. The marketplace is shifting, with more

**Table 1-6B. Parentage of common and new apple cultivars.**

Cultivar	Female parent		Male parent	Country/area of origin	Comments/notes	Synonyms
Akane	Jonathan	x	Worcester Permain	Aomori, Japan		Tohoku #3
Ambrosia	chance seedling			British Columbia, Canada	Possibly from Red and Golden Delicious	
Arlet	Golden Delicious	x	Idared	Wadenswil, Switzerland		Swiss Gourmet
Autumn Crisp	Golden Delicious	x	Monroe	Geneva, New York		NY 674
Autumn Gold	chance seedling			Tieton, Washington	One parent is Golden Delicious	
Braeburn	chance seedling			Nelson, New Zealand	Possibly Lady Hamilton x ?	
Cameo	chance seedling			Dryden, Washington		Carousel
Cortland	Ben Davis	x	McIntosh	Geneva, New York		
Crimson Crisp	PCFW2-134	x	PRI 669-205	New Brunswick, New Jersey		Co-op 39
Cripps Pink (Pink Lady)	Golden Delicious	x	Lady Williams	Australia	Correctly it should be called Cripps Pink	
Delicious	chance seedling			Peru, Iowa	Possibly seedling from Yellow Bellflower	
Elstar	Golden Delicious	x	Ingrid Marie	Wageningen, Netherlands		
Empire	McIntosh	x	Delicious	Geneva, New York		
EverCrisp	Fuji	x	Honeycrisp	Midwest Apple Improvement Association		MAIA 1
Fuji	Ralls Janet	x	Delicious	Aomori, Japan		
Gala	Kidd's Orange	x	Golden Delicious	Wairarapa, New Zealand		
GalaSupreme	chance seedling			Wenatchee, Washington		
Ginger Gold	chance seedling			Nelson County, Virginia	One parent may be Winesap	
Golden Delicious	chance seedling			Clay County, West Virginia	Possibly Grimes Golden x Golden Reinette	
Golden Supreme	chance seedling			Fruitland, Idaho		
GoldRush	Golden Delicious	x	Co-op 17	West Lafayette, Indiana		
Granny Smith	chance seedling			Sydney, Australia		
Honeycrisp	Keepsake	x	MN1627	Excelsior, Minnesota		Honey Crunch
Idared	Jonathan	x	Wagener	Moscow, Idaho		
Jonagold	Golden Delicious	x	Jonathan	Geneva, New York		
Jonathan	chance seedling			Kingston, New York		
Lodi	Montgomery	x	Yellow Transparent	Geneva, New York		
Ludacrisp	Honeycrisp	x	Unknown	MAIA program	1 week prior to EverCrisp	MAIA L
Macoun	McIntosh	x	Jersey Black	Geneva, New York		
McIntosh	chance seedling			Ontario, Canada		
Melrose	Jonathan	x	Delicious	Wooster, Ohio	State apple of Ohio	
Mutsu/Crispin	Golden Delicious	x	Indo	Aomori, Japan	Triploid with sterile pollen	
Nittany	chance seedling			Biglerville, Pennsylvania	Probably a York Imperial x Golden Delicious	
Northern Spy	chance seedling			Ontario County, New York		
Pacific Rose	Gala	x	Splendour	New Zealand		Scirose
Paulared	chance seedling			Sparta, Michigan		
Pink Lady	see Cripps Pink above					
Pixie Crunch	PCF 2-134	x	PRI 669-205	Cream Ridge, New Jersey		Co-op 33
Rome Beauty	chance seedling			Proctorville, Ohio		
Rosalee	Fuji	x	Honeycrisp	MAIA program	Ripens with Golden Delicious	MAIA 11
Sansa	Gala	x	Akane	Morioka, Japan	Does not do well in warm growing areas	
Shizuka	Golden Delicious	x	Indo	Japan		
Silken	Honeygold	x	8C-27-96	Summerland, British Columbia		
SnowSweet	Sharon	x	Connell Red	Minnesota		Wildung, MN 1797
Spigold	Red Spy	x	Golden Delicious	Geneva, New York		
Stayman	chance seedling			Leavenworth, Kansas	Incorrectly called Stayman Winesap	
Summerset	Fuji	x	Honeycrisp	MAIA program	Ripens with Honeycrisp	MAIA 12
Suncrisp	Golden Delicious	x	(Cortland x Cox's Orange)	New Brunswick, New Jersey		
Sundance	Golden Delicious	x	PRI 1050-201	New Brunswick, New Jersey		Co-op 29
Sunrise	10C-10-19	x	PCF 3-120 9	Summerland, British Columbia		
Topaz	Vanda	x	Rubin	Czech Republic		
Wild Twist	Honeycrisp	x	Cripps Pink	Washington		Regal 10-45, SweetCheeks
WineCrisp	Rock 41-112	x	PRI 841-103	Cream Ridge, New Jersey		Co-op 31
Winesap	chance seedling			New Jersey?		
York Imperial	chance seedling			York, Pennsylvania		
Zestar!	State Fair	x	MN 1691	University of Minnesota		MN #1824, Minnewashta

emphasis on taste and quality. Produce managers are looking for different color combinations to use in displaying apples. Following are comments from around the country on some of the popular cultivars being planted. Additional information can be found in Table 1-6. The harvest dates suggested in the table should produce apples with the most flavor. These periods will probably not coincide with harvest dates that are optimal for extended storage. For more information on harvesting for storage, refer to Part VI, Harvest and Postharvest Handling. The following are brief synopses of some of the more prominent cultivars.

**Akane** was developed in Japan as a cross between Jonathan and Worcester Permain. The fruit is medium to small in size, round to oblate, and dark red. It matures one week ahead of Jonathan. Storage life is only about three weeks.

**Ambrosia** was a chance seedling in an orchard in British Columbia. The parentage is believed to be a combination of Delicious and Golden Delicious and the fruit favors the conical shape of Delicious. Originally released to the general public, it was shortly placed under restrictions that limited its planting to Canadian growers. The U.S. restrictions expired in 2018. Trees are upright growing and difficult to spread. The growth habit is that of a semi-spur and branches break out easily when trying to spread them. Fruit is fine grained and sweet with a smooth red over yellow finish with no russetting. Fruit matures in late September to early October. The fruit are easy to thin in the spring with chemical thinners. The harvest window of the cultivar is narrow.

**Arlet**, also known as Swiss Gourmet, was developed in Switzerland as a cross between Golden Delicious and Idared. Apples are medium to large, round to conical, and brightly red striped. Harvest is reportedly 10 days sooner than that of Jonathan, but there is discrepancy in the literature. Fruit appearance has been very poor in the NE-183 planting at Rock Springs. Based on this, we are not recommending planting of Arlet.

**Blondee** was originally tested as MO 1040 by International Plant Management. It is a limb sport of Kidd's D-8 Gala that ripens one week before Gala. It is a completely yellow apple with Gala texture and Golden Delicious flavor. Storage is approximately two months in regular atmosphere. The cream-colored flesh of the fruit shows good resistance to browning.

**Braeburn** is a chance seedling from New Zealand most likely of Granny Smith parentage. Fruit is oval, small to medium, with slightly red shoulders over a green background. Braeburn has a long storage life. Red mutations are being discovered, primarily in New Zealand. There is disagreement over its exact maturity date. One source places maturity around Rome Beauty season. These maturity differences may be related to nitrogen fertilization practices and strains. The cultivar is very precocious and growers should be careful not to fruit the trees too soon. Trees at Rock Springs were not very productive and may have been overly sensitive to either spring frosts or chemical thinners.

**Cameo** was originally introduced as Carousel and was also tested as Wenatchee 66. It is a chance seedling of unknown parentage. The fruit is an attractive bright red striped over a yellow-green ground color. Fruits are round to slightly elongated and medium to large in size. The flesh is firm and creamy white. Flavor has been reported as sweet-tart and well received by consumers. Storage life is reported to be up to one year in CA storage. Fruit matures in mid-October, after Delicious and about the same time as Braeburn.

**Cortland** was developed at Cornell from a cross of Ben Davis and McIntosh made in 1898. The fruit are roundish oblate, attractively red colored, with a heavy bloom. Trees tend to be precocious and set heavy crops. Being a tip bearer, growth habit is similar to that of Rome Beauty. Standard Cortland may not color well in southern Pennsylvania. Therefore, two new strains having exceptional coloring capability, Redcort and Royal Court, are recommended for planting.

**Creston** was developed in British Columbia as a Golden type. Fruit is medium to large with a green color that occasionally has a red shoulder. Flesh texture is firm and fine-grained. Fruit ripens around the middle of September in central Pennsylvania.

**Cripps Pink (Pink Lady®)** is the correct name of the apple cultivar that is being marketed as Pink Lady. When trees are purchased, the grower receives a royalty-free license from Pink Lady America LLC, allowing the grower to use the Pink Lady name. It was developed in western Australia from a cross between Golden Delicious and Lady Williams. The fruit is medium in size and oblong in shape. The fruit has a pink blush over a yellow background with cream-colored flesh. The fruit has very firm flesh and has a long storage life. Trees are vigorous and upright growing, and are susceptible to fire blight. It should only be planted in southern Pennsylvania. In central Pennsylvania fruit are harvested still immature around November 5. Two new sports that mature earlier than standard Cripps Pink are Maslin and Lady in Red. The first, however, has some difficulties with unstable budwood. However, they do mature before the original Cripps Pink.

**Criterion** is a chance seedling found in a Delicious and Golden Delicious orchard in Washington. Fruit is medium to large with a shape similar to that of Delicious. It is a clear yellow with an occasional red blush. Fruit matures around Rome Beauty season. The flesh is cream colored with a mildly sweet flavor that is juicy and aromatic.

**Delicious** is not a new cultivar, but new strains are available. Considering current economic factors, only spur types are recommended for planting. The following new spur types are available:

*Ace Spur* is as a limb sport of Oregon Spur and was developed by Columbia Basin Nursery. Although a spur type, it is a very vigorous-growing spur type. Fruit color is similar to that of Oregon Spur but is earlier coloring.

*Adams Apple* is a very early coloring strain that developed as a limb mutation of Oregon Spur in an orchard in Washington state. Fruit develops 100 percent red color shortly after fruit set. Growth habit is similar to that of Oregon Spur.

*Early Red One*, although not a spur type, is a weaker-growing nonspur. It deserves mention as one of the darkest strains evaluated. In some areas, it may color too intensely.

*Hawkeye* is reported to be the original Delicious strain that was found in Peru, Iowa. Colors as a red stripe over green. Trees do not have a vigorous growth habit.

*Midnight Spur* is an early solid red coloring strain developed as a mutation of Oregon Spur.

*Oregon Spur II* is a higher-coloring sport of the original Oregon Spur. It also develops stripes, and vigor is similar to that of its parent. Trials in West Virginia indicate that it is a heavy bearer. It will probably replace its parent in new plantings.

*Redchief (Campbell)* has been one of the best early coloring strains evaluated, but one drawback is its lack of vigor. It is very precocious and if fruited too early will run out and not fill the allotted space. If designing plantings with this strain, either use a more vigorous rootstock than other spur types or plant trees 1 to 2 feet closer in the row. This strain is no longer patented and may be listed in some catalogs simply as Campbell Delicious.

*Schlect Spur*, an early coloring strain that may mature earlier as well, was found in Yakima, Washington.

*Superchief* is a whole tree mutation of Redchief. Like its parent tree, the fruit fills in as a stripe but earlier than Redchief. The tree has the same compact growth habit, so care must be taken not to fruit the tree too soon or it may run out.

Older strains continue to be productive, but they take longer to develop color than the strains mentioned above. Starkrimson, Oregon Spur I, Redspur, Sturdeespur, and Wellspur have consistently rated lower in color evaluations at 145 to 150 days after bloom. Growers who desire early, high-coloring strains are advised not to depend on these.

**Delblush** is a cross between Golden Delicious and Blushing Golden and is known in France as Tentation™. Fruit size is medium and bruises easily. The color is golden yellow with an orange blush over the shoulders. The fruit has a slightly sweet to subacid flavor as grown in Pennsylvania. Harvest is approximately four days after Golden Delicious.

**Earligold** is another chance seedling found in Selah, Washington. Fruit size is medium, having a clear yellow finish with little or no russeting. Fruit from plantings in central Pennsylvania mature approximately five days before Ginger Gold. Storage life of this fruit was shorter than that of Ginger Gold. At this point, Earligold should be considered primarily for roadside market sales.

**Elstar**, sometimes also referred to as Lustre Elstar, was developed in Holland as a cross between Golden Delicious and Ingrid Marie. Fruit is medium to large, round to conical, with red striping over a bright yellow background. Elstar matures in early to mid-September and has a medium storage life. In Europe it is marketed as a red blushed Golden Delicious. Fruit from plantings in central Pennsylvania appear nearly solid red. Fruit is heavily russeted across the shoulders.

**Enterprise**. See discussion below on scab resistant apple cultivars.

**EverCrisp** was developed by the Midwest Apple Improvement Association (MAIA), a private grower-funded organization. It is a cross of Fuji with Honeycrisp and resembles its maternal parent, Fuji, in shape and appearance. Fruit texture is similar to Honeycrisp. Fruit are described as sweet with a long harvest and storage window. To purchase trees the individual must be a member of the MAIA and agree to pay a royalty per tree once they begin producing.

**Fortune** was developed by Cornell University and was tested as NY429. Fruit are large to very large with an attractive overall red color. The flesh is creamy white, and the tree may tend toward biennial bearing. We do not know how it will perform in the warmer areas of the state. It is recommended for trial only in areas where McIntosh is grown.

**Fuji** was developed in Japan as a cross between Ralls Janet and Delicious. Fruit is medium-sized, round to conical. The strong biennial bearing habit of the cultivar makes it imperative that the trees are adequately thinned. This cultivar would be a good candidate for midseason applications of NAA to enhance return bloom. There are a number of early maturing strains of Fuji available, which would allow the cultivar to be grown in nearly all portions of the state. Following are some comments on the various available strains:

Early maturing strains of Fuji:

*Autumn Rose* is a full tree mutation of Nagafu 12 found in Oregon.

*Auvel Early Fuji (Fuji 216)* was discovered in Washington and ripens three to four weeks before standard Fuji. It contains apple mosaic virus and therefore should not be grafted onto G.16 rootstock.

*Daybreak Fuji (Rankin strain)* was found as a limb sport of Yataka in an orchard in Adams County, Pennsylvania. It ripens about five days ahead of Yataka and has better color and a smoother skin.

*Jubilee Fuji (formerly known as September Wonder Fuji)* is an early maturing strain of standard Fuji. In 2002 it ripened in mid-September in Pennsylvania and had excellent fruit color.

*Morning Mist Fuji* ripens three to four weeks ahead of standard Fuji with a thin striping pattern of red color.

*Rising Sun* matures four to five weeks before standard Fuji with a bright pinkish-red blush.

Normal maturing strains of Fuji:

*Aztec (DT2 cultivar)* was discovered in New Zealand and produces a blush coloration pattern.

*BC#2 (Morihofu #2)* is another irradiated selection from Japan that develops a striped color pattern.

*Brak (Kiku™)* is a branch mutation found in Japan by a grower from Italy. This strain, if it meets grading standards, can be sold by a licensed broker under the brand name of Kiku Fuji.

*Coe (Ebbourcoe strain)* was discovered as a whole tree sport of BC Fuji in Washington producing a solid red blushed fruit.



*Lynd's Spur Fuji* was found at Lynd's orchard in central Ohio, but the color pattern has not been reported.

*Fuji Supreme™ (CABp cultivar)* was discovered in Central Hawkes Bay, New Zealand, and is characterized by its rare red-striped color.

*Nagafu #2*, *Nagafu #6*, and *Nagafu #12* were all developed at the Nagano Research Station in Japan. *Nagafu #6* is a striped red, while the other two are blush colored. Of the three, *Nagafu #2* is reported to develop the most color.

*Sun Fuji* is a sport discovered in California and is reported to have a better color than any of the other strains.

*Myra Red Fuji (Broetje strain)* is a red sport found in the Pacific Northwest.

*TRECO Red Fuji (Cooper strain)* has a red-striped color pattern.

*Top Export Fuji (Snyder strain)* is a striped sport of BC#2 with better color capabilities.

**Gala** was developed in New Zealand as a cross between Kidd's Orange Pippin and Golden Delicious. Fruit is small to medium in size and uniformly oval to round. The original Gala is pale to golden yellow, with bright red-orange stripes. The fruit matures at the end of August in the southern portions of Pennsylvania. Storage life is rated at approximately three to six months. Gala requires multiple pickings for best quality. Available strains include Original (Kidd's D8), Autumn Gala (Harry Black), Brookfield Gala, Buckeye Gala (Peace Valley strain), Crimson Gala (Waliser), Extra Red Gala (Wyles), Galaxy Gala (Kiddle), Gale Gala (Malaga), Imperial Gala (Tenroy), Lydia's Red Gala (Hilltop), Spur Gala (Lynd), Pacific Gala (Olsen), Regal Gala (Fulford), Regal Gala (Applewaites), Royal Gala (Tenroy), Scarlet Gala (Creech), Star Gala (Weaver), TRECO Red Gala No. 42 (Cooper), Twin Bee Gala, Ultima Gala (Banning), and Ultrared Gala (Obrogala).

**Ginger Gold** is a chance seedling found in a commercial orchard in Virginia. It is sold as an early maturing Golden type, harvested in early to mid-August. Fruit finish is very smooth with little russetting. Storage potential is very good. Trees are very precocious. In test plantings in central Pennsylvania, second leaf trees on M.9 size rootstocks have had up to 15 fruits per tree. Trees are susceptible to powdery mildew and very easy to chemically thin.

**Golden Supreme** is a Golden Delicious-like fruit that occasionally has a pink blush. It is a chance seedling and produces fruit that is pleasantly sweet but better and tarter than Golden Delicious. It is also more vigorous than Golden Delicious. In the NE-183 plantings, it is one of the most attractive-looking apples with very little russet. A drawback is that it has not been very precocious. May need multiple harvests and tends toward biennial bearing like Golden Delicious.

**Hampshire** is a chance seedling found in New Hampshire that is being evaluated in the 1999 NE-183 planting. Fruit is medium to large and has a well-colored red surface. It has some McIntosh-looking characteristics. Flowers may have some frost tolerance since this cultivar did not seem to be excessively affected by late frosts in 2002.

**Honeycrisp** was developed at the University of Minnesota and tested as Minnesota #1711R. Fruits are large with a 50 to 90 percent solid to mottled scarlet red over green. Storage life in common storage has been as long as six to seven months. Noted for outstanding crispness and juiciness. Leaves of Honeycrisp frequently exhibit a yellow mottling during the summer due to a buildup of carbohydrates in the leaves. The tree is not very vigorous, and if planted on M.9 or B.9, trees should be spaced close together. Several new, higher coloring strains, B42, Cameron Select, Firestorm, Premier (DAS 10), and Royal Red, are available from various nurseries. In Europe, it is known as Honeycrunch. For further information on this and the other cultivars released by the University of Minnesota, go to [www.apples.umn.edu](http://www.apples.umn.edu).

**Jonagold** was developed in New York as a cross between Golden Delicious and Jonathan. Although introduced in 1968, Jonagold became more popular in Europe. Because of this demand, however, it is gaining favor in the United States. Jonagold is rated as one of the best-tasting apples. Fruit is large and conical, similar to Golden Delicious. Jonagold may have only medium storage potential. It is a vigorously growing triploid and therefore cannot be used as a pollen source. It is also intersterile with Golden Delicious. As with Gala, red sports are being released and there is similar concern about marketplace acceptance of noncoloring strains. Some of the more popular strains are Morren's Jona-go-red, DeCoster (Swillen), Jonastar (Lentz), Jonica (Schneica), Nicobel, Rubinstar (Herr), Jored (Nicolai's King Jonagold), and Wilamuta. In addition, many strains are being developed and tested in Europe. These include Crimson, Jomured, Jonabel, Crowngold, and others.

**Nittany**, discovered as an open-pollinated seedling of York Imperial (pollen source most likely was Golden Delicious), it has the flesh color, texture, and firmness of York. Fruit have been described as attractive, oblong, and light cherry red, with a good, sweet, tart flavor. It is a vigorous tree. The major problems seem to be storage and calcium-related disorders.

**Orin** is a cross of Golden Delicious by Indo developed in Japan. It has the same parentage as Shizuka and Mutsu. Fruit are medium to large, oblong, and yellow-green in color. The flesh is firm, aromatic, juicy, and very sweet. Test plantings at Rock Springs, however, have shown a tendency for prominent markings of the lenticels. This cultivar will probably not be of sufficient quality to be grown in Pennsylvania.

**Pink Pearl** was developed by a private breeder, Albert Etter, in California and patented by California Nursery Company. The distinguishing characteristic of this cultivar is its pink flesh that is slow to oxidize and a tart flavor. Skin color is a greenish-white translucent color. Trees are susceptible to apple scab and fire blight. Matures the middle to the end of August. Storage life is about two months.

**Pristine.** See section on scab-resistant cultivars.

**RubINETTE** is a high-quality introduction from the Swiss breeding program, a cross between Golden Delicious and Cox's Orange Pippin. The fruit has a brilliant red stripe over a golden ground with a faint russet. Fruit is small and has a

very sweet flavor with a slight tang and aroma. Tree growth habit is like that of Golden Delicious; moderately susceptible to powdery mildew and moderately resistant to apple scab.

**Sansa** is attractive, crisp, aromatic, medium-sized, and sweet-flavored. It may be stored for up to two months. One report says that Sansa is resistant to apple scab. The fruit matures in central Pennsylvania about two weeks before Gala. Good-quality fruit for its season. In southern Pennsylvania and farther south conditions may be too warm to produce good-quality fruit, and fruit may break down while still on the tree. The trees have weak vegetative growth, and it is unknown if this is the natural condition of the cultivar.

**Shizuka** was developed in Japan from a cross between Golden Delicious and Indo. It has the same parentage as Orin and Mutsu. Fruit is very large with a green to yellow skin that occasionally shows a pink blush. Fruit is sweeter than Mutsu, but fruit quality is not as good. Fruit is harvested in late September. Tree growth is very spreading. Shizuka is being promoted as a replacement for Mutsu because it does not appear to be susceptible to Blister spot. It is a triploid, and therefore the pollen is not viable.

**Silken** is a cross between Honeygold and a numbered selection (8C-27-96) developed at the Summerland Research Centre in British Columbia. It is an early apple, ripening in August. The skin has a soft, yellow, almost translucent quality. Fruit is crisp and juicy. Trees are slow growing, but precocious. Limited commercial availability.

**SnowSweet (Wildung cv.)** is a release from the University of Minnesota. It was developed from a cross between Sharon and Connell Red. The flesh is sweet with a hint of tartness and bright white that does not oxidize very easily. Tree growth habit is more willowy. Fruit ripen approximately two weeks after Honeycrisp. For further information on this and the other cultivars released by the University of Minnesota, go to [www.apples.umn.edu](http://www.apples.umn.edu).

**Suncrisp** (NJ 55) is a large, late season yellow apple, with striped orange cheek over a lemon-yellow ground color, conic fruit with a crisp yellow flesh, unique spicy pear flavor, and good storage potential. Harvest season is about one week after Delicious. Trees are very precocious. Fruit quality improves with a short storage period.

**Sunrise** is a release from British Columbia and ripens just before Gala. Fruit color is an attractive pinkish-red over a yellow ground color that is medium in size. Fruit flavor is mild to slightly sweet.

**Zestar!** is a release from the Minnesota breeding program. It is an early season apple that ripens in late August. It was developed from a cross of State Fair and MN 1691. The apples are globose with an average diameter of 3 inches and are typified by a red striping. As a young tree the growth habit is upright. It is susceptible to fire blight. Growers should only make trial plantings of this cultivar. For further information on this and the other cultivars released by the University of Minnesota, go to [www.apples.umn.edu](http://www.apples.umn.edu).

### Scab-resistant cultivars

Many scab-resistant cultivars have been released as a result of breeding programs in the United States and elsewhere. They were developed primarily for resistance to apple scab, but some are also resistant to cedar apple rust, powdery mildew, and fire blight. Most of the commercially available disease-resistant cultivars use the Vf gene from *Malus floribunda* as their resistance. Unfortunately, several races of apple scab have been identified. Most of these scab races are not located in the United States. There are other genes that can incorporate scab resistance in some newer apple cultivars. The Vr, VM, Vb, and VA genes have been identified as providing resistance to apple scab. Disease resistance does not mean total freedom from pesticides since none of these cultivars are immune to insect damage or summer diseases like sooty blotch or flyspeck. There are some new cultivars coming from Germany that will have multiple resistances to such diseases as powdery mildew and fire blight, among others. These are being marketed as “ReZista Series.”

Earlier releases such as Prima and Priscilla were not well accepted because of poor fruit quality. Since their release, newer cultivars now available may have promise for commercial orchards. Following are comments on selected apple-scab-resistant cultivars (see also Table 1-6):

**Crimson Crisp** (Co-op 39) was named by the Purdue Rutgers Illinois (PRI) cooperative breeding program. The medium to dark red fruit have a cream-colored, mildly acidic, coarse flesh. The fruit will store about six months in regular storage. In addition to apple scab they are moderately resistant to rusts and powdery mildew. It is susceptible to fire blight. Fruit matures around the middle to end of September and hangs well on the tree.

**Crimson Gold** was originally tested as Svatava from the Czech Republic. While resistant to scab it is slightly susceptible to powdery mildew and susceptible to fire blight. Fruit are medium size with fine texture, juicy, and have a good acid balance. Fruit ripen just before Golden Delicious. Storage life is seven to eight months. May not be suitable for more northern areas of PA as it has been reported to produce better under warmer conditions.

**Crimson Topaz** was developed in the Czech Republic from a cross between the Czech apple cultivars Vanda and Rubin. Topaz is a medium to medium-large apple. The skin color is yellow overlain with a red and crimson flush. The flesh is crisp and cream colored. The trees are moderately vigorous and very precocious. Trees are resistant to apple scab and moderately resistant to powdery mildew. Fruit matures about one week after Golden Delicious.

**Enterprise** (Co-op 30) was released by the PRI program as a later-maturing, scab-resistant apple cultivar. Flesh is yellow, with a 75 percent red skin. Fruit is of good quality. Flavor is very good although on the tart or acid side. Enterprise matures around October 15 in south-central Pennsylvania and about a week later in central Pennsylvania. The tree has a very vigorous growth habit. It is suggested for both home-owner and commercial trials. It is believed prone to corking, but this has been controlled in south-central Pennsylvania plantings with standard calcium chloride programs.

**Freedom** (NY58553-1) is ready for harvest around the end of September. Fruits are large and their external appearance is not very good, having a rough-looking finish. This cultivar does not store well, having ripened unevenly on the tree. Suggested for home plantings only.

**Galarina** is a Gala-like apple that is resistant to apple scab and can be stored for longer periods. It was developed in France from a Gala and Florina cross. The medium-size fruit matures one to two weeks after Gala. The skin color is 65 to 100 percent orange red over greenish yellow with flesh that is yellowish white. The flavor is aromatic and slightly tart. Trees are moderately vigorous.

**GoldRush** (Co-op 38) was released by the PRI program and is resistant to apple scab. The tree is moderately vigorous with an upright growth habit. The fruit ripens very late. Its growing season may be too long to be planted from central Pennsylvania northward. Fruit quality is excellent, and fruit has an approximately seven-month storage period. Fruits are medium to large and have a spicy to slightly acid taste at harvest, becoming better after a period of two months in storage. GoldRush produces a very good single-blend hard cider.

**Jonafree** ripens with Jonathan and has a 95 percent red over-color much like Jonathan's, but it is less susceptible to fire blight and powdery mildew than Jonathan. Jonafree is a very hard apple that does not develop a good flavor until after a period of storage. This cultivar has very vigorous growth and tends to be a tip bearer as well as an alternate year bearer. May work for processing.

**Liberty** (NY55140-19) is dark red and resistant to rusts, mildew, and fire blight. Its harvest date is from the last week in September to the first week in October in central Pennsylvania. The fruit tends to be small and may require multiple pickings; flavor is better after storage. Japanese beetles and European apple sawfly favor this cultivar to the extent that extra sprays are needed to control the pests. It is not recommended for southern Pennsylvania due to high summertime temperatures affecting fruit color and quality.

**Novamac** is a McIntosh type released from Kentville, Nova Scotia. In plantings at Rock Springs on M9 rootstocks, the trees have been very precocious and have been consistent croppers. The fruit looks and tastes like McIntosh. This cultivar holds promise for both backyard and commercial use in areas where McIntosh is grown. Severe preharvest fruit drop.

**Nova Spy** was developed in Nova Scotia as a scab-resistant "Spy-type" apple. It is a juicy, firm-fleshed red apple. It is moderately susceptible to rusts and only lightly susceptible to powdery mildew. It was developed in Canada from a cross between Nova Easygro and NY-44411-1. The fruit are attractive, moderate high quality, long keeping, and similar to Northern Spy. Fruit are medium in size, globose conical, and slightly ribbed. The flesh is creamy yellow, fine, very firm, crisp, and juicy. The fruit mature between Delicious and Northern Spy. It is an excellent processing cultivar. The tree is upright and moderately vigorous.

**Otava** was developed in the Czech Republic from a cross between Sampion and Jolana. The globose and ribbed fruit matures with Golden Delicious and has yellow skin with a slight red-orange blush. The flesh is yellow to cream with fine-grained texture, juicy, and has a sweet subacid flavor. It is resistant to apple scab and tolerant to powdery mildew.

**Pixie Crunch** (Co-op 33) was released from the Purdue, Rutgers, and Illinois cooperative breeding program. The blushed dark red to purple fruit have a yellow flesh that is extremely crisp, medium to fine grained, and juicy. Storage life is at best two months. The flavor is moderately to mildly acid. Fruit size tends to be small (2.5 inches in diameter), which may decrease its value as a commercial cultivar. It is immune to apple scab, susceptible to powdery mildew, and moderately susceptible to fire blight.

**Pristine** (Co-op 32) was released from the Purdue, Rutgers, Illinois breeding program. It is also moderately resistant to fire blight, slightly resistant to cedar apple rust, and resistant to powdery mildew. Fruit matures with Lodi and should be used as a replacement for Lodi. Plantings have been very productive. Fruit color is green to yellow.

**Querina** is also known as Florina and was developed in France. Fruit size is similar to Empire. Tree is moderately susceptible to powdery mildew and tolerant of fire blight. Matures about two weeks after Golden.

**Redfree** is a red-skinned summer apple. Harvest is around the middle of August in central Pennsylvania (six to seven weeks before Delicious). Storage life is only about two months; shows moderate tolerance to fire blight and powdery mildew. Tree wood is very brittle and weak. Redfree tends to be a tip bearer like Rome Beauty. Suggested only for roadside markets.

**Rubinola** is resistant to apple scab and powdery mildew and matures 10 days before Golden Delicious. The trees are vigorous. The cultivar was the result of a cross between Prima and Rubin. The fruit are medium to large, flat, globose, and with a skin that is bright red over most of the surface, although some russeting can occur. The flesh is yellow, firm, fine textured, juicy, and has a sweet aromatic flavor.

**Scarlet O'Hara** was released from the PRI cooperative breeding program. It was previously tested as Co-op 25. It is a midseason red apple that ripens one week before Delicious. The fruit are round to slightly conic. The overcolor is described as 75 to 90 percent medium red to orange with a green yellow to yellow undercolor. The flesh is yellow to cream colored, firm, and crisp. The flavor is sweet to mildly subacid. The tree and fruit are field immune to scab, moderately resistant to powdery mildew, highly resistant to cedar apple rust, and highly susceptible to fire blight.

**Sundance** (Co-Op 29) was released from the PRI cooperative breeding program. The pale yellow fruit are large and attractive. They have moderate stem-end russet. The flesh is medium to coarse cream colored with a very firm and crisp texture. The fruit have good storage potential and mature about 2.5 weeks after Delicious. Fruit tastes best after about a month in storage. Sundance is moderately resistant to powdery mildew and highly resistant to cedar apple rust and fire blight.

**Williams Pride** is one of the earliest-ripening cultivars released from the PRI breeding program. Matures around the middle of August. The dark red fruits are large with a semi-tart flavor that is very good. May have uneven ripening, requiring multiple pickings. Growth observations indicate that the tree is very willowy. Suggested for roadside markets. Shows a strong tendency toward bitter pit.

**WineCrisp** (Co-op 31) was released as the nineteenth apple cultivar developed by the PRI cooperative breeding program. The fruit is 100 percent dark red stripe with small lenticels. Fruit size is similar to Gala. Flavor is subacid to mild. Fruit firmness and the crisp texture are maintained in regular storage for an extended period. There is some tendency for fruit to drop when ripe. Needs a storage period of about a month to obtain maximum quality. Field observations indicate the tree has good resistance to fire blight and moderate resistance to powdery mildew. It is susceptible to cedar apple rust. Tree growth is classified as vigorous.

### The future of scab-resistant cultivars

Many more cultivars are being developed and tested in Europe. The Czech Republic, Italy, France, and Latvia all have active breeding and testing programs. The limitations to obtaining these cultivars is the inability to import new plant materials without going through a lengthy screening process. The other limitation to the wide adoption of scab-resistant cultivars is that most of the cultivars only carry the Vf gene for resistance. Establishing solid plantings of Vf-resistant cultivars may cause a breakdown in resistance of scab protection. In Switzerland where they have been growing scab-resistant cultivars, it is recommended that even if the cultivar is scab resistant a minimum number of sulfur sprays be applied each year to prevent the buildup of apple scab populations that can overcome the Vf resistance.

### Pruning

Fruit growers are constantly manipulating tree canopies to maximize fruit production. This is done in two ways: by pruning to remove limbs or shoots or by bending limbs or shoots in specific orientations. Pruning and training are therefore horticultural manipulations done to modify naturally occurring growth patterns within plants. The primary processes being modified are apical dominance (see below) and the natural flowering and/or fruiting characteristics of the trees.

The first point to remember is that pruning is a dwarfing process. A pruned tree will always be smaller than a same-aged tree that was not pruned. For pruning to be effective, however, it must be practiced with an understanding of how trees respond to branch or shoot removal and of how those removals affect future tree growth.

The second point to remember is that training affects primarily tree form, while pruning affects mainly function. Training determines the general character and even the details of the plant's outline and its branching and framework. Pruning is meant to determine how and when the tree will fruit. Therefore, training and pruning are two different aspects of modifying naturally occurring growth patterns. Training involves tree development and form, whereas pruning involves tree function and size.

Training takes place in the first four to five years of the tree's life. Pruning is conducted for the entire life of the tree. In a tree's early productive years, the goal of pruning is to contain excessive vigor. During declining years, pruning's emphasis shifts to promoting vigor and allowing maximum sunlight to penetrate the tree canopy.

### Types of pruning cuts

Regardless of the kind of fruit tree (or, for that matter, kind of plant), only two types of pruning cuts are made: heading back cuts and thinning out cuts. Every other cut you may hear discussed is a variation of these two. A heading back cut is the partial removal of a shoot, limb, or branch. In orchards this may range from the tipping of leaders or branches to the use of mechanical hedging machines. A thinning out cut is the removal of an entire shoot, limb, or branch at its point of origin. In orchards this can include the removal of a primary or secondary scaffold limb, removal of a spur system, or desuckering interior water sprouts arising from horizontal limbs.

### Impact of flower position

The difference in how a tree or plant responds to these two cuts is the basis for the different training systems. Concurrent with knowledge of how a tree responds to these two cuts is knowing where the particular species produces flowers and fruits. Every bud on a tree is regarded as a potential flower bud; therefore, flowers can occur in many areas. In general, however, they occur (a) terminally on long or short growths, (b) laterally in the axils of the current or past season's leaves, and (c) adventitiously from any point on the exposed bark of limbs, trunks, or roots (rarely).

As a rule, the position of the flower or inflorescence on the shoot relative to the current season's growth is characteristic of the species or cultivar and does not change much. In apples fruit buds are borne terminally, unfolding to produce leafy shoots that terminate in flower clusters. Most of these terminal flowers are on short two-year and older shoots called spurs. However, they can occur at the ends of long shoots, especially in the "terminal bearers" such as Rome Beauty, Granny Smith, and Cortland. Flowers may occasionally also be found as laterals arising on last year's wood. In most instances, in Pennsylvania and the Mid-Atlantic areas, these flowers do not set fruit. When the lateral flowers do set fruit, the resulting apples are usually small and of poor quality. The proportion of spur growth and flowering sites to terminal long shoot flowers is characteristic of a given cultivar and must be assessed when pruning in the field.

Flowering position differs for stone fruits. In peaches and nectarines, flowers are borne laterally on the previous season's growth. On healthy trees, there are usually two single flower buds per node with a single leaf bud in between. The most productive shoots are those that are approximately pencil size in diameter and 12 to 18 inches long. Cherries, plums, and apricots produce flowers terminally and laterally on one-year-old wood and in spurs on older wood.

### Apical dominance

Regardless of basic growth habit, all trees respond similarly to a given type of pruning cut. Heading cuts remove the growing point and developing leaves if applied during the summer and the terminal bud if applied during the winter. This operation severely

changes the shoot's hormonal balance and forces the plant to react accordingly. The tendency for suppression of the lateral bud break is referred to as the apical dominance of the terminal bud.

This young growing point or terminal bud is the site of manufacture of the class of plant hormones known as auxins. Removing either the shoot tip or the young growing leaves stimulates the growth of lateral buds immediately below the cut into side shoots because of the removal of that site of auxin manufacture. The lateral buds are inhibited in growth by auxins produced in the young meristematic tissues contained in the shoot tip and transported back downward. This effect must occur when the leaves are very young because removing young, developing leaves can stimulate lateral bud break; but removing fully expanded leaves cannot stimulate growth.

There are two ways to overcome this apical dominance effect from shoot tips. One is to remove the shoot tip as in a heading cut and the other is to bend a shoot tip to a more horizontal position. The latter works because auxins generally move in response to gravity.

Research has suggested that the inhibition of flower bud formation can be explained by the alteration of three plant hormones: cytokinin, auxins, and gibberellins. All three occurred in higher concentrations in the conductive tissues of trees that were pruned. Cytokinin-like substances were doubled in the conductive tissues at the very beginning of growth in the spring. In mid-June, after a month of growth, auxin levels were much higher in pruned trees than in nonpruned trees. This was followed by higher levels of gibberellins from the middle of June to the end of July in the pruned trees, compared to controls.

### **Trees given no pruning**

When growth begins, the terminal and subterminal buds are usually the first to start; in most deciduous trees and vines (less so in shrubs) they produce the longest and strongest shoots, although shoots may grow from many of the lower buds. However, seldom do all the lateral buds start, and as a rule the largest percentage of those remaining dormant are on the basal portion of the shoot.

### **Response to heading cuts**

The result of a heading cut is the loss of apical dominance as mentioned above, with the removal of the inhibiting effect on the lateral buds. The net result is an increase in total shoot growth. Both shoot number and length are affected, but the impact is affected by shoot age, severity of cut, growth habit, and shoot orientation.

### **Shoot age**

The stimulation of shoot growth is most pronounced when heading cuts are made into one-year-old wood. Such cuts usually result in very vigorous shoots from the three to four buds immediately below the cut. These shoots can develop very narrow angles. Heading cuts made near the top of these shoots induce the top five to seven buds to grow, usually within 6 to 9 inches below the cut (although this will also vary by severity of cut and orientation of the branch).

### **Severity of cut**

Severity can be long, medium, short, or very short (with a very short cut removing the most wood). Regrowth is related to the severity of cut in a bell curve response and time of season that

pruning is done. Strong shoots have well-developed buds along the upper three-fourths of the shoot. At the shoot base, however, the buds normally are not as well developed. This difference may explain why the strongest regrowth usually occurs when shoots are headed by one-half to three-fourths their length. At the same time, heading back close to the annual ring (where growth began or very short will likely lead to less regrowth. The results of dormant shoot heading thus are influenced by the condition of the bud that becomes uppermost after heading. Heading cuts made in the dormant season stimulate the most regrowth, while those made late in the summer stimulate less regrowth.

Heading into older wood is not as invigorating as cuts made in one-year-old wood. Nevertheless, it still increases total shoot growth.

### **Growth habit**

Researchers have classified apple cultivars into four general growth and flowering habits. They use the terms acropetal or acrotonic to describe cultivars that we call tip bearers, such as Rome Beauty or Granny Smith. At the opposite end of the spectrum are basipetal or basitonic cultivars. These produce mostly spur growth and are typified in the extreme by Redchief, the Campbell strain of Delicious. Lightly heading back basitonic cultivars (spur Delicious types) does not generate as much vigorous shoot regrowth as heading back those that do not have a strong spur growth habit. Heading back the acrotonic (weeping) growth habit cultivars increases regrowth to a greater extent and also reduces flower bud formation.

### **Shoot orientation**

Regrowth response is also affected by a shoot's orientation from the horizontal. The more upright the shoot, the greater the regrowth. Generally, heading cuts into upright shoots produces shoots in the two to four buds immediately below the heading cut that have a very narrow angle and that are very vigorous. These vigorous shoots create undesirable shade and have very low fruiting potential.

Not all heading cuts are detrimental to a tree, however. In some instances heading cuts are needed to stimulate growth to keep a tree in balance. They should be used to stimulate lateral growth and branching. Heading cuts should also be made to shorten and to stiffen branches. These cuts are necessary when a cultivar tends to produce too much fruit on the end of branches. In peaches, owing to the site of flower production, heading cuts are a necessity.

### **Response to thinning cuts**

Thinning cuts primarily are used for two purposes: (1) to increase light penetration and (2) to remove competing or crowding shoots or limbs. Vigorous shoot growth may develop in the immediate vicinity of the pruning cut, but the effect on adjacent parts of the tree is minimal. Thinning cuts do not change the relationship of various parts of the shoot or branch to each other as heading cuts do, because either the entire shoot or the branch is removed or left intact. The ratio of terminal to lateral buds is largely undisturbed, and as a result, thinning cuts do not increase shoot growth as much as heading cuts. Thinning cuts also reduce flower formation less and can increase flowering when better light penetration is achieved. Yield is reduced only to the extent that the bearing surface is removed and is not reduced because of invigorating buds to form shoots rather than flowers.

## Pruning and Training in Young Trees

During the first year or two of a tree's existence in an orchard, most time is spent on training the tree to develop a strong framework. The next period can be considered the “formative years”—when growth is directed and early intervention is performed to ensure that a proper structure develops. Intervention most frequently takes the form of limited pruning and training.

Scaffold selection occurs during the first one to two years. In most training systems the first scaffold should not be any lower than 18 to 20 inches above the ground. Thereafter, shoots should be selected so that they are spaced about 4 to 8 inches apart vertically and well distributed around the trunk.

The major mistake growers often make during the formative years is allowing the top of the tree to develop too soon. The result is that the tree forms a “sail” top and can be blown over, and the lower limbs do not develop sufficiently. Treetops naturally tend to develop sooner and to a greater extent because they are the most vigorous area of the tree and are exposed to the highest light levels. One rule of thumb for this area of the tree is the “one-half to two-thirds” rule. When branches on the central axis are between one-half and two-thirds the diameter of the central axis, they should be removed.

On the other hand, in some cultivars the dominance of the central leader is sometimes lost. This can result either from overcropping or from allowing too many limbs to develop from one area. It may then be necessary to rehead the leader back to invigorate it.

One exception to the rule of reduced pruning occurs with spur-type Delicious. It is not unusual for trees to fail to form sufficient numbers or quality of scaffold limbs the year of planting. In this case it is necessary to cut back the tree severely. This is accomplished by heading the central leader back to an inch or two above where you headed the tree last year. The side limbs that did grow are also cut back using what is commonly called a Dutch or bevel cut. By drastically reducing the top of the tree, you invigorate the tree and encourage greater growth. The Dutch cut is made to force new scaffolds to develop on the underside of the original shoot having a naturally wider angle. The disadvantage of this system is a delay in early bearing by one year.

Once the initial lower framework and tree structure is established, then pruning during the early bearing years is a matter of repeated intervention to ensure good sunlight exposure and to develop a series of tiers of branching structures. As you move progressively up in the tree, each tier should get shorter and weaker.

## Summer Pruning of Apples and Peaches

Rising costs have forced tree fruit growers to turn to more intensive planting systems to increase production per acre and per man-hour. As a consequence, tree crowding with a loss of productivity and fruit quality has occurred in some plantings. Traditional dormant pruning restricts root growth and reduces tree trunk enlargement, while it stimulates growth near the cuts. Such growth can worsen tree crowding and reduce light penetration. Fruit growers may turn to summer pruning as a means of controlling growth and enhancing light penetration. Summer pruning also offers a way to balance the workload by reducing the time spent on dormant pruning.

First, what is summer pruning? It is removing any vegetative growth when there are leaves or flowers on the tree. This includes

desuckering the interior of trees, selecting scaffolds on young trees, tipping terminal growth, summer topping of peaches, and dormant-style pruning conducted during the growing season. With all pruning, be it dormant or summer, the ultimate effect is to control tree size.

### Effects on growth

Probably the most mistaken idea is that summer pruning restricts growth more than winter pruning. Work in Virginia and Ohio on apples and in New Jersey on peaches has shown that summer pruning causes more vigorous vegetative growth the following year than traditional dormant pruning. Summer pruning does restrict increases in trunk enlargement, branch diameter, and root growth. However, tree crowding in intensive plantings is the result of shoot growth, and summer pruning does not suppress shoot growth as much as dormant pruning.

In assessing tree response to summer pruning, it is important to compare that response with the effects of comparable dormant pruning. For example, at the growing season's end, a tree pruned in summer will obviously look much different from a dormant-pruned tree. After comparable dormant pruning, however, both trees look very similar.

The later you summer prune the less likely the chance of re-growth during the season of pruning. Pruning in mid- to late August can be beneficial to open the canopy up and to allow better sunlight penetration for enhanced color development of fruit.

### Effects on flowering and fruiting

Research conducted on the effect of summer pruning on flowering and fruiting has had mixed results. In studies on apple trees pruned in late July or August, no increase in flowering took place the following year. Summer pruning done earlier, in June or early July, was shown to increase flowering in apples. Pruning Redhaven peaches on July 1 or August 1 reduced the number of flower buds proportional to the length of shoots removed; however, the August 1 pruning increased the number of flower buds per node.

In peaches, summer topping was shown to reduce the cold hardiness of flower buds on two out of four sampling dates. Flowering of summer-topped Sunqueen peach trees also appeared advanced, compared to that of dormant-pruned trees.

Effects on overall yield have been variable. In the Virginia apple studies, total fruit weight and numbers per tree did not consistently increase. In Ohio, fruit yield per tree was reduced, but yield per canopy volume was unaffected. Sunqueen peaches mechanically topped over a two-year period had a yield 9 percent lower than yields of dormant-pruned or normal summer-pruned trees. Overall, in individual cases, responses to flowering and fruiting probably depend on variety, timing, and severity of pruning.

### Effects on fruit quality

The influence of summer pruning on fruit quality depends on variety and overall tree vigor. Summer pruning has been shown to increase fruit color, especially in crowded plantings where light levels are low. Severely summer-pruned trees tend to produce smaller fruit and lower soluble solids when pruning is done earlier in the season. On the favorable side, summer pruning tends to reduce bitter pit and enhance color in apples. Flesh firmness of Loring peaches was increased by summer topping. Summer de-

suckering of peaches has been shown to be beneficial in improving fruit color without the side effects on fruit size. Desuckering consists of removing only the large vigorous upright shoots in the center of the tree.

The development of excessively vigorous upright shoots (water sprouts) in peaches is often apparent in some cultivars by mid-season. Removing some but not all of the vigorous water sprouts in the center of the tree has been shown to increase fruit size and occasionally increase fruit color. Timing for shoot removal is three to four weeks before anticipated harvest. In general, summer pruning of peaches should be limited to thinning cuts to open up areas for better light penetration. The resulting higher light levels in the tree will keep fruiting wood healthy.

### Economic effects

Dormant-type pruning of apples even done in the summer may not lower overall pruning costs, but it does allow a better distribution of the labor force. Summer pruning offers the grower the option of maintaining a constant number of employees by shifting some of the winter workload to the summer. In mature peach trees, summer topping can save a grower 20 to 25 percent in pruning costs, although there may be a loss in yield after topping.

Summer pruning is a useful tool in fruit production, with certain limitations. It should never be viewed as the sole method of pruning. The best practice is to combine selective summer pruning with yearly dormant pruning. Summer pruning can help improve fruit color, alter fruit quality, train trees, and allow a better distribution of labor.

Before embarking on a program of summer pruning, growers must know what effect they wish to achieve. The earlier in the season summer pruning is completed, the greater the flowering and vegetative regrowth. Conversely, the later in the season summer pruning is done, the less it will affect flowering and the less regrowth there will be. Late season pruning enhances fruit color but can reduce soluble solids and final fruit size.

### Deciding on a Production System

#### Cost

Generally, cost of trees in the long run is a small part of production costs. The big expense is in the labor required for early training and pruning. This expense should decrease over time, but the higher the density, the greater the labor requirements. A good rule of thumb is: "The more intensive, the more expensive." A spreadsheet is available at [extension.psu.edu/orchard-support-system-costs-spreadsheet](http://extension.psu.edu/orchard-support-system-costs-spreadsheet) to help you determine the cost of materials needed for a support system.

#### Spacing

For optimal production, it is necessary to make best use of the surface area of available land. Spacing that is too wide makes for inefficient planting, while spacing that is too narrow means that excessive labor will be needed to contain trees in their allotted spaces. Once a production system is worked out, spacing is determined by cultivar to be planted, rootstock, soil vigor, and slope. The spreadsheet at the link in the previous paragraph allows you to compare MM.111 and M.9 cumulative cash flow graphs as an example the importance of early production.

### "Horticultural Skill"

Any given production system will be only as good as the grower's ability to manipulate the trees. The more intensive the system, the more growers or their workers must be familiar with how trees grow. There is less room for error in high-density production. The step-by-step directions for various apple tree training systems are described later in this chapter.

### Labor requirements

A high-density orchard requires greater management skills; it also requires that labor be spread over a longer time period. Pruning can be done in both winter and summer. Because tree size is smaller, production becomes more efficient. Brains and nimbleness replace the need for brute strength, allowing greater flexibility in the labor you can hire. High-density orchards also make it easier for fewer people to take care of more trees, but in a smaller area.

### Common misconceptions clarified

- There is no perfect production system. You need to develop your own style and a production system that suits your abilities, growing conditions, and chosen cultivars.
- High density does not necessarily mean greater yields. It is very possible to achieve more than 1,000 bushels per acre on well-managed, standard trees. However, it takes more years to reach full production capacity with standard trees than with dwarf trees. Labor efficiency is lower with standard trees because of the need for excessive ladder use for harvesting and pruning.
- Yields and dollar returns do not always occur more quickly in high-density production. Mismanaging a high-density system in the early years can delay fruiting and production. Since the purpose of high-density plantings is to have early production, anything that delays early production will delay returns.

Finally, do not pass judgment on a particular system without adjusting all the factors.

Too often, growers give up on a system because they have tried to handle it the way they handle all their other systems. Make allowances for different row spacings to accommodate smaller equipment.

### Production Systems for Apples

As the Pennsylvania industry moves from conventional medium-density, freestanding orchards to high-density, supported orchards, many pruning and training modifications must be made. In the medium-density central leader system, portions of trees are cut back severely for several years to stimulate growth. Emphasis is placed on building a large, strong framework to support future crops.

Conversely, in high-density systems excessive growth is discouraged; and instead of a large, strong framework, a weak-framed tree is desirable. To achieve these ends in a system such as tall spindle or French axe, very little pruning is done in early years. The goal is to promote early fruiting, which itself will reduce future growth. All high-density systems require a greater knowledge and understanding of plant growth and of how the tree will respond to cuts. In early years, more attention is paid to training and positioning limbs than to pruning them. As trees

mature, most high-density systems will be more productive if trees are pruned in both winter and summer.

High-density systems also demand greater precision in spacing trees. Since trees are not meant to be vigorous, too wide a spacing is an uneconomical use of the land. Conversely, too narrow a spacing will necessitate more pruning, increasing vigor and reducing light and fruit quality. Below are “cookbook recipes” on pruning and training several apple systems. You can also view this information by visiting the following resources:

- [extension.psu.edu/pruning-and-training-apple-trees](http://extension.psu.edu/pruning-and-training-apple-trees)
- [extension.psu.edu/pruning-basics](http://extension.psu.edu/pruning-basics)
- [extension.psu.edu/cookbook-guidelines-for-training-various-apple-production-systems](http://extension.psu.edu/cookbook-guidelines-for-training-various-apple-production-systems)
- [extension.psu.edu/the-apple-orchard-system-blueprint](http://extension.psu.edu/the-apple-orchard-system-blueprint)

### Tall spindle

This is a supported training system that depends on utilizing well-feathered (branched) trees that can produce a crop the year after planting and continue to increase fruiting in the immediate subsequent years. The tall spindle was developed as an offshoot of the slender spindle training system to take advantage of increased canopy volume by increasing tree height. To develop this training system, several components are important: (1) plantings must utilize high densities (800 to 1,500 trees per acre); (2) fully dwarfing rootstocks such as M.9, B.9, G.41, G.16 must be used; (3) nursery trees must have 10 to 15 feathers; (4) minimal pruning occurs at planting; (5) feathers are bent below horizontal after planting; (6) permanent scaffold branches are not be allowed to develop; (7) branches are renewed as they get too large. Go to [extension.umass.edu/fruitadvisor/resources/tall-spindle-apple](http://extension.umass.edu/fruitadvisor/resources/tall-spindle-apple) to see an extensive listing of publications and videos from the University of Massachusetts on tall spindle training.

### First leaf

- At planting: Plant highly feathered trees (10 to 15 feathers) at a spacing of 3 to 4 feet by 11 to 12 feet. Adjust graft union to 3 to 4 inches above soil level. Some pomologists recommend setting the bud union higher; however, it is better to use a more dwarfing rootstock or closer spacing than to expose more of the rootstock shank. Remove all feathers below 24 inches using a flush cut. Do not head the leader or the feathers. Remove any feathers that are larger than one-half the diameter of the leader.
- If there are insufficient feathers, a properly timed branch-inducing treatment of dormant paint or foliar spray of new growth of cytokinin 6BA or 6BA plus gibberellins should be applied. (See “Inducing Branching in Growth Regulators in Apple and Pear Production.”)
- At 3 to 4 inches of growth: Rub off the second and third shoots below the new leader shoot to eliminate competitors to the leader shoot.
- May: Install a three- to four-wire tree support system that will allow the tree to be supported to 9 to 10 feet as soon as possible after planting. Attach the trees to the support system with a permanent tree tie above the first tier of feathers, leaving a 2-inch-diameter loop to allow for trunk growth.

- Early June: Tie or bend down each feather that is longer than 10 inches to a pendant position below horizontal.

### Second leaf

- Dormant: Do not head leader or prune trees unless there are scaffolds that are more than half the diameter of the central axis.
- Make sure the leader is securely fastened to the support wires or conduit
- At 4 to 6 inches of growth: Pinch the lateral shoots in the top fourth of last year’s leader growth, removing about 2 inches of growth (the terminal bud and four to five young leaves).
- Early June: Hand-thin the crop to single fruit 4 inches apart (target 15 to 20 fruit per tree if tree growth was good; otherwise, base crop load on tree trunk diameter and bearing habit according to the table below).

### Third leaf

- Dormant: Do not head the leader. Remove all broken branches by heading back or renewal cut to a spur. Remove overly vigorous limbs that are more than two-thirds the diameter of the leader using a bevel cut.
- Late May: Chemically thin according to crop load, tree strength, and weather conditions, and then follow up with hand-thinning to the appropriate levels to ensure regular annual cropping and adequate fruit size (target 50 to 60 fruit per tree). See the table below to adjust crop load based on trunk diameter and cultivar.
- June: Tie the developing leader to the support system with a permanent tie.
- August: Lightly summer prune to encourage good light penetration and fruit color.

**Number of fruit to leave on young bearing apple trees**

Trunk diameter (in.)	Annual bearing habit	Biennial bearing habit
0.75	17	11
1.00	30	20
1.25	48	32
1.50	68	46
1.75	93	62
2.00	122	81
2.25	154	103
2.50	190	127
2.75	230	153
3.00	274	182

### Fourth leaf

- Dormant: Do not head the leader. Remove overly vigorous limbs that are more than two-thirds the diameter of the leader using a bevel cut.
- Late May: Chemically thin and follow up with hand-thinning to the appropriate levels to ensure regular annual cropping and adequate fruit size (target 100 fruit per tree).
- June: Tie the developing leader to the support system with a permanent tie at the top of the pole.
- August: Lightly summer prune to encourage good light penetration and fruit color.



**Mature tree pruning (fifth to twentieth leaf)**

Dormant: Limit the tree height to 90 percent of cross-row spacing by cutting the leader back to a fruitful side branch. For example, if the cross-row spacing is 11 feet, then  $11 \times 0.9 = 9.9$  or 10 feet. Annually, remove at least two limbs, including the lower-tier scaffolds that are more than two-thirds the diameter of the leader, using a bevel or Dutch cut. Columnarize the branches by removing any side branches that develop. Remove any limbs larger than 1 inch in diameter in the upper 2 feet of the tree. On varieties like Delicious, Gala, Golden Delicious, and McIntosh, if shoots start to taper down to smaller than pencil size in diameter, head them back to where they are pencil size, preferably to a slightly upright growing shoot or spur.

**Vertical or French axe**

Developed in France, it differs from the trellis or slender spindle mainly in ultimate tree height. Trees in the French axe system are allowed to grow 10 to 14 feet tall, depending on the cultivar. The simplest way to picture this system is to consider a pole with short fruiting limbs.

Trees are planted closer together than in other systems. A critical point in establishing the French axe system is to immediately stake or tie the tree's central axis the first year. Trees can be headed at planting to a height of 28 to 30 inches, but thereafter they are never headed. To achieve the narrowest tree, only a single upright-growing branch is left to grow during the first year. Variations to produce a wider tree permit weak-growing horizontal branches to remain on the tree. Vigorous branches should be removed or tied down early in the season.

The easiest way to control vigorous branches at the top is to allow the leader to bend over with fruit. Later, the drooping portion of the central leader is cut back to a weak-growing side branch. Dormant pruning each year consists of removing vigorous, upright- or downward-growing shoots. Vigorous top branches can also be controlled with timely summer pruning. If performed properly, summer pruning can encourage a greater fruiting surface. If a branch has fruited and needs to be replaced, make an stub cut. A new branch will emerge from adventitious buds that were at the base of the branch that was removed.

The following is a "cookbook" method of how to train and prune trees to a vertical axe system.

**At planting**

- Remove all scaffolds below 18 inches, flush to the trunk. Trees with fewer than three branches should be headed at 30 inches. Attach trees to the support system as soon as possible. Trees with three or more branches offer two options depending on the vigor of the scion and rootstock. Always remove any scaffolds that are more than one-half the diameter of the central trunk. The alternatives in order of low vigor to high vigor are:
- Option 1: Head leader 10 to 12 inches above the uppermost branch and do not head the side branches. Bend the side branches to horizontal by using weight string or elastics.
- Option 2: Do not head leader or side branches. This second option is best used when there are three to five good feathery (branches).

**First growing season**

- May: Remove the two or three buds that began to grow below the chosen leader if you headed the tree back at planting. Bend the side branches to horizontal by using weights, string, or elastics.
- June: Clothespin new shoots when they are as long as, or just longer than, the clothespin.

**Second leaf**

- If additional scaffolds are needed, score above desired buds in the late dormant season (four to six weeks before bud break) or apply a properly timed branch inducing treatment of dormant paint or foliar spray to the new growth of cytokinin 6BA or 6BA plus gibberellins. (See "Inducing Branching in Growth Regulators in Apple and Pear Production.")
- *Do not head the leader.* If additional scaffolds are needed, notch above desired buds in the late dormant season (four to six weeks before bud break) or apply GA 4+7 + 6BA or 6BA by itself in 3 to 4 applications when growth reaches approximately 30 inches or mix one of these products with white latex paint and apply prior to bud swell.
- June: When 3 to 6 inches of new growth develops on shoots in the top half of the leader, pinch the new growth back by one-third their length. Position permanent scaffolds horizontally by using weights, elastics, or string. Position vigorous shoots below horizontal by means of weights, elastics, or string.
- July: Repinch all laterals as outlined above, as needed. If tree is vigorous, pinching the shoots a third time in August may be necessary.

**Third leaf**

- *Do not head the leader.* Tie down vigorous upright limbs below horizontal. Remove any side branches above the main scaffolds that are more than one-half the diameter of the central axis with a Dutch cut.
- June: When 3 to 6 inches of new growth has developed on shoots in the top third of last year's central leader, pinch them back by one-third to one-half their length.

**Fourth leaf**

- *Do not head the leader.* Prune out overly vigorous limbs that are of no use.
- June/July: Position excessively vigorous limbs slightly below horizontal.

~OR~

- August: Summer prune, removing vigorous limbs, to maintain pyramid shape and improve light interception.

**Fifth and succeeding years**

- *Do not head the leader.* Shorten bottom tier scaffolds by pruning back to a side branch. If desired begin removing/renewing scaffolds by thinning out the one or two of the most vigorous limb in the bottom middle and top of the tree. Remove any side branches above the main scaffolds that are more than one-half the diameter of the central axis with a Dutch cut. Leave all weak fruiting wood. Shorten pendulant branches back to a more horizontal position. Summer prune as needed in August to maintain light interception.

**Final leader height**

- The ideal situation is that the leader will bend with a crop to restrict the tree height. This is termed the “crop and flop” method. However, in some cultivars the leader does not bend, and the tree continues to grow upward. If this occurs, you can cut the leader back to a lower more horizontal branch, but only do so after the upper portion of the tree has fruited.

**Central leader system**

This is a popular system in Pennsylvania for freestanding trees. With the range of rootstocks available (see Apple Tree Spacing), trees can vary from 7 to 20 feet tall. Trees can be kept smaller by periodically heading back the central leader into two-year-old wood to stiffen the central axis. Size and vigor can also be controlled by selecting less-vigorous branches as the central leaders.

Trees are trained into a Christmas tree shape with the tops always narrower than the lower branches. Annual pruning is required for maximum sunlight penetration into the tree’s interior and for greater production. In some instances, summer pruning is also beneficial.

The cost of establishing this system is relatively low because no tree supports are used and there are fewer trees per acre. In early years, efforts are focused on trying to invigorate trees to fill their allotted spaces. Early production years are then spent in slowing the trees down and getting them into an annual bearing habit. Later, as the planting grows older, it is necessary to maintain fruit spur quality by pruning annually and keeping tree tops from overshadowing lower branches.

The following is a “cookbook” method of how to prune and train trees to a central leader system.

**At planting**

- Remove all scaffolds below 18 inches flush to the trunk. Trees with fewer than three scaffold branches should be headed at 30 inches and all feathers removed with a bevel or Dutch cut. Trees with three or more branches offer three options depending on the vigor of the scion and rootstock. Always remove any scaffolds that are more than half the diameter of the central trunk. The options in order of low vigor to high vigor are as follows:
- Option 1: Head leader 10 to 12 inches above the uppermost branch and all branches by a third.
- Option 2: Head leader 10 to 12 inches above the uppermost branch and do not head the side branches.
- Option 3: Do not head leader or side branches.

**First growing season**

- May: Remove two or three competing buds that broke and began to grow below the chosen leader if you headed the tree back at planting. Spread the scaffolds horizontally if you had left them on at planting.
- June: Clothespin new shoots when they are as long as, or just longer than, the clothespin.

**Second leaf**

- Dormant: If additional scaffolds are needed, score above desired buds in the late dormant season (four to six weeks before bud break) or apply Gibberellins A<sub>4</sub>A<sub>7</sub> + 6BA when

terminal growth is 1 to 3 inches long or straight 6BA mixed with latex paint to dormant trees after bud swell but before leaf tissue emergence.

- *Do not head the central leader.* Select three to five first-tier scaffold branches of moderate vigor with wide crotch angles and remove the rest. Care should be taken to attain good spacing of branches around the trunk, both radially and vertically. Scaffold branches that are evenly distributed around the tree will assure even light distribution and scaffolds that are spaced out vertically will assure that leader dominance is maintained.
- June: Position permanent scaffolds at a 50- to 75-degree angle from vertical using spreaders, weights, elastics, or string.

**Third leaf**

- Head the central leader, removing half to a third of previous year’s growth. Thin out overly vigorous limbs that are of no use.
- June: Position permanent scaffolds at a 50- to 75-degree angle from vertical using spreaders, weights, elastics, or string. When 3 to 6 inches of new growth has developed in the top third of last year’s central trunk growth, select shoots to be the second-tier scaffolds. Pinch out the most and least vigorous shoots, leaving three to four of moderate vigor. Clothespin these second tier scaffolds to obtain wide crotch angles.

**Fourth leaf**

- *Do not head the leader.* Prune out only overly vigorous limbs that are of no use.
- June/July: Position first-tier scaffolds at a 50- to 75-degree angle, and position second-tier scaffolds horizontally using spreaders, weights, elastics, or string. Position overly vigorous limbs below horizontal.

**Fifth and succeeding years**

- *Do not head the leader until it has bent over with a crop.* Maintain good light distribution by making a minimal number of thinning cuts. Continue to position scaffold limbs with spreaders until this function is replaced by the weight of a crop. Shorten bottom tier of scaffolds by pruning back to side branch. Shorten pendulant branches back to a more horizontal position. Summer prune as needed in August to maintain light penetration.

**Final leader height**

- The ideal situation is that the leader will bend with a crop to restrict the tree height. This is termed the “crop and flop” method. However, in some cultivars the leader does not bend and the tree continues to grow upward. If this occurs you can cut the leader back to a lower, more horizontal branch, but only do so after the upper portion of the tree has fruited.
- 

**Slender spindle**

This system is suited for densities of 400 to 1,000 trees per acre, but tree height is kept below 7 feet. It requires a very dwarfing rootstock, some form of support, and early fruiting to restrict tree size. Since all pruning can delay the onset of fruit production,

little or no pruning is done in the first few years. The overall shape of trees resembles that of the Christmas tree central leader. However, secondary and tertiary branches off the scaffolds are not created or maintained unless they are very weak growing.

The ideal is to start with a well-branched, one-year-old tree. At planting, remove only those branches lower than 18 inches. Heading should not be performed on any of the scaffolds. If the new tree is an unbranched or poorly branched whip, head the tree at 28 to 30 inches. Side shoots, however, should not be headed. Any vigorous branches that arise from the severe heading are then tied or weighed down during the early growing season to reduce their growth and encourage flowering. Failure to restrict the growth of these vigorous shoots in the first year will delay fruiting.

To control tree height and reduce growth, a strong, upward-growing branch should not be chosen as the central leader, but rather a less vigorous shoot tilted at an angle of 20 to 60 degrees above the horizontal. The effect is to create a zig-zag central axis. This weaker lateral is tied to the support pole so that it becomes the new leader for that growing season. It is always important to keep the top of the tree subservient to the lower part. If the top becomes too vigorous, it will shade out the lower portions. All overly vigorous and vertical-growing shoots should be removed. When a branch becomes too long, a heading cut is made to a weak-growing branch or spur.

The following is a “cookbook” method on how to train and prune trees to a spindle system.

#### *At planting*

- Remove all scaffolds below 18 inches, flush to the trunk. Trees with fewer than three branches should be headed at 30 inches and all feathers removed with a bevel or Dutch cut. Trees with three or more branches should be headed 12 inches above the top-most scaffold limb. Remove any feathers that are one-half or more the diameter of the central trunk. Attach trees to the support post or conduit as soon as possible.

#### *First growing season*

- May/June: Select the most vigorous upright growing shoot that develops below the headed leader. Remove the two or three competing buds below the chosen leader. Clothespin new shoots that will become future scaffolds or tie down existing shoots to a more horizontal position using string, elastics or weights.

#### *Second leaf*

- Dormant: Head the central leader on a weak growing tree by removing one-half to one-third of previous year’s growth. On very vigorous trees remove the leader and tie up a weaker leader from a branch below. Alternatively, vigorous leaders can be bent to a 90-degree angle or greater.
- June/July: Remove two to three competing buds below the leader if the tree was headed in the dormant season. Tie developing leader to the support post. Position overly vigorous limbs and shoots horizontally with weights. Tie up scaffolds that may bend under weight of fruit. Remove any branch that is more than one-half the diameter of the central leader utilizing a Dutch cut.

#### *Third leaf*

- Dormant: Head the central leader on weak growing trees by removing one-half to one-third of the previous year’s growth. On vigorous trees remove the shoot and tie up a weaker leader from a branch below, or bend the leader over to 90-degree angle.
- June/July: Remove two to three competing shoots that broke below the leader if the tree was headed in the dormant season. Install clothespins to spread new developing side shoots. Remove any vigorous vertical growing shoots. Position overly vigorous limbs and shoots horizontally with weights. Tie up scaffolds that may bend under weight of fruit.

#### *Fourth leaf*

- Dormant: Remove overly vigorous leaders, and replace each with a suitable side scaffold. Reduce the length of scaffold branches that do not appear capable of supporting a fruit crop by cutting back to a side branch.
- August: Summer prune if necessary to maintain pyramidal shape and to encourage light interception. Remove vigorous upright growing shoots.

#### *Fifth and succeeding years*

- Minimize winter pruning to renew vigorous scaffold limbs in the top half of the tree. Maintain tree height at 6 to 8 feet by cutting the leader to a weak side scaffold as needed to prevent excessive growth in the top of the tree. Remove pendulant branches and spur complexes by cutting to a more horizontal shoot or spur system. Shorten bottom tier scaffolds as needed to maintain fruit quality by pruning back to a side branch.

#### **Trellis systems**

The traditional trellis system developed in Pennsylvania was maintained at a height of 6 to 8 feet tall because the desire was to perform all orchard tasks from the ground. However, higher yields are possible with a taller trellis and the interest in orchard platforms. Research has shown that 10-foot-tall trellis walls can be as productive as tall spindle or axe systems. Additionally, once the basic trellis framework has been developed, it may possible to maintain the canopy density through mechanical shearing and traditional summer pruning. It will be necessary, however, to periodically open the canopy up with judicious removal of overlapping branching systems.

A trellis system relies on the use of three to four wires to serve as support and training aids. Several ultimate tree forms or training patterns may be chosen in developing a trellis. Certain components critical to this system must be understood and avoided regardless of the tree form chosen:

1. Branches to be trained to the wires should always originate on the main trunk below the wire. Bending branches from the main trunk or axis down to the wire will encourage upright water sprouts at the point of the bend. Water sprouts are unproductive and lead to an overabundance of growth.
2. Do not keep every branch on the tree. Branches growing vigorously into the drive row should be removed. Do not try to bend every branch back into the wire.
3. As trees get older do not allow the upper portions of the trellis to become overly vigorous and shade out the lower branches. Maintain a pyramidal shape or flat surface.

4. It is not necessary to stop branches from extending into adjoining trees. The ideal is to create an interwoven wall of bearing surface.

The following is a “cookbook” method for training trees to a Penn State low hedgerow four-wire trellis system.

Oblique Palmette has a central-axis tree with four pairs of oblique scaffolds spaced equally apart in a narrow vertical plane. Scaffolds from adjacent trees cross each other, forming a lattice framework on which bearing wood is developed and managed as the fruiting mantle of the trellis hedgerow.

### *At planting*

- **Nonfeathered trees:** A one-year whip is planted vertically and headed at 18 inches, or the height of the bottom wire. Usually, three shoots appear as a “crow’s foot.” The center one is selected to be the leader of the tree, and is secured to the bottom wire. At the same time, or a little later, two lateral shoots about 3 to 4 inches below the wire, one on each side of the tree, are selected to become a pair of scaffold limbs. When about a foot in length, these are inclined at a slope of approximately 60 degrees and secured to the bottom wire. When 2 to 3 feet in length, they are reset at a 45-degree slope. The leader is allowed to elongate and secured to the second wire when its wood has matured sufficiently for tying. Other lateral growth usually is removed. In the fall, the tree’s central axis, leader, and scaffolds are secured to the trellis wires for overwintering.
- **Feathered trees:** A tree is planted vertically and oriented so that two feathers on opposite or nearly opposite sides of the tree occur approximately 14 to 15 inches from the ground (3 to 4 inches below the lowest trellis wire at 18 inches). These are inclined at a 45-to-60-degree slope, depending on length (vigor), and secured to the lowest trellis wire. If a suitable pair of feathers is located only above the bottom wire, training is possible for developing them into suitable scaffolds, provided they are located within 4 to 5 inches from the bottom wire. Training is a two-step operation. First, the basal part of a feather is bent horizontally or arched down to the wire. After tying, the remainder of the lateral is brought upward and fixed by dropping either a string or several ties attached together from the second wire. If of sufficient length, it is positioned at 45 to 60 degrees. Otherwise, it is just raised so that the terminal bud becomes the highest point. In a raised position, continued elongation of the young scaffold is ensured. After sufficient growth, repositioning may be done. Thus, a high originating lateral may be made into a suitable scaffold. Its appearance would resemble that of a scaffold originating 3 to 4 inches below the bottom wire.

### *Second year*

- The tree’s leader and scaffolds are allowed to elongate. Lateral growth normally is retained unless too vigorous, showing dominance on a scaffold or on the central axis. Lowest scaffolds are allowed to elongate at a 30- to 45-degree slope. When the two low scaffolds from adjacent trees pass the second wire, they are crossed and tied together at the middle of the second wire. Some repositioning of the tie on the first

wire may be necessary to develop an even slope in the scaffold. Any strong lateral growth from these scaffolds showing dominance is headed at approximately 6 inches to either a downward or lateral growing shoot. One-year wood over 12 inches in length is usually pruned in half. If a terminal in a scaffold sets fruit, the fruit is removed and the leader renewed.

- Lateral shoots usually develop naturally on the central leader. At each trellis wire, a pair of suitable laterals is selected to become scaffolds. These should arise approximately 3 to 4 inches below the wire. Laterals are inclined and attached to give about a 45-degree slope. Later in the season, these are repositioned at approximately 30 degrees. If a young scaffold is not sufficiently long to be positioned, it may be marked for later identification, which is easily done with a spring clothespin. Growth may be enhanced by tying to about 60 degrees. Any strong lateral growth below and/or immediately above a pair of selected shoots is removed.
- This procedure for developing scaffolds is followed at each wire or level in the trellis. However, if suitable laterals fail to develop naturally, a heading cut may be made similar to that done at planting. The cut should be at or near a trellis wire for laterals to arise about 3 to 4 inches below the wire.

### *Third and subsequent years*

- Training follows that outlined for the second leaf. If lateral shoots do not arise naturally at or near the desired location for scaffolds, the tree is headed at the wire to stimulate branching.
- When the central leader of the tree extends a foot or more above the top wire, it is bent to one side along the fourth wire to form half of the top tier. It is tied in a horizontal position. A suitable lateral, originating below the arch on the opposite side of the tree, is trained to form the other half of the fourth pair. However, it is usually inclined to the top wire before being trained horizontally. In future years, as scaffolds from the third tier (below) reach the top wire, top scaffolds are headed back periodically to reduce their shading on those immediately below. Eventually, fourth-tier scaffolds may be no longer than 12 inches in length. All vertical shoots and wood are removed from the top of the trellis (fourth-scaffold tier). This pruning is usually done in early August.
- Scaffolds are arrested in further elongation when they reach the middle of an adjacent tree. This is usually accomplished by not tying up the terminal. Occasionally, tipping or cutting back to a downward-growing lateral may be needed.
- Annual pruning is both summer and dormant pruning. Summer pruning is in August, about three months after bloom, and is considered mainly a grooming operation. All vertical vigorous growth from the top of the trellis is removed, which reduces shading, aids in suppression of the vigor in the top scaffolds, and maintains a hedgerow height of 6 to 8 feet. In addition, all vertical growth within the hedgerow itself is removed, but this may be done at any time during the summer. Further, all lateral shoots 12 inches or longer are stubbed by heading back to three basal shoot leaves, or to about  $\frac{1}{2}$  or  $\frac{3}{4}$  inches. This August stubbing of shoots is the most important pruning of the year and is what distinguishes the Penn State system. Besides increasing the exposure of bearing wood and

maturing fruits to sunlight, stubbing enhances the development of bearing wood by manipulating vigorous growth into short shoots and spurs. Dormant pruning is largely heading back of older bearing wood, making corrective cuts, thinning out spurs, and, where necessary, re-stubbing to continue the control of vigorous wood.

- If a suitable pair of feathers is located only above the bottom wire, training is possible for developing them into suitable scaffolds, provided they are located within 4 to 5 inches from the bottom wire. Training is a two-step operation. First, the basal part of a feather is bent horizontally or arched down to the wire. After tying, the remainder of the lateral is brought upward and fixed by dropping either a string or several ties attached together from the second wire. If of sufficient length, it is positioned at 45 to 60 degrees. Otherwise, it is just raised so that the terminal bud becomes the highest point. In a raised position, continued elongation of the young scaffold is assured. After sufficient growth, repositioning may be done. Thus, a high originating lateral may be made into a suitable scaffold. Its appearance would resemble that of a scaffold originating 3 to 4 inches below the bottom wire.

### Tree Support Systems

As apple growers move to higher-density production systems using more dwarfing rootstocks, tree support becomes more of a concern. Most of the very dwarfing rootstocks require support, but there are somewhat more vigorous rootstocks that can perform well without support under certain conditions. However, depending on cultivar, soil type, slope, vigor, and cropping conditions, support may be necessary for semi-dwarf stocks.

Support systems should be installed soon after planting. Tall spindle and vertical axe training systems depend on installing the system shortly after planting to keep the leader upright and growing vigorously.

The cost of tree support systems varies widely. One system sometimes used is a single wire set 9–10 feet off the ground and attached to a 12-foot piece of conduit or steel stake driven into the ground. The cost of conduit has risen to the point that growers are now looking at using four or five wires spaced 1.5–2 feet apart as the support system. This latter wire system may reduce workers' ability to move through the rows, but it is cheaper to install.

### Construction considerations

Factors to consider that lead to the success, or failure, of a trellis system include:

- soil type
- potential wind forces
- tree canopy type

These three aspects of your site will determine the material needs, post depth, and in-line spacing. Remember that larger diameter posts are stronger than smaller posts.

End posts are relatively standard: pressure-treated wood, 5 to 6 inches in diameter, driven 4 feet into the ground. The length of the posts depends on the desired height of your trees. These

posts should be hydraulically driven to help prevent pullout. A hydraulically driven post is seven times stronger than a hand-set post. In-line posts should be 4 to 5 inches in diameter and driven 3 feet deep. They should be a maximum of 30 feet apart (closer on rolling terrain).

Construction of a single-span brace assembly at the end of each row is recommended for most types of high-tensile wire trellises. These require a 4-inch brace post, an 8-foot by 4-inch horizontal brace, and a 5-inch end post. The brace post and end post should be driven 4 feet deep, with post length determined by the desired tree height. With shorter tree rows, tie-back posts are an option. Tie-back posts should be 5 to 6 inches in diameter and driven 4-feet deep. Tie-backs need to be angled slightly away from the direction of the pull of your system.

Wire should be high-tensile, class 3, 12.5-gauge, 0.099-inch galvanized steel wire. The 12.5-gauge wire is more cost effective than other gauges of wire. Wires should be 1.5 to 2.5 feet apart, allowing leaders to be fastened securely. Wire tension should be between 200 and 250 pounds per strand. However, overtensioning the wires will weaken them. High-tensile wire has greater breaking strength than other potential trellis wires. Because of this higher breaking strength, high-tensile wire can be pulled tighter and provide greater support across the entire trellis system. Furthermore, high-tensile wire is resistant to corrosion. Corroded wire is another potential source of failure. Loose or sagging wires can serve as starting points for stretching and breaking—and potential failure points in the trellis. Wires should be secured to the posts using 2-inch, 8-gauge, double-barbed, class 3 galvanized staples.

The staples should be driven into the posts so that they are at a 45-degree angle from vertical. Vertical staples are likely to separate the wood grain of your post and weaken your trellis. Staples should be driven so that the legs of the staples spread outward; this makes them much less likely to be pulled out. Staples driven so that each leg curves away from the vertical centerline of the post have 40 percent more pull-out resistance than staples driven incorrectly. Staples should not be driven so that their tapered ends are pointing inward. Wire can be run through drilled holes in the posts. Without proper airflow (a 3/8-inch hole is required per wire per post), the wire may corrode much more quickly than it otherwise would.

Joining of the wire can be done by use of crimping sleeves and a crimping tool for full-strength connections. Other options on the market include Fastlocks, Gripples, or Quick Splices. See [extension.psu.edu/trellis-construction-workbook](http://extension.psu.edu/trellis-construction-workbook) for an Excel spreadsheet called “Trellis Construction Workbook” that will autocalculate the cost of a theoretical system based on many variables you can adjust, such as number of wires and length of system.

A video on trellis construction is available in English at [extension.psu.edu/apple-trellis-construction-for-high-density-orchard-systems](http://extension.psu.edu/apple-trellis-construction-for-high-density-orchard-systems) and in Spanish at [extension.psu.edu/construccion-de-enrejados-para-huertas-con-sistemas-de-alta-densidad](http://extension.psu.edu/construccion-de-enrejados-para-huertas-con-sistemas-de-alta-densidad).

### Apple Tree Spacing

Apple orchards are a long-term investment, so it is essential to choose a tree spacing and a production system that will make best use of land and capital to produce fruit. Potential acre yields

depend on the volume of bearing wood maintained in an orchard. Increasing the number of trees per acre is one way to increase the volume of bearing wood and thus yield. Yield can also be increased through proper pruning, training, and management. Growers must consider their ability or inability to manage a particular production system.

To determine in-row tree spacing, consider the following factors.

### 1. Variety

Table 1-6 lists common Pennsylvania-grown varieties and their characteristics, including vegetative vigor. For example, Pink Lady® is among the most vigorous and spur Delicious is among the least.

### 2. Type of production systems

#### *French axe or tall spindle*

These systems are similar in that trees must be trained to a narrow pyramid-shaped canopy. The canopy depth to the main axis should be no more than 3 to 3.5 feet, about the length of your arm from the shoulder. In both systems the leader is not headed and pruning is kept to a minimum. Shoot pinching is practiced on the new shoots that form directly below the leader the first year after planting to develop weak growing fruiting structures. The bottom branches of the axe may or may not be permanent. Tall spindle has no permanent branches, as they are removed once they reach more than half the diameter of the main trunk. Suitable rootstocks and suggested in-row spacings are M.9 and their strains, and B.9, G.41, and G.11 (3 to 5 feet).

#### *Low-trellis hedgerow*

This system requires that the grower have a thorough understanding of tree growth and a large commitment of time and money. In a trellis hedgerow, trees are trained to a three- or four-wire trellis to develop a solid hedge about 6 to 8 feet tall and 2 to 3 feet across. Branches originate from a main trunk below the wire and are trained up and across the wires. Trellising has the potential for high yields and early bearing and is a desirable system for growers limited by land or equipment. Suitable rootstocks and suggested in-row spacings are M.9 and their strains, B.9 (4 to 6 feet), and EMLA 26 and G.935 (7 to 9 feet) for spur types. Between-row spacing should be 12 to 14 feet on slopes and 10 to 11 feet on level ground.

#### *Freestanding central leader tree on semi-dwarf rootstocks*

This system uses a more vigorous rootstock to provide tree support. The tree is kept small by periodically heading back the central leader into two-year-old wood to stiffen the tree's central axis. Trees are trained to a central leader system and pruned annually to keep them within their allotted spaces. The cost of establishing this system is relatively low because no tree supports are used and there are fewer trees per acre. Suggested rootstocks and in-row spacings are EMLA 26 (8 to 10 feet), EMLA 7 (9 to 12 feet), M.9/MM.106 and M.9/MM.111 (10 to 13 feet), EMLA 106 (11 to 14 feet), M2 (12 to 15 feet), and EMLA 111 (15 to 18 feet). The use of B.118 can also be utilized with the latter two in-row spacings.

#### *Freestanding central leader tree on semi-standard and standard rootstocks*

In this system tree height is not as severely controlled. Grower knowledge, time, and expense may be the lowest of any other system. Potential yields and returns are also the lowest, especially in the early years. The age of bearing and early production will be inversely related to the ultimate size of the tree. The system still requires early pruning and spreading of branches. Suggested rootstocks and in-row spacings are EMLA 106 (16 to 20 feet), EMLA 111 (17 to 20 feet), seedling (18 to 24 feet).

### 3. Rootstock effect

The effect of the rootstock on ultimate size, precocity, cultural practice, and spacing is another factor to consider. Penn State has been a leader in testing and evaluating rootstocks for tree fruit. Test plantings of all the new rootstocks for apples are located at either University Park or Biglerville. The more common rootstocks are listed in Table 1-7. Certain rootstocks in each size category may overlap into the next largest tree size owing to scion variety, production system, or soil type.

In the future there will be numerous rootstocks from which to choose. Growers are advised that many of these rootstocks have had only limited testing in Pennsylvania. We recommend proceeding with caution when trying new rootstocks, but urge you to try small test plantings with the cultivars that you grow. In the section titled "Apple Rootstocks," we provide brief descriptions of apple rootstocks that you might see in nursery catalogs.

### 4. Soil vitality

Soil type, fertility, depth, water-holding capacity, and replant conditions all affect tree spacing. Pennsylvania soils have been divided into five classes according to potential productive capacity. A listing of these classes is available at county extension offices. Soils in Classes II and III are best suited for orchards. Soils in Class I are the most fertile and can lead to overly vigorous plantings.

In-row spacings should be adjusted according to soil strength. For Class I soils the widest in-row spacing is recommended, for Class II the middle range, and for Class III the narrowest spacing. Orchard soil should be a minimum of 2 to 3 feet deep. For shallower soils, in-row spacing can be reduced. Soils with a high water-holding capacity usually encourage more vigorous growth, while droughty soils slow growth.

Old orchard sites require special attention as discussed previously under Replanting an Orchard Site. Continually replanting the same sites can lead to poor tree growth and production. Before being replanted, soil should lie fallow or be put into rotation crops for two or more years. Every effort should be made to replenish soil nutrients before replanting. Before removing the old trees, take a soil test and nematode analysis. After removing trees, apply the recommended amounts of lime and fertilizer. Then subsoil the site and work in the fertilizer. Organic matter additions are also suggested. For more information on improving the soil after orchard removal, see [extension.psu.edu/planting-sorghum-sudangrass-following-orchard-removal](http://extension.psu.edu/planting-sorghum-sudangrass-following-orchard-removal), Models for the Future: Apple Budget at [extension.psu.edu/models-for-the-future-apple-budget](http://extension.psu.edu/models-for-the-future-apple-budget), and a video titled "Orchard Site Preparation: Bio-renovation" at [extension.psu.edu/orchard-site-preparation-bio-renovation](http://extension.psu.edu/orchard-site-preparation-bio-renovation).

**Table 1-7. Comparisons of apple rootstock characteristics.**

Rootstock	Size class	Support	Suckering	Burrknots	Fire blight	Collar rot	Woolly Apple Aphid	Availability
Malling 27	VD	Yes	No	No	Susc.	Resis.	Susc.	Some
Budagovsky 9	D	Yes	Yes	No	Tolerant	Resis.	Susc.	Widely
Geneva 16	D	Yes	No	No	Resis.	Resis.	Susc.	Widely
Geneva 11	D	Yes	Unknown	No	Resis.	Mod. Resis.	Mod. susc.	Widely
Geneva 41	D	Yes	Some	No	Resis.	Resis.	Resis.	Widely
Geneva 214	D	Yes	Unknown	Unknown	Resis.	Resis.	Resis.	Limited
Malling 9*	D	Yes	Some	Some	Very susc.	Resis.	Very susc.	Widely
Ottawa 3	D	Yes	No	No	Susc.	Resis.	Very susc.	Limited
Geneva 935	D	Yes	No	?	Resis.	Resis.	Susc.	Widely
Budagovsky 10	D/SD	Yes	Some	No	Tolerant	Unknown	Susc.	Some
Vineland 1	SD	Sometimes	No	No	Resis.	Unknown	Unknown	Some
Geneva 213	D	Yes	Yes	No	Resis.	Tolerant	Resis.	Limited
Geneva 214	D/SD	Yes	No	No	Resis.	Tolerant	Resis.	Widely
Geneva 814	D/SD	Yes	Medium	Medium	Resis.	Tolerant	Susc.	Limited
Malling 26	SD	Sometimes	No	Yes	Very susc.	Susc.	Very susc.	Widely
Geneva 210	SD	Sometimes	Some	No	Resis.	Resis.	Resis.	Some
Geneva 202	SD	Sometimes	No	No	Very resis.	Tolerant	Resis.	Some
Geneva 969	SD	Sometimes	Unknown	Unknown	Resis.	Unknown	Resis.	Widely
Supporter 4 (Pi.80)	SD	Sometimes	No	No	Susc.	Unknown	Unknown	Some
Geneva 30	SD	Sometimes	No	No	Resis.	Resis.	Susc.	Widely
Geneva 222	SD	Yes	No	No	Very resis.	Tolerant	Resis.	Limited
Geneva 890	SD	Yes	Yes	Yes	Very resis.	Tolerant	Resis.	Widely
Malling 7	SD	Sometimes	Yes	Some	Mod. resis.	Mod. resis.	Susc.	Widely
Malling Merton 106	SV	No	No	No	Susc.	Very susc.	Resis.	Widely
Malling Merton 111	SV	No	No	Yes	Resis.	Resis.	Resis.	Widely
Malling 2	SV	No	No	Some	Resis.	Resis.	Unknown	Limited
Budagovsky 118	V	No	No	Unknown	Unknown	Resis.	Susc.	Some
Poland 18	V	No	No	No	Mod. resis.	Resis.	Susc.	Some
Seedling	V	No	Some	Some	Variable	Variable	Susc.	Widely

\*Refers to NAKB 337 clone of M9.

Size class: VD = very dwarf; D = dwarf; SD = semi-dwarf; SV = semi-vigorous; V = vigorous

Some of the information in this table was derived from the Geneva Apple Rootstocks Comparison Chart v.4 at <https://ctl.cornell.edu/wp-content/uploads/plants/GENEVA-Apple-Rootstocks-Comparison-Chart.pdf>.

## 5. Cultural practices

Mulching, weed control, irrigation, and other cultural practices all affect orchard spacing. Mulching helps conserve moisture in the soil and reduces the number of competing weeds, but it can also attract meadow and pine voles. Eliminating weeds from under the tree helps reduce competition and produces a larger tree. Although Pennsylvania has a humid climate, frequent dry spells can affect tree growth and performance. Irrigation will become more important as the climate changes and rainfall may become erratic.

## 6. Equipment

The size of equipment to be used in the orchard depends largely on the between-row spacing. Adjustments downward can be made when narrower tractors and sprayers are used. When a new, more efficient planting is being established, between-row spacing should not be based solely on the width of old equipment. Until the trees fill their allotted space, larger equipment can be used. Smaller tractors can be substituted as the planting ages. The Penn State Extension Energy Team has developed a fuel consumption calculator to help growers assess equipment options for orchards of various tree spacings, available from [extension.psu.edu/fuel-consumption-spreadsheet](http://extension.psu.edu/fuel-consumption-spreadsheet). The use of smaller tractors and implements can result in a 25 to

45 percent reduction in fuel usage even though travel distance in intensive orchards is greater.

## 7. Between-row spacing

The most light-efficient row orientation is to locate drive rows that run north to south as much as possible. However, this may not be feasible at all sites due to steep slopes. Nevertheless, maximum sunlight penetration occurs in orchard blocks that have north-to-south drive rows. Research has shown that the most critical factor in determining early production and high yields in an orchard is the rapidity with which the canopy of the trees develops and fills its allotted space. In designing an orchard, growers are often more concerned about planting trees too close. Spacing trees too far apart, however, can be just as detrimental.

The overriding factor in determining optimum row spacing is to choose a spacing that will capture the most sunlight while not shading the adjacent rows. Orchards whose rows are spaced too far apart capture less than the optimum amount of sunlight. The old rule of thumb in determining row spacing is to take the in-row spacing and add 8 feet to it to equal the distance between rows. However, growers switching to small trees should avoid the mistake of keeping wide drive rows to accommodate old equipment.

As mentioned previously, in-row spacing depends on root-stock, cultivar, training system, and other factors. Between-row spacing is determined by all of the previously mentioned factors plus the ultimate tree height. Many growers in their quest for small trees do not realize that to achieve optimal yields they must also move the rows closer together. Failure to do this will result in significantly lower yields than old standard or semi-dwarf plantings. The following are three methods that can be used to arrive at possible between-row spacings.

- $(\text{desired tree height} \div 2) + \text{in-row spacing} = \text{between-row spacing}$
- $(2 \times \text{desired tree height}) - 6 = \text{between-row spacing}$
- $\text{desired tree height} \div 0.9 = \text{between-row spacing}$  (recommended formula for tall spindle systems)

As an example, assuming you want to maintain your trees at 7 feet within the row and no more than 10 feet tall, the above formulas can be used to help estimate row spacings.

- $10 \div 2 = 5$  feet,  $5 \text{ feet} + 7 = 12$  feet between rows
- $(2 \times 10) - 6 = 14$  feet between rows
- $10 \div 0.9 = 11$  feet between rows

Therefore, the optimum distance between rows is 11 to 14 feet apart.

Finally, one way to evaluate older plantings to see if they are spaced properly is to observe them late in the afternoon on a sunny day. Looking at the base of the trees in a row, if the shadow cast from the adjacent row is covering less than 10–20 percent of the lower canopy then the trees are spaced properly. If the shadow from the adjacent tree is covering more than 20 percent of the canopy of the adjacent row, then the trees are too close together. If no shadow strikes the adjacent row, then the trees are spaced too far apart. (Portions adapted from T. Robinson, Dept. of Horticultural Sciences, NYAES, Cornell University)

**Using Beds to Attain Higher-Density Orchards**

Most orchards in Pennsylvania have uniform distance between all the rows in a block. The term “bed” in fruit production originated in the Netherlands, where growers have tested three- to eight-row beds. No equipment traveled between the rows in a bed, and the beds were kept weed free. In Pennsylvania, wide weed-free beds are not advisable because of the likelihood of excessive erosion, so Dutch-style bed production probably is not workable.

In a broader sense, however, “beds” for tree fruit production can simply be thought of as plantings with unequal distances between rows. Beds in this sense have been around a long time.

Some Pennsylvania growers have alternated narrower rows, where no bin handling occurs, with wider rows where bin handling does occur. Thus, for example, where a row spacing of 14 feet might be standard in an orchard with uniform row spacing, this 14-foot spacing can be alternated with 10-foot row middles, resulting in an average row spacing of 12 feet.

Since most Pennsylvania growers prefer to use relatively wide row middles for spraying and especially for bin handling, row spacing becomes a limiting factor in designing moderately high-density orchards. Thus, growers desiring 6 to 8 feet for operating large equipment cannot obtain significantly higher tree densities. However, growers could design “Pennsylvania bed orchards,” in which single, wide row middles are used for spraying and for hauling bins. Figure 1-4 presents examples of the traditional arrangement, a two-row bed, and a three-row bed. Note that within the bed, trees might be staggered to allow spray to penetrate. With the smaller trees being planted today, spray deposition is likely to be more than adequate.

Table 1-8 gives an expanded example of trees at different row widths. The example shows that the increase in trees per acre could range from a low of 7.5 percent to as much as 23.4 percent. The bed itself can be designed with row spacings so that mowing can be done with a small tractor, but spraying would not normally be

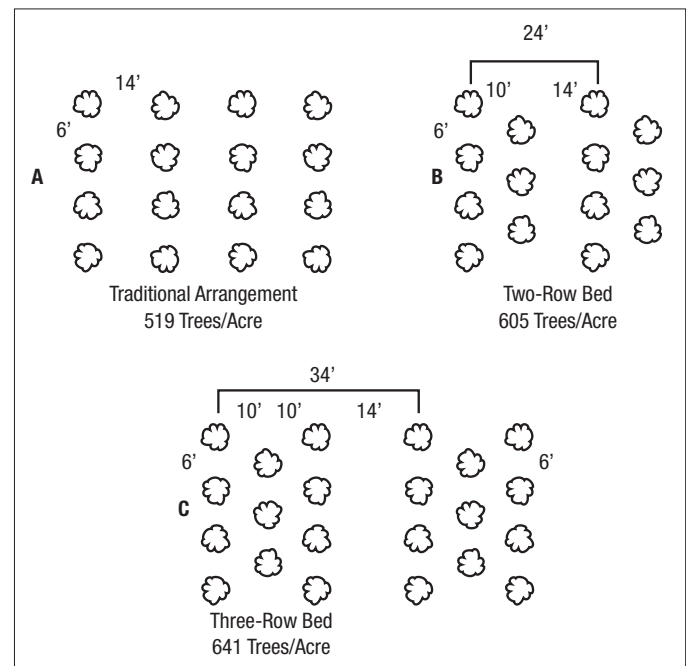

Figure 1-4. Traditional arrangement and possible arrangements of two- and three-row beds.

Table 1-8. Increase in tree density made possible using beds.

Conventional planting			Bed planting specifications					Percent increase trees/A
In-row tree spacing	Row spacing	Trees/A	In-row tree spacing	Wide row spacing	In-bed row spacing	Rows/bed	Trees/A	
6	14	519	6	14	12	2	558	7.5
			6	14	12	3	576	10.4
			6	14	10	2	605	16.5
			6	14	10	3	641	23.4
14	22	141	14	22	18	2	156	10.6
			14	22	18	3	161	14.2
			14	22	16	2	164	16.3
			14	22	16	3	173	22.7



done within the bed. Alternatively, small compact sprayers can be used. Six-row beds of this design have been used by some South Carolina peach producers. This arrangement would result in significantly higher tree densities and may be a workable plan that would enable Pennsylvania growers to obtain higher tree densities while keeping wide row middles for large equipment.

### Determining the Number of Trees per Acre in Bed Plantings

As discussed above, bed systems can be used in many forms in commercial orchards. Beds in the Dutch system have very closely spaced trees with a vegetation-free area. The concept proposed above allows for herbicide strips directly underneath the tree rows within the bed and grassed drive rows between the bed tree rows and the wider drive rows. In either case, it is necessary to alter the traditional method of determining the trees per acre (TPA) for bed systems. The following can be used to determine the TPA in a bed planting:

1. Measure the distance from the trunk of the edge tree in one bed to the trunk of the tree in a similar position in the adjacent bed.
2. Divide this distance by the number of rows in the bed to get the average row spacing.
3. Multiply the average row spacing by the distance between trees in a row to get the square feet occupied by one tree.
4. Divide 43,560 square feet (1 acre) by the square feet occupied by one tree (from Step 3). This gives the TPA in the bed system you have designed.

Example: From the diagrams in Figure 1-4, the TPA is determined as follows:

Two-row bed	Three-row bed
24 feet (10 + 14)	34 feet (10 + 10 + 14)
$24 \div 2 \text{ rows} = 12 \text{ feet}$	$34 \div 3 = 11.3 \text{ feet}$
$12 \text{ feet} \times 6 \text{ feet} = 72 \text{ feet}$	$11.3 \text{ feet} \times 6 \text{ feet} = 67.8$
$43,560 \div 72 = 605$	$43,450 \div 67.8 = 642.5$
605 trees per acre	642 trees per acre

## Apple Rootstocks

### History

Rootstocks to control tree size have been used in apple production for over 2,000 years. Historically, most of the clonal apple rootstocks that we use in the United States traditionally originated in Europe. In the mid-1800s horticulturists began referring to rootstocks by name. They were called Paradise (or French Paradise) or Doucin (or English Paradise), the former being more dwarfing than the latter. These plants, however, showed much variation in size control. In addition, many new stocks had been introduced inaccurately under these names; undoubtedly viruses and genetic mutations had occurred in the plant material. In the late 1800s one author described 14 different kinds of Paradise rootstocks. This diversity led researchers at England's East Malling Research Station to gather the selections to determine their trueness to name. The researchers concluded that indeed there were numerous misnamed and mixed collections of plant material.

Dr. R. Hatton decided that because of the confusion he would drop the proper names and assign each stock a number. He assigned a Roman numeral to each of 24 selections but did not

number them in any order with respect to tree size. Hence, M.9 with a larger number is a smaller tree than M.2. Most of these, with the exception of M.9, M.7, M.2, M.8, and M.13, were never commercially important in the United States. In succeeding years some rootstocks were developed from controlled crosses, M.26 and M.27 being the most famous.

In 1917 a second research station, the John Innes Institute of Merton, England, joined with the East Malling station to begin a breeding program. Their efforts, oriented mainly toward developing rootstocks resistant to woolly apple aphids, produced the Malling-Merton series of rootstocks, of which MM.106 and MM.111 are still used some today.

In the late 1960s, researchers began work to remove many of the viruses naturally present in the rootstocks in order to reduce incompatibility problems caused by the viruses. The first rootstock to be partially cleaned up was M.7; it was designated M.7a. Later still, more viruses were removed from all of the Malling and Malling-Merton series of rootstocks. These were then designated EMLA for the East Malling and Long Ashton research stations in England. While the viruses have been removed, some of the rootstocks' size control has been lost. Therefore, the old "dirty" M.9 will produce a smaller tree than the "clean" M.9EMLA. Currently in the industry nearly all apple rootstocks are virus free.

More recent years have seen the introduction of several new rootstocks, many developed in Europe. The first to be available was the Budagovsky series. Designated as either Bud or B, they were developed in the central plains of Russia at Michurinsk College for their cold hardiness. Currently B9, B10 and B118, increasing vigor, are rootstocks that are available in the United States. Work at Penn State showed that B9 had some resistance to fire blight. The next rootstocks that were released to be tested were from Poland and are called the "P-series." Like the Russian series, they are expected to have some cold hardiness. The P-series was developed from crosses between M.9 and common Antonovka. These stocks have good resistance to collar rot. To date, only a limited number of these rootstocks are available.

A rootstock breeding program was started here in the United States at Cornell University and in cooperation with the USDA breeding program. The main characteristic they are looking to select for is resistance to fire blight, crown and root rots (*Phytophthora* spp.), and replant disease complex. Many of these rootstocks are also resistant to other problems such as apple scab and woolly apple aphids, and exhibit a reduction in burr knot formation. Cornell has produced a comparison chart of all the Geneva rootstocks that is available as a PDF at [www.cit.cornell.edu/plants/GENEVA-Apple-Rootstocks-Comparison-Chart.pdf](http://www.cit.cornell.edu/plants/GENEVA-Apple-Rootstocks-Comparison-Chart.pdf).

A large multistate research program known as the NC-140 Research Project is primarily responsible for conducting most evaluations of these new rootstocks. Penn State has been a member of this project since its inception in the late 1970s.

Growers should be aware of each rootstock's known capabilities and limitations. Many of the newer rootstocks will probably be available to the commercial industry before they have been thoroughly evaluated with different cultivars.

### Specific rootstocks

Following are brief descriptions of and comments on apple rootstocks. Rootstocks are listed in order from smallest to largest.

Much of the information was gleaned from research reports of the NC-140 committee from around the country. More information and images of trees on the different rootstocks are available through eXtension website at [www.extension.org/pages/66189/apple-rootstocks:-understanding-and-choosing-the-right-rootstock#.VeM-v31p0\\_w](http://www.extension.org/pages/66189/apple-rootstocks:-understanding-and-choosing-the-right-rootstock#.VeM-v31p0_w).

**Malling 27 (M.27):** A very dwarfing rootstock. Unless the central leader is supported, the tree will be very small. Little is known about disease or insect susceptibility. To date, most commercial nurseries are using this rootstock only as an intermediate stem piece on MM.106 or MM.111. If handled and spaced properly, it can be a very productive stock for a vertical axe system.

**Budagovsky 9 (B.9 or Bud9)** is a dwarfing rootstock bred in the Soviet Union from the cross of M.8 x Red Standard (Krasnij Standart). Like the other stocks in this series, the leaves are a distinctive red. Trees on this stock are 25 to 35 percent smaller than M.9EMLA depending on the cultivar. In a 10-year trial at University Park, York Imperial, Rome Beauty, and Empire on B.9 were approximately 25 percent smaller than the same cultivar on M.9EMLA; while Jonagold, Golden Delicious, and McIntosh were approximately 35 percent smaller. B.9 appears to be resistant to collar rot and is very cold-hardy. In limited trials, it has performed very well across a wide range of conditions. Trees will need to be supported.

**Malling 9 (M.9):** The traditional and best-known dwarfing rootstock. It should be planted on a well-drained site. Trees on this rootstock always require leader support. The rootstock is very susceptible to fire blight and can develop burr knots. Numerous clones of M.9 are now being sold by nurseries, including M.9 NAKB 337, the current dominant strain used. It is a virus-free clone from the Netherlands and appears to be 5–10 percent less vigorous than M.9EMLA. M.9EMLA is a virus-free clone from the East Malling/Long Ashton research stations. It is approximately 25–30 percent more vigorous than M.9. Pajam 1 (Lancep) and Pajam 2 (Cepiland) are French selections that are relatively new. They are 35 to 40 percent more vigorous than M.9 NAKB 337. One other clone is M.9 RN 29, selected by Rene Nicolai in Belgium. In plantings at University Park with Gala, it is approximately 30 percent larger than M.9 NAKB 337.

**Geneva 16 (G.16)** was released from Cornell University's breeding program. Like others in the series, it is resistant to fire blight. It is tolerant of crown and root rots. It is susceptible to woolly apple aphid and powdery mildew. Size was initially reported to be between that of M.9 and M.26. However, in a trial at Rock Springs with the scion cultivar of Golden Delicious at the end of the tenth growing season, it was approximately 20 percent smaller than trees on M.9T337 and 65 percent smaller than M.26. It does appear, however, to induce wider branch angles in the scion cultivar. Geneva 16 is very sensitive to latent viruses in apple and should only be propagated with virus free scion wood on top.

**Geneva 41** resulted from a cross between M.27 and Robusta

5 and was introduced by the New York State Agricultural Experiment Station. Geneva 41 and has been tested as CG 3041 and is a full dwarf; compared to M.9 NAKBT337 it is approximately 25 to 50 percent smaller than trees on M.26EMLA. G.41 has higher yield efficiency and produces few root suckers. It is highly resistant to fire blight, woolly apple aphids, and *Phytophthora*. Tests indicate that G.41 appears to be tolerant of replant disease. A major drawback to wider adoption of this rootstock is its tendency to form a brittle graft union with some scions, especially Cripps Pink and Honeycrisp. Therefore, well-branched trees need to be staked immediately after planting to prevent breakage due to high winds. G.41 is believed to be better suited to high pH soils.

**Budagovsky 10 (B10)** has become available. It is a release from the Michurinsk University of Agriculture (Russia) breeding program, which is trying to select for improved winter hardiness. A 10-year trial in Pennsylvania with Golden Delicious as the scion cultivar showed that trees on this rootstock were similar in size to trees on G.935 and M.9 T337 (15 percent smaller). Main scaffold branch angle was close to 90 degrees. Production efficiency and total yield were slightly better than trees on M.9 T337.

**Ottawa 3 (O.3):** This rootstock was bred in Canada for its cold hardiness from a cross between Robin crabapple and M.9. The rootstock roots poorly in stoolbeds and is often micropropagated. Trees on O.3 are about the size of M.9EMLA but smaller than M.26. Induces early bearing. Resistant to collar rot, but susceptible to fire blight and woolly apple aphids. Ottawa 3, although being available for many years, has not been popular with the nursery industry. Ottawa 3 is very susceptible to apple mosaic virus, so only material known to be virus free should be planted on this rootstock.

**Vineland 1 (V.1):** This rootstock came from the breeding program at the Vineland station in Ontario, Canada. Tree size is comparable or slightly larger than M.26. Yield efficiency and fruit size are equal to or greater than M.26. However, unlike M.26, it appears to be highly resistant to fire blight. It has good cold hardiness.

**Malling 26 (M.26):** A more vigorous rootstock than M.9. It can be used to produce either a dwarf or a semi-dwarf tree, depending on scion variety, production system, and soil type. It is susceptible to collar rot and fire blight and should not be planted in a wet site. Certain varieties, such as Rome, Stayman, Golden Delicious, and many triploids, when grafted onto this rootstock may exhibit signs of graft union incompatibility. When incompatibility occurs, the trees may break off at the union in high winds. Because exposed portions of the rootstock have a strong tendency to produce burr knots, the union between the scion variety and the rootstock should be set no more than 1 to 2 inches above the final soil level.

**Geneva 214 (G.214)** is a cross of Robusta 5 and Ottawa 3 and tested as CG.4214. Trees on this rootstock will need to be supported and can produce a tree about 30 to 35 percent the size of seedling with vigor and precocity similar to M.9,

Nic.29, and M.26. Trees are more productive than those rootstocks, have good cold hardiness, and are resistant to fire blight and woolly apple aphid.

**Geneva 935 (G.935)** is a cross of Ottawa 3 and Robusta 5. Size is reported to be slightly larger than M.26, but the rootstock has resistance to fire blight and crown rot. It is not resistant to woolly apple aphid. Production efficiency is rated equal to M.9. In the Golden Delicious trial at Rock Springs at the end of the tenth growing season, tree size was about 15 percent smaller than M.9. However, with the more vigorous Fuji, tree size was comparable to M.9. Production efficiency was not significantly different although slightly higher than M.9. The rootstock seems to induce wider angled branching in the scion. Geneva 935 is sensitive to latent viruses in apple and should only be propagated with virus-free scion wood on top.

**Geneva 11 (G.11):** The second release of the Cornell breeding program; only limited plantings exist in Pennsylvania. In the 2007 Fuji trial G.11 was about 25 percent smaller than trees on M.9T337 but more productive. Has the advantage of being resistant to fire blight and crown rot as well as only rarely producing suckers or burr knots. Tissue-cultured trees are larger than trees propagated by stool beds.

**Geneva 202 (G.202)** is a semi-dwarfing rootstock that produces a tree slightly larger than M.26. It was developed from a cross of M.27 and Robusta 5. It is fire blight and *Phytophthora* resistant as well as having resistance to woolly apple aphids. The rootstock has been mainly tested in New York and New Zealand. In New Zealand they are looking at this rootstock as a possible replacement for M.26 since it is more productive than M.26. In a nine-year study with the scion cultivar of Liberty, G.202 was about 50 percent smaller than M.7 but had much greater production efficiency.

**Geneva 210 (G.210)** is a semi-dwarfing rootstock that is 50 to 60 percent the size of seedling and resistant to fire blight (*Erwinia amylovora*) and crown rot (*Phytophthora* spp.). It is a hybrid from a cross between Ottawa 3 and Robusta 5, and is larger than Ottawa 3 but smaller than Robusta 5. It is similar in size to Malling 7 but more productive and precocious.

**Geneva 890 (G.890)** is a semi-dwarfing rootstock hybrid from a cross of Robusta 5 and Ottawa 3 and about 55 to 65 percent the size of seedling. It is resistant to fire blight (*Erwinia amylovora*), crown rot (*Phytophthora* spp.), and woolly apple aphid and has good cold hardiness. Tree does produce root suckers, but we have not seen any evidence of burr knot formation. Tree size is reported to be approximately the same as M.7 to MM.106 but with yield efficiency similar to M.9. Rootstock was released for use as a freestanding tree for processing orchards or as supported trees with weak scion cultivars.

**Geneva 969 (G.969)** is a semi-dwarfing rootstock hybrid from a cross of Robusta 5 and Ottawa 3. It is resistant to fire blight, crown rot, and woolly apple aphid and has good cold hardiness. It is classified as having growth control similar to M.7. Honeycrisp on this rootstock at Rock Springs produces the same size tree at the end of the fifth growing season.

The rootstocks produce few root suckers or burr knots. Suggested for trial for growers desiring a freestanding tree, although NC-140 trials have all been with trees grown with support.

**Pillnitzer Supporter 4 (Pi.80)**, a cross between M.9 and M.4, was introduced from Germany. It is reported similar in size and in anchorage to M.26. Yield capacity is reported to be better than that of M.26. A planting with McIntosh as the cultivar was established at Rock Springs. Supporter 4 grew to about 15 percent larger than M.7 EMLA. Yield was nearly double that of McIntosh/M.7EMLA and 50 percent greater than McIntosh/M.26EMLA.

**Interstems:** This stock is composed of an understock such as seedling MM.111 or MM.106, onto which an intermediate stem piece of M.9 or M.27 is grafted. The variety is budded or grafted onto M.9 or M.27. Size control is directly related to the length of the intermediate stem piece. Interstem apple trees offer a strong root system while reducing the size of the overall tree. Interstem trees should be planted so that a portion of the interstem is buried. Test plantings in Pennsylvania indicate that interstems on either MM.106 or MM.111 sucker, and very vigorous varieties and Stayman have not performed well on interstems.

**Geneva 30 (G.30):** The advantages of this M.7-size rootstock are early production, fewer burr knots, and less suckering. Tests at Rock Springs do indicate that trees on this rootstock come into bearing earlier and produce more fruit than M.7. Unfortunately, questions have arisen about the graft compatibility of this rootstock with Gala. In tests around the country in the NC-140 trials, there have been occasions where Gala/G.30 have snapped off at the bud union during high winds. Therefore, it is recommended that if Gala is propagated on G.30, the trees be supported by two wires, one at approximately 36–40 inches above the ground and a second wire at 8–9 feet. Individual stakes or poles have not been sufficient because they allow excessive twisting of the trees in the wind.

**Geneva 222 (G.222):** This rootstock was developed from a cross of Robusta 5 and Malling 27. The semi-dwarfing rootstock is reported to be approximately 45 to 55 percent the size of seedling and needs to be supported. Trees on this rootstock are similar in vigor to M.7 but more precocious and productive with good cold hardiness and resistance to fire blight, *Phytophthora* root rot, and woolly apple aphid.

**Malling 7 (M.7):** This rootstock produces a semi-dwarf tree that is freestanding in deep well drained soils. In rocky, steep, or shallow soils, it tends to lean. High budding and deeper planting will help remedy this problem. The rootstock may sucker profusely and is susceptible to collar rot. M.7a is a clone of the original M.7 that has had some of the inherent viruses removed.

**Malling-Merton 106 (MM.106):** A rootstock, slightly larger than M.7, that produces freestanding, early bearing trees. Trees on MM.106 are susceptible to collar rot when planted in wet soils and are not recommended for poorly drained sites. Delicious on MM.106 is susceptible to apple union necrosis.

**Malling 2 (M.2):** An older rootstock that is reappearing in nurseries and orchards. It produces a semi-dwarf to semi-standard freestanding tree, depending on scion variety. Trees are strong, crop well, and do not have collar rot problems.

**Poland 18 (P.18):** This stock holds the most promise for those wanting a larger tree about the size of MM.111. Its other advantages are tolerance to fire blight and resistance to collar rot. It will probably perform better in wet or heavier soils.

**Malling-Merton 111 (MM.111):** A well-anchored rootstock, resistant to woolly apple aphids, and tolerant of drier soil conditions. It is the most cold-hardy rootstock readily available. Trees on MM.111 are semi-standard to standard in size. Planting depth of this rootstock is critical. The union should be no higher than 1 to 2 inches above the final soil line.

**Budagovsky 118 (B.118)** is a more vigorous clone out of the Minsk breeding program. It is more vigorous than the other rootstocks in the series but still imparts the high degree of winter-hardiness. It propagates easily in stool beds and does not sucker. It has moderate resistance to fire blight but is susceptible to *Phytophthora*. Because of the vigor of the rootstock it is only recommended for spur strains of apple or in weak soil or replant situations.

**Seedling:** A rootstock from apple seeds, with a variable genetic makeup and suckering and disease susceptibility. Varieties on this rootstock produce the largest trees. Few nurseries that supply commercial fruit growers have trees grafted onto seedling for sale anymore.

### Planting Depth

Apple rootstocks are usually propagated clonally in stool beds and have been selected because they root well. The roots are induced on aboveground parts of a stem. When apple trees are budded high on rootstocks and planted with a union at the ground, the belowground portion of the rootstock has the ability to form roots.

When the union is planted 4 or more inches aboveground, the exposed portion is unable to form normal roots and may form root initials or burr knots instead. Burr knots are areas of rootstocks where roots try to form but cannot because they are not in a medium conducive to root growth. Rootstocks with burr knots do not enlarge radially in a normal fashion because phloem and xylem cells do not develop all the way around the tree. Several species of tree borers may enter burr-knot areas. Thus, apple rootstocks should be planted with the union at approximately 2–3 inches above ground level. When mechanical tree planters are used, trees may be set too high. However, trees can be set 1 or 2 inches deeper and manually adjusted to the proper depth. Research suggests that the height of the union also will influence the amount of dwarfing induced by a rootstock. The more of the rootstock shank that is exposed the greater the dwarfing. A general rule of thumb is that for every inch of exposed rootstock shank below the graft union you can expect 10 percent more dwarfing. The tall spindle training system relies on some of its dwarfing ability by planting unions 4 to 6 inches above soil level. Leaving this much of the root tissue exposed can increase the risk of winter injury and potential development of burr knots on the rootstock shank.

### Pollination

Pollination is the sexual portion of a tree's life cycle and involves the integration of several biological and physical factors, including cultivar compatibility, synchronous blooming, insects, and proper weather conditions. If any one of these components is missing or limiting, crop yield and fruit quality (size and shape) can be affected. Pollinators are important for all tree fruit crops, whether cultivars are self-fertile or self-sterile. Bees are by far the most important group of pollinators, but some types of flies, such as syrphids, some beetles, and some types of thrips may also assist to lesser degrees. Honey bees are the most widely used bee for pollination because they are easy to manage and can be moved in and out of orchards for bloom. However, several species of mason bees (*Osmia* spp.) are also managed for tree fruit pollination, and more than 120 species of wild bees frequent tree fruit orchards and contribute significantly to pollination.

Cold periods during flowering can reduce pollination and subsequent fruit set. Pollen may fail to germinate when temperatures are below 41°F, and pollen tube growth is extremely slow below 51°F. Therefore, in some situations, temperatures could be warm enough for bees to fly (65°F for the honey bee, 5 to 10 degrees cooler for bumble bees and solitary bees), but if the weather turns cold, the pollen tubes may not grow fast enough before the embryo sac deteriorates.

### Effective pollination period (EPP)

After pollination it takes a certain time for the pollen tube to reach the embryo sac. Once a flower opens, the embryo has only a limited time when it is receptive. If the pollen tube does not reach the embryo before it degenerates, then the flower will not set and a fruit will not develop. Typically, pollination and fertilization must occur within two to four days after the flowers open; otherwise, the embryo sac will degenerate before fertilization can occur. Called the effective pollination period (EPP), this is the difference between the period of time for pollen tube growth and that of ovule longevity. The longer the effective pollination period, the greater the likelihood of adequate fertilization and seed development. Studies have shown that this period can vary depending on cultivar. The growth of the pollen tube and eventual fertilization of the embryo is largely dependent on temperature and its relationship to the effective pollination period. The EPP was introduced as a way of establishing the time frame between when a flower is pollinated and when the embryo becomes unreceptive. The length of the EPP will vary by flower position within the cluster and by certain cultural practices. In general, the EPP can be as short as 3 days and as long as 12 days; Delicious has one of the shortest EPPs. Williams and Wilson developed a temperature response index to allow the estimation of the time required for a pollen tube to elongate and reach the embryo (see below). The index is based on the daily mean temperature over a period of days. When the index reaches or exceeds 100 percent, the pollen tube should have reached the embryo and fertilized the egg. As an example, suppose the average mean temperature over the past five days had been 50, 54, 50, 52, and 59 degrees. Pollen tube growth would be expected to be  $14 + 20 + 14 + 17 + 50 = 115$  percent, meaning pollen tube growth would have taken slightly less than five days.

The Pollen Tub Growth Model (PTGM) is another tool that predicts how long it takes the pollen tube to reach and fertilize

the ovule at the base of the flower. This model was developed and tested by researchers at Virginia Tech for several different cultivars. Growers can access and utilize the PTGM from the NEWA website ([www.newa.cornell.edu](http://www.newa.cornell.edu)) under the Crop Management tab. For more information on the use of the PTGM, see the section on chemical thinning of apples.

#### Effective Pollination Period Index

Mean daily temp (°F)										
41	43	45	46	48	50	52	54	55	57	59
Pollen tube growth index (%)										
8	9	10	11	12	14	17	20	25	35	50

#### Pollinizer varieties

All apple cultivars require cross-pollination with a pollinizer (not to be confused with a pollinator, such as a bee) to ensure commercial quality fruit and yields. A pollinizer is the source of pollen necessary to set fruit, such as a co-blooming cultivar or crabapple with compatible pollen in the orchard that serves as the source of pollen necessary for flowers to set fruit or a bouquet of flowering branches apples placed in the orchard. Varieties differ in their self-fruitfulness. For example, Golden Delicious is considered partially self-fruitful, while Red Delicious is not. Regardless of the degree of self-fruitfulness, provide cross-pollination in every planting with pollinizer varieties that bloom at the same time as the target variety. With respect to cross-pollination, all red sports and spur types are considered the same as the parent variety. For example, Yorking is not a pollinizer for York Imperial. Closely related varieties may not pollinate one another—for example, McIntosh and Early McIntosh. Triploid varieties, such as Mutsu (Crispin), Shizuka, Stayman and Jonagold do not pollinate any varieties because they produce nonviable pollen. Otherwise, all varieties with satisfactory pollen are pollinizers of one another if the bloom periods overlap. It is advisable to have three pollinizer varieties in all blocks that have triploid cultivars.

See Table 1-6 for a partial listing of the pollen nature of apple varieties. Your extension pomologist can provide information about the pollination requirements of varieties not listed. Five conditions are necessary for satisfactory cross-pollination:

- Pollinizer and main variety bloom periods must overlap.
- The pollinizer variety must have viable diploid pollen.
- The pollinizer variety must be located near the producing tree.
- Bees and other insects must be present in the orchard and be active at bloom.
- Weed blossoms, such as dandelions, mustard, and wild radish, should not be present in quantity since they attract bees away from fruit tree blossoms.

#### Pollinizer placement

The placement of pollinizers is important. Ideally, every tree in an orchard should be located as close to a pollinizer tree as possible. However, efficient orchard production practices do not include scattering pollinizers of commercial cultivars throughout a block. (An exception is listed below in the discussion of ornamental crabapples.) The preferred arrangement of pollinizers is in solid rows. One scheme is to alternate two rows of pollinizers between

four rows of the major cultivar. An exception is planting cultivars, such as Delicious, that have a tendency to be less self-fruitful. In these instances, and when it is desirable to maximize pollination, a pollinizer row should be set every third row.

Trees that provide sufficient compatible pollen for the main cultivar(s) in the block are necessary for pollination. A desirable arrangement is a pollinizer located not more than 100 feet from the variety to be pollinated. In larger blocks, plant two rows of pollinizer (starting on the windward side of the block), four rows of main variety, two rows of another pollinizer, four rows of the main variety, then two rows of the first pollinizer, etc., and repeat the arrangement across the block. We recommend that no fewer than three pollen-compatible varieties be planted in an orchard. Thus, for example, if you are planting a Delicious block, select two additional suitable pollinizer varieties to plant. Where additional pollen is needed, graft a pollinizer branch into each tree. Select main variety and pollinizer trees with overlapping annual bloom times. Large bouquets of pollinizer branches placed in drums of water near main variety trees may be used when no other pollinizers are available. The nearer the pollinizer to the producing tree, the better distribution by the bees of pollen to all blossoms.

Certain varieties have a biennial bearing tendency. During the “off” year of the pollinizer, the adjacent variety, although an annual bearer, will tend to become biennial because of the lack of cross-pollination. Summer applications of NAA or ethephon can help promote return bloom. This is discussed later in the plant growth regulator section of this chapter. This is not as serious when one of the two is relatively self-fruitful; however, the problem must be considered along with all the other factors that affect pollination.

All fruit species require pollination to set fruit. Some species are self-fruitful and do not require more than one cultivar per block. Peaches, nectarines, tart cherries, most apricots, and some European plums are self-fruitful, and a solid block of one cultivar may be planted. Apples, pears, and older sweet cherry cultivars require mixed plantings of different cultivars for adequate cross-pollination. Many of the newer sweet cherry cultivars are self-fertile and solid blocks can be planted. The percentage of flowers that need to be set varies greatly between fruit crops. For crops like cherries, for which each individual flower yields a good-sized fruit at harvest without thinning, yield is directly determined by pollination, and so 20 to 60 percent of sweet cherry and 20 to 75 percent of sour cherry blossoms need to be set for a commercial crop. For other fruit crops where size is more important commercially or to prevent biennial cropping, the percentage of flowers that need to be pollinated is much lower: apple, 2 to 8 percent; pear, 3 to 11 percent; peach, 15 to 20 percent; apricot, 20 to 25 percent; and plum, 3 to 20 percent. This is the reason for hand-thinning many crops like peaches later in the season or for chemical thinning apples and pears since under normal conditions these crops will tend to set too many fruit that, if left to mature, will be too small commercially.

The need for higher pollination levels in cherry generally means that honey bee hives are required in addition to the pollination by wild bees, but in other crops such as apples and pears where the percentage of fruit set is much lower, wild pollinators in a diverse landscape setting with wooded borders and fencerows within 200 yards may provide significant, if not all, pollination

needs. Over half of all New York and Pennsylvania apple growers now rely on wild pollinators rather than honey bees and save significantly on honey bee rentals. Most peach and some apple growers in Pennsylvania that have not used honey bees for several decades now have not had noticeable losses in fruit quality or yields.

Maximizing pollination increases production owing to larger and better-shaped fruit and/or a greater number of fruit per tree. Research in Massachusetts has shown that fruit size and calcium content are directly related to the number of seeds per fruit, with the number of seeds being dependent on good pollination. The more pollinizer trees in a planting, the better the potential for cross-pollination. However, using rows of apple pollinizers means the loss of some efficiency in orchard operations. Having two or more cultivars in an orchard may pose problems in spray-to-harvest limitations and cultural practices, and it may confuse pickers, resulting in bins of mixed cultivars. There also may be an inefficient use of land owing to differences in growth habits. These disadvantages, however, are far outweighed by the greater yields associated with pollinizer use.

### Pollinizer placement

The placement of pollinizers is important. Ideally, every tree in an orchard should be located as close to a pollinizer tree as possible. However, efficient orchard production practices do not include scattering pollinizers of commercial cultivars throughout a block. (An exception is listed below in the discussion of ornamental crabapples.) The preferred arrangement of pollinizers is in solid rows. One scheme is to alternate two rows of pollinizers between four rows of the major cultivar. An exception is planting cultivars, such as Delicious, that have a tendency to be less self-fruitful. In these instances, and when it is desirable to maximize pollination, a pollinizer row should be set every third row.

### Supplemental pollination practices

Even with an adequate allowance for pollinizers, it may sometimes be necessary to provide for additional pollen when weather conditions do not favor cross-pollination. Using honey bee hive inserts with commercially obtained pollen is a common practice that can increase pollen sources. Inserts are specially constructed to fit in the entrance of hives and are filled on a frequent basis with pollen. The inserts are constructed so that bees are forced to track across the pollen and carry it to the flowers as they forage. An alternative method of increasing pollen is to cut bouquets of flowering branches from trees elsewhere in the orchard and place them in large containers of water within the tree rows. Bouquets should be checked daily and replenished as needed. A third method is to graft selected limbs with a compatible pollinizer branch. The disadvantage of this method is the necessity to clearly mark the limb to prevent it from being pruned out in the winter and prevent harvest crews from mixing the fruit in bins. All these methods should be viewed as supplemental means of increasing pollination. The best pollination method is to have an adequate number of pollinizer cultivars and strong, healthy honey bee colonies.

### Using ornamental crabapples as pollinizers

Planting annual blooming ornamental crabapple trees to provide additional pollen and improve cross-pollination has been suggested

and has been tested by a number of Pennsylvania growers. Ornamental crabapples are noted for their abundant annual production of flowers. Frequently, flowering crabapples will bloom on both spurs and one-year-old wood. The wide variety of available cultivars allows the grower to achieve enough overlap of bloom that even the latest flowers on the main cultivar have an equal opportunity for cross-pollination. Crabapple trees for this use are propagated on dwarfing rootstocks and placed between the trees of the main cultivars to be pollinated are pruned so that they do not crowd the commercial cultivar. Using ornamental crabapples has several advantages. First, it allows the grower to plant a single cultivar block and to manage the block as a single unit. Second, it eliminates the need for less profitable cultivars in a planting solely for their use as pollen sources. Third, it prevents pickers from mixing two similar apple cultivars in harvest bins and reduces the need for multiple harvests in blocks of mixed cultivars.

Some of the more commonly used crabapple cultivars are Manchurian, Pioneer Scarlet, Rosedale, Golden Hornet, Snowdrift, and Simpson 10-35. Nearly every tree fruit nursery sells ornamental crabapples. Growers should exercise caution, however, in selecting a particular crabapple for their orchards.

Not all crabapples are suitable for use as pollinizers. Research has shown crabapple cultivars with white single flowers are better for cross-pollination because these flowers are most similar to cultivated apple flowers. Crabapples with darker colored flowers may alter honey bee visitation patterns. Care must be taken with using crabapples as pollinizers as they are often more susceptible to fire blight than the apple they are planted into and the disease can spread from these trees. The following table showing crabapple varietal susceptibility to fire blight was adapted from Durham et al. (1999) and Beckerman (2006). Susceptibility may vary by location and parent rootstock.

**Crabapple varietal susceptibility to fire blight.**

Highly susceptible	Moderately susceptible	Moderately resistant
Bechtel	Brandywine	Centurion
Hyslop	Dolgo	Coralburst
<i>Malus aldenhamensis</i>	Donald Wyman	David
Manchurian	Golden Hornet	Evereste
Mary Potter	Hopa	Indian Summer
Old Hope	Indian Magic	Prairie Fire
Ormiston Roy	Kelsey	Profusion
Pioneer Scarlet	<i>Malus hilleri</i>	Radiant
Red Barron	Manchurian	Red Vein Russian
Red Jade	Red Splendor	Simpson 10-35
Royalty	Rosedale	Thundercloud
Snowdrift	Snow Cloud	Vanguard
Strathmore	Spring Snow	White Cascade
Transcendent		

We recommend a minimum of two to three different cultivars with slightly different bloom seasons. How many pollinizers to plant will vary with how difficult it is for the apple cultivar to set fruit. Golden Delicious blocks require fewer pollinizers, whereas Delicious blocks require more trees per block. A common scheme is to plant a crabapple between every third tree in every third

row. This situates every tree of the main cultivar adjacent to a pollinizer. Crabapples can also be interplanted in existing blocks that have a traditional pollinizer arrangement. The addition of the crabapples will increase the potential for pollination and help in situations where the fruiting pollinizers may have lost their flowers due to cold injury or become biennial.

### **Pollination services: honey bees**

European honey bees are the primary managed pollinators in orchards because their abundance can be managed from year to year. However, due to competing demands, disease, the introduction of parasitic mites (mainly *Varroa destructor*), and likely impacts from insecticide and fungicide use in the field, the pollination picture has changed. Despite intense efforts to protect their bees, beekeepers are losing large numbers of colonies to mites and the diseases they transmit. In addition, since 2006 there have been additional dramatic die-offs of tens of thousands of honey bee colonies from a phenomenon known as Colony Collapse Disorder (CCD), although the past few years have seen fewer losses attributed to CCD than at its peak between 2006 and 2014. The result has been annual losses ranging between 30 and 45 percent of commercial colonies, which has left many beekeepers devastated and some growers without the quantity and quality of bees needed to pollinate crops.

Healthy hives are key to maintaining high pollination activity during bloom. Because honey bees are vulnerable to many of the pesticides used to control insects, pathogens, and weed species, growers who depend on honey bee pollination must constantly maintain a delicate balance between protecting their crops from pests and pathogens and protecting pollinators. It is generally advisable to err on the precautionary side when using pesticides.

### ***Best practices for growers renting honey bees for pollination services***

- Know the pesticides you are using and their toxicity to bees (do not depend on a third party to provide this information). See Tables 1-9 and 4-4 for toxicity information.
- *Read the label and follow the label directions.*
- *Never* use a pesticide on a blooming crop or on blooming weeds if honey bees are present.
- The use of a pesticide prebloom, just before bees are brought onto a crop, is not recommended. If a pesticide must be used prebloom (for example, at pink in apples), select a material that has a lower toxicity to bees and a short residual toxicity, and apply only when bees are not foraging, preferably just after dark. Research has shown that moving plant-systemic insecticide applications from the pink or white bud stage to the half-inch green stage in apples (about 7 to 10 days earlier) will greatly reduce or even eliminate some insecticide levels in the nectar and pollen at bloom.
- Do not apply insecticides postbloom (e.g., petal fall) until after the bees have been removed from the crop.
- Blooming time varies depending on cultivars. Bees pollinating one variety or crop may be at risk while another crop or variety is being treated postbloom with insecticides. Also, while crops may have completed blooming, bees may be visiting blooming weeds in and around crops. Be aware of these situations and

avoid the application of pesticides on a nonblooming crop if there is risk of drift onto blooming crops and weeds if bees are present. If a spray must be applied, use the least toxic material and apply only when bees are not foraging.

- Protect water sources from contamination by pesticides. If necessary, provide a clean source of water close to honey bee colony locations prior to their arrival in the orchard or crop.
- The mode of action of many fungicides in terms of toxicity to bees is poorly understood. Some are known to synergize with insecticides, and together these can be more toxic to bees. Avoid the application of the more toxic fungicides mancozeb and captan on blooming crops when bees are present. The use of and lime sulfur during bloom has been shown to be repellent to bees for several days as well.
- For more information on toxicity, also see other online resources such as [www.northeastipm.org/about-us/publications/ipm-insights/ipm-resource-wild-pollinators-of-eastern-apple-orchards-and-how-to-conserve-them](http://www.northeastipm.org/about-us/publications/ipm-insights/ipm-resource-wild-pollinators-of-eastern-apple-orchards-and-how-to-conserve-them) and [catalog.extension.oregonstate.edu/pnw591](http://catalog.extension.oregonstate.edu/pnw591) or [https://pollinator.cals.cornell.edu/sites/pollinator.cals.cornell.edu/files/shared/Pesticide % 20Decision-Making % 20Guide % 20to % 20Protect % 20Pollinators % 20in % 20Tree % 20Fruit % 20Orchards.pdf](https://pollinator.cals.cornell.edu/sites/pollinator.cals.cornell.edu/files/shared/Pesticide%20Decision-Making%20Guide%20to%20Protect%20Pollinators%20in%20Tree%20Fruit%20Orchards.pdf) and several online publications at [pesticidestewardship.org/pollinator-protection](http://pesticidestewardship.org/pollinator-protection).
- Do not assume that organically approved compounds are safe to bees. For more information, go to [xerces.org/pollinator-conservation/organic-farms/organic-approved-pesticides](http://xerces.org/pollinator-conservation/organic-farms/organic-approved-pesticides).
- As a result of high annual colony losses, fewer beekeepers are providing fewer honey bee colonies for growers and at much higher prices. In addition, the strength of honey bee colonies, at times, may be marginal for the purpose of pollination. Never before has the pollination situation been so critical. To ensure maximum crop yields, growers now must give careful attention and consideration to crop pollination.
- Contact beekeepers early. Since honey bee colonies may be in short supply during some years, it is critical to contact beekeepers as early as possible so they know you are depending on them to supply bees. If you do not have a past relationship with the beekeeper, you should make initial contact with him or her in the fall. Beekeepers assess the survival and strength of their colonies from mid-February to mid-March. Contact your beekeeper during this time to be certain that enough bees are available for spring pollination. In addition, you should make every effort to give beekeepers at least 48 hours' notice to move bees onto the crop.
- Draw up a pollination contract (Figure 1-5). To prevent misunderstandings, it is a good idea to have a written pollination agreement between the grower and the beekeeper. This will ensure that enough pollinators are provided and that beekeepers are protected from pest control practices that may injure bees.
- Obtain an adequate number of colonies. The number of honey bee colonies you will need will vary depending on the crop, location, attractiveness of the crop, density of the flowers, length of the blooming period, colony strength, and competitive plants in the area. The rule of thumb is to start with one colony per acre and make adjustments from there.

**Table 1-9. Toxicity of insecticides, miticides, fungicides, and blossom- and fruit-thinning agents to bees, and suggested timing of application.**

Active ingredients (example trade names)	Highly toxic	Moderately toxic	Slightly toxic	Nontoxic	Guidelines for timing of applications	Residual toxicity
<b>Insecticides</b>						
Abamectin/avermectin (Agri-Mek), ≤0.025 lb ai/A	X				Apply only during late evening	8 hours
Abamectin/avermectin (Agri-Mek), >0.025 lb ai/A	X				Do not apply on blooming crops or weeds	1–3 days
Acetamiprid (Assail)			X		Apply only in late evening, night, or early morning	
Azadirachtin (Azatin, Neemix)		X			Apply only in late evening, night, or early morning	Up to 2 hours
<i>Bacillus thuringiensis</i> , Bt (Dipel)				X	Apply at any time	
Bifenthrin (Brigade), < 0.04 lb ai/A	X				Apply only in late evening, night, or early morning	
Bifenthrin (Brigade), 0.04 lb ai/A	X				Apply only in late evening	
Bifenthrin (Brigade), ≥0.06 lb ai/A	X				Do not apply on blooming crops or weeds	Up to 1 day
Buprofezin (Centaur)				X	Apply at any time	Sublethal reproductive effects on adults within 24 hours of application; contaminated pollen lethal to larvae
Carbaryl 4F (Sevin), 1 lb ai/A or less	X				Apply only in late evening	
Carbaryl 4F (Sevin), 2 lb ai/A	X				Do not apply on blooming crops or weeds	
Carbaryl WP (Sevin)	X				Do not apply on blooming crops or weeds	3–7 days
Carbaryl XLR (Sevin), ≤1.5 lb ai/A	X				Apply only in late evening	8 hours
Carbaryl XLR (Sevin), ≥1.5 lb ai/A	X				Do not apply on blooming crops or weeds	Less than 2 days
Chlorantraniliprole (Altacor)				X	Apply only in late evening, night, or early morning	2 hours
Chlorpyrifos EC (Lorsban)	X				Do not apply on blooming crops or weeds	4–6 days
Clothianidin (Clutch)	X				Do not apply on blooming crops or weeds	If applied before bloom, pollen and nectar will be contaminated
<i>Cydia pomonella</i> granulosis virus (Carpovirusine, Cyd-X)				X	Apply at any time	
Cyfluthrin (Baythroid)	X				Do not apply on blooming crops or weeds	Less than 2 days
Deltamethrin (Delta Gold)	X				Apply only in late evening, night, or early morning	4 hours
Diazinon EC or WP	X				Do not apply on blooming crops or weeds	2 days
Dinotefuran (Venom/Scorpion)	X				Do not apply on blooming crops or weeds	If applied before bloom, pollen and nectar will be contaminated
Emamectin benzoate (Proclaim)	X				Apply only in late evening, night, or early morning	2 hours
Esfenvalerate (Asana), ≤0.025 lb ai/A	X				Apply only in late evening	
Esfenvalerate (Asana), 0.0375 lb ai/A	X				Do not apply on blooming crops or weeds	1 day
Fenpropathrin (Danitol)	X				Do not apply on blooming crops or weeds	1 day
Flonicamid (Beleaf 50SG)			X		Apply only in late evening, night, or early morning	
Flupyradifurone (Sivanto)			X		Apply only in late evening, night, or early morning	
Horticultural mineral oils		X			Apply only in late evening, night, or early morning	3 hours
Imidacloprid (Provado), ≤0.1 lb ai/A	X				Do not apply on blooming crops or weeds	8 hours; if applied before bloom, pollen and nectar will be contaminated
Indoxacarb (Avaunt)	X				Apply only in late evening, night, or early morning	3 hours
Kaolin clay (Surround)				X	Apply at any time	



**Table 1-9. Toxicity of insecticides, miticides, fungicides, and blossom- and fruit-thinning agents to bees, and suggested timing of application (continued).**

Active ingredients (example trade names)	Highly toxic	Moderately toxic	Slightly toxic	Nontoxic	Guidelines for timing of applications	Residual toxicity
Lambda-cyhalothrin (Warrior), ≤0.02 lb ai/A	X				Apply only in late evening	
Lambda-cyhalothrin (Warrior), ≥0.03 lb ai/A	X				Do not apply on blooming crops or weeds	1 day
Lime sulfur				X	Apply at any time	Repellent for up to 7 days
Malathion EC	X				Apply only in late evening	6 hours
Malathion ULV, ≤3 fl oz ai/A	X				Apply only in late evening, night, or early morning	3 hours
Malathion ULV, 8 fl oz ai/A	X				Do not apply on blooming crops or weeds	6 days
Malathion WP	X				Do not apply on blooming crops or weeds	2 days
Methodathion (Supracide)	X				Do not apply on blooming crops or weeds	3 days
Methomyl (Lannate)	X				Apply only in late evening	2 hours
Methoxyfenozide (Intrepid)				X	Apply at any time	
Novaluron (Rimon)	X	X			Do not apply on blooming crops or weeds	Sublethal reproductive effects on adults within 24 hours of application; contaminated pollen lethal to larvae
Oxamyl (Vydate), ≤ 0.5 lb ai/A	X				Apply only in late evening, night, or early morning	3 hours
Oxamyl (Vydate), ≥1 lb ai/A	X				Apply only in late evening	8 hours
Permethrin (Ambush, Pounce), 0.1 lb ai/A	X				Do not apply on blooming crops or weeds	Up to 2 days
Phosmet (Imidan), 1 lb ai/acre	X				Do not apply on blooming crops or weeds	Less than 4 days
Potassium salts of fatty acids/soap (M-Pede)				X	Apply at any time	
Pyrethrins (Pyrenonee, Pyroicide)	X				Apply only in late evening, night, or early morning	2 hours
Pyridaben (Nexter)	X				Apply only in late evening, night, or early morning	2 hours
Pyriproxyfen (Esteem)				X	Apply at any time	Sublethal reproductive effects on adults within 24 hours of application; contaminated pollen lethal to larvae
Rotenone		X			Apply only in late evening, night, or early morning	
Spinosad (Entrust, Success)	X				Apply only in late evening, night, or early morning	2 hours
Spinetoram (Delegate)	X				Apply only in late evening, night, or early morning	2 hours
Spirotetramat (Movento)			X		Apply at any time	
Sulfoxaflor (Closer)	X				Do not apply on blooming crops or weeds; check <a href="http://isoclasttankmix.com">isoclasttankmix.com</a> before tank-mixing.	14 days; if applied before bloom, pollen and nectar will be contaminated
Sulfur				X	Apply at any time	
Tebufenozide (Confirm)				X	Apply at any time	
Thiacloprid (Calypso)			X		Apply only in late evening, night, or early morning	
Thiamethoxam (Actara)	X				Do not apply on blooming crops or weeds	14 days; if applied before bloom, pollen and nectar will be contaminated
<b>Miticides</b>						
Abamectin/avermectin (Agri-Mek), ≤0.025 lb ai/A	X				Apply only during late evening	8 hours
Abamectin/avermectin (Agri-Mek), >0.025 lb ai/A	X				Do not apply on blooming crops or weeds	1–3 days
Acequinocyl (Kanemite)				X	Apply at any time	
Bifenazate (Acramite)		X			Apply only in late evening, night, or early morning	
Bifenthrin (Brigade), < 0.04 lb ai/A	X				Apply only in late evening, night, or early morning	

(continued)

**Table 1-9. Toxicity of insecticides, miticides, fungicides, and blossom- and fruit-thinning agents to bees, and suggested timing of application (continued).**

Active ingredients (example trade names)	Highly toxic	Moderately toxic	Slightly toxic	Nontoxic	Guidelines for timing of applications	Residual toxicity
Bifenthrin (Brigade), 0.04 lb ai/A	X				Apply only in late evening	
Bifenthrin (Brigade), ≥0.06 lb ai/A	X				Do not apply on blooming crops or weeds	Up to 1 day
Clofentezine (Apollo)				X	Apply at any time	
Etoxazole WDG (Zeal)				X	Apply at any time	
Fenbutatin-oxide (Vendex)				X	Apply at any time	
Fenpyroximate (Portal)				X	Apply at any time	
Hexythiazox (Onager, Savey)				X	Apply at any time	
Horticultural mineral oils		X			Apply only in late evening, night, or early morning	3 hours
Spirodiclofen (Envidor)	X				Do not apply on blooming crops or weeds	Toxic to larvae w/ contaminated pollen
<b>Plant Growth Regulators</b>						
Ethephon (Ethrel)				X	Apply at any time	
NAA/1-Naphthaleneacetic acid				X	Apply at any time	Possibly repellent
<b>Fungicides</b>						
Captan		X			Applying a half rate of 3 lb/A in combination with other fungicides for disease resistance management does not appear to affect HB; avoid the 5–6 lb/A high rate close to and during bloom	
Chlorothalonil				X	May synergize insecticide applications made at the same time	
Dodine (Syllit)				X	Systemic fungicide that has been shown to be slightly toxic at field rates to mason bee adults and larvae; do not apply after ½ inch green stage	
Lime sulfur, sulfur				X		Possibly repellent
Mancozeb				X	The full 6 lb/A rate has been shown to be ovicidal to beneficial insects, so use half rate in combination with other fungicides to combat disease resistance close to and during bloom	
Sterol inhibitors (Indar/Nova/Rally/Rubigan)				X	Systemic fungicides that may be found at low levels in pollen and nectar if applied just prior to or during bloom; slightly toxic to Mason bees; may synergize insecticide applications made at the same time	
Strobilurins (Flint/Sovran)				X		

Insecticide toxicity is generally measured using acute contact toxicity values  $LD_{50}$  (the exposure level that causes 50 percent of the population exposed to die). Toxicity thresholds are generally as follows to adult bees and indicated in the table:

- Highly toxic = acute  $LD_{50}$  of < 2/μg/bee
- Moderately toxic = acute  $LD_{50}$  of 2–10.99μg/bee
- Slightly toxic = acute  $LD_{50}$  of 11–100μg/bee
- Non-toxic = acute  $LD_{50}$  of > 100μg/bee

Do not return managed bees to the field until after the time period when residuals remain toxic. Additional label restrictions may apply; see pesticide label.

Source: Adapted from Hooven, Sagili, and Johansen (2013), “How to Reduce Bee Poisoning from Pesticides. Pacific Northwest,” Oregon State Extension Publication 591, <http://ir.library.oregonstate.edu/xmlui/bitstream/handle/1957/42829/PNW%20591.pdf>; May, Wilson, and Isaacs (2015), “Minimizing Pesticide Risk to Bees in Fruit Crops,” Michigan State University Extension Bulletin E3245, <http://msue.anr.msu.edu/uploads/236/68700/E-3245.pdf>; and unpublished data from Biddinger, Joshi, Rajotte, Shugure, and Phan.

**POLLINATION AGREEMENT**

This agreement is made \_\_\_\_\_, 20\_\_\_\_, between \_\_\_\_\_, and \_\_\_\_\_.  
 (date) (grower's name) (beekeeper's name)

**I. TERM OF AGREEMENT**

The term of this agreement shall be for the 19\_\_\_\_ growing season.

**2. RESPONSIBILITIES OF THE BEEKEEPER**

a. The beekeeper shall supply the grower with \_\_\_\_\_ hives (colonies) of honeybees to be delivered to the \_\_\_\_\_ as follows:  
 (orchard, field, etc.)

*(Fill in the appropriate line or lines and cross out those that do not apply)*

Approximate date of introduction: \_\_\_\_\_. Number of days after written notice from the grower: \_\_\_\_\_.

Time in relation to the following amount of bloom:

\_\_\_\_\_

Description of location(s): \_\_\_\_\_

\_\_\_\_\_

\_\_\_\_\_

\_\_\_\_\_

*(For additional space attach a separate sheet dated and signed by both parties)*

The beekeeper shall locate said bees in accordance with directions of the grower, or, if none are given, according to his/her judgment in providing the maximum pollination coverage.

b. The beekeeper agrees to provide colonies of the following minimum standards:

Disease-free colonies with a laying queen as evidenced by brood.

\_\_\_\_\_ frames with brood, with adult bees to cover.

\_\_\_\_\_ pounds of honey stores or other food.

\_\_\_\_\_ story hives.

The beekeeper agrees to open and demonstrate the strength of colonies randomly as selected by the grower.

c. The beekeeper agrees to maintain the bees in proper pollinating condition by judicious inspection and supering or honey removal as needed.

d. The beekeeper agrees to leave the bees on the crop until:

*(Fill in the appropriate line or lines and cross out those that do not apply)*

Approximate date of removal: \_\_\_\_\_. Number of days of written notice from grower: \_\_\_\_\_.

Time in relation to amount of crop bloom: \_\_\_\_\_

Other: \_\_\_\_\_

\_\_\_\_\_

\_\_\_\_\_

\_\_\_\_\_

*(Please complete reverse side)*

Figure 1-5. Pollination agreement.

*(continued)*

**3. RESPONSIBILITIES OF THE GROWER**

- a. The grower agrees to provide a suitable place to locate the hives. The site must be accessible to a truck and other vehicles used in handling and servicing the colonies. The grower shall allow the beekeeper entry on the premises whenever necessary to service the bees, and the grower assumes full responsibility for all loss and damage to his fields or crops resulting from the use of trucks or other vehicles in handling and servicing such colonies of honeybees.
- b. The grower agrees not to apply pesticides toxic to bees to the crop while the bees are being used as pollinators nor immediately prior to their movement if the residue would endanger the colonies. See Beekeeping Topics No. 4 "Honey Bees and Pesticides" for determining which pesticides are hazardous to bees.
- c. The following pesticides, other agricultural chemicals, and methods of application are mutually agreed to be suitable while the bees are on the crop.

---



---



---



---

- d. The grower also agrees to properly dispose of all pesticide solutions in such a manner that bees will not be able to contact the material while searching for a water source.
- e. The grower agrees to give the beekeeper a 48-hour notice if hazardous materials not listed need to be applied. The cost of moving the bees away from and back to the crop to prevent damage from highly toxic materials shall be borne by the grower.
- f. The grower agrees to pay for \_\_\_\_\_ colonies of bees at the rate of \$ \_\_\_\_\_ per colony. Payment shall be made to the beekeeper as follows: \$ \_\_\_\_\_ per colony on delivery and the balance on or before \_\_\_\_\_ of said year.  

(date)

 Additional moves or settings shall require \$ \_\_\_\_\_ per hive per move.
- g. The grower agrees to provide adequate watering facilities for the bees if none are available within one-half mile of each colony used in pollinating the crop.

Signed: \_\_\_\_\_  

Grower
Beekeeper

Address: \_\_\_\_\_  
 \_\_\_\_\_  
 \_\_\_\_\_

Phone: \_\_\_\_\_

Areas well populated with wild bees will not need as many rented colonies.

- Obtain bees at the appropriate time. For apples and other tree fruit, move honey bee colonies in at 10 to 25 percent bloom. If primary blossoms produce the choice apple fruit, however, bees should be present at the start of bloom or when king bloom on the south side of trees starts to open. As a precaution, competing bloom from other flowers in the orchard, such as dandelions, should be eliminated by mowing, cultivation, or the use of herbicides.
- Place colonies for maximum effect. Place colonies in groups of four to eight in favorable locations throughout the orchard or field to provide even distribution of the bees. In large orchards or fields, pollination is just as effective if groups of 10 to 20 hives are strategically distributed in sunny, wind-protected spots. Colonies should be protected from the wind and exposed to the sun from early morning until evening. Bales of straw or packing boxes stacked behind colonies offer wind protection. Colony entrances that face east or southeast encourage bee flight. Hives should be placed off the ground, and front entrances should be kept free of grass and weeds. If pesticides are applied during bloom, hives should be placed in protected areas or applications should be made at night or early morning when the bees are not active if possible.
- Do not place colonies under trees or in the shade. Bee activity is determined by weather and by conditions within the hive. Honey bees rarely fly when the exterior temperature is below 55°F. Wind speeds above 15 mph seriously slow activity, and activity stops when winds are between 21 and 25 mph. The stronger the colony, the lower the temperature at which bees initiate flight. Cold, rainy weather inhibits foraging. Under marginal weather conditions, foraging is limited to trees close to the hives. An extended period of inclement weather may require greater hive distribution to obtain adequate coverage.
- Assess colony strength; be sure you are getting strong colonies. It is important that the colonies you rent are healthy and contain a large enough population to do the job. For pollination, package bees (bees purchased through the mail and recently installed) and small hives are inferior to strong, overwintered colonies. The field bee population generally is correlated with the amount of brood in the hive. In packages and weak colonies, most of the hive population must remain in the hive to maintain temperatures of 93 to 95°F and rear brood. Two weak colonies are not equal to one strong colony!

Colony strength can be assessed in several ways:

1. Inspect hives. This method is the most time consuming but also the most accurate for assessing the quality of your investment in rented honey bee colonies. Colonies used for springtime pollination should have the following at minimum:
  - a laying queen
  - one and one-half or two stories (hive bodies or boxes)
  - four to six frames of brood
  - enough adult bees to cover six to eight frames

These are minimum requirements; stronger colonies with larger populations make superior pollination units and may

command a higher price. As these stronger colonies are opened, bees will “boil out,” or cover the tops of the frames. When smoked, however, the bees move down onto the frames and may not cover the frame tops. In this case, the frames themselves should be covered with bees. Note that there will be some variability in the quality of the colonies you rent. As a general rule, a group of colonies with 10 percent falling below the minimum standard is acceptable if 10 percent are above the minimum standard. Also, for a variety of reasons, some colonies may become queenless for a time; however, if these colonies meet all the other minimum requirements they still will be effective pollination units.

The Pennsylvania Department of Agriculture Apiary Inspection Service runs a hive evaluation program for colonies used in pollination situations. Inspections are performed by request only. Requests may be made by either the grower or the beekeeper and should be arranged through the state apiarist at the PDA Bureau of Plant Industry, 2301 North Cameron Street, Harrisburg, PA 17110; telephone 717-772-5225. Requests for inspections should be made as early as possible to facilitate scheduling. If an evaluation is requested by the grower, the beekeeper will be informed that a request has been made. Inspections are performed by the local or state apiarist. Colonies are inspected objectively to determine the colony size (number of supers), the presence of a laying queen, the number of frames of brood and adult bees, and the presence of disease and parasites. At least 10 percent of the colonies in an apiary, or a minimum of five colonies, are selected at random for inspection. Inspected colonies are identified by sticker. If selected colonies are banded or stapled, these are not refastened by the inspector. A copy of the evaluation report is given to both the grower and the beekeeper.

2. Assess traffic at hive entrance. This method is less time consuming but also less accurate. On a warm (70 to 80°F), calm day between 11:00 a.m. and 3:00 p.m., bee traffic at hive entrances should be heavy. During a one-minute observation period, strong colonies should have 50 to 100 or more bees arriving and leaving the hive. Bees also should be seen arriving with pollen pellets on their back legs. In weak colonies, perhaps only 10 to 20 bees will be seen arriving and leaving. Colonies that are being used for summer pollination should have even heavier traffic at the hive entrance. Another crude way to assess colony strength is to observe entrances when temperatures are cool (between 55 and 60°F). The stronger the colony, the lower the temperature at which bees will fly. In general, weaker colonies rarely fly when temperatures are below 60°F. Strong colonies will fly when temperatures are between 55 and 60°F. In general, honey bees rarely fly when temperatures are below 55°F.
3. Assess bee density on the crop. This method allows you to assess the contribution of feral or other honey bee colonies in the area, if present, in addition to rented bees. If you are using rented colonies, however, this method tells you little about the quality of the bees you have rented. We suggest that if you use this technique and find that the number of bees on the crop is low, you then use options (1) or (2) to assess the strength of the rented bees before renting additional bees. For apple trees, make observations in late morning during king

bloom; at a glance you should see one to two bees foraging on blooms. Make several assessments at different locations around the orchard. Note: This guideline is appropriate only for honey bees and is not accurate for bumble bees or solitary bees. It is only a rough guideline and may change depending on variety and planting conditions.

Note that careful consideration should be used when applying honey bee attractants on trees. Research on sugar-based attractant sprays for improving pollination indicates that such materials are generally ineffective. The entire tree is sprayed with the attractant and bees collect the sugar off the leaves, usually without visiting the flowers. Although this brings more bees into the field or orchard, more pollination does not necessarily occur. In addition, the sugar may be detrimental if it serves as a medium for the growth of sooty molds. Other attractants containing bee-derived communication pheromones, such as geraniol, have proved more successful, but further testing is needed before a full recommendation can be made. One of the newest and most promising attractants, Fruit Boost, contains honey bee queen mandibular pheromone. Canadian research has shown that when it is sprayed on flowering crops, queen mandibular pheromone can result in dramatic increases in yields for some crops. This product is sold in both Canada and the United States, and is being marketed mainly for use on pears, highbush blueberries, Gala apples, and in vegetable seed production. U.S. distributors are located in the Pacific Northwest. For more information, contact Contech Enterprises Inc., Unite 115-19 Dallas Rd., Victoria, BC V8V 5A6, Canada; phone: 800-767-8658; fax: 604-940-9433; their Grand Rapids Office, phone: 616-459-4139; fax 616-459-4140; or email: [info@contech-inc.com](mailto:info@contech-inc.com).

Other precautions and requirements: Beekeepers should be given at least 48 hours' notice to move bees onto or off the crop. Insecticides applied on or near the crop before or during bloom are a serious threat to bees, and certain fungicides may also pose a risk. Give the beekeeper at least 48 hours' advance notice of any applications so that the bees can be removed from the field or orchard. Honey bees need water for temperature regulation and brood production. Provide a clean water supply near the hives. Keep orchard wheel ruts and areas around the pesticide sprayer fillpoint drained to eliminate a possible insecticide-laden water source.

#### Additional information

The publications listed below are available from your local extension office, the Center for Pollinator Research ([ento.psu.edu/pollinators](http://ento.psu.edu/pollinators)), the Penn State Department of Entomology (814-865-1895), and the Penn State Extension website [extension.psu.edu/insects-pest-and-diseases](http://extension.psu.edu/insects-pest-and-diseases)). Available books and online resources about beekeeping include:

- Beekeeping Basics
- Beekeeping Topics: Sources of Bees for Pollination in Pennsylvania, Bees and Insecticides, Pollination Contracts, Basic Biology and Management of the Japanese Hornfaced Bee
- Pennsylvania Pollinator Protection Plan (P4): [ento.psu.edu/pollinators/pollin-spotlight-items/the-pennsylvania-pollinator-protection-plan-p4](http://ento.psu.edu/pollinators/pollin-spotlight-items/the-pennsylvania-pollinator-protection-plan-p4)
- Beekeeping 101: [extension.psu.edu/beekeeping-101](http://extension.psu.edu/beekeeping-101)

#### Sources of honey bee rentals for pollination services

Growers who need bees should make contracts with the beekeepers as early as possible (mid-February) so that proper preparations can be made. Specialized management is necessary in order to establish and maintain strong, efficient colonies, especially for early spring pollination. Therefore, beekeepers need to know how many colonies are needed and the approximate time of delivery as early as possible.

For up-to-date information about beekeepers with honey bee colonies for rental, visit the Pennsylvania State Beekeeper Association (PSBA) website at [www.pastatebeekeepers.org](http://www.pastatebeekeepers.org) or contact your county extension office or the Penn State Department of Entomology at 814-865-1896.

#### Pollination services: mason bees

Growers of bee-pollinated crops, particularly apples, may be interested in the possible use of solitary bees as managed pollinators. Two species of mason bees (in the genus *Osmia*) are currently being used for tree fruit pollination: the blue orchard bee (*Osmia lignaria*) and the Japanese orchard bee, JOB (*Osmia cornifrons*). The latter was introduced by the USDA into Mid-Atlantic region fruit orchards from Japan in the 1990s and is generally easier to manage and less likely to disperse from nests than the blue orchard bee. JOB has been used to pollinate the majority of the apple crop in Japan for more than 80 years and more recently in Korea. At least two other species of managed *Osmia* are used for commercial fruit pollination in parts of Europe and several species of wild *Osmia* are important for lowbush blueberry pollination in Maine and raspberry pollination in Oregon.

Surveys conducted by Penn State and the Pennsylvania Department of Agriculture determined that the Japanese orchard bee is now established in the wild throughout most of eastern US and Michigan, and that it co-exists with the blue orchard bee (eastern BOB) in areas adjacent to fruit orchards. The survey also revealed that another Japanese mason bee, *Osmia taurus*, is found in many areas of the state, although this species was not introduced intentionally and therefore was not quarantined for parasites and pathogens. *O. taurus* is very similar in appearance to JOB but is considered by the Japanese to be a pest species and a parasite of JOB.

Adults of these and most other mason bee species emerge early in the spring and begin to fly at approximately the same time as apricot or red maple bloom (usually early to mid-April). Unlike honey bees, mason bees are solitary, meaning that each female establishes and provisions their own nests (rather than having one queen laying eggs and tens of thousands of workers foraging). Although these bees are solitary, they are sometimes gregarious and will nest near other mason bees. An aggregation pheromone has been identified in mason bee cocoons which will increase their likelihood of staying by artificial nests and not dispersing into the landscape. Under natural conditions, mason bees nest in hollow reeds or stems of plants or in similar crevices. For example, they have been found nesting in piles of firewood, slash removed from orchards, and in cavities excavated by boring beetles in deadwood. In the Mid-Atlantic region, mason bees are active for roughly six to eight weeks, from about mid-April through mid-June. Males tend to emerge about one week before pear trees bloom in the spring. Female mason bees emerge two to three days after males, or longer, depending on weather condi-

tions. Mating occurs immediately after females emerge.

Several days after mating, females begin locating suitable nest spaces and provisioning them. Though both male and female bees visit flowers to sip nectar, only females gather pollen, carrying it in stiff hairs on the underside of their abdomens (unlike honey bees, which carry pollen on their hind legs). On a bee for bee basis, the Japanese orchard bee has been found to be at least 80 times more efficient at apple pollination than the honey bee because it carries up to 100 times more pollen and it carries it dry which facilitates pollen movement. Honey bees on the other hand gather mostly nectar to make honey and carry pollen wetted down from nectar to make it pack easier. For these reasons, the Japanese orchard bee was found to successfully pollinate up to 2,450 apple blossoms in a day compared to only 50 blossoms for the honey bee. Most mason bees also fly in cooler weather than honey bees, which is important for early season blooming crops such as tree fruit. Female mason bees provision cells within the nest with a mass of pollen roughly the size of a pea combined with a small amount of nectar. The female will lay a single egg onto each provision, and after the egg is laid, a mud wall is constructed around the egg to protect it. Under favorable conditions, a female mason bee can make one or more cells a day, often arranging cells linearly within a cavity or plant stem.

Newly laid eggs hatch in approximately a week, followed by a period of a month or more during which the larvae will consume the pollen ball. In early summer, after the feeding period, larvae then spend a week spinning a thick silk cocoon in which complete metamorphosis (pupation) takes place. Mason bees develop into fully formed adults in the late summer and remain dormant inside the nest throughout the winter. The bees will chew out of their cocoon and mud walls to emerge in the early spring at apricot bloom or about one week before peach or pear bloom. Mason bees have only one generation per year, with adult bees dying off at the end of the nesting season.

### Management of mason bees

Mason bees are relatively easy to manage using artificial nests constructed from wood blocks (drilled with a series of holes), cardboard tubes (with one end plugged), or sections of reed and bamboo with a stem node intact on one end (creating a dead end). Individually, such artificial nests should have internal tunnel dimensions roughly  $\frac{5}{16}$  inch in diameter and with a depth of 6 to 8 inches. These types of nests are bundled together and hung horizontally throughout the orchard (several feet above ground level) under some type of rainproof shelter (UV reflective blue plastics seem to help foraging bees locate nests) to mimic a cluster of natural hollow cavities (such as a cluster of beetle borer holes in a stump). In addition to the nests themselves, having a steady supply of mud near the nests (such as an excavated hole in the ground with a dripping hose or a slowly leaking water bucket) is essential for nesting success.

Depending on the location and the surrounding bee population, simply hanging these types of nests out may be sufficient to attract wild bees. Where wild mason bee populations are limited, it may be easier to establish a population by acquiring dormant cocoons from another orchard that is already managing mason bees. Experience has shown that species of mason bees obtained from the western United States may not adjust well to conditions in the Mid-Atlantic region. In addition, bringing bees in from out

of state may spread pathogens into new populations. **Only acquire bees from local sources.** Under favorable conditions, and with an abundance of nest sites, mason bee populations can increase almost tenfold from year to year, but near sprayed orchards, two- to threefold increases are more common. Females tend to nest in the same area where they originally emerge in the spring (instead of flying off to seek a new nesting site) when there are three to five empty nest tubes available for each female bee.

Mason bees are susceptible to a number of parasites and diseases, which tend to increase over time, especially when the same nest materials are used repeatedly for multiple seasons. Small parasitic wasps (*Monodontomerus*), which attack the developing bees if they are left in the field during June and July, can be common parasites. Although typically very small in size, most of these wasp species can penetrate bee nests by drilling through wood or cardboard nests with their stingerlike egg-laying ovipositor and laying a series of eggs on the developing bee. Those eggs go on to hatch and the larvae feed on the host bee, eventually killing it. To reduce wasp parasitism, it is advisable to very carefully (without jostling) remove the nests from the field in summer and move them to a dry, unheated, non-air-conditioned building, such as a barn, and store them vertically with the nest entrances facing up. If wasp damage continues to be a problem even inside barns, the nests can be stored in very fine mesh nets by burying them in sand or vermiculite to prevent wasp movement around the nest tubes. Similarly, pollen mites (*Chaetodactylus*) and fungal diseases (chalkbrood) may kill developing bees (in the case of pollen mites, they feed on stored pollen, causing starvation of the host bee). For more information about pollen mites, see [crawford.tardigrade.net/bugs/BugofMonth35.html](http://crawford.tardigrade.net/bugs/BugofMonth35.html).

One challenge of mite and fungal disease management is that mason bees will use the same nests year after year if allowed, ultimately spreading reproductive mites and disease spores through an entire cluster of nest tunnels, as mites and disease spores will cling to the bodies of adult bees as they pass through contaminated nests. Because infestations can develop quickly, disease and mites can kill the majority of developing bees in contaminated nests in only a couple of seasons if not controlled. Mites themselves are very small and hard to see without magnification, but infested cells are recognizable by the fluffy remains of shed mite skins and consumed pollen debris (rather than a compact ball of yellow pollen). Diseases like chalkbrood are recognizable in nests as either soft, gray moldy bodies or as hard, brittle, white bee cadavers, depending on the stage of fungal development.

The most effective way to control mites and diseases is providing mason bees with new or sanitized nesting materials each year. This is best achieved by removing the dormant cocoons from the nesting materials during the early winter months (November to January) in an unheated area. This is easily done in bamboo or reed sections by splitting them or by unraveling the paper straw inserts in the cardboard tubes, but this is impossible with wooden blocks. Specially built wooden blocks are available, consisting of grooved boards that fit together to create a series of tunnel nests (e.g., the commercially available Binder Boards, [www.binderboard.com/Binderboards/Osmiabb.htm](http://www.binderboard.com/Binderboards/Osmiabb.htm)). Research has shown that 8 mm diameter holes are optimal for the development of both the blue orchard bee and the Japanese orchard bee. The Japanese orchard bee will preferentially nest in the 5.5 mm diameter hole blocks used

for raising alfalfa leafcutter bees, but this results in only male bees being produced and is not recommended. Once removed from the nest, healthy cocoons can be physically separated from infected cells and stored in bulk containers in a refrigerator until orchard crops are about to bloom. Research has shown best protection from pollen mites is to wash the loose cocoons in cold water in a wide mesh container to remove any pollen or mud remnants as this will also remove most mites clinging to the cocoons as well. Washing the cocoons in weak insecticide or bleach solutions to remove the mites is recommended at some sites, but is not necessary. Any nest blocks intended for reuse should be scrubbed clean of pollen and mud residue in hot water and if diseases are found, washed with a weak bleach-water solution.

Refrigerated storage is optimal for the Japanese orchard bee and the blue orchard bee during the winter months since both species require a cold period before they can emerge from their cells. Refrigerated storage will help prevent premature emergence of bees during midwinter thaws. Optimal storage conditions are roughly 36°F and 50 to 75 percent humidity (typical ranges for most kitchen refrigerators). Long-term freezing and long-term midwinter exposure to warm temperatures should be avoided for the blue orchard bee, but the Japanese orchard bee is more cold hardy and can handle temperatures well below freezing for extended periods of time. Japanese orchard bees can be stored at ambient outdoor temperatures in the mid-Atlantic until temperatures begin to increase in early March. In the spring, release of the bees into the orchard can be delayed if necessary due to cold weather or for a later blooming crop such as apple or pear; but bees should be released no later than late mid-May in most cases to reduce mortality. Natural emergence in the mid-Atlantic generally coincides with red maple or apricot bloom. To release bees in the field, the cocoons should be removed from the refrigerator and packed firmly with paper towels in a cardboard container with a few 8 to 10 mm exit holes. Having the cocoons packed tightly rather than loosely simulates the natural nests where cocoons are held in place firmly and the adult bee has leverage to chew through the tough cocoon. Loose cocoons move and do not provide this leverage and bees often exhaust themselves and die before emergence. Emergence boxes should be installed immediately next to new clean nesting materials. Male bees will typically emerge as soon as the following morning if daytime temperatures are at least 55°F. Female emergence will follow several days or weeks later depending on temperatures. Upon emergence, females will conduct an orientation flight to identify the location of the nest from which they emerged. If this orientation flight is prevented or if the nests and emergence box is moved more than a few inches after emergence, the bees will abandon the site for new nests. Do not move the nests during the spring when bees are active.

In addition to the mason bees described here, more than 500 species of other wild, solitary bees are common throughout the Mid-Atlantic region. It may be possible to encourage these bees to form aggregations in your orchard simply by providing foraging habitat and nesting sites and restricting the use of pesticides during the short period that these bees are active. In addition, providing supplemental wildflowers adjacent to the orchard throughout the growing season will increase the health and reproduction rate of both managed and wild pollinators.

### Additional information

To learn more about the management of mason bees and where to obtain these bees and/or cardboard nesting tubes, contact your county extension office or the Penn State Department of Entomology at 814-865-1896. A very good source of information on mason bee management with links to other sources of information on solitary bees is Pollinator Paradise ([www.binderboard.com/default.htm](http://www.binderboard.com/default.htm)) and the book *Managing Alternative Pollinators: A Handbook for Beekeepers, Growers, and Conservationists* ([www.sare.org/Learning-Center/Books/Managing-Alternative-Pollinators](http://www.sare.org/Learning-Center/Books/Managing-Alternative-Pollinators)).

### Pollination services: wild bees

Managed pollinators like honey bees and mason bees are important pollinators for orchards, but research has shown that wild bees also contribute significantly to fruit tree pollination. For example, a study involving a broad range of crops found that visitation by wild bees significantly improved fruit set whether or not honey bees were abundant in fields. On a per-visit basis, individual wild bees can be more effective pollinators than honey bees (see mason bee example) meaning they do not need to be as abundant as honey bees in order to provide quality pollination. Wild bees that fly in the early spring are better adapted for flying under poor weather conditions than most other bees. They visit flowers and pollinate in cool and cloudy conditions when honey bees are less active. In warm, sunny weather, wild bees often begin foraging earlier in the morning and fly later into the afternoon.

Supporting a diversity of bees has advantages over relying on a single species (such as the honey bee) to provide stable pollination. If bee diversity is high in an orchard, when populations of one or several species fluctuate seasonally due to parasites or disease, other species continue to provide stable pollination. By encouraging wild bee diversity, growers can benefit from wild bee contributions to orchard pollination. Ongoing research at Penn State has shown the foraging ranges of most wild bees other than bumble bees is limited to only about 200 yards from nesting habitat. Bumble bees fly much farther, but they are limited in early season fruit crops to only a relatively few overwintering queens that have not yet begun to reproduce workers. So far research has also shown that wild bees are still almost exclusively nesting in fencerows, woodlots, and other unmanaged habitat adjacent to orchards, but not in the orchards themselves, probably due to pesticides. Smaller Pennsylvania orchards of 10 acres surrounded by woodlots are probably close to ideal for pollination by wild bees; in these landscape situations, if pesticides are managed for pollinators, wild bees can provide most if not all the pollination requirements of an orchard. For larger blocks or for orchards surrounded by other crops with no habitat, pollinator strips of wildflowers with supplemental nesting materials should be used as “stepping stones” for bees to move in from suitable habitat nearby or honey bees can be used to fill in pollination gaps due to distance.

At least 120 species of wild native bees can be found in fruit orchards during the growing season, according to surveys conducted by Penn State, Cornell University, and the Pennsylvania Department of Agriculture. Most of these bees live solitary lives. Each female works alone to build her small nest and to provide provisions for her offspring to have plenty to eat while they grow.



Most of the bees in orchards are ground-nesting bees, digging slender tunnels underground in which they build cells for each egg and its provisions. Many prefer to nest in bare patches of well-drained soil, and some will line nest cells with a waxy substance to protect their offspring from fluctuating soil moisture levels. Mining bees (*Andrena* spp.) are important pollinators in orchards and are often out for only several weeks in the spring. Cellophane bees (*Colletes* spp.), named for the waterproof cellophane-like substance they use to coat the inside of their nests, tend to nest in aggregations. While some people express concern over aggregations of ground-nesting bees, most bees are very docile and will not sting or defend their nest sites. Sweat bees (*Lastiglossum* spp., *Halictus* spp., *Augochlorella* spp., and more) are a very diverse group; some species live solitary lives, while some nest in aggregations, and others form semi-social colonies where they live cooperatively with their sisters. They are referred to as “sweat bees” for their penchant to lap up salty sweat. Some species are a stunning bright metallic green, and others are tiny and dark.

Other bees common in orchards nest in tunnels inside wood, such as those made by boring beetles, or the bees may chew into the old growth of pithy stems to create their own tunnel. Some of these tunnel nesting bees use materials such as mud, resin, and portions of leaves or flower petals to construct their nests. Mason bees (*Osmia* spp.) are among the most valuable tunnel-nesting bees in orchards. They use mud as partitions within their tunnel nests to separate individual cells and to seal nest entrances. Many mason bees will nest readily in artificial nest blocks constructed of reeds, bamboo, or small holes drilled into hard wood. Small carpenter bees (*Ceratina* spp.) are tiny blue-green metallic bees that excavate the old growth of pithy stems of shrubs such as raspberry, sumac, wild rose, or elderberry. Large carpenter bees (*Xylocopa virginica*) create their nests by chewing directly into hard wood. Over time, an accumulation of large carpenter bee nest tunnels may create structural issues in barns, picnic tables or decks, and so large carpenter bees are often considered pests. However, they can be effective pollinators of fruit trees.

Large, fuzzy bumble bees (*Bombus* spp.) can be common visitors to flowers of tree fruits. Bumble bees are social bees that live in colonies founded by a queen. Worker bees, the daughters of the queen, help in nest building, brood-rearing, and defense of the nest. Queen bumble bees hibernate through the winter and initiate a nest in the early spring. Queens select an insulated cavity as a nest site, perhaps under clumps of bunch grass or in old rodent nest, and will forage widely to provision that nest. The queen will then remain in the nest and sit on her clump of eggs to keep them warm, similar to birds incubating their eggs. Queen bumble bees are usually the only individuals that are active during the period when orchards are in bloom. One single queen bumble bee can be worth several hundred individual bumble bees over time, as a colony will grow in size through the spring and summer. In the fall, a new queen will be reared and the rest of the colony will die off when winter arrives.

### Habitat for wild bees

Research indicates that habitat near or on farms is the key to sustaining pollinators. Unlike honey bees, which can be moved around in hives, wild bees are fixed in the landscape and they need forage sources when the main crop is not in bloom. Many different species visit tree fruit flowers, but their flight/nesting

periods extend significantly beyond the bloom time of the crop (Figure 1-6). Flight periods of various bee groups extend before and after the bloom time of tree fruit crops. If no other flowering plants are near the orchard, the crop alone will not provide enough resources to support wild bee populations or boost the health of managed bees. If apple trees are the only blooming plants in the landscape, when apples are blooming, resources are plentiful, but bees go hungry before or after apple bloom. Protect semi- or natural habitat such as woodlots, hedgerows, or field borders present on or adjacent to a farm. Supporting pollinators in orchards is a win-win situation. When habitat for pollinators is protected in or near orchards, wild bee populations are conserved, growers can benefit from their fruit pollination, and the habitat also supports populations of other beneficial insects, including those that prey on or parasitize orchard pests.

Bees have two basic habitat needs: a diversity of flowering plants, and nesting sites. Additionally, there are a number of farm practices that can be adjusted to reduce bee mortality. The following are simple farm strategies for pollinator conservation.

1. Plant flowers. Many native wildflowers will attract wild bees as well as managed bees, including milkweeds, wild hyssop, purple coneflower, bee balm, cup plant, prairie clovers, and New England aster. Planting wildflowers with overlapping bloom times will support pollinators from spring through fall (Figure 1-7). Moisture-loving wildflowers like blazing star, boneset, or goldenrods can be planted in ditches or filter strips. Native flowering trees and shrubs such as willows, New Jersey tea, hawthorn, serviceberry, and spirea are also broadly attractive to pollinators and provide important early spring resources when little else is blooming in the landscape (Figure 1-8). Nonnative and noninvasive annuals such as cosmos, buckwheat, and lacy phacelia attract bees and other beneficial insects and can be great options for a low-cost insectary field borders. Clovers or siberian squill can be planted in the understory of orchards. Use space creatively since even small plantings may be beneficial to pollinators.

Wild bees	March	April	May	June	July	Aug.	Sept.	Oct.
Cellophane bees								
Mining bees								
Mason bees								
Dark sweat bees								
Metallic sweat bees								
Bumble bees								
Large carpenter bees								
Small carpenter bees								

Figure 1-6. Phenology of tree fruit bloom time and wild bee flight periods

<b>Wildflowers</b>	<b>April</b>	<b>May</b>	<b>June</b>	<b>July</b>	<b>Aug.</b>	<b>Sept.</b>	<b>Oct.</b>
Golden Alexanders <i>Zizia aurea</i>							
Blue False Indigo <i>Baptisia australis</i>							
White Beardtongue <i>Penstemon digitalis</i>							
Wild Bergamot <i>Monarda fistulosa</i>							
Mountain Mint <i>Pycnanthemum virginianum</i>							
Swamp Milkweed <i>Asclepias incarnata</i>							
Marsh Blazing Star <i>Liatris spicata</i>							
Spotted Joe Pye Weed <i>Eupatoriadelphus</i>							
Wingstem <i>Verbesina alternifolia</i>							
New York Ironweed <i>Vernonia noveboracensis</i>							
Sneezeweed <i>Helenium autumnale</i>							
New England Aster <i>Symphotrichum novae-angliae</i>							

**Figure 1-7.** Example of meadow wildflowers valuable to bees. Plantings for bees should include a number of wildflowers with overlapping bloom times.

- Provide shelter. In addition to requiring floral resources, pollinators need shelter (see “nesting habitat needs” table on the next page). Many ground-nesting bees prefer to locate their nests in well-drained soil, often in small patches of exposed ground in sunny locations. Minimize deep soil tillage and the use of plastic mulch, as these can prevent bees from nesting in the ground. Leave snags or brush piles, along with undisturbed tall grassy areas, to provide nesting sites for tunnel-nesting bees as well as bumble bees. Hedgerows, shelterbelts, and windbreaks containing native flowering trees and shrubs can offer multiple farm benefits. While helping to reduce erosion and provide screening, they also provide nesting habitat for bees as well as food. Nest habitat for mason bees can be supplemented by placing small wooden nesting blocks with drilled holes or small bundles of bamboo tubes throughout the farm (see above section for more information about creating and maintaining artificial nest blocks).
- Minimize pesticide use. Many insecticides and fungicides can be a general danger and harmful to managed honey bees, but they can have more serious impacts on wild bees, particularly solitary bees that are solely responsible for founding a nest and providing for offspring. Wild bees reproduce more

<b>Shrubs</b>	<b>March</b>	<b>April</b>	<b>May</b>	<b>June</b>	<b>July</b>	<b>Aug.</b>
Pussy Willow <i>Salix discolor</i>						
Red Maple <i>Acer rubrum</i>						
Fragrant Sumac <i>Rhus aromatica</i>						
Black Chokeberry <i>Photinia melanocarpa</i>						
Serviceberry <i>Amelanchier stolonifera</i>						
Sandcherry <i>Prunus pumila</i>						
New Jersey Tea <i>Ceanothis americanus</i>						
Devil's Walking Stick <i>Aralia spinosa</i>						
Steeplebush <i>Spirea tomentosa</i>						
Swamp Rose <i>Rosa palustris</i>						
Sweetpepperbush <i>Clethra alnifolia</i>						
Buttonbush <i>Capalanthus occidentalis</i>						

**Figure 1-8.** Example of trees and shrubs that are valuable to bees. Plantings for bees should include a number of trees or shrubs with overlapping bloom times.

slowly than honey bees and may have more (or in some cases, less) severe responses to pesticide exposure. In addition, while honey bees can be moved out of the orchard after bloom, wild bees living in or near orchards can be exposed to pesticides throughout the season. Avoid use of highly toxic pesticides that are dangerous to bees when possible and do not use them on blooming plants or near areas of pollinator habitat. Reduce direct exposure to bees by spraying in the evening (soon after dark) when pollinators are less active, and reduce drift by calibrating spray equipment. Alternatives to insecticides, such as kaolin clay pest barriers (like the product Surround), fruit bags, pheromone traps for specific pests, or crop rotation and diversity, can help reduce pest outbreaks. Integrate different approaches for pest management, such as cultural and biological controls, to keep insect pests and diseases below economic levels. Reducing the use of insecticides will likewise benefit predatory and parasitic

insects that can help reduce crop pests. Keep in mind that bees are present in orchards before and after bloom and may even nest within orchard rows.

### Technical and financial support for pollinator conservation

To help farmers create pollinator habitat, the USDA Natural Resources Conservation Service (NRCS) now offers technical and financial assistance for conservation practices such as establishing wildflower meadows, field borders, or hedgerow plantings. Programs such as the Environmental Quality Incentives Program (EQIP) and the Conservation Stewardship Program (CSP), among others, offer various opportunities to help growers meet conservation goals. Additional information about these and other programs, as well as contact information for NRCS offices, is available at [nrcs.usda.gov](http://nrcs.usda.gov).

### Additional information

The Xerces Society maintains an online database of pollinator conservation information, including publications from USDA and extension programs, and downloadable Xerces publications, such as *Farming for Bees*, through the Pollinator Conservation Resource Center ([www.xerces.org/pollinator-resource-center](http://www.xerces.org/pollinator-resource-center)).

*Attracting Native Pollinators* (available from [www.xerces.org](http://www.xerces.org) and elsewhere) provides extensive background information and an identification guide to common native bees of North America along with chapters on native bee nest construction and habitat restoration.

*Wild Pollinators of Eastern Apple Orchards and How to Conserve Them* is available from [www.northeastipm.org](http://www.northeastipm.org) as a PDF free or in hard copy for purchase.

The Integrated Crop Pollination Project has resources available on crop pollination and wildflower enhancements for pollinators (available at [www.projecticp.org/tools-for-growers](http://www.projecticp.org/tools-for-growers)).

Pennsylvania Pollinator Protection Plan (P4): Best Practices for Forage and Habitat is available at [ento.psu.edu/pollinators/publications/p4-best-practices-for-forage-and-habitat](http://ento.psu.edu/pollinators/publications/p4-best-practices-for-forage-and-habitat).

### Nesting habitat needs of wild bees and nest habitat supplementation techniques.

Bee group	Nesting sites	Nest habitat supplementation techniques
<i>Ground-nesting bees</i>		
Cellophane bees Dark sweat bees Metallic sweat bees Mining bees	Exposed patches of well-drained soils protected from compaction or tilling	Nesting sites are difficult to re-create, so protect existing nest sites and maintain patches of nonerodible bare ground; reduce tillage when possible
<i>Tunnel-nesting bees</i>		
Mason bees Large carpenter bees Small carpenter bees	Snags and stumps with beetle borings, hollow plant stems, pithy stems	Maintain snags, brush piles; plant shrubs with pithy stems (e.g., cane berries, rose bushes, sumac)
<i>Cavity-nesting bees</i>		
Bumble bees	Insulated cavities above or below ground, such as old rodent burrows or under grass thatch	Leave some tall, grassy areas unmown, leave brush piles

**Table 1-10. Sources of nitrogen, nitrogen content, and application rates.**

Nitrogen source	Nitrogen content	Actual amount of material to apply per tree
Urea	46%	0.04 lb or 0.7 oz or 20 g
Ammonium sulfate	21%	0.09 lb or 1.5 oz or 43 g
Monammonium phosphate	11%	0.18 lb or 2.9 oz or 83 g
Diammonium phosphate	18%	0.11 lb or 1.8 oz or 50 g
Calcium nitrate	15.5%	0.13 lb or 2.1 oz or 59 g
Sodium nitrate	16%	0.125 lb or 2.0 oz or 57 g
19-19-19	19%	0.10 lb or 1.7 oz or 48 g
10-10-10	10%	0.20 lb or 3.2 oz or 91 g
5-5-5	5%	0.40 lb or 6.4 oz or 182 g

### Fertilizing Newly Planted Apple Trees

Newly planted apple trees require special attention where nitrogenous fertilizers are concerned. Lack of application, improper placement, or high rates can seriously damage young trees. Incorporating fertilizer into the hole at planting is not recommended because this practice can kill trees by burning young roots. Failure to apply nitrogen after planting can result in less-than-ideal growth. The rule of thumb when fertilizing newly planted trees is to apply 0.02 pound of actual nitrogen three times in May, June, and July of the first year. In subsequent years, apply 0.02 pound of actual nitrogen per year/age of the orchard up until 0.2 pound. After this period, nitrogen application should be based on leaf analysis results and shoot growth. Any phosphorus or potassium as recommended by a soil test should have been applied to the field before planting and incorporated.

Follow the suggestions below for newly planted apple trees:

- Apply all fertilizer on undisturbed soil and keep the material 12 inches away from any disturbed soil (for trees planted by either auger or tree planter).
- If the nitrogen source is not critical, use whatever material is cheapest per unit of nitrogen. Some growers have been utilizing ammonium sulfate, which has a lower level of actual nitrogen at 21 percent. The sulfate component in this fertilizer can lead to acidification of the soil and should be used sparingly. Table 1-10 lists the amounts of various nitrogen sources to be applied per tree to achieve the required 0.02 pound of actual nitrogen per year. If you use a source other than those listed, calculate the amount of material needed in the following fashion. First, multiply 0.02 by 1 (for a result in pounds per tree); or by 16 (for ounces per tree); or by 454 (for grams per tree). Divide the result by the decimal equivalent of the percentage of nitrogen in the material.
- Example: You have a material with a nitrogen content of 46 percent. You wish to find out how many ounces to apply per tree before the beginning of the second growing season.
 
$$0.02 \times 16 \text{ oz} = 0.32 \text{ oz}$$

$$0.32 \text{ oz} / 0.46 = 0.7 \text{ oz}$$

$$0.7 \text{ oz} \times 2 \text{ years} = 1.4 \text{ oz per tree at the beginning of the second year}$$

### Cork Spot and Bitter Pit Fruit Disorders

Cork spot and bitter pit, along with other calcium-deficiency physiological disorders such as lenticel breakdown and senescent

breakdown, cause significant economic losses. These disorders are related to low levels of calcium and sometimes high levels of nitrogen, potassium, and/or magnesium in the fruit flesh. Fruit flesh calcium content is influenced by many factors. Good horticultural management techniques that improve soil conditions, encourage uniform annual cropping, and encourage moderate tree vigor will decrease calcium-related fruit disorders.

Corking, characterized by spherical dead areas in the flesh, is an orchard disorder, while bitter pit generally occurs just prior to harvest or following storage and usually attacks the skin and adjacent cells. Symptoms vary according to area, variety, and environmental conditions, making this distinction less than clear cut.

While corking is worse under conditions of low calcium, lack of calcium does not appear to be the sole cause. Corking is also influenced by excessive tree vigor or moisture stress and has been most severe on Delicious and York Imperial. Bitter pit is worse on Honeycrisp and Golden Delicious and is aggravated by low crop loads and early harvest.

During the past 20 years much research has been conducted on calcium nutrition of apples in South Africa, Australia, New Zealand, England, and the United States. From this research, as well as research conducted in Pennsylvania, a comprehensive program is recommended to reduce corking and bitter pit.

A program to control bitter pit and corking should involve almost all cultural practices conducted in apple production, since no one practice guarantees control of the disorder below the economic injury level. An effective program should be based on the consideration of all five factors explained below, since in any specific orchard block one factor could be primarily responsible for the problem. Growers are urged to use these recommendations when the cost of control practices is less than losses from the disorders.

The five points in the program are listed as a person should think of them in the life of an orchard and not in order of effectiveness. Calcium chloride sprays, though listed last, offer many advantages over other parts of the program mainly because they can be started in June the year of harvest, while some of the other practices take years to accomplish.

### Soil conditions

Poor soil conditions can contribute to low-calcium fruit; factors to consider are explained in Table 1-11. Water stress caused by either excessive or deficient soil moisture can contribute to increases in corking and bitter pit. Tiling to remove excessive moisture and irrigation to supply supplemental water should be practiced as appropriate.

Correcting low soil pH with agricultural limestone is recommended to reduce the availability of soil aluminum and manganese, thereby maximizing the size of the root system. The magnesium content of the lime should be regulated by the tree's requirement for magnesium and the total amount of lime needed. High-magnesium (dolomitic) lime should not be used for routine soil pH correction. High-magnesium lime should be used when a soil test indicates the need for lime and a leaf analysis indicates the need for a large amount of magnesium.

### Balanced nutrition

Soil testing to check soil pH and leaf analysis to determine the plant's uptake of essential nutrients are necessary in managing an orchard fertilization program. Listed in Table 1-12 are the

nutritional elements that need to be managed to produce high-calcium fruit, their modes of action, and grower actions. Avoid excessive levels of nitrogen, potassium, and magnesium and deficient levels of calcium, boron, and zinc, since these conditions may contribute to deficient fruit-calcium levels. Ratios of some elements may be indicators of potential corking and bitter pit problems. High N/Ca, K/Ca, Mg/Ca, and (N+K+Mg)/Ca ratio in fruit peel and/or leaf samples may indicate a propensity for corking and bitter pit to show up in storage.

Although soil testing and leaf analysis are not practiced by all growers, they are universally recognized as the best methods on which to base a sensible nutritional program. These two tools will minimize wasted money on unnecessary fertilizer, prevent the application of nutrient elements already present in adequate or excessive amounts, and recommend application of only those fertilizer elements necessary to ensure a profit for the grower.

### Gypsum/calcium sulfate

The use of gypsum (calcium sulfate), also called landplaster, to correct poor soil structure is a reasonably old practice. Gypsum can improve soil structure by increasing the aggregation of several small soil particles into larger particles. This can result in faster rates of water infiltration. Gypsum also is used as a source of calcium for soil applications on some crops. Peanuts in the southeastern U.S. are routinely sidedressed with about 1,000 pounds of gypsum annually. The use of gypsum to improve the calcium status of apple trees and fruits has been investigated in only two North American sites.

In Massachusetts, a series of studies has been conducted on Delicious and Cortland apple trees. In general, it appears that it takes two to three years for results to appear in the fruit. The treatments raised leaf and fruit calcium levels (20 percent and 10 percent, respectively), depressed leaf and fruit magnesium levels (20 percent and 5 percent, respectively), but had no effect on leaf and fruit potassium levels. Little or no effect was seen on fruit firmness at harvest or after storage, but bitter pit (50 percent reduction) and senescent breakdown after storage were reduced. Although high rates were used in early studies, in later studies it appeared that annual rates of as low as 3 to 4 tons per treated acre per year were effective. In a Nova Scotia study, annual applications of 5 tons per treated acre, for five years, raised leaf and fruit calcium levels in years two through seven of the study but lowered magnesium levels.

For growers who have persistent calcium problems and who feel adventurous, the following treatment regime is suggested on an experimental basis. Apply 3 tons per treated acre, banded under the trees. Follow a strict soil and leaf analysis program on an every-other-year basis to avoid nutritional problems. Special attention should be paid to magnesium, as gypsum may depress magnesium uptake.

Gypsum comes in various grades based largely on its color, with white grades being more expensive. For this use, the only relevant characteristic is the percentage of calcium in the product. *The use of gypsum will not reduce the grower's need for lime.*

### Moderate tree vigor

Since the vegetative portions of a tree have relatively high concentrations of calcium and are seldom deficient in it, excessive tree vigor can use calcium that otherwise might be available for the fruit. Table 1-13 contains a list of factors that need to be considered to promote moderate vegetative vigor in apple trees. Excessive prun-

**Table 1-11. Poor soil conditions that may result in low-calcium fruit disorders, their modes of action, and corrective measures.**

MODES OF ACTION	CORRECTIVE MEASURES
<b>Excessive soil moisture</b> 1. Water stress in trees owing to lack of air for roots. 2. Restricted root system caused by poor root growth.	1. Plant orchards on deep, well-drained soils with good water-holding capacity. 2. Install drainage tile.
<b>Deficient soil moisture</b> 1. Water stress in trees caused by deficient soil moisture. 2. Restricted root system owing to poor root growth.	1. Plant orchards on deep, well-drained soils with good water-holding capacity. 2. Irrigate as needed to reduce water stress.
<b>Low soil pH</b> 1. Restricted root growth caused by aluminum and manganese toxicity. 2. Deficient soil calcium. 3. Deficient soil magnesium.	Maintain soil pH between 6.0 and 6.5 with high-calcium lime. Avoid the use of magnesium in lime applications unless called for in a leaf analysis test. Use high-magnesium (dolomitic) lime only in proven cases where leaf analysis indicates magnesium is very low. Dolomitic lime should probably be thought of as a potent magnesium fertilizer and a liming agent.

**Table 1-12. Nutritional imbalances that may interfere with production of high-calcium apples, their modes of action, and corrective measures.**

MODES OF ACTION	CORRECTIVE MEASURES
<b>Excessive nitrogen (N)</b> 1. The flesh of fruit from high N trees is more likely to have corking (direct effect). 2. High N trees normally are overly vigorous, resulting in Ca being preferentially directed to shoot growth and not to the fruit (indirect effect).	Regulate the N status of trees with the aid of leaf analysis and field observations. Keep other nutrients in balance so the desired vigor level can be attained with minimal N levels.
<b>Excessive potassium (K)</b> 1. Some calcium deficiency disorders appear to be related to high levels of K as well as low calcium. 2. Direct cation competition between K and calcium in soil and at the root surface.	1. Regulate the K status of trees with the aid of leaf analysis. 2. Do not apply K unless it's definitely needed.
<b>Excessive magnesium (Mg)</b> 1. Some calcium deficiency disorders appear to be related to high levels of Mg as well as low calcium. 2. Direct cation competition between Mg and calcium in soil and at the root surface.	1. Regulate the Mg status of trees with the aid of leaf analysis. 2. Do not apply Mg unless it's definitely needed. 3. Do not correct low soil pH with high magnesium (dolomitic) lime.
<b>Deficient calcium (Ca)</b> Many physiological disorders of apples are directly related to low fruit flesh Ca levels although low Ca may not be the direct cause.	1. Maintain a soil pH of 6.0 to 6.5 with high-calcium lime. 2. Use high-magnesium (dolomitic) lime only in cases with a proven need for large quantities of magnesium. 3. Apply Ca sprays. 4. Use all other parts of the program to increase fruit Ca levels.
<b>Deficient boron (B)</b> 1. B deficiency can directly cause fruit flesh deformities. 2. Some B deficiencies appear to increase corking. 3. Some B deficiencies appear to interfere with normal translocation of calcium.	1. Regulate the B status of trees with the aid of leaf analysis. Maintain 35 to 60 ppm of leaf B. 2. Make ground applications of borax or tree sprays of boron when needed.

ing and nitrogen fertilization are often interrelated and can result in overly vigorous trees. Excessive tree vigor can also result from an inadequate fruit load. Growth regulators should be used to obtain a uniform fruit load in order to promote uniform, moderate tree vigor.

### Moderate fruit density

High levels of corking and bitter pit may be found on trees with a light crop. When trees bear a light crop of apples, the fruits are normally very large and low in calcium. They are prone to low-calcium physiological disorders. Apples on trees with an excessively large crop usually have little corking and bitter pit but seldom reach optimum size to maximize profitability. Table 1-14 contains a list of factors that need to be managed to produce annual crops of moderately sized fruit. Some factors that can affect the uniformity of cropping are frost, pollen amount and source, bee population, and weather during pollination.

A prerequisite for achieving moderate annual fruit density is the annual production of high-vigor fruit buds. An essential ingredient in this program is the effective use of growth regulators to thin excessive crops and to encourage the production of high-

vigor flower buds for the following year's crop. Many registered growth regulators are available for this purpose, including NAA, NAD, ethephon, benzyladenine, carbaryl, and oxamyl. See other sections of this guide for current recommendations in the proper use of these products.

More information can be found in these resources:

- [extension.psu.edu/apple-pgrs-factors-that-affect-performance-in-orchards](http://extension.psu.edu/apple-pgrs-factors-that-affect-performance-in-orchards)
- [extension.psu.edu/chemical-thinning-of-apples](http://extension.psu.edu/chemical-thinning-of-apples)
- [extension.psu.edu/modifying-tree-growth-and-increasing-return-bloom-in-orchards](http://extension.psu.edu/modifying-tree-growth-and-increasing-return-bloom-in-orchards)
- [extension.psu.edu/apple-preharvest-drop-control-sprays](http://extension.psu.edu/apple-preharvest-drop-control-sprays)

Bitter pit in Honeycrisp apples can be especially difficult to control. Research has shown that crop load will impact the severity of bitter pit. In Pennsylvania, moderate crop loads of five to seven fruit per square centimeter of trunk cross-sectional area reduce the incidence of bitter pit. Lower crop loads of two to four fruit tend to produce larger fruit that are more prone to exhibit

**Table 1-13. Causes of excessive vegetative growth that may compete for available calcium, their modes of action, and corrective measures.**

MODE OF ACTION	CORRECTIVE MEASURES
<b>Excessive pruning</b> Severe pruning can overinvigorate an apple tree.	<ol style="list-style-type: none"> <li>1. Reduce tree vigor so that moderate pruning can be used to maintain tree size.</li> <li>2. Maintain an annual, moderate pruning program.</li> </ol>
<b>Excessive nitrogen (N)</b> Excessive N fertilization often results in overly vigorous trees.	Maintain a nutritionally healthy tree so that a minimum level of N can be used to maintain moderate tree vigor.
<b>Inadequate spacing</b> Planting trees too close together can result in a vicious cycle of excessive vigor.	Integrate variety, rootstock, soil type, and your management intentions into pruning followed by excessive vigor.
<b>Low fruit load</b> Trees bearing a light crop normally divert growth into excessive vegetation.	Maintain a system of annual cropping to avoid excessive tree vigor.

**Table 1-14. Factors that may result in a small crop of large fruit, their modes of action, and corrective measures.**

MODE OF ACTION	CORRECTIVE MEASURES
<b>Poor fruit bud formation</b> Production of annual crops must integrate the production of a fruit crop and good numbers of fruit buds each year.	<ol style="list-style-type: none"> <li>1. Maintain moderate tree vigor and tree health to encourage production of a bud crop each and every year.</li> <li>2. Use growth regulators NAA or ethephon in mid-June sprays to encourage fruit bud formation.</li> <li>3. Thin excessive fruits to encourage annual production.</li> </ol>
<b>Insufficient desirable pollen</b> Without adequate pollen for cross-pollination, a crop cannot be produced.	<ol style="list-style-type: none"> <li>1. Plant two desirable pollen-source cultivars for the main cultivars in all blocks. Can be crabapples.</li> <li>2. Add bouquets at full bloom</li> <li>3. Plant additional pollinizers in mature orchards.</li> <li>4. Graft additional pollinizers onto trees of the main variety.</li> <li>5. Use pollen inserts in beehives.</li> </ol>
<b>Poor weather conditions</b> Cross-pollination by insects is most easily accomplished in warm sunny weather.	
<b>Not enough bees</b> Cross-pollination by insects is considered essential for fruit set. Additional bees should normally be placed in an orchard if other factors are not optimal. Encourage other pollinator species by establishing beds of plants that are attractive to native pollinators.	Under normal conditions, use one hive for each acre.
<b>Frost damage</b> <ol style="list-style-type: none"> <li>1. Eliminating or reducing the crop severely upsets any management system for annual production</li> <li>2. Crop reduction results in stimulation of vegetative growth and excessive fruit size.</li> </ol>	<ol style="list-style-type: none"> <li>1. Select frost-free sites for orchards.</li> <li>2. Use techniques such as wind machines or overhead irrigation to reduce frost damage.</li> </ol>

bitter pit under Pennsylvania conditions. The heavier crop loads, however, require the use of NAA/ethephon return bloom sprays during the growing season to maintain annual bearing capacity.

### Calcium sprays

Sprays of calcium chloride have been successful in reducing or commercially controlling corking and bitter pit, but seldom have these sprays completely eliminated the problem. Extensive research has been conducted around the world to define the products, rates, and timings that will minimize the incidence of low-calcium physiological disorders in apples. The major portion of Pennsylvania research has been conducted on Golden Delicious and York Imperial. However, recommendations developed from this research in Pennsylvania have effectively controlled corking and bitter pitting in nearly all varieties.

The effective use of calcium chloride tree sprays may be the most cost-effective, quickest cultural practice for reducing low-calcium physiological disorders in apples. We recommend applying 4 to 14 pounds of actual calcium per acre per season in six to eight cover sprays. Calcium in the form of calcium chloride is recommended because of its proven effectiveness and lower cost.

Other products that supply calcium are available. Many are recommended at rates that supply insufficient amounts of calcium. These products may be beneficial when only small amounts

of calcium are needed to correct the deficiency. To evaluate other materials effectively, growers should compare the cost per pound of actual calcium and the amount of formulation needed to achieve a rate of 4 to 14 pounds of elemental calcium per acre per season needed to control problems. See “Determining the amount of elemental calcium in a commercially formulated product.” Growers experiencing severe bitter pit on summer cultivars, especially Summer Rambo, may need to apply special calcium sprays in addition to cover sprays.

*4–5 pounds per acre per year (or 15–20 pounds calcium chloride):* This is the lowest rate that should be used. It will give some control of bitter pitting and corking, will cause no leaf burning, and will probably not enhance storage life of the fruit.

*6–8 pounds per acre per year (or 20–30 pounds calcium chloride):* This rate should give good control of preharvest physiological disorders and probably should be the standard rate where these disorders are chronic problems. It will not cause any significant leaf injury and will probably not enhance the storage life of the fruit.

*9–11 pounds per acre per year (or 30–40 pounds calcium chloride):* This rate should give excellent control of corking

and bitter pitting and should be the intermediate rate for Pennsylvania. It may somewhat enhance the storage potential of apples and should result in almost no leaf injury.

*12–14 pounds per acre per year (or 40–50 pounds calcium chloride):* This is probably the highest rate that should be used in Pennsylvania and should give outstanding control of corking and bitter pit. This rate may result in some slight burning on the edges of the leaves, but it usually does not appear until mid-September or October. This rate may enhance the storage life of the fruit. Research conducted at Virginia Tech and West Virginia University demonstrated that Honeycrisp sometimes requires the higher levels of calcium for any significant, consistent reduction in bitter pit.

### **Applying calcium chloride sprays**

*Time of application:* Include in all cover sprays. Do not pre-mix calcium chloride with Solubor in a small volume of water before adding to the tank, when both materials are to be applied together.

*Gallons per acre:* No restrictions; sprays with as little as 20 gallons per acre have been effective.

*Compatibility:* At the rates recommended, calcium chloride and/or Solubor may be mixed with spray oil (Superior 70 Sec.), with WP formulations, or with EC formulations of the more common fruit pesticides. Compatibility of materials other than calcium chloride is uncertain, and growers should either check the label for information or conduct a compatibility test in a small jar.

*Leaf injury:* Some leaf injury may occur from calcium chloride sprays following wet, cool springs or hot, dry summers.

When injury is noticed, reduce calcium chloride to one-half the rate in the next spray or delete calcium chloride from the cover sprays until one-half inch of rain has fallen.

*Equipment:* Calcium chloride can corrode some types of spray equipment. Few problems have occurred if sprayers and tractors are rinsed after use. The newer sprayers made of stainless steel, fiberglass, or various plastics that are rust resistant are desirable.

*Special considerations:* If early maturing cultivars continue to exhibit bitter pitting and storage breakdown after the standard rate of 1 to 2 pounds per acre per cover spray of calcium chloride has been applied, a higher rate should be used. Only calcium that hits the skin of the fruit can increase fruit quality. Therefore, in the standard program, 8 to 12 pounds of calcium per acre per year may be applied to Delicious, Rome Beauty, and Golden Delicious, but earlier maturing cultivars such as Honeycrisp, Lodi, and Summer Rambo may be receiving only 4 pounds of calcium per acre per year prior to harvest. Recent work in the Mid-Atlantic has shown that with Honeycrisp full season rates of up to 23.5 pounds of elemental calcium may be needed to reduce bitter pit.

In summary, many factors influence fruit calcium concentration, and since it is difficult to raise fruit calcium level, growers should use all methods possible to gain the upper hand against corking, bitter pitting, and other low-calcium-related disorders. Cultural practices involve soil and nutritional factors as well as

tree vigor and fruit crop load.

### **Determining the amount of elemental calcium in a commercially formulated product**

Follow the steps outlined below to determine the amount of calcium for products other than calcium chloride, or go to [extension.psu.edu/calcium-rate-calculator-for-determining-optimum-rate-to-minimize-bitter-pit](http://extension.psu.edu/calcium-rate-calculator-for-determining-optimum-rate-to-minimize-bitter-pit) to download a PDF titled “Calcium Rate Calculator for Determining Optimum Rate to Minimize Bitter Pit” that will automatically perform the calculations using your information. There is another interactive PDF for “Individual Product Comparisons” available at [extension.psu.edu/orchard-nutrition-calcium-rate-calculator-for-individual-product-comparison](http://extension.psu.edu/orchard-nutrition-calcium-rate-calculator-for-individual-product-comparison).

1. Look for, or determine, the percentage of elemental calcium in the product. This should be listed somewhere on the label.
2. For a liquid formulation multiply the percentage by the weight of the material per gallon. For a solid multiply the percentage by the weight of material you will add to the tank. Result equals the pounds of calcium per gallon or pound of formulated product.
3. Determine the rate of formulated material you intend to apply per acre per application. For a specific calcium product this is usually listed on the label.
4. Multiply the amount of material per acre by the number of applications to be made during the season. Result equals the amount of total product per acre per season.
5. Multiply the amount of total product per acre per season (from Step 4) by the pounds of calcium per gallon or pound of formulated product (from Step 2). Result equals the total amount of elemental calcium per acre per season.
6. Compare the result from Step 5 with our recommendation of 4 to 14 pounds of elemental calcium per acre per season.
7. Compare the season-long cost of materials. Multiply the amount of material used per season times the cost of the material.

**Example 1.** Product A sells for \$6.50 per gallon and is a liquid listed as containing 15 percent elemental calcium. The weight per gallon is 12 pounds. The label recommends 2 to 4 quarts per acre per application with eight applications suggested per season. You decide to apply 2 quarts per acre per application.

Step 1: Product contains 15% elemental calcium.

Step 2:  $12 \text{ lb} \times 0.15 = 1.8 \text{ lb}$  of elemental calcium per gal.

Step 3: You choose to apply 2 quarts (or 0.5 gal) per acre per application.

Step 4:  $0.5 \text{ gal per acre per application} \times 8 \text{ applications per season} = 4 \text{ gal of material per acre per season}$ .

Step 5:  $4 \text{ gal} \times 1.8 = 7.2 \text{ lb}$  of elemental calcium per acre per season.

Step 6: Our recommendation is 4 to 14 lb of elemental calcium per acre per season.

Step 7:  $4 \text{ gal} \times \$6.50 \text{ per gal} = \$26.00$ .

**Example 2.** Product B sells for \$1.50 per pound and is a solid powder containing 30 percent elemental calcium. The label recommends 3 to 4 pounds per acre per application with eight applications suggested per season.

Step 1: Product contains 30% elemental calcium.

Step 2:  $1 \text{ lb} \times 0.30 = 0.30 \text{ lb}$  of elemental calcium per lb of material.

Step 3: You choose to apply 3 lb of material per acre per application.

Step 4:  $3 \text{ lb per acre per application} \times 8 \text{ applications per season} = 24 \text{ lb of material per acre per season}$ .

Step 5:  $24 \text{ lb} \times 0.30 = 7.2 \text{ lb}$  of elemental calcium per acre per season.

Step 6: Our recommendation is 4 to 14 lb of elemental calcium per acre per season.

Step 7:  $24 \text{ lb} \times \$1.50 \text{ per lb} = \$36.00$ .

### Comparing costs

You wish to compare the cost per pound of elemental calcium in two products. From Products A and B above, we can determine which is cheaper.

1. Determine the pounds of elemental calcium per gallon or pound of formulated product for each product you are considering (same as in Step 2 above).
2. Determine the cost per pound of elemental calcium in each product.
3. Compare the two materials' cost.

**Example:** From Products A and B above, determine which is cheaper per pound of elemental calcium.

Step 1: Product A =  $12 \text{ lb} \times 0.15 = 1.8 \text{ lb}$  of elemental calcium  
Product B =  $1 \text{ lb} \times 0.30 = 0.30 \text{ lb}$  of elemental calcium

Step 2: Product A =  $\$6.50 \text{ per gallon} \div 1.8 \text{ lb calcium per gal of material} = \$3.61 \text{ per lb}$   
Product B =  $\$1.50 \text{ per lb} \div 0.30 \text{ lb calcium per lb of material} = \$5.00 \text{ per lb}$

Step 3: Product A costs  $\$3.61 \text{ per lb}$  of elemental calcium-  
Product B costs  $\$5.00 \text{ per lb}$  of elemental calcium

### Determining the amount of product needed to apply 14 pounds of elemental calcium

You are comparing two products to determine what rate you need to apply to achieve 14 pounds of elemental calcium per acre per season. Again use the same two materials outlined above and assume that you will be making eight applications during the season.

1. Divide the number of pounds of elemental calcium desired per season by the number of applications. Result is the pounds of elemental calcium needed per acre per application.
2. Divide the amount of elemental calcium per gallon or pound of material by the pounds of elemental calcium needed per acre per application. Result is the gallons or pounds of formulated material needed per acre per spray.

**Example:** Step 1:  $14 \text{ lb of elemental calcium per acre per season} \div 8 \text{ applications per season} = 1.75 \text{ lb}$

Step 2: Product A =  $1.75 \div 1.8 \text{ lb elemental calcium per gal} = 0.97 \text{ gal per application}$

Product B =  $1.75 \div 0.3 \text{ lb elemental calcium per lb} = 5.83 \text{ lb per application}$

Warning: The maximum labeled rate per application for

Product B is 4 pounds per acre per application. Therefore, you are exceeding recommended labeled rates by using Product B to achieve a 14-pound recommended rate.

In summary, to effectively evaluate materials other than calcium chloride, you need to compare the cost per pound of actual calcium with the amount of the formulation needed to achieve the 4 to 14 pounds of actual calcium per acre per season needed to control problems.

### Preharvest Assessment of the Potential for Bitter Pit in Honeycrisp

Bitter pit severity varies with cultivar and season, but Honeycrisp is particularly susceptible. Results from a Penn State study in commercial Honeycrisp orchards led to the development of a model for predicting bitter pit potential.

In the three-year study in six orchards, the percentage of fruit on a tree that developed bitter pit ranged from 0 to 74 percent. When the percentage of fruit with bitter pit was correlated with concentrations of various mineral nutrients measured in the fruit peel three weeks before harvest, bitter pit was negatively correlated with calcium (Ca) and consistently positively correlated with potassium (K), phosphorus (P), and ratios of magnesium to calcium (Mg/Ca), potassium to calcium (K/Ca), and nitrogen to calcium (N/Ca). Bitter pit also increased as average shoot length increased, and decreased as crop load (number of fruit per square centimeter of trunk cross-sectional area) increased. The best combination of variables for predicting bitter pit was average shoot length plus the N/Ca ratio in the fruit peel.

### Estimating average shoot length

Select 20 typical trees per block and record the length of five typical terminal shoots around the tree. For best results, select current-season shoots with moderate branch angles (avoiding strong vertical shoots or weak shoots hanging below a horizontal orientation). Sum the lengths of the five shoots from the 20 trees and divide by 100 to obtain the average shoot length for the block.

### Estimating N/Ca ratio of fruit peel

Three weeks before anticipated harvest select three typical fruit from each of the same 20 trees per block. (Shoot length measurements and collection of fruit samples can be done simultaneously if that is more practical for you.) Within a block, select fruit of similar size. Scrub the apples in tap water to remove any residues. Use a potato peeler to remove 1-centimeter-wide (about  $\frac{3}{8}$ -inch) strips of peel from around the circumference at the calyx end of the fruit (Figure 1-9). Be careful to avoid removing flesh with the peel because it is difficult to grind for analysis. If there is flesh attached to the peel, use a dull knife or spoon to scrape the flesh off the peel. Combine the peel tissue from the 60 apples and place them on a cookie sheet on parchment paper and dry in an oven at 180 degrees for several hours until dry. Submit the samples to the Penn State Agricultural Analytical Services Lab with a Standard Plant Analysis Kit (see [agsci.psu.edu/aasl/plant-analysis/plant-tissue-total-analysis](http://agsci.psu.edu/aasl/plant-analysis/plant-tissue-total-analysis)). When filling out the information form, include the average shoot length. Results sent to the person submitting the sample will be limited to values for mineral elements and there will be no interpretation. Results will also be sent to a fruit specialist, who will send the grower an interpretation.





Figure 1-9. How to sample peel tissue. The peel already on the plate shows the size of the sample needed from one apple. Peel from the second apple is being removed from the calyx end of the fruit, exercising care to not cut into the flesh.

Method A: The table below shows the percentage of fruit that may be expected to develop bitter pit from trees with varying combinations of average shoot lengths and N/Ca ratios in the fruit peel. For example, trees with a N/Ca ratio of 10 would be expected to have no bitter pit if average shoot length is less than 5 inches, but 36 percent of the fruit may develop bitter pit if average shoot length is 15 inches. If a tree has an average shoot length of 25 inches or more, we would expect 59 percent of the fruit to develop bitter pit even when the N/Ca is only 2.

N/Ca	Average shoot length (inches)		
	5	15	25
2	0	20	59
6	0	28	67
10	0	36	75
14	5	44	83
18	13	52	91
22	21	60	99

Method B: This method uses the same parameters of average shoot length and peel nutrient analysis as described above. However, the chart below allows you to interpolate for values not specifically in the table. The three lines in the chart represent average shoot length from the table. The bottom line represents a block with an average shoot length of no more than 5 inches. The middle line is for a block with average shoot lengths of 5 to 15 inches and the topline is for trees with average shoots of 15 to 25 inches. First locate the N/Ca ratio from your foliar analysis on the horizontal axis. Follow that point upward to the approximate average shoot length. At the intersection follow that point across to the left vertical column and arrive at the potential percent predicted bitter pit.

Sometimes a block of trees will contain trees with varying crop loads, or tree vigor may vary across a block. In those cases it may be preferable to submit samples from different sections of the block or from trees with light or heavy crops.

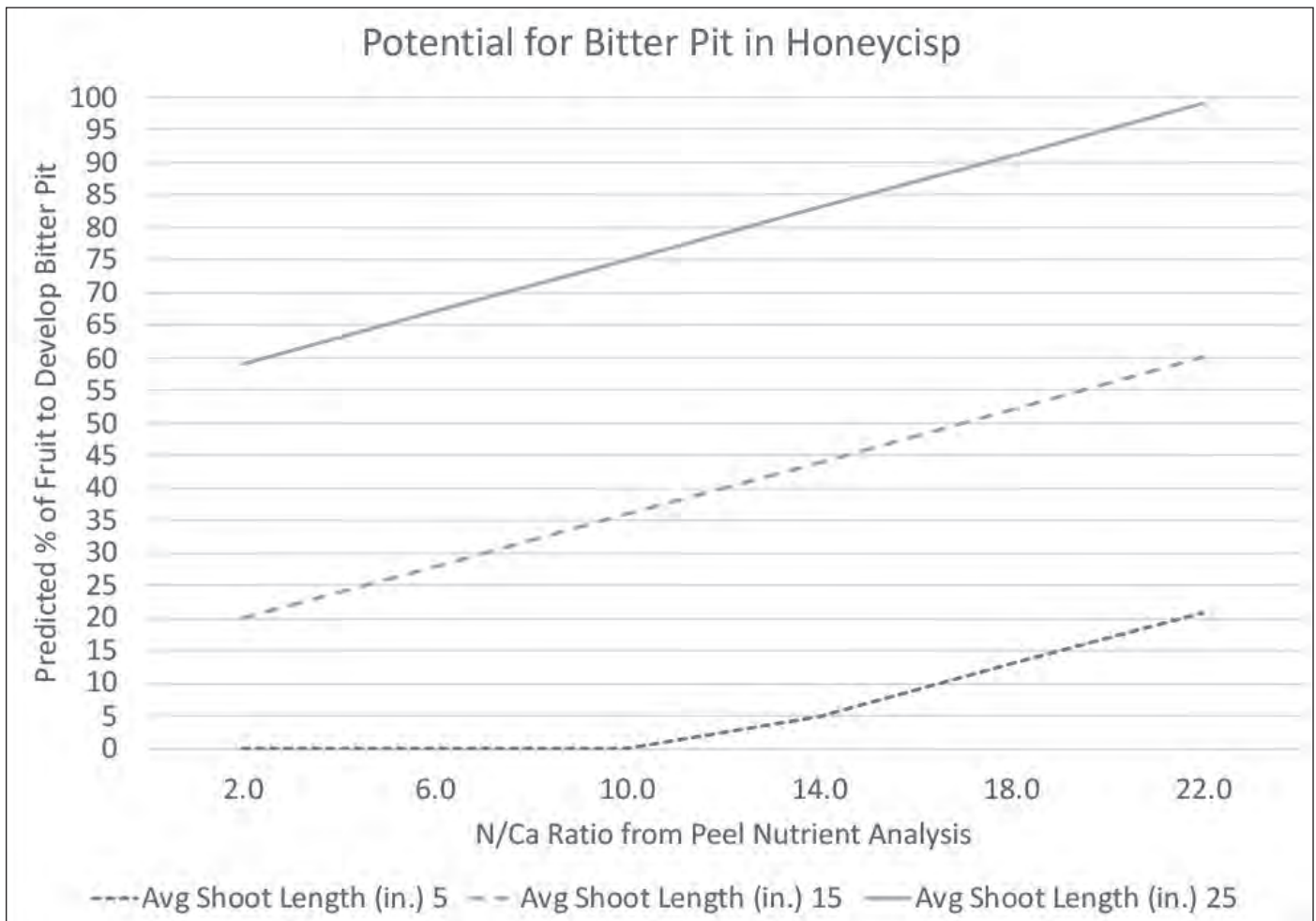

### Implications for best management of Honeycrisp in orchards

The predictive model also has implications for Honeycrisp management in the orchard. Growers have long understood the importance of a multifaceted approach for controlling calcium-related disorders in bitter-pit-prone cultivars, but in the case of Honeycrisp it has been difficult to ascertain which practices are most important relative to its high susceptibility to the disorder. The two-variable model suggests the focus should be on managing terminal shoot growth and increasing the ratio of calcium to nitrogen in the fruit.

## GROWTH REGULATORS IN APPLE AND PEAR PRODUCTION

Plant growth regulators (PGRs) are chemicals used to modify tree growth and structure, remove excess fruit, or alter fruit maturity. In order to be effective, PGRs must be applied with adequate coverage, and then be absorbed by the plant and translocated to the site of activity in sufficient concentration to give the desired response. Consequently, numerous factors affect PGR performance. Weather conditions before, during, and after application may impact their effectiveness. The environmental conditions before the application can alter leaf characteristics and affect the amount of chemical that will enter the plant. The environmental conditions (temperature and humidity) during the application and the details of the application itself (gallons of water applied, coverage, and surfactants) also can affect the amount of chemical that will enter the plant. The environmental conditions after the application can influence the responsiveness of the tree to the chemical that has entered the plant. Thus, the process of actually modifying plant growth processes is very complicated, and much research must be conducted to develop effective programs.

The amount of water in which PGRs are applied can also alter performance. In general, the more water in which PGRs are applied, the more uniform will be the response. We recommend that you determine the dilute spray gallonage requirement for your orchard blocks based on tree row volume (see the section on calculating tree row volume in Part III of this guide under “Orchard Spraying”). Although many pest control sprays are applied at 50 gallons per acre, we recommend a minimum of 100 gallons per acre for PGR application in most instances.

### Increasing Branching

Application of different growth regulator products composed of a cytokinin alone or in combination with gibberellins can be applied in the nursery, the summer after planting or to nonbearing trees to stimulate additional branches to grow on fruit trees. Exilis 9.5SC or MaxCel are proprietary products containing the cytokinin, 6-benzyladenine (6-BA). Perlan, Promalin or Typy are products containing 6-BA plus two types of gibberellins, GA4 and GA7. Regardless of the product used or timing, increased branching will only occur when applied to one-year-old wood.

Some of the products can be applied to dormant buds when mixed with latex paint. Note that not all labeled 6-BA and 6-BA + GA products are labeled for the latex paint application method for all the tree species listed. Additionally, some products are only labeled for sweet cherries. Regardless of the product used or timing, increased branching will only occur when applied to 1-year-old wood.

### Dormant applications in latex paint mixtures

The paint mixture must be applied before the buds begin to swell, but before shoots emerge. Do not apply after the buds break. Applications made after buds have broken may cause injury to tender shoot tips and fail to promote growth from that point. The application rate is 5,000 to 7,500 ppm (0.2 to 0.33 pint per pint of latex paint). Add a buffering agent or a nonionic wetting agent to the latex paint at a rate of 0.5 to 1 percent (0.1 to 0.15 ounce per pint of paint) before adding the branch inducing material. The wetting agent improves the dispersion of the product in the latex paint; it also improves wetting and absorption through the waxy layer of the bark.

Uniformly apply the BA+GA-latex paint mixture with a brush or sponge and thoroughly cover the bark surface. NOTE: Apply only to one-year-old wood (Table 1-15A). Notching the bark above the bud with a hacksaw blade prior to treatment will greatly increase efficacy of obtaining bud break on one-year-old wood.

### Foliar applications during the growing season

Foliar applications should be made when new shoot growth is approximately 1 to 3 inches long, approximately two to four weeks after bloom. Follow labeled directions for rates. Thoroughly soak the area of the tree where branching is desired. A buffering agent or nonionic wetting agent should be added to the tank before adding the chosen growth regulator product. The final spray solution should have a pH no greater than 8.

Thoroughly wet the foliage and bark of trees to be treated. Five to 10 gallons of spray mixture applied with a pressurized hand sprayer will treat 200 to 300 nonbearing trees. When using MaxCel at high concentrations for branching (up to 500 ppm), the relatively large dose of surfactant in the formulation may “pull” streptomycin residues into the tree causing the typical strep-related marginal yellowing.

To learn more about how this technique works go to [umassfruitnotes.com/v80n1/a2.pdf](https://umassfruitnotes.com/v80n1/a2.pdf) to see an article by Jon Clements from the University of Massachusetts and [www.horticulturalnews.org/94-3/a1.pdf](https://www.horticulturalnews.org/94-3/a1.pdf) for an article by Win Cowgill et al. from Rutgers University.

### Shoot Growth Suppression

Prohexadione calcium (Apogee, Kudos, Pro-Hex) is a PGR for vigor control in apples to reduce the length of shoot growth. Prohexadione calcium (PCa) is also labeled for the control or reduction of fire blight in apples. Shoot growth suppression by PCa is very consistent when the first application is properly timed and where a sufficient dosage is applied during the active growth season. PCa acts to retard shoot growth by blocking the production of gibberellic acid (GA). By decreasing the level of GA in the plant, PCa will inhibit the shoots’ ability to elongate, thereby resulting in shorter shoots. Since there is some residual GA in the plant, it usually takes about 10 days for shoot extension growth to slow. One application of PCa will last for about two to four weeks, depending on tree vigor and dosage used. Repeated applications of PCa are required to maintain growth control when conditions are favorable for further growth. PCa sprays can be suspended when seasonal shoot growth on untreated trees is completed.

It is critical that the first application be applied when the longest shoots on the trees are between 1 and 3 inches long. In most situations, this will be between late bloom and petal fall. Careful monitoring is essential to time this application.

**Table 1-15A. Growth regulators for apples and pears.**

Purpose	Trade name	Rate of commercial product/gal, product/A	Comments
<b>Growth regulators affecting fruiting capacity</b>			
Blossom thinning—apples	NovaSource Lime Sulfur Solution	6–10% used alone; 1.5–2% when tank-mixed with an approved oil.	Make two applications, one at 20–30% open bloom and one at 80–100% open bloom, or time sprays using the pollen tube growth model on NEWA.
Fruit thinning—apples	MaxCel (1.9% ai), RiteWay (1.9% ai), or Exilis 9.5 SC (9.5% ai)	Refer to label and see Table 1-15B for 6BA formulation comparisons.	One to two applications can be made per season for thinning and to increase fruit size. Apply when king fruits are 5 to 17 mm in diameter and when warm temperatures are likely to occur over a period of several days following application. Use of 6BA in combination with either Sevin or Vydate results in more effective thinning. Rates vary by product; refer to the label.
	Amid-Thin W (8.4% ai)	2.4–8 oz/100 gal (15–50 ppm)	Rates vary by cultivar. Apply at petal fall or within 5–7 days after petal fall.
	Ethephon 2, Motivate, or Verve (21.7% ai)	0.5–1 pt/100 gal (2–4 pt/A)	Apply 10–20 days after full bloom. If used for thinning may not be used for fruit loosening in fall. Especially useful for thinning larger-sized fruit. Do not treat low-vigor trees.
	Fruitone, PoMaxa, Refine	2–20 ppm (see label for rates)	Applications should be made between petal fall and 21 days past full bloom. See notes in discussion on thinning. Do not use on cultivars that ripen before McIntosh.
	Sevin XLR Plus or Sevin SL or Sevin 4F or carbaryl 4L	1–3 qt/A	Apply between 80% petal fall and 16 mm. Use lower rates on easy-to-thin cultivars and apply between 10- and 16-mm fruit size. Use higher rates on more difficult-to-thin cultivars and apply between 80% petal fall and 16-mm fruit size. Remove all bee hives from the orchard to be treated prior to spraying. Can increase mite problems. Do not exceed 6 pints per acre per application. Note: Commercial formulation already incorporates a surfactant.
	Vydate L (24% ai)	1–2 pt/100 gal or 2–4 pt/A	Apply 5 to 30 days after full bloom or at 5- to 20-mm fruit diameter. Do not add oil when applying Vydate, but a surfactant may be added. Vydate can also be tank-mixed with other thinning materials such as carbaryl or ethephon. Vydate L may increase russeting on varieties prone to russet.
Fruit thinning—pears	Amid-Thin W	1.6–8 oz/100 gal (10–50 ppm)	Rates vary by cultivar. Apply at petal fall or within 5–7 days after petal fall. Labeled for use only on Bartlett and Bosc pears.
	Fruitone L, PoMaxa, Refine	5–10 ppm (refer to label)	Response varies by variety and climatic conditions. Use lower rates when thinning easily thinned varieties such as D'Anjou. Recommended temperature range is daytime high in the 70s.
	MaxCel (1.9% ai), RiteWay (1.9% ai), Exilis 9.5SC (9.5% ai)	150–175 ppm (see label for rates)	Apply when average fruit diameter is 5–7 mm. Use sufficient volume to ensure complete coverage.
Increasing fruit set—apples and European pears	ReTain	1 pouch per acre	Apply as a single spray between pink/white bud stage and full bloom. Do not apply after petal fall.
<b>Growth regulators affecting fruit quality—apples</b>			
Improve “typyness” and/or weight of apples under conditions of an extended bloom	Perlan, Promalin, Typy (1.8% ai 6BA + 1.8% ai GA4+7)	1–2 pt/A in 50–200 gal/A or 0.5–1 pt/A	Apply when king bloom is just opening and secondary flowers are at full balloon stage. Wetting agents may improve response. Or, make two sprays as a split application, the first at the first bloom and the second applied 3–21 days later at full bloom.
Setting a partial crop following frost/freeze	Perlan, Promalin	1–2 pt/A in 50–200 gal/A	Apply when crop is in bloom within 24 hours after a freeze to set a partial crop of parthenocarpic (seedless) fruit. Parthenocarpic fruit may be misshapen and should not be expected to store well.
Increase fruit size	MaxCel, Exilis 9.5SC, Riteway	10–50 ppm	Make 2 to 4 applications starting at petal fall and continuing at 3- to 10-day intervals.
Fruit russet suppression in apples	ProVide (10% ai), Novagib (0.95% ai)	See label	Apply at beginning of petal fall, then at 7- to 10-day intervals for 3 more sprays. Do not exceed 40 oz/A/yr. Do not use a spreader sticker. If used to reduce fruit russet, then may not be used for cracking.
Reduce cracking of Stayman apples	ProVide, Novagib,	See label	Apply 3–6 times at 2- to 3-week intervals at least 2–3 weeks before fruit cracking is likely (begin in mid-June). Use wetting agent. If used to reduce fruit russet, then may not be used for cracking.

(continued)

**Table 1-15A. Growth regulators for apples and pears. (continued).**

Purpose	Trade name	Rate of commercial product/gal, product/A	Comments
Promote early skin coloration	Ethephon 2, Motivate, Verve (21.7% ai)	For McIntosh and earlier varieties, 1–4 pt/A; for later maturing varieties, 2–4 pt/A	Begin spraying 2–3 weeks before normal harvest date and about 1–2 weeks before desired harvest date. Apply as a normal dilute spray using sufficient water for thorough uniform coverage. Do not apply ethephon to more acreage than can be harvested in 1–2 days. Note: Always apply NAA 4–5 days before ethephon is applied. Ethephon promotes ripening. Red color may not improve when weather conditions are unfavorable, but fruit maturity will accelerate when ethephon is used.
Promote red skin coloration	Blush (5.2% ai), Blush 2X (10% ai)	1–2 sprays of 26 to 52 fl oz (Blush) or 13 to 52 fl oz (Blush 2X) per 100 gallons	One or two sprays, with first spray 30–42 days before harvest, and second spray 7–14 days after first. Use higher rates when coloring conditions are less favorable.
Loosen fruit	Ethephon 2, Motivate, Verve	Early varieties, 2.5 pt/A; later varieties (after McIntosh): 5 pt/A	Apply 7–14 days before normal harvest. Air temperature 60–70°F.
Reduce preharvest fruit drop	Fruitone, PoMaxa, Refine	5–20 ppm (refer to label for rates)	Apply when first sound fruits begin to drop. Do not apply within 2 days of harvest. No more than 2 applications can be made. Same restrictions and cautions as above.
Reduce preharvest fruit drop, delay harvest, manage reduce watercore	ReTain (15% ai)	1 or 2 pouches/A (50–100 g ai/A)	Apply 1–4 weeks before anticipated harvest for the current year in enough water to thoroughly and uniformly wet the fruit and foliage. Use with an organosilicone surfactant at 0.05–0.1% v/v (6.5–13 fl oz/100 gallons). ReTain should be applied under slow-drying conditions and the spray solution should be adjusted to a pH of between 6 and 8.
Increase storage life, delay loss of fruit firmness and watercore development, reduce fruit scald, maintain sugar-to-acid ratio in fruit	SmartFresh or Fysium	Rate depends on size of room	Fruit is fumigated in airtight rooms or containers no later than 2 weeks after harvest. The product comes premeasured in a proprietary generator system. The fruit must remain sealed in the room for 24 hours. At the end of the treatment time, allow 30 minutes to vent the room of the gas.
<b>Growth regulators affecting fruit quality—pears</b>			
Increase fruit size of pears	Splendor (CPPU)	16 fl oz/100 gallons	Apply 1 spray 15–25 days after petal fall.
Reduce preharvest fruit drop	Fruitone or PoMaxa or Refine	See label	Treatments become effective 3–4 days after application. Do not apply more than 2 sprays for this use.
Reduce preharvest fruit drop, delay harvest, manage fruit maturity	ReTain	1 or 2 pouches/A (50–100 g ai/A)	Apply 21–28 days before anticipated normal harvest in this season in enough water to thoroughly and uniformly wet the fruit and fruit foliage. Addition of an organosilicone surfactant such as Silwet L-77 at 0.05 to 0.1% v/v (6.5 to 13 fl oz /100 gal) is highly recommended.
Delay maturity, reduce preharvest drop, provide additional time for improved color and fruit size, maintain fruit firmness, delay starch hydrolysis, delay watercore, increase storage life	Harvista (3.8% ai)	Apple: 37.6–112.7 oz/A (1.43–4.28 oz ai/acre)	Apple: Do not apply more than 112.7 oz per A per crop. Allow a minimum of 3-day PHI.
		Pear: 9.4–37.6 oz/A (0.36–1.43 oz ai/acre)	Pear: Do not apply more than 37.6 oz per A per crop. Allow a minimum of 3-day PHI.
<b>Growth regulators affecting vegetative characteristics—apples</b>			
Shoot growth suppression	Apogee, Kudos (27.5% ai)	2–6 oz/100 gal	From 3 to 5 applications will be necessary to get season-long shoot growth suppression. The first application should be applied when the longest shoots are 1–3 inches long. Apogee /Kudos can also reduce the severity of fire blight on shoots. Applications for fire blight management can begin at pink. See Part III for a complete discussion of Apogee/Kudos.
Reduce water sprouts on limbs	Tre-Hold Sprout Inhibitor A112 (15.1% ai)	8 gal/92 gal or 10 fl oz/118 fl oz	Dormant season after pruning. Do not treat more than one-third of the limb surface. Substitute 1 qt interior water base white latex paint for an equal amount of water to reflect sun.
Reduce root suckers	Tre-Hold Sprout Inhibitor A112 (15% ai)	8 gal/92 gal	Dormant season or 4 weeks after petal fall when regrowth is 6–12 inches tall.

**Table 1-15A. Growth regulators for apples and pears (continued).**

Purpose	Trade name	Rate of commercial product/gal, product/A	Comments
Improve branching on one-year-old shoots, apples (bearing and nonbearing)	Perlan, Promalin	4–16 fl oz/5 gal of solution (125–500 ppm) or	When new growth is 1–3 inches, with a pressurized hand sprayer. Add 1–2 oz of nonionic wetting agent.
		3–5 oz/pt of latex (5,000–7,000 ppm)	Apply as a brush-on application paint in spring when terminal buds begin to swell before shoots emerge.
Improve branching on 1-year-old shoots, pears (nonbearing only)	Perlan, Promalin	0.5–2 pt/5 gal of solution (250–1,000 ppm)	When new growth is 1–3 inches, with a pressurized hand sprayer. Add 1–2 oz of nonionic wetting agent.
Increase branching of nursery stock and young trees of apple, sweet cherry, peach	MaxCel, Exilis 9.5 SC	250–500 ppm (see label)	Make 3 to 4 applications on 5- to 10-day schedule, when terminal shoots are 28 to 30 inches. May also be applied in latex (see label).
Increase flower bud development	Ethephon II, Motivate, Verve		Treat only vigorous healthy trees. On trees with fruit present some size reduction can occur.
Nonbearing trees	Ethephon II, Motivate	2–8 pt/A	Apply 2–4 weeks after full bloom on nonbearing trees.
Bearing trees	Ethephon II, Motivate, Verve, or Fruitone, PoMaxa, or Refine	0.5–3 pt/A or 2 oz/100 gal	Apply 6 weeks after full bloom on bearing trees or those just coming onto bearing. Treatments begin 6 weeks after petal fall and repeat weekly or every 2 weeks for a minimum of 3 applications.

**Table 1-15B. 6BA conversion chart for fluid ounces per 100 gallons of water.**

ppm	Maxcel/Riteway (1.9% 6BA)	Exilis Plus (2% 6BA)	Exilis 9.5 SC (9.51% 6BA)
	fl oz		
10	6.5	6.2	1.3
25	16.0	15.0	3.2
50	32.0	30.0	6.4
100	64.0	61.0	12.8
125	80.0	76.0	16.0
150	96.0	91.0	19.2
175	112.0	107.0	22.4
200	128.0	122.0	25.6

The interval between sprays can range from one to four weeks, depending on tree vigor and the dosage of PCa that had been previously applied. Subsequent applications should be made when the first few shoots show signs of regrowth. Failure to reapply PCa when conditions are still favorable for growth can result in loss of growth control.

The rate of PCa recommended for shoot growth control varies from 3 to 12 ounces per 100 gallons of dilute spray. The rate of PCa to be applied per acre should be calculated by determining the tree row volume of a block and multiplying the dilute rate by this figure.

$$\frac{\text{ounces of PCa}}{100 \text{ gallons of water}} \times \frac{\text{tree row volume (in 100s of gallons)}}{\text{acre}} = \frac{\text{ounces}}{\text{acre}}$$

The total dosage and timing of sprays will depend on the inherent vigor in an orchard. The vigor in an orchard is dependent on many factors, including fruit load, rainfall, cultivar, variety, rootstock, soil type, nutritional status, and pruning severity. Pruning is a major factor in increasing the vigor and shoot growth of trees. These factors should all be considered when selecting an application regime for a specific orchard block.

Apply PCa with sufficient water to obtain thorough coverage and use a nonionic surfactant. The sprayer must be able to deliver the spray to the parts of the tree that have excessive vigor. Conversely, if shoot growth suppression is desired in only a portion of the tree, it is possible to spray only that portion of the tree.

If calcium is present in the spray water, the water is said to be “hard” and it deactivates PCa. Therefore, when the source of spray water is hard, a proprietary water conditioner or high-grade, sprayable, ammonium sulfate should be used. The amount of conditioner to use depends on the degree of hardness. Test strips for water hardness can be obtained through swimming pool and spa suppliers.

Likewise, calcium fertilizer materials applied in the tank with PCa deactivates it. Therefore, it is recommended that a PCa application be delayed until ½ inch of rain has fallen after a spray of calcium has been applied. It is permissible to apply calcium sprays a few days after an PCa spray without a reduction in effectiveness.

PCa is labeled to decrease June drop in apples when applied at between 10 and 12 ounces per 100 gallons. This would be 30 to 36 ounces per acre for an orchard with a tree row volume of 300 gallons. However, at lower rates typically used for shoot growth control, PCa also may increase the set of apples. Avoid the use of excessive rates of PCa during the thinning window to minimize this effect. When PCa is used for shoot growth control, the aggressiveness of

the thinning program may need to be increased. This may include increasing the strength of the thinner or making an additional application of thinner, depending on the circumstances.

The quantity of PCA needed per application and the number of applications needed to reduce shoot growth in a specific apple block is dependent on the inherent vigor in a block. Listed below are some suggested rates and timings that may prove to be useful.

**Suggested rate and timing scenarios to control excessive shoot growth in apples with prohexadione calcium (rate in ounces per 100 gallons).**

Tree Vigor	1–3	+10–14	+10–14	+10–14	+10–14	Total mat./ year/100 gals of dilute spray
	inches of shoot growth					
Medium 1	3	2	2			7
Medium 2	4	3	2			9
High 1	4	3	3			10
High 2	5	4	3	3		15
V. High 1	5	4	4	3		16
V. High 2	6	4	4	3		17
Crop Loss 1	6	4	4	3	3	20
Crop Loss 2	6	6	4	4	3	23

In an orchard with a tree row volume of about 300 gallons, the following treatment regimens seemed to work well: 16, 12, and 8 ounces per acre in a pruned orchard, and 12, 10, and 6 ounces per acre in an unpruned orchard.

### Management of Fire Blight Using PCA

Apple trees are less susceptible to fire blight when sprayed with PCA for shoot growth reduction. Results obtained in Pennsylvania tests indicate that the rate of 12 ounces per 100 gallons applied in a single application when new shoot growth is 3 inches long is more than 95 percent effective in preventing shoot infection in mature semi-dwarf York Imperial trees following wound inoculation with the fire blight pathogen. Making two applications at the rate of 6 ounces per 100 gallons at seven-day intervals was 99 percent effective in preventing infection, while making three applications of 4 ounces per 100 gallons was 88 percent effective in preventing fire blight shoot infection. PCA may be applied as early as pink for fire blight control. PCA is not directly active against the fire blight bacterium (*Erwinia amylovora*) but induces resistance in the treated trees. The time required for resistance to become active in the tree following treatment is 7 to 10 days. The resistance remains active in newly developing shoots for about 21 days. On high-vigor trees that are highly susceptible to fire blight shoot infection, repeated applications are necessary until three weeks before the end of the terminal shoot growth period. Follow the growth reduction timings and rates to control fire blight using PCA.

### Increasing Return Bloom

An effective chemical thinning program is essential to obtaining adequate return bloom; however, in some years it is desirable to enhance return bloom on apple cultivars that tend to be biennial. This is especially important on trees that have a full crop load. Applications of NAA applied starting six to eight weeks after bloom will increase return bloom even on cultivars that tend to be biennial bearers. This timing is after any potential thinning from NAA has passed. Fruits that are 1 inch in diameter won't respond to NAA thinning action. Flower bud initiation has already begun but can

be enhanced by NAA treatments during the next 30 days after the thinning period ends. The rate of NAA applied per acre should be adjusted to tree row volume levels. The applications can be concentrated. These sprays can be added right to the cover sprays during that time period. Some years these treatments do not perform well, especially during drought years. Cultivars that have a moderate to high biennial bearing tendency should be considered for bloom-enhancement sprays. Fruitone L, Fruitone N, PoMaxa Refine 3.5L, or Refine 3.5WSG should be applied at the 5-ppm concentration of NAA. Multiple applications (three to four) of a low rate work better than a single application of a stronger concentration. Multiple applications should be spaced at 7 to 10 days apart.

Summer applications of ethephon can also enhance return bloom by the application of 2 to 8 pints of material per acre at two to four weeks after bloom on young nonbearing apple trees or application of 0.5 to 3 pints of material per acre at six weeks after bloom on bearing trees. However, summer ethephon can in some years thin 1-inch-diameter fruit and may also advance maturity of early maturing varieties.

Treatments during extremely hot temperatures (maximum temperatures above 85°F) should be avoided.

### Blossom Thinning of Apples

As of 2019, NovaSource™ Lime-Sulfur Solution can be used for apple crop thinning in Pennsylvania and several other eastern states. This registration extends the range of effective chemical thinning options to include bloom. Additionally, seven variety-specific pollen tube growth models are available to commercial apple growers in 2019 through the Network for Environment and Weather Applications (NEWA; [newa.cornell.edu](http://newa.cornell.edu)). These models are used to help with application timing of lime sulfur thinning programs.

Lime sulfur thins flowers by inhibiting pollen germination and pollen tube growth, preventing fertilization of the flower. Unlike other pollinicides, LS has about 24 hours of kick-back after the pollen grain germinates. This post-germination activity extends the time for making an effective thinning spray. LS is also a photosynthetic inhibitor. A temporary reduction of apple leaf photosynthesis can also contribute to thinning by causing a brief period of carbon stress. Spray oil can be added to LS to enhance its penetration and boost its efficacy.

Application of LS as a blossom thinner targets the pistil of unfertilized flowers. Thorough coverage is essential. For well-pruned dwarf and semi-dwarf trees, a spray volume 80 to 100 gallons per acre is typically used. For small trees with narrow open canopies, 50 gallons per acre may be enough, while older larger trees may require 200 gallons per acre to obtain thorough coverage. Avoid excessive spray volume to minimize leaf damage and fruit russeting. The action of LS is based on its concentration, not on the rate per acre. Do not concentrate the chemicals when spraying at lower volume.

LS is applied at 6 to 10 percent (v/v) when used alone. When mixed with oil, use LS at 1.5 to 2 percent (v/v). Oil options include fish oil at 2 percent (v/v), dormant petroleum oil at 1 percent, or summer oil at 1 to 1.5 percent v/v. Trials in the Mid-Atlantic indicate that an oil + LS combination is more effective than LS alone.

Two LS applications during bloom are suggested if possible. If weather conditions are not conducive to a second application or less aggressive blossom thinning is desired, a solitary appli-

cation would still be of benefit in multistep thinning programs (nibble approach). In years of a protracted bloom period, a third application is possible. Do not make more than three applications of LS for blossom thinning per season.

NovaSource™ LS has an REI of 48 hours. Refer to the label for a list of PPE for pesticide handlers, applicators, and early reentry. Note that LS is hazardous to eyes, so spray applicators and other handlers must wear goggles or a face shield.

### Postbloom Chemical Thinning of Apples

Chemical thinning applications are probably the most important sprays in a season. Small fruit do not have a strong market and the effects of less return bloom following a heavy crop can affect overall profitability.

Current thinking suggests that the susceptibility of fruit to chemical thinners is affected by the carbohydrate status of the tree. When carbohydrates are in abundance it is more difficult to thin. Conditions such as cloudy weather and high nighttime temperatures, adversely affect the carbohydrate reserves, and make trees easier to thin.

Weather conditions during the two days before and the four days after the application of the growth regulator thinners (NAA, NAD, 6BA) can have a major impact on the efficacy of a thinner application. If faced with applying a thinner when weather conditions are cold because the fruit is at the ideal size, delay the application until more favorable weather is expected. This suggestion applies to the range of fruit size between 5 and 17 millimeters. Likewise, thinners applied when daytime high temperatures exceed 85°F may thin excessively, so the application should be postponed until temperatures moderate.

Along with the effects of weather, certain materials can be more effective at different fruit sizes. NAA materials and the carbamates (carbaryl and Vydate) can be effective from petal fall to fruit sizes of 17 millimeters. NAA materials, however, should not be applied to Spur Delicious fruit when the size is above 9 millimeters in diameter. Applications above 9 millimeters in diameter may result in excessive production of pygmy fruit. NAD can also stimulate the formation of pygmy fruit and should not be used on Delicious or Fuji.

### Rapid method for estimating average fruit diameter

Response to chemical thinners is influenced by several factors, but fruit size is by far the most important. Fruit that are 10 to 12 mm in diameter are most susceptible to thinners, other than ethephon. Fruit that are 23 to 28 mm in diameter are most sensitive to ethephon. Measuring many individual fruits is time consuming. Fruit diameter per block can be estimated accurately by weighing 100 fruits with stems attached. Collect 2 spurs from each of 20 trees per block. Remove the 3 largest fruit with stems attached, that appear to be growing from each spur until you have 100 fruit. If a spur has only 1 or 2 fruit that appear to be growing, then use those fruit. Place the fruits in a paper sandwich bag and record the weight in ounces or grams. To convert from ounces to grams multiply ounces by 28.4. The table below gives the fruit diameter corresponding to the weight of 100 fruits for conical (Red Delicious, Golden Delicious, and Gala) and round varieties (Fuji, York, Rome, McIntosh and Empire). The graphs also provide a similar method to determine the average fruit diameter

### Converting fruit weight to fruit diameter.

Weight of 100 fruit with stems		Average fruit diam. (mm)	
Ounces	Grams	Conical	Round
0.88	25	5.1	5.4
1.06	30	5.9	6.4
1.40	40	7.1	7.9
1.80	50	8.0	9.0
2.50	70	9.3	10.5
3.20	90	10.3	11.6
3.90	110	11.1	12.6
4.60	130	11.8	13.2
5.60	160	12.7	14.2
7.00	200	13.7	15.2
8.50	240	14.6	16.2
9.90	280	15.4	16.9
11.60	330	16.4	17.7
13.80	390	17.5	18.5
15.90	450	18.6	19.5
18.40	520	19.7	20.5
20.80	590	20.9	21.7

*Example 1:* If 100 Red Delicious fruit weigh 4.6 ounces (130 grams), then average fruit diameter is 11.8 mm.

*Example 2:* If 100 Gala fruit weigh 1.8 ounces (50 grams), then average fruit diameter is 8.0 mm.

*Example 3:* If 100 York fruit weigh 9.9 ounces (280 grams), then average fruit diameter is 16.9 mm.

*Example 4:* if 100 Fuji fruit weigh 3.9 ounces (110 grams), then average fruit diameter is 12.6 mm.

Alternatively, the two graphs below can be used to make a visual interpolation for the two different fruit shapes. Average fruit diameter is on the vertical axis while weight of 100 fruit is on the horizontal axis. Locate the approximate fruit weight on the horizontal axis follow that upward to the intersection with the line and then across to the vertical axis to arrive at the average diameter of the fruit.

Certain materials should not be mixed together on certain varieties. Do not make applications of 6BA and NAA materials to the same trees of Delicious or Fuji. The combination of these two chemistries can result in excessive formation of pygmy fruit.

### Materials for postbloom thinning of apples

#### 6BA

6BA is a cytokinin—an active fruit thinner that can also enhance cell division. Therefore, an advantage of 6BA is an increase in fruit size above that achieved by thinning alone. There are several formulations of 6BA labeled for thinning apple (e.g., 6-BA, MaxCel, RiteWay, Exilis 9.5SC), each with slightly different concentrations and different label restrictions, requiring the applicator to carefully read the label before use. 6BA is an effective thinner at a concentration of 75 to 150 ppm, and many varieties are thinned satisfactorily at about 100 ppm (see Table 1-17). Varieties, such as Fuji and spur-type Delicious, that are considered difficult to thin with NAA may

### Conical Fruit (Delicious, Golden Delicious, Gala)

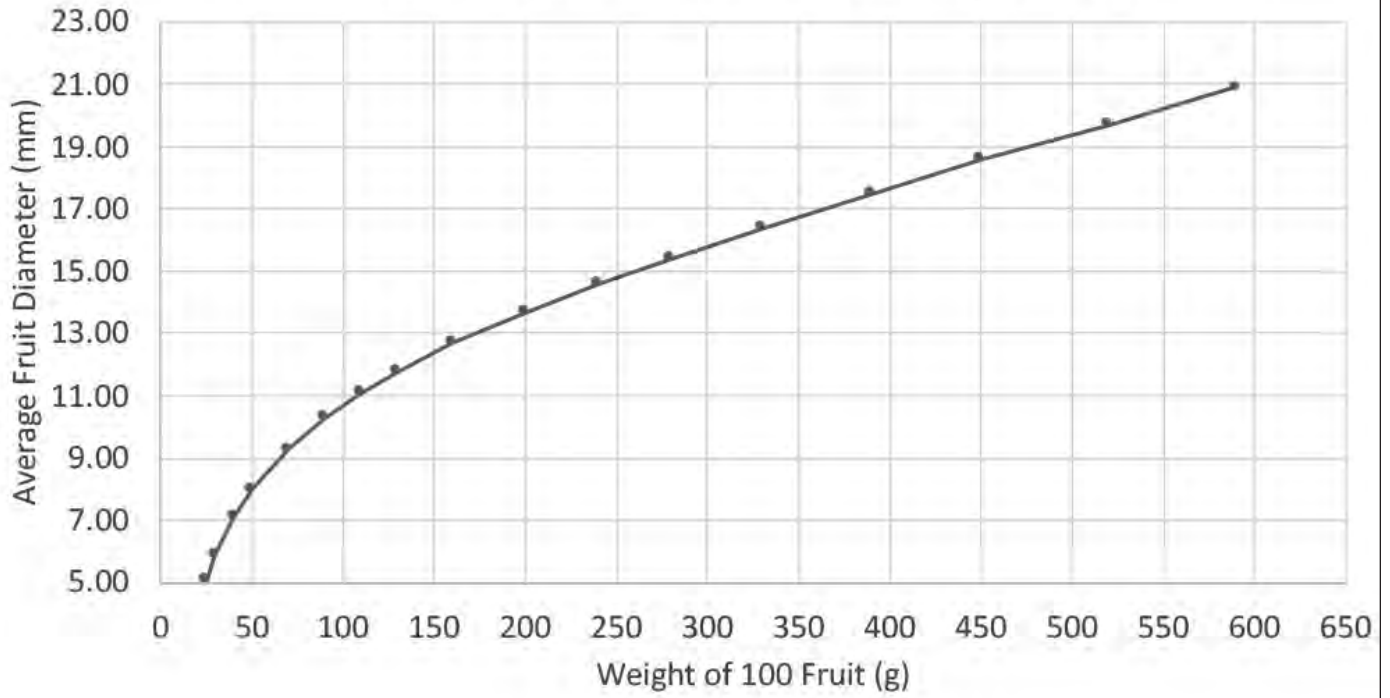

### Round Cultivars (Fuji, York, Rome, McIntosh, Empire)

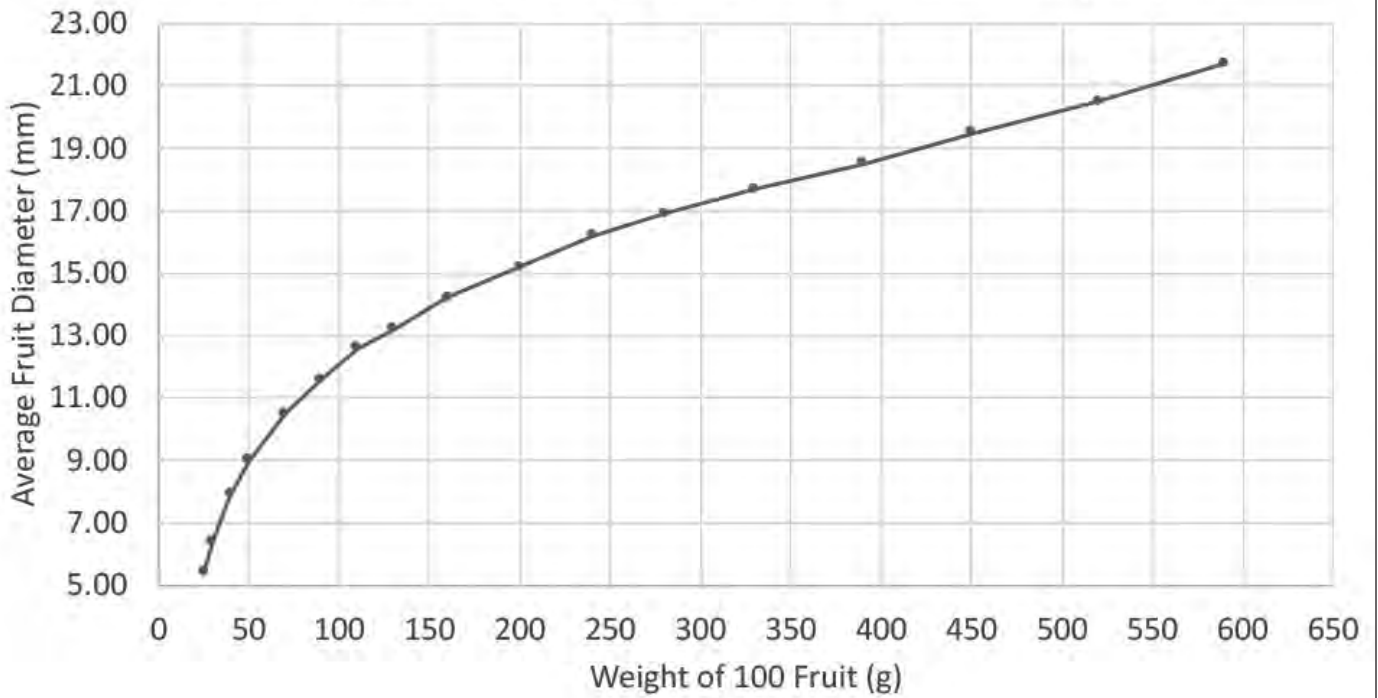



thin more easily with 6BA. Regardless of the formulation used, 6BA thins best when daytime high temperatures reach 70 to 75°F for several days during and following the application. The efficacy of 6BA is enhanced when used in combination with carbaryl or Vydate. Never mix 6BA and NAA products in the same season on Delicious or Fuji, as severe pygmy fruit may result.

### Amid-Thin W

Napthalene acetamide (NAD) is the amide salt of NAA and a relatively mild thinner. It has less hormonal activity than NAA but remains active over a longer period. Because NAD has fewer side effects on vegetative growth, it is recommended for use on sensitive early cultivars and as an early thinner at the late bloom to petal fall timing. Because NAD is a mild thinner, it is usually used either as a first step in a multiple-spray thinning strategy or tank-mixed with Sevin or Vydate at petal fall to increase the thinning response. Application in less than 100 gallons per acre of NAD has not given satisfactory thinning. Amid-Thin should not be applied to Delicious, as pygmy fruit may result. Also see Amid-Thin in Part III.

#### **Ounces (oz) of Amid-Thin W to add to a quantity of water (x) to achieve a given ppm solution**

Amount/ Amid-Thin W ppm	oz of Amid-Thin W added to specific amount of water				
	50 gal	100 gal	200 gal	300 gal	500 gal
1	0.08	0.16	0.32	0.48	0.8
10	0.8	1.6	3.2	4.8	8.0
15	1.2	2.4	4.8	7.2	12.0
20	1.6	3.2	6.4	9.6	16.0
25	2.0	4.0	8.0	12.0	20.0
30	2.4	4.8	9.6	14.4	24.0
35	2.8	5.6	11.2	16.8	28.0
40	3.2	6.4	12.8	19.2	32.0
45	3.6	7.2	14.4	21.6	36.0
50	4.4	8.0	16.0	24.0	40.0

### Ethephon

Ethephon (Ethephon 2, Motivate, Verve) is most effective as a thinner when fruits are larger than 17 millimeters in diameter, and it is especially valuable when other thinners have been used and insufficient thinning has occurred. Ethephon offers the opportunity for “rescue thinning” as it has been shown to effectively remove apples up to 24 to 27 millimeters in size. As with other PGR-based thinners, ethephon thins more when temperatures are warm (in the 70s to low 80s). Ethephon may be mixed with carbaryl and with horticultural spray oil to increase the thinning response, if needed. Golden Delicious and Rome are easily overthinned with ethephon, and the thinning response to ethephon is especially great when daytime highs reach the upper 80s. Lower rates and caution are called for in these circumstances.

Addition of a nonionic surfactant can enhance treatment effectiveness. Buffering spray solution to a pH of 3 to 5 can improve performance where water is alkaline. Use a spray volume sufficient to cover trees thoroughly and uniformly. Also see ethephon in Part III.

### NAA

Napthaleneacetic acid (NAA) has been used as a thinner for many years. Fruitone L and PoMaxa and Refine 3.5L liquid formulations and Fruitone N and Refine 3.5 WSG dry formulation are registered for use as chemical thinners for apple and pear. NAA may be applied between bloom and 17-millimeter fruit diameter, although the traditional target window for optimal response to NAA is 10- to 12-millimeter fruit diameter. When possible, apply chemical thinners such as NAA when daytime high temperatures are forecasted to be in the 70s for several days. Timing of application depends in part on the cultivar being treated. Delicious, Fuji, and Gala should be treated earlier than other cultivars. Late applications to these varieties can cause small fruit, called pygmies, to remain on the tree until harvest. Also see NAA in Part III.

### Carbaryl

Several formulations of carbaryl (carbaryl 4L, Sevin 4F, Sevin SC, and Sevin XLR Plus) are labeled for fruit thinning. The Sevin XLR Plus label indicates that it can be used for thinning fruit between 80 percent petal fall and a fruit size of 16 millimeters. Sevin is a mild thinner and is used in combination with other thinners. Some problems have been encountered with poor fruit finish under extremely humid, warm conditions, especially when oil is used as an adjuvant.

In light of the toxicity of carbaryl to honey bees, we strongly urge you to follow the cautions listed on the label and preferentially use the XLR formulation.

Also see Sevin in Part III.

### Vydate (oxamyl)

Vydate L may be used as a thinner in Pennsylvania, New Jersey, Virginia, and West Virginia. Vydate is a carbamate like Sevin and has similar thinning properties. Work in Virginia suggests that the thinning response may be dose dependent. Since Vydate is a little less toxic to certain predators than Sevin, it may be a better choice than Sevin.

The label recommends applying one to two dilute sprays between 5 and 30 days after full bloom. This period coincides with petal fall, when fruit is approximately 5 millimeters in diameter, to when it is approximately 20 millimeters in diameter. The application rate should be 2 to 4 pints per acre, and not more than 8 pints in any one year. Vydate can be tank-mixed with ethephon, 6BA, or NAA. There is a warning about the possibility for increased russetting on russet-prone cultivars such as Golden Delicious or Stayman. A surfactant such as Regulaid, LI 700 or Tween 20 can be used to increase the effectiveness of Vydate. Do not apply oil with Vydate, as russetting can be increased. Also see Vydate in Part III.

### General Comments on Thinning

Chemical thinning increases fruit size and enhances return bloom. Many factors influence fruit thinning (examples are given in Table 1-16), and the grower will need to consider all these factors when deciding how to chemical thin. Table 1-17 provides general apple thinning guidelines to provide a starting point for these deliberations.

- Use chemical thinners only in blocks where bloom density and pollination were adequate to set an excessive crop.

- First key to making the right call on thinning: accurate assessment of initial set.
- Second key: understanding the role of light and temperature and getting an accurate weather forecast.
- Sunny weather: harder to thin. Heavy clouds for two to three days: easy to thin.
- Cool weather (below 65°F): less thinning. Hot weather (above 80°F): more thinning.
- “2X4”—The temperatures and sunlight on the two days before and the four days following thinner spray are the most crucial.
- Use fruit diameter as a centering date, but the best timing is a blend of temperature, light, and fruit diameter.
- 6BA is not very effective when the temp is below 68°F.
- Carbamates (Sevin and Vydate) still somewhat effective in suboptimal temperatures.
- NAA also has some thinning activity when temperatures are suboptimal, but this increases the chances of mummies and pygmies.
- Mummies and pygmy fruits can result from postbloom sprays of certain thinners (NAA and 6BA), and this risk rises with increasing chemical rate and with later thinning timing.
- All thinners work best when temps in the 70s, and all chemistries have the potential to overthin when temperatures are in the mid- to high 80s. There is no “safe” thinner at high temperatures.
- Adding carbaryl in a tank mix with NAA or 6BA increases thinning response. Adding oil at 1 quart per 100 gallons of finished spray mix boosts efficacy of all thinners.
- Varieties once considered chemically hard to thin (Golden Delicious, Gala, Fuji) may not be hard to thin with 6BA/carbaryl tank mix.
- For most effective thinning, no less than 100 gallons of water per acre should be used for adequate coverage, and sufficient wetting time must be allowed to permit foliage to absorb the thinner.
- Use extra caution if freezing temperatures occurred during bloom. Delay thinning until you are certain that fruits are growing. Consider reduced rates of chemical thinner in this circumstance.
- Trees less than five years old are more apt to be overthinned, so lower rates of thinners and fewer applications are warranted.
- Be sure to leave several nonsprayed trees so that you can check the results of using thinner.
- In some instances, it may be desirable to remove all fruit from the trees. In such cases, a mixture of 3 quarts of 6BA, 1 quart of carbaryl, and 1 quart of spray oil per 100 gallons of water applied at petal fall is largely effective.

**Table 1-16. Tree and weather conditions affecting fruit thinning with chemicals.**

**Trees are easy to thin under the following conditions:**

1. Bloom is heavy, especially after a heavy crop.
2. Nitrogen is low or moisture inadequate.
3. Fruit spurs are low in vigor on the shaded inside branches.
4. Root systems are weak due to injury or disease.
5. Trees are young, with many vigorous upright branches.
6. Trees are self-pollinated or poorly pollinated.
7. Fruit-set appears heavy on easily thinned cultivars such as Delicious or Ginger Gold.
8. Fruit sets in clusters rather than singles.
9. The cultivars tend to have a heavy June drop.
10. Bloom period is short with many varieties and species in bloom simultaneously.
11. High temperature is accompanied by high humidity before or after spraying.
12. Blossoms and young leaves are injured by frost before the spray application.
13. Foliage is conditioned for increased chemical absorption by prolonged cloudy periods before spraying.
14. Prolonged cloudy periods reduce photosynthesis before or after application of chemicals.
15. Rain occurs before or after spray application.

**Trees are difficult to thin under the following conditions:**

1. Insects are active in orchards of cross-pollination varieties.
2. Trees are in good vigor with 12 to 18 inches terminal growth and no mineral deficiencies.
3. Precocious trees come into fruiting with good vigor and mature bearing habit.
4. Fruits are developing on spurs in well-lighted areas of tree (tops and outer canopy).
5. Trees bear biennially.
6. Trees have horizontal or spreading fruiting branches.
7. Fruit sets in singles rather than clusters.
8. Cultivars such as Golden Delicious and the heavy-setting spur-types are to be thinned.
9. Ideal fruit growth is occurring before and after thinning.
10. Low humidity causes rapid drying of the spray, and decreased absorption occurs before and after spraying.
11. Mild, cloudy to partly cloudy periods after bloom without tree stress.
12. Bloom was light, and high leaf-to-fruit ratio occurs (with the exception of young trees).
13. Limbs and/or spurs slightly girdled from winter injury.
14. Endogenous ethylene production is low.
15. When sprays of 10 ounces or more per 100 gallons of Apogee or Kudos have been used for growth control or for fire blight control.

*Adapted from Edgerton, L. J., and M. W. Williams, “Chemical Thinning of Apples,” chapter 8 in Tree Fruit Growth Regulators and Chemical Thinning: Shortcourse Proceedings 1981, edited by R. B. Tukey and M. W. Williams (Pullman: Washington State University Coop. Ext. Service, 1981).*

**Table 1-17. Suggested apple thinning recommendations.**

Type of variety	Level of thinning needed	Application Timing		Notes	
		Rates are per 100 gallons dilute tree row volume			
		Petal fall	7- to 12-mm diameter		
Easy to thin Examples: Braeburn, Ginger Gold, Granny Smith, Idared, Pink Lady, and others	Light	—	Carbaryl, 0.5 lb		
	Moderate	—	Carbaryl, 0.5 lb, plus NAA, 2.5 ppm		
	Heavy	Carbaryl, 0.5 lb	<b>plus</b> Carbaryl, 0.5 lb, plus NAA, 5 ppm <b>OR</b> Carbaryl, 0.5 lb, plus 6BA, 75 ppm		
Moderately difficult to thin Examples: Cameo, Empire, Gala, Jonagold, Std. Rome, and others	Light	—	Carbaryl, 0.5–1 lb, plus NAA, 5–7.5 ppm	High NAA rates and later timing increase risk of pygmy fruit for Delicious, Fuji, or Gala.	
			Carbaryl, 0.5–1 lb, plus 6BA, 100 ppm	Check 6BA label; maximum rate varies by formulation.	
			Carbaryl, 1 lb, plus spray oil, 1 qt	Spray oil rate is per 100 gal finished spray mix; do not concentrate oil.	
	Moderate	Carbaryl, 0.5–1.0 lb	<b>plus</b>	Carbaryl, 0.5–1 lb, plus NAA, 5–7.5 ppm	High NAA rates and later timing increase risk of pygmy fruit for Delicious, Fuji, or Gala.
				Carbaryl, 0.5–1 lb, plus 6BA, 100 ppm	Check 6BA label; maximum rate varies by formulation. Spray oil rate is per 100 gal finished spray mix; do not concentrate oil.
				Carbaryl, 1 lb, plus spray oil, 1 qt	
Heavy	Carbaryl, 1 lb	<b>plus</b>	Carbaryl, 1, plus NAA, 7.5 ppm, plus spray oil, 1 qt	High NAA rates and later timing increase risk of pygmy fruit for Delicious, Fuji, or Gala.	
			Carbaryl, 1 lb, plus 6BA, 100 ppm, plus spray oil, 1 qt	Check 6BA label; maximum rate varies by formulation.	
Difficult to thin Examples: Fuji, Golden Delicious, Spur Delicious, Spur Rome, York Imperial, and others	Light	—	Carbaryl, 1 lb, plus NAA, 10–15 ppm	High NAA rates and later timing increase risk of pygmy fruit for Delicious, Fuji, or Gala.	
			Carbaryl, 1 lb, plus 6BA, 100–150 ppm	Check 6BA label; maximum rate varies by formulation.	
			Carbaryl, 1 lb, plus NAA, 10–15 ppm	Do not concentrate oil.	
	Moderate	Carbaryl, 1 lb; spray oil, 1 qt	<b>plus</b>	Carbaryl, 1 lb, plus 6BA, 10–15 ppm	Check 6BA label; maximum rate varies by formulation.
				Carbaryl, 1 lb, plus Ethephon, 1–1.5 pt	
Heavy	Carbaryl, 1 lb; spray oil, 1 qt	<b>plus</b>	Carbaryl, 1 lb, plus 6BA, 100–150 ppm, plus spray oil, 1 qt	Do not concentrate oil. Check 6BA label; maximum rate varies by formulation.	
			Carbaryl, 1 lb, plus Ethephon, 1–1.5 pt, plus spray oil, 1 qt	Do not concentrate oil.	

While chemical fruit thinning is not an exact science because of differences between orchard blocks, cultivars, sites, and years, nevertheless the materials are standard. For a discussion of specific materials used in thinning, please turn to Part III, Chemical Management. Materials are listed alphabetically in this section.

### Alternate bearing

Some apple cultivars have a tendency to produce a large quantity of flowers or fruit one year and a small quantity of flowers or fruit the next year. This condition is referred to as alternate or biennial bearing. The tendency for a cultivar to be biennial may have numerous causes. Frost or cold weather during the flower-

ing period can result in reduced fruit set or low pollination due to poor bee flight. Leaving too many fruit on the tree the previous year can reduce the production of flowers for the next year. Growing conditions the previous year such as high temperatures, low sunlight levels or other factors that reduce flower formation can cause trees to become biennial bearing.

There are also inherent genetic tendencies of some cultivars towards naturally producing fewer flowers. The degree of the biennial production can also vary. The table below lists certain apple cultivars and their tendency for biennial bearing. The table was created based on observations of different apple cultivars over a number of years.

**Biennial bearing tendency of some apple cultivars.**

Akane	Low
Ambrosia	Low
Autumn Crisp	Medium
Blondee	Low
Cameo	Medium
Cortland	Low
Crimson Crisp	Medium
Delicious	High
Empire	Medium
Enterprise	Medium
EverCrisp	Medium
Fortune	High
Fuji	High
Gala	Low
Ginger Gold	Low
GoldRush	Medium
Golden Delicious	High
Honeycrisp	High
Idared	High
Jonagold	Medium
Liberty	Medium
Macoun	Medium
McIntosh	Low
Melrose	High
Modi	Medium
Mutsu/Crispin	High
Pink Pearl	Medium
Pixie Crunch	Low
Pristine	Low
Sansa	Low
Shizuka	High
Suncrisp	Low
Sundance	High
Sunrise	Low
York Imperial	High

**Late thinning**

When fruit diameter reaches 18 millimeters, apples become difficult to thin with NAA and 6BA. Once the fruit reach about 24 millimeters, they begin to become unresponsive to chemical thinners. Apple fruits grow about 1 millimeter per day in warm weather, so when fruit are 18 millimeters in diameter, you have only four to six days to apply chemical thinners.

The two chemistries that still have thinning activity at this advanced stage of fruit growth are carbaryl and ethephon. Where mild thinning is all that is required, carbaryl at 1 pint to 1 quart per 100 gallons may suffice. To create a moderately strong late thinning spray, add 1 quart of spray oil per 100 gallons of finished spray mix to the 1 quart rate of carbaryl. Oil and captan cause phytotoxicity, so if you are using oil in this spray, keep captan out of the orchard for the next two cover sprays.

If a strong thinning combination is called for, then combine

**Table 1-18. A quick comparison of compounds registered as stop drops.**

Parameter	ReTain	Fruitone, Po-Maxa, or Refine	Harvista
Active ingredient	AVG	NAA	1-MCP
What is blocked	Ethylene production	Stem loosening	Ethylene action
Drop delay (approximate)	10–14 days	5–7 days	10–14 days
Fruit ripening	Slowed	Advanced	Slowed
Fruit color	Delayed	No effect	Somewhat delayed
Fruit softening	Delayed	No change or advanced	Delayed
Applied (relative to drop)	4 weeks before	Just prior to	Just prior to
Rescue option?	No	Yes	Yes
Days to “take effect”	>7	~2	~2
Split sprays helpful?	No	Yes	Not applicable
REI	12 hours	48 hours	4 hours
PHI	7 days	2 days	3 days

ethephon, at 1.5 pints per 100 gallons, with 1 quart of carbaryl and oil. One quart of horticultural spray oil can be added to this tank to boost the thinning response. Golden Delicious and Rome are sensitive to ethephon. Reduce the ethephon rate to 12 fluid ounces per 100 gallons for Rome and to 1 pint per 100 gallons for Golden Delicious.

**Apple Preharvest-Drop-Control Sprays**

As apples mature they begin to produce large amounts of the ripening hormone, ethylene. One of the ripening processes stimulated by ethylene is stem loosening. Ethylene stimulates the production of enzymes that break down the cell walls in the abscission zone of the stem, leaving the fruit connected to the tree by only the vascular strands, which are easily broken. Once this natural process is complete, susceptible varieties begin to drop. It should also be noted that enzymatic cell wall breakdown is an irreversible process. Once the fruit stems loosen, there is no way to strengthen them up!

Stop drops are plant growth regulators that interfere with the enzymatic breakdown of the cell walls in the abscission zone. Three plant growth regulators are currently registered for control of preharvest drop in apples. Harvista, naphthaleneacetic acid (NAA), and ReTain (aminoethoxyvinylglycine, or AVG) are all effective, but they are very different compounds with respect to the modes of action, optimal timing, and effect on the fruit. This section offers a brush up on stop drops—how they work and how to optimize control of preharvest drop with each of them (Table 1-18).

**Harvista**

Harvista is a 1-MCP product designed for preharvest application to apples. 1-MCP blocks the ripening effects of ethylene by binding up the ethylene receptors on the plant cell membranes, making them unresponsive to ethylene action. Treatment with Harvista slows starch disappearance, fruit softening, red color development, and preharvest drop, and can delay the onset of watercore. Because Harvista can be applied close to anticipated harvest date (to within three days prior to harvest), the desired characteristics of fruit maturity can develop normally, and treatment can be applied just before deleterious effects begin. Do not use Harvista on stressed trees. The effects of using Harvista with other stop drops has not been fully evaluated. Harvista is applied

by a proprietary in-line injector system. Contact AgroFresh for additional information.

### ReTain

The active ingredient in ReTain is aminoethoxyvinylglycine (AVG), a “look-alike” for one of the chemical precursors to ethylene. When absorbed into plant tissues, AVG binds irreversibly with a key enzyme. This prevents the ethylene precursor from binding, thus blocking the production of ethylene. Natural ripening processes are slowed, including stem loosening, fruit flesh softening, starch disappearance, and red color formation. ReTain is labeled for apples, pears, nectarines, peaches, plums, prunes, and apricots. ReTain can be applied during bloom for increasing fruit set in apple, cherry, and European pear, or applied before harvest for maturity management of apple, pear, peach, nectarine, plum, apricot, and interspecific hybrids of stone fruits such as apriums and pluots.

There are several potential harvest management benefits to slowing the fruit maturation process. Growers can spread the effective harvest window for a given variety, retaining fruit firmness and without excessive drop. Apples on unstressed healthy trees will continue to grow at the normal rate following ReTain treatment (about 1 millimeter per day). An additional week on the tree can add a quarter inch to fruit diameter. Fruit red color can be increased in cases where a delay in harvesting exposes the fruit to improved weather for coloring (warm sunny days and cool nights). The incidences of fruit disorders associated with ripening, such as water core and stem end cracking, can be reduced.

In order for AVG to be effective it must be applied well in advance of the climacteric rise in ethylene production that signals the onset of fruit maturity. The label recommends applying ReTain three to four weeks before anticipated harvest for cultivars that are normally harvested in a single picking. This has sometimes caused confusion, as the grower is timing the spray relative to some future date. ReTain should be applied four weeks before the natural climacteric rise in fruit ethylene. There is a fairly wide window when ReTain can be applied with optimal results, and a fairly easy way to determine when to apply it (Figure 1-10).

For early season varieties, such as McIntosh, start by estimating when you would normally expect to begin harvesting the variety if no ReTain or ethephon were used. Take the earliness of the season into consideration. For instance, if the bloom date and the ripening pattern of cherries, peaches, and summer apple varieties

suggest that the season is about 10 days earlier than normal, the anticipated harvest date can be adjusted accordingly. Then count back four weeks and mark the calendar from that date through the next seven days. This is your application window for that early season variety. Watch for good spray conditions and a six-hour drying time within that week and apply the material at the first opportunity. Repeat the same process for later varieties, keeping in mind that later varieties are usually less affected by seasonal variation in maturity than stone fruit or early apple varieties. It is usually unnecessary to account for seasonal variation in fruit maturity for Empire and later varieties.

There is an alternative application timing for cultivars that have multiple harvest days, such as Gala or Honeycrisp. Apply ReTain 7 to 14 days before the anticipated beginning of harvest (first pick). Application at this time usually does not delay the first harvest but will help control maturity for later harvests.

Varieties differ in the production of ethylene and consequently differ in their response to ReTain. Low ethylene producers such as Gala are strongly influenced, while ethylene production is much harder to control for high ethylene varieties such as McIntosh. Fruit maturity of Gala on dwarfing rootstocks can be slowed with 6 to 7.5 ounces (one-half to two-thirds of the pouch) of ReTain if timing and application recommendations are followed closely. Most varieties, however, require a full pouch of ReTain per acre in order to obtain satisfactory results. In 2015, the ReTain label was expanded to allow use of up to two pouches per acre either as a single spray or a split application for apple. ReTain use on pear is limited to a single pouch per spray, with up to two sprays allowed per season.

Growers who are planning to use an ethephon product (Ethephon 2, Ethrel, Motivate, Verve) to promote red fruit color should apply the full rate of ReTain at least 10 days before spraying ethephon. Research suggests ReTain used at an optimal timing can offset the deleterious effects of ethephon on fruit maturity and fruit softening. ReTain can also be combined with NAA for additional stop-drop control.

Use a 100 percent organosilicone surfactant, such as Silwet L-77 or Sylgard 309, at 12 ounces per 100 gallons. For optimum results, apply ReTain with 100 gallons of water per acre as a complete spray. Do not tank-mix ReTain with sunburn-reducing products.

Trees under stress from such things as mites, drought, and heat are less responsive to ReTain and are poor candidates for its use.

Ideally, no rain should fall for at least six hours after ReTain is

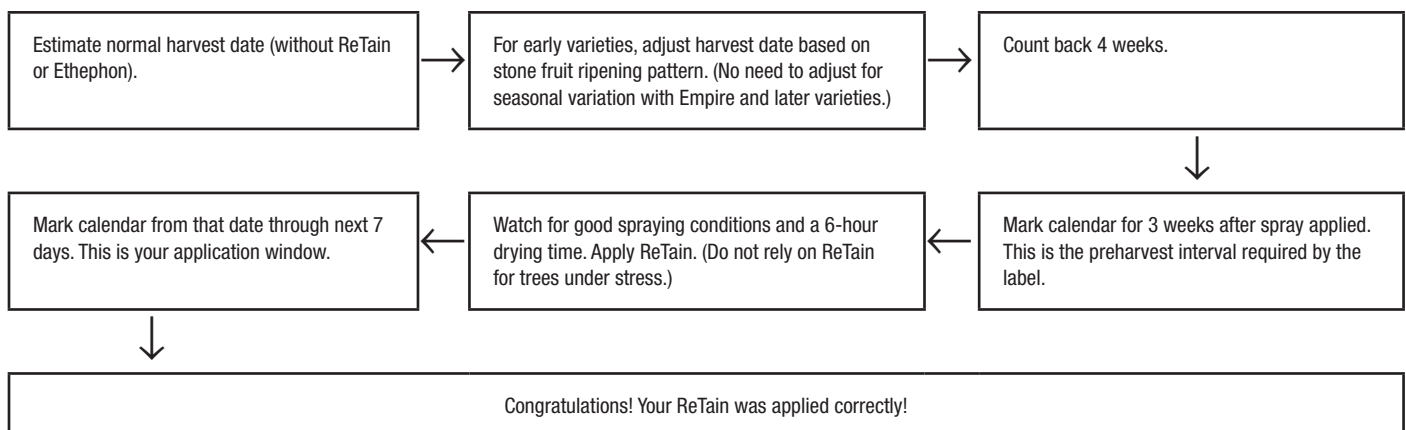

Figure 1-10. Determining application timing for ReTain to increase effective harvest window, increase fruit firmness, and reduce preharvest drop.

applied; however, if the coverage was good, the ReTain spray was applied with a full rate of Silwet, and the residue dried before it rained, you probably got most of the benefit of the spray. Monitor drop and fruit maturity to determine if a second application is warranted.

Application of ReTain under slow drying conditions is beneficial; however, spraying ReTain on wet foliage can result in a loss of performance due to the material dripping off before it can be absorbed. Postpone sprays until the foliage dries. If you must apply ReTain to damp foliage, reduce the rate of Silwet to 6 fluid ounces to reduce the sheeting action and possible runoff.

## NAA

Synthetic auxins interfere directly with the enzymes that create the abscission zone. Several formulations of the auxin NAA are labeled (Fruitone L, Frutone N, PoMaxa, Refine 3.5 WSG, Refine 3.5L).

Unlike ReTain or Harvista, fruit maturity of apples treated with NAA is not delayed. In hot weather and with high rates of NAA, fruit maturity may be accelerated. Since the optimal application time for NAA is just a few days before the onset of drop, NAA offers a “rescue” treatment, should the threat of preharvest drop be increased due to unforeseen circumstances.

A single spray of NAA can provide about seven days of drop control. Since it is less expensive than ReTain, it may be more cost effective to use NAA when only a few days of drop control are needed to conduct an orderly harvest. For example, when using ethephon to promote fruit coloring, growers may also use NAA to prevent excessive fruit drop resulting from accelerated fruit maturation. When NAA is used to control drop on ethephon-treated trees, the two may be tank-mixed if the fruit are to be harvested within seven days. If the fruit are to be left on the tree longer than seven days after the ethephon, then NAA should be applied two to three days after the ethephon.

Timing an NAA stop-drop spray requires monitoring of fruit maturity (Figure 1-11). A single spray of 10 to 20 ppm NAA can control drop for 7 to 10 days from the date of application, but it takes two or three days to “kick in.” If NAA is applied too early, then effective drop control may wear off too soon. If NAA is applied a few days too late, a significant portion of the crop may drop before it takes effect. Predictive degree-day models and the pattern of starch disappearance, as gauged by the starch index test, can provide a general indication of whether the potential for drop is earlier or later than normal, but more direct monitoring is desirable for the actual timing of the sprays.

Varieties that are susceptible to preharvest drop should be

monitored to determine when fruit drop is beginning. Limb tapping is one method that can be used to determine the onset of drop as fruit near maturity. Bump several scaffold limbs or leaders of 3 or 4 inches in diameter throughout the block on a daily basis. Use the palm of your hand with a short firm stroke, striking the limb at its mid-point. If zero to one apple per limb drops on average, it is too soon to apply NAA. If the average is about two, check again later the same day or the next morning. When several apples drop in response to limb bumping, it is time to harvest within two days or apply NAA.

A concentration of 10 ppm NAA is usually adequate for an effective stop drop. To obtain the maximum drop control, use a split application of 10 ppm in the first spray, followed by a second spray of 10 ppm five days after the first. Split applications can provide some drop control for 10 to 14 days from the date of the first application.

NAA must be applied with good coverage and plenty of water. Concentrating beyond four times (less than 75 gallons of water per acre for 300 gallon TRV trees) may diminish the effectiveness. The use of alternate row spraying is discouraged. Use of a nonionic or organosilicone surfactant is recommended to enhance uptake.

Weather conditions following the application also impact efficacy. Rewetting within one to two days of the spray application and spraying under slow drying conditions (high humidity) will increase the uptake of NAA. Temperatures in the mid-70s produce a better response than cooler temperatures, while excessively hot weather immediately following an NAA spray will likely result in accelerated fruit ripening.

When used as a stop-drop, NAA may advance ripening, especially at concentrations over 10 ppm and when applied in hot weather (>85°F). The primary impact of this advance in maturity is loss of firmness in storage.

The deleterious effects of NAA sprays on fruit maturity and fruit softening may be minimized in Delicious by making repeated applications of 5 ppm NAA at four weekly intervals prior to harvest. This “preloading” technique has been included as an application option on the Fruitone labels. NAA preloading for McIntosh and other early season, high-ethylene varieties is not recommended. Growers should use caution when trying preloading on high-ethylene-producing varieties until more is known about how different varieties will respond.

The use of NAA on trees previously treated with ReTain results in drop control that is superior to that obtained by using either product alone. Fruit treated in this manner and then left for an extended time on the tree may have limited storage potential. Half rates of ReTain

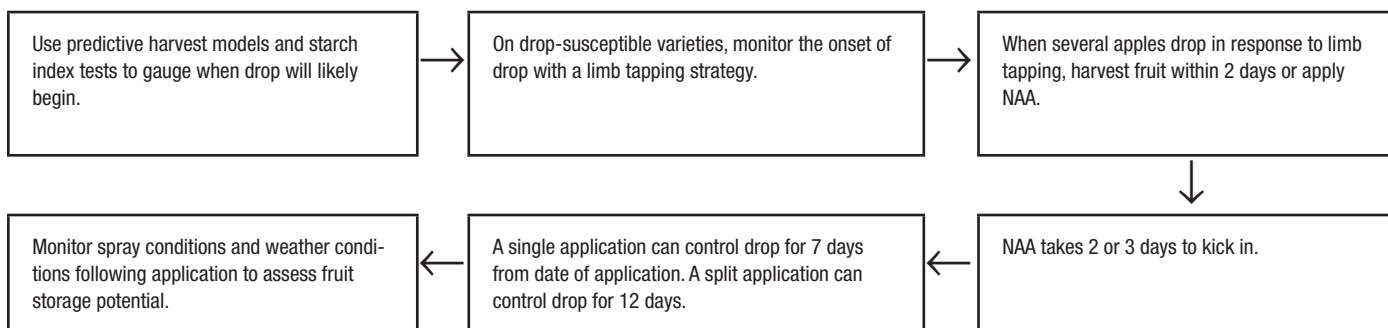

Figure 1-11. Determining application timing for NAA to extend harvest window and reduce preharvest drop.

**Plant Growth Regulator Evaluation Checklist****Keep annual records for each treatment block**

Treatment block: \_\_\_\_\_

Date: \_\_\_\_\_

**Environmental conditions**

Time applied: starting: \_\_\_\_\_ ending: \_\_\_\_\_

Air temperature at application or range \_\_\_\_\_

Relative humidity \_\_\_\_\_ Wind speed and direction: \_\_\_\_\_

High temperature the day of application: \_\_\_\_\_

Did it rain within 8 to 12 hours after application?  yes  noWeather conditions for two days *prior* to applicationDay 1:  sunny  cloudy daily temperatures: high \_\_\_\_\_ low \_\_\_\_\_Day 2:  sunny  cloudy daily temperatures: high \_\_\_\_\_ low \_\_\_\_\_Weather conditions for the two days *following* applicationDay 1:  sunny  cloudy daily temperatures: high \_\_\_\_\_ low \_\_\_\_\_Day 2:  sunny  cloudy daily temperatures: high \_\_\_\_\_ low \_\_\_\_\_**Tree Vigor**

Fruitlet size (mm) \_\_\_\_\_ Age of trees: \_\_\_\_\_

Cultivar(s): \_\_\_\_\_

General vigor of the block:  high  medium  lowPrevious season production:  high  medium  low**Dosage details**

What chemical or mix of chemicals was applied? \_\_\_\_\_

How much formulated material was added to the spray tank? \_\_\_\_\_

How large was the spray tank? \_\_\_\_\_

How many gallons of water were applied per acre? \_\_\_\_\_

When was the sprayer last calibrated? \_\_\_\_\_

**Tree Response**

What was the tree response? How well did the treatment work? \_\_\_\_\_

\_\_\_\_\_  
\_\_\_\_\_

are not sufficient to prevent the advanced ripening sometimes caused by NAA. If the fruit is destined for storage, then a full rate of ReTain should be used when tank-mixing ReTain and NAA.

Table 1-18 summarizes the attributes of ReTain and NAA. Both stop drops are useful compounds, although they're quite different with respect to activity and timing.

### Record Keeping for the Application of Plant Growth Regulators

Evaluating your application of plant growth regulators to your orchards is an important but often overlooked aspect of record keeping. The response of most PGRs is highly influenced by the weather conditions before, during, and after they are applied to the trees. Therefore, it is important that you have good weather records so you can learn how weather influences your use of PGRs in your orchard. On the previous page is a sheet that can be duplicated and used to track conditions under which you applied your thinners, growth-controlling compounds, or preharvest drop materials.

## PEARS

### Site Selection and Soil Preparation

Our remarks on site and soil selection for apples (see Orchard Establishment) apply equally to pears. Maintain pear blocks in permanent sod cover. Use herbicides to keep grass and weeds away from tree trunks.

Pears are considered self-unfruitful under eastern United States conditions. Cross-pollination should be provided to ensure commercial crops. There is one case of incompatibility in pear varieties—the Bartlett-Seckel combination. If these two are planted, a third variety is needed to ensure commercial crops. Both Magness and Waite are pollen sterile. D'Anjou, Bosc, Highland, Flemish Beauty, and Clapps Favorite are excellent pollinators.

The same materials registered for thinning apples are registered for chemical thinning pears. Amid-Thin W (NAAm) may be applied between petal fall to seven days after full bloom. Typical rates for Amid-Thin are 25 to 40 ppm. The only NAA products labeled for pears is Fruitone L. The typical rate for NAA on pears is 5 to 7.5 ppm, applied 7 to 14 days after full bloom. 6-BA products are also labeled for pear thinning. Typically this application is made 7 to 14 days after full bloom at 75 to 200 ppm.

Fire blight susceptibility may be increased by excessive nitrogen. Shoot growth over 18 inches annually indicates excessive nitrogen. It is recommended that no more than 0.01 pound of actual nitrogen per tree per year of age be applied annually up to 15 years old. After that, do not apply more than 0.225 pound of actual nitrogen per tree regardless of its age.

### Asian Pears

Asian pears, also called Apple Pears, Oriental, Korean, Chinese, Sand, and Nashi pears, depending on where they are grown in the country, are unique and different from our traditional European pears. Asian pears are very popular in Japan, China, and Korea. In Pennsylvania the market tends to be located in larger cities where ethnic populations are in greater numbers. Asian pears can be just as susceptible to fire blight as traditional pears. Our

**Table 1-19. Fluid ounces of Fruitone L or PoMaxa or ounces of Fruitone N or Refine 3.5 WSG to apply per acre in enough water to thoroughly wet the foliage at a given ppm.**

ppm	gal/A						
	25	50	100	200	300	400	500
2	0.2	0.4	0.8	1.6	2.4	3.2	4.0
4	0.4	0.8	1.6	3.2	4.8	6.4	8.0
6	0.6	1.2	2.4	4.8	7.2	9.6	12.0
8	0.8	1.6	3.2	6.4	9.6	12.8	16.0
10	1.0	2.0	4.0	8.0	12.0	16.0	20.0
12	1.2	2.4	4.8	9.6	14.4	19.2	24.0
14	1.4	2.8	5.6	11.2	16.8	22.4	28.0
16	1.6	3.2	6.4	12.8	19.2	25.6	32.0
18	1.8	3.6	7.2	14.4	21.6	28.8	36.0
20	2.0	4.0	8.0	16.0	24.0	32.0	40.0

**Table 1-20. Concentration of NAA (ppm) applied based on amount of Po-Maxa, Fruitone L, Fruitone N, or Refine 3.5 WSG desired per acre (from Table 1-19) and gallons of water to be applied per acre.**

oz	gal/A					
	25	50	100	200	300	400
2	20	10	5	2.5	1.7	1.3
4	40	20	10	5.0	3.3	2.5
6	60	30	15	7.5	5.0	3.8
8	80	40	20	10.0	6.7	5.0
10	100	50	25	12.5	8.3	6.3
12	120	60	30	15.0	10.0	7.5
14	140	70	35	17.5	11.7	8.8
16	160	80	40	20.0	13.3	10.0
18	180	90	45	22.5	15.0	11.3
20	200	100	50	25.0	16.7	12.5
22	220	110	55	27.5	18.3	13.8
24	240	120	60	30.0	20.0	15.0
26	260	130	65	32.5	21.7	16.3
28	280	140	70	35.0	23.3	17.5
30	300	150	75	37.5	25.0	18.8
32	320	160	80	40.0	26.7	20.0

**Table 1-21. Parts per million (ppm) of NAA in tank based on amount of Amid-Thin W added to tank of (x) size.**

Amount/Amid-Thin W		ppm of NAA in tank size			
lb	oz	50 gal	100 gal	200 gal	500 gal
0.125	2	25	13	6	3
0.188	3	37	19	9	4
0.250	4	50	25	12	5
0.313	5	62	31	16	6
0.375	6	75	37	19	7
0.438	7	87	44	22	9
0.500	8	100	50	25	10
0.563	9	112	56	28	11
0.625	10	125	62	31	12
0.688	11	137	69	34	14
0.750	12	150	75	37	15
0.813	13	162	81	41	16
0.875	14	175	87	44	17
0.938	15	187	94	47	19
1.000	16	200	100	50	20
1.063	17	212	106	53	21
1.125	18	225	112	56	22
1.188	19	237	119	59	24
1.250	20	250	125	62	25
1.313	21	262	131	66	26
1.375	22	275	137	69	27
1.438	23	287	144	72	29
1.500	24	300	150	75	30
1.563	25	312	156	78	31



traditional pears can serve as pollinizers for Asian pears, but the two groups rarely have an overlap in bloom to provide sufficient pollination opportunities.

There are three types of Asian pears: (1) round or flat fruit with yellow to green skin, (2) round or flat fruit having bronze-colored skin with russeting, and (3) pear-shaped fruit with either smooth or russeted skin.

### **Cultivars Evaluated at Penn State** (listed in order of ripening)

To view a presentation on the Penn State Asian Pear Trial, go to [shaponline.org/wp-content/uploads/2012/03/Early-Results-of-an-Asian-Pear-Cultivar-Trial-Rob-Crassweller.pdf](http://shaponline.org/wp-content/uploads/2012/03/Early-Results-of-an-Asian-Pear-Cultivar-Trial-Rob-Crassweller.pdf).

**Shinsui** is a round, golden orange fruit that is russeted. It matures in central Pennsylvania in late August to early September. Trees have a little more spreading habit than most Asian pear cultivars. The harvest window is fairly short. Fruit size is small to medium. Very susceptible to fire blight. Produces fruit with high sugar levels.

**Shinseiki** is a round, firm, yellow-skinned fruit that can be stored up to three months in common storage. This cultivar under California conditions is self-fruitful and does not require cross-pollination. Fruit hangs well on the tree and requires multiple harvests. Shinseiki is one of the top cultivars in California.

**Kosui** is a round, russeted, orange-colored fruit. It matures in central Pennsylvania in early to mid-September over a ten-day window. The growth habit of the tree is very upright. Fruit size is medium.

**Ishiiwase** is a brown-skinned round fruit with non-prominent lenticels. Fruit matures around mid-September in central Pennsylvania. It was developed from a cross of Jijisseiki and Doitsu in 1906 in Japan. Fruit size is medium. Fruit has a long stem.

**Hosui** is a very large, juicy, sweet, low-acid, bronze, russet-skinned fruit that ripens in September and has a long window of harvest needing five to six harvests. Trees are extremely vigorous and develop an open and spreading tree; they are very susceptible to fire blight. The fruit does not store longer than two to three months and may become soft in storage sooner than other cultivars.

**Yoinashi** is a yellow-brown-skinned fruit with good flavor. It ripens along with 20th Century. The Pacific Northwest Testing Association suggests that it may be a replacement for 20th Century.

**20th Century**, also known as Nijisseiki in Japan, originated in Japan about 100 years ago and is responsible for the popularity of Asian pears in that country. The fruits are round and yellow skinned, but bruise easily. They can be stored up to six months in common storage. Trees must be thinned aggressively to ensure adequate fruit size. Optimum flavor develops when fruit is slightly overripe, imparting a distinctive flavor.

**Ya Li** is one of the most important pears grown in China. Fruits are green to yellow-green with a pear shape and large. The flavor is sweet but mild. Fruit begins to ripen the beginning of October in central Pennsylvania. Storage life

is up until February. This cultivar is reportedly resistant to fire blight and pear psylla.

**Niitaka** is a large, firm, brown russet fruit with non-prominent lenticels. Its major attraction is its large size. Trees are very productive. The pollen is reported to be not viable, so this cultivar cannot be used as a pollinizer for other cultivars. Fruit matures mid- to late October in central Pennsylvania.

**Atago** is a large, golden brown fruit that matures the end of October. Trees are very productive. It is reported to have a long bloom period, making it a good pollinizer cultivar.

**Shinko** is a large, round to slightly flattened fruit with a bronze russet skin. Trees are well shaped and very productive with no tendency toward biennial bearing. Shinko is reported to be nearly resistant to fire blight. Fruit will only store approximately two months. Fruit matures in late October in central Pennsylvania.

**Olympic** is variously known as A-Ri-Rang, Olympic Giant, or Korean Giant and is a cultivar developed in Korea. Fruits are very large, late, and round and have an attractive golden russeted skin. Reportedly this pear's bloom period overlaps with Bartlett, and the two make compatible pollinizers. Olympic has the longest storage life of the Asian pears. In some years fruit may show internal browning. Olympic has been rated as tolerant to fire blight.

### **Other cultivars**

**Ichiban and Nashi** are an early maturing brown fruit. Their major asset is that they are early enough to fit into a niche market.

**Kikusui** is a flat, yellow-green, medium-sized fruit. It has an excellent flavor, but the skin is too tender to withstand shipping. The fruit is suitable for roadside markets if handled carefully. Preharvest drop can be a problem in some years. This cultivar is very susceptible to fire blight.

**Chojuro** is an old cultivar with fruit that is brown to orange and flat. The trees are very productive. This pear is not nearly as juicy as other cultivars and hence is losing favor. Fruit should be harvested when the first yellow-brown color appears and can be kept in storage for five months.

**Tse Li** is a large, pear-shaped, green fruit. Its quality is best after a period of storage. In California it is reported that only Ya Li can pollinate this cultivar.

### **Rootstocks**

Most pears are propagated on seedlings collected from open-pollinated seeds of Bartlett fruit. Of all tree fruit rootstocks, these are generally the most tolerant of wet, poorly drained soils. Since they are open-pollinated seedlings, there can be some variability in their growth patterns. These seedlings are fire blight susceptible, so every effort must be made to reduce suckering of the rootstocks.

Some nurseries now offer a group of fire blight resistant stocks selected from Old Home x Farmingdale crosses. These rootstocks are clonally propagated and cost more than seedlings. Besides being resistant to fire blight, they have dwarfing ability, and are earlier bearing. Those currently available are OHxF87 and

OHxF97; the former is semi-dwarf and the latter semi-standard. OHxF87 is precocious and has performed well in high-density plantings at 6-foot by 14-foot spacing.

Quince has been the most common dwarfing rootstock for pears. The three clones available are Quince A, Provence, and Quince C. Pears on Quince A and Quince C are dwarfs, while those on Provence are slightly larger. Orchard performance of most quince rootstocks has been variable. Quince is very susceptible to fire blight and low winter temperatures; it should be planted at only the most favorable sites and in areas with good soil drainage. Certain cultivars, such as Bartlett, Bosc, Seckel, D’Anjou, and Clapp’s Favorite, are incompatible with quince and require an Old Home interstem.

Two new quince clones, Provence Quince (Le Page Series C) and Provence Quince (BA 29-C), may also be available in limited supplies. Reports from France indicate that BA 29-C is a virus-free selection of Provence Quince, Le Page Series C. Both are reported to be precocious and high yielding and produce a tree one-half to two-thirds the size of standards. They are also susceptible to fire blight. Quince rootstocks are not recommended unless they have proven successful in trial plantings in your orchard.

## PEACHES

### Site Selection and Soil Preparation

Site selection for peaches and all stone fruits is similar to that for apples (see Orchard Establishment), with the following additional considerations:

First, more attention must be paid to minimum winter temperatures. Areas of Pennsylvania having winter temperatures of  $-10^{\circ}\text{F}$  or below should not be considered for growing peaches or other stone fruits.

If stone fruit is to be followed with stone fruit in the same field, a nematode sample should be taken before removing the old orchard. Follow the directions listed earlier in this guide under the Replanting an Orchard Site section. Do not use broadleaved crops such as soybeans or alfalfa since they may harbor the stem pitting virus. Corn or small grains are suitable. For more information on nematode problems and site preparation, see Nematode Problems in Deciduous Fruit Trees in Part II. The season before planting it is important to take care in choosing the herbicide program for the agronomic crop. Avoid high rates of atrazine during that year.

All commercial peach varieties are considered to be self-fertile. Even so, it is advisable to place bees in large blocks of one variety to ensure adequate pollination.

Using a water-soluble, exterior grade, white latex paint on stone fruit tree trunks may reduce winter injury. A good grade of dairy whitewash paint will also work. Apply to the southern and southwestern sides of stone fruit tree trunks, including the bases of main branches. The paint reflects much of the sunshine striking the trunk during bright winter days and reduces the amount of heat entering the bark. This lowers the possibility of bark splitting and subsequent tree damage.

It is particularly important to paint stone fruit tree trunks and the bases of main limbs up to 8 to 10 years of age. Smaller trunks and main limbs of younger trees respond more to the extreme

fluctuations of winter temperatures and may be injured more severely than older trees.

### Nursery Tree Quality

A problem in Pennsylvania orchards is the presence of a virus called stem pitting, which causes early death in peach trees. In response to the problem, the Pennsylvania Department of Agriculture (PDA), Bureau of Plant Industry, has established a virus-free certification program in cooperation with Pennsylvania nurseries. The program seeks to provide and maintain virus-free sources of budwood for state nurseries and growers. Pennsylvania nurseries can therefore offer two grades of trees: Penn Standard and Penn Premium. Penn Standard trees are certified for virus-free budwood, but not for virus-free rootstocks. Penn Premium trees are certified for both virus-free budwood and rootstocks.

Other states may also have certified virus-free trees. Growers are encouraged to take advantage of these programs. When ordering trees ask the nursery if it belongs to such a program.

Tree caliper is another measure of nursery tree quality. Trees of a larger caliper—greater than  $\frac{5}{8}$  inch in diameter—often are not suited for today’s orchards. The larger a tree’s diameter, the less choice you will have in selecting scaffolds. Thicker trees tend to be taller, and it may be difficult to force branches low to the ground. In addition, after a larger-caliper tree is headed back, *Cytospora* canker may infect the large wound area, eventually resulting in the tree’s death. Small-caliper trees, less than  $\frac{1}{2}$  inch, are easier to train for certain production systems, such as the central leader, but they need extra care the year of planting to prevent competition from weeds.

### Planting Depth

Problems with stone fruits in Pennsylvania have been attributed to setting the bud union 6 to 10 inches below ground. Because many sites have limited topsoil, trees may be planted too deep for optimal growth. At the lower depths oxygen is inadequate for root growth. Rootstocks used for stone fruits are normally propagated by seeds and thus are anatomically true root tissues. The aboveground portions of stone fruit rootstocks cannot form roots. Therefore, trees should be planted at the same level they were in the nursery.

### Peach and Nectarine Cultivars

Peaches are the second most important tree fruit crop grown in Pennsylvania. Unlike apples, however, there has been and continues to be extensive breeding of new and improved cultivars. Breeding programs at Rutgers University and Clemson University, the USDA programs in Kearneysville, West Virginia, and Byron, Georgia, and with private programs in Michigan have produced a number of new cultivars. Extensive evaluations of these cultivars were performed by Jerry Frecon, professor emeritus with the Rutgers Cooperative Extension system.

Interest in white-fleshed peaches and nectarines has waned as they have become less of a novelty and most were developed in California, where they were not bred for resistance to bacterial spot. In Table 1-22 the white-fleshed cultivars are indicated with an asterisk next to their name. The table is set up according to average ripening dates for south-central Pennsylvania. The cultivars listed under the Peaches column are those that begin to ripen during the particular period. The next column reflects our opinion as to the best cultivars in that particular time frame.

**Table 1-22. Commercially grown and promising peach and nectarine cultivars for Pennsylvania.**

Ripening date in southern PA	Best peach cultivars	Best nectarine cultivars	Promising peach cultivars for trial	Promising nectarine cultivars for trial
June 30–July 5	RichMay Desiree Spring Snow (W) Flamin Fury PF 5B Carored Earlistar	Mayfire	Spring Prince Manon (W)	
July 6–July 12	Harrow Diamond Sugar May (W) Ruby Prince Sentry	Arctic Star (W) Jade (W)	Harrow Dawn Scarlet Pearl (W) Flamin Fury PF 5D Big	Silvergem (NJ N100) NectaFest
July 13–July 19	Glenglo Garnet Beauty Summer Serenade Flamin Fury PF7 July Rose (NJ354)	Arctic Glo (W) Easternglo Silvergem (NJN100) (W)	Vulcan BuenOs II (NJF15) Flamin Fury PF 8 Ball	Honeyblaze Avalon
July 20–July 26	Flavorcrest GaLa	Arctic Sweet (W) Harblaze Flamin Fury PF 11	BuenOs NJF15 Sature (NJF1) (W) Snowbride (W) Vinegold	Brigantine (NJN102) Silverglo (NJN103) (W)
July 27–August 3	John Boy Redhaven White Lady (W) Flamin Fury PF Lucky 13 Starfire Flamin Fury PF 9A-007 Bellaire Redstar	Harflame Summer Beaut Firebrite	Blazing Star Snow Beauty (W) Galactica (W) TangOs (NJF16) Evelynn (NJ357)	Emeraude (W)
August 4–August 10	Salem Ernies Choice Coralstar Klondike (W) Bounty	Arctic Jay (W) Flavortop Sunglo	Harrow Fair Flamin Fury PF 19A-007 Flamin Fury PF 20-007 John Boy II TangOs NJF 17 (W)	
August 11–August 18	Flamin Fury PF17 Loring JulyPrince Flamin Fury PF 22-007 Flamin Fury F 23 Flamin Fury PF 24-007 Contender	Redgold	Allstar Flavrburst Carolina Belle (W) Glowingstar Beaumont	
August 19–August 26	August Rose (W) Gloria (NJ 351) Cresthaven Messina (NJ352)	Fantasia Zephyr (W)	Sugar Giant (W) Blushingstar (W) Flamin Fury PF 24C	Honey Royale
August 27–September 3	Flamin Fury PF 28-007 Flamin Fury PF 27A Jerseyqueen Redskin		Lady Nancy (W) Summerfest Flamin Fury PF 36-007 Tiana (NJ358)	
September 3–September 10	Autumn Star Encore Flameprince Laurol		AutumnGlo Snow Giant (W) Flamin Fury PF Fat Lady Selena (NJ 359)	Arctic Pride (W)
September 11 and Later	Parade Victoria (NJ353)		Big Red (CVN #3) September Snow (W) Flamin Fury PF Big George	

“W” indicates the cultivar is white fleshed.

Table developed by Jerry Frecon, Professor Emeritus, Rutgers University.

The third column contains suggestions for peach cultivars to try on an experimental basis. We do not know how well they will perform, but based on limited observation they seem worth trying on a small scale. The final column indicates all nectarines that ripen during that period.

### Pruning and Training Peaches

Peach trees are pruned to maintain tree size and shape and to help manage light and crop load. For helpful online resources, see [extension.psu.edu/peach-tree-pruning-managing-light-and-crop-load](http://extension.psu.edu/peach-tree-pruning-managing-light-and-crop-load).

#### Growth habit of peach trees

There are several different growth habits for peach trees, ranging from weeping to very upright, but the two that are commercially available are referred to as “Standard” and “Pillar or Upright” type trees, and the standard type is by far the most important.

**Standard** type trees are easily trained to an open center or vase shape with three or four primary scaffold branches or they can be trained to V-shaped trees with just two scaffold branches. Training standard type trees to a central leader form is possible, but it is not recommended because trees require considerable pruning and yields tend to be lower than for open-center trees. Because standard trees can be maintained at 7 or 8 feet in height with good pruning and most commercial cultivars are the standard form, this discussion on pruning will pertain primarily to standard type trees.

**Pillar-shaped** trees were developed by USDA, and two cultivars, ‘Crimson Rocket’ and ‘Sweet-N-Up’, have been commercially available for several years. Trees are very upright with narrow crotches. Nonpruned trees have multiple leaders, a canopy diameter of about 6 feet, and attain a height of about 14 feet. Research with pillar trees is limited, but trees can be planted at spacings of about 6 feet by 12 feet. It is difficult to maintain an open tree canopy because branches tend to grow upright even after spreading. Multiple leader trees tend to be more productive and require less pruning than trees trained as central leaders. At this time it seems that pruning and tree training should be minimal to avoid excessive tree vigor. Judicious pruning of young trees to prevent excessive shading within the canopy will allow the expression of the natural growth habit and encourage fruiting.

**Compact** trees have shorter internodes, wider branch angles, and a greater number and longer laterals than standard trees. Examples of compact trees include ‘Com-Pact Redhaven’ and ‘Compact Elberta’. The trees tend to be about 20 percent smaller than standard trees, but the canopies tend to be dense and light penetration into the canopy may be inadequate for production of high-quality fruit.

#### Types of pruning cuts

There are two types of pruning cuts, heading and thinning. Thinning refers to removing a limb or shoot at its point of origin along an older branch. Thinning cuts do not induce vegetative growth near the pruning cut and are usually preferred for minimizing tree size and removing excess shoots. Thinning cuts are also used in older trees as a method of fruiting shoot renewal. When a shoot that fruited the previous season is removed, there are buds imbed-

ded in the bark in the collar of the shoot that are released from dormancy and may develop into desirable fruiting shoots for the next year. Heading cuts remove the terminal buds that produce plant hormones that normally inhibit shoots from developing from buds below the terminal bud. Heading a one-year-old section of a shoot encourages shoot development from the two or three buds below the cut. Heading older branches encourages shoot development from buds imbedded in the bark within several inches below the cut. Heading cuts are used to shorten and stiffen branches and to induce branching. Heading cuts are usually limited to the year of planting to induce branches from which scaffolds will be selected. “Bench cuts” are a special type of heading cut where terminal section of a branch is removed just above a side branch. Bench cuts are sometimes necessary to redirect upright-growing branches to the outside, but they should be avoided if possible because watersprouts will develop on the flat branch section below the bench cut.

#### Types of buds and shoots

Peach trees have only two types of buds (vegetative and fruit). The terminal bud at the end of a shoot is always vegetative and produces a leafy shoot. Axillary buds develop during the summer at the bases of leaves on current season’s shoots and can be either leaf (vegetative) or flower buds. Peach flower buds are termed “pure” or “simple” because they contain only flower tissue. A peach flower bud produces a single flower that can set one fruit. Each node (the point on the shoot where a leaf is attached) on a vegetative shoot may have from zero to three buds. Nodes at the terminal end of a shoot usually have single buds. The small, pointed buds are vegetative and the larger, rounder, and more hairy buds are flower buds. Many of the nodes on the lower two-thirds of a shoot have two or three buds arranged side by side. There can be any combination of flower (F) and leaf (L) buds (FL, FF, FLF, FFF), but most often a leaf bud is flanked by flower buds (FLF). The number and distribution of flower buds on a shoot can vary with tree vigor, the cultivar, and the light environment in which the shoot developed. Some cultivars have 25 flower buds per foot of shoot length, whereas others may have only 15 flower buds per foot of shoot length. Short shoots, less than 6 inches, generally have the most fruit buds per inch of growth. Current-season shoots developing on trees with heavy crop loads also have fewer fruit buds on the basal third of the shoot. Shoots developing in low light environments (less than 40 percent full sun) have fewer flower buds than shoots in high light regions of the canopy. Shoots longer than 2 feet often produce few flower buds at the base and terminal ends of the shoot. Moderately vigorous shoots have a high proportion of nodes with two flower buds.

Vegetative buds at most nodes have the potential to develop into lateral shoots that may be fruitful in subsequent years. Axillary buds develop along the growing shoot and normally remain dormant until the following spring. However, some axillary buds on vigorous current season’s shoots (greater than 2 feet long) remain dormant for only a few days and grow to produce secondary shoots or “syllaptic shoots.” Syllaptic shoots are not very fruitful because few nodes have fruit buds. The ideal fruiting shoot is 12 to 24 inches long and  $\frac{3}{16}$  to  $\frac{1}{4}$  inch thick at its base, with no syllaptic shoots. Proper pruning, fertilization, irrigation, and fruit thinning must be practiced to ensure adequate annual shoot growth to produce appropriate numbers of fruit buds for the following season. Remove short shoots (less than 6 inches long) because they tend to produce small fruit due to inadequate leaf area in the vicinity of the fruit.

### The role of light

Leaves intercept light and in the biochemical reaction called photosynthesis, light energy is used to produce carbohydrates. These carbohydrates are used for growth of all parts of the tree (leaves, shoots, trunks, roots, and fruit). Light penetrates only about 3 or 4 feet into the tree canopy. The fruiting zone of an open-center tree can be thought of as doughnut supported by scaffold branches. The ring-shaped fruiting zone is about 4 feet wide and 4 feet deep. If light becomes limiting, the fruiting zone will move higher above the ground with little fruiting in the lower portion of the tree. The critical light levels differ for different types of growth and at different times of the season. Flower bud development requires about 20 percent full sun, especially during June and July. Low light levels later in the season have little effect on flower bud production or fruit set the following year. Production of large, highly colored fruit with high sugar levels requires 25 percent full sun during the final six weeks before harvest. By pruning to minimize shade, peach trees can be held to 8 feet in height with fruit developing throughout most of the canopy. Shoots developing in very shaded regions of the canopy tend to die during the growing season. Dead short shoots in the tree interior is indicative of a canopy that is too dense and shoots creating the shade should be removed.

### Time of pruning

Peach trees can be pruned in the summer or during the dormant season, but the objectives of pruning vary with time of pruning. Summer pruning is performed in July, when sylleptic shoots are visible, to select scaffold branches on young trees and to redirect the growth of young scaffold branches. For fruiting age trees removing upright and vigorous shoots in June and July will reduce shading to maintain fruiting wood in the canopy interior. Light during June and July, but not later in the season, is critical for flower bud development. Summer pruning to reduce shade two to four weeks before harvest will moderately increase fruit red color, but fruit size and sugar levels will be unaffected. Dormant pruning is used to remove upright and vigorous shoots that shade the tree interior, to limit the size of the tree and to remove excess fruiting shoots. Dormant pruning alone will not reduce shading enough to maintain fruiting wood in the lower regions of the canopy. Trees that are summer pruned each year often require little dormant pruning. Pruning temporarily reduces a tree's tolerance to low temperatures. Therefore, avoid pruning before late February and before predicted low temperatures.

### Pruning to manage crop load

Fruit size is negatively related to the number of fruit on a tree. Crop load is typically adjusted within 45 days after bloom by removing excess fruit and leaving fruit about 6 inches apart on a shoot. The hand-removal of fruits requires much labor and is expensive because it can require up to 130 man-hours per acre. Retaining fewer fruiting shoots during pruning and leaving fruit 4 inches apart on the shoot can reduce thinning time and improve fruit size. The distance between fruit on a shoot or the number of fruit per tree is not very important, but the number of fruit per acre is critical for fruit size. Therefore, if trees are pruned lightly to retain many fruiting shoots, fruit should probably be thinned to at least 8 inches between fruit. Also consider the genetic component of the cultivar for fruit size. In general, early season cultivars produce smaller fruit than late season cultivars. Therefore, early season cultivars

should have lower crop loads and this can partially be achieved by retaining fewer fruiting shoots per acre. The optimum numbers of fruit per acre depend on the cultivar and availability of irrigation. For small-size cultivars, a provisional number of fruit per acre is about 45,000, which would require 11,250 shoots if the fruit are thinned to four fruit per shoot. For medium-size cultivars, a reasonable target crop load is 70,000 fruits on 17,500 shoots per acre, and for large-fruited cultivars, 100,000 fruit on 25,000 shoots per acre is suggested. To calculate the desired number of shoots per tree, simply divide the desired number of shoots by the number of trees per acre. For example, for large-fruited cultivars with a tree density of 150 trees per acre, retain 167 shoots per tree and four fruit per shoot to produce 100,200 fruit per acre.

### Pruning open-center trees

The most common training system for peach during the past 100 years is the open center because relatively small trees with good light distribution throughout the tree can be maintained fairly easily. Young peach trees must be pruned carefully to develop and maintain fruiting wood near the tree center. It is fairly easy to maintain fruiting wood at the tree interior with a combination of summer and dormant pruning, but once lost, it is very difficult to develop new fruiting wood at the tree interior.

Pruning may vary slightly depending on the specific objectives and capabilities of individual peach producers, but the following guidelines can be followed to develop low, spreading, open-center trees.

### Pruning at planting

Peach trees are pruned at planting to balance the tree top with the small root system and to induce branching on the trunk. Fall-planted trees should be pruned the following spring before bud break. The height of the scaffold limbs above the ground depends on the height of the initial heading cut. Most growers desire scaffold limbs originating 20 to 24 inches above the ground to facilitate herbicide application, grass mowing, and other orchard practices. Small trees, particularly those from southern nurseries that are "June-budded," usually have no side branches and should be headed at 24 to 30 inches above ground. Trees that are budded in June are small because they grow for only three months after budding. August-budded trees are larger because they grow for about five months during the season following budding. The scaffold branches will develop within 4 to 6 inches below the heading cut, so if one desires branches higher on the trunk, then a higher heading cut can be used. Larger trees usually arrive from the nursery as branched whips. Since most of the side branches are weak, they should be pruned to two or three buds. Shoots often develop from these stubs and may be suitable for major scaffold limbs. Strong branches with wide crotch angles should be pruned to six or seven buds and can be retained for scaffold branches. The height at which branched trees can be headed depends on the size of the tree and positions of good side branches. Trees 3 to 6 feet tall can be headed at 24 to 30 inches above ground. It is usually preferable to head larger trees at 3 to 4 feet because low side branches on the trunks are damaged or removed for shipping. An alternative method of heading large trees with few desirable branches involves heading trees at 10 inches above the ground. This will allow the tree to grow a new central leader from which scaffold branches can be selected during the first winter. About 10 percent of large trees (trees with trunks more than  $\frac{3}{4}$  inch in diameter) may

not survive the severe heading, but little tree mortality has been observed with moderate size trees.

### ***The first summer***

Trees should be pruned at least once and possibly two times during the summer before growth ceases. Summer pruning reduces the amount of dormant pruning required the first winter and will direct growth into the desirable scaffold branches. In late May and again in July, remove low shoots on the trunk to a height of 20 inches. Remove all shoots forming angles less than 45 degrees with the trunk. Remove vertical shoots that are unacceptable as scaffold branches. Encourage a spreading growth habit by pinching upright-growing shoots back to an outward-growing bud or sylleptic (secondary) shoot. Pinching used in this way is actually a type of bench cut. Pinching should be done in late June and/or July while shoots are actively growing. Another approach to pruning first-year trees involves retaining the top few shoots with poor crotches and head them half in late June. Growth of the headed shoots is suppressed while encouraging growth of the lower shoots that have wide crotches. The small “bush” in the tree center is removed during the winter to leave the lower wide-crotched branches.

### ***The first winter***

At the end of the first season, some trees will have many desirable limbs, but others will have limbs on only one side or may have vertical growth habits and upright leaders. The first winter is the most important time to select branches that will develop into a strong framework capable of carrying heavy crops in the future.

If trees were pruned during their first summer, very little pruning will be needed during their first winter. The pruned trees should begin to resemble an open vase. Remove branches on the trunk within 20 inches from the ground and branches that form angles of less than 45 degrees with the trunk. Branches with narrow crotches are weak and may split from the trunk because bark extends into the crotch. Narrow crotches are also susceptible to winter injury, *Cytospora* canker, and borers. Some trees produce only two limbs that resemble a Y. If the two limbs form a strong wide crotch (U-shaped) they can both be retained, otherwise remove one of the limbs and new limbs should develop along the trunk in subset years.

Each peach tree is fairly unique, so there are at least two basic methods of developing an open-center tree that has a strong framework, and they seem to be equally effective. The most common method involves selecting three primary branches with wide crotch angles and that are spaced evenly around the trunk. Some trees will not have three acceptable limbs at the end of the first season, but excellent trees can be developed with only two main branches. Sometimes, four to six desirable limbs will grow at one point on the trunk. Remove all but three of these branches because there will eventually be three dominant limbs and the others will be squeezed out. The other method of developing an open-center form is to head the tree at 3 to 4 feet at planting; this is often preferable with the larger nursery trees. Select three to five limbs that are distributed evenly on the trunk and spaced 4 to 6 inches apart vertically. After the first year’s growth, peach trees with three main branches at 24 to 30 inches above ground look quite different from those that have four or five main limbs extending to 4 feet. However, as these trees grow for several years and are trained to the open center, they will

appear much more uniform. Northern peach growers often prefer trees with five to eight branches in case one of more branches are injured by low winter temperatures.

Avoid horizontal limbs on young trees because they will bend downward with the weight of a crop and will eventually need to be removed to allow equipment to move under the tree. Watersprouts (upright shoots developing along the upper side of a branch) will also arise along the top of a horizontal limb. An angle of 40 to 50 degrees from the vertical is most desirable. Remove root suckers, downward-growing shoots, and strong vertical shoots that shade the tree center. Keep the tree balanced by shortening the strongest branches. Encourage early fruiting by retaining as much of the tree as possible, including the smaller side shoots growing from the selected main branches. Head the scaffold limbs above an outward-growing secondary shoot to encourage a spreading growth habit. Sometimes a tree will produce a strong shoot from the soil line and the rest of the tree is weak or dead. If the shoot originates below the bud union, it is the rootstock and the tree should be replaced. If it develops from above the bud union, it should be pruned to a strong shoot. Secondary limbs with wide crotches developing at the appropriate height on these shoots can later be selected as scaffold limbs.

### ***Second summer***

Pruning trees during the second summer helps improve light penetration into the tree center and develop fruiting wood for the third season. Shoots developing on the trunk below the scaffold branches should be removed in June. Remove vigorous upright shoots developing near the tree center. By late June, when sylleptic (secondary) shoots develop on growing shoots, the upright portion of the terminal shoot can be pinched just above an outward-growing sylleptic shoot. This will encourage the spreading growth of the tree and direct growth into the desired secondary shoot. Summer pruning should be completed by mid-July.

### ***Second winter***

Peach trees that have grown well for two years may be 5 to 7 feet tall, 6 to 8 feet wide, and have trunks 3 to 6 inches in diameter. Such trees will also have numerous flower buds, and, if pruned moderately, may produce 20 to 40 pounds of fruit during the third summer. Excessive pruning will reduce yield the third summer. Trees should have two or more well-spaced scaffold branches with wide crotch angles. If this is not the case, try to select appropriate scaffold branches and remove all others. Remove all large watersprouts originating near the tree center. Scaffolds with less than 30 inches of new growth and have several side branches should be pruned to leave two or three well-spaced side branches. Remove shoots developing on the lower sides of scaffold limbs because fruit on these shoots will pull the scaffolds down, interfering with herbicide application. Retain most of the other one-year shoots throughout the tree. Sometimes two shoots of equal size will develop near the end of a scaffold branch and will form a V-crotch. One shoot should be removed to prevent weak crotches. The terminal ends of scaffold branches often grow upright. In the event that the tip of a scaffold is oriented vertically, it may be redirected outward by pruning to an outward-growing secondary shoot. This type of bench cut is preferably performed during the summer but can be performed during the winter.

**Third year**

Trees develop best when low branches and watersprouts are removed in June. Upright portions of terminal shoots should be pinched just above an outward-growing secondary shoot to encourage the spreading form. After the third season, peach trees are usually 6 to 9 feet tall, 7 to 9 feet wide, and have trunks 4 to 7 inches in diameter. During the fourth summer, peach trees may produce 50 to 80 pounds of fruit. Trees should be pruned the same as during the second winter to maintain a low spreading form. It is most important to remove watersprouts, low branches, and excess fruiting shoots.

**Pruning young fruiting trees**

During the first three years, the primary objective of pruning peach trees is grow a tree with a strong structure capable of supporting heavy future crops. As the trees fill their allotted spaces during years four, five, and six, the orchardist must encourage a transition from vegetative growth to fruit production. After three growing seasons, a well-trained peach tree should have three to five scaffold branches with wide angles, evenly distributed around the tree. Young fruiting trees usually grow fairly vigorously and moderate corrective pruning is needed to keep their centers open and maintain the desired tree size. The weight of fruit on the limbs encourages a spreading growth habit and heavy pruning should not be necessary. Continue annual summer pruning to eliminate vertical watersprouts and to tip upright scaffold limbs to outward-growing secondary shoots. Remove large, vigorous upright shoots and watersprouts with sylleptic shoots. These shoots may be 4 to 7 feet long; they are not very fruitful, and they shade the tree center. Rather than shortening these vigorous shoots to retain side shoots with flower buds, completely remove them because several vigorous shoots will emerge and continue to create a vigor problem. Retain nonbranched shoots that have flower buds, even if they are oriented vertically. The weight of fruit will pull these shoots down and suppress their vigor. Do not remove all fruiting shoots in the center of the tree. The most productive open-center trees have fruiting wood throughout the tree canopy. It is fairly easy to maintain fruiting wood inside the tree; but, once it is lost, it is difficult to re-establish. Remove some excess of branches to permit light to reach the tree center. However, maintain a supply of shoots that have strong flower buds. Depending on the cultivar and tree spacing, a properly trained peach tree will produce 50 to 80 pounds of fruit during the fourth and fifth seasons.

**Pruning middle-aged trees**

Peach trees have a shell of fruit-bearing wood about 4 feet in depth. This shell may be 4 to 8 feet above ground on low trees or 8 to 12 feet on taller upright trees. Total yield is usually greater for the taller trees, but the increased cost of pruning, thinning, harvesting, and spraying tall trees usually offsets the higher yields. Trees that are 7 to 9 feet tall have been very profitable in the East. Careful, annual selective pruning is required to maintain low, spreading trees that have much of their growth on a low, horizontal plane. Every season, some of the smaller twigs die, especially in shaded parts of the tree. Some of the older branches also become weak and die from other causes such as canker and borers. Remove the larger dead and badly cankered branches. It is not economical to remove all small, dead twigs, but some should be removed because they may rub and puncture fruit, and the bases of such shoots are entry sites for canker.

By the sixth year, the canopy should be fully developed for maximum yields. The objectives of pruning peach trees during years 6 through 10 are to maintain tree heights of 7 to 9 feet above ground and to maintain productive fruiting wood throughout the tree. The low spreading tree form can be maintained with proper pruning and fertilization. Remove all vigorous watersprouts that grow vertically; do not cut them to side shoots. Retain 12- to 18-inch fruiting shoots regardless of their orientation. Remember that flowers and fruit are borne on wood produced the previous year. If left unchecked, fruiting wood tends to grow farther out on the ends of branches each year. Prune each year to keep the tree within bounds and to prevent the branches from breaking. Stimulate growth of one-year fruiting wood in the tree center by thinning-out and heading-back inside branches. As trees come into bearing, weight of fruit bends some branches toward the ground, and these limbs may not return to an orientation above the horizontal after harvest. Some limbs, especially on the lower portions of the tree, should be removed by thinning to a shoot that is oriented above the horizontal. Some years, peach trees produce more fruiting wood than other years. Because pruning is used to manage crop load, more shoots should be removed when ample fruit buds exist, especially for varieties with small fruit. Thin-out fruiting shoots to a spacing of about 4 to 6 inches apart along the limbs to stimulate better growth of remaining shoots, to prevent excess fruiting and fruit thinning, and improve fruit size. Also remove the 3- to 6-inch-long fruiting shoots that are mixed with the more desirable 12- to 18-inch shoots. The shorter shoots produce small fruit. A thorough pruning job requires time and labor (10 to 15 minutes per tree), but it also saves time and labor during thinning and harvest.

**Pruning older trees**

Peach trees in the Mid-Atlantic region often remain profitable until they are 15 to 20 years old. As peach trees age, they become less vigorous. Good fruiting wood becomes scarcer and is often located at the ends of long, leggy limbs. A major objective of pruning older trees is to encourage the production of good fruiting shoots. Old trees can be invigorated by cutting back into wood that is three or more years old. Cut to good outward-growing side limbs. New shoots will develop from dormant buds under the bark near the pruning cuts. Pruning to invigorate old trees reduces the following season's crop because much bearing surface is removed, but it is the only way to renew a tree. Increasing the nitrogen fertilizer by 10 to 20 percent may also help encourage new growth. Heavy pruning encourages growth of new wood during the two seasons following treatment. Such severe pruning to renew old trees is profitable only in blocks where most of the trees are still present and in reasonably good vigor. Where more than 20 percent of the trees are missing or are weak, renewal pruning may not be profitable and it may be time to remove the old trees and replant the entire block.

**Pruning Perpendicular V trees**

During the past 20 years a number of Mid-Atlantic peach growers have transitioned to the "Perpendicular V" or "Kearney Agricultural Center Perpendicular V" (KAC-V) orchard system for peaches and nectarines. Trees are planted at spacings of about 5 or 6 by 18 feet and trained to two scaffold branches oriented perpendicular to the row to form V-shaped trees. The primary

advantages of this system are that the trees are uniform and easier to prune and thin, the tree form is more conducive to mechanization, and yields are higher for the first two or three fruiting years because the orchard canopy develops faster than for open-center trees. The primary disadvantage is that orchard establishment costs are higher due to increased tree densities and the trees are taller, so if mechanization is not available, increased costs associated with ladder work may offset the benefits.

### **First year**

At planting head the trees 18 to 24 inches above ground. Large trees with branches can be pruned to retain one wide-crotch branch growing into the row middles on each side of the tree. When shoots are 14 to 22 inches long (probably in mid-July), select two branches growing perpendicular to the row towards the row middles and competing branches should be headed to half their original length. Avoid selecting branches that are too horizontal (more than 45 degrees from vertical) or too vertical (less than 20 degrees from vertical) with narrow crotches. The ideal branch angle for primary scaffolds is 25 to 40 degrees from vertical. During the winter, remove low branches and all branches competing with the two primary scaffold branches. Remove vigorous upright shoots from each scaffold. Avoid heading the scaffold branches unless it is necessary to redirect the growth of an improperly oriented shoot. If a tree grew poorly the first summer, then select two primary scaffold limbs growing perpendicular to the row and cut them back to a length of about 8 to 16 inches. This type of severe pruning usually stimulates regrowth the following summer with many strong shoots from which to select scaffold branches. Summer pruning these trees the second summer when shoots are 18 to 22 inches long is important to select the proper scaffolds and to eliminate shading in the lower canopy.

### **Second year**

The second summer the trees should be pruned in July to maintain the dominance of the selected scaffold branches. Minimize shading by removing watersprouts and vigorous upright shoots that shade the tree interior. Pruning the second winter is similar to the first year. Remove vigorous upright shoots a thin out fruiting shoots (shoots with fruit buds) to regulate crop load. Avoid heading the scaffold unless shoots need to be redirected. Avoid severe heading cuts that may create flat branches (bench cuts) where watersprouts tend to arise. The tree should consist of two scaffold branches with moderately vigorous shoots (12 to 28 inches long) spaced 6 to 10 inches along the length of the scaffold. These shoots will produce a moderate crop the third year.

### **Third and fourth years**

Trees are now transitioning to the fruiting stage and pruning is similar to the previous year. The primary concern is preventing shading between and within trees by eliminating large and vigorous shoots. Summer prune in June or July to remove upright and vigorous shoots that shade the lower parts of the tree. Keep the center of the tree open to allow light penetration to the lower fruitwood. While dormant pruning, remove large competing branches and strong side shoots. As trees approach their permanent height (usually about 10 to 12 feet), cut scaffolds back to an upright fruiting shoots.

### **Mature trees**

As trees fill their space and transition to the fruiting stage, only slight summer pruning should be needed in July to remove vigorous upright shoots that shade the lower parts of the tree. Remove these shoots totally, do not head them because they will remain vigorous and shade out the tree center. Dormant pruning is relatively simple because trees are fairly uniform. Remove branches that are older than one year. When dormant pruning is completed, each scaffold branch should give rise to only one-year-old fruiting shoots (sometimes called “hangers”). A system of renewal pruning can be established by completely removing previous season’s fruiting shoots. New fruiting shoots for the following year will develop from buds imbedded around the base of the shoot that was removed. The ideal fruiting shoots to retain are 10 to 18 inches long with a basal diameter of  $\frac{3}{16}$  to  $\frac{5}{16}$  inch. One of the major problems with parallel-V trees is a tendency to leave two-year-old branches or too many one-year-old shoots on the scaffold limbs, which leads to limb crowded and shading. When dormant pruning is completed, one should be able to walk between trees within a row without touching branches.

### **Pruning to Quad-V system**

The Quad-V orchard system is somewhat of a compromise between open-center and parallel-V. Trees are typically planted at spacings of about 6 or 7 by 18 feet. The mature tree will have four fairly upright scaffold branches spaced at approximately 90 degrees from each other around the trunk and look similar to two V-shaped trees inserted at right angles to each other, and pruning of the Quad-V is similar to the Parallel-V. Results from trials in Pennsylvania indicate that the Quad-V may be more profitable than open-center or Parallel-V systems.

### **First year**

At planting head the trees 18 to 24 inches above ground. Large trees with branches can be pruned to retain one to four wide-crotch branches oriented around the tree. Two or more branches on one side of the tree are undesirable and all but one should be removed. When shoots are 14 to 22 inches long (mid-July), select up to four branches growing arising as close to 90 degrees from each other around the trunk as possible and head competing branches to half their original length. Avoid selecting branches that are too horizontal (more than 40 degrees from vertical) or too vertical (less than 20 degrees from vertical) with narrow crotches. The ideal branch angle for primary scaffolds is 25 to 35 degrees from vertical. During the winter, remove low branches and all branches competing with the four scaffold branches. Remove vigorous upright shoots from each scaffold. Avoid heading the scaffold branches unless it is necessary to redirect the growth of an improperly oriented shoot. If a tree grew poorly the first summer, then select up to four scaffold limbs and cut them back to a length of about 8 to 16 inches.

### **Second year**

During the second summer the trees should be pruned in July to maintain the dominance of the scaffold branches. Minimize shading by removing watersprouts and vigorous upright shoots that shade the tree interior. Pruning the second winter is similar to the first year. Remove vigorous upright shoots a thin out fruiting shoots (shoots with fruit buds) to regulate crop load. Avoid



heading the scaffolds unless shoots need to be redirected. Avoid severe heading cuts that may create flat branches (bench cuts) where watersprouts tend to arise. At the end of the second year, a well-grown tree should consist of four scaffold branches with moderately vigorous shoots (12 to 28 inch long) spaced 8 to 12 inches along the length of the scaffold. These shoots will produce a moderate crop the third year.

### **Third and fourth years**

As trees fill their space the primary concern is preventing shading between and within trees by eliminating large and vigorous shoots. In June or July remove vigorous shoots that shade the lower parts of the tree. Keep the center of the tree open so light can penetrate to the lower fruitwood. While dormant pruning, remove large competing branches and strong side shoots. As trees approach their permanent height (usually about 9 to 11 feet tall), cut scaffolds back to an upright fruiting shoot.

### **Mature trees**

As trees fill their space and enter the fruiting stage, trees need only slight summer pruning in July to remove vigorous upright shoots that shade the lower parts of the tree. Remove these shoots totally, do not head them because they will remain vigorous and shade out the tree center. Dormant pruning consists of removing branches that are older than one year. When dormant pruning is completed, each scaffold branch should give rise to only one-year-old fruiting shoots (“hangers”). Shoot renewal is encouraged by completely removing previous season’s fruiting shoots. New fruiting shoots for the following year will develop from buds imbedded around the base of the shoot that was removed. The ideal fruiting shoots to retain are 10 to 18 inches long with a basal diameter of  $\frac{3}{16}$  to  $\frac{5}{16}$  inch.

### **Rootstocks**

At present, no known adaptable peach rootstocks induce dwarfing in peaches. Peach seedlings are still the principal rootstock source for commercial peach trees. Seedlings can be divided into three classes: wild types (e.g., Tennessee Natural), commercial cultivars (Halford and Lovell), and seedlings developed for use as rootstocks (Siberian C, Bailey, Rutgers Red Leaf). Interspecific hybrids are also being evaluated in Pennsylvania. They have been developed from crosses between peaches and almonds (Nemaguard, GF 677). Following are comments about specific rootstocks that are currently available:

**Halford:** Grown in California as a canning clingstone type.

Some nurseries obtain seed from this open-pollinated fruit, while others have seed blocks and collect fruit only from self-pollinated trees. Seedlings from self-pollinated fruit usually produce the most uniform trees. Halford is compatible with all commercial cultivars.

**Lovell:** Also grown in California as a clingstone for dried fruit. Seeds are obtained from self-pollinated blocks and perform like Halford.

**Bailey:** Developed in Iowa for its cold hardiness. In Pennsylvania trials, Bailey has had high yield, yielded a higher proportion of large fruit, and had a slight degree of tree size control, with low mortality.

**Guardian®:** Developed to tolerate peach tree short life (PTSL), a disease complex often encountered in the southeastern United States. Its tree size is 95 percent that of Lovell, with similar yield, and survival in Pennsylvania thus far is 100 percent. Guardian® is increasingly offered for sale in our region and our preliminary recommendation is that it is interchangeable with other standard size rootstocks.

The following peach rootstocks, which may be available from certain nurseries, are not recommended for use in Pennsylvania for the reasons listed. Siberian C and Krymsk 1 do not survive well in areas with fluctuating winter temperatures. Nemaguard has been found not to be cold hardy in this region. *P. tomentosa* and *P. besseyi* lack vigor and have compatibility problems.

### **Split Pit**

Split pit of peaches is a problem for Pennsylvania growers, particularly with early maturing cultivars. Cultivars such as Candor or Garnet Beauty may have 25 to 50 percent split pits, especially if overthinned. Irregular moisture levels during pit hardening can also induce pit splitting. The term normally refers to the opening of the pit at the stem and splitting of fruit. This split becomes evident during the third stage of fruit growth, the final swell. However, the weakening of the pit that leads to opening at the stem end probably occurs in the latter stages of pit hardening. Fruit with split pit generally develops rot much faster than sound fruit. Also, by federal grade standards, split pit is considered a defect.

### **Shattered Pit**

Shattered pit differs from split pit in that it is an internal problem that federal inspectors are looking for. Fruit with pits broken into more than three pieces plus gum deposits near the flesh are considered out of grade. While the split pits develop at the stem end and are visible, the opposite is true of shattered pits. Fruit with visible split pits at the stem end may also have fractured pit halves and considerable gumming in the pit cavity. In shattered-pit peaches, the damage is centered at the blossom end of the fruit, and growers cannot see and thus remove all peaches with fractured pits during the grading process.

The exact causes of pit breakage are not known. Some researchers suspect that low temperatures and/or freezing damage during flowering and early fruit development are factors. Studies conducted in the south showed that shattered pit is much less severe in fruits possessing viable seeds. However, it is not known if the pit shatters because of seed death or if breakage of the pit actually causes seed death. The studies suggested that the problem is much worse in early peach varieties. Generally, cultural practices that enhance fruit size—such as thinning, applying nitrogen, or irrigating—usually increase the incidence of split and shattered pits in susceptible cultivars. When freezes excessively reduce fruit yields, pit breakage problems usually increase.

Growers are limited in what they can do culturally to minimize pit breakage. The first line of defense is to select and/or eliminate cultivars with a consistent history of these problems. Avoiding low or frosty sites can help reduce the possibility of light crops caused by cold damage. Finally, on early maturing cultivars it may be necessary to leave heavier crop loads, although in doing so you must settle for smaller size.

## Nectarine Pox

Nectarine pox is a disorder that reduces packout of commercially grown nectarines. It was first identified and studied in West Virginia and has since been found in nearly all areas of the Cumberland-Shenandoah fruit-growing regions.

The disorder is characterized by superficial warty or raised outgrowths that in some years may occur on 20 to 80 percent of the fruit in an orchard block. Symptoms are usually observed within 40 days after full bloom as pale white or light-colored circular spots or raised areas. In some instances spots may cluster together, forming a large irregular rough raised area. As fruit develops and enlarges, the spots expand and raise higher than surrounding tissue. Raised areas are usually redder than the surrounding tissue. Slicing through the raised areas shows normal fruit tissue below.

Research results suggest that the disorder is accentuated in overly vigorous trees and in trees with high levels of fruit nitrogen and potassium and low levels of fruit calcium. Suggested control measures include the use of cultural practices that reduce excessive shoot growth. Such practices are proper fertilization, good pruning, and regular leaf analysis to monitor nutrient levels. Root pruning has also been shown to help reduce the incidence of nectarine pox, probably owing to the effects of reducing shoot growth. Avoid excessive nitrogen applications and excessive dormant pruning. Since this disorder appears to have the same causes, growers may want to try, on an experimental basis, the control strategies used for corking in apples. See page 57. More information can be found in Part II: Diseases, Disorders, Pests, and Natural Enemies.

## CHERRIES

### Site Selection and Soil Preparation

Site preparation and nursery tree selection are similar to that for apples (see Orchard Establishment). Most older commercial sweet cherry cultivars (except Stella and Duke) are considered self-unfruitful. Many of the newer cultivars, however, are self-fruitful. Tart cherry pollen will pollinate sweet cherries, but the bloom periods do not overlap. Tart cherries are self-fruitful and will produce commercial crops when set in solid blocks of trees.

### Growth Regulators

#### Young trees

Early flowering in a newly planted cherry orchard can delay vegetative development and lower long-term productivity. The use of gibberellic acid (GA<sub>3</sub>) in the products Falgro 2X LV, Falgro 4L, ProGibb 4%, and ProGibb LV Plus beginning the year after planting can prevent overflowering in young trees (Table 1-23).

Applications should be made as dilute sprays with a handgun, or airblast sprayer, in 25 to 50 gallons of spray per acre. Apply the spray two to four weeks after bloom, with three weeks the optimal timing. Apply 50 to 100 ppm as a fine mist. Use higher rates for trees growing in poorer soils and lower rates for trees in high-vigor soils.

Promalin, Perlan, MaxCel, and Exilis 9.5SC may also be used to increase branching in young sweet cherry trees. Use it as you would for apples (see Growth Regulators to Aid in Apple Tree Training). Application can only be made, however, in a mixture with latex paint. Apply the mixture to nodes where branches are

desired. Do not apply after buds have broken, or young shoots may be damaged (see Table 1-23).

### Bearing or mature trees

Foliar applications of GA<sub>3</sub> (Falgro 2X LV, Falgro 4L, ProGibb 4%, ProGibb LV Plus) can help reduce blind wood and increase fruiting of tart cherries. The material works by affecting lateral bud differentiation, which is apparent the year after application. Therefore, changes in shoot, spur, and flower production will not be evident until two or three years after the program is begun. Once this period is satisfied, response will be yearly provided annual applications have been made.

Apply GA<sub>3</sub> as a foliar spray from 14 to 28 days after bloom (or up to 14 days after shuck split). Use full coverage sprays of 50 to 150 gallons per acre on medium to large bearing trees. Be sure entire trees receive good coverage. A surfactant will aid in foliar wetting.

GA<sub>3</sub> is also labeled for increasing fruit size and firmness of sweet cherries. Apply GA<sub>3</sub> at 16 to 48 fluid ounces per acre when cherries are at the straw color stage of ripening.

Ethephon (Ethephon 2, Motivate, Verve) may be used to loosen red tart cherries for mechanical harvest. Caution: Ethephon has caused severe gummosis in some Pennsylvania tart cherry orchards, affecting low-vigor trees most severely. Apply ethephon only to trees making optimum growth. Do not use more than 2.5 pints ethephon or less than 50 gallons of water per acre. Apply 7 to 14 days before anticipated harvest. Do not apply when the temperature is below 60°F or above 85°F. Be sure to leave some trees unsprayed for comparative purposes.

### Rain Cracking of Cherry Fruit

Rain cracking severely limits production of sweet cherries in the eastern U.S. In recent years researchers have been evaluating the physiology and steps that lead to rain cracking. There are two causes of cherry fruit cracking. External, free standing water that lays on the surface often in the basin where the stem attaches to the fruit can increase cracking. Research in Europe has shown as cherry fruit begins the final period of rapid growth/fruit swell; the fruit skin becomes thinner and small microscopic cracks develop. Water with extended contact to the skin and these microscopic cracks is absorbed easier and bowl or shoulder cracks develop. Under situations of frequent rains water can form droplets on the distal portion of the fruit opposite the stem bowl. This extended and frequent water contact can also be absorbed through the microscopic cracks resulting in cracking on the bottom or sides of the fruit. The use of rain exclusion covers or high tunnels can reduce this potential damage. The duration of water contact is related to the potential for cracking to occur. Therefore, frequent showers under cool conditions where the water does not rapidly evaporate from the fruit can be more deleterious and induce more fruit cracking. In some instances, growers have resorted to using their orchard sprayers to “blow-dry” the fruit to reduce the wetting period.

The second cause relates to the plant’s internal water relations through the tree’s vascular system. Under saturated soil water conditions water uptake causes pressure build up within the fruit. The inner epidermal cells increase tensile forces under the skin inside the fruit. As more water is absorbed, the inner epidermal cell walls swell and detach from sub-epidermal cells. Cellular contents are lost from epidermal cells near the fracture. Swelling in the epidermal cell wall region results in cuticular fracturing

**Table 1-23. Growth regulators for stone fruit.**

Purpose	Trade name	Rate of commercial product/A or ai/A	Comments
Reduce preharvest fruit drop, delay harvest, maintain fruit firmness, additional time for fruit size increase, improve fruit quality	ReTain	0.73 lb/A (1 pouch)	Apply 1 to 2 weeks prior to anticipated harvest. Apply in 100 gal/A or enough volume for adequate coverage without excessive runoff. PHI = 7 days. Use of an organosilicone adjuvant is recommended at 0.1% v/v. <b>Do not use on cherries.</b>
Increase fruit set on cherries	ReTain	0.73–1.56 lb/A (1–2 pouches)	Apply between popcorn stage to first flowering for best results. Do not apply after petal fall.
TART CHERRIES	Ethephon 2, Motivate,	3–4 pt/A dilute or 0.6–1 pt/A concentrated spray	Apply when fruit ground color changes from bright green to yellow. Do not treat when air temperatures exceed 85F. PHI = 7 days and REI = 48 hrs.
SWEET CHERRIES	Verve (21.7% ai)	3–4 pt/A dilute or 2–3 pt/A concentrated spray	Same as above.
Produce larger, brighter colored, firmer fruit (sweet cherries)	ProGibb, Falgro, N-Large formulations	See product label	Apply a single spray when fruit is translucent green to straw colored. For cultivars with uneven maturity, make two applications. Apply 1/3 to 1/2 of the total desired amount when the majority of the fruit is translucent green. Apply remaining material 3–7 days later.
Increase fruiting capacity and reduce blind wood of bearing tart cherries	ProGibb, Falgro, N-Large formulations	See product label	Apply when at least 1–3 inches of terminal growth has occurred. This is usually 14–28 days after full bloom. Use higher rates on vigorous trees and lower rates on low-vigor trees.
Reduce flowering and fruiting in young nonbearing stone fruit trees	ProGibb, Falgro, N-Large formulations	See product label	Make one application during flower bud initiation period in the second leaf and in third leaf if later fruiting is desired in the fourth season. Discontinue use one year before commercial harvest is desired.
Stone fruits to increase fruit firmness and improve fruit quality in the season of application	ProGibb, Falgro, N-Large formulations	See product label	Apply as a single spray 1 to 4 weeks prior to the beginning of harvest. Use sufficient water to achieve complete coverage of fruits and foliage. This application has been known to cause a reduction in flower counts the year following the application, especially if it is made during the months of May through July.
Increase lateral branching of nonbearing sweet cherries	Promalin, Perlan, Typy, Exilis, or MaxCel	See product label	Treat growing tips of trees after they have reached a terminal height at which lateral branching is desired.
Increase lateral branching of nonbearing sweet cherries	Promalin, Perlan, Typy, Excelis, or MaxCel	See product label	Apply in the spring when terminal buds begin to swell but before buds begin to break shoots. Apply only to one-year-old wood.
Reduce vegetative growth of sweet cherries	Apogee, Kudos, Pro-Hex	High-vigor trees: 8–20 oz/A	Do not apply more than 20 ounces per acre within a 14-day interval. Do not apply more than 40 ounces per acre per year.
		Medium-vigor trees: 6–12 oz/A	Do not apply more than 12 ounces per acre within a 14-day interval. Do not apply more than 30 ounces per acre per year.
		Low-vigor trees: Do not apply	
Increase fruit size, reduce cracking in sweet cherries	Splendor (CPPU)	16–24 fl oz per 100–200 gal/A	Apply 1 or 2 sprays at bloom, shuck split, or when fruit is straw colored. PHI = 7 days.

that generally precedes fruit cracking. Irrigation, rain showers and plant nutrition are interlinked with this cause of cracking.

Other related factors that impact water buildup within the fruit are effects of crop load and application of gibberellic acid. Light crops producing large fruit tend to be more susceptible to cracking. Application of gibberellic acid as the fruit begins to take on the straw color stage of development acts to temporarily reduce tree transpiration briefly. However, once the transpiration rates recover increases in water content may result in fruit cracking. Research in Oregon also suggests that training systems, such as the Upright Fruiting Offshoot (UFO) or Kym Green Bush system, provide better leaf cover to the fruit and may result in less rain cracking. Current approaches are attempting to look at potential genetic characteristics that may be selected to reduce cracking. The table below shows differences that seem to exist based upon genetic variation between cultivars.

**Sweet cherry cultivar susceptibility to fruit cracking based on rainfall events in The Dalles, Oregon (200–2018).**

High	High to Moderate	Moderate	Low
Bing	Early Robin	Attika	Big Star
Brooks	Radiance Pearl	Benton	Black Pearl
Early Robin	Sandra Ros	Chelan	Black Star
Rainier	Selah	Coral Champagne	Burgundy Pearl
Royal Edie	Sweetheart	Cristalina	Suite Note
Royal Helen	Tieton	Ebony Pearl	
Santina		Lapins	
Selah		Regina	
Skena		Royal Hazel	
Utah Giant		Samba	
Van		Tamara	

Source: C. Kaiser, L. Long, and L. Brewer. "Understanding and Preventing Sweet Cherry Fruit Cracking." EM9227. Oregon State Univ. Extension Service, 2019.

### Foliar Nutrient Sprays

Some studies have suggested that foliar nutrient sprays may help reduce rain cracking. As cherry fruit matures the sugar concentration increases with in the fruit. Correspondingly rainwater has a very low concentration of solutes. The difference in the solute concentration can cause osmotic movement of the rainwater into the fruit and cause cracking. Applications of calcium chloride prior to a rainfall event can increase the solute concentration of the rainwater surrounding the fruit and the fruit skin strength. Unfortunately, there is the possibility of calcium chloride residues requiring postharvest cleaning of the fruit.

### Cuticle protectants

Products such as RainGard® and Parka™ are mixtures of food grade fatty acids and vegetable-based esters or phospholipids that can help reduce fruit cracking. The ingredients in RainGard are approved by FDA for human consumption. RainGard decreases the uptake of rain through the fruit cuticle by maintaining the integrity of the cuticle. For these products to be effective the entire fruit surface must be covered with the products. Therefore, for products like these to be effective thorough spray coverage is essential using large volumes of water and slower tractor speeds.

The two protectants act differently. RainGard is an inelastic cover and as the fruit continues to grow and expand small cracks in the coating develop. Therefore, repeated applications of the product are needed every 7 to 10 days at least 2 hours before anticipated rain. Parka, on the other hand, is a coating that can stretch as the fruit expands by supplementing the fruit's natural cuticle formation. Gibberellic acid can be used with both, however, be sure to follow directions and timing on the appropriate label.

To apply a protectant product, fill a clean spray tank with half the required water, turn on the agitator and slowly add 102 ounces of the product per 100 gallons to the tank. Add the remaining water to reach the desired dilution of 0.8% V/V basis. The volume of water will depend upon tree sized and density of the canopy. The correct dilution ratio can also be obtained by mixing one 6.4 gallon pail of the product with 800 gallons of water.

Three applications of RainGard at 102 ounces per 100 gallons give the best results. The first application should be made four weeks before anticipated harvest followed by an additional two applications at 7- to 10-day intervals. Timing can be adjusted based on weather conditions. Single applications just before a rain event have proved to be less efficacious. RainGard is compatible with most commonly used agricultural products, but *do not tank-mix with organosilicone surfactants*. Do not apply if air temperatures reach or exceed 85°F.

Vapor Gard is sometimes recommended as a material that can prevent rain cracking. However, this product is an antitranspirant and prevents the fruit and leaves from giving off excess moisture. In theory it sounds good if you can reduce the loss of water from the fruit. However, many studies in the Pacific Northwest have shown the product to be ineffective.

### Rain exclusion covers

Shielding fruit from rain exposure can also help to reduce rain cracked fruit. However, they may be less effective if excessive precipitation occurs and water is absorbed through the root

system. Under heavy rain precipitation water running off the exclusion covers can saturate the soil and run underneath the covers. To reduce this type of event, the installation of gutters on the covers or directing the run-off away from the tree root zone. Additionally, planting the trees in raised beds may also reduce their exposure to wet soils.

### Helicopters and wind machines

Since some fruit cracking is due to the residual water laying on the fruit surface and creating a difference in osmotic potential it seems logical the less time moisture lays on the fruit the less chance of that occurring. Helicopter and wind machines can increase air movement in the orchard and may result in faster drying of the fruit. For helicopters to be effective they must operate immediately after the rain has ceased and they must fly at very low elevations. Existing wind machines may provide some relief, but their range is limited. Tree training systems will interact with the use of wind to dry the fruit. Narrow open canopies such as with the UFO system may see more benefit than central leader or Kym Bush training systems. (For more details on cherry fruit cracking, see C. Kaiser, L. Long, and L. Brewer, "Understanding and Preventing Sweet Cherry Fruit Cracking," Bulletin EM9227 (Oregon State University Extension, 2019.)

### Cultivars

Two important species of cherries are grown for commercial production: *Prunus avium*, sweet cherry, and *Prunus cerasus*, tart cherry. They can be grafted onto each other and, when cross-pollinated, produce seeds that become Duke hybrid cultivars.

Sweet cherries are more difficult to produce than tart. They are scarcely more hardy than peaches, bloom early, and thus are frequently caught by spring frosts. Many sweet cherry cultivars experience severe cracking if water is allowed to remain on the skin for a few hours before harvest. Rains at harvest time will often ruin a crop.

Many common cultivars were originally developed in Europe and brought to this country. European cultivars still grown in the United States are Black Tartarian, Napoleon, Hedelfingen, and Schmidt. Windsor, Vista, Van, Vega, Summit, and Stella are cultivars developed in Canada. Ulster and Hudson were introduced in New York, while Angella and Utah Giant were introduced in Utah.

There are four kinds of sweet cherries: light-colored hearts, dark-colored hearts, and light- and dark-colored Bigarreaus. Hearts are mostly soft-fleshed fruit best suited for home use or eating fresh. Light-colored hearts produce nearly colorless juice and have a predominantly yellow skin with or without a red blush. Dark-colored hearts have red to deep red juice, and soft fruit. Black Tartarian is the best known example.

Bigarreaus produce firmer fruit and are widely planted by the commercial industry. They also are divided into light- and dark-colored groups. The lights have yellowish skin and nearly colorless juice, and are used mainly for brining and maraschino production.

Sweet cherries are further classified based on their ability to cross-pollinate with one another (Table 1-24). Nearly all older sweet cherry cultivars appear to be self-unfruitful. They produce viable pollen, but not all cultivar combinations are fruitful. There are many cross-incompatible groups of sweet cherries. Cultivars within a group should not be planted together without a suitable pollinizer. Washington state and British Columbia have active



breeding programs to develop new cultivars. Their cultivars are grown under an arid climate and may have a tendency to crack more than cultivars developed in more humid climates. For more information about sweet cherry pollination and incompatibility problems, go to [www.rosbreed.org/breeding/dna-tests/cherry/cross-compatibility](http://www.rosbreed.org/breeding/dna-tests/cherry/cross-compatibility). A complete listing of the s allele genotype list in an Excel table can be viewed by clicking on the “functional genotype list” on this page highlighted in blue. Additional information on sweet cherry pollination can be viewed at [treefruit.wsu.edu/web-article/sweet-cherry-pollination](http://treefruit.wsu.edu/web-article/sweet-cherry-pollination).

Following are some of the more common cross-incompatible groupings:

- I Black Tartarian, Summit
- II Samba, Van, Early Robin, Cristalina, Olympus, Sonnet, Oktavia, Regina
- III Somerset, Burgundy Pearl, Bing, Napoleon (Royal Ann), Emperor Francis, Lambert
- IV Victor, Vega, Viva
- V Attika (Kordia), Starks Gold
- VI Hedelfingen
- VII Rainier, Black Republican, Bada, Sylvia, Hudson
- VIII Royalton, Sam
- IX Chelan, Burlat, Tieton
- X Schneiders 0900 Ziraat

Tart or sour cherries are a different species from sweet cherries. As a group tart cherries are probably as hardy as any other fruit. Their ability to adapt to various soils and climates is much greater than that of sweet cherries. Tart cherries are self-fruitful and will produce heavy commercial crops when planted in solid blocks. They do not have severe cracking problems or as much brown rot as sweet cherries.

#### Self-fertile sweet cherry cultivars

Due to the problems associated with cross-pollination of sweet cherries, plant breeders have been developing self-fertile sweet cherry cultivars. These cultivars do not require pollen from a different cultivar to set fruit. The self-fertile cultivars can therefore be planted in solid blocks (Table 1-25). Very little is known about their performance in Pennsylvania, and some are reported to be susceptible to rain-induced fruit cracking in other states. Growers should be cautious when ordering these cultivars because of the unknown crack susceptibility.

#### Sweet cherry cultivars

##### *White or yellow-fleshed cherries (used mainly for brining)*

**Blushing Gold (NY 8182):** Midseason-blooming yellow-skinned cultivar developed by Cornell. Shows good rain cracking resistance and would be a better choice than Napoleon/Royal Ann. Could be harvested mechanically and stemless.

**Corum:** July 8 ripening. Semi-firm, but productive and hardy.

**Emperor Francis:** July 10 ripening. Major cultivar used in the East. Can be eaten fresh or used for brining. Old standard brining cultivar.

**Gold:** July 15 ripening. Trees are hardy and productive.

Flower buds more hardy than most other cultivars. Fruit is small. As part of a unique pollination group, Gold can serve as a pollinizer for many other brining cultivars.

**WhiteGold (NY 13688, Newfane cv.):** Early to midseason self-fertile cultivar released by Cornell University. Fruit can be used for fresh or processing purposes. WhiteGold can serve as a universal pollinator for other sweet cherry cultivars. Fruits are yellow with a red blush. Reported to bloom later than other white-fleshed cherries and to have good field tolerance to bacterial canker and leaf spot.

#### *Dark sweet cherries*

**Attika (Kordia):** Chance seedling from the Czech Republic. Dark red colored skin with red flesh. Blooms late and therefore may impart some frost avoidance. Young trees are very vigorous.

**Benton:** Self-fertile cultivar that resembles Bing but blooms later. Developed in Washington state. Harvests a few days before Bing but blooms later with potential to escape frost damage.

**BlackGold (NY 13791):** A mid- to late season self-fertile cultivar released by Cornell University. It is the latest blooming cultivar in the Cornell collection, giving it a good tolerance to spring frost. The fruit, which has dark skin and flesh, can be used for both fresh and processing purposes.

**Chelan:** Developed in Washington. Round fruit resembles Bing with good size and firmness. Fruit are firm, heart shaped, with red flesh.

**Cristalina (Sumnue):** The large, dark red fruit developed in British Columbia can be harvested stemless. The fruit are dark red and considered extremely attractive. Fruit are moderately large at 10.6 grams average weight. The flesh is moderately firm and nearly as dark as the skin.

**Hartland:** Developed in New York, it ripens in early to mid-season productive black sweet cherry. The tree is winter hardy and disease-tolerant. Fruit are medium to large and medium firm better than Hedelfingen.

**Hedelfingen:** July 17 ripening. Early bearing and very productive. Reported not to crack in the Geneva area, but severe cracking occurs on the West Coast.

**Hudson:** July 25 ripening, making it the latest-ripening cherry commercially available. Very firm fruit of very good quality, low susceptibility of fruit to cracking in the field. Tree of medium hardiness and productivity.

**Kristin:** Originated in New York and widely tested in Norway, where it has performed well. Average ripening date of July 15. Fruit size averages 1 inch. Precocious and moderately productive. Moderate resistance to rain cracking.

**Regina:** Developed in Germany at the Jork Institute. The very large, firm, deep red fruit ripen late about 14 to 17 days after Bing. Harvest should be delayed until fruit soluble solids reaches 20 to 22 percent. Productivity of the cultivar has been low, but the use of more dwarfing and precocious

**Table 1-25. Critical temperatures for various fruits.**

Stage of development	10% kill (°F)	90% kill (°F)	Stage of development	10% kill (°F)	90% kill (°F)	Stage of development	10% kill (°F)	90% kill (°F)
<i>Apples<sup>a</sup></i>			<i>Pears<sup>b</sup></i>			<i>Apricots</i>		
Silver tip	15	2	Scales separating	15	0	First swelling	15	-
Green tip	18	10	Blossom buds exposed	20	6	Tip separates	20	0
½-inch green	23	15	Tight cluster	24	15	Red calyx	22	9
Tight cluster	27	21	First white	25	19	First white	24	14
First pink	28	24	Full white	26	22	First bloom	25	19
Full pink	28	25	First bloom	27	23	Full bloom	27	22
First bloom	28	25	Full bloom	28	24	In the shuck	27	24
Full bloom	28	25	Post bloom	28	24	Green fruit	28	25
Post bloom	28	25	<i>Sweet cherries</i>			<i>Adapted from 1989 Spray Guide for Tree Fruits in Eastern Washington. Bulletin EBO419. E. H. Beers, coordinator.</i>		
<i>Peaches</i>			First swelling	17	5	<i>a. For Red Delicious. Golden Delicious and Winesap are approximately 1 degree hardier. Rome Beauty is 2 degrees hardier, except after petal fall when all cultivars are equally tender.</i>		
First swelling	18	1	Side green	22	9	<i>b. For Bartlett. D'Anjou is similar but may bloom earlier and therefore may be more tender than Bartlett at the same date.</i>		
Calyx green	21	5	Green tip	25	14			
Calyx red	23	9	Tight cluster	26	17			
First pink	25	15	Open cluster	27	21			
First bloom	26	21	First white	27	24			
Full bloom	27	24	First bloom	28	25			
Post bloom	28	25	Full bloom	28	25			
			Post bloom	28	25			

rootstocks and increased placement of additional pollinizers the productivity has improved.

**Royalton (NY 11390):** The exceptionally large fruit ripens midseason with Hedelfingen. Trees are vigorous with an upright growth habit. Fruit are firmer than Hedelfingen and may be a good replacement for that cultivar

**Sam:** July 6 ripening. Good rain-cracking resistance, but this may be related to soft fruit texture. Hardy, but only moderately productive. Late blooming. Fruit of some trees has a bitter aftertaste. Black fruit, ¾ to ⅞ inch in size.

**Sandra Rose:** It is a midseason self-fruitful cherry cultivar that blooms relatively late. Gibberellic acid sprays are recommended to maintain fruit firmness. Low productivity and the more productive Gisela 6 or 12 should be used as rootstocks.

**Santina:** Fruit ripen five to seven days before Bing and are light mahogany to mahogany at maturity. The fruit are described as somewhat bland and low acid. The large fruit and early harvest are positive aspects of this cultivar.

**Selah:** The fruit ripen between Lapins and Bing and is firm and very large. It is self-fertile but not overly productive. Fruit set in loose clusters that improve harvest efficiency and potentially result in reduced disease incidence compared to cultivars fruiting in more dense clusters.

**Skeena:** This self-fertile cultivar ripens about the same time as Lapins. The light mahogany to mahogany colored fruit are very large and firm. Although self-fertile, the tree is not precocious and would benefit from increased pollinizers and vigorous rootstocks.

**Somerset (NY6476):** Developed by the Geneva Experiment

Station. Fruit looks similar to Bing in shape but are much darker and ripen later than Bing. Fruit has a high tolerance to cracking. The tree is very precocious and produces many lateral branches.

**Stardust:** Blush-colored fruit ripens after Bing. The cultivar is self-fruitful, making it a late market Ranier type fruit. Late blooming makes it suitable as a pollinizer for Regina and Attika as well as frost avoidance.

**Stella:** The first named self-fruitful sweet cherry cultivar developed in British Columbia. Cracking can be a problem.

**Sweetheart:** The fruit are moderately large and the tree has an open growth habit and is very precocious and productive. However, the trees require heading of all new shoots each year. Without annual heading, the tree can overset fruit. Pitting of the fruit can also be a problem if the fruit overset. Trees are very susceptible to powdery mildew.

**Tieton:** Large, mahogany red skin and red flesh cultivar developed in Washington. Fruit has a tendency to double and are susceptible to rain cracking. Fruit quality is also not very good.

**Ulster:** July 14 ripening. Nearly black fruit, ¾–⅞ inch. Medium hardness but productive. Resembles Schmidt but more productive. Moderate resistance to rain cracking most years.

**Valera:** Introduced from Vineland, ripening a few days before Bing. Medium-sized, semi-firm, good-quality fruit. More consistent cropping record than Venus. Cracking susceptibility unknown.

**Vandalay (V690618):** Developed at the Vineland Research station in Canada from a Van x Stella cross. Trees are self-fertile. Cracking may be a problem.

**Viscount:** Another introduction from Vineland. Medium to large, firm, good-quality, dark glossy red cherries that ripen with Bing. Productive, with good resistance to cracking.

**Viva:** July 4 ripening. Dark red,  $\frac{3}{4}$  inch, semi-firm fruit. Good cracking resistance, but this may be due to its soft texture.

#### Sweet cherries not recommended

Several cultivars that are not recommended or that have problems with rain cracking: Napoleon (known as Royal Ann on the West Coast), Ranier, Bing, Chinook, Compact Lambert, Lambert, Schmidt, and Summit.

#### Cornell University ‘Pearl’ series

The ‘Pearl’ series of sweet cherry were some of the last cultivars that Dr. Bob Andersen was working on just before he retired from Cornell University. He selected these cultivars for their large, dark fruit, crack resistance, productivity, and winter hardiness. While trials in Massachusetts showed they were not immune to cracking, they did crack in wet years. In drier years, Black Pearl had a little less cracking than Burgundy Pearl and Ebony Pearl. All three are early season cherries and the order of ripening is Ebony Pearl, Burgundy Pearl, and Black Pearl. Since these were selected in Cornell, resistance to rain cracking was one of the dominant characteristics in their selection and should be favored over those developed in the Pacific Northwest.

#### Processing sweet cherry cultivars

Two cultivars that are especially suited for processing were released by Cornell University.

**Andersen:** Tested as NY 9295, this cultivar is named after Dr. Bob Andersen. It is a large-size cherry that may have good use as a cocktail cherry. The tree blooms mid to late with BlackGold and Gold and is self-incompatible. Fruit are moderately susceptible to cracking and tend to carry the fruit as large singles. The skin color is a red blush with a yellow ground color

**Nugent:** Tested as NY 518, this cultivar is named after Dr. Jim Nugent. The fruit are all yellow and are similar in appearance to Gold. Bloom is early to midseason, but fruit ripen the same time as Gold. The tree is spreading and quite willowy with heavy yields.

#### Tart cherry cultivars

Tart or sour cherries are a different species from sweet cherries. As a group, tart cherries are probably as hardy as any other fruit. Their ability to adapt to various soils and climates is much greater than that of sweet cherries. Tart cherries are self-fruitful and will produce heavy commercial crops when planted in solid blocks. They do not have severe cracking problems or as much brown rot as sweet cherries.

**Montmorency:** This is the most widely grown tart cherry cultivar. Some nurseries offer spur-bearing Montmorency types.

**Balaton:** A tart cherry from Hungary that was released through Michigan State University. Fruit are red-fleshed and the juice is red. It has a higher sugar content than Montmorency, but is still classified as a tart cherry.

**Danube:** Released from Michigan State, this tart cherry is dark red and sweeter than Montmorency. Fruit juice is very dark red, indicating high levels of anthocyanins. Fruit ripen a few days before Montmorency. This cultivar produces the largest of the three tart cherries.

**Jubileum:** A second dark red skin, flesh, and juice released from Michigan State. Has very high sugar levels (18 to 19 Brix). Fruit average 5.5 to 6 grams each. Fruit ripen early midseason. Suitable for fresh market sales.

#### Rootstocks

Rootstocks now available for cherries are Mazzard, Mahaleb, and Colt. Mazzard is a sweet cherry seedling adaptable to both sweet and tart cherries. It is tolerant of heavier soils. Trees on Mazzard are larger than the same cultivar on Mahaleb. Mahaleb is the standard rootstock for tart cherries because it is slightly dwarfing, more tolerant of drought and cold, and more precocious than Mazzard. It is not, however, compatible with all sweet cherry cultivars.

Colt, an introduced rootstock from England, is reported to be precocious and semi-dwarfing. A size reduction of 25 percent was reported over standard rootstocks for cherries. However, trees on Colt have been found to be drought sensitive and not cold hardy. Therefore, Colt is recommended only for warmer areas with irrigation.

The Gisela series of rootstocks was developed in Germany at Justus Liebig University in Giessen by Drs. Werner Gruppe and Hanna Schmidt. Several of the more promising selections were imported into the United States. From these trials, four rootstocks are commercially available: Gisela 3, Gisela 5, Gisela 6, and Gisela 12. Size control ranges from 45 to 80 percent of the size of similar cultivars on Mazzard. Nevertheless, they do offer some size control. Growers should take care that the trees do not overcrop in the early years and fail to develop proper canopy size. In general, tree support is recommended for all the Gisela stocks that have been released. A series of publications and videos developed by Rutgers University, Oregon State University, University of Massachusetts, and Michigan State is available online at [www.giselacherry.com](http://www.giselacherry.com). Below are descriptions of the four.

**Gisela 3:** This selection is the most dwarfing of the series, but it is not widely planted in the United States. It is recommended only for the deep, moist fertile soils due to its dwarfing capabilities. German reports indicate the rootstock will provide high early yields and the trees can be intensively pruned and managed to produce high-quality fruit. Trees are free of root suckers and produce wide branch angles. Trees should be supported and planted in high-density systems such as the super slender axe. Gisela 3 is well adapted for growing under covered orchards or high tunnels.

**Gisela 5:** Tested as Gi148/2, this is very precocious, producing a tree about 50 percent the size of Mazzard. The rootstock seems to induce an open canopy with wide branch angles. Trees produce few suckers. Trees must be pruned hard and the crop load intensely managed or the tree may runt out. Do not plant on dry, sandy soils. It should be grown in cooler climates such the northeastern United States.



**Gisela 6:** Tested as Gi148/1, this is a precocious rootstock that produces trees about 65 to 95 percent of the size of trees on Mazzard. It induces early bloom and is tolerant of viruses. Extra care must be taken to ensure that desired shoot extension growth is maintained. This is the most popular Gisela clone.

**Gisela 12:** Tested as Gi195/2, this is a semi-dwarf type producing a tree slightly more vigorous than Gisela 6, although this may vary by cultivar. It is reported to have good virus resistance and does not sucker. The rootstock is adapted to a wide range of soils and is somewhat better anchored than Gisela 6.

The Krymsk rootstock series of rootstocks are also being studied and is available from some nurseries. These semi-dwarfing rootstocks, Krymsk 5 and Krymsk 6, were developed in the Black Sea region of Russia. Krymsk 5 is said to be more tolerant to heavy soils than Mazzard and is adapted to cold climates. Trees on Krymsk 5 are said to be similar in size to Gisela 6. Trees on Krymsk 6 are 75 to 80 percent the size of Gisela 12. This rootstock is also adapted to heavier soils but does have moderate suckering. Both rootstocks are sensitive to prune dwarf virus (PDV) and prunus necrotic ring spot virus (PNRSV). At this time, neither has been tested in Pennsylvania, and only small test trials are recommended. In central Pennsylvania, John Boy peaches on Krymsk 1 all died in less than seven years. While the Krymsk series may withstand deep cold temperatures, it may not perform well under the fluctuating temperatures in the Mid-Atlantic region.

For additional information on sweet cherry rootstocks, go to Long, L, & C. Kaiser. 2010. *Sweet Cherry Rootstocks for the Pacific Northwest*, PNW Publication 619, [pubs.wsu.edu/ItemDetail.aspx?ProductID=15396](http://pubs.wsu.edu/ItemDetail.aspx?ProductID=15396).

## Pruning Cherries and Production Systems

A PDF on cherry training systems located at [catalog.extension.oregonstate.edu/pnw667](http://catalog.extension.oregonstate.edu/pnw667) describes the natural growth habit of cherry trees, options for rootstocks that can affect tree growth and precocity, pruning and training techniques to achieve managed and efficient orchard production of high-quality fresh market fruit, and the matching of rootstocks and training systems to variations in orchard site growth conditions. It is available free as a downloadable file for printing or as a free application for computer tablets like the iPad or Android-based tablets. The Pruning Guide tablet app is easily navigated by touching pictures of each system, swiping across the screen to switch between systems or pull up expanded illustrations, and/or scrolling up and down through each year of training operations.

Seven distinct tree canopy training systems are described, three multiple leader systems and four single leader systems. The multiple leader systems include the Kym Green Bush (KGB), the Spanish Bush (SB), and the Upright Fruiting Offshoots (UFO), which is a trellised system to create either a vertical narrow fruiting wall (UFO) or dual inclined narrow fruiting walls (UFO-Y). The single leader systems include the Steep Leader (SL), the Vogel Central Leader (VCL), the Tall Spindle Axe (TSA), and the Super Slender Axe (SSA), which also creates a vertical narrow fruiting wall. The description of each training system includes recommended rootstocks, tree spacing, and year-by-year training goals, and developmental steps.

The cherry training systems Guide can be supplemented by a 30-segment video series (over three hours total, developed by Jon Clements, extension specialist at University of Massachusetts, and Win Cowgill, retired extension specialist at Rutgers University) of pruning demonstrations by Gregory Lang and Lynn Long available on the Gisela Cherry YouTube channel at [www.youtube.com/user/giselacherry/videos](http://www.youtube.com/user/giselacherry/videos).

**Table 1-26. Management practices for apples and stone fruits.**

Month	Apples	Stone fruits
January, February	Mouse control. Prune. Repair bulk bins. Check for rabbit damage. Cut out fire blight.	
March, April	Pesticide sprays. Bees for pollination. Grafting. Chemical weed control. Calibrate sprayer.	Begin pruning older peach and tart cherry when buds swell. Calibrate sprayer. Pesticide sprays. Apply leaf curl spray before buds swell.
May	Pesticide sprays. Chemical thinning. Solubor sprays. Chemical weed control.	Pesticide sprays. Chemical weed control. Cut out Cytospora canker.
June	Pesticide sprays. Check minimum intervals between last application and harvest. Calcium sprays. Summer pinch new shoots. Pull suckers.	Pesticide sprays. Complete hand thinning. Check minimum interval between last application and harvest. Take soil sample for nematode analysis. Cut out Cytospora canker.
July	Calibrate sprayer. Calcium sprays. Summer prune. Pesticide sprays. Take soil sample for mineral analysis. Pull suckers. Budding. Order trees needed in two years. After July 15 take leaf samples for nutrition analysis.	Calibrate sprayer. Pesticide sprays. Summer prune. Order trees needed in two years. After July 15 take leaf samples for nutrition analysis. Prune sweet cherry trees after harvest.
August	Pesticide sprays. Ethephon sprays. Calcium sprays. Budding. Before August 15 take leaf samples for nutritional analysis.	Complete summer pruning. Pesticide sprays. Control peach tree borers. Before August 15 take leaf samples for nutritional analysis.
September	Nematode test for current and new plantings. Pesticide sprays. Calcium sprays. Ethephon sprays. Take soil sample for mineral analysis.	Nematode test for current and new plantings. Soil fumigation where needed. Control peach tree borer. Take soil sample for nematode analysis.
October	Mouse control. 2,4-D for dandelions. Take soil sample for mineral analysis. Clean and store sprayer. Mow close for mouse control. Place mouse bait stations in orchards.	Fumigate soil for nematodes. Control peach tree borers (late September). Clean and store sprayer. Take soil samples for nematode analysis and mineral analysis.
November	Prune. Mow orchard. Winterize equipment. Take soil sample for mineral analysis. Apply rodenticides. Apply fall herbicides.	Paint tree trunks white. Take soil sample for mineral analysis. Apply fall herbicides. Apply leaf curl spray.
December	Prune. Apply rodenticides.	Paint tree trunks white.





# DISEASES, DISORDERS, PESTS, AND NATURAL ENEMIES

## CONTENTS

<b>IPM Approach.....</b>	<b>103</b>
--------------------------	------------

<b>Basics of Insect Monitoring with Sex Pheromone Traps .....</b>	<b>103</b>
---	------------

Integrated Pest Management Supply Sources.....	105
--	-----

<b>Diseases, Disorders, Insects, Mites, and Beneficial Insects: Biology, Monitoring, and Management.....</b>	<b>105</b>
--	------------

Diseases and Disorders in Pennsylvania.....	105
---	-----

2,4-D Damage.....	105
-------------------	-----

Alternaria Blotch Apple.....	105
------------------------------	-----

Alternaria Rot .....	106
----------------------	-----

Anthrachnose of Peach .....	106
-----------------------------	-----

Apple Scab.....	106
-----------------	-----

Apple Mosaic Virus .....	108
--------------------------	-----

Apple Stem Grooving Virus .....	108
---------------------------------	-----

Apple Stem Pitting Virus .....	108
--------------------------------	-----

Apple Union Necrosis and Decline .....	108
--	-----

Bacterial Canker .....	108
------------------------	-----

Bacterial Spot .....	109
----------------------	-----

Bitter Pit and Cork Spot.....	110
-------------------------------	-----

Bitter Rot of Apple .....	110
---------------------------	-----

Black Knot of Plum .....	111
--------------------------	-----

Black Rot and Frogeye Leaf Spot of Apple.....	112
---	-----

Blister Spot on Crispin (Mutsu).....	112
--------------------------------------	-----

Blue Mold of Apple .....	113
--------------------------	-----

Brooks Fruit Spot of Apple.....	113
---------------------------------	-----

Brown Rot .....	114
-----------------	-----

Calyx-end Rot of Apple.....	114
-----------------------------	-----

Cherry Leaf Spot .....	114
------------------------	-----

Core Rot of Apple.....	115
------------------------	-----

Cornyeum Blight of Stone Fruit .....	115
--------------------------------------	-----

Crown Gall.....	116
-----------------	-----

Cytospora Canker of Stone Fruits .....	116
--	-----

Fire Blight.....	117
------------------	-----

Frost Damage.....	120
-------------------	-----

Glyphosate Herbicide Damage .....	120
-----------------------------------	-----

Gray Mold of Pome Fruits.....	120
-------------------------------	-----

Hail Damage .....	120
-------------------	-----

Marssonina Blotch of Apple .....	120
----------------------------------	-----

Moldy Core of Apple.....	121
--------------------------	-----

Necrotic Leaf Blotch of Apple.....	121
------------------------------------	-----

Nectarine Pox .....	121
---------------------	-----

Nectria Twig Blight of Apple .....	122
------------------------------------	-----

Peach Leaf Curl .....	122
-----------------------	-----

Peach Scab.....	122
-----------------	-----

Peach Stem Pitting.....	123
-------------------------	-----

Pear Leaf Blight and Fruit Spot.....	123
--------------------------------------	-----

Pear Leaf Spot .....	123
----------------------	-----

Pear Scab .....	124
-----------------	-----

Phytophthora Collar, Crown, and Root Rots .....	124
---	-----

Plum Leaf Spot .....	124
----------------------	-----

Plum Pockets .....	125
--------------------	-----

Plum Pox Virus .....	125
----------------------	-----

Powdery Mildew of Apple.....	126
------------------------------	-----

Powdery Mildew of Cherry and Plum .....	126
---	-----

Powdery Mildew of Peach, Nectarine, and Apricot.....	126
--	-----

Rapid Apple Decline.....	127
--------------------------	-----

Rhizopus Rot of Stone Fruits.....	127
-----------------------------------	-----

Rust Disease of Apple.....	128
----------------------------	-----

Rust Disease of Pear .....	129
----------------------------	-----

Rusty Spot of Peach .....	129
---------------------------	-----

Sooty Blotch and Flyspeck of Apple .....	129
--	-----

Sooty Mold of Pear.....	130
-------------------------	-----

Southern Blight of Apple.....	130
-------------------------------	-----

Southwest Trunk Injury .....	130
------------------------------	-----

Sunburn.....	130
--------------	-----

White Rot of Apple.....	130
-------------------------	-----

<b>Insect and Mite Pests in Pennsylvania .....</b>	<b>131</b>
--	------------

American Plum Borer .....	131
---------------------------	-----

Apple Grain Aphid.....	132
------------------------	-----

Apple Leafminer .....	132
-----------------------	-----

Apple Maggot .....	132
--------------------	-----

Apple Rust Mite.....	133
----------------------	-----

Black Cherry Aphid.....	133
-------------------------	-----

Brown Marmorated Stink Bug.....	134
---------------------------------	-----

Buffalo Treehopper .....	134
--------------------------	-----

Cherry Fruit Fly and Black Cherry Fruit Fly.....	135
--	-----

Codling Moth.....	135
-------------------	-----

Dogwood Borer .....	137
---------------------	-----

European Apple Sawfly .....	137
-----------------------------	-----

European Red Mite.....	138	Ladybird Beetles (Coccinellidae).....	165
Green Aphids (Apple Aphid and Spirea Aphid).....	140	Multicolored Asian Ladybird Beetle ( <i>Harmonia axyridis</i> ).....	165
Green Fruitworms.....	141	Green and Brown Lacewings (Chrysopidae and Haemorobiidae).....	165
Green Peach Aphid.....	141	Minute Pirate Bug— <i>Orius insidiosus</i> .....	166
Gypsy Moth.....	142	Syrphid Flies.....	166
Japanese Beetle.....	142	Sand Wasps—Carbronidae.....	166
Lesser Appleworm.....	142	Lepidopteran Predators—Ground Beetles.....	166
Lesser Peachtree Borer.....	143	(Carabidae) and Rove Beetles (Staphylinidae).....	166
Mullein Plant Bug.....	143	Woolly Apple Aphid Parasitoid— <i>Aphelinus mali</i> .....	166
Obliquebanded Leafroller.....	144	Lepidopteran and Stink Bug Parasitoids.....	166
Oriental Fruit Moth.....	144		
Peachtree Borer.....	145	<b>Weeds in Deciduous Fruit Crops.....</b>	<b>167</b>
Pear Psylla.....	146	<b>Scouting for Weeds.....</b>	<b>167</b>
Pear Slug.....	147	<b>Nematode Problems in Deciduous Fruit Trees.....</b>	<b>168</b>
Pear Thrips.....	147	Peach Stem Pitting and Apple Union Necrosis.....	168
Pearleaf Blister Mite and Pear Rust Mite.....	147	Replant Problems and the Root-Lesion Nematode.....	168
Periodical Cicada.....	148	Detection and Sampling for Plant-Parasitic Nematodes.....	169
Plum Curculio.....	149	<b>Mammal Control in Orchards.....</b>	<b>170</b>
Potato Leafhopper.....	150	White-Tailed Deer.....	172
Redbanded Leafroller.....	150	<b>Special Section: Brown Barmorated Stink Bug—New Exotic Insect Pest.....</b>	<b>174</b>
Rose Leafhopper.....	150	Unique Elements of BMSB Biology.....	175
Rosy Apple Aphid.....	150	BMSB Behavior.....	175
San Jose Scale.....	151	Efficacy of Insecticides.....	175
Shothole Borer.....	152	Suggestions for BMSB Management in Pennsylvania Fruit Orchards.....	175
Spotted Lanternfly.....	153	Planning for a Seasonal Insect Control Program.....	176
Spotted Tentiform Leafminer.....	153	Maintaining the Integrity of IPM in Pennsylvania While Battling the Brown Marmorated Stink Bug.....	177
Spotted Wing Drosophila.....	154		
Tarnished Plant Bugs, other Plant Bugs, and.....	155	<b>Color Section of Diseases and Disorders, and Insect and Mite Pests.....</b>	<b>178</b>
Native Stink Bugs.....	155		
Tufted Apple Bud Moth.....	156		
Twospotted Spider Mite.....	158	<b>TABLES</b>	
Variigated Leafroller.....	159	<b>Table 2-1.</b> Calculating apple scab infection periods using the Revised Mills Table.....	107
Western Flower Thrips.....	159	<b>Table 2-2.</b> Susceptibility of apple rootstocks and cions to apple union necrosis and decline disease.....	108
White Apple Leafhopper.....	160	<b>Table 2-3.</b> Using temperature and wetness hours to determine cedar-apple rust infection periods.....	128
White Peach Scale.....	160	<b>Table 2-4.</b> Degree-day look-up table for codling moth (lower threshold 50°F, upper threshold 88°F, horizontal cut off, using sine-wave curve).....	136
Woolly Apple Aphid.....	161	<b>Table 2-5.</b> European red mite densities predicted from the percentage of mite-infested leaves.....	139
		<b>Table 2-6.</b> Relationship between number of European red mites per leaf at their peak and accumulated number of mite days per leaf.....	139
		<b>Table 2-7.</b> Timing of insecticide applications on	
<b>Natural Enemies/Biological Control in Deciduous Fruit Crops.....</b>	<b>162</b>		
Types of Biological Control Agents.....	162		
Biological Control of Mites.....	162		
<i>Typhlodromus pyri</i> (Phytoseiidae).....	162		
<i>Neoseiulus fallacis</i> (Phytoseiidae).....	163		
<i>Zetzellia mali</i> (Stigmaeidae).....	164		
<i>Stethorus punctum</i> (Coccinellidae).....	164		
Biological Control of Aphids.....	165		
Aphid Midge— <i>Aphidoletes aphidimyza</i> (Cecidomyiidae).....	165		

apples and peaches to control the Oriental fruit moth based on crop stage or degree days from biofix.....	145
<b>Table 2-8.</b> Emergence of different broods of periodical cicada in Pennsylvania counties by year.....	148
<b>Table 2-9.</b> Counts of sap-feeding spotted tentiform leafminer mines to determine infestation status and the necessity for treatment .....	154
<b>Table 2-10.</b> Relation between percentage of egg hatch and degree-day accumulations from the first pheromone trap capture of adult tufted apple bud moth.....	157
<b>Table 2-11.</b> Recommended spray timing for conventional pesticides (e.g., Altacor, Delegate, Intrepid) based on degree-day accumulations for tufted apple bud moth depending on application method .....	157
<b>Table 2-12.</b> Recommended spray timing for products containing <i>Bacillus thuringiensis</i> (Bt) based on degree-day accumulations for tufted apple bud moth depending on application method. Use only complete sprays.....	157
<b>Table 2-13.</b> Degree-day look-up table for tufted apple bud moth (lower threshold 45°F, upper threshold 91°F) and Oriental fruit moth (45–90°F) (horizontal cut off, using sine-wave curve).....	158
<b>Table 2-14.</b> Orchard weeds identified as reservoirs of tomato ringspot virus .....	168
<b>Table 2-15.</b> Plant-parasitic nematodes and their treatment guideline .....	169
<b>Table 2-16.</b> Efficacy of various insecticides against BMSB adults during direct contact laboratory bioassay.....	176
<b>Table 2-17.</b> Suggested timings and product options for the control of brown marmorated stink bug in fruit orchards....	176

## FIGURES

<b>Figure 2-1.</b> How to make an integrated pest management decision .....	104
<b>Figure 2-2.</b> Eradicating <i>Cytospora</i> canker.....	118
<b>Figure 2-3.</b> Action thresholds for mites in Pennsylvania ....	139
<b>Figure 2-4.</b> Tomato ringspot virus transmission.....	168
<b>Figure 2-5.</b> Examples of specific (and unique) challenges presented by brown marmorated stink bug to Pennsylvania fruit growers.....	174

## PHOTOS

### Diseases and Disorders

Anthracnose on peach fruit .....	178
Apple union necrosis.....	178
Alternaria leaf blotch .....	178
Apple scab on leaves.....	178
Bacterial canker on a cherry limb .....	178
Alternaria fruit rot on cherry.....	178
Apple scab on fruit.....	178
Bacterial spot on peach fruit .....	178
Bacterial spot on peach leaves .....	179
Black knot of plum.....	179
Black rot on apple branch .....	179
Bitter pit .....	179
Black rot on apple fruit .....	179
Blister spot on Crispin .....	179
Bitter rot on apple fruit .....	179
Frogeye leaf spot on apple leaves .....	179
Blue mold on apple fruit .....	179
Brooks fruit spot of apple .....	180
Brown rot blossom blight on peach .....	180
Cherry leaf spot .....	180
Brown rot on peach fruit .....	180
Burr knot on apple rootstock .....	180
Crown gall on apple .....	180
Brown rot on apple fruit.....	180
Calyx-end rot on apple fruit.....	180
Crown gall on apple roots .....	180
Crown rot of apple .....	181
Fire blight (blossom blight) .....	181
Frost damage .....	181
<i>Cytospora</i> canker on peach .....	181
Fire blight (shoot blight).....	181
Fruit cracking due to excessive rain.....	181
<i>Cytospora</i> canker on peach .....	181
Fire blight (canker blight) .....	181
Glyphosate herbicide damage on pear .....	181
Gray mold on apple fruit.....	182
Marssonina blotch on apple leaves .....	182
Mucor rot on apple fruit.....	182
Hail damage on apple.....	182
Marssonina blotch on apple leaves .....	182
Necrotic leaf blotch .....	182
Honeycrips leaf yellows.....	182
Moldy core of apple .....	182
Nectarine pox .....	182
Nectria twig blight .....	183
Peach stem pitting .....	183
Phytophthora crown/collar/root rot on apple .....	183
Peach leaf curl .....	183
Pear leaf blight .....	183
Plum leaf spot .....	183
Peach scab on peach fruit.....	183

Pear scab .....	183	Japanese orchard bee hotel.....	188
Plum pockets.....	183	Green fruitworm larvae.....	188
Plum pox virus on leaves .....	184	Japanese beetle adults .....	188
Plum pox virus on mature fruit.....	184	Lesser appleworm adult moth.....	188
Powdery mildew on apple fruit.....	184	Obliquebanded leafroller injured apple terminal.....	189
Plum pox virus on leaves .....	184	Oriental fruit moth larva .....	189
Powdery mildew on apple blossom.....	184	Pear blister mite symptoms on foliage.....	189
Powdery mildew on cherry leaves .....	184	Oriental fruit moth adult .....	189
Plum pox virus on immature fruit.....	184	Peachtree borer empty pupal exuvia.....	189
Powdery mildew on apple leaves.....	184	Periodical cicada adult .....	189
Rhizopus rot on cherry fruit.....	184	Oriental fruit moth injured shoot (flagging).....	189
Rhizopus rot on peach fruit.....	185	Pear psylla adults .....	189
Sooty blotch and flyspeck on apple fruit.....	185	Plant-bug-injured fruit.....	189
Quince rust on apple fruit .....	185	Plum curculio adult on shoot sprayed with Surround.....	190
Rust disease on apple leaves .....	185	Skunk damage from hunting for grubs in orchard.....	190
Cedar-apple rust gall .....	185	White apple leafhopper nymph.....	190
Pear trellis rust on pear leaves.....	185	Rosy apple aphid colony.....	190
Rust disease on apple fruit .....	185	Spirea aphid on foliage .....	190
Quince rust on cedar .....	185	White peach scale .....	190
Pear trellis rust on pear fruit.....	185	Tufted apple bud moth adults .....	190
Rusty spot on peach fruit .....	186	Woolly apple aphid aerial colony.....	190
Southwest trunk injury.....	186		
White rot on apple fruit.....	186		
Sooty mold of pear on leaves.....	186		
Sunburn injury on apple.....	186		
Southern blight on apple .....	186		
White rot canker on apple.....	186		
<b>Insect and Mite Pests</b>			
Apple leafminer injury on leaf.....	187		
Brown stink bug (native).....	187		
Codling moth larva.....	187		
Brown marmorated stink bug adult and nymph.....	187		
Bumble bee on apple flower.....	187		
Dogwood borer larva .....	187		
Brown marmorated stink bug freshly hatched egg mass .....	187		
Codling moth adult moth .....	187		
European apple sawfly injured fruit.....	187		
European apple sawfly larva .....	188		
Green peach aphid on nectarine .....	188		
Japanese orchard bee on crabapple .....	188		
European red mite adults on leaf .....	188		
Gypsy moth caterpillar .....	188		

## IPM APPROACH

The modern approach to managing pests is referred to as integrated pest management (IPM). IPM involves compiling detailed, timely information about a crop and its pests to ensure that pest management decisions are economically, environmentally, and socially sound. In addition, IPM advocates integrating as many suitable pest management tactics as possible.

At the farm level, IPM is approached as a series of activities that culminate in a decision made by the grower (Figure 2-1). The first activity is gathering information about the environment, pest, and crop. This activity is termed scouting, or monitoring, and is performed frequently during the growing season. In scouting pests, the grower assesses the growth status and general health of the crop and determines the presence and intensity of pest infestations or the potential for future pest problems. The resulting data are entered into a record-keeping system such as a notebook or computer database.

The next step includes comparing pest levels noted during scouting with threshold values. Thresholds may be economically determined when the damage to the crop caused by a given pest population is compared with the cost of implementing a control procedure against that pest. If pest damage is higher, control is warranted. Other thresholds may be used depending on the goals of the fruit grower.

Once an over-the-threshold determination has been made, a control tactic or set of tactics can be selected and used. Tactics include biological control: using one organism to control another by predation, parasitism, or competition; cultural control: using horticultural practices such as planting disease-resistant cultivars, specialized pruning, and orchard sanitation; behavior modification, such as mating disruption; and/or use of necessary pesticides. The success of the control tactic should be assessed at a later date, usually the next monitoring period, and corrective action taken if necessary. All IPM activities should be permanently recorded so they can be used for making decisions in subsequent years. Increasingly, pesticide spray records are necessary for GAP, PRIMUS, and eco-label certifications to document pesticide use patterns and possible residues on fruit for export.

Some IPM practices should be performed in anticipation of future pest problems. These include pruning and shaping the tree to improve air circulation and prevent disease, selecting cultivars resistant to various pests, and managing the orchard to be hospitable to beneficial organisms, such as the mite predator *Typhlodromus pyri*. Other IPM practices occur after the growing season. Fruit from the orchard at harvest time represents a cumulative record of insect and disease activity for the season. This record can provide valuable insight into how well an IPM program is working and what changes in the program need to be made the following year. A sample of fruit from each orchard block should be inspected, insect and disease damage identified, and a written record made. The grower can refer to this record in subsequent years to make decisions about insect and disease control.

## BASICS OF INSECT MONITORING WITH SEX PHEROMONE TRAPS

The presence (or absence) of insect pest species in the orchard can be detected and monitored by a wide variety of traps and/or other methods, but the utilization of traps with an insect sex pheromone is probably the simplest and, at the same time, the most accurate way to monitor insect pests. Although various designs of traps work best for various pests, the general principle of how the average trap works is almost always the same: each trap needs to have a source of pheromone or attractant (usually rubber- or plastic-based lure/septa with incorporated sex pheromone and/or attractant), means to capture visiting moths (usually floor or liner coated with nondrying glue) and some kind of plastic or paper dome to protect the lure and floor.

The pheromone traps can be used to monitor insect species that are able to release pheromones. Most lepidopteran insects (moths and butterflies) produce pheromone to improve the ability of one gender individuals to find the individuals of the opposite gender. As long as the sex pheromone for the species is identified and can be manufactured, there is a possibility that pheromone traps can be used for monitoring of this species. And although the pheromone traps are a great tool for insect monitoring, they will not control insect pests by themselves. In the specific orchard ecosystem, traps are competing with the female moths in attracting male moths, but since normally there are a lot of more wild moths than traps, there is a strong possibility that mating occurs anyway and female moths will still be able to deposit viable eggs.

In Pennsylvania orchards, numerous insect pests can be responsible for injuries on fruit. The importance of individual pest species fluctuates from year to year, but almost always the most important pests will be part of the leafroller complex with tufted apple bud moth (TABM), obliquebanded leafroller (OBLR), internal fruit feeders complex with Oriental fruit moth (OFM) and codling moth (CM), or borers such as dogwood borer or peachtree borer. Fortunately, with the current emphasis on practical implementation of IPM methods, the sex pheromone traps for all of those species are commercially available.

A single trap should be used to monitor only a single insect species. In properly monitored orchard, at least two traps per species should be used per block. In larger blocks—more than 20 acres—at least one trap per every 10 acres should be employed. It is important traps within each block be placed in such locations to provide accurate readings of moth pressure. Placing traps too far away from, or close to, possible moth sources such as large bin piles or abandoned or neglected orchards may provide inaccurate image of actual pest pressure. In orchards where only the absolute minimum trapping program is to be implemented, and traps will be used only to provide information about the best timing for insecticide applications, at least two traps per species have to be used per farm.

For proper monitoring of various insect pests, the pheromone traps should be placed no closer to the border of the blocks than on the second or third row/tree from outside of the orchard. All traps placed in the orchard should be easily accessible by the person who will monitor them. The optional height for trap placement on the tree is at about 5 to 7 feet from above the ground, although traps for some pest species, especially codling moth,

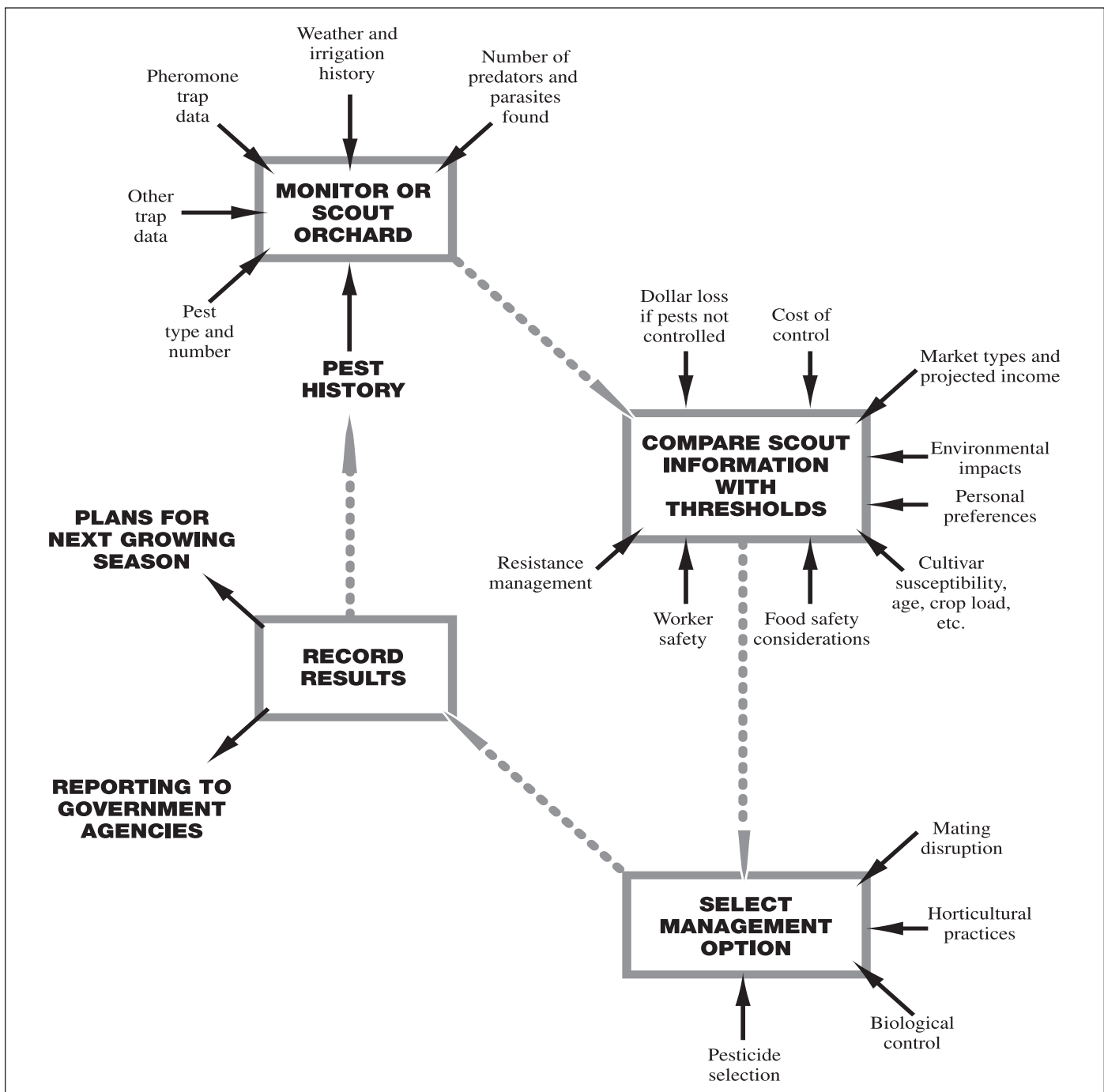

Figure 2-1. How to make an integrated pest management decision.

should be placed in the upper fourth of the tree height. For this higher placement, traps can be attached to bamboo posts and elevated into the upper part of the canopy. All traps should be placed within a tree's foliage, not outside of the tree. To make it easier for the person who will monitor traps during the season, traps for different pest species can be located on adjacent trees. It also may be helpful if the trees and tree rows with the traps will be marked with contrasting flagging tape.

The pheromone-loaded rubber lure attracts moths only for a set period of time, usually from four to eight weeks depending on the lure specification. In order to maintain reliable pest monitoring, the lure needs to be replaced before its attractiveness starts to deteriorate. Usually, the manufacturer provides the information

for how long a lure will be active in the orchard. The glue-coated floors or liners also need to be replaced regularly, especially if high numbers of moths are being collected regularly and the glue layer is no longer sufficient to capture moths. In contrast to lures, which cannot be reused, the liners after cleaning and coating with new layer of glue can be reused in traps. It is very important that the reusable liners be used only in the traps for the same species as they were used previously.

Insect pheromones are species specific, and each species use a different set of chemicals to attract individuals from the opposite sex. Therefore, unless the trap (or the lure) is contaminated with some other pheromone specific chemicals, only the addressed species should be encountered in the trap. Of course, various



colors of the traps can also attract other insects by visual attraction, but the presence of other insect species in the trap most likely will be incidental and/or sporadic.

With the yearly estimated price of monitoring system for one species (two traps, 10 lures, 10 liners) circulating around \$40 to \$70 (without labor), the traps will pay for themselves in no time. A vigilant monitoring system should help growers avoid problems with unexpected occurrence of pests in the orchard. Even, as a result of pest monitoring, additional insecticide application will be necessary to manage detected problem, dealing with the infestation before actual fruit damage occurred seems to be a much better approach than dealing with injured fruit at harvest.

Unfortunately, in our Mid-Atlantic fruit region, a number of other common pest species such as stink bugs, apple maggot, plum curculio, European apple sawfly, or various plant feeding bugs also can create a serious threat to fruit. This group of pests does not have a good sex-pheromone-based monitoring system; however, other trapping/monitoring methods using other means such as visual attractants or food-odor-related cues are also being used for pest detection. It is very important that growers monitor these pests as well.

Even though the best designed and most complete monitoring program will not eliminate the insect problems from the orchards, such activity will certainly help to better manage fruit pests.

### Integrated Pest Management Supply Sources

Supplies such as pheromones, traps, and environmental monitors may be purchased at some local orchard supply dealers or ordered by mail. Some mail order outlets are:

AgBio Inc.  
Westminster, CO 80031  
Ph.: 303-469-9221  
Fax: 303-469-9598  
Email: agbio@agbio-inc.com  
Web: www.agbio-inc.com

Alpha Scents  
1089 Williamette Falls Dr.  
West Linn, OR 97068  
503-342-8611  
Email: sales@alphascents.com  
Web: www.alphascents.com

Gempler's  
211 Blue Mounds Rd.  
Mt. Horeb, WI 53572  
800-382-8473  
Email: custservice@gemplersmail.com  
Web: www.gemplers.com

Great Lakes IPM  
10220 Church Rd.  
Vestaburg, MI 48891  
800-235-0285  
Email: glipm@greatlakesipm.com  
Web: www.greatlakesipm.com

Suterra LLC  
20950 NE Talus Place  
Bend, OR 97701  
541-388-3688  
Email: agsales@suterra.com  
Web: www.suterra.com

Trece Inc.  
PO Box 129  
Adair, OK 74330  
866-785-1313  
Email: custserv@trece.com  
Web: www.trece.com

## DISEASES, DISORDERS, INSECTS, MITES, AND BENEFICIAL INSECTS: BIOLOGY, MONITORING, AND MANAGEMENT

This section gives descriptions of common diseases, disorders, insect and mite pests, and natural enemies. Included in each description is a brief discussion of life cycle, habits, and damage symptoms; instructions for monitoring for IPM decision-making; and suggestions for nonchemical or cultural management techniques. A color section of diseases and insect pests begins on page 177.

## Diseases and Disorders in Pennsylvania

### 2,4-D DAMAGE

The herbicide 2,4-D has been labeled for use in tree fruit production for many years. Like glyphosate, it is one of the tools that can be used to control perennial orchard weeds. Damage may show up shortly after application or the following year. Typically, the damage appears as twisting, curling, or fanning of foliage. The damage results from the effects of 2,4-D stimulating abnormal cell growth due to disruption of the vascular system and photosynthesis. In general, the leaf petiole will twist, causing the leaf to turn upside down. With the release of dicamba-tolerant field crops, you may see damage from this herbicide. Trees exposed to dicamba drift will show the production of tissue proliferations at the nodes of the plant. Dicamba drift can sometimes be distinguished by a greater cupping of individual leaves as opposed to twisting of the leaf petiole.

### ALTERNARIA BLOTCH APPLE

Alternaria blotch of apple has been a serious issue in North Carolina for several decades. The disease was first observed in West Virginia in 2008. In Pennsylvania, Alternaria blotch of apple is present, but hasn't been an economical issue. Severity can vary from year to year; however, Alternaria blotch severity is affected by severe mite infestation. Consequently, a good mite management program is important for managing this disease.

#### Symptoms

Lesions first appear on leaves in late spring or early summer as small, round, purplish or blackish spots, gradually enlarging to 1/8 to 1/4 inch in diameter and have a purple border. Some spots turn grayish brown, but most lesions may coalesce or undergo secondary enlargement and become irregular and much darker, acquiring a "frog-eye" appearance. When lesions occur on petioles, the leaves turn yellow and 50 percent or more defoliation may occur. Severe defoliation leads to premature fruit drop. Fruit infections result in small, dark, raised lesions associated with the lenticel. Alternaria blotch is most likely to occur on Delicious strains and should not be confused with Marssonina blotch, frog-eye leaf spot, captan spot, or Golden Delicious necrotic leaf blotch. Marssonina blotch will always have small, black fruiting bodies visible on the surface of the lesion. Frog-eye leaf spot usually appears earlier in the season and is associated with nearby dead wood or fruit mummies. Captan spot spray injury occurs when captan fungicide is applied under wet conditions and associated with two to four leaves on terminals, representing a spray event. Golden Delicious necrotic leaf blotch commonly occurs in July and August as a result of physiological stress caused by fluctuating soil moisture. Alternaria leaf blotch tends to be uniformly distributed throughout the tree.

#### Disease cycle

Caused by *Alternaria mali*, the fungus can overwinter as mycelium on dead leaves on the orchard floor, in mechanical injuries in twigs, or in dormant buds. Primary infection takes place about one month after petal fall. The disease advances rapidly in the optimum temperature range of 77 to 86°F and wet weather. At optimum temperatures infection occurs with 5.5 hours of wetting, and lesions can appear in the orchard two days after infection, causing a serious outbreak. The fungus produces a chemical toxin that increases the severity of the disease on susceptible cultivars.

### Disease management

Protective fungicides (mancozeb, ziram, captan, etc.) are recommended at the time of primary infection (petal fall to mid-June), as well as for a summer disease program since these chemicals will protect the fruit. In addition, some strobilurin fungicides (FRAC Group 11) are registered for management of *Alternaria* blotch in the U.S. Chopping leaves with a mower or removing them from the orchard will help reduce the inoculum level for the following season. Since defoliation from the disease is more severe if high mite populations are present, mites should be maintained at or below the established IPM thresholds.

#### ALTERNARIA ROT

*Alternaria* rot is a common fungus found on stone and pome fruit. The disease can occur during preharvest and postharvest.

#### Symptoms

*Alternaria* rot is characterized by circular, dry, firm, shallow lesions covered with dark, olive green to black surface mycelial growth. The infected tissue is brown, like that caused by brown rot. The disease typically develops near insect feeding injuries, when fruit is overripe, in split pits of fruit, around skin breaks, or at the calyx or stem insertion.

#### Disease management

Preventing skin injury is key to managing this disease. The strobilurin class of fungicides (FRAC Group Code 11) is most effective for managing *Alternaria* rot on both pome and stone fruit.

#### ANTHRACNOSE OF PEACH

The first report of anthracnose occurring in the United States came from California in 1916, where it was found on almond. Significant losses from peach anthracnose were prominent during the late 1940s, especially in the southeastern states. Most years, anthracnose is considered a minor disease of peach. In past years the disease has occurred sporadically on fruit. If left unchecked, peach anthracnose can cause serious fruit rot infection.

Peach anthracnose is caused by fungal species in the *Colletotrichum* genus, which includes members in the *C. acutatum* species complex and *C. gloeosporioides* species complex. These species can also cause bitter rot of apple and pear. These fungi have a very broad host range, including apples, pears, nectarines, plums, tart cherries, grapes, nuts, vegetables, various legumes, herbaceous annuals, and perennials. Because of this wide host range, the disease can become established in peach orchards in a short time.

#### Symptoms

The disease begins as lesions characterized by small, brown spots that become darker, circular, and slightly sunken as they age. Young lesions may be confused with those of brown rot caused by *Monilinia* species, and *Botryosphaeria* species (black rot and white rot). At this stage, identification depends on laboratory isolations. In time the lesions become brown and sunken. Large, sunken anthracnose lesions are firm to the touch and are often covered with concentric rings of salmon-colored spore masses. The salmon-pink sticky spore mass is a characteristic symptom of anthracnose on peach and other fruits.

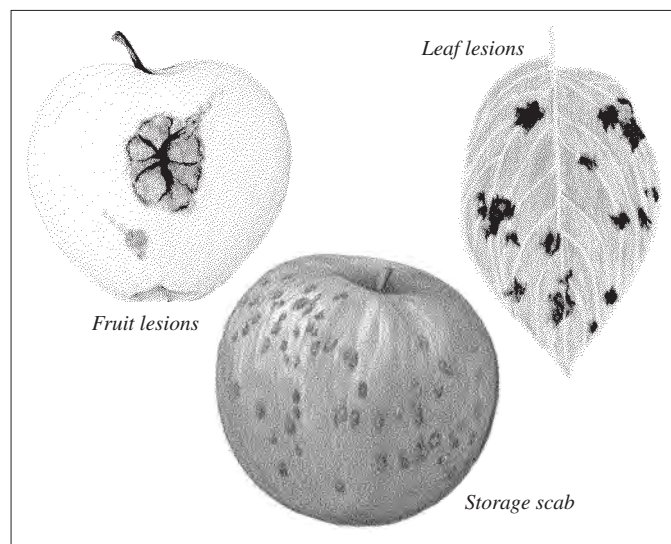

Apple Scab

#### Disease cycle

The fungus overwinters on mummified fruit and in cracks and crevices in the bark. The fungus can also overwinter on other host species near the orchard. Anthracnose is spread by the dispersal of fungal spores that occurs by splashing rain. Warm, moist weather favors disease development (75–86°F). Once young peach fruit are infected, the fungus grows through the fruit and into the phloem of the twig. The infected twig remains alive throughout the winter and dies in the spring. Once the twig dies, the fungus sporulates on the surface of the twig.

#### Disease management

Orchard floor and perimeter management that eliminates leguminous hosts and wild *Prunus* species should be practiced to prevent the spread of disease. Captan and fungicides in FRAC Group 11 will control this fruit rot.

#### APPLE SCAB

Apple scab is Pennsylvania's most important apple fungal disease, attacking wild and cultivated apple and crabapple. Early season disease management is directed primarily at controlling apple scab.

#### Symptoms

The first infections often occur on the leaves surrounding flower buds. Dull, olive green areas visible on the undersides of leaves are the first evidence of the disease. As the lesions (infected areas) become older, they assume a definite outline as olive-green or brown circular spots. Leaves are susceptible to infection for about five days after they unfold. Severe early leaf infection can result in dwarfed, twisted leaves, which may drop later in the season.

Early infection may occur on the calyx (blossom end of the fruit) or on the pedicel (fruit stem). Severe pedicel infection results in fruit drop. Fruit may become infected at any time in its development. Typical fruit lesions are distinct, almost circular, rough-surfaced, olive-green spots up to ¾ inch in diameter. Heavily infected fruits are usually misshapen and may crack and drop prematurely. When leaf infection is active just before harvest, the fruit may become infected. These spots do not show at harvest time but develop slowly, while the apples are in storage. This phase of apple scab disease is termed storage scab.

### Disease cycle

The apple scab fungus (*Venturia inaequalis*) overwinters in infected leaves that have fallen to the ground. Fruiting bodies are produced within the dead leaf tissue. As spring approaches these begin to mature and produce spores (ascospores; primary phase) that are discharged into air currents and carried to developing apple buds. The fruiting bodies in the fallen leaves must be wet for the spores to discharge. The ascospores are not all discharged with the first spring rains, for they mature over a four- to six-week period. This period usually coincides with the time that elapses from ¼ inch green until two to three weeks after petal fall. Mature ascospores peak from late pink through petal fall, which is the most critical time for protection during the primary phase of the disease, especially if ideal environmental conditions favoring disease are present.

When the spores land on wet apple buds, leaves, or fruit, and if they remain wet for a few hours, they germinate and grow into the apple tissue. The time required for germination and penetration depends on temperature and the presence of a wet surface. At 39°F, 28 hours of continuous wetting is required for infection, while at 61 to 75°F, only six hours are required (Table 2-1). After the fungus has penetrated, it continues to grow and enlarge beneath the cuticle. After 9 to 17 days (development occurs most rapidly at higher temperatures) a visible scab lesion is produced. On its surface appear more spores (conidia; secondary phase), which are easily dislodged when the lesions are wet. The spores are splashed around by rain and blown by wind to new leaf and fruit surfaces within the tree. They germinate on wet surfaces, infect the tissue, and produce a new lesion. In this manner, several secondary infection cycles may occur in the course of a growing season. Infection is rare above 78°F.

### Disease management

Sanitation can be effective for managing apple scab. Leaf tissue is necessary for the spores to survive and orchards are self-infecting since spores can travel about 100 feet. To reduce the number of available overwintering spores present, apply a 5 percent solution of urea (46-0-0) in water to apple trees as leaves begin to fall in the autumn to aid in the breakdown of leaf tissue (42 pounds of urea in 100 gallons of water). Urea may also be sprayed on the leaves on the ground, after all of the leaves have fallen. If urea is not used, any ammonium-based nitrogen will be sufficient. Since nitrogen is being applied, adjust your fertilizer program accordingly. Shredding leaf litter using a flail mower or remove leaf litter by raking, sweeping, or vacuuming are additional options. Shredding leaf litter assists the decay of the plant material, as well as aids in the reorienting the leaves, thereby disrupting ascospore discharge.

Scab infections may be prevented by applying fungicides at regular intervals throughout the growing season. The object is to provide a protective coating that will inactivate any spores landing on the fruit and foliage. It is critical to control scab early in the season from bud emergence through the second cover period. The most important time during this period will be from late pink through petal fall. This will be the greatest threat for infection if disease conditions occur since the maximum amount of mature ascospores will be available. If disease conditions are favorable from late pink through petal fall, growers are encouraged to use complete sprays for greatest protection. If scab infection can be prevented during the time all the ascospores are discharged from

**Table 2-1. Calculating apple scab infection periods using the Revised Mills Table.**

Temperature (°F) <sup>a</sup>	Wetness (hours) <sup>b</sup>	Lesion appearance (days) <sup>c</sup>
34	41	—
36	35	—
37	30	—
39	28	—
41	21	—
43	18	17
45	15	17
46	13	17
48	12	17
50	11	16
52	9	15
54–56	8	14
57–59	7	12–13
61–75	6	9–10
77	8	—
79	11	—

- Add lowest and highest temperatures during wet period and divide sum by 2 to get average.
- Calculate hours of wetting by either (1) beginning the count at the time leaves first become wet and ending the count when the relative humidity drops below 90 percent, or (2) adding consecutive wet periods (hours) if the leaves are again wetted within 8 hours from the time relative humidity dropped below 90 percent.
- Number of days required for lesions to appear after infection has been initiated. If conditions are unfavorable for lesion development (prolonged periods above 80°F or very dry weather), additional days may be required.

the fruiting bodies in the fallen leaves, the disease cycle is broken and no further source of infection remains for the rest of the season. However, if the cycle is not controlled and leaf and fruit infection occurs, then conidia are produced on these lesions and scab will remain a constant threat all season whenever wet weather occurs.

Growers are encouraged to rotate chemicals by FRAC Groups when controlling for apple scab, as well as tank-mixing with a broad-spectrum fungicide, such as a rainfast mancozeb to minimize fungicide resistance. During very wet conditions early in the season, using a rainfast mancozeb or adding a spreader-sticker adjuvant to the tank mix will allow mancozeb to persist a little longer despite heavy rainfall. This will allow a buffer time for reapplication of fungicides. See Part III for more information on fungicide resistance management strategies.

### Apple Chlorotic Leaf Spot Virus

Apple chlorotic leaf spot virus (ACLSV) is one of the most widely distributed viruses of fruit trees and is found in many pome and stone fruit trees. ACLSV does not cause readily observable symptoms in most commercial cultivars in production and is considered a latent virus. No natural vector of this virus is known. Chance root grafting in apple orchards is one method of tree-to-tree transmission of the virus.

### Disease management

Virus certification programs are the only effective means of control since ACLSV is transmitted only through grafting.

**APPLE MOSAIC VIRUS**

Apple mosaic virus (ApMV) is found wherever apple trees are grown. In the spring, pale yellow to cream-colored areas develop on expanding leaves of infected apple trees. These areas may appear as small spots, flecks, irregular blotches, vein-net patterns, line patterns, or bands along major veins. As the season advances, they become light chrome yellow or white and then soon become necrotic. Severely affected leaves drop prematurely. Reduction in yield are slight; no symptoms develop on most fruit cultivars. There is no known vector of this virus. Perpetuation of the virus in orchards is primarily due to using infected stock material and through chance root grafting.

**Disease management**

Rogueing infected trees and using certified disease-free planting stock are effective control measures.

**APPLE STEM GROOVING VIRUS**

Apple stem grooving virus (ASGV) in conjunction with apple stem pitting virus and apple chlorotic leaf spot virus comprise the three common viruses in apple that are considered latent and do not induce acute symptoms. No natural vector of this virus is known.

**Disease management**

Virus certification programs are the only effective means of control since ASGV is transmitted only through grafting.

**APPLE STEM PITTING VIRUS**

Apple stem pitting virus (ASPV) is latent in most common commercial apple cultivars. There are no obvious symptoms associated with infection on most scion/rootstock combinations, but there is still potential for reduced production, as reported for Golden Delicious apples when infected with the three latent viruses: ASGV, ASPV, ACLSV. No natural vector of this virus is known.

**Disease management**

Virus certification programs are the only effective means of control since ASGV is transmitted only through grafting.

**APPLE UNION NECROSIS AND DECLINE**

Apple union necrosis is an economic problem only in commercial apple orchards. Ornamental crabapples and other *Malus* species appear unaffected, as do most apple cultivars on seedling rootstocks. Tomato ringspot virus (ToRSV) has been isolated from clonally propagated, size-controlling rootstocks and Malling Merton 106 (MM.106) is the most frequently, naturally infected clone.

**Symptoms**

Apple trees infected with ToRSV normally begin to exhibit symptoms when they reach bearing age. Foliation is delayed on infected trees, the leaves are small and sparse, and their color is a dull, pale green. Terminal shoot growth is reduced, the stem internodes are short, and infected trees flower heavily and set large crops of small, highly colored fruit. Partial or complete separation of the graft union is common on severely affected trees. Removal of the bark above and below the graft union

**Table 2-2. Susceptibility of apple rootstocks and scions to apple union necrosis and decline disease.**

<b>Susceptible rootstocks</b>					
M.26	MM.106	MAC-30	MAC-39	P-2	
<b>Partially susceptible rootstocks</b>					
M.27	MM.111	Bud9	MAC-1	MAC-9	Ottawa 3
P-18					
<b>Resistant rootstocks</b>					
C6	Robusta 5	M2	Bud-146	M4	Bud-490
M7	Bud-491	M9	Kansas-14	M13	NAC-24
P-1	MM.102	P-13	OAR-1	P-16	Ottawa 7
P-22	Ottawa 11	CG10	CG24		
<b>Susceptible scions</b>					
Stayman	Paulared	Tydemans' Early	Ginger Gold		
Spartan	Winesap	Red Delicious			
<b>Resistant scions</b>					
Rome Beauty Empire		Golden Delicious			

*Note: Rootstocks and scions that are not listed have not been tested under controlled conditions.*

reveals abnormally thick, spongy, orange-colored bark and a distinct necrotic line at the scion-rootstock union.

The severity of apple union necrosis is influenced by the cultivar-rootstock combination. Red Delicious on MM.106 rootstocks is the most severely affected combination and may exhibit severe graft union necrosis followed by decline and death. The symptoms are generally less severe on other cultivars. See Table 2-2 for a summary of rootstocks and scions that have been reported as resistant or susceptible to apple union necrosis and decline disease. Rootstocks and scions not on the list have not been reported.

**Disease management**

Although dagger nematodes are the primary vectors of ToRSV, other factors are important in the spread of the virus in woody fruit crops. Because apples are propagated by grafting, it is important to purchase certified virus-free trees. A good weed management program is necessary since infected weeds act as reservoir hosts and can play a major role in spreading ToRSV.

**BACTERIAL CANKER**

While bacterial canker can occur on all stone fruit trees, and on apple and pear blossoms, it is important only on sweet cherry and ornamental flowering cherry trees in the northeastern United States. It is caused by the bacterium *Pseudomonas syringae*. Several other names (most commonly, gummosis and sour sap) have been used for the same disease.

**Symptoms on sweet cherry trees**

Bacterial canker affects branches, twigs, buds, leaves, and fruit. The most conspicuous symptoms are the cankers and the dying branches they girdle. On twigs cankers are darkened areas often located at the base of buds. On limbs or trunks cankers are frequently darker than normal bark, sunken in their centers, and may extend for a considerable distance. Gumming is frequent in the spring and fall, when the disease is most active. Leaves and shoot growth beyond the canker may wilt and die during the growing season when cankers girdle a branch or the trunk. Leaf and flower buds are killed during the dormant season, probably as a result of infection during the fall. Small cankers often develop at the base of these dead buds. At times, infected fruiting spurs blossom normally, only to wilt and die shortly afterward.

During periods of cool, wet weather after bloom, leaf and fruit infections may be common. The leaf spots are mostly angular in

shape and dark purple, brown, or black; they are common on leaf margins. The infected areas of the leaf may drop out, producing a tattered appearance, or the entire leaf may yellow and fall. Fruit infection shows as deep, black depressions, as does infection of fruit stems.

#### **Disease cycle**

Causal bacteria overwinter in the margins of cankers in wood and in infected buds. In spring, during wet periods, the bacteria multiply and ooze from the cankers. Spread by rains, they enter the plant through natural openings or wounds. Periods of frequent rain, cool temperatures, and high winds are most favorable for infection. Frost-injured leaves and blossom spurs and cold-injured trees seem especially susceptible. With the higher temperatures of late spring and summer, disease development stops. At this time the newly formed buds become infected through either leaf scars or bud scales, or both.

#### **Disease management**

While bacterial canker can be a severe disease, it is often much more severe on cold-injured trees and trees growing in sites with poor internal soil drainage.

The causal bacteria can be transmitted by pruning tools, so these should be disinfected between prunings if bacterial canker is present. For trees with a known history of bacterial canker, pruning is best completed after harvest during the summer when conditions are hot and dry. Bacterial populations will be at their lowest during this period and the risk for infection is reduced. Affected limbs should be pruned several inches below the canker so that an “ugly stub” remains in order to limit the spread into the tree.

Sprays during the growing season have not been effective in controlling the disease. Some benefit has been achieved from copper applications made when most of the leaves have dropped in the fall and just before bud swell in the spring. For maximum benefit, these sprays should be continued for several years on susceptible trees. Research out of Oregon has shown that using an application of 10 percent lime sulfur starting at leaf drop (September–October) is very helpful controlling the disease for the coming season. Ideally, daytime temperatures should be 70–75°F, which will allow the lime sulfur to heat up and kill the bacteria. Since lime sulfur will wash off, rain should not be in the forecast at the time of application. Only one application per season is necessary.

#### **BACTERIAL SPOT**

Bacterial spot occurs in most countries where stone fruits are grown. The disease is caused by a bacterium *Xanthomonas arboricola* pv. *pruni* (formerly *Xanthomonas campestris* pv. *pruni*). Other names for the disease are bacteriosis, bacterial leaf spot, or bacterial shot hole. Common hosts include peach, nectarine, prune, plum, and apricot. Other hosts are sweet and tart cherry, almond and wild peach. Cultivars within *Prunus* species vary widely in their susceptibility to this disease. The disease affects fruit, leaves, and twigs. Fruit loss on some cultivars can be very high. Early and severe defoliation can affect fruit size and the winter hardiness of buds and wood.

#### **Symptoms**

The symptoms of bacterial spot are quite different from other diseases of stone fruits. They may be confused with nitrogen deficiency and spray injury. The disease first appears as small, water-soaked, grayish areas on leaves. Later the spots become angular and purple, black, or brown in color; the lesions always are delineated by the leaf veins. The mature spots remain angular and are most numerous at the tip ends and along the midribs of leaves. The infected areas may drop out, giving the infected leaves a shot hole, tattered appearance. On plum, the shot-hole effect is more pronounced than on other stone fruits. Infected leaves eventually turn yellow and drop. Severe defoliation often results in reduced fruit size and increased sunburn and fruit cracking. As a result, tree vigor and winter hardiness are also reduced. Other leaf spot diseases and spots due to spray injury tend to be much more circular in outline. These spots can vary in size from a pinprick to larger depending on the size of the water droplet. These are typically not confined by veins in the leaf like bacterial spot.

Fruit infected early in the season develop unsightly deep-pitted blemishes and may exhibit gumming. Since the infected areas cannot expand with increased fruit size, the spots crack as the fruit matures. Pits or cracks on the fruit surface extend into the flesh and create large, brown to black depressed areas on the fruit surface. Shallow pitted lesions that develop after pit hardening are usually superficial and give the fruit a mottled appearance. On plum, the fruit symptoms are likely to be quite different in that large, black, sunken areas are most common. On a few cultivars small, pitlike spots occur. Cracks on fruit serve as points of infection by the brown rot fungus as the fruit ripens.

On peaches and nectarines, twig symptoms usually consist of cankers on the previous year's growth associated with and initially extending to about an inch on either side of leaf and flower buds; these affected buds usually fail to open. These overwintering cankers, often termed spring cankers, are first visible during bloom. A canker extending downward from the terminal bud that fails to open is referred to as a “black tip.” When conditions are moist, the canker surface has a black, water-soaked appearance. As the season progresses, the canker can lengthen and the bark surface cracks. Summer cankers are formed on current-season growth and are visible early to midsummer (June through early August).

#### **Disease cycle**

The bacterial spot pathogen overwinters in association with buds, in protected areas on the woody surface of the tree (e.g., cracks in the bark), and in leaf scars that become infected during leaf drop the previous season. In late winter as temperatures are above 65°F, leaf and flower buds swell, new tissue emerges, and the bacteria begin to multiply. The bacteria are spread from cankers by dripping dew and in splashing and/or wind-blown rain to the newly emerging leaves. Bacteria can also infect through natural openings or wounds. High-moisture conditions (frequent rain and humidity) are very favorable for both leaf and fruit infections. Leaf infections can occur for at least as long as terminal growth and leaf emergence continue. Severe fruit infections are more common when frequent periods of rainfall or even extended heavy dews and very high humidity occur from late bloom to near pit-hardening. Bacterial spot is more severe in areas where peaches are grown in light, sandy soils and disease is more severe on stressed trees. Wind and wind-blown sand can

increase the severity of bacterial spot by creating wounds for the bacteria to infect.

### Disease management

Bacterial spot is very difficult to control on highly susceptible cultivars. Under optimal environmental conditions for disease development, control can be difficult even on moderately susceptible cultivars. Control and management measures must be applied preventatively to successfully reduce losses from this disease. Once bacterial spot symptoms are observed, it is almost impossible to bring the disease under control if environmental conditions remain favorable. Environmental conditions that favor bacterial spot development include heavy rain events when temperatures are above 75°F. Extended periods of hot, dry weather reduce the threat of the disease.

Planting resistant cultivars is the most effective control measure. An increasing number of good peach cultivars are highly resistant to bacterial spot. Resistance in plums, nectarines, and apricots is not as common. Most, if not all, cultivars developed west of the Rocky Mountains are highly susceptible because they are bred in an environment unsuitable for disease development. Many of the new low-acid white and yellow stone fruit cultivars are highly susceptible to bacterial spot infection. Check with the nursery on the bacterial spot susceptibility before purchasing and planting new stone fruit cultivars.

Major outbreaks of bacterial spot in young orchards are often attributed to poor cultural practices. Trees in poor vigor are more susceptible, so orchard management programs should be designed to maintain good vigor. High populations of ring nematode have also been associated with increased bacterial spot, which may be related to stress caused by the nematodes. Minimize blowing sand and/or soil particles within and surrounding the orchard by employing appropriate ground covers and/or by use of appropriately placed windbreaks to blunt the damaging effects of strong winds while still allowing for air movement through the orchard.

There are no completely successful spray programs for control of bacterial spot. Chemical sprays with copper-based bactericide and the antibiotic oxytetracycline have moderate efficacy but must be used preventatively. Copper-based sprays are applied from dormant to shuck-split phenology stages to reduce initial inoculum. Because of high sensitivity of peach foliage to copper, rates are reduced progressively in successive sprays during this period. For the cover sprays that start at shuck-off, copper can be used at 0.5–1.0 oz/A of metallic copper. This low rate can still cause phytotoxicity; however, it will be a tool that can be used with other products in rotation. Other products include the antibiotic oxytetracycline (Mycoshield or FireLine), which helps suppress the development of the disease but does not eliminate it. Bacterial-based products (Serenade, Double Nickel) have shown utility in Pennsylvania when used in rotation with copper under conditions of low to moderate disease pressure. Including Regalia in rotation has shown efficacy, particularly for cultivars with moderate susceptibility. Because chemical control is uncertain, planting resistant cultivars appears to be the best long-term control strategy. If crop loss results from severe winter temperatures or early spring freezes, bacterial spot must still be managed on susceptible varieties during the season to prevent defoliation and inoculum buildup for the next season.

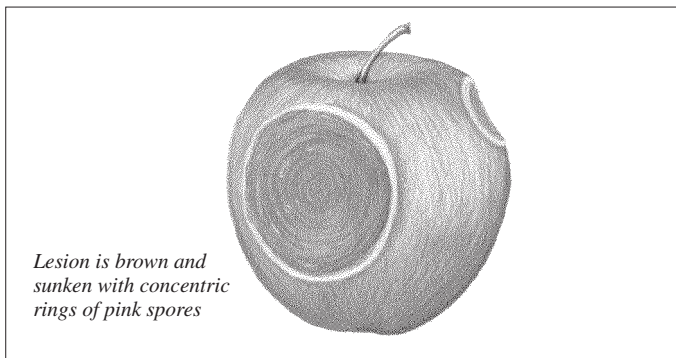

Lesion is brown and sunken with concentric rings of pink spores

### Bitter Rot

When using copper during cover sprays, be mindful of conditions that will promote phytotoxicity, such as slow drying conditions, acidic spray mixtures, and tank mixing with foliar fertilizers or adjuvants.

### BITTER PIT AND CORK SPOT

Bitter pit is the result of a calcium deficiency in apples. The cause of this disorder is complex and involves the cultivar, the growing season, calcium levels in the fruit, moisture levels, crop load, and shoot growth. It is a particular problem with Honeycrisp, York Imperial, Golden Delicious, and Delicious. For a detailed discussion of the causes and treatment, see Cork Spot and Bitter Pit Fruit Disorders in Part I.

### BITTER ROT OF APPLE

For the last several years, bitter rot has become an important fruit rot on apple in Pennsylvania. Bitter rot on apple and pear fruit is caused by the pathogenic fungi in the *Colletotrichum* genus, specifically those species in the *C. acutatum* and *C. gloeosporioides* species complexes. Similar causal pathogens are also responsible for anthracnose disease on peach, anthracnose fruit rot on blueberry and strawberry, ripe rot on grape, anthracnose on pepper, and blossom-end rot of green burrs on chestnuts. The predominant species causing bitter rot on apple in Pennsylvania is *C. fioriniae*. *Glomerella cingulata* (sexual stage of *C. gloeosporioides*) causes a leaf spot disease and this does not occur in Pennsylvania because we do not have the fungal species in apple orchards. *G. cingulata* is predominantly found in southern states, such as North Carolina.

### Symptoms

Bitter rot occurs only on fruit. Cankers can form on twigs, but they are rare. The fungus is one of the few fruit rot organisms that can penetrate the unbroken skin of the fruit. When the spore penetrates the skin, the infection will then go dormant (quiescent phase) for a period of time. During this time, the spore does not grow and is not susceptible to fungicides. Consequently, fungicides need to be applied prior to the initial infection of the spore. Maturity of the fruit, temperature, humidity, and presence of disease are factors that determine when the quiescent period ends and the disease symptoms manifest. Bitter rot typically manifests in July and August, and fruit susceptibility increases as it begins to mature. The disease is noticed first as a small, light brown, circular spot. One or many spots may appear; if temperature and humidity are high, they enlarge quite rapidly and soon change to a dark brown. By the time the spots are  $\frac{1}{8}$  to  $\frac{1}{4}$  inch in diameter, they

are distinctly sunken or saucer shaped. When they reach ½ inch in diameter, small black dots, the fruiting bodies of the fungus, appear in the sunken lesion. These may be arranged in concentric rings. Later, they ooze a gelatinous, salmon-pink mass of spores, washed by rains to other fruit. When cutting through the lesion on the horizontal axis of the apple, the flesh is light brown and watery in a cone-shaped area, with the small end of the cone toward the fruit center. As the fruit ripens, it decays rapidly and finally shrivels into a mummy.

#### **Disease cycle**

Bitter rot spores are suspected to overwinter in buds, mummified fruit, cracks and crevices in the bark, and cankers produced by either the bitter rot fungus or other diseases. Spores have been detected as early as pink bud. With the advent of warm weather the fungus produces spores washed by rains to developing fruit. The optimal conditions for the disease to develop are rainfall, relative humidity of 80 to 100 percent, and a temperature of 80 to 90°F. Frequent rain events, which lead to extensive wetness hours during bloom and during the latter half of the season (July through September), have yielded significant bitter rot outbreaks.

#### **Disease management**

Cultivars vary in their susceptibility with the most susceptible being Rome, Honeycrisp, Jonagold, Empire, Nittany, McIntosh, and Liberty. Sanitation is important for any kind of fruit rot management: removal of old fire blight cankers, dead wood, mummified fruit, and encouraging breakdown of brush. Currently, full season management is necessary to prevent bitter rot. Warm temperatures and frequent wetting events, which cause prolonged wetness hours, during bloom will need to be monitored closely. Fungicide sensitivity assays performed at Penn State have shown few products control the predominant fungal species causing bitter rot in Pennsylvania (*C. fioriniae*). To date, the most effective products managing bitter rot include mancozeb, captan, and pyraclostrobin, which is found in Merivon and Pristine. The pathogen is resistant to trifloxystrobin (Flint Extra and Luna Sensation), kresoxim-methyl (Sovran) and thiophanate methyl (Topsin-M). Tank mixtures of Merivon and mancozeb are encouraged to be applied from bloom through first cover (as least two complete applications). Rain events and prolonged wetness hours will have to be monitored closely during the summer, as well. During summer cover sprays, regular captan (3 lb/A) applications are necessary. To control late season infections and postharvest rots, another application of Merivon is recommended near harvest.

#### **BLACK KNOT OF PLUM**

Black knot of plum, caused by the fungus *Dibotryon morbosum*, is well-named because of the characteristic black, warty knots it forms on branches of infected trees. Such trees grow poorly and gradually become stunted; occasionally, their limbs may be girdled. The disease is most important on plum trees and, secondarily, on cherry trees.

#### **Symptoms**

The disease is present only in the woody parts of trees, occurring most frequently on twigs and branches and sometimes on trunks and scaffold limbs. The warty swellings first become visible in late summer or the following spring on new shoots. At first the

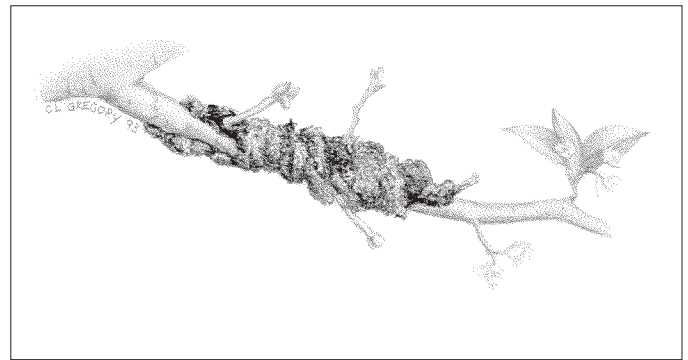

**Black Knot of Plum**

knots are somewhat greenish and corky, but with age they become black and hard. They vary in length from an inch to nearly a foot. Many times they do not completely circle the branch. Those a year old or older may become covered with the pinkish white mold of another fungus and may become riddled with insects, especially lesser peach borers.

#### **Disease cycle**

About the time new seasonal growth is ½ inch long, spores of the fungus are discharged from tiny sacs in the surface of the knots. These are spread by rain and wind to the new growth, where infection takes place. Spore discharge and infection are greatest during wet periods, at temperatures ranging from 55 to 75°F. Infections continue to occur until terminal growth stops. A few greenish, corky swellings may become visible the fall after infection occurs, but most will not be noticed until the following spring. Generally, the knots produce no spores until the second spring after they become visible. The fungus in woody tissues continues to grow in the spring and fall, increasing the knots' length. Their eventual size depends greatly on the host species and cultivar.

#### **Disease management**

New plantings of plums should not be made next to old ones with black knot. Remove any wild plum and cherry trees from nearby woods and fencerows for at least 500 feet from the new orchard. Once the disease appears in the trees, remove the knots. When they occur on twigs and small branches, prune out the infected branches about 4 inches below the knot. On large branches and trunks the knots can be cut out. This is done most successfully during August when the fungus does not extend far beyond the visible swelling. Be sure to remove any infected branches in the winter if black knot returns after August. Remove the diseased wood and about 1 inch of clean wood around the knot. It is best to remove knots before growth begins in the spring and to take them away from the orchard, as they will continue to produce spores for several weeks after removal. Be sure to destroy infected plant tissue to limit spread of spores. Once the knots have been removed, fungicide sprays can be applied to control the disease. Sprays must be applied in early spring to protect young green shoots. Begin fungicide treatment when flower buds are just beginning to open. Repeat sprays according to label instructions (typically every 7 to 10 days) until shoots mature or the weather is consistently warm and dry. Sprays are most effective when applied before a rain event when temperatures are warmer than 60°F. When spore levels are high because of an established black

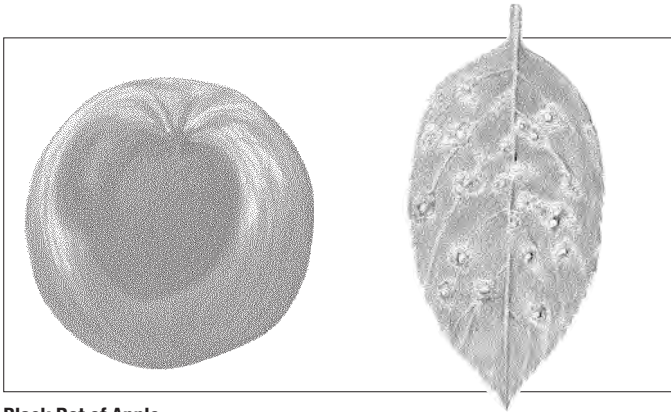

**Black Rot of Apple**

knot problem or a neighboring abandoned orchard, protection may be needed from bud break until early summer.

#### **BLACK ROT AND FROGEYE LEAF SPOT OF APPLE**

The black rot and frog-eye leaf spot fungus, *Diplodia seriata* (*Botryosphaeria obtusa* syn.), covers a wide geographical range, attacking the fruit, leaves, and bark of apple trees and other pomaceous plants. The fungus is a vigorous saprophyte and may colonize the dead tissue of many other hosts. However, its parasitic activities are confined mainly to pome fruits.

The disease may occur in three forms: a fruit rot, leaf spot, and limb canker on apple trees, and a fruit rot on pear and quince. In northern regions, losses from black rot result principally from the cankering of large limbs and dieback of twigs and branches. Losses from fruit rot and defoliation resulting from leaf spot can be considerable, especially in warm, humid areas of southern and central fruit-growing regions of the eastern United States.

#### **Symptoms**

The first signs of black rot are small, purple spots appearing on the upper surfaces of leaves and enlarging into circles  $\frac{1}{8}$  to  $\frac{1}{4}$  inch in diameter. Leaf margins remain purple, while the centers turn brown, tan, or yellowish brown, giving the lesions a “frog-eye” appearance. Multiple small, black pycnidia (pimplelike fruiting bodies of the fungus) may appear in the centers and can be viewed easily using a hand lens.

Infected areas of branches and limbs are reddish brown and are sunken slightly below the level of surrounding healthy bark. These cankers may expand each year, a few eventually reaching several feet in length. The margins of older cankers are slightly raised and lobed, and the bark within their centers usually turns light-colored, loosens, and scales off raggedly. This characteristic is not confined to black rot cankers, so it is not a good diagnostic symptom. Pycnidia form on dead wood of the cankered areas.

Fruit rot usually appears at the calyx end of the fruit. It can originate at any wound that penetrates the epidermis, including insect injuries. There is usually one spot per fruit, a characteristic that distinguishes black rot from bitter rot. In addition, when cutting through the lesion, the decayed flesh will not be in the shape of a cone (like bitter rot). Initially, the infected area becomes brown and may not change in color as it increases in size, or it may turn black. As the rotted area increases, often a series of concentric bands form, darker bands of mahogany brown to black alternating with brown bands. The flesh of the decayed area remains firm and leathery. Eventually, the apple completely decays, dries, and shrivels into a mummy. Pycnidia

containing spores of the black rot fungus appear on the surface of rotted tissue.

#### **Disease cycle**

The fungus overwinters in fruiting bodies (pycnidia and perithecia) on dead bark, dead twigs, and mummified fruit. It can invade almost any dead, woody tissue and is frequently found in tissue killed by fire blight. Early leaf infections often are visible as a cone-shaped area on the tree, with a dead twig or mummified fruit at the apex.

In the spring, black pycnidia and perithecia release conidia and ascospores, respectively. Conidia may continue to be produced during wet periods throughout the summer and may remain viable for long periods. When wet, the pycnidium produces a gelatinous coil containing thousands of spores. Disseminated by splashing rains, wind, and insects these spores can infect leaves, the calyxes of blossoms, tiny fruit, and wounds in twigs and limbs. Leaf infection develops during petal fall, at which time conidia attach, germinate in a film of moisture within five to six hours, and penetrate through stomata or wounds. Infections of fruit and wood may not become visible for several weeks.

Initial fruit infections occur during the bloom period but are not usually apparent until midsummer as the apple approaches maturity. Throughout the growing season, infections occur through wounds. Harvest injuries may become infected and the fruit may decay during or after storage, especially if the fruit was harvested during a wet period. Dead fruit spurs or twigs, particularly those killed by fire blight, pruning wounds, winter injuries, and sun scald, are commonly invaded by the black rot fungus.

#### **Disease management**

Timing of chemical treatments and cultural control strategies can affect the level of control achieved for black rot. Captan and fungicides containing a strobilurin (FRAC Group 11 Fungicides) as an active ingredient are effective controlling black rot on fruit. Management programs based on sanitation to reduce inoculum levels in the orchard are the primary means of control.

1. Prune out cankers, dead branches, twigs, etc., which serve as inoculum sources and dispose of dead wood. This should be an important component of both current-season and long-range management.
2. Prune and remove cankers at least 15 inches below the basal end; properly dispose of prunings by burial or burning.
3. Remove all mummified fruit.
4. Control fire blight by pruning out infected wood or controlling insect vectors.
5. Maintain healthy trees and prevent tree stress.

#### **BLISTER SPOT ON CRISPIN (MUTSU)**

Crispin apples are highly susceptible to the blister spot bacterial infections about two weeks after petal fall for a period of two to four weeks. The causal bacteria, *Pseudomonas syringae*, overwinter in the infected buds and multiply on the leaf surface in spring. Rain washes the bacteria onto the fruit where they infect through the lenticels to cause the reddish spot. A brief shower is all that is required to distribute the bacteria to new infection sites. The standard recommendation for control of this disease is



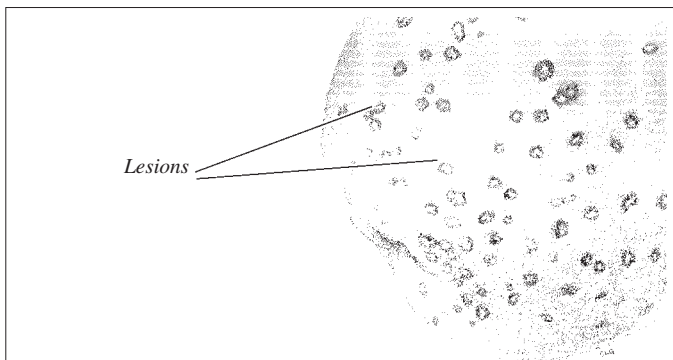

Blister on Crispin

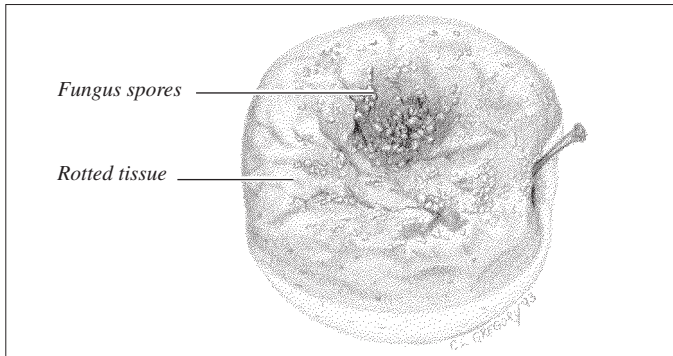

Blue Mold

to apply streptomycin at ½ pound per 100 gallon dilute rate 10 to 14 days after petal fall. If the weather pattern of rain continues, two additional sprays should be applied at weekly intervals. Resistance of these bacteria to streptomycin has been documented in commercial orchards in the northeastern United States. Refer to the streptomycin label for specific use recommendations and limitations.

#### BLUE MOLD OF APPLE

Blue mold, a common rot of stored apples and pears, is caused by the fungus *Penicillium expansum*. Blue mold is the most important postharvest disease of apples worldwide. Other names for the disease are soft rot, bin rot, and *Penicillium* rot. Aside from losses in fruit caused by rot, sound fruit in the same container as decaying fruit may absorb a moldy odor and flavor.

#### Symptoms

Soft rot appears as soft, light brown, watery spots that begin around injuries or lenticels on the outer surface of fruit. Rotted fruits have a characteristically moldy odor and flavor. When the relative humidity is high, grayish blue masses of spores may appear on the fruit surface.

#### Disease cycle

Spores of the soft rot fungus are present almost everywhere and can survive long periods of unfavorable conditions. Bulk bins, field crates, packhouse lines, and storage rooms are usually contaminated. Injuries to fruit, especially during picking and handling operations, are the primary points of entry. At ordinary temperatures, infected fruit can rot in two weeks or less.

#### Disease management, cultural

To control blue mold, it is important to prevent fruit from becoming injured during picking and handling. It is also essential

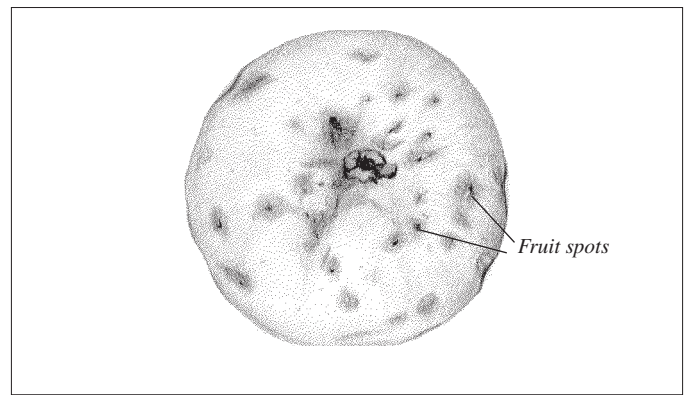

Brooks Fruit Spot

to move harvested fruit into cold storage as rapidly as possible. Packing line equipment and storage rooms should be cleaned and clean water maintained in water dumps and antiscald solutions.

#### Disease management, chemical

Picking bins and boxes can be disinfected with fungicides or steam. Disinfectants or fungicides can be used in fruit dips and combined with wax applications. Preharvest applications of Merivon or Pristine (FRAC Groups 7 and 11), which are labeled for blue mold control, will also help mitigate blue mold occurring on apples in storage.

#### BROOKS FRUIT SPOT OF APPLE

Caused by the fungus *Mycosphaerella pomi*. The disease attacks apple and crabapple trees and is rarely found in well-sprayed orchards. When cover sprays are stopped too soon, or when trees are not well-pruned and sprayed, severe losses can occur. Varieties such as Jonagold, Golden Delicious, Fuji, Mutsu (Crispin), Gala, Rome Beauty, Stayman, Jonathan, and Grimes Golden are quite susceptible.

#### Symptoms

Spots on fruit are about ¼ inch in diameter. They are somewhat irregular in shape, slightly sunken, and usually most numerous on the calyx end. On red fruit surfaces spots are red to black; on green and yellow fruit surfaces they are dark green. Spots may be quite inconspicuous at harvest. Unless infected fruit is placed in cold storage immediately after harvest, the spots increase in size and become more sunken, thus more visible.

#### Disease cycle

The disease cycle is much like that of apple scab, except it begins later in the spring. About the time of petal fall, ascospores are discharged from fallen leaves. Rain and high humidity favor spore discharge and infection of fruit. Ascospores penetrate the fruit through the lenticels and the leaves through the stomata. Fruit are most susceptible 10 to 30 days after petal fall. Fruit lesions appear mid- to late summer. Leaf infections remain quiescent until late summer, when small purple spots begin to appear.

#### Disease management

Routine fungicide applications normally control this disease in Pennsylvania. Summer fungicide applications should not be extended beyond 14-day intervals.

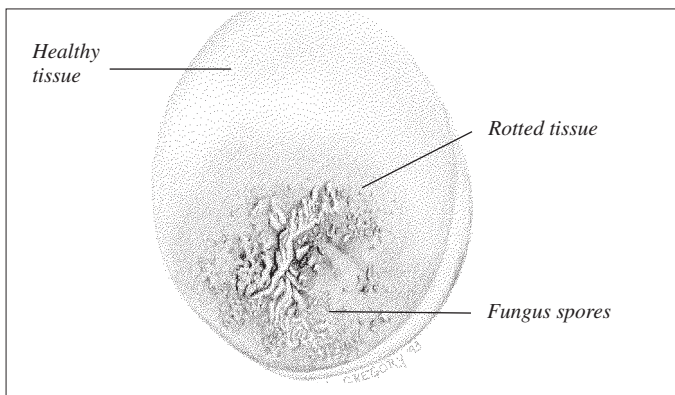

**Brown Rot (on nectarine)**

### BROWN ROT

Brown rot is caused by the fungus *Monilinia fructicola*. The disease can also infect apple fruit late in the season, especially if the orchard is in proximity to stone fruit with a high incidence of brown rot. It is one of the major stone fruit diseases in Pennsylvania.

#### Symptoms

Brown rot first affects blossoms, which wilt and turn brown. Blossom infections may also extend into twigs, causing necrosis and eventual girdling. The infected blossom parts serve as a source of fungus spores for future fruit infections. Fruit decay occurs as the fruit ripens. The infections begin as small brown spots, and the entire fruit can rot within a few hours under favorable conditions. Under wet and humid conditions, ash-gray to brown tufts of fungus develop over the surface of the infected area. If favorable weather conditions persist, the infection can spread from the fruit into small twigs and cause a canker. The canker may girdle the twig, causing it to die. Rotted fruits dry out and become mummified.

#### Disease cycle

The fungus overwinters in mummies and cankers formed the previous season. The mummies persist in the trees or on the ground over winter. The first fungus spores are formed about the time the blossoms begin to open. Upon wetting, the spores are forcibly ejected into the air to be blown by the wind to blossoms. Infected blossoms serve as a source of the fungus for future fruit infections; however, infected blossoms do not need to occur for fruit infections later in the season. Environmental conditions are important for the development of the disease. Warm, wet, or humid weather is very favorable for the development of the disease. The severity of brown rot increases as the fruit ripens. Wounded fruit is more susceptible to infection. Mature fruit can completely decay in two days from the time of infection under favorable weather conditions.

#### Disease management

Removing all rotted fruit after harvest helps to reduce the amount of fungus overwintering in orchards. In addition, remove dead or cankered wood when pruning. Summer pruning will increase air circulation, allowing faster drying and fewer fruit infections. Apply fungicide sprays during bloom and at 18 days, nine days, and one day before peach harvest. Captan used as a cover spray has shown to decrease the available spore load leading to harvest. To reduce the risk of resistance, alternate fungicides by FRAC Group.

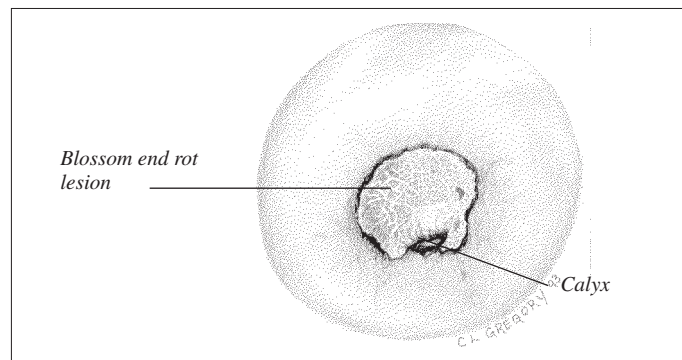

**Blossom End Rot**

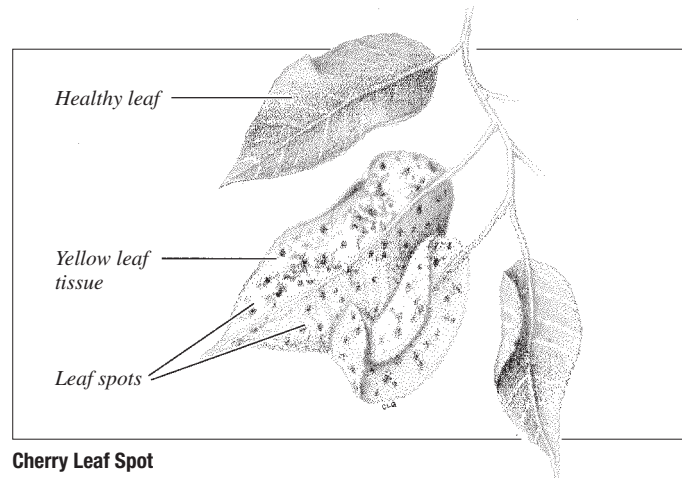

**Cherry Leaf Spot**

### CALYX-END ROT OF APPLE

Calyx-end rot is not a major problem in Pennsylvania. This disease can be caused by various fungi (*Sclerotinia sclerotiorum*, *Botrytis cinerea*) just before or during petal fall. The infected area is seen as a small, ¼- to ½-inch-diameter lesion next to or including part of the calyx. Usually brown, the spot is slightly sunken and often has a red border. A shallow, dry or corky rot develops in the flesh beneath the spot. It is often referred to as “dry eye rot” or “blossom end rot.”

Calyx-end rot appears to be more common in seasons of prolonged cool, wet weather during and shortly after bloom. Mancozeb, captan, and Topsin M have shown efficacy; however, the efficacy of other fungicides is unknown. This disease is typically sporadic, and losses are minimal.

### CHERRY LEAF SPOT

Cherry leaf spot, caused by the fungus *Blumeriella jaapii* (formerly *Coccomyces hiemali*), attacks the leaves, leaf stems, fruit, and fruit stems of tart, sweet, and English Morello cherries. The disease is most severe on leaves and may cause them to drop prematurely. When defoliation occurs before harvest, the fruit fails to mature normally, remaining light-colored and low in soluble solids. Buds and wood become susceptible to winter injury, which may show the next season as poor growth, dead spurs, and dead limbs.

#### Symptoms

The disease first emerges on upper sides of leaves as tiny, red to purple, angular spots. These enlarge to ⅛ to ¼ inch in diameter and become red-brown to brown. By then, spots show brown on

the undersides of leaves, and during wet periods tiny, whitish, feltlike patches appear in their centers. These contain the spores (conidia) of the causal fungus. On sweet cherry leaves the spots tend to be somewhat larger. Some spots may drop out, leaving a shotholed appearance. After the leaves become infected, they turn yellow and fall.

#### **Disease cycle**

The fungus overwinters in diseased leaves on the ground. Around bloom or shortly afterward, sexual spores (ascospores) mature and are discharged. They are blown to young, expanded leaves where infection takes place through the stomates on the undersides. These first infections are often so few in number that they may be overlooked. However, conidia from the feltlike centers of spots on leaf undersides mature 10 to 15 days after the first infections. They are spread by rain. Each succeeding wave of infection becomes heavier, and severe defoliation begins.

#### **Disease management**

The fungus overwinters in diseased leaves that have fallen to the ground. Rotary mowing the orchard after leaves drop in the fall will hasten leaf decay and reduce the spore numbers in which the fungus can overwinter. Otherwise, fungicide applications are the primary means of control beginning at the bract leaf stage during bloom time and continued throughout the season as disease conditions persist. Two postharvest fungicide sprays are recommended to prevent premature defoliation. The goal is to have the trees hold onto their leaves through September. Premature defoliation in July and August can cause the tree to be more susceptible to winter damage, which ultimately could lead to tree death.

### **CORE ROT OF APPLE**

The most susceptible cultivars to core rots (wet and dry) are Delicious, Golden Delicious, Gravenstein, and Idared, which all have an open sinus extending from the calyx into the core region.

#### **Symptoms**

Dry core rot is a slow, dry, and corky rot that affects the mesoderm tissue (flesh) surrounding the core. External symptoms are rare, except infected fruit may color and fall prematurely. Wet core rot is a more aggressive wet rot that rapidly develops further during storage and may cause partial or complete fruit rot.

#### **Disease cycle**

Dry rot causal fungi (*Alternaria* spp.) colonize flower parts during or shortly after bloom. They grow from the flower parts into the open calyx tube and into the core region. Subsequent growth and mesoderm infection are most likely influenced by several physiological and environmental conditions. Disease appears to be favored by mild temperatures and wet weather during bloom, as well as in late summer.

Wet core rot infections, caused by *Penicillium* spp., *Fusarium* spp., *Diplodia seriata*, and *Botrytis cinerea*, can take place within the orchard, as well as during fruit dipping in contaminated water in the packinghouse. Wet core rot infections in packinghouses are influenced by fruit shape and fungal population sizes in dip solutions. Immersion depth and time may also influence the incidence of wet core rot.

#### **Disease management**

Core rots have been controlled with fungicides. Apples riper than normal at harvest may have a high incidence of infection and should not be stored.

### **CORNYEUM BLIGHT OF STONE FRUIT**

Coryneum blight, also called “shot hole disease,” is caused by the fungus *Coryneum carpophilum*. The disease can affect peaches, apricots, and sweet cherries. Economic loss results when fruits are disfigured and blemished (spots and lesions) by the fungus. The fungus is difficult to eradicate because it produces spores from infected buds and twigs for two to three years. Currently, this is not a severe problem in Pennsylvania.

#### **Symptoms**

The fungus overwinters in infected leaf buds, flower buds, and small twig cankers. Spore production begins in early spring. First symptoms are observed on young leaves as small red spots that enlarge and become purple with a white center. These spots drop out leaving a “shot hole.” On fruit, early season infections are characterized by the presence of a reddish-purple halo surrounding a light tan, scablike center spot, which is the dead fruit skin killed by the fungus. These symptoms are similar to San Jose Scale damage. Depending on environmental conditions, the spots may remain tiny or enlarge to ¼ inch in diameter. In severe cases, lesions coalesce and cause skin cracking. Similar to bacterial spot on fruit early in the season, fruit infections can also have gummy ooze on the surface. Late season fruit infections (up to four weeks before harvest) are different and lack the scab-like center and pronounced reddish-purple halo. Infections on the maturing fruit produce sunken brownish spots up to ½ inch in diameter in a fairly short time.

#### **Disease cycle**

Coryneum blight is serious in years when frequent light showers occur during the summer. Wind currents disperse the spores from infected twigs in and leaves to uninfected branches. These spores require four hours of contact with free water droplets on the fruit, leaf, or twig surface in order to germinate and cause infection. The blight may spread rapidly within an individual tree, with movement from tree to tree somewhat slower. Leaf infections are a constant threat to fruit infection, since leaf lesions produce spores that can infect fruit whenever weather conditions are favorable. Temperatures of 70 to 80°F are optimum for Coryneum infections. Lesions can develop at 45°F, but at a much slower rate. It takes from two to five days for a spore to initiate infection and cause a visible lesion.

#### **Disease management**

Once established in an orchard, Coryneum blight is difficult to eradicate. Bud and twig lesions may continue to produce spores for two to three years, but the fungus does not overwinter in old infected leaves. The best preventive approach is application of chlorothalonil products (like Bravo) or copper-containing products in the fall when the leaves are easily knocked off the shoots. This protects twigs and buds from infection during wet fall weather and reduces disease carry-over to the next season.

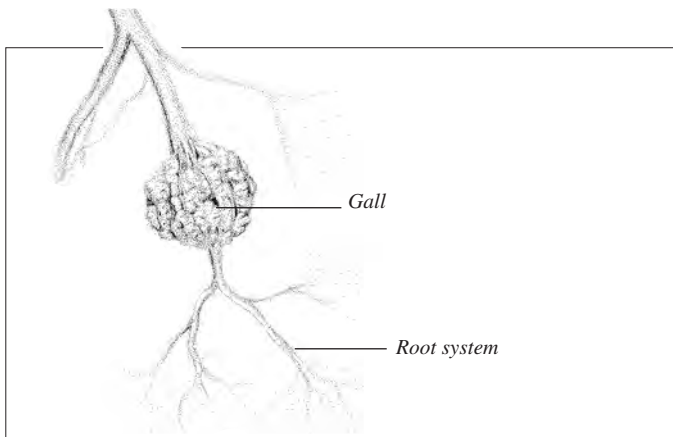
**Crown Gall**

Where disease incidence is or has been high, fungicides may be needed throughout the growing season. Applications should begin between the petal fall and shuck fall stages. Chlorothalonil products give best protection but cannot be applied to fruit after shuck fall. Copper products such as applied at the low rate described for bacterial spot control will also help to provide protection. Chemical control for brown rot throughout the season will also aid in controlling Cornyeum blight.

#### **CROWN GALL**

Crown gall is caused by a bacterium, *Agrobacterium tumefaciens*, and affects peaches, nectarines, apricots, plums, cherries, apples, pears, and quince. Peach and Mazzard cherry rootstocks are especially susceptible. The disease is common in tree fruit nurseries and can occur in orchards.

#### **Symptoms**

Crown gall is readily recognized by wartlike swellings, or galls, on tree roots and crown. Occasionally, the galls may be seen aboveground on trunks or branches. Young galls are light in color and with age become dark and hard, ½ inch to 3 or 4 inches in diameter. When galls are numerous, or if located on major roots or the crown, they may disrupt the flow of water and nutrients. Trees show reduced growth, an unhealthy appearance, and possibly nutritional deficiency symptoms.

#### **Disease cycle**

The bacteria causing crown gall are distributed widely in numerous soils and can attack many different kinds of plants. Soil may become contaminated if planted with infected nursery stock.

Bacteria entering the plant must do so through a wound. Wounds are commonly made during digging and tree-planting operations, by tillage equipment, and by injury from root-feeding insects and nematodes. Secondary galls may develop a considerable distance from the initial infection. These may be formed in the absence of the crown gall bacteria, apparently due to a tumor-inducing substance produced at the site of the original infection.

#### **Disease management**

Avoid planting infected stock by closely inspecting the roots of trees prior to planting. Prevent wounding trees at planting. The only product labeled for preventive crown gall infection is Galltrol-A, which is used on the roots prior to planting.

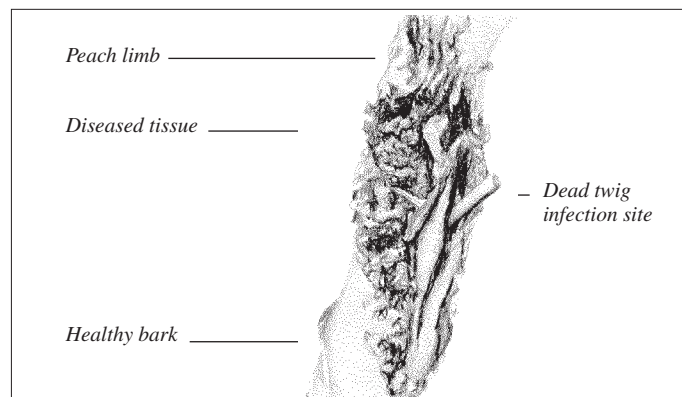
**Cytospora Canker**

#### **CYTOSPORA CANKER OF STONE FRUITS**

Cytospora canker is one of the most destructive diseases of peaches, nectarines, apricots, sweet cherries, and plums in Pennsylvania. Also known as perennial canker, peach canker, Leucostoma canker, and Valsa canker, the disease may cause trees in young orchards to die. Infected trees in older orchards gradually lose productivity and slowly decline.

#### **Symptoms**

The fungus attacks the woody parts of stone fruit trees through bark injuries and pruning cuts, and through dead shoots and buds. Visible first is the exudation of gum at the point of infection. The canker forms from a small necrotic center that slowly enlarges with the collapse of the inner bark tissue. Cankers enlarge more along the length than the width of the branch. Older cankers are therefore oval to elongated in outline.

Outer bark of new cankers usually remains intact, except at points of gumming. In older cankers the bark in the center becomes torn. The gum turns black from alternate wetting and drying and from the presence of saprophytic fungi. Older cankers are surrounded by a roll of callus tissue. Each year the canker enlarges by repeated invasion of healthy tissue. With renewed growth in the spring, the tree forms a callus ring around the canker as a defense mechanism. This can be a very effective defense except when the lesser peachtree borer breaks the callus ring by burrowing through it into healthy tissue.

#### **Disease cycle**

The fungi causing the disease overwinter in cankers and dead twigs. Small black fruiting bodies appear on the smooth bark covering diseased areas of dead wood and begin to produce spores once temperatures are above freezing. Wet weather washes the spores from the fruiting structures. Because infections do not usually occur when trees are growing vigorously, most occur during fall, early spring, and winter.

Healthy bark or buds are not attacked by the fungus. Cold-injured buds or wood and pruning cuts are the most important sites of infection. The fungus can also penetrate brown rot cankers, Oriental fruit moth damage, sunscald wounds, hail injury, leaf scars, and mechanical wounds. Once established in the wood, the fungus forms a canker by invading the surrounding healthy tissue.

#### **Disease management**

Managing Cytospora canker involves total orchard management. Since no stone fruit tree is immune, and fungicide treatments

alone are not effective, control efforts must be aimed at reducing tree injuries where infection could begin.

### **Planning a new orchard**

- Select a site well away from old *Cytospora*-infected trees. This has proven to be the best method of keeping canker out of newly planted orchards.
- Select a site with deep, well-drained soil and good air drainage to reduce the possibility of winter injury.
- Plant only the hardier varieties, especially if *Cytospora* canker has been a major problem in your orchard. Also, painting the trunks and lower scaffold limbs of cold-susceptible cultivars with white latex paint will somewhat moderate temperatures under the bark and reduce cold injury and canker in critical areas of the tree.
- Plant only disease-free nursery stock. Trees planted when infected with *Cytospora* will probably not live to produce fruit.
- Plant whips no larger than  $\frac{9}{16}$  inch in diameter. Large-diameter whips do not heal properly when headed back and may become rapidly infected with *Cytospora*. The infection becomes obvious in the crotch of the tree when it is three to four years old. Completely remove all branches, leaving no stubs and taking care not to injure the buds at the base of each branch.

### **Fertilizing**

- To avoid late, cold-tender growth in the fall, fertilize in late winter or early spring.
- Avoid excessive nitrogen fertilization. Excessively vigorous trees are slow to harden off in the fall and may be injured by cold if early frosts occur. Cold-injured tissue is very susceptible to *Cytospora* infection.

### **Training and pruning**

- Start training young trees early to prevent broken limbs as a result of poor tree structure. Broken branches are sites of *Cytospora* infection.
- Prune regularly so that large cuts will not be necessary. Prune during or after bloom; actively growing trees can protect pruning cuts from infection. Do not leave pruning stubs; stubs die and can harbor the disease, which may then infect healthy branches. Remove or spread narrow-angled crotches since they tend to split and serve as infection sites. Remove all weak and dead wood and fruit mummies. Spray newly pruned trees the same day if possible or before the next rain with a fungicide used to control brown rot.

### **Controlling insects and other diseases**

- Control the lesser peachtree borer—it aids in canker expansion and death of the tree.
- Control brown rot and remove any brown-rotted fruit from trees before cankers form on the twigs. Annual brown rot cankers may serve as infection sites for *Cytospora*.
- Control the Oriental fruit moth and peachtree borer. Injuries inflicted by these insects serve as infection sites.

### **Eradicating *Cytospora* canker**

- During bloom or later, remove all cankers on small branches, cutting at least 4 inches below the margin of the canker.
- Surgically removing cankers on younger trees may prevent the slow decline and ultimate death of the tree. Recent research trials have shown that although this procedure is time-consuming (the average treatment time ranges from one to five minutes per canker), it is nearly 100 percent effective. If the surgery is done improperly, however, the canker is almost never eradicated. When surgery is conducted before too many cankers are evident per tree, cankers can be eliminated from young orchards before extensive infection and tree death occur.

The best time of the year for canker surgery is May and June. Do not attempt surgery on cankers encompassing more than half the branch diameter. The diseased tissue often extends beyond the canker margin that is visible at the surface of the bark. To remove diseased tissue and promote maximum healing, take the following steps (Figure 2-2):

1. Place your knife at the top of the canker  $\frac{1}{2}$  to 1 inch above visible diseased tissue.
2. Outline the area to be removed, maintaining a  $\frac{1}{2}$ - to 1-inch margin beyond the canker. Outline a point at the top and at the bottom of the area to be removed. When outlining, press the knife blade straight through the bark into the wood.
3. Push the knife blade beneath the bark of the outlined area and remove the diseased tissue. It is not necessary to dig into the hardwood. Clean out all diseased tissue. Note: If the diseased brown tissue extends into the margin of the cut, expand the margin until only healthy (green) tissue is evident at the margin.
4. Keep the margin of the cut clean; torn tissue will not heal properly.
5. Do not paint cut surfaces with standard wound dressings (water asphalt emulsions, oil-based paints, or latex paints). They have not proven beneficial in the wound-healing process.

### **FIRE BLIGHT**

Fire blight is destructive to apples and quince and is the most serious pear disease in the eastern United States. Caused by the bacterium *Erwinia amylovora*, the disease can attack some 75 species of plants of the rose family. Fire blight also occurs frequently on pyracantha, spirea, hawthorn, and mountain ash. In fruit trees, the disease can kill blossoms, fruit, shoots, limbs, and tree trunks. Varieties and rootstocks vary in susceptibility.

### **Symptoms**

The disease gains entry to the tree through two main points, blossoms and new shoots, and often appears first in spring as blossom, fruit spur, and new shoot blight. Infected blossoms wilt rapidly and turn light to dark brown. Bacteria may move through the pedicel to the fruit spur and out into the leaves. Here they follow the midrib and main veins, which soon darken. The leaves wilt, turning brown on apples and quince and dark brown to black on pear. The blighted flowers and leaves remain attached for much, if not all, of the growing season. Some remain even after normal leaf fall.

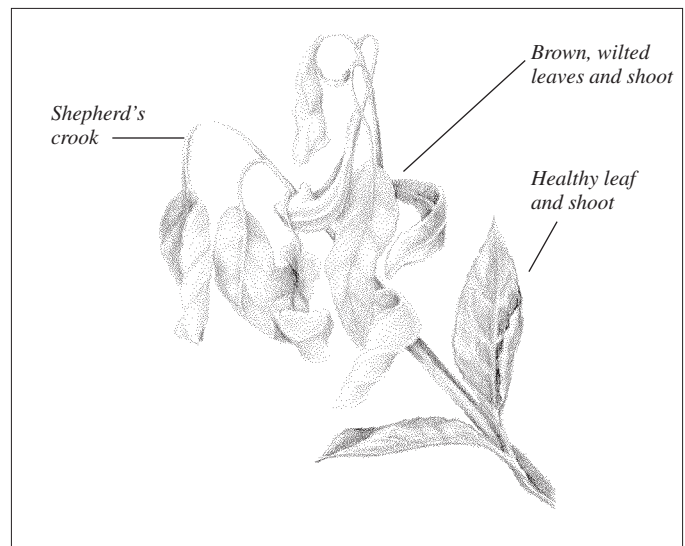
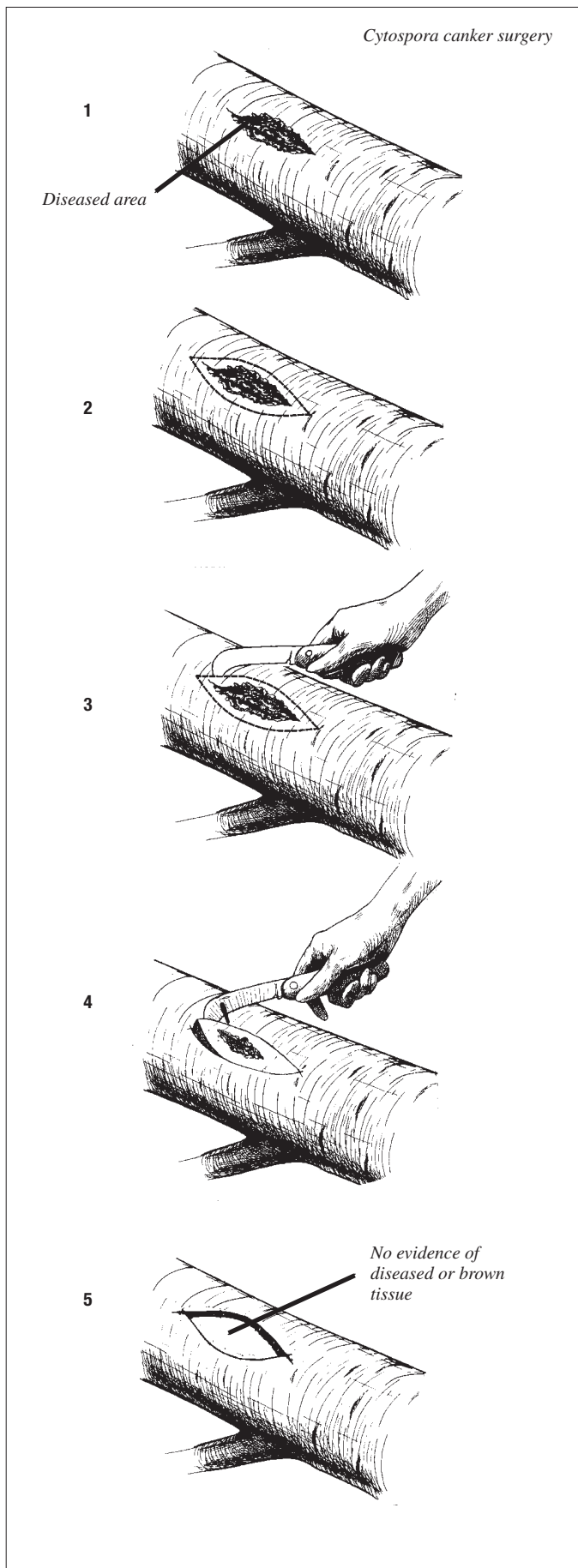

**Fire Blight**

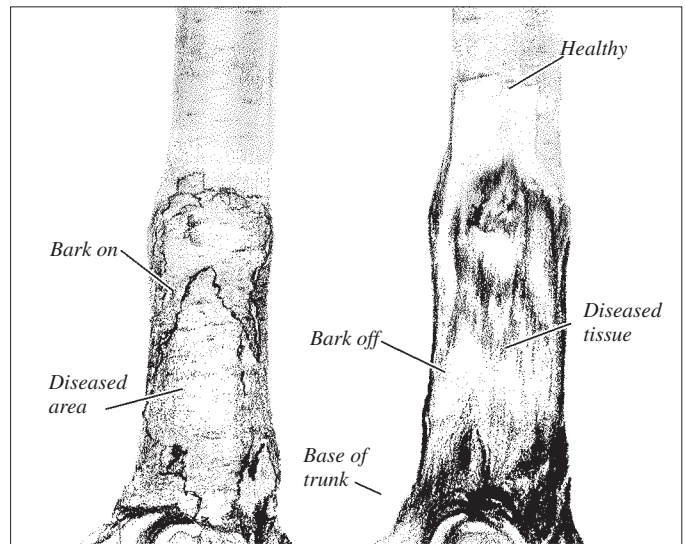

**Fire Blight Root**

Fire blight's two main symptoms are shoot blight and cankers on limbs. Shoot blight begins with the infection of the young, succulent growing tip. It may occur any time during the season while the shoots are still growing and when environmental conditions are most favorable for the disease. The leaves wilt rapidly, turn dark, and remain attached as in the case of spur blight. A characteristic symptom of shoot blight is the bending of terminal growth into the shape of a shepherd's crook. Pearly or amber-colored droplets of bacterial ooze are often present on diseased blossoms, fruit, and leaf stems, on succulent shoot stems, and on the exterior of infected fruits. Inside these droplets are millions of bacteria, which may cause new infections.

Fire blight bacteria can move from blighted spurs and shoots through the vascular system into larger limbs and tree trunks. Infected branches may be girdled, resulting in loss of the entire branch. Suckers at the base of trees are often invaded and may blight back to the trunk or rootstock, causing the loss of the entire tree in one season. This is true of susceptible pears, especially Bartlett, Bosc, and Clapp's Favorite, and certain clonal apple rootstocks, especially M.26 and M.9.

**Figure 2-2.** Eradicating *Cytospora* canker.

Cankers, slightly sunken areas of various sizes surrounded by irregular cracks, occur on small to large limbs, trunks, and even roots. They often begin at the bases of blighted spurs, shoots, and suckers. Active blight cankers are characterized by an amber or brown exudate on their surfaces or on the bark below. If previous-season cankers remain in the tree, shoot blight will arise from these cankers from year to year. During the growing season, the bacteria continue to replicate and move through the vascular system. They will ultimately move from the cankered regions to growing tissue, thereby causing shoot blight. This is also referred to as “canker blight.”

The bacteria may also invade fruit, which becomes water-soaked. Droplets of bacterial ooze appear on the surface. Later the fruit becomes leathery, turns brown (apples) and black (pears and quince), shrivels, and usually remains attached to the fruit spur.

### **Disease cycle**

Bacteria overwinter in the margins of cankers on branches and trunks. Once the temperature reaches about 65°F, bacteria begin to multiply and appear on the outsides of the cankers in drops of clear to amber-colored ooze. The bacteria are spread to blossoms primarily by wind and rain with some transmission by pollinators. Blossom-to-blossom transmission is carried out mainly by bees and other insects that visit the flowers. The bacteria reside on the flower stigma where they do not cause disease, but replicate to high numbers when temperatures are favorable. Insects also transmit bacteria to growing shoots. If the average temperature is 60°F or above and relative humidity is 60 percent or more, or there is rain, new infections can occur. Infections occur when the bacteria are washed off from the stigmas and move down into the nectarhodes of the blossom. Bacteria need this natural opening to enter the plant; they cannot directly penetrate plant tissue. Shoots become infected through natural wounds, such as broken leaf hairs. At 75°F, blossom blight and shoot blight will be evident in four to five days. Bacterial ooze appears on the new infections soon after the symptoms, providing additional sources of bacteria for new infections. In early to midsummer, during prolonged periods of muggy weather, blighted shoots and spurs, infected fruit, and new branch cankers all may have droplets of ooze on them.

Wounds are also important entry points to leaves, shoots, and fruit. Aphids, leafhoppers, lygus bugs, and other insects with piercing mouthparts may transfer fire blight bacteria directly into susceptible tissues. Wounds from hail often lead to a severe outbreak of fire blight. Any fresh wound can serve as an entry point.

### **Disease management**

Temperatures just before and during bloom will determine if fire blight becomes serious in early spring. Daily temperatures must average 60°F or above during pink through petal fall for bacterial populations to grow enough to cause severe disease. The disease also occurs later in the season when bacteria enter late opening blossoms or growing tips of new shoots.

Where this disease was present the previous year, we suggest the following management program:

- During dormancy, prune out all cankers. Cut apple limbs at least 8 to 12 inches below external evidence of the canker. Pruning tools do not need to be disinfected.
- At green tip, apply a copper spray aiming to have 2 pounds per acre of metallic copper equivalent to kill bacteria on tree surfaces.
- When daily temperatures average 60°F or higher during bloom through petal fall, make at least two complete applications of a streptomycin formulation. Apply the first streptomycin spray after first blossoms open when daily average temperatures are above 60°F and a wetting event is anticipated within 24 hours. Repeat sprays at five- to seven-day intervals through late bloom if disease conditions persist. A minimum of two applications is necessary to provide control.
- For semi-dwarf trees and older dwarf trees that have filled their tree space, applications of prohexadione calcium (Apogee, Kudos) beginning at bloom are effective for mitigating shoot blight that may occur during the season, be it from infected blossoms or leftover cankers. Shoots harden off 10 to 14 days after application and are no longer susceptible to infection. Several applications are typically recommended.
- For newly planted or young dwarf trees, combining streptomycin with a product that stimulates the plant’s immune system at bloom (e.g., Actigard) will help mitigate blossom blight and will offer some protection of growing shoots shortly after bloom
- Another option to mitigate shoot blight on young dwarf trees is low-rate copper applications (e.g., Cueva). To prevent fruit injury, use every other spray and be mindful of slow-drying conditions and the pH of the spray solution since acidic conditions increase copper phytotoxicity.
- When it comes to pruning decisions when fire blight occurs, use the following guidelines to prioritize:
  - Young orchards three to eight years old with just a few strikes are highest priority.
  - Young orchards three to eight years old with severe strikes.
  - Orchards with a few strikes.
  - The “walk away” group: orchards with so many strikes that most of the tree would need to be removed; severe pruning can stimulate new growth that can become infected (lowest priority).
  - If fire blight is to be pruned, use the “ugly stub” method by cutting branches between nodes and several inches away from the central leader or other branch union:
    - Two-year-old wood (and older) is more resistant to fire blight and can stop infection movement into the tree. Since the bacteria can travel inside the tree well ahead of the visible infection (up to several feet), make cuts 8 to 12 inches below the last signs of browning, leaving a 4- to 6-inch naked stub in two-year-old or older wood.
    - A canker will form in the stub, which can be cut off with the canker during the next winter.
    - Disinfecting pruning tools is ineffective for minimizing spread of the disease since the bacteria often are present internally in mature bark well in advance of symptom margins.
- When terminal growth stops, the spread of fire blight should also stop. The most important thing to do to control fire blight

during the summer is to control sucking insects like aphids and leafhoppers. Applying streptomycin sprays within 24 hours after hail or a storm with severe winds to prevent new infections is also a good practice.

#### **FROST DAMAGE**

Frost damage on fruit can be manifested in many ways. One of the most common ways is the appearance of rings of russeted skin tissue on the fruit. Other forms of damage may cause fruit to appear distorted and ribbed, similar to the way pumpkins appear. This type of injury is almost always associated with damage to the calyx leaves. Both of these types of injury usually result when frost or freezing temperatures occur after the fruit has set.

#### **GLYPHOSATE HERBICIDE DAMAGE**

The herbicide glyphosate is an important tool in controlling perennial weeds in orchards. Unlike most herbicides, glyphosate has systemic action and can be absorbed not only by weeds but also fruit trees. When glyphosate spray accidentally drifts onto low-hanging branches in fruit trees, it is absorbed and translocated within the tree to roots and other parts of the tree. Normally, fruit trees can withstand doses that kill vegetative weeds. However, in some instances the glyphosate can drift onto tree fruit foliage, be absorbed by fruit trees, and then impact shoot growth the following season. The carryover damage is evidenced by the emergence of thin straplike leaves the next spring. In established trees, these symptoms usually disappear after one season.

#### **GRAY MOLD OF POME FRUITS**

Gray mold is the most important postharvest disease of pears and is second to blue mold in importance to apple. The disease develops very quickly at cold storage temperatures. Also known as nest rot or cluster rot, gray mold can cause large losses because of its ability to spread from infected to adjacent healthy fruit in storage.

#### *Symptoms*

Gray mold lesions first appear as pale tan areas without sharp margins. Infections may originate from wounds, stem punctures, or the stem or calyx end of the fruit. As the decay enlarges, the older portions of the decay may turn darker brown, but the edges often remain a paler color. On red apples, dark areas may persist around lenticels even after the fruit are completely decayed, and these give the fruit a speckled appearance. On firm green pears, the decay is often water soaked and gray green, but it is brown on riper fruit and at higher temperatures. On less mature apples and pears, the rotted tissue is firm and does not separate easily from healthy tissue, but the rot is softer on riper fruit. In advanced stages, the decayed flesh has a sweet, cedarlike odor. Under high relative humidity, grayish spore masses and/or fluffy white or gray-white mycelium may develop on the surface of decayed areas. Occasionally infections can produce sclerotia (hard, black fruit bodies) on the surface of the infected fruit.

#### *Disease cycle*

Gray mold is caused by *Botrytis cinerea*. Gray mold rot is seldom seen in the field, although *B. cinerea* is a common saprophyte on decaying organic matter on the orchard floor. Wounds or injuries are the primary infection points for initiation of gray mold. Conidia from the orchard soil or other organic debris are brought in via storage bins and containers. Fruit decay during storage

produce additional inoculum. The conidia are most typically water dispersed in flumes in packing houses. Once established in the wound, the fungus can quickly spread from infected fruit to adjacent healthy fruit during storage. The fruit-to-fruit spread causes the phenomenon known as nesting and can result in the loss of many fruit as a consequence of a single original infection.

#### *Disease management*

Bin sanitation is an important measure for control of gray mold in order to minimize spores brought in from the field. Postharvest fungicides are also effective for controlling gray mold; however, fungicide resistance is an issue and rotating chemicals with different FRAC Groups is recommended. Preharvest applications of Merivon or Pristine (FRAC Groups 7 and 11), which are labeled for gray mold control, will also help mitigate gray mold occurring on apples in storage.

#### **HAIL DAMAGE**

Hail damage can occur at any time during the growing season. The damage on the fruit at harvest will depend on how mature the fruit was and how large and hard the hail was when it struck. Damage can range from a deep depression and deformation to a more bruise-like appearance. When hail damage occurs, fruit are more susceptible to fruit rot. It is important fruit continue to be protected from disease and insects until the end of the season. In addition, apple and pear trees should be treated with streptomycin within 24 hours of a hail event to limit the trauma blight phase of fire blight.

#### **MARSSONINA BLOTCH OF APPLE**

Marssonina blotch, caused by *Marssonina caronaria*, is found on leaves and fruit of apple. The disease is widely distributed and has been reported in North America, Europe, and Asia. Most recently, it was found in Pennsylvania in 2017. The disease can cause severe defoliation.

#### *Symptoms*

Leaf spots first appear on the upper surface of mature leaves around the middle of June. They are 5 to 10 millimeters in diameter, grayish, brown-black, and tinged purple at the periphery. Small, black acervuli are often visible on the surface. When lesions are numerous, they coalesce, the surrounding tissue turns chlorotic, and defoliation results. Severe defoliation may start in early summer. Cultivars do not differ significantly in susceptibility to the disease. Fruit infection is uncommon and restricted to trees with numerous leaf infections. Clear, brown spots appear on the surface of the fruit; become oval, depressed, and dark brown with age; and are almost black at harvest. The surface of the fruit is somewhat indented, and small, black acervuli are visible in the lesions.

#### *Disease cycle*

Primary infections are initiated by ascospores produced on overwintered leaves. Mature ascospores are found just before the bloom stage of bud development. Ascospore discharge usually lasts for three to four weeks. Rain is required for spore release. Primary symptoms appear in the middle of June, usually on mature leaves. Infection of leaves by conidia takes place most frequently at 68 to 77°F, and symptoms are present within eight days of inoculation. Defoliation begins about two weeks after the symptoms appear.



**Disease management**

Disease control is managed through orchard sanitation, pruning, and the use of fungicides. Removal of overwintered leaves on the ground may reduce the inoculum level. Conventional fungicides commonly used for early and summer apple diseases easily keep this disease in check to prevent premature defoliation. Anecdotally, sulfur has provided limited control.

**MOLDY CORE OF APPLE**

Moldy core is caused by several different fungal pathogens. Many cultivars of apples are affected, including Golden Delicious, which is very susceptible. Moldy core may develop into dry core rot if the pathogen penetrates into the core flesh, but the fungus is generally restricted to the core or carpel region.

**Symptoms**

Moldy core is characterized by the growth of fungus mycelium within the locules (the seed cavity) without penetration into the flesh of the fruit. External symptoms are rare, except infected fruit may color and fall prematurely. The disease isn't noticed until the fruit are cut open.

**Disease cycle**

The moldy core fungi colonize the flower parts as soon as the blossoms open. The fungi then enter the developing fruit through an opening in the calyx. Moldy core is primarily a problem during years with light fruit set or when dry weather in early summer is followed by heavy rains in late summer. In addition, wet weather during bloom may cause conditions favorable for the fungi to produce spores.

**Disease management**

Apple cultivars vary in their susceptibility to moldy core. Those most susceptible, such as Delicious or Idared, have an open sinus extending from the calyx into the core. Use of fungicides to control moldy core during bloom time has had mixed results. To promote fast drying in the orchard, which discourages spore development and germination, employ cultural practices of orchard training and pruning, which allow for good air movement and light penetration.

**NECROTIC LEAF BLOTCH OF APPLE**

The cause of necrotic leaf blotch of apple is not known; it is considered a physiological disorder. The disorder is most common on Golden Delicious worldwide.

**Symptoms**

The disorder is characterized by irregularly shaped necrotic blotches on older leaves, limited by the veins. These necrotic areas do not have spores, unlike necrotic spots caused by pathogens resulting in frogeye leaf spot, Marssonina blotch, and Alternaria spot. Necrotic areas can range in size and midshoot leaves are most affected. Affected leaves turn yellow in about four days and subsequently fall off the tree. Other characteristics of the disorder are that the symptoms develop suddenly, appearing overnight, and it can occur in waves from July through August. The disorder tends to be more common and severe later in the summer; however, usually appearing when a cool, rainy period is followed by hot summer weather. Some orchards or trees within

an orchard may show little or no defoliation, while other orchards or trees reach 50 percent defoliation or more.

**Management**

Although no bacteria or fungi have been associated with the necrotic leaf blotch, the disorder has been reduced where the fungicide ziram is used in the summer spray program. Foliar applications of zinc oxide also have been effective in reducing the severity of the disorder.

**NECTARINE POX**

Nectarine pox is a disorder that reduces packout of commercially grown nectarines. Three years of research in Pennsylvania orchards demonstrated that it is more likely to be a problem when crop load is light; shoot growth is excessive; foliar levels of nitrogen, potassium, and/or magnesium are excessive; and calcium and/or boron levels are low. The disorder tends to be more prevalent during seasons with cool spring temperatures and above-normal rainfall in June. Cool May temperatures inhibit uptake of boron and sometimes reduce crop load. June rainfall may cause growth spurts at a susceptible developmental stage.

**Symptoms**

The disorder is characterized by superficial warty outgrowths on the fruit that begin to form approximately 40 days after bloom. Initially, the protuberances are only slightly raised and similar in color and surface texture to the surrounding epidermal tissue. The "warts" expand as fruit enlarge and the skin of the raised area becomes redder than the surrounding tissue. Paring through the outgrowth reveals flesh tissue that appears normal. Symptoms are generally distinguished by singular rounded or pointed outgrowths, although the warts can become clustered together to form larger, irregular areas of rough, raised tissue.

**Management**

Research and grower observations indicate that nectarine pox is similar to cork spot on apples in that it is associated with any factor that contributes to an irregular rate of fruit growth. Conditions that predispose trees to nectarine pox include high nitrogen (and other macronutrients) and uneven moisture. As with cork spot, it is important to maintain optimum boron and calcium levels. A comprehensive best management program includes:

- Avoiding practices that encourage excessive shoot growth (especially spurts of growth in late May/early June)
- Utilizing management tools that encourage even growth over the season (such as regularly scheduled irrigation)
- Maintaining nitrogen, phosphorus, potassium, and magnesium at moderate levels
- Maintaining calcium and boron at optimum levels

Collect leaves for tissue analysis in mid-July to mid-August. Optimum levels of leaf nitrogen are 2.5 to 3 percent, while the optimum levels for boron are 31 to 59 ppm. It is important not to exceed boron recommendations provided by the analytical lab, as excess boron can cause phytotoxicity. A long-term program to avoid nectarine pox includes selecting varieties that are less prone to the disorder, planting nectarines on sites that are not overly fertile, and planting on sites with excellent air drainage.

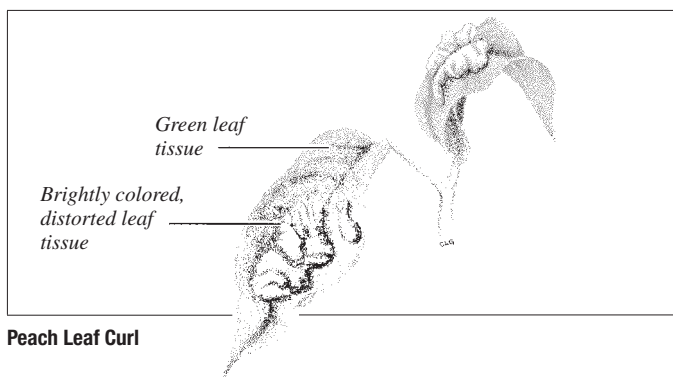

Peach Leaf Curl

### NECTRIA TWIG BLIGHT OF APPLE

Nectria twig blight, caused by the fungus *Nectria cinnabarina*, is a minor disease that breaks out occasionally. Because its symptoms are similar to those of fire blight, growers need to be able to recognize it. The chemical controls used for fire blight would be wasted on nectria twig blight.

#### Symptoms

In late spring and early summer leaves and shoots of infected twigs wilt and turn brown. Close examination will show that a canker has girdled the twig at the point where shoots begin to grow. Most often this spot is located at the base of the previous season's cluster bud. Orange to coral-colored fruiting structures of the fungus may appear on the cankered region. Rome Beauty, characterized by enlarged cluster-bud bases, is very susceptible.

#### Disease management

Since this disease hasn't been severe enough, no chemical control measures have been developed. The disease seems to be most prevalent during severe fire blight years since the fungus takes advantage of cankered areas as well. The best management technique is to reduce inoculum by removing infected plant parts from the orchard.

### PEACH LEAF CURL

The peach leaf curl fungus, *Taphrina deformans*, destroys early peach leaves. Although new leaves develop, their growth reduces established food reserves, weakens the tree, and may reduce yield. Defoliation by peach leaf curl in successive seasons may kill the tree.

#### Symptoms

Infected leaves, which begin appearing in mid-May, are easily distinguished from healthy leaves in that they are puckered and thicker than normal. Deformed areas are red to yellow at first and then turn brown. Eventually the infected leaves fall from the tree.

#### Disease cycle

Spores of the leaf curl fungus overwinter on the surface of peach twigs. In spring, the spores multiply during periods of moist weather until the leaf buds swell and open. Rain is necessary for infection. The spores are carried on a film of water into the buds, where leaves are infected. Cool, wet weather slows leaf development and allows more time for leaf curl infection. Infection occurs readily at 50° to 70°F. Dry weather during bud swell and bud break limits leaf curl infection.

After the deformed and discolored leaves turn brown and fall, they produce powdery gray spores. These are blown by winds to peach twig surfaces and remain there for the winter.

#### Disease management, chemical

Peach leaf curl is not difficult to control. A single fungicide (copper or chlorothalonil) application made in the fall after leaves have dropped or in spring before bud swell will control the disease. The spring application must be made before bud swell. If spring applications are made, temperatures must be monitored closely. Unusually warm weather during late winter months can encourage bud swell, thereby making fungicide sprays ineffective. Once the fungus enters the leaf, the disease cannot be controlled.

The fungicide kills the spores on twig surfaces. For either the spring or the fall spray to be effective, application must be thorough. Complete coverage of the twigs, branches, and trunks is essential. Applications made from one side of the tree or with highly concentrated sprays may not be effective.

#### Disease management, cultural

Where leaf curl is severe, it is very important to maintain tree vigor by (1) thinning fruit to reduce demand on the tree, (2) irrigating to reduce drought stress, and (3) fertilizing trees with nitrogen by June 15. Be careful not to overstimulate trees.

### PEACH SCAB

Peach scab is an important disease in warm, humid peach-producing areas of the world. The fungus can be extremely damaging to trees throughout the Mid-Atlantic region because of the typically warm, wet weather during the day through the mid-season period. The disease appears to affect all cultivars of peach and is known to occur on nectarines and apricots as well.

#### Symptoms

The most notable symptoms of peach scab occur on the fruit, where small, greenish, circular spots gradually enlarge and deepen in color to black as spore production begins. Lesions are most noticeable on the stem end of the fruit where spores wash from infected areas of the twigs onto the fruit. Unlike bacterial spot, there is no pitting of the skin and no symptoms on leaves. The overwintering twig lesions are clearly visible during the early season as small, grayish, more or less circular, slightly sunken lesions on the previous season's shoot growth.

#### Disease cycle

The pathogen overwinters in small twig lesions on last season's shoots. Conidiospores, produced in these cankers during the early spring, are splashed by rain to young fruits and new shoot growth. Rain is required for infection and a very long incubation of 42 to 77 days is needed for symptom development. Although the fruits remain susceptible through harvest, it is usually only infections that occur during the shuck split to pit hardening stage of development that have an opportunity to show symptoms before harvest. Twig infections that result in the formation of small overwintering lesions can occur throughout the season. Secondary infections may occur on twigs but usually do not appear on fruit, except on late season cultivars.

**Disease management**

Monitoring orchards for peach scab during the current season is an important step for managing the disease the following year. The critical time for effective disease control begins at the shuck split stage of fruit development. By the time the disease appears, it is too late to do anything about it during the current growing season. Proper and regular pruning facilitates air movement, reduces length of wet periods, and improves spray penetration into trees. Fungicide sprays, applied at 10- to 14-day intervals, should be made beginning at petal fall and continuing until 40 days before harvest. Fungicides used to manage peach scab will also manage brown rot. Consequently, rotating fungicides by FRAC Group is encouraged to limit fungicide resistance.

**PEACH STEM PITTING**

Trees infected with tomato ringspot virus (ToRSV) have the general appearance of being girdled, and the leaves appear drought stressed. Superficially, the symptoms may be confused with those of a number of disorders and injuries, including root rot, nutrient deficiencies, herbicide damage, mouse girdling, and implement injury.

**Symptoms**

Characteristic symptoms include reduced terminal growth and drooping leaves that may curl upward lengthwise. Leaves of infected trees may turn yellow and drop earlier than those on comparable healthy trees. Generally, infected trees produce a large number of fruits, which tend to ripen early and be highly colored and small.

Bark from belowground portions of the trunk is unusually thick and corky. When bark is removed from an infected rootstock, pits or grooves may be seen in the wood. The severity of pitting varies with tree variety and stage of disease development. The pitting may or may not extend across the graft union. Some affected trees may break off easily at ground level or below. The tendency to break is apparently correlated with the tree's age at the time of infection. Breakage may be confused with incompatibility of the graft union. Trees infected with ToRSV lose vigor and eventually die. Once infected, they do not recover and cannot be cured. Although feeding by the dagger nematode is the only natural means of virus infection, peach stem pitting may also be spread by grafting and budding.

**Disease management**

No sources of genetic resistance to ToRSV have been identified for peaches or nectarines. Virtually all other stone fruits, including apricots, cherries, and plums, are likewise susceptible to ToRSV. Therefore, it is important to only purchase trees that have been certified virus free. The virus can be introduced into an orchard in plantings or infected trees or in seeds of infected weeds. ToRSV is transmitted by the dagger nematode *Xiphinema americanum*. The virus can infect a number of commonly found weeds, including dandelion. Dagger nematodes will feed on the infected roots of weeds or trees and spread the virus to healthy trees. Prior to planting soils should be tested for nematodes to determine dagger nematode presence. Nematode control is most effective prior to planting. In addition, weed control in the orchard is also recommended to decrease the availability of virus reservoir sources.

**PEAR LEAF BLIGHT AND FRUIT SPOT**

This disease should not be confused with the fire blight or leaf spot diseases of pears. Leaf blight and fruit spot is caused by the fungus *Fabraea maculata*, which infects the leaves, fruit, and shoots of pear and quince trees and the leaves of apple trees. The disease can build up rapidly, even in orchards where it has not been a problem. If conditions favor the disease and it is not controlled, pear trees may become defoliated in a few weeks.

**Symptoms**

Leaf spots first appear as small purple dots on the leaves nearest the ground. They grow to circular spots about ¼ inch in diameter, becoming purplish black or brown. A small black pimple appears in the center of the spot. When the leaf is wet, a gelatinous mass of spores oozes from the pimple and gives the spot a creamy, glistening appearance. Each lesion may have dozens of spots, resulting in extensive defoliation. Fruit lesions are much like those on leaves, but they are black and slightly sunken. They may be so numerous as to run together and make the fruit crack.

Lesions on twigs occur on current-season growth. They are purple to black, with indefinite margins. The lesions may run together and form a superficial canker.

Early defoliation leads to small fruit, weak bud formation, and fall blossoming. Infected fruit has no sale value and often is cracked and misshapen.

**Disease cycle**

The sexual spore stage develops on fallen, overwintered leaves. Conidia, asexual spores, may also develop in the spots on overwintered leaves, or they may be produced in the previous season's shoot infections. Often the first infections do not occur until mid-June to the first of July. Secondary infections begin about one month later and reoccur throughout the season during periods of rain.

**Disease management**

Routine fungicide sprays normally control this disease in Pennsylvania.

**PEAR LEAF SPOT**

The pear leaf spot fungus, *Mycosphaerella pyri*, infects the leaves of pear, quince, and occasionally apple trees. Numerous leaf spots can produce defoliation. Fortunately, this does not often occur before fall, except in nurseries.

**Symptoms**

Mature leaf spots are easily recognized by their grayish white centers with sharply defined margins. Appearing first on upper leaf surfaces as small, brown lesions, they enlarge to ⅛ to ¼ inch in diameter. The borders become dark brown, and small black pimples appear in the centers.

**Disease cycle**

Sexual spores are produced on overwintered, fallen leaves and are carried by air currents to newly formed leaves. About a month after infection, new spores are generated in the centers of the grayish white leaf spots, from which they are washed by rain to other leaves. These secondary infections usually peak in late summer or early fall.



Pear Scab

### Disease management

Routine fungicide sprays normally control this disease in Pennsylvania.

### PEAR SCAB

Pear scab resembles apple scab in nearly all respects and is caused by the closely related fungus *Venturia pirina*. Although it is not particularly common, pear scab is very destructive when it does occur. Its symptoms and disease cycle are so similar to those of apple scab that they need not be repeated here. A major difference is the frequent appearance of pear scab on twigs, where it can overwinter and start new infections in spring. Leaf infection of pear is not as common as apple scab on apple leaves.

### Disease management

Routine fungicide sprays normally control this disease in Pennsylvania.

### PHYTOPHTHORA COLLAR, CROWN, AND ROOT ROTS

Phytophthora collar, crown, and root rots continue to be a major cause of tree death in Pennsylvania orchards. These rots can affect both pome and stone fruit. It is often observed on three- to eight-year-old trees grown on Malling-Merton (MM) 104, MM.106, M.7, and to a lesser degree MM.111 rootstocks. The disease is often observed in low-lying areas of orchards with heavy, poorly drained soils, and is more problematic during rainy seasons and the year following a very rainy season.

### Symptoms

Crown rot refers to symptoms on rootstock tissue type extending from the graft union down to the proximal ends of the primary roots, whereas collar rot specifically refers to symptoms on the scion (above the graft union) at or slightly above the soil line. When symptoms appear beyond the proximal junction of the primary roots to crown tissue, the disease is referred to as root rot. Aboveground symptoms resulting from Phytophthora infection are only indicators of a dysfunctional root system, vascular system, or both and are identical to those from other root diseases and abiotic disorders, such as winter injury and root asphyxiation. The first symptoms to appear in the spring are delayed bud break, leaf discoloration, and twig dieback. While infected trees may survive the growing season, they show symptoms of stunting, leaf and bark discoloration and premature leaf drop in the fall. The most obvious symptom found on affected trees is a partial or complete girdling of the trunk. Close examination of the roots often reveals reddish-brown, water-soaked areas of

necrotic tissue located at the base of the root where it attaches to the rootstock. The entire underground portion of the stem is usually water soaked and brown, and the necrotic area usually extends upward to the graft union.

### Disease cycle

*Phytophthora* spp. can cause severe collar, crown, and root rots on pome and stone fruit. *Phytophthora* spp. can survive in the soil for one to two years, which is important to note if replacing an older orchard. Old trees can tolerate this microorganism, whereas younger trees cannot. The fungus requires high levels of moisture and cool temperatures for growth and reproduction, and grows best at temperatures around 56°F. Trees are therefore attacked at about blossom time (April) and during the onset of dormancy (September). The fungus can infect apple trees in the following ways: (1) collar rot, infection above the tree union; (2) crown rot, infection of the lower trunk and root bases; and (3) root rot, infection of the lateral and fibrous root system.

### Disease management, cultural

- **Rootstock susceptibility.** Of the rootstocks preferred by growers, none are completely resistant to crown rot. The rootstocks M.7, MM.104, and MM.106 have appeared to be the most susceptible. Although less susceptible, M.2 and MM.111 can be infected by crown rot under favorable conditions. Resistant and moderately resistant rootstocks include B.9, M.4, M.9, and M.27. Geneva rootstocks have shown resistance. Note: Because a number of Phytophthora species cause root, crown, and collar rot, it is difficult to make absolute statements about the relative susceptibility of different rootstocks to these diseases.
- **Orchard site selection.** Avoid planting orchards in heavy, poorly drained soils. These sites favor fungal growth and development. Crown rot prevention is difficult and eradication almost impossible in low-lying, poorly drained sites. Be mindful of locations that were previously an orchard. Fumigation may be necessary. Using raised beds is another option for limiting crown and root rot.
- **Horticultural.** If the tree has not been completely girdled, remove the soil from the base of the tree; then scrape the surface of the discolored area and leave exposed to dry. Drying often stops crown rot from progressing further. In-arch grafting may also be used to bridge the damaged area.

### Disease management, chemical

Chemical management is only successful when used in a preventative sense to protect plantings in poorly drained soils or during years with considerable rainfall. Alliette, Ridomil Gold SL, and phosphorous acid/potassium phosphite products (e.g., Rampart, ProPhyt, Phostrol) are currently registered for control of crown rot on apple and stone fruits. Refer to the label for specific use recommendations.

### PLUM LEAF SPOT

Leaf spot of plums and prune-type plums is caused by the fungus *Blumeriella jaapii*. The fungus, its life cycle, and the disease it causes are very similar to those of cherry leaf spot. On plum leaves the spots tend to be smaller, and severely infected leaves often have a tattered appearance. Unlike cherry infection, severe plum leaf infection is often followed by a heavy fruit drop.

### Disease management

Most cultivars are susceptible to the disease, so fungicide sprays along with the sanitation practices suggested for cherry leaf spot are necessary for control. A light discing should be done just before overwintered spores on leaves are ready to be discharged, about the time of shuck fall.

#### PLUM POCKETS

A number of diseases of stone fruit are caused by fungi similar to the leaf curl fungus. In the northeastern United States, the most important disease affecting American-type plums is known as plum pockets, or bladder plum. It is caused by *Taphrina communis*.

#### Symptoms

First evidence of the disease on fruit are small, white blisters. These enlarge rapidly and soon involve the entire fruit. The fruit becomes spongy and tissues of the seed cavity wither and die. Enlarging rapidly, fruits grow 10 times their normal size, turn reddish, and become so misshapen that they are hardly recognizable. As their spongy interiors dry up, the plums turn velvety gray as spores grow on their surfaces.

New shoots and leaves are usually infected as well as fruit. Shoots thicken and are often curled or twisted. Diseased leaves are thickened and curled as in leaf curl.

#### Disease cycle

Spores overwinter on twigs and during cool, wet periods in early bloom may be splashed to the opening buds, where infection takes place. Developing ascospores give the infected fruit a velvety gray appearance, thus completing the disease cycle.

#### Disease management

Routine fungicide sprays normally control this disease in Pennsylvania.

#### PLUM POX VIRUS

Plum pox virus (PPV), or Sharka, is a viral disease that infects not only plum but other economically important *Prunus* species, including peach, nectarine, apricot, almond, and cherry, and ornamentals, such as flowering almond and purple leaf plum. PPV is known to infect wild *Prunus* and a large number of native and introduced weeds under laboratory conditions. Some common plants that can become infected with PPV include lamb's quarter (*Chenopodium* spp.), shepherd's purse (*Capsella bursa-pastoris*), ground cherry (*Physalis* spp.), buttercup (*Ranunculus* spp.), red and white clover (*Trifolium* spp.), and sweet clover (*Melilotus* spp.). Common garden hosts include tomato, pea, petunia, and zinnia.

#### Symptoms

Symptoms on leaves may consist of mild light green discoloration bordering the leaf veins (vein yellowing) or yellow to light green rings. These symptoms may be barely visible to the eye, depending on factors described above. Flower symptoms can occur on varieties with showy blossoms, but do not always occur.

Peach and apricot fruit may develop lightly pigmented yellow rings or line patterns resulting from several rings running together on the surface of the fruit. Fruit may become deformed or irregular in shape and develop necrotic or brown dead areas. Apricot fruit may show no external evidence of disease, but may have a white ring or line patterns on the seed.

Plums generally are more severely affected and show more severe symptoms than other stone fruits. Therefore, plums are a good indicator host to observe for symptoms of infection, allowing growers to monitor for PPV infection in orchards. For some plum cultivars, infected fruit drops prematurely from the tree. Infected plum fruits often are severely deformed and develop darker rings or spots on the skin and a reddish discoloration of the flesh.

Infected trees may or may not produce visual symptoms on leaves and fruits, but crop yield may be reduced even on symptomless trees. PPV also reduces fruit quality, resulting in reductions in grade, and eventually debilitates the tree, shortening its productive life. PPV symptoms may vary considerably with the cultivar, age, nutrient status of the host plant, and the temperature. In addition, different strains of PPV vary in the severity of the disease they cause and the resulting symptoms. Not every leaf or fruit on an infected tree will show symptoms. The virus can often be detected at the bottom of a branch but not the tip; however, once a branch shows symptoms, it will continue to display them in subsequent years.

#### Mechanisms of PPV transmission and spread

**Short-distance spread in and between orchards.** In commercial settings such as orchards, PPV is spread over short distances by aphids. At least six North American aphid species are able to vector PPV, and four of these are common in Pennsylvania orchards. One of the most efficient vectors is the green peach aphid (*Myzus persicae*), which colonizes peaches and other stone fruits in Pennsylvania.

**Long-distance spread between orchards or geographical regions.** Long-distance spread of PPV and the introduction of the virus to new regions where it previously has not been known to exist occurs primarily by movement of infected plants or plant parts by human activity. Buds taken from infected trees will carry the virus and transfer it when grafted to healthy trees.

#### Identification and eradication of PPV in Pennsylvania

The plum pox virus is an introduced pathogen and given quarantine status by USDA/APHIS. After its discovery in Pennsylvania in 1999 an aggressive eradication program was developed to prevent it from spreading and eliminate it if possible. The eradication program included surveys to identify infected trees, destruction of infected orchards, creation of buffer zones and a moratorium on replanting *Prunus* in quarantined areas, among other efforts. After 10 years and the destruction of over 1,500 acres of fruit trees, Pennsylvania was declared free of PPV in October 2009 and the moratorium on replanting *Prunus* was rescinded across the state.

Although the eradication program was successful, the occurrence of PPV in Pennsylvania serves to remind everyone of the importance and the need for strict plant quarantine and testing procedures associated with imported nursery materials. In almost all cases, intercontinental spread of plant disease causal agents is associated with human transfer of infected host materials. Therefore, once the diseases have been eliminated, careful regulation and inspection, combined with education of importers and travelers, could prevent the reintroduction of exotic plant diseases such as PPV from threatening U.S. crops. The Pennsylvania Department of Agriculture (PDA) will continue to monitor for PPV on a reduced scale for an additional 10 years

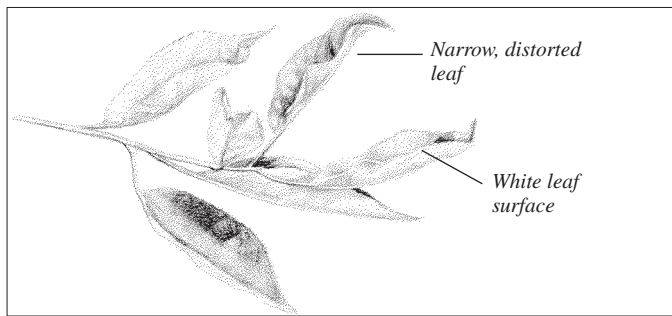

Powdery Mildew of Apple (leaf)

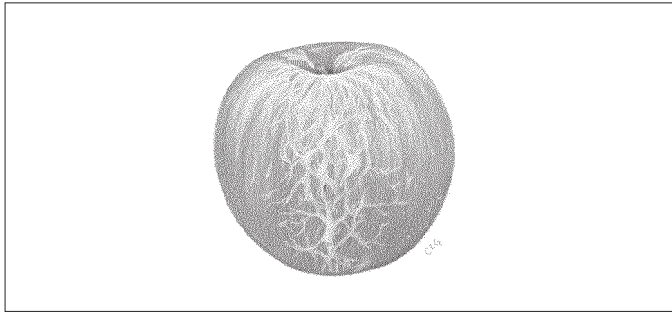

Powdery Mildew of Apple (fruit)

to ensure that reservoirs of the virus did not escape detection. In addition, growers that spot suspect fruit are urged to bring it to the attention of PDA for testing.

#### Disease management

Once PPV becomes established in a geographical region, it is very difficult to control or eradicate. Therefore, the primary focus is placed on preventing the introduction of PPV to new fruit-growing areas. Commercial growers and nursery propagators are reminded to purchase only certified virus-free planting stock that has been tested and verified to be free of PPV and other fruit viruses. In the future, it will be important for growers to verify that certified stone fruit nursery stock from any source also has been tested for PPV.

#### POWDERY MILDEW OF APPLE

Powdery mildew, caused by the fungus *Podosphaera leucotricha*, attacks buds, blossoms, leaves, new shoots, and fruit of wild and cultivated apples and crabapples. It interferes with the proper functioning of leaves, reduces shoot growth, reduces fruit set, and produces a netlike russet on the fruit of some cultivars. It is often a serious problem in apple nurseries.

#### Symptoms

The first sign of powdery mildew in spring is a three- to four-day delay in the opening of infected buds. Leaves and blossoms of these buds soon become covered with a white to light gray powder, the spores of the powdery mildew fungus. Flowers do not develop normally, are likely to be greenish white, and produce no fruit. On leaves of new shoot growth symptoms of powdery mildew are feltlike, white patches on the margins and lower surfaces. Infected leaves curl upward and soon become covered with a powdery coating of spores. New infections of succulent leaves and growing shoots reduce the size of the entire shoot. By midsummer, leaves and shoots may turn brown. Fruit infections develop on severely diseased trees and will have a net russetting appearance.

#### Disease cycle

The fungus overwinters as mycelium (fungus threads) inside infected buds. As these buds open in spring, all of their parts become covered with a powdery coating of spores. The spores, easily wind-blown, infect new leaves, fruit, and shoots. Fruit infection takes place during and shortly after the blossom period. Leaf and shoot infection may continue as long as shoot growth continues. Buds can become infected as they begin to form until they are matured for overwintering. Infections occur at temperatures of 65 to 80°F when relative humidity is high, such as at night. No moisture is required for spore germination to occur. Consequently, powdery mildew is often called the “dry weather disease.”

#### Disease management

Mildew sprays should begin at the tight cluster bud stage, where the disease is severe. Fungicides need to be continued until new shoots stop growing or about the fourth cover spray. Sterol inhibitor fungicides (FRAC Group 3 fungicides) applied to control apple scab are very effective in controlling powdery mildew. SDHI fungicides (FRAC Group 7) vary in their efficacy in mitigating powdery mildew; however, premix fungicides, such as those mixed with FRAC Group 11, have shown efficacy. Sulfur is also another control option, particularly for organic management.

#### POWDERY MILDEW OF CHERRY AND PLUM

The disease is caused by *Podosphaeria oxycantha*, one of the common species of the powdery mildew group of fungi. The same fungus reportedly causes powdery mildew in peach, apricot, apple, pear, quince, and persimmon trees, and a few ornamental plants. This discussion will be limited to the disease as it affects plums and tart and sweet cherries.

The fungus attacks leaves and twigs, producing symptoms much like powdery mildew on apples. Infected leaves curl upward. Newly developed leaves on new shoot growth become progressively smaller, are generally pale, and are somewhat distorted. New shoots are shorter in length than normal. By midseason the whitish fungus can be seen growing over the leaves and shoots, sometimes in patches and other times covering most of the new growth. Such symptoms are especially common in nursery trees. In Pennsylvania, powdery mildew has not been observed on the cherry fruit.

#### Disease cycle

The fungus may overwinter on diseased, fallen leaves, but usually it does so in infected buds, as in apple powdery mildew. As infected buds expand in spring, new growth is overrun by the fungus. Much of the visible white growth consists of conidia, which are spread by wind to other new leaves and shoots. Warm temperatures without rain, but with sufficiently high humidity for morning fog or dews, are ideal for rapid increase of the disease.

#### Disease management

FRAC Groups 3, 7, and 11 fungicides (and their premixes) may be applied as the disease develops. In addition, powdery-mildew-only products for stone fruit, such as Quintec (FRAC Group 13) and Vivando (FRAC Group U8), can be used; however, if managing other fungal diseases, another fungicide must be included.

#### POWDERY MILDEW OF PEACH, NECTARINE, AND APRICOT

Powdery mildew, sometimes called rose mildew (it affects some

woody ornamentals), is not often serious. The causal fungus, *Sphaerotheca pannosa*, attacks leaves, twigs, and fruit.

### Symptoms

On fruit the disease first appears as round, whitish spots two to four weeks after shuck fall. The spots get bigger until they cover much of the fruit. The white spots are produced by the fungus mycelium and its spores. About the time of pit-hardening, the skin of the fruit under the spot turns pinkish, and the fungus and its spores disappear. Eventually the skin becomes leathery or hard, turns brown, and may crack.

Diseased leaves often fail to unfold normally, while those of new shoots become narrow, straplike, and distorted. New shoots are shorter than normal and distorted. The white mycelium and spores of the fungus may cover infected leaves and shoots or may appear as whitish patches.

### Disease cycle

The fungus overwinters on shoots infected the previous season. Quite likely it survives behind leaf bud scales. Flower buds of infected shoots often do not survive the winter. As leaf buds expand in spring, young leaves become infected and the spores produced on the leaves serve to infect young fruit, new shoot growth, and newly expanding leaves.

### Disease management

Routine fungicides adequately control this disease.

## RAPID APPLE DECLINE

Rapid apple decline (RAD) is mysterious syndrome affecting young dwarf apple trees with no known cause to date. For the last several years, there have been many reports throughout Pennsylvania and other apple-growing regions throughout the United States and Canada. The issue has been labeled “rapid apple decline” (RAD) or “sudden apple decline” (SAD) based on how fast the trees die from the first obvious symptoms to total collapse of the tree. The common denominator in all situations seems to revolve around the graft union. This situation is not to be confused with root, crown, or collar rot diseases, or rootstock blight resulting from *Erwinia amylovora* infection.

RAD was named by Pennsylvania Department of Agriculture due to the rapid or sudden collapse of apple trees from the time the first symptoms appear to tree death. The diagnostic characteristics are as follows:

- A block can have a mix of dead, declining, and healthy trees dispersed fairly evenly throughout a block.
- Young (two- to eight-year-old) dwarf trees are most susceptible (to date, semi-dwarf rootstocks have not been associated with this issue); affects multiple varieties and rootstocks (M9 most affected; several reports involving G41 and G935).
- The graft union is affected; severe shedding of bark around graft union and cankers are present.
- Necrosis begins at the graft union and it proceeds up the trunk of the tree.
- Affected wood is usually solid and not spongy.
- The rootstock is healthy, as indicated by many rootstock suckers present, as well as a healthy root system.

- The leaves on the trees begin to look pale yellow and then reddish (indicating tree girdling), and within two weeks the tree can be dead.
- Trees can collapse with a full load of large fruit.

Tree stress, such as severe winters or drought, appear to be a predisposing factor leading to RAD; however, not all affected regions have experienced these tree stressors. To date, affected trees fitting the mysterious RAD description have not tested positive for *E. amylovora*, *Phytophthora*, phytoplasma, tomato ringspot virus, or nematode issues. Borers, such as black stem borer and Ambrosia beetles, have been associated with declining trees; however, these insects are not attracted to healthy trees but rather to ethanol, which is emitted from stressed or declining trees.

Growing stronger, healthier trees that withstand stresses is the best action to help try to prevent RAD: irrigation; painting trunks white to limit southwest injury; yearly foliar and soil tests to be sure nutrients are balanced; planting trees in well drained areas or using raised beds; reduce weeds; season-long disease and insect management; and protect graft unions from rodent damage.

## RHIZOPUS ROT OF STONE FRUITS

Rhizopus rot, caused by *Rhizopus nigricans*, can be very destructive to harvested fruit and is only problematic on ripe fruit. While it can develop in hail-injured or cracked fruit on the tree, it most commonly affects fruit in storage, during transit, and at the marketplace. Peaches, nectarines, sweet cherries, and plums are most susceptible.

### Symptoms

Rhizopus rot begins much like brown rot—as a small, brown, circular spot—but with a detectable difference. The skin of Rhizopus rot-infected fruit slips readily from the underlying flesh, while the skin of brown rotted areas is tough and leathery. At normal temperatures, the small spots of Rhizopus rot enlarge rapidly and can involve the entire fruit in 24 to 48 hours. A white, whiskery mold appears on the surface of infected fruits, spreading to nearby fruit and the walls of the container. By this time the fruit tends to leak and to smell like vinegar. Finally, tiny, black, spherical structures are produced on stalks above the white mold. Each of these contains thousands of spores (sporangiospores) that are released to float in the air. At this stage the mold looks mostly black.

### Disease cycle

Rhizopus rot occurs on all decaying vegetation, including ripe fruits and vegetables. When environmental conditions are not favorable, it produces thick-walled zygospores that can withstand long periods of cold and drying. These are present on dead vegetation, in used fruit containers, and in packhouses and storages. Thus, some type of spore of the Rhizopus rot fungus is always present where fruit is handled.

An injury through the skin of fruit must be present for the first infections to occur, and injuries as tiny as the prick of a pin are sufficient. In packed fruit or clustered ripe fruit on trees, the fungus can spread over the uninjured skin from an infected fruit nearby

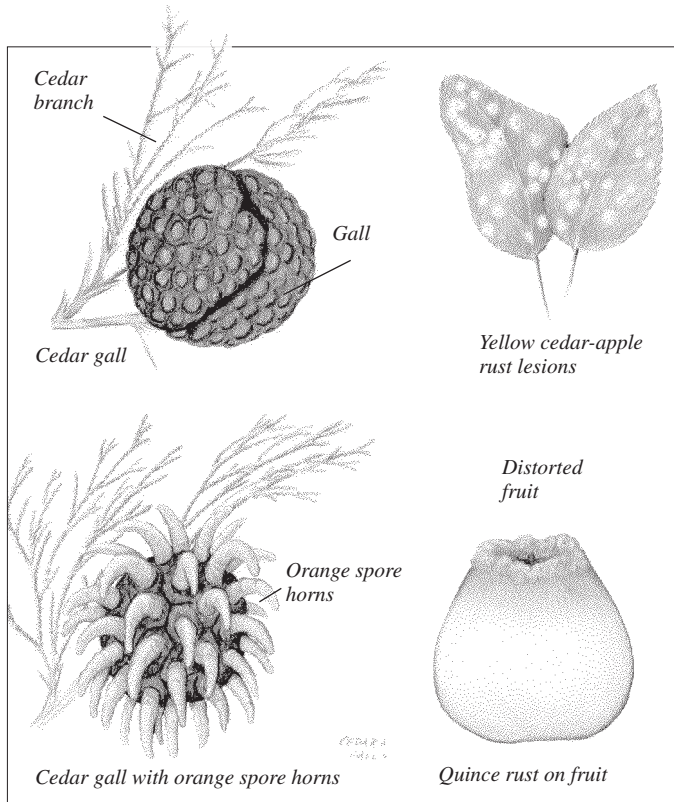

#### Cedar-Apple and Quince Rust

and eventually cause a rot. High temperature and humidity favor the rapid growth of the fungus and decay of fruit.

#### Disease management

Preharvest fungicides for mitigating brown rot should include at least one fungicide application from FRAC Group 11. This class of fungicide is the most effective for preventing *Rhizopus* rot. More important, preventing skin cuts and punctures during harvest and packing is prime in controlling *Rhizopus* rot. Clean containers and good housekeeping in the packing shed and storage will aid greatly in reducing the spore population. Quickly removing field heat drastically slows decay, as does refrigerating fruit until it is sold to the consumer or is processed.

#### RUST DISEASE OF APPLE

There are three rust diseases: cedar-apple rust, hawthorn rust, and quince rust. The most common is cedar-apple rust. All three must spend part of their life cycles on red cedar. These diseases can cause economic losses in several ways. Severe leaf infection and defoliation may make trees susceptible to winter injury. Severe defoliation reduces fruit size and quality, and infected fruit is deformed, sometimes very seriously. The hosts of cedar-apple rust are leaves and fruit of apple and crabapple trees. Of hawthorn rust, hosts are leaves of pear, hawthorn, apple, and crabapple; and of quince rust, hosts are the leaves and fruit of quince and the fruit of pear, apple, and crabapple.

#### Symptoms

On leaves, cedar-apple rust, caused by the fungus *Gymnosporangium juniperi-virginianae*, first appears as small, pale yellow spots on the upper surfaces. The spots enlarge to about 1/8 inch in diameter. Eventually, tiny, black, fruiting bodies (pycnia) become visible. Often a number of orange-yellow protuberances, called

**Table 2-3. Using temperature and wetness hours to determine cedar-apple rust infection periods.**

Average temperature (°F)	Basidiospore formation	Wetting period (hr)	
		Light infection	Severe infection
34	NB	24	NSI
39	NB	12	24
42	NB	8	10
46	7	6	7
50	5	5	6
52	4	4	5
57	4	3	5
61	4	3	4
64	4	3	4
68	4	2	4
72	4	2	4
77	4	2	4
79–86	NB	NI	NI

Source: Adapted from APS Compendium of Apple and Pear Diseases.

NB = no basidiospores formed at this temperature; NSI = no severe infection observed at this temperature; NI = no infections observed at these temperatures.

aecia, are produced in each spot on the underside of the leaf. Infected leaves may remain on the tree or may become yellowed and drop. Unlike other fungal diseases, rust leaf and fruit infections will not produce additional infections in the tree.

Fruit lesions appear on the blossom (calyx) end. They are somewhat like leaf lesions but much larger and often cause fruit to become disfigured or to develop unevenly.

Light brown to reddish brown galls form on the branches of red cedar. When they are dry and hard they may be 1/2 to 2 inches in diameter and are known as “cedar apples.” The galls’ surfaces are covered with depressions much like those on a golf ball. In the spring, when the “cedar apples” become wet, a yellow, gelatinous horn (telial horn) up to 2 inches long protrudes from each depression.

#### Disease cycle

Spores discharged from these gelatinous telial horns on red cedar are easily windborne, infecting apple leaves and fruit. Spore discharge begins about the pink stage of apple bloom and is usually completed in a few weeks. Following a few wet periods, the cedar galls die. Basidiospores are produced within four hours at 52–77°F (Table 2-3). Lesions on leaves begin to appear 10 to 14 days after infection. Visible fruit infections require a somewhat longer time. Quince rust is economically important primarily when an extended wetting period (more than 48 hours) with a mean temperature above 50°F occurs between tight cluster and late pink bud stages.

Aecia on the undersides of apple leaves or on fruit lesions themselves produce spores. Borne by winds, the spores may be carried back to the red cedar. After lodging in leaf axils or in crevices on cedar twigs, they germinate, infect the twig, and produce tiny galls the following spring. One year later, these galls become able to produce gelatinous horns bearing spores that can infect apple trees.

#### Disease management

To minimize cedar-apple rust infections, remove cedar trees located near orchards. Fungicide applications using EBDCs,



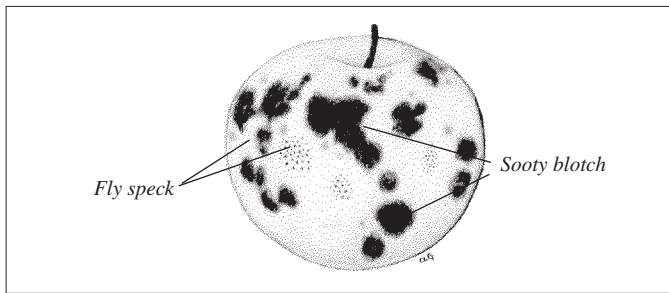

**Sooty Blotch and Flyspeck of Apple**

such as ferbam, ziram, and manzate, should be made beginning at the pink bud stage of apples and continue through first cover. FRAC Group 3 products are effective; several FRAC Group 11 products are labeled for “suppression” only. Once rust lesions are observed on leaves and fruit, it is too late for control. Unfortunately, effective organic options are not available.

### **RUST DISEASE OF PEAR**

Pear trellis rust is a new disease for Pennsylvania as of 2014 and has been in the Northeast since 2011. It is caused by the rust fungus *Gymnosporangium sabinae*. The disease can cause losses in pear crops and impact the health of ornamental pear trees. Like other rust diseases in pome fruit, pear trellis rust has a complex life cycle involving two susceptible hosts: ornamental (*Pyrus calleryana*) and orchard (*Pyrus communis*) pear trees and many species of juniper (*Juniperus* spp.).

#### **Symptoms**

Symptoms on pear begin as yellowish-orange leaf spots early in the season. Young fruit and twigs can also be infected. Leaf spots can become bright reddish orange during the summer. By mid-summer, tiny black dots (pycnia) appear in the center of the leaf spots. These do not produce infectious spores but play a role in the development of spore structures later in the season on the lower leaf surface. By late summer, brown, blisterlike swellings form on the lower leaf surface just beneath the leaf spots. This is followed by the development of acorn-shaped structures (aecia) with open, trellis-like sides that give this disease its common name. Aecio-spores produced within the aecia are wind-blown to susceptible juniper hosts, where they can cause infections on young shoots. These spores are released from late summer until leaf drop.

#### **Disease cycle**

Both pear and juniper hosts are required for this pathogen to complete its life cycle. The fungus may also overwinter in twig or branch galls on pear hosts that can serve as a source of new pear infections the following spring. On juniper, shoot infection results in a spindle-shaped gall. In the second spring after infection, orange gelatinous masses of spores are produced during wet weather. These spores are wind-blown and infect expanding pear leaves, young fruit, and shoots. Galls will produce spores for several years, unlike the galls of the closely related cedar-apple rust, which only produce spores for one season. The spores can be wind-blown for distances up to about three to four miles. Juniper health is not usually severely impacted by this disease.

#### **Disease management**

Removal of the second host (juniper) from the area where pears are grown will reduce the amount of disease. If removal is not

possible, galls can be pruned from the secondary host. Fungicides are not currently labeled specifically for this disease. Those labeled for control of other *Gymnosporangium* rusts on pear may offer some protection.

### **RUSTY SPOT OF PEACH**

Minor issue in Pennsylvania and is caused by the same fungus as apple powdery mildew. Loring is a susceptible variety.

#### **Symptoms**

Young peach fruit become infected and exhibit white nonpowdery lesions that are small, spherical, and later turn orange-tan in color. Leaves and stems are not affected.

#### **Disease management**

Routine fungicides control this disease. Controlling mildew in adjacent apple orchards reduces rusty spot incidence in peach orchards.

### **SOOTY BLOTCH AND FLYSPECK OF APPLE**

Affecting apple, crabapple, and pear trees, sooty blotch and flyspeck of apple are separate diseases, but both are normally present on the same fruit. They cause surface blemishes that detract from fruit appearance, lowering fruit quality and market value. Sooty blotch also shortens fruit storage life because of increased water loss. Sooty blotch is a disease complex caused by several unrelated fungi. Flyspeck is caused by the fungus *Zygophiala jamaicensis*.

#### **Symptoms**

Sooty blotch appears on fruit surfaces as sooty or cloudy blotches with indefinite borders. These blotches, which are olive green to black, can be removed by rubbing vigorously. Flyspeck looks like true “flyspecks” characterized by sharply defined, small, black, shiny dots in groups of a few to nearly 100 or more.

#### **Disease cycle**

Both fungi overwinter on the twigs of many woody plants as well as apple and pear. The diseases are spread by these overwintering hosts. Spores of the fungi are windblown into and throughout the orchard; fruit infection can occur any time after petal fall but is most prevalent in mid- to late summer. There are several disease models, which are variations on the original model published by Brown and Sutton (1995), to predict sooty blotch and flyspeck infection periods. For the Brown and Sutton model, leaf wetness hours greater than four hours starting 10 days after petal fall are counted. The threshold to start treatment begins approximately at 220 hours of leaf wetness. Disease outbreaks are favored by extended periods of above-normal summer temperatures combined with frequent rainfall and high humidity. New infections can be observed as late as September. These diseases usually appear on fruit late in the season.

#### **Disease management**

Routine fungicide sprays normally control this disease in Pennsylvania. Summer fungicide applications should not be extended beyond 14-day intervals. Cultural controls include removing alternate hosts such as brambles from the orchard and surrounding hedgerows. Dormant and summer pruning that opens up the tree canopy and facilitates air movement and the drying of fruit after rainfall helps control these diseases. Thinning to separate the fruit clusters also helps prevent disease.

No cultivar resistance to these diseases is known. Prune trees

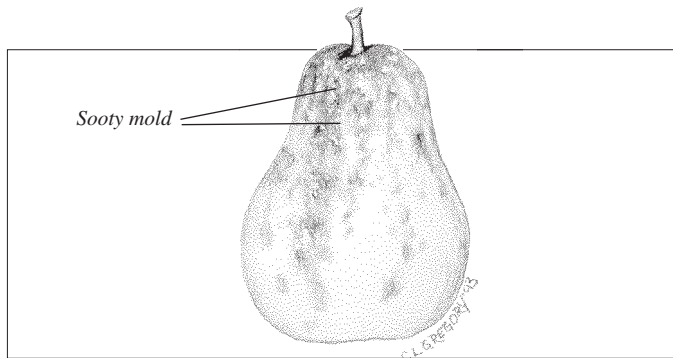
**Sooty Mold of Pear**

annually to improve air circulation and reduce the potential for disease. Cool fruit after picking to retard disease development.

#### **SOOTY MOLD OF PEAR**

Sooty mold fungi of the genus *Capnodium* cause an unsightly blackening over the surface of fruit and leaves. Sooty mold attacks many plants and is most common on pear, although it can affect all tree fruits and tree nuts. The fungi live on honeydew excreted by insects such as aphids, psylla, and white flies. When only a few insects are present on host plants, thus excreting a small amount of honeydew, sooty mold appears in spots. When insect secretions are abundant, the surfaces of leaves and fruit may have a near-continuous coating of the black, tissuepaper-thin sooty mold.

#### **Disease management**

Control is directed against the insects producing the honeydew. These insects need to be identified before appropriate controls can be undertaken.

#### **SOUTHERN BLIGHT OF APPLE**

Southern blight of apple has been primarily found in the southern half of the United States (North Carolina and South Carolina to California). It was identified in Pennsylvania in 2018 and the causal organism was identified as *Sclerotium delphini* (formerly known as *Sclerotium rolfsii* var. *delphini*). It is most common on young trees (less than three years old), but older dwarf trees have been observed to be susceptible, as well, under the right conditions.

#### **Symptoms**

A web of white mycelium is often found on the soil and/or the trunk at the base of an infected tree. Under moist conditions, the mycelium may progress up the trunk several inches in a fanlike pattern. Within a few days it disappears, and during periods of high humidity, masses of sclerotia develop. The sclerotia are white to tan at first and tan brown at maturity. They may also be found at the base of the tree and on roots up to 5 inches deep in the soil. There are often white mycelia throughout the soil of the roots of an infected tree. When the fungus attacks, the leaves will wilt and show characteristic yellowing or reddening discoloration indicative of the crown being girdled.

#### **Disease cycle**

Sclerotia are the principal means of overwintering and long-term survival of the fungus. Infection usually takes place directly by the penetration of young, uninjured bark, but injuries to the bark may facilitate entry of the pathogen. Factors that promote high incidence of disease are summer temperatures 77 to 95°F, high levels of soil moisture, good aeration, and an abundance of organic debris. The distribution of disease in the field rarely shows

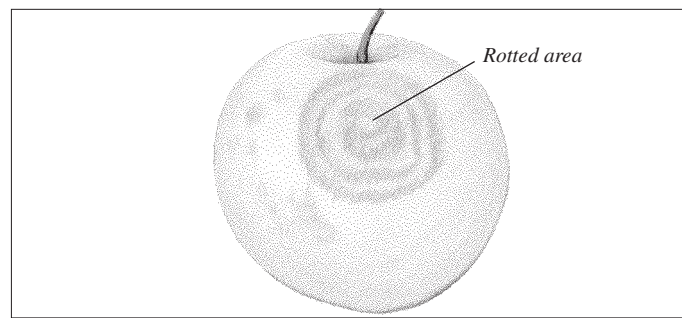
**White Rot of Apple**

a pattern. Young trees are most susceptible; however, under ideal conditions, older dwarf trees are vulnerable.

#### **Disease management**

Cultural control methods include controlling weeds around the tree collar, rouging diseased trees, and avoiding fields known to be infested or planted previously to soybean. A similar pathogen causes a disease in soybean. The pathogen can be controlled by fumigation. All apple rootstocks are susceptible.

#### **SOUTHWEST TRUNK INJURY**

Bark splitting on fruit tree trunks can occur during the winter when the winter sun shines on the trunk during the day and warms the surface of the bark as much as 30 degrees above the air temperature. Once the sun goes below the horizon, the temperature of the bark quickly drops to the air temperature. This sudden change in temperature can result in splitting of the bark. It is called southwest injury because it tends to occur on the side of the trunk that is facing southwest, which is the general aspect the sun shines from during the winter. This splitting can occur to any species of fruit tree. To prevent or reduce the damage, paint tree trunks on the southwest facing side with white latex paint in the late fall. Repeat applications of the latex paint will be necessary every two to three years. Alternatively, white-colored tree wraps may be used to help reflect the sun's heat.

#### **SUNBURN**

Sunburn damage to fruit is caused by ultraviolet-light radiation striking the fruit under high temperatures in the summer. Fruit has the ability to absorb and store more heat than leaves and cannot easily cool itself down, especially when it is well exposed. The result is the occurrence of photo-oxidative injury that expresses itself when the fruit peel will whiten from exposure to the sun and then brown later. Normally, sunburn is more of a problem in high-temperature growing regions such as Washington State. However, in the eastern United States, with increasing summer temperatures and newer training systems that expose more fruit to direct sunlight, there has been an increase in the incidence of sunburn. Cultural practices such as summer pruning that suddenly expose previously shaded fruit can result in the potential for sunburn. Sunburn on fruit can also be caused by crop load. A heavy crop load can pull branches down to expose previously shaded fruit to higher radiation levels later in the growing season.

#### **WHITE ROT OF APPLE**

The white rot fungus, *Botryosphaeria dothidea*, often referred to as "Bot rot" or *Botryosphaeria* rot, is most important on apple trees, but

it also attacks crabapple, pear, grape, and chestnut. On apple trees it can be observed as a distinct canker on twigs, limbs, and trunks. This relatively weak fungal pathogen is only problematic when the tree is stressed, such as due to drought, winter injury, insect damage, or fire blight. The fungus also causes fruit rot, which can be considerable, especially in southeastern regions of the United States.

### Symptoms

New infections on twigs and limbs start to become evident by early summer, appearing as small circular spots or blisters, sometimes with an orange tint. As the lesions expand, the area becomes slightly depressed. Cankers stop enlarging in late fall and can be indistinguishable from black rot canker (caused by *Diplodia seriata*), making isolation of the pathogen necessary for correct identification of the causal organism. By spring small, black pycnidia, the spore-containing structures of the fungus, appear on the smooth surface of new cankers. On older cankers, these may be present throughout the year. Cankers exhibit a scaly, papery outer bark that is often orange. The scaly, papery bark can be easily peeled off of the tree. Tissues beneath the canker surfaces are watery or slimy and brown. Most cankers are not deep, extending at most to the wood.

Fruit rot infection results in two types of symptoms, depending on the developmental stage of the fruit. One type originates from external infections and the other appears to start internally. External rot is first visible as small, slightly sunken, brown spots that may be surrounded by a red halo. As the decayed area expands, the core becomes rotten and eventually the entire fruit. Red-skinned apple varieties may bleach during the decay process and become a light brown. Because of this characteristic, the disease may be referred to as “white rot.”

This external rot of fruit can be confused with both black rot and bitter rot. The decayed apple flesh of black rot is firm and somewhat leathery, the surface of the spot is not sunken, and pycnidia eventually form. Decayed flesh of *Botryosphaeria* rot is at first cup- or egg-shaped. The rot is soft, the surface of the spot slightly sunken. Bitter rot causes cone-shaped areas of decay, the surface is sunken, and concentric rings of orange spores form on the surface.

### Disease cycle

Similar to black rot, the fungus grows best under warm conditions, with the optimum temperature for infection about 86°F. Conversely, for black rot infection the optimum temperature is about 68°F.

White rot overwinters in fruiting bodies on dead, woody tissue. During spring and summer rains, spores ooze from these structures and are splashed to other parts of the tree. Dead wood and fire-blighted twigs and branches are especially susceptible to invasion, but living twigs, branches, and trunks may also be attacked. Fruit infections can occur at any time from the bloom period to harvest. Infections in young apples usually are not evident until the apples are nearly mature. External rot lesions are found most commonly on the sides of fruit exposed to high temperatures. Drought, heat stress, mechanical wounding, and winter injury favor disease development of the wood tissue.

### Disease management

Management is the same as for black rot of apple. Since stress predisposes the tree to this disease, be sure to take measures in

minimizing stressors such as water stress, winter injury, disease, and insect damage.

## INSECT AND MITE PESTS IN PENNSYLVANIA

This section was designed to collate information from selected, high-quality publications and from our experience and knowledge. It contains information compiled from several sources listed at the end of this guide including research and extension publications from universities in most apple-growing states. The reader who desires further information on these pests is referred to this literature list.

Pests of pome and stone fruit are organized alphabetically. “Description and life cycle” and “Monitoring and management” sections are included for each pest. Life cycles are based on a “normal” year in south-central Pennsylvania. When dates are given, growers should make appropriate adjustments based on the difference in growing season for their region of the state. When the pest life cycle is based on the stage of the trees, generally no adjustments need to be made. The “Monitoring and management” section is subdivided for some pests. These divisions include “Monitoring,” “Cultural management,” and “Chemical management.”

### AMERICAN PLUM BORER

American plum borer, *Euzophera semifuneralis*, became a major indirect pest of tart cherries after widespread use of mechanical cherry harvesters, which caused shaker wounds that allow this pest to penetrate bark to feed on the underlying cambium. The severity of injuries by the American plum borer, which is in the same family as European corn borer (Lepidoptera: Pyralidae), has also increased in apples with the use of some clonal rootstocks, which allow access to the cambium through advantageous root growths called burr knots.

#### Description and life cycle

Adults are night-flying moths with front wings that vary from a reddish brown to a grayish brown with a broad black or dark purple band transversing the outer third of the wing. The hind wings are a light dusky tan color with slightly darker veins. They are about 1 inch long when at rest with the wings folded and have a wingspan of  $\frac{3}{4}$  to 1 inch. Larvae range in color from a dirty white with a greenish tinge along the underside to a deep reddish purple, have a dark brown head capsule, and reach about 1 inch at maturity. Pupae are about  $\frac{1}{2}$  inch long and are found in a white silken cocoon under the bark with reddish frass scattered around, but not part of, the cocoon. Larvae of lesser peachtree borer occupy a similar habitat but are white with a yellowish brown head capsule. The pupae of the lesser peachtree borer are similar in size, but the cocoons are dark brown, with frass forming an integral part of their construction. Emerged pupal skins of the plum borer do not extrude from the cocoon or from the bark as do those of the lesser peachtree borer.

American plum borer has two generations per year in Pennsylvania. Nearly full-grown larvae overwinter within silken hibernaculae near the cambium feeding sites or on the underside of overlying dead bark. Most larvae pupate within the hibernacula as soon as the cherry buds begin to open, and first adult emergence occurs by the white bud stage about two weeks later. Peak adult emergence of the first generation occurs just after full bloom. The majority of eggs of the first generation are

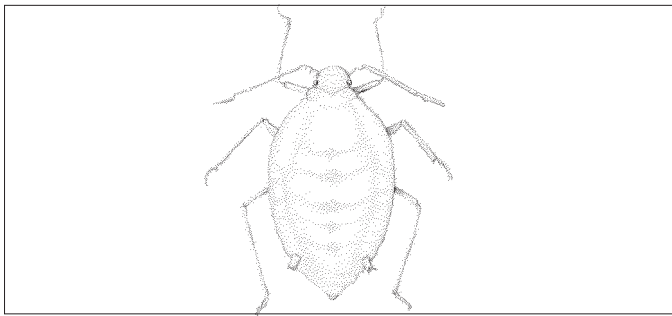

**Apple Grain Aphid**

laid by petal fall, although adult emergence often continues for another three weeks. Adult emergence of the second generation begins in June, peaks in mid-July, and continues into August or September. Peak emergence and egg laying coincides with the mechanical harvesting of cherries when there is an abundance of fresh cracks and wounds suitable for oviposition and chemical control is impossible because of residues on the harvested fruit.

Females are attracted to fresh wounds and lay very small pink eggs singly around the wound. The eggs quickly turn white, and upon hatching the larvae immediately enter the wound to feed. In all tree fruits except plum, the larvae feed exclusively on the cambium. Sweet cherries and plums appear to be more tolerant of damage than tart cherries. About 90 percent of larvae are found girdling the trunk and lower scaffold limbs within 4 feet of the ground where the clamps from trunk shakers have caused damage. The use of limb shakers, however, may cause infestations above this height as may heavy top pruning. Populations of over 10 larvae per tree are common in some cherry-growing regions of Michigan and can girdle an 18-inch trunk in less than 10 years. The decrease in the life of a tart cherry orchard with populations this high has been estimated at 25 percent owing to the entry of disease into these wounds and the eventual complete girdling of the trunk or limb. A gradual decrease in yield would also be expected but has not been investigated. Although larvae may feed on plum on the trunks and on limbs in black knot growths, this host appears more tolerant of damage than tart cherries. This borer may be found feeding in burr knots in apples alongside the dogwood borer, especially where NAA (naphthalene acetic acid) has been used to kill the burr knots, but they are easy to distinguish from the creamy white dogwood borer larvae.

### Monitoring

The need for control and timing of sprays for American plum borer management can be predicted by trapping adults using a commercially available sex pheromone to monitor male flight. At least two monitoring traps per 10 acres should be placed as close to the orchard center as possible to minimize drawing adults from alternate hosts in adjacent woodlots. If the average catch exceeds six moths per trap per week during the adult flight of either generation, this species is likely causing economic damage.

A more accurate way to measure infestation levels is to check for the white hibernacula and reddish frass around shaker wounds by peeling away any overlying dead bark near the wound. This should be done in the early spring before white bud or in midsummer just before harvest so that new hibernacula can be distinguished from those of previous generations by the presence of live larvae or pupae. The sample trees should be scattered throughout the block, and examination of wounds often requires the use of a

long-handled screwdriver or wood chisel to pry away dead bark. A threshold is more than two to three larvae in fresh hibernacula in each of several visibly wounded trees from previous years.

### Cultural management

Minimize shaker injury.

### Chemical management

A dilute handgun application of a long residual insecticide is recommended at petal fall if treatment thresholds are exceeded. Chlorpyrifos 4E (at 3 quarts per 100 gallons) or Lorsban Advanced at the same rate applied to the trunk and lower scaffold limbs at petal fall controls hatching larvae of both generations. Chlorpyrifos-containing products can be used only once during the entire season and are highly phytotoxic to the foliage of sweet cherries.

### APPLE GRAIN APHID

Apple grain aphid, *Rhopalosiphum fitchii*, rarely causes damage to apples, but it is the first aphid to appear on apples in spring and may appear in large, but innocuous, numbers.

### Description and life cycle

This aphid overwinters as an egg on apple and related trees and moves to grass and grain hosts for the spring and summer. Overwintering eggs are shiny black and hard to distinguish from the eggs of green aphids and rosy apple aphids, but usually hatch around silver tip or about 7 to 10 days earlier than the others. Nymphs are dark green with a light-colored stripe running down the back. This stripe darkens as the aphid gets older. Apple grain aphids are distinguished from other species by antennae much less than half the body length and very short cornicles. In the fall, aphids return to apple trees, produce sexual forms, mate, and lay eggs.

### Monitoring and management

Monitoring and management of this species in most orchards is unnecessary since it rarely causes a problem.

### APPLE LEAFMINER

Apple leafminer, *Lyonetia prunifoliella*, has become fairly common in young, nonbearing trees since in the 1980s, but has not resulted in economic injury.

### Description and life cycle

Adults are similar to the spotted tentiform leafminer, but larvae make a winding linear mine that widens into a blotch mine on the upper surface of the leaf. Frass ejected from the mine through holes chewed in the lower epidermis is commonly seen hanging from the mine in threads. Portions of the leaf beyond the mine frequently become chlorotic. Pupation occurs outside the mine, often on another leaf, where the pupa is suspended beneath in a silken “hammock.” Most infestation is in leaves on succulent shoots and sprouts.

### Monitoring and management

This leafminer does not appear to be economically damaging.

### APPLE MAGGOT

Apple maggot, *Rhagoletis pomonella*, also known as the “railroad worm,” is abundant in untreated orchards and backyard trees.

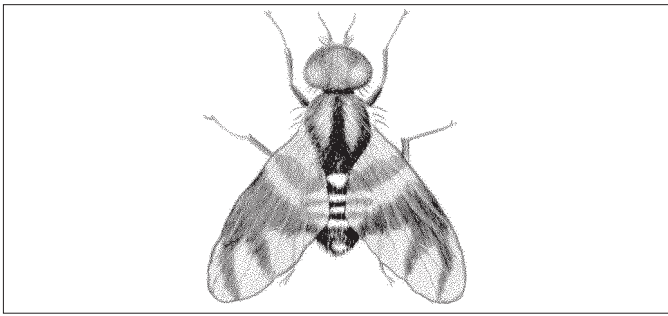

**Adult Apple Maggot Fly**

Although adults are found above treatment thresholds in many commercial orchards in Pennsylvania, use of broad-spectrum insecticides in July and August prevents injury.

#### **Description and life cycle**

The adult fly is black, about the size of a house fly, with three or four white stripes across the body in the males and females, respectively, and has a prominent white spot in the middle of the back. The wings are clear, with four black bands shaped somewhat like the letter “W.” Maggots are white and legless and reach about ¼ inch at maturity. Pupae resemble a grain of wheat.

Host range includes apples, cherries, and hawthorns. Early maturing and thin-skinned apples are often most severely infested. In many apple cultivars more than 90 percent of the maggots in the fruit fail to survive if the apple remains on the tree.

Apple maggots have only one generation per year. Pupae overwinter in the soil. Adults emerge during the summer (mid-June), with peak emergence in July and August. After a 7- to 10-day mating and pre-oviposition period females begin depositing eggs singly just under the skin of the fruit. Eggs hatch in a few days and the young maggots start to feed, working their way through the fruit. Injury is characterized by pitting and dimpling on the apple surface, and brown, winding trails caused by maggot tunneling and excrement along with an associated bacteria. Infested apples drop prematurely and the mature maggots leave to pupate in the soil.

#### **Monitoring**

Adult apple maggot flies are monitored most effectively by sticky red spheres baited with apple volatile lures and/or ammonium superchargers or less effectively with baited yellow sticky traps. Three traps are recommended per block, placed near the border, one to two rows in from the edge. Traps should be placed in the orchard around mid-June, about head height, positioned so they are surrounded by fruit and foliage but not touched by them or obstructed from view. Traps should be inspected and cleaned weekly. If no active insecticide residue remains on protected fruit, a contact insecticide application is recommended immediately when an average of five flies per red sticky sphere are captured.

#### **Cultural management**

Remove abandoned apple trees and alternate hosts from 100 yards around the orchard. Infestation may be reduced in small orchards by trapping out adults using unbaited sticky red traps at the rate of one trap per 100 to 150 apples. Insecticide-treated spheres have been developed to provide control and reduce pesticide use. Frequently picking up and destroying dropped apples may reduce the problem the following year, but it will not be effective

if infested, abandoned apple trees are nearby.

#### **Chemical management**

Effective control of apple maggots requires spray coverage when trap thresholds are exceeded. Insecticides are directed against adult flies, before eggs are laid. In areas with a history of apple maggot problems, regular applications of broad-spectrum contact insecticides in July, August, and possibly early September, with thorough coverage of all foliage, should provide adequate control of this important pest. Refer to Table 4-6 for recommended assortment of effective insecticides.

#### **APPLE RUST MITE**

Apple rust mite, *Aculus schlechtendali*, is a commonly found but rarely important pest of apple in Pennsylvania. It is usually controlled by natural predators or acaricide sprays such as Envidor or Portal applied against other mite pests. Rust mite populations can build to injurious levels only in rare situations.

#### **Description and life cycle**

The motile stages of this mite are cone-shaped, and are very difficult to see with the unaided eye. Examination of the leaf midrib with a strong hand lens is usually needed to verify mite presence.

Apple rust mites overwinter as adult females under the bud scales of apple trees. At bud break they become active and feed and reproduce until July or early August when overwintering females are produced. In low numbers, apple rust mites are considered beneficial in that they provide an alternate food source for *T. pyri* and other mite predators of European red mites and twospotted spider mites. They are not, however, a good food source for *Stethorus* beetle.

These mites feed on the underside of the leaf, usually causing little if any damage. Under some conditions mite populations may expand, and their feeding can cause the leaf to take on a silvery appearance as leaf cells are destroyed and chlorophyll is lost. Silvering symptoms do not appear until mite populations build beyond 200 mites per leaf. Under increasing damage from larger populations or more prolonged feeding, apple leaves may longitudinally roll, giving the appearance that the tree is under drought stress. Sometimes these mites will move to the fruit and may be found at either the calyx or the stem end. In extremely rare cases they will russet the fruit.

#### **Monitoring and management**

Monitoring should begin before petal fall and continue through the first week of August. A good hand lens or microscope is required. Inspect 10 leaves from 10 different trees. Concentrate the inspections on the basal third of the leaf midrib on the underside of the leaf. It is too tedious to count the exact number of mites, so a quick estimate should be made on each leaf. When more than an average of about 200 mites per leaf is found, then a pesticide treatment is recommended. A treatment is also recommended upon the appearance of plant symptoms such as silvering or leaf rolling. See Table 4-6 for the list of compounds effective against apple rust mite.

#### **BLACK CHERRY APHID**

The black cherry aphid, *Myzus cerasi*, is the most common aphid attacking cherries, primarily sweet cherries, in most parts of North America.

### Description and life cycle

Adults and nymphs are readily identified by their shiny black coloration. The adults are 1/8 inch long and have both winged and wingless forms. Nymphs are similar in appearance, but smaller.

Although the aphid can survive on most cherries, it prefers commercial cherry varieties, mostly sweet cherries. Napoleon, Black Tartarian, Schmidt, and Windsor are most susceptible to injury, while Dykeman and Yellow Spanish are not very susceptible. Alternate summer weed hosts include water cress, peppergrass, and members of the mustard (Brassicaceae) family of plants.

The black cherry aphid overwinters as an egg on the bark of small branches. The eggs begin to hatch as soon as cherry buds break, with young aphids moving to new green tissue. After three to four weeks wingless, stem mother females have established large colonies on growing shoots. Two to three generations occur on cherry trees by early July when most of the aphids move to alternate hosts for the summer. In September or October winged males and females return to cherry trees, mate, and lay eggs.

Feeding causes curling and stunting of leaves and stems. Heavy infestations may kill young trees and reduce crop quality and quantity and return bloom on mature trees. Honeydew from these aphids also causes the growth of black sooty fungus.

### Monitoring and management

Trees should be scouted in early spring to detect the presence of stem mothers on actively growing shoots. It is important to determine aphid severity before the leaves curl. While no thresholds have been established for mature trees, young trees cannot tolerate even low numbers of aphids. Delayed dormant applications of oil and insecticides applied to control other cherry pests usually control the black cherry aphid. Aphid natural enemies including syrphid flies, lacewings, and lady beetles are often abundant enough to control this species.

#### BROWN MARMORATED STINK BUG

The brown marmorated stink bug (BMSB), *Halyomorpha halys*, is an exotic insect species naturally occurring in Japan, southern China, and Korea. Since the late 1990s BMSB populations have become established in North America, with the first official identification record from Lehigh County, Pa., dated September 2001. At the time of this initial finding, the species was already well established in the Allentown, Pa., area and was reported to cause damage to various home garden products and ornamental plants. During this initial detection period, brown marmorated stink bug adults were frequently reported as a nuisance to homeowners as they tended to overwinter inside houses and other dwellings. Currently, BMSB is reported from most counties in Pennsylvania and more than 45 states across United States and in Canada.

### Description and life cycle

The brown marmorated stink bug has two generations in southern Pennsylvania. Under normal conditions, overwintering adults emerge from their winter hideouts in early spring to mid-June and immediately move to feed on available hosts. The feeding of BMSB adults and nymphs are reported from more than 300 host plants. Their ability to survive and reproduce on various plants and to move unrestricted among various hosts is one of the main

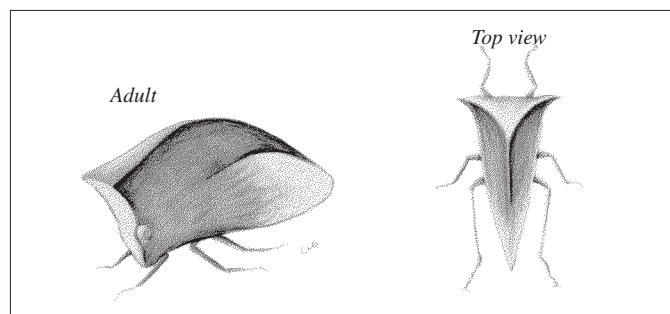

Buffalo Treehopper

factors contributing to the continuous and quite unpredictable presence of this pest in orchards.

Feeding damage on fruit caused by BMSB can occur throughout most of the season. Although the mechanism of BMSB feeding is similar during various parts of the season, the injury caused by stink bugs can have various appearances based on the time of the season the feeding takes place. Early feeding injury can result in misshapen fruit, while late season feeding on maturing fruit can cause the formation of necrotic tissue (corking) close to the skin surface. Sometime stink bug injuries on fruit can be confused with the physiological disorder called “corking” caused by calcium deficiency.

### Monitoring and management

Visual observations remain the most accurate method to monitor the occurrence of brown marmorated stink bug adults and nymphs. Commercially available traps and lures for BMSB monitoring could also provide valuable information and help growers decide if insecticide treatments are needed to manage BMSB. Stink bug traps and lures from Ag-Bio ([www.agbio-inc.com/dead-inn-pyramid-trap.html](http://www.agbio-inc.com/dead-inn-pyramid-trap.html)), Trece ([www.trece.com/pherocon.html](http://www.trece.com/pherocon.html)), and Sterling International ([www.rescue.com/product/reusable-outdoor-stink-bug-trap](http://www.rescue.com/product/reusable-outdoor-stink-bug-trap)) are available for purchase and starting from mid-July should help with effective monitoring of BMSB adults and nymphs in orchards. Although traps by themselves will not control BMSB, by capturing adults and nymphs, traps can be utilized as an early warning system in orchards. With a constant threat of new BMSB adults migrating into the orchard from surrounding vegetation such as woods or field crops, monitoring traps are the most practical tools to detect the presence of this pest. Insecticides with various modes of action can effectively control the brown marmorated stink bug. While a number of commonly used products are effective against this pest (e.g., neonicotinoids, carbamates, or pyrethroids), the continuous challenge revolves around the unrestricted influx of new stink bug adults from surrounding vegetation and therefore causes the necessity for multiple, repeated applications of insecticides. Detailed management options and possible ways to reduce their impact on integrity of the Pennsylvania IPM system are discussed in “Special Section: Brown Marmorated Stink Bug—New Exotic Insect Pest” on page 173.

#### BUFFALO TREEHOPPER

Buffalo treehopper, *Stictocephala bisonia*, is an occasional pest of fruit trees in Pennsylvania. It gets its name from its hump-backed resemblance to the shape of a buffalo.

### Description and life cycle

The buffalo treehopper adult is green,  $\frac{3}{8}$  inch long, triangle-shaped when viewed from above and hump-backed when viewed from the side. The nymphs are spiny. Females lay eggs from July until October in the bark of the upper sides of small branches of apple, pear, cherry, prune, and quince trees. A row of slits is cut along the branch, and 6 to 12 eggs are laid in each slit. The slits heal and gradually enlarge, giving the branch a rough and scabby appearance. Young trees may be significantly damaged by heavy infestations because severe scarring can stunt and weaken limbs. In May or June the overwintered eggs hatch and the nymphs move to nearby grasses and weeds. Weedy orchards or those near weedy fields are most often affected.

### Monitoring and management

Young trees should be checked for the presence of scarring in autumn or winter. Severely scarred branches should be pruned out. Controlling weeds should reduce alternate feeding sites. Since the egg-laying period lasts several months, insecticide spray timing is difficult. Insecticides should be used only if economic damage is occurring to young trees beyond the control ability of winter pruning.

### CHERRY FRUIT FLY AND BLACK CHERRY FRUIT FLY

Cherry fruit fly, *Rhagoletis cingulata*, and black cherry fruit fly, *R. fausta*, are found on cherry, pear, plum, and wild cherry trees. These insects are common in alternate hosts, but can be effectively managed in commercial orchards.

### Description and life cycle

These flies are slightly smaller than the common house fly and have wings marked with distinctive black bands. The cherry fruit fly female has four white bands crossing the abdomen lacking in the black cherry fruit fly. They are much bigger and not related to the spotted wing drosophila (SWD), which only has two small black spots on the male fly wings. Fruit fly maggots are creamy white, legless, tapered at the head end, blunt in the rear, and reach  $\frac{5}{16}$  inch at maturity, which is much bigger than the larvae of SWD.

Both species have one generation per year. Adults emerge from the soil in June and July. The black cherry fruit fly emerges about a week before the cherry fruit fly. Females lay eggs in cherries over a three- to four-week period. Newly hatched maggots burrow into the fruit as they feed on the flesh. There are three larval instars lasting a total of 10 to 21 days. The last instar emerges from the fruit, falls to the ground, and burrows down 3 inches where it pupates.

Maggot-infested fruit is often shrunken and misshapen, ripens earlier than surrounding fruit, and is unmarketable.

### Monitoring and management

Adults can be monitored using adhesive-covered yellow panel traps baited with an ammonium-carbonate lure. Traps should be placed in the fruiting canopy of the tree, with fruit and foliage removed from around it for 12 to 18 inches. Traps are used to detect the beginning of fly emergence, but they are not good indicators of the level of infestation.

Management is directed against the adults because once the maggot burrows into the fruit it is protected from insecticides. Insecticide treatments should begin about one week after the

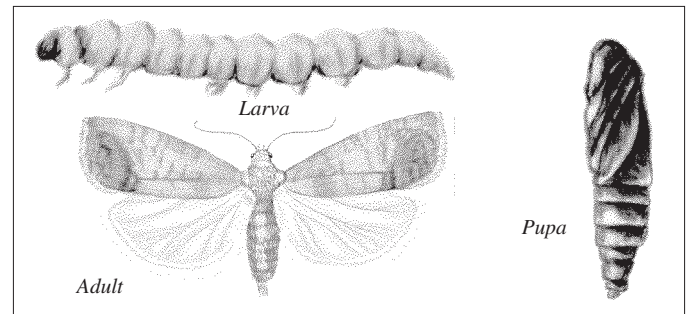

Codling Moth Life Stages

first fly emerges. A long-residual insecticide should be applied every 10 to 21 days until after harvest to kill adults before they can lay eggs.

### CODLING MOTH

Codling moth, *Cydia pomonella*, was introduced from Europe in colonial times and now occurs throughout North America as well as most of the world, wherever apples are grown. In the past in Pennsylvania, the codling moth was maintained at low population levels by insecticides sprayed to control other pests and usually did not seriously affect apple production in commercial orchards. In the last 10 years, the significance of this pest has increased drastically mainly due to insecticide resistance. Codling moth has been known to infest 95 percent of the apples in an orchard when control measures were not taken against it. Given this insect's ability to adapt to various fruits (e.g., the ability to coincide with different fruiting times) and to develop resistance to insecticides, fruit growers must continually be on guard against a resurgence of codling moth.

### Description and life cycle

The adult female moth is approximately  $\frac{3}{8}$  inch long and grayish in color. The male is slightly smaller and has a grouping of hairlike scales near the wing base. The wing is generally a darker shade of gray near the base, with a dark patch containing coppery scales near the inside wing tip. The larvae have a cream to pinkish body and a brown head with dark speckles on the prothoracic shield behind the head. Larvae reach  $\frac{1}{2}$  to  $\frac{5}{8}$  inch long at maturity. Codling moth larvae are often confused with the Oriental fruit moth larvae, which are smaller, lack spots on the prothoracic shield, and have a comblike structure (anal comb) on the posterior end visible under magnification. Codling moth eggs, laid singly, appear as flat, slightly oval discs. At first translucent, they later become reddish, and finally enter the black head stage just before hatching, when the dark head capsule can be seen.

Codling moth overwinter as full-grown larvae within a cocoon under leaf litter, loose bark scales, or any other sheltered place they may encounter. Pupation occurs at about first pink, with first flight occurring about full bloom, and flight occurring approximately 2 to 10 weeks after full bloom. First-generation eggs are laid on leaves near fruit or on the fruit and hatch in about 6 to 10 days. Newly hatched larvae bore through the fruit surface, generally at the side of the fruit, and feed near the surface for a time before boring to the core. Larvae feed on the seeds and surrounding flesh until they are fully grown in three to four weeks. They then exit the fruit, seek shelter, spin a cocoon, and may or may not pupate. Some first-generation larvae do pupate, emerge as adults in two to three weeks at about the fourth or fifth

**Table 2-4. Degree-day look-up table for codling moth (lower threshold 50°F, upper threshold 88°F, horizontal cut off, using sine-wave curve).**

To find the total degree-days for a day, locate the minimum and maximum temperatures and follow the rows to where they intersect. For temperatures between those listed, use the nearest shown. Temperatures and degree-days must be determined on a daily basis.

		Minimum temperature																										
		30	32	34	36	38	40	42	44	46	48	50	52	54	56	58	60	62	64	66	68	70	72	74	76	78	80	
Maximum temperature	50	0	0	0	0	0	0	0	0	0	0	0	0	0	0	0	0	0	0	0	0	0	0	0	0	0	0	
	52	0	0	0	0	0	0	0	0	0	1	1	1	2														
	54	1	1	1	1	1	1	1	1	1	1	2	2	3	4													
	56	1	1	1	1	2	2	2	2	2	2	3	4	5	6													
	58	2	2	2	2	2	3	3	3	3	3	4	5	6	7	8												
	60	3	3	3	3	3	3	3	4	4	4	5	6	7	8	9	10											
	62	3	3	4	4	4	4	4	5	5	5	6	7	8	9	10	11	12										
	64	4	4	4	4	5	5	5	5	6	6	7	8	9	10	11	12	13	14									
	66	5	5	5	5	6	6	6	6	7	7	8	9	10	11	12	13	14	15	16								
	68	6	6	6	6	6	7	7	7	8	8	9	10	11	12	13	14	15	16	17	18							
	70	6	7	7	7	7	8	8	8	8	9	9	10	11	12	13	14	15	16	17	18	19	20					
	72	7	7	8	8	8	8	9	9	10	10	11	12	13	14	15	16	17	18	19	20	21	22					
	74	8	8	8	9	9	9	10	10	11	11	12	13	14	15	16	17	18	19	20	21	22	23	24				
	76	9	9	9	10	10	10	11	11	12	12	13	14	15	16	17	18	19	20	21	22	23	24	25	26			
	78	10	10	10	11	11	11	12	12	13	13	14	15	16	17	18	19	20	21	22	23	24	25	26	27	28		
	80	11	11	11	11	12	12	13	13	14	14	15	16	17	18	19	20	21	22	23	24	25	26	27	28	29	30	
	82	11	12	12	12	13	13	14	14	15	15	16	17	18	19	20	21	22	23	24	25	26	27	28	29	30	31	
	84	12	13	13	13	14	14	15	15	16	16	17	18	19	20	21	22	23	24	25	26	27	28	29	30	31	32	
	86	13	14	14	14	15	15	16	16	17	17	18	19	20	21	22	23	24	25	26	27	28	29	30	31	32	33	
	88	14	14	15	15	16	16	17	17	18	18	19	20	21	22	23	24	25	26	27	28	29	30	31	32	33	34	
90	15	15	16	16	17	17	18	18	19	19	20	21	22	23	24	25	26	27	28	29	30	31	32	33	34	35		
92	16	16	16	17	17	18	18	19	19	20	20	21	22	23	24	25	26	27	28	29	30	31	32	33	34	35		
94	16	16	17	17	18	18	19	19	20	20	21	22	23	24	25	26	27	28	29	30	31	32	33	34	35	35		
96	17	17	17	18	18	19	19	20	20	21	22	23	23	24	25	26	27	28	29	30	31	32	33	34	35	35		
98	17	17	18	18	19	19	20	20	21	21	22	23	24	25	26	27	28	29	30	30	31	32	33	34	35	36		
100	18	18	18	19	19	20	20	21	21	22	22	23	24	25	26	27	28	29	30	31	32	32	33	34	35	36		

cover spray, and produce a second codling moth generation. The majority of the second generation overwinter as mature larvae.

First-generation larvae that do not pupate enter a quiet diapausing phase, overwinter as last instar larvae, and become first-generation adults the following year. Some larvae of the second generation may also pupate and produce a third generation at the seventh or eighth cover spray. This generation of larvae, which most of the time do not survive the winter, is termed a suicide generation. Individual larvae can, however, inflict additional late season fruit injury.

Damage to apples may be shown either by a tunnel emanating from the apple side or calyx and extending to the core, or by “stings,” small shallow holes the size of pin pricks, with a little dead tissue on the cavity walls. Stings are caused by early instar larvae that have been poisoned and die shortly after puncturing the apple skin. Larvae that feed on the core characteristically leave frass exuding from the point of entry. Stings lower the value of the fruit from fresh market to processing grade apples. Tunneling causes the fruit to be rejected.

**Monitoring and management**

Pheromone traps for monitoring populations of adult male codling moths should be used to determine if and when controls are necessary. Traps should be placed at a density of at least one trap per 5 acres (but no less than two traps per block) by the pink stage and situated on the outside of the tree, preferably in the upper fourth of the canopy. The higher the trap placement, the better codling moth is monitored. In the spring, traps should be checked daily until the first adult is caught to set biofix for phenology models using degree-day accumulations and then weekly thereafter. In orchards without mating disruption, if the

action threshold of five moths per trap per week is exceeded an insecticide application should be made within five to eight days. Repeat applications should be made if the number of captured moths exceeds this threshold 14 days after the insecticide application. In orchards implementing mating disruption for codling moth control, monitoring should be done using special CM DA Combo (CM DAC) lures.

Optimum timing of insecticide applications based on egg hatch can be determined with the aid of a degree-day model (Table 2-4). First adult capture in a pheromone trap is used as a biofix, and degree-days are accumulated thereafter. Growers wishing to time sprays based on egg development and hatch should make an application of broad-spectrum insecticide at 250–350 degree-days (base 50°F) after the first capture of males in the sex pheromone traps. A second application, if needed, can be applied 14 to 21 days following the initial application. If insecticides with ovicidal activity are planned for codling moth control, the first application should be performed no later than at about 150 DD after the biofix. Due to frequently extended codling moth flight observed in many orchards, additional insecticide treatments may be necessary after the second application. The delayed timing for initial insecticide application is recommended in orchards where observations from pheromone traps during previous seasons detected extended CM flight, often lasting until end of June.

Mating disruption represents a valuable alternative to insecticide treatment for isolated orchards with a low codling moth population. The hand-applied pheromone dispensers and various forms of sprayable pheromones are commercially available and can be used for codling moth control. If Oriental fruit moth is also a problem in the same block, then Isomate CM/OFM CTT, CideTrak CMDA OFM Meso, CideTrak CM OFM Combo or



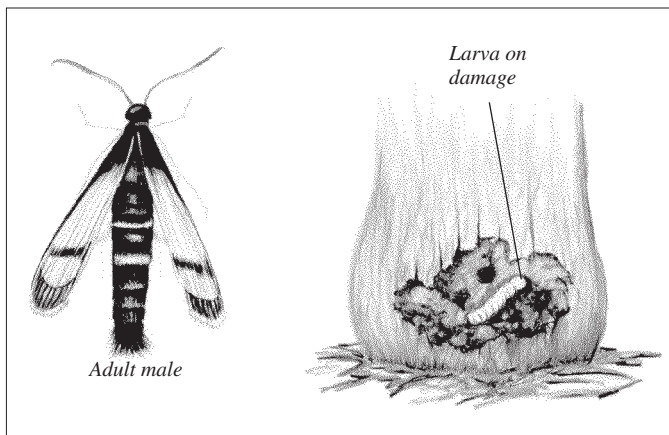

**Dogwood Borer**

CheckMate Puffer CM-OFM Pro should be used for the control of both species. A combination of mating disruption and codling moth granulosis virus is recommended to effectively control this pest. Also, the recently registered insecticides with new modes of action, such as Altacor, Exirel, or Delegate, are very effective against this pest. Refer to Table 4-6 for a recommended assortment of effective products.

#### **DOGWOOD BORER**

Dogwood borer, *Synanthedon scitula*, was found for the first time in the 1980s as a common pest in the burr knots of apple trees on clonal rootstocks in northern Virginia, Pennsylvania, Michigan, and the rest of the Northeast. Untreated infestations may reduce yields and in rare cases girdle young trees. This pest is especially troublesome in young orchards and apple trees that have been top-worked by grafting to a new variety.

#### **Description**

Adults are typical black and yellow clear-winged moth similar to but smaller than adult lesser peachtree borer and peachtree borer, with a wingspan of only  $\frac{3}{4}$  inch. Females have a wide yellow band on the fourth abdominal segment, compared to a much narrower band on the same segment of the males. Larvae are nearly white to light pink with a deep brown head capsule, and reach  $\frac{1}{2}$  inch at maturity. They may take 13 to 22 months to complete larval development. Larvae pupate in galleries in a cocoon made up of silken thread and covered by a layer of its reddish frass. Pupal cases often protrude slightly from the tree and remain visible for up to a year after the adults have emerged.

Dogwood borers normally feed on a wide variety of forest trees. On apple, larvae feed inside burr knots, which usually develop on the exposed aboveground portion of clonal rootstocks. Malling and Malling-Merton rootstocks have a tendency to develop burr knots, enhanced by low light conditions around the trunk due to shading by weeds, low limbs, suckers, opaque tree guards, and shallow planting. These aggregations of partially developed root initials occur in clusters at or below the graft union. Reddish frass on the surface of a burr knot is a visible sign of an active infestation by dogwood borer.

Larvae overwinter in a hibernaculum in one of their galleries and emerge early in the spring to continue feeding. Pupation lasts about 25 days and begins in early June. Adults emerge over a period of about three months, beginning in June. Mating

and egg laying occur within a few days of emergence. Females lay eggs on or near burr knots and are particularly attracted to trees with infested burr knots. Eggs hatch after eight to nine days and larvae bore into the tissue between the root initials and begin feeding. Dogwood borer almost never enter healthy bark or pruning wounds in apple trees.

Feeding is initially confined to the burr knot, but it sometimes spreads to healthy bark outside it. Feeding in the burr knot itself does little or no damage to the tree, while feeding below the bark is much more destructive and may eventually girdle the tree. Although these borer injuries can kill trees, several consecutive years of infestation are often needed before the tree shows decline. Persistent infestations over several years can contribute to a slow decline of the tree and reduced yields.

#### **Monitoring**

Dogwood borer is monitored by checking under tree guards in the spring to locate active infestations. Pheromone traps can be used to estimate the timing of peak flight. These traps should be placed at about 4 to 6 feet above the ground for optimal catch. Placement much higher or lower in the tree may cause as much as a fivefold decrease in catch.

#### **Cultural management**

Although NAA can be used to control burr knots, this is not desirable because it forces the larvae to feed into healthy cambium at the edges of burr knots. Also, other borers, such as the American plum borer, may establish in the dead burr knots. Rootstocks M.9, M.9/MM.106, M.26, MM.106, and MM.111 show some difference in susceptibility, but only MM.111 has a considerably lower infestation level. Undiluted white latex paint applied by brush to the lower trunk before egg laying will significantly reduce infestations. Tree guards should not be left on longer than necessary.

#### **Chemical management**

Dogwood borer can be controlled with trunk applications of a long-residual insecticide. Lorsban 4E and Lorsban Advanced at 2.0 quarts per 100 gallons of water are effective when applied diluted as a directed spray to the burr knots and graft union. Thorough coverage of burr knots and surrounding areas of the lower trunk in single sprays timed from pink stage through late June should provide excellent control. The postbloom applications of any product containing chlorpyrifos can be applied only to the tree trunk, without contacting foliage. Only a single application of any product containing chlorpyrifos is allowed per growing season. The mating disruption product Isomate DWB is also very effective in reducing the numbers of dogwood borer larvae, although multiyear treatments need to be applied for the best efficacy.

#### **EUROPEAN APPLE SAWFLY**

Since 1985, European apple sawfly (*Hoplocampa testudinea*), a type of wasplike insect, has extended its range from the northeastern portion of Pennsylvania to the Maryland border. Now this pest is common throughout Pennsylvania.

#### **Description and life cycle**

European apple sawfly adults are wasplike insects that are about  $\frac{5}{16}$  inch long with a broad attachment of the thorax and

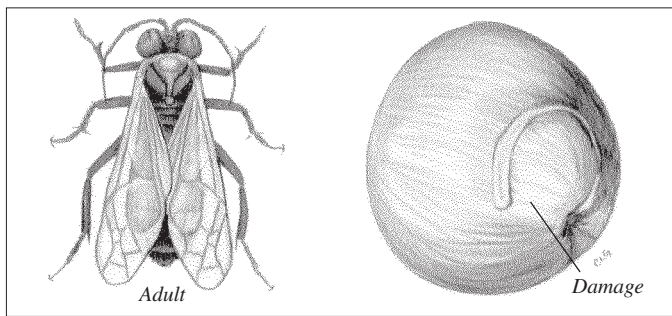

European Apple Sawfly

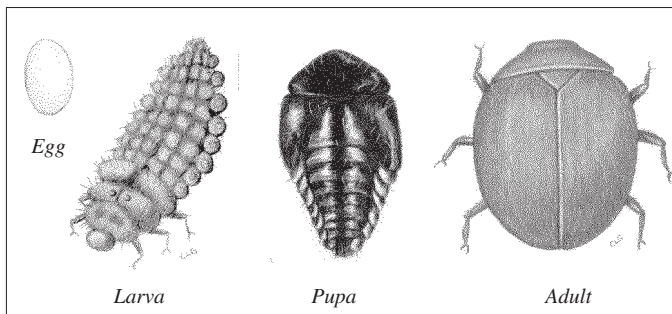
*Stethorus punctum*, Black Ladybird Beetle Life Stages

abdomen. They are brown on top but yellow-red below. Sawfly larvae resemble caterpillars but have prolegs on each abdominal segment. They also have a strong odor. Sawflies overwinter as larvae in the soil and have only one generation per year. Adults emerge during late pink and early bloom. Eggs are laid on the calyx end of developing fruit. The first instar larvae tunnel just under the epidermis of the fruit, resulting in the typical ribbon-like scar (primary injury). These apples usually remain on the tree when these small larvae are killed with a petal fall spray, and the presence of the scars at harvest can reduce fruit value. The second and older instar larvae bore deeply into the seed chamber of the fruit and can penetrate several additional fruit, usually causing fruit abortion. Later instar injuries on fruit are easy to detect with reddish-brown frass similar to that seen from codling moth damage. Another sawfly species called the dock sawfly, *Ametastegia glabrata* (Fallen), can be found in fruit at harvest when its normal host weed grows high enough to reach the lower scaffold of apple. The larvae of this sawfly are bright green in color with a striped head capsule, whereas the larvae of the European apple sawfly are white with an amber head capsule.

#### Monitoring and management

Sticky, rectangular, non-ultraviolet-reflecting, white traps should be placed at a density of one per 3 to 5 acres along the orchard periphery at the pink stage of apples on the south sides of trees at 5 to 6 feet above the ground. Insecticide treatment thresholds are five wasps per trap by petal fall if no prebloom insecticide has been applied. An application of an effective insecticide as soon as pollination is complete is the best control tactic for orchards with a history of this sawfly. Neonicotinoid insecticides applied at petal fall for rosy apple aphid control have not provided effective control of this pest, and currently only phosmet at petal fall has proved effective. Optimal timing to prevent injury would be at bloom, which is not possible due to insecticide impacts on bees.

Numerous predators and parasitoids of European apple sawfly are reported from Europe, but no native biocontrol agents are

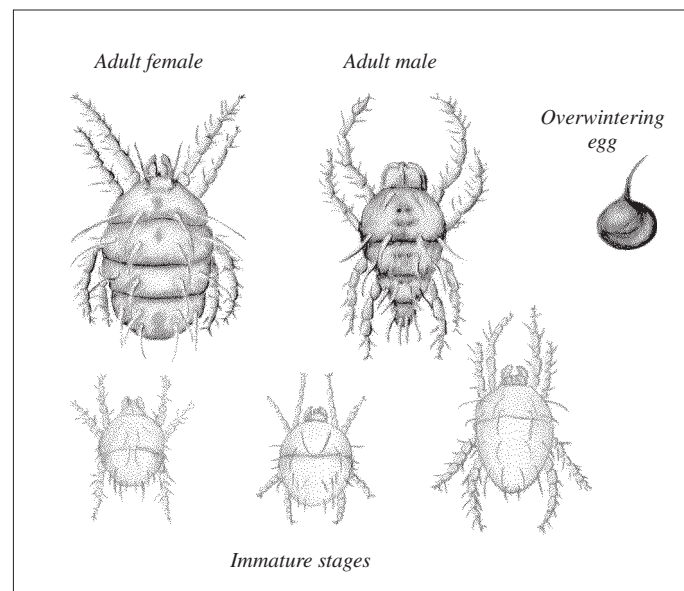

European Red Mite Life Stages

reported to be effective in North America. A partially successful classical biological control program was initiated in Canada to introduce a solitary larval endoparasitoid *Lathrolestes ensator* Brauns (Hymenoptera: Ichneumonidae) for the control of this pest. Other options for biological control of European apple sawfly are the Heterohabditid and Steinernematid entomopathogenic nematodes, which are still being investigated in laboratory and semi-field conditions.

#### EUROPEAN RED MITE

European red mite, *Panonychus ulmi*, a major tree fruit pest attacking apples, stone fruits, and pears, is considered by many growers throughout Pennsylvania to be one of the most important apple pests. The mite was introduced into North America from Europe in the early 1900s and is now established in most fruit-growing areas.

#### Description and life cycle

Eight-legged females are  $\frac{1}{64}$  inch long, bright red, and have four rows of white hairs on their backs. Males are smaller, lighter in color, and have pointed abdomens. Overwintering eggs are round, bright red, and have a small stalk, approximately the length of the diameter of the egg, arising from the top. Summer eggs are pale and translucent. Six-legged nymphs hatch from the eggs, molt to eight-legged protonymphs, then deutonymphs, and finally adults.

Overwintering eggs are laid individually on roughened bark, in crevices and cracks, and around bud scales on twigs and branches. Eggs begin to hatch at prepink bud stages and continue throughout bloom. Young mites move to newly opened leaves where they feed, mature, and reproduce. The first generation requires approximately three weeks to develop; summer generations are completed in 10 to 18 days. The rate at which mites develop is primarily temperature dependent. Hot, dry weather favors development, while cool, wet weather delays mite activities. Each female is capable of laying 35 eggs during her average life span of 18 days. Eight to 10 generations can occur during a single season.

Mites feeding on leaves cause injury to the tree by removing leaf tissue. The most serious injury occurs in early summer when

**Table 2-5. European red mite densities predicted from the percentage of mite-infested leaves.**

Percentage of mite-infested leaves <sup>a</sup>	Expected density in mites/leaf	Limits of mite populations in mites/leaf <sup>b</sup>
40	0.7	0.25–1.20
45	0.9	0.35–1.45
50	1.1	0.45–1.75
55	1.3	0.60–2.15
60	1.6	0.80–2.65
65	2.0	1.05–3.25
70	2.6	1.35–4.10
75	3.4	1.85–5.35
80	4.7	2.55–7.25
85	6.8	3.85–10.55
90	11.4	6.50–17.55
95	26.4	15.30–40.30

a. Leaves with at least 1 motile stage.

b. 95% confidence interval.

**Table 2-6. Relationship between number of European red mites per leaf at their peak and accumulated number of mite days per leaf.**

Peak number of mites/leaf	Expected accumulated number of mite days	Expected limits of number of mite days <sup>a</sup>
5	88	0–332
10	176	0–420
15	263	10–507
20	351	107–595
25	439	195–683
30	527	283–771
35	615	371–859
40	702	458–946
45	790	546–1,034
50	878	634–1,122

a. 95 percent confidence interval—there is only a 1 in 20 chance of the accumulated mite-day value falling outside of this range.

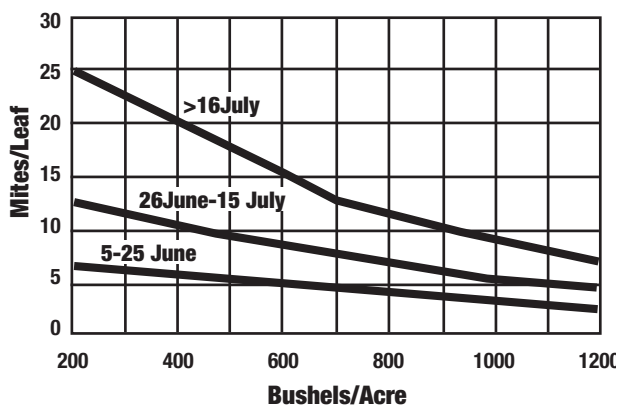

Figure 2-3. Action thresholds for mites in Pennsylvania.

trees are producing fruit buds for the following season. Moderate to heavily infested trees produce fewer and less vigorous fruit buds. Mites feeding on leaves also reduce the ability of leaves to manufacture enough food for desirable sizing of fruit. A characteristic brown foliage that, in severe cases, becomes bronze, results from heavy mite feeding. Left unchecked, mite populations can affect fruit color and result in premature fruit drop.

### Monitoring

Our integrated mite management program for apples depends largely on the phytoseiid predatory mites *Typhlodromus pyri*

(Scheuten) and *Neoseiulus fallacis* (Garman) to regulate pest mites to low levels during the cooler spring and late summer/fall months. Once established, *T. pyri* is capable of maintaining pest mite populations at very low levels if not disrupted due to the use of toxic pesticides (see Table 4-5 for toxicity ratings). *T. pyri* is able to regulate pest mites at much lower levels than the black ladybug, *Stethorus punctum*, which it has largely replaced in many grower orchards. It also generally prevents mite injury to the leaves, called “bronzing,” that control by *Stethorus* alone often allowed. For more information on establishing and conserving this predatory mite or *Stethorus*, refer to the “Natural Enemies” section.

**Overwintering eggs:** European red mite eggs may be evaluated in the dormant period up to prepink. Inspect with a hand lens the bases of twigs and spurs on the 5 to 10 selected trees. Look for clusters of tiny (less than  $1/50$  inch), red spheres. If overwintering eggs are easily visible, especially to the unaided eye, then a prebloom application of oil or a miticide-ovicide is recommended to prevent mite injury through June.

At pink stage and beyond, before a miticide that kills motile mites is applied in the current season, scan 5 to 10 leaves on each of the selected trees for mites. A leaf is mite infested if it contains one or more motile mite. Record each leaf as either “mite infested” or “mite free.” Divide the number of mite-infested leaves by the total number of leaves examined. Multiply the number by 100 to compute the percentage of mite-infested leaves. As mite populations increase, so will the percentage of infested leaves. Refer to Table 2-5 to estimate the expected number of mites per leaf for the given percentage of mite-infested leaves.

After a miticide has been sprayed to control motile mites in the current season, follow the above procedures except that the number of motile mites (all stages except eggs) per leaf should be counted. Determine the average number of mites per leaf by dividing the total number of mites found on all leaves by the number of leaves examined.

***Stethorus*:** When the percentage of mite-infested leaves reaches 65 to 75, begin estimating the *Stethorus* population by counting the number of adults and larvae seen in three minutes while walking slowly around the tree periphery. *Stethorus* is described in this part under “Natural Enemies.”

**Predatory mites:** The impact of beneficial phytoseiid predatory mites *N. fallacis* and *T. pyri* and the stigmatid predatory mite *Zetzellia mali* on phytophagous mite population is described under the “Natural Enemies” section. In general, however, only one phytoseiid mite predator (either species) is necessary for every 10 spider mites to obtain biological mite control. The lemon-yellow, diamond-shaped *Z. mali* is generally less effective in controlling pest mites only by itself as it is slow moving, only feeds on eggs, and has only two to three generations per year.

### Mite action thresholds and predator/prey ratio calculations

This section offers guidelines for incorporating the economic impact of mite management into the decision-making process. Variables such as time of season, crop load, and miticide costs and efficiency are considered, along with predatory mite and *Stethorus* counts. Action thresholds have been developed to aid in making mite management decisions. An action threshold is a mite population level at which control measures should be taken to prevent economic damage. Factors that tend to lower action thresholds are damage by other pests (e.g., white apple

leafhopper) and severe weather conditions (e.g., extremely dry conditions intensify the losses from mite damage).

Figure 2-3 includes mite action thresholds for various crop loads at different times of the growing season. To use this figure, determine the number of mites per leaf based on either percent mite-infested leaves or actual counts after an acaricide has been applied. Next, estimate the projected production per acre (harvested bushels) for the affected block. Select the threshold line on the figure for the appropriate time of the growing season. For a given time of the growing season and a given estimated crop load, if the mites per leaf exceed the threshold, then control either by using predatory mites, *Stethorus punctum*, or by applying miticides. If you are using the alternate row middle system of spraying to make your miticide applications, reduce the action threshold to one-half the figure value since you are only spraying one-half of the tree. These levels apply to healthy, vigorous trees with mite damage occurring only after June 5 (Table 2-6).

If the mites per leaf do not exceed the action threshold, no control action needs to be taken. Typically, orchards with stable populations of *T. pyri* never reach these thresholds as they never leave the tree and exert their control over pest mites in the spring and fall. Mite control with *N. fallacis* is much more variable. *N. fallacis* do not overwinter on the tree but instead move up from the weeds in the ground cover midseason and sometimes arrive too late to exert their control over pest mites. Alternate row middle spray with a selective miticide is sometimes useful to establish the proper predator-to-pest ratio for biological control with *Stethorus*. But generally, if a miticide application is deemed necessary and you are relying on phytoseiid predatory mites, it is best applied as a complete spray to prevent movement of pest mites to unsprayed parts of the tree and for resistance management purposes. For both *T. pyri* and *N. fallacis*, a predator-to-prey ratio of one predator to 10 pest mites will almost always ensure biological mite control if not disrupted with toxic pesticides. *Z. mali* is strictly an egg predator and mostly supplements early and late season control with the other predator mites. For biological control with *Stethorus*, populations should be assessed by determining a predator-to-mite ratio. To calculate predator-to-mite ratios, divide the number of *Stethorus* adults and larvae counted in three minutes by the number of motile mites per leaf. Example: 25 *Stethorus* adults and larvae divided by 10 motile mites per leaf equals a predator-to-mite ratio of 2.5. If the predator-to-mite ratio is less than 2.5 and the action threshold has been reached, then a miticide application is justified. The orchard should be checked again in five to seven days.

#### **Biological control with *Stethorus* and predatory mites**

- Avoid pesticides that are toxic to the natural enemies (see Table 4-5).
- The alternate row middle pesticide application method is sometimes recommended for mite control with *Stethorus*, but spray applications should not be made for predatory mites.
- The population densities of the pest mites and *Stethorus* or predatory mites must be known in order to determine whether the predator populations are sufficient to overcome the mite population or the aid of a miticide is needed.

#### **Chemical management**

- Closely monitor mite populations.

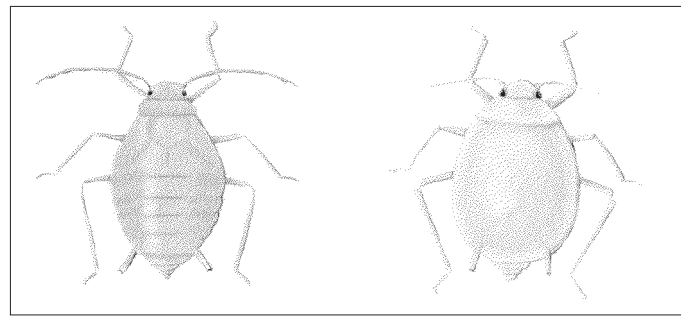

**Rosy Apple Aphid**

**Green Apple Aphid**

- Encourage natural enemies into the orchard by using insecticides and miticides more selectively.
- Use action thresholds to determine the necessity of spraying.
- Rotate miticides within the same season (i.e., do not use the same miticides or products with the same mode of action or IRAC Group more than once in the same growing season).
- Spray late in the evening or at night for better coverage and contact.
- Increase the volume of water to 100 gallons per acre if coverage is a problem.

The efficacy of various acaricides is detailed in Table 4-6 (apple), Table 4-10 (pears), and Table 4-12 (stone fruit).

#### **GREEN APHIDS (APPLE APHID AND SPIREA APHID)**

Spirea aphid, *Aphis spiraecola*, has largely displaced the apple aphid, *A. pomi*, in apple since the mid-1980s. The spirea aphid has a broader host range and is more likely to immigrate into apple than apple aphid, which may stay on apple year round or immigrate later in the season. The spirea aphid also tends to be less susceptible to insecticides than the apple aphid. However, these two species are difficult to distinguish and are managed together as green aphids.

#### **Description and life cycle**

Overwintering eggs are small, shiny, and black and cannot be distinguished from those of other aphid species. Stem mothers are wingless females that are pear-shaped and bright green. Immature green aphids can readily be distinguished from immature rosy apple aphids by shorter antennae and less well-developed cornicles. In the summer aphids vary from a yellow-green to a light green and have black cornicles.

Eggs are laid on bark and/or on buds in the fall by the wingless female. They hatch at about silver tip into stem mothers which give birth to a generation of green viviparous aphids, about three-quarters of which develop into winged females. The other aphids remain wingless. The winged forms spread the species to other parts of the tree or other trees. About half of the second generation and some of the later generations may develop wings and migrate.

Unlike the rosy apple aphid, green aphids may live on the apple tree all year, breeding continuously during the summer. In August and during the autumn months, these aphids are found almost exclusively on watersprouts or terminal branches of young trees that are still growing, and where male and female sexual forms are produced.

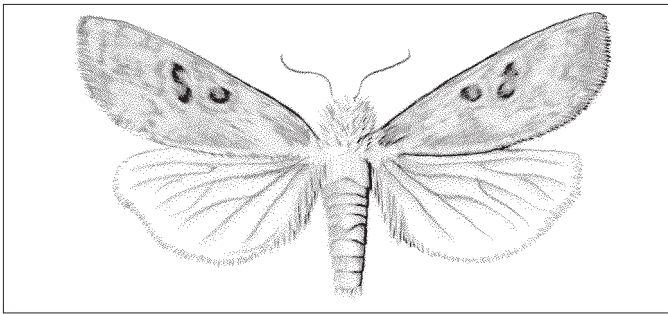

Adult Green Fruitworm

### Monitoring

Since the overwintering eggs are indistinguishable from rosy apple aphid eggs, early season scouting and management for both species are identical. However, because this aphid complex does not migrate to alternate hosts as rosy apple aphids do, it must be scouted for and managed until the terminals harden off. Beginning in early June, select 10 growing shoots, not watersprouts, on each of five trees of the major variety within the block. On each shoot, determine the number of leaves that have wingless aphids. If an average of more than four leaves per shoot are aphid infested, and less than 20 percent of the aphid colonies have predators, an insecticide application is recommended.

### Cultural management

A number of natural enemies of aphids have proved effective for biological control of aphids in Mid-Atlantic apple orchards. They include syrphid fly larvae, aphid midge, lacewing larvae, ladybird beetle adults and larvae, and some Braconid wasps. The predators appear as soft-bodied and sometimes very colorful larvae feeding right in the aphid colonies, whereas the wasps leave hollowed-out, brown “mummies.” A single syrphid larva can clean a leaf of aphids in days. A pesticide application may be delayed or eliminated if 20 percent of the colonies have predators. Use of pesticides with low toxicity to the predators (see Table 4-4) will increase the chance for biological control.

### Chemical management

Insecticides with aphicidal activity are listed in Table 4-6.

### GREEN FRUITWORMS

The speckled green fruitworm, *Orthosia hibisci*, is the most common of several green fruitworm pests occurring in commercial orchards. The larvae feed on a variety of deciduous shade, forest, and fruit trees including apple, pear, and cherry. These pests have only one generation annually.

### Description and life cycle

Adults are night-fliers whose flight period closely parallels apple bud development. Flight begins at about green tip, peaks at tight cluster, and ends by the pink stage. Adults are about  $\frac{2}{3}$  inch in length. Their forewings are grayish pink, each marked near the middle by two purplish gray spots outlined by a narrow, pale border. The hind wings, not visible when the moth is at rest, are slightly lighter in color than the forewings. Freshly laid eggs are white with a grayish tinge and have numerous ridges radiating from the center. Shortly before hatching the egg takes on a mottled appearance. Newly hatched larvae are  $\frac{1}{4}$  inch long and

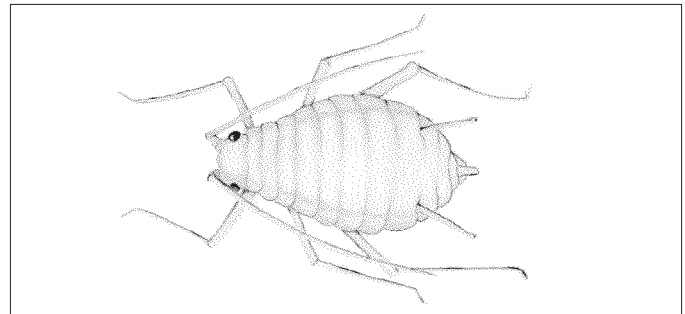

Green Peach Aphid

have a grayish green body with a brown head and thoracic shield. Mature larvae are  $1\frac{3}{16}$  to  $1\frac{5}{8}$  inches long and have a light green body and head. Several narrow white stripes run longitudinally along the top of the body, while a slightly wider, more distinct white line runs along each side. The green areas between the stripes are covered with numerous white speckles. Pupae are dark brown and about  $\frac{5}{8}$  inch long.

Females begin egg laying on twigs and developing leaves when apples are in the  $\frac{1}{2}$ -inch green stage. A female is capable of laying several hundred eggs but normally deposits only one or two at any given site. Young larvae feed on new leaves and flower buds and can often be found inside a rolled leaf or bud cluster. Older larvae damage flower clusters during bloom and continue to feed on developing fruit and leaves for two to three weeks after petal fall. They then drop to the ground, burrow 2 to 4 inches beneath the soil surface, and pupate over the winter.

Most flower buds and blossoms damaged by larvae abort. Most fruit damaged just before and shortly after petal fall also drop prematurely. Some, however, remain at harvest and exhibit deep corky scars and indentations. This injury is indistinguishable at harvest from that caused by the overwintering larvae of the obliquebanded leafroller.

### Monitoring and management

Orchards with a history of green fruitworm injury should benefit from effective insecticide applications at petal fall.

### GREEN PEACH APHID

The green peach aphid, *Myzus persicae*, is a common pest of peach and nectarine in Pennsylvania. Resurgence of this aphid on peaches following sprays of broad-spectrum foliar insecticides is attributed to the destruction of natural predators and to insecticide resistance.

### Description and life cycle

The green peach aphid is recognized by three longitudinal dark green stripes on the pale green body. This species has a complex life cycle, with five distinct morphological forms and two different behavioral forms. Its primary host and overwintering source is peach trees. Green peach aphids overwinter as wingless females and/or eggs underneath peach buds. Eggs hatch and young nymphs develop into stem mothers, which produce living young. After several generations of wingless adults, winged aphids appear during June, and all aphids leave peach trees during June and July. These migrant aphids do not affect peaches because they infest other crops and weeds. Large numbers of green peach aphids may develop on weeds in the ground cover of peach

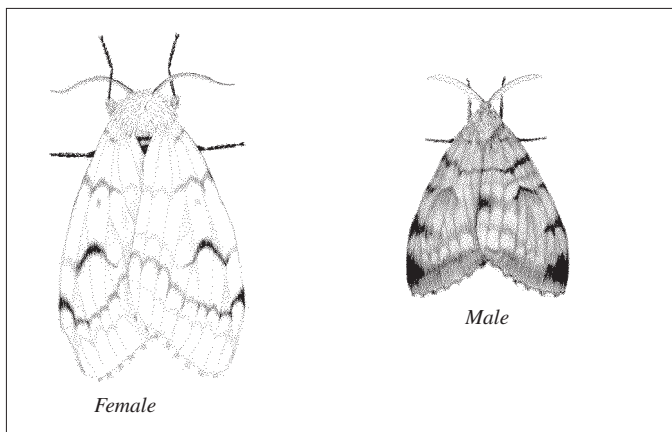

Gypsy Moth

orchards. Aphids return in the fall to peach trees to overwinter.

#### Monitoring and management

Trees should be inspected weekly from petal fall until the terminals harden off. For nectarines the treatment threshold is one colony per tree, and for peaches the threshold is five or more colonies per tree. Large trees can tolerate higher levels of infestation. Currently available insecticides provide excellent control of green peach aphid. Neonicotinoid compounds (e.g., Actara, Assail, Belay, Provado) or Movento or Closer are the most effective insecticides. Predators such as syrphid fly larvae, leatherwing beetle, and ladybird beetles often contribute to biological control of this aphid.

The green peach aphid is a known vector of the quarantine stone fruit disease plum pox (Sharka), which was identified in late 1990s in some south-central Pennsylvania peach and nectarine orchards. Plum pox disease is one of the most devastating diseases of stone fruit in Europe, but it has been eradicated in Pennsylvania.

#### GYPSY MOTH

Gypsy moth, *Lymantria dispar*, may attack fruit trees, especially apple, causing defoliation that can stunt or kill young trees.

#### Description and life cycle

Egg masses deposited in July on trees, rocks, and other surfaces hatch the following year in April and May. Orchards may be invaded by young larvae ballooning long distances on silk threads. Larvae pupate in mid- to late June and adults emerge in July. Females cannot fly.

#### Monitoring and management

Trees should be inspected in May through June. If gypsy moth larvae are found, they may be killed using product such as Intrepid, which is very effective against this pest with long residual activity and low toxicity to other animals and bees.

#### JAPANESE BEETLE

Japanese beetle, *Popillia japonica*, is one of the best-known pests to be encountered by Pennsylvania fruit growers, nursery operators, and gardeners. It is often the most important pest of tree-ripened peaches and can cause severe damage to other important crops.

#### Description and life cycle

Japanese beetle adults have metallic green bodies with coppery brown wing covers surrounded with 12 white tufts of hair. Eggs

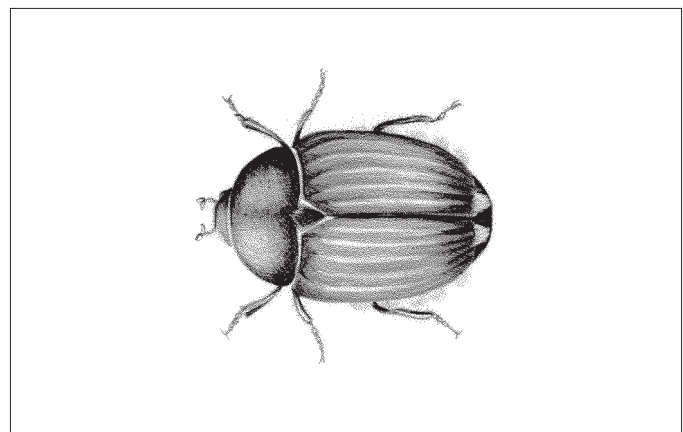

Japanese Beetle

are pearly white, elliptical, and  $\frac{1}{16}$  inch in diameter. The soft-bodied grubs are whitish with a brown head, "C" shaped, and are 1 inch long at maturity.

Japanese beetles overwinter in the soil as grubs and complete their growth in early spring. Adults emerge in greatest numbers during July and are active for a month. The gregarious beetles are most active on warm, sunny days on favorite hosts. Adults enter the ground in early evening. Females lay 40 to 60 eggs that hatch in two weeks. Grubs feed on organic matter and fine grass roots until late fall. They reach maturity in early spring and, after spending three to four weeks in the pupal stage, emerge as adults. There is only one generation per year.

Adults feed on leaves and fruit. They chew leaf tissue between veins and leave a lacelike skeleton. Severely injured leaves soon turn brown and often drop. Fruit of early ripening peach trees may be gouged in irregular, shallow patches.

#### Monitoring and management

Fruit and foliage may be protected from damage by spraying insecticides at regular intervals when beetles first cause unacceptable injury. Because sprayed trees can be reinvaded, they should be inspected weekly when adults are present.

#### LESSER APPLEWORM

Lesser appleworm, *Grapholita prunivora*, is a common native North American species, although infrequent as a pest in Pennsylvania orchards. Larvae are general fruit feeders attacking apples, pears, peaches, apricots, plums, and cherries.

#### Description and life cycle

Adults are only  $\frac{1}{4}$  inch long and are brownish and yellowish colored. When the moth is at rest, a gold band becomes evident across its back. Eggs are white to yellowish and are laid singly on leaves and fruit. Larvae are pinkish, have an anal comb, and reach  $\frac{3}{8}$  inch when mature.

Lesser appleworm has two and possibly a partial third generations in Pennsylvania. This insect overwinters as full-grown larvae in a cocoon on the tree, under loose bark scales, or in litter on the ground. The life cycle timings overlap closely with codling moth.

Larvae form extensive shallow mines under the fruit skin and may burrow deeper as they mature, although not into the core. Feeding injury in the fall is often limited to the calyx region.

**Monitoring and management**

Management procedures for codling moth (except codling-moth-only mating disruption) also control this pest. Oriental fruit moth pheromone lures will attract this pest and pheromone mating disruption for Oriental fruit moth will also disrupt lesser appleworm mating.

**LESSER PEACHTREE BORER**

Lesser peachtree borer, *Synanthedon pictipes*, is an important pest in peach and cherry orchards throughout Pennsylvania and surrounding states. Problems are almost always associated with widespread incidence of *Cytospora* canker and, to a much lesser extent, pruning wounds, winter injury, and mechanical damage.

**Description and life cycle**

Adults are day-flying moths that resemble wasps. Veins and margins of transparent wings are fringed with steel-blue scales; the body is blue and narrowly fringed with yellow. Males of lesser peachtree borer have yellow scales on the top of the head between the eyes and black scales between the antennae. This combination differentiates them from peachtree borer males, which have black scales between the eyes and yellow scales between the antennae. Lesser peachtree borer larvae are white with a yellowish brown head and reach 1 inch at maturity.

There are two and possibly a partial third generations each year; the first flight occurs during May and June, and the second during August and September. The lesser peachtree borer overwinters as larvae and reaches full growth during April and May. Larvae eat an exit hole nearly through the bark, spin a cocoon, and pupate in a small cavity. In three to four weeks, a clear-winged moth emerges, leaving an empty pupal skin projecting from the burrow. Adults are active for several weeks. The female moth is capable of laying several hundred eggs in cracks, under bark scales, and in cankered areas. Moths are attracted to trees that have been injured or previously infested. Eggs hatch in a week to 10 days, and young worms move to the inner bark and continue to feed.

**Monitoring**

Growers first notice evidence of borer infestation by checking for pupal skins in cankered areas. An early sign of lesser peachtree borer injury is the presence of wood chips, sawdust, and frass produced by feeding borers in the gum in cankered areas. If the gum does not contain this particulate material, the injury is probably not caused by borers. As an aid in timing sprays, growers should obtain pheromone trap records on flight activity. Treat at peak flight, usually toward the end of June, if there is an average of more than two borers per tree, and again in late summer. If fewer than two pupal skins are located in each tree, target only the second generation in late summer.

**Cultural management**

Any horticultural practice that prevents canker and maintains good tree development will help prevent borer damage.

**Mating disruption**

The Isomate PTB Dual pheromone product is commercially available for the control of lesser peachtree borer and peachtree borer on peach, nectarine, cherry, prune, plum, and apricot. Dispensers release pheromones for 100 to 120 days and should

be placed in the orchard before moth emergence in the spring. For effective control of lesser peachtree borer, use at least 150 pheromone dispensers per acre. Over several years, however, this rate of dispensers may cause a shift to the more damaging peachtree borer, which is harder to disrupt and needs a higher rate of pheromone dispensers for control. To improve the efficacy of mating disruption, distribute the dispensers uniformly throughout the entire block.

**Chemical management**

High-volume handgun insecticide applications thoroughly wetting trunk and scaffold limbs are necessary, with at least 1 gallon of spray mixture applied per tree. The late summer spray can be applied after harvest. If peachtree borer is also a problem this spray should be made within the first two weeks of September. If only lesser peachtree borer is present, sprays may be applied to late maturing varieties in early August. Do not allow spray residue to contaminate fruit.

**MULLEIN PLANT BUG**

Mullein plant bug, *Campylomma verbasci*, is a “two-edged sword” of the insect world. During one part of its life it is a beneficial insect feeding on pests such as aphids, thrips, and pear psylla, but in the early season when fruits are forming it feeds on flowers and developing fruitlets potentially causing serious direct damage to the crop.

**Description and life cycle**

Mullein plant bug adults are gray-brown, elongate-oval, and  $\frac{1}{10}$  inch long. Nymphs are pale green, and when older, develop black spines on the legs. Nymphs may be confused with white apple leafhopper, but have a stouter-looking body and thicker, distinctly segmented antennae with a dark stripe near the base.

This plant bug overwinters as eggs in the woody tissues of several host plants, including apple and pear. Only a small part of the egg ( $\frac{1}{28}$  inch long) is visible without slicing into the host tissue. In the spring, eggs hatch beginning about tight cluster and finishing about petal fall. There are two to four generations per year, with each lasting about three to four weeks.

Mullein plant bug stays primarily on woody host plants such as apple and pear in the spring, but later generations move to weedy hosts, most notably mullein, for most of the summer. In the fall they move back to woody hosts, mate, and lay eggs. Around bloom and early fruit development mullein plant bug feeding on fruit produces a dark, raised, corky wart, often surrounded by a shallow depression. Multiple feeding punctures or “stings” on a fruit may cause the fruit to be misshapen. Stings are more notable on Golden Delicious than on red cultivars, and the scars may be light tan in color. Early blooming cultivars are more seriously affected. Many of the injured fruits will drop during June.

**Monitoring and management**

At this point, the mullein plant bug is an infrequent pest in Pennsylvania. If orchard records indicate feeding damage in past years, especially on yellow-skin varieties, then attention should be paid to this pest around the flowering period. If fruit damage was present but not heavy the previous year, then populations should be assessed just prior to and during bloom. A beating tray or close visual examination of flowering and fruiting structures

may be used to determine the presence of small nymphs. If fruit damage was heavy in the previous year, an effective insecticide application is needed at the petal fall stage. Mullein plant bugs seen later in the season are not harmful to the crop.

#### **OBLIQUEBANDED LEAFROLLER**

Obliquebanded leafroller, *Choristoneura rosaceana*, is native to and widely distributed throughout temperate North America. Larvae feed on a wide range of plants. Their preferred hosts are plants from the family Rosaceae, including apple, peach, and pear. Although historically this leafroller has been considered a minor pest in Pennsylvania, occasional outbreaks in several areas have been a cause for concern.

#### **Description and life cycle**

This species is one of the larger leafrollers feeding on tree fruit in Pennsylvania. Adults are ½ inch long with a wingspan of 1 inch. The forewings are light reddish-brown and are crossed by three oblique chocolate brown bands. The hind wings, not visible when the moth is at rest, are pale yellow. Egg masses are laid on the upper surfaces of leaves, are greenish yellow, are about ¾ by ⅜ inches in area, and may contain 200 or more eggs. The black head capsules of embryonic larvae become visible just before they hatch. Newly hatched larvae have a yellowish green body and a black head and thoracic shield. Mature larvae are 1 inch long and distinct from other leafrollers by the combination of either a black or variably brown head and thoracic shield with a green body. Pupae are dark brown, about ½ inch long, and are usually found in rolled leaves on the tree.

Obliquebanded leafroller has two generations per year, overwintering as small larvae in the trees. The overwintering larvae become active when trees break dormancy, and they complete their development about two weeks after the apple blossom period. Adults begin to emerge in late May or early June. Females can lay up to 900 eggs during a seven- to eight-day oviposition period. Eggs hatch in about 10 to 12 days. This generation takes almost two months to complete development. Adult flight of the second generation occurs in August, and the larvae hatch in August and September. Young larvae construct hibernation sites on twigs or bark to spend the winter.

This species has three feeding periods during the year. Overwintered larvae feed on developing flower buds and floral parts throughout the blossom period. After petal fall, these larvae continue to feed on developing fruit. Newly hatched first generation (summer) larvae move to and feed on tender growing terminals, watersprouts, or developing fruit. As these larvae reach the third instar, they display an increasing propensity to damage fruit. The second-generation larvae, which develop in late summer and fall, feed primarily on leaves until they enter diapause, although they may occasionally damage fruit.

#### **Monitoring and management**

Scout for larval shelters during bloom to petal fall. A petal fall treatment with an insecticide effective on mid-sized to large larvae such as Intrepid, Exirel, or Altacor should control overwintered larvae. The flight of adults can be monitored with pheromone traps. The trap data can establish biofix and estimate the population density. The second window of control is in June/July, when most summer-brood eggs have hatched and rolled or

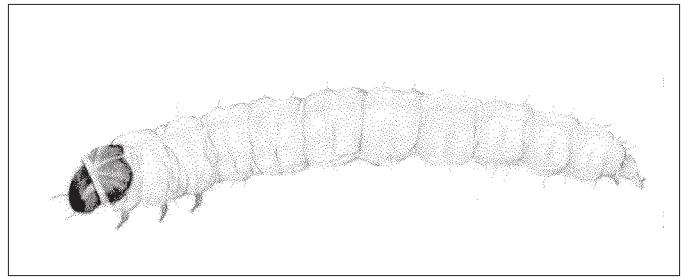

**Oriental Fruit Moth (larva)**

injured terminals can be seen.

The efficacy of various insecticides for control of obliquebanded leafroller larvae is listed in Table 4-6. Since the larvae preferably feed on or inside young growing terminals, it is recommended to repeat insecticide applications if intensive new terminal growth occurs.

#### **ORIENTAL FRUIT MOTH**

Oriental fruit moth, *Grapholita molesta*, is a pest of most stone and pome fruits. In pome fruits, its appearance and injury is similar to that of the codling moth and lesser appleworm.

#### **Description and life cycle**

Adult moths are gray, with a wing spread of ¼ inch; the wings are gray with dark markings. Eggs are single, flat, whitish ovals on twigs or the undersides of leaves. Larvae are pinkish white with a black head and reach ½ inch at maturity. Larvae are distinguished from codling moth by the presence of a black anal comb on the bottom of the last body segment.

Oriental fruit moths have four to five generations per year in Pennsylvania, with the first and last two generations most numerous. They overwinter as larvae in silken cocoons on the tree or on the ground, and they pupate and begin to emerge as adults during April, shortly before peach trees bloom. These females lay up to 200 eggs, primarily during May. The succeeding overlapping generations extend into September and October.

The earliest indication of injury is a dying back of the new growth of twigs in spring. A first-generation larva enters at a peach leaf axil near the tip of a shoot and bores down the central core for several inches, causing the terminal to wilt, or “flag.” Shoot injury in apples from the first generation is minor, with entries only an inch or so deep and often with high mortality. Later generation larvae may enter the fruit near the stem end and make feeding burrows that can extend to the pit or to the core. In peaches, the mature larva exits the fruit from the side, leaving a large gumming hole with much frass.

#### **Monitoring and management**

Spray timing can be aided by using pheromone traps to establish a biofix (i.e., first sustained capture of two or more moths per trap) and then calculating and recording degree days to determine the percent egg hatch for each generation. To establish the biofix, place sex pheromone traps in stone fruit and/or apple orchards in early April and check daily until biofix is determined. Then, monitor traps weekly throughout the season. Table 2-13 gives degree-day calculations for OFM. To use this table, you must record the local temperature each day, beginning with the establishment of biofix. Timing of broad-spectrum insecticide sprays for the first and second generations on peaches are as follows: first generation—150 to



**Table 2-7. Timing of insecticide applications on apples and peaches to control the Oriental fruit moth based on crop stage or degree days from biofix.**

Crop	Application timing <sup>a</sup>			Comments <sup>b</sup>
	OFM brood	Crop stage or DD (°F)	Approximate egg hatch (%)	
Peach	1	170–195	10–15	Most important spray on peach for first brood. Pest monitoring should be used to determine if second application is needed.
	1	350–375	55–60	
Apple	1	Pink	0	To kill adult moths. Most important spray on apple for first brood.
	1	350–375	55–60	
Peach	2	1,150–1,200	15–20	Most important spray for second brood. Pest monitoring should be used to determine if second application is needed.
	2	1,450–1,500	65–70	
Apple	2	1,450–1,500	65–70	Very important if trap threshold exceeded (>10 moths/trap/week) and/or fruit or shoot injuries are found. Use only a single application for second brood on apple.
Peach	3	2,100–2,200	10–20	Very important if trap threshold exceeded (>10 moths/trap/week) and/or fruit injury is found.
	3	2,450–2,500	50–60	
Apple	3	2,450–2,500	50–60	Important if trap threshold exceeded (>10 moths/trap/week) and/or fruit injury is found.
	3	2,900–3,000	?	
Both	4	September	?	Important if trap threshold exceeded (>15 moths/trap/week) and/or fruit injury is found.

a. Application timings for products with ovicidal activity (e.g., *Rimon*, *Intrepid*, *Assail*) may be earlier (e.g., 100–150 DD) than those specified due to their mode of action.

b. Moth captures in pheromone traps and monitoring for pest injury (e.g., flagging and fruit injury) should be used to determine the site-specific necessity to spray.

200 and 350 to 375 degree-days following biofix; second generation—1,150 to 1,200 and 1,450 to 1,500 degree-days; and for the third generation, 2,100 to 2,200 and 2,450 to 2,500 degree-days for peaches and 2,450 to 2,500 and 2,900 to 3,000 degree-days for apples. See Table 2-7 for more information about insecticide timing for OFM control. The differences in larval development due to feeding on various food sources (e.g., terminals, fruits, apple, peach) and possible adult movement between adjacent apple and peach orchards contribute to significant overlapping between generations late in the season. Using pheromone traps to monitor the OFM population in each block is necessary to assess the potential problems caused by this pest.

Mating disruption materials such as sprayable pheromones and hand-applied dispensers (e.g., *Isomate OFM TT*, *Cidetrak OFM Meso*, or *Checkmate OFM*) can be used to manage this pest. If codling moth is also a problem in the same block, then *Isomate CM/OFM TT*, *CideTrak CM OFM Combo*, *CideTrak CMDA OFM Meso* or *Checkmate Puffer CM-OFM Pro* should be used to control both species. Hand-applied dispensers should be placed in the upper level of the tree canopy at the label rate no later than at the pink stage on apples. Various kinds of hand-applied dispensers are available on the market, but even the dispensers with the short-

est pheromone release time remain effective for at least 90 days. The sprayable pheromones can be applied together with routine pesticide applications. Their effective time depends on pheromone formulation, rate, and weather conditions. Ideally, orchards should be at least 5 to 10 acres in size for mating disruption to be effective. Moreover, monitoring should proceed as usual to check the effectiveness of disruption. If using mating disruption in peaches, biological control of the first (shoot-feeding) generation larvae is often higher than 50 percent and due to a braconid larval parasitoid, *Macrocentrus delicatus*.

### PEACHTREE BORER

The peachtree borer, *Synanthedon exitiosa*, is primarily a pest of peach and nectarine trees, but it also attacks apricot, cherry, and plum. This native American borer has been known since colonial times and is a pest wherever peaches are grown.

#### Description and life cycle

Adults resemble wasps when flying and are often mistaken for them. Female moths are dark blue with a broad orange band around the body and forewings darker than the clear hind wings. The male is smaller and has three to four narrow yellowish bands across the body; both pairs of wings are clear. Males of peachtree borer have black scales on the top of the head between the eyes and yellow scales between the antennae. This combination differentiates them from males of lesser peachtree borer, which have yellow scales between the eyes and black scales between the antennae. Larvae are white with a brown head and 1.5 inches long at maturity.

Peachtree borer has a single generation per year, but it can result in severe losses if not managed correctly. This borer overwinters in a wide range of larval stages. Larvae become active and resume feeding in April, with larger larvae completing their feeding during June and July. Most adults emerge and lay up to 500 eggs during July and August on tree trunks, in cracks or under bark scales, and in soil near the tree trunk. Eggs hatch in 10 days and young larvae feed on tree bark, working their way into the trunk as they become larger. One of the first signs of peachtree borer attack is a mass of gum exuding from the trunk base approximately 3 inches above to 1 foot below soil surface. This gum mass contains bits of wood chips, sawdust, and frass produced by the feeding larvae. Burrowing larvae weaken the tree, resulting in lower fruit production or, if borers are numerous, death of the tree. Neglected trees or those suffering from drought or winter injury are most likely to be infested.

#### Monitoring

Pheromone trap capture peaking at less than 10 moths per week generally indicates that this species is not causing losses. If any evidence of feeding is observed on trees up to three years old, a treatment is warranted. Older trees with more than one larva per tree should be treated.

#### Cultural management

Maintain healthy trees.

#### Mating disruption

The *Isomate PTB Dual* mating disruption pheromone dispensers are registered for the control of peachtree borer on peach, nectarine,

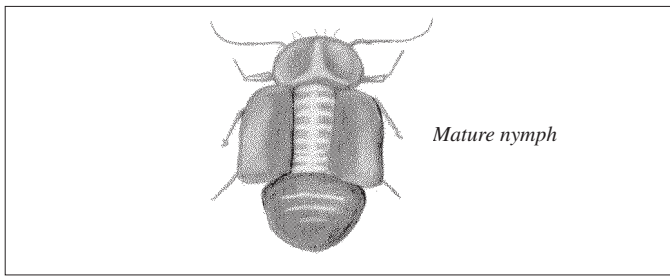

Pear Psylla

cherry, prune, plum, and apricot. Dispensers release pheromones for 100 to 120 days and should be placed in the orchard before moth emergence in early June. For effective control of peachtree borer, use at least 200 Isomate PTB Dual pheromone dispensers per acre. To improve the efficacy of mating disruption, distribute the dispensers uniformly throughout the entire block. The Isomate PTB Dual will also control lesser peachtree borer, but has to be placed in the orchard earlier in the spring before adult LPTB emergence.

### Chemical management

Roots should be dipped in an insecticide solution before planting. Protective trunk sprays with products containing chlorpyrifos should be applied in the summer from the lower scaffold branches to the soil line (see Part V, IPM Spray Programs). Soak the bark to runoff, so that a puddle of solution can be seen at the base of the tree.

## PEAR PSYLLA

Pear psylla, *Cacopsylla pyricola*, can be a limiting factor in pear production. It is a native species that produces abundant honeydew, which allows a sooty fungus to grow on the fruit surface. The associated loss of foliage can result in severe tree injury.

### Description and life cycle

Pear psylla adults look like small, dark reddish brown, 1/10-inch-long cicadas. Eggs, just visible to the naked eye, are pear-shaped, yellowish, and are laid in cracks in the bark and around the buds. They become dark yellow before hatching. Nymphs have sucking mouthparts and feed on plant sap. The young nymphs are soft-bodied and creamy yellow. As they mature they become dark brown and more oval in shape, with distinct wing pads present on the late instars. These late instar nymphs are commonly referred to as “hard shells.”

There are generally four generations of pear psylla per year. The adults, which overwinter on trees or other sheltered places, become active anytime the temperature is above 40°F. Females begin laying eggs in late March and continue through the white bud stage. One female can produce as many as 650 eggs. The peak of egg laying is green tip to green cluster bud. Eggs hatch begins at the green cluster bud to white bud stage, with peak hatch occurring about petal fall. Nymphs move to succulent stems and developing leaves to feed, with the heaviest concentration along the midveins of leaves and at the calyx end of fruit. They pass through five instars, each subsequent stage becoming more difficult to control. The early nymphal stages produce more honeydew than the later, larger stages. The first summer adults mature about 20 to 25 days past full bloom. They begin laying eggs on growing shoots as the population shifts from spur leaves to the more succulent shoot leaves. Late season infestations are typically found on water sprouts.

The pear psylla secretes large amounts of honeydew, which runs down over foliage and fruit and in which a sooty fungus grows. This causes the skin of the fruit to become blackened and scarred and the foliage to develop brown spots. Heavy infestations may cause partial to complete defoliation of trees, reducing vitality and preventing the formation of fruit buds. Return bloom and fruit set are often reduced the following season. Overall tree growth can be stopped or stunted with heavy psylla injury. These combined effects are often termed “psylla shock.” There is also limited evidence that psylla inject some type of toxin into the tree, causing a disease known as pear decline. In addition, pear psylla has been implicated in the transmission of fire blight.

### Monitoring

Growers should monitor for the presence of pear psylla using their most sensitive pear variety (e.g., Bartlett). To sample for pear psylla nymphs in the early season, examine at least 10 leaves (five spur and five recently expanded shoot leaves) per tree on a minimum of five trees per block. The action threshold at this time is 0.5 nymph per leaf. For the summer generations again examine at least 10 leaves (recently expanded shoot leaves) per tree on a minimum of five trees per block. The action threshold now is 1.5 nymphs per leaf. When the psylla population is primarily in the adult stage, examine the leaves for the presence of adult activity and egg laying.

### Cultural management

Several cultural control practices will reduce psylla populations and dependence on insecticidal control. First minimize heavy pruning, which encourages the proliferation of terminal shoot growth. An overabundance of terminals provides more feeding sites for the psylla. Second, pear trees should receive the minimum amount of nitrogen fertilization necessary for proper tree and fruit growth. Overfertilization can cause extended terminal growth and delay hardening off, allowing optimal feeding conditions for the psylla. Third, and most important, is to remove water sprouts during late June and early July. Because water sprouts provide one of the only sources of succulent leaves at this time of the year, this technique can eliminate a large portion of the psylla population.

### Chemical management

In orchards with a history of psylla infestations, insecticidal control begins with a strong prebloom spray program designed to eliminate as many overwintering adults as possible before they have the opportunity to lay many eggs. As with all psylla sprays, good coverage is critical for control of this pest. All sprays should be applied to both sides of the trees and in a volume of water high enough to thoroughly wet and cover the entire tree. In most situations, this requires at least 100 gallons per acre. Surfactants may be added to achieve better coverage. Alternate row middle applications are not recommended unless tree size is quite small.

The first application should include oil, which has been shown to delay egg laying by over 95 percent for a five-week period, plus an adulticide to eliminate adult psylla overwintering on the tree. This application also serves to concentrate in time a higher proportion of pesticide-vulnerable individuals later in the season. Typically, egg deposition and hatch occurs over a long period of time, making pesticide timing difficult. Early season oil sprays “bunch up” the population so sprays can be more easily targeted.

The early season oil application must be applied prior to egg maturation in the female psylla. For growers in south-central Pennsylvania, this application should be made in most years by March 15–20.

With the oviposition period delayed, the delayed dormant spray (bud burst) becomes extremely important because additional adult control can be achieved by waiting until adult psylla that are living away from the pear tree return from their overwintering sites. This spray should again contain oil as well as an adulticide such as one of the synthetic pyrethroids.

The next prebloom spray should be applied between the green cluster bud stage and the white bud stage. This is the period when first-generation eggs begin to hatch. A number of very effective insecticides are available for this spray, including Centaur, Esteem, and synthetic pyrethroids.

The next vulnerable period occurs at petal fall, when the first generation nymphal population is usually at its peak. The best materials currently available are Agri-Mek, Delegate, and Actara. Since petal fall is a key period for the activity of other pests that attack pears, it is usually necessary to add a broad-spectrum organophosphate insecticide at this time. If the four applications recommended thus far are carefully applied, psylla populations should be very low.

The next major period to control psylla is not until the second generation of nymphs begins hatching about mid-June. Insecticides such as Delegate or Exirel and/or neonicotinoid insecticides such as Provado, Actara, Assail, or Belay are probably the insecticides of choice owing to their activity against early instar nymphs. A second application should be repeated within 10 to 12 days of the first to control additional nymphs hatching from eggs. If the population warrants additional applications, these can be made against the third generation of nymphs, which usually begin hatching around mid- to late July. Since the second and third generations tend to overlap during the season, close attention should be given to determining which nymphal stages are present, since insecticides are most effective when directed against the early instars. Growers should rotate to different insecticidal chemistries for each spray. The efficacy of various insecticides for control of pear psylla is listed in Table 4-10.

#### PEAR SLUG

The pear slug, *Caliroa cerasi*, resembles a slug in appearance, but it is actually a sawfly. It is rarely a pest in commercial pear orchards but may appear as sprays for other insects are reduced.

#### Description and life cycle

Adults are small ( $\frac{1}{5}$  inch), black sawflies with transparent wings. Larvae are shiny black and sluglike with seven pairs of prolegs in addition to three pairs of true legs, and reach  $\frac{1}{3}$  inch long at maturity.

Pupae overwinter in the soil. Adults emerge in the spring and begin oviposition by inserting eggs into small slits in the leaf, laying two to five eggs per leaf. Females produce eggs without mating. Larval feeding results in skeletonization of the upper leaf surface, leaving only leaf veins uneaten. Mature larvae drop to the ground and burrow into the soil about 4 inches to pupate. A second generation emerges midsummer and continues skeletonizing leaves. Second-generation damage is usually more severe, sometimes retarding tree growth the following year.

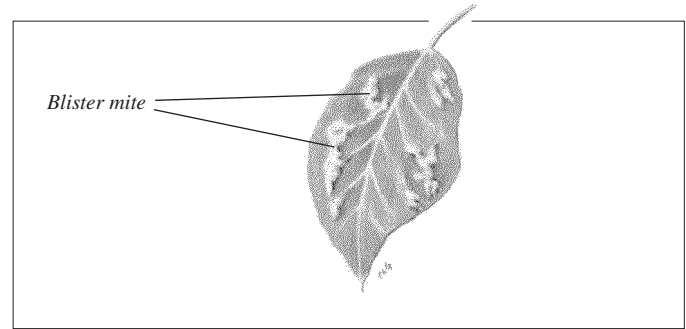

Pearleaf Blister Mite

#### Monitoring and management

The extent of skeletonization should be observed weekly beginning in midsummer. No thresholds are available. Minor feeding is acceptable.

#### PEAR THRIPS

Pear thrips, *Taeniothrips inconsequens*, was introduced early this century, probably from Europe. It can be a severe pest of sugar maple. Thrips feeding in nectarine blossoms and fruitlets in areas of the state where sugar maples are common has caused scarring injury on the fruit.

#### Description and life cycle

Pear thrips produce just one generation per year. Adults are dark brown and occur only as females in North America. Adult emergence occurs around the time of leaf flush of sugar maple. In outbreak years pear thrips may infest many deciduous hosts that are in bloom at this time, including most tree fruits. Adult and larvae feeding on developing nectarine fruit can cause scarring injury that expands as the fruit matures. Pear thrips injury to apple blossoms has occurred in New England but is not known in Pennsylvania.

#### Monitoring and management

Monitoring should begin at bloom in areas at risk for pear thrips. Sample blooms from 10 to 12 trees at each of three to four sites per orchard. Blooms should be slapped against a light yellow surface to determine abundance of adults. The presence of larvae is determined by dissecting at least 50 blooms per orchard. The threshold is adult infestation of more than five per 50 blooms or presence of larvae.

#### PEARLEAF BLISTER MITE AND PEAR RUST MITE

Pearleaf blister mite, *Phytoptus pyri*, and pear rust mite, *Epitimerus pyri*, are similar species, virtually invisible to the naked eye, that often are common on unsprayed trees.

#### Description and life cycle

Pearleaf blister mite adults are white to light red and extremely small ( $\frac{1}{100}$  inch). The body is sausage-shaped. Nymphs resemble adults, but are smaller. This species causes brownish blisters that appear on the undersides of leaves and fruit. On pear trees, blisters first appear as small greenish pimples that become reddish, then brown. They may cover the lower leaf surface. On developing fruit, early feeding causes depressed russeted spots surrounded by clear halos that look like blisters. Since these mites do not move very quickly or very far, their infestations are often confined to single trees or even single branches. Pear rust mite is similar in appearance to blister mite, but the injury is characterized by a smooth russetting of the fruit.

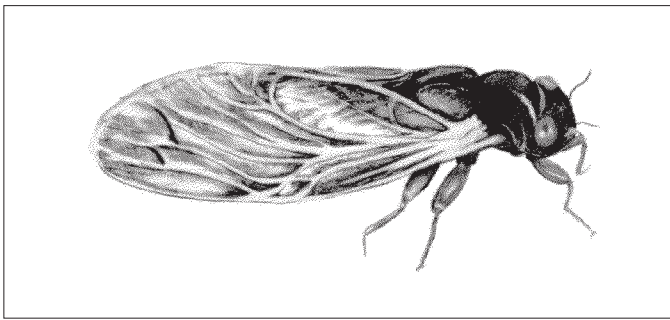

Cicada

**Table 2-8. Emergence of different broods of periodical cicada in Pennsylvania counties by year.**

Year	Brood	County
2021	X	Adams, Bedford, Berks, Blair, Bucks, Carbon, Chester, Clinton, Columbia, Cumberland, Dauphin, Delaware, Franklin, Fulton, Huntingdon, Juniata, Lackawanna, Lancaster, Lebanon, Lehigh, Luzerne, Lycoming, Mercer, Mifflin, Monroe, Montgomery, Montour, Northampton, Perry, Philadelphia, Schuylkill, Snyder, Somerset, Union, York
2025	XIV	Adams, Bedford, Berks, Blair, Centre, Clearfield, Clinton, Cumberland, Franklin, Huntingdon, Lackawanna, Lehigh, Luzerne, Lycoming, Mifflin, Montour, Northumberland, Perry, Potter, Schuylkill, Snyder, Tioga, Union, York
2029	I	Adams, Cumberland, Franklin
2030	II	Berks, Bucks, Carbon, Chester, Dauphin, Delaware, Lancaster, Lebanon, Lehigh, Luzerne, Monroe, Montgomery, Northampton, Philadelphia, Pike, Schuylkill, Wyoming
2033	V	Fayette, Greene, Somerset, Washington, Westmoreland
2035	VII	Allegheny, Butler, Washington, Westmoreland
2036	VIII	Allegheny, Armstrong, Beaver, Butler, Cambria, Clarion, Crawford, Fayette, Forest, Huntingdon, Indiana, Lawrence, Mercer, Venango, Washington, Westmoreland

Adult blister mites enter bud scales in August to September to overwinter. They become active at bud break, migrate to the tender, new leaves, and burrow beneath the epidermis of the undersides of leaves to feed. This results in a gall, or blister, in which the eggs are laid. The nymphs remain in the blister, emerging as adults to migrate a short distance to form new galls.

#### Monitoring and management

Examine terminal and fruit buds for mites during dormant and again just before bloom. During the summer, examine shoot foliage and the calyx end of developing fruit. Applications of Vydate or Diazinon at delayed dormant or prepink should provide a good control of blister mite.

#### PERIODICAL CICADA

The periodical cicada, *Magicicada septemdecim*, is a large flying insect with a unique life history. It lives most of its 17-year life underground (Table 2-8).

#### Description and life cycle

Beginning about the third week in May and continuing into June, mature nymphs (young) dig themselves out of the ground in great numbers, crawl to the nearest tree trunk, shrub, or other vertical surface, and climb several inches up. The nymph's skin

then splits down the back, and the winged, sexually mature adult emerges. The adult is about 1.5 inches long, mostly black, with red eyes and other reddish markings. The wings are large and clear except for orange-red veins. Males are capable of producing an ear-splitting, high-pitched whine. Females, which produce no sound, are attracted to the males to mate.

A week to 10 days after the males begin "singing," the females begin to lay eggs. Each female lays up to 400 eggs in 40 to 50 pockets in the wood of several small branches of many types of trees. More than 75 species of trees are known to be attacked. The type of branch preferred by the females is about the width of a pencil up to ½ inch in diameter or a little larger. To lay eggs a female slices into the wood of the branch with her egg-laying apparatus and places the egg into the wood. She usually lays one to several dozen eggs in a single branch before moving to another branch or tree. This egg-laying activity lasts approximately 30 days, and about six to seven weeks later the eggs hatch into tiny white nymphs. The nymphs fall to the ground and burrow into the soil to feed on grass roots and, eventually, tree roots for the next 17 years. A numbering system established in 1893 to keep track of these broods is still used today.

Cicadas damage fruit trees in two ways. The most obvious damage is done during the egg-laying process. The slits made by the female in small branches severely weaken them; often the weakened branches snap off in the wind. Under a heavy attack a majority of the branch tips may be killed. In larger trees, where most of the branches are larger than the preferred thickness for egg laying, the loss of even most of the branch tips may not severely damage the tree. However, in small trees four years old or less, most of the branches are of the preferred size. Under a heavy attack such a tree can be severely damaged and sometimes killed. Therefore, control measures should be concentrated on these small trees. Moreover, with the emphasis placed on early training and pruning of fruit trees, the loss of incipient scaffold limbs can affect the productivity of a tree for the rest of its life. This type of injury also leaves trees susceptible to fire blight infections, much as might occur after a summer hail storm.

The second type of damage is less obvious. After entering the ground the nymphs eventually attach themselves to the roots of the fruit tree, insert their needlelike mouthparts into the roots, and feed on nutrients that would otherwise help the tree grow and produce fruit. Feeding by hundreds or even thousands of these insects on a tree root system for 17 years probably affects the tree productivity, although this has never been fully documented.

#### Monitoring

It is difficult to predict whether or not a particular orchard will be severely affected. The best strategy is to be alert for the first signs of male "singing" and to scout the orchards intensively a week later to look for egg-laying females. Considering the potential damage this insect can cause, a fruit grower can take several actions to minimize any detrimental effects.

#### Cultural management

Such actions include delaying planting to avoid cicada emergence and postponing until summer the winter pruning of trees less than four years old. Delayed pruning would decrease the probability of damage to incipient scaffold limbs and give the grower a chance to remove damaged wood after cicadas have finished laying eggs. Summer pruning and the removal of trimmings from the orchard,

if done within the four- to six-week period after eggs are laid but before nymphs fall to the ground, would allow the grower to prevent many cicadas from feeding on tree roots for the next 17 years.

During the emergence period the most immediate problem is to protect trees (especially young trees) from damage caused by egg laying. There are two strategies to accomplish this objective, depending primarily on the size of the orchard. Trees in small orchards or backyards can be protected mechanically by enclosing them in netting or some other kind of cloth for the duration of the egg-laying period. This cloth should have a mesh size no larger than about ¼ inch. The netting should be placed on trees when the first male singing is heard and removed after adult activity has stopped. All branches less than ½ inch in diameter should be protected.

### Chemical management

If netting is too expensive or too time consuming, pesticide sprays may need to be used. There are several pesticide options. Pyrethroid insecticides, with quick knockdown, a fairly long residual action, and repellent properties, are recommended for young fruit trees. The frequency of applications will depend on egg-laying pressure. We recommend scouting the orchard every two or three days during the egg-laying period to check on the effectiveness of any insecticide applications that have been applied. If much egg-laying activity is apparent, another repeat application should be considered. Neonicotinoid insecticides (e.g., Assail) should also provide adequate control of adult cicadas but have shorter residual activity.

Remember that a constant vigil must be kept during an outbreak because cicadas can invade an orchard from adjacent woodlots. Be aware that pyrethroids can be disruptive to the predatory mite–*Stethorus* balance in the orchard and will probably cause mite outbreaks later in the season. Flare-ups of San Jose scale and woolly apple aphid have also been seen after such sprays. With small trees, however, this is usually manageable. In orchards with older trees pyrethroid use is not recommended because subsequent mite problems may be costlier than the cicada injury. For larger trees, we recommend a mix of Lannate and neonicotinoid insecticides. These compounds kill cicadas although they lack the quick knockdown of the pyrethroids. We do not recommend using carbaryl because of its possible impact on thinning and mites.

### PLUM CURCULIO

Plum curculio, *Conotrachelus nenuphar*, is an injurious pest of apples, cherries, nectarines, peaches, pears, and plums throughout the state. The characteristic crescent-shaped oviposition scars are being observed more frequently in Pennsylvania as narrow-spectrum insecticides are used without an organophosphate insecticide after bloom.

### Description and life cycle

Adult beetles are ¼ inch long, dark brown with whitish patches, with four humps on their wing covers, and a protruding snout one-third its body length. Eggs are pearly white. Larvae are yellowish white with a brown head, lack legs, and are ¼ inch long when fully grown.

Adult plum curculio beetles first appear in orchards during the time of apple bloom. Most beetle activity occurs during the first warm period after petal fall, when the maximum temperature is 70°F or higher. Periods of cool, rainy weather with maximum

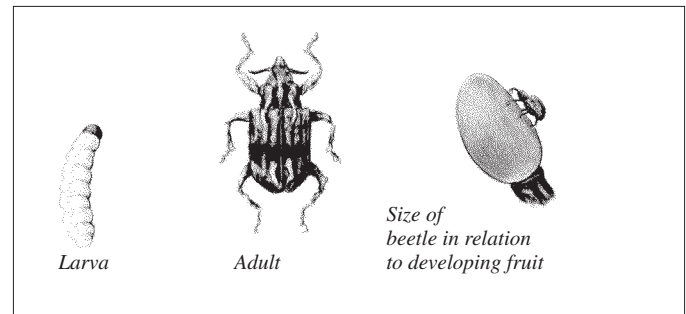

Plum Curculio

temperatures below 70°F are not suitable for curculio activity. The plum curculio is usually more abundant on fruit trees adjacent to woods, fencerows, and trashy fields. Adults can be found in orchards for five to seven weeks. Slight feeding occurs on petals, buds, and blossoms, but there is little injury until the fruit is available. Eggs are laid singly in a small cavity underneath the fruit skin during the first warm periods after petal fall; eggs hatch in seven days. When fruit is approximately ½ inch in diameter, it provides abundant food and a suitable place for egg laying. Early blooming varieties are the first to provide suitable locations for feeding and depositing eggs.

Adults average over 100 feeding and/or egg punctures during their normal life. Feeding punctures are small, round holes extending ⅛ inch into the fruit; egg punctures are distinguished by a characteristic crescent-shaped cut that partly surrounds the sunken egg. Larvae are most likely to develop in fruit that drops. They make large irregular cavities and feed for about 16 days before maturing. Larvae then leave the fruit and enter the soil where they pupate and emerge as adults during August. These adults feed for a short time before seeking winter quarters. In some years a partial second generation may occur in southern portions of the state. When the eggs fail to hatch, a half-moon scar forms. When the eggs hatch and the larvae begin to feed, the scar is indented and does not expand. These larvae may deform the fruit but rarely complete development in fruit that remains on the tree.

### Monitoring and management

The critical period for controlling plum curculio is during the first few days of warm and humid weather following petal fall, when maximum temperatures remain approximately 70°F. Control is more difficult when feeding is greatly reduced by low temperatures and moderate rains because spray deposits are washed from fruit and foliage. Low temperatures also extend the period during which curculio is active in orchards. Temperature monitoring is important in timing sprays. A spray residue should be maintained for 308 DD base 50 following petal fall (on McIntosh apples). On stone fruits, sprays should be timed for the petal fall stage and repeated if needed.

In blocks with a history of plum curculio injury, the following are important considerations: (1) shorten interval between sprays during peak curculio activity (this may be necessary on outside rows only), (2) increase insecticide rate during peak activity, and (3) select the most effective insecticides without sacrificing control of other pests or interfering with the integrated pest management program. See Table 4-6 for the list of effective insecticides.

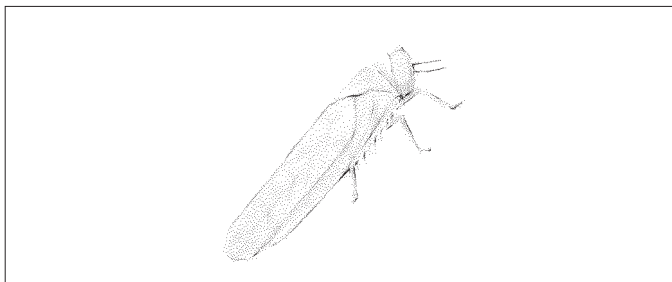

Potato Leafhopper

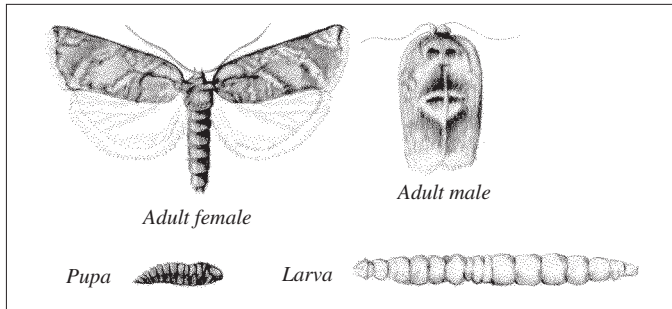

Redbanded Leafroller

### POTATO LEAFHOPPER

Potato leafhopper, *Empoasca fabae*, is a migratory pest of many crops. It feeds on leaves of rapidly growing apple terminals and may aid in spread of fire blight.

#### Description and life cycle

Nymphs and adults of the potato leafhopper are yellowish green to pale green and otherwise resemble white apple leafhoppers. Nymphs move sideways and quickly retreat to the opposite side of the leaf when disturbed.

Potato leafhoppers overwinter as adults in southern states and move northward mainly through the action of storm fronts. They arrive in southern Pennsylvania in late May or early June. Their movement and severity depend on many weather-related phenomena as well as the availability and proximity of alternate food sources. Therefore, the seriousness of this pest is sporadic. It is most damaging from mid-June to mid-August.

Unlike the white apple leafhopper, the potato leafhopper feeds near the edges of leaves. A triangular chlorotic area extends from the feeding site to the leaf edge. If several feeding sites are present on a leaf, the leaf will cup downward. If several leaves on a shoot are affected, shoot growth may be greatly stunted. Feeding by the potato leafhopper in the vascular tissue is such that it may spread fire blight.

#### Monitoring and management

Scout often after mid-May following frontal systems. No threshold is currently available. Fire blight susceptible varieties and young trees where this species has been a problem in the past should be protected when the first adults appear. Neonicotinoid insecticides (e.g., Actara, Assail, Belay, or Provado) have excellent activity against potato leafhopper and are generally first applied soon after tart cherries begin to color.

### REDBANDED LEAFROLLER

Redbanded leafroller, *Argyrotaenia velutinana*, is considered a minor pest of apples and many other deciduous fruit crops throughout most of Pennsylvania.

#### Description and life cycle

Adults have a wingspread of  $\frac{1}{2}$  inch. The forewing is marked with a band that widens towards the edge. Egg masses of the first brood are deposited on the undersides of larger limbs, while the eggs of the later broods are laid mostly on the upper leaf surface. Larvae are pale green with yellowish heads, and reach  $\frac{5}{8}$  inch at maturity.

This leafroller has three generations in Pennsylvania. Pupae overwinter in the ground cover. Moths emerge during April and May. First generation larvae hatch at late petal fall. Subsequent flights occur in July and late August. Larvae may be found from May to late September.

Larvae skeletonize leaves from the underside, folding and webbing them together. They feed on the fruit, especially when leaves touch it, making shallow, irregular channels.

#### Monitoring and management

In orchards with a history of redbanded leafroller problems, the pheromone traps should be used for monitoring moth activity. The redbanded leafroller injury can be controlled by insecticide sprays directed against the early larval instars. See Table 4-6 for the list of effective insecticides.

### ROSE LEAFHOPPER

Rose leafhopper, *Edwardsiana rosae*, is a minor pest on apple in the Mid-Atlantic region. Orchards in the vicinity of multiflora rose or brambles are especially at risk.

#### Description and life cycle

Rose leafhopper resembles the white apple leafhopper in appearance, habits, and tree injury. However, this species is distinguished as a nymph by the presence of small black spots on the thorax and wing pads. Adults are indistinguishable unless dissected. Rose leafhopper overwinters on multiflora rose and brambles. The first of the three generations per year stays on the overwintering host, with the adults dispersing to apple trees in early June. Nymphs appear on apple trees in early July and adults again in early August, preceding the appearance of white apple leafhopper adults. Watersprouts often have heavier populations of second-brood leafhoppers than other areas of the tree. Moderate drought conditions favor outbreaks.

Besides injuring leaves, leafhoppers deposit numerous small spots of excrement on fruit, potentially reducing its quality. Honeydew secreted by leafhoppers may cause black specks on fruit and foliage.

#### Monitoring and management

Examine five trees per block, 20 leaves per tree, and check the undersides of leaves for nymphs. One leafhopper per leaf during second-generation activity (third cover) is justification for applying an insecticide. Populations of two or more leafhoppers per leaf during third-brood activity in August and September should be treated. Sprays should be timed for young nymphs. Insecticides recommended for aphid control should adequately control leafhoppers also. Neonicotinoid insecticides such as Provado, Actara, Belay, or Assail provide excellent control, although *Stethorus* beetle populations may be adversely affected.

### ROSY APPLE APHID

The rosy apple aphid, *Dysaphis plantaginea*, has been a major pest of apple trees since the end of the nineteenth century. While

apple trees are its preferred host, this species also feeds on pear and hawthorn trees.

### **Description and life cycle**

The body of this aphid has a waxy coating and usually a slight purplish or rosy tinge; hence the name. Eggs are laid on the bark of apple trees, are oval, and about  $\frac{3}{100}$  inch long. When first laid they are a bright yellow that gradually changes to greenish yellow and finally within two weeks to shiny jet black.

Egg hatch occurs between silver tip and  $\frac{1}{2}$ -inch green. The young, as soon as they hatch, seek out the opening buds of the apple, seeming to prefer the fruit buds. They feed on the outside of the leaf bud and fruit bud clusters until the leaves begin to unfold. Then they work their way down inside the clusters and begin sucking the sap from the stems and newly formed fruits. Their feeding causes the leaves to curl, affording the aphids protection from insecticide applications and some natural enemies.

The first young develop into stem mothers when apple trees are coming into the pink stage. The production of young usually begins two or three days after the last molt and continues without interruption for over a month. A single female produces an average of about 185 young. Normally, the period of reproduction extends from about May 10 to June 20 or later. The maximum period of productive activity often coincides with the period when young fruits are beginning to set and grow actively.

Young aphids congregate closely around the stem mother. In some cases, the congregations are made up of more than one layer of aphids. This habit soon causes the death of the infested leaves and the consequent migration of the aphids. When several stem mothers congregate on a single leaf, forced migration soon follows. The young move actively to locate a suitable feeding ground. It is at this period that they are frequently found congregated on the forming fruits or attacking the new succulent unfolding foliage.

Nymphs of the second generation, all of which are females, reach maturity in two to three weeks; the great majority begin to reproduce on the apple, although a few may develop wings and migrate to the weed plantain. The third generation is produced in June and early July. Although in the past the majority of this generation developed wings and migrated to plantain, recent evidence shows that the biology of this pest has changed and most populations in orchards no longer need to go to this alternate host but can breed continuously on apple. In the fall, the winged females are darker than those migrants in the spring, and females lay eggs, from which males also develop. The males mate with the females, which then deposit eggs on the bark.

These aphids cause a decrease in tree vigor because of foliage loss and damage to the fruit through dwarfing, misshaping, and staining. The severe curling of foliage caused by this species is probably the most characteristic feature of its work. A single stem mother located on the underside of a leaf near the midrib will cause the leaf to fold almost as tightly as the outer wrappings of a cigar. The presence of only a few stem mothers can cause a severe curling of all leaves surrounding an opening flower bud; within such curls ideal protection is afforded to the rapidly developing aphids. A cool, wet spring favors aphid development because it provides conditions unfavorable for parasites and predators of aphids.

### **Monitoring**

Starting at early pink, 5 to 10 trees should be selected from each block. Sensitive varieties such as Rome Beauty, York Imperial, Golden Delicious, and Stayman should be selected if present. Treatment is justified if more than one aphid-infested cluster is observed per tree.

### **Cultural management and biological control**

Maintain properly trimmed trees to make conditions less favorable to aphids and to achieve better spray coverage. Biological control by lady beetles and other predators generally occurs too late to prevent stunting of the fruit.

### **Chemical management**

Optimum timing for control of rosy apple aphid is at green tip to half-inch green. In the past, pyrethroid insecticides and Lorsban (chlorpyrifos) were often used at this time for control, but this pest about 15 years ago developed widespread resistance to these compounds in most orchards and control shifted to the use of neonicotinoid insecticides. Esteem and Beleaf are also effective at this time, and with a high level of bee safety, Beleaf can be used and is effective for scale as late as the pink stage. For a while, neonicotinoid insecticides were used at a later prepink to pink timing to also control tarnished plant bug and other pests, but concerns about neonicotinoid insecticides' toxicity to honey bees and other pollinators from residues found in the nectar and pollen during bloom from these timings has caused us to shift our recommendation for RAA sprays back to the earlier green tip to half-inch green timings. Recent research has shown that moving RAA sprays from pink by 10 days or so earlier eliminates most if not all of the insecticide residues found flowers (nectar and pollen) during bloom while still giving comparable control of this pest. The only insecticides we recommend to apply as late as pink are of the more bee-safe compounds Assail, Beleaf or Sivanto. Although per its label Assail is allowed to be applied during bloom. By petal fall, most RAA damage to apple fruit has already occurred, but if a cleanup spray is necessary for populations that slipped through the more effective prebloom sprays, then again the bee-safe Assail or Sivanto is recommended if any bloom remains because native bees will still be attracted into the orchards. An alternative to the neonicotinoids that we have been researching is the systemic insecticide Beleaf, which has a unique modes of action and is currently considered to be bee safe. It has been equally effective in controlling RAA at the half-inch green to pink timings as the neonicotinoids.

### **SAN JOSE SCALE**

The San Jose scale, *Quadraspidiotus perniciosus*, is a pest of fruit trees, but it attacks many other trees as well as shrubs. Once established, most scale insects are difficult and expensive to control.

### **Description and life cycle**

Female scales are very prolific and over a six-week period can produce approximately 400 young. San Jose scale produce living young called crawlers; most other scales produce eggs. Crawlers move around for a short period in search of a suitable place to settle. It takes 25 days for males to mature and 31 days for females.

There are two to three generations of the San Jose scale each year. The scale overwinters as immature blackcaps; adults mature during the bloom period. Males emerge and mate at petal

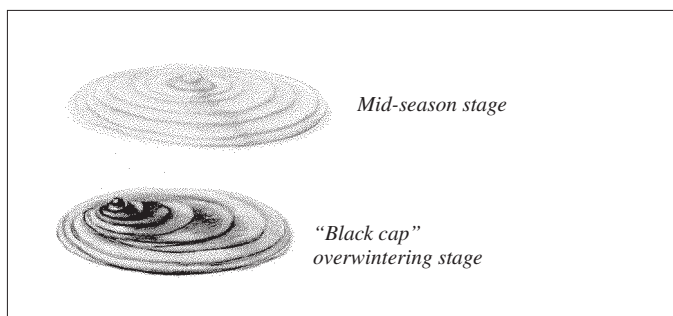

**San Jose Scale**

fall. First-generation crawlers begin appearing in early June in southern areas and continue for a month. These crawlers develop into mature adults by late July. Second-generation adults appear from late July to early September; and, if a third generation occurs, it appears in late October to early November. The life cycle is completed in about 37 days. Crawlers can usually be found from early June until a hard frost in the fall.

Crawlers are lemon-colored and very small,  $\frac{1}{25}$  inch long. When they settle, they secrete a waxy substance that produces a grayish-yellow scale covering which becomes darker with age. The male scale is oblong, with a small black spot near one end, and is much smaller than the female. Color varies with age; very young females are round and nearly white but turn dark gray as they mature. There is a characteristic black spot in the center of the scale.

Scales on new growth and fruit produce deep purplish-red coloration in the tissue. When scales are removed from the fruit, a light-colored bull's eye is evident. Additional injury to the tree is caused by loss of plant sap, which depletes vigor and decreases yield. Prolonged attack causes cracking and splitting of the wood; if the scale is not controlled, the tree may die.

### Monitoring

Sex pheromone traps are available for monitoring male adult emergence. These traps should be hung in trees with known or suspected overwintering scale populations. Traps should be placed at the pink stage and monitored weekly. Later in the season, usually from early to mid-June, the crawlers can be monitored. Locate infested branches and wrap black electrician's tape around the branch at each end of the infestation. Coat the middle section of the tape with a very thin film of petroleum jelly. Check the tape often for the presence of crawlers trapped in the jelly. Apply an insecticide when the first crawler is observed. If fruit is to be exported, levels greater than 0.1 percent of harvested fruit should be treated the following spring. If branches or limbs infested with scales are found during pruning, treatments should be applied at the appropriate time.

### Cultural management and biological control

Prune out infested branches to reduce the population and improve spray penetration. Several species of tiny parasitoid wasps (*Aphytis* and *Encarsia*) exist that can provide effective biological control of San Jose scale in most years if not disrupted with pyrethroid sprays. *Encarsia* is also attracted to San Jose scale pheromones and can be used with sticky traps, not only to monitor the pest, but also its main biological control agent.

### Chemical management

Scale is especially difficult to control on large trees with rough

bark. The secret to successful control is coverage with high water volume. If scale is present, then trees would benefit from an oil or Lorsban (chlorpyrifos) at the dormant or delayed dormant period, but we have seen some orchards we suspect have developed Lorsban resistance. The high vapor pressure from residues on apple foliage or from flowers in the groundcover of the orchard can "fumigate" the orchard of wild bees for up to a week after application even if applied at night. Postbloom, at around the same time as the first codling moth spray (slightly before first cover), the crawlers can be targeted with applications of Esteem, Centaur, or Movento. Centaur has also proved to be very effective in some trials with prebloom sprays.

### SHOTHOLE BORER

The shothole borer, *Scolytus rugulosus*, sometimes called the fruit tree bark beetle, is a native of Europe but now occurs throughout the United States. It attacks a wide variety of deciduous fruit trees and other trees, but it usually attacks only trees that have been weakened by some other condition.

### Description and life cycle

The adult is a dark brown to black beetle, blunt on both ends, about  $\frac{1}{10}$  inch long. The tips of the antennae, legs, and wing covers are reddish brown. The wing covers are striated with rows of shallow punctures. Larvae are white with a reddish head, legless, and about  $\frac{1}{8}$  inch long when fully grown.

Adult shothole borers drill holes, such as might be made by small shot, in the bark and wood of twigs, branches, and trunks of infested trees. The holes usually occur in clusters and may be either entrance or exit holes. Entrance holes are often near a lenticel and thus can be identified. Adults feed and reproduce beneath the bark, creating 2-inch-long tunnels that usually run parallel with the grain. Larval galleries leave the main tunnel and radiate out across the grain. Galleries are easily visible when the bark of infested trees is removed.

Shothole borer damage usually is limited to weak, declining trees, and borer infestations frequently hasten tree or limb death. Beetles are rarely the primary cause of death. When borers are abundant, they will occasionally attack apparently healthy trees nearby. Attacks on healthy trees may be evident on small twigs where adults bore in or around buds. This injury usually is indicated by small droplets of gum exuding from the tiny, round feeding sites. Buds are often destroyed and twig dieback can result.

Shothole borers overwinter as larvae beneath the bark. They pupate in early spring and adults usually emerge in April to May. Adults can fly considerable distances. Females mate, then locate unhealthy trees and bore through their bark. They excavate tunnels beneath the bark and lay eggs along the sides. Larvae hatch, burrow across the grain, away from the parent gallery, and feed on sapwood for about a month. Larval galleries are generally packed with frass and sawdust, while parent galleries are usually clean. Pupation occurs at the end of the larval gallery, and adults exit directly through the bark. Soon after emerging, the beetles reinfest trees to deposit eggs for the next generation. Two generations or more may develop in a tree after it dies.

### Monitoring and management

Good horticultural practices are important in preventing shothole



borer infestations. Keep trees healthy and vigorous. Eliminate breeding sites by removing and destroying infested trees or limbs as soon as they are found. Prunings should be removed and destroyed before adults emerge each April. Wild fruit trees and other potential breeding sites near the orchard should also be removed. Painting tree trunks with whitewash or white water-based latex paint is sometimes helpful in repelling adult beetles, especially on young trees. Infested trees can also be sprayed with a residual insecticide to prevent reinfestation. There are no effective controls for insects already in the trees.

### SPOTTED LANTERNFLY

The spotted lanternfly, *Lycorma delicatula*, an invasive plant hopper, was first detected in Pennsylvania in the fall of 2014. As of September 2017, this insect pest species has a very limited range, being recorded in only six counties in the southeast part of Pennsylvania.

#### Description and life cycle

Adult hoppers have a black head and grayish wings with black spots. They are about 1 inch long. Flying adults will also display hind wings that are red at the base and black at the tip with a white stripe dividing them. The abdomen is bright to pale yellow with bands of black on the top and bottom surfaces. Females deposit 30 to 50 eggs in egg masses covered with mudlike substance in late September to early October usually on smooth bark, stone, and other vertical surfaces. The first-instar nymphs are wingless and black with white spots. As the nymphs grow, they develop red patches in addition to the white spots.

In Pennsylvania, the spotted lanternfly overwinters in egg masses. The first nymphs are normally being observed in May, while the adults usually appear in late July. Spotted lanternfly feeds on many plant species, including grapes, fruit trees, and many wild hosts. In its native range, the preferred host appears to be tree of heaven/paradise tree (*Ailanthus altissima*); however, it is also frequently found on oaks, walnuts, poplars, willows, maples, birch, and others but has only caused damage to grapes until now. Spotted lanternfly has one generation per year.

In fruit orchards, many of the insecticides used in the management of other late season pests should also limit/eradicate the spotted lanternfly. The most effective products tested to date are the neonicotinoids Venom, Scorpion, and Actara, and the most effective pyrethroids are Brigade and Warrior. The older products Imidan, Carbaryl, Lannate, Endigo, and Avaunt have also been effective in controlling both nymphs and adults of spotted lanternfly, but other products even in the same classes have been less effective. Other insecticide options are continually being evaluated; about a dozen have 2(ee) label amendments list spotted lanternfly control specifically on the label. For the latest pesticide recommendations by Penn State, go to [extension.psu.edu/updated-insecticide-recommendations-for-spotted-lanternfly-on-tree-fruit](https://extension.psu.edu/updated-insecticide-recommendations-for-spotted-lanternfly-on-tree-fruit).

Spotted lanternfly is under a quarantine to stop its movement to new areas and to slow its spread within the quarantine zone. If the insect is detected, notify the Pennsylvania Department of Agriculture by entering your finding at <https://services.agriculture.pa.gov/SLFReport/> or calling the Bad Bug hotline at 888-422-3359.

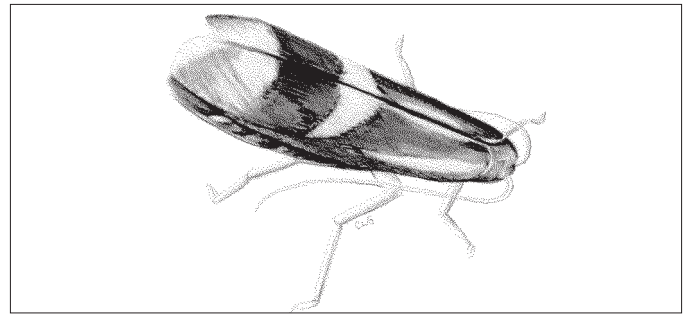

Spotted Tentiform Leafminer

### SPOTTED TENTIFORM LEAFMINER

The spotted tentiform leafminer, *Phyllonorycter blancardella*, affects the leaves of apple trees throughout the growing season. This pest has declined greatly in importance since the introduction of the neonicotinoids and products like Intrepid, Altacor, and Delegate, which effectively control this pest.

#### Description and life cycle

The adult moth is  $\frac{1}{8}$  inch long and brown with white transverse stripes margined with black. Eggs are  $\frac{1}{10}$  inch in diameter, oval, and creamy to transparent in color. They are laid on the undersides of the leaves and are more difficult to see on cultivars with hairy foliage. Full-grown larvae are yellowish and  $\frac{1}{8}$  inch long at maturity.

This leafminer overwinters as pupae in apple leaves on the orchard floor. Adults begin to emerge at the  $\frac{1}{2}$ -inch green stage and continue activity through bloom. Females lay approximately 25 eggs singly on leaves. As they hatch in 6 to 10 days, young larvae chew a hole through the egg and into the leaf. They go through two developmental stages: sap-feeding and tissue-feeding. The sap-feeding stage is composed of very small larvae that pierce plant cells and feed on sap. The tissue-feeding stage has well-developed mouthparts and feeds on leaf tissue. A complete generation requires 35 to 55 days; there are three to four generations each year.

Damage caused by this insect consists entirely of leafmining. Each completed mine reduces the leaf's green tissue by about 5 percent. Sap-feeding mines are visible as light areas on the bottom of the leaf. The completed tissue-feeding mine buckles the leaf like a small tent and has white spots on the upper surface, hence the name spotted tentiform leafminer. Excessive mining combined with drought is particularly destructive. Because mines remain visible after the leafminer has emerged or been killed they must be opened to determine if they are active.

#### Monitoring and management

Control decisions for first generation can be based on sap-feeding mine counts. A procedure developed at Cornell University for determining threshold levels is as follows:

1. During petal fall, select three fruit clusters from around the canopy of each tree sampled.
2. Using a magnifier, count the sap-feeding mines on the undersides of the second, third, and fourth leaves in each cluster, counting leaves in the order they unfolded.
3. After two trees have been sampled, begin comparing the accumulated total number of mines found with the limits for that number of trees.

**Table 2-9. Counts of sap-feeding spotted tentiform leafminer mines to determine infestation status and the necessity for treatment.**

First generation (petal fall) No. of trees	Lower limit	Upper limit
2	7	30
3	13	41
4	20	52
5	27	63
6	35	73
7	63	63
Second generation No. of trees	Lower limit	Upper limit
15	12	46
20	22	55
25	31	65
30	41	75
35	51	85
40	61	95
45	70	105
50	98	98

- If the number of mines falls between the two values given, sample another tree. If the total is less than the lower limit, sampling is stopped and no treatment is required. If the total is greater than the upper limit, sampling is stopped and a treatment is recommended. If seven trees are sampled and the total number of mines is less than or equal to 63, no treatment is necessary.

For second brood, which begins to appear in early to mid-June, proceed as follows:

- Sampling should be done once, about five days after peak male moth catch (early July).
- Start at the orchard edge and, moving toward its center, sample every other tree until enough trees have been sampled. Select five mature terminal leaves from each tree, and count the sap-feeding mines on the undersides of those leaves using a magnifier.
- After 15 leaves have been examined, begin comparing the accumulated total number of mines found with the limits given in Table 2-9 for that number of leaves. If the number of mines falls between the two values given, take more leaf samples (five per tree), continuing to add the number of mines found to the running total while checking the chart again. If the total is less than the lower limit, sampling is stopped and no treatment is required. If the total is greater than the upper limit, sampling is stopped and a treatment is required.

#### **Chemical management**

Not a problem for the last 10 years due to the introduction of many new products used to control codling moth or other pests such as Delegate, Altacor, Intrepid, and so forth. Refer to Table 4-6 for the list of insecticides effective against spotted tentiform leafminer. Actara, Agri-Mek, Assail, Belay, Delegate, and Provado are very effective in controlling sap-feeding larvae in the mines.

#### **SPOTTED WING DROSOPHILA**

The spotted wing drosophila (SWD), *Drosophila suzukii*, is an invasive species originally from Asia. It was introduced into North America around 2008 and has spread from coast to coast in less than four years. Although some strains from different regions of Asia are quite cold tolerant, the U.S. introduction appears to have spent at least 10 years in Hawaii adapting to the warm local conditions before moving to the continental United States. Subsequently, the U.S. strain of SWD appears to suffer from heavy winter mortality. Discovered in 2011, it has since spread throughout most of the state. Here SWD attacks midsummer crops starting with black raspberries and blueberries, and then populations peak with the most damage in fall crops like blackberries and primocane raspberries.

While in Oregon it is a major pest of cherries and in North Carolina a pest of spring strawberries, it appears numbers are too low for it to attack those crops in Pennsylvania because of the heavy winter mortality. Reports so far of SWD attacking cherries, peaches, plums, and grapes have proved to be from overripe or damaged fruit rather than from attacks initiated on ripening and undamaged fruit. As SWD adapts to colder weather, it will be able to survive in higher numbers and attack earlier crops, so crops will have to be continually monitored for changes in susceptibility. Evidence that SWD can adapt to cold weather can be seen in Michigan, where it has become a major pest of blueberries. Certain blueberry varieties have been shown to be less susceptible to SWD because of thicker skins—the same reason most grapes, nectarines, and especially peaches with additional “fuzz” seem to be protected from these tiny flies. “Split-pit” peaches, grapes with black rot infections or yellow jacket damage, and fruit with Japanese beetle damage would obviously be more at risk to SWD damage, but reports of attacks on plums and tomatoes need to be investigated further. SWD eggs are also unique as they have long filament spiracles used to “breathe” in a liquid environment, but generally a microscope is necessary for identification because of the minute size.

#### **Description and life cycle**

The basis for the name “spotted wing fruit fly” is one obvious dark spot on each of the male wings. Females do not have spots on their wings. What makes this pest different from other pumice/vinegar flies is that females have a sharp ovipositor that allows them to attack fruit before it is ripe, rather than just attacking overripe or damaged fruit like its close relatives. Many other pumice/vinegar flies can be found in Pennsylvania fruit orchards. For more information about identification, see “Spotted Wing Drosophila, Part 1: Overview and Identification” at [extension.psu.edu/spotted-wing-drosophila-part-1-overview-and-identification](https://extension.psu.edu/spotted-wing-drosophila-part-1-overview-and-identification). Like other vinegar flies, SWD is also attracted to damaged and rotting fruit, where it will reproduce quickly with up to a dozen generations in a year.

Adult flies survive the winter in protected locations. The early season activity in Northeast starts in May to mid-June. Adults live from couple weeks up to two months during the growing season. Multiple generations are usually observed until October. A single female can lay up to 600 eggs, depositing them under the skin of mature and immature fruit. Larvae can hatch in two hours to three days after egg deposition. Depending on the food source and temperature, maggots can feed inside of the fruit

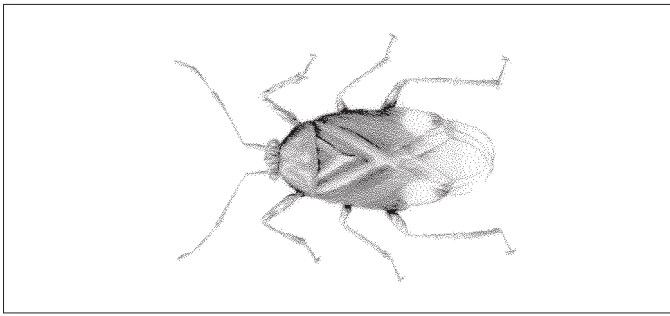

Tarnished Plant Bug

from 3 to 15 days. Pupation can occur either inside of the fruit or on the ground. Mature females usually start depositing eggs within two days after emergence. Female adults exposed to cold temperatures lay only few eggs, which can be killed by several days of constant exposure to temperatures around freezing. More on the natural history of SWD can be found in “Spotted Wing Drosophila, Part 2: Natural History,” available at [extension.psu.edu/spotted-wing-drosophila-part-2-natural-history](http://extension.psu.edu/spotted-wing-drosophila-part-2-natural-history).

### Monitoring

Spotted wing fruit flies are attracted to many volatiles, including those in vinegar, wine, yeast, and fruit. Apple cider vinegar was originally thought to provide a good attractiveness, but recently a yeast attractant (1 tablespoon of dry yeast and 4 tablespoon of white sugar dissolved in 2 cups of water) proved to be very effective in monitoring flies and a commercial yeast lure in a plastic capsule is available with less mess. Using apple cider vinegar with a few drops of soap to make the flies sink increases the attractiveness of the lures and serves as a killing and preserving fluid in the traps. Also a Merlot-type wine mixed with apple cider vinegar was very attractive in monitoring flies during late season. Inexpensive traps can be made from clear drink cups with lids. A line of small holes ( $\frac{3}{16}$  inch) should be drilled in the upper part of the container. For best results, place traps in the field at least two weeks before fruit begins to color, optimally near the suspected overwintering shelter areas. More monitoring information can be found in the “Spotted Wing Drosophila, Part 3: Monitoring,” available at [extension.psu.edu/spotted-wing-drosophila-part-3-monitoring](http://extension.psu.edu/spotted-wing-drosophila-part-3-monitoring).

### Management

Cultural management includes removal of all ripe and cull fruit from the plantation/orchard. Frequent harvesting will also help reduce the fly population. Removed fruit should be buried at least 2 feet deep to prevent emergence of flies. Composting or simply placing infested fruit away from the orchard will not stop the development of flies or possibility another infestation. Insecticides from different groups such as pyrethroids, spinosyns, diamides, organophosphates, and carbamates should provide effective control of spotted wing fruit flies. Unfortunately, frequent in-season insecticide applications may be required to prevent flies from continuously infesting fruit. Management information for this new pest is changing monthly as new insecticides are registered for use and field trials are being conducted. Spray coverage has been almost as important as pesticide selection with even the most effective pesticides failing to give control unless thorough penetration and coverage of the entire crop canopy is achieved. Airblast sprayers used for tree fruit have been the most effective.

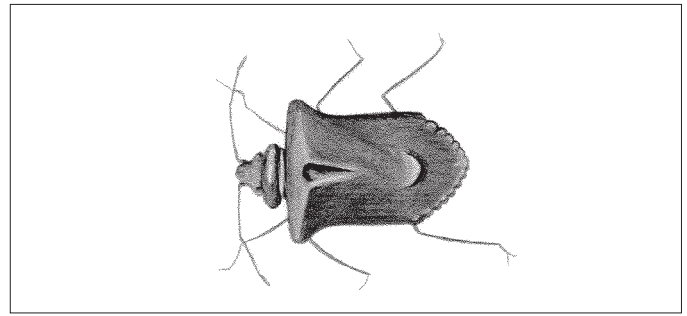

Dusky Stink Bug

More management information is available in “Spotted Wing Drosophila, Part 4: Management,” available at [extension.psu.edu/spotted-wing-drosophila-part-4-management](http://extension.psu.edu/spotted-wing-drosophila-part-4-management).

### TARNISHED PLANT BUGS, OTHER PLANT BUGS, AND NATIVE STINK BUGS

Tarnished plant bugs, *Lygus lineolaris*, other plant bugs, and various species of stink bugs feed on various tree fruits and on many wild and cultivated plants and make up a unique pest complex.

### Description and life cycle

Tarnished plant bug adults are about  $\frac{1}{4}$  inch long, oval, fragile-looking insects, green to dark brown, flecked with white, yellow, reddish brown, and black markings. Nymphs are pale yellow to green. Stink bugs are broadly shield-shaped, flattened, with a narrow head and rather short legs, and are green to brown. All have the front half of the forewing leathery and the back half membranous. Mouthparts are the piercing-sucking type; the beak is three- or four-segmented, arises on the front of the head, and is held below the body, between the legs, when not in use. Antennae are usually long and four- or five-segmented. Compound eyes are normally large. Nymphs (immature stage) are generally similar to adults but do not have wings.

These bugs feed by sucking sap from plants. They are believed to inject a saliva into the plant when feeding to break down plant tissues. Their feeding is very destructive to fruit and other tender plant parts. On apples tarnished plant bugs feed on developing fruitlets and cause dimpling. Earliest injury to peaches is caused by tarnished plant bugs, other *Lygus* spp., and possibly stink bugs, which are active in the early spring. Tarnished plant bugs often cause the most damage, because they are normally present in high numbers when peaches start to grow. They feed on swelling fruit and leaf buds, causing the buds to dry up. When fruit buds are damaged, blossoms may never open or may be deformed. Later, feeding on open blossoms or small fruit usually causes the damaged blossoms or fruit to fall. If damaged peaches do not fall, they become scarred and malformed (catfacing injury) as they grow. Cold weather or hail may cause similar injury. Tarnished plant bug feeding on young, tender, terminal or lateral shoots can also cause wilting and dying back, sometimes giving young trees a brushy appearance.

Most severe catfacing damage is done immediately following bloom, from petal fall until peaches are  $\frac{1}{2}$  to  $\frac{3}{4}$  inch in diameter. Cells are destroyed and fruit development inhibited at the feeding site, while surrounding tissues continue to grow and expand. As peaches increase in size, feeding by plant bugs or stink bugs causes less scarring and distortion of the fruit. Native stink bugs attack mostly mature or nearly mature peaches. Beads or strings of gum may exude from the feeding site and shallow, dry, corky, sunken areas may develop. Peaches on the edges of orchards

bordering woodlands, fence rows, or fields are usually the first and most severely damaged.

These bugs overwinter as adults in protected places, such as in ground debris or between the leaves of various plants. A newly introduced species of stink bug—brown marmorated stink bug, *Halyomorpha halys* (Stål)—will attempt to overwinter inside houses or other buildings. Many may become active periodically on warm days during the winter. Time of emergence from hibernation in the spring varies with species, but most bugs emerge in early spring (see also “Brown Marmorated Stink Bug” and “Special Section: Brown Marmorated Stink Bug—A New Exotic Insect Pest”).

Tarnished plant bugs are often present in peach orchards by the time buds begin to swell. They feed on the flower buds of peach trees and numerous other plants. They are strongly attracted to orchards with winter annual weeds in bloom. Egg laying begins shortly after adults emerge, most eggs being laid in the tender shoots or flower heads of herbaceous weeds, vegetables, and legumes. Few eggs are laid in peaches. Eggs hatch in about 10 days and emerging nymphs begin to feed. The nymphal stage lasts about a month. There are several generations of tarnished plant bugs each year, but the bugs normally begin to leave peaches shortly after petal fall and move to other hosts. Populations in peach trees usually decline significantly by shuck fall.

Stink bugs feed throughout the growing season. They have one or two generations per year, depending on species. The complex of native stink bugs includes more than 20 different species present in the Mid-Atlantic region.

### Monitoring

Plant bug and stink bug populations may be monitored by trapping, sampling, and fruit survey. Trapping is most successful in apple where visual sticky white cards are hung out about two feet from the ground from an outer branch at silver tip and checked weekly. Traps should be placed at the edge of the block at one per three to five acres. The economic injury level is 2.4 tarnished plant bug adults per trap by tight cluster and 4.1 per trap by late pink. Monitoring in peaches and nectarines is critical at petal fall to shuck fall. Sweep net sampling of blooming ground cover in sections of orchards bordering woodlands, fencerows, or other favorable hibernation sites is used to indicate populations that can move into the trees. Two hundred fruit should be checked periodically per block to pick up fresh feeding.

### Cultural management and biological control

Preventing broadleaved winter annual weeds and legumes in and around orchards can reduce the populations of these bugs. Legumes such as clover and vetch should be avoided as cover crops. Good control of early blooming broadleaved weeds may improve the performance of catfacing sprays. A diverse group of predators and parasitoids keeps our native stink bugs and, to a lesser extent, tarnished plant bugs at relatively low levels outside orchards, where the main populations build, just as with BMSB. Most of these bio-control agents, however, are greatly reduced by pesticides within the orchards. Specialist predators and parasitoids of stink bugs that queue in on the stink bug odor include more than 10 species of scelionid egg parasitoids (*Trissolcus* and *Telenomus* spp.), four to five species of tachinid flies, which attack both the adults and nymphs, and several species of crabronid wasps that prey on the nymphs. Some of these have already shifted to utilizing BMSB

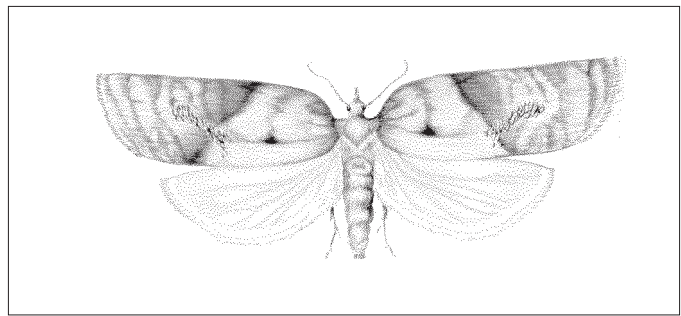

Adult Tufted Apple Bud Moth

as a food source or are in the process of doing so.

### Chemical management

Preventing serious catfacing injury depends largely on well-timed, early season insecticide applications. On pome fruit critical timings for the control of tarnished plant bug and most native stink bugs are pink and petal fall. On stone fruits applications at petal fall, shuck fall, and 10 days after shuck fall typically provide good control. Applications during pink are often unnecessary because most fruit injured at this time aborts. Please refer to Table 4-6 for the list of insecticides effective against tarnished plant bug.

### TUFTED APPLE BUD MOTH

The tufted apple bud moth (TABM), *Platynota idaeusalis*, is a serious direct pest of apples in the five-state Cumberland-Shenandoah region of the eastern United States, but over the last 15 years it has become a rather minor pest. Initially, this was due to the introduction of leafroller-specific insecticides such as Confirm and Intrepid, but more recently it is due to products such as Altacor, Delegate, etc., which are targeted for codling moth but give long residual control of this and other leafroller pests as well.

### Description and life cycle

The adult female moth is approximately ½ inch long, the male slightly smaller. Wing color is generally one-third grayish at the base, gradually darkening to brown at the tips, with a lighter-colored margin along the leading edge of the wings. The moth is named for the tufted scales that can be seen as two or three groups on the tops of the wings. Moths are extremely well camouflaged on tree trunks.

Larvae are a light brown to grayish tan with a chestnut-brown head capsule, a darker prothoracic shield (hardened area between the head and body), and a dark stripe down the back of the body. This coloration distinguishes TABM larvae from various other leafrollers. The redbanded leafroller has a pale green body with a yellowish green head; the obliquebanded leafroller has a yellowish green body with a brown to black head and a pale-yellowish-green to black prothoracic shield; and the fruit-tree leafroller has a translucent apple-green body with a reddish to dark brown head and an amber prothoracic shield. Bud moths deposit their eggs in an ovoid apple-green mass consisting of as many as 150 eggs or more. The mass is usually deposited on the upper leaf surface, and along a leaf vein.

TABM produce two generations per year. Larvae overwinter as second through fourth instars in shelters such as leaves and decaying fruit beneath trees in apple, cherry, peach, and pear orchards and

**Table 2-10. Relation between percentage of egg hatch and degree-day accumulations from the first pheromone trap capture of adult tufted apple bud moth.**

First brood		Second brood	
% egg hatch	Degree days*	% egg hatch	Degree days*
1	480	1	2,210
10	530	10	2,280
20	585	20	2,355
30	640	30	2,435
40	695	40	2,510
50	750	50	2,585
60	805	60	2,665
70	855	70	2,740
80	910	80	2,815
90	965	90	2,890
100	1,020	100	2,960

\*Degree days accumulated from the capture of first adult TABM in a sex pheromone trap using a lower threshold base of 45 and upper base of 91°F (min/max). Degree days are rounded to the nearest 0 or 5.

**Table 2-11. Recommended spray timing for conventional pesticides (e.g., Altacor, Delegate, Intrepid) based on degree-day accumulations for tufted apple bud moth depending on application method.**

Alternate row-middle applications					
First brood			Second brood		
Spray no.	Degree days* from		Spray no.	Degree days* from	
	First moth catch	Hatch (%)		First moth catch	Hatch (%)
1	475–505	0–5	1	2,210–2,245	0–5
2	610–640	25–30	2	2,395–2,435	25–30
3	750–775	50–55	3	2,585–2,625	50–55
4	885–910	75–80	4	2,775–2,815	75–80
Complete applications					
First brood			Second brood		
Spray no.	Degree days* from		Spray no.	Degree days* from	
	First moth catch	Hatch (%)		First moth catch	Hatch (%)
1	530–585	10–20	1	2,280–2,355	10–20
2	805–855	60–70	2	2,665–2,740	60–70

\*Degree days accumulated from capture of the first adult TABM in a sex pheromone trap using a lower threshold base of 45 and upper base of 91°F (min/max). Degree days are rounded to the nearest 0 or 5.

**Table 2-12. Recommended spray timing for products containing *Bacillus thuringiensis* (Bt) based on degree-day accumulations for tufted apple bud moth depending on application method. Use only complete sprays.**

First brood			Second brood		
Spray no.	Degree days* from		Spray no.	Degree days* from	
	First moth catch	Hatch (%)		First moth catch	Hatch (%)
1	585–640	20–30	1	2,355–2,435	20–30
2	805–855	60–70	2	2,585–2,665	50–60
			3	2,815–2,890	80–90

\*Degree days accumulated from capture of the first adult TABM in a sex pheromone trap using a lower threshold base of 45 and upper base of 91°F (min/max). Degree days are rounded to the nearest 0 or 5.

in woods. The larvae become active in early spring and complete their development on root suckers or various broadleaf weeds such as dandelion, dock, and wild strawberry in the ground cover. The larvae pupate and emerge as adults around the beginning of May. They start laying eggs about the beginning of June. First-instar larvae disperse by crawling or ballooning (floating on the wind). First and second instars then feed along a leaf midrib, and, beginning with the third instar, create shelters by rolling leaves, tying leaves to other leaves or fruit, and building shelters within fruit clusters. Larvae generally pupate within these shelters, emerge as adults, and begin second-brood egg-laying about the beginning of August. Late season, second-brood larvae (second through fourth instars) drop to the ground to overwinter as leaves fall in autumn.

Although TABM belongs to a family of moths known as leafrollers, the leafrolling activity has little economic impact on the fruit grower and little physiological impact on the tree. It is when this insect webs a leaf onto the apple and feeds directly on the fruit that it becomes a pest. Damage appears as tiny holes (early instar feeding), as irregular scarring or galling of the apple surface, or as an area of rot, generally found around the stem. Rot or corking around the stem occurs usually after the larvae have finished feeding and have pupated. Larvae occasionally enter the apple calyx and feed unnoticed within the seed cavity. Most damage to apples is caused by second-brood feeding, although in some years first-brood damage can exceed that caused by the following generation. Damage to fruits destined for fresh markets has a greater economic impact, since their cash value is much higher than that of processing grade apples. Generally, TABM injury does not reduce the grade of processing apples, but it can affect the storageability of those apples by promoting decay.

### Monitoring and management

A commercially available plastic delta-shaped sex pheromone trap containing a rubber septum dispenser loaded with synthetic TABM sex pheromone should be used. At least two or three traps are needed for every block of apples of 5 acres or less. For blocks greater than 5 acres, use three or more traps. Each should be attached to a limb at a height of 5 to 6 feet in the outer third of the tree canopy. Place traps in the orchard by bloom of apples. Check traps every day until the first TABM adult is caught, and record this date. Thereafter, check the traps on the same day once a week (traps should be checked and cleaned more frequently during high TABM pressure so the trap bottom does not become clogged with moths and unable to trap anymore). During each visit to the trap, record the number moths caught and remove them from the trap (or replace with clean trap bottom). Also remove any other debris.

Similar to the case of the spotted tentiform leafminer, the importance of this pest has greatly diminished due to the introduction of a number of codling moth control products that have excellent residual control of the tufted apple bud moth even if codling moth sprays are not ideally timed for TABM control. If TABM damage from the previous season is too high for your apple marketing plans, an insect growth regulator (IGR) insecticide (Intrepid or Rimon), ryanodine receptor agonist insecticide (e.g., Altacor, Voliam Flexi, and Besiege), or Delegate can be used at approximately third cover or as close to sometime in the first two weeks of September. Both timings will also enhance control of oblique- and redbanded leafrollers.

**Table 2-13. Degree-day look-up table for tufted apple bud moth (lower threshold 45°F, upper threshold 91°F) and Oriental fruit moth (45–90°F) (horizontal cut off, using sine-wave curve).**

To find the total degree-days for a day, locate the minimum and maximum temperatures and follow the rows to where they intersect. For temperatures between those listed, use the nearest shown. Temperatures and degree-days must be determined on a daily basis.

		Minimum temperature																											
		30	32	34	36	38	40	42	44	46	48	50	52	54	56	58	60	62	64	66	68	70	72	74	76	78	80		
Maximum temperature	44	0	0	0	0	0	0	0	0																				
	46	0	0	0	0	0	0	0	0	1																			
	48	1	1	1	1	1	1	1	1	1	2	3																	
	50	1	1	1	1	1	2	2	2	3	4	5																	
	52	2	2	2	2	2	2	3	3	4	5	6	7																
	54	2	3	3	3	3	3	4	4	5	6	7	8	9															
	56	3	3	4	4	4	4	5	5	6	7	8	9	10	11														
	58	4	4	4	5	5	5	6	6	7	8	9	10	11	12	13													
	60	5	5	5	5	6	6	7	7	8	9	10	11	12	13	14	15												
	62	6	6	6	6	7	7	8	8	9	10	11	12	13	14	15	16	17											
	64	6	7	7	7	8	8	8	9	10	11	12	13	14	15	16	17	18	19										
	66	7	8	8	8	9	9	9	10	11	12	13	14	15	16	17	18	19	20	21									
	68	8	8	9	9	9	10	10	11	12	13	14	15	16	17	18	19	20	21	22	23								
	70	9	9	10	10	10	11	11	12	13	14	15	16	17	18	19	20	21	22	23	24	25							
	72	10	10	11	11	11	12	12	13	14	15	16	17	18	19	20	21	22	23	24	25	26	27						
	74	11	11	12	12	12	13	13	14	15	16	17	18	19	20	21	22	23	24	25	26	27	28	29					
	76	12	12	12	13	13	14	14	15	16	17	18	19	20	21	22	23	24	25	26	27	28	29	30	31				
	78	13	13	13	14	14	15	15	16	17	18	19	20	21	22	23	24	25	26	27	28	29	30	31	32	33			
	80	14	14	14	15	15	16	16	17	18	19	20	21	22	23	24	25	26	27	28	29	30	31	32	33	34	35		
	82	15	15	15	16	16	17	17	18	19	20	21	22	23	24	25	26	27	28	29	30	31	32	33	34	35	36		
84	15	16	16	17	17	18	18	19	20	21	22	23	24	25	26	27	28	29	30	31	32	33	34	35	36	37			
86	16	17	17	18	18	19	19	20	21	22	23	24	25	26	27	28	29	30	31	32	33	34	35	36	37	38			
88	17	18	18	19	19	20	20	21	22	23	24	25	26	27	28	29	30	31	32	33	34	35	36	37	38	39			
90	18	19	19	20	20	21	21	22	23	24	25	26	27	28	29	30	31	32	33	34	35	36	37	38	39	40			
92	19	20	20	21	21	22	22	23	24	25	26	27	28	29	30	31	32	33	34	35	36	37	38	39	40	41			
94	20	20	21	21	22	22	23	24	25	26	27	28	29	30	31	32	33	34	35	36	37	38	39	40	41	42			
96	21	21	21	22	22	23	24	24	25	26	27	28	29	30	31	32	33	34	35	36	37	38	39	40	41	42			
98	21	22	22	22	23	24	24	25	26	27	28	29	30	31	32	33	34	35	36	37	37	38	39	40	41	42			
100	22	22	23	23	24	24	25	26	27	28	29	30	31	32	33	34	35	36	37	37	38	39	40	41	41	42			

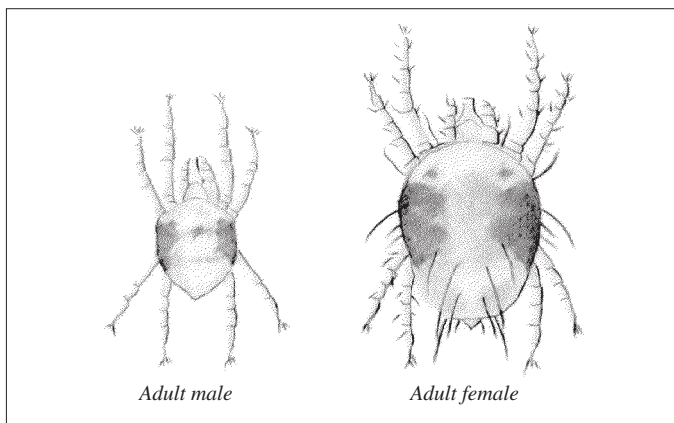

Twospotted Spider Mite

**Predicting TABM egg hatch based on degree days**

A close relationship exists between the number of accumulated degree days beginning with first pheromone trap capture of an adult tufted apple bud moth and egg hatch for both first and second brood. This means that by monitoring orchard temperatures on a daily basis, a fruit grower can confidently predict the best time to apply an insecticide. The egg hatch prediction can be used in conjunction with, or independent of, the fruit damage prediction method. The egg hatch period is a time when the larvae of this pest are most susceptible to insecticides. Table 2-10 lists the percentage of eggs that are hatched for various degree-day totals for both broods of TABM. Tables 2-11 and 2-12 list the optimum spray periods for applying insecticides.

Table 2-13 gives degree days for TABM. To use these tables you must record the local temperature daily beginning at first TABM pheromone trap catch (see Environmental Monitoring in Orchards, Part I). If alternate row middle sprays are used, consult the first section of Table 2-11 to determine the best degree-day accumulation targets for each spray. If complete sprays are to be used, consult the lower section of Table 2-11. An insecticide application should be applied when a degree-day target is reached according to the measured orchard temperature conditions.

**TWOSPOTTED SPIDER MITE**

The twospotted spider mite, *Tetranychus urticae*, while a pest of apple, peach, and other fruit trees, also feeds on a wide range of both wild and cultivated plants. As the name implies, this mite produces much more webbing on the leaves than the European red mite.

**Description and life cycle**

Twospotted spider mite adult males are pale yellow, pale to dark green, brownish, or at times faintly orange. An inconspicuous dark area is generally present on each side, and other dark areas are frequently seen along the middle. Females are oval, about 3/100 inch long and about 2/100 inch wide and vary in color, with gradations ranging from light yellow, straw color, green, brown, and black to various shades of orange. Newly emerged females have two large black spots, one on each side just back of the eye-spot. After feeding, black splotches show up in irregular patterns in other parts of the body. Males are readily distinguished from females in this stage by the smaller size of the body, the pointed abdomen, and the small size of the spots.

Eggs are spherical in shape. When first deposited they are clear and watery, becoming opaque and glassy as incubation progresses. Eggs turn a pale straw color just before hatching. The embryo's red eyespots are plainly visible at this time. Newly hatched larvae are round, about the size of the egg, have six legs, and are colorless except for red eyes. Feeding begins at once and the color changes to pale green, brownish-green, or very dark green; two black spots appear, one on each side of the eyespot. Protonymphs, larger and more oval in outline than the larva, have four pairs of legs. They are pale green to dark green, sometimes brownish green. The two spots are larger and more pronounced than in the larvae. Deutonymphs are generally a shade of green, which apparently is influenced by food. The spots are larger and more distinct.

Full-grown females and some immature mites overwinter under bark scales on tree trunks or among fallen leaves and in other protected places on the ground. With the arrival of warm weather in the spring, these mites leave their places of hibernation and start wandering about looking for food plants. Almost all of those on tree trunks crawl down to the ground, where they feed on weeds and grasses.

The first eggs can usually be found about the first week in May. In warm weather, they hatch in five to eight days. A complete generation from egg to adult may require no more than three weeks. There are from five to nine generations in the orchard each season, depending on the weather. In mid- or late summer, when drought and other factors, such as herbicide applications, cause poor food conditions among weeds and grasses, mites move from the old host up tree trunks or to low-hanging apple branches in contact with ground vegetation. Low-hanging branches that touch grass or weeds are usually attacked first; then the mites spread upward and into the tree interior.

Once established, the population may become a serious infestation and may cause injury. Injury to leaves resembles that caused by the European red mite, except that a grayish cast is more prevalent. As indicated previously, these mites also spin a fine silken web over many infested leaves. In the fall the adults either leave the trees and hibernate among weeds, leaves, or in the soil, or remain in the tree.

#### **Monitoring and management**

Twospotted spider mites should be monitored and managed in much the same way as European red mites. Counts of the two species should be combined in determining whether thresholds are exceeded. Both *Stethorus* and phytoseiid predatory mites (i.e., *T. pyri* and *N. fallacis*) are effective against this mite pest as well. Refer to Table 4-6 for a list of insecticides effective against twospotted spider mite.

#### **VARIEGATED LEAFROLLER**

Although the variegated leafroller, *Platynota flavedana*, like the tufted apple bud moth, was an important pest in Virginia and West Virginia, it was only occasionally a minor pest in southern Pennsylvania. Its biology, habits, and insecticide-resistance levels are similar to those of the tufted apple bud moth, and new pesticides used for controlling codling moth have all but eradicated this pest from our orchards.

#### **Description and life cycle**

Variegated leafroller is a general feeder whose hosts include strawberry, apple, azalea, blackberry, clover, sunflowers, maple, peach, and rose. Adult males have a ½-inch wingspan and are brown with a cream-colored band towards the end of the wings. Females are larger (½- to ¾-inch wingspan) and have varying shades of brown and reddish-brown on the wings. There is a dark spot on the leading edge of the front wings. Small larvae (first and second instar) are yellowish with a black head. Older larvae are green with a light brown head and thoracic shield.

The life cycle and overwintering hosts and sites are almost identical to tufted apple bud moth, although adults emerge 7 to 10 days later in the spring.

#### **Monitoring and management**

Injury to both the foliage and the fruit cannot be distinguished from that of tufted apple bud moth. Monitoring is accomplished using pheromone traps. Traps should be hung at the beginning of May, 6 feet high in the apple tree. At peak flight, around the end of May, start searching for and marking the location of several egg masses. Monitor the marked egg masses. When eggs turn black then insecticides should be applied. Although thresholds have not been well worked out, 1 percent fruit damage in the previous generation should alert the grower to a problem.

#### **WESTERN FLOWER THRIPS**

Widespread fruit loss from western flower thrips, *Frankliniella occidentalis*, feeding on both nectarine and peach fruit during harvest in some areas of southern Pennsylvania and adjoining Mid-Atlantic states was first observed in early 1990. Although this species is well established, damage has been lower in subsequent years.

#### **Description and life cycle**

Western flower thrips, formally limited to western North America, has become virtually cosmopolitan since the 1970s. This species is a key pest in the greenhouse production of flowers and vegetables. Out-of-doors it is a pest of several field and vegetable crops and also tree fruits. Although oviposition by this species causes a condition called pansy spot on some apple varieties in the west, it has not been shown to injure apples in the east. In addition to direct feeding injury, it transmits tomato spotted wilt virus.

Adult females are slender, about 1/16 inch long, yellow or brown, and hold their fringed wings over their backs. Males are about two-thirds the size of females and generally lighter in color. Larvae resemble adults but lack wings and are smaller. This species is difficult to distinguish from less injurious species of flower thrips.

Dark brown adult females overwinter in leaf litter and other organic matter and emerge in late April and May. Populations build up on crop and weed hosts throughout the season, peaking in the summer. Generation time in summer conditions is about two weeks. Drought conditions and above-average temperatures can result in damaging populations of this thrips.

Western flower thrips causes two types of direct injury to nectarine and peach trees. The first occurs during the bloom period when adult and larval thrips feed in flower parts and on the developing fruitlet under the shuck. Early season feeding causes scars on the fruit surface that expand as the fruit grows. Scarring injury has not been commonly observed in Pennsylvania.

The second type of injury occurs primarily just prior to and during harvest when adults move from alternate weed or crop hosts to the fruit. Adults and larvae feed on the fruit surface in protected sites, such as in the stem end, the suture, under leaves and branches, and between fruit. Feeding on the surface of ripe fruit removes cell contents and results in silver stipling or patches. Silvering injury is particularly obvious on highly colored varieties. Silvering that covers more than a 1/8-inch-square area can result in downgrading of the fruit. Injured fruit also may contain thrips eggs.

#### **Monitoring and management**

Monitoring should begin at bloom in areas where this species is common. Extension guidelines in California recommend sampling blooms from 10 to 12 trees at each of three to four sites per orchard. Blooms should be slapped against a light yellow surface to determine abundance of adults. The presence of larvae is determined by dissecting at least 50 blooms per orchard. The extension guidelines recommend treatment if adults infest more than five per 50 blooms or if larvae are present.

The second critical monitoring period is when the first fruit ripens. Count the number of adult thrips on 10 fruits at each of five sites per orchard. Sample fruit from the ends of branches in the lower third of the canopy. Five adult thrips per 50 fruits and the presence of silvering may indicate a damaging population.

#### **Cultural management**

Several cultural practices may reduce injury by western flower thrips. These include proper thinning to reduce the amount of protected feeding sites between fruit, reducing the amount of clover in row middles, not mowing adjacent fields or weedy row middles during bloom or harvest, and avoiding the use of insecticides, such as Sevin, that are not effective against these thrips and may actually increase the amount of injury occurring during harvest by killing natural enemies.

#### **Chemical management**

Lannate has a short preharvest interval, therefore it can be used to control thrips during harvest. Also, Delegate can be used on nectarines and peaches, within one day of harvest. An application after the first harvest may prevent subsequent losses; however, an additional application may be needed if thrips pressure is severe.

#### **WHITE APPLE LEAFHOPPER**

White apple leafhopper, *Typhlocyba pomaria*, was abundant in many apple orchards throughout the state until the introduction of the neonicotinoids about 10 years ago. As opposed to rose and potato leafhoppers, this species' primary host is apple. Its pest status relates to its injury to the leaves, excrement on the fruit, and nuisance to workers. The importance of this pest has been greatly reduced since the introduction of the neonicotinoid insecticides, which are extremely effective on it when used at petal fall for plum curculio control.

#### **Description and life cycle**

Adults are white and 1/8 inch long. Leafhopper nymphs are whitish green, smaller, and wingless, and are usually found on the undersides of older leaves. They move quickly sideways as well as forward.

White apple leafhoppers overwinter as eggs in the bark of one- to five-year-old wood. Hatch begins at pink and may continue for three to four weeks during May and June when weather is variable. The nymphs develop over several weeks. Adults then lay eggs in the petiole and veins of leaves. Second-generation eggs begin to hatch during late July and August. The nymphs feed during August and are fully grown by late August or September. Overwintering eggs are laid during September and early October.

White apple leafhopper adults and nymphs feed on leaves and do not directly attack the fruit, although excrement on the fruit can reduce its quality. Leaves become speckled or mottled with white spots as green tissue is destroyed where leafhoppers suck sap from the leaves. Abundant adults during harvest can be a severe nuisance factor.

#### **Monitoring**

One leafhopper per leaf during first-brood activity (petal fall to second cover) is justification for applying an insecticide. Populations of two or more leafhoppers per leaf during second-brood activity in August and September should be treated. Examine five trees per block, 20 leaves per tree, and check the undersides of leaves for nymphs.

#### **Chemical management**

Young leafhoppers are much easier to control than adults. Effective control of the first generation may directly reduce high populations of the second. The first generation is a better target since the hatch is fairly synchronous, and leafhoppers of the age vulnerable to insecticides are present at one time. Also, insecticides may be used at lower rates since less foliage is present during the first generation. Thorough coverage of upper and lower leaf surfaces is necessary and considered essential for effective control. Neonicotinoid insecticides (e.g., Actara, Assail, Belay, Provado) are very effective against this pest.

#### **WHITE PEACH SCALE**

White peach scale, *Pseudaulacaspis pentagona*, is considered an economic pest of peach and woody ornamentals in southeastern United States, especially New Jersey. After the 2011 season, white peach scale infestation was also observed in few isolated Pennsylvania peach orchards.

#### **Description and life cycle**

The female scale is 1 to 2.5 millimeters in diameter, oval shaped, and white to yellowish in color. The female is immobile on the host plant and has a protective shell that is created by incorporating the cast skins from her previous molts with newly secreted wax. The male adult scale is a small, two-winged insect that looks as a gnat but has two tail filaments. Male white peach scale coverings are elongate, snowy white, and commonly found in clusters.

Eggs are deposited under the scale covering and on the surface of plants, and range in color from orange (female) to white (male). Each female deposits up to 150 eggs, which hatch within five days. Upon hatching, crawlers immediately move to new sites. Female crawlers are generally more active and disperse throughout the tree. Within seven to nine days crawlers molt and begin forming their own scale covering. After three to five molts, adult males emerge from under the covering and mate. Usually, two to three generations of white peach scale are ob-



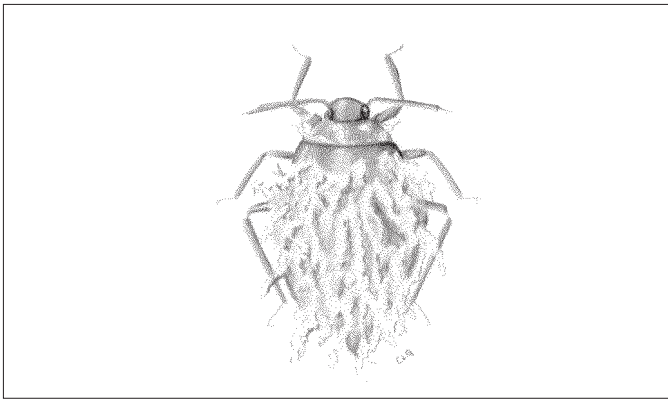

**Woolly Apple Aphid**

served per season. White peach scale overwinters as fertilized females beneath scale coverings.

### **Monitoring**

To monitor crawler emergence, double-sided sticky tape or black electrician tape covered with petroleum jelly should be wrapped around a limb heavily infested with scales. After crawlers begin to emerge, migrating crawlers can be observed on the tape as small, oval, whitish to orange insects with six legs.

### **Management**

Several parasites and predators attack white peach scale, but in commercially managed orchards, natural enemies are seldom effective. Insecticidal control is difficult as scales protect themselves very effectively with a hard, waxy armor. The most effective control can be provided in the spring during first-generation crawler migration. One or two oil applications during crawler emergence are very effective in controlling soft-bodied crawlers. In-season control treatments also have to be directed toward crawlers, as it is extremely difficult to penetrate female coverings. Products such as Centaur, Esteem, and Movento should provide effective control of white peach scale.

### **WOOLLY APPLE APHID**

The woolly apple aphid, *Eriosoma lanigerum*, is a widely distributed pest of apple trees, especially where its predators and parasitoids have been killed by insecticides. It can also be found on pear, hawthorn, mountain ash, and elm trees.

### **Description and life cycle**

Some apple varieties, such as Northern Spy, are resistant to this pest. Elm trees in the vicinity of orchards increase the migration of the aphid to apple trees. Infested nursery stock is also a source for spreading aphids.

Injury caused by the woolly apple aphid consists of gall-like formations and swollen enlargements on roots and shoots. Once started, these galls increase in size from year to year as a result of aphid feeding. Galls form favorable places for fungi to attack.

Aboveground colonies of aphids may develop around leaf axils on sprouts or on new growth, particularly at abrasions or cuts, and they prevent injured bark from healing. They are often found on the crowns of trees just above the roots. They may also develop in large knots on roots and underground parts of the trunk. Infested trees often have many short fibrous roots. The underground forms are more damaging, while the aboveground forms cause little damage, especially on larger trees. The foliage

of infested trees takes on a yellowish appearance. Young trees are easily uprooted when infested.

The aphids' bodies are nearly covered by a woolly mass of long waxy fibers that gives them a whitish, mealy appearance and that are much shorter on the root-inhabiting aphids.

The aphid spends winter in two stages: the egg stage and the immature nymphal stage. Nymphs hibernate underground on the roots of the tree. When elms were prevalent, eggs were usually laid in fall in the cracks or crevices of bark. Eggs hatched in the spring into wingless, parthenogenetic, viviparous stem mothers. These fed on elm buds and leaves for two generations during May and June, causing the elm leaves to curl into a rosette. They then produced a winged third generation that migrated to apple, hawthorn, or mountain ash. After establishing new colonies the migrants produced repeated generations during the summer. They fed in wounds on the trunk and branches of the tree. In fall, winged aphids developed in both the aerial and the root colonies. They flew back to the elm, where they gave birth to males and females. Both males and females were wingless. A few days after mating, the female laid a single, long, oval, cinnamon-colored egg almost as large as her body. The egg was laid in the crevices of bark.

With the disappearance of elm trees, the woolly apple aphid lives primarily on apple trees throughout the year. Each group of aphids, small or large, is termed a colony. Aphids are present year-round on the roots. Females in the aerial colonies may give birth to crawlers at any time in spring, summer, or fall.

Newborn nymphs are very important in the distribution of woolly apple aphid. They spread either through some mechanical agent or directly by crawling. Birds and insects can also transport aphids. Crawlers are generally more abundant in spring and fall. They are not able to work into and through the soil. In orchards, the swaying back and forth of trees by wind and the presence of organic matter, clods, stones, and other factors may provide pathways to the roots. Crawlers begin to infest the roots early in the season. Their downward motion begins any time the crawlers are numerous, especially in early summer and fall. Infestations by aerial colonies are not a true indication of root infestations, since trees can have aerial infestations over a season without their roots becoming infested.

### **Monitoring and management**

Some pesticides, such as certain carbamates, the chitin inhibitor IGR Rimon, multiple applications of neonicotinoids, and pyrethroids, encourage outbreaks by killing parasites and predators. These products should be used sparingly when woolly apple aphids are present. An application of a summer aphid treatment (e.g., Movento or diazinon) should control woolly apple aphids. Recent data has also shown good control of this pest from dormant applications of chlorpyrifos before green tip when applied for SJS due to its long residual with higher rates. Diazinon is still registered for a single application for this pest and is very effective. Movento is also very effective if used with a penetrant such as oil or penetrating surfactant and, unlike Diazinon, will also give control of SJS depending on the timing. Movento has given less consistent control of WAA on large trees where penetration of the bark for systemic activity has been a problem. There are currently no control methods for underground aphids.

### Cultural management and biological control

The best control of woolly apple aphid is genetic. Plant resistant rootstocks like M.106. The Malling-Merton series of rootstocks was bred specifically for woolly apple aphid resistance. Effective biological control agents are number of syrphid flies (*Heringia calcarata* and *Eupeodes americanus*), whose larvae are predators, and the tiny wasp *Aphelinus mali*, which was resistant to organophosphate insecticides. All are easily disrupted by pyrethroid sprays and, to a much lesser extent, Delegate and neonicotinoid insecticides

## NATURAL ENEMIES/BIOLOGICAL CONTROL IN DECIDUOUS FRUIT CROPS

Natural enemies and environmental factors limit populations of insect and mite pests in natural ecosystems. When natural enemies are killed by human's actions in any habitat or when pests are introduced to new habitats without their natural enemies, natural control often fails and results in pest outbreaks. Biological control of pest species by predators, parasitoids, and pathogens has been a cornerstone of IPM since its inception. It has been difficult to utilize the full potential of biological control in tree fruit and other crops that receive periodic sprays of broad-spectrum pesticides and/or have high quality standards. The best pest targets for biological control in tree fruits are generally the secondary foliage-feeding pests that do not cause direct fruit injury (e.g., mites, aphids, and leafminers). Populations of pests that feed directly on the fruit (e.g., codling moth, Oriental fruit moth, and plum curculio) generally cannot be tolerated at levels high enough for special biological control agents to reproduce.

While biological control is often thought of as a biopesticide where a single species of beneficial arthropod is released or conserved, the best results are most often achieved where a complex of many species of natural enemies, including predators and parasitoids, each contribute to reducing pest populations at different times of the season and on different developmental stages. While the development of pesticide resistance (mainly to organophosphates) has occurred in *Stethorus punctum*, the black ladybeetle predator, and several species of predatory mites, such resistance is generally much slower to develop in beneficial arthropods. Resistance to pesticides in tree fruit pests is generally through enzymatic degradation of the pesticide within the pest's body. Plant-feeding pests developed these enzymes before the use of pesticides to degrade the toxic chemical defenses of their host plants. Many predators/parasitoids do not possess these multipurpose enzymes and hence are less able to deal with pesticides. Thus, the biological control potential of the vast majority beneficial arthropods is not realized unless they develop resistance to pesticides, no pesticides are used, or only pesticides that are selective and nontoxic to these arthropods are used.

### Types of Biological Control Agents

#### Predators

- Consume many prey during development.
- Generally larger than prey.
- All stages may be predators.
- Are often generalists rather than specialists on any one prey type and eat both adults and immatures.

#### Parasitoids

- Immatures feed only on a single host and almost always kill it.
- Are smaller than the host.
- Are often specialized in their choice of host species and life stages thereof.
- Only the female attacks the host and lays eggs or larvae on or in the host.
- Immatures remain on or in the host, adults are free living and mobile and may be predaceous, feed on nectar, or not feed at all.

#### Parasites

- Smaller than host and generally don't kill it (e.g., mites).

#### Pathogens

- Diseases caused by fungi, bacteria, and viruses that kill the host.
- Some are naturally occurring and some have been commercially developed.
- *Bacillus thuringiensis* (Bt) toxins and spores—Dipel, etc.
- Fermentation products from fungi are precursors to making abamectin (Agri-Mek) and spinosad (SpinTor).
- Codling moth polyhedrosis virus available commercially for control as Cyd-X.
- Naturally occurring *Beauveria* and *Hirsutella* fungal pathogens.

#### Biological Control of Mites

The most successful biological control programs in eastern tree fruits have centered on the conservation of native species of mite predators to control the European red mite and twospotted spider mite. After 40 years of use, some of these predators have developed resistance to organophosphate insecticides (e.g., *Stethorus*), but are suppressed or eliminated when broad-spectrum carbamate and pyrethroid insecticides are used. The use of pheromone mating disruption, horticultural oils, and some of the more selective reduced-risk insecticides and miticides will allow a natural increase of predators capable of regulating pest mite populations to tolerable levels without the use of miticides. Mite control through biological control has the additional advantage of stopping the development of miticide resistance and, once established, is sustainable long-term if the use of certain harmful pesticides is avoided. The routine use of carbamates and pyrethroids in stone fruits, pears, grapes, and small fruits currently prevents reliable biological control agents even though many of the same predators found in apples can be present.

Below are descriptions of the main biological mite predators found in Pennsylvania apple orchards.

#### **TYPHLODROMUS PYRI (PHYTOSEIIDAE)**

Discovered in Pennsylvania for the first time in 2003, this predatory mite is currently the most reliable and effective mite predator in eastern U.S. apple orchards. Pear shaped and slightly larger than a European red mite adult, they are white/translucent until they feed. When feeding on adult red mites or apple rust mites, its abdomen may appear reddish. It is very similar in appearance

to *Neoseiulus fallacis*, also commonly found in apple orchards, but the predatory mite is an omnivore and much more closely associated with its apple host. *T. pyri* is very active and moves rapidly to consume up to 350 mite prey in a lifespan of about 75 days. Females may lay up to 70 eggs each and have several generations per season. Populations, therefore, can build rapidly in response to pest mite populations. Most effective in the cooler weather of the spring and fall, *T. pyri* is somewhat less effective in the summer months. It overwinters on the apple tree under the bark where it is less susceptible to dormant oil applications and is very tolerant of Pennsylvania's winters.

Preferring spider mites, *T. pyri* is able to regulate pest mite populations well below injury thresholds of less than five pest mites per leaf. It is able to reproduce well on relatively harmless apple rust mite populations when spider mites are absent and can subsist for long periods on other predatory or scavenger mite species, and on pollen and fungal spores when pest mite populations are low. It is also known to feed on immature thrips and scale crawlers. Well adapted to living in apple, *T. pyri* does not leave the tree during the season and once populations are established, sustainable mite control is virtually assured when the predator-to-prey ratio is at least 1:5 and is highly probable at a ratio of 1:10. For apple varieties less susceptible to spider mites than Delicious, predator-to-prey ratios as low as 1:20 may still result in successful biological control if they occur during the cooler spring and fall months. This seasonal association with its apple host, however, makes them very susceptible to toxic pesticides. Because they do not disperse quickly, they may take several growing seasons to reestablish after elimination by harmful pesticides unless artificially reintroduced. Once populations are identified or artificially established, conservation is therefore very important and applications of certain pesticides have to be avoided (see Table 4-5). Natural populations are most likely to be found in grower orchards that rely primarily on organophosphate and reduced-risk insecticides and where pheromone mating disruption is being used. *T. pyri* can sometimes be found in orchards with large, standard-sized trees despite harmful pesticide applications because inadequate spray coverage may leave refuge areas for populations to persist. Establishment of *T. pyri* into orchards where it is absent is relatively simple and can be accomplished in one to two seasons once "donor" orchards with abundant *T. pyri* populations have been identified as a source. Transfers of *T. pyri* from these orchards can be successful by physically moving blossom clusters or shoots in May and June. (See orchard transfer methodology sections below.)

#### Conservation and augmentation of *Typhlodromus pyri*

While a number of mite predators such as *Stethorus punctum*, *Neoseiulus fallacis*, and *Zetzellia mali* may contribute to the biological control of European red mites and twospotted spider mites in apples, only the conservation of native populations of *Typhlodromus pyri* have proved to give consistent, long-term control. Once established, *T. pyri* can almost completely regulate pest mite populations without the need for miticides, if the use of certain toxic pesticides is avoided.

1. The first step for apple growers in establishing mite control with *T. pyri* is to determine if it exists in significant numbers in their orchards. The most likely sites are:

- Those that have not received pyrethroid or methomyl applications for several seasons.
- Older orchards with large trees where spray coverage is not complete.
- Abandoned orchards.
- Reduced-risk pesticide orchards or those relying mostly on pheromone mating disruption to control codling moth and Oriental fruit moth.

Sample several trees in each block by examining with a hand lens (10 to 15X) the underside, mid-veins of 25 leaves per tree for fast-moving, teardrop-shaped mites. They will appear to be clear or slightly reddish, but not red or bright yellow in color or have spots. The best time to sample orchards would be midseason (June or July) or when pest mites are beginning to build. Samples taken early in the spring and in the fall may have relatively low populations that are difficult to detect.

2. If *T. pyri* is present, do not use pyrethroids or carbamate insecticides after bloom (with the exception of carbaryl for fruit thinning). *T. pyri* begins to emerge from overwintering sites deep in bark crevices at the beginning of bloom, so prebloom pesticides have little effect on them. In addition, dormant and summer oil applications have little effect on *T. pyri*, but help suppress pest mite populations. Applications of pyrethroids and methomyl after bloom cause near complete elimination of populations, and may require two to three seasons to return naturally. If a ratio of at least one predator to every ten pest mites is not reached, it may be necessary to suppress the pest populations with a selective miticide (see Table 4-5).
3. If *T. pyri* is not present in particular orchards, they can be introduced from shoots or blossom clusters cut from identified "donor" sites.

In order to have the best chance of establishing *T. pyri* populations in a single season, transfers of shoots and leaf spurs are best made early season after petal fall (and June), but before the hot weather of summer (July and August). Transfers after July appear to be less likely to establish populations. Also effective are transfers of flower clusters during bloom when *T. pyri* are concentrated in order to feed on pollen. Transfers should be made at two shoots or clusters to every sixth tree in high-density plantings and every third tree in normal plantings. Cutting with hand pruners from a *T. pyri* donor orchard and placing the shoots or flower clusters in the tree canopy of a new orchard takes approximately 1.5 hours per person per acre.

#### NEOSEIULUS FALLACIS (PHYTOSEIIDAE)

Almost indistinguishable from *T. pyri* except under a microscope, this predator is currently more widespread in distribution in Pennsylvania apple orchards than *T. pyri*, due to a higher tolerance for some pesticides and the use of alternative plant hosts. Like *T. pyri*, *N. fallacis* is also very active, but is able to build populations three times faster during the hotter summer months. This predator lives only about 20 days with each female laying 40 to 60 eggs and may have six to seven generations per year. Like *T. pyri*, *N. fallacis* is resistant to organophosphate insecticides, but it is very susceptible to pyrethroids and carbamates.

This predator is not as tolerant of cool weather in the spring

and fall and is susceptible to winter kill in Pennsylvania. Purely a predator, *N. fallacis* is not able to coexist on apple trees without pest spider mite populations to consume and will often leave the tree to feed on mites in the orchard ground cover. Apple rust mites are not an attractive alternative prey for this predator. Because its association with the apple host is not nearly as close as that of *T. pyri*, *N. fallacis* populations often do not build until mid- to late summer, leaving trees susceptible to early season mite injury. Because it can also survive in the orchard ground cover, however, *N. fallacis* is not as susceptible to elimination in the orchard due to applications of toxic pesticides applied to the tree. If conserved using selective pesticides, *T. pyri* gradually replaces *N. fallacis* after several seasons. The predator-to-prey ratio of *T. pyri* also applies to *N. fallacis* and distinguishing between the two species is not important as long as this ratio is reached.

#### ZETZELLIA MALI (STIGMAEIDAE)

An omnivore like *T. pyri* that is able to exist on pollen, fungi, and rust mites when spider mite populations are absent, *Z. mali* is very slow moving and feeds only on the eggs of pest and predatory mites. Its diamond shape and bright yellow coloration (turning more reddish after feeding) make it easy to distinguish this predator from other predatory mites. It is smaller in size than the European red mite. Because it is less active, it is able to exist on pest mite populations even lower than *T. pyri*. Like *T. pyri*, it is also more active in the cooler spring and fall months. However, with only a couple of generations each season and a consumption rate of only two to three eggs per day, it cannot usually be relied on to control mite pests alone. It is a valuable supplement to control by other mite predators and is much more tolerant of most pesticides, including carbamates and pyrethroids. Generally, populations of more than one per leaf are necessary to exert significant control of spider mite populations.

#### STETHORUS PUNCTUM (COCCINELLIDAE)

Once the cornerstone of biological mite control in Pennsylvania apple orchards, this small, black ladybeetle predator has greatly declined in importance over the last five years. Although one of the smallest of all ladybird beetles, *S. punctum* was the most important beneficial insect in Pennsylvania apple orchards starting in the mid-1970s and conservation of this predator reduced miticide use by 50 percent for over 30 years. While tolerant of many organophosphate insecticides, the decline of this predator was mainly due to the greater use of pyrethroids and the introduction of several new neonicotinoid and IGR insecticides that are toxic to various life stages of this predator. Reproducing only when populations of pest mites exceed eight to ten mites per leaf, relying on *S. punctum* alone requires grower tolerance of some foliar mite injury. With the registration of newer, more effective miticides in recent years, most growers are not willing to tolerate this injury, despite the high cost of miticides. *S. punctum* is now much less common in orchards and generally in small localized “hot spots” of mites. The main advantage of this predator is its ability to fly and quickly colonize areas of high mite populations.

#### Description and life cycle

*Stethorus* adults are tiny ( $\frac{1}{20}$  inch long), oval, convex, uniformly shiny black, and covered with sparse, fine, yellowish to white hairs. Eggs are very small ( $\frac{1}{50}$  inch long), pale white, and oval.

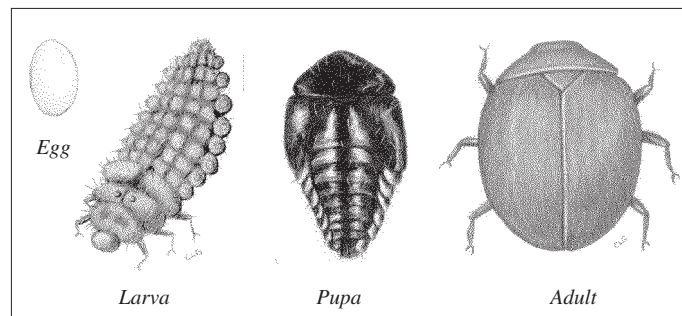

*Stethorus punctum*, Black Ladybird Beetle Life Stages

They become blackish just before the larva emerges. Larvae are gray to blackish and have many long-branched hairs and black patches. As the larva matures it becomes reddish, at first on the edges; just prior to pupation the entire larva turns reddish. Pupae are uniformly black, small, and flattened. The wing pads are prominent and the entire body is covered with yellow hairs. For a short period after it is formed, the pupa is orange.

*Stethorus* produces three generations per year in south-central Pennsylvania. The average period from the time the egg is laid to the appearance of the adult is 23 days. The adults feed for an average of 25 days before beginning to lay eggs. This time lag between emergence and egg-laying is of little consequence because there is such an overlapping of active adults in the trees at all times. Adults overwinter beneath the trash cover under fruit trees and in other protected habitats near the orchard. The distribution of *Stethorus* in the orchard ground cover is closely associated with the leaf litter, especially around root suckers. About 70 percent of the adults are located immediately around the trunks, 20 percent are located in the border of the herbicide strip and the row middles, and the remaining 10 percent reside in the rest of the herbicide strip. The overwintering adults emerge from these sites and move into the trees between tight cluster and petal fall.

*Stethorus* adults are very active when in fruit trees and if disturbed will often fall to the ground. They are good fliers and thus tend to concentrate where prey is plentiful and to disappear when the mite population becomes low. Indications are that areas in the orchard having at least five mites per leaf are necessary to keep *Stethorus* active, and that from eight to ten mites per leaf are needed in these “pockets” to encourage the beetle to reproduce. The beetles feed on all stages of mites, and the adult can consume approximately nine mites per hour, or about 75 to 100 mites per day.

During early May *Stethorus* females begin to lay eggs on the leaves of fruit trees. The eggs are laid singly on their sides, with one to ten per leaf depending on mite density. Most of the eggs are laid close to the primary veins of the leaf and adhere tightly, with 95 percent on the under surface of the leaf and 5 percent on the upper surface. Egg-laying continues through mid-August.

After a five-day development period, larvae hatch and begin feeding on all stages of mites. Larvae go through four stages in an average of 12 days. The peak periods of larval activity in south-central Pennsylvania are mid-May, mid-June, and mid-August, but this is highly dependent on mite populations. The larva eats an average of approximately 10 mites per hour. After feeding for the 12-day period the fourth-stage larva fastens itself to the leaf and remains there in a motionless state for 24 to 48

hours before pupation. The pupal stage lasts an average of five days. Although pupae are constantly in the trees, the peak pupal periods are late May, late June, and late August, again dependent on the availability of mites to consume.

#### **Monitoring and management**

It is advisable not to disturb the area in the herbicide strip near the trunk of the tree from November 1 to mid-April. Adults are active in the orchard from mid-April to late October. See “European red mite” for determining the predator-to-prey ratio for making decisions about mite management.

### **Biological Control of Aphids**

#### **APHID MIDGE—APHIDOLETES APHIDIMYZA (CECIDOMYIIDAE)**

The aphid midge, *Aphidoletes aphidimyza*, often contributes to biological control of spirea and green aphids in pome fruits. They feed on many species of aphids on many type of crops, but are not generally found in stone fruits because of their susceptibility to pyrethroids. Generally tolerant to organophosphate insecticides as immatures and slightly less so as adults, all stages are susceptible to carbamates, pyrethroids, neonicotinoid, and certain miticides. This species can be reared and is sold from biological control companies for mass releases in many crops, but especially for aphid control in greenhouses.

#### **Description and life cycle**

Adults are tiny, delicate flies ( $\frac{1}{16}$  inch) similar to mosquitoes and feed on honeydew. Each female may lay up to 70 reddish-orange eggs that are laid singly or in groups, in numbers that are proportional to aphid density. The tiny larvae are bright orange to red maggots that are about  $\frac{1}{10}$  inch long with the head at the pointed end. A single larva may eat from 7 to 80 aphids to complete development, with early instars also feeding on mites. The life cycle lasts from three to six weeks with three to six generations per year, depending on the temperature and host species. Larval development lasts from 12 to 17 days with 15 to 32 days spent as pupae in the soil beneath the trees.

#### **Monitoring and management**

A ratio of one midge egg or larvae per five aphids may result in complete aphid control within a few days, but ratios of one egg per larvae to 15 aphids may still be adequate for control over a longer period of time. Insecticides used during the period that aphid colonies are building should be chosen with regard to the level of toxicity to predators (see Table 4-4).

#### **LADYBIRD BEETLES (COCCINELLIDAE)**

Adults from these easily recognized beetles are oval, often brightly colored and spotted, and vary in size from 1.5 to 6 millimeters. Approximately a dozen of the 450 species found in North America are found in fruit, with most feeding primarily on aphids; however, some, like *Stethorus*, specialize on mites, while others specialize on scales and mealybugs. A number of species require pollen as adults to reproduce and some can be important predators of moth eggs.

#### **MULTICOLORED ASIAN LADYBIRD BEETLE (HARMONIA AXYRIDIS)**

The multicolored Asian ladybird beetle has recently become the most common and most effective aphid predator in Pennsylvania orchards, replacing *Coccinella septempunctata* and several native species. *H. axyridis* is native to Asia, but was released in Pennsylvania in 1978 and 1981. However, overwintering individuals were not recorded until 1993, and the populations that have become established may have resulted from an accidental introduction by an Asian freighter in New Orleans.

#### **Description and life cycle**

Adults are about  $\frac{3}{32}$  inch long and  $\frac{7}{32}$  inch wide. They are oval or convex in shape and range from yellow to orange above. The segment behind the head hides the head from view and is cream to yellow in color, with a black “M” design in the center. Underneath, the adults are black with an orange border around the abdomen. The wing covers have from zero to 19 black spots. Eggs are laid in upright clusters of 15 to 20 and are oval and yellow. Larvae are elongate, covered with spines, and are black and orange.

Overwintering occurs as adults, often in houses and other buildings. Eggs are laid on the undersides of leaves of various plants. The life cycle from egg to adult takes about 30 to 36 days with larvae eating 600 to 1,200 aphids during development and adults eating 90 to 270 aphids per day. Adults may live for over a year.

#### **Monitoring and management**

Highly mobile fliers and voracious as both adults and larvae, ladybird beetles are often the most important aphid predators in apple orchards and can quickly control extremely high pest populations. They are also important predators of the brown marmorated stink bug eggs, causing up to 25 percent mortality. These beetles have a slight tolerance to organophosphate insecticides, but should be conserved by selective pesticide use (see Table 4-5).

#### **GREEN AND BROWN LACEWINGS (CHRYSOPIDAE AND HAEMORBIIDAE)**

Green lacewing adults are  $\frac{6}{10}$  to  $\frac{9}{10}$  inch in length, green with transparent wings with an interconnecting network of fine veins. The many different species are difficult to distinguish, but the adult of the most common green lacewing species has golden eyes. The adults feed on nectar, honeydew, and pollen with females producing 400 to 500 eggs each over a relatively long life of up to three months. Green lacewing eggs are laid on the tips of long, white, hairlike stalks to prevent cannibalism. The larvae (called aphid lions) are generalist predators of mites, thrips, soft scales, and almost any other soft-bodied prey. They are voracious aphid predators, eating 100 to 600 aphids during a one- to two-week development period and can be important predators of moth eggs and larvae as well. Prey are seized in hollow, sickle-like jaws protruding from the head and sucked dry. The larvae make a small, round, and white pupal case, often on the stem or calyx end of the fruit where they overwinter or, in the case of one species, overwinter as adults in bark crevices and other protected places.

Brown lacewings are smaller ( $\frac{1}{5}$  to  $\frac{9}{10}$  inch long) and are predatory, both as adults and larvae. They are much more tolerant of colder weather than the green lacewings and are more useful predators early in the season. Females lay 100 to 460 eggs, but

not on stalks like the green lacewings. Larvae may consume more than 20 aphids per day or 30 to 40 mites per day. Developmental times are slower with most species only having two generations per season. Both types of lacewings have some tolerance to organophosphate insecticides, but should be conserved by selective pesticide use (see Table 4-5).

#### **MINUTE PIRATE BUG—ORIVUS INSIDIOSUS**

Generalist predators of aphids and mites, these are very small  $\frac{1}{10}$  inch, black, somewhat oval-shaped bugs that look like miniature, dark, tarnished plant bugs. They are most easily recognized by white, shiny wing patches on the adults. Able to feed on a wide variety of small prey, including thrips, leafhoppers, moth eggs, and young larvae, they are able to subsist on pollen or plant juices when prey are not available. This habit of feeding on plant juices may make them more susceptible to plant systemic products like some neonicotinoid insecticides. They are efficient at searching out high-prey densities and will aggregate where there is an abundance of prey. When handled, Pirate Bugs are capable of causing a mild sting with their beak. *Orius* has several generations/year and take about 20 days to develop from egg to adult. The adults live about 35 days with each female inserting about 130 eggs into plant tissues. Immature stages and adults can eat about 30 mites/aphids per day. Adults appear in late April, continue to feed all season until early fall, and then overwinter in the leaf litter both inside and outside orchards. They have some tolerance to organophosphate insecticides, but should be conserved by selective pesticide use (see Table 4-4).

#### **SYRPHID FLIES**

Several species of syrphid flies are among the most voracious of aphid predators in Pennsylvania orchards.

##### *Description and life cycle*

Adults are known as hover flies and resemble bees except that they have only one pair of wings. They are generally brown to black with yellowish areas. Their food source is pollen, nectar, and aphid honeydew, which is necessary for proper development of the eggs. Eggs are white, elliptical, and less than  $\frac{1}{100}$  inch long. The larvae, or maggots, are elongate, tapering gradually toward the head end and may be cream, yellow, gray, or a combination of these colors.

Adults lay eggs in the midst of aphid colonies. Larvae cast their head side to side to locate aphids, which they pierce and consume. A single larva may destroy hundreds of aphids as it completes its three development stages in about three weeks. There may be five to seven generations per year with most species overwintering as adults or last instar larvae.

##### *Monitoring and management*

Check for the presence of eggs and larvae in aphid colonies. Control of green aphids may result if 20 percent of the aphid colonies have syrphid larvae present.

#### **SAND WASPS—CARBRONIDAE**

Several species of these wasps are specialist predators of stink bugs and actively queue in on their smell to find their host. *Bycertes quadrifasciata* is a species that looks like a smaller version of the cicada killer wasp whose nests in the sand have been found to have prey consisting almost entirely of brown marmorated stink bug

nymphs from which the wasps develop quite normally. Each female is capable of collecting up to 50 nymphs, which they paralyze and place in several burrows 6–8 inches into sandy ground. Another species, *Astata unicolor*, has also been seen to collect nymphs, but nests have not yet been found. This species is commonly found around our orchards as it prefers to nest in heavier ground. Like most predatory and parasitic wasps, it needs to visit flowers as adults to obtain nectar for food to mature its eggs.

#### **LEPIDOPTERAN PREDATORS—GROUND BEETLES (CARABIDAE) AND ROVE BEETLES (STAPHYLINIDAE)**

These are two of the largest families of beetles with 1,500 ground beetle and 3,000 rove beetle species in North America. Many are generalist predators that are effective in controlling pests that pupate or overwinter in the ground cover or on the trunks (e.g., codling moth, Oriental fruit moth, apple maggot, plum curculio, European apple sawfly, leafrollers). Many live in the ground cover away from pesticide applications made to tree foliage, but some may climb trunks. All are very pesticide susceptible and are often used as indicators of environmental quality.

#### **WOOLLY APPLE APHID PARASITOID—APHELINUS MALI**

These adult wasps are very small and they insert their eggs singly into the body of aphids, where they will develop internally to kill the host. There are six to seven generations each year with each generation taking about 20 to 25 days to develop. Larvae or pupae overwinter within the mummified body of the aphid. *A. mali* are most effective in reducing small woolly apple aphid colonies in the spring when colonies are small. If biological control is disrupted with toxic pesticides, *A. mali* are less effective in controlling larger colonies later in the season. These very small wasps are able to attack only the aphids on the periphery of the colony and cannot successfully penetrate the wax and mass of aphid bodies to attack the center of the aphid colony, thus the percentage of parasitism actually decreases as the aphid colonies get larger in size. From midsummer to late season woolly apple aphid colonies are usually brought under control by a complex of syrphid fly species and generalist predators, such as brown and green lacewings. Ladybug larvae and adults are occasional predators of woolly apple aphids but do not appear able to deal with the waxy covering and give little control.

Rootstocks with resistance (e.g., M.106 and M111) to woolly apple aphid and *A. mali* provide adequate control of both root and aerial colonies of this pest during most seasons, unless biological control is disrupted with toxic pesticides. This parasitoid has some tolerance to organophosphate insecticides but should be conserved by selective pesticide use (see Table 4-4). Multiple applications of some chitin-inhibiting IGRs and spinosyn-type products appear to be toxic to *A. mali* and can cause woolly apple aphid flare-ups.

#### **LEPIDOPTERAN AND STINK BUG PARASITOIDS**

**Tachinid Flies**—important parasitoids of leafrollers in the spring. One species, *Actia interrupta*, is currently the most important parasitoid of the obliquebanded leafroller. Eggs are laid on the skin of larvae to hatch and develop externally on the larvae to eventually leave just an empty husk of skin. Pupae are generally found near the host remains and resemble a grain of wheat in size and shape. *Trichopoda pennipes*, an important parasitoid of the squash bug, is also now undergoing a host shift to attack the brown marmorated stink bug with eggs being present at levels of

up to 20 percent in some locations, but successful development on this host remains low so far. All species appear to be very susceptible to pesticides and are important only in pheromone disruption or orchards with minimal pesticide sprays.

**Scelionid Wasps**—several species of *Trissolcus* and *Telenomus* wasps are egg parasitoids of our native stink bug species, are the primary regulatory agents of these pests outside our orchards, and reduce their numbers so they are of minor importance when they move into the orchards from other hosts. Several species are in the process of undergoing host shifts to the brown marmorated stink bug, but current rates of parasitism are under 5 percent. An adventive population of a specialist BMSB egg parasitoid, *Trissolcus japonicus*, was recently discovered in the United States (including in Pennsylvania) and is expected to dramatically improve the biological control of BMSB. *T. japonicus* is the most important biological control agent for BMSB in Asia, where it parasitizes up to 80 percent of BMSB eggs.

**Braconid and Ichneumon Wasps**—with approximately 120,000 known species and many as yet undescribed, this is a virtually untapped source of biological control in modern agriculture. With various complex life histories, often alternating between several hosts and attacking specific life stages, these wasps have not been important sources of biological control in tree fruit since the introduction of disruptive broad-spectrum insecticides. Previous to this, however, they provided almost complete control of many of the leafroller species. Currently, there are more than 40 different wasp parasitoids capable of attacking tufted apple bud moth in Pennsylvania apple orchards. All species appear to be very susceptible to pesticides and are important only in pheromone disruption or orchards with minimal pesticide sprays. Braconid species appear to be most important late in the growing season.

**Trichogramma Egg Parasitoid**—most commonly employed as a biopesticide obtained from biological supply houses for mass releases into many crops. These tiny wasps complete their development inside a single egg of their moth or butterfly host. Native populations of mostly *T. minutum* attack many different orchard pests in Pennsylvania (most important are the several species of leafrollers, codling moth, and Oriental fruit moth). The life of the adults and the number of eggs laid are greatly increased with the provision of nectar sources and females may then live up to two weeks and lay over 80 eggs. Although present during most of the growing season, populations generally do not build to be significantly important in controlling these orchard pests until late summer. *Trichogramma* is very susceptible to pesticides and is important only in pheromone disruption or orchards with minimal pesticide sprays.

## WEEDS IN DECIDUOUS FRUIT CROPS

Weeds compete with fruit plants for water and nutrients, and an overabundant weed population can severely stunt the growth of desired plants. Many common orchard weeds may also serve as reservoirs of important plant viruses. Weeds can be classified into three broad categories: annuals, perennials, and biennials. An annual plant is one that completes its life cycle in one year. It grows from seed, produces seed, and then dies. Summer annuals

germinate in the spring or summer, while winter annuals germinate in the fall. A perennial plant grows and produces seed year after year. Herbaceous perennials, such as quackgrass and Canada thistle, die back to the ground each year. Woody perennials may drop their leaves, but they do not die back to the ground. The longer that perennial weeds are allowed to grow uncontrolled, the larger their root system becomes, the more they spread, and the harder they are to control.

A biennial plant, such as marestail, wild carrot, and dandelion, requires two growing seasons to complete its life cycle. During the first season after the seed germinates, the plant develops an extensive root system and a dense cluster of leaves, and generally dies back to ground level at the growing season's end. The next year the plant regrows from the root system, produces seed, and dies. Ways of managing these various types of weeds are discussed in Herbicide Management in Part IV.

## SCOUTING FOR WEEDS

Although weeds are present in every field, there are wide variations in the species growing and the density of each population. Just as scouting for insects and diseases is well established in integrated pest management, the need to scout for weeds is also critical. Information gathered from weed scouting will allow you to match effective herbicides for the weed species present and determine the most effective time to control the plants. Scouting helps you discover patches of weeds before they spread throughout the orchard, and identify areas in your orchard for spot treatments.

Scouting for weeds can be done while looking for insects and diseases, although a separate walk through the field may allow more detailed observations and collections. Here are some basic first steps:

- Identify the type of weed: is it a grass or broadleaf?
- Identify life cycle: is it an annual, biennial, or perennial?
- Identify the weed location(s): is it on the orchard edge, in discrete patches, or uniformly spread throughout the orchard?

If you are unsure of the name of the weed, collect a sample for verification. The sample should include roots, flowers, and shoots if available. Place the sample in a paper bag and place the paper bag within a plastic bag to reduce potential desiccation. Be sure to mark on the bag where in your orchard it came from and how prevalent it is at that site.

As with collecting a leaf sample for nutrient analysis, walk your orchard blocks in a zigzag pattern. Bring a notebook with you to write down the names of the weeds present and the severity of the infestation. Permanent recording of the weed(s) and their population will provide long-term records of weed emergence patterns and problem areas in the orchard.

Identifying weeds: You will need a few simple tools to scout for weeds—first is a good hand lens to note specific peculiarities or small identifying details of the weed; having a good weed identification book such as *Weeds of the Northeast* by Uva, Neal, and DiTomaso is also recommended. The book can be ordered online or most bookstores can obtain a copy for you. Weed identification websites are listed in the appendix of this guide.

Note plant characteristics of the weed(s). Note the number of

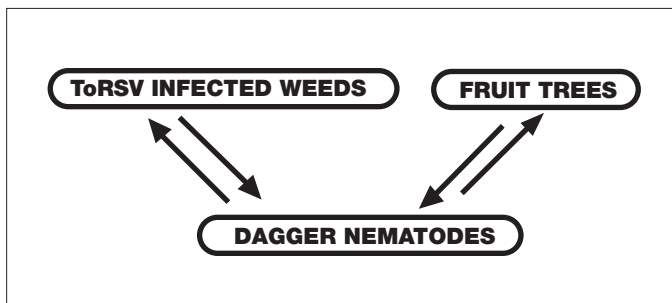

Figure 2-4. Tomato ringspot virus transmission.

leaves and their shape. Are the leaves borne opposite each other or do they attach to the stem/stalk alternating up and down the stem/stalk? Note the presence or absence of flowers and their color. Finally, be sure to write down weed's location so that you can return to the site if you are not sure of the weeds' identity.

## SCOUTING FOR WEEDS

Although weeds are present in every field, there are wide variations in the species growing and the density of each population. Just as scouting for insects and diseases is well established in integrated pest management, the need to scout for weeds is also critical. Information gathered from weed scouting will allow you to match effective herbicides for the weed species present and determine the most effective time to control the plants. Scouting helps you discover patches of weeds before they spread throughout the orchard, and identify areas in your orchard for spot treatments.

Scouting for weeds can be done while looking for insects and diseases, although a separate walk through the field may allow more detailed observations and collections. Here are some basic first steps:

- Identify the type of weed: is it a grass or broadleaf?
- Identify life cycle: is it an annual, biennial, or perennial?
- Identify the weed location(s): is it on the orchard edge, in discrete patches, or uniformly spread throughout the orchard?

If you are unsure of the name of the weed, collect a sample for verification. The sample should include roots, flowers, and shoots if available. Place the sample in a paper bag and place the paper bag within a plastic bag to reduce potential desiccation. Be sure to mark on the bag where in your orchard it came from and how prevalent it is at that site.

As with collecting a leaf sample for nutrient analysis, walk your orchard blocks in a zigzag pattern. Bring a notebook with you to write down the names of the weeds present and the severity of the infestation. Permanent recording of the weed(s) and their population will provide long-term records of weed emergence patterns and problem areas in the orchard.

Identifying weeds: You will need a few simple tools to scout for weeds—first is a good hand lens to note specific peculiarities or small identifying details of the weed; having a good weed identification book such as *Weeds of the Northeast* by Uva, Neal, and DiTomaso is also recommended. The book can be ordered online or most bookstores can obtain a copy for you. Weed identification websites are listed in the appendix of this guide.

Note plant characteristics of the weed(s). Note the number of

Table 2-14. Orchard weeds identified as reservoirs of tomato ringspot virus.

Common chickweed	Lambsquarters	White-head aster
Oxeye daisy	Common thistle	Dandelion
Wild carrot	Swine cress	Pennycress
Leafy spurge	Prostrate spurge	Red clover
White clover	Common polkweed	Buckhorn plantain
Common mullein	Common plantain	Sheep sorrel (red)
Curly dock	Wild strawberry	Broadleaf plantain

leaves and their shape. Are the leaves borne opposite each other or do they attach to the stem/stalk alternating up and down the stem/stalk? Note the presence or absence of flowers and their color. Finally, be sure to write down weed's location so that you can return to the site if you are not sure of the weeds' identity.

## NEMATODE PROBLEMS IN DECIDUOUS FRUIT TREES

Nematodes are economically important pathogens on fruit crops. They reduce tree vigor and crop yields by parasitizing tree roots; they predispose trees to disease, reduce winter hardiness, and transmit viruses. Two of the most serious nematode problems in Pennsylvania are peach stem pitting and apple union necrosis and decline. Both diseases are caused by the tomato ringspot virus (ToRSV), transmitted by the dagger nematode (*Xiphinema* spp.).

The only natural means of infection with ToRSV is by dagger nematode transmission (Figure 2-4). The nematode acquires ToRSV when it feeds on an infected plant and transmits the virus when it feeds on a healthy plant. In the absence of dagger nematodes the virus does not naturally spread to fruit trees.

ToRSV can be transported over great distances in the seed of some weeds, such as dandelion. See Table 2-13 for a list of common orchard weeds that have been identified as hosts for ToRSV. Dagger nematodes and ToRSV are both common in orchards of the Mid-Atlantic states.

### Peach Stem Pitting and Apple Union Necrosis

Two of the most serious nematode problems in Pennsylvania are peach stem pitting and apple union necrosis and decline. Both diseases are caused by the tomato ringspot virus (ToRSV), transmitted by the dagger nematode (*Xiphinema* spp.). See the detailed description of each disease under Diseases and Disorders in Pennsylvania earlier in Part II.

The only natural means of infection with ToRSV is by dagger nematode transmission (Figure 2-4). The nematode acquires ToRSV when it feeds on an infected plant and transmits the virus when it feeds on a healthy plant. In the absence of dagger nematodes the virus does not naturally spread to fruit trees. ToRSV can be transported over great distances in the seed of some weeds, such as dandelion. See Table 2-14 for a list of common orchard weeds that have been identified as hosts for ToRSV. Dagger nematodes and ToRSV are both common in orchards of the Mid-Atlantic states.

### Replant Problems and the Root-Lesion Nematode

Replanted fruit trees frequently have difficulty becoming reestablished, often because of interactions between nematodes and other soil microorganisms. The root-lesion nematode, *Pratylenchus penetrans*, is often the cause of the problem. It is perhaps the



**Table 2-15. Plant-parasitic nematodes and their treatment guidelines**

Nematode	Number/100cc <sup>a</sup>	
	Peach	Apple
Lesion	60–80	40–60
Stunt	60–80	60–80
Spiral	40	40
Stubby Root	16	16
Dagger	Any (as virus vector) 16+ for feeding injury	Any (as virus vector) 16+ for feeding injury
Ring	24	30
Cyst	Not economic	Not economic
Sting	8–10	8–10
Lance	40–60	40–60
Root Knot	Any in new plantings	Not economic

Adapted from the 2015 New Jersey Commercial Tree Fruit Production Guide.

<sup>a</sup>Thresholds given are not based on experimental data, but rather on field experience and observations in commercial orchards.

most widespread and best-known nematode pest of fruit trees. It damages roots through feeding and intracellular migration, which destroys tissue in the root cortex. Root damage caused by this nematode promotes infection by root-rotting microorganisms. The resulting damage is greater than that caused by the nematode alone.

Root-lesion nematodes migrate and seek new feeding sites when roots become crowded or decayed. Although root impairment results in a loss in vigor and yield of mature trees, the role of root-lesion nematodes in the development of replant problems is of greater economic importance.

Orchards affected by replant disease never reach their full production potential, and there are no remedial measures that can fully correct problems after the orchard is established. Depending on the extent of the problem, infested orchards force the grower to make tough economic decisions, such as whether to keep trees that are not highly profitable or to reestablish a new orchard at major expense and loss of several years' productivity. However, replant disease can be prevented by assessing the risk of problems with preplant nematode assays and by proper site preparation.

The symptoms of orchard replant disease include stunting, yellowing of leaves, discolored and necrotic feeder roots, and in severe cases, tree death within the first few years after planting. Necrotic roots may or may not show obvious lesions. Typically, affected trees show a patchy distribution, and the severity of disease may be quite variable within the orchard.

Nematode management is based on rotating crops, using synthetic soil fumigants or nematicides, or incorporating green manure of rapeseed, which releases nematicidal chemicals. These methods are outlined in Nematode Management in Parts III and IV.

### Detection and Sampling for Plant-Parasitic Nematodes

Whenever nematode damage is suspected, and especially before planting young trees, an examination of both soil and roots is recommended. Soil and root samples must be adequate in size and collected in a manner that will make evaluation possible. The nematode diagnostic service at the Fruit Research and Extension Center in Biglerville has been discontinued. Other university-affiliated labs that will accept out of state samples for nematode testing are listed below. Sample submission information, instructions, and fees can be found at the websites for each lab. Additional laboratories providing this service can be found by searching the Internet with the terms “Nematode

Testing Services” or “Nematode Diagnostic Service.” Be sure to contact the facility prior to sending samples. Please note that some facilities charge fees. Table 2-15 includes the list of plant-parasitic nematodes with treatment guidelines.

#### Clemson Plant Problem Clinic and Nematode Assay Lab

511 Westinghouse Road  
Pendleton, SC 29670  
Phone: 864-646-2133  
Fax: 864-646-2178  
Email: [nemalab@clemson.edu](mailto:nemalab@clemson.edu)  
[clemson.edu/plantclinic](http://clemson.edu/plantclinic)

#### Rutgers Plant Diagnostic Laboratory and Nematode Detection Service

Rutgers NJAES  
PO Box 550  
Milltown, NJ 08850-0550  
Phone: 732-932-9140  
Fax: 732-932-1270  
[www.njaes.rutgers.edu/services](http://www.njaes.rutgers.edu/services)

### Suggestions for collecting nematode soil samples on orchard sites

1. If the soil in the area to be sampled is fairly uniform and is 2 acres or less in size, one composite sample will suffice. If the field is larger than 2 but less than 4 acres, divide the field into two blocks of approximately equal size and take composite samples from each block. Fields larger than 4 acres should be divided into blocks accordingly, each of which is not larger than 2 acres and has a uniform history and soil type. This is only a guideline. The smaller the area sampled, the more accurately the sample will represent the site.
2. In each site to be assayed, take a sample from each area that has a common cropping history and that will be planted with a single crop. For example, if a 2-acre field is to be planted with peaches next year and if half the field was in apples last season and the rest in woods, collect a sample from each area.
3. If the soil in the area to be sampled is variable, such as having a heavy clay soil in one portion and a sandy soil in another, take one composite sample from each soil type.
4. Preferably using a 1-by-12-inch sampling tube (or a trowel, small shovel, or similar tool if a sampling tube is unavailable), *take at least 20 cores of soil* from each sampling area. Samples should be taken to a depth of 8 to 12 inches in the root zone. Send only a single blended sample from the sampling area.
5. Feeder roots, found at varying depths, are usually most abundant at the dripline, directly below the outer leaf canopy. *Soil samples should be taken from the same area where the roots are growing.*
6. Do not sample from dead or nearly dead trees. Nematodes feed on live roots and may migrate away from dying plants. Therefore, when sampling problem areas, the samples should be taken from adjacent trees that either appear healthy or show early symptoms of stress.

Since nematodes are not uniformly distributed in a field, a carefully prescribed sampling procedure must be followed to obtain root and soil samples representative of the area surveyed. In addition, the samples must be properly handled and shipped to ensure that the nematodes remain alive until they are processed in the laboratory. If there has been a prolonged dry spell, or if the soil has been saturated with water for an extended period, wait until normal soil-moisture conditions return before sampling.

### Handling samples

1. Make certain that all information is included on the nematode assay form that is requested by the Nematode Diagnostic Clinic you choose to use. This information is needed to identify the sample and to aid in interpreting assay data. If you collect more than one sample, you must assign a field number to each area sampled and place that number in the appropriate area of the form. Each plastic bag of soil should be sealed tightly.
2. Soil samples must remain cool until processed. Keep samples out of direct sunlight to avoid overheating. Samples may also be damaged by heat if they are stored in the trunk of a car, open bed of a pickup truck, or other hot location. *Heat kills nematodes, and dead nematodes are unsuitable for identification.* It is best to transport soil samples from the orchard in an ice-filled cooler and store them in the refrigerator until they are sent to a lab for processing. If the samples will be mailed to the lab, it is best to include a “blue ice pack” and wrap the sample with some type of insulation such as newspaper, bubble wrap, or Styrofoam to keep the sample in good condition.

## MAMMAL CONTROL IN ORCHARDS

### Voles

#### Identification

Voles are small rodents with short legs, stocky bodies, small eyes and ears, and short tails. Two species, the meadow vole (*Microtus pennsylvanicus*) and the woodland or pine vole (*Microtus pinetorum*), may damage fruit trees and become serious pests in orchards.

The meadow vole is approximately 5.5 to 7.5 inches long. It has brown fur mixed with black, and its tail is approximately twice the length of its hind foot. The pine vole is Pennsylvania’s smallest vole. It is 4 to 5 inches long and has chestnut or auburn fur and a short tail approximately as long as or shorter than the hind foot.

#### Distribution

The meadow vole is one of the most widespread mammals in Pennsylvania. It abounds in grassy fields, moist meadows, orchards, or any area with a dense ground cover of grasses. Pine voles are most abundant in southeastern Pennsylvania, where they are common in old fields, thickets, gardens, orchards, and the edges of agricultural land, particularly where the soil is loose and sandy.

#### General biology and behavior

Voles are primarily vegetarians, feeding on grasses, tubers, and seeds. They also consume the bark of young trees. Unlike many

other small mammals, voles do not hibernate. Instead, they are active throughout the year, both day and night, with peak activity at dawn and dusk.

Meadow voles create surface runways in the grass, and in winter, both are active in runways beneath the snow. Woodland voles build underground tunnels in loose, crumbly soil. As they build the tunnels they push out dirt, producing small conical piles of soil on the ground surface. Both voles build large globular nests of dry grasses and leaves. The nests are located close to tree trunks, in tussocks of grass, and at the end of burrows.

Voles are extremely prolific. Their peak breeding activity occurs between March and October, but when winters are mild, voles may breed all year long. A female meadow vole could potentially produce over 70 young in a year. Voles become sexually mature at between four and six weeks of age. As a result, under ideal conditions vole populations can reach densities as high as 270 voles per acre. Scientists have found that voles exhibit regular population fluctuations at approximately four-year intervals. Populations apparently crash to levels as low as 10 voles per acre after peak years and then begin to build up again. Extensive damage may occur in orchards, particularly during peak population years.

#### Damage

Voles may cause extensive damage to fruit trees and orchards as a result of girdling seedlings and trees and damaging roots. Damage occurs primarily during winter when other types of food are scarce. The most common form of tree injury caused by meadow voles is trunk girdling at or near the ground surface. Since voles burrow in the snow, they may damage tree trunks as high as snow accumulates. Young trees are especially susceptible to attack. Occasionally, meadow voles will burrow in the soil and damage roots, resulting in weak, unhealthy trees.

Damage from pine voles is harder to detect because it occurs underground as they consume small roots, girdle large roots, and eat bark from the base of trees. By the time orchardists note weak, unhealthy trees, the damage is already extensive.

#### Monitoring

The most easily identified sign of meadow vole presence is a system of surface runways in the grass. Meadow voles create these runways by their feeding activities and keep them free of vegetation. The runways are generally about 1.5 inches wide. After a close mowing, the pattern of runways is often visible. Bits of freshly cut vegetation and accumulations of vole droppings (brown or green in color and shaped like rice grains) in the runway are positive evidence they are being used. Vegetation, small roots, or mold in the runways indicate that the voles are no longer using them. Pine voles do not use surface runways, so their presence is much harder to detect. In apple orchards, tiny, elongated tooth marks on apples on the ground are signs of both meadow voles and pine voles. Probing the area under the tree with your fingers may help determine if there are woodland vole runs close to the surface.

The apple indexing method is a way to determine the distribution of voles in an orchard and their relative abundance. Place a slice of apple into a meadow vole runway or in a pine vole tunnel. Check the apple after 24 hours for vole tooth marks. The presence of tooth marks will indicate where vole activity is highest and which trees are at risk. To obtain an estimate of the abundance

of voles, weigh the apple before putting it out and after 24 hours. One pine vole consumes approximately 0.5 ounce of apple in a 24-hour period and one meadow vole consumes about 0.7 ounce.

Most orchardists do not need to know the exact number of voles present, but they may want to know whether the population is increasing or decreasing, or whether a particular treatment had an impact on population size. Monitoring vole numbers with the apple indexing method is a means of achieving these goals.

Trapping can also be used to assess the effectiveness of a vole-control program. Before initiating the control program, select approximately 10 trees and place four wooden-base (mouse-size) snap traps in runways near these trees (for trap placement see section on trapping below). Record the number of voles trapped in a three- to five-day period. After the control program is finished, set the traps in the same place and, for the same length of time, compare the number of voles caught after treatment with the number caught before treatment. If the program has been successful, you should trap no more than two or three voles.

The number of voles that can be tolerated is a trade-off between cost of control and cost of damage, and it depends on the orchardist. A single vole may cause damage, but most damage occurs at high population levels. Monitoring vole populations enables growers to assess when populations are starting to increase and to begin control programs at that time.

## Management

### *Biological control*

Hawks, owls, snakes, weasels, raccoons, foxes, and coyotes all feed on voles. These predators are beneficial in orchards because they help keep vole populations under control. Whenever possible, orchardists should encourage these predators, or at least not harass them. American kestrels are small falcons that feed heavily on voles and other small mammals as well as insects. They are cavity nesters and can be attracted to an orchard by providing nest boxes. See Pennsylvania's Farmland Raptor program at [www.hawkmountain.org/raptorpedia/pa-farmland-raptor-project/page.aspx?id=3176](http://www.hawkmountain.org/raptorpedia/pa-farmland-raptor-project/page.aspx?id=3176) for information on attracting American kestrels to your orchard.

When natural controls are inadequate, artificial methods must be used to control vole populations. The fall is the best time for initiating control programs. A number of different control methods are listed below. The greatest success is usually achieved by using a variety of techniques at once.

### *Habitat modification*

In orchards, the major food sources for voles are normally not the fruit trees, but roots and stems of grasses and other ground cover. As a result, habitat modification, that is, reducing or eliminating grasses and cover, is one of the best long-term methods for controlling voles. Repeated mowing that maintains ground cover at a low level serve to limit both food and cover and expose voles to predators. Where possible, mow or till both between trees in a row as well as along tree rows. Too much delay between mowings results in excessive vegetation, which when cut forms a thatch layer that protects voles.

Establishing vegetation-free zones under tree canopies that extend at least 2 feet from tree trunks will discourage voles from living near the bases of trees, where they cause the most damage. Vegetation-free zones may be established by mowing, applying

herbicides, cultivating, or placing a layer of crushed stone or gravel 3 to 4 inches deep that extends 15 to 18 inches from the trunk. Do not allow mulch, prunings, or decaying vegetation to accumulate around the bases of trees or in tree rows. Drops should be cleaned up quickly.

### *Exclusion*

Hardware cloth barriers can be used to keep voles from girdling small trees. Wrap a strip of ¼ mesh hardware cloth around the base of small trees. The hardware cloth should be set 4 to 6 inches into the ground and be approximately 18 to 24 inches high. The guards should be at least 4 inches higher than anticipated snow depth. Tree guards should be large enough to allow for five years of growth. This method is very effective but extremely labor intensive and expensive when a larger number of trees need protection.

### *Trapping*

Trapping is not an efficient way of controlling voles in large orchards, but it is an effective and safe control method for small orchards or around selected trees. Use standard wooden-base snap traps (mouse size) and bait them with a peanut butter and oatmeal mixture or apple slices. For meadow voles, place the traps in runways, flush with the ground and perpendicular to the runway. Place the trigger end in the runway. For pine voles, locate a tunnel and place the trap within the tunnel and perpendicular to it. Put a cover such as a bent roofing shingle or box over the traps. This helps protect most nontarget animals and makes the voles more likely to take the bait. In some situations it may be necessary to drill a hole in the corner of the trap, attach a string or wire, and use a large nail to stake it in the ground. Occasionally, cats will remove the vole and the trap.

### *Repellents*

The repellent Thiram 24/7 (a fungicide) or repellents containing capsaicin (the ingredient that makes chili peppers hot) are registered for vole control. Little data is available on the effectiveness of repellents to deter vole damage; therefore, repellents should not be used as the sole method of vole control.

Thiram 24/7 is labeled for use on tree seedlings, shrubs, ornamental plantings, nursery stock, and nonbearing fruit trees and vines.

Capsaicin-based products are labeled for use on ornamental trees, fruit and nut trees, fruit bushes and vines, nursery stock, shrubs, and lawns. Capsaicin should be applied only before the fruit sets or after the harvest. Capsaicin is registered for use on vegetable plants and agricultural crops only before edible portions and/or heads begin to form.

To prevent a feeding pattern from developing, apply repellents before damage becomes significant or, in the case of monitored populations, before damage occurs. They must be reapplied after a rain, heavy dew, or new plant growth. Always follow label directions for the repellent being used. Never apply repellents to any portion of a plant likely to be eaten by humans or livestock unless the label permits it.

### *Toxicants*

Used in conjunction with habitat modification, rodenticides are an important component of most control programs because they provide the quickest and most practical means of bringing large populations of voles under control. Two types of rodenticides are

often used—one to provide a quick reduction in numbers (high toxicity and fast acting, a single-dose toxicant), and the other to provide protection throughout the winter (one of the anticoagulant baits). ZP Rodent Bait AG is a registered single-dose toxicant and Ramik Brown is an anticoagulant. Both are currently registered for use in Pennsylvania orchards. To determine if a specific rodenticide can still be used, read the label very carefully. The label will provide information on rates and applications, and lists legal uses for the product. Note any restrictions placed on the product. Most rodenticides may be used only during the dormant season when trees are not bearing fruit, and most are labeled as a restricted-use pesticide and can only be purchased and used by a certified pesticide applicator. If the label does not specifically state that it is legal for use in orchards, you can call the Department of Agriculture, Division of Agronomic Services, at 717-772-5212, check [npirpublic.ceris.purdue.edu/state](http://npirpublic.ceris.purdue.edu/state), or send an email to [lbrylewski@pa.gov](mailto:lbrylewski@pa.gov) and ask them to check if the product is registered for use in Pennsylvania orchards.

Zinc phosphide is acutely toxic to all vertebrates and therefore presents risks to nontarget wildlife. The anticoagulant baits are more toxic to rodents than other birds and mammals and pose less of an overall risk to nontarget wildlife. But in both cases, efforts should be made to protect nontarget wildlife. Both acute and chronic rodenticides are available in pelleted bait formulations, which are superior to grain baits because they are more effective against voles and are not as hazardous to ground-feeding birds and other nontarget wildlife.

Bait shyness occurs when animals consume sublethal doses of acute toxicants, then develop an aversion to the bait. Therefore, growers are advised not to apply zinc phosphide baits more often than once every six months. Ideally, growers can reduce the pest population with an initial application of a zinc phosphide bait and then after two days conduct an apple-slice index to assess the need for a follow-up application with an anticoagulant bait.

Recommended application rates for acute rodenticides are 2 pounds per acre when hand-placing zinc phosphide pellets in runways and 10 pounds per acre for broadcast application. Do not apply to bare ground. Recommended application rates for chronic rodenticides are 10 pounds per acre when hand-placing pellets or 15 to 20 pounds per acre for broadcast applications. Chronic rodenticides may be reapplied 30 to 60 days later if the vole problem persists.

Bait placement is critical to the success of a control program. Broadcast distribution of pellets and hand placing of pellets at recommended rates will work, but the best results are achieved by using bait stations. In addition, bait in stations is less available to nontarget wildlife.

Bait stations can be made from discarded beverage cans. Enlarge the opening in the end of the can so that it is about 1.5 inches in diameter. Dent the side of the can. Put bait in the can and place it dented side down in the area to be protected. Mark the bait containers with flags or stakes so they can be relocated. Another type of bait station that has been successful is made from an automobile tire split longitudinally. Tires are placed with the hollow side down, and the bait is placed in a small cup under the tire. The tire halves are then distributed one per tree or one every 10 yards throughout the area. Discontinue use if nontarget animals are coming into contact with bait.

Pine voles are not as active above ground, so bait should be placed directly in runways and burrow openings at two to four locations under infested trees. If runways and burrows cannot be found, roofing shingles, boards, or other objects placed on the ground at each placement site provide voles with shelters where they may build tunnels or nests. Place bait under these shelters after they have been in place for several weeks.

Timing also influences the success of control programs. Wet weather reduces the effectiveness of rodenticides, so apply baits when weather is likely to be fair and dry for at least three days. Baits are most effective when naturally occurring foods, such as green vegetation and fruit drops, are limited. Late fall is an important time to bait voles because it serves to reduce populations before the onset of winter, when vole damage is most severe and snow cover precludes rodenticide use. When winter survival is high, baits should be applied in the spring before the breeding season and before renewed growth of ground cover diminishes bait acceptance. Most rodenticide labels stipulate that bait can only be applied during the dormant season, after harvest, and before bud burst in the spring.

For additional information on controlling voles, see the “Wild-life Damage Control: Voles” fact sheet, available from your local extension office.

## White-Tailed Deer

### Distribution

The white-tailed deer is one of the most widely distributed and well-known mammals of North America, and it is a common species throughout Pennsylvania. Deer prefer early successional forests that are in the shrub-tree sapling stage. They are also abundant in agricultural areas where field crops and orchards are interspersed with forest habitat.

### General biology and behavior

Deer are most active during early morning and evening hours. They have a home range of several hundred acres, but this varies with season, habitat, sex, and even individual characteristics. Whitetails are creatures of habit; most use the same home range year after year. They also tend to establish one part of their home range as a feeding area, and another part for resting. For instance, if deer establish an orchard as a source of food, they will habitually move into the area a little before sunset to feed, and move back to the woods before dawn to rest.

The natural food habits of deer depend on the time of year and the plant species available. During the winter months, deer consume evergreen and dry leaves, as well as dormant buds. In the spring and summer, they eat new growth on woody and herbaceous plants. From late summer to early winter, fruits and nuts compose a large part of a deer’s diet.

White-tailed deer can mate from September to late January. Adult bucks are polygamous, mating with as many does as possible. A doe’s reproductive ability is influenced by her age and nutritional condition. Adult does will usually bear twins, while younger does more often bear single fawns.

### Damage

Deer cause damage to orchards year-round, but the most serious damage occurs in the winter months when the availability of natural foods is limited. Dwarf, semi-dwarf, and young standard fruit

trees are the most susceptible because most of the tree is within reach of the deer. In winter, browsing on dormant terminal buds may lead to stunted or misshapen growth in standard fruit trees under three years old. Browsing on fruit buds of dwarf and semi-dwarf trees may lower fruit production. In either case, severe winter browsing can reduce tree vitality and even cause death.

During the spring and summer, natural sources of forage are readily available to whitetails. However, they may browse new growth on orchard trees and eat ripening fruit. In autumn, deer may continue to browse and eat fruit within the orchard. Additionally, they can cause severe damage by rubbing their antlers on trees. This can result in broken limbs, girdling of the trunk, and subsequent death of the tree if the deer removes enough bark.

### Monitoring

The extent of damage caused by deer can be monitored through direct and indirect observation. They may be caught “in the act” during active periods of evening and early morning. Indirect observation means recognizing signs that deer leave behind. Whitetails selectively browse leaves and twigs from various plants, but prefer some species over others. In spite of this preference, they may heavily browse one plant while ignoring another of the same species that is close by.

Lacking upper incisor teeth, deer characteristically tear off vegetation, leaving jagged edges that you can use to identify browsed trees. In comparison, browsing by rodents and rabbits leaves a clean-cut surface. However, the height of the damage may be all you need to eliminate any mammal other than deer. Another method for determining deer as the source of damage is to search for tracks. They leave a distinctive split-hoofed track that can easily be seen in damp soil or snow. Monitoring your orchard for damage is an important, ongoing process and the first step in a successful management plan.

### Management

Effective management begins by anticipating the extent of damage by regularly monitoring deer signs and responding with the appropriate control.

Before deciding on a control method, if any, you should consider the cost benefits of the control program. If the damage you incur is economically greater than the cost of a control measure, you should apply the control measure. In most instances, an integrated pest management (IPM) plan is the best approach. This strategy combines ongoing population management of the local deer herd with either repellents or fencing, depending on the extent of damage.

### Hunting

In Pennsylvania, the Game Commission is authorized to manage the size of the deer herd through regulated hunting of antlered and antlerless deer. As a landowner, you should encourage hunting in your area, especially if your orchard is subject to heavy deer damage. Posted areas that are closed to hunting serve as refuges for deer during the hunting season and may compound the damage to an orchard by concentrating the deer population.

If a commercial orchard is your primary means of gaining a livelihood, those members of your immediate family living on the premises, as owner, lessee, or tenant, as well as any hired help regularly and continuously assisting in the cultivation of the land,

may hunt without a license during regular hunting season on the property, and on detached lands that are operated under written lease as part of the same operation. This applies only to persons who are otherwise eligible to be issued a hunting license. Consult your local game warden for information on opening your land to hunters, or on eligibility requirements for hunting.

The Hunter Access Program is a cooperative program between the Pennsylvania Game Commission and private landowners to allow access for hunters on private land. The increased hunting pressure benefits the landowner by increasing the deer harvest and reducing future deer damage. If you are not currently enrolled in the Hunter Access Program and are interested in learning more, contact your local game warden. For more information on the public access programs or to view the state-wide map detailing these properties, visit [www.pgc.pa.gov/HuntTrap/Hunting/HunterAccessProgram/Pages/default.aspx#VseG6PkrJhF](http://www.pgc.pa.gov/HuntTrap/Hunting/HunterAccessProgram/Pages/default.aspx#VseG6PkrJhF).

The Red Tag Program is a special permit for deer control related to agricultural depredation. Applications for the deer control permits provided under this program are obtained through the local game warden. Applications are accepted only from landowners who have been enrolled in one of the commission’s public access programs (Farm Game Project or Safety Zone) for a minimum of two years and are currently enrolled in the program. The permit authorizes the landowner (permittee) to enlist the aid of licensed hunters (sub-permittees) who are not associated with the farm to come on the property and harvest depredating deer. The permit is valid for antlerless deer only. For program details, see [www.pgc.pa.gov/InformationResources/GetInvolved/LandownerPrograms/Pages/RedTagProgram.aspx](http://www.pgc.pa.gov/InformationResources/GetInvolved/LandownerPrograms/Pages/RedTagProgram.aspx).

The Deer Management Assistance Program (DMAP) is designed to help landowners manage deer numbers on their properties. Qualified landowners participating in DMAP receive a limited number of coupons (determined by acreage) that they may make available to hunters. The coupons are then redeemed for a DMAP antlerless deer permit to hunt on the property for which they were issued. For more information on this program, visit [www.pgc.pa.gov/InformationResources/GetInvolved/LandownerPrograms/DeerManagementAssistanceProgram/Pages/default.aspx](http://www.pgc.pa.gov/InformationResources/GetInvolved/LandownerPrograms/DeerManagementAssistanceProgram/Pages/default.aspx).

### Shooting

Even though your land is open for hunting, you may still experience problems with deer when they are no longer in season. Because of this, you may be eligible to kill any deer witnessed to be causing or about to cause damage to your orchard, outside of the regular hunting season. You must contact your local game warden when you plan to shoot deer. There are procedures and regulations that you must follow if you are planning to protect your orchard in this manner. If the property is open to hunting, the orchard owner may keep one deer for personal use; all other deer must be field-dressed and turned over to the Game Commission. If the land is not open to hunting, all deer must be field-dressed and turned over to the Game Commission. Be sure to contact the local game warden before you act to ensure complete understanding of all the regulations.

### Repellents

Repellents are most effective when integrated into an IPM plan that

includes repellents, fencing, and hunting. If you have had damage in the past, apply repellents before the first sign of damage to prevent deer from establishing a feeding pattern at the site. There are two types of repellents: area and contact. Area repellents repel deer by odor and are applied close to plants in need of protection. By applying the repellents along the orchard borders, you can protect many trees at a relatively low cost. Area repellents include tankage (putrefied meat scraps), ammonium soaps, bone tar oil, blood meal, and human hair. Contact repellents work by taste and must be applied directly on the plant. These repellents work best if you apply them in the dormant season on dry days when temperatures are above freezing. Examples of contact repellents are putrescent egg solids, thiram, kaolin clay, and hot pepper sauce. Remember, whenever you apply a commercial repellent, the law requires strict compliance to the label. Hinder (ammonium soap) and Deer Stopper (certified organic food product) are currently the only products registered for use on edible plant materials.

Repellents have variable results; what works for one grower may not work for another, and success differs from year to year. Some repellents do not weather well and require repeated applications during the season. Also, if deer are very hungry and the area lacks other, more palatable food resources, they may ignore the repellents. Success must be measured by how much the damage has been reduced, since it is rarely eliminated. In areas where deer density is low and damage is light, repellents may be a cost-effective part of your IPM strategy.

### Fencing

Fencing deer out of the orchard is the most efficient way to reduce damage when deer density is high and damage extensive. The conventional 8-foot woven-wire fence effectively excludes deer by forming a barrier around the orchard. The fence consists of two widths of 4-foot woven wire and 12-foot posts. To prevent deer from crawling under, keep the wire close to ground level. Unfortunately, deer-proof fencing is expensive, but it is effective, long lasting, and requires little maintenance.

An alternative to barrier fencing is the use of an electric fence. This type of fence is designed to change the deer's behavior. Although deer can easily jump an electric fence, they will instead try to go through or under. An electric fence takes advantage of this behavior and successfully trains the deer to stay 3 to 4 feet away from the wires. Adding an attractant such as peanut butter on aluminum strips will entice deer to touch the fence with their mouth and nose. Touching the fence with sensitive tongue and lips will aid in training them to avoid the fence.

Researchers at Penn State have developed a low-cost, five-wire electric fence. Through tests conducted statewide, the design has shown to be an adequate means of deer control. The fence incorporates high-tensile steel wire; in-line wire strainers; and high-voltage, low-impedance energizers. High-tensile fence can absorb the impact of deer and tree limbs, thereby eliminating some of the problems associated with softwire fences. In addition to Penn State's five-wire fence, other high-tensile electric fence designs are available.

The disadvantages of electric fences are that they require high maintenance and regular inspections. You must maintain a 6- to 8-foot mowed strip along the fence perimeter to discourage deer from jumping and to decrease the weed load on the fence. You must also check the electric current regularly to ensure that the shocking power is sufficient for turning the deer. The advantages

**Brown marmorated stink bug (aka Asian stink bug) is not your usual insect pest.**

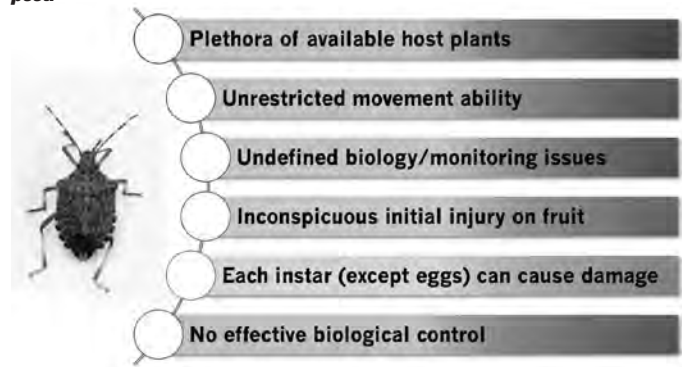

**Figure 2-5.** Examples of specific (and unique) challenges presented by brown marmorated stink bug to Pennsylvania fruit growers.

include a relatively low cost and, when properly maintained, a long-lasting fence.

### Other

Some growers have successfully protected their orchards by keeping dogs within the orchard. Deer tend to avoid these orchards because of the dogs, and any that do enter are chased out. The dogs are kept in the orchard by an invisible electric fence.

## SPECIAL SECTION: BROWN BARMORATED STINK BUG—NEW EXOTIC INSECT PEST

The brown marmorated stink bug (BMSB), *Halyomorpha halys* (Stål) (Heteroptera-Pentatomidae), has established itself in our surroundings and most likely will continue to pose an extremely serious threat to our agricultural systems for years to come. During the last few years researchers and extension specialists throughout the Mid-Atlantic States have documented the enormous potential of this insect to destroy the quality of various fruits, vegetables, and some agronomic crops, such as soybean and corn. According to information recently gathered by the U.S. Apple Association, the estimated losses during the 2010 season for this region's fruit growers exceeded \$37 million.

Damage on fruit caused by BMSB feeding can occur throughout the entire growing season. Although the mechanism by which BMSB feeds on fruit is similar throughout the season, the time of the season the feeding occurs can have a profound influence on the type and appearance of the injury. For example, early season feeding usually causes misshapen fruit, whereas, late season feeding usually causes depressions on the fruit surface and the appearance of necrotic tissue (corking) just below the fruit surface. Late season feeding injury is often confused with the physiological disorder called "corking," which is caused by a calcium deficiency. Although the amount of damage varied significantly among various locations throughout the state in 2010, some stone or pome fruit orchards suffered more than 60 percent injured fruit by harvest.

The management options for BMSB populations are quite complicated and, as observed during the last few seasons by some growers dealing with this challenging pest, also quite frustrating (Figure 2-5). Despite using the best available practices to conserve our IPM program and utilizing the most effective insecticide prod-

ucts and tactics to control BMSB, fruit injury levels in affected orchards ranged from low to extremely high, with most being well above acceptable levels to growers and consumers.

Following are some of the possible reasons for the observed problems in the management of BMSB.

### Unique Elements of BMSB Biology

Although more observations suggest BMSB adults can survive winter without the protection of human-made structures, at this time we still believe the majority of BMSB adults overwinter inside some kind of dwellings located mostly outside of orchards or other agricultural settings. In the spring, BMSB adults leave their overwintering shelters, looking for any green plants to serve as possible food source. The spring emergence of adult bugs from overwintering sites is usually very extended, lasting from late April until early June. These differences in the starting point for overwintering adults likely create a situation that allows all possible BMSB nymphal and adult stages to be present in the orchard at the same time. Throughout the season at any point BMSB adults can start moving into orchards or between orchards. BMSB feeding on stone fruits is a preferred early season behavior, but peaches and nectarines are not exclusive food source, and any green, growing plants (including pome fruits) can also be utilized. Reports in scientific literature estimate BMSB can feed on 250–300 different host plants. Later in the season (i.e., late June, July, August, and September), various instars of BMSB are frequently observed feeding on apple, pears, and small fruits, including berries and strawberries.

### BMSB Behavior

BMSB host plant choice is still not well understood. We still do not know exactly when and, more important, why BMSB moves from one host to another. It is important to understand BMSB can move to orchards at any time from May until October, including possible multiple, consecutive influxes from surrounding vegetation.

Effective control of one wave of stink bugs in the orchard does not prevent another wave of BMSB from entering the orchard a short time later. Since BMSB is not a resident pest in the orchard, even the best management activities against it in the spring will not prevent new stink bugs from invading again later in the season, even in October. Therefore, in addition to using effective insecticides, the most crucial, practical element for successful BMSB management is the development of a reliable pest detection and monitoring strategy.

### Efficacy of Insecticides

Our laboratory bioassays demonstrated the availability of multiple active ingredients effective against brown marmorated stink bug. These bioassays also identified a large group of currently registered products that provided very minimal direct mortality of BMSB adults. Although evaluations of available insecticides were conducted using different bioassay methods, the results provide a good complementary picture of what to expect from various products. The “lethality index” developed by USDA researchers provides information on efficacy of products against adult BMSB after exposing them for six hours to a dry residue of insecticides, while the Penn State “percent mortality” readings provide information on mortality of adult stink bugs after direct

contact with a 2 µl of an insecticide solution applied directly to the dorsal part of the insect abdomen. Both methods utilized long-term observations (up to 120 hours after treatment) to develop the final results (Tables 2-16 and 2-17).

### Suggestions for BMSB Management in Pennsylvania Fruit Orchards

The laboratory bioassays demonstrated various efficacies of currently registered insecticides against BMSB adults (Table 2-16). With 10 various active ingredients (from four different Insecticide Resistance Action Committee [IRAC Groups]) causing above 50 percent mortality during the direct contact bioassays, it appears there are enough products to control BMSB populations entering orchards throughout the entire growing season (Table 2-17). However, a big challenge with this seasonal approach is to manage the usage of these various products so they provide not only the best control for all injury causing stages of stink bug but also all other pests present in orchard throughout the season. Available insecticides are not equal in their efficacy against stink bugs and they are also not equal in their activity against other pests at the time when insecticide applications might be needed. A grower can choose to ignore these other pests and concentrate only on the management of BMSB, but based on our experience from the era “before the stink bug,” it might not be the best option especially with known pressures in our orchards from such pests as codling moth, Oriental fruit moth, and leafrollers.

When developing a seasonal strategy to manage BMSB at any particular location, the following factors need to be considered during the planning process:

#### Insecticides

The efficacy ratings for either direct contact or residual toxicity against BMSB are two of the most important factors in choosing the best product(s), but growers should also consider the time of the season and what other pests are likely to be active in the orchard. Also, factors such as an insecticide’s preharvest interval (PHI), the number of allowed applications per season, and the amount of an insecticide active ingredient that can be used for the entire season (be aware of multiple products with the same active ingredients) need to be critically assessed. While it may be wise on stone fruit to use the more effective products earlier in the season, the same products on apples may be much more valuable for BMSB control in August, September, or October. Since all products have a limited number of applications and active ingredients that can be used during a season, utilizing the most effective insecticides before they are essentially needed will likely leave us with only less effective alternatives later in the season.

#### Expected sources of BMSB influx

Population pressure from BMSB is not uniform outside or within any particular orchard, but it fluctuates during various times of the season. Some orchard blocks located next to woods may not have to deal with stink bugs until later in the summer; blocks next to various kinds of dwellings most likely will be affected earlier in the season; while blocks located inside other large groups of orchards may experience only low pest pressure throughout the season. However, in every orchard, due to the

**Table 2-16. Efficacy of various insecticides against BMSB adults during direct contact laboratory bioassay.**

Active ingredient (IRAC group)	Product (rate tested)	Percent direct mortality at 24/72 hours after <sup>a</sup>	Number of applications per season <sup>b</sup>	Comments <sup>c</sup>
acetamiprid (IRAC 4A)	Assail 30 SG (6 oz)	87/87	SF: 4 PF: 4	7-day PHI on SF and PF
clothianidin (IRAC 4A)	Belay (6 oz)	100/100	Peach: 2 PF: 2 app	Not registered on nectarines
imidacloprid (IRAC 4A)	Admire Pro (7 oz)	82/87	SF: 1 PF: 1 app	21-day PHI on SF and PF
	Leverage 360 (2.8 oz, mix)	95/93	SF: 1 PF: 1	7-day PHI on SF and PF, includes beta-cyfluthrin
thiamethoxam (IRAC 4A)	Actara (4 oz)	92/97	SF: 2 PF: 3	No more than 0.25 lb ai per season on PF, and 0.17 lb ai on SF
	Endigo ZC (5 oz, mix)	98/100	SF: 3 PF: 4	See comments for Actara and Warrior
	Voliam Flexi (6 oz, mix)	100/100	SF: 2 PF: 2	See comments for Actara
methomyl (IRAC 1A)	Lannate SP (16 oz)	92/98	Apple: 5 Nectarine: 3 Peach: 6	Strong rate response
	Lannate LV (3 pt)	87/92	Apple: 5 Peach: 6	Not registered on nectarines
oxamyl (IRAC 1A)	Vydate (6 pt)	68/73	Apple: 1	Thinning caution
fenprothrin (IRAC 3)	Danitol (16 oz)	95/82	SF: 2 PF: 2	3-day PHI on SF, 14-day PHI on PF
lambda-cyhalothrin (IRAC 3)	Warrior II (2.5 oz)	73/72	SF: 4 PF: 4	No more than 0.16 lb ai per season
	Lambda-Cy (4.4 oz)	52/40	SF: 5 PF: 5	No more than 0.16 lb ai per season
	Voliam Xpress (10 fl oz, mix)	40/40	SF: 4 PF: 4	See comments on Warrior
	Endigo ZC (5 oz, mix)	98/100	SF: 3 PF: 4	See comments on Actara and Warrior
dinotefuran (IRAC 4A)	Scorpion 35 SL (5 oz)	97/98		Registered for use only on peach and nectarine under a Supplemental Label

Source: Dr. Greg Krawczyk, Penn State Fruit Research and Extension Center, 2017.

- Dead and moribund BMSB adults grouped as dead.
- SF = stone fruit, PF = pome fruit. Always read and follow the most current pesticide label.
- Other tested products (rate) with adult BMSB direct mortality lower than 50 percent: Altacor (3 oz); Asana (14 oz); Avaunt (6 oz); Baythroid XL (2.8 oz); Beleaf (2.8 oz); Delegate (7 oz); Diazinon 50 W (3 lb); Esteem (5 oz); Imidan (4 lb); M-Pede (2%); Neemix 4.5 (16 oz); Pounce 25 WP (16 oz); Rimon (30 oz); Sevin XLR Plus (3 pt); Stylet oil (2%).

ability of adult BMSB to rapid move quickly among various hosts, a constant and vigilant monitoring program is the very basis for successful management. Commercially available traps and lures for BMSB monitoring provide valuable information and can help growers decide if insecticide treatments are needed to manage BMSB. Stink bug traps and lures from Ag-Bio ([www.agbio-inc.com/dead-inn-pyramid-trap.html](http://www.agbio-inc.com/dead-inn-pyramid-trap.html)), Trece Inc. ([www.trece.com/pherocon.html](http://www.trece.com/pherocon.html)), and Sterling International ([www.rescue.com/product/reusable-outdoor-stink-bug-trap](http://www.rescue.com/product/reusable-outdoor-stink-bug-trap))

**Table 2-17. Suggested timings and product options for the control of brown marmorated stink bug in fruit orchards.**

Timing	Other pests to manage <sup>a</sup>	BMSB product options <sup>b</sup>	Comments
After bloom (May–June)	Aphids, CM, leafhoppers, OBLR, OFM, PC, TABM	Actara, Admire, Assail, Besiege, Voliam Flexi	To suppress early season populations
Midsummer	Aphids, AM, JB, leafhoppers, mites, scales	Actara, Admire, Assail, Belay, Danitol, Leverage, Scorpion <sup>c</sup> , Vydate	Control on stone fruit; suppression on pome fruit
Late summer	CM, leafhoppers, OFM, TABM	Danitol, Endigo, Lannate, Scorpion <sup>c</sup> , Warrior	Control on pome fruit

- AM = apple maggot; CM = codling moth; EAS = European apple sawfly; JB = Japanese beetle; OBLR = obliquebanded leafroller; OFM = Oriental fruit moth; PB = peachtree borer; PC = periodical cicada; RAA = rosy apple aphid; TABM = tufted apple bud moth.
- Suggested assortment of products is based on “direct mortality” assessed during laboratory bioassays conducted at the Penn State Fruit Research and Extension Center (September 2017).
- Scorpion is registered for use only on peaches and nectarines.

are available for purchase and should be very helpful with effective monitoring of BMSB adults and nymphs in orchards. Although traps by themselves will not control BMSB, by capturing adults and nymphs, traps can be utilized as an effective warning system in orchards.

### Crop/block-specific characteristics

Factors such as different harvest dates for fruit, the mixture of cultivars, surrounding vegetation as a possible source or barrier for BMSB populations during the season, and the attractiveness of the crop to BMSB mandate individual treatment strategies for each separate orchard or block within the orchard. While some fruit blocks might require seasonal, intensive management options against BMSB, other blocks might require a less intensive program. Unfortunately, there is no “one size fits all” recipe for successful management in dealing with this pest.

### Necessity of controlling other pests

In orchards experiencing continuous, seasonal pressure from BMSB, seasonal control options must be carefully selected. While selecting best control options, growers should also consider what other fruit pests and the beneficial natural enemies may be affected by their selection of products used against BMSB. Detailed monitoring of all pests will be crucial in order to prevent additional crop losses caused by the “normal pests.”

### Planning for a Seasonal Insect Control Program

Since we cannot predict when BMSB will move into orchards and how intensive feeding will be during the season, we should prepare ourselves for a season-long monitoring and management program. Also, the results of our early season management activities will likely not minimize the pest pressure in late summer and early fall. While BMSB can cause fruit damage at any point during the season, maturing fruit likely represent the most



attractive source of nutrients for this insect and, therefore, pest pressure may be the strongest as we move into the late summer and early fall period.

### **Maintaining the Integrity of IPM in Pennsylvania While Battling the Brown Marmorated Stink Bug**

Pennsylvania tree fruit growers have embraced the principles of integrated pest management (IPM) since the late 1960s and early 1970s. By one definition, IPM is the “utilization of all suitable techniques and methods in as compatible manner as possible and maintains the pest populations at levels below those causing economic injury.” The goal of IPM is to minimize the number and severity of perturbations in the agroecosystem while reducing the economic, environmental, and human health costs associated with the particular management options(s).

Fruit growers in Pennsylvania are now faced with the next major perturbation and challenge to their crops and their IPM program—the invasion of the brown marmorated stink bug. The near-term solutions for BMSB will involve many different types of insecticides. Unfortunately, the most effective insecticides for BMSB control belong primarily to the chemistries of the synthetic pyrethroids, the carbamate group methomyl, and a couple of the neonicotinoids. Pyrethroids and methomyl are considered broad-spectrum insecticides that are highly toxic to many, if not all, of the natural enemies found in tree fruits. Because of this toxicity to natural enemies, in the past we have only recommended the pyrethroids before bloom on apple to minimize their toxicity. Growers who have used these products postbloom on apples in the past have seen many flare-ups from European red mites, woolly apple aphids, San Jose Scale, and so forth.

Given the seriousness of the BMSB situation, and that the most effective products for BMSB control are methomyl, pyrethroids, and some of the neonicotinoid products (e.g., Actara), how can growers successfully control BMSB and not completely destroy all natural enemies and the integrity of the IPM program in Pennsylvania? Growers will need to understand and employ all of the tactics used in applying the principles of ecological selectivity to this group of broad-spectrum insecticides. Listed below are some tactics growers can use to minimize the toxicity these products to natural enemies while still controlling BMSB.

#### **Selection of an insecticide**

All insecticides are not equal in their toxicity to natural enemies. When selecting an effective product for BMSB control, always refer to Table 4-4 in this guide and determine its toxicity for the various natural enemies that may also be present. Choose the product that is the least harmful to the natural enemies.

#### **Timing of an insecticide**

Proper timing is often the most effective and economical method of achieving differential insecticide selectivity for the pest/natural enemy complex. Only apply a highly effective insecticide for BMSB when they are in your orchards; therefore, growers must be very, very vigilant to monitor their blocks and surroundings and only apply these highly toxic insecticides when BMSB is present and a threat to their crops.

#### **Dosage**

The toxicity of any chemical compound is directly related to its dose. When using one of these broad-spectrum insecticides for BMSB control, always apply the lowest effective dose possible. Not only will the lowest dose likely conserve some of the natural enemies, but it will also save you some money.

#### **Application techniques and methods**

The only purpose in applying an insecticide is to kill the intended pest(s). Many growers in Pennsylvania have used the alternate row middle (ARM) technique of spraying to apply pesticides to their crops for over 40 years. We know from many years of research that this technique will provide effective pest control if done properly, but at the same time will allow for the survival of many natural enemies. Given the likelihood that the most effective control of BMSB will occur through the direct contact of the insecticide to this pest, the ARM method of spraying may be the best method to apply these broad-spectrum insecticides. By integrating low rates and frequent applications of insecticides (i.e., the original idea behind using the ARM method), better control of BMSB will likely be achieved while causing less harm to natural enemies.

#### **Selective placement**

Restricting an insecticide to a specific part of the tree or location within an orchard is another method to minimize the impact of toxic insecticides to natural enemies. Since BMSB is highly likely to move into orchards from the outside (e.g., woods, neighboring crops [soybeans, corn, vegetables, etc.], buildings), restricting the application of these broad-spectrum insecticides to border rows, etc., will likely conserve many natural enemies.

The brown marmorated stink bug is here and most likely will be an important and serious threat to our fruit system for a long time. Over time, we will learn how to manage this pest more effectively. New tools such as insect behavior modifying materials (e.g., a sex pheromone, an attractant, repellent, or deterrent) will likely be required to successfully control and minimize the threat from this pest. In the meantime, with the knowledge we have and the tools that are available, we need to try to “outsmart” this pest in order to continue to produce the best quality fruits. This exotic pest requires new management approaches, but until we can field test some of our BMSB management hypotheses, these ideas will remain just “concepts” that may prove attractive in theory but difficult or even impractical to implement.

Overcoming the challenges of effective and sustainable BMSB control will not be an easy task in the near term. Much research needs to be done in order for us to develop the most effective management program for the long-term control of this pest. In the meantime, however, we also encourage growers to not lose sight of our current IPM program in Pennsylvania. We have achieved so much over the years and we have learned how to deal with those pest perturbations that seem to always occur. If we are not careful in how we manage BMSB, we may be causing many future pest problems for our industry by destroying the natural enemies that help us keep many of the other pests of tree fruits in balance.

Current and new updates and recommendations are being posted weekly during the season at the Penn State Fruit Research and Extension Center website ([agsci.psu.edu/frec](http://agsci.psu.edu/frec)).

## DISEASES AND DISORDERS



**2,4-D damage**  
*Rob Crassweller*



**Alternaria leaf blotch**  
*Keith Yoder*



**Alternaria fruit rot on cherry**  
*Kari Peter*



**Anthracnose on peach fruit**  
*John Hartman, University of Kentucky, Bugwood.org*



**Apple scab on leaves**  
*Kari Peter*



**Apple scab on fruit**  
*Kari Peter*



**Apple union necrosis**  
*John Halbrendt*



**Bacterial canker on a cherry limb**  
*Kari Peter*



**Bacterial spot on peach fruit**  
*Kari Peter*

## DISEASES AND DISORDERS



**Bacterial spot on peach leaves**  
*Kari Peter*



**Bitter pit**  
*Rob Crassweller*



**Bitter rot on apple fruit**  
*Kari Peter*



**Black knot of plum**  
*Joseph O'Brien, USDA Forest Service, Bugwood.org*



**Black rot on apple fruit**  
*Jim Travis*



**Frog-eye leaf spot on apple leaves**  
*Alan Biggs*



**Black rot on apple branch**  
*Alan Biggs*

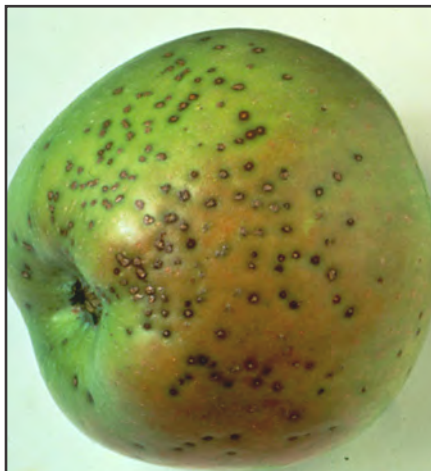

**Blister spot on Crispin**  
*Alan Biggs*



**Blue mold on apple fruit**  
*Kari Peter*

## DISEASES AND DISORDERS



**Brooks fruit spot of apple**  
*Alan Biggs*



**Brown rot on peach fruit**  
*Kari Peter*



**Brown rot on apple fruit**  
*Brian Lehman*



**Brown rot blossom blight on peach**  
*Jim Travis*



**Burr knot on apple rootstock**  
*Rob Crassweller*



**Calyx-end rot on apple fruit**  
*Mary Ann Hansen, Virginia Polytechnic Institute and State University, Bugwood.org*



**Cherry leaf spot**  
*Kari Peter*



**Crown gall on apple**  
*Bryan Butler*



**Crown gall on apple roots**  
*Kari Peter*

## DISEASES AND DISORDERS



**Crown rot of apple**  
*Kari Peter*



**Cytospora canker on peach**  
*Jane Stewart*



**Cytospora canker on peach**  
*Jane Stewart*



**Fire blight (blossom blight)**  
*Kari Peter*



**Fire blight (shoot blight)**  
*Kari Peter*



**Fire blight (canker blight)**  
*Kari Peter*



**Frost damage**  
*Rob Crassweller*



**Fruit cracking due to excessive rain**  
*Rob Crassweller*



**Glyphosate herbicide damage on pear**  
*Rob Crassweller*

## DISEASES AND DISORDERS



**Gray mold on apple fruit**

*Kari Peter*



**Hail damage on apple**

*Kari Peter*



**Honeycrisp leaf yellows**

*Rob Crassweller*



**Marssonina blotch on apple leaves**

*Kari Peter*



**Marssonina blotch on apple leaves**

*Kari Peter*



**Moldy core of apple**

*Kari Peter*



**Mucor rot on apple fruit**

*Kari Peter*



**Necrotic leaf blotch**

*Kari Peter*



**Nectarine pox**

*Kari Peter*

## DISEASES AND DISORDERS



**Nectria twig blight**  
*Scott Weikert*



**Peach leaf curl**  
*Kari Peter*



**Peach scab on peach fruit**  
*Kari Peter*



**Peach stem pitting**  
*I. M. Smith, EPPO, Bugwood.org*



**Pear leaf blight**  
*Kari Peter*



**Pear scab**  
*Bruce Watt, University of Maine, Bugwood.org*



**Phytophthora crown/collar/root rot on apple**  
*Ken Hickey*



**Plum leaf spot**  
*Joseph O'Brien, USDA Forest Service, Bugwood.org*



**Plum pockets**  
*Whitney Cranshaw, Colorado State University, Bugwood.org*

## DISEASES AND DISORDERS



**Plum pox virus on leaves**  
*Ralph Scorza*



**Plum pox virus on leaves**  
*Jim Travis*



**Plum pox virus on immature fruit**  
*Ralph Scorza*



**Plum pox virus on mature fruit**  
*Ruth Welliver*



**Powdery mildew on apple blossom**  
*Kari Peter*



**Powdery mildew on apple leaves**  
*Kari Peter*



**Powdery mildew on apple fruit**  
*Kari Peter*



**Powdery mildew on cherry leaves**  
*Kari Peter*



**Rhizopus rot on cherry fruit**  
*Kari Peter*



## DISEASES AND DISORDERS

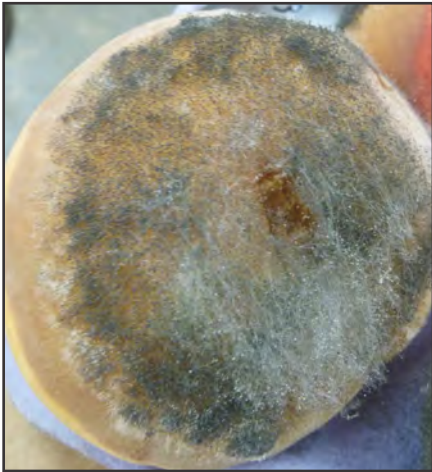

**Rhizopus rot on peach fruit**  
*Kari Peter*



**Rust disease on apple leaves**  
*Kari Peter*



**Rust disease on apple fruit**  
*Kari Peter*



**Sooty blotch and flyspeck on apple fruit**  
*Kari Peter*



**Cedar-apple rust gall**  
*Kari Peter*



**Quince rust on cedar**  
*Kari Peter*



**Quince rust on apple fruit**  
*Ken Hickey*



**Pear trellis rust on pear leaves**  
*Kari Peter*



**Pear trellis rust on pear fruit**  
*Kari Peter*

## DISEASES AND DISORDERS



**Rusty spot on peach fruit**  
*Kari Peter*



**Sooty mold of pear on leaves**  
*Kari Peter*



**Southern blight on apple**  
*Kari Peter*



**Southwest trunk injury**  
*Rob Crassweller*



**Sunburn injury on apple**  
*Rob Crassweller*



**White rot canker on apple**  
*Jim Travis*



**White rot on apple fruit**  
*Kari Peter*

## INSECT AND MITE PESTS



**Apple leafminer injury on leaf**  
*Greg Krawczyk*



**Brown marmorated stink bug adult and nymph**  
*Greg Krawczyk*



**Brown marmorated stink bug freshly hatched egg mass**  
*Greg Krawczyk*



**Brown stink bug (native)**  
*Greg Krawczyk*



**Bumble bee on apple flower**  
*David Biddinger*



**Codling moth adult moth**  
*Greg Krawczyk*



**Codling moth larva**  
*Greg Krawczyk*



**Dogwood borer larva**  
*Greg Krawczyk*



**European apple sawfly injured fruit**  
*Greg Krawczyk*

## INSECT AND MITE PESTS



**European apple sawfly larva**  
*Greg Krawczyk*



**European red mite adults on leaf**  
*Greg Krawczyk*



**Green fruitworm larvae**  
*Greg Krawczyk*

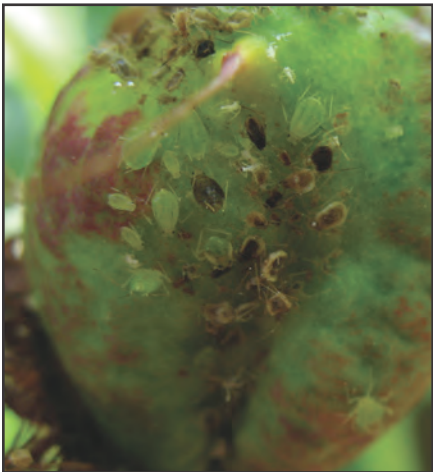

**Green peach aphid on nectarine**  
*Greg Krawczyk*



**Gypsy moth caterpillar**  
*Greg Krawczyk*

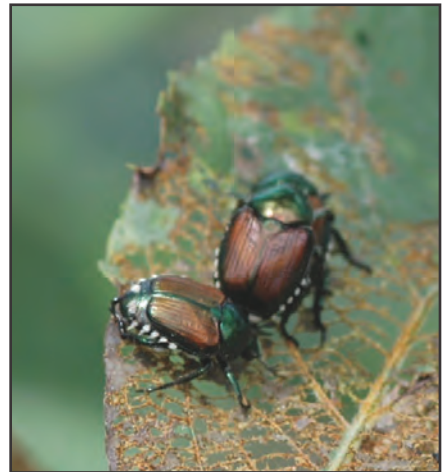

**Japanese beetle adults**  
*Greg Krawczyk*



**Japanese orchard bee on crabapple**  
*David Biddinger*



**Japanese orchard bee hotel**  
*Margarita López-Uribe*



**Lesser appleworm adult moth**  
*Greg Krawczyk*

## INSECT AND MITE PESTS



**Obliquebanded leafroller injured apple terminal**  
*Greg Krawczyk*



**Oriental fruit moth adult**  
*Greg Krawczyk*



**Oriental fruit moth injured shoot (flagging)**  
*Greg Krawczyk*



**Oriental fruit moth larva**  
*Greg Krawczyk*



**Peachtree borer empty pupal exuvia**  
*Greg Krawczyk*



**Pear psylla adults**  
*Greg Krawczyk*



**Pear blister mite symptoms on foliage**  
*Greg Krawczyk*



**Periodical cicada adult**  
*Greg Krawczyk*



**Plant-bug-injured fruit**  
*Greg Krawczyk*

## INSECT AND MITE PESTS



**Plum curculio adult on shoot sprayed with Surround**  
*Greg Krawczyk*



**Rosy apple aphid colony**  
*Greg Krawczyk*



**San Jose scale injured fruit**  
*Greg Krawczyk*



**Skunk damage from hunting for grubs in orchard**  
*Rob Crassweller*



**Spirea aphid on foliage**  
*Greg Krawczyk*



**Tufted apple bud moth adults**  
*Greg Krawczyk*



**White apple leafhopper nymph**  
*Greg Krawczyk*



**White peach scale**  
*Greg Krawczyk*



**Woolly apple aphid aerial colony**  
*Greg Krawczyk*



# CHEMICAL MANAGEMENT

## CONTENTS

<b>Using Pesticides Safely .....</b>	<b>193</b>
<b>Pesticide Toxicity .....</b>	<b>193</b>
Acute Toxicity and Acute Effects .....	193
Signal Words .....	194
Chronic Toxicity and Chronic Effects.....	194
<b>Symptoms of Pesticide Poisoning .....</b>	<b>194</b>
Responding to Pesticide Poisoning Symptoms.....	194
<b>First Aid For Pesticide Poisoning.....</b>	<b>195</b>
Basic First Aid Instructions.....	195
Specific First Aid Instructions.....	195
<b>Safe Storage of Pesticides.....</b>	<b>196</b>
<b>Safe Disposal of Pesticides.....</b>	<b>196</b>
<b>Current Status of Restricted-Use Pesticides in Pennsylvania .....</b>	<b>196</b>
<b>Worker Protection Standard for Agricultural Pesticides .....</b>	<b>197</b>
<b>Water Quality and Its Impact on Pesticide Efficacy .....</b>	<b>198</b>
<b>Pesticides and Performance at Various Solution pHs.....</b>	<b>204</b>
<b>The Jar Test .....</b>	<b>204</b>
<b>Orchard Spraying .....</b>	<b>205</b>
Tree Spraying.....	205
Selecting a Nozzle.....	205
Sprayer Calibration .....	206
General Recommendations .....	207
Ground Spraying.....	210
After Applying an Herbicide.....	212
Factors Affecting the Efficacy of Nematicides .....	213
<b>Bactericides, Fungicides, Herbicides, Insecticides, Nematicides, Soil Fumigants, and Plant Growth Regulators .....</b>	<b>213</b>
<b>Adjuvants .....</b>	<b>251</b>
<b>Fungicide Resistance Management Strategies.....</b>	<b>253</b>
Understanding Types of Fungicides.....	253
Cultural Control and Fungicide Use Patterns .....	254
Fungicide Resistance Issues and Mitigation Strategies for Specific Diseases.....	254
Frequently Asked Questions About Fungicide Resistance ..	256
The Future of Tree Fruit Disease Control .....	256

<b>Using Insect Sex Pheromones for Monitoring and Mating Disruption .....</b>	<b>256</b>
<b>Management of Codling Moth With a CM Granulovirus.....</b>	<b>258</b>
<b>Resistance Management Approach for Insecticides/Miticides in Tree Fruits .....</b>	<b>260</b>
Mechanisms of Insecticide/Miticide Resistance in Tree Fruit Pests .....	260
Use of the New Chemical Tools in a Resistance Management Approach .....	261
<b>Nematode Management Strategies .....</b>	<b>261</b>
Benefits of Nematicides and Soil Fumigants .....	261
Dagger Nematode Control with Green Manure.....	262
Biorational Nematode Control .....	262

## TABLES

<b>Table 3-1.</b> EPA numbers and Worker Protection Standard reentry and personal protective equipment guidelines.....	199
<b>Table 3-2.</b> Total gallons per minute sprayed (both sides) for various row spacings and gallons-per-acre rates, when sprayer moves at 1.5, 2, and 2.5 mph .....	206
<b>Table 3-3.</b> Nozzle flow (gal/min) of various cone tips at various pressures .....	206
<b>Table 3-4.</b> Converting dilute spray rate to concentrate rate of pesticide materials.....	208
<b>Table 3-5.</b> Calculating tree row volume.....	209
<b>Table 3-6.</b> Simplified tree row volume table.....	210
<b>Table 3-7.</b> Comparison of insecticide modes of action based on Insecticide Resistance Action Committee (IRAC) classification.....	214
<b>Table 3-8.</b> Comparison of fungicide modes of action based on Fungicide Resistance Action Committee (FRAC) classification .....	215
<b>Table 3-9.</b> Herbicide Resistance Committee (HRAC) classification of herbicides according to mode of action .....	218
<b>Table 3-10.</b> Copper formulations for fruit crops.....	227
<b>Table 3-11.</b> Adjuvants available for use on tree fruit.....	252
<b>Table 3-12.</b> Target pH ranges and half-lives of selected orchard insecticides and miticides .....	263
<b>Table 3-13.</b> Target pH ranges and half-lives of selected orchard fungicides .....	263
<b>Table 3-14.</b> Target pH ranges and half-lives of common herbicides.....	263

**FIGURES**

**Figure 3-1.** Application Exclusion Zones for low-drift (25 feet) and high-drift applications (100 feet). Illustration by Garo Goodrow ..... 198

**Figure 3-2.** Representation of ground acre, herbicide strip acre, and foliar canopy acre ..... 209

**Figure 3-3.** Various scenarios for applying a CpGV product for codling moth control..... 259



If Pennsylvania growers are to produce a commercially acceptable and profitable product, they often need to rely on the use of pesticides. For years, many growers in the state have practiced and continue to practice integrated pest management (IPM) where pesticides play a vital role. Applicators must clearly understand their legal obligations when using pesticides. Furthermore, applicators who implement pesticide safety practices and take proper precautions will greatly reduce the possibility of accidents.

## USING PESTICIDES SAFELY

### General Guidelines for Pesticide Safety

#### **Always read the label!**

It is important to consider many factors when selecting a pesticide to use if chemical control is necessary. Before using any pesticide product, always read the label, as it is a legal document. The label provides information on which pests can be controlled, on which crops the pesticide product can be used, and the recommended rates and times of application. Using a pesticide in a way that is not allowed by the label is a violation of both federal and state laws. Correct use of pesticides is essential to protect human, animal, and plant health as well as to protect the environment. It is also critical to help ensure pest control without damaging crops. For example, in some cases when rates that are higher than recommended by the label are used, crop injury occurs. Proper use will ensure that chemical residues on crops and livestock do not exceed legal limits (tolerances).

- Before using any pesticide, READ THE LABEL.
- Become familiar with current federal and state pesticide laws and regulations.
- Follow all safety precautions on the label.
- Wear protective clothing and use protective equipment (both are referred to as personal protective equipment, PPE) according to instructions on the pesticide label.
- Minimum clothing requirements found on a label are long pants, long-sleeved shirt, socks, and shoes. In addition, the applicator should wear chemically resistant gloves (nitrile, butyl, or neoprene) and unlined rubber boots.
- If a respirator is required, the user must receive a medical evaluation and respirator fit test.
- Be careful when handling pesticide materials to avoid spilling on skin or clothing.
- Never eat, drink, smoke, or use tobacco products while applying pesticides.
- When selecting pesticides, consider the type of formulation and the application equipment required.
- Avoid drift to nontarget areas, which may endanger other plants or animals. Dusts drift more than sprays and airblast sprayers create more drift than boom sprayers.
- For record-keeping requirements, record the date, time, location, amount of each pesticide used, and any other required information within 24 hours of the application. In addition, if workers/handlers are employed that are covered under the Worker Protection Standard (WPS), this information must be documented at the completion of the application. It must also be available at a central location where employees have unrestricted access to the information.
- Bathe or shower in hot, soapy water after applying pesticides.
- Wash clothing worn while applying pesticides separately from other laundry, in hot, soapy water. Contaminated clothing must be handled with the same precautions as the pesticide itself.

## PESTICIDE TOXICITY

For all pesticides to be effective against the pests they are intended to control, they must be biologically active, or toxic. Because pesticides are toxic, they are also potentially hazardous to humans and animals. Any pesticide can be poisonous or toxic if absorbed in excessive amounts. Pesticides can cause skin or eye damage (topical effects) and can also induce allergic responses. However, if used according to label directions and with the proper personal protective equipment (PPE), pesticides can be used safely. For this reason, people who use pesticides or regularly come in contact with them must understand the relative toxicity and the potential health effects of the products they use. The risk of exposure to pesticides can be illustrated with the following simple equation:

### **Hazard of Pesticide Use = Toxicity × Actual Exposure**

Toxicity is a measure of a pesticide's ability to cause injury, which is a property of the chemical itself. Pesticide toxicity is determined by exposing test animals to different dosages of the concentrated active ingredient. Tests are also done with each different formulation of the product (for example, liquids, dusts, and granulars). By understanding the difference in toxicity levels of pesticides, a user can minimize the potential hazard by selecting the pesticide with the lowest toxicity that will control the pest.

Exposure is the opportunity for a pesticide to contact or enter the body. This is impacted by the length of time the exposure lasts and to which part of the body the exposure occurs. Applicators may have little or no control over the availability of low-toxicity products or the toxicity of specific formulated products; however, exposure can be significantly reduced or nearly eliminated by using the correct PPE. For example, over 90 percent of all pesticide exposure comes from dermal exposure, primarily to the hands and forearms. By wearing chemically resistant gloves, this exposure can be reduced by at least 90 percent. Therefore, by wearing the correct PPE, the hazard of pesticide use can be reduced significantly for the applicator.

### **Acute Toxicity and Acute Effects**

Acute toxicity of a pesticide refers to the chemical's ability to cause injury to a person or animal from a single exposure, generally of short duration. The four routes of exposure are dermal (skin), inhalation (lungs), oral (mouth), and ocular (eyes). Acute toxicity is determined by examining the dermal toxicity, inhalation toxicity, and oral toxicity of test animals. In addition, the potential for eye and skin irritation are also examined.

Acute toxicity is usually expressed as LD<sub>50</sub> (lethal dose 50) or LC<sub>50</sub> (lethal concentration 50) values. This is the amount or concentration of a toxicant required to kill 50 percent of a test population of animals under a standard set of conditions. The most common practice is for the toxicity of pesticides to be referred to by their LD<sub>50</sub> values, which refer to ingestion or dermal exposure. The LD<sub>50</sub> of a pesticide is recorded in milligrams of pesticide per kilogram of body weight of the test animal (mg/kg), or in parts per million (ppm). LC<sub>50</sub> values of pesticides are recorded in milligrams of pesticide per volume of air or water (ppm). To put these units into perspective, 1 ppm is analogous to 1 inch in 16 miles or one minute in two years.

The LD<sub>50</sub> and LC<sub>50</sub> values are useful in comparing the toxicity of different active ingredients as well as different formulations of

the same active ingredient. The lower the LD<sub>50</sub> value of a pesticide, the less it takes to kill 50 percent of the test population, and therefore the greater the acute toxicity of the chemical. Pesticides with higher LD<sub>50</sub> values are considered the least acutely toxic to humans when used according to the directions on the product label.

The LD<sub>50</sub> and LC<sub>50</sub> values are found in the products' Safety Data Sheets (SDS), which are available from the supplier or product manufacturer when pesticide products are purchased. Most are also available from various online sources, including the manufacturer's website or through various search engines as listed on the Pesticide Education Program's website at [extension.psu.edu/pests-and-diseases/pesticide-applicators](http://extension.psu.edu/pests-and-diseases/pesticide-applicators). For many reasons, especially in an emergency situation, maintaining a file with copies of the label and SDS for each pesticide product used is highly recommended.

### Signal Words

The LD<sub>50</sub> of the chemical is the basis for assigning pesticides to a toxicity category and determining the appropriate signal word for the product label. Pesticides that are classified as "highly toxic," on the basis of either oral, dermal, or inhalation toxicity, must have the signal words **DANGER** and **POISON** (in red letters) and a graphic of a skull and crossbones prominently displayed on the package label. **PELIGRO**, the Spanish word for danger, must also appear on the label of highly toxic chemicals. Acute oral LD<sub>50</sub> values for pesticide products in this group range from a trace amount to 50 mg/kg. An exposure of a few drops of a highly toxic material taken orally could be fatal to a 150-pound person.

Some pesticide products are labeled with the signal word **DANGER** without the skull and crossbones symbol. A **DANGER** signal word in this instance does not provide information about the LD<sub>50</sub> value of the chemical. Instead, this signal word means that potentially damaging skin or eye effects (due to the product's irritant or corrosive properties) are more severe than the acute toxicity (LD<sub>50</sub>) of the product would indicate.

Pesticide products considered "moderately toxic" must have the signal words **WARNING** and **AVISO** (Spanish) displayed on the label. Acute oral LD<sub>50</sub> values range from 50 to 500 mg/kg. An exposure of 1 teaspoon to 1 ounce could be fatal to a 150-pound person.

Pesticide products classified as either "slightly toxic" or "relatively nontoxic" are required to have the signal word **CAUTION** on the pesticide label. Acute oral LD<sub>50</sub> values are greater than 500 mg/kg. Pesticides considered practically nontoxic and nonirritating (oral LD<sub>50</sub> greater than 5,000 mg/kg and dermal LD<sub>50</sub> greater than 20,000 mg/kg) are not legally required to have a signal word, though most manufacturers will include a **CAUTION**.

### Chronic Toxicity and Chronic Effects

Any harmful effects that occur from repeated small doses over a period of time are called chronic effects. The chronic toxicity of a pesticide is determined by observing symptoms in test animals that result from long-term exposure to the concentrated active ingredient.

Some of the potential chronic effects from exposure to certain pesticides include birth defects (teratogenesis); fetal toxicity (fetotoxic effects); production of tumors (oncogenesis), either benign (noncancerous) or malignant (cancerous/carcinogenesis); genetic

changes (mutagenesis); blood disorders (hemotoxic effects); nerve disorders (neurotoxic effects); and reproductive effects. The chronic toxicity of a pesticide is more difficult to determine through laboratory analysis than is acute toxicity. However, the product's SDS also contains information regarding chronic symptoms of pesticide exposure based on laboratory animal test results.

## SYMPTOMS OF PESTICIDE POISONING

The symptoms of pesticide poisoning can range from a mild skin irritation to coma or even death. Different classes or families of chemicals cause different types of symptoms. Individuals also vary in their sensitivity to different levels of these chemicals. Some people may show no reaction to an exposure that may cause severe illness in others. Because of potential health concerns, pesticide users and handlers must recognize the common signs and symptoms of pesticide poisoning.

The effects, or symptoms, of pesticide poisoning can be broadly defined as either topical or systemic. Topical effects generally develop at the site of pesticide contact and are a result of either the pesticide's irritant properties (from either the active and/or inert ingredient) or an allergic response by the person exposed. Dermatitis, or inflammation of the skin, is accepted as the most commonly reported topical effect associated with pesticide exposure. Symptoms of dermatitis range from reddening of the skin to rashes and/or blisters. Some individuals exhibit allergic reactions when using pesticides or when these materials are applied in or around their homes or places of work. Symptoms of allergic reactions range from reddening and itching of the skin and eyes to respiratory discomfort that often resembles an asthmatic condition.

Systemic effects are quite different from topical effects. They often occur away from the original point of contact, as a result of the pesticide being absorbed into and distributed throughout the body. Systemic effects often include nausea, vomiting, fatigue, headache, and intestinal disorders.

Seeking prompt medical attention and providing information about the potential of a pesticide exposure causing the symptoms is important. However, the development of certain symptoms is not always the result of exposure to a pesticide. For example, common illnesses such as the flu, heat exhaustion or heat stroke, pneumonia, asthma, respiratory and intestinal infections, and even a hangover can cause symptoms similar to pesticide exposure. Carefully consider all possible causes of your symptoms and provide medical personnel with all of the information they need to make an informed diagnosis.

### Responding to Pesticide Poisoning Symptoms

Be alert for the early symptoms of pesticide poisoning. Responding immediately and appropriately when pesticide exposure is suspected will help minimize the effects of exposure and, in extreme cases, may save a life. If you are having symptoms but are unsure whether they are pesticide related, at least notify someone in case your symptoms become worse. If you are not feeling well and suspect it may be due to a pesticide exposure, call the National Poison Center at 1-800-222-1222 for guidance on the proper response to your symptoms. This number will direct your call to the nearest poison center, which is staffed on a 24-hour basis.

If safe to do so, take the pesticide container to the telephone.

However, if the pesticide container is contaminated, write down the EPA registration number, product name and percentage of active ingredients, and take that information to the phone. The product label provides medical personnel information such as active ingredients, an antidote, and an emergency contact number for the manufacturer of the product. If you must go to the hospital or doctor's office, take the entire container, including the label, with you. In order to avoid inhaling fumes or spilling the contents, make sure the container is tightly sealed and never put it in the enclosed passenger section of a vehicle. If the Safety Data Sheet (SDS) is available, also take this with you because it frequently contains additional information for medical personnel to determine treatment options.

In addition to posting emergency numbers or having them readily available by a telephone, keep these numbers in all service vehicles involved in transporting pesticides. Additional pesticide information can also be obtained by contacting the National Pesticide Information Center (NPIC) located at Oregon State University at 1-800-858-7378. The NPIC provides a variety of unbiased information about pesticides to anyone in the United States.

## FIRST AID FOR PESTICIDE POISONING

*Reviewed by J. Ward Donavan, medical director of Pinnacle Health Toxicology Center, Harrisburg Hospital*

Immediate and appropriate action, such as providing basic first aid, may be necessary to prevent serious injury to a victim of pesticide poisoning. The situation can be a life-or-death matter. Providing immediate care is important; however, it is more important to provide the correct assistance and protect yourself in the process. The product label should be one of the first sources of information in a pesticide exposure emergency, in addition to calling 911 and the National Poison Center (1-800-222-1222). *First aid is only the "first response" and is not a substitute for professional medical help.*

### Basic First Aid Instructions

- Most important, be sure to protect yourself by wearing appropriate protective clothing and equipment if there is a likelihood of being directly exposed to a pesticide while administering first aid or removing the victim from an enclosed area.
- Have current labels and SDSs available.
- Have emergency response telephone numbers readily available.
- Assemble a first aid kit with necessary supplies.
- Always have a source of clean water available. In an extreme emergency, even water from a farm pond, irrigation system, or watering trough could be used to dilute the pesticide.
- If oral or dermal exposure has occurred, the first objective is usually to dilute the pesticide and prevent absorption.
- If inhalation exposure occurs, first protect yourself, and then get the victim to fresh air immediately.
- Never give anything orally to an unconscious person.
- Become familiar with the proper techniques of artificial respiration; it may be necessary if a person's breathing has stopped or become impaired.

### Specific First Aid Instructions

If the victim **IS NOT** breathing:

- **FIRST**—Evaluate the surroundings of the victim. Protect yourself from pesticide exposure prior to and while giving assistance.
- **SECOND**—Administer artificial respiration and call 911.
- **THIRD**—Call the National Poison Center (1-800-222-1222).
- **FOURTH**—Decontaminate the victim immediately; wash thoroughly and quickly. Speed is essential.

If the victim **IS** breathing:

- **FIRST**—Evaluate the surroundings of the victim. Protect yourself from pesticide exposure prior to and while giving assistance.
- **SECOND**—Decontaminate the victim immediately; wash thoroughly and quickly. Speed is essential.
- **THIRD**—Call 911 if the victim has ill effects from the exposure.
- **FOURTH**—Call the National Poison Center (1-800-222-1222).

**If the pesticide has been spilled on the skin or clothing**, remove any contaminated clothing immediately and thoroughly wash the skin with soap and water. Avoid harsh scrubbing, as this enhances pesticide absorption. Rinse the affected area with water, wash again, and rinse. Gently dry the affected area and wrap it in a loose cloth or blanket, if necessary. If chemical burns of the skin have occurred, cover the area loosely with a clean, soft cloth. Avoid the use of ointments, greases, powders, and other medications unless instructed by medical personnel.

Heavily contaminated clothing should be disposed of properly. If clothing is not heavily soiled, wash all contaminated clothing separately from any other laundry, in hot water, at a high water level, and with a heavy duty liquid detergent. Run the washer through a complete cycle with detergent and no clothes to remove pesticide residue from the washer drum before the next load of laundry. Store washed protective clothing separately from other clothes. Also, do not store protective clothing and equipment in pesticide storage areas.

**If the pesticide has entered into the eyes**, hold the eyelid open and immediately begin gently washing the eye with clean running water, so that the water flows away from the nose. If contact lenses are worn, remove and discard the contacts before beginning this process. Do not use chemicals or drugs in the eye wash water. Continue washing for 15 minutes. If only one eye is involved, avoid contaminating the other one. Flush under the eyelids with water to remove debris. Cover the eye with a clean piece of cloth and seek medical attention immediately.

**If the pesticide has been inhaled**, get the victim to fresh air immediately. However, do not attempt to rescue someone who is in an enclosed area unless you are wearing appropriate protective equipment. Have the victim lie down and loosen their clothing. Call 911. Keep the victim warm and quiet. If the victim is convulsing, watch their breathing and protect their head. Keep the chin up to keep air passages free for breathing. If breathing stops, administer artificial respiration. Call the National Poison Center (1-800-222-1222) after the victim is stabilized for further advice.

**If the pesticide has been swallowed**, contact the National Poison Center (1-800-222-1222) and provide them with the EPA registration number, product name, and approximate amount of material that was ingested. Call 911 immediately if the victim has symptoms from the exposure. If the pesticide has entered the mouth but has not been swallowed, rinse the mouth with large amounts of water. **Inducing vomiting is rarely advised for any poisoning, including pesticide poisonings.** Check the product label to determine the appropriate immediate action.

**If a petroleum product** (kerosene, gasoline, oil, lighter fluid, EC pesticides) **has been swallowed**, call the National Poison Center (1-800-222-1222) and 911 immediately for further instruction.

**If a corrosive poison** (a strong acid or alkali) **has been swallowed**, dilute with water or milk immediately. Consult the National Poison Center (1-800-222-1222) and 911 immediately. The victim may experience severe pain and have extensive mouth and throat burns. Fortunately, most commonly used pesticides are not corrosive, but some cleaners, disinfectants, and germicides fall into this category.

## SAFE STORAGE OF PESTICIDES

- Read the label for specific storage instructions and precautions.
- Store pesticides in a clean, cool, dry, and well-ventilated building. Always lock the area to prevent entry by children and unauthorized persons. Post the storage facility with an appropriate warning sign.
- Maintain proper temperature control. For example, if emulsion-type materials freeze, the emulsion may be destroyed, resulting in loss of effectiveness and possible serious plant injury.
- To avoid the danger of cross-contamination, do not store herbicides with other pesticides.
- Keep dry materials above liquid materials.
- Do not store pesticides where food, water, feed, seeds, fertilizers, or personal protective clothing and equipment (such as respirators) can become contaminated.
- Store pesticides in their original containers. Never store pesticides in any food or drink containers.
- Do not remove the labels. Keep lids tightly closed.
- Check containers frequently for leaks.
- Clean up spilled chemicals promptly and properly. Dispose of broken or damaged containers and any pesticide waste in an approved and safe manner as directed on the product label.
- Keep an inventory of all chemicals. Mark each container with the year of purchase.
- Inform your local fire department of any chemicals (including fertilizers) stored in large quantity.

## SAFE DISPOSAL OF PESTICIDES

- Read the pesticide label for specific disposal instructions.
- Avoid disposal problems by purchasing only the amount of material needed for one growing season. Do not stockpile.
- Use proper personal protective clothing and equipment when you dispose of pesticide wastes and containers.

- Mix only the amount of pesticide required for a particular application. If you mix too much, use the surplus by applying the material at the recommended rate to one of the crops or sites listed on the label.
- Do not dump pesticides or pesticide rinsates on the ground or pour them down sinks, toilets, or other drains, including storm sewers.
- Pressure rinse or triple rinse empty pesticide containers with water according to label instructions. Pour the rinse water into the spray tank, making sure to drain the container for 30 seconds each time.
- After rinsing containers, puncture them or in some way render them unusable. Where possible, recycle plastic containers through a Plastic Pesticide Container Recycling Program; in some states these are sponsored by the state's Department of Agriculture. Contact the Pennsylvania Department of Agriculture, your local Extension office, or your state pesticide regulatory agency for further information. Otherwise, disposal in a sanitary landfill is desirable if conducted in accordance with local regulations.
- Send large metal or plastic drums to a reconditioning company.
- Before disposing of pesticide concentrates, check with the Pennsylvania Department of Agriculture or your state pesticide regulatory agency, which may provide disposal options for unwanted and outdated pesticide concentrates free of charge. In Pennsylvania, this can be accomplished by participating in the CHEMSWEEP program sponsored by the Pennsylvania Department of Agriculture.
- Do not reuse empty pesticide containers for any purpose.
- Clean up thoroughly after handling and disposing of pesticides.

## CURRENT STATUS OF RESTRICTED-USE PESTICIDES IN PENNSYLVANIA

Under the authority of the amended Federal Insecticide, Fungicide, and Rodenticide Act (FIFRA), applicators who apply restricted-use pesticides (RUPs) in the production of an agricultural crop must be certified as a private applicator or must work under the direct supervision of a certified applicator. Furthermore, only certified applicators can purchase restricted-use pesticides. The pesticide dealer is required by law to record the name, address, and certification number of the purchaser of RUPs, as well as the identity of the product, amount sold, and date of purchase. Either photo identification or two other acceptable forms of identification are required to be presented to the dealer when RUPs are delivered. Commercial and public pesticide applicators must be certified to use both general and restricted-use pesticide products.

RUPs include all pesticide products designated as restricted-use by the U.S. Environmental Protection Agency; however, for use to be legal, products must also be registered by the state. In addition, states may choose to assign restricted-use status to other products if it is deemed in the interest of the public health and welfare. States may also refuse to register a pesticide for use if they choose. If a pesticide is a federally restricted-use product, this status will be clearly marked on the label.

## WORKER PROTECTION STANDARD FOR AGRICULTURAL PESTICIDES

The Worker Protection Standard (WPS) affects all producers of agronomic crops, not just field crops. WPS covers any plant or plant parts grown for sale or distribution. If you apply any type of pesticide (general or restricted use) and employ any workers or pesticide handlers (this includes family members), have your spray equipment serviced, or contract with a custom applicator, then parts of the WPS will apply to you. Pesticides include insecticides, herbicides, fungicides, miticides, and fumigants, as well as many organic products.

The WPS includes requirements designed to reduce the risks of illness or injury to agricultural workers and pesticide handlers from occupational or accidental exposure to pesticides in the production of agricultural plants on farms, nurseries, greenhouses, and forests. The EPA revised the WPS in 2015, and it is now being enforced including the use of the new expanded training materials, the expanded pesticide safety information (poster), and the Application Exclusion Zone (AEZ) off the grower's property.

Workers who do hand-labor tasks in pesticide-treated areas within 30 days after the last restricted-entry interval (REI) expires are protected under the WPS. Pesticide handlers are employees who mix and load pesticides, apply pesticides, and/or fix and clean application equipment, and are also covered under the WPS. The EPA developed the WPS regulations with non-English-speaking workers specifically in mind. Safety warnings, information, and training must be given in "a manner and language the worker can understand."

Although the immediate family members of the establishment's owner are exempt from most of the WPS protections, they must still comply with label requirements such as personal protective equipment (PPE) and restricted-entry intervals (REIs). The immediate family exemption now includes the owners, their children, step and foster children, parents, step and foster parents, brothers, sisters, grandparents, grandchildren, nephews, nieces, aunts, uncles, first cousins, and in-laws.

The WPS requires that information be provided to pesticide handlers and agricultural workers in the following manner:

- Give notification of a pesticide application and restricted-entry intervals either orally or by posting or both. All pesticides with agricultural uses have at least a four-hour REI, while others can have REIs over 48 hours—be sure to check the label.
- Provide annual pesticide safety training using EPA-approved training materials before any employee does any WPS work.
- Place the pesticide safety information poster at the central location with unrestricted access where it can easily be seen by all workers and handlers. Note: Growers with several distinct work sites (geographically) need to have a central location at each site, unless all the workers and handlers begin the workday at the same site before dispersing.
- Inform pesticide handlers and early entry workers of pesticide label safety information.
- Establish a centrally located listing of pesticide applications plus REIs and Safety Data Sheets (SDS) of pesticide applications made in the previous 30 days plus the REI.

WPS is more than just the exchange of information. Label-specific requirements include statements specifying what personal protective equipment must be provided, maintained, and worn; REIs; and special requirements for early entry into treated areas under an REI.

Generic requirements are intended to eliminate or reduce exposure to pesticides and inform employees about the occupational hazards of pesticides. The employer must make sure that employees are provided with the following for their protection and use of pesticides:

- Decontamination supplies within a quarter of a mile of employee's work area.
- Permanent decontamination sites or temporary decontamination supply sites for eleven or more employees need to be marked by the pesticide safety information (poster).
- Handlers require at least three gallons of water, soap, single-use towels, and an emergency change of clothes. Handlers working with pesticide products requiring eye protection must have "immediate access" to at least a pint of eyewash water. In an emergency situation, clean natural waters that are closer than the decontamination supplies can be used, but decontamination supplies must still be provided.
- Mix and load sites where pesticide products requiring eye protection are handled must have an eyewash system capable of providing 0.4 gallon of water for fifteen minutes.
- Workers must be provided with at least one gallon of wash water, soap, and single-use towels per work period for routine washing.
- Pesticide safety training and information.
- Notification of pesticide applications and the Safety Data Sheets for those pesticide products used.
- Clean and properly maintained personal protective equipment.
- Prompt emergency assistance when required.
- Annual medical evaluations, respirator fit tests, and respirator training for handlers working with pesticide products that require a respirator.

The revised WPS introduces a new concept called the Application Exclusion Zone (AEZ). The AEZ establishes a 25-foot "bubble" (think of a circle drawn 25 feet out in every direction from the application equipment) for low-drift applications, which includes those sprayed higher than 12 inches above the soil using medium or large spray droplets, and 100-foot "bubbles" (a circle 100 feet in every direction from the equipment) for high-drift applications which include aerial, airblast, or small-droplet applications (Figure 3-1). Application only needs to be suspended until the AEZ does not include any people. (For more information about the revised WPS regulation, including the Application Exclusion Zone, refer to *How to Comply with the 2015 Revised Worker Protection Standard for Agricultural Pesticides: What Owners and Employees Need to Know*, which can be found on EPA's Occupational Pesticide Safety and Health website.)

Should you require a commercial applicator to make an application to your property, you are required to inform the applicator of where you have made applications within the past thirty days and they must provide you with the information on their

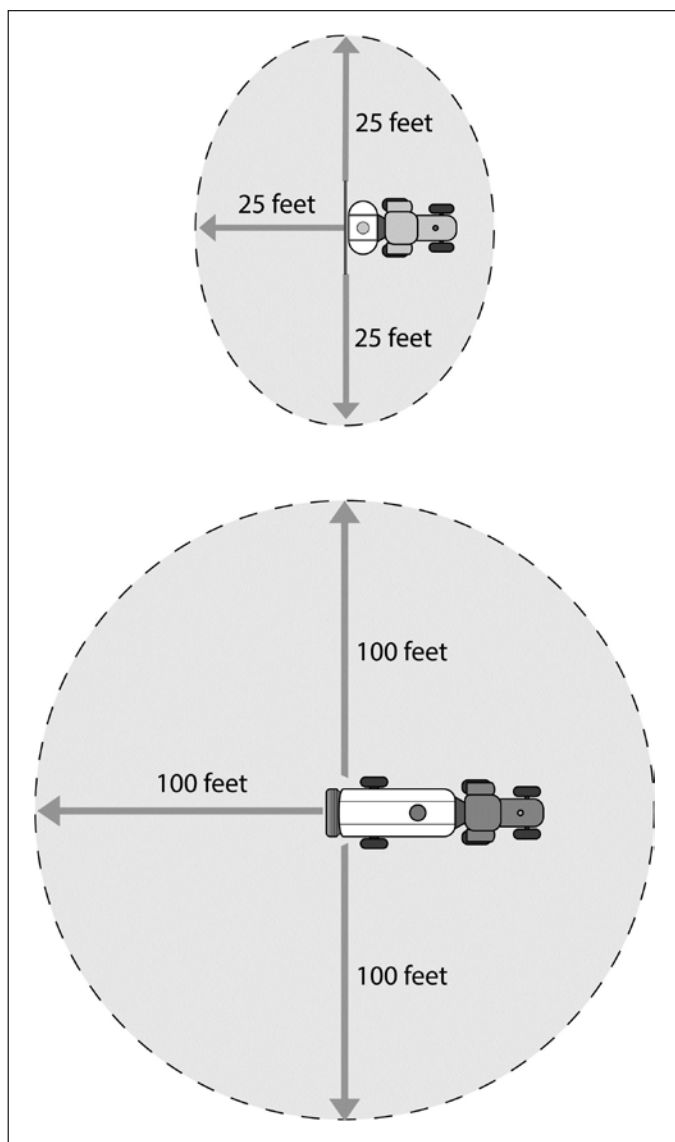

**Figure 3-1.** Application Exclusion Zones for low-drift (25 feet) and high-drift applications (100 feet). Illustration by Garo Goodrow.

applications for you to pass onto your employees. Similarly, if the equipment used in pesticide applications needs to be serviced or repaired, you must inform the repair person of the types of pesticide residues they might encounter on the equipment.

See Table 3-1 for insecticides, acaricides, fungicides, bactericides, growth regulators, and herbicides and their EPA registration number, common name, REI, applicator PPE requirements, and early entry PPE requirements. This table may not include all known pesticides. It is recommended that users refer to the product specimen label for any product not listed for necessary information needed to use the product.

## WATER QUALITY AND ITS IMPACT ON PESTICIDE EFFICACY

Water may be called the universal solvent, but its properties can sometimes interfere with the efficacy of some pesticides used in the orchard. Water quality can vary dramatically depending on its source, the geologic formation it is being drawn from, and even

the time-of-the-year when the water is being withdrawn from the ground or impoundment. While most farms and orchards are not using a public water supply its quality may also adversely impact the efficacy of some pesticides since water pH is frequently adjusted upwards to lessen the potential for corrosivity in pipes.

There are several aspects of water quality that are a concern for growers in respect to pesticide mixing and application. The first area of concern is water pH. Most pesticides are formulated to perform best when the water is slightly acidic. When some pesticides are mixed with water that has a high pH it can cause the pesticide to hydrolyze or break down in the spray tank resulting in a loss of efficacy. In cases where the water pH is very low or strongly acidic it may cause some products like copper-based fungicides to be more reactive resulting in plant injury to some species or it may increase the potential for volatility or drift of some auxin-type herbicides.

Water pH is frequently governed by the source of the water and the geologic source that it is emanating from. Ground water being drawn from limestone aquifers is often described as hard or as having a high alkalinity. While high alkalinity in itself is not necessarily a bad thing it will increase the buffering capacity of the water which may require the use of higher rates of spray buffers to adjust the pH of the water in the spray tank. The higher the water alkalinity of the water source the more resistant it will be to a change in pH.

Water pulled from surface impoundments, springs, or streams may also have a high pH. While some surface water sources emanate from limestone aquifers most surface water sources are heavily influenced by rainfall and water run-off and they typically have very low water alkalinity levels. Water sources with very low alkalinity are said to be poorly buffered and their pH will vary dramatically based on the time of day that the pH is measured. Ponds with low alkalinity levels and substantial aquatic plant populations may observe wide fluctuations in their water pH. Some growers have observed a pH of 5.0 at 5:00 a.m. and a pH of 10.0 at 2:00 p.m. due to low alkalinity levels and high populations of photosynthesizing aquatic plants in the pond.

The alkalinity level of any water source used for mixing pesticides should be known by the grower. By knowing the alkalinity level of your water source, you will know how your water will react with the products that you are mixing in your spray tank. If a farm or orchard has multiple water sources available for use, select the water source that has the lower water alkalinity level and a pH that is slightly acidic (< 7.0).

Water turbidity is another water quality concern for growers mixing pesticides since it can bind with some products resulting in a loss of efficacy. In most cases turbid water is observed in surface water impoundments where clay particles are suspended in the water. Filtration of the water to improve clarity may prevent a loss in pesticide efficacy. For example, herbicide products containing glyphosate frequently experience a loss in efficacy when mixed into cloudy or turbid water.

Water quality can change on the farm by the hour in many areas. In order to maximize your spray dollar and to maintain pesticide efficacy, growers should equip their operations with some basic water testing equipment. Colorimetric pH test strips are a practical and low cost means to evaluate the pH of the spray water and the pesticide solution in the spray tank. High-quality

**Table 3-1. EPA numbers and Worker Protection Standard reentry and personal protective equipment guidelines.**

**Worker notification:** Under most circumstances, worker employers must make sure that workers are notified about areas where pesticide applications are taking place or where restricted-entry intervals are in effect. For details on notification requirements both for these products and those not represented below, refer to the product label and the Worker Protection Standard, 40 CFR part 170.

Product	EPA reg. no.	Common name	REI (hours)	Applicator PPE	Early entry PPE
<b>Insecticides and Acaricides</b>					
Acramite 50WS	400-503	**bifenazate	12	ach	cfk
Actara 25WDG (non-RUP)	100-938	**thiamethoxam	12	acf	cfk
Admire Pro 4.6SC (non-RUP)	264-827	**imidacloprid	12	acf	cfk
§Agree 3.8WS	70051-47	Bt	4	abcl	bck
*Agri-Flex SC	100-1350	**abamectin, **thiamethoxam	12	acf	cdf
*Agri-Mek 8SC	100-1351	**abamectin	12	acf	cdf
Altacor 35WDG (non-RUP)	279-9607	chlorantraniliprole	4	ac	ac
*Ambush 25WP	5481-502	**permethrin	12	acfi	cfhk
Apollo 4SC	66222-47	**clofentezine	12	acf	cfk
*Asana XL 0.66EC	59639-209	**esfenvalerate	12	acfh	cfhk
Assail 30SG	8033-36	**acetamiprid	12	acfj	bck
Avaunt 30WDG	279-9587	**indoxacarb	12	acf	efg
§Aza-Direct 1.2L	71908-1-10163	**azadirachtin bee toxicity not in label	4	acf	cfk
§Azatin XL 0.27EC	70051-27-59807	**azadirachtin bee toxicity not in label	4	acfh	cfhk
*Baythroid XL 1EC	264-840	**beta-cyfluthrin	12	acfh	cfhk
Beleaf 50SG	71512-10-279	flonicamid	12	abcl	bc
*Brigade 10WSB	279-3108	**bifenthrin	12	abc	bck
*Brigade 2EC	279-3313	**bifenthrin	12	acf	cfk
§Carpovirusine 0.99SC	66330-55	granulosis virus	12	acfhlo	chfk
Centaur 0.7WDG (non-RUP)	71711-21	buprofezin	12	abc	bck
§Checkmate CM-F 14.4S	56336-37	pheromone	4	abc	bcd
§Checkmate OFM-F 24.6S	56336-24	pheromone	0	abc	—
§Checkmate Puffer CM-OFM	73479-11	pheromone	0	—	—
§Cyd-X 0.06SC	70051-44	granulosis virus	4	abcl	bck
*Danitol 2.4EC	59639-35	**fenpropathrin	24	acfh	cfhk
Delegate 25WG	62719-541	**spinetoram toxic to bees	4	ac	cfk
§Deliver 18WG	70051-69	Bt	4	abcl	bck
§Des-X 4.07LC	67702-22-70051	insecticidal soap	12	dfghij	dfghj
*Diazinon 50WP	66222-10	**diazinon	96	acf	efgj
Dimethoate 4EC (non-RUP)	19713-231	**dimethoate	10 days	acfhil	efgj
Dimethoate 400 (non-RUP)	34704-207	**dimethoate	10 days	acfilh	efgj
§Dipel 10.3DF	73049-39	Bt	4	abc	bck
*Endigo ZC	100-1276	**lambda-cyhalothrin, **thiamethoxam	24	dfgij	dfgj
§Entrust 80WP	62719-282	**spinosad	4	ac	bck
§Entrust 2SC	62719-621	**spinosad	4	ac	cfk
Envidor 2SC	264-831	**spirodiclofen toxic to bees	12	abc	abc
Esteem 35WP	59639-115	pyriproxyfen	12	ac	bce
Exirel 0.83E (non-RUP)	279-9615	**cyantraniliprole	12	acf	cfk
*Gladiator EC	279-3441	**zeta-cypermethrin, avermectin B1	12	acf	cfk
Imidan 70W (non-RUP)	10163-169	**phosmet	3–7 days (E)	acfi	cfjk
Intrepid 2F (non-RUP)	62719-442	methoxyfenozide	4	acf	cfk
§Isomate-CM/OFM TT	53575-30	pheromone	0	b	—
§Isomate-PTB Dual	53575-34	pheromone	0	b	—
§Isomate OFM TT	53575-29	pheromone	0	b	—
§Isomate CM/OFM Mist	53575-44	pheromone	0	b	—
§Isomate DWB	53575-40	pheromone	0	b	—
§Javelin 7.5WDG	70051-66	Bt	4	abcl	bck
§JMS Stylet-Oil	65564-1	paraffinic oil	4	acf	cfk

(continued)

**Table 3-1. EPA numbers and Worker Protection Standard reentry and personal protective equipment guidelines (continued).**

Kanemite 15SC	66330-38	acequinocyl	12	acf	cfk
*Lambda-Cy 1EC	70506-121	**lambda-cyhalothrin	24	acfh	acf
*Lannate 90SP	352-342	**methomyl	48–96 (E)	acfh	cfhk
*Lannate LV 2.4L	352-384	**methomyl toxic to bees	48–96 (E)	acfh	cfhk
*Leverage 360	264-1104	**imidacloprid, **beta-cyfluthrin	12	acf	cfk
*Lorsban 4E	62719-220	**chlorpyrifos	96	efgj	dfgj
Lorsban 75WG	62719-301-10163	**chlorpyrifos	96	acefgij	dfgj
*Lorsban Advanced 3.76EC	62719-591	**chlorpyrifos	96	acgfij	dfgj
§Madex HP	69553-1	insecticidal virus	4	abc	bck
Magister SC	10163-322	**fenazaquin	12	acf (k)	ckf
Malathion 57EC	34704-108	**malathion	12	acfh	cfk
Movento 240SC	264-1050	spirotetramat	24	acf	cfk
§M-Pede 49L	10163-324	insecticidal soap	12	ac	bck
Nealta	7969-336	cyflumetofen	12	acf	cfk
§Neemix	70051-9	**azadirachtin	4	acfh	cfhk
Nexter 75WS	81880-4-10163	**pyridaben	12	abchj	bchjkl
Onager 1EC	10163-277	hexythiazox	12	acf	cfk
Portal 0.4EC	71711-19	fenpyroximate	12	acfh	cfhk
Portal XLO 0.4EC	71711-40	fenpyroximate	12	acfh	dfgh
*Pounce 25 WP	279-3051	**permethrin	12	abci	ckf
*Proclaim 5SG	100-904	**emamectin benzoate	12	acef	cfhk
§PyGanic 1.4EC	1021-1771	**pyrethrins	12	acf	acf
§Pyrenone 6L	432-1033	**pyrethrins, PBO	12	acfh	cfk
Rimon 0.83EC (non-RUP)	66222-35-400	novaluron	12	acfh	cefh
Savey 50DF	10163-250	hexythiazox	12	abc	bck
§Seduce Insect Bait	67702-25-70051	spinosad bee toxicity not in label	4	ac	bck
Sevin XLR Plus	61842-37	**carbaryl	12	acfi	dfgj
Sevin 4F	61842-38	**carbaryl	12	acfi	dfgj
SPLAT OFM 30M-1	80286-1	pheromone	4	acfh	cfhk
*Supracide 2EC	10163-236	methidathion	72	acfil	dfghj
§Surround 95WP	61842-18	kaolin	4	acl	ac
*Vendex 50WP	70506-211	hexakis	48	dfghij	cfhk
Voliam Flexi WDG (non-RUP)	100-1319	**thiamethoxam, chlorantraniliprole	12	acf	cfk
*Voliam Xpress EC	100-1320	**lambda-cyhalothrin, **chlorantraniliprole	24	acf	cfk
*Vydate 2L	352-372	**oxamyl	48	dfghij	cfhk
*Warrior II 2.08 CS	100-1295	**lambda-cyhalothrin	24	acfh	cfk
Zeal Miticide1 72WS	59639-138	etoxazole	12	acf	acf
<b>Fungicides and Bactericides</b>					
Academy	100-1529	difenoconazole, fludioxonil	—	abc	—
Agri-mycin 17WP	55146-96	streptomycin	12	acf	cfhk
Agri-fos	71962-1	phosphite	4	abch	bcdh
Aliette WDG	264-516	fosetyl-Al	12	abch	cfhk
Apogee 27.5%	7969-188	prohexadione calcium	12	acf	cfk
Badge SC	80289-3	copper oxychloride, copper hydroxide	48	acf	efgjh
§Badge X2	80289-12	copper oxychloride, copper hydroxide	48	acfh	dfgjh
Bravo Weather Stik	66222-276	chlorothalonil	12	acf	cfhk
Bravo Ultrex	66222-277	chlorothalonil	12	dfghij	dfghj
Cabrio EG	7969-187	pyraclostrobin	12	acf	cfk
Captan 50WP	66330-234	captan	24 (E)	acfil	cfhk
Captan 80WDG	66222-58	captan	24(E)	acfhil	cfhk
Champ Formula-2 4.6F	55146-64	copper hydroxide	48	acfh	cfhk
C-O-C-S WDG	34704-326	copper oxychloride, basic copper sulfate	48	acfh	efghj



**Table 3-1. EPA numbers and Worker Protection Standard reentry and personal protective equipment guidelines (continued).**

§Cueva Fungicide	67702-2-70051	octanoic acid	4	acf	acf
Cuprofix Ultra Dispers 40DF	70506-201	basic copper sulfate	48	ac	efghj
§Double Nickel 55	70051-108	Bacillus amyloliquefaciens	4	abcl	bck
§Double Nickel LC	70051-107	Bacillus amyloliquefaciens	4	abcl	bck
Echo 720	60063-7	chlorothalonil	12	acfh	cfhk
Echo 90DF	60063-10	chlorothalonil	12	acfh	cfhk
Elevate 50WDG	66330-35	fenhexamid	12	acf	cfk
Ferbam Granuflo	45728-7	ferbam	24	afl	cfk
Fireline	80990-1	oxytetracycline HCl	12	cdfhjl	cdfh
Firewall	80990-4	streptomycin	12	acfl	cfk
Flint	264-777	trifloxystrobin	12	acf	cfk
Fontelis	352-834	penthiopyrad	12	ac	fck
GEM 500 SC	264-826	trifloxystrobin	12	acf	cfk
Indar 2F	62719-416	fenbuconazole	12	acfj	cfk
Inspire Super	100-1317	difenoconazole, cyprodinil	12	acf	cfk
§JMS Stylet-Oil	65564-1	paraffinic oil	4	acf	cfk
Kocide 3000	91411-2-70051	copper hydroxide	48	abc	cfhk
§Kocide 3000—O	91411-11-70051	copper hydroxide	48	abc	cfhk
Luna Tranquility	264-1085	fluopyram, pyrimethanil	12	acf	cef
Manzate ProStik	70506-234	mancozeb	24	acf	cfk
Merivon	7969-310	pyraclostrobin, fluxapyroxad	12	acf	cfk
Mertect 340-F	100-889	thiabendazole	12	ac	cfk
§Microthiol Dispers	70506-187	sulfur	24	acfh	cfhk
Mycoshield 17WP	55146-97	oxytetracycline HCl	12	cdfhjl	cdfh
No Scald DPA EC-283	2792-45	diphenylamine	psthvst	acf	—
OxiDate	70299-12	**hydrogen peroxide, peroxyacetic acid (toxic to bees)	1	ac	bce
Penbotec 400SC	43813-32-64864	pyrimethanil	psthvst	acf	—
Penncozeb 75DF	70506-185	mancozeb	24	acfh	cef
Penncozeb 80WP	70506-183	mancozeb	24	cephi	cef
Phostrol	55146-83	phosphite	4	acfh	cfhk
Polyram 80DF	7969-105-34704	metiram	24	efgil	cfk
Pristine 38WDG	7969-199	pyraclostrobin/boscalid	12	acfh	cfhk
Procure 480SC	400-518	triflumizole	12	acf	cfk
Prophyt	42519-22-5905	potassium phosphite	4	abc	bck
Quash	59639-147	metconazole	12	acf	cfk
Quintec	62719-375	quinoxifen	12	acf	cfk
Rally 40WSP	62719-410	myclobutanil	24	acf	cfk
Ridomil Gold SL	100-1202	mefanoxam	48	acf	cfk
Rovral 4 Flowable	279-9564	iprodione	24	acf	cfk
Scala	264-788	pyrimethanil	12	acfj	acfj
Scholar SC	100-1242	fludioxonil	psthvst	—	—
§Serenade ASO (organic)	264-1152	Bacillus subtilis	4	abc	bck
Sovran 50WDG	7969-154	kresoxim-methyl	12	acf	cfk
Syllit FL	55260-6	dodine	48	dfghij	dfghj
Thiophanate Methyl 85WDG	66222-145	thiophanate-methyl	48(E)	acf	efgj
Thiram Granuflo	45728-21-400	thiram	24	acfi	cfk
Tilt	100-617	propiconazole	12	acfh	cfhk
Topguard	279-3557	flutriafol	12	acf	cfk
Topsin M WSB	8033-125	thiophanate-methyl	48	acf	efgj
Topsin 4.5FL	8033-122	thiophanate-methyl	48	acfi	efgj
TREE TECH OTC	64014-11	oxytetracycline Ca	0	acfh	—
Vanguard WG	100-828	cyprodinil	12	acfl	cfk

(continued)

**Table 3-1. EPA numbers and Worker Protection Standard reentry and personal protective equipment guidelines (continued).**

Wettable sulfur	5905-289	sulfur	24	acf	cfk
Ziram 76DF	70506-173	ziram	48	acfh	cfhk
<b>Growth Regulators</b>					
6-BA	71368-60-71089	6-benzyladenine	12	acf	cfhk
Amid-Thin W	5481-426	NAD	48	acf	cfhk
Apogee	7969-188	prohexadione Ca	12	afc	cfk
Blush	62097-29-82917	prohydrojasmon	4	abc	abck
Ethrel	264-267	ethephon	48	acfh	efghj
Ethephon 2	228-660	ethephon	48	acfh	efghj
Ethephon 2SL	66222-151	ethephon	48	acfh	efghj
Exilis 9.5 SC	62097-33-82917	6-benzyladenine	12	acf	cfk
Falgro 4L	62097-2-82917	GA3	4	cdfh	cdfh
Fruitone L	5481-541	NAA	48	acf	cfhk
Fruitone N	5481-427	NAA	48	acf	cfhk
Kudos	62097-41-82917	prohexadione Ca	12	acf	cfk
Maxcel	73049-407	6-benzyladenine	12	acf	cfk
Motivate	85678-9-82917	ethephon	48	acfh	efghj
N-Large	57538-18	GA3	4	ac	cfk
N-Large Premier	57538-20	GA3	4	ac	cfk
Novagib 10L	62097-7-82917	GA4+7	4	acfhij	abck
Novagib 5L	62097-47-82917	GA4+7	4	acfhij	abck
Perlan	62097-6-82917	GA4+7 + 6-benzyladenine	4	acphi	abck
PoMaxa	73049-487	NAA	48	acf	cfhk
§ProGibb 4%	73049-15	GA3	4	acfh	cfhk
ProGibb 40% WSG	73049-1	GA3	4	abc	bce
PRO-HEX	62097-41-82917	prohexadione Ca	12	acf	cfk
Promalin	73049-41	GA4+7 + 6-benzyladenine	4	abc	bck
§Pro-Vide 10% SG	73049-409	GA4+7	4	ac	cfk
Refine 3.5 WSG	62097-37-82917	NAA	48	acf	acfk
Refine 24.2L	62097-38-82917	NAA	48	acf	acfk
Refine 6.25L	62097-39-82917	NAA	48	acf	acfk
Refine 3.5L	62097-48-82917	NAA	48	acf	acfk
ReTain	73049-45	AVG	12	abcl	bck
RiteWay	71368-60	6-benzyladenine	12	acf	cfk
Splendor	71049-4	forchlorfenur	12	acfh	acfh
Typy	55146-78	GA4+7 + 6-benzyladenine	24	dfghijl	achfl
Verve	228-660	Ethephon	48	acfh	efghj
<b>Herbicides</b>					
Aim EC	279-3241	carfentrazone-ethyl	12	abc	abc
Alion	264-1106	indaziflam	12	abc	cfk
*Bonedry	82557-1	paraquat	24	acfhilm	cfhk
Broadworks	100-1131	mesotrione	12	acf	acf
Casoron 4G	400-168	dichlobenil	12	acf	cfk
Casoron CS	400-541	dichlobenil	12	acf	cfk
Chateau SW	59639-99	flumioxazin	12	acf	cfk
Chateau WDG	59639-119	flumioxazin	12	acf	cfk
Cheetah	71368-112	glufosinate-ammonium	12	acphi	dfgh
Clean Slate	228-491	clopyralid	12	acfh	cfhk
Diuron 4L	19713-36	diuron	12	acfil	cfk
Drexel Diuron 4L	19713-36	diuron	12	acfil	cfk
Drexel Diuron 80DF	19713-274	diuron	12	acfil	cfk
Fusilade DX	100-1070	fluzifop-p-butyl	12	acfi	cfk
Goal 2XL	62719-424	oxyfluorfen	24	efgij	cfk

**Table 3-1. EPA numbers and Worker Protection Standard reentry and personal protective equipment guidelines (continued).**

GoalTender	62719-447	oxyfluorfen	24	efghij	cfk
*Gramoxone SL2.0	100-1431	paraquat	24	acfhilm	cfhk
Kerb SC	62719-578	pronamide	24	bdgij	bdgj
*Kerb 50WP	62719-397	pronamide	24	bdgij	bdgj
Matrix SG	352- 768	rimsulfuron	4	acf	cfk
Oryzalin 4AS	66222-138	oryzalin	24	acfi	cfk
*Paraquat SL	82557-1	paraquat	24	acfhilm	cfhk
Poast	7969-58	sethoxydim	12	dfghij	dfghj
Pronamide 3.3SC	87290-22	pendamethalin	24	abc	bck
Pronamide 50WSP	87290-3	pendamethalin	24	abc	bck
Prowl H2O	241-418	pendamethalin	24	abc	bck
Rely 280	264-829	glufosinate-ammonium	12	acphi	dfgh
Roundup WeatherMax	524-537	glyphosate	4	acf	cfk
Sandea	81880-18-10163	halosulfuron-methyl	12	ac	cfk
Simazine 4L	19713-60	simazine	12	acf	cfk
Simazine 90DF	19713-252	simazine	12	acf	cfk
Sinbar WDG	61842-27	terbacil	12	acf	cfk
Solicam DF	61842-41	norflurazon	12	abc	bck
Solida	279-3576	rimsulfuron	4	acf	cfk
Spur	42750-89	clopyralid	12	acfh	cfhk
Starane Ultra	62719-577	fluroxypyr	24	acfh	cgkh
Stinger	62719-73	clopyralid	12	acfh	cfhk
Surflan AS	70506-43	oryzalin	24	acfi	cfk
Touchdown HiTech	100-1182	glyphosate	12	ac	bck
TreeVix	7969-276	saflufenacil	12	acfh	cfhk
Trellis	62719-580	isoxaben	12	acf	acef
Venue	71711-25	pyraflufen ethyl	12	acf	cfk
Zeus Prime XC	279-3337	sulfentrazone + carfentrazone-ethyl	12	ach	cef

Source: Adapted with permission from the 2017 *Cornell Pest Management Guidelines for Commercial Tree Fruit Production*.

<b>Key</b>					
PPE	personal protective equipment	f			chemical-resistant gloves; see label for specifics
REI	reentry interval	g			chemical-resistant footwear and socks
§	potentially acceptable in certified organic programs	h			protective eyewear; see label for specifics
*	restricted-use pesticide	i			chemical-resistant apron when cleaning equipment, mixing, or loading
**	active ingredient meets EPA criteria for acute toxicity to bees	j			chemical-resistant headgear for overhead exposure
a	long-sleeved shirt and long pants	k			coveralls
b	waterproof gloves	l			respirator; see label for specific requirements
c	shoes plus socks	m			face shield for mixing and loading
d	coveralls over short-sleeved shirt and short pants	psthvst			postharvest use only
e	coveralls over long-sleeved shirt and long pants	(E)			refer to label for details of restricted entry interval

colorimetric pH papers typically have enough color separation between the reference points on the pH scale to read easily. If a grower has difficulty in utilizing colorimetric pH strips a pH meter could be utilized instead. pH meters are a more expensive, but much more accurate means to test water pH and spray solution pH. While they are typically more accurate than pH test strips they are only accurate if a grower calibrates the pH meter prior to its use.

Water alkalinity can be measured using alkalinity test strips or by using an alkalinity test kit, which relies on titrating a weak acid into a water-reagent solution. Most alkalinity test strips have a limit of 240 ppm or less and should not be used where the water alkalinity levels exceed the uppermost value on the test strip. In areas where the water alkalinity level tends to exceed the capacity of the test strips a grower may have no other recourse than to use an alkalinity test kit that relies on acid titration to measure total alkalinity.

## PESTICIDES AND PERFORMANCE AT VARIOUS SOLUTION PHs

Many pesticides are formulated to function best when mixed in water that is considered to be slightly acidic. When the water or solution pH is too high, alkaline hydrolysis can occur in the spray tank which can cause some pesticides to break down resulting in a loss of efficacy. The rate of the reaction or breakdown of pesticides in the spray tank is governed by four factors: (1) the pesticide product that is being used and its level of susceptibility to alkaline hydrolysis, (2) the pH of the water, (3) the temperature of the pesticide/water solution, and (4) the length of time that the pesticide is in contact with the high-pH water.

Fungicides as a group are known to be more sensitive to high water pH than insecticides or herbicides, but to ensure success and to maximize your spray dollar, growers should know the pH requirements of each pesticide product that they plan to employ in the orchard. Unfortunately, most pesticide labels do not list the preferred spray tank solution pH for the pesticide products being used in the orchard. In order to obtain this information a grower may have to contact the pesticide manufacturer to obtain the optimum spray solution pH for the product that they wish to employ.

Pesticide manufacturers may also provide data to growers that defines the half-life (50 percent breakdown) of a pesticide product at a specific solution pH. Imidan (phosmet) is a common organophosphate insecticide that had been used historically by the orchard industry. Imidan performs best when the pH of the spray solution is at 5.0. If the pH of the spray solution is 8.0 the half-life of the Imidan in the spray tank is 4 hours. Hypothetically, if a grower planned to spray an orchard block with Imidan at 5:00 a.m. with a spray tank solution pH of 8.2 and the spray application was delayed until 9:00 a.m. the product in the spray tank would have seen a reduction in efficacy of 50 percent. This reduction in efficacy may translate into poor insect control and a higher incidence of crop damage by the insect that it was targeting.

In order to maximize your spray dollar growers should first obtain the preferred or optimum solution/water pH ranges for all pesticide products that are to be employed in the orchard from

the manufacturers. Next the grower should determine the pH of the water source that they plan to use to dilute pesticides with. Because of seasonal variation in water quality, the pH of the water and the resulting spray solution should be checked when filling and mixing all pesticides prior to application. If the water or solution pH is outside the optimum range for the pesticides being used the grower should either consider another water source or should adjust the pH of the spray solution using a spray buffer to decrease the pH of the spray solution in the tank. Note: Spray tank solutions containing fixed copper fungicides, sulfur, and/or lime sulfur should never be acidified using a spray buffer or plant injury will result.

## THE JAR TEST

The phrase “jar test” can mean a variety of things to pesticide applicators. For some applicators, a jar test is used to test the compatibility of pesticides that a grower wishes to use in a tank mix. If the pesticides that a grower wishes to tank mix combine readily in the jar and do not precipitate out, then the tank mix is often deemed successful, which may clear the way for its use in the field.

When high water pH is the concern, the grower can use a jar test to determine how much spray buffer will need to be added to the spray tank to adjust the pH down to the target pH range or level of the pesticide products being utilized. To conduct a “jar test” first obtain a quart jar that can be clearly labeled for use only in your pesticide mixing area. Fill the quart jar with exactly one pint (16 ounces) of water that you will be using to mix your pesticides with. Check the pH of the spray water with pH paper or a calibrated pH meter to determine your starting point and record that number in your spray records. If the water pH is too high for the pesticide product or products that you plan to apply, take a standard eyedropper and add three drops of a spray buffer to the measured pint of water. Stir the water and spray buffer solution with a clean glass rod or non-porous utensil (like a plastic spoon). Recheck the solution pH to see if the buffer has reduced the pH to the target range. If it has not, add another three drops of buffer solution, stir thoroughly, and then re-check the pH of the water/buffer solution. This process is repeated until the desired pH range is reached in the quart jar. Record the number of “sets of three” drops that you used to reduce the water pH to the target range for that specific pesticide.

Prior to adding any pesticides to your sprayer, fill the tank to the desired level needed for the application. For every 100 gallons of water in the spray tank add 2 ounces of spray buffer for each set of “three drops” of spray buffer that was added to the measured pint of water in the quart jar in the “jar test.” Add the spray buffer with the agitator running into the spray tank or mix the solution in the spray tank by hand. Collect a sample of the spray water from the tank and check the solution pH using pH test strips or a calibrated pH meter. If the pH of the spray solution is too high, consider adding more spray buffer to the spray tank. Once the pH of the water in the spray tank is at the target range for the pesticide to be used the pesticides can be added to the spray tank with no anticipated loss in efficacy due to alkaline hydrolysis.

The keys to maintaining pesticide efficacy in the spray tank are

(1) knowing the target pH range of the crop protectant chemistries being utilized in the orchard; (2) regular testing of the spray water and the precision deployment of the spray buffers into the spray tank water to reduce the spray water pH to the target range for the chemistries being utilized, and (3) utilizing the spray solution in the tank as soon as possible. The longer a pesticide is in contact with water that falls outside of its desired pH range the more likely that alkaline hydrolysis or pesticide breakdown will occur.

See Tables 3-12, 3-13, and 3-14 on page 263 for target pH ranges and half-lives of selected orchard insecticides and miticides, orchard fungicides, and common herbicides, respectively.

## ORCHARD SPRAYING

Orchard spraying falls into two classes: (1) tree spraying for disease and pest control, nutrition, growth regulation, and chemical thinning, and (2) ground spraying for weed control. Each class requires different equipment. Air-blast sprayers are generally used for tree application, and hydraulic sprayers and granular applicators are used for ground application. Air-blast sprayers use water and air as diluents and carriers for the chemical, while hydraulic sprayers use water and pressure. Growers with very small orchards may want to consider using a handgun (for dilute spraying only).

### Tree Spraying

The air-blast sprayer plays an important role in achieving the level of pest control obtained with a specific amount of pesticide. Best results are obtained when the sprayer has enough fan capacity to blow the spray through the trees and at least 10 feet beyond, even when operating against a 5-mph wind. Maximum spray deposit requires that the droplets be forced against the object to be covered. Spray that drifts at slow speeds past tree tops is not sufficient.

Many sprayers are unable to achieve adequate deposit on trees over 20 feet high. Most sprayers should be operated at 2.5 mph or less on mature trees. When low air volume sprayers are being used, the ground speed usually must be limited to 2 mph or less, even on trees of small to moderate size. Sprays should be applied only when there is little or no wind. Large trees require sprayers with large air volume capacities. Match the sprayer capability to the tree size. Air capacity and air speed are not the same. Use water-sensitive paper targets in the trees to evaluate coverage.

Low-volume (concentrate) spraying involves reduced amounts of water per acre, generally a reduction from 350 to 400 gallons per acre for dilute sprays to 20 to 100 gallons. The term "low volume" is derived from the fact that a smaller volume of water, not air, is used to carry the chemical. Runoff is eliminated with low-volume spraying. Individual sprayers are designed to operate most efficiently at certain gallonages per acre, and best spray coverage and deposit are obtained within the manufacturer's recommended range. Tree size and number of trees per acre as well as spray droplet size influence the gallonage needed for adequate coverage.

Choose the gallonage per acre best suited to your equipment, tree size, and orchard problems. Then add the amount of chemical needed per acre to that amount of water. Spraying less than 40 gallons of water per acre onto trees over 18 feet high usually

results in unsatisfactory coverage. See "Tree Row Volume" in this section.

The amount of pesticide per acre in low-volume spray is reduced in comparison with the amount needed in a standard 400 gallons of dilute spray per acre. For example, a fungicide might be suggested at 8 pounds in 400 gallons of water per acre. With low-volume sprays on apples and sweet cherries, the 8 pounds can be reduced about 20 percent. In low-volume sprays for peaches, pears, nectarines, plums, and tart cherries, the rate can be reduced by about 25 percent or to 5.25 pounds per acre. For lower rates to be effective, the entire tree must be covered without runoff.

The advantages of low-volume spraying are less pesticide, water, labor, and time, with fewer refills. The disadvantages are in the increased care required to calibrate the sprayer, maintain a constant ground speed, select good spraying conditions, and train a skilled operator. As gallonage is reduced, errors become more critical. In addition, some materials such as dormant oil and growth regulators need to be applied at higher water gallonage per acre to be effective. Rates of water of 100 to 300 gallons per acre may be required. Fire blight sprays should be applied at full dilute rate. Dual "flop over" nozzles, multiple-orifice nozzles, or adjustable flow to air-shear nozzles are convenient time savers.

Application costs decrease most rapidly when changing from 400 gallons to 50 gallons of spray solution per acre. Below 50 gallons per acre the savings are smaller, and complete coverage will be difficult even on moderate-size trees. The additional savings with less than 50 gallons per acre may not be worth the additional risks.

Alternate middle row spraying often is used by fruit growers. The basic plan calls for one complete coverage of apple trees before the first scab infection period in the spring. Then alternate rows are sprayed at a fixed interval, such as every seven days. This method permits frequent application of low amounts of pesticides, many of which are short-lived on the tree. With minor modifications, it is the preferred method in pest management programs and in other programs where minimum use of pesticides is a major goal. If the advantages of the alternate-row spraying method are to be realized, it is essential that the sprayer have adequate air volume and velocity to provide at least light spray coverage on at least 90 percent of the tree each half spray. With full-size apple trees planted in rows 30 to 40 feet apart, large sprayers delivering 90,000 to 100,000 cubic feet of air per minute at 80 mph or more are satisfactory for alternate-row spraying. Smaller trees and closer rows permit sprayers with smaller air capacities to be used. For good results, the sprayer should push some spray 10 to 15 feet beyond the tree.

### Selecting a Nozzle

- Select ground speed (rate of travel) to be used.
- Determine the distance between tree rows.
- Decide gallons of spray wanted per acre based on tree size, material to be applied, and efficient operation of your sprayer.
- From Table 3-2 determine spray output per minute needed for the entire sprayer (two sides). For example, to apply 50 gallons of spray per acre at 2 mph, 4 gallons per minute will be needed for rows 20 feet apart and 6.1 for 30-foot rows. If one-side delivery is used, the amount needed is one-half the amount in the table.

**Table 3-2. Total gallons per minute sprayed (both sides) for various row spacings and gallons-per-acre rates, when sprayer moves at 1.5, 2, and 2.5 mph.**

<b>WHEN SPRAYER MOVES AT 1.5 MPH</b>											
(Use twice these gallons per minute when traveling 3 mph, which is too fast for tall and thick trees.)											
Distance between rows (ft)	gal of spray/A										
	20	30	40	50	60	70	80	90	100	300	400
	gal/min (both sides)										
40	2.4	3.6	4.8	6.1	7.3	8.5	9.7	10.9	12.1	36.4	48.5
38	2.3	3.4	4.6	5.8	6.9	8.1	9.2	10.4	11.5	34.5	46.1
36	2.2	3.3	4.4	5.5	6.5	7.6	8.7	9.8	10.9	32.7	43.6
34	2.1	3.1	4.1	5.2	6.2	7.2	8.2	9.3	10.3	30.9	41.2
32	1.9	2.9	3.9	4.8	5.8	6.8	7.8	8.7	9.7	29.1	38.8
30	1.8	2.7	3.6	4.5	5.5	6.4	7.3	8.2	9.1	27.3	36.4
28	1.7	2.5	3.4	4.2	5.1	5.9	6.8	7.6	8.5	25.5	33.9
26	1.6	2.4	3.2	3.9	4.7	5.5	6.3	7.1	7.9	23.6	31.5
24	1.5	2.2	2.9	3.6	4.4	5.1	5.8	6.5	7.3	21.8	29.1
22	1.3	2.0	2.7	3.3	4.0	4.7	5.3	6.0	6.7	20.0	26.7
20	1.2	1.8	2.4	3.0	3.6	4.2	4.8	5.5	6.1	18.2	24.2
18	1.1	1.6	2.2	2.7	3.3	3.8	4.4	4.9	5.5	16.4	21.8
16	1.0	1.5	1.9	2.4	2.9	3.4	3.9	4.4	4.8	14.5	19.4
14	0.8	1.3	1.7	2.1	2.5	3.0	3.4	3.8	4.2	12.7	17.0

<b>WHEN SPRAYER MOVES AT 2 MPH</b>											
Distance between rows (ft)	gal of spray/A										
	20	30	40	50	60	70	80	90	100	300	400
	gal/min (both sides)										
40	3.2	4.8	6.5	8.1	9.7	11.3	12.9	14.5	16.2	48.5	64.6
38	3.1	4.6	6.1	7.7	9.2	10.7	12.3	13.8	15.4	46.1	61.4
36	2.9	4.4	5.8	7.3	8.7	10.2	11.6	13.1	14.5	43.6	58.2
34	2.8	4.1	5.5	6.9	8.2	9.6	11.0	12.4	13.7	41.2	55.0
32	2.6	3.9	5.2	6.5	7.8	9.1	10.3	11.6	12.9	38.8	51.7
30	2.4	3.6	4.8	6.1	7.3	8.5	9.7	10.9	12.1	36.4	48.5
28	2.3	3.4	4.5	5.7	6.8	7.9	9.0	10.2	11.3	33.9	45.2
26	2.1	3.2	4.2	5.3	6.3	7.4	8.4	9.5	10.5	31.5	42.0
24	1.9	2.9	3.9	4.9	5.8	6.8	7.8	8.7	9.7	29.1	38.8
22	1.8	2.7	3.6	4.4	5.3	6.2	7.1	8.0	8.9	26.6	35.5
20	1.8	2.7	3.2	4.0	4.8	5.7	6.5	7.3	8.1	24.2	32.3
18	1.5	2.2	2.9	3.6	4.4	5.1	5.8	6.5	7.3	21.8	29.1
16	1.3	1.9	2.6	3.2	3.9	4.5	5.2	5.8	6.5	19.4	25.8
14	1.1	1.7	2.3	2.8	3.4	4.0	4.5	5.1	5.7	17.0	22.6

<b>WHEN SPRAYER MOVES AT 2.5 MPH</b>											
Distance between rows (ft)	gal of spray/A										
	20	30	40	50	60	70	80	90	100	300	400
	gal/min (both sides)										
40	4.0	6.1	8.1	10.1	12.1	14.1	16.2	18.2	20.2	60.6	80.8
38	3.8	5.8	7.7	9.6	11.5	13.4	15.4	17.3	19.2	57.6	76.8
36	3.6	5.5	7.3	9.1	10.9	12.7	14.5	16.4	18.2	54.5	72.7
34	3.4	5.2	6.9	8.6	10.3	12.0	13.8	15.5	17.2	51.6	68.7
32	3.2	4.8	6.5	8.1	9.7	11.3	12.9	14.5	16.2	48.5	64.6
30	3.0	4.5	6.1	7.6	9.1	10.6	12.1	13.6	15.2	45.5	60.0
28	2.8	4.2	5.7	7.1	8.5	9.9	11.3	12.7	14.1	42.4	56.6
26	2.6	3.9	5.3	6.6	7.9	9.2	10.5	11.8	13.1	39.4	52.5
24	2.4	3.6	4.8	6.1	7.3	8.5	9.7	10.9	12.1	36.4	48.5
22	2.2	3.3	4.4	5.6	6.7	7.8	8.9	10.0	11.1	33.3	44.4
20	2.0	3.0	4.0	5.1	6.1	7.1	8.1	9.1	10.1	30.3	40.4
18	1.8	2.7	3.6	4.5	5.5	6.4	7.3	8.2	9.1	27.3	36.4
16	1.6	2.4	3.2	4.0	4.8	5.7	6.5	7.3	8.1	24.2	32.2
14	1.4	2.1	2.8	3.5	4.2	4.9	5.7	6.4	7.1	21.2	28.3

NOTE: The output in gallons per minute should be 25 percent less at 1.5 mph than at 2 mph and 25 percent more at 2.5 mph than at 2 mph. It should be 50 percent more at 3 mph than 2 mph. Increasing ground speed from 2 to 3 mph without recalibration results in 33 percent less spray per acre.

**Table 3-3. Nozzle flow (gal/min) of various cone tips at various pressures.**

Nozzle <sup>a</sup>	Pressure (psi)				
	60	80	100	150	250
D4-25	0.35	0.40	0.45	0.54	0.68
D4-45	0.43	0.50	0.56	0.68	0.86
D6-45	0.72	0.83	0.93	1.15	1.48

a. Typical air-blast sprayer nozzles. For each nozzle, the first number describes the disc and the second identifies the whirl plate.

- Consult the dealer or the operator’s manual for capacity of discs and whirlers, after determining the pressure at the nozzle outlet. Then select those needed to give the desired output per minute, with conventional air-blast sprayers, nozzles should be selected and installed to allow delivery of 85 percent of the spray volume to the top two-thirds of the tree; 50 percent of the spray volume should be delivered to the top third of the tree. Sprayers with air-shear nozzles should be adjusted for similar distribution. Tower air-blast sprayers should have even or nearly uniform nozzles with slightly bigger ones on the top. On full dwarf and trellised trees, the nozzles can be nearly uniform since all parts of the trees are about the same distance from the nozzles. Table 3-3 illustrates how various combinations of discs and whirl plates can be used to achieve a wide range of flow rates. See your sprayer dealer or company representative for a complete range of choices.

### Sprayer Calibration

Proper calibration can help growers make sure pesticide applications are getting to the target at the proper rate. Worn nozzles or other equipment malfunctions can mean some areas of the target receive too much or too little pesticide, thus having a negative effect on pest control. Always calibrate sprayers before each season of use. During the season periodically check calibration. Replace worn nozzles and check pressure gauges at least once a year. (See Calibrating Sprayers for Herbicide Applications below) The calibration of pesticide application equipment helps ensure accuracy of the application with selected nozzles, pressure, sprayer design, and travel speed.

Actual application rates in the field may vary from the nozzle catalog values due to pressure gauge error, wheel slip, speedometer error, and friction loss in the plumbing. The sprayer must be checked under actual operating conditions to adjust the pressure for the exact application rate required.

Applying a chemical at the wrong application rate is disadvantageous. Using more than the desired amount of chemical is wasteful, may violate label rates, and may pollute the environment. Too low of an application rate probably will not be effective, and money will have been wasted on the material and its application.

Ideally sprayers should be calibrated at the beginning of the season, whenever nozzles are changed, or when changing the nozzle set up based on the crop and desired coverage. The challenge with air blast sprayer calibration is accuracy and efficiently collecting and comparing the output from the individual nozzles. As a result, growers most often calibrate by determining how much spray material they had in the tank when they started the application and how much remained in the tank at the completion of the application and then dividing that amount by the total number of acres covered during the application. This method will tell growers an approximate gallons per acre for the application but does not give an accurate picture of where the actual material

was applied. For example, if that method indicated that 50 gallons per acre was applied, a leak in a hose or somewhere else on the equipment may mean that part of that “application” actually ended up on the ground. If one or more of the nozzles are clogged or worn, then 50 gallons per acre may not be accurately applied to the crops. Furthermore, an uneven application means uneven control of the pest population, which can lead to damage to part of the crop, reducing yields.

### Calibrating the sprayer—first method

Sprayers often do not deliver the calculated amount of spray per minute. There are several ways to check this. The following method is suggested.

1. Fill the sprayer tank completely with water only.
2. Pressurize the system to desired level and spray for three minutes. With PTO units, be sure that the pump speed and pressure are identical to that used when spraying.
3. Determine the amount of water required to refill tank.
4. Calculate gallons per minute and compare that amount with what should have been used (see Table 3-2).
5. Adjust pressure, nozzle sizes, or flow control and repeat the procedure until the delivery is correct.
6. Further check application rate by observing the acreage covered by a tankful (1 acre equals 43,560 square feet).

Example: We pressurize a sprayer to 200 psi and spray (in place) for three minutes. Carefully measuring, we determine that it requires 14.5 gallons to refill the sprayer tank to previous level. To determine the rate, divide the amount delivered (14.5 gallons) by the time (three minutes) to calculate the delivery rate (4.8 gallons per minute). If we are to spray an orchard having a distance between rows of 26 feet at a rate of 50 gallons of spray per acre with the sprayer traveling at 2 mph, we find that the rate should be 5.3 gallons per minute (by checking Table 3-2). To increase application, we can increase pressure, increase nozzle size or flow rate, decrease travel speed, or any combination of these. Make changes and rerun calibration test.

### Calibrating the sprayer—second method

1. Fill sprayer completely or to known level with water only.
2. Spray a known area such as  $\frac{1}{4}$  or  $\frac{1}{2}$  acre. Area sprayed can be determined by counting trees sprayed (two half trees equals one tree) and multiplying by area occupied by each tree (row spacing  $\times$  in-row spacing). One acre equals 43,560 square feet.
3. Return to filling site and try to position sprayer and tractor in same position as in (1) above.
4. Carefully measure amount of water needed to refill to previous level.
5. Convert to an acreage rate. For example, if enough trees are sprayed to cover  $\frac{1}{4}$  acre (10,890 square feet) and 12 gallons are required to refill the tank, the application rate is 48 gallons per acre.

Example: We want to spray a block of apples planted 14 feet apart in 22-foot-row spacing (14 feet  $\times$  22 feet). Each tree (or two

half trees) occupies 308 (14  $\times$  22) square feet of area. Therefore, there are 140 (43,560 square feet per acre  $\div$  308 square feet) trees per acre, or 35 trees in  $\frac{1}{4}$  acre. We spray 35 trees at desired speed and pressure and return to filling spot.

Carefully measuring the amount of water required to refill to previous level, we find that we sprayed 12 gallons. The application rate per acre is 48 (12  $\times$  4) gallons per acre. Adjust pressure, driving speed, nozzle flow, or any combination to change rate.

### General Recommendations

Economic considerations favor low-volume over dilute sprayers. A low-volume sprayer will cover more acreage in a given time period than a sprayer calibrated for dilute application. However, some tree fruit production chemicals, such as growth regulators and oil sprays, are more effective when applied in larger amounts of water per acre than can be applied with some low-volume sprayers. Check maximum application rate when purchasing a sprayer.

Select nozzle sizes to distribute the spray droplets throughout the air stream. Distribution depends on tree shape, size, and distance from the sprayer (also row spacing with two-side delivery). Adjustments should be made throughout the growing season and when moving to a block of different size trees.

A wear-resistant nozzle, such as those with ceramic or hardened stainless-steel orifices, should be used. A worn orifice will result in poor droplet formation and distribution. To check orifice wear, mark a section of your orchard covered properly by one tankful of spray mixture when the nozzles are new and the sprayer is calibrated properly. Each time this marked section of the orchard is sprayed, it serves as a check on the flow regulation of the nozzle set in your sprayer. Anytime the variation is more than 5 percent, the nozzles should be replaced. Where whirlplates are used, replace them when nozzles are replaced.

When using a mist sprayer equipped with air-shear nozzles, make sure the fan (engine or PTO shaft) is operating at correct speed. Correct air velocity is very important for proper size of droplet formation as well as tree canopy penetration.

When using PTO-powered units, be sure to match tractor size to sprayer requirements. The tractor must have enough total horsepower to operate the sprayer at rated PTO speed and to maintain a constant ground speed on all terrain conditions. Check sprayer manufacturer’s specifications to determine the horsepower requirement of the unit. Be certain the tractor can be operated at the desired ground speed when the engine is operating the PTO at the standard speed. For example, assume a PTO-powered sprayer is operating at 2 mph; the tractor must have sufficient horsepower to provide a ground speed of 2 mph and operate the PTO shaft at the 540 rpm required for proper sprayer operation. Allow 15 to 30 horsepower for transporting the sprayer, depending on its loaded weight and the terrain. Check tractor ground speeds at standard PTO speed to make sure there is a gear that will provide an acceptable rate of travel.

Always check the spray coverage obtained. One rule of thumb is that some spray mist should be 10 feet beyond the tree to obtain complete coverage. Some spray mist should pass through the tree. This is most important when alternate-row spraying is practiced. The effective coverage is less than the extent of visible mist. The mist that carries farthest from the sprayer contains very small droplets and therefore very low amounts of chemi-

**Table 3-4. Converting dilute spray rate to concentrate rate of pesticide materials.**

When dilute spray rate/100 gal is:	Amount of chemical/100 gal							
	100 gal/A		50 gal/A		30 gal/A		20 gal/A	
	Large trees <sup>a</sup>	Small trees	Large trees	Small trees	Large trees	Small trees	Large trees	Small trees
0.25 lb	0.8	0.7	1.6	1.4	2.7	2.2	4.0	3.3
0.25 pt (see 4 fl oz)								
0.40 lb	1.2	1.1	2.4	2.1	4.0	3.5	6.0	5.3
0.50 lb	1.6	1.3	3.2	2.5	5.3	4.2	8.0	6.4
0.75 pt or lb	2.4	2.0	4.8	3.9	8.0	6.5	12.0	9.8
1.00 lb, pt, or qt	3.2	2.6	6.4	5.2	10.7	8.7	16.0	13.1
1.25 lb	4.0	3.3	8.0	6.5	13.3	10.9	20.0	16.4
2.50 lb	4.8	3.9	9.6	10.5	21.3	17.5	32.0	26.3
2.00 lb	6.4	5.3	12.8	10.5	21.3	17.5	32.0	26.3
3.00 lb	9.6	7.9	19.2	15.7	32.0	26.2	48.0	39.4
4.00 fl oz or lb	12.8	10.5	25.6	21.0	42.6	35.0	64.0	52.5
5.00 lb	16.0	13.1	32.0	26.2	53.5	43.7	80.0	65.5
6.00 lb	19.2	15.8	38.4	31.5	63.9	52.4	96.0	78.8
<b>For miscible superior oil</b>								
2.00 gal	4.5	3.5	9.0	7.0	15.0	11.7	22.5	17.5

a. Large trees are generally taller than 15 feet. However, trees vary considerably in foliage density and other factors that may affect spray coverage.

cal. These very small droplets probably will not deposit on the trees. Techniques using a fluorescent tracer and a black light or water-sensitive paper will provide a more accurate evaluation. The ultimate check is the degree of pest control obtained.

#### How much pesticide in my spray tank?

An accurate and easy way to suggest the amount of pesticide in low-volume sprays is the amount of pesticide per acre. We especially encourage all who use low-volume sprays (usually 20–100 gallons of spray per acre) to calibrate and recalibrate sprayers accurately. When the sprayer is calibrated according to the methods suggested, you must determine the number of gallons of spray needed per acre. Choose this figure based on your sprayer's limitations, in order to adequately cover the most difficult plantings. Wide rows, dense or tall trees, and low-to-moderate air volumes require more water for best coverage. Then add the amount of pesticide wanted per acre to the amount of water to be used per acre. For example, if 6.5 pounds is wanted in 50 gallons of water per acre, then 13 pounds is added to 100 gallons of water for 2 acres, or 65 pounds to 500 gallons of water for 10 acres.

For those who want to make their own calculations, use the amount of pesticides in low-volume sprays on mature apples and sweet cherry trees based on the amount of pesticides suggested for 400 gallons of dilute spray per acre minus 20 percent. For example, Captan 50WP usually is suggested for early season apple scab control at 2 pounds per 100 gallons of dilute spray. At 400 gallons per acre, this would be 8 pounds Captan 50WP per acre. This is reduced by 20 percent for low-volume sprays to 6.4 or 6.5 pounds per acre. Variations from this formula can be made as needed or desired.

Further pesticide reductions per acre can be made where trees are open and less than 18 feet in height. Reductions in pesticides needed per acre due to minor variations in tree size or thickness can be accomplished by closing nozzles or increasing the rate of travel. It is not necessary to recalibrate the sprayer with every change from one tree size to another. For example, going from mature apple trees to peach trees, if you increase the rate of travel from 2 to 3 mph, you will reduce gallons per acre by 33 percent. One or more nozzles at the top or at the bottom of the manifold may not be needed and may be turned off. Determine

the number of gallons of spray needed per acre for each orchard on the farm and mix the amount of pesticide needed in that amount of water. For example, it may be found by trial that the sprayer can be adjusted quickly to apply 65 gallons of spray per acre on peaches. Mix the amount of pesticide needed per acre in 65 gallons of water and apply that amount per acre.

In Part V of this guide, alternate row middle applications and half-spray recommendations are given as pesticide treatment options. Alternate row middle applications can result in more efficient pesticide use and lower application costs. This practice also helps protect beneficial insects and mites in the orchard. In the alternate row middle system, the sprayer is driven down every other row instead of every row. Most of the spray material is thus deposited on only one side of the tree, providing both adequate pest control until the next spray period and a refuge for beneficial insects. At the next spray period, the sprayer is driven down the rows that were not treated previously. This system not only uses half the amount of pesticide normally required per acre, but it also provides superior pest control when the spray intervals are kept relatively short, the sprayer is correctly calibrated, the orchard is properly monitored, and the correct chemical rates are used at the proper times.

#### Converting dilute to concentrate rates

The accurate way to use pesticides is on a sprayed-area basis. We encourage all who use low-volume sprays to practice this method and to accurately calibrate sprayers. Some may choose to convert dilute rates per 100 gallons directly to low-volume rates per 100 gallons. Table 3-4 provides a general conversion. It will be fairly accurate for most, but not all, pesticides.

#### Tree row volume

Fruit growers face the challenge of accurately applying pesticides to fruit trees of various sizes and shapes. For environmental and economic reasons, it is essential to apply enough pesticide for good control without being wasteful. To aid in this effort, the tree row volume (TRV) concept was developed. As an example:

Imagine two 1-acre blocks of fruit trees. Block A has very large trees, while block B has much smaller ones. Obviously, these two blocks should be sprayed differently, since there are more trees to spray in block A than in block B. But how do we decide how much liquid it will take to spray these different blocks, or



how much pesticide should be applied to the trees?

One way is to try different amounts of water in the orchard until optimum coverage is obtained. This method is time-consuming and usually requires years of experience. The other method is to calculate the actual volume of the tree canopy—the tree row volume. In such calculations a row of trees is considered as a continuous hedge of foliage, and the volume is calculated as shown in Table 3-5. These calculations take into consideration tree height, width, and distance between rows in a particular orchard. The methods for determining the proportion of the acre sprayed are shown in Figure 3-2.

#### Adjusting gallons per acre with TRV

Once you have calculated the volume of foliage to be sprayed, you must determine the volume of water applied per acre based on the dilute (400 gallons per acre) spraying of “standard-sized” trees. In other words, if an orchard with standard-sized trees (height = 20 feet, width = 23 feet, space between rows = 35 feet) is sprayed at 400 gallons per acre, then another orchard with half the TRV

**Table 3-5. Calculating tree row volume.**

1. Determine the number of linear feet of tree row per acre (L).  
43,560 square feet per acre ÷ distance between rows (ft) = L (ft)
2. Measure the average tree height (H) and the tree canopy diameter (W). For orchards with large and small trees interplanted, use measurements for larger trees.
3. Calculate the amount of tree row volume (TRV) per orchard acre.  
 $L \times W \times H = \text{cubic feet TRV per acre}$

#### ADJUSTING GALLONS PER ACRE WITH TRV

$$\frac{\text{TRV (cu ft /A)} \times 0.7 \text{ gallon}}{1,000 \text{ cu ft}} = \text{gallons per acre (dilute basis)}$$

#### ADJUSTING CHEMICAL RATES PER ACRE WITH TRV

$$\text{TRV (cu ft /A)} \times \text{product rate} = \text{ounces of product}$$

Example: Rally 40 WP, 0.1 ounce per 10,000 cubic feet;

TRV = 500,000 cubic feet per acre;

$$\frac{500,000 \text{ cubic feet per acre} \times 0.1 \text{ ounce}}{10,000 \text{ cubic feet}} = 5 \text{ ounces per acre}$$

of the standard would be sprayed at 200 gallons per acre. This means that every 1,000 cubic feet of foliage is sprayed with 0.7 gallon of spray solution. This technique of adjusting gallons per acre for differences in TRV has been used in North Carolina for applying chemical thinners. Recommendations in North Carolina also include a range of rates from 0.7 to 1 gallon per 1,000 cubic feet to account for differences in canopy density. Recent studies conducted in Pennsylvania indicate that canopy density is not an important factor to be considered in TRV calculations in well pruned orchards.

#### Adjusting chemical rates per acre with TRV

The distribution and canopy coverage with conventional airblast sprayers are better at rates above 50 GPA. Low-volume sprayers are designed to apply rates from 20 to 40 GPA. Recent research results show that pest control is poor to inadequate when pesticide rates are adjusted below a proportional rate of less than 0.5. Until additional results are obtained, it is not recommended that a pesticide be used below label amounts, unless TRV rates are given on the label.

The pesticide rates given in the *Penn State Tree Fruit Production Guide* have been adjusted for Pennsylvania orchards and may be listed at below labeled rates based on our testing and experience. Therefore, we recommend that TRV calculations should be limited mainly to application volumes and that full rates from the production guide or the label should be used.

#### Chemical thinning tree row volume

Old standard-sized trees (height = 20 feet, width = 23 feet, tree rows = 35 feet) would be sprayed at 400 gallons per acre in a full dilute spray. This orchard has a tree row volume of 572,502 cubic feet. Therefore, it was felt that a full dilute spray would take 0.7 gallon of spray per 1,000 cubic feet of tree canopy. The table below is based on this assumption.

To use Table 3-6, compute the area of the trees (height times width) at the end of a tree row. For example, a tree 15 feet tall and wide would have a tree row end view area of 225 square feet. Then follow across from the 225 square feet, in the left-hand column, until you are under the row width for your block. If these trees were planted in rows 22 feet apart, then the tree row volume for that block would be 312 gallons. This figure is the volume of spray

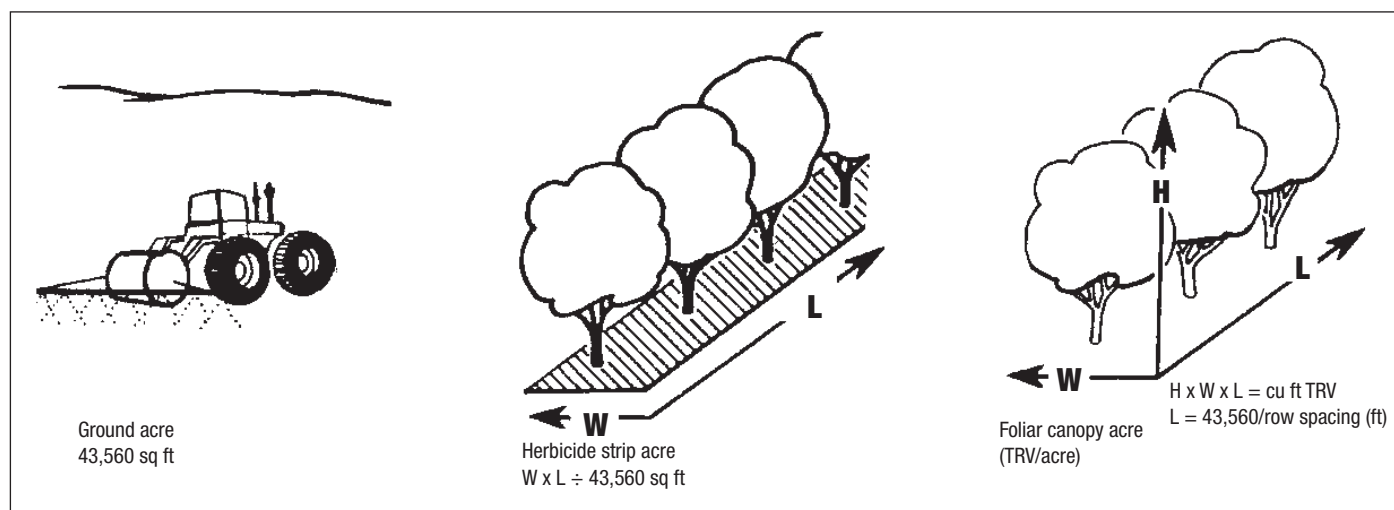

Figure 3-2. Representation of ground acre, herbicide strip acre, and foliar canopy acre.

**Table 3-6. Simplified tree row volume table.**

Tree row end view area (ft <sup>2</sup> )	Figures in the body of the table are the gallons/acre dilute based on spraying 1,000 cubic feet of canopy with 0.7 gallon of spray.												
	Row width (ft)												
	10	12	14	16	18	20	22	24	26	28	30	32	34
25	76	64	54	48	42	38	35	32	29	27	25	24	22
50	152	127	109	95	85	76	69	64	59	54	51	48	45
75	229	191	163	143	127	114	104	95	88	82	76	71	67
100	305	254	218	191	169	152	139	127	117	109	102	95	90
125	381	318	272	238	212	191	173	159	147	136	127	119	112
150		381	327	286	254	229	208	191	176	163	152	143	135
175			381	334	296	267	243	222	205	191	178	167	157
200				381	339	305	277	254	235	218	203	191	179
225					381	343	312	286	264	245	229	214	202
250						381	347	318	293	272	254	238	224
275							381	349	322	300	280	262	247
300								381	352	327	305	286	269
325									381	354	330	310	291
350										381	356	333	314
375											381	357	336
400												381	359

*CAUTION: This table can be used for other spray applications, but caution is advised when making pest control applications on very small trees. Poor control has been noted when spraying very small trees with the amount of chemical determined with the tree row volume method.*

water needed to spray your block on a dilute basis. This dilute gallonage can be used to determine the quantity of thinners to apply to an acre of that orchard. For example, Ethrel is recommended at a dilute rate of 0.5 to 1 pint per 100 gallons, so for this example Ethrel should be used at from 1.6 (0.5 × 3.12) to 3.1 (1 × 3.12) pints per acre.

In a similar way, Vydate L is labeled at 1 to 2 pints per 100 gallons but not over 2 to 4 pints per acre. In this example, Vydate L should be applied at between 3.1 (1 × 3.12) to 4 pints per acre. Note that the higher rate is determined by the maximum rate of Vydate L allowed per acre and not by a tree row volume calculation.

### Advantages and disadvantages

The TRV concept has several advantages. One is that TRV makes it possible to apply pesticides and growth regulators with greater accuracy. Therefore, you may attain better pest control while saving money and reducing pesticides in the environment.

One disadvantage is that it takes time to make the volume calculations for each block. It also puts extra demand on spraying techniques. As pesticides are reduced, weak links in the system become noticeable. Improperly calibrated sprayers, worn nozzles, and varying travel speeds can seriously affect the distribution of chemicals within the tree and, ultimately, the degree of pest control. Additionally, pesticides applied at marginal rates may cause field failures, increase selection pressure for pests to develop resistance, and leave growers in a tenuous legal position with the pesticide companies if the product fails in the field.

### Mixing oil and pesticide

Tank-mixing oil and pesticides necessitates some special precautions. To prevent oil-pesticide combinations from separating, or “buttering out” a surfactant may be added. Check the label for rates, mixing instructions, and when to add to the sprayer tank. Add the pesticide when the tank is one-half to two-thirds full, and add the oil last. The spray tank must be clean, because residues from the

previous tank of spray may cause the emulsion in the oil to separate. Rinsing the tank with water after each load may help minimize the problem. Buildups of the “butter” can be removed by using a heavy-duty cleaner or low-flammable solvent and by vigorous agitation. Dissolving the buildup may require up to 20 minutes.

### Ground Spraying

In fruit production, chemical weed control is usually the least expensive option. Controlling weeds underneath fruit tree plantings benefits the plantings, as well as production, in several ways: (1) Herbicides reduce injury from mice by keeping vegetation away from the tree trunk; (2) herbicides prevent root and bark injury caused by disking; (3) herbicides allow the soil to remain undisturbed, helping to prevent weed seed germination and soil erosion; (4) reducing vegetation around fruit plants can help prevent virus, disease, and insect problems.

Before establishing any fruit crop, it is important to eliminate persistent perennial weeds from the field. For tree fruits it is best to establish the grass cover crop the year before planting. The cover crop will help prevent erosion and allow you to get into the field earlier in springtime to plant. The fall before planting, treat the field with a 2,4-D herbicide to eliminate any perennials that were established with the grass cover. Immediately before planting, treat rows where trees will be planted with glyphosate to kill grass and aid in planting.

Getting the most from herbicides requires good management. Sprayer calibration, dosage, soil type and organic matter content, and rainfall all affect the success of a weed control program. Below are cautions and reminders to be aware of before applying herbicides:

### Sprayer calibration

Always calibrate sprayers before each season of use. During the season periodically check calibration. Replace worn nozzles and check pressure gauges at least once a year. (See “Calibrating sprayers for herbicide applications,” below.)

### Correct dosage

Newly established plantings are more susceptible to overdoses than established plantings. On young plantings use the lower suggested rates. Rates listed in this publication are given as pounds of material per treated acre. The actual area of land treated in a fruit planting may be one-third of the land surface covered by trees. Avoid overlapping or doubling dosages. If a tank runs out in the middle of a block, carefully mark the last treated area.

### Soil type and organic matter

Sandy soils or soils low in organic matter allow easy penetration and quick uptake, which can damage plants. Clay soils or soils high in organic matter require higher rates of materials for adequate control to be achieved. Read the herbicide label and adjust rates, if needed, based on soil type. Applying certain herbicides to soils having less than 0.5 percent organic matter is apt to damage plants. Most chemicals will not damage plants in soils with 2 percent or more organic matter. Some herbicides give poor results when used on soils with organic matter over 4 percent. Under these conditions, select herbicides that are systemic or that are absorbed through foliage.

### Rainfall (irrigation)

Most residual herbicides work best when incorporated into the soil by rainfall or irrigation. They will have maximum effect if the water is applied within 4 to 10 days after application. Failure to water adequately can diminish the herbicide's effectiveness. Generally, 0.5 inch of water is sufficient.

### Tank-mixing of herbicides

Concentrated herbicides should never be added directly to an empty tank. Add one-half of the necessary water to the tank, then the herbicide concentrate, and finally the rest of the water. Never allow a sprayer with mixed chemicals to stand without agitation.

When applying combinations, add them to the tank in this order: (1) wettable powders, (2) flowables, (3) water solubles, (4) adjuvants, (5) emulsifiable concentrates. Constant agitation is especially important when combinations of pesticides are in a tank.

Combining two different preemergent materials at lower rates or a preemergent and a postemergent will usually give broader-spectrum control. A labeled herbicide may be tank-mixed with any other labeled herbicide to be applied at the same time, provided both materials are being applied according to their respective labels. All precautions and limitations respective of both materials must be followed when they are applied together. If there is a days-to-harvest limitation on either or both materials, you must follow the more stringent one—that is, the longest limitation.

Before tank-mixing, be sure to check the compatibility of the materials. If you are unsure of the compatibility, use the following test: (1) At rates proportional to field use, add herbicides to 1 pint of water in a quart jar. (2) Close the jar and mix contents by inverting jar 10 times. (3) Inspect immediately. (4) Allow jar to stand quietly for 30 minutes and inspect again.

If the mixture remains uniform for 30 minutes, the combination can be used. If it does not, add a surfactant or compatibility agent to the jar and test again. If the mixture separates after 30 minutes but remixes readily with 10 jar inversions, the mixture can be used if good agitation is maintained in the tank.

### Herbicide sprayers

Herbicides may be applied with a hydraulic sprayer operating at pressures ranging from 10 to 40 psi. Flat-fan, flooding, or off-center nozzles should be used for spraying herbicides. Flooding nozzles permit complete coverage with the boom located nearer the ground to avoid low-hanging limbs.

What size of area should be treated with herbicides? What is a sprayed acre? The area to be treated may be a continuous strip along either side of the tree row or an area around the trunk of each tree. In general, the treated area should be wide enough so that all grass is kept away from the trunk (to reduce the possibility of mouse damage or mower damage to the trunk).

To avoid confusion about the meaning of "treated acre," use the following to calculate the area to be treated in your orchard. One acre equals 43,560 square feet. The area in each example equals a treated acre:

- A 2-foot-wide strip on either side of the row (4 feet overall) and 10,900 feet long (43,560 square feet per 4 ft)
- A 3-foot-wide strip on either side of the row (6 feet overall) and 7,260 feet long

- A 4-foot-wide strip on either side of the row (8 feet overall) and 5,500 feet long
- A 5-foot-wide strip on either side of the row (10 feet overall) and 4,360 feet long

For selective-area spraying, such as in tree rows, a special boom with nozzle(s) mounted on the end or a hand-held gun is satisfactory. A swivel nozzle with an off-center nozzle tip can be used. The band width can be increased by adding flat-fan tips along the boom. The application rate per treated acre should be the same from all nozzles. Use low pump pressures, in the range of 20 to 40 psi.

When wettable powders are applied, agitation in the tank is required to maintain the suspension. Jet or mechanical agitation is recommended. Agitation is easily accomplished by placing a jet in the bottom of the tank to provide a stirring action. On a sprayer equipped with either a roller or a piston pump, run a separate line from a point between the pump and the pressure regulator to the jet agitator in the tank. If a centrifugal pump is used, there is adequate volume from the bypass line, and the jet agitator may be attached directly to the end of the line. For uniform mixing, the agitator should be operating with some water in the tank when the chemical is added.

### Calibrating sprayers for herbicide applications

1. Measure band width covered by all nozzles and express the width in feet; for example, 34 inches = 2.8 feet. If mixing nozzle types (e.g., OC and flat nozzles) make sure that the gallons per acre (GPA) of all nozzles is the same. Record tractor rpm's and pressure at the pump or boom.
2. Divide 340 square feet by the band width (in feet) determined in step 1. This gives you the distance to drive to cover 340 square feet.
3. Measure a course of that distance.
4. Drive the course (without the sprayer running) and determine the time to cover the course. If you are calibrating a PTO weed sprayer, you must drive with the tractor operating at the same rpm's as it did in step 1.
5. With the tractor stopped (brakes locked, please) and the sprayer operating as in step 1, catch the nozzle output for the time determined in step 4 (the same nozzles used for determining band width in step 1).
6. The number of fluid ounces caught equals the GPA applied by making an application with the nozzle setup and pressure used in step 1 and the driving speed used in step 4.
7. To increase GPA, either increase pressure or drive slower.
8. To decrease GPA, either decrease pressure or drive faster.

**Minimizing spray drift.** It is important to minimize drift for economical, effective control and to protect the environment. Small droplets tend to drift, so it is better to use nozzles that produce a large droplet. Use low pressure, large orifices, and drift reduction adjuvants, and avoid spraying on windy days.

### Surface temperature inversions

Applications must not occur during a local surface temperature inversion because drift potential is high. Surface inversions restrict vertical air mixing, which causes small suspended droplets to remain close to the ground and move laterally in a concentrated cloud. Surface inversions are characterized by increasing temperature with altitude and are common on nights with limited cloud cover and light to no wind. They begin to form as the sun sets and often continue into the morning. Their presence can be indicated by ground fog; however, if fog is not present, inversions can also be identified by the movement of smoke from a ground source or an aircraft smoke generator. Smoke that layers and moves laterally in a concentrated cloud (under low wind conditions) indicates a surface inversion, while smoke that moves upward and rapidly dissipates indicates good vertical air mixing.

### Shielded sprayers

Shielding the boom or individual nozzles can reduce the effects of wind. However, it is the responsibility of the applicator to verify that the shields are preventing drift and not interfering with uniform deposition of the product.

### Sensitive areas

The pesticide should only be applied when the potential for drift to adjacent sensitive areas (e.g., residential areas, bodies of water, known habitat for threatened or endangered species, nontarget crops) is minimal (e.g., when wind is blowing away from the sensitive areas).

### Cleaning the sprayer

Cleaning the sprayer is very important. At the end of each day's spraying, completely rinse the inside and outside of the sprayer with clean water. When changing from one chemical to another, or at the end of the spraying season, give the sprayer a thorough cleaning according to manufacturer's recommendations. If these are not available, use the following procedure:

Remove the nozzle tips and screens and clean them with a toothbrush, using a detergent and activated charcoal solution, ammonia solution, or trisodium phosphate. Flush the system with clean water. Rinse it thoroughly with a detergent solution. Rinse again with clean water.

It is difficult to remove 2,4-D compounds from sprayers; therefore, sprayers used for applying these compounds should not be used for any purpose other than applying herbicides. The 2,4-D-type materials can be removed if the following steps are taken immediately after use:

- Flush the entire system with a detergent solution.
- Fill the tank and prime the spray system with a 10 percent ammonia solution and let stand for 12 to 24 hours.
- Disassemble nozzles and soak caps, screens, etc., in the ammonia solution.
- Rinse thoroughly with water and circulate it through sprayer. A weed sprayer should not be used for any other purpose.

### Granular applicators and their calibration

Instead of sprayers, granular applicators may be used to apply

certain herbicides in orchards. Special spinner spreaders can be attached to a telescopic boom, or commercial units are available that can be mounted directly on the tractor. For small orchards, a hand-carried spinner spreader, which gives satisfactory results, can be used. Uniform distribution of the granules is necessary and application should be made only when there is very little or no wind.

Granular applicators may be calibrated by operating equipment over a known area, such as 0.1 acre. There are 43,560 square feet in an acre. Disconnect the spinner and catch the granules in a plastic bag. Make adjustments and repeat until desired rate is obtained. Remember to maintain the same travel speed at all times.

Granular applicators must be calibrated with the same material that is to be applied. Therefore, a check test must provide some means to collect and weigh the granules. When herbicides are applied in a band along the tree row, it is important to understand that only a portion of the orchard floor is being treated. This portion, called the treated acreage, receives the same rate of application as if broadcast application were being used. The important difference is that only part of the orchard acreage is treated and therefore band application requires less chemical than broadcast application.

Disconnect the spreading mechanism (if one is used) and attach a catchpan, plastic or paper bag, pail, or other appropriate container to catch the granules. Select a test plot of known area. Select an area large enough so the amount of granules collected can be accurately weighed on an available scale. Remember that an acre is equal to 43,560 square feet. Operate the equipment at the recommended settings and ground speed for the desired rate. Be sure to operate only over the measured course and to catch all the material that flows through the applicator.

For example, if you want to apply 150 pounds per treated acre in a 4-foot band, you will travel 10,890 feet per acre ( $43,560 \div 4$ ). For the test, however, you can select a smaller area. The ideal choice is a plot large enough to minimize errors and small enough to be practical. Assuming scales are available to accurately weigh samples in the 5- to 15-pound range ( $1/10$  to  $1/30$  to acre), let's select a  $1/20$ -acre test plot. One-twentieth of an acre is a band 545 feet long ( $10,890 \div 20$ ). When the check is run, 7.5 pounds ( $150 \div 20$ ) of granules should be collected. If the actual amount is different, adjust and rerun until the desired rate is obtained.

Repeat calibration for any change in conditions (temperature, humidity, lot number of granules), when you use a different chemical, drive at a different speed, or change the agitator speed.

**CAUTION:** Strict control of herbicide application is necessary, as weed killers can injure trees. Proper design and calibration of the equipment are necessary. Always read the label on the herbicide container and follow the directions. Assistance is available from your county extension office.

### After Applying an Herbicide

Any time you apply a pesticide, make a complete record of it. Record the date of application, material, formulation, rate, area treated, volume of water, growth stage of crop and weeds, and comments on anything unusual. To be able to assess the treatment's effectiveness, also record the following weather factors: temperature, cloud cover, and time to next 0.5 inch rainfall.

If the material did not work, check your records to see why. You may need to alter the time or rate of application, application technique, or chemical used. If trees are injured, accurate records will help you determine what changes must be made to prevent injury from reoccurring.

### Factors Affecting the Efficacy of Nematicides

As with any pesticide, the two factors that determine efficacy are concentration and exposure time. If toxic concentrations of a nematicide do not come in contact with the nematode for a sufficient period of time, then acceptable levels of control will not occur. Many factors can dilute the concentration of nematicide available in the soil and/or effectively shorten the time that nematodes are exposed.

Good site preparation is extremely important. The soil should be thoroughly tilled several weeks before application to break up clods and encourage the decomposition of plant debris. Large root pieces should be removed. Nematicides can adsorb to organic debris and thus reduce the amount of compound free in the soil. Large soil clods can interfere with the uniform distribution of nematicides and serve as protected areas for nematodes.

Fumigant nematicides such as Telone or Vapam volatilize *quickly* and move through the soil as a gas. These gases penetrate the nematode cuticle and interfere with vital processes, causing death. The mode of action is relatively quick. The movement of a fumigant through the soil is strongly affected by factors such as temperature, moisture, and soil texture. Fumigants tend to move upwards through the soil and will dissipate quickly unless the surface is sealed after treatment. Follow the label to ensure that you are applying the correct dose for your conditions.

Most nonfumigant nematicides are organophosphate or carbamate compounds, which are potent cholinesterase inhibitors. These products are extremely water soluble, and their redistribution in the soil depends on water movement. Excessive rain or irrigation creates a risk of diluting the nematicide below the level needed to be effective. On the other hand, too little water may prevent the nematicide from being distributed effectively in the root zone. Unlike fumigant nematicides, contact nematicides act relatively slowly. Although high concentrations are lethal, the lower concentrations in soil generally kill by behavior modification. The affected nematodes typically are unable to move, find a host, feed, or find a mate. Eventually, they die. If exposure to the nematicide is too short or at a low concentration, however, these behavioral modifications can be reversed and the treatment is not effective.

## BACTERICIDES, FUNGICIDES, HERBICIDES, INSECTICIDES, NEMATOCIDES, SOIL FUMIGANTS, AND PLANT GROWTH REGULATORS

Pesticide suggestions are based on the need for pest control under average conditions. Applying reduced amounts of pesticide is practical under relatively ideal conditions, which include using highly effective chemicals and efficient sprayers, as well as having an orchard with no special pest problems. Conditions can change rapidly, especially during periods of unusually moist weather. Be prepared to adjust the amount and frequency of pesticide applications to handle such situations in accordance with label limitations.

The pesticides listed below appear in alphabetical order. They are described under the trade name if that trade name is unique or under the common name if more than one trade name exists for the same material (active ingredient). Common names begin with a lowercase letter, and trade names begin with a capital letter. **Restricted-use pesticides are indicated by an asterisk (\*).** Each chemical is followed by notes describing its activity and some special use characteristics, including the restricted-entry interval (REI) and preharvest interval (PHI). Where available, each insecticide is also assigned to a specific IRAC (Insecticide Resistance Action Committee [www.ircac-online.org](http://www.ircac-online.org)) group based on active ingredient mode of action; see Table 3-7. Additional information about FRAC (Fungicide Resistance Action Committee) can be found at [www.frac.info](http://www.frac.info); see Table 3-8. The classification of herbicide modes of action (Herbicide Resistance Action Committee) are presented in Table 3-9. For personal protective equipment (PPE) requirements of products, see Table 3-1, which includes insecticides, acaricides, fungicides, bactericides, growth regulators, and herbicides and their EPA registration number, common name, REI, applicator PPE requirements, and early entry PPE requirements. This table may not include all known pesticides. It is recommended that users refer to the product specimen label for any product not listed for necessary information needed to use the product.

*An important note regarding soil fumigants:* In 2012, a final set of soil fumigant product label changes (phase 2) went into effect, implementing new protections for workers and bystanders. The new measures include buffer zones and posting emergency preparedness and response measures, training for certified applicators supervising applications, fumigant management plans, and notice to state lead agencies that wish to be informed of applications in their states. Only soil fumigant products bearing the phase 2 label measures may be sold and distributed by registrants. However, growers and applicators may apply products bearing old labels until those supplies have been exhausted.

It is imperative that applicators comply with current regulations and requirements. The information provided for the chemicals listed in this chapter are guidelines; they are not meant to be a substitute for the specimen label. The approved labels are available through the Pesticide Product Label System (PLS) at [www.epa.gov/pesticide-labels](http://www.epa.gov/pesticide-labels). More information about soil fumigants and the requirements for their safe use can be obtained from the EPA's Office of Pesticide Program's Soil Fumigant Toolbox at [www.epa.gov/soil-fumigants](http://www.epa.gov/soil-fumigants). This information does not substitute for label information. Before applying any pesticide, read and follow label directions. The full text of most pesticide labels and Safety Data Sheets can be found at the Crop Data Management Systems Inc. website at [www.cdms.net/Label-Database](http://www.cdms.net/Label-Database) or from Greenbook Data Solutions (C&P Press, Inc.) at [www.greenbook.net](http://www.greenbook.net). Agrian ([home.agrian.com](http://home.agrian.com)) is another site that also allows you to search for products that have the same active ingredient and whether or not the product is labeled in your state.

**1-MCP (Fysium, SmartFresh)** is a tool for postharvest management of apples, pears, and Asian pears. 1-Methylcyclopropene (1-MCP) acts by inhibiting the ripening process by attaching to ethylene-binding sites and rendering the fruit insensitive to ethylene exposure. This binding results in fruit that maintains firmness and acidity levels higher than untreated fruit. For

**Table 3-7. Comparison of insecticide modes of action based on Insecticide Resistance Action Committee (IRAC) classification** (issued July 2017).

Mode of action	Chemical subgroup	Active ingredients	Examples of trade name(s)
1. Acetylcholinesterase inhibitors	1A. Carbamates	carbaryl methomyl oxamyl	Carbaryl, Sevin Lannate Vydate
	1B. Organophosphates	chlorpyrifos diazinon phosmet	Chlorpyrifos, Lorsban, Nufos, Warhawk, Yuma Diazinon Imidan
3. Sodium channel modulators	3A. Pyrethroids, Pyrethrins	bifenthrin cyfluthrin cyhalothrin deltamethrin esfenvalerate fenpropathrin permethrin zeta-cypermethrin	Brigade, Discipline, Fanfare, Tundra Baythroid, Leverage, Tombstone Proaxis, Taiga Z, Warrior, Voliam Xpress Battalion, Delta Gold Asana XL, Adjourn Danitol Ambush, Arctic, Permethrin, Pounce Mustang Max
4. Nicotinic acetylcholine receptor agonists	4A. Neonicotinoids	acetamiprid clothianidin dinotefuran imidacloprid	Assail Belay Venom, Scorpion Admire Pro, Couraze, Imida, Leverage, Pasada, Prey, Provado, Sherpa Actara, Voliam Flexi
		thiamethoxam	Closer
	4C. Sulfoxamines	sulfoxaflor	Sivanto
5. Nicotinic acetylcholine receptor allosteric activators	4D. Butenolides	flupyradifurone	Delegate Entrust, Spintor
5. Spinosyns	5. Spinosyns	spinetoram spinosad	Delegate Entrust, Spintor
6. Chloride channel activators	6. Avermectins, Milbemycins	abamectin emamectin benzoate	Agri-Mek, Abacus, Abba Proclaim
7. Juvenile hormone mimics	7C. Pyriproxyfen	pyriproxyfen	Esteem
9. Chordotonal organ TRPV channel modulators	9B. Pyridine azomethine derivatives	pyrifluquinazon	PQZ
	9D. Pyropenes	afidopyrofen	Versys
10. Mite growth inhibitors	10A. Clofentezine, Hexythiazox	clofentezine hexythiazox	Apollo Savey, Onager
	10B. Etoxazole	etoxazole	Zeal
11. Microbial disruptors of insect midgut membranes	11. <i>Bacillus thuringiensis</i> and the insecticidal proteins it produces	<i>Bacillus thuringiensis</i> subsp. <i>aizawai</i> <i>Bacillus thuringiensis</i> subsp. <i>kurstaki</i>	Agree Biobit, Deliver, Dipel
15. Inhibitors of chitin biosynthesis, type 0, Lep.	15. Benzoylureas	diflubenzuron novaluron	Dimilin Rimon
16. Inhibitors of chitin biosynthesis, type 1, Hom.	16. Buprofezin	buprofezin	Centaur
18. Ecdysone receptor agonists	18. Diacylhydrazines	methoxyfenozide tebufenozide	Intrepid Confirm
20. Mitochondrial complex III electron transport inhibitors (Coupling site II)	20B. Acequinocyl	acequinocyl	Kanemite
	20D. Bifenazate	bifenazate	Acramite
21. Mitochondrial complex I electron transport inhibitors	21A. METI acaricides	fenpyroximate pyridaben	FujiMite, Portal Nexter
		tolfenpyrad	Apta, Bexar
22. Voltage-dependent sodium channel blockers	22A. Indoxacarb	indoxacarb	Avaunt
23. Inhibitors of acetyl CoA carboxylase	23. Tetrionic and tetramic acid derivatives	spirodiclofen	Envidor
		spirotetramat	Movento, Ultor
25. Mitochondrial complex II electron transport inhibitors	25A. Beta-ketonitrile derivatives	cyflumetofen	Nealta
28. Ryanodine receptor modulators	28. Diamides	chlorantraniliprole	Altacor, Besiege, Voliam Flexi
		cyantraniliprole	Exirel, Minecto
29. Chordotonal organ modulators	29. Flonicamid	flonicamid	Beleaf
31. Baculoviruses	31. Granuloviruses	CpGv	Cydex, Madex HP, Virosoft CP4
UN. Compounds of unknown or uncertain mode of action	UN. Azadirachtin	azadirachtin	Aza-Direct, Azatin, Neemix
UNB. Bacterial agent of unknown or uncertain MoA (non-Bt)	Dicofol	dicofol	Dicofol, Kelthane
		<i>Burkholderia</i> sp.	Venerate

Source: [www.irc-online.org](http://www.irc-online.org)

Table completed in September 2017. Modified to include insecticides commonly used by fruit growers.

**Table 3-8. Comparison of fungicide modes of action based on Fungicide Resistance Action Committee (FRAC) classification** (issued February 2019).

FRAC code (mode of action)	Trade name(s)	Active ingredient(s)
Group 1 (benzimidazole)	Mertect	thiabendazole
	Protocol	thiophanate-methyl + propiconazole (not a benzimidazole)
	Topsin-M, Cercobin	thiophanate-methyl
Group 2 (dicarboximides)	Rovral, Meteor, Iprodione 2F Select	iprodione
Group 3 (demethylation inhibitor, DMI)	Academy	difenoconazole + fludioxonil (not an SI)
	Bumper, PropiMax, Tilt	propiconazole
	Indar	fenbuconazole
	Inspire Super	difenoconazole + cyprodinil (not an SI)
	Luna Experiencee	tebuconazole + fluopyram (not an SI)
	Orius	tebuconazole
	Protocol	propiconazole + thiophanate-methyl (not an SI)
	Quash	metconazole
	Rally	myclobutanil
	Rubigan	fenarimol
	Procure, Trionic	triflumizole
Topguard, Rhyme	flutriafol	
Group 4 (phenylamide)	Ridomil Gold SL	mefenoxam
Group 7 (succinate dehydrogenase inhibitor, SDHI)	Aprovia	benzovindiflupyr
	Fontelis	penthiopyrad
	Kenja	isofetamid
	Luna Experience	fluopyram + tebuconazole (not an SDHI)
	Luna Sensation	fluopyram + trifloxystrobin (not an SDHI)
	Luna Tranquility	fluopyram + pyrimethanil (not an SDHI)
	Merivon	fluxapyroxad + pyraclostrobin (not an SDHI)
	Pristine	boscalid + pyraclostrobin (not an SDHI)
	Sercadis	fluxapyroxad
Group 9 (anilinopyrimidine, AP)	Inspire Super	cyprodinil + difenoconazole (not an AP)
	Luna Tranquility	pyrimethanil + fluopyram (not an AP)
	Scala, Penbotec	pyrimethanil
	Vanguard	cyprodinil
Group 11 (strobilurin, QoI)	Cabrio	pyraclostrobin
	Flint Extra	trifloxystrobin
	Luna Sensation	trifloxystrobin + fluopyram (not a QoI)
	Merivon	pyraclostrobin + fluxapyroxad (not a QoI)
	Pristine	pyraclostrobin + boscalid (not a QoI)
	Sovran	kresoxim-methyl
Group 12 (pyrrole)	Academy	fludioxonil + difenoconazole (not a pyrrole)
	Scholar	fludioxonil
Group 13 (quinoline)	Quintec	quinoxifen
Group 17 (hydroxyanilid)	Elevate	fenhexamid
Group M 01 (copper)	Badge X2, Badge SC	copper oxychloride + copper hydroxide
	Champ, Kocide, NuCop	copper hydroxide
	C-O-C-S	copper oxychloride + copper sulfate
	Cueva	copper octanoate
	Curpofix Ultra 40 Dispers	basic copper sulfate
	Magna-Bon CS 2005, MasterCop	copper sulfate pentahydrate
	Nordox	cuprous oxide

(continued)

**Table 3-8. Comparison of fungicide modes of action based on Fungicide Resistance Action Committee (FRAC) classification (issued February 2019) (continued).**

FRAC code (mode of action)	Trade name(s)	Active ingredient(s)
Group 1 (benzimidazole)	Mertect	thiabendazole
	Protocol	thiophanate-methyl + propiconazole (not a benzimidazole)
	Topsin-M, Cercobin	thiophanate-methyl
Group 2 (dicarboximides)	Rovral, Meteor, Iprodione 2F Select	iprodione
Group 3 (demethylation inhibitor, DMI)	Academy	difenoconazole + fludioxonil (not an SI)
	Bumper, PropiMax, Tilt	propiconazole
	Indar	fenbuconazole
	Inspire Super	difenoconazole + cyprodinil (not an SI)
	Luna Experiencee	tebuconazole + fluopyram (not an SI)
	Orius	tebuconazole
	Protocol	propiconazole + thiophanate-methyl (not an SI)
	Quash	metconazole
	Rally	myclobutanil
	Rubigan	fenarimol
	Procure, Trionic	triflumizole
	Topguard, Rhyme	flutriafol
Group 4 (phenylamide)	Ridomil Gold SL	mefenoxam
Group 7 (succinate dehydrogenase inhibitor, SDHI)	Aprovia	benzovindiflupyr
	Fontelis	penthiopyrad
	Kenja	isofetamid
	Luna Experience	fluopyram + tebuconazole (not an SDHI)
	Luna Sensation	fluopyram + trifloxystrobin (not an SDHI)
	Luna Tranquility	fluopyram + pyrimethanil (not an SDHI)
	Merivon	fluxapyroxad + pyraclostrobin (not an SDHI)
	Pristine	boscalid + pyraclostrobin (not an SDHI)
	Sercadis	fluxapyroxad
Group 9 (anilinopyrimidine, AP)	Inspire Super	cyprodinil + difenconazole (not an AP)
	Luna Tranquility	pyrimethanil + fluopyram (not an AP)
	Scala, Penbotec	pyrimethanil
	Vanguard	cyprodinil
Group 11 (strobilurin, QoI)	Cabrio	pyraclostrobin
	Flint Extra	trifloxystrobin
	Luna Sensation	trifloxystrobin + fluopyram (not a QoI)
	Merivon	pyraclostrobin + fluxapyroxad (not a QoI)
	Pristine	pyraclostrobin + boscalid (not a QoI)
	Sovran	kresoxim-methyl
Group 12 (pyrrole)	Academy	fludioxonil + difenoconazole (not a pyrrole)
	Scholar	fludioxonil
Group 13 (quinoline)	Quintec	quinoxifen
Group 17 (hydroxyanilid)	Elevate	fenhexamid
Group M 01 (copper)	Badge X2, Badge SC	copper oxychloride + copper hydroxide
	Champ, Kocide, NuCop	copper hydroxide
	C-O-C-S	copper oxychloride + copper sulfate
	Cueva	copper octanoate
	Curpofix Ultra 40 Disperss	basic copper sulfate
	Magna-Bon CS 2005, MasterCop	copper sulfate pentahydrate
	Nordox	cuprous oxide
Group M 02 (sulfur)	Lime Sulfur	sulfur
	Microthiol disperss	



**Table 3-8. Comparison of fungicide modes of action based on Fungicide Resistance Action Committee (FRAC) classification (issued February 2019). (continued).**

FRAC code (mode of action)	Trade name(s)	Active ingredient(s)
Group M 03 (dithiocarbamates, EBDC)	Dithane, Penncozeb, Manzate, Koverall	mancozeb
	Ferbam	carbamate
	Polyram	metiram
	Thiram	thiram
	Ziram	ziram
Group M 04 (pthalimides)	Captan, Captec	captan
Group M 05 (chloronitrile)	Bravo Weather Stik, Chloronil, Equus, Initiate	chlorothalonil
Group U6 (phenylacetamide)	Torino	cyflufenamid
Group U12 (guanidine)	Syllit	dodine
Group 19 (polyoxins)	Oso 5% SC fungicide, Ph-D	polyoxin D zinc salt
Group 21 (hexopyranosyl antibiotic)	Kasumin	kasugamycin
Group 25 (glucopyranosyl antibiotic)	Agri-mycin 17, FireWall	streptomycin sulfate
Group 29	Omega	fluazinam
Group 39 (quinazoline)	Magister	fenazaqun
Group 41 (tetracycline antibiotic)	Mycoshield, FireLine	oxytetracycline
Group 44 (microbial)	Double Nickel	<i>Bacillus amyloliquefaciens</i> strain D747
	Serenade	<i>Bacillus subtilis</i> strain QST 713
Group 50 (aryl-phenyl-ketones)	Vivando	metrafenone
Group P 01 (benzothiadiazole)	Actigard	acibenzolar-S-methyl
Group P 04 (natural compound)	Vacciplant	laminarin
Group P 05 (plant extract)	Regalia	<i>Reynoutria sachalinensis</i>
Group P 06 (microbial)	LifeGard	<i>Bacillus mycooides</i> isolate J
Group P 07 (formerly Group 33; phosphonates)	Phostrol, ProPhyt, Rampart, Aliette	phosphorous acid and salts; fosetyl-Al
NC (not classified)	Aleo	garlic oil
	Kaligreen	potassium bicarbonate
	Sil-Matrix	potassium silicate
	Thyme Guard	thyme oil

Source: [www.frac.info](http://www.frac.info)

Table modified in September 2019 to include fungicides and bactericides commonly used by fruit growers.

**Table 3-9. Herbicide Resistance Committee (HRAC) classification of herbicides according to mode of action** (issued 2015).

WSSA Group*	Chemical	Trade name	Chemical family	Mode of action
1	fluzifop-P-butyl	Fusilade	aryloxyphenoxy-propionate	Inhibition of acetyl CoA carboxylase
1	clethodim	Arrow, Prism, Select Max	cyclohexanedione	
1	sethoxydim	Poast	cyclohexanedione	
2	rimosulfuron	Grapple, Hinge, Matrix, Pruvin, Solida	sulfonylurea	Inhibition of acetolactate synthase ALS
2	halosulfuron methyl	Permit, Sandea	sulfonylurea	
3	oryzalin	Surflan plus others	dinitroaniline	Microtubule assembly inhibition
3	pendimethalin	Prowl, Prowl H2O, plus others	dinitroaniline	
3	pronamide	Kerb	benzamide	
4	2,4-D	Several brands	phenoxy-carboxylic acid	Action like indoleacetic acid
4	clopyralid	Clean Slate, Garrison, Spur, Stinger	pyridine carboxylic acid	
4	fluroxypyr	Comet, Starane Ultra, Stave	pyridine carboxylic acid	
5	simazine	Princep plus others	triazine	Inhibition of photosynthesis at photosystem II
5	terbacil	Sinbar	uracil	
7	diuron	Karmex plus others	urea	Inhibition of photosynthesis at photosystem II
9	glyphosate	many brands	glycine	Inhibition of EPSP synthase, amino acid synthesis enzyme
9	sulfosate	Touchdown	glycine	
10	glufosinate	Rely, Cheetah, Reckon, and others	phosphinic acid	Inhibition of glutamine synthase
12	norflurazon	Solicam	pyridazinone	Inhibition of carotenoid biosynthesis
14	saflufenacil	Treevix	pyrimidinedione	Inhibition of protoporphyrinogen oxidase enzyme (PPO inhibitor)
14	oxyfluorfen	Collide, Galigan, Goal, GoalTender, OxyStar	diphenylether	
14	pyraflufen-ethyl	Venue	phenylpyrazole	
14	flumioxazin	BroadStar, Chateau, Tuscany	n-phenylphthalimide	
14	carfentrazone-ethyl	Aim	triazolinone	
14	sulfentrazone	Zeus Prime XC	triazolinone	
20	dichlobenil	Casoron	nitrile	Inhibition of cell wall synthesis (cellulose inhibitor site A)
21	isoxaben	Gallery, Isoxaben, Trellis	benzamide	Inhibition of cell wall synthesis (cellulose inhibitor site B)
22	paraquat	Gramoxone SL, Parazone, and others	bipyridylum	Photosystem-1-electron diversion
27	mesotrione	Broadworks	triketone	HPPD inhibitor (pigment inhibitor)
29	indaziflam	Alion	alkylazine	Cellulose inhibitor

\*WSSA = Weed Science Society of America

Source: [hracglobal.com](http://hracglobal.com)

Table modified in September 2017 to include herbicides commonly used by fruit growers.

treatment purposes, 1-MCP is a gas and needs to be applied in an airtight room or chamber. The amount of 1-MCP needed to treat apples depends on the size of the room in which the fruit will be treated. 1-MCP has been shown to be very active at low concentrations. Its label rate for application is 1 ppm for a period of 24 hours. At the end of the 24-hour period, the room must be vented for at least 30 minutes before entering. Other benefits include inhibition of superficial scald in varieties like Delicious and Granny Smith that are prone to scald occurrence. Applications of 1-MCP should be made on fruit that is designated for intermediate to long-term storage. Do not treat fruit that have had a preharvest application of ethephon. 1-MCP will not solve all postharvest problems, but it is an important tool in providing a quality product to the consumer.

**1,3-dichloropropene (\*Telone II, \*Telone C-17, \*Telone C-35, \*Telone EC).** Products including the active ingredient 1,3-dichloropropene are effective soil fumigants for the control of plant-parasitic nematodes and other soilborne pests. Telone products are very effective against nematodes; the primary difference is the addition of chloropicrin to Telone C-17 and Telone C-35, which increases its

efficacy against soilborne fungi. These products can only be used as preplant soil fumigants, and tree death will result if the soil is not allowed to aerate sufficiently before planting. Rates vary with soil texture and efficacy is strongly affected by soil moisture and temperature. Therefore, careful attention must be given to label recommendations and site preparation. For retail sale to and use only by certified applicators or those under their direct supervision, and only for those uses covered by the certified applicator's certification.

**2,4-D (Weedar 64, Orchard Master, Amine 4, Saber, 2,4-D Amine 4, and others) (HRAC Group 4 Herbicide) 2,4-D** 2,4-D is a postemergent herbicide used to control broadleaved weeds. 2,4-D products are not effective on grasses. They are particularly useful for controlling annual and perennial broadleaved weeds that escape preemergence treatments. Do not apply 2,4-D compounds to bare ground or under hot, dry conditions. Exercise extreme caution if using these materials in fields adjacent to growing grapes. Applications made early in the spring or postharvest will give the best results. Use only low-volatile amine formulations and do not use ester formulations of 2,4-D, as plant injury can occur due to vaporization. Symptoms of 2,4-D damage to both target weeds and

nontarget plants include a downward cupping of the leaves and a twisting of the growing stem. Observe restrictions on days-to-harvest limitations as stone fruits and pome fruits have different limits. Days-to-harvest restrictions also vary by product. Growers are also cautioned that some 2,4-D materials are not registered on all tree fruit crops. Be sure to check the label to see if the material you have is labeled for the crop to which you intend to apply it. Some labels allow two applications per growing season if applications are separated by at least 75 days.

**6-benzyladenine (6-BA, Exilis 9.5SC, MaxCel, RiteWay)** is a cytokinin, a class of growth regulator that promotes cell division. 6BA acts as a thinner when applied shortly after bloom. Compared to other chemical thinners, it may increase fruit size beyond what would occur during the normal crop-thinning process. Response to 6BA is very temperature dependent. Do not apply if temperatures are below 65°F. The product should be applied in the morning or evening when conditions are best for slow drying. Do not exceed a total of 308 ounces per acre per season. The products are labeled for both apples and pears. Note that Exilis Plus has a slightly higher percent active ingredient, so rates need to be adjusted accordingly. The 6BA products MaxCel and Exilis Plus can also be used to induce branching. 6-BA and RiteWay are not labeled for branching uses. Exilis Plus can also be used to help improve tree structure of nursery stock and young apples, pears, and cherries. To induce branching apply 250 to 500 ppm on a 5- to 10-day interval beginning when trees have at least 29 to 30 inches of growth and directed to shoot tips of the trees. MaxCel and Exilis Plus can also be applied in latex paint to dormant apple, pear, and cherry trees immediately after planting to induce branching. Mix at a rate of 5,000 to 7,500 ppm (3.5 to 5.8 fluid ounces per pint of latex paint) using a brush or sponge to cover the bud and bark surface. Apply only to one-year-old wood. Do not apply following bud break.

**6-benzyladenine + gibberellins A<sub>4</sub>A<sub>7</sub> (Promalin, Typy, Perlan)** is a mixture of two plant growth regulators cytokinin and gibberellins—and has two uses in tree fruit production. On bearing apple trees, foliar applications increase the length-to-diameter ratio of fruit, producing more elongated fruit at harvest. The spray is more effective when daytime high temperatures reach or exceed 70°F. Mild thinning may occur with later applications

The material also can be used to increase branch angles and the number of lateral branches on apple, pear, and cherry trees. On apples, it may be applied as a directed foliar spray or in a latex paint mix on young bearing or nonbearing trees, either in the nursery or the orchard. On pears, it may be applied only as a foliar spray on young nonbearing trees, either in the nursery or the orchard. On sweet cherries, it may be applied as a foliar spray only to nonbearing trees in the nursery, or in a latex paint mix to nonbearing trees in the orchard.

**\*Abacus—see abamectin.**

**\*Abba—see abamectin.**

**abamectin (\*Abacus, \*Abba, \*Agri-Flex, \*Agri-Mek, \*Reaper, \*Zoro)** (IRAC Group 6 Insecticide) is an avermectin miticide-insecticide with both contact and stomach action labeled for use on pears, apples, peaches, nectarines, cherries, plums, and prunes. Abamectin must be applied with a summer oil or other penetrant

before the leaves harden off. This allows translaminar movement into the leaves and thus residual control. For apples, abamectin is recommended at petal fall to about 10 days after petal fall to control European red mite and spotted tentiform leafminer and to suppress white apple leafhopper. For pears, abamectin is applied at petal fall to about 10 days after petal fall to control pear psylla. Abamectin is toxic to bees when sprayed but poses no additional danger once it has moved into the leaves. It is nonphytotoxic when used as directed. See the oil section for incompatibilities and potential phytotoxicity problems if oil is used as the penetrant. Do not exceed 0.023 pound of ingredient per acre of abamectin in any product per season. Do not make more than two applications per growing season. If a second application is necessary, do not retreat within 21 days. On apples and pears, do not apply within 28 days of harvest. On plums and prunes, the PHI is 21 days. Agri-Flex is a mixture product of abamectin and thiametoxam registered only for use on apples, pears, and grapes.

Abamectin is a restricted-use pesticide because of its toxicity to fish, mammals, and aquatic organisms. The following precautions are to be observed when spraying in the vicinity of aquatic areas such as lakes, reservoirs, permanent streams, marshes or natural ponds, estuaries, and commercial fish farm ponds: spray last three rows windward of aquatic areas using nozzles on one side only, with spray directed away from aquatic areas; avoid spray going over tops of trees by adjusting or turning off top nozzles; shut off nozzles when turning at end of rows and passing tree gaps in rows; do not apply when weather conditions favor drift to aquatic areas; do not apply within 110 feet upwind of aquatic areas or when wind speed is above 8 mph; and do not apply during a temperature inversion.

**Academy (difenoconazole and fludioxonil mixture) (FRAC Groups 3 and 12 Fungicides).** Academy is a postharvest fungicide used for pome fruit to control postharvest fungal diseases, such as Alternaria rot, bitter rot, blue mold, bull's-eye rot, gray mold, Phacidiopycnis rot, Rhizopus rot, speck rot, Sphaeropsis rot, and white rot. It can be used as an in-line dip/drench or flooper or an in-line aqueous or fruit coating spray application. Do not make more than one postharvest application of Academy to the fruit. Apply either once before storage or once after storage, just prior to marketing. Do not make more than two postharvest applications of fludioxonil-containing products to the same fruit.

**acequinocyl—see Kanemite.**

**acetamiprid (Assail, Cormoran) (IRAC Group 4A Insecticide).** The active ingredient acetamiprid belongs to the family of chemistries known as neonicotinoids. Acetamiprid interrupts the function of the insect nervous system by acting as an agonist (or promoter) of the nicotinic receptor on the postsynaptic membrane of the nerve cells. The compound has low mammalian toxicity (toxicity category III). Acetamiprid is active on sucking insects such as aphids, leafhoppers, leafminers, stink bugs, and pear psylla. In contrast to other insecticides from the neonicotinoid group, acetamiprid also possesses good activity against codling moth and Oriental fruit moth. The compound provides systemic, translaminar activity and is active as an ovicide through direct kill of insect eggs. Assail should be applied in a minimum finished spray volume of at least 80 gallons per acre using 2.5 to 8 ounces of Assail 30SG per acre. Assail has a 12-hour REI and

a seven-day PHI. The product is toxic to bees exposed to direct treatment. Cormoran is a mixture of acetamiprid and novaluron registered for use on pome fruit with specific label directions for use on pears.

**acibenzolar-S-methyl—see Actigard.**

**Acramite (bifenazate)** (IRAC Group 20D Insecticide). Acramite's active ingredient, bifenazate, belongs to the carbazate class of chemistry, providing a unique mode of action for this acaricide. This summer acaricide is registered for the control of mobile forms of mites on apples, pears, peaches, nectarines, plums, prunes, grapes, hops, and strawberries. Acramite is very active against all stages of two-spotted mites and motile stages of European red mite, but it will not control rust mites. Acramite can be used up to seven days before harvest (PHI) on apples and pears; 14 days on grapes and hops; three days on peaches, nectarines, plums and prunes; and one day on strawberries. On all registered crops the REI is 12 hours, except for some activities on grapes where the REI is extended to five days. The compound provides quick mite knockdown through contact activity and long residual control. Acramite is not systemic in action; therefore complete coverage is essential for product activity. The recommended rate is 0.75 to 1 pound per acre in minimum of 50 gallons per acre. Only one application per season is permitted.

**Actara—see thiamethoxam.**

**Actigard 50WG (acibenzolar-S-methyl)** Actigard is a selective, non-pesticidal systemic compound used for the control of several fungal, bacterial, and viral plant diseases. Actigard 50WG is an inducer of host plant resistance. It exhibits a unique mode of action which mimics the natural systemic activated resistance (SAR) response found in most plant species. Actigard WG has no direct activity against target pathogens. Actigard must be applied far enough in advance of the infection in order to allow time for plant defenses to be activated. Actigard can be tank-mixed antibiotics for improved efficacy. General recommendations are to apply at 1 to 2 ounces per acre as a fire blight treatment during bloom (usually two to three applications between 20 percent bloom and petal fall), but do not apply closer than a seven-day interval. Actigard may also be applied as "paint" application after pruning cuts or grafts with Pentrabark or a similar penetrant or as a soil drench or through chemigation. Do not apply more than 12.8 ounces of Actigard or other acibenzolar-s-methyl-containing products per year. For foliar applications, do not apply within 60 days of harvest. The REI is 12 hours.

**Admire Pro—see imidacloprid.**

**Advise—see imidacloprid.**

**Agree—see Bt.** This product is OMRI registered.

**\*Agri-Flex—see abamectin and thiametoxam.**

**\*Agri-Mek—see abamectin.**

**Agri-mycin 17—see streptomycin sulfate.**

**Aim—see carfentrazone-ethyl.**

**Aleo (garlic oil) (FRAC Group Not Classified).** Brandt Organics Aleo is 78 percent garlic oil used as a bactericide and fungicide. It has been shown to be effective in controlling bacterial pests, such as *Pseudomonas* spp., *Xanthomonas* spp., and *Erwinia*

amylovora. In addition, this product has shown control or suppression of fungal diseases affecting pome and stone fruit caused by *Botrytis cinerea* and *Venturia inaequalis*. The use of adjuvants (spreaders and/or penetrants) is highly recommended for improving performance. There are no restrictions on the number of applications per season. This product does not require an REI or PHI. It can be applied any time up to the day of harvest. This product is OMRI listed.

**Aliette (fosetyl-AI)** (FRAC Group P07 Fungicide). Aliette 80WDG is a systemic phosphonate fungicide labeled for collar rot caused by the *Phytophthora* fungus. It can also be used in a program with other bactericides to manage fire blight and blister spot. It is registered for use on nonbearing and bearing apple trees and on nonbearing stone fruit trees. Apply Aliette at a rate of 5 pounds per 100 gallons of water beginning at the start of the growing season. Apply at 30- to 60-day intervals and do not exceed 20 pounds per acre per season. CAUTION: Tank-mixing Aliette with copper products, fertilizers, and some adjuvants may cause phytotoxicity to foliage. The use of adjuvants is not recommended. The REI is 12 hours.

**Allias—see imidacloprid.**

**\*Alion (indaziflam)** (HRAC Group 29 Herbicide). The herbicide Alion is a preemergent material for use in pome and stone fruits for control of grass and broadleaf weeds. Alion will only control weeds before they emerge; if weeds are present, then a postemergent contact material should be included in the application. It is most effective when activated by rain or applied when the soil is moist. In trials in Pennsylvania it was most effective when applied in the fall but also provided good weed control when applied in the early spring to bare ground. Alion works by inhibiting cellulose biosynthesis. The REI is 12 hours and the preharvest interval is 14 days. Do not apply more than 10.3 ounces per year. A supplemental label is available for mixing Alion with rimsulfuron products (Matrix, Pruvion, and Solida). The tank mix plus a burndown material can improve control of weeds that have germinated but not yet emerged. Alion may be applied in orchards where replants have been set in established orchards if (1) soil is completely settled around the newly planted trees, (2) the trunks of the replants are protected from spray contact by nonporous wraps, and (3) the trees are exhibiting good health and vigor.

**Altacor (chlorantraniliprole/rynaxypyr)** (IRAC Group 28 Insecticide). Altacor has a unique mode of action: activation of the insect's ryanodine receptors within the cells of their muscles. A treated insect exhibits a rapid cessation of feeding, lethargy muscle paralysis, and eventual death. The primary route of exposure to pests is through ingestion, but there is some reported ovicidal (i.e., egg) and ovicidal activity for codling moth. It also is highly effective against a number of serious pests—codling moth, Oriental fruit moth, tufted apple budmoth, obliquebanded leafroller, other leafrollers, and leafminers. Altacor also has reported activity against the European apple sawfly. The rate per acre (ounces per acre) for Altacor on pome fruits ranges from 3.0 to 4 ounces with a seasonal maximum of 9 ounces per acre. In our research trials, Altacor has provided excellent residual control of CM, OFM, and the leafrollers at a rate of 3 ounces per acre. Altacor is registered as reduced-risk insecticides (i.e.,

low impact to humans, the environment, nontarget organisms, and natural resources). The product is highly selective for pests with minimal or no impact on our existing natural enemies present—*Typhlodromus pyri*, *A. fallacies*, *Stethorus punctum*, and a group of aphid predators (e.g., lady beetles, syrphid fly larvae). Altacor has a four-hour REI and should not be applied less than five days before harvest on pome fruit and 10 days before harvest on stone fruit.

**\*Ambush—see permethrin.**

**Amid-Thin W (1-naphthalenaacetamide, NAAm).** Amid-Thin is an auxin used to thin fruit on pears and early maturing apple cultivars and to prevent preharvest fruit drop because it is safer to the foliage than NAA. Depending on cultivar, Amid-Thin may be applied on apples at petal fall (90 percent of petals off) at 25 to 50 ppm, often tank-mixed with carbaryl. Applications on selected later maturing cultivars at 15 to 50 ppm can be made 2 to 2.5 weeks after petal fall. Application on Bartlett and Bosc pears at 10 to 50 ppm can also be made at 2 to 2.5 weeks after full bloom. Best results are obtained using Amid-Thin in dilute sprays. REI of 48 hours. See also Amid-Thin W in Part I.

**Amine 4—see 2,4-D.**

**amino ethoxyvinylglycine—see ReTain.**

**Apogee—see prohexadione calcium.**

**Apollo (clofentezine)** (IRAC Group 10A Insecticide). Apollo is registered for mite control on apples, pears, peaches, nectarines, apricots, and cherries. Apollo possesses ovicidal activity against eggs and nymphs of the European red mite and twospotted spider mite. The Apollo SC label for apple allows applications up to 45 days before harvest, while on pears, apricots, cherries, peaches, and nectarines the PHI is 21 days. The appropriate timing for Apollo SC would be petal fall or first cover. An application at this time should perform better in most years than an application at formerly recommended tight cluster. Applications on other crops should be made when mites are first found because Apollo acts primarily against the eggs, and control of the mite population may take 10 to 14 days. Thorough coverage of foliage is necessary for long residual control. Apollo has low toxicity to mammals and is nonphytotoxic. Apollo SC is not disruptive to beneficial insects and mites. Only one application is recommended per season. If additional miticide applications are needed, apply a miticide with a different mode of action. To prevent the buildup of resistance, do not alternate Apollo SC with other miticides with a similar mode of action (e.g., Savey).

**Aprovia (benzovindiflupyr)** (FRAC Group 7 Fungicide). Aprovia is an SDHI fungicide labeled for control of diseases of pome fruit. It has activity on apple and pear scab, *Alternaria* blotch and rot, cedar apple and quince rust, sooty blotch and flyspeck, and powdery mildew. It is labeled for the suppression of black and white rot, bitter rot, and Brooks spot. The labeled use rate is 5.5 to 7 fluid ounces per acre. Only two applications should be applied on a seven-day interval. Additional applications should be no closer than 14 days. The maximum amount of Aprovia applied per season is 27.6 ounces. Apply Aprovia preventively to reduce the potential for resistance development. Tank-mixing with protectant fungicides and other modes of action should be

considered for resistance management. The preharvest interval is 30 days and the REI is 12 hours.

**Apta—see tolfenpyrad.**

**\*Arctic—see permethrin.**

**Arrow 2EC—see clethodim.**

**\*Asana XL (esfenvalerate)** (IRAC Group 3A Insecticide). Products containing esfenvalerate are broad-spectrum pyrethroid insecticides with contact and stomach action. Esfenvalerate is registered for use on apples, peaches, apricots, nectarines, plums, prune plums, cherries, and pears. Esfenvalerate is a restricted-use product because of toxicity to fish and other aquatic organisms. Esfenvalerate is highly toxic to bees exposed to direct treatment and residues on plants. Use recommendations are generally limited to before bloom in Pennsylvania to conserve *Stethorus* and other predators of European red mite.

**Assail—see acetamiprid.**

***Aureobasidium pullulans*—see Blossom Protect.**

**Avaunt (indoxacarb)** (IRAC Group 22A Insecticide). Avaunt has a unique mode of action: it inhibits the sodium ion entry into nerve cells, resulting in pest paralysis and death. This class of chemistry, with no evidence of cross-resistance to other chemistries, has a perfect fit into current IPM practices. Avaunt is registered for the control of codling moth, Oriental fruit moth, lesser appleworm, redbanded leafroller, tufted apple bud moth, white apple leafhopper, potato leafhopper, plum curculio, tarnished plant bug, and apple maggot. Avaunt is not effective against obliquebanded leafroller. The compound should be applied at 5 to 6 ounces per acre with no more than four applications per season. For best results, Avaunt should be applied with 50 to 150 gallons of water per acre. Avaunt is highly toxic to bees exposed to direct treatment on blooming crops or weeds, so the product should not be applied or allowed to drift to blooming plants while bees are actively visiting the treatment area. Avaunt is registered for use on pome and stone fruits.

**azadirachtin (Aza-Direct, Azatin XL, Neemix)** (IRAC Group UN Insecticide). Azadirachtin-based biological insecticide, repellent, antifeedant, and insect growth regulator are used mostly in soft, organic insect control programs. This active ingredient controls pests on contact and by ingestion. Aza-Direct can be applied using standard spraying equipment up to the day of harvest. This pesticide is toxic to fish and aquatic invertebrates. AzaDirect is OMRI listed.

**Aza-Direct—see azadirachtin.**

**Azatin XL—see azadirachtin.**

***Bacillus amyloliquefaciens* strain D747—see Double Nickel.**

***Bacillus subtilis* strain QST 713—see Serenade.**

***Bacillus thuringiensis*—see Bt.**

**\*Basamid G—see dazomet.**

**\*Baythroid—see cyfluthrin.**

**Belay (clothianidin)** (IRAC Group 4A Insecticide). Belay is a neonicotinoid insecticide that inhibits binding to the acetylcho-

line receptor and shows rapid and residual activity by contact and ingestion. The compound is registered for use on pome fruit and peach (no other stone fruit registration) for the control of aphids, leafhoppers, codling moth, plum curculio, apple maggot, leafminers, leafrollers, Oriental fruit moth, and pear psylla. Clothianidin is also very effective against brown marmorated stink bug. Belay is registered only for postbloom applications and should not be applied within seven days of harvest on pome fruit and 21 days of harvest on peach. No more than 12 ounces of Belay (0.2 pound of active ingredient) can be applied per season. Multiple applications of Belay are reported to cause mite flare-ups. Previously Belay used to be marketed under the trade name Clutch.

**Beleaf (flonicamid)** (IRAC Group 29 Insecticide). Beleaf is a member of the chordonal organ modulators class of chemistry. It provides control of a wide spectrum of aphids and plant bugs by provoking rapid and irreversible feeding cessation. It controls pests by contact and ingestion. The product is registered for use on pome fruit (21-day PHI) and stone fruits (14-day PHI). No more than three applications at 2.8 ounces per acre are allowed per season.

**Belt (flubendiamide)** (IRAC Group 28 Insecticide). The active ingredient of Belt SC flubendiamide belongs to chemical class known as phthalic acid diamides, which bind to ryanodine receptors located in insect muscles and interfere with regulation of calcium balance. Flubendiamide is an oral toxicant, affecting feeding larvae at a very low dose. On fruit, Belt is registered for the control of codling moth, Oriental fruit moth, leafroller complex, leafminers, green fruitworm, and lesser appleworm. The recommended rate on pome fruit is 5 ounces per acre and 4 ounces per acre on stone fruit. Belt has 12-hour REI and a 14-day PHI on pome fruit and a seven-day PHI on stone fruit. Belt is very safe to beneficial insects. See also *Tourismo*. As of September 2017, the insecticide Belt is no longer being distributed in the United States; however, it is still legal to use the remaining product inventories already in grower's hand.

**benzovindiflupyr**—see *Aprovia*.

**Bexar**—see *tolfenpyrad*.

**bifenazate**—see *Acramite*.

**bifenthrin (\*Bifenture, \*Brigade, \*Brigadier, \*Discipline, \*Fanfare, \*Sniper, \*Tundra)** (IRAC Group 3A Insecticide). Bifenthrin-based insecticides are broad-spectrum pyrethroid insecticides with contact and stomach action. Among pests listed on the label, bifenthrin is very effective against brown marmorated stink bug. Bifenthrin-containing products in fruit system are registered only for use on pears. All formulations are restricted-use product due to toxicity to fish and other aquatic organisms. Bifenthrin is highly toxic to bees exposed to direct treatment and residues on plants. Use recommendations in Pennsylvania are generally limited to use before bloom or to control brown marmorated stink bug.

**Biobit**—see *Bt*. This product is OMRI listed.

**BioCover (petroleum oils)**. A group of highly refined, 98 percent petroleum oils (BioCover UL, BioCover LS, BioCover MLT, and BioCover SS) registered for dormant, delayed dormant and foliar applications on apples, pears, apricots, cherries, peaches, plums, and prunes. Due to possible severe phytotoxic effects,

this oil cannot be applied within 30 days of sulfur or lime sulfur application and 14 days before or after Captan application. For summer application do not exceed 1.5 gallons per acre per application. Apply in a minimum of 50 gallons water per acre. Excellent coverage is essential for efficacious control of soft-bodied insects. Also please see dormant oils and summer oils.

**Blossom Protect (*Aureobasidium pullulans*)** (FRAC Group 44 Bactericide/Fungicide). Blossom Protect is a product that consists of two strains of a microorganism that is labeled for use on pome fruit to prevent fire blight. It is a living yeast and the product must be refrigerated. It works by colonizing the base of flower blossom and competes with bacteria for space and nutrients. Blossom Protect must be applied preventively and only during primary bloom prior to when conditions favor disease development. The addition of Buffer Protect will help accelerate the propagation of the microorganism in Blossom Protect. Many fungicides are not compatible with Blossom Protect. Under cool, wet conditions, Blossom Protect may cause fruit russetting. Apply Blossom Protect at 1.25 pounds per acre in 50 to 200 gallons of water. Tank-mix Buffer Protect at 8.75 pounds per acre. Apply up to four treatments at 10, 40, 70, and 90 percent bloom. The REI is four hours. This product is OMRI listed.

**Blush (prohydrojasmon)** is plant growth regulator that can promote fruit color in red apples. There are two formulations; one has a 5.25 percent active ingredient and the other has a 10 percent active ingredient. It must be applied in sufficient water to ensure thorough coverage of the canopy. Make one to two applications at appropriate rates for the percent active ingredient formulation you are using seven to 42 days before anticipated harvest with a second application seven to 14 days later. Apply Blush under slow-drying conditions, avoiding the warmest part of the day. For trees that normally color well and conditions favoring color development, the effects of increased color may be less. REI is four hours unless wearing appropriate PPE. Under conditions where red color development is acceptable, use of Blush twice may not result in significant additional red color.

**boscalid**—see *Pristine*.

**Bravo Weather Stik**—see *chlorothalonil*.

**\*Brigade**—see *bifenthrin*.

**\*Brigadier**—see *bifenthrin and imidacloprid*. Premix of bifenthrin and imidacloprid.

**Broadworks (mesotrione)** (HRAC Group 27 Herbicide) is an herbicide labeled for nectarines, plums, and prunes. Ironically it is not labeled for peaches or other stone fruits. Trees must be established at least 12 months in the orchard. The herbicide acts by disrupting carotenoid synthesis in the plants resulting in a bleaching of the plant foliage due to a lack of chlorophyll production. It has both pre and postemergent activity; although preemergent activity benefits when 0.25 inch of rain falls shortly after application. It works primarily on broadleaves and is less effective on grasses. Studies have shown that when applied alone or combined with simazine or rimsulfuron was effective suppressing horseweed, Palmer amaranth, and fleabane. In general, it is more effective on broadleaves and therefore should be combined with a grass control herbicide. There is a 12-hour REI. Do not exceed 12 fl oz per acre in one 12-month period or more than three applications. There is a 30-day PHI.

**Bt (*Bacillus thuringiensis*) (Agree, Biobit, Crymax, Deliver, Dipel, Javelin, XenTari)** (IRAC Group 11A Insecticides). *Bacillus thuringiensis* are aerobic, spore-forming, rod-shaped bacteria that form crystals of protein called delta-exotoxins. Several different types of exotoxins are produced by two *B. thuringiensis* subspecies and their various strains which, when ingested, damage the stomach wall of Lepidoptera larvae. These types of exotoxins are produced in varying proportions by the different strains and are formulated for use in tree fruits. *B. thuringiensis* subsp. *aizawai* products include Agree and XenTari. *B. thuringiensis* subsp. *kurstaki* products include Biobit, Crymax, Dipel, and Javelin.

Bts in general provide control of larvae of tufted apple bud moth, other leafrollers, green fruitworm, and most forest-orchard species (gypsy moth, tent caterpillars, webworms) that feed on foliage. Control of Oriental fruit moth and codling moth larvae is less successful because these larvae feed internally and may not ingest enough toxin. Although Bts are generally safe for applicators and to most nontarget species, XenTari is highly toxic to honey bees and other natural enemies exposed to direct spray.

Since Bts are effective only against larvae and not eggs, they should be applied beginning about one week later, when 20 percent of the eggs have hatched. Extenders that block ultraviolet degradation may improve the efficacy of Bts. If mixing Bts with other products, always add the Bt first and use good mechanical agitation. Bts are incompatible with mixtures having a high pH. Thorough spray coverage is needed to provide a uniform deposit of Bts insecticide at the site of larval feeding. Most products containing Bt are OMRI listed.

**buprofezin—see Centaur.**

**Cabrio (pyraclostrobin)** (FRAC Group 11 Fungicide). Cabrio is effective against brown rot of cherries (sweet and tart cherry). Do not make more than two sequential applications of Cabrio before alternating to a labeled fungicide with a different mode of action/FRAC Group. The maximum rate per acre per season is 47.5 ounces. The REI is 12 hours and PHI is zero days.

**Caliber 90—see simazine.**

**Calypso (thiacloprid)** (IRAC Group 4A Insecticide). Calypso is no longer registered for use in fruit systems.

**caprylic acid (Homeplate, Suppress)** is an organically labeled postemergent herbicide that acts as a total vegetation killer. It is an eight-carbon saturated fatty acid. It will not prevent later seedling germination. Control effects will depend on concentration of the solution and thorough coverage with the solution. Recommended solution concentrations are 3, 6, or 9 percent solutions of the product to water. The products can also be used to burn down succulent rootsuckers at the 6 to 9% concentration. Suppress has a 24 hour REI and Homeplate has a 12 hour REI. There is no minimum age of tree establishment listed on the label. The inclusion of this type of herbicide may improve efficacy of other herbicides by increasing absorption and burndown.

**captan (Captan, Captec)** (FRAC Group M4 Fungicide). Captan is a fungicide with protective action formulated as wettable powders, water-dispersible granules, liquids, and various dust mixtures for use on fruit. Captec is a liquid formulation, but there are other liquid formulations of captan as well. Captan is effective

against scab, black rot, white rot, bitter rot, Brooks spot, and blossom end rot on apples. It is effective against sooty blotch and flyspeck if the last spray application is not more than 30 to 40 days before harvest. It is not effective against the rusts, fire blight, or powdery mildew. In some cases, captan may cause an increase in the amount of powdery mildew compared to unsprayed trees.

If the early season apple scab control program fails and scab becomes established in the trees, captan at low rates cannot be expected to provide control. However, this fungicide is highly effective in reducing spore germination. Use at least 5 to 6 pounds per acre in low-volume sprays applied at intervals of no more than 10 to 14 days.

On stone fruits, captan is a good fungicide for the control of brown rot and scab when adequate spray schedules are followed. Captan is effective against cherry leaf spot and brown rot on tart cherries under low to moderate disease pressure if the spray intervals do not exceed two weeks.

Captan can cause necrotic spotting, yellowing, and dropping of leaves when used under poor drying conditions or in combination with sulfur, especially on Delicious, Stayman, Baldwin, and King apple varieties. Foliage of d'Anjou pears has been stunted and cupped. Necrotic spots on fruit and foliage have occurred on both plums and prunes where captan was used from petal fall until the fruit begins to ripen. Its use usually results in acceptable fruit finish on apples, peaches, and nectarines. Captan residues on peaches at harvest may cause increased skin discoloration from abrasions that occur during picking and packing. The leaves of some sweet cherry varieties may be injured by repeated captan applications. A full-season program of captan may require the use of miticides or close adherence to a pest management program.

Captan will be most effective in sprays solutions when the pH is 5.0; the higher the pH, the less effective captan will be. Captan has few spray incompatibilities, but it should not be used with spreader-sticker adjuvants, oil, lime, or other alkaline materials. The use of captan within a week either before or after an oil application may result in leaf injury on apple trees. Combinations with sulfur may result in increased injury under high temperatures and high relative humidity. Check the label for rates. REI restrictions vary from 24 hours to four days, so check the label of the product you are using. PHI is zero days.

**carbaryl (Carbaryl, Sevin)** (IRAC Group 1A Insecticide). Carbaryl is a carbamate insecticide with contact and stomach action, and slight systemic activity. Carbaryl is highly toxic to bees and should not be used near bloom. Sevin XLR Plus is formulated to be less hazardous to bees and other beneficial insects and to provide a longer period of residual activity. When applied between petal fall and 20-millimeter fruit diameter, carbaryl acts as a fruit thinner on many varieties. Carbaryl is not recommended for season-long programs because of high toxicity to mite predators that may lead to rapid increase in mite populations. See also Sevin in Part I.

**carfentrazone-ethyl (Aim, Shark)** (HRAC Group 14 Herbicide). The herbicide is a burndown material that is labeled for broadleaf weeds in all tree fruits. It can also be used to suppress root suckers when they are green and succulent. Application rates of 0.5 to 2 fluid ounces per acre should be applied when weed vegetation is still succulent and green. The addition of a nonionic surfactant at 0.25 percent v/v (2 pints per 100 gallons) or crop oil concentrate

at 1 percent v/v (1 gallon per 100 gallons) will enhance control. Do not apply more than 2 fluid ounces per acre per application or more than 7.9 fluid ounces per acre per season. Sequential applications should be a minimum of 14 days apart. Allow a minimum of three days PHI with a 12-hour REI. Do not allow spray to come in contact with any green tissue. Aim may also be used to suppress grass row middles during the growing season to reduce the necessity to mow the middles.

**Casoron (dichlobenil)** (HRAC Group 20 Herbicide). There are two formulations of Casoron a granular form (4G) and a liquid (CS). Casoron's active ingredient, dichlobenil, acts by inhibiting germination and actively dividing meristems of growing points and root tips. It is absorbed primarily from the soil by the root system. Because dichlobenil volatilizes under warm conditions, applications should be made only under cool or cold weather conditions in late fall or very early spring. A fall application may be necessary to control many perennials, such as fescues, orchardgrass, quackgrass, docks, and dandelion. Dichlobenil is labeled for use on apples, pears, and cherries. A liquid formulation of Casoron CS makes it easier to use in orchard production. Casoron CS should be applied preemergent to early postemergent. It should not be applied until after the trees have been established for at least one year, while the granular formulation can be applied anytime after four weeks from planting. Do not apply Casoron CS under warm, dry conditions; optimal activity will be achieved when applications are made at temperatures below 70°F to moist soil and/or followed by rainfall to activate the dichlobenil ingredient. The REI varies depending on the product formulation. The CS formulation has a 24-hour REI, while the 4G formulations have a 12-hour REI.

**Centaur (buprofezin)** (IRAC Group 16 Insecticide). The active ingredient in Centaur belongs to a group of insect growth regulators and is effective against the nymph stages of scales and immature stages of other molting insects by inhibiting chitin biosynthesis. Buprofezin also suppresses oviposition of adults and reduces viability of eggs. For effective pest control excellent coverage is essential. Centaur is registered for the control of scales and leafhoppers on apples (one application per season), scales and pear psylla on pears (up to two applications), and scales on peaches (two applications per season). For the best control of scales the application should be made at the peak crawler emergence. Centaur should not be applied later than 14 days before harvest.

**CheckMate CM 2.0 Flowable—see sprayable pheromones.**

**CheckMate CM XL 2.0 Dispenser—see CheckMate MD products.**

**CheckMate MD products**—a group of mating disruption products for the control of codling moth (CheckMate CM, CheckMate CM-F), Oriental fruit moth (CheckMate OFM Dispenser and CheckMate OFM-F), or both species at the same time (CheckMate Puffer CM-OFM). The hand-applied dispensers should be placed in the orchards before the spring emergence of the pests (biofix) or when the moths are first detected in pheromone traps. CheckMate Puffer products provide mating disruption of target species with a low density dispenser system. Similarly to other mating disruption materials, the CheckMate products will not have an effect on female moths, eggs, or larvae. The CheckMate pheromone dispensers (pouches) are placed on trees by hand and

therefore require high labor input. The time of application, length of activity, number of dispensers per acre, and placement within the tree vary from species to species, and detailed instructions from the product label should be followed to achieve success. Mating disruption usually works better under lower pest pressure and may require supplemental insecticide treatments. It is recommended that mating disruption be used on the whole orchard or block. Most of CheckMate hand-applied MD products are OMRI listed (for more information, see “Using pheromones for mating disruption”).

**CheckMate OFM Dispenser—see CheckMate MD products.**

**CheckMate OFM-F—see CheckMate MD products.**

**CheckMate OFM-SL+—see CheckMate MD products.**

**CheckMate Puffer CM (8,10 dodecadien-1 ol, E,E)**. Puffer CM is used as a MD product with Puffer aerosol cabinet—an automated metered dispenser—delivering a single puff of pheromone every 15 minutes through the night to disrupt the nocturnal mating behavior of codling moth. (For more information, see “Using pheromones for mating disruption” and “CheckMate MD products.”)

**CheckMate Puffer CM-OFM Pro [E,E-8,10-Dodecadien-1-ol, (Z)-8-Dodecen-1-yl acetate, (E)-8-Dodecen-1-yl acetate, (Z)-8-Dodecen-1-ol]**. Puffer CM-OFM PRO is used as a MD product with Puffer aerosol cabinet—an automated metered dispenser—delivering a single puff of pheromone every 15 minutes through the night to disrupt the nocturnal mating behavior of codling moth and Oriental fruit moth. (For more information, see “Using pheromones for mating disruption” and “CheckMate MD products.”)

**CheckMate Puffer OFM-0 [(Z)-8-Dodecenyl acetate, (E)-8-Dodecenyl acetate, and (Z)-8-Dodecenol]**. Puffer OFM is a MD product with Puffer aerosol cabinet—an automated metered dispenser—delivering a single puff of pheromone every 15 minutes to disrupt the mating behavior of Oriental fruit moth. (For more information, see “Using pheromones for mating disruption” and “CheckMate MD products.”)

**chlorothalonil (Bravo, Bravo Weather Stik, chlorothalonil 720, Initiate 720, Equus)** (FRAC Group M5 Fungicide). Bravo and the other chlorothalonil formulations are nonsystemic foliar fungicides with protective action registered for the control of brown rot blossom blight; leaf curl of stone fruits; Coryneum blight (shothole) and scab on peaches, nectarines, and apricots; and is excellent for cherry leaf spot. These products are recommended at 3.1 to 4.1 pints per acre depending on the disease pressure and the application timing. Bravo is not registered for use after shuck split and before harvest, but it can be used after harvest for cherry leaf spot control. Chlorothalonil is also recommended for control of black knot on cherries and plums. Chlorothalonil is a severe eye irritant with special reentry restrictions. Read the label for exact rates/restrictions depending on the chlorothalonil brand/formulation used.

**chlorpyrifos (\*Chlorpyrifos, \*Cobalt, \*Cobalt Advanced, \*Lorsban, \*Lorsban Advanced, \*Nufos, \*Warhawk, \*Yuma)** (IRAC Group 1B Insecticide). Chlorpyrifos is an organophosphate insecticide with nonsystemic contact, stomach, and vapor action highly effective on a wide range of insects on apples, peaches, and nectarines. This material is formulated as an emul-



sifiable concentrate and as a wettable powder. Chlorpyrifos 4E, Lorsban 4E, and Lorsban Advanced are products labeled for dormant to delayed dormant applications on apples, peaches, nectarines, and plums to control scale and other pests. Trunk sprays of these products thoroughly wetting all bark areas from ground level to scaffold limbs will control peachtree borer. Apply only one borer application per season, and do not apply within 14 days of harvest. As a postharvest spray, these products at 1 to 2 quarts per 100 gallons are effective on second-generation lesser peachtree borer. Lorsban 4E or Lorsban Advanced can be used to directly treat burr knots for control of dogwood borer and other borers on apples. Apply 1.5 to 3 quarts of Lorsban Advanced per 100 gallons. On young trees, as little as 6 fluid ounces per tree can provide successful control. Optimum dogwood borer control timing is after the bloom and during the summer at peak flight. Do not apply the last treatment within 28 days before harvest. On apples, peaches, and nectarines only one application of product containing chlorpyrifos is allowed per year.

Lorsban 75 WG is labeled for use on apples at the rate of 0.33 to 0.67 pound per 100 gallons of water in dilute sprays and no less than 1 pound per acre in concentrate sprays. Lorsban cannot be applied as a foliar application after petal fall.

**Cidetrak CM (8E, 10E)-8,10-dodecadien-1-ol.** Mating disruption formulation for codling moth. For more information, see “Using pheromones for monitoring and mating disruption.”

**Cidetrak CMDA + OFM Meso [8E,10E-Dodecadien-1-ol, Ethyl (2e4Z)-2,4-decadienoate, (Z)-8-Dodecen-1-yl acetate, (E)-8-Dodecen-1-yl acetate, (Z)-8-Dodecen-1-ol].** Low-rate (30 dispensers per acre) mating disruption product to control codling moth and Oriental fruit moth. For more information, see “Using pheromones for monitoring and mating disruption.”

**Cidetrak CM-OFM Combo [8E,10E-Dodecadien-1-ol, (Z)-8-Dodecen-1-yl acetate, (E)-8-Dodecen-1-yl acetate, (Z)-8-Dodecen-1-ol].** Mating disruption product to control codling moth and Oriental fruit moth. For more information, see “Using pheromones for monitoring and mating disruption.”

**Cidetrak OFM-L (Z-8-Dodecen-1-yl Acetate, E-8-Dodecen-1-yl Acetate, Z-8-dodecen-1-ol).** Mating disruption formulation for Oriental fruit moth. For more information, see “Using pheromones for monitoring and mating disruption.”

**Cidetrak OFM Meso (Z-8-Dodecen-1-yl Acetate, E-8-Dodecen-1-yl Acetate, Z-8-dodecen-1-ol).** Low-rate (30 dispensers per acre) mating disruption formulation for Oriental fruit moth. For more information, see “Using pheromones for monitoring and mating disruption.”

**Clean Slate—see clopyralid.** This product is only labeled for use in stone fruits.

**clethodim (Arrow, Clethodim, Envoy Plus, Intensity One, PS Clethodim Select, Section 2EC, Select Max, Shadow, TapOut, Tide Clethodim 2EC, Vaquero, Volunteer)** (HRAC Group 1 Herbicide). Clethodim is a postemergent herbicide for the control of annual and perennial grasses in nonbearing tree fruit and some nut crops. Nonbearing plants are described as those that will not have a crop for 12 months after application. It does not control sedges or broadleaved weeds. It should be applied as a directed spray to the base of the trees. Do not apply over the tops

of plants grown for rootstocks. Rate varies depending on the weed species and stage of growth. There are several different named products that contain clethodim. Apply higher rates to control perennial grasses. Do not apply to grasses that are under stress. EPA requires the signal word “WARNING” to appear on the label. A reentry restriction period of 12 hours is required after application. Multiple applications should be spaced at least 14 days apart. Clethodim products are more effective against annual blue grass. Note that different company’s products may have different percent active ingredient; be sure to read the label to determine the correct rates before using. The REI is 24 hours.

**clofentezine—see Apollo.**

**clopyralid (Clean Slate, Stinger, Spur)** (HRAC Group 4 Herbicide). This is a postemergent herbicide labeled for stone fruits and apples to help control some of the problem perennial weeds that invade orchards. Note that Clean Slate is only labeled for stone fruits and does not have a label for pome fruits. Clopyralid gives excellent control of dandelion, horseweed, nightshades, and thistles. Application rate is  $\frac{1}{3}$  to  $\frac{2}{3}$  pint per treated acre in one to four applications per crop per year, not to exceed  $\frac{2}{3}$  pint per treated acre per year. The PHI is 30 days. REI is 12 hours. There are several other manufacturers of clopyralid; however, not all the different products are labeled for both pome and stone fruits. Be sure you have a product that allows you to apply the material to the crops you grow. Clopyralid can seep or leach through soil and under certain conditions contaminate groundwater that may be used for irrigation or drinking purposes. Do not apply where soils have a rapid to very rapid permeability throughout the soil profile and the underlying aquifer is shallow. Unusual for an herbicide, it is also highly toxic to bees.

**Closer (sulfoxaflor)** (IRAC Group 4C Insecticide). This is a sulfoximine insecticide with a unique mode of action for control of sap feeding insect pests. Sulfoxaflor is a high efficacy nAChR agonist with low affinity to the imidacloprid binding site. Sulfoxaflor kills insect pests both by contact and through ingestion to provide rapid knockdown and residual control. Sulfoxaflor displays translaminar movement (moves to the opposite leaf surface) when applied to foliage and is xylem mobile. Closer SC is registered for use on pome and stone fruit for control of sap feeding insects: aphids, including woolly apple aphid, plant bugs, and white apple leafhopper. Closer SC is also listed as a suppressant against pear psylla, San Jose scale, and western flower thrips. Product should not be applied within seven days of harvest. Closer SC should not be used until after petal fall.

**clothianidin—see Belay.**

**Clutch—see Belay.**

**\*Cobalt—see chlorpyrifos.** Premix of chlorpyrifos and gamma-cyhalothrin.

**\*Cobalt Advanced—see chlorpyrifos.** Premix of chlorpyrifos and lambda-cyhalothrin.

**codling moth granulosus virus (CpGV) (Cyd-X, Cyd-X HP, Madex HP, Virosoft CP4).** CpGV is a biological insecticide registered for the control of codling moth in apples, pears, and walnuts. A codling moth larva must ingest the virus in order to

become infected. Larval mortality is not immediate, but infected larvae will stop feeding within a few days and eventually die. Multiple applications per generation are recommended for the best efficacy of this product. The first application should be made at the beginning of egg hatch and repeated every seven days. Mating disruption in combination with codling moth granulosis virus should provide very good control of pesticide-resistant codling moth populations. In laboratory tests conducted at the Penn State Fruit Research and Extension Center, codling moth granulosis virus was also effective in controlling neonate Oriental fruit moth. Cyd-X and Cyd-X HP are OMRI listed. See also “Management of codling moth with codling moth granulosis virus.”

**Collide—see oxyfluorfen.**

**Comet—see fluoxypyr.**

**copper compounds** (FRAC Group M1 Fungicide). Copper is a general biocide with protective activity. Copper works by denaturing proteins, thereby destroying the enzymes that are essential for cells to function. Due to these properties, damage to plant tissue can occur, so the right balance of copper must be used that will kill fungal and bacterial cells yet minimize harm to plant cells. There are two types of copper available to growers: fixed coppers and bluestone coppers (copper sulfate pentahydrate). Fixed coppers are somewhat safer or more forgiving due to their lower solubility, but high rates of fixed copper can still damage plant tissues. Bluestone coppers are highly soluble, so the copper ions are released rapidly upon application, leaving little residual activity. Copper sprays can become more phytotoxic in acid solution; the pH of the spray water should be checked. Copper ions are slowly released as each time a plant surface becomes wet, so slower drying times can also increase the risk of phytotoxicity. Mixing phosphonate products (e.g., Phostrol, Prophyt, Rampart) and other foliar fertilizers with copper compounds can intensify injury, and these compounds should not be tank-mixed with coppers. Adjuvants should also not be tank-mixed with coppers. The addition of hydrated lime (calcium hydroxide) to the tank raises the pH and decreases the solubility, which can help minimize the damage to plant tissue. It is recommended that hydrated lime always be added to compounds that contain bluestone copper to reduce the risk of phytotoxicity and increase residual activity, unless used as a dormant spray. Leaves of stone fruit tend to be more sensitive to copper phytotoxicity than apples and different varieties of stone fruit can vary in their sensitivity; however, fruit russetting can occur on apple fruit when copper is used as early as bloom. Fixed coppers include basic copper sulfate (Cuprofix), copper octanoate (Cueva), copper oxide (Nordox 75WG), copper oxychloride (C-O-C-S WDG, Badge), and copper hydroxide (Champ, Kocide, Nu-Cop, Previsto). MasterCop and Magna-Bon are copper sulfate pentahydrate, which is a soluble copper. Read the label of the product you intend to apply to determine the type of copper, the percent active ingredient, and any other precautions that should be taken. Some copper products are approved for organic production and are OMRI listed. Refer to Table 3-10 for a list of copper products used in fruit crops.

**Cormoran—see acetamiprid and novaluron** (IRAC Group 4A and 15 Insecticides).

**Couraze—see imidacloprid.**

**Crymax—see Bt.**

**cyantraniliprole—see Exirel.**

**cyazypyr—see Exirel.**

**Cyd-X—see codling moth granulosis virus.** This product is OMRI listed.

**Cyd-X HP—see codling moth granulosis virus.** This product is OMRI listed.

**cyflufenamid—see Torino.**

**cyflumetofen—see Nealta.**

**cyfluthrin (\*Baythroid XL, \*Tombstone)** (IRAC Group 3A Insecticide) is a broad-spectrum pyrethroid insecticide with contact and stomach action. It is registered for use on apples, crabapples, pears, quince, peaches, apricots, nectarines, plums, prune plums, and cherries. Similar to other pyrethroids, cyfluthrin-containing products are restricted-use pesticides due to their toxicity to fish and other aquatic organisms. Baythroid is highly toxic to bees exposed to direct treatment and residues on plants. Use recommendations are generally limited to only before bloom in Pennsylvania to conserve *Stethorus* and other predators of spider mites.

**Cyprodinil—see Inspire Super and Vanguard WG.**

**Damoil—see dormant and summer oils.**

**\*Danitol (fenpropathrin)** (IRAC Group 3A Insecticide). Danitol is a broad-spectrum pyrethroid insecticide with contact and stomach action. It is registered for use on both pome and stone fruit groups. On apples, the product is registered for a very wide range of insect pests, including brown marmorated stink bug, potato leafhopper, white apple leafhopper, rosy apple aphid, spirea aphid, spotted tentiform leafminer, tarnished plant bug, plum curculio, European apple sawfly, Japanese beetle, apple maggot, obliquebanded leafroller, tufted apple bud moth, Oriental fruit moth, and many more. On pears, Danitol is registered for the control of codling moth and pear psylla. The rate for Danitol varies from 10.67 to 21.33 fluid ounces per application, with no more than 42.67 fluid ounces per season. The product is highly toxic to fish and aquatic organisms. Due to fenpropathrin toxicity to beneficial organisms, the compound is recommended mainly for prebloom insecticide applications in Pennsylvania unless directed against BMSB later during the season.

**dazomet (\*Basamid G).** Basamid is a broad-spectrum soil fumigant used for the preplant control of nematodes, weeds, and soilborne diseases. Unlike other fumigants, Basamid is a granular product that must be mechanically incorporated into the soil. A soil fumigation rig is not required. Toxic gases are not released until after the product begins to absorb moisture from the soil. Basamid's efficacy is affected by the same soil conditions and features that affect other fumigants, including moisture, temperature, texture, organic matter content, site preparation, and effective surface sealing after application. The product is phytotoxic and will harm trees if the gases have not completely dissipated from the soil before planting. Any certified applicator supervising a soil fumigant application must have successfully completed one of the soil fumigant training programs listed at [www.epa.gov/soil-fumigants/soil-fumigant-training-certified-applicators](http://www.epa.gov/soil-fumigants/soil-fumigant-training-certified-applicators)

**Table 3-10. Copper formulations for fruit crops.**

Product	Copper form	Amount of active ingredient	Metallic copper equivalent	Unit type	Metallic copper per unit	OMRI listed*
Dry formulations						
Badge X2	copper oxychloride	23.82%	28%	1 lb	0.28 lb	yes
	copper hydroxide	21.49%				
Basic Copper 53	basic copper sulfate	98%	53%	1 lb	0.53 lb	yes
Basic Copper Sulfate	copper sulfate	98%	53%	1 lb	0.53 lb	no
Champ WG	copper hydroxide	77%	50%	1 lb	0.50 lb	yes
Champ Dry Prill	copper hydroxide	57.6%	37.5%	1 lb	0.375 lb	no
C-O-C-S WDG	copper oxychloride	74.8%	50%	1 lb	0.50 lb	no
	copper sulfate	14.2%				
Copper sulfate = bluestone = blue vitriol	copper sulfate pentahydrate	99%	25%	1 lb	0.25 lb	yes
Cuprofix Ultra 40 Disperss**	basic copper sulfate	71.1%	40%	1 lb	0.40 lb	no
Kentan DF	copper hydroxide	61.3%	40%	1 lb	0.40 lb	no
Kocide 2000	copper hydroxide	53.8%	35%	1 lb	0.35 lb	yes
Kocide 3000	copper hydroxide	46.1%	30%	1 lb	0.30 lb	yes
Nordox	cuprous hydroxide	56.4%	50%	1 lb	0.50 lb	yes
Nordox 30/30 WG	cuprous oxide	33.8%	30%	1 lb	0.30 lb	yes
Nordox 75 WG	cuprous oxide	83.9%	75%	1 lb	0.75 lb	yes
Nu-Cop 50DF	copper hydroxide	77%	50%	1 lb	0.50 lb	yes
Nu-Cop 50 WP	copper hydroxide	77%	50%	1 lb	0.50 lb	yes
Nu-Cop HB	copper hydroxide	77%	50%	1 lb	0.50 lb	yes
Nu-Cop 30 HB	copper hydroxide	46.1%	30%	1 lb	0.30 lb	yes
Liquid formulations						
Badge SC	copper oxychloride	16.81%	20%	1 gal	2.27 lb	no
	copper hydroxide	15.36%				
Champ Formula 2 Flowable	copper hydroxide	37.5%	24.4%	1 gal	4.5 lb	no
Cueva Fungicide Concentrate***	copper octanoate (copper salt of fatty acid)	10%	1.8%	1 gal	0.15 lb	yes
Cuproxtat FL	basic copper sulfate	27.1%	15.2%	1 gal	1.6 lb	yes
Cuproxtat Flowable Copper Fungicide	basic copper sulfate	27.1%	15.2%	1 gal	1.6 lb	no
Magna-Bon CS 2005	copper sulfate pentahydrate	19.8%	5%	1 gal	0.418 lb	yes
MasterCop	copper sulfate pentahydrate	21.5%	5.4%	1 gal	0.6 lb	yes
Nu-Cop XLR	copper hydroxide	17.06%	10%	1 gal	1.0 lb	no
Previsto	copper hydroxide	5%	3.3%	1 gal	0.3 lb	yes

Source: Adapted with permission from the 2016 *Michigan Fruit Management Guide* (courtesy of William Shane, MSU Extension).

Check labels for crops listed. Copper sulfate formulations are generally more soluble than other types and thus are more prone to phytotoxicity and wash-off unless combined with lime as a safening agent.

\*OMRI = Organic Materials Review Institute ([www.omri.org/omri-lists](http://www.omri.org/omri-lists)); if the product is listed, it is deemed suitable for organic production. However, the organic certifying agency ultimately determines whether a product can be used or not.

\*\*Cuprofix Disperss, a copper sulfate formulations, also contains gypsum, a calcium-containing compound, which provides some safening of the copper, much like the lime in Bordeaux.

\*\*\*Fatty and rosin acid forms are not compatible with lime.

Sources and further information: Rosenberger, Dave, "Spring copper sprays for fruit diseases," *Scaffolds Newsletter* 20, no. 2 (March 28, 2011), [www.scaffolds.entomology.cornell.edu/2011/110328.pdf](http://www.scaffolds.entomology.cornell.edu/2011/110328.pdf); Ritchie, David, "Copper-containing fungicides/bactericides and their use in management of bacterial spot on peaches," *Southeast Regional Newsletter* 4, no. 1 (March 2004), [www.give2all.org/pdf/bactericide/3.pdf](http://www.give2all.org/pdf/bactericide/3.pdf); and Lalancette, Norman, "Copper Bactericides for Peach Bacterial Spot Management," *Rutgers Cooperative Extension Plant and Pest Advisory* (May 15, 2014), <https://plant-pest-advisory.rutgers.edu/copper-bactericides-for-peach-bacterial-spot-management/>.

for the active ingredient(s) in this product. The training must be completed in the time frames listed on the website. The fumigation management plan must document the date and location where the soil fumigant training program was completed.

**Deadline Bullets (metaldehyde)**—registered product to control slugs and snails. The product should be applied to the ground at the rate of 20 to 40 pounds per acre. Cannot be applied directly to or contaminate edible portions of the plant.

**\*Declare—see gamma-cyhalothrin.**

**Delegate (spinetoram)** (IRAC Group 5 Insecticide). Delegate is a member of the spinosyn class of insecticides derived from fermentation of *Saccharopolyspora spinosa* but with chemical modifications. Spinetoram causes excitation of the insect nervous system by altering the function of nicotinic and GABA-related ion channels. Delegate exhibits good translaminar activity but not systemic activity. Delegate is registered for use on pome fruit, stone fruit, bushberries, caneberries, and grapes. For pome and stone fruit the in-season recommended rate is from 4.5 to 7 ounces per acre. Delegate provides excellent control of leaf-rollers, leafminers, codling moth, Oriental fruit moth, thrips, pear psylla, and suppression of apple maggot and plum curculio. As a larvicide, the compound needs to be ingested by the insect for optimal pest control. Due to the same mode of action as SpinTor, no more than three consecutive applications of those two compounds are recommended. No more than four applications are allowed per season. Delegate has a seven-day PHI on apples, cherries, plums, and prunes; a 14-day PHI on apricots; and a one-day PHI on peaches and nectarines.

**Deliver—see Bt products.** This product is OMRI listed.

**\*Delta Gold—see deltamethrin.**

**deltamethrin** (IRAC Group 3A Insecticide). This product is a broad-spectrum pyrethroid insecticide with contact and stomach action. It is registered for use on pome fruits such as apples, loquat, mayhaw, quince, and pears but is not registered for the use on stone fruits. Deltamethrin is extremely toxic to fish and other aquatic organisms. The product is also highly toxic to bees exposed to direct treatment and residues on plants. In Pennsylvania use recommendations are generally limited to only before-bloom applications to conserve *Stethorus* and other predators of spider mites.

**Des-X (potassium salts of fatty acids)**—insecticidal soap that kills pests by disrupting membrane and cellular function of soft-bodied insects. Direct contact of the solution with insect body is necessary for the product to provide pest mortality. Product is OMRI registered.

**diazinon (\*Diazinon)** (IRAC Group 1B Insecticide). Diazinon is a nonsystemic, organophosphate insecticide with contact, stomach, and respiratory action. Diazinon has a broad spectrum of insect control. It is recommended in the apple programs in the ½-inch green and prebloom sprays for scale control and as a foliar application after bloom to control wooly apple aphid. No more than two applications per season are allowed on both stone and pome fruit. Diazinon AG500 is registered for use on stone fruit but not on pome fruit. Diazinon 50W carries a 21-day PHI.

**dichlobenil—see Casoron.**

**difenoconazole—see Academy and Inspire Super.**

**Dimate (dimethoate)** (IRAC Group 1B Insecticide). Organophosphate insecticide registered only for application on pears against aphids, leafhoppers, pear psylla, and mites. The PHI is 28 days, and the REI is 10 days.

**dinotefuran (Scorpion, Venom)** (IRAC Group 4A Insecticide). Dinotefuran-containing products were recently registered for use on peach and nectarines for the control of stink bugs and leafhoppers and suppression of aphids, peach tree borer, and plum curculio. Dinotefuran is not registered for use on apple or other pome fruit. At the higher registered label rate, Scorpion and Venom (at 7 fluid ounces per acre; Venom at 4 ounces) are effective against brown marmorated stink bug adults and nymphs. Scorpion can be applied up to three days of harvest.

**Dipel—see Bt.**

**Direx—see diuron.**

**\*Discipline—see bifenthrin.**

**DiTera DF (dried fermentation solids and solubles of *Myrothecium verrucaria*)**. DiTera DF may be applied to the soil as a preplant, at planting or postplant treatment for the control of plant-parasitic nematodes. Preplant treatments should be applied as close to actual planting times as possible. DiTera DF must be incorporated into the soil either mechanically or by irrigation for best results. In perennial crops, the optimal application time is just prior to a flush of root growth. Do not apply DiTera directly to foliage. This product is OMRI listed.

**diuron (Direx 4L, Diuron, Diuron 80DF, Diuron 80WDG, Karmex DF)** (HRAC Group 7 Herbicide). Diuron is a substituted urea herbicide that is applied as a preemergent and is effective primarily on broadleaved weeds with some postemergent activity. After being taken up by the roots and spread throughout the plant, it acts to inhibit photosynthesis. At high rates the material is relatively nonselective and can injure trees. It should not be applied to soils that have less than 1 percent organic matter or to sand, loamy sand, gravelly soil, or exposed subsoils. The label also recommends not to replant the site for at least two years after the last treatment. Trees on M.9 rootstock and its clones may show sensitivity to its use. Diuron has a low acute toxicity to mammals even though it carries the signal word “WARNING” on the label. The signal word is applied because the compound can cause eye and throat irritation. It is much less of an irritant to intact skin. Do not apply diuron alone to apple or pear trees that have been established less than one year or to peach trees established less than three years in the orchard. Diuron will not control emerged weeds such as dandelion, plantains, or yellow rocket. The use of the combination of diuron plus terbacil (Sinbar) on apples and peaches established at least two years in the orchard gives a broader spectrum of control. Note that some of the liquid formulations of diuron have different maximum rates; be sure to read the label carefully. The REI is 12 hours.

**dodine—see Syllit.**

**Dormant Oil 435—see dormant oils.**

**dormant oils (BioCover, Damoil, Dormant Oil 435, Mite-E-Oil, Omni Supreme Spray, Par F70 Soluble Oil, PureSpray Oil, Spray Oil 415, Sunspray 6E, Super 94 Spray Oil, Superior Spray Oil,**

**Supreme 470 Spray Oil.** Oils are physical pesticides, which are effective as a smothering film on European red mite eggs and young nymphs, and several other pests. Oils in the 60- or 70-second viscosity range are recommended as a control measure for preventing San Jose scale and European red mite. These oils are safer than earlier dormant oils because they are more volatile, resulting in less persistence on the tree. They remain on the tree long enough to kill the pest, but not so long as to interfere with vital plant processes or oil-incompatible pesticides that may be applied later. Because of this safety factor these oils can be applied up to the prepink stage of tree development. Oil applied during silver tip to ¼-inch green is not nearly as effective on mites as it is when applied between ½-inch green and full pink. Use 2 gallons of oil per 100 gallons dilute between half-inch green and tightcluster. To lower the possibility of tree injury after oil applications, reduce the oil rate to 1 gallon per 100 gallons dilute if application is made after tightcluster. Oils should never be mixed with fungicides containing sulfur. Do not apply captan products immediately before or after applying oil.

**Double Nickel (*Bacillus amyloliquefaciens*)** (FRAC Group 44 Bactericide/Fungicide). Double Nickel is broad-spectrum bacterial fermentation product for the control or suppression of pome and stone fruit diseases. It is effective as a rotational product or tank-mixed with other registered fungicides/bactericides. Apply at a rate of 0.5 to 6 quarts per acre on a 3- to 10-day schedule. REI is four hours and PHI is zero days. This product is OMRI listed.

**EcoSwing (extract of *Swinglea glutinosa*)** (FRAC Group Not Classified). EcoSwing is a biofungicide for use to control multiple fungal diseases, such as brown rot. Optimum disease control is achieved when the biofungicide is used according to label directions and applied in a regularly scheduled preventive spray program. EcoSwing is a multisite mode of action biofungicide and can be used in a resistance management program on both pome and stone fruit. The REI is four hours and PHI is zero days. This product is OMRI listed.

**Elevate (fenhexamid)** (FRAC Group 17 Fungicide). Elevate is fungicide labeled for the control of Botrytis on pears and cherries as well as brown rot on stone fruit. Elevate should be used in conjunction with other products for season-long protection. Do not make more than two consecutive applications of Elevate before using an alternative fungicide for resistance management. Elevate has a 12-hour REI and can be applied up to the day of harvest (zero-day PHI).

**\*Endigo (premix of thiamethoxam and lambda-cyhalothrin)** (IRAC Group 3A and Group 4A Insecticides mixture). Endigo is premix product containing neonicotinoid and pyrethroid active ingredients. Endigo is registered for use on pome and stone fruit for the control of wide array of pests including stink bug species. It may flare overwintering mite eggs and interfere with biological control of mites and WAA. This product is extremely toxic to fish and aquatic organisms, highly toxic to bees, and toxic to wildlife. See also thiametoxam and lambda-cyhalothrin.

**endosulfan (Thionex)** (IRAC Group 2A Insecticide). Endosulfan is no longer registered for use on fruit.

**Entrust.** OMRI-listed product with spinosad as active ingredient. See SpinTor for more information.

**Envidor (spirodiclofen)** (IRAC Group 23 Insecticide). Envidor is a nonsystemic foliar miticide belonging to the chemical class of tetrone and tetramic acid derivatives. Envidor's unique mode of action is classified as lipid biosynthesis inhibitor and is active by contact against all developmental stages of mites including eggs and female adults. Adult males are not affected. The product is registered for use on pome and stone fruits. Envidor is registered for the control of European red mites, twospotted spider mites, peach silver mites, and rust mites. Only one application is allowed per growing season.

**Esteem (pyriproxyfen)** (IRAC Group 7C Insecticide). Esteem is an insect growth regulator that acts by suppressing embryogenesis within the insect eggs and by inhibiting metamorphosis (the change from one stage to another, for example from pupa to adult) and adult emergence of target pests. Esteem has no activity on adult insects, but hatching of eggs laid by treated adults will be suppressed (sterile activity). Pyriproxyfen exhibits translaminar movement in leaves. On apples, it is registered for the control of codling moth, San Jose scale, leafminers, and aphids. On pears, Esteem is additionally registered for the control of pear psylla. The addition of oil has been shown to improve the control of codling moth and San Jose scale. Esteem should not be applied more than twice during the growing season. This pesticide is toxic to fish and aquatic invertebrates.

**ethephon (Ethepon 2, Ethepon 2SL, Ethrel, Motivate, Verve).** Ethepon is an ethylene-releasing material that can advance fruit maturity, increase red color, increase flowering, and thin fruit in apples. In cherries, it can be used to increase color and help loosen fruit. Ethepon must be applied in spray mixtures that have a pH less than 8.5. At a pH above 8.5, ethephon does not break down to form ethylene. Do not apply ethephon on cherries when temperatures exceed 85°F, or on apples when temperatures exceed 90°F. Ethepon may be used as a fruit thinner for apples, but the amount of thinning can be excessive, especially when hot (above 80°F) weather follows the application. Ethepon will thin apples up to 20 millimeters in diameter, making it valuable as a rescue thinner. To improve fruit loosening and red color in apples, apply seven days before normal harvest and include a suitable stop-drop material such as NAA. Where ethephon is applied to bearing trees to increase flowering for the next year, some reduction in fruit size can occur. To avoid a thinning response on apples when trying to increase flowering, delay application until six weeks after bloom or June drop, whichever is later. Ethepon is not very mobile within the tree; therefore, to obtain the desired response good spray coverage is essential so that the material reaches the fruit. The REI is 48 hours and PHI is seven days.

**etoxazole—see Zeal.**

**Exirel (cyantraniliprole, cyazypyr)** (IRAC Group 28 Insecticide) is a second-generation anthranilic diamide broad-spectrum insecticide active against sucking and chewing insect pests such as codling moth, Oriental fruit moth, leafrollers, leafminers, leafhoppers, plum curculio, apple maggot, pear psylla, Japanese beetle, thrips, spotted wing drosophila, and rosy apple aphid. Ingestion or contact by cyazypyr results in feeding cessation by the insect; however, the time of death may take one to three days

after exposure. Exirel should not be applied within seven days of application of strobilurin fungicides as phytotoxicity may occur. Exirel is registered for use on pome and stone fruit and carries a three-day PHI on both crop groups.

**\*Fanfare**—see **bifenthrin**.

**fenarimol**—see **Rubigan EC**.

**fenazaquin**—see **Magister SC**.

**fenbuconazole**—see **Indar**.

**fenbutatin oxide**—see **\*Vendex**. No longer registered.

**fenpropathrin**—see **\*Danitol**.

**fenpyroximate**—see **Portal**.

**ferbam (Ferbam 76WDG)** (FRAC Group M3 Fungicide) is labeled for pome fruit for scab, rust, sooty blotch and flyspeck, leaf spot, and many rots. Ferbam is also labeled for peach, apricot, cherry, and plum. It is effective for brown rot, leaf curl, *Coryneum* blight, and cherry leaf spot. Do not use with Bordeaux or fixed copper plus hydrated lime. Ferbam may produce unsightly residues on leaves and fruit. On Golden Delicious, Jonathan, and other varieties that russet easily, injury may result from using ferbam, especially if it is applied in the pink through first cover periods. The best time to use it is in the prepink period or in the second or later cover sprays. Read the label for exact rates and restrictions for individual crops. The REI is 12 hours, and it has a seven-day PHI for pome fruit and plums; a 21-day PHI for peach and apricot; and a four-day PHI for cherry.

**FireLine**—see **oxytetracycline**.

**FireWall**—see **streptomycin sulfate**.

**Flint Extra (tryfloxystrobin)** (FRAC Group 11 Fungicide). Flint Extra is a broad-spectrum strobilurin fungicide that is labeled on pome fruit to control apple scab, powdery mildew, cedar-apple rust, sooty blotch, and flyspeck and for suppression of bitter rot and white rot. It is labeled on stone fruit to control of cherry leaf spot, powdery mildew, rust, scab, and shothole, as well as suppression of brown rot blossom blight. Begin applications preventively and continue applications as needed on a 10- to 14-day interval. Do not make more than four applications per season or two sequential applications to limit the potential for development of disease resistance. Do not apply more than 10.5 fluid ounces per acre per season on pome fruit and 15.2 fluid ounces of Flint Extra per acre per season on stone fruit. The PHI is 14 days on pome fruit and one day on stone fruit. The REI is 12 hours.

**flonicamid**—see **Beleaf**.

**fluazifop-p-butyl**—see **Fusilade**.

**fluazinam**—see **Omega**.

**flubendiamide**—see **Belt**.

**fludioxonil**—see **Academy and Scholar**.

**flumioxazin (BroadStar, Chateau SW, Chateau WDG, Flumi 51WDG, Tuscany, Varsity)** (HRAC Group 14 Herbicide). This contact and residual herbicide controls primarily broadleaf weeds in bearing and nonbearing orchards. Weeds that are especially well controlled include marehail, lambsquarters, pigweeds, and

nightshade. It can be used in the year of planting if the trees are shielded from contact by nonporous wraps, grow tubes, or waxed containers. It is labeled for pome and all stone fruits. As a contact material it is most effective when applied while the emerged weeds are very small. Application rate is 6 to 12 ounces (0.188 to 0.38 lb ai/A) per treated acre. The REI is 12 hours and the PHI is 60 days. Do not apply more than 12 ounces in a single application and do not exceed more than 24 ounces in any 12-month period. Do not make sequential application within 30 days of the first application. There are two formulations WDG and an SW formulation. Note that BroadStar is a granular product with an active ingredient concentration of only 0.25 percent; it is primarily used in nurseries. Additional restrictions and warnings include restrictions on soil types, danger of damage from dust from soils drifting onto trees, and proximity of nondormant pears to the application site. Flumioxazin formulations should be applied only prior to pink bud and bud break in stone fruit and pears. The preferred timing of application is in the fall to take advantage of the potential for rain to activate the material.

**flupyrpyr**—see **Luna Experience, Luna Sensation, Luna Tranquility, and Velum Prime**.

**flupyradifurone**—see **Sivanto**.

**fluroxypyr (Comet, Starane Ultra, Stave)** (HRAC Group 4 Herbicide). This postemergent herbicide for broadleaf perennial and annual weeds is registered for use on apples and pears, including Asian pears and quince. Starane Ultra registration is as a supplementary label; Comet and Stave list application to pome fruits on the main label. It is a synthetic auxin in the same class of herbicides as clopyralid. Trees must be established in the orchard for at least four years. There is a 24-hour REI and a 14-day PHI. Fluroxypyr is sensitive to environmental conditions at the time of application. Optimum effectiveness occurs at air temperatures of 55 to 85°F to dry weeds that are actively growing. Frost three days before or three days after application may reduce weed control and crop tolerance. Use sufficient spray volume to adequately cover the plants but not more than 40 gallons of water per acre. The spectrum of weeds controlled or suppressed will depend on the rate used.

**flutriafol**—see **Rhyme and Topguard**.

**fluxapyroxad**—see **Merivon and Sercadis**.

**Fontelis (penthiopyrad)** (FRAC Group 7 Fungicide). Fontelis is a broad-spectrum single-site succinate dehydrogenase inhibitor (SDHI) fungicide that controls scab, powdery, rust, and *Alternaria* leaf spot on apple and pear at 10 to 20 fluid ounces per acre. A tank-mix rate of 10–12 fluid ounces is recommended with another fungicide to effectively manage apple scab. Fontelis also provides control of brown rot, gray mold, powdery mildew, rust, scab, and shothole and suppression of cherry leaf spot on stone fruits at 14 to 20 fluid ounces per acre. Fontelis rapidly penetrates into plant tissue and is rainfast within one hour of application. Tank mixtures with other non-Group 7 fungicides is recommended to broaden disease control spectrum and/or manage potential resistance. Do not make more than two sequential applications and do not exceed 61 fluid ounces per year. REI is 12 hours. PHI is zero days on stone fruit and 28 days on pome fruit.

**fosetyl-AI**—see **Aliette**.

**Fruitone**—see **NAA**.

**FujiMite**—see **Portal**.

**Fusilade (fluazifop-p-butyl)** (HRAC Group 1 Herbicide). This selective phenoxy herbicide is used for postemergence control of annual and perennial grass weeds. It is registered for use in nonbearing apple and pear orchards that will not be harvested within a year after application. It may be applied to bearing stone fruit orchards. It will control most emerged annual and perennial grasses, but not broadleaved weeds. Either a crop oil concentrate (2 pints per 25 gallons) or nonionic surfactant (0.5 pint per 25 gallons) must be added to the tank mix. Applications should be made to young (2- to 8-inch) actively growing grasses before seedhead development. Do not apply more than 72 fluid ounces of product in any one year. For best response, weed species should be actively growing and not under any stress. Where a mixture of weeds exists, treat the area when the first weed to be controlled reaches the recommended growth stage. This material has no residual activity. Fusilade is a slightly toxic compound which carries the signal word “CAUTION” on its label. A single dose of the formulated compound (Fusilade DX) can cause severe stomach and intestinal disturbance. Ingestion of large quantities may cause problems in the central nervous system such as drowsiness, dizziness, loss of coordination, and fatigue. Breathing small amounts of the product may cause vomiting and severe lung congestion.

**Fysium**—see **1-MCP**.

**Galigan**—see **oxyfluorfen**.

**Gallery**—see **isoxaben**.

**gamma-cyhalothrin (\*Declare,\*Proaxis)** (IRAC Group 3A Insecticide). Gamma-cyhalothrin is a synthetic pyrethroid insecticide that controls insects by contact and ingestion. The compound is registered for the control of multiple pests on pome and stone fruit. On pome fruit, product cannot be applied within 21 days of harvest, while on stone fruit, within 14 days of harvest. Gamma-cyhalothrin is extremely toxic to fish and aquatic organisms and toxic to wildlife. This product is also highly toxic to bees exposed to direct treatment and/or residues on blooming crops or weeds.

**Gibberellins** are plant growth regulators that promote plant cell elongation and affect numerous facets of tree fruit growth. In general, they stimulate the germination of pollen and pollen tubes, induce the development of seedless fruit, reduce fruit russetting, and promote fruit and shoot growth. Three main forms of gibberellins are used in fruit production: GA<sub>3</sub>, GA<sub>4</sub>, and GA<sub>7</sub>. The latter two are found together in commercial products used for tree fruit. They may also be in products by themselves in Novagib 10L and ProVide 10SG. There are numerous proprietary products containing GA<sub>3</sub> from many companies. Within some companies there may be multiple products that have different percent active ingredients.

**GA<sub>3</sub>**. There are numerous products containing GA<sub>3</sub>. These include Falgro, GibGro, and ProGibb formulations. Most of these are used in stone fruits. Their use extends from increasing bearing capacity for cherries to increasing fruit firmness and reducing flowering on stone fruits. The percent active ingredient differs by product; read the labels carefully to avoid overdosing or underdosing trees. In tart cherries, GA<sub>3</sub> can be applied to re-

duce blind node production and increase fruit bearing wood. In sweet cherries, it can help to produce larger, brighter colored and firmer fruit. The treatment may also delay color development and harvest. The delay in color and maturity is especially evident in yellow cultivars such as Rainier (Royal Ann) and similar cultivars. Multiple GA<sub>3</sub> applications on sweet cherries may also result in a reduction in return bloom the year following application. The products can also reduce flowering and fruiting of nonbearing sweet and tart cherries and other stone fruit to minimize the competitive effects of fruiting on tree growth and development. Seasonal applications can increase fruit firmness and improve fruit quality of all stone fruit. On Italian prunes, GA<sub>3</sub> applications can reduce internal fruit browning and increase fruit size and quality. Rates will vary based on tree age and vigor. Applications to increase fruit size of sweet cherries should be made on large, mature trees when the fruit is light green to straw colored. To reduce flowering and fruiting on young sweet and tart cherry trees, make an application two to four weeks after bloom. These products can also be used on other stone fruit trees to increase fruit firmness and fruit quality with a single application at one to four weeks prior to the beginning of harvest. Applying GA<sub>3</sub> during flower bud initiation for the following season will reduce flowering and fruiting of young stone fruit trees. Spray water pH must be less than 8.5. The material is best absorbed under slow-drying conditions, and nighttime applications will be more effective.

**GA<sub>4+7</sub> (Novagib 5L, Novagib 10L, ProVide 10SG)** products are a blend of two gibberellins—plant growth regulators that suppress fruit russetting of apples and reduce preharvest cracking of Stayman fruit. To reduce russetting on apples, apply in two to four applications beginning at petal fall and continuing at 7- to 10-day intervals. Rates are 10 to 13 ounces in 100 gallons of water per acre. No additional surfactants should be added to the tank when applying ProVide for suppressing russet. Application of ProVide to suppress cracking on Stayman apples is done at least two to three weeks before fruit cracking is likely to be observed. Depending on the orchard’s location in Pennsylvania, applications may begin as early as July 1. Application rates are 16 to 32 ounces per acre per spray at 14- to 21-day intervals between sprays. For control of fruit cracking, add a nonionic wetting agent approved for use on food to improve spray coverage and enhance absorption. Note that Novagib 10L has only 0.95 percent active ingredient, while Novagib 5L has 5 percent active ingredient. If ProVide is used for russet suppression on a variety, it may not be used for cracking suppression in the same year.

**\*Gladiator (premix of zeta cypermethrin and avermectin)** (IRAC Groups 3A and 6 Insecticide mixture). This pyrethroid product is registered for use on pome and stone fruit for a control of wide range of pests. Gladiator is extremely toxic to fish and other aquatic organisms. The product is also highly toxic to bees exposed to direct treatment and residues on plants. In Pennsylvania, use recommendations are generally limited to before-bloom applications only to conserve *Stethorus* and other predators of spider mites.

**glufosinate** (HRAC Group 10 Herbicide). Glufosinate is available under multiple trade names, including Cheetah, Forfeit 280, Glufosinate 280SL, Interline, Leopard, Lifeline, Reckon 280SL,

Refer 280SL, and Rely 280. Glufosinate is a nonselective foliar active contact herbicide with no residual activity. It is used to control emerged annual and perennial weeds. The mode of action is similar to that of glyphosate. Glufosinate should be applied only to nonstressed weeds. Weeds under stress or in dense populations will require usage at the highest labeled rate. Response is best when the material is applied under warm conditions with bright sunshine and high relative humidity. Do not apply more than 164 fluid ounces per acre to stone fruit in a 12-month period. Do not apply more than 246 fluid ounces to pome fruit in any calendar year. The PHI is 14 days for all fruit crops.

CAUTION: Trunk damage has been observed in Pennsylvania when interstem trees with root suckers have received two applications in a single year with handgun applications

**glyphosate (Glyphomax, Rattler, Roundup Ultra, Touchdown HiTech, Touchdown Total, and many other brand names)** (HRAC Group 9 Herbicide). Glyphosate is usually formulated as an isopropylamine salt. While it can be described as an organophosphorus compound, glyphosate is not an organophosphate ester but a phosphanoglycine, and it does not inhibit cholinesterase activity. Glyphosate is registered for use on apples and pears and in stone fruit orchards. It is effective in controlling many emerged annual and perennial grasses and broadleaved weeds. Best results occur when applied in 20 to 40 gallons of water per acre. It is labeled as a directed spray on apples, pears, and cherries. In other stone fruits it must be applied through a wick applicator. Glyphosate has no preemergence activity; therefore, for residual activity it should be combined with a preemergent material.

Glyphosate is sold under a variety of brand names. Manufacturers and distributors continue to develop new formulations and/or marketing strategies to differentiate themselves from competing glyphosate products. Growers should thoroughly read the label on the product they purchase. Different formulations may or may not require the addition of a surfactant. The reentry interval also varies by the formulation. Selecting the proper rate for the situation and using appropriate additives are important considerations in obtaining consistent control with glyphosate products. Since several different concentrations of glyphosate are now being marketed, it is important to adjust rates according to the product used.

In comparing different glyphosate products it is important that you compare the acid equivalent of the products. This is the actual amount of glyphosate acid that is in the product. It is different from the active ingredient, which includes both the acid equivalent plus the associated salt. Glyphosate products are always formulated with some form of a salt to keep the compound stable; however, the salt portion of the compound does not produce any herbicidal effects. Typical salts are an isopropylamine salt, a potassium salt, or a diammonium salt. To compare glyphosate products divide the price per gallon by the acid equivalent. The result will be the price per pound of glyphosate acid.

All glyphosate brands recommend the addition of ammonium sulfate (AMS) if using hard water as the carrier. Always add 8.5 to 17 pounds AMS per 100 gallons to the tank before adding the glyphosate product.

CAUTION: Avoid all contact with tree foliage. The chemical is not readily metabolized by plants, and accidental coverage could cause injury the following year. Glyphosate should not

be stored or applied in galvanized steel or unlined steel (except stainless) containers or tanks. It can react with these containers to produce highly combustible hydrogen gas mixtures. Glyphosate has a high affinity for soil particles. Dirty water from streams or ponds can reduce glyphosate effectiveness.

**Goal—see oxyflourfen.** glyphosate may not be applied when wind speeds exceed 15 mph

\***Gramoxone—see paraquat.**

**Grandevo (*Chromobacterium subsugae* strain PRAA4-1 and spent fermentation media).** Grandevo is a biological insecticide (no IRAC Group available) acting as a stomach poison. Grandevo is registered by OMRI for use in organic production.

\***Guthion—see azinphos-methyl** (IRAC Group 1B Insecticide). Product is no longer registered for use on fruit.

**GF-120 NF Naturalyte Fruit Fly Bait** (IRAC Group 5 Insecticide). For selective attractance and control of tephritid flies such as apple maggot and cherry fruit fly. The GF-120 NF is a bait concentrate of spinosad, sugars, and attractants that need to be diluted with water to attract various flies. The GF-120 NF is registered for use on pome and stone fruit in conventional and organic orchards. The product should be diluted up to 1:5 (GF-120 NF to water) and applied to the lower leaf surface of protected plants with the droplets size of 4,000 to 6,000 microns. Applications need to be repeated every seven to 14 days. This product is OMRI listed.

**halosulfuron-methyl (Sanda)** (HRAC Group 2 Herbicide) is primarily a preemergent herbicide with some postemergent activity for broadleaf weeds and nutsedge. It is labeled for apples, pears, Asian pears, and quince. You will need a copy of the supplemental label and the original in your possession. The greatest use of this herbicide will be for controlling nutsedge. For nutsedge control, apply Sandea postemergent as a single spray at a minimum of 0.75 ounce per acre when nutsedge plants are in the three- to five-leaf stage. If needed, a second treatment may be applied later in the season to any secondary nutsedge emergence. Do not treat orchards where the trees are established less than one year. The PHI is 14 days and the REI is 12 hours. For preemergent treatment, application to bare ground works best. If small weeds are present, include a broad-spectrum postemergent material as well. Include a nonionic surfactant in the mixture.

**Harvista** (1-MCP) is a sprayable formulation of 1-MCP that is labeled for apples and pears. On apples it should be applied three to seven days before the beginning of anticipated harvest and on pears seven days before the beginning of anticipated harvest. There is a four-hour REI and three-day PHI. Harvista is applied by a proprietary in-line injector system. Contact [www.agrofresh.com](http://www.agrofresh.com) for additional information. Harvista comes in water soluble plastic bags and should not come into contact with water prior to adding the product to the spray tank. It should be applied at 1.43 to 4.28 ounces of active ingredient per acre in enough solution to wet all the fruit and foliage. Application should allow the delay of harvest from seven to 14 days, allowing additional time for color and size development, delayed starch hydrolysis, delayed incidence of water core, and enhanced storage potential. A spray oil adjuvant and an organosilicone surfactant must be added to the spray mixture in a specific order.



Do not agitate the spray mixture for more than 10 minutes and do not agitate the mixture when applying it to the trees. Harvista should be applied under slow drying conditions. Do not apply Harvista when temperatures exceed 90°F or during the day or early evening when fruit is still hot.

**hexythiazox**—see **Savey**.

**Homeplate**—see **caprylic acid**.

**imidacloprid (Admire Pro, Advise, Alias, Couraze, Lada, \*Leverage, Macho, Mallet, Montana, Nuprid, Pasada, Prey, Sherpa, Widow)** (IRAC Group 4A Insecticide). This systemic insecticide has contact and stomach activity and is labeled for use on apricots, cherries, nectarines, peaches, plums, apples, and pears. Its mode of action is similar to that of nicotine. Imidacloprid is used postbloom in apples for control of leafhoppers, leafminers, and aphids. For first-generation spotted tentiform leafminer, apply imidacloprid-containing products while the larvae are still in the sap-feeding stage, or within about five days after pollination is complete. For second and succeeding generations, apply two weeks after peak of pheromone trap catch for each generation. A second application may be required if severe pressure continues or if generations are overlapping. For white apple leafhopper, target nymphs of the first and, if necessary, the second generation. Imidacloprid is toxic to bees. Do not apply products containing imidacloprid or allow them to drift to blooming crops or weeds if bees are visiting the treatment area.

**Imidan (phosmet)** (IRAC Group 1B Insecticide). Imidan is a nonsystemic organophosphate insecticide with predominantly contact action. Imidan is an excellent material for the control of major pests except mites, aphids, and leafhoppers. It is particularly effective against plum curculio. It fits well with the integrated pest management program because the major mite predators tolerate applications at the suggested rates. It has a lower order of toxicity to humans and animals than most of the other organophosphate insecticides. Imidan is highly toxic to bees. White apple leafhopper may become numerous with Imidan schedules. Do not use with water that has a high pH. Due to a recent change on the Imidan label, the REI was increased to four days on apples, nectarines, and peaches; seven days on apricots, plums, and pears; and three days on cherries.

**Indar (fenbuconazole)** (FRAC Group 3 Fungicide). Indar is a systemic fungicide registered to control brown rot, blossom blight, and fruit rot on apricots, cherries, nectarines, peaches, and plums; scab on peaches; and cherry leaf spot on cherries. It is registered for scab, powdery mildew, rusts, flyspeck, and sooty blotch on apple. The best disease control is achieved when Indar is applied prior to infection and tank-mixed with a broad-spectrum fungicide. The addition of an adjuvant, such as LI-700, is recommended to enhance the activity. Resistance and cross-resistance of fungi to the sterol-inhibitor fungicides (FRAC Group 3) including Indar requires growers to evaluate how they use these fungicides for disease management in their orchards. Use of this product should conform to resistance management strategies outlined later in this section of the guide.

For blossom blight control, begin applications at early red bud stage before infections occur. If conditions are favorable for disease development, apply again at full bloom and at petal

fall. For fruit rot control on stone fruit, begin applications two to three weeks before harvest using a 7- to 10-day spray interval. In Pennsylvania and Maryland, growers are allowed to use 12 ounces per acre for stone fruit; do not apply more than 48 fluid ounces per acre per season on apricots, cherries, nectarines, and peaches and 24 ounces per season on plums.

For scab control on peaches, begin applications at shuck split. Make two to three subsequent thorough coverage applications at 10- to 14-day intervals.

Do not make more than four applications or apply more than 32 fluid ounces of Indar 2F per acre per season on apple. REI is 12 hours; PHI is 14 days for apple and up to the day of harvest for stone fruit.

**indoxacarb**—see **Avaunt**.

**Initiate**—see **chlorothalonil**.

**insecticidal soap**—see **M-Pede**.

**Inspire Super (difenoconazole and cyprodinil mixture)** (FRAC Groups 3 and 9 Fungicide). Inspire Super is labeled for use on pome fruit (apple, crabapple, loquat, mayhaw, pear, Oriental pear, and quince) to manage apple and pear scab, cedar apple and quince rust, powdery mildew, sooty blotch and flyspeck, brooks fruit spot, and Alternaria leaf blotch. On stone fruit (apricot, tart cherry, nectarine, peach, plum, plumcot, and prune) it is labeled for Alternaria spot and fruit rot, anthracnose, brown rot, powdery mildew, scab, and shothole. Apply Inspire Super (12 fluid ounces for pome fruit and 16–20 fluid ounces for stone fruits per acre per application) preventively and combine with a protectant fungicide for improved disease control. The risk of resistance and cross-resistance of apple scab to the sterol-inhibitor fungicides (Group 3 Fungicides), including Inspire Super, requires growers to evaluate how they use these fungicides for apple scab management in their orchards. To help prevent resistance, do not make more than two consecutive applications before alternating to a different mode of action (non-Group 3 and non-Group 9) or more than 60 fluid ounces (pome fruit) or 80 fluid ounces (stone fruit) of Inspire Super per acre per season. The REI is 12 hours and PHI is 14 days on pome fruit and two days on stone fruit.

**Intrepid (methoxyfenozide)** (IRAC Group 18 Insecticide). Intrepid is modeled on the natural insect molting hormone, 20-hydroxyecdysone, and belongs to the MAC (Molting Accelerating Compound) family of insecticides. When ingested by the larvae, within hours it induces a premature lethal molt of the larvae and cessation of feeding. Subsequently, larvae die of dehydration and starvation within a few days. The compound is registered for use on pome and stone fruit. On pome fruit Intrepid is registered for the control of leafrollers (obliquebanded leafroller, redbanded leafroller, fruittree leafroller, variegated leafroller, eyespotted budmoth, tufted apple bud moth), internal fruit worms (codling moth, Oriental fruit moth, lesser appleworm), and spotted tentiform leafminer. Intrepid is active on all larval feeding stages of target Lepidoptera species. The compound also possesses the ability to move translamarily through the plant tissue. Intrepid has no effect on any other order of insects or Arthropods except Lepidoptera. Good coverage is critical for efficacy of this compound. For trees less than 10 feet tall, Intrepid should be applied with a minimum of 50 gallons of water per acre, while for trees taller than 10 feet

Intrepid should be applied with a minimum of 100 gallons of water. The rate of application varies from 6 to 16 fluid ounces per acre. The lower rate can be used for tufted apple bud moth control. Do not apply more 64 fluid ounces of Intrepid per acre per season. To prevent or delay the development of resistance, Intrepid should be rotated with insecticides of alternate modes of action.

**iprodione**—see **Rovral**.

**isofetamid**—see **Kenja 400SC**.

**Isomate CM/OFM Mist Plus**. Low density (one to two units per acre) emitter-style mating disruption product. See Isomate MD Products.

**Isomate CM/OFM TT**—see Isomate MD products.

**Isomate DWB**—see Isomate MD products.

**Isomate MD products**. The commercial formulations of various insect sex pheromones used for mating disruption of insect pest species. Isomate C TT is registered for control of codling moth, Isomate OFM TT for control of Oriental fruit moth, Isomate CM/OFM TT and Isomate CM/OFM Mist Plus for control of codling moth and Oriental fruit moth, and Isomate PTB Dual for control of peach tree borer and lesser peach tree borer. Additional Isomate pheromone products are commercially available for control of other insect species, mainly lepidopteran pests. The Isomate pheromone dispensers (ties or twin tubes) are placed on trees by hand and therefore require high labor input. The time of application, length of activity, number of dispensers per acre, and placement within the tree vary from species to species, and detailed instructions from the product label should be followed to achieve success. In general, for the best results of mating disruption materials, place dispensers as high in the tree canopy as possible. Mating disruption usually works better under lower pest pressure and may require supplemental insecticide treatments. It is recommended that mating disruption be used on the whole orchard or block, preferably including all blocks within an orchard. Most of the Isomate MD products are OMRI listed. (For more information, see “Using pheromones for monitoring and mating disruption.”)

**Isomate OFM TT**—see **Isomate MD products**.

**Isomate PTB Dual**—see **Isomate MD products**.

**isoxaben (Gallery, Isoxaben, Trellis)** (HRAC Group 21 Herbicide). The herbicide isoxaben is labeled for all nonbearing tree fruit crops for preemergent control of certain broadleaved weeds. “Nonbearing” is defined as plants that will not bear fruit for at least one year after treatment. Application rates are 0.66 to 1.33 pounds of material per treated acre depending on the weeds present. A repeat application (at 1 pound per acre or more) should not be made sooner than 60 days after the previous application. Do not apply more than 4 pounds per acre in any 12-month period. The EPA requires that the signal word “CAUTION” appear on all isoxaben labels. The restricted reentry period for isoxaben is 12 hours.

**Javelin**—see **Bt**.

**JMS Stylet Oil (white paraffinic oil)**. A highly refined, mineral oil registered for dormant, delayed dormant and foliar applications on apples, pears, apricots, cherries, peaches, plums, and prunes. Due to possible severe phytotoxic effects, this oil cannot be applied within 30 days of sulfur or lime sulfur application and 14 days before or after Captan application. For summer applica-

tion do not exceed 1.5 gallons per acre per application. Apply in a minimum of 50 gallons water per acre. Excellent coverage is essential for efficacious control of soft-bodied insects. JMS Stylet Oil is also registered for the control of powdery mildew (FRAC Group NC Fungicide [not classified]). Also see dormant oils and summer oils. Organic JMS Stylet Oil is OMRI listed.

**Kaligreen (potassium bicarbonate)** (FRAC Group Not Classified). Kaligreen is a contact fungicide composed of microencapsulated potassium bicarbonate that disrupts the potassium ion balance in fungal cells, thereby causing the cell walls to collapse. It is labeled for the control of fungal diseases of pome and stone fruit. Since it is a contact fungicide, thorough coverage is required for it to be effective. Begin applications at the first sign of disease development and apply at 2.5 to 3 pounds per acre on 7- to 10-day intervals. Kaligreen can be applied up to the day of harvest (zero-day PHI). The REI is four hours.

**Kanemite (acequinocyl)** (IRAC Group 20B Insecticide). Kanemite belongs to the phenoxy pyrazole class of insecticides. Its mode of action is a mitochondrial electron transport inhibitor (METI) blocking cellular respiration. This mode of action is similar to the mode of action of two other acaricides: Nexter and Portal. Therefore, no more than one application of compounds from the METI group is recommended per season. Kanemite is effective against European red mites and twospotted spider mites but is not effective against rust mites. Kanemite provides quick knockdown activity and up to 21 days of residual activity. Only one application per season is recommended. The compound has a 14-day PHI.

**kaolin**—see **Surround**.

**\*Karate**—see **lambda-cyhalothrin**.

**Karmex**—see **diuron**.

**kasugamycin**—see **Kasumin**.

**Kasumin (kasugamycin)** (FRAC Group 24 Bactericide). Kasumin is registered for use on pome fruit to control fire blight. Apply at a rate of 64 fluid ounces per acre in 100 gallons of water. Kasumin can be applied during bloom when conditions favor fire blight infection at three- to six-day intervals. Applications are limited to four per year. Do not make more than two consecutive applications without alternating with another product registered for fire blight and discontinue use after petal fall. Do not apply more than 256 fluid ounces of Kasumin per acre per year. The PHI is 90 days and the REI is 12 hours.

**Kenja 400SC (isofetamid)** (FRAC Group 7 Fungicide). Kenja 400SC is an SDHI fungicide that is labeled for pome and stone fruit. On pome fruit, Kenja 400SC controls apple scab and pear scab; it suppresses powdery mildew. On stone fruit, Kenja 400SC controls blossom blight and brown rot caused by *Monilinia* spp. For fungicide resistance management, do not make more than two sequential applications of Kenja 400SC or other Group 7 Fungicides. Do not make more than six applications per acre per year for pome fruit; do not make more than three applications per acre per year on stone fruit. REI is 12 hours, and the PHI is 20 days for pome fruit and one day for stone fruit.

**\*Kerb**—see **pronamide**.

**kresoxim-methyl**—see **Sovran**.

**Kudos**—see prohexadione calcium.

**Lada**—see imidacloprid.

**\*Lambda-Cy**—see lambda-cyhalothrin.

**\*Lambda-T**—see lambda-cyhalothrin.

**lambda-cyhalothrin (\*Endigo, \*Karate, \*Lambda-Cy, \*Lambda-T, \*Lamcap, \*Warrior II with Zeon Technology)** (IRAC Group 3 Insecticide). Lambda-cyhalothrin belongs to a well-known group of pyrethroid ester insecticides. Among other crops, lambda-cyhalothrin is registered for use on pome fruits (apple, pear, crabapple, loquat, mayhaw, Oriental pear, and quince), stone fruit (apricot, sweet cherry, sour cherry, nectarine, peach, plum, Chickasaw plum, damson plum, Japanese plum, plumcot, and prune), and tree nuts. The compound can be used for control of a wide spectrum of pests, including leafrollers, internal fruit feeders, leafminers, leafhoppers, apple maggot, plum curculio, plant bug, stink bug, periodical cicada, rosy apple aphid and apple aphid, pear psylla, fruit infestation of San Jose scale, wood borer complex of stone fruit, rose chafer, and black cherry aphid. The REI for each crop is 24 hours. On pome fruit the PHI is 21 days, while on stone fruit and tree nuts the PHI is 14 days. On pome and stone fruits no more than 1.6 pints per acre (0.2 pound of active ingredient) can be applied during an entire year, but no more than 1.28 pints per acre (0.16 pound of active ingredient) per year can be applied postbloom. Lambda-cyhalothrin is highly toxic to bees and extremely toxic to fish and aquatic organisms. Endigo is a premix product of thiametoxam and lambda-cyhalothrin.

**\*Lamcap**—see lambda-cyhalothrin.

**\*Lannate (methomyl)** (IRAC Group 1A Insecticide). Lannate is a limited systemic carbamate insecticide with contact and stomach action. Lannate is effective on brown marmorated stink bug, leafrollers, fruitworms, aphids, leafminers, thrips, and white apple leafhoppers.

Do not apply Lannate on Early McIntosh and Wealthy apple varieties. Do not stretch spray intervals when using methomyl alone because of its short residual activity. Methomyl is registered for use on peaches for control of the Oriental fruit moth and green peach aphid. Outbreaks of woolly apple aphid may result from continuous use. Lannate is highly toxic to predatory mites. Do not use Lannate in highly alkaline solutions. Lannate LV can be used on apples (five applications per season), peaches (six applications per season), and pears (two applications per season), but it is not registered for use on nectarines in Pennsylvania. Lannate SP can be used on nectarines (three applications per season), peaches (six applications per season), apples (five applications per season), and pears (two applications per season).

**\*Leverage (pre-mix of imidacloprid and cyfluthrin mixture)** (premix of imidacloprid and cyfluthrin mixture) (IRAC Groups 4A and 3A Insecticides). Leverage SC insecticide contains a mixture of two insecticides from different IRAC groups: pyrethroids (cyfluthrin) and neonicotinoids (imidacloprid). The product is registered on pome fruit (PHI = seven days) and stone fruit (PHI = seven days) against wide range of pests: brown marmorated stink bug, codling moth, Oriental fruit moth, leafroller complex, leafminers, apple maggot, European apple sawfly, plum curculio, crawlers of San Jose scale, stink bugs, and aphids (except woolly

apple aphid). Due to bee toxicity, Leverage should not be applied prebloom or during the bloom of pome or stone fruit. See also cyfluthrin and imidacloprid.

**LifeGard (*Bacillus mycooides*)** (FRAC Group P 06 Biological Plant Activator). LifeGard is a biological agent that triggers plant defense mechanisms for the control or suppression of pome fruit diseases. Unlike some other *Bacillus* products, it has no direct effect on the pathogens. Therefore, it must be applied preventively. Initial plant defense responses begin within minutes, but maximum plant protection won't be reached for three to five days. It is effective as a rotational product or tank-mixed with other registered fungicides/bactericides. If disease symptoms have already appeared, apply LifeGard with a curative product. Apply at a rate of 4.5 ounces per 100 gallons of water. The REI is four hours and PHI is zero days. This product is OMRI listed.

**Lime sulfur (calcium polysulfide)** (FRAC Group M2 Fungicide) is a contact fungicide that is effective for leaf curl, Coryneum blight, powdery mildew, and brown rot control on stone fruit. Late season applications will also help control cherry leaf spot. High rates will also help control scale insects, mites, borers, and aphids on stone fruit. On pome fruit, it is labeled for apple and pear scab and powdery mildew. Lime sulfur may help control other pests on pome fruit as well, including aphids, pear psylla, San Jose scale, and mites. Several formulations are available. Lime sulfur is incompatible with most pesticide formulations and should be used alone. The REI is 48 hours. CAUTION: Do not use within 14 days of an oil spray or when temperatures are above 85°F as burning of foliage may occur during periods of warm temperatures. Do not use on Ginger Gold. It can be repellent to bees for several days after application.

**\*Lorsban**—see chlorpyrifos.

**Luna Experience (fluopyram and tebuconazole mixture) (FRAC Groups 7 and 3 Fungicides)**. Luna Experience is a broad-spectrum fungicide with preventive and systemic properties. It is labeled on stone fruit to control brown rot, powdery mildew, rusty spot, shothole, green fruit rot, and peach leaf curl at the 6- to 10-fluid-ounce application rate, and scab and rust at the 8- to 10-fluid-ounce application rate. Begin applications preventively and continue as needed on a 7- to 14-day interval and use the higher rates and/or shorter intervals when disease pressure is high. Restrictions: Do not apply more than 34 fluid ounces of Luna Experience per year. To limit the potential for development of disease resistance, do not make more than two sequential applications of Luna Sensation or any Group 7- or Group 3-containing fungicide before rotating with a fungicide from a different FRAC Group. Do not apply more Luna Experience within 14 days of harvest. REI is 12 hours.

**Luna Sensation (fluopyram and trifloxystrobin mixture)** (FRAC Groups 7 and 11 Fungicides). Luna Sensation is a broad-spectrum fungicide with preventive and systemic properties for the control of apple scab, powdery mildew, summer diseases, and fruit rots on pome fruit; and brown rot, powdery mildew, rusty spot, cherry leaf spot, scab, shothole, green fruit rot, Botrytis, peach leaf curl, and Anthracnose on stone fruit. Restrictions on pome fruit: do not apply more than 21 fluid ounces per acre per season. On stone fruit, do not apply more than 27.1 fluid ounces

per acre per season. It is recommended to begin fungicide application preventively and continue as needed on a 7- to 10-day interval depending on disease conditions. Use higher rate and/or shorter intervals when disease pressure is severe. To limit the potential for development of disease resistance, do not make more than two sequential applications of Luna Sensation or any Group 7– or Group 11–containing fungicide before rotating with a fungicide from a different FRAC Group. Do not make more than four applications per acre per season. REI is 12 hours, and PHI is 14 days for pome fruit and one day for stone fruit.

**Luna Tranquility (fluopyram and pyrimethanil mixture)** (FRAC Groups 7 and 9 Fungicides). Luna Tranquility is a broad-spectrum fungicide labeled for the control of apple scab and powdery mildew. It consists of chemicals from two chemical classes: an SDHI (fluopyram) and an aniline-pyrimidine (pyrimethanil), which is the active ingredient found in Scala. For apple scab, use 11.2 to 16 fluid ounces per acre. For powdery mildew, use 11.2 to 16 fluid ounces per acre. Begin applications preventively and continue as needed on a 7- to 10-day interval and use the higher rates and/or shorter intervals when disease pressure is high. Restriction: Do not apply more than 54.7 fluid ounces per acre per season or make more than two sequential applications of any Group 7– or Group 9–containing fungicide before rotating with a fungicide with a different FRAC Group. REI is 12 hours and PHI is 72 days.

**M-Pede (insecticidal soap).** M-Pede is a “natural” pesticide for insect and mite control on fruit trees. This soaplike material, consisting of long-chain biodegradable fatty acids, is thought to disrupt the cellular metabolism of insects and mites. It has been used to control a variety of insects on various crop and noncrop plants. Insecticidal soap is only effective in the liquid state as it contacts the insect or mite. Once dried, it is not toxic to the pest. Testing at the Penn State Fruit Research and Extension Center and elsewhere indicates that, in certain situations, this pesticide can be an effective alternative to traditionally used insecticides. In addition, it is extremely safe for humans and other animals. There are no worker reentry restrictions, and sprays can be applied up to the day of harvest. There is, however, a lingering concern about fruit russetting associated with the product, especially in dilute applications. Moreover, it may be toxic to *Stethorus*, the black ladybird beetle mite predator. Therefore, at present we recommend insecticidal soap only for nonbearing apple and pear trees.

On apples, M-Pede has proved effective for motile stages of mites, aphids, and white apple leafhoppers. Apply one part M-Pede and 50 parts soft water (i.e., 2 gallons of soap per 100 gallons of water) to foliage. Be aware that agitation in the spray tank may cause excessive foaming and require the use of defoamer (see label on soap container). On pears, M-Pede is effective against pear psylla and mites in postbloom applications at the same rate recommended for apples. However, it is not effective against many other pear pests during postbloom. It can be mixed with a one-half rate of an organophosphate insecticide, and this mixture can be used in sprays alternated with Mitac sprays. M-Pede is OMRI listed.

**Macho—see imidacloprid.**

**Madex HP.** *Cydia pomonella* granulosis virus isolate V22, biological insecticide to control larvae of codling moth and Oriental fruit moth. After ingestion by larva, the virus multiplies within the cells of the host insect causing fatal infection. Mortality occurs

within three to seven days after ingestion. Madex HP breaks under direct exposure to sunlight in six to eight days. Applications of Madex should start before the beginning of the egg hatch period for each targeted insect pest. Multiple applications are usually necessary to provide effective control of codling moth and/or Oriental fruit moth larvae. Madex HP is registered by OMRI for use in organic fruit production. See also “Management of codling moth with codling moth granulosis virus.”

**Magister SC** (IRAC Group 21A Acaricide and FRAC Group 39 Fungicide). Magister SC acts by contact to provide rapid knockdown of mites and certain insects. It provides control of eggs by contact and controls immature adult mites by both contact and ingestion. In addition, Magister SC has proven fungicidal activity. It controls powdery mildew in cherries and suppresses powdery mildew in apples. It is labeled for both pome and stone fruit. Only one application per year and applications must occur after petal fall. REI is 12 hours, and PHI is seven days for pome fruit and three days for stone fruit.

**malathion (Malathion)** (IRAC Group 1B Insecticide). Malathion is a nonsystemic organophosphate insecticide recommended for the control of black cherry aphids. Malathion is also effective against spotted wing fruit fly. Malathion is registered for use on apricots, nectarines, pears, peaches, and many other small fruit crops. Alkaline solution will reduce its residual toxicity.

**Mallet—see imidacloprid.**

**mancozeb (Dithane, Manzate, Penncozeb, Roper)** (FRAC Group M3 Fungicide). Mancozeb products are ethylenebisdithiocarbamate (EBDC) fungicides with protective action for controlling apple scab and apple rusts, but they are not effective on powdery mildew. Mancozeb usage is restricted to the early season on apples. Two application programs may be used (do not integrate the two programs):

1. Prebloom through bloom. Applications begin at the ¼- to ½-inch green tip stage and continue at 7- to 10-day application intervals through bloom. Do not apply more than 6 pounds per acre per application. There is a limit to the amount of EBDC fungicide that can be applied per acre each year. Refer to the label of the product you are using for specific yearly application limits.
2. Extended application. Begin applications at the ¼- to ½-inch green tip stage and continue at 7- to 10-day application intervals through the second cover spray. Do not apply more than 3 pounds per acre per application. There is a limit to the amount of EBDC fungicide that can be applied per acre each year. Refer to the label of the product you are using for specific yearly application limits.

Generally, all formulations are compatible with oil. Under high scab conditions or during periods of peak spore release, other more effective fungicides (Aprovia, Flint, Fontelis, Indar, Inspire Super, Luna Sensation, Luna Tranquility, Merivon, Procure, Rally, Sercadis, and Sovran) should be added to improve control. REI is 24 hours and PHI is 77 days.

It is recommended to use rainfast mancozeb products (e.g., Mazate Pro-Stick, Dithane Rainshield) to enhance the efficacy of mancozeb, especially during frequent rain events. A spreader-

sticker adjuvant (e.g., Induce) can be added to any mancozeb product to make it rainfast. Generally, all formulations are compatible with oil. Under high scab conditions or during periods of peak spore release, other more effective fungicides should be tank-mixed to improve control. REI is 24 hours and PHI is 77 days.

**Matrix FVN**—see rimsulfuron.

**MaxCel**—see 6BA.

**mefenoxam**—see Ridomil Gold SL.

**MeloCon WG (*Paecilomyces lilacinus* strain 251)**. MeloCon WG is a water-dispersible granule formulation that is a biological nematicide containing spores of a beneficial fungus that must germinate and grow in order to infect and kill plant-parasitic nematodes in the soil. For some applications it may be desirable to mix MeloCon WG with other products to also control insects and diseases or to enhance soil penetration. Apply 2 to 4 pounds per acre by drip irrigation, injection, or soil-directed spray. Ensure aboveground foliage and fruit are not contacted by spray. Apply sufficient water during or immediately after application to thoroughly wet soil into the root zone. To enhance penetration of spores into the root zone, consider mixing with a soil wetting agent. Repeat applications every two to four months or during root flush, as needed. MeloCon can be used preplant or postplant for pome and stone fruit. This product is OMRI listed.

**Merivon (fluxapyroxad and pyraclostrobin mixture)** (FRAC Groups 7 and 11 Fungicides). Merivon is a combination of a new fungicide, fluxapyroxad (21.26 percent), and pyraclostrobin (21.26 percent), the same chemical groups as in Pristine. For apple and pear, it is effective against scab, powdery mildew, summer diseases, blue mold, and gray mold; it is labeled for the suppression of quince and cedar-apple rust. For stone fruit, Merivon is effective against *Alternaria* leaf spot, anthracnose, leaf spot, powdery mildew, rust, scab, shothole, blue mold, gray mold, and brown rot. Merivon is recommended at 4 to 5.5 fluid ounces per acre on pome fruit, beginning application prior to disease development and continuing on a 7- to 10-day interval. A maximum of four applications per season on apple, and two consecutive applications and 22 fluid ounces per acre per season on pome fruit. On stone fruit, use 4 to 6.7 fluid ounces per acre, with a maximum of three applications per season, or two consecutive applications and 20.1 fluid ounces per acre per season. Rotate with fungicides with mode of actions different from FRAC Groups 7 and 11. REI is 12 hours and PHI is zero days for apple and stone fruits.

**Mertect (thiabendazole)** (FRAC Group 1 Fungicide). Mertect is a systemic fungicide that aids in the control of blue mold rot, bull's eye rot, gray mold, stem end, and neck rot on pome fruit apples and pears. Dip, flood, or spray harvested fruit with a suspension of 16 fluid ounces of Mertect in 100 gallons of water. Do not treat for over three minutes. Treat apples only before and after storage for maximum decay control. Resistance management is recommended when using this product, alternating with chemicals of different modes of action (FRAC Groups) since blue mold resistance to Mertect has been described. Treat pears only once. REI is 12 hours.

**mesotrione**—see Broadworks.

**metam-sodium**—see \*Vapam HL

**metconazole**—see Quash.

**methomyl**—see Lannate.

**methoxyfenozide**—see Intrepid.

**metiram**—see Polyram.

**metrafenone**—see Vivando.

**\*Minecto Pro (cyantraniliprole and abamectin)** (IRAC Group 28 and 6 Insecticides). Minecto Pro insecticide shares its two active ingredients with Exirel and Agrimek. The product is registered for use on pome (28-day PHI) and stone fruit (21-day PHI). Minecto Pro can be applied twice during the season; however, due to yearly limits in the amount of active ingredients, if abamectin (in products such as Agri-Mek and Agri-Flex) is applied for mite or pear psylla control at the normally recommended timing at the petal fall, only one application of Minecto Pro can be made later during the season.

**Mite-E-Oil (petroleum oil)**. Mite-E-Oil is a highly refined 90 percent petroleum oil registered for dormant, delayed dormant, and foliar applications on apples, pears, apricots, cherries, peaches, plums, and prunes. Due to possible severe phytotoxic effects, this oil cannot be applied within 30 days of sulfur application and 14 days before or after Captan application. For summer application do not exceed 1.5 gallons per acre per application. Apply in a minimum of 50 gallons of water per acre. For summer mite control excellent coverage is essential.

**Montana**—see imidacloprid.

**Movento**—see spirotetramat.

**\*Mustang**—see zeta-cypermethrin.

**\*Mustang Max**—see zeta-cypermethrin.

**myclobutanil**—see Rally 40WSP.

**Mycoshield**—see oxytetracycline.

***Myrothecium verrucaria* (dried fermentation solids and solubles)**—see DiTera ES.

**NAA (naphthalene acetic acid) (Fruitone L, Fruitone N, PoMaxa, Refine)**. NAA is an auxin plant growth regulator used to chemically thin apples and pears. The effective range for thinning is 2.5 to 20 ppm depending on the variety and crop load. NAA has thinning activity from full bloom through 17-millimeter fruit diameter. Early timings provide milder thinning activity, and the optimal range is 10- to 12-millimeter fruit diameter. Later applications may still be effective, but they may result in unacceptable levels of pygmy fruit, especially when high rates of NAA are used. Delicious and Fuji are especially prone to development of NAA-induced pygmies. NAA also may be used to stimulate return bloom. When no additional thinning is desired, three to four sprays of 5 ppm solutions for return bloom should begin five to six weeks after petal fall. When applied close to harvest it helps prevent preharvest fruit drop. One spray of 20 ppm or two sprays of 10 ppm will delay preharvest drop for 7 to 11 days, respectively.

**NAAM**—see **Amid-Thin W**.

**NAD (naphthalene acetamide)**—see **Amid-Thin W**. See Part I for more information on apple thinning with Amid-Thin W.

**naphthalene acetamide**—see **Amid-Thin W**. See Part I for more information on apple thinning with Amid-Thin W.

**Nealta (cyflumetofen)** (IRAC Group 25A Insecticide) is a contact acaricide from benzoylacetone nitrile class of chemistry (METI Complex II) and is active against all life stages of tetranychid mites including eggs, nymphs, and adults of European red mites and twospotted mites. Nealta is not toxic to our common predatory mites such as *T. pyri* and *A. fallacis*. Nealta does not possess translaminar activity, so thorough coverage is necessary for effective mite control. Nealta is rainfast one hour after an application has dried. Nealta is registered for use only on pome fruit.

**Neemix**—see **azadirachtin**. This product is OMRI listed.

**Nexter (pyridaben)** (IRAC Group 21 Insecticide). Nexter is a new formulation of Pyramite, which was registered in 1997 for use on apples to control motile stages of European red mites and twospotted spider mites, and on pears to control mites and pear psylla. Recently, additional registrations were also granted for use on apricots, cherries, nectarines, peaches, plums, and prunes. Nexter has a unique mode of action as a mitochondrial electron transport inhibitor, blocking cellular respiration. Nexter is very active against immature mites at 4.4 ounces per acre, but has low activity against adult female twospotted spider mites. Nexter should be applied when mites exceed action thresholds. Although the label allows two applications per season on apricots, cherries, nectarines, peaches, plums, and prunes, we recommend only one application per season for resistance management. This product can give up to 45 days of mite control, but also is toxic to *Stethorus*. For pear psylla, Nexter is most effective against the small nymphs. On apples and pears do not apply more than 10.67 ounces per acre; make no more than one application per season. Use at least 100 gallons per acre. Nexter also controls pear rust mites. Note that the Nexter label specifies 30 days between applications and a 25-day PHI on apples and a seven-day PHI on other crops. On apricots and cherries, Nexter can be only used after harvest (300-day PHI). Applications are prohibited within 110 feet of surface water.

**NoMate CM Spiral ((E,E)-8,10-Dodecadien-1-ol)**. Mating disruption product for the control of codling moth (for more information, see “Using pheromones for monitoring and mating disruption”).

**NoMate OFM Spiral (Z-8Dodecen-1-yl acetate, E-8 dodecen-1-yl acetate, Z-8 Dodecenol)**. Mating disruption product for the control of Oriental fruit moth (for more information, see “Using pheromones for monitoring and mating disruption”).

**norflurazon**—see **Solicam**.

**Novagib**—see **GA<sub>4+7</sub>**.

**novaluron (Rimon, Cormoran)** (IRAC Group 15 Insecticide). Novaluron belongs to a class of insecticides called the benzoylphenyl ureas (insect growth regulators) and it affects chitin synthesis of immature insects disrupting their normal growth and development. The compound is registered for the control of codling moth, Oriental fruit moth, obliquebanded leafroller, tufted apple budmoth, and pear psylla. Novaluron is effective on CM/OFM eggs if eggs

are deposited on active residue of the compound. Rimon does not kill the adult stages of insects. Novaluron must be ingested and/or contacted by insects to be fully effective. Excellent tree coverage is necessary to obtain optimum pest control. To benefit from Rimon’s ovicidal activity, the compound should be applied earlier than older insecticides (e.g., at 75 to 150 DD base 50 for the first spray to control codling moth). The compound has a 12-hour REI and a 14-day PHI. Rimon and Cormoran are registered on pome fruit with a special direction for use on pears and stone fruit. No more than four applications of novaluron containing products are allowed per season. During field trials conducted over the past few years at the Penn State Fruit Research and Extension Center in Biglerville, it was always observed that multiple applications of Rimon resulted in an increased number of European red mites on treated trees. In order to prevent the development of resistance, it is recommended that Rimon be used only for a single generation of CM and OFM during the growing season.

**Nuprid**—see **imidacloprid**.

**Omega (fluazinam)** (FRAC Group 29 Fungicide). Omega is a unique fungicide with a multisite mode of action that disrupts energy production in fungi. It is labeled for scab and numerous diseases on apples. It is also labeled for control and suppression of certain mites on apple. It is not labeled for powdery mildew. Start applications at green tip for scab and spray on 7- to 10-day intervals. Read the label for specific rates and instructions. Do not make more than 10 applications or apply more than 8.625 pints of Omega per growing season. REI is 12 hours and PHI is 28 days.

**Omni Supreme Spray**—see **dormant and summer oils**.

**Onager (hexythiazox)** (IRAC Group 10A Insecticide). Onager (hexythiazox is also sold under the name Savey) is an ovicidemicicide used commonly on apples since 1995. It is effective against eggs and larvae of mites. Onager is recommended at 12–24 ounces per acre and can be applied up to 28 days before harvest. The product is also registered for use on pears, apricots, cherries, nectarines, peaches, and plums. Because Onager and Apollo have similar modes of action, these two products should be rotated between years to forestall resistance development. The use of alternate row middle spraying for an Onager application is not recommended. It is recommended that Onager be applied prior to adult mite buildup (less than one mite per leaf). Onager is toxic to fish and aquatic invertebrates.

**Orchard Master**—see **2, 4-D**.

**Orius 20AQ**—see **tebuconazole**.

**oryzalin (Fugitive, Oryzalin, Phoenix, Harrier, Surface, Surflan)** (HRAC Group 3 Herbicide) is a selective surface-applied preemergence herbicide used to control annual grasses and broadleaved weeds in fruit trees, nut trees, and vineyards. It inhibits the growth of germinating weed seeds. It is available in aqueous suspension, dry flowable, and wettable powder formulations. It can be used safely on all newly planted trees after the soil has settled. Treated areas must be free of established weeds and other vegetation. A half inch of rain is necessary to activate the herbicide. Surflan has low acute toxicity to mammals. Surflan can cause mild irritation to the skin or eye. It may cause allergic skin reactions in some individuals. The oral LD<sub>50</sub> for technical oryzalin in rats and mice is more than 5,000 mg/kg. Harrier is only labeled for nonbearing fruit trees.

**Oso (polyoxin D zinc salt)** (FRAC Group 19 Fungicide). Oso is a biofungicide that inhibits cell wall formation in fungi. It is labeled for pome fruits to control *Alternaria* leaf spot, leaf blot, and powdery mildew, and for the suppression of scab. Apply 3.75 to 13 ounces per acre over 7- to 14-day intervals. For powdery mildew, begin as a preventive spray. For scab suppression, a preventive rate of 6.5 ounces per acre may be used alone or tank-mixed with another fungicide before the onset of symptoms. Otherwise, use 13 ounces per acre at 7- to 10-day intervals. Do not apply more than 4.2 ounces of active ingredient per acre per season (six applications of the maximum rate). The REI is four hours and the PHI is zero days. This product is OMRI listed.

**oxamyl**—see **\*Vydate**.

**oxyfluorfen (Collide, Goal, Goal 2XL, Galigan, GoalTender, OxyFlo, OxyStar)** (HRAC Group 14 Herbicide). Oxyfluorfen is a selective pre- and postemergent herbicide used to control certain annual broadleaved and grassy weeds. It is a contact herbicide and requires light to affect target plants. It is available as an emulsifiable concentrate. It is unique because it has preemergent and some postemergent effects in controlling broadleaved annuals. Apply only to dormant trees; dormancy determines the suitability and safety of using the material. Application rates for postemergent weed control are 2 to 8 pints per treated acre. Since oxyfluorfen has contact activity, thorough coverage of emerged weeds is essential; therefore, apply it in at least 20 gallons of solution per acre. The addition of 0.25 percent v/v of a registered nonionic surfactant will enhance control of emerged weeds. For preemergent weed control, the rates recommended are 5 to 8 pints per treated acre. The most effective postemergence weed control is achieved when oxyfluorfen is applied to seedling weeds (less than four-leaf stage). For postemergence control of certain grassy and broadleaved weeds, a tank mixture of oxyfluorfen and either paraquat or glyphosate is recommended. Irrigation or rainfall within three to four weeks after application is necessary for maximum effectiveness. mProducts containing oxyfluorfen must bear the signal word “WARNING” on the label. Oxyfluorfen is moderately toxic by ingestion and slightly toxic by dermal absorption. Vapors may cause irritation of the nose, throat, skin, and eyes, and other forms may cause irritation to skin and eyes. Note: the percent active ingredient varies on different labels; therefore, the rates will also vary accordingly.

**oxytetracycline 17% (FireLine, Mycoshield)** (FRAC Group 41 Bactericide). Mycoshield and FireLine are registered for the control of fire blight on apple and pear, and bacterial spot on peach and nectarine. For fire blight, use 1 pound of product per 100 gallons of water (200 ppm) and begin spraying at 10 percent bloom, but do not exceed five applications per entire season. Repeat spray applications at four- or six-day intervals depending on disease severity. Caution is advised because these products can cause phytotoxicity to the fruit and/or foliage of sensitive varieties of pears, especially Asian varieties. For bacterial spot, apply 6 ounces of the product per 50 gallons of water or 12 ounces per 100 gallons (150 ppm) on a weekly schedule starting at shuck split. Applications the first five weeks are likely to be the most critical for disease control. Do not use for fire blight after petal fall. REI is 12 hours, and PHI is 60 days for apple and pears and 21 days for peaches and nectarines.

***Paecilomyces lilacinus* strain 251**—see **MeloCon**.

**Par F70 Soluble Oil**—see **dormant and summer oils**.

**paraquat (\*Bonedry, \*Gramaxone SL, \*Paraquat 3SL, \*Parazone 3SL, and many other brand names)** (HRAC Group 22 Herbicide) is a quaternary nitrogen herbicide widely used for postemergent weed control. It is a quick-acting, nonselective compound that destroys green plant tissue on contact and by translocation within the plant. It is effective in killing most annual weeds and in suppressing some perennial weeds. It is most effective when applied to growing weeds less than 4 to 6 inches tall. It may be combined with other herbicides, but not with oil. We recommend adding a nonionic surfactant to paraquat. Paraquat is a restricted-use pesticide and is banned for use in several Scandinavian countries. Paraquat is highly toxic to animals by all routes of exposure and is labeled with the signal word, “DANGER—POISON.” The REI is 24 hours, and the PHI varies by crop. The maximum number of applications is three per year for stone fruits and five per year for pome fruits.

**CAUTION:** Paraquat is very toxic to humans, particularly if inhaled during mixing or if swallowed. Use a full-face shield, gloves, and apron when filling and mixing. Avoid contact with skin and clothing. Wash after mixing and spraying. New regulations will require that paraquat may only be applied by certified applicators. Applicators must receive safety training every 3 years.

**\*Parazone 3SL**—see **paraquat**.

**Parrot**—see **diuron**.

**Pasada**—see **imidacloprid**.

**Penbotec**—see **pyrimethanil**.

**pendimethalin (Acumen, Framework, Pavilion, Pendimethalin, PendiPro, Prowl, Prowl H2O, Satellite, Stealth)** (HRAC Group 3 Herbicide). Pendimethalin is a selective herbicide used to control most annual grasses and certain broadleaved weeds. It is a meristematic inhibitor that interferes with the plant's cellular division process (mitosis). Only Prowl H2O is labeled for both bearing and nonbearing orchards; all other products are only labeled for nonbearing orchards. The preharvest limitation for Prowl H2O is 60 days for both stone fruits and pome fruits. It may be applied to newly planted trees after the soil has settled. It controls weeds as they germinate but does not control established weeds. Best results are obtained when rainfall or irrigation occurs within 21 days of application. Products containing pendimethalin must bear the signal word “CAUTION” or “WARNING” depending on the formulation. Pendimethalin is slightly toxic if ingested, inhaled, or absorbed through the skin.

**pen thiopyrad**—see **Fontelis**.

**Perlan**—see **6-benzyladenine + gibberellins A<sub>4</sub>A<sub>7</sub>**.

**permethrin (\*Ambush, \*PermaStar, \*Perm-Up, \*Pounce, \*Arctic)** (IRAC Group 3 Insecticide). Permethrin is a nonsystemic pyrethroid insecticide with contact and stomach action, having a slight repellent effect. The compound is registered for use on apples, cherries, peaches, nectarines, and pears (prebloom only). Ambush or Pounce are generally not recommended after bloom to prevent outbreaks of European red mite.

**\*PermaStar—see permethrin.**

**Permit—see halosulfuron-methyl.**

**\*Perm-Up—see permethrin.**

**PFR 97 (*Isaria fumosorosea* Apopka strain 97)** (microbial insecticide) is registered for the control of aphids, thrips, spider mites, leafminers, and plant bugs. This product is OMRI listed.

**Ph-D (polyoxin D zinc salt)** (FRAC Group 19 Fungicide). Ph-D is a biofungicide that inhibits cell wall formation in fungi. It is labeled for pome fruits to control *Alternaria* leaf spot, leaf, and powdery mildew, and fruit rots and for the suppression of apple scab. It is labeled for stone fruit to control for *Alternaria*, gray mold, powdery mildew, scab, and *Rhizoctonia* root rot. Apply 6.2 ounces per acre over 7- to 10-day intervals. For powdery mildew, begin as a preventive spray and apply at 10- to 14-day intervals. For root and crown rots, apply as a drench every 14 to 28 days. Do not apply more than 4.2 ounces of active ingredient per acre per season (six applications of the maximum rate). The REI is four hours and the PHI is zero days.

**pheromone—see Sprayable Pheromone, Isomate MD Products, CheckMate MD Products.**

**phosmet—see Imidan.**

**phosphorous acid and salts** (FRAC Group P07 Fungicide). Several products containing phosphorous acid (phosphonates, phosphites) are sold as nutritional supplements and “plant conditioners,” but a few products (Phostrol, ProPhyt, Rampart) are registered for use as fungicides for the control of several foliar and soilborne diseases of pome and stone fruit. Phosphorous acid fungicides are especially effective against oomycete pathogens, such as *Phytophthora* and *Pythium*. These are true systemic fungicides, such that once it penetrates the plant tissue, the fungicide will move throughout the plant. Phosphorous acid has both a direct and indirect effect on these pathogens. It inhibits a particular process (oxidative phosphorylation). In addition, some evidence suggests that phosphorous acid has an indirect effect by stimulating the plant’s natural defense response against pathogen attack. Usage rate recommendations vary among different products. The products mentioned here have a four-hour REI and a zero-day PHI. Obtain and read the label of each product prior to use. Do not combine with copper.

**Phostrol—see phosphorous acid and salts.**

**plant oil extracts—see Aleo and Thyme Guard.**

**Poast (sethoxydim)** (HRAC Group 1 Herbicide) is a selective postemergent herbicide used for control of annual and perennial grass weeds in bearing and nonbearing apple, apricot, cherry, nectarine, peach, pear, and quince orchards. It is not labeled for bearing plum or prune orchards, but can be applied to nonbearing plum and prune orchards. (Nonbearing trees are those that will not have any fruit for one year from application.) Poast is specific to grasses and will not control sedges and broadleaf weeds. Apply 0.5 to 2.5 pints per treated acre to actively growing grasses at the proper stage of development, depending on the grass to be controlled. Do not apply to grasses that are dormant, under water stress, or under cold-temperature growing conditions. A

nonphytotoxic oil concentrate must be added to the spray tank. The label recommends the use of the product Dash HC as the oil concentrate of choice. Do not apply Poast within 25 days of harvest on bearing stone fruits and within 14 days of harvest on apples and pears. Do not apply more than 5 pints of Poast per treated acre in any 12-month period for stone fruits and 7.5 pints in pome fruit orchards. Poast in combination with 2,4-D may be used to control grass growth of orchard floor middles. An application after the sod has greened up in early spring and before bloom will provide growth suppression of cool-season grasses for five to eight weeks. The addition of 2,4-D will help control broadleaf weeds such as dandelion before they hamper pollination.

**polyoxin D zinc salt—see Oso and Ph-D.**

**Polyram (metiram)** (FRAC Group M3 Fungicide). Polyram is a nonsystemic foliar EBDC fungicide with protective action effective in controlling apple scab and apple rusts, but not effective in controlling powdery mildew. The use of Polyram is restricted to the early season on apples. Two application programs may be used:

1. Prebloom through bloom. Applications begin at the ¼- to ½-inch green tip stage and continue at 7- to 10-day application intervals through bloom. Do not apply more than 6 pounds per acre per application. There is a limit to the amount of Polyram fungicide that can be applied per acre each year. Refer to the label of the product you are using for specific yearly application limits.
2. Extended application. Begin applications at the ¼- to ½-inch green tip stage and continue at 7- to 10-day application intervals through the second cover spray. Do not apply more than 3 pounds per acre per application. There is a limit to the amount of Polyram that can be applied per acre each year. Refer to the label of the product you are using for specific yearly application limits. Note: Do not combine or integrate the two programs. Polyram is compatible with oil. REI is 24 hours and PHI is 77 days.

**PoMaxa—see NAA.**

**Portal (fenpyroximate)** (IRAC Group 21 Insecticide). Portal belongs to the phenoxypropylazole class of acaricides. Its mode of action is a mitochondrial electron transport inhibitor (METI) blocking cellular respiration. This mode of action is similar to the mode of action of two other acaricides: Nexter and Kanemite. Therefore, no more than one application of compounds from the METI group is recommended per season. Portal is active on larvae, nymphs, and adult mites as well as on pear psylla, leafhoppers, and mealybugs. It halts feeding damage and oviposition within hours after application, and the mortality of mites within four to seven days. Portal is registered for use on the pome and stone fruit. Portal can be applied up to 14 days before harvest on pome fruit and seven days before harvest on stone fruit, but no more than one application per season is recommended. Similarly, as with all other acaricides, excellent coverage is necessary to achieve good mite control. Portal was previously sold for use on fruit market under the trade name Fujimite.

**potassium bicarbonate—see Kaligreen.**

**potassium silicate—see Sil-Matrix.**



**\*Pounce—see permethrin.**

**PQZ Insecticide (pyrfluquinazon)** (IRAC Group 9B Insecticide). PQZ Insecticide is registered for the control of aphids (excluding woolly apple aphid) on pome and stone fruit. PQZ Insecticide works primarily through contact, by ingestion, and is translaminar on plants. Product should not be applied as alternate-row applications. REI is 12 hours, and PHI is 14 days on pome fruit and 7 days on stone fruit.

**Prey—see imidacloprid.**

**Princep—see simazine.**

**Pristine (boscalid and pyraclostrobin mixture)** (FRAC Groups 7 and 11 Fungicides). Pristine is a mixture of pyraclostrobin (12.8 percent) and boscalid (25.2 percent), the same chemical groups as Merivon. Pristine is labeled for many pome fruit diseases, including apple scab, Alternaria blotch, bitter rot, blue mold, gray mold, black rot, white rot, Brooks spot, sooty blotch, flyspeck, powdery mildew, pear scab; suppression only for cedar apple and quince rusts. For stone fruit, Pristine is effective against Alternaria leaf spot, anthracnose, leaf spot, powdery mildew, rust, scab, shothole, blue mold, gray mold, and brown rot. On stone fruit, begin applications at pinkbud or prior to the onset of disease development and continue on a 7- to 14-day interval. Use shorter intervals and/or higher rates when disease pressure is high. On apple and pear, begin applications prior to disease development and continue on a 7- to 10-day interval. Do not make more than two sequential applications of Pristine before alternating to a labeled fungicide with a different mode of action. Do not make more than five applications (stone fruit) or four applications (pome fruit) of Pristine or related fungicide with FRAC Groups 7 or 11 per season. REI is 12 hours and PHI is zero days.

**\*Proaxis—see gamma-cyhalothrin.**

**\*Proclaim (emamectin benzoate)** (IRAC Group 6 Insecticide). Proclaim is a contact insecticide but is most efficacious when ingested. The product should be applied to target small larvae; addition of summer oil should increase the compound efficacy. Proclaim is effective against leafrollers and leafminers and provides suppression of internal fruit feeders. On pome fruit Proclaim has 48-hour REI and 14-day PHI. This compound should not be used at the rate below the lowest label rate and no more than 14.4 ounces per acre is allowed per season.

**Procure 480SC (triflumizole)** (FRAC Group 3 Fungicide). Procure 480SC is a systemic fungicide for the control of scab, powdery mildew, and cedar-apple rust on apples and scab on pears. Procure is also used for the control of powdery mildew, leaf spot, blossom blight, and fruit rot on sweet and tart cherries. See caution on resistance and cross-resistance to sterol-inhibitor fungicides.

On apples and pears, Procure 480SC should be tank-mixed with standard protectant fungicides labeled for control of other diseases during the season for maximum fruit disease control. Make applications at 7- to 10-day intervals through the first cover and at approximately 10- to 14-day intervals thereafter as needed. Use higher rates depending on disease pressure and susceptibility of cultivar. Do not apply more than 64 fluid ounces per season.

REI is 12 hours and PHI is 14 days.

On sweet and tart cherries, Procure 480SC can be applied throughout the season from delayed dormant to within one day of harvest. For powdery mildew control, apply 8 to 16 ounces per acre. Begin treatments at early popcorn stage and continue at 7- to 14-day intervals until terminal growth ceases. For blossom blight and fruit rot control, apply 10 to 16 ounces per acre. Treatments should be applied at early popcorn, full bloom, and petal fall. Complete coverage must be obtained throughout the bloom period. For leaf spot control, Procure 480SC applications used for powdery mildew and blossom blight will suppress the development of leaf spot. Procure 480SC should be tank-mixed with other products registered for leaf spot control. REI is 12 hours and PHI is one day.

**ProGibb—see gibberellic acid.**

**Pro-Hex—see prohexadione calcium.**

**prohexadione calcium (Apogee, Kudos, Pro-Hex)** is a plant growth regulator that has the ability to eliminate the production of gibberellins (GAs) in apple trees. This reduction in the level of GAs reduces the rate of shoot growth. This effect may reduce pruning costs, increase the red color of apples when light in the tree is limiting, make the tree canopy easier to spray, and aid in the control of some disease and insect pests. Apogee is also labeled for the control or reduction of fire blight in apples. Apogee is recommended to be applied when shoot growth is about 1–3 inches in length. This period usually occurs around petal fall. Rates are 3 to 12 ounces per 100 gallons on a dilute basis or 9 to 36 ounces per acre, depending on the vigor and current crop load of the trees. In south-central Pennsylvania, most growth occurs in May and June, so two to four applications may be needed to get season-long shoot growth suppression. It takes about 10 to 14 days for Apogee to have an effect on growth, and the growth suppression lasts for about two to four weeks. Significant regrowth may occur in the tops of trees when sprays are terminated too soon or where spray coverage is poor. Kudos is also labeled for sweet cherries to control shoot growth. However, Apogee is only labeled for sweet cherries in the states of California, Oregon, and Washington. Recommended rates for Kudos on sweet cherries are lower with the maximum total amount allowed in any one year at 40 ounces per acre. REI is 12 hours.

**Promalin—see 6-benzyladenine + gibberellins A<sub>4</sub>A<sub>7</sub>.**

**pronamide (\*Kerb 50W, Kerb SC, \*Pronamide, Pronamide 3.3SC)** (HRAC Group 3 Herbicide) is an herbicide used before weeds emerge (preemergence) and/or after weeds come up (postemergence) in nonbearing apple, apricot, cherry, nectarine, pear, plum and prune orchards. It controls a wide range of annual and perennial grasses, as well as certain annual broadleaved weeds. Pronamide is usually incorporated into the soil by cultivation, irrigation, or rain immediately following application. The toxic action of this herbicide is selective, meaning that it kills specific target plants while sparing other desirable plants. Pronamide should be applied in the fall, before the ground freezes, to control annual and perennial grasses, winter annuals, and existing quackgrass. It acts by inhibiting root and shoot growth. It will not provide full-season control of many summer annual weeds; therefore, it should be used in conjunction with other materials to obtain full-season control

of most annual weeds. Use lower rates on coarse soils and higher rates on clay soils or soils having percent organic matter equal to or greater than 4 percent. For optimum weed control, clear the area to be treated of all surface litter (dead or decaying weeds and leaves, grass clippings, etc.). Do not treat blocks less than one year old or spring-planted trees less than six months old. Pronamide is classified by EPA as a slightly poisonous herbicide. Products containing pronamide must bear the signal word “CAUTION.” Mixers and applicators are expected to receive the most exposure to this material through skin contact. Pronamide products may not be applied to fall-planted trees less than one year old or to spring-transplanted trees transplanted less than six months.

**ProPhyt—see phosphorous acid and salts.**

**propiconazole (Bumper, PropiMax, Tilt)** (FRAC Group 3 Fungicide). Propiconazole is a systemic foliar fungicide for control of brown rot, cherry leaf spot, and powdery mildew on cherries (sweet and tart), apricots, nectarines, peaches, and plums. For brown rot blossom blight, apply 4 fluid ounces per acre at early bloom. If disease pressure is high, a second application of 4 fluid ounces per acre may be needed through petal fall. If blossoming is prolonged or if conditions favorable for disease persist, make a third application from 75 to 100 percent bloom through petal fall. For fruit brown rot, apply a maximum of two preharvest sprays at 4 fluid ounces per acre during the period beginning three weeks before harvest through the day of harvest. Follow the brown rot blossom blight schedule and read the label if additional applications are warranted. Propiconazole may also be used for the control of powdery mildew and provides only moderate control of cherry leaf spot. Resistance and cross-resistance of the brown rot fungus to the SI fungicides requires growers to evaluate how they use these fungicides for disease management in their orchards. Propiconazole has a 12-hour REI and zero-day PHI. Due to an effect on size and shape, Stanley plums have a 21-day PHI.

**Protocol (thiophanate methyl and propiconazole mixture)** (FRAC Groups 1 and 3 Fungicides). Protocol controls diseases on stone fruit (brown rot, cherry leaf spot, powdery mildew, rust) at 1.33 pints per acre, and peach scab and black knot at 2.5 to 3.75 pints per acre. REI is 48 hours and PHI is one day.

**Provado—see imidacloprid.**

**ProVide—see GA<sub>4+7</sub>.**

**Prowl—see pendimethalin.**

**Pruvin—see rimsulfuron.**

**PureSpray Oil—see dormant and summer oils.**

**PyGanic (natural pyrethrins IRAC Group 3A Insecticide)** is a botanical insecticide derived from chrysanthemums with very short period of activity. Registered for a wide range of pests with no preharvest interval. This product is OMRI listed.

**pyraclostrobin—see Cabrio, Merivon, Pristine.**

**Pyramite (pyridaben).** Pyramite is no longer available for commercial use. See Nexter.

**pyridaben—see Nexter.**

**pyrifluquinazon—see PQZ Insecticide.**

**pyrimethanil (Penbotec, Scala)** (FRAC Group 9 Fungicide). Scala is an anilopyrimidine fungicide that inhibits or interferes with the secretion of enzymes necessary for infection in several plant-pathogenic fungal species. When applying Scala alone, do not make more than two consecutive applications without alternating with a fungicide from a different FRAC Group to help prevent resistance development. Scala cannot be used on cherries.

Stone fruit: On apricots, nectarines, peaches, and plums, Scala can be used for brown rot blossom blight, shothole, and gray mold. Apply when bud tissue is susceptible to infection. If conditions continue to be favorable for disease development, apply at full bloom or at petal fall. Preharvest applications should be made on seven-day intervals or longer. Apply 9 to 18 fluid ounces per acre, however, do not make more than three applications of Scala alone or more than 54 fluid ounces per acre and within two days of fruit harvest.

Pome fruit: On apple and pear, Scala can be used for inhibiting scab. Begin applications at green tip or as soon as conditions become favorable for disease development. Apply 7 to 10 fluid ounces of Scala alone or 5 fluid ounces when using in tank mixes. Do not apply more than 40 fluid ounces of Scala per crop and do not apply within 72 days of harvest. REI is 12 hours and PHI is 72 days.

Penbotec 400 SC is a postharvest preventive and curative fungicide for blue and gray mold control on pome fruit. It is an anilopyrimidine fungicide that does not exhibit cross-resistance to sterol-inhibiting or benzimidazole fungicides. It is recommended for dip and drenchers (16 to 32 fluid ounces per 100 gallons), aqueous line spray (32 fluid ounces per 100 gallons), and wax line spray (64 fluid ounces) for a one-minute treatment.

**pyriproxyfen—see Esteem.**

**Quash (metconazole)** (FRAC Group 3 Fungicide) is a broad-spectrum systemic SI fungicide registered for use on stone fruits (apricot, cherry, nectarine, peach, and plum) for control of brown rot, cherry leaf spot, powdery mildew, and scab. Quash can be applied pre- or postinfection, but the best results are obtained when applications are made prior to infection. To prevent wash-off, Quash should not be applied if rain is expected within two hours after application. Label recommendations: 4 ounces (0.125 pound of active ingredient per acre) per acre per application with a maximum of two sequential applications and no more than three applications per season. Since orchard tree sizes vary, refer to the label for specific rate recommendations. See caution on resistance and cross-resistance to SI fungicides. REI is 12 hours and PHI is 14 days.

**quinoxifen—see Quintec.**

**Quintec (quinoxifen)** (FRAC Group 13 Fungicide). Quintec is a protectant fungicide labeled for the control of powdery mildew on cherry. Quintec does not control existing or latent powdery mildew disease and must be applied at 7 fluid ounces per acre per application on a 7- to 14-day protectant schedule. Do not apply more than 37 fluid ounces of Quintec per season. REI is 12 hours and PHI is seven days.

**Rally 40WSP (myclobutanil)** (FRAC Group 3 Fungicide). Rally 40WSP is a systemic SI fungicide registered for use on apples to

control apple scab, powdery mildew, and cedar-apple rust. Best control of labeled diseases is achieved when the fungicide is applied on a 7- to 10-day application schedule. Orchard tree heights, tree spacing, and pruning practices vary. Refer to the label for specific rate recommendations. Resistance and cross-resistance of the apple scab fungus to the sterol-biosynthesis-inhibiting fungicides (FRAC Group 3), including Rally, requires growers to evaluate how they use these fungicides for disease management in their orchards to prevent the onset of resistance development.

For scab (prebloom), begin application at green tip. During periods favorable for primary scab development, use high rates and a seven-day application schedule. Apply Rally alone or tank-mix with a protective fungicide. For scab (postbloom), use Rally in a tank mixture with the recommended use rate of a protectant fungicide. For scab (postinfection), Rally provides 96-hour postinfection control or curative activity and suppresses sporulation of established lesions when used in two or more applications. Apply as soon as possible after an infection period. Follow with a standard protectant spray schedule. For powdery mildew, begin application at tight cluster and continue through the second cover spray. Additional sprays beyond second cover may be needed on susceptible varieties or under heavy disease pressure. Use high label rate if powdery mildew was present in previous years. For rusts, begin applications at pink stage and continue through the second cover spray. *Restrictions:* Do not apply more than 5 pounds of Rally per acre per season. Do not graze livestock in treated areas or feed cover crops grown in treated acres to livestock. REI is 24 hours and PHI is 14 days.

**RainGard** is a proprietary mixture of food-grade fatty acids and vegetable based esters that can help to reduce rain cracking in sweet cherries. It should be applied in an 0.8 percent v/v solution in three applications the first beginning four weeks before anticipated harvest and followed by two more applications at 7- to 10-day intervals. Alternatively, mix 102 ounces of the product per 100 gallons of spray. Do not include organosilicate surfactants in the spray mixture. Volume of spray per acre will depend on tree size and canopy density. To be effective the material must contact and cover the fruit. Cracking caused by turgor pressure from the roots is not controlled.

**Rampart—see phosphorous acid and salts.**

**Raynox Plus** Raynox Plus is a sunburn protectant to reduce sunburn browning of fruit. Some apple cultivars are susceptible to sunburn damage, including Cameo, Golden Delicious, Fuji, Granny Smith, Gala, Jonagold, Delicious, and Braeburn. The principal ingredients include carnauba wax, clay, and emulsifiers. Apply Raynox at 2.5 gallons of product per acre in either 50 or 100 gallons per acre of finished spray. Alternatively, it can be applied to just the western side of the trees that receive the afternoon sun. The first application should be made between seven to nine weeks after full bloom; the second application seven to 10 days later. The third application should be made three weeks later. A fourth application, if needed, is made four weeks after the third application. Compatibility with other orchard products is unknown at the present time. After application the sprayer should be cleaned immediately by adding water to the spray tank and spraying water through the nozzles. If any product dries on the sprayer, it may be necessary to clean with hot water and detergent.

**Reaper—see abamectin.**

**Refine—see NAA.**

**Regalia (extract of *Reynoutria sachalinensis*)** (FRAC Group P 05 Biological Plant Activator). Regalia is a biofungicide/bactericide derived from plant (giant knotweed) extract that acts to boost a plant's defense mechanism to protect it from certain pathogens. Induced resistance usually happens in one to two days, so it must be applied as a preventive treatment. Regalia is labeled for numerous pome fruit and stone fruit diseases. Apply in rotation or tank-mix with other fungicides on a 7- to 14-day interval for control or suppression of disease. Use Regalia as rotational product for less susceptible apple, pear, and stone fruit cultivars. Use at 1 to 4 quarts per acre for both pome fruit and stone fruit foliar applications. Regalia can also be applied as a soil drench, plant dip, or through chemigation. REI is four hours and PHI is zero days. This product is OMRI listed.

**Rely—see glufosinate.**

**ReTain (amino ethoxyvinylglycine AVG).** ReTain works as an ethylene biosynthesis inhibitor to delay the ripening of apples and associated preharvest fruit drop. It can also retard the loss of firmness, loss of starch, increase in soluble solids, and development of watercore and red color. It may indirectly increase the red color on fruit by allowing the fruit to remain on the tree longer for additional color development to a period when cooler. See Part I for more information on ReTain.

***Reynoutria sachalinensis*—see Regalia.**

**Rhyme (flutriafol)** (FRAC Group 3 Fungicide). Rhyme is a locally systemic fungicide registered for the control of diseases on pome fruit and stone fruit. On pome fruit, it is labeled for powdery mildew and cedar apple and quince rust at 4 to 6 fluid ounces per acre, and on apple and pear scab at 6.5 fluid ounces per acre. On stone fruit, it is labeled for powdery mildew, brown rot, shothole, and cherry leaf spot at 7 fluid ounces per acre. When applying Rhyme, tank-mix with a protectant fungicide and limit the number of Group 3-containing fungicides before rotating with a fungicide from a different FRAC Group. Do not apply more than 26 fluid ounces per acre per year on pome fruit or 28 fluid ounces per acre per year on stone fruit. Do not make more than four applications per year. Rhyme can be applied up to 14 days before harvest on pome fruit and seven days before harvest on stone fruit. The REI is 12 hours.

**Ridomil Gold SL (mefenoxam)** (FRAC Group 4 Fungicide). Ridomil Gold SL is a systemic fungicide labeled for *Phytophthora* collar, crown, and root rot that is absorbed through the leaves, stems, and roots. It is registered for use on both bearing and non-bearing apple and stone fruits—apricots, cherries (sweet and tart), nectarines, peaches, plums, and prunes. Ridomil applications should be made before symptoms appear, especially in areas of the orchard favorable for disease development. Ridomil will not revitalize trees showing moderate to severe disease symptoms.

In stone fruit, make the first application two weeks after planting. Additional applications should be made at two- to three-month intervals or to coincide with periods most favorable for root, crown, or collar rot development. For established plantings, the application should be made in spring before the plants start growth. Additional applications should be made at two- to three-month intervals or to coincide with periods most favorable

for root, crown, or collar rot development. Apply 2 quarts per treated acre (1.5 fluid ounces per 1,000 square feet) in sufficient water to obtain thorough coverage of the soil under the canopy of the trees. Up to three applications can be made per year.

In apples two application methods can be used. For broadcast spray or banded applications apply 2 quarts per treated acre (1.5 fluid ounces per 1,000 square feet) in sufficient water to obtain thorough coverage. The treated area is the area under the tree canopy or the area of the sprayed row (similar to the herbicide strip). Soil surface applications of Ridomil Gold SL will not be effective until the fungicide is moved into the root zone by rainfall or irrigation. Applications should be made in early spring before growth starts and in the fall after harvest but before the ground freezes. For drench mix 0.5 pint of Ridomil Gold SL with 100 gallons of water. Apply the amount of diluted mixture indicated in the table below around the trunk of each tree. Applications should be made in early spring before growth starts and in the fall after harvest but before the ground freezes. For new plantings, delay the first application until two weeks after planting. To determine trunk diameter, measure the trunk 12 inches above the soil line.

**Restrictions:** Do not dip roots of trees in or spray bare roots with solutions containing Ridomil Gold SL. Do not apply to trees under stress. Do not graze or feed cover crops in treated orchards, or illegal residues may occur. REI is 48 hours.

Trunk diameter	Quarts of diluted mixture per tree
< 1 inch	1
1–3 inches	3
> 5 inches	4

**Rimon—see novaluron.**

**rimsulfuron (Grapple, Hinge, Matrix, Pruvina, Solida, Trampa)** (HRAC Group 2 Herbicide) is labeled for use in stone fruit, nut crops, pome fruit, and grapes that have been established at least one year in the field. It provides selective control of certain broadleaf weeds and grasses. Optimum control occurs when the material is applied preemergence or early postemergent. Degree of control will depend on weed density, plant size, and environmental conditions at and following treatment. Rimsulfuron is absorbed through the roots and foliage of the weeds and acts to inhibit weed growth. Best results are obtained when the soil is moist at the time of application and a 0.5 inch of rain occurs within three weeks. The restricted-entry interval is four hours and the preharvest interval is seven days for pome fruit and 14 days for stone fruit, nut trees, and grapes. A partial list of weeds controlled includes crabgrass, foxtails, quackgrass, henbit, common mallow, pigweeds, and spurge. Rimsulfuron can also be used to suppress yellow nutsedge. Treatment regimes for nutsedge control are either a preemergence plus early postemergence or early postemergence followed by an application 14 days after the first. When applied as a banded treatment (50 percent band or less), Rimsulfuron may be applied two times per year but only apply 4 ounces for any one treatment.

**RiteWay—see 6-benzyladenine.**

**Roundup Ultra—see glyphosate.**

**Rovral (iprodione)** (FRAC Group 2 Fungicide). Rovral Brand 4 Flowable is a contact fungicide. It is highly effective for controlling brown rot of stone fruits during bloom. Rovral is

recommended at 1 to 2 pints per acre. The higher rate is recommended under severe disease conditions. Apply when bud tissue is susceptible to disease development. If conditions favorable for disease development persist, apply at full bloom or at petal fall. Do not apply more than two applications per season. This product may not be applied after petal fall. REI is 24 hours.

**Rubigan E.C. (fenarimol)** (FRAC Group 3 Fungicide). Rubigan E.C. is a locally systemic fungicide. It is registered for the control of scab, powdery mildew, and rusts of apples; scab and powdery mildew of pears; and leaf spot and powdery mildew of cherries. When applying Rubigan alone, it is recommended to use a surfactant. In apples, Rubigan may be used from ½-inch green to 30 days before harvest. Rubigan may be applied at 8 to 12 fluid ounces per acre alone or at 4 or more fluid ounces per acre in combination with a protectant fungicide. When tank-mixing with a protectant fungicide, use recommended rates of the protectant fungicide. Do not apply more than 12 fluid ounces of Rubigan E.C. per acre per application and more than 84 fluid ounces per season. It may be used in dilute sprays at 3 fluid ounces alone or in tank-mix combination at 3 to 4 fluid ounces per 100 gallons of water and applied to the point of runoff. Resistance and cross-resistance of the apple scab fungus to the sterol-biosynthesis-inhibiting fungicides (FRAC Group 3), including Rubigan, requires growers to evaluate their use frequently for apple scab management in their orchards. Tank-mixing with a protectant fungicide, such as captan, is recommended for resistance management.

**Saber—see 2,4-D.**

**Sandea—see halosulfuron-methyl.**

**Savey—see Onager.**

**Scala—see pyrimethanil.**

**Scholar (fludioxonil)** (FRAC Group 12 Fungicide). Scholar is a fungicide recommended as a postharvest dip, drench, flood, or spray for the control of postharvest diseases caused by blue mold, gray mold, bull's-eye rot, Rhizopus rot, bitter rot, white rot, Alternaria rot, and brown rot on pome fruit and all stone fruit. In apple and pear, apply 5 to 8 fluid ounces per 100 gallons as bin/truck drench or in-line dip/drench or flood. Ensure proper fruit coverage. For in-line drench or dip applications, treat fruit for 15 to 30 seconds and allow to drain. Fruit coatings may be applied separately after aqueous fungicide treatments. In stone fruit, use 8 to 16 fluid ounces per 100 gallons for in-line dip/drench, 8 to 16 fluid ounces per 200,000 pounds of peach/nectarine and other stone fruit, or 8 to 16 fluid ounces per 50,000 pounds of cherries for in-line aqueous or fruit-coating spray application. Do not make more than one postharvest application to the fruit. To manage resistance, alternate or tank-mix Scholar with other labeled fungicides that have a different mode of action. Use sanitation and other cultural practices to minimize disease and prevent or delay disease development.

**Scorpion—see dinotefuran.**

**Scythe (pelargonic acid)** (HRAC Group 17 Herbicide) is a contact nonselective broad-spectrum foliar herbicide. It will only control actively growing, emerged, green vegetation. The active ingredient is pelargonic acid. It may also act as an enhancer when

used with glyphosate at a rate of 1–3 percent solution. Recommended rates when used by itself are 3–10 percent on a volume/volume basis. It may also be used to control root suckers as long as they are treated when they are still green. Do not allow spray to contact any desirable green foliage. Do not apply to trees until they have been established in the orchard for at least one year unless an impervious trunk protection is in place.

**Select—see clethodim.**

**Sekor—see diuron.**

**Sercadis (fluxapyroxad)** (FRAC Group 7 Fungicide). Sercadis is a broad-spectrum single-site succinate dehydrogenase inhibitor (SDHI) that is labeled for diseases on apple. It is label for apple scab and powdery mildew at 3.5 to 4.5 fluid ounces per acre and cedar apple and quince rust, *Alternaria* and frog-eye leaf spot, and flyspeck at 4.5 fluid ounces per acre. For improved disease control, apply Sercadis prior to disease development and use a protectant fungicide for resistance management. Apply on a 7- to 10-day interval for scab and powdery, and at seven to 14 days for other diseases. It is not recommended to use with crop oil concentrates or methylated seed oil (MSO) adjuvants. Do not make more than two sequential applications of Sercadis before alternating to a non-Group 7 fungicide. The maximum number of applications per season is four. The REI is 12 hours and the minimum time from application until harvest is zero days.

**Serenade (*Bacillus subtilis* FRAC Group 44 Bactericide/Fungicide)** (Serenade ASO, Serenade Opti) is a broad-spectrum bacterial fermentation product for the control or suppression of pome and stone fruit diseases. It is effective as a rotational product with other registered fungicides/bactericides. Serenade Opti is a dry formulation and apply at a rate of 14 to 20 ounces per acre. Serenade ASO is a liquid formulation, and the recommended rate, depending on disease conditions, is 2 to 4 quarts per acre. REI is four hours and PHI is zero days. This is OMRI listed.

**sethoxydim—see Poast.**

**Sevin—see carbaryl.** See Part I for more information on apple thinning with Sevin.

**Shadow—see clethodim.**

**Shark—see carfentrazone-ethyl.**

**Sherpa—see imidacloprid.**

**Sil-Matrix (potassium silicate)** (FRAC Group Not Classified). Sil-Matrix is a broad-spectrum preventive fungicide labeled for use on pome and stone fruit. Do not apply more than 10 quarts per acre per application; do not apply more than 20 gallons per acre per season. The REI is four hours and PHI is zero days. This product is OMRI listed.

**simazine (Princep 4L, Princep Caliber 90, Simazine 4L, Sim-Trol, plus many others)** (HRAC Group 5 Herbicide). Simazine is a selective triazine herbicide and is used to control broadleaved weeds and annual grasses. It is available in several formulations and can be used around apple, peach, pear, plum, and cherry trees established at least one year in the orchard. Simazine should be applied before weeds emerge or after removal of weed growth. It does not kill emerged weeds but may be used in combination with paraquat or glyphosate. Rates vary by fruit crop. Use lower

rates on light soils and soils low in organic matter, higher rates on heavy soils and soils high in organic matter. Products containing simazine must bear the signal word “CAUTION.” Note that some products have a 12-hour REI and some have a 48-hour REI. Likewise, a few products have a 150-day PHI for apples. Be sure to read the label thoroughly.

**Sinbar (terbacil)** (HRAC Group 5 Herbicide). Terbacil is a selective herbicide used to control annual weeds and perennial grasses. It is sprayed on soil surfaces preferably just before, or otherwise during, the period of active weed growth. Terbacil works in plants by interfering with photosynthesis. It is part of a family of chemicals called substituted uracils. Terbacil at full rates is recommended for use on apple and peach trees established at least three years. Apply it either before weeds emerge in the spring or after harvest in the fall.

Terbacil controls barnyard grass, annual bluegrass, chickweed, crabgrass, seedling dandelion, foxtail, henbit, knotweed, lambs-quarters, pigweed, purslane, ragweed, and smartweed. Use lower rates on light soils and soils with low organic matter; higher rates on soils with higher organic matter content. Do not use on soils with less than 1 percent organic matter or on areas with exposed tree roots. Sinbar should not be used on sandy or gravelly soils. Do not replant treated areas to any crop within two years after application. Terbacil may be applied with diuron at reduced rates for broader-spectrum control. The EPA requires the signal word “CAUTION” on containers of formulated terbacil.

A supplemental label for the use of Sinbar was approved to allow application on newly transplanted trees at rates of 0.5 to 1 pound per acre. Up to two applications at the 0.5-pound rate can be made in a year. You must have a copy of the supplemental label in your possession to apply Sinbar in this fashion.

**Sivanto (flupyradifurone)** (IRAC Group 4D Insecticide) is a member of butenolide group of insecticides acting on nicotinic acetylcholine receptors (nAChR). The active ingredient was inspired by natural product stemofoline present in the plant *Stemona japonica*. Sivanto provides quick cessation of feeding and knockdown of adult insects. The product exhibits translaminar movement within the foliage and is also xylem mobile within the plant, providing good protection of new plant growth. Sivanto is registered for use on pome and stone fruit to control aphids, leafhoppers, pear psylla, and scale insects. The product is safe to most beneficial insects. Sivanto has no adverse effect on honey bee brood and colony development; however, it is toxic to adult bees via oral exposure.

**SmartFresh—see 1-MCP.**

**Snapshot** (HRAC Groups 3 and 21 Herbicide) is a proprietary granular mixture of 2 percent trifluralin plus 0.5 percent isoxaben that is labeled for nonbearing fruit trees. The material will control a variety of broadleaf and grass weeds depending on the application rates. Application rate is 100 to 200 pounds per treated acre, or 2.3 to 4.6 pounds per 100 square feet. REI is 12 hours.

**\*Sniper—see bifenthrin.**

**Solicam (norflurazon)** (HRAC Group 12 Herbicide). Solicam is recommended for preemergent control of annual grasses and certain broadleaved weeds in apples, apricots, cherries, nectarines, peaches, and plums. In apples, norflurazon may be applied the

year of planting once the ground has firmed and settled with no cracks in the soil. In cherries, norflurazon should not be applied on sandy or loamy-sand soils, nor may it be applied sooner than 18 months after trees have been established in the orchard. In apricots, pears, plums, and prunes, it may not be applied to trees established in the orchard for less than 12 months. Application to peaches and nectarines may be made no sooner than six months after planting. Irrigation or rainfall is recommended within four weeks after soil application. Apply norflurazon in the fall post-harvest or early in the spring before weeds germinate.

**Solida—see rimsulfuron.**

**Sovran (kresoxim-methyl)** (FRAC Group 11 Fungicide). Sovran is a fungicide registered for use on apple, crabapple, pear, and Oriental pears. It is highly effective against apple scab and apple powdery mildew and is also effective for controlling fruit rots, sooty blotch, and flyspeck. Sovran is labeled for the suppression of quince and cedar-apple rust. Part of the Sovran spray residue is absorbed by leaves and fruit relatively quickly and moves within the leaf, but it is not translocated to other leaves.

For control of early season diseases (scab, powdery mildew, apple rust, frog-eye leaf spot) Sovran should be applied as protective sprays at 7- to 10-day intervals, but has curative action against scab when used up to 92 hours postinfection. The label recommends the use of Sovran for control of flyspeck, sooty blotch, white rot, and Brooks fruit spot beginning at second cover and continuing at 7- to 14-day intervals. Sovran or other strobilurin fungicides (FRAC Group 11; Flint, Cabrio, Pristine, Merivon) should not be applied in more than four applications per season, using no more than two consecutive applications. See caution on resistance and cross-resistance to QoI fungicides. Apply Sovran in alternation with labeled nonstrobilurin fungicides with a different mode of action. REI is 12 hours and PHI is 30 days.

**spinetoram—see Delegate.**

**spinosad—see SpinTor.**

**SpinTor (spinosad)** (IRAC Group 5 Insecticide) is a member of the naturalyte class of insecticides labeled for control of leaf-rollers and thrips on peaches, plums, cherries, nectarines, prunes, and apricots. It is formulated as a suspension concentrate. This product, with both contact and ingestion activity, provides about seven to eight days of residual activity on the tree. SpinTor can be used to manage various lepidopterous pests and also has activity against apple maggot. Control of spotted tentiform leafminer is very good with one application per brood. The addition of a penetrating adjuvant is necessary for optimum activity. Excellent control can be achieved for tufted apple bud moth and obliquebanded leafroller with two applications per generation. Only one generation of these pests should be targeted with SpinTor in a given year. Targeting the first generation of tufted apple bud moth or the summer generation of obliquebanded leafroller may offer the advantage of a shorter period of egg hatch and a higher level of leafminer control.

SpinTor can be used on nectarines to control thrips. The label specifies the rate of 4 to 8 fluid ounces per acre. No more than 29 ounces can be applied per season; a one-day PHI exists for nectarines. Growers wishing to use this product should carefully check early ripening fruit for the presence of silvering, the damage caused by the feeding of the thrips on the skin of the fruit. It is extremely

important that fruits are thoroughly covered since the thrips hide underneath leaves covering the fruit or around the stem end. SpinTor usage in tree fruit is being replaced with a newer product with similar mode of action, Delegate. It is highly toxic to bees by contact.

**spirotetramat—see Envidor.**

**spirotetramat (Movento, Ultor)** (IRAC Group 23 Insecticide). Systemic foliar insecticide belonging to the tetracyclic acid chemical class. The active ingredient acts as a lipid biosynthesis inhibitor. The product is active via ingestion against immature stages and has high efficacy against female insects by reducing fecundity and survival of offspring. Following the application to plant foliage, spirotetramat is absorbed into the leaf and readily hydrolyzed into a form that is highly mobile within the plant vascular system (phloem and xylem), able to be transported to new shoots and to the roots of the plant. Movento and Ultor are nontoxic to most beneficial insect groups but moderately harmful to predatory mites. On pome fruit, the product is registered to control aphids, including woolly apple aphid, pear psylla, San Jose scale, white peach scale, mealybugs, and whiteflies. For the best pest control, Movento must be mixed with a spray adjuvant/additive that has spreading and penetrating properties. The use of Induce is prohibited in a mixture with Movento and Ultor on stone and pome fruit. The PHI is seven days on pome fruit and stone fruit.

**spray oil—see dormant and summer oils.**

**sprayable pheromone OFM (Z-8-Dodecenyl acetate, E-8-Dodecenyl acetate, Z-8-Dodecenol) (CheckMate OFM-F).** Sprayable pheromones are time-release microencapsulated pheromone concentrates used for mating disruption of the Oriental fruit moth. The product is registered to help manage Oriental fruit moth populations in apples, peaches, and any other crop where OFM is a problem. It can reduce or prevent mating by interfering with chemical communication system between OFM males and females. Supplemental insecticides may be required if initial populations in the treated area are too high or if a major source of mated OFM females is present adjacent to the treated area. The pheromone can be applied with conventional ground application equipment. It is recommended that the first application will be made before the start of flight of controlled moth generation. Pheromone trap monitoring is necessary for initial assessment of the treatment efficacy. Recommended rate is 2 fluid ounces of formulated product per acre per application. No more than 22 fluid ounces of product can be applied per acre per season.

**Spur—see clopyralid.**

**Starane Ultra—see fluroxypyr.**

**Stave—see fluroxypyr.**

**streptomycin sulfate (Agri-mycin 17, FireWall)** (FRAC Group 25 Bactericide). Streptomycin sulfate is used for the control of fire blight on apples and pears. There are several formulations of agricultural streptomycin sulfate in the market, such as Agri-mycin 17, FireWall 17, and Ag-streptomycin. Bloom sprays are most effective when applied at slow-drying conditions such as at night and combined with Regulaid. See discussion of bloom sprays in apple and pear spray programs for amounts and timing; read the label for exact rates and restrictions on the streptomycin-

cin formulation used. Do not apply after petal fall unless a hail event occurs. REI is 12 hours and PHI is 30 days for pear and 50 days for apple.

**Stylet oil (white mineral oil)**—see **JMS Stylet Oil**.

**sulfur** (FRAC Group M2 Fungicide). There are numerous formulations of sulfur on the market and the percentage of sulfur in each formulation has a very broad range (5 to 98 percent). There are many types of spray sulfurs and dusting sulfurs, including Flowable Sulfur, Liquid Sulfur Six, Microdisperse Wettable Sulfur (MicroSulf, Microthiol Disperss, Microfine Sulfur, Dusting Sulfur, Spray Sulfur, and Sulfur DF), to name a few. Because so many types of sulfurs are available, it is important to read the label carefully since some sulfur formulations can be phytotoxic to plants. Sulfur is very effective against powdery mildew of apples and cherries and scab on peaches and nectarines. Confine traditional wettable powder formulations to the prebloom period on sulfur-sensitive apple varieties. Jonathan and Cortland are more tolerant than Stayman and Delicious. Rome Beauty is intermediate. Do not use sulfur in combination with oil and allow at least 14 days between oil and sulfur. Some of the newer sulfur formulations can be used in seasonal programs on apples without injury. In organic treatment trials, sulfur was found to provide excellent control of apple scab on some cultivars. Do not use sulfur when temperatures exceed 90°F and on humid days due to risk of crop injury. Do not apply to d'Anjou. REI is 24 hours and PHI is one day on apple. Some sulfur formulations are labeled for organic production and are OMRI listed.

**summer oils (BioCover, Damoil, JMS Stylet oil, Mite-E-Oil, Omni Supreme Spray, Par F70 Soluble Oil, PureSpray Oil, Spray Oil, Sunspray Ultrafine Oil, Super 94 Spray Oil, Superior Spay Oil, Supreme Oil)**. These are horticultural “superior oils” with a narrow 10–90 percent distillation range that permits relatively safe use on apple foliage during the summer months. In orchards under an effective prebloom mite control program, a summer oil can effectively suppress mite populations when applied at petal fall and in two subsequent cover sprays at rates of 1 to 2 gallons per 100 gallons finish spray solution, using a minimum of 100 gallons of spray per acre. Some leaf spotting may occur at the rate of 2 gallons per 100 gallons. The rate of 1 gallon per 100 in these three applications may not be adequate for season-long control under conditions of severe population pressure; however, effective control has been achieved in such conditions using 0.5 to 1 gallon per 100 in a seasonal program starting at petal fall and continuing on a two-week schedule until mid-August. Using oil at concentrate rates increases the likelihood of phytotoxicity and is therefore not recommended. Apple variety and spray drying conditions should be taken into account to minimize any possible effects on fruit finish. The slow drying conditions and extremes of cool or hot conditions should be avoided when applying horticultural mineral oils. Treatment with other materials is generally not recommended at this time unless all previous sprays were either omitted or completely ineffective.

**Sunspray 6E**—see **dormant oil**.

**Sunspray Ultrafine Oil**—see **summer oils**.

**Super 94 Spray Oil**—see **dormant and summer oils**.

**Superior Spray Oil**—see **dormant and summer oils**.

**Supreme Oil**—see **dormant and summer oils**.

**Suppress**—see **caprylic acid**.

**Surflan**—see **oryzalin**.

**Surround (kaolin clay)**. Surround is a nontoxic material that forms a mechanical barrier film to protect fruit against insect and solar damage. Surround is registered for use on pears, apples, and stone fruit. Surround suppresses insects by creating a protective white particle barrier on plant surfaces, which repels and irritates insects. For best results, the material should be first used before expected insect appearance and reapplied every 7 to 14 days throughout the season. At least 25 to 50 pounds of Surround have to be applied during a single application. Uniform and consistent coverage is essential for effective insect suppression and control. Special washing may be required at harvest to remove residue from fruit. Surround is OMRI listed.

**Swinglea glutinosa**—see **EcoSwing**.

**Syllit FL (dodine)** (FRAC Group U12 Fungicide). Syllit is effective for scab on apples and pears, as well as cherry leaf spot and peach leaf curl. For controlling scab, use 1.5 pints per acre of Syllit FL to maintain scab control beginning at green tip and seven days later to clean the orchard of overwintering scab at the start of the season. Alternatively, apply Syllit FL preventively at weekly intervals from green tip to pink bud. Do not apply more than two applications per year and do not use past pink bud. For resistance management, Syllit must always be tank-mixed with captan (1.5 to 2 pounds of active ingredient per acre) or mancozeb (2.25 pounds of active ingredient per acre). For cherry leaf spot, use 1.5 to 3 pints per acre at petal fall or when first leaves unfold. Repeat application thereafter at a 7- to 10-day interval. If conditions favor leaf spot, continue applications through harvest. For peach leaf curl, use 3 pints per acre just before buds swell in the spring. Application of Syllit FL to cherries may cause spotting to foliage or fruit when temperatures and humidity are excessive. If leaf curl was moderate to severe the previous season, use 4.5 pints per acre one month before buds swell in the spring and again just prior to bud swelling. Read label for specific restrictions based on the crop. When tank-mixing Syllit FL with captan or mancozeb, fill the spray tank with clean water half of final desired volume; start agitation; slowly add Syllit FL at the specified rate. Once mixed, slowly add captan- or mancozeb-based formulation at the specified rate. Add water to desired final volume. Mix thoroughly and apply at once. Maintain sufficient agitation during mixing and spraying operations to ensure a uniform spray mixture. REI is 48 hours, and PHI is seven days for pear and cherries and 15 days for peaches.

**tebuconazole (Orius 20AQ)** (FRAC Group 3 Fungicide). Orius 20AQ is effective in controlling brown rot (blossom blight and fruit rot) on peaches, nectarines, and cherries; leaf spot and powdery mildew on cherries; and rust on peach. Orius 20AQ is not registered for use on apricots. Orius 20AQ is used at 8.6 to 17.2 ounces per acre. To control blossom blight, begin application at white bud on cherry or pink bud on peach and nectarine. Apply again at 50 percent bloom and at petal fall if conditions continue to be favorable for disease development. For fruit rot, begin applications two to three weeks

before harvest and at 7-day intervals through the day of harvest. The blossom and fruit stages must be protected for optimum control of brown rot. If Orius 20AQ is applied during only one of these stages, another registered fungicide should be applied to the other stage to provide optimum protection. Additional cover sprays during the early postbloom period are also important for preventing quiescent fruit infections in sweet cherry and peach. For controlling leaf spot, begin application at petal fall or when first leaves unfold, and continue applications at 7- to 14-day intervals. Applications should be made at seven-day intervals early in the growing season when terminal growth is rapid and/or under severe disease conditions. A postharvest application may be made to maintain control and reduce overwintering inoculum. For controlling powdery mildew, follow leaf spot schedule until terminal growth ceases. For controlling rust, begin applications after canker emergence and continue applications at 14-day intervals under severe disease conditions. Orius 20AQ may be tank-mixed or alternated with a protectant chemical for resistance management strategy. May be applied up to and including the day of harvest (zero-day PHI). Do not apply more than 103 ounces of Orius per acre per crop season. REI is 12 hours.

**\*Telone—see 1,3-dichloropropene.**

**terbacil—see Sinbar.**

**thiabendazole—see Mertect.**

**thiamethoxam (Actara, Agri-Flex, \*Endigo, Voliam Flexi)** (IRAC Group 4A Insecticide). Thiamethoxam is a second-generation neonicotinoid insecticide belonging to the thianicotinyl subclass of chemistry. Thiamethoxam interferes with a unique receptor site in the insect nervous system, the nicotinic acetylcholine receptor. The compound is very effective against brown marmorated stink bug and many chewing and sucking insects: aphids, leafminers, leafhoppers, mullein bug, plum curculio, European apple sawfly, and pear psylla. Thiametoxam exhibits rapid translaminar penetration into plant surfaces and is rainfast as soon as the spray dries. Actara is registered for use on pome fruits (apples, crabapples, loquat, mayhaw, quince, and pear fruit) and stone fruits (apricots, cherries, nectarines, peaches, plums, and prunes). Actara should be used from 2 to 5.5 ounces per acre per application depending on target pest. No more than 8 ounces per acre can be applied during a single growing season. Actara should be applied with a minimum of 50 gallons of water per acre. Thiametoxam is very toxic to bees exposed to direct treatment. Agri-Flex is a premix product of thiametoxam and abamectin; Endigo is a mixture product of thiametoxam and lambda-cyhalothrin; Voliam Flexi is a mixture product of thiametoxam and chlorantraniliprole.

**Thionex.** Endosulfan is no longer registered for use on fruit.

**thiophanate-methyl—see Topsin M.**

**Thiram Granuflo (thiram)** (FRAC Group M3 Fungicide). Thiram is a broad-spectrum protective fungicide. It is registered for use on peach for control of brown rot and peach leaf curl, and for peach scab on peach. Thiram can be effectively used as a companion fungicide for mixtures with strobilurin (FRAC Group Code 11), sterol inhibitors (FRAC Group Code 3), and other unrelated fungicides. Precautions on the label for applicators and handlers should be noted, and personal protective equipment should be used by persons sensitive to Thiram. Thiram can be applied at

prebloom, calyx, early cover sprays, and late cover sprays. REI is 24 hours and PHI is seven days.

**Thyme Guard (thyme oil extract)** (FRAC Group Not Classified). Thyme Guard is an essential oil extracted from the thyme herb. It is a 100 percent biodegradable broad-spectrum contact liquid organic bactericide, fungicide, and insecticide for use in all crops. Thyme Guard is tank-mixable with most other chemicals. Do not mix with peroxides and/or sulfonated fungicides, which may cause phytotoxicity. Can be used anytime, including the day of harvest.

**Tilt—see propiconazole.**

**tolfenpyrad (Apta, Bexar)** (IRAC Group 21A Insecticide; FRAC Group 39 Fungicide) is an active ingredient in two contact insecticides registered for use on pome and stone fruit for the control of aphids, leafhoppers, cherry fruit fly, apple maggot, pear psylla, and plum curculio. It also should provide suppression of spotted wing drosophila, stink bugs, codling moth, and thrips. Tolfenpyrad belongs to mitochondrial complex I electron transport inhibitors (METI), with the site of action defined as complex I (NADH dehydrogenase) in the mitochondrial electron transport chain. This active ingredient works by inhibiting cellular respiration in the mitochondria. Apta is harmful to many beneficial insects and highly toxic to pollinators when exposed to direct contact. Apta and Bexar are also registered for the suppression of powdery mildew. Both products can be used two times per season and have a 14-day PHI.

**\*Tombstone—see cyfluthrin.**

**Topguard (flutriafol)** (FRAC Group 3 Fungicide). Topguard is a locally systemic fungicide registered for the control of scab, powdery mildew, and rusts of apples. It has shown excellent activity against powdery mildew in our field tests. In apples, Topguard may be used from ½-inch green to 14 days before harvest, but we recommend it be used for primary scab, powdery mildew control, and cedar-apple rust (i.e., between ½-inch green and first cover sprays). Fungicide resistance management strategies must be used when using FRAC Group Code 3 fungicides. Topguard may be applied at 8 to 13 fluid ounces per acre alone depending on the disease targeted, and it should be tank-mixed with a protectant fungicide. When tank-mixing with a protectant fungicide, use recommended rates of the protectant fungicide. Do not apply more than 52 fluid ounces per acre per season and do not more than four applications per growing season. In stone fruit, apply Topguard at 14 fluid ounces per acre per application to control brown rot. Start applications at 5–10 percent bloom, followed by a second application at 50–100 percent bloom. Reapply Topguard 7–14 days after an application if disease pressure is severe. To control powdery mildew, apply 14 fluid ounces per acre at 100 percent bloom to petal fall followed by two more applications on a two- to three-week interval if disease conditions are favorable. To control cherry leaf spot, apply 14 fluid ounces per acre with a protectant fungicide. Start application at white bud, followed by one at 50–100 percent bloom, petal fall, and then every two weeks if conditions for leaf spot are favorable. Do not apply more than 56 fluid ounces per acre per season and do not make more than four applications per growing season. REI is 12 hours and PHI is seven days on stone fruit and 14 days on pome fruit.



**Topsin M (thiophanate-methyl)** (FRAC Group 1 Fungicide). Topsin M WSB is a systemic fungicide labeled for use on apples and all stone fruits. Due to widespread fungal resistance to this fungicide, it is no longer recommended for use in controlling apple scab. Topsin M is still highly effective in controlling sooty blotch and flyspeck and is widely used late in the season to control these diseases. Topsin M is also labeled on pear for the control of scab, sooty blotch and flyspeck, powdery mildew, and *Fabraea* leaf spot. Apply at intervals of 5 to 10 days from green tip through petal fall. Apply again at 7- to 14-day intervals in cover sprays. Do not exceed 4 pounds of product per acre per season. REI is 48 hours and PHI is one day for both apple and pear.

**Torino (cyflufenamid)** (FRAC Group U6 Fungicide). Torino is translaminar fungicide that is effective against powdery mildew only. It is labeled for cherries (sweet and tart) and pome fruit. One application of this fungicide can be used per calendar year for pome fruit; two applications per year for cherries. REI is four hours, and PHI is six days for cherries and 14 days for pome fruit.

**Tourismo (flubendiamide and buprofezin mixture)** (IRAC Groups 28 and 16 Insecticides). As of September 2017, the insecticides containing flubendiamide (Belt and Turismo) are no longer being distributed in the United States; however, it is still legal to use the remaining product inventories already in the grower's hand.

**Trellis—see isoxaben.**

**Treevix (saflufenacil)** (HRAC Group 14 Herbicide) is an herbicide labeled for use on apples and pears as a burndown material for broadleaf weeds with a limited amount of preemergence action. It will not burn down grasses or sedges. Test trials showed a good broad spectrum of control, including marehail. It is formulated as a water-dispersible granule (WG). It may be applied up to four times per year as long as one or two of the applications occur during the dormant period of postharvest through winter dormancy. Recommended rates are 1 ounce per acre per application with a suitable adjuvant. Multiple applications in a year must be 21 days apart. Do not apply to apples or pears less than nine months old. Tree guards should be used until adequate bark has formed to protect trees from potential injury (typically by two to three years after establishment). REI is 12 hours and PHI is one day on pome fruit.

**trifloxystrobin—see Flint Extra.**

**triflumizole—see Procure and Trionic.**

**trifluralin** (HRAC Group 3 Herbicide) is sold under various brand names as an herbicide labeled for use in apricot, nectarine, peach, plums and prunes. It is especially effective against pigweeds, barnyardgrass, bindweed, chickweed and foxtails. The rate of application will vary depending on soil type. The material must be incorporated into the soil, which will probably limit its use in orchards. It can be applied prior to planting and then incorporated. The PHI is 60 days.

**Trilogy (neem oil)** is a clarified hydrophobic extract of neem oil. Trilogy is registered as a broad-spectrum fungicide with activity also against mites. This product is OMRI listed.

**Trionic (triflumizole)** (FRAC Group 3 Fungicide). Trionic 4SC is

a systemic fungicide labeled for the control of apple scab, powdery mildew, and cedar-apple rust on apples and scab on pears. On cherries, it is labeled for the control of powdery mildew, brown rot, and cherry leaf spot. On apples and pears, Trionic should be tank-mixed with standard protectant fungicides labeled for control of other diseases during the season for maximum fruit disease control. Apply at 8 to 16 fluid ounces per acre for ground applications. Use higher rates under heavy disease pressure and on susceptible cultivars. The PHI is 14 days for apples and pears.

For cherries, apply 8 to 16 fluid ounces per acre for powdery mildew control, and 10 to 16 fluid ounces per acre for brown rot and leaf spot control. It should not be applied less than 14 or 21 days apart between second and third subsequent applications. The PHI for cherries is one day. Do not make more than four applications of Trionic per year or apply more than 56 fluid ounces per season. The REI is 12 hours.

**\*Tundra—see bifenthrin.**

**Typy—see 6-benzyladenine + gibberellins A<sub>4</sub>A<sub>7</sub>.**

**Ultor—see spirotetramat.**

**Vacciplant** (FRAC Group P 04 Biological Plant Activator). Vacciplant is a systemic plant defense stimulant extracted from the plant *Laminaria digitate* that is used to protect plants from certain pathogens. Induced resistance usually happens in one to two days, so it must be applied as a preventive treatment. Vacciplant is labeled for numerous pome fruit and stone fruit diseases. It is labeled for numerous diseases on pome fruit and stone fruit and can be applied as a foliar spray, plant dip, or soil drench. Use 14 to 60 fluid ounces and apply in rotation or tank-mix with other fungicides on a 7- to 14-day interval for control or suppression of disease. Use Vacciplant as rotational product under lighter disease pressure or on less susceptible cultivars. The REI is four hours and the PHI is zero days.

**Vanguard WG (cyprodinil)** (FRAC Group 9 Fungicide). Vanguard WG is an acropetal penetrant fungicide that is highly effective against apple and pear scab. It is also recommended for brown rot blossom blight on all stone fruits except sweet cherry. The disease control spectrum on apple is broadened to include cedar-apple rust if combined with the effective EBDCs Manzate, Dithane, Polyram, Penncozeb, or the fungicides Thiram or Ziram. When applying to pears, apply as a tank mixture only. The control of powdery mildew is also enhanced if combined with sulfur or the sterol-inhibitor fungicides (Rally, Procure, Rubigan). Vanguard has shown no cross-resistance to other classes of fungicides, but it has a high risk for resistance development, so the number of applications per season should be limited. When using Vanguard WG to control brown rot blossom blight on stone fruit (not sweet cherries), do not apply more than 10 ounces per acre per year. Vanguard WG can be applied alone or used in tank mixtures with the recommended rate of another fungicide registered for stone fruit. The REI is 12 hours and the PHI is zero days.

**\*Vapam HL (metam-sodium).** Vapam is a broad-spectrum bioicide that can be used to control plant-parasitic nematodes and a number of other soilborne diseases, fungi, and weeds. The product is a water-soluble liquid that quickly decomposes in soil to a gaseous fumigant consisting mainly of toxic methylisothio-

cyanate. Vapam can only be used as a preplant treatment and phytotoxicity will result if the soil has not been given sufficient time to aerate after treatment. The efficacy of Vapam is affected by soil moisture, temperature, texture and organic matter content. Careful site preparation is essential for good nematode control. In preparation of replant sites, it is recommended that as much root debris as possible be removed from the old orchard in preparation for Vapam treatment. Any certified applicator supervising a soil fumigant application must have successfully completed one of the soil fumigant training programs listed on the EPA website at [www.epa.gov/soil-fumigants/soil-fumigant-training-certified-applicators](http://www.epa.gov/soil-fumigants/soil-fumigant-training-certified-applicators) for the active ingredient in this product. The training must be completed in the timeframes listed on the website. The fumigation management plan must document the date and location where the soil fumigant training program was completed.

**Velum Prime (fluopyram)** (FRAC Group 7 Fungicide). Velum Prime is a broad-spectrum fungicide and nematicide for use as a soil treatment for suppression of certain crop diseases and suppression of plant pathogenic nematodes. Velum Prime is registered as a nematicide only for pome fruit and stone fruit. Velum Prime can be used on bearing and nonbearing fruit trees and is applied by chemigation into the root zone through low-pressure drip, trickle, micro-sprinkler, or equivalent equipment. Soil must be prewetted to break soil surface tension prior to applications. Do not apply within seven days of harvest.

**\*Vendex (fenbutatin oxide)** (IRAC Group 12B Insecticide). Vendex is a nonsystemic organotin miticide with contact and stomach action. Vendex 50WP miticide is recommended for mite control on apples and pears. Thorough coverage of foliage and fruit is necessary for optimum mite control. Do not apply more than three times between petal fall and harvest.

**Venerate** (heat-killed *Burkholderia* spp. strain A396 cells and spent fermentation media) (IRAC Group UNB Insecticide) is registered for the control of plum curculio, leafrollers, pear psylla, and stink bugs on pome and stone fruit. Venerate control insect targets by enzymatic degradation of exoskeletal structures and interference with the molting process. Venerate is OMRI listed.

**Venom**—see **dinotefuran**.

**Venue (pyraflufen ethyl)** (HRAC Group 14 Herbicide) is a nonselective postemergent herbicide labeled for broadleaf weeds in all bearing and nonbearing tree fruit. Rates for postharvest, dormant, or prebloom are 1 to 4 fluid ounces per treated acre and not to exceed three applications per season. Green nonwoody suckers can also be treated postharvest, dormant, or prebloom at 3 to 4 ounces per treated acre. Do not allow spray to contact green tissue or damage will occur. Do not treat trees that have green bark. Trees should be established in the orchard at least one year or their trunks should be protected with an impervious trunk wrap. Applications can also be made during the growing season at the same rate, but the number of applications cannot exceed two applications. There is a zero-day PHI. Exercise caution and do not allow spray material to drift up into the canopy of the trees.

**Versys (afidopyropen)** (IRAC Group 9D Insecticide). The active ingredient afidopyropen, also called Inscalis Insecticide, is registered on pome and stone fruit to control aphids, including suppression of woolly apple aphid. Versys demonstrates trans-

laminar activity, although it is not fully systemic. The product disrupts the gating of transient receptor potential vanilloid channel complexes in chordotonal stretch receptor in target insects and disrupts insect feeding. The product carries 12-hour REI and a 7-day PHI on both pome and stone fruit.

**Verve**—see **ethephon**.

**Virosoft (CpGV)**—see **codling moth granulosis virus**. This product is OMRI registered.

**Vivando (metrafenone)** (FRAC Group 50). Vivando affects several stages in the infection process of the powdery mildew pathogen. It is labeled for apricots, peaches, nectarines, and sweet and tart cherries. Vivando is a different mode of action compared to other fungicides used to control powdery mildew. Vivando must be applied before visual symptoms of powdery mildew appear. Vivando has no curative properties and will not control latent or established infections of powdery mildew. If powdery mildew infection is established, Vivando should be applied in a tank mixture or following application of a curative fungicide. Make no more than two applications per year; the maximum product rate per application is 15.4 fluid ounces per acre. The REI is 12 hours and the PHI is seven days.

**Voliam Flexi (thiamethoxam and chlorantraniliprole mixture)** (IRAC Groups 4A and 28 Insecticide). Voliam Flexi shares its active ingredients with Altacor and Actara. Voliam Flexi exhibits translaminar and locally systemic movement into plant tissue. The product is registered for use on pome fruit (PHI = 35 days) and stone fruit (PHI = 14 days) for the control of codling moth, Oriental fruit moth, leafroller complex, leafminers, European apple sawfly, plum curculio, and aphids. Voliam Flexi is highly toxic to bees exposed to direct treatment. See also Altacor and Actara.

**\*Voliam Xpress (lambda cyhalothrin and chlorantraniliprole mixture)** (IRAC Group 3 and 28 Insecticide). Voliam Xpress shares its active ingredients with Altacor and Warrior II. The product is registered for use on pome fruit (PHI = 21 days) and stone fruit (PHI = 14 days) for the control of codling moth, Oriental fruit moth, apple maggot, Japanese beetle, leafroller complex, leafminers, plum curculio, thrips, plant bugs, leafhoppers, periodical cicada, aphids, and suppression of pear psylla and spirea aphid. Voliam Xpress is highly toxic to bees exposed to direct treatment. See also Altacor and Warrior II. For the fruit market, Voliam Xpress is distributed under the name Besiege.

**\*Vydate (oxamyl)** (IRAC Group 1A Insecticide). Vydate is a carbamate insecticide/miticide/nematicide/plant growth regulator with contact and systemic activity. It is a contact, moderate-residual insecticide when applied as a foliar spray. It is labeled for use on apples to control spotted tentiform leafminer, European red mite, white apple leafhopper, rosy apple aphid, and twospotted spider mite.

Vydate, like Sevin, acts to promote chemical thinning, but it is not as harmful to predatory insects. Because of this quality we think Vydate will provide a slightly better IPM approach for thinning. When used at petal fall Vydate may provide some insecticidal benefits in addition to the thinning benefits. Vydate should be applied as a dilute spray between five and 30 days

after full bloom (5- to 20-millimeter fruit diameter). Vydate may increase russet on cultivars prone to russet. When using Vydate as a thinner, a spray oil or surfactant such as Tween 20, LI 700, Regulaid, or their equivalent may enhance the thinning effect. Vydate is incompatible with alkaline materials.

When applied to the soil (preplant or postplant, nonbearing only), Vydate L acts as a nonfumigant nematicide. Vydate can be used as a preplant or postplant treatment for control of plant-parasitic nematodes on nonbearing trees only (i.e., trees that will not bear for at least 12 months). When used as a preplant treatment, Vydate is most effective if incorporated into the top 4 to 8 inches of soil and trees are planted within 24 hours. In postplant situations, the efficacy of surface-applied Vydate will improve if followed by rain or irrigation water. Foliar-applied oxamyl will be translocated within plants; however, foliar applications for nematode control are not recommended. See Part I for more information on apple thinning with Vydate. Do not make more than four applications of oxamyl per season to apple for insect control and thinning uses.

**\*Warrior II** — see lambda-cyhalothrin.

**\*Warhawk** — see chlorpyrifos.

**Weedar 64** — see 2,4-D.

**Widow** — see imidacloprid.

**XenTari** — see Bt.

**\*Yuma** — see chlorpyrifos.

**Zeal (etoxazole)** (IRAC Group 10B Insecticide). Zeal is a miticide primarily effective against eggs and larval stages of tetranychidae mites (European red mites and twospotted spider mites), but it also sterilizes adult mites. The compound works by inhibiting the molting process through disruption of the cell membrane. Etoxazole exhibits translaminar movement in plant leaves. Since the compound has no acute toxicity to adults, mite control may not be observable for several days after application. The compound will not control rust mites. Zeal can be applied only once per season on pome and stone fruits at the rate of 2 to 3 ounces per acre. Etoxazole has little to moderate toxic effect on most beneficial insect and mites. Zeal should not be applied within 14 days of harvest on pome fruit and seven days of harvest on stone fruit.

**zeta-cypermethrin (\*Mustang, \*Mustang Max)** (IRAC Group 3 Insecticide). Pyrethroid insecticides with a broad spectrum of controlled insect pests. Very toxic to beneficial insects and bees. Registered for use on pome (PHI = 14 days) and stone fruit (PHI = 14 days).

**Zeus Prime XC (sulfentrazone + carfentrazone-ethyl)** (HRAC Group 14 Herbicides) is an herbicide with two active ingredients for control of broadleaf weeds in apple. Sulfentrazone is a chemistry in the triazolinone group of chemicals. The other ingredient is carfentrazone-ethyl, which is the active ingredient in Aim EC. The herbicide mainly controls broadleaf weeds, including morning glory, nightshade, marestail, and pigweeds, and suppresses yellow nutsedge. It only has a supplemental label for apples that have been established at least three years and carries a 12-hour REI and 14-day PHI. Zeus should not be tank-mixed with Chateau (flumioxazin). Zeus works best when the soil is moist or ½ inch of rain or irrigation is supplied within 10 days of application. Because

the herbicide contains a low level of Aim EC, do not allow drift onto any foliage or fruit of the trees.

**Ziram (ziram)** (FRAC Group M3 Fungicide). Ziram 76DF is a contact foliar fungicide with protective action. It is registered for control of apple scab, cedar-apple rust, quince rust, sooty blotch, flyspeck, bitter rot, and necrotic leaf blotch on apples; Fabrea leaf spot and pear scab on pears; peach scab and brown rot on peaches and nectarines; and shothole and brown rot on apricots. Applications of ziram have shown efficacy in abating the physiological disorder necrotic leaf blotch in Golden Delicious and cultivars with Golden Delicious as a parent. Ziram is less effective against apple scab than captan and about the same as Thiram. It may be used in combination with oil or near-oil applications for scab control during the early sprays. Ziram is registered for control of apple scab when used at 1 to 2 pounds per 100 gallons or 6 to 8 pounds per acre from green tip through early cover sprays. It has shown good control of sooty blotch and flyspeck during the late cover sprays. Apply Ziram after leaf drop and/or prior to budswell to control leaf curl on peaches and nectarines at the rate of 3.75 to 8 pounds per acre. It is also registered for control of brown rot when used at pink, 25 to 75 percent bloom, and petal fall and early cover sprays. Do not apply Ziram within 14 days of harvest on apples, pears, peaches, nectarines, and cherries. Do not apply Ziram on apricots within 30 days of harvest. Recommendations vary between crops; read the label carefully.

**\*Zoro** — see abamectin.

**Z-8-Dodecyl acetate** — see Sprayable Pheromone OFM.

## ADJUVANTS

Adjuvants are added to spray mixtures to increase the effectiveness of the main active ingredient. There are many classes of adjuvants, each with its own spectrum of activity. An adjuvant may have more than one mode of action. When the cost of the adjuvant is less than that of the chemical, there may be clear economic advantages in using an adjuvant rather than a high rate of a chemical. For example, the rate of NAA may be reduced 50 percent when a suitable surfactant is added to the spray mixture.

The use of adjuvants with pesticides may significantly enhance their activity. Plant growth regulators are applied to modify plant growth; to be effective they must enter the plant as with other systemic pesticides. This is in contrast to most other pesticide applications, in which a uniform deposit is desired on the outside of the plant. Because leaf exteriors have waxes, cutin, pectin, and cellulose between the chemical and the cell contents, anything we can do to bring about a uniform deposit and penetrate these barriers to uptake must be seriously considered.

The wholesale use of adjuvants with orchard sprays may not be warranted. Many pesticides contain adjuvants to stabilize the product and to make it effective in the spray tank. Thus, growers should be cautious in using adjuvants and should rely on reputable sources of information for data regarding the selection of a suitable adjuvant. See Table 3-11 for a list of adjuvants available from major ag chemical suppliers. This list is a representation and not complete; for all available products check with the supplier. Check labels of specific products before using in any application. In addition, be mindful of the type of adjuvant that may be used in a tank mixture containing products prone to causing phytotoxicity (such as captan, copper, and sulfur).

**Table 3-11. Adjuvants available for use on tree fruit.**

This list was updated September 2017 using the current listing of chemicals at [www.cdms.net/Label-Database](http://www.cdms.net/Label-Database). This list serves as a representation of some of the available products in each adjuvant category.

Class	Trade name	Manufacturer
Acidifier	Aero Dyne-Amic	Helena
	Choice	Loveland
	LI 700	Loveland
	Spray Aide	Miller
	Zandar	Helena
Antitranspirant	Vapor Gard	Miller
Buffering agent	Optima	Helena
	Penetrator Plus	Helena
	Quest	Helena
Compatibility agent	Blendex VHC	Helena
	Complex	WinField United
	E-Z Mix	Loveland
	Spray Aide	Miller
Crop oil	Agri-Dex	Helena
	Dyne-Amic	Helena
Crop oil concentrate	Crop Oil Concentrate	Multiple manufacturers
	Herbimax	Loveland
	Maximizer	Loveland
	MSO	Loveland
	Prime Oil	WinField United
Defoamer	Defoamer	Multiple manufacturers
	Fighter F 10	Loveland
	Fighter F Dry	Loveland
	Foam Fighter	Miller
	Unfoamer	Loveland
Drift retardant	Intac	Precision Laboratories, LLC
	Reign Deposition Aid Drift Control Agent	Loveland
	Windcheck	WinField United
Extender	Complex	WinField United
	Exit	Miller
	Nu-Film IR	Miller
Penetrant	Activator 90	Loveland
	Freeway	Loveland
	Kinetic*	Helena
	Kinetic HV*	Helena
	LI 700	Loveland
	Oil Concentrate	Multiple manufacturers
	Zandar	Helena

Class	Trade name	Manufacturer
Sticker	Bond	Loveland
	Complex	WinField United
	Intac	Precision Laboratories, LLC
	Lastick	Helena
	Nu-Film IR	Miller
	Surfix	Helena
Surfactant	Aero Dyne-Amic	Helena
	Bio-Film Extra	Kalo
	Bond	Loveland
	Methylated Oil Con- centrate	Multiple manufacturers
	Optima	Helena
	Rivet	WinField United
	Windcheck	WinField United
	Zandar	Helena
Surfactant, nonionic	Activator 90	Loveland
	Activate Plus	WinField United
	Agri-Dex	Helena
	Complex	WinField United
	Dispatch AMS	Loveland
	Dyne-Amic	Helena
	Miller Exit	Miller
	Freeway	Loveland
	Induce	Helena
	Kinetic*	Helena
	Kinetic HV*	Helena
	LI 700	Loveland
	Methylated Seed Oil	Loveland
	Nu-Film IR	Miller
	Patrol 25-0-0	Helena
	Regulaid	Kalo
Silkin*	WinField United	
Silwet L-77 Surfac- tant*	Helena	
Surfix	Helena	

\*Organosilicone surfactant

Below are different classifications of adjuvants.

**Acidifier.** Acidifiers are adjuvants that have the ability to reduce the pH of solutions. They are useful when the pH of the spray water is too high. However, because acidifiers can only lower the pH, their indiscriminate use is not recommended. In some cases if the spray water pH is correct or lower than the recommended pH for the chemical in question, then the use of an acidifier can reduce the pesticide's effectiveness.

**Antifoaming agent.** See defoamer.

**Antitranspirant.** Antitranspirants are chemicals that can reduce transpiration in plants. They can be applied as main chemicals or may be used to enhance the activity of other chemicals. Antitranspirants can be effective in transplanting nursery stock, especially when leaves are present and low humidity and/or high winds are expected.

**Buffering agent.** Buffering agents raise or lower the pH of the spray mixture to the designed pH of that buffering agent. Thus, buffering agents can be useful when the spray water pH is either too high or too low.

The quantity of buffering agent needed in a spray tank may be difficult to determine. Various buffering agents have different powers to buffer. In addition, merely measuring the pH of a spray solution may not give an indication of the quantity of buffering agent needed. For example, sulfuric acid and acetic acid (the acid in vinegar) may both have low pH values. However, sulfuric acid is a much stronger acid than acetic acid, and much more buffering agent would be needed to change the pH of a sulfuric acid solution than an acetic acid solution.

**Compatibility agent.** Compatibility agents are adjuvants that allow easier mixing of two or more components in a solution. Using compatibility agents may allow the use of two or more chemicals in a tank that would otherwise be incompatible.

**Crop oil.** Crop oils normally contain 95 to 98 percent petroleum oil with 1 to 2 percent added surfactant. Crop oils can be effective as penetrants and as surfactants.

**Crop oil concentrate.** Crop oil concentrates normally contain between 80 and 85 percent petroleum oil with 15 to 20 percent surfactant. These products can be effective as penetrants and as surfactants.

**Defoamer.** Defoamers are adjuvants that reduce foaming when there is excessive foam in a spray tank. Excessive foaming can be a significant problem with some agitation systems in sprayers, especially when the water level in a tank gets low enough that a mechanical agitation system would cause excessive foam.

**Drift retardant.** Drift retardants are used to reduce off-target drift of pesticides and are often used with aerial applications. Since aerial applications normally are made with highly concentrated spray mixtures, spray nozzles that create small droplets are often used. Since small droplets can travel farther than larger droplets, some drift retardants work by increasing mean droplet size.

**Extender.** Extenders are adjuvants that can extend the useful life of a spray chemical. They work by increasing the chemical's adhesion to the leaf, by reducing any factor that can diminish chemical effectiveness, or by enhancing chemical weatherability.

Since many pesticides are broken down by ultraviolet light, some extenders have the ability to intercept ultraviolet light.

**Organosilicon surfactants** are a new class of surfactants. Generally they are more effective per unit of active ingredient than the more traditional surfactants.

**Penetrant.** Penetrants are adjuvants that help chemicals penetrate plants.

**Spreader.** Spreaders are surfactants. See surfactants.

**Sticker.** Stickers are adjuvants that aid in the attachment of a chemical to a surface. They can lengthen the time that a chemical is attached to a plant surface. Stickers generally make pesticide deposits less easily removed from leaves by forces such as rain or wind.

**Sticker-spreader (spreader-sticker).** Sticker-spreaders are compounds that perform two functions at the same time. They stick and spread chemicals to plant surfaces. See stickers and surfactants for descriptions of individual types of adjuvants.

**Surface active agent.** Surface active agents are surfactants. See surfactants.

**Surfactant.** Surfactants are adjuvants that reduce the surface tensions of solutions, helping them spread and cover surfaces more effectively. Surfactants are probably the best-known class of adjuvants. Most adjuvants are a double-ended molecule, one end being water soluble and one end being oil soluble. Therefore, these molecules can line up between waterlike compounds and oillike compounds and make them more compatible. Surfactants can be uncharged (nonionic), positively charged (cationic), or negatively charged (anionic).

**Suspension agent.** Suspension agents aid the suspension of one material in another. These types of adjuvants are often used in liquid fertilizer mixes as well as in liquid pesticide formulations to help maintain a uniform product mix.

**Thickener.** Thickeners are adjuvants that increase the viscosity of solutions. Calcium dips were proven more effective in increasing fruit calcium levels when a thickener was added to the calcium dipping solution, compared to a water solution.

**Vegetable oil concentrate.** These adjuvants are similar to crop oil and crop oil concentrates except that vegetable oils are used instead of petroleum oils.

**Wetting agent.** This is another name for surfactants. See Surfactants.

---

## FUNGICIDE RESISTANCE MANAGEMENT STRATEGIES

Resistance has sometimes resulted in pest-management-program failures. In many cases resistance is inevitable, and our main strategy is to manage pests and pesticide use to delay the onset of resistance as long as possible. Below are presented tactics to help delay resistance to fungicides.

### Understanding Types of Fungicides

Pesticides used for managing fungi-caused fruit diseases are either fungicidal (they kill fungi) or fungistatic (they inhibit fungal growth). Fungicides can be separated into two categories:

protectants and systemics.

Protectant fungicides protect the plant against infection at the site of application. These are commonly known as contact fungicides. Their characteristics are as follows:

- They provide protection against infection.
- They do not penetrate into the plant and can be easily washed off.
- They require uniform distribution over the plant surface.
- They require repeated application to renew deposit.
- They have a multisite mode of action against fungi.
- Fungi are not likely to become resistant to protectant fungicides.
- Protectant fungicides are classified as FRAC Group M Fungicides. Some common protectant fungicides are Bravo, captan, copper, dithane, manzate, polyram, sulfur, and ziram. Some common protectant fungicides are Bravo, captan, copper, Dithane, Manzate, Polyram, sulfur, and Ziram.

Systemic fungicides prevent disease from developing on parts of the plant away from the site of application. Their characteristics are as follows:

- They penetrate into the plant and are absorbed into the plant tissue.
- They move within the plant, either locally systemic (within the leaf, translaminar) or systemic throughout the whole plant.
- They control disease by protectant and/or curative action.
- They often have a very specific mode of action against fungi.
- Some translaminar fungicides are Aprovia, Indar, Luna Tranquility, Merivon, and Topsin-M.
- Some systemic fungicides include Aliette, ProPhyt, Rampart, and Ridomil Gold SL.

### Cultural Control and Fungicide Use Patterns

Due to environmental conditions, disease is inevitable in the Mid-Atlantic growing region and use of chemical controls is a necessity; however, following cultural practices that favor decreasing disease pressure will help decrease the opportunity for resistance. Using resistant varieties, minimizing tree stress, and maintaining proper soil fertility reduces disease incidence since pathogens do not reproduce well on trees that are less susceptible to disease. As a result, the chance of resistance decreases. Avoid selecting sites with high disease pressure, such as low-lying areas where plant tissue may stay wet longer, since this increases the chance of selecting for resistant fungi. Using dormant copper sprays and removing inoculum sources such as leaves (using urea or a flail mower), mummified fruit, and dead twigs/branches reduces the initial pathogen population. It is important to be sure sprayers are appropriately calibrated every season and covering trees effectively. Achieving good spray coverage, not extending spray intervals, tank-mixing with protectants, and alternating fungicides with different modes of action (FRAC Group) reduces populations exposed to selection.

### Fungicide Resistance Issues and Mitigation Strategies for Specific Diseases

#### Apple scab and brown rot

Fungicides in FRAC Groups 3, 7, 9, and 11 are highly effective against scab infection on apples and brown rot on stone fruit.

However, apple scab and brown rot fungi can become resistant to these fungicides, especially if any of them are continually applied alone. Growers using one of these fungicides to control apple scab or brown rot must be certain to not only alternate it with an unrelated fungicide but also use it in combination with a broad-spectrum fungicide, like captan, metiram (Polyram), mancozeb, Ziram, thiram, sulfur, or ferbam. Another strategy to prevent resistance is to alternate the use of these materials throughout the season. The less any one of them is used in an orchard during a given season, the lower the chances that resistance will develop.

#### *Mitigating fungicide resistance for apple scab*

Using cultural controls, such as removing inoculum sources (fallen leaves), is important for decreasing disease incidence; however, during seasons where the disease pressure is high (frequent rains, warm temperatures), fungicide applications will be important. It is critical to monitor disease conditions since this will play a crucial role in deciding which fungicides to use and when. In addition, if the alternate row middle (ARM) method is being used, it is very important to not stretch intervals, especially during frequent warm and rainy conditions. Sometimes this may mean shrinking intervals to three to four days, especially if disease conditions are favorable. There have been incidences where apple scab “broke through” as a result of stretching ARM intervals too long during very wet periods.

**Dormancy.** Applications of copper to apple trees during late winter or early spring will help limit available apple scab spores and fire blight bacteria for the coming season. Use copper at the rate of 2 pounds of metallic copper per acre. To determine the amount of copper product to use, pay attention to the percent metallic copper equivalent (and amount of metallic copper per unit) listed on the label of the copper being used.

**From green tip through tigh cluster.** Scab spores will begin to be dispersed from overwintering leaves starting at green tip; however, the spore numbers will be low, gradually increasing over time. If conditions are dry, focus on managing powdery mildew by using products such as Indar, Rally, Topguard/Rhyme, Trionic/Procure, or sulfur tank-mixed with a broad-spectrum fungicide (EBDC, ferbam, metiram, ziram). Include a spreader-sticker in the tank mix to allow the EBDC to be rainfast (if not using a rainfast mancozeb product). This will allow the EBDC to persist longer during rainy periods. Dry weather plus low scab spore numbers equals low disease pressure. Although some strong powdery mildew products are not as effective against scab, a broad-spectrum fungicide will keep the disease in check. If disease conditions are favorable for scab (warm and wet), then consider using other fungicides from FRAC Groups 3 or 9, such as Indar, Inspire Super, Procure/Trionic, Scala, or Vanguard, during this period. Be sure to rotate FRAC Groups. Growers are highly encouraged not to use the FRAC Group 7 fungicides during this time period; these fungicides are best saved for peak apple scab pressure, which is from pink through petal fall.

**From pink through petal fall.** Scab spores will start to peak (the maximum number of available spores dispersing from the overwintering leaves) beginning late pink and will remain high through approximately late petal fall. In our experience with monitoring scab spore dispersal from overwintering leaves, available scab spores remain high (more than 10,000–20,000)

for approximately two weeks (from pink through petal fall). During this period, growers are highly encouraged to use complete sprays instead of ARM, especially if frequent rain events favor extended wetness periods. During this time, it is best to use FRAC Group 7 (SDHI) fungicides, such as Aprovia, Fontelis, Kenja, Luna Sensation, Luna Tranquility, Merivon, Pristine, or Sercadis, and tank-mix with a broad-spectrum fungicide. Limit FRAC Group 7 fungicides to two applications during this period of high disease pressure. A maximum of four complete applications are allowed per year for FRAC Group 7 fungicides. Save two FRAC Group 7 fungicide sprays (if possible) for the end of the season when Luna Sensation, Merivon, or Pristine should be applied in order to mitigate late season and storage fruit rots. In addition, tank-mix with a rainfast EBDC or add a spreader-sticker to allow the EBDC to be rainfast. This will allow the broad-spectrum activity to persist longer during very rainy periods.

**From post petal fall through second cover.** Although the number of overwintering scab spores drastically decreases after petal fall, spores are still available and can wreak havoc, especially if conditions favorable for disease are present. During this time, use products from FRAC Group 3 and 9, such as Inspire Super, Indar, Rally, Procure/Trionic, Scala, or Vanguard, plus a broad-spectrum fungicide. One recommendation is to use an EBDC through first or second cover and then switch to captan for the later summer cover sprays. Use products that may have a long PHI (such as Scala) earlier rather than later. These products could also be used in rotation with the FRAC Group 7 fungicides that are used from pink through petal fall.

**After harvest.** To reduce the available inoculating spores for next season, spray trees with urea as close to leaf drop as possible. Spores need the leaf tissue to survive the winter and urea assists in the microbial breakdown of the tissue: leaves with extra nitrogen stimulate the growth of these beneficial microbes. Using urea will reduce inoculum by 50 to 80 percent for the next season. Dissolve 40 pounds of feed-grade urea in 100 gallons of water (5 percent solution), spraying 100 gallons per orchard acre. Feed-grade urea is recommended due to the ease of dissolving it in water. If you choose to not use urea, be sure your nitrogen comes from an ammonium source. Good coverage of the leaves is desired for leaves to absorb the urea. If the leaves have already fallen off the tree, urea can also be sprayed to the fallen leaves on the orchard floor. Additional breakdown of the leaf tissue can be assisted by using a flail mower, which will chop up the leaves. Using urea and a flail mower can reduce spores for the next season by at least 90 percent. When there are no sources of spores on the orchard floor or within 100 feet, there is a very low risk of early infections from these diseases. Finally, late season urea application does not compromise cold hardiness and has shown to help with tree health for the next season.

#### ***Mitigating fungicide resistance for brown rot***

Many factors influence brown rot development. During dormancy, removal of brown rot blossom blight cankers and fruit mummies will decrease the number of available spores during the season. Green fruit are not susceptible to infection by the brown rot pathogen. However, immature fruit that are not properly pollinated or become injured can become infected and begin to rot. Remove any infected green fruit and drop them to the ground.

Near harvest, as fruit are maturing, drop any rotting fruit to the ground to prevent fruit from becoming mummies, thereby reducing overwintering inoculum for next year.

**Dormancy.** Applications of copper to stone fruit trees during late winter or early spring will help limit available fungal (brown rot) and bacterial pathogens (bacterial spot) for the coming season. Use copper at the rate of 2 pounds of metallic copper per acre. To determine the amount of copper product to use, pay attention to the percent metallic copper equivalent (and amount of metallic copper per unit) listed on the label of the copper being used.

**Bloom through cover sprays.** The relative efficacies of current fungicides available are listed in Table 4-14. Depending on disease conditions during bloom, one or two sprays will be needed for protection from blossom blight caused by the brown rot pathogen. For cover sprays, sulfur and captan will keep brown rot spores in check. Research from Rutgers has shown that captan sprays during the final two cover sprays before the preharvest brown rot sprays are very important. The rate should be no less than 3.125 pounds per acre.

**Preharvest sprays for brown rot.** Preharvest sprays for brown rot. If frequent rains continue throughout the summer and harvest season, then a three-spray preharvest program is highly recommended. The recommended timing for this program is 18 days, nine days, and one day preharvest, with a final captan cover spray at 28 days preharvest. Note that the final preharvest spray can be applied immediately before the first picking, or alternatively between the first and second picking; the idea is to provide protection throughout the handling process. Of course, the fungicide used at this time must have a zero- or one-day PHI and appropriate REI. For resistance management reasons, a minimum of two different chemistries should be applied to each cultivar block (alternated). However, use of three different chemistries is strongly recommended given that some of these chemistries are rated as high risk for development of resistance. An excellent three-spray program that utilizes all three chemistries is Flint Extra (FRAC Group 11), Indar (FRAC Group 3), and Fontelis (FRAC Group 7). For those fungicides composed of two active ingredients, simply alternate with the third chemistry. For example, apply a fungicide with FRAC Groups 7 and 11, FRAC Group 3, and FRAC Groups 7 and 11. As you progress through the harvest season spraying different cultivar blocks, simply continue with the rotation.

**Fungicide rates for brown rot management.** In general, a good starting point is the middle of the rate range, and using somewhat higher rates, but not necessarily the maximum, as conditions become more disease favorable. The FRAC Group 3 fungicides are a special case in that using higher rates is also a resistance management tactic. In this regard, note that Indar has an EPA 24(c) special local needs registration in Pennsylvania that allows application up to 12 fluid ounces per acre; the recommended rate for Indar is 9 fluid ounces per acre.

#### **Powdery mildew**

Frequent applications of fungicide may be required for mildew control. Fungicides in FRAC Groups 3 and 7 are effective for controlling powdery mildew. There are currently no documented cases of apple powdery mildew resistance to these materials.

### Cedar-apple rust

Only a brief part of the life cycle of the cedar-apple rust fungus is spent on apple trees. Infection of apple leaves or fruit occurs between the pink and first cover spray periods. The cedar-apple rust fungus survives 19 months or longer on red cedar. The contact between the fungus and the fungicide applied to apples is relatively short, reducing the potential for resistance to develop. If a resistant cedar-apple rust fungus does develop, it must also survive on red cedar. Therefore, resistance of the cedar-apple rust fungus to any fungicide is not likely.

### Bitter rot

Bitter rot has become a very important apple rot pathogen the last several years. The predominant species causing bitter rot on apple in Pennsylvania is *C. fioriniae*. This pathogen is naturally resistant to trifloxystrobin (Flint Extra and Luna Sensation), kresoxim-methyl (Sovran), and thiophanate methyl (Topsin-M). To date, the most effective products for managing bitter rot include mancozeb, captan, and pyraclostrobin, which is found in Merivon and Pristine. Although pyraclostrobin, trifloxystrobin, and kresoxim-methyl are FRAC Group 11 Fungicides, they are in different groupings within the class: pyraclostrobin is in the methoxy-carbamate group, whereas trifloxystrobin and kresoxim-methyl are in the oximino-acetate group. The mechanism of resistance of *C. fioriniae* for the latter is currently unknown.

### Frequently Asked Questions About Fungicide Resistance

#### Does the type of fungicide used affect the potential for a fungus to develop fungicide resistance?

Broad-spectrum fungicides like copper, captan, and sulfur act by interfering with several of the fungus's vital life functions. These fungicides have multiple modes of action, which allows little chance for resistance since the fungus must undergo multiple changes to counteract the fungicide.

Systemic fungicides like Inspire Super, Vanguard, Scala, Flint Extra, Sovran, Merivon, Pristine, Luna Sensation, Luna Tranquility, Fontelis, Kenja, Rubigan, and Rally are highly effective against many tree fruit diseases. They are single-target-site fungicides interfering with one vital life function, so one change is needed for the fungus to become resistant. Thus, the potential for resistance to these fungicides is much greater than to broad-spectrum fungicides.

#### How do fungi develop resistance to a fungicide in an orchard?

As previously discussed, resistance is more likely to develop against fungicides that have a single mode of action, especially if they are used alone for a long time. In the orchard, resistant fungi may occur naturally within the population in very small numbers even before the fungicide is first used. When a fungicide is applied, it reduces the number of susceptible apple scab and brown rot fungi. The few scab and brown rot fungi that are resistant to the fungicide can increase in number. As the fungicide is repeatedly used, the number of resistant fungi increases. The fungicide becomes less effective as the fungus becomes more tolerant to it. It is also important to note there are some fungi, such as those species in the *Colletotrichum* spp. that cause bitter rot, that are naturally resistant to certain classes of fungicides.

#### Are resistant apple scab and brown rot fungi “super” fungi?

No, apple scab and brown rot fungi that are resistant to certain fungicides are still susceptible to others that have a different toxic action against the fungi. Using fungicide mixtures will delay the buildup of resistant scab and brown rot fungi. Mixtures are most effective when used before resistance becomes a problem. Alternating chemicals that have different modes of action/FRAC code is another strategy to prevent resistance from developing.

#### Can sensitivity can return to certain fungicide classes?

Fungicides are not created equal when discussing persistence of tolerance of the fungus to a class of fungicides. For instance, sensitivity of *V. inaequalis* can return to fungicides in the FRAC Group 3 if these fungicides are not used for a period. This is due to resistance being a fitness cost to the fungus, i.e., the fungus will not maintain resistance since it will prevent the fungus from surviving over time. In contrast, sensitivity of *V. inaequalis* will not return to fungi that are resistant to the fungicides in FRAC Group 11 since the nature of the resistance is based on the mutation of one gene that is stable and not linked to fitness.

#### If I experience fungicide failure during the season, should I automatically believe it is due to fungicide resistance?

No. Many variables must be ruled out first before considering fungicide resistance is to blame. Ask yourself the following questions, which could impact the efficacy of fungicide applications:

- Were the spray intervals during the primary apple scab period too far: more than 7 days for complete sprays or more than 3.5 days for alternate row middle sprays?
- Were fungicides not reapplied after a very rainy period?
- Was the sprayer calibrated?
- Is the affected location in a low-lying area and not drying out completely?
- Has the pH of the spray water been tested: was the pH too high? (High pH can decrease the effectiveness of fungicides.)
- Was enough water used to achieve adequate coverage of the entire tree?
- Was it windy during the time of application such that the spray did not contact the trees?
- Other considerations: suddenly adjusting the fan speed or speed of the tractor?
- Has it been raining all of the time with little chance of applying fungicides appropriately?

### The Future of Tree Fruit Disease Control

Growers can prevent resistance by practicing good cultural control methods, using fungicide mixtures, tank-mixing with a broad-spectrum protectant, and alternating chemicals by FRAC Group (“spraying by the numbers”; see Table 3-8).

### USING INSECT SEX PHEROMONES FOR MONITORING AND MATING DISRUPTION

A pheromone is a chemical messenger produced naturally by an organism and released into the environment. When detected by a second individual of the same species, the pheromone changes



the behavior of that individual. A sex pheromone is used to help one sex (typically the male in insects) orient toward and find the other sex for mating. Sex pheromones can be detected over hundreds of yards on wind currents, and by flying upwind in the pheromone plume, the male can almost always find the female.

Chemists have extracted and analyzed natural pheromones and have created processes to produce these complex chemicals in large quantities. This has given entomologists several new tools to use in pest management. To date, the most successful and widespread use of pheromones has been in monitoring traps. Monitoring traps consist of cardboard or plastic devices that contain a pheromone emitter and a sticky surface. A male moth, fooled into thinking that the emitter is a female releasing a pheromone, flies into the trap and is caught on the sticky surface.

Monitoring traps are placed in the orchard before the beginning of moth emergence. They are checked daily to record the first capture, or biofix, and then at weekly intervals. Each week the trapped insects and debris are removed. Traps and pheromones are replaced as necessary. The biofix can be used to begin accumulating degree days to predict future insect stage distribution. By recording the number of males found each week, a grower may monitor the development of a pest population over time.

Each season the information on moth capture in pheromone traps for codling moth, Oriental fruit moth, leafrollers, and various other insect species in Biglerville is available at the Penn State Fruit Research and Extension Center (FREC) website ([agsci.psu.edu/frec](http://agsci.psu.edu/frec)) and published by Penn State Extension in the monthly newsletter *Fruit Times* at [extension.psu.edu/forage-and-food-crops/fruit](http://extension.psu.edu/forage-and-food-crops/fruit). Degree days based insect development models (eggs hatch models) are also used to track insect development and provide the information to growers so they will know the optimum timing to control the various pests. This information can be combined with scouting information from individual orchards and used in making pest management decisions.

Recently mating disruption, another pheromone-based tool, has emerged as a useful method in insect management. Mating disruption by pheromones takes place when enough artificial sources of pheromone are placed in an area that the probability of a female being found by a male, mating, and laying viable eggs is reduced below the point where economically significant damage occurs. Mating disruption pheromone systems are available for the codling moth, Oriental fruit moth, dogwood borer, peachtree borer and lesser peachtree borer as well as for some leafroller species. These are used extensively in the western states and a number of growers are using them in the eastern seaboard.

Large-scale mating disruption implementation trials have yielded significant reductions in pesticide use while keeping crop damage levels acceptably low. Because of difficulties in managing high populations of pests, mating disruption programs should not be viewed as stand-alone strategies, but rather as one tactic within the toolbox of pest management options.

The advantages of pheromone-based pest management systems include the following:

- Negligible health risks to applicator and consumer.
- Virtually no detectable residues for some types of dispensing systems.
- No accumulation in groundwater or wildlife.

- Virtually no worker reentry restriction in orchards after application and nonexistent preharvest intervals.
- Strong tool for managing insecticide resistance to other pesticides and no documented cases of resistance to the pheromone itself.
- Highly selective to the pest species being targeted for disruption without causing secondary pest outbreaks due to the elimination of biological control agents. This selectivity creates opportunities for the biological control of other pest species. Nontarget effects are generally not seen within or outside of the treated orchard.
- Improved control of the targeted pest if overlaid onto the standard insecticide program.

The disadvantages of pheromone-based pest management include the following:

- The high degree of selectivity can also be a disadvantage when other pests are able to move into orchards because insecticide targeted for the primary pest is eliminated and often unrealized collateral control of these other pests is released. For example, in apple, disruption of codling moth often releases leafrollers from pesticide control, and in peaches, mating disruption of the Oriental fruit moth has led to an increase of stink bug injury.
  - High development and production costs that often make these products significantly more expensive than the synthetic pesticides they may be replacing.
  - Requirements for specialized application techniques or equipment with some types of pheromone products and possible increases in labor costs.
  - The need to supplement expensive pheromone programs in high pest pressure situations with other pesticides for the same target pest.
  - Effectiveness is often directly related to the size of the orchards being disrupted, and products may be less effective in orchards fewer than 5 acres in size. Effectiveness may be reduced along borders with other orchards/crops that are not being disrupted as well.
  - Monitoring the target pest in a disrupted orchard can be a problem because the pheromones used to disrupt mating will prevent moths from locating pheromone traps. The use of high dose lures or combination of sex pheromone and kairomone that still attract some moths even under mating disruption is useful for tracking the flights of pests like codling moth or Oriental fruit moth and to assess effectiveness of the MD program.
  - Treatment thresholds have been developed using these high dose lures, but in most cases are dependent on levels of injury from previous seasons or on the trap catches of pest generations previous to disruption.
- Special considerations are necessary for type of mating disruption product, rate, and application method being used. Borders of disrupted blocks are often at higher risk because of pest mating occurring outside the disrupted area and therefore efficacy increased with the size of the block treated. Peach and apple orchards adjacent to each other benefit from disruption in both crops for pests like the Oriental fruit moth. The residual activities of many of these products vary greatly. Below are some

of the type of pheromones and special considerations in use.

**Sprayable pheromones.** Microencapsulated pheromones are enclosed in a polymer capsule that controls the pheromone release rate. These capsules are small enough and durable enough to be applied in water through normal airblast sprays in the same manner as conventional pesticides. This makes them very attractive to use by many fruit growers. Residual activity is generally up to four to six weeks, which gives them some flexibility in pest management programs but also means they may need to be reapplied several times in a season for a target pest. Residual activity may be reduced by rainfall soon after application and a sticker type spray adjuvant is often recommended. Currently, the only available effective material is for the control of Oriental fruit moth (Check-Mate OFM-F). Several formulations for codling moth and several species of leafrollers and wood-boring insects have been tested and even sold commercially, but have not provided reliable control.

**Hand-applied dispensers.** Include systems with an impermeable reservoir fitted with an impermeable membrane for regulating pheromone release. Pheromone impregnated polymer spirals, ropes, dispensers, or tubes are most commonly used products currently. Wires, clips, or circular twin tubes allow these dispensers to be twist-tied, clipped, or draped directly onto the plant. The larger reservoirs of these products allow for longer residual activity ranging from 60 to 140 days. This may allow early season applications to suppress mating for most or all of the growing season depending on the type of dispenser and pest species. Application rates vary from one to several dispensers per tree (2 to 400 dispensers per acre) and can be labor intensive. Costs for these products tend to be significantly higher than the chemical control programs they are replacing, especially in high pest pressure situations where supplemental insecticides would be needed for acceptable control.

Hand-applied dispensers can be used to control either a single species or multiple species of pests. The examples of single-species hand-applied dispensers for the control of Oriental fruit moth include Isomate OFM TT, Isomate CM TT, CheckMate OFM, CheckMate Puffer OFM, CideTrak OFM, CideTrak OFM Meso, NoMate OFM, and Disrupt OFM. Control of codling moth only can be achieved by the use of Checkmate CM, CideTrak CM, CheckMate Puffer CM, or NoMate CM. Available hand-applied mating disruption products with a dual action against codling moth and Oriental fruit moth include Isomate CM/OFM TT, CideTrak CM/OFM Combo, CideTrak CMDA OFM Meso, and CheckMate Puffer CM-OFM Pro.

## MANAGEMENT OF CODLING MOTH WITH A CM GRANULOVIRUS

Many apple growers in Pennsylvania continue to do battle with the internal fruit feeding pest complex, the codling moth (CM) *Cydia pomonella*, and the Oriental fruit moth (OFM) *Grapholita molesta*. Most growers continue to rely on insecticides as their principal control tool for this pest complex, but more and more growers are also adding sex pheromone mating disruption to their management toolbox. Despite the loss of some valuable insecticides due to the Food Quality Protection Act (FQPA) and the development of insecticide resistance to a number of other

remaining products, the toolbox for the control of the internal fruit-feeding complex continues to expand each year. Among the many new tools available to control CM is a naturally occurring virus that was identified back in 1964 in Mexico on infected CM larvae. Because of its high selectivity toward this pest, it is called the codling moth granulovirus (CpGV). It does show some activity to a couple of closely related species (e.g., OFM), but it is noninfectious toward beneficial insects, fish, wildlife, livestock, and humans.

**Mode of action.** Each CpGV particle is naturally microencapsulated within a protein occlusion body (OB) that protects it to some degree from degradation. These viral OBs are extremely small, 400 by 200 nanometers (i.e., 4,000 OBs placed end to end are approximately 1/16 inch). Depending on the product, a single ounce of the aqueous suspension concentrate can contain more than one to three trillion OBs. In order for the virus to be effective, the tiny particles must be ingested by the larva—there is no contact activity with CpGV. It only takes a couple of these OBs to cause death in a young larva. Once the larva ingests the virus, the OBs are dissolved in the alkaline gut of the larva, rapidly releasing the viral particles. The virus rapidly penetrates the gut lining, causing the virus to replicate numerous copies of itself, which then rapidly spread to other organs within the larva. This multiplication causes the larva to stop feeding within a few days, becoming sluggish and discolored as the virus moves throughout the body of the insect. Upon death, the larvae “melts,” spreading billions of the viral OBs that can be ingested by other CM larvae. Each OB is capable of causing a new infection within other newly hatched larvae.

**Products.** In Pennsylvania, four products are currently available for use by fruit growers: Cyd-X, Cyd-X HP, and Madex HP (all from Certis, USA) and Virosoft CP4. Madex HP is also registered for the control of Oriental fruit moth. All products can be used right up to the day of harvest and have a four-hour reentry window. The products should be refrigerated until use because warm temperatures cause degradation of the OBs. Also, these products are certified for use in organic orchards.

We have been researching CpGV products at the Fruit Research and Extension Center and have achieved much success in substantially reducing CM populations, especially where CpGV was integrated with some form of sex pheromone mating disruption for CM. There are a number of opportunities for using CpGV in a CM management program. Before using a CpGV product there are a number of important points to understand: (1) the virus must be ingested by the larva, thus timing and coverage are extremely critical; (2) the virus breaks down rapidly in an orchard environment due to both UV rays from the sun and rainfall, thus spray intervals should not be stretched for more than seven to nine days; and (3) the feeding larva causes some injury to the fruit, commonly referred to as a “sting”—injury less than 1 to 2 millimeters in depth—before the virus eventually kills the larva.

**Timing.** Since CpGV is most active against young larvae and these larvae usually penetrate the fruit within 24 hours of hatching from the egg, it is very important to have the virus present when egg hatch begins (approximately 200 to 250 degree days [DD] following biofix—first sustained adult capture in a sex pheromone trap). If CpGV is intended as the primary control tactic for CM,

then the first application should be timed to coincide with the beginning of egg hatch (Figure 3-3A). Depending on the length of the egg hatch period, normally a total of three to five applications each spaced about seven days apart will be necessary to cover this time frame. Recently, in some apple orchards in Pennsylvania, we have observed the egg hatch period for CM to extend over a longer period of time than what is normally predicted by the CM developmental model. Under these conditions, it may be prudent to apply an insecticide with ovicidal activity (e.g., against the eggs, Esteem, Intrepid, or Rimon) at approximately 75 to 150 DD, then start the CpGV applications at about 300 to 350 DD, and repeat the applications every seven to nine days or approximately every 125 to 150 DD following this initial application (Figure 3-3B). Since the virus rapidly breaks down in the orchard environment, it is our experience that frequent applications of a lower rate are better than high rates applied at longer spray intervals.

As stated above, the CpGV must replicate itself within the larva in order to be effective, thus allowing the larva to continue to feed for a few days and causing some shallow feeding damage

(“stings”) to a fruit. If growers are trying to decide when to use a CpGV product, they may want to restrict their use of a CpGV product to the first generation. If stings or even some deep entries do occur in the small fruits during June from the first-generation larvae, those fruit often fall from the tree or can be thinned off. In addition, at this time of the season, the fruit on the tree are still small and canopy volume is still not complete, thus allowing more thorough coverage of the fruit.

CpGV products are compatible with most fungicides and insecticides sprayed on apples. However, since CpGV is sensitive to high alkaline conditions, it should not be mixed with copper fungicides or lime sulfur. In addition, it is recommended to use a buffer to neutralize the spray mix if the pH is above 9 or below 5. Also, Dr. Larry Gut, entomologist at Michigan State University, has cautioned Michigan growers to avoid tank-mixing CpGV with neonicotinoid insecticides, such as Assail, since these compounds have some anti-feeding activity, which may interfere with the larva ingesting the virus.

Since UV light can rapidly break down the virus particles, it is

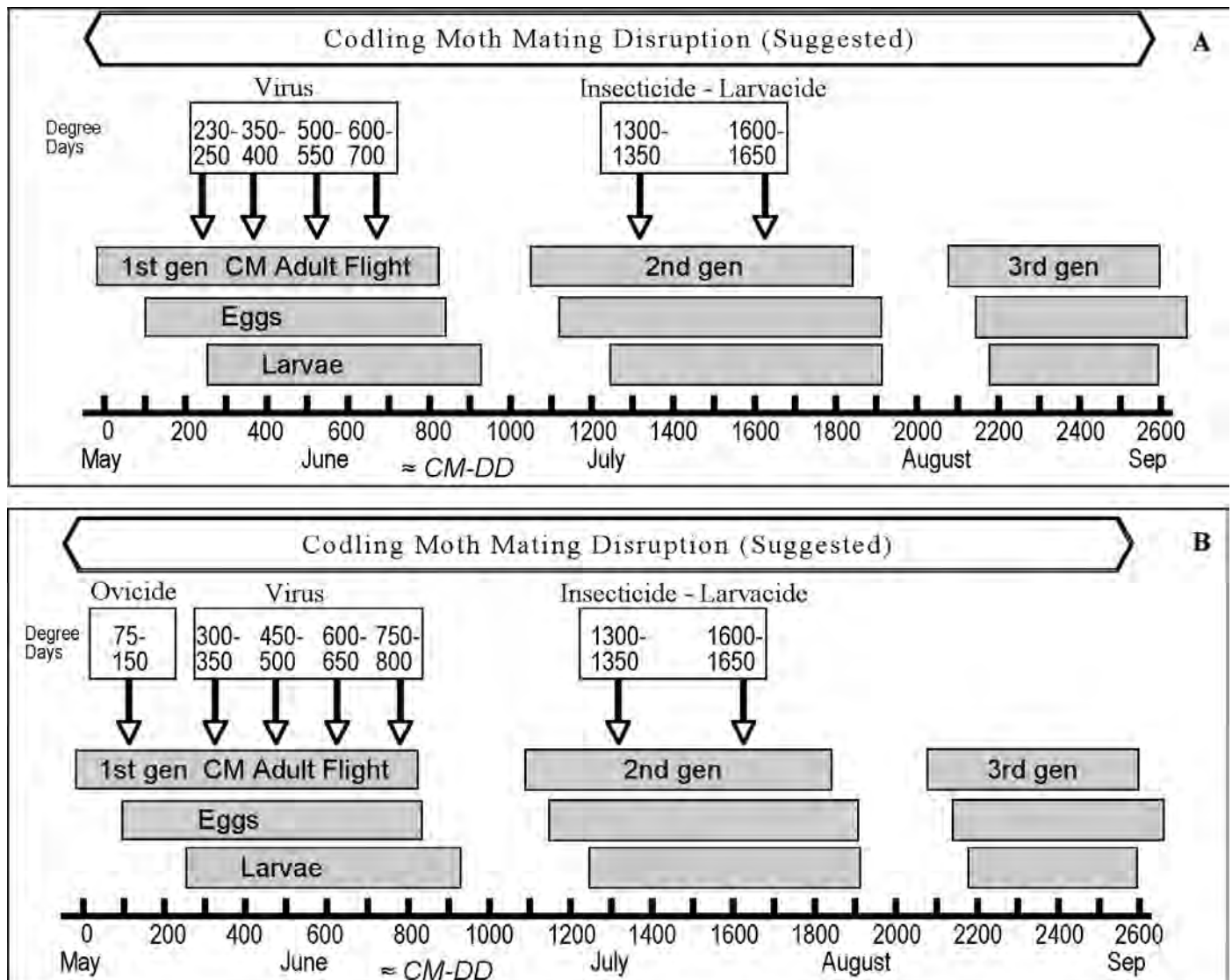

Figure 3-3. Various scenarios for applying a CpGV product for codling moth control. (A) timing when using a CpGV product and CM mating disruption. (B) timing of CpGV applications when using an ovicidal insecticide to begin control of first-brood CM, followed by a CpGV product.

also recommended that growers avoid applying the virus during periods of intense sunlight conditions. Also, if rain is forecast in the immediate future, try to wait until after the rain period to make the application.

Many growers in Pennsylvania commonly make their pesticide applications using the alternate row middle (ARM) method of spraying. We have used CpGV successfully with ARM sprays, but the studies have always been conducted with sex pheromone mating disruption for CM as a basic component of the program. Thus, here are recommendations for applying CpGV using the ARM approach:

- Since the virus must be consumed, thorough coverage is critical. Thus, ARM sprays must provide some coverage on the unsprayed side of the trees.
- Depending on the size of the tree, water volumes of at least 50 (trees 6 to 10 feet in height) to 100 GPA (trees larger than 10 feet in height) should be used.
- Dependent on pest pressure and weather conditions, ARM intervals should not stretch beyond five to seven days between sprays.
- This method of applying CpGV should only be used in conjunction with some form of CM mating disruption.

Recommended use options for CpGV products within Pennsylvania apple orchards:

- Make the first application at the beginning of egg hatch (i.e., approximately 200 to 250 DD after biofix) (Figure 3-3A).

~OR~

- Use an ovicidal insecticide at approximately 75 to 150 DD, then begin virus applications at roughly 300 to 350 DD (Figure 3-3B).

~AND~

- Repeat applications every seven days or roughly every 125 to 150 DD.
- Use a higher rate of CpGV for the first application.
- Repeat applications at lower rates for subsequent applications.
- Apply three to five applications for the first brood depending on the length of the adult flight and egg hatch period.
- Use primarily for first-brood CM control.
- For more effective control, combine with CM mating disruption, especially where CM populations are high and/or fruit injury from CM was present last season.

## RESISTANCE MANAGEMENT APPROACH FOR INSECTICIDES/MITICIDES IN TREE FRUITS

The best resistance management tool for secondary pests that do not feed directly on the fruit (mites, aphids, leafminers, scales, etc.) is often to encourage biological control by predators, parasitoids, and pathogens. This not only reduces selection pressure by reducing the number of sprays for that pest, but biocontrol agents can reduce resistance levels by indiscriminately feeding on both resistant and susceptible prey. For pests feeding directly on the fruit and for which there is almost no tolerance for fruit injury, pesticides will likely remain the best means of control. Fruit

growers throughout Pennsylvania now have at their disposal some highly effective and selective chemical tools to assist them in their battle against codling moth (CM), Oriental fruit moth (OFM), and the leafroller complex, which includes the tufted apple bud moth (TABM) and obliquebanded leafroller (OBLR). Both CM and OFM have caused serious problems for many growers over the past 10–15 years, resulting in the rejection of many loads of fruit destined for both the fresh and processing markets. The leafrollers have been serious pests since the early 1970s. All four of these pests have developed varying levels of resistance to a number of insecticidal chemistries over the years, including the organophosphates, carbamates, and pyrethroids. Additionally, spider mites and pear psylla have outstripped all other fruit pests in their ability to develop resistance to pesticides of multiple classes in only a few short years and deserve special consideration for resistance management. With the introduction of more than thirty new insecticides/miticide active ingredients as chemical tools for pest management, fruit growers need to adopt an approach to prevent this group of pests from developing resistance quickly to these new products.

The following list contains the trade names and registrant for each of these new chemical tools:

- Altacor (FMC)
- Delegate (Corteva)
- Envidor (Bayer)
- Exirel (FMC)
- Minecto (Syngenta Crop Protection)
- Movento/Ultor (Bayer)
- Voliam Flexi (Syngenta Crop Protection)
- Zeal (Valent)

Refer to the “Fungicides, Herbicides, Insecticides, Nematicides, and Plant Growth Regulators” section in Part III: Chemical Management and Table 3-7 for a further description of their mode of action, a list of registered uses and activity against various pests.

### Mechanisms of Insecticide/Miticide Resistance in Tree Fruit Pests

**Target site change.** This has really only been shown in mites and pear psylla in our fruit crops, but it is more common in other pests on cotton. It involves a modification of the action site in the pest to make it less sensitive to the pesticide as in the classical studies with the neurotoxic organophosphate insecticides and changes in the neurotransmitter acetylcholine. Many of our older miticides worked by inhibiting the mitochondrial electron transport (METI) system that governs cellular respiration. Changes to this system led to widespread resistance to products like Pyramite, Nexter, Portal, and Fujimite within only three to five years. Alternating products with differing modes of action is usually an effective strategy with this type of resistance.

**Enzymatic detoxification.** This consists of several mechanisms in tree fruit pests where mixed-function oxidases (MFOs) are the most important in leafminers, but resistance in most lepidopteran pests like codling moth and leafrollers is thought to be mostly based on a group of esterase enzymes. These enzymatic systems are thought to have been evolved in insects and mites to deal with toxic compounds in plants while feeding and have only relatively recently been utilized to also chemically break down pesticides. Predators and parasitoids eat pests that have already broken down these plant

poisons and do not have extensive enzymatic detoxification systems in general and are much less likely to develop resistance to pesticides for this reason. Since this enzymatic system's efficiency is based on the type of chemical bond in the pesticide, mode of action of the pesticide has little to do with its susceptibility to breakdown. Resistance to pesticides of different classes has been shown in our leafrollers where the esterase enzymes that broke down Guthion also broke down the insect growth regulator Dimilin before it had ever been used because of similar chemical bonds between the two compounds, despite completely different modes of action. Alternatively, leafrollers that were resistant to the OP insecticide azinphos-methyl were not resistant to chlorpyrifos, which is also an OP with the same mode of action, because its molecular bonds were not susceptible to the same enzymes that broke down azinphos-methyl. To a lesser extent glutathione-S transferase enzymes are also important in breaking down pesticides in some fruit pests. Pear psylla is such a potent adversary for pesticide resistance because it not only has target site resistance, but also all the types of enzymatic resistance. Synergism of pesticides with products like piperonyl butoxide (PBO) or some sterol-inhibitor fungicides like Rally occur when these nontoxic compounds bind up the enzymatic systems of resistant pest to allow the pesticide to work uninhibited.

### Use of the New Chemical Tools in a Resistance Management Approach

How should growers use these new products within the same season? Much is made of Insecticide Resistance Action Committee (IRAC) codes for rotating pesticides of differing modes of action, but this is really most effective on pests where target site modifications are the main source of resistance. As outlined in the previous section above, rotations of pesticides with differing modes of action is less effective when enzymatic detoxification is the main source of resistance. It is, however, the best place to start as pesticides of differing classes often have greatly differing chemical structures. To be truly sure of a good resistance management rotation, however, routine bioassays of field populations of pests should be conducted to determine if their efficacy is holding.

According to the IRAC mode of action classification (see Table 3-7), Altacor, Besiege, Exirel, Minecto, and Voliam Flexi have a similar mode of action (i.e., ryanodine receptor modulators), thus they belong to Group 28. Delegate has a totally different mode of action (i.e., nicotinic acetylcholine receptor allosteric activators), thus it belongs to Group 5 (see Table 3-7).

Second, all of these products are highly active against CM, OFM, and the two major leafrollers, TABM and OBLR. Since five of the products have a similar mode of activity (i.e., they are chemically related) and we want to delay the onset of resistance to either group for many years, we highly suggest that they be used only against a specific generation of a pest(s) and that the grower should rotate to other compound(s) or to other chemical classes (e.g., Group 1—organophosphates and carbamates, Group 4—Nicotinic acetylcholine receptor agonists [Assail, etc.]) of compounds to control the next generation of the targeted pest(s). For example, if a grower decides to use Delegate (Group 5) during the first generation of CM flight and egg hatch, then the grower should rotate to products in Group 28 or some other nonrelated group for the second-generation flight of CM. The same approach applies to OFM and the leafrollers.

A new trend in pesticide companies is the use of prepackaged

mixtures to make a selective product more broad spectrum—in a sense, making a “new azinphos-methyl.” While this may at first give some level of synergism (not always proved), it can lead to the creation of a “super bug,” which has developed enzymes that break down both types of pesticides. For resistance management, the most current thought is to rotate pesticides rather than to mix them in each spray for this reason. The use of premixes can also mean loss of biocontrol of mites, aphids, and scales and are not always appropriate for each application since only one type of pest (e.g., codling moth) might be present. While premixes may be convenient when applying for codling moth and brown marmorated stink bug at the same time, growers may lose some flexibility in what they want to apply.

All the products listed above are excellent and highly effective insecticides, and some have activity against other pests as well. In order for these chemicals to be used most effectively, it is extremely important that growers achieve thorough coverage since the pests must ingest many of these products for them to be effective. If thorough coverage is not achieved, the desired level of control will not be attained. Many of these products are fairly residual in their activity, but growers should not stretch the period between sprays too long. And, finally, if your pest management plans call for using both of these chemical groups during 2016 and beyond, use one chemical group for a single generation of a pest and then rotate to the other chemical group or some other unrelated group for the next generation. Do **not** use any of these products for consecutive generations of a targeted pest within the same growing season.

We highly encourage growers to use these products carefully and sparingly so we do not lose them to pest resistance in the future.

## NEMATODE MANAGEMENT STRATEGIES

Nematode problems in orchards are difficult to control and therefore good nematode management should focus on preventive measures. In general, nematode control is accomplished with nematicides and/or cultural practices. The benefits of each strategy are outlined below.

### Benefits of Nematicides and Soil Fumigants

Treating orchard soil before planting trees will reduce replant problems, control parasitic nematodes, and reduce the incidence of soilborne virus diseases, such as stem pitting in stone fruit and union necrosis in apple. Broad-spectrum fumigants may be used for all three purposes and are effective against most replant disorders. Fumigant and contact-type nematicides effectively control nematodes, including species that transmit soilborne viruses. See Table 4-3.

Decisions regarding chemical control options should be based on the history of the site and the results of a nematode diagnostic test. Options include treating the entire site (broadcast treatment), treating strips along the proposed tree rows, or treating only individual trees. Broadcast treatments effectively limit contamination and reinvasion by nematodes from untreated areas. If plant-parasitic nematodes are the only problem, a strip fumigation may be sufficient. Postplant treatment with nonfumigant-type materials may be desirable in areas that have received a preplant treatment with a fumigant-type material.

Soil fumigants should be applied during the late summer or fall and trees planted the following spring. Spring application

is an option but poses a risk of phytotoxicity if not timed well. Poor decomposition of root debris and previous cover crops will reduce the effectiveness of the fumigant. Adequate soil aeration is essential. Nonfumigant nematicides work well if applied in the spring when soil moisture and rainfall are plentiful. Fall application is an option if conditions are good.

Management of soilborne virus diseases in tree fruits requires control of the nematode vectors and the weeds that serve as virus reservoirs (see Table 2-14). Careful attention should be given to eliminating such weeds from tree rows as well as the groundcover in row middles. Consult Table 4-2 for recommended herbicides.

### Dagger Nematode Control with Green Manure

In recent years some fumigants have been identified as a threat to public health by groundwater contamination or ozone depletion. As a result, many of the most effective soil fumigants are no longer available because they have either been banned for environmental protection reasons or withdrawn from the market due to the high cost of meeting new safety regulations and requirements. Products that remain on the market have become increasingly expensive; thus, there is a need to develop safe and environmentally sound alternatives.

Over the past decade or more, many labs have evaluated a variety of novel rotation and green manure crops for the treatment of replant sites. This work showed that some plants naturally reduce populations of plant-parasitic nematodes and improve soil structure. Based on these results we recommend the use of selected sorghum-sudangrass hybrids and rapeseed varieties to help control dagger nematodes. Refer to details described in Part I under “Replanting an Orchard Site” for specific details on utilizing the sorghum-sudangrass and rapeseed rotation for remediation of soils with dagger nematodes.

#### Which rapeseed varieties to plant?

Some rapeseed varieties are more effective at suppressing nematode populations than others, and some varieties will not overwinter or bloom too early in summer to be useful. The winter varieties Dwarf Essex and Humus work well for both spring and fall planting dates. When planted in the spring, these varieties do not bloom but instead grow vigorously and help crowd out weeds.

Some seed companies have started to develop their own line of biofumigant rotation crop (usually a rapeseed or mustard variety) selected for use in different regions and sold under different trade names. A search on the web using keywords such as biofumigation, nematicidal rapeseed, or nematicidal mustard may help in finding a local source of seed.

#### Tips:

- Rapeseed (and mustard) requires a firm, smooth seedbed that is free of weeds, heavy residue, and large clods.
- Seed may be drilled or broadcast. Avoid planting too deep! A seeding depth of  $\frac{3}{8}$ -inch is good or if broadcast, a cultipacker may be used.
- A preplant herbicide treatment such as Treflan at 1.5 pints per acre can help prevent noxious weeds from becoming established.
- A seeding rate of 7–8 pounds per acre works well.
- Rapeseed is sensitive to broadleaf herbicide carryover.
- Fall-planted rapeseed should have 8 to 10 true leaves and a 5- to 6-inch taproot with a  $\frac{3}{8}$ -inch-diameter root neck before the ground freezes.
- Sulfur is necessary for rapeseed to produce nematicidal compounds. Although most orchard soil is not deficient in sulfur, a soil test to test the availability of this element may be beneficial.
- To maximize the nematicidal properties, chop the rapeseed into small pieces, quickly disc the field to incorporate the “green manure” into the soil, and seal the soil surface with water/irrigation or cultipacking.

### Biorational Nematode Control

The efficacy of cultural practices such as crop rotation and green manure to control nematodes varies with the nematode species being controlled because of differences in biology, host range, and life cycle. What works for one nematode may not work for others. In some cases, a rotation crop that suppresses one plant-parasitic nematode may actually stimulate an increase in another. Therefore, it is important to know which nematodes are present when developing a nematode management plan. While rapeseed green manure has been shown to effectively suppress dagger nematodes, this practice is not very effective against the lesion nematode and rapeseed green manure is not recommended if there is a potential lesion nematode problem.

The lesion nematode has a broad host range and is notoriously difficult to control with rotation crops. Several plants capable of suppressing lesion nematode populations have been identified but have not proven practical on a commercial scale because of cost or because they are very difficult to establish. Marigold and black-eyed-Susan are two examples. Forage Pearl Millet looks promising as an effective lesion nematode suppressive rotation crop; however, more research is needed before commercial recommendations can be made.

**Table 3-12. Target pH ranges and half-lives of selected orchard insecticides and miticides.**

Product	Target pH range	Half-Life
Acramite	<7.0	pH 9.0 = 2 hours; pH 7.0 = 20 hours; pH 5.5 = 5.5 days
Actara	4.0	pH 4.0 = 16 weeks; pH 7.0 = 5 weeks
Admire	7.5	> 31 days at a pH 5.0–9.0
Agri-Mek	6.0–7.0	Stable at pH 4.0–7.5
Apollo	6.0–7.0	pH 5.0 = 10 days; pH 7.0 = 34 hours; pH 9.2 = 4.8 hours
Assail	5.0–6.0	Unstable below 4.0 and above 7.0
Avaunt	None listed	Stable for 3 days at pH of 5.0–10.0
Delegate	5.0–9.0	
Dimethoate	5.0	pH 9.0 = 48 minutes; pH 6.0 = 12 hours; pH 4.5 = 20 hours
Dipel	6.0	Unstable in solutions above pH 8.0
Entrust	7.0	Stable at pH 6.0–9.0
Envidor	5.0–7.0	pH 4.0 = 63 days; pH 7.0 = 31 days; pH 9.0 = 5 days
Imidan	5.0	pH 8.0 = 4 hours; pH < 7.0 = 12 hours; pH 5.0 = 7 days
Malathion	5.0	pH 9.0 = 5 hours; pH 8.0 = 19 hours; pH 7.0 = 3 days; pH 6.0 = 8 days
Rimon	5.0–7.0	pH 9.0 = 100 days
Sevin XLR	7.0	pH 9.0 = 24 hours; pH 8.0 = 2–3 days; pH 7.0 = 24 days; pH 6.0 = 100 days
Warrior II	6.5	Stable at pH 5.0–9.0

Source: Adapted from the British Columbia Tree Fruit Production Guide (<https://www.bctfpg.ca/resources/reference/pesticide-resistance-management/>).

**Table 3-13. Target pH ranges and half-lives of selected orchard fungicides.**

Product	Target pH range	Half-Life
Aliette	4.0	Stable at pH 4.0–8.0
Bravo	6.0–7.0	Stable over a wide range of pH; pH 9.0 = 39 days
Captan	5.0	pH 8.0 = 10 minutes; pH 7.0 = 8 hours; pH 4.0 = 32 hours
Cercobin (thiophanate methyl)	4.5–7.0	Do not combine with products that are highly alkaline
Elevate	5.5–6.5	No data
Mancozeb	6.0	Most stable at pH 5.5–6.0
Ridomil	5.0–7.0	pH 9.0 = 88 days
Rovral	None listed	pH 7.0 = 1–7 days; pH 9.0 = < 1 hour

Source: Adapted from the British Columbia Tree Fruit Production Guide (<https://www.bctfpg.ca/resources/reference/pesticide-resistance-management/>).

**Table 3-14. Target pH ranges and half-lives of common herbicides.**

Common Name	Target pH range	Half-Life
Paraquat	None listed	Not stable in pH above 7.0
Glufosinate	5.5	
Simazine	5.0–7.0	pH 4.5 = 20 days; pH 5.0 = 90 days; pH 9.0 = 24 days
Pendimethalin	5.0	Stable from pH 5.0–10.0
Sethoxydim	3.0–4.0	Stable in pH 4.0–10.0

Source: Adapted from the British Columbia Tree Fruit Production Guide (<https://www.bctfpg.ca/resources/reference/pesticide-resistance-management/>).





# IV

## CHEMICAL MANAGEMENT TABLES

---

### CONTENTS

<b>Herbicide Management .....</b>	<b>266</b>
<b>Nematicide Management .....</b>	<b>266</b>
<b>Insecticide and Fungicide Management.....</b>	<b>266</b>
<b>Reentry and Preharvest Intervals.....</b>	<b>266</b>

### TABLES

<b>Table 4-1.</b> Tree fruit herbicide registration by crop.....	267
<b>Table 4-2.</b> Herbicides labeled for use in orchards .....	270
<b>Table 4-3.</b> Soil fumigants and nematicides.....	271
<b>Table 4-4.</b> Toxicity of pesticides to mite and aphid predators, at rates recommended in Part V .....	272
<b>Table 4-5.</b> Apples: insecticide and miticide timing .....	274
<b>Table 4-6.</b> Apples: insecticide and miticide efficacy.....	275
<b>Table 4-7.</b> Apples: fungicide timing. ....	277
<b>Table 4-8.</b> Apples: fungicide and antibiotic efficacy. ....	278
<b>Table 4-9.</b> Pears: insecticide and miticide timing.....	279
<b>Table 4-10.</b> Pears insecticide and miticide efficacy. ....	279
<b>Table 4-11.</b> Stone fruit: insecticide and miticide timing. ....	280
<b>Table 4-12.</b> Stone fruit: insecticide and miticide efficacy....	281
<b>Table 4-13.</b> Stone fruit: fungicide and antibiotic timing. ....	282
<b>Table 4-14.</b> Stone fruit: fungicide and antibiotic efficacy....	283
<b>Table 4-15.</b> Reentry (REI) and preharvest (PHI) or spray-to-harvest intervals. ....	284

This part groups many of the large, frequently used chemical management tables into an easily located position in the guide. Chemicals covered include herbicides, plant growth regulators, nematicides, insecticides, miticides, bactericides, and fungicides.

## HERBICIDE MANAGEMENT

Tables 4-1 through 4-2 deal with herbicides recommended for use in Pennsylvania orchards, along with their restrictions, application times and rates, and efficacy.

## NEMATICIDE MANAGEMENT

Table 4-3 outlines the use of soil fumigants and nematicides.

## INSECTICIDE AND FUNGICIDE MANAGEMENT

Table 4-4 presents rankings of toxicity for common pesticides to bees and natural enemies of mites and aphids. This information is used to allow pesticide-use decisions that facilitate biological control by existing natural enemies. Determine if planned pesticide uses are toxic to bees. See Table 4-4 to determine if pesticides to be used are highly or moderately toxic to bees, and Table 1-9 for guidelines on when to time applications depending on how long the pesticide may remain toxic to bees in the field. Develop an IPM plan to prevent and/or mitigate risks to pollinators from pesticides. Keep in mind that wild bees will be present in the orchard before and after the bloom period.

Tables 4-5 through 4-14 are presented with the best timing for applying pesticides and the efficacy of available products for

various pest species. The timing and efficacy tables for the crop and type of pest (either insects and mites or diseases) are paired to show the best timing together with the efficacious products. Tables are presented for apples (insects/mites and disease), pears (insects/mites), and stone fruits (insects/mites and disease).

## REENTRY AND PREHARVEST INTERVALS

During the last month before harvest, it is possible to deposit excessive pesticide residues on fruit if time limitations before last spray and harvest are not followed closely. Short residual or high-tolerance materials should be used in preharvest sprays. A spray residue may be within legal limitations and still be highly undesirable for fresh consumption or export because of visible residue. In general, avoid highly colored chemicals or mixtures that leave a heavy, spotted residue in the late cover sprays. The time limitations for pesticides and plant growth regulators between final spray and harvest are summarized in Table 4-15. *Be certain about the control of late season insects and diseases before ending spray programs. Sprays on apples may be needed until mid-September for tufted apple bud moth—and even into October for brown marmorated stink bug control—in many areas and for fruit rots, sooty blotch, flyspeck, and scab control on varieties ripening after McIntosh.*

Table 4-1. Tree fruit herbicide registration by crop.

2,4-D (amine formulations)	Allon	Bradworks	carfentrazone-ethyl	Casoron	clethodim	clopyralid	diuron	diuron + Sinbar	fiumioxazin	fluoxypyr	Fusilade	glufosinate <sup>3</sup>	glyphosate	halosulfuron methyl	isoxaben	oryzalin	oxyfluorfen	paraquat	pendimethalin	Poast	pronamide	Prowl H2O	rimsulfuron	Scythe	simazine	Sinbar	Snapshot	Solicam	Trevis	trifluralin	Venue	Zeus Prime XC	
Apple	▲			▲	▲	▲	▲	▲	▲	▲	▲	▲	▲	▲	▲	▲	▲	▲	▲	▲	▲	▲	▲	▲	▲	▲	▲	▲	▲	▲	▲	▲	
Apricot	▲			▲	▲	▲	▲	▲	▲	▲	▲	▲	▲	▲	▲	▲	▲	▲	▲	▲	▲	▲	▲	▲	▲	▲	▲	▲	▲	▲	▲	▲	
Cherry, tart	▲			▲	▲	▲	▲	▲	▲	▲	▲	▲	▲	▲	▲	▲	▲	▲	▲	▲	▲	▲	▲	▲	▲	▲	▲	▲	▲	▲	▲	▲	
Cherry, sweet	▲			▲	▲	▲	▲	▲	▲	▲	▲	▲	▲	▲	▲	▲	▲	▲	▲	▲	▲	▲	▲	▲	▲	▲	▲	▲	▲	▲	▲	▲	
Nectarine	▲			▲	▲	▲	▲	▲	▲	▲	▲	▲	▲	▲	▲	▲	▲	▲	▲	▲	▲	▲	▲	▲	▲	▲	▲	▲	▲	▲	▲	▲	
Peach	▲			▲	▲	▲	▲	▲	▲	▲	▲	▲	▲	▲	▲	▲	▲	▲	▲	▲	▲	▲	▲	▲	▲	▲	▲	▲	▲	▲	▲	▲	▲
Pear	▲			▲	▲	▲	▲	▲	▲	▲	▲	▲	▲	▲	▲	▲	▲	▲	▲	▲	▲	▲	▲	▲	▲	▲	▲	▲	▲	▲	▲	▲	▲
Plum	▲			▲	▲	▲	▲	▲	▲	▲	▲	▲	▲	▲	▲	▲	▲	▲	▲	▲	▲	▲	▲	▲	▲	▲	▲	▲	▲	▲	▲	▲	▲
Prune	▲			▲	▲	▲	▲	▲	▲	▲	▲	▲	▲	▲	▲	▲	▲	▲	▲	▲	▲	▲	▲	▲	▲	▲	▲	▲	▲	▲	▲	▲	▲
Quince	▲			▲																													

(continued)



**Table 4-1. Tree fruit herbicide registration by crop (continued).**

Days-to-harvest limitation<sup>d</sup> and safe worker reentry interval (REI)

2,4-D (amine formulations)	Allion	Broadworks	carfentrazone-ethyl	Casoron	clethodim	clopyralid	diuron	diuron + Sinbar	flumioxazin	fluoxypyr	Fusilade	glufosinate <sup>a</sup>	glyphosate	halosulfuron methyl	isoxaben	oryzalin	oxyfluorfen	paraquat	pendimethalin	Poast	pronamide	Prowl H2O	rimsulfuron	Scythe	simazine	Sinbar	Snapshot	Softcam	Trevix	trifluralin	Venue	Zeus Prime XC
Apple	14-80 <sup>c</sup>	14	3	30	365	30	60	60	60	14	365	14	14	14	365	NL <sup>e</sup>	dormant or postharvest only	NL	365	14	1-Jan	60	7	NL	14	60	365	60	1	0	0	
Apricot	40-80 <sup>c</sup>	14	3	365	30	30	60	60	60	14	14	14	17	14	365	NL	dormant or postharvest only	28	365	25	1-Jan	60	14	NL	NL	365	60	60	60	0	0	
Cherry, tart	40-80 <sup>c</sup>	14	3	30	365	30	60	60	60	14	14	14	17	14	365	NL	dormant or postharvest only	28	365	25	1-Jan	60	14	NL	14	365	60	60	0	0	0	
Cherry, sweet	40-80 <sup>c</sup>	14	3	30	365	30	60	60	60	14	14	14	17	14	365	NL	dormant or postharvest only	28	365	25	1-Jan	60	14	NL	14	365	60	60	0	0	0	
Nectarine	40-80 <sup>c</sup>	14	30	3	365	30	60	60	60	14	14	14	17	14	365	NL	dormant or postharvest only	28	365	25	1-Jan	60	14	NL	14	365	60	60	0	0	0	
Peach	40-80 <sup>c</sup>	14	3	365	30	30	60	60	60	14	14	14	17	14	365	NL	dormant or postharvest only	14	365	25	1-Jan	60	14	NL	14	60	365	60	60	0	0	
Pear	14-80 <sup>c</sup>	14	3	30	365	30	60	60	60	14	365	14	14	14	365	NL	dormant or postharvest only	NL	365	14	1-Jan	60	7	NL	14	365	60	1	0	0	0	
Plum	40-80 <sup>c</sup>	14	30	3	365	30	60	60	60	14	14	14	17	14	365	NL	dormant or postharvest only	28	365	365	1-Jan	60	14	NL	14	365	60	60	0	0	0	
Prune	40-80 <sup>c</sup>	14	30	3	365	30	60	60	60	14	14	14	17	14	365	NL	dormant or postharvest only	28	365	365	1-Jan	60	14	NL	14	365	60	60	0	0	0	
Quince			3				60	60	60	14	14	14	14	14	365	NL	dormant or postharvest only	365	14			7	NL							0	0	
REI (hours)	48	12	12	12	24	12	12	12	12	24	12	12	4-24	12	12	24	24	12	24	12	24	24	4	12	12-	12	12	12	12	12	12	

a. Some glufosinate products are only labeled for apples and not other tree fruits. For list of product names, see description of glufosinate in Part III of this guide.

b. Planting = can be used in year of planting. Other values indicate earliest time after planting that material can be used.

c. This material must be applied to these stone fruits in Pennsylvania only under the tree row using a wick applicator.

d. Days-to-harvest limitations vary by manufacturer. Be sure to read the label of the product you are using.

e. NL = none listed on the label; however, herbicides should not be applied when fruit is on the ground.

**Table 4-2. Herbicides labeled for use in orchards.**

Common name	Trade name(s)	Crops	Amount/A
<b>For orchards the year of planting (do not apply until after the ground has settled and there are no visible cracks in the soil)</b>			
carfentrazone-ethyl	Aim, Shark	AP, AT, CH, NE, PE, PL, PR	0.5–2 fl oz
clethodim	numerous trade names	AP, AT, CH, NE, PE, PL	rate varies by product formulation
dichlobenil	Casoron 4G	AP, CH, PR	100–150 lb
fluazifop-p-butyl	Fusilade DX	AP, AT, CH, NE, PE, PL, PR	16–24 fl oz
norflurazon	Solicam DF	AP, NE <sup>a</sup> , PE <sup>a</sup>	2.5–5 lb
oryzalin	Fugitive, Oryzalin, Phoenix Harrier, Surface, Surflan	AP, AT, CH, NE, PE, PL, PR, QU	2–6 qt
oxyfluorfen	Collide, Goal, Galigan, Oxyflo, OxyStar	AP, AT, CH, NE, PE, PL, PR, QU	2–8 pt
	GoalTender	AP, AT, CH, NE, PE, PL, PR, QU	1–4 pt
paraquat	Bonedry, Gramoxone SL, Parazone SL, plus others	AP, AT, CH, NE, PE, PL, PR	2.5–4 pt
	Helmquat, Parazone 3SL, Firestorm	AP, AT, CH, NE, PE, PL, PR	1.7–2.7 pt
pendimethalin	Acumen, Framework, Pavilion, Pendimethalin, PendiPro, Prowl 3.3EC, Satellite, Stealth	AP, AT, CH, NE, PE, PL, PR	2.4–4.8 qt
	Prowl H2O	AP, AT, CH, NE, PE, PL, PR	2–4.2 qt
sethoxydim	Poast	AP, AT, CH, NE, PE, PL, PR, QU	0.5–2.5 pt
terbacil	Sinbar	AP, AT, CH, PE, PL, PR	0.5–1 lb
trifluralin	Trifluralin 4EC, Treflan 4EC	AT, NE, PE, PL	1–2 pt
<b>For orchards established at least one year (any of the previously listed materials may also be used)</b>			
2,4-D (note there are many formulations of 2,4-D; check local suppliers)	2,4-D Amine 4, Saber, Weedar 64	AP, AT, CH, NE, PE, PL, PR	1–3 pt
	Orchard Master	AP, CH, NE, PE, PL, PR	2–3 pt
	Unison	AP, CH, PE, PL, PR	0.6–1.15 gal
	Weedestroy AM-40	AP, CH, NE, PE, PL	3 pt
clopyralid	Spur, Stinger	AP, AT, CH, NE, PE, PL	0.33–0.67 pt
	Clean Slate	AT, CH, NE, PE, PL	
dichlobenil	Casoron CS	AP, CH, PR	1.4–2.8 gal
diuron	Diuron 4L, Direx 4L	AP, PR	3 qt, 3.2 qt
	Diuron DF, Karmex DF, Diuron 80WDG, Diuron 80DF, Karmex XP	AP, PR	4 lb or 2 + 2 lb
flumioxazin	Broadstar, Chateau, Tuscany	AP, AT, CH, NE, PE, PL, PR	6–12 oz/A
glufosinate	Cheetah, Refine, Rely 280, and others	AP	48–82 oz
halosulfuron-methyl	Sandea, Permit	AP	0.75–2 oz
isoxaben	Gallery, Isoxaben, Trellis,	AP, CH, NE, PE, PL, PR	0.66–1.33 lb
isoxaben + trifluralin	Snapshot 2.5TG	AP, AT, CH, NE, PE, PL, PR, QU	100–200 lb
mesotrione	Broadworks	NE, PL, PR	3–6 oz
norflurazon	Solicam DF	AT, PR, PL	2.5–5 lb
pelagornic acid	Scythe	AP, AT, CH, NE, PE, PL, PR, QU	3–10% solution
pronamide	Kerb, Pronamide	AP, AT, CH, NE, PE, PL, PR	2–8 lb
pyraflufen ethyl	Venue	AP, AT, CH, NE, PE, PL, PR, QU	0.7–4 fl oz
rimsulfuron	Matrix FNV, Pruvini, Solida, Grapple, Hinge	AP, AT, CH, NE, PE, PL, PR, QU	4 oz
saflufenacil	Treevix	AP, PR	1 oz
simazine	Caliber 90, Simazine 90DF	AP, sour CH, PR	2.2–4.4 lb
	Caliber 90, Simazine 90DF	PE, PL, sweet CH	1.75–4.4 lb
	Princep 4L, Simazine 4L, Sim-Trol 4L	AP, sour CH, PR	2–4 qt
	Princep 4L, Simazine 4L	PE, PL, sweet CH	1.6–4 qt
terbacil + diuron	Sinbar + Karmex	AP, PE	1–2 lb + 1–2 lb
<b>For orchards established at least two years (any of the previously listed materials may also be used)</b>			
diuron + terbacil	(Diuron 4L, Direx 4L) + Sinbar	AP, PE	0.8–1.6 qt + 1–2 lb
diuron + terbacil	(Diuron 80, Diuron 80DF, Diuron DF, Karmex DF, Karmex XP) + Sinbar	AP, PE	1–2 + 1–2 lb

**Table 4-2. Herbicides labeled for use in orchards. (continued).**

Common name	Trade name(s)	Crops	Amount/A
glyphosate	Roundup, Touchdown, and many others	AP, PR, CH	Rate varies by formulation
	Rattler, Glyphomax, and many others	AT, NE, PE, PL	33% solution in a wick applicator
norflurazon	Solicam DF	CH <sup>b</sup>	2.5–5 lb
<b>For orchards established at least three years (any of the previously listed materials may also be used):</b>			
diuron	Direx 4L, Diuron 4L	PE	1.6–3.2 qt
	Diuron 80, Diuron 80DF, Diuron DF, Karmex DF, Karmex XP	PE	2–2.75 lb
	Diuron 80WDG	PE	2–5 lb
diuron plus	Diuron 4L	AP	1.5–2 pt
diuron + oryzalin	Diuron 4L + Surflan	AP	0.75–1.5 pt + 2–6 qt
indaziflam	Alion	AP, AT, CH, NE, PE, PL, PR	5–6.5 oz
sulfentrazone + carfentrazone-ethyl	Zeus Prime XC	AP	7.7–15.2 fl oz
terbacil	Sinbar	AP, PE	2–4 lb

Crop codes: AP = apples; AT = apricots; CH = cherries; NE = nectarines; PE = peaches; PR = pears; PL = plums; QU = quince

a. Do not apply until trees have been established at least 6 months in the orchard.

b. Do not apply sooner than 18 months after trees have been planted, and do not apply on sandy or loamy-sandy soils at any age.

**Table 4-3. Soil fumigants and nematicides.**

Product name	Pests controlled	Application method	Rate per treated acre	Notes
<b>Soil fumigants (preplant only)</b>				
Basamid G	Nematodes, diseases, weeds	Incorporate (rotovate) and seal	220–450 lb depending on soil and target nematode	Soil temperature at the depth of application should be 43–90°F (54–69°F considered optimal). Soil must be moist.
Telone II	Nematodes	Inject and seal	27–35 gal	Soil temperature at the depth of application should be 40–80°F. See label for determination of required soil moisture level.
Telone C-17	Nematodes	Inject and seal	32–42 gal	Soil temperature at the depth of application should be 40–80°F. See label for determination of required soil moisture level.
Telone C-35	Nematodes	Inject and seal	39–50 gal	Soil temperature at the depth of application should be 40–90°F. See label for determination of required soil moisture level.
Vapam HL	Nematodes, diseases, weeds	Till, irrigate or inject, and seal	37.5–75 gal	Soil temperature at the depth of application should be 40–90°F. Soil moisture should be 60–80% field capacity.
<b>Nematicides (preplant or postplant)</b>				
DiTera DF	Nematodes	Incorporate or irrigate	13–100 lb	Do not apply to foliage. OMRI listed.
MeloCon WG	Nematodes	Incorporate or irrigate	2–4 lb	OMRI listed.
Velum Prime	Nematodes	Irrigate	6.5–6.84 fl	Best results on newly planted trees.
Vydate L	Nematodes	Incorporate or irrigate	2 gal (pre); 2–4 pt (post)	Nonbearing only (trees that will not bear for 12 months).

Note: It is a violation of federal law to use pesticides in a manner inconsistent with their labeling. Read and follow all label precautions and directions. Pesticides should be used only by individuals trained in their proper use. The EPA Soil Fumigant Toolbox website at [www.epa.gov/soil-fumigants](http://www.epa.gov/soil-fumigants) is a good source of information on current fumigation regulations.

**Table 4-4. Toxicity of pesticides to mite and aphid predators, at rates recommended in Part V.**

Material	<i>Stethorus punctum</i>	Bees	<i>Typhlodromus pyri</i>	<i>Neoseiulus fallacis</i>	<i>Zetzellia mali</i>	<i>Aphidoletes</i>	Ladybugs	Minute pirate bugs	Lacewings	Fly and wasp parasitoids
<b>Insecticides</b>										
Actara	+++	+++	+	+	0	++	++	++	++	+++
Agri-Flex	+++	+++	+	+	0	++	++	++	++	+++
Altacor	0	0	0	0	0	0	0	0	0	0
Apta	—	+++	—	—	—	—	—	—	—	—
Asana XL	+++	+++	+++	+++	+++	+++	+++	+++	+++	+++
Assail	++	+	+	0	0	++	++	++	++	+++
Avant	++	++	0	0	0	+	++	+	+	+++
azadirachtin	+	++	—	—	—	—	+	—	—	+
Baythroid XL	+++	+++	+++	+++	+++	+++	+++	+++	+++	+++
Belay	+++	+++	++	++	0	++	++	++	++	+++
Beleaf	—	+	—	—	—	—	—	—	—	—
Besiege	+++	+++	++	+++	++	+++	+++	+++	+++	+++
Bexar	—	+++	—	—	—	—	—	—	—	—
Bt	0	0	0	0	0	0	0	0	0	0
carbaryl	+++	+++	+	++	+	++	+++	++	++	+++
Centaur	++	+	+	+	+	—	—	—	—	—
Closer	+++	+++	+	+	0	++	++	++	++	+++
codling moth granulosis virus	0	0	0	0	0	0	0	0	0	0
Cormoran	+++	+++	0	0	0	++	+++	++	+++	+++
cyfluthrin	+++	+++	+++	+++	+++	+++	+++	+++	+++	+++
Danitol	+++	+++	+++	+++	++	++	+++	++	+++	+++
Delegate	+	+	++	++	+	+	+	+	+	++
deltamethrin	+++	+++	+++	+++	+++	+++	+++	+++	+++	+++
diazinon	+	+++	+	+	+	+++	++	+	++	+++
Endigo	+++	+++	+++	+++	+++	+++	+++	+++	+++	+++
Esteem	+++	+	0	0	0	0	+++	+++	+++	+++
Exirel	++	+++	+	+	+	+	++	+	+	++
Gladiator	+++	++	+++	++	+++	+++	+++	+++	+++	+++
imidacloprid	++	+++	+	+	0	+	++	++	++	++
Imidan	+	+++	0	0	0	+	++	++	++	+++
Intrepid	0	0	0	0	0	0	0	0	0	0
Lannate	++	+++	++	+++	++	+++	+++	++	+++	+++
Leverage	+++	+++	++	+++	—	—	+++	—	—	+++
Lorsban (dormant)	+	+	+	0	0	0	+	0	0	++
malathion	+	+++	0	0	0	+	++	+	+	++
Minecto Pro	+++	+++	++	+++	++	+++	+++	+++	+++	+++
Movento	+	++	0	0	0	+	+	+	+	—
Mustang Max	+++	+++	+++	+++	++	+++	+++	+++	+++	+++
Nealta	0	0	0	0	0	0	0	0	0	0
Permethrin	+++	+++	++	+++	++	+	++	++	++	+++
PQZ	—	+	—	—	—	—	—	—	—	—
Proaxis	+++	+++	++	+++	++	+++	+++	+++	+++	+++
Rimon	++	+++	0	0	0	—	+++	++	+++	+++
Scorpion/Venom	+++	+++	+	+	0	++	++	++	++	+++
Sevin XLR	+++	+++	+	++	++	+++	++	++	++	+++
Sivanto	++	+++	0	0	0	++	++	++	++	+++
Surround	++	+	++	++	++	++	++	—	+	++
Ultor	+	++	0	0	0	+	+	+	+	—
Venerate	0	0	0	0	0	0	0	0	0	0
Versys	—	+	—	—	—	—	—	—	—	—
Voliam Flexi	++	+++	+	0	0	++	++	++	++	+++
Warrior II	+++	+++	+++	+++	+++	+++	+++	+++	+++	+++
<b>Miticides</b>										
Acramite	0	++	++	++	++	+	0	0	0	—
Agri-Mek	++	+++	+	++	+	+	+	+	+	—
Apollo SC	0	0	0	+	+	0	0	0	0	—

(continued)



**Table 4-4. Toxicity of pesticides to mite and aphid predators, at rates recommended in Part V (continued).**

Material	<i>Stethorus punctum</i>	Bees	<i>Typhlodromus pyri</i>	<i>Neoseiulus fallacis</i>	<i>Zetzellia mali</i>	<i>Aphidoletes</i>	Ladybugs	Minute pirate bugs	Lacewings	Fly and wasp parasitoids
Envidor	++	+	0	0	0	—	—	—	—	—
Kanemite	+	0	+	+	+	—	—	—	—	—
Nealta	+	0	0	0	0	—	—	—	—	—
Nexter	++	+++	+++	+++	++	++	++	++	++	—
Portal	++	0	+++	++	+	—	—	—	—	—
Savey/Onager	0	0	0	+	+	0	0	0	0	—
Sivanto	—	+	0	0	0	—	—	—	—	—
summer oil	+	++	++	++	+	+	+	+	+	—
Vendex	+	++	++	++	++	+	+	+	+	—
Vydate	++	+++	+++	+++	+++	++	++	+++	+++	+++
Zeal	0	0	+	++	++	+	—	—	—	—
<b>Fungicides</b>										
Bravo	0	+	—	—	—	—	—	—	—	—
captan	+	+	+	+	+	—	—	—	—	—
Flint	+	+	0	0	0	—	—	—	—	—
Inspire Super	+	0	0	0	0	—	—	—	—	—
lime sulfur	++	+*	++	+++	+++	—	—	—	—	—
mancozeb	+	+	+	++	+	—	—	—	—	—
Polyram	+	+	++	++	+	—	—	—	—	—
Pristine	+	+	0	0	0	—	—	—	—	—
Procure	+	0	0	0	0	—	—	—	—	—
Rally	+	+	0	0	0	—	—	—	—	—
Sovran	0	0	0	0	0	—	—	—	—	—
sulfur	++	+*	+	++	+	—	—	—	—	—
Syllit (dodine)	0	++	0	0	0	—	—	—	—	—
Thiram	+	+	+	+	—	—	—	—	—	—
Topgard	+	0	0	0	0	—	—	—	—	—
Topsin M	+	0	+	+	++	—	—	—	—	—
Vangard	0	0	0	0	0	—	—	—	—	—
Ziram	+	+	+	+	+	—	—	—	—	—

+ = slightly toxic, ++ = moderately toxic, +++ = highly toxic, — = no data available, 0 = nontoxic, \* = repellent for more than one day

Some information adapted from New York Agricultural Experiment Station data, Midwest Biological Control News, and Washington State University Tree Fruit and Extension Center.

**Table 4-5. Apples: insecticide and miticide timing.**

Time of spray	Pest																								
	AM	ARM	BMSB	CM	EAS	ERM	GA	GFW	LAW	OBL	OFM	PC	PLH	RAA	RBL	RLH	SB	SJS	STLM	TABM	TPB	TSM	WAA	WALH	
Dormant	—	—	—	—	—	—	+	—	—	—	—	—	—	++	—	—	—	++	—	—	+	—	—	—	—
½-inch green	—	—	—	—	—	+	+	++	—	—	+	—	—	++	+	—	—	++	+	—	—	+	—	—	—
Prepink	—	—	—	—	—	—	—	—	—	—	—	—	—	—	—	—	—	—	—	—	—	—	—	—	—
Bloom	—	—	—	—	—	—	—	—	—	—	—	—	—	—	—	—	—	—	—	—	—	—	—	—	—
Petal fall	—	+	+	++	++	++	+	++	+	++	++	++	—	+	++	—	+	++	++	++	—	++	—	—	++
First cover spray	—	++	+	++	+	+	++	+	++	+	++	++	—	+	++	—	+	++	++	+	+	+	—	—	+
Second cover spray	+	++	+	++	—	+	++	—	++	+	++	++	+	+	++	+	+	++	++	++	++	+	+	—	+
Third cover spray	++	++	++	++	—	+	++	—	+	++	++	+	++	—	+	++	+	+	++	++	++	+	+	—	—
Fourth cover spray	++	+	++	++	—	++	+	—	+	++	++	—	++	—	+	++	+	+	+	+	+	+	++	+	—
Fifth cover spray	++	+	++	++	—	++	+	—	++	+	++	—	+	—	++	++	++	++	++	++	++	+	++	+	++
Sixth cover spray	++	—	++	++	—	+	+	—	+	++	++	+	—	—	++	+	++	++	++	++	++	+	+	+	++
Seventh cover and late season sprays	++	—	++	++	—	—	+	—	++	++	++	—	—	—	++	++	++	++	++	++	++	+	+	+	—

++ = ideal timing of spray for insect control; + = presence of pest and possible control; — = control generally not needed

AM = apple maggot; ARM = apple rust mite; BMSB = brown marmorated stink bug; CM = codling moth; EAS = European apple sawfly; ERM = European red mite; GA = green apple aphid, spirea aphid; GFW = green fruitworm; LAW = lesser appleworm; OFM = Oriental fruit moth; OBL = obliquebanded leafroller; PC = plum curculio; PLH = potato leafhopper; RAA = rosy apple aphid; RBL = redbanded leafroller; RLH = rose leafhopper; SB = native stink bug; SJS = San Jose scale; STLM = spotted tentiform leafminer; TABM = tufted apple bud moth; TPB = tarnished spider mite; TSM = two-spotted spider mite; WAA = woolly apple aphid; WALH = white leafhopper

Table 4-6. Apples: insecticide and miticide efficacy.

Pesticide <sup>a</sup>	Pest																							
	AM	ARM	BMBS	GM	EAS	ERM	GA	GFW	LAW	OBL	OFM	PC	PLH	RAA	RBL	RLH	SJS	STLM	TABM	TPB/SB	TSM	WAA	WALH	
Acramite	—	0	—	—	—	3	—	—	—	—	—	—	—	—	—	—	—	—	—	—	—	—	—	—
Actara	—	—	1	4	3	—	1	—	—	—	—	2	1	1	—	1	—	2	—	2	—	—	—	1
Admire Pro	4	—	2	—	—	—	1	—	—	—	—	—	1	1	—	1	3	1	—	3	—	—	4	1
Agri-Flex	—	2	4	—	3	1	1	—	—	—	—	2	1	1	—	1	—	1	—	—	—	—	—	1
Agri-Mek	—	2	4	—	—	1	—	—	—	—	—	—	—	—	—	—	—	1	—	—	—	—	—	3
Altacor	4	—	4	1	—	—	—	1	1	1	1	4	—	—	—	1	—	1	1	—	—	—	—	—
Apollo	—	4	—	—	—	2	—	—	—	—	—	—	—	—	—	—	—	—	—	—	—	—	—	—
Apta	2	—	—	4	—	—	2	—	—	4	4	3	2	3	4	2	—	—	4	—	—	—	—	2
Asana XL	2	—	3	3	2	—	3	2	1	2	2	3	2	4	1	2	4	1	2	2	—	—	4	2
Assail	3	—	1	2	2	—	1	—	1	4	1	1	1	1	4	1	4	1	4	2	—	—	3	1
Avant	3	—	4	2	2	—	4	2	2	4	2	1	4	3	2	4	4	4	2	2	—	—	—	2
Baythroid XL	2	—	2	3	—	—	3	2	2	2	2	3	2	3	1	2	4	1	2	2	—	—	4	2
Belay	—	—	1	3	—	—	1	—	2	—	2	—	1	1	—	1	—	1	—	—	—	—	—	1
Beleaf	—	—	4	—	—	—	2	—	—	—	—	—	—	—	—	—	—	—	—	2	—	—	—	—
Bestige	4	—	2	1	2	—	—	1	1	1	1	3	1	—	1	—	—	1	1	2	—	—	—	1
Bexar	2	—	—	4	—	—	2	—	—	4	4	3	2	3	4	2	—	—	4	—	—	—	—	2
<i>B. thuringiensis</i>	—	—	—	—	—	—	—	2	4	2	4	—	—	—	—	—	—	—	—	—	—	—	—	—
carbaryl	3	—	3	3	3	—	4	3	2	4	3	2	1	4	3	1	4	3	4	3	—	—	4	1
Centaur	—	—	—	—	—	—	—	—	—	—	—	—	—	—	—	—	—	—	—	—	—	—	—	—
chlorpyrifos	—	—	2	—	—	—	1	2	—	—	—	—	—	—	2	2	—	—	—	3	—	—	—	—
Closer 2SC	—	—	3	—	—	—	1	—	—	—	—	—	1	3	—	1	2-3	—	—	2	—	—	—	1-2
Cormoran	3	—	2	2	3	—	1	2	2	2	2	2	1	1	2	1	4	1	2	2	—	—	4	1
Cp GV	—	—	—	1	—	—	—	—	—	—	2	—	—	—	—	—	—	—	—	—	—	—	—	—
cyfluthrin	2	—	2	2	—	—	3	2	1	2	2	3	2	3	1	2	4	1	1	1	—	—	—	—
Danitol	2	—	1	2	1	—	3	2	1	2	2	2	2	3	1	2	4	1	2	2	—	—	—	2
deltamethrin	2	—	—	2	2	—	4	2	1	3	2	3	1	3	1	1	4	1	2	2	—	—	—	1
Delegate	3	—	4	1	—	—	—	—	1	1	1	3	—	—	—	—	—	—	1	1	—	—	—	—
diazinon	—	—	4	4	—	—	2	—	—	—	4	—	—	—	1	—	3	4	—	2	—	—	—	—
dormant oil	—	—	—	—	—	1	3	—	—	—	—	—	—	3	—	—	—	—	—	—	—	—	—	—
Endigo	2	—	1	2	2	—	2	—	—	—	1	1	1	1	—	—	—	1	—	1	—	—	—	—
Envidor	—	1	—	—	—	—	—	—	—	—	—	—	—	—	—	—	—	—	—	—	—	—	—	—
Esteem	—	—	4	3	—	—	—	—	—	3	2	—	—	2	—	—	1	1	3	—	—	—	—	—
Exirel	2	—	—	1	2	—	—	1	2	1	1	3	3	2	1	2	—	—	1	1	—	—	—	—
Gladiator	2	—	3	3	2	2	3	2	2	3	2	3	1	3	1	1	4	1	2	2	1	—	—	2
imidacloprid	4	—	2	—	—	—	1	—	—	—	—	—	—	1	—	1	3	1	—	3	—	—	—	3
Imidan	2	—	4	2	2	—	3	3	1	3	2	1	4	4	3	4	4	4	3	3	—	—	—	4
Intrepid	—	—	4	2	—	—	—	1	2	1	2	—	—	—	—	—	—	—	2	1	—	—	—	—
Kanemite	—	—	4	—	—	—	—	—	—	—	—	—	—	—	—	—	—	—	—	—	—	—	—	—
lambda-cyhalothrin	2	—	2	2	2	—	2	2	1	2	1	3	1	3	1	1	4	1	1	1	—	—	—	—
Lannate	4	—	1	2	3	—	3	2	2	2	2	3	2	3	1	2	3	2	1	1	—	—	—	4

(continued)

**Table 4-6. Apples: insecticide and miticide efficacy (continued).**

Pesticide <sup>a</sup>	Pest																							
	AM	ARM	BMSB	CM	EAS	ERM	GA	GFW	LAW	OBL	OFM	PC	PLH	RAA	RBL	RLH	SJS	STLM	TABM	TPS/SB	TSM	WAA	WALH	
Leverage	2	—	1	3	2	—	1	2	3	2	2	2	1	2	2	1	4	1	2	2	—	—	4	1
Minecto	2	2	—	1	2	1	—	1	2	1	1	3	3	2	1	2	—	1	1	—	—	—	—	2
Movento Pro	—	—	—	—	—	—	1	—	—	—	—	—	—	2	—	—	1	—	—	—	—	1	—	—
Mustang Max	—	—	3	2	2	—	2	—	1	2	1	—	—	—	1	—	—	1	1	1	—	—	—	1
Nealta	—	—	—	—	—	1	—	—	—	—	—	—	—	—	—	—	—	—	—	—	—	—	—	—
Neemix	—	4	4	—	4	4	3	4	—	4	—	4	4	4	4	4	4	4	4	4	4	4	4	4
Nexter	—	1	—	—	—	3	—	—	—	—	—	—	—	—	—	—	—	—	—	—	—	—	—	2
Onager	—	4	—	—	—	2	—	—	—	—	—	—	—	—	—	—	—	—	—	—	—	—	—	—
permethrin	—	—	3	3	2	—	3	2	—	3	2	3	—	3	1	2	4	2	—	1	—	—	4	2
Portal	—	—	—	—	—	1-2	—	—	—	—	—	—	—	—	—	—	—	—	—	—	—	—	—	—
Proclaim	—	—	4	3	—	—	—	2	3	1	3	—	—	—	1	—	—	1	1	—	—	—	—	—
PQZ	—	—	—	—	—	—	1	—	—	—	—	—	—	2	—	—	—	—	—	—	—	—	—	—
Rimon	—	—	—	2	—	—	—	—	2	2	2	—	—	—	1	—	—	1	1	—	—	—	—	—
Sivanto	—	—	—	—	—	—	1	—	—	—	—	—	1	1	—	1	3	1	—	—	—	—	4	1
summer oil	—	—	—	4	—	1	—	—	4	—	4	—	—	—	—	—	3	4	—	—	—	—	—	—
Surround	3	—	3	3	—	3	—	—	3	4	3	3	3	—	4	3	3	4	4	4	4	—	—	4
Ultror	—	—	—	—	—	—	1	—	—	—	—	—	—	2	—	—	1	—	—	—	—	—	—	1
Vendex	—	2	—	—	—	3	—	—	—	—	—	—	—	—	—	—	—	—	—	—	—	—	—	—
Venerate	—	—	3	—	—	—	—	—	—	—	—	—	3	—	—	—	3	—	—	3	—	—	—	—
Versys	—	—	—	—	—	—	2	—	—	—	—	—	—	2	—	—	—	—	—	—	—	—	—	—
Voliam Flexi	4	—	1	1	3	—	1	1	1	1	1	2	1	1	1	1	—	1	1	2	—	—	—	1
Vydate	—	2	—	—	—	3	3	—	—	—	—	—	2	2	—	2	4	2	—	2	2	4	2	2
Warrior II	2	—	2	2	2	—	2	2	1	2	1	3	1	2	1	1	4	1	1	1	1	—	—	1
Zeal	—	—	—	—	—	1-2	—	—	—	—	—	—	—	—	—	—	—	—	—	—	—	—	—	—

See Table 4-5 for pest name abbreviations.

Pest control rating system when used at recommended rates: 1 = excellent, 2 = good, 3 = fair, 4 = poor; — = not rated for this insect or mite. Ratings are based on moderate insect or mite pressure. Heavy infestation may require either higher dosage or shorter intervals, or both.

Fruit finish on yellow varieties when used as directed excellent for all products except the following: good for diazinon.

a. Uppercase names are trade names; lowercase names are common names for products with more than one trade name.

b. Danitol is less effective for late season ERM control.

**Table 4-7. Apples: fungicide timing.**

	Disease									
	Alternaria leaf blotch	Apple scab	Bitter rot	Black rot	Calyx-end rot	Flyspeck	Powdery mildew	Rusts	Sooty blotch	White rot
½-inch green	—	++	—	—	—	—	—	—	—	—
Prepink	—	++	—	—	—	—	++	—	—	—
Pink	—	++	—	—	—	—	++	++	—	—
Bloom period	—	++	++	++	+	—	++	++	—	++
Petal fall	++	++	++	++	+	—	++	++	—	++
First cover spray	++	++	++	++	+	—	++	+	—	++
Second cover spray	++	++	++	++	—	+	++	—	+	++
Third cover spray	+	+	++	++	—	+	—	—	+	++
Fourth cover spray	+	+	++	++	—	++	—	—	++	++
Fifth cover spray	+	+	++	++	—	++	—	—	++	++
Sixth cover spray	+	+	++	++	—	++	—	—	++	++
Seventh cover spray	+	+	++	++	—	++	—	—	++	++

++ = ideal timing of material for disease control; + = presence of disease and possible control; — = control generally is not needed at that time

**Table 4-8. Apples: fungicide and antibiotic efficacy.**

	Disease										
	Alternaria leaf blotch	Apple scab	Bitter rot	Black rot	Calyx-end rot	Fire blight	Flyspeck	Powdery mildew	Rusts	Sooty blotch	White rot
Aprovia <sup>c</sup>	3	1	3	3	3	6	2	3	3	2	3
Blossom Protect <sup>a</sup>	6	6	6	6	6	3	6	6	6	6	6
captan <sup>b</sup>	6	2	2	1	3	6	3	5	5	2	1
copper <sup>b,d</sup>	6	2	6	6	6	3	6	6	6	6	6
Double Nickel	6	3	3	3	6	3	3	3	4	3	3
ferbam <sup>b</sup>	3	3	3	2	4	6	3	5	2	3	2
Flint Extra <sup>b,c</sup>	6	1	5	2	6	6	2	1	3	1	6
Fontelis <sup>c</sup>	6	1	6	6	6	6	6	3	1	6	6
Indar <sup>b,c</sup>	6	1	6	6	6	6	1	3	1	1	6
Inspire Super <sup>b,c</sup>	1	1	6	6	6	6	1	2	1	1	6
kasugamycin	6	6	6	6	6	3	6	6	6	6	6
Kenja <sup>b,c</sup>	6	1	6	6	6	6	6	3	6	6	6
LifeGard	6	6	6	6	6	3	6	6	6	6	6
Luna Sensation <sup>b,c</sup>	6	1	5	1	6	6	1	1	2	1	1
Luna Tranquility <sup>c</sup>	6	1	6	6	6	6	6	1	6	6	6
Magister	6	6	6	6	6	6	6	1	6	6	6
mancozeb	2	2	2	2	2	6	4	5	2	4	2
Merivon <sup>b,c</sup>	1	1	1	1	1	6	1	1	2	1	1
Omega	3	2	3	2	6	6	2	6	3	2	3
oxytetracycline	6	6	6	6	6	4	6	6	6	6	6
polyoxin D zinc salt	3	3	3	3	6	6	2	3	6	2	3
potassium bicarbonate	3	2	5	5	6	6	5	3	6	4	5
Pristine <sup>b,c</sup>	1	1	1	1	1	6	1	1	2	1	1
Procure/Trionic <sup>b,c</sup>	6	2	6	6	6	6	6	1	1	6	6
Rally <sup>b,c</sup>	6	2	6	6	6	6	6	1	1	6	6
Regalia	6	3	3	3	6	3	3	3	3	3	3
Rhyme/Topguard <sup>c</sup>	6	2	6	6	6	6	6	1	2	6	6
Rubigan <sup>b,c</sup>	6	3	6	6	6	6	6	2	2	6	6
Scala <sup>c</sup>	6	1	6	6	6	6	6	6	6	6	6
Sercadis <sup>b,c</sup>	2	1	6	3	6	6	3	1	3	3	3
Serenade Opti	6	6	3	3	3	6	3	3	3	4	3
Sovran <sup>b,c</sup>	1	1	5	2	6	6	2	1	3	1	2
streptomycin <sup>c</sup>	6	6	6	6	6	1	6	6	6	6	6
Sulfur, lime	6	3	6	6	6	3	6	2	6	6	6
sulfur <sup>b</sup>	3	3	3	3	3	6	3	2	4	3	3
Syllit <sup>c</sup>	6	1	6	6	6	6	6	3	2	6	6
thiophanate-methyl <sup>b,c</sup>	6	4	6	3	2	6	1	2	6	1	3
Torino	6	6	6	6	6	6	6	1	6	6	6
Vanguard <sup>c</sup>	6	1	6	6	6	6	6	6	6	6	6
Ziram <sup>b</sup>	3	3	2	2	6	6	3	6	2	2	2

Degree of control: 1 = best, 2 = good, 3 = fair, 4 = slight, 5 = none, 6 = no registration; not labeled.

Uppercase names are trade names; lowercase names are common names for products with more than one trade name.

a. Blossom Protect can cause significant russetting when conditions favor apple scab during bloom and petal fall.

b. Fruit finish on yellow varieties when used as recommended: very good for captan, Flint Extra, Indar, Inspire Super, Kenja, Luna Sensation, Merivon, Pristine, Procure/Trionic, Rally, Rubigan, Sercadis, and Sovran; good for thiophanate-methyl and Ziram; poor for copper, ferbam, and sulfur.

c. Rankings assume no resistance in the pathogen population in an orchard; however, it is recommended to tank-mix with a broad-spectrum fungicide for maximum efficacy.

d. Not all coppers are labeled the same; refer to the specimen label of the copper being used for diseases covered.

**Table 4-9. Pears: insecticide and miticide timing.**

Time of spray	Pest													
	BMSB	CM	ERM	GA	GFW	LR	OFM	PC	PLBM	PP	PRM	SJS	TPB/SB	TSM
Dormant	—	—	+	+	+	—	—	—	+	++	+	++	—	—
Cluster bud	—	—	++	+	++	+	—	—	+	++	++	++	++	—
White bud	—	—	—	—	—	—	—	—	—	—	—	—	—	—
Petal fall	—	+	+	+	++	+	++	+	+	++	+	++	++	+
First cover spray	+	++	+	+	+	+	++	++	+	+	++	+	+	+
Second cover spray	+	++	++	+	—	+	+	++	+	++	+	++	+	++
Third cover spray	++	+	++	+	—	+	+	+	+	++	+	++	+	++
Fourth cover spray	++	+	++	+	—	+	+	—	—	+	+	+	+	++
Fifth cover spray	++	++	+	—	—	+	++	—	—	++	+	+	+	+

++ = ideal timing of material for control; + = presence of pest and possible control; — = control generally not needed

BMSB = brown marmorated stink bug; CM = codling moth; ERM = European red mite; GA = green aphids; GFW = green fruitworm; LR = leafrollers; OFM = Oriental fruit moth; PC = plum curculio; PLBM = pearleaf blister mite; PP = pear psylla; PRM = pear rust mite; SJS = San Jose scale; TPB = tarnished plant bug/native stink bugs; TSM = twospotted spider mite

**Table 4-10. Pears insecticide and miticide efficacy.**

Pesticide <sup>a</sup>	Pest													
	BMSB	CM	ERM	GA	GFW	LR	OFM	PC	PLBM	PP	PRM	SJS	TPB	TSM
Acramite	—	—	1	—	—	—	—	—	—	—	—	—	—	1
Actara	1	—	—	1	—	—	—	2	—	1	—	—	—	—
Agri-Flex	4	—	1	1	—	—	—	1	1	1	1	—	1	1
Agri-Mek	4	—	1	—	—	—	—	—	1	1	1	—	—	1
Altacor	4	1	—	—	1	1	1	4	—	—	—	—	—	—
Apollo	—	—	1	—	—	—	—	—	—	—	—	—	—	1
Apta	—	—	—	1	—	—	—	2	—	2	—	—	—	—
Asana XL	3	2	—	2	2	2	2	3	—	2	—	4	1	—
Assail	1	1	—	1	2	4	1	2	—	2	—	2	2	—
Avaunt	4	2	—	—	—	4	2	2	—	—	—	—	—	—
Belay	1	1	—	1	—	—	1	3	—	1	—	2	2	—
Beleaf	4	—	—	2	—	—	—	—	—	—	—	—	—	—
Besiege	2	1	—	2	—	1	1	—	—	1	—	—	—	—
Bexar	—	—	—	1	—	—	—	2	—	2	—	—	—	—
bifenthrin	1	3	—	3	2	1	3	3	—	2	—	4	1	—
Brigade	1	3	—	3	2	1	3	3	—	2	—	4	1	—
Bt	—	3	—	—	2	2	2	—	—	—	—	—	—	—
Centaur	4	—	—	—	—	—	—	—	—	2	—	1	—	—
chlorpyrifos	2	—	—	1	1	—	—	—	—	3	—	1	—	—
Closer	4	—	—	1	—	—	—	—	—	3	—	2-3	2	—
Cormoran	2	2	—	2	2	2	3	2	—	2	—	3	2	—
Cp GV	—	1	—	—	—	—	2	—	—	—	—	—	—	—
cyfluthrin	2	2	—	2	2	1	1	—	—	1	—	—	1	—
Danitol	1	2	2 <sup>b</sup>	—	—	2	1	3	—	1	—	—	—	—
Delegate	4	1	—	—	—	1	1	3	—	1	—	—	—	—
deltamethrin	—	2	—	2	1	1	1	3	—	1	—	—	1	—
diazinon	4	—	—	—	—	—	—	—	—	3	—	1	—	—
dormant oil	—	—	1	3	—	—	—	—	—	2	3	1	—	—
Endigo	1	2	—	1	—	1	1	—	—	1	—	—	1	—
Envidor	—	—	1	—	—	—	—	—	—	—	1	—	—	1
Esteem	4	1	4	4	—	2	—	—	—	2	—	1	—	—

(continued)

**Table 4-10. Pears insecticide and miticide efficacy (continued).**

Pesticide <sup>a</sup>	Pest													
	BMSB	CM	ERM	GA	GFW	LR	OFM	PC	PLBM	PP	PRM	SJS	TPB	TSM
Exirel	—	1	—	2	1	1	1	2	—	2	—	—	—	—
fenpyroximate	—	—	1	—	—	—	—	—	—	1	2	—	—	1
imidacloprid	—	—	—	1	—	—	—	—	—	2	—	3	4	—
Imidan	4	1	—	4	2	4	1	1	—	4	—	4	3	—
Intrepid	4	2	—	—	1	1	2	—	—	—	—	—	—	—
Kanemite	—	—	1	—	—	—	—	—	—	—	—	—	—	1
Lannate	1	2	—	1	1	1	2	3	—	3	—	4	2	—
Leverage	1	3	—	1	2	2	3	2	—	1	—	4	2	—
Minecto	—	1	1	2	1	1	1	2	—	1	—	—	—	1
Movento	—	—	—	1	—	—	—	—	—	1	—	1	—	—
Movento Pro	—	—	—	1	—	—	—	—	—	1	2	1	—	—
Mustang Max	3	2	—	2	2	1	1	—	—	2	—	—	1	—
Nealta	—	—	1	—	—	—	—	—	—	—	—	—	—	1
Nexter	—	—	1	—	—	—	—	—	—	3	1	—	—	3
Onager	—	—	1	—	—	—	—	—	—	—	1	—	—	1
permethrin	3	2	—	2	2	2	2	3	—	2	—	4	—	—
PQZ	—	—	—	2	—	—	—	—	—	—	—	—	—	—
Proclaim	4	3	—	—	2	1	3	—	—	—	—	—	—	—
Sivanto	—	—	—	1	—	—	—	—	—	2	—	2	—	—
Surround	3	3	—	—	—	4	3	3	—	2	—	3	—	—
Ultor	—	—	—	1	—	—	—	—	—	1	2	1	—	—
Venerate	—	—	—	3	—	—	—	—	—	3	—	3	—	—
Versys	—	—	—	1	—	—	—	—	—	—	—	—	—	—
Voliam Flexi	1	1	—	1	1	1	1	2	—	1	—	—	—	—
Vydate	2	—	1	3	—	—	—	—	2	3	2	—	1	1
Warrior II	2	2	—	2	2	1	1	1	—	1	—	—	1	—
Zeal	—	—	1	—	—	—	—	—	—	—	—	—	—	1

Pest control rating system when used at recommended rates: 1 = excellent, 2 = good, 3 = fair, 4 = poor; — = not registered or efficacy unknown

Fruit finish, when used as recommended, is excellent for all products except good for diazinon and fair for M-Pede.

See Table 4-9 for pest name abbreviations.

- a. Uppercase names are trade names; lowercase names are common names for products with more than one trade name.
- b. Danitol is less effective for late season ERM control.

**Table 4-11. Stone fruit: insecticide and miticide timing.**

Time of spray	Pest															
	BMSB	ERM	GPA	JB	LPTB	LR	LS	OFM	PC	PT	PTB	SB	SJS	TPB	TSM	WFT
Dormant	—	+	+	—	—	—	++	—	—	—	+	—	++	—	—	—
Pink	—	—	—	—	—	—	—	—	—	—	—	—	—	—	—	—
Petal fall	++	+	++	—	—	—	+	++	+	++	—	+	+	++	—	+
Shuck fall	++	+	+	—	—	+	+	+	++	—	+	+	+	++	—	+
First cover	++	+	+	+	+	+	+	+	++	—	+	+	+	+	+	—
Second cover	++	++	+	+	++	+	++	++	+	—	+	+	+	+	+	—
Third cover	++	++	—	++	++	+	++	++	—	—	++	+	++	+	+	—
Fourth cover	++	++	—	++	+	+	+	++	—	—	++	++	++	+	+	+
Fifth cover	++	++	—	++	+	++	+	++	—	—	++	++	++	+	+	++

++ = ideal timing of material for control; + = presence of pest and possible control; — = control generally not needed

BMSB = brown marmorated stink bug; ERM = European red mite; GPA = green peach aphid; JB = Japanese beetle; LPTB = lesser peachtree borer; LR = leafrollers; LS = lecanium scale; OFM = Oriental fruit moth; PC = plum curculio; PT = pear thrips; PTB = peachtree borer; SB = native stink bugs; SJS = San Jose scale; TPB = tarnished plant bug; TSM = twospotted spider mite; WFT = western flower thrips



**Table 4-12. Stone fruit: insecticide and miticide efficacy.**

Pesticide <sup>a</sup>	Pest															
	BMSB	ERM	GPA	JB	LPTB	LR	LS	OFM	PC	PT	PTB	SB	SJS	TPB	TSM	WFT
Acramite	—	1	—	—	—	—	—	—	—	—	—	—	—	—	1	—
Actara	1	—	1	3	—	—	—	—	2	—	—	1	—	1	—	—
Altacor	4	—	—	—	—	1	—	1	4	—	—	—	—	—	—	—
Apollo	—	1	—	—	—	—	—	—	—	—	—	—	—	—	1	—
Apta	—	—	1	—	—	3	—	—	2	3	—	3	—	—	—	3
Asana XL	3	—	3	2	1	1	4	2	3	—	1	2	—	2	—	2
Assail	1	—	1	2	4	4	2	1	2	—	4	2	2	2	—	—
Avaunt	4	—	—	2	3	2 <sup>b</sup>	—	2	1	—	3	2	—	3	—	—
Belay	1	—	1	—	—	—	—	—	2	—	—	1	2	1	—	—
Beleaf	4	—	2	—	—	—	—	—	—	—	—	3	—	3	—	—
Besiege	2	—	—	—	—	1	—	1	3	—	—	2	—	1	—	—
Bexar	—	—	1	—	—	3	—	—	2	3	—	3	—	—	—	3
Bt	—	—	—	—	—	2	—	4	—	—	—	—	—	—	—	—
carbaryl	3	—	4	1	4	4	4	2	3	—	4	3	4	3	—	4
Centaur	4	—	—	—	—	—	1	—	—	—	—	—	1	—	—	—
chlorpyrifos	2	—	—	—	1	—	1	—	—	—	1	—	1	—	—	—
Closer	3	—	1	—	—	—	4	—	—	3-4	—	3	2	2	—	2-3
Cormoran	2	—	1	2	—	2	—	2	2	4	—	2	3	1	—	2
cyfluthrin	2	—	3	2	—	1	—	1	—	—	—	2	—	2	—	—
Delegate	4	—	—	—	—	1	—	1	3	—	—	—	—	—	—	1
diazinon	4	—	—	—	—	—	1	—	—	—	—	3	1	3	—	—
dinotefuran	1	—	2	4	4	—	4	4	3	—	4	2	4	4	—	—
dormant oil	—	1	3	—	—	—	1	—	—	—	—	—	1	—	—	—
Endigo	1	—	1	2	—	1	—	1	1	—	—	1	—	1	—	—
Envidor	—	1	—	—	—	—	—	—	—	—	—	—	—	—	1	—
Esteem	4	—	4	—	—	—	1	2	—	—	—	—	1	—	—	—
Exirel	—	—	3	4	—	1	—	1	2	—	—	—	—	—	—	—
Gladiator	3	2	3	1	2	3	4	3	2	—	3	3	—	2	2	—
imidacloprid	2	—	1	3	—	—	—	—	3	—	—	2	2	3	—	—
Imidan	4	—	4	2	4	3	4	2	1	—	4	3	3	3	—	—
Intrepid	4	—	—	—	—	1	—	2	—	—	—	—	—	—	—	—
Lannate	1	—	2	2	—	1	—	2	2	—	—	1	—	1	—	2
Leverage	1	—	1	2	—	1	—	1	—	—	—	1	—	1	—	—
Madex HP	—	—	—	—	—	—	—	3	—	—	—	—	—	—	—	—
Minecto	—	1	3	4	—	1	—	1	2	—	—	—	—	—	1	—
Movento Pro	—	—	1	—	—	—	1	—	—	—	—	—	1	—	—	—
Mustang Max	3	—	—	—	—	1	—	1	—	—	—	2	—	1	—	—
Nexter	—	1	—	—	—	—	—	—	—	—	—	—	—	—	2	—
Onager	—	1	—	—	—	—	—	—	—	—	—	—	—	—	1	—
permethrin	3	—	3	2	2	1	—	1	3	—	2	3	—	3	—	2
Portal	—	1	—	—	—	—	—	—	—	—	—	—	—	—	1	—
PQZ	—	—	2	—	—	—	—	—	—	—	—	—	—	—	—	—
Ultor	—	—	1	—	—	—	1	—	—	—	—	—	1	—	—	—
Venerate XC	3	—	2	4	—	3	—	3	3	2	—	3	4	3	—	—
Versys	—	—	2	—	—	—	—	—	—	—	—	—	—	—	—	—
Voliam Flexi	1	—	2	3	—	1	—	1	2	—	—	2	—	2	—	—
Warrior II	2	—	3	2	—	1	—	2	3	—	—	2	—	2	—	—
Zeal	—	1	—	—	—	—	—	—	—	—	—	—	—	—	1	—

Pest control rating system when used at recommended rates: 1 = excellent, 2 = good, 3 = fair, 4 = poor, — = not rated for this insect or mite

See Table 4-11 for pest name abbreviations.

a. Uppercase names are trade names; lowercase names are common names for products with more than one trade name.

b. Avaunt will not provide control of obliquebanded leafroller.

**Table 4-13. Stone fruit: fungicide and antibiotic timing.**

Time of spray	Disease						
	Bacterial spot	Brown rot	Cherry leaf spot	Cytospora canker	Leaf curl	Powdery mildew <sup>a</sup>	Scab <sup>a</sup>
Dormant	++ <sup>b</sup>	—	—	—	++ <sup>b</sup>	—	++ <sup>b</sup>
Pink	—	—	—	++	—	++	+
Bloom	—	++	++ <sup>c</sup>	++	—	++	++
Petal fall	—	—	++	++	—	++	++
Shuck split	++	++	++	++	—	++	++
Shuck fall	++	—	++	++	—	++	++
First cover spray	++	++	++	++	—	++	++
Second cover spray	++	++	++	++	—	++	++
Third cover spray	++	+	++	—	—	—	—
Fourth cover spray	++	++	++	—	—	—	—
Fifth cover spray	++	++	—	—	—	—	—
Preharvest	—	++	—	—	—	—	—
Postharvest	—	+	++	—	—	—	—

++ = ideal timing of material for control; + = presence of pest and possible control; — = control generally not needed

a. Control for the primary phase of the disease indicated. If disease is controlled early, third through harvest covers will not be necessary.

b. Dormant copper applications.

c. For cherry leaf spot control, begin applications at bloom when bract leaves have emerged and continue applications at 7- to 14-day intervals. A postharvest application is recommended to maintain control and reduce overwintering inoculum.

**Table 4-14. Stone fruit: fungicide and antibiotic efficacy.**

Pesticide <sup>a</sup>	Disease						
	Bacterial spot	Brown rot	Cherry leaf spot	Cytospora canker	Leaf curl	Powdery mildew	Scab
Bumper, Tilt	6	1	1	6	6	2	3
Cabrio <sup>b</sup>	6	1	6	6	6	1	6
captan	6	2	4	6	4	4	2
chlorothalonil	6	2	1	6	1	4	6
copper	2	5	2	4	1	3	4
Elevate	6	2	6	6	6	6	6
ferbam	6	3	2	4	1	4	4
Flint Extra <sup>b,c</sup>	6	1	1	6	6	1	1
Fontelis <sup>b,c</sup>	6	1	1	6	6	1	1
Indar <sup>b,c</sup>	6	1	1	6	6	6	2
Inspire Super <sup>b,c</sup>	6	1	6	6	6	1	3
iprodione <sup>b,c</sup>	6	2	6	6	6	6	2
Kenja	6	1	6	6	6	6	6
Luna Experience <sup>c</sup>	6	1	6	6	1	1	1
Luna Sensation <sup>c</sup>	6	1	1	6	6	1	1
Magister SC	6	6	6	6	6	1	6
Merivon <sup>c</sup>	6	1	1	6	6	1	1
Orius <sup>b</sup>	6	1	1	6	6	1	6
oxytetracycline	2	6	6	6	6	6	6
Pristine <sup>c</sup>	6	1	1	6	6	1	1
Quash <sup>b,c</sup>	6	1	1	6	6	1	1
Quintec <sup>c</sup>	6	6	6	6	6	1	6
Rally <sup>c</sup>	6	3	6	6	6	1	6
Regalia	3	3	3	6	6	3	3
Rhyme, TopGuard	6	2	2	6	6	2	6
Scala <sup>c,d</sup>	6	2	6	6	6	6	6
Serenade Opti/ASO	3	3	3	6	6	3	6
sulfur, lime	6	3	6	6	6	2	3
sulfur	6	4	6	6	4	3	3
Syllit <sup>c,d</sup>	6	3	2	6	1	6	2
thiophanate-methyl	6	1	2	6	5	2	2
Thiram Granuflo	6	1	6	6	1	6	1
Torino	6	6	6	6	6	1	6
Vivando	6	6	6	6	6	1	6
Ziram	6	2	4	6	1	6	3

Degree of control: 1 = best, 2 = good, 3 = fair, 4 = slight, 5 = none, 6; no registration or not labeled

a. Uppercase names are trade names; lowercase names are common names for products with more than one trade name.

b. Rankings assume no resistance to the active ingredient of the bactericide or fungicide in the pathogen population in your orchard.

c. Effectiveness on stone fruit diseases are recommended to tank-mix the product with captan, especially during the early season.

**Table 4-15. Reentry (REI) and preharvest (PHI) or spray-to-harvest intervals.**

isted below are pesticides used on tree fruits. Not all materials listed here are suggested in the spray schedules. Pesticides used at the rates and times suggested should be within the legal residue tolerance at harvest. Pomace made from apples or pears sprayed according to these suggestions may contain illegal residues if used for animal feeds. Always check the label for the actual REI and PHI.

**Key**

—	no registration	D	dormant only	NE	not established	SD	soil drench or spray
0–60	PHI	EC	early cover sprays	P	to pink bud	SF	to shuck fall
B	remove residue by brushing	FB	full bloom	PB	Prebloom	SS	to shuck split
BBB	do not apply after bud break	HG	½-inch green	PF	to petal fall		
BH	before harvest	LB	to late bloom	PH	postharvest		
BPH	before pit hardening (stone fruit)	LC	to late cover sprays	SC	second cover or ½-inch fruit diameter		

	REI (hrs)	PHI (days)						
		Apple	Pear	Peach	Nectarine	Apricot	Cherry	Plum
<b>Antibiotics</b>								
agricultural streptomycin	12	50	30	—	—	—	—	—
Agri-mycin 17 (streptomycin)	12	50	30	—	—	—	—	—
Blossom Protect	4	FB–LB	FB–LB	—	—	—	—	—
FireLine (oxytetracycline)	12	60	60	21	21	—	—	—
FireWall (streptomycin)	12	50	30	—	—	—	—	—
Kasumin (kasugamycin)	12	90	90	—	—	—	—	—
Mycoshield (oxytetracycline)	12	60	60	21	21	—	—	—
<b>Fungicides</b>								
Aliette WDG (bearing—pome fruit)	12	14	14	—	—	—	—	—
Aliette WDG (nonbearing—pome fruit and stone fruit)	12	365	365	365	365	365	365	365
Aprovia	12	30	30	—	—	—	—	—
Bravo Weather Stik	12	—	—	SS	SS	SS	SS (PH)	SS
Bumper 41.8 EC	12	—	—	0	0	0	0	21
Cabrio EG	12	—	—	—	—	—	0	—
Captan <sup>a</sup>	24	0	—	0	0	0	0	0
Chlorothalonil 720	12	—	—	SS	SS	SS	SS (PH)	SS
<b>Copper<sup>b</sup></b>								
Double Nickel	4	0	0	0	0	0	0	0
Elevate 50 WDG	12	—	0	0	0	0	0	0
Ferbam 76 WDG	24	7	7	21	—	21	4	7
Flint Extra	12	14	14	1	1	1	1	1
Fontelis	12	28	28	0	0	0	0	0
Indar 2F	12	14	—	0	0	0	0	0
Inspire Super	12	14	14	2	2	2	2	—
Kenja 400SC	12	20	20	—	—	—	—	—
Lime sulfur	48	D–PF	0	0	0	—	0	0
Luna Experience	12	—	—	14	14	14	14	14
Luna Sensation	12	14	14	1	1	1	1	1
Luna Tranquility	12	72	—	—	—	—	—	—
Magister SC	12	7	7	3	3	3	3	3
Mancozeb <sup>c</sup>	24	77	77	—	—	—	—	—
Merivon	12	0	0	0	0	0	0	0
Meteor	24 <sup>a</sup>	—	—	PF	PF	PF	PF	PF
Omega 500F	12	28	—	—	—	—	—	—
Orius 20AQ	12	—	—	0	0	0	—	—
Oso 5% SC	4	0	0	0	0	0	0	0
Ph-D	4	0	0	0	0	0	0	0

**Table 4-15. Reentry (REI) and preharvest (PHI) or spray-to-harvest intervals (continued).**

	REI (hrs)	PHI (days)						
		Apple	Pear	Peach	Nectarine	Apricot	Cherry	Plum
Phostrol	4	0	0	0	0	0	0	0
Polyram 80 DF	24	77	—	—	—	—	—	—
Pristine	12	0	0	0	0	0	0	0
Procure 480SC	12	14	14	—	—	—	1	—
ProPhyt	4	0	0	0	0	0	0	0
PropiMax EC	12	—	—	0	0	0	0	21
Protocol	48	—	—	1	1	1	1	1
Quash	12	—	—	14	14	14	14	14
Quintec	12	—	—	7	7	7	7	7
Rally 40WSP	24	14	—	0	0	0	0	0
Rampart	4	0	0	0	0	0	0	0
Regalia	4	0	0	0	0	0	0	0
Rhyme	12	14	14	7	7	7	7	7
Ridomil Gold SL	48	365	365	365	365	365	365	365
Rovral	24 <sup>a</sup>	—	—	PF	PF	PF	PF	PF
Rubigan E.C.	12	30	30	—	—	—	0 (PH)	—
Scala SC	12	72	72	2 <sup>d</sup>	2 <sup>d</sup>	2 <sup>d</sup>	—	2 <sup>d</sup>
Sercadis	12	0	—	—	—	—	—	—
Serenade	4	0	0	0	0	0	0	0
Sil-Matrix	4	0	0	0	0	0	0	0
Sovran	12	30	30	—	—	—	—	—
Sulfur	24	LC <sup>e</sup>	LC <sup>f</sup>	LC	LC	LC	LC	LC
Syllit FL	48	TC	7	7	7	—	7	—
Thiram Granuflo	24	—	—	7	—	—	—	—
Tilt	12	—	—	0	0	0	0	21
Topguard	12	14	14	7	7	7	7	7
Topsin M WSB	48	1	1	1	1	1	1	1
Torino	4	14	14	—	—	—	6	—
Trionic 4SC	12	14	14	—	—	—	1	—
Vanguard WG	12	0	0	2	2	2	2 <sup>g</sup>	2 <sup>d</sup>
Vivando	12	—	—	7	7	7	7	—
Ziram 76DF	48	14	14	14	14	30	14	—
<b>Plant defense inducers</b>								
Actigard	12	60	—	—	—	—	—	—
LifeGard	4	0	0	—	—	—	—	—
Vacciplant	4	0	0	0	0	0	0	0
<b>Plant growth regulators</b>								
Amid-Thin W	48	NE	NE	—	—	—	—	—
Apogee	12	45	—	—	—	—	20	—
Blush	4	NE	—	—	—	—	—	—
Ethephon	48	7	—	—	—	—	7	—
Exilis Plus	12	86	—	—	—	—	—	—
Exilis Plus (in latex paint)	12	BBB	BBB	—	—	—	BBB	—
Falgro 4L	4	—	—	0	0	0	0	0
Fruitone L	48	2	2	—	—	—	—	—
Fruitone N	48	2	2	—	—	—	—	—
Fysium	24.5	NE	—	—	—	—	—	—
GibGro 4LS	4	NE	—	0	0	0	0	0
Harvista	4	3	3	—	—	—	—	—
Kudos	12	45	—	—	—	—	20	—

(continued)

**Table 4-15. Reentry (REI) and preharvest (PHI) or spray-to-harvest intervals (continued).**

	REI (hrs)	PHI (days)						
		Apple	Pear	Peach	Nectarine	Apricot	Cherry	Plum
MaxCel (bearing—apple and pear)	12	86	86	—	—	—	—	—
MaxCel (branching nonbearing trees)	12	365	365	—	—	—	365	—
MaxCel (in latex paint)	12	BBB	BBB	—	—	—	BBB	—
Motivate	48	7	—	—	—	—	7	—
Novagib 10L	4	NE	—	—	—	—	NE	—
Perlan	4	NE	365	—	—	—	365	—
PoMaxa	48	2	2	—	—	—	—	—
ProGibb 4%	4	—	—	0	0	0	0	0
ProGibb 40%	4	0	—	—	—	—	7	—
Promalin (for branching)	4	NE	365	365	—	—	365	—
Promalin (for fruit shape)	4	NE	—	—	—	—	—	—
ProVide	4	NE	—	—	—	—	—	—
ReTain	12	7	7	7	7	7	—	7
ReTain (increase fruit set)	12	PF	PF	—	—	—	—	—
RiteWay	12	86	86	—	—	—	—	—
SmartFresh	24.5	NE	—	—	—	—	—	—
Splendor	12	NE	—	—	—	—	7	—
TRE-HOLD A-112	12	D	D	—	—	—	—	—
Typy (for fruit shape)	24	NE	—	—	—	—	—	—
Typy (for branching)	24	NE	365	365	—	—	365	—
Verve	48	7	—	—	—	—	7	—
<b>Insecticides/miticides</b>								
Abacus	12	28	28	21	21	21	21	21
Abba 0.15EC	12	28	28	21	21	21	21	21
Acramite 50WS	12	7	7	3	3	3	3	3
Actara	12	14–35 <sup>h</sup>	14–35 <sup>h</sup>	14	14	14	14	14
Admire PRO	12	7	7	0	0	0	7	7
Agree	4	0	0	0	0	0	0	0
Agri-Flex	96	35	35	—	—	—	—	—
Agri-Mek 0.15EC	12	28	28	21	21	21	21	21
Altacor	4	5	5	10	10	10	10	10
Ambush 25W	12	PF	PB	14	—	—	3	—
Apollo SC	12	45	21	21	21	21	21	—
Apta	12	14	14	14	14	14	14	14
Arctic 3.2 EC	12	PF	PB	14	14	—	3	—
Asana XL	12	21	28	14	14	14	14	14
Assail 30SG	12	7	7	7	7	7	7	7
Avaunt	12	14	28	14	14	14	14	14
Aza-Direct	4	0	0	0	0	0	0	0
Azatin XL	4	0	0	0	0	0	0	0
Baythroid XL	12	7	7	7	7	7	7	7
Belay	12	7	7	21	—	—	—	—
Beleaf 50 SG	12	21	21	14	14	14	14	14
Besiege	24	21	21	14	14	14	14	14
Bexar	12	14	14	14	14	14	14	14
Biobit HP	4	0	0	0	0	0	0	0
BioCover MLT	4	0	0	0	0	0	0	0
Brigade 2 EC/WSB	12	—	14	—	—	—	—	—
Carbaryl 4L	12	3	3	3	3	3	3	3

**Table 4-15. Reentry (REI) and preharvest (PHI) or spray-to-harvest intervals (continued).**

	REI (hrs)	PHI (days)						
		Apple	Pear	Peach	Nectarine	Apricot	Cherry	Plum
Carpovirusine	4	0	0	—	—	—	—	—
Centaur WDG	12	14	14	14	14	14	14	14
chlorpyrifos 4E	96	PB/28	PB	PB/14 <sup>i</sup>	PB/14 <sup>i</sup>	PB/14	21	PB/21 <sup>i</sup>
Closer	12	7	7	7	7	7	7	7
Cormoran	12	14	12	8	8	8	8	8
Cyd-X	4	0	0	—	—	—	—	—
Cyd-X HP	4	0	0	—	—	—	—	—
Danitol 2.4EC	24	14	14	3	3	3	3	3
Declare	24	21	21	14	14	14	14	14
Delegate	4	7	7	1	1	14	7	7
Deliver	4	0	0	0	0	0	0	0
Delta Gold	12	21	21	—	—	—	—	—
Diazinon 50W	96	21 <sup>j</sup>	21 <sup>j</sup>	21 <sup>j</sup>	21 <sup>j</sup>	21	21 <sup>j</sup>	21 <sup>j</sup>
Dimate 4E	240	—	28	—	—	—	—	—
Dimethoate 4EC	48	—	28	—	—	—	—	—
Dimilin25W	12	—	14	—	—	—	—	—
Dipel	4	0	0	0	0	0	0	0
Discipline	12	—	14	—	—	—	—	—
Dormant plus oil	12	D	D	D	D	D	D	D
Endigo ZC	24	35	35	14	14	14	14	14
Envidor 2SC	12	7	7	7	7	7	7	7
Esteem 0.86EC/35WP	12	45	45	14	14	14	14	14
Entrust	4	7	7	1	1	14	7	7
Exirel	12	3	3	3	3	3	3	3
Gladiator	12	28	28	21	21	21	21	21
Imidan 70WP	168	14	14	14	14	14	—, 7 <sup>k</sup>	7
Intrepid 2F	4	14	14	7	7	7	7	7
JMS Stylet oil	4	0	0	0	0	0	0	0
Kanemite 15SC	12	14	14	—	—	—	7	—
Karate	24	21	21	14	14	14	14	14
Lambda-Cy	24	21	21	14	14	14	14	14
Lannate SP, LV	72–96	14	7	4	1 <sup>l</sup>	—	—	—
Leverage 2.7 SE	12	7	7	7	7	7	7	7
Lorsban 75WG	96	PF	—	—, 14 <sup>m</sup>	—, 14 <sup>m</sup>	—	—, 21 <sup>m,n</sup>	—
Lorsban Advanced	96	PB <sup>o</sup>	—	PB/14	PB/14	—	PB/21	—
Madex HP	4	0	0	0	0	0	0	0
Magister SC	12	7	7	3	3	3	3	3
Malathion 5EC	12–24	—	1	7	7	6	3	—
Malathion 8	12	—	—	7	7	7	—	—
Malathion 57	12–24	—	1	7	7	6	3	—
Malathion ULV	12	—	—	—	—	—	1	—
Minecto Pro	12	28	28	21	21	21	21	21
Mite-E-Oil	4	0	0	0	0	0	0	0
Movento	24	7	7	7	7	7	7	7
M-Pede	12	0	0	0	0	0	0 <sup>p</sup>	0
Mustang Max	12	14	14	14	14	14	14	14
Nealta	12	7	7	—	—	—	—	—
Neemix 4.5	12	0	0	0	0	0	0	0
Nexter	12	25	7	7	7	300	300	7
Onager	12	28	28	7	7	7	7	7

(continued)

**Table 4-15. Reentry (REI) and preharvest (PHI) or spray-to-harvest intervals (continued).**

	REI (hrs)	PHI (days)						
		Apple	Pear	Peach	Nectarine	Apricot	Cherry	Plum
Permethrin 3.2EC	12	PF	PB	14	14	—	7	—
Perm-Up 3.2 EC, 25DF	12	PF	PB	14	14	—	3	—
Portal XLO	12	14	14	7	7	7	7	7
Pounce 25WP	12	PF	PB	14	14	—	3	—
PQZ	12	14	14	7	7	7	7	7
Prey 1.6	12	7	7	0	0	0	7	7
Proaxis	24	21	21	14	14	14	14	14
Proclaim	12–48	14	14	—	—	—	—	—
Provado 1.6F	12	7	7	0	0	0	7	7
Rimon 0.83EC	12	14	14	8	8	8	8	8
Scorpion	12	—	—	3	3	—	—	—
Sevin XLR	12	3	3	3	3	3	3	3
Sivanto	4	14	14	14	14	14	14	14
Superior Spray Oil	12	0	0	0	0	0	0	0
Surround WP	4	0 <sup>a</sup>	0 <sup>a</sup>	0 <sup>a</sup>	0 <sup>a</sup>	0 <sup>a</sup>	0 <sup>a</sup>	0 <sup>a</sup>
Tombstone	12	7	7	7	7	7	7	7
Trilogy	4	0	0	BPH	BPH	BPH	BPH	BPH
Tundra EC	12	—	14	—	—	—	—	—
Ultor	24	7	7	7	7	7	7	7
Vendex 50WP	48	14	14	14	14	—	14	14
Venerate XC	4	0	0	0	0	0	0	0
Versys	12	7	7	7	7	7	7	7
Virosoft CP4	4	0	0	—	—	—	—	0
Voliam Flexi	12	35	35	14	14	14	14	14
Vydate L	48	14	14	—	—	—	—	—
Warhawk	96	PB	PB	D/14	D/14	—	D/21	D
Warrior II	24	21	21	14	14	14	14	14
Yuma 4E	96	D	D	D/14	D/14	—	D/21	D
Zeal 72WDG	12	14	14	7	7	7	7	7
Zoro	12	28	28	—	—	—	—	21
<b>Nematicides and fumigants</b>								
Basamid G	120	1 year	1 year	1 year	1 year	1 year	1 year	1 year
DiTera DF	4	—	—	—	—	—	—	—
Telone (all formulations)	120	—	—	—	—	—	—	—
Vapam HL	120	—	—	—	—	—	—	—
Velum Prime	12	7	7	0	0	0	0	0
Vydate L	48	—	—	—	—	—	—	—

- a. Do not enter or allow worker entry into treated areas during the restricted entry interval of 48 hours for grapes. The restricted entry interval for all other WPS uses is 24 hours.
- b. Copper restrictions vary with formulations and active ingredients. Read the label for the specific copper being applied.
- c. Some equivalent products include Dithane, Manzate, and Penncozeb.
- d. Do not make more than two applications of a Group 9 fungicide within 30 days of harvest.
- e. Do not apply to sensitive apple varieties.
- f. Do not apply to D'anjou pear.
- g. Do not apply to sweet cherry.
- h. 14-day PHI for Actara used at rate equal or less than 2.75 ounces per acre; 35-day PHI for use of more than 2.75 ounces per acre.
- i. Exceptions are PTB and LPTB trunk-only sprays.
- j. Only one dormant and one application per growing season are allowed.
- k. Imidan is not registered for use on sweet cherries; up to seven days preharvest on tart cherries.
- l. Lannate LV is not registered for use on nectarines.
- m. Lorsban 75 WG can be applied directly to tree trunk for borer control on cherries (PHI is 21 days) and peach and nectarine (PHI is 14 days).
- n. Lorsban is recommended for sour cherries only.
- o. Lorsban Advanced and 50W can be used on apples as a direct trunk spray for the control of borers with a 28-day PHI.
- p. Do not use M-Pede on sweet cherries when fruit are present.
- q. To avoid Surround residue on fruit, it is recommended that applications be stopped in adequate time before harvest (see the label).



# V

## INTEGRATED PEST MANAGEMENT SPRAY PROGRAMS

### CONTENTS

<b>Apple IPM Program.....</b>	<b>290</b>	Apricots—Petal Fall.....	314
Apples—Dormant to Silver Tip.....	290	Apricots—Shuck Split, First, Second Cover to Preharvest....	314
Apples—Green Tip.....	290	Apricots—Postharvest Disorders and Diseases .....	316
Apples—½-Inch Green Delayed Dormant .....	290	<b>Sweet Cherry IPM Program.....</b>	<b>316</b>
Apples—Tight Cluster to Open Cluster.....	291	Sweet Cherries—Dormant.....	316
Apples—Pink.....	292	Sweet Cherries—Prebloom.....	316
Apples—Bloom.....	294	Sweet Cherries—Bloom.....	317
Apples—Petal Fall.....	294	Sweet Cherries—Petal Fall.....	317
Apples—First Cover.....	296	Sweet Cherries—Shuck Fall, First Cover.....	318
Apples—Second, Third, and Fourth Covers.....	297	Sweet Cherries—Second Cover.....	319
Apples—Fifth Cover.....	299	Sweet Cherries—Preharvest .....	320
Apples—Sixth and Seventh Covers.....	300	Sweet Cherries—Postharvest Disorders and Diseases.....	321
Apples—Final Cover to Postharvest.....	301	<b>Tart Cherry IPM Program .....</b>	<b>321</b>
<b>Pear IPM Program.....</b>	<b>302</b>	Tart Cherries—Dormant .....	321
Pears—Dormant to Green Tip .....	302	Tart Cherries—Prebloom.....	321
Pears—Green Cluster Bud.....	302	Tart Cherries—Bloom.....	322
Pears—White Bud, Popcorn Stage .....	303	Tart Cherries—Petal Fall .....	322
Pears—Bloom.....	303	Tart Cherries—Shuck Fall .....	323
Pears—Petal Fall, First through Fifth Covers.....	303	Tart Cherries—First, Second (Maggot Spray), Third Covers .....	324
Pears—Sixth Cover, Early August.....	305	Tart Cherries—Preharvest.....	325
Pears—Final Cover to Postharvest.....	306	Tart Cherries—Postharvest .....	326
<b>Peach and Nectarine IPM Program .....</b>	<b>306</b>	<b>Plum and Prune IPM Program .....</b>	<b>326</b>
Peaches and Nectarines—Dormant, Before Bud Swell.....	306	Plum and Prune—Dormant.....	326
Peaches and Nectarines—Pink to First Open Bloom .....	306	Plum and Prune—Prebloom .....	326
Peaches and Nectarines—Bloom.....	307	Plum and Prune—Bloom.....	326
Peaches and Nectarines—Petal Fall.....	307	Plum and Prune—Petal Fall, Shuck Fall, First and Second Covers .....	326
Peaches and Nectarines—Shuck Split, Shuck Fall.....	309	Plum and Prune—Third and Fourth Covers.....	328
Peaches and Nectarines—First, Second, Third Covers.....	310	Plum and Prune—Fifth Cover, Preharvest.....	329
Peaches and Nectarines—Fourth and Later Covers.....	311	Plum and Prune—Postharvest Disorders and Diseases .....	329
Peaches and Nectarines—Before Harvest.....	312		
Peaches and Nectarines— Postharvest Disorders and Diseases.....	313		
Peaches and Nectarines—Fall Leaf Drop.....	313		
<b>Apricot IPM Program.....</b>	<b>313</b>		
Apricots—Dormant.....	313		
Apricots—Pink to First Open Bloom .....	313		
Apricots—Bloom.....	314		

Below are pesticide application timings and some recommended options for pest control. The “pesticide” column lists some possible pesticide options to apply and the “recommended rate per acre” column lists the rate per acre. We recommend that at least 50 gallons per acre be applied in most situations and that at least 100 gallons per acre be applied for particularly serious situations, such as heavy mite populations, potential for severe scab infection, high probability of fruit damage from the leafrollers and internal fruit feeders (e.g., Oriental fruit moth, codling moth), or on large trees. Note that the amount per sprayed acre is equivalent to spraying 1 acre of orchard if both sides of the tree are sprayed and 2 acres of orchard if alternate sides of the tree are sprayed. To help growers with pesticide resistance management, FRAC and IRAC Group codes are included with fungicide and insecticide options.

## APPLE IPM PROGRAM

An important part of an integrated pest management (IPM) program can be implemented by applying pesticides using either complete or alternate row middle (ARM) sprays. If using ARM sprays, do not stretch intervals between half-sprays beyond seven days unless pest pressure is low. When using fungicides, ARM spray application intervals should be 3 to 4 days during the early season when controlling for apple scab, especially if conditions are favorable for disease and frequent rain events occur, causing fungicides to wash off. Growers are advised to use complete sprays, instead of ARM, from bloom through petal fall because the greatest threat for apple scab occurs during this period since the available number of overwintering apple scab spores is at its highest. In addition, complete sprays are necessary during bloom for managing fire blight. When using insecticides, if multiple sprays are necessary to control codling moth, for the first spray at egg hatch consider using a complete spray that covers the whole tree, rather than an ARM spray, to get maximum fruit protection at this critical time before larvae get into the fruit and are protected. Previous research showed that only about 20 percent of the spray can be found on the opposite side of the tree in an initial ARM spray. Additional sprays for codling moth can then be made by ARM 12 to 14 days later, but on a seven-day schedule for the rest of the generation. However, some products, such as Intrepid, have been shown to be much more effective in controlling codling moth and other pests when applications are made complete (every row-middle) on a 12- to 14-day schedule than when applied ARM on a seven-day schedule.

For ARM sprays to be effective for insect and disease control: (1) Use a sprayer capable of partial coverage of the nonsprayed side of each tree row. Sprayers with less than 90,000 cfm and 180 psi are not likely to be successful in this program unless trees are not more than 12 feet high or the rows 25 feet apart. Intermediate airflow sprayers can be used when they are properly matched with the tree size to be sprayed. (2) Adjust the interval between half-sprays as pest pressures increase or decrease.

The advantages of integrated pest management programs include the following: (1) less pesticide is used and it is optimally targeted to the pest at critical times; (2) time and orchard equipment are managed more efficiently; (3) predators and parasitoids are conserved for biological mite, aphid, and scale control; (4) populations of other parasites and predators for other pests may also increase; and (5) the

probability of pesticide resistance development is decreased. If scab, powdery mildew, and other diseases were present the previous year or if weather conditions become favorable for disease outbreaks, shorten spray intervals and increase rates.

## Apples—Dormant to Silver Tip

**Special fire blight and apple scab spray.** Where apple scab and/or fire blight were severe last year, applying a copper spray at silver tip will aid in reducing the amount of bacteria and scab fungi available for infection later in the spring. Do not apply copper to apples after ¼-inch green leaf stage or when drying conditions are slow, as severe injury can occur. The recommended rate for dormant copper applications is 2 pounds of metallic copper per acre. Copper and its residue have many compatibility problems with other pesticides. For more information, see copper in Part III.

**Special dormant oil or chlorpyrifos spray for insects.** Oil is effective in San Jose scale and mite control, killing the mites by forming a film over the overwintering eggs or the whole scale to suffocate them, so coverage is critical. For mite and/or San Jose scale control, make oil applications between silver tip and ½-inch green and use a minimum of 100 gallons of water per acre and a rate of at least 3 to 4 gallons per acre. Oil for mites can be applied until ½-inch green at this rate. Oil can cause plant injury if used improperly and is not compatible with Captan, but it is compatible with copper sprays for fire blight and apple scab at this same timing (see also Part III: Chemical Management). The use of chlorpyrifos (Lorsban) at dormant appears to be losing some of its efficacy on San Jose scale, and it is ineffective on rosy apple aphid in most orchards. The long residual activity of chlorpyrifos on twigs, however, has been shown to give seasonal control of woolly apple aphid. Use of chlorpyrifos for the tree canopy spray after delayed dormant stage is illegal and can be very toxic to honey bees and wild bees for several days after application due to its high vapor activity.

## Apples—Green Tip

**Apple scab and fire blight.** In most years apple scab spores are mature and available for infection by green tip. The first fungicide application for apple scab should be applied at green tip. If copper was not applied during dormancy or a significant amount of rain has occurred since the dormant application, a copper application at this time will contribute to the control of many of the early season apple diseases including apple scab and fire blight. The recommended rate for dormant copper applications is 2 pounds of metallic copper per acre. Read the label of the copper material you are using for restrictions.

## Apples—½-Inch Green Delayed Dormant

**Apple scab.** For effective scab control, apply at least two half-sprays or one complete spray before the first infection period.

**Rosy apple aphid.** Oil alone will not prevent rosy aphid (RAA) injury, and most orchards have some level of resistance to either chlorpyrifos or pyrethroids. In apple, pyrethroids are now mostly just effective on tarnished plant bugs. When Esteem is used in alternate row middle sprays, apply the first spray at green tip and the second spray no later than ½-inch green. In orchards where

rosy apple aphids have caused problems in the past, an aphicide such as Assail, Beleaf, or Sivanto may be needed. Only the most bee-safe of the neonicotinoid compounds (Assail, Sivanto, and Beleaf) are recommended for prebloom applications. Beleaf is a neonicotinoid alternative that is very effective on RAA and considered to be very safe for bees. Beleaf is also systemic and has been found in the pollen and nectar from pink applications, but because of its safety to bees, application timing is more flexible and we recommend a single application anytime from ½-inch green to pink. Assail is not recommended at any time during the bloom period. Petal fall sprays also put localized wild pollinators at risk that are feeding on late blossoms. See Table 4-4 for pesticide impacts on bees.

<b>Pesticide recommendations for apples, ½-inch green.</b>		
FRAC or IRAC Group	Pesticide	Recommended rate per acre
U12	Syllit FL <sup>a,b</sup>	1.5 pt
	Lime sulfur <sup>c</sup>	2.5–3% solution
M3	Penncozeb 75DF <sup>d,e</sup>	3 lb
M3	Polyram 80DF <sup>d,e</sup>	3 lb
M3	Ziram 76DF	3 lb
M4	Captan 80WDG <sup>e,f</sup>	2.5–3 lb
<b>OR select one of the following to be applied alone:</b>		
M3	Ferbam 76WDG	4 lb
M3	Penncozeb 75DF <sup>d</sup>	6 lb
M3	Polyram 80DF <sup>d</sup>	6 lb
M3	Ziram 76DF	6–8 lb
M4	Captan 80WDG <sup>f</sup>	5 lb
<b>PLUS:</b>		
	Dormant oil <sup>1</sup>	3 gal
<b>PLUS one or more of the following based on the insect pest complex requiring control:</b>		
3A	Asana XL 0.66EC	6–12 fl oz
4A	Assail 30 SG	2.5–4 oz
3A	Battalion 0.2EC	7–14 fl oz
3A	Baythroid 2E2	2.8 fl oz
9C	Beleaf 50SG	2.8 oz
3A	Danitol 2.4 EC	10.7–21.3 fl oz
7C	Esteem 35WP	4–5 oz
3A	Mustang Max	1.3–4 fl oz
3A	Permethrin 2EC	8–12 fl oz
3A	Permethrin 3.2EC	5–7.5 fl oz
3A	Permethrin 25WP	0.5–0.75 lb
3A	Proaxis 0.5EC	2.5–5.1 fl oz
4D	Sivanto 200SL	10.5 oz
3A	Warrior II	1.3–2.5 fl oz

### Fungicide and Antibiotic Notes

- a. Tank-mix Syllit with 3 pounds of mancozeb.
- b. Do not apply after tight cluster.
- c. Use on sensitive cultivars (e.g., Delicious) may cause injury.
- d. Some equivalent products include Dithane, Koverall, and Manzate. Check the label for rates.
- e. In lieu of applying Syllit, tanking mixing captan and mancozeb will be sufficient to keep trees protected this early from apple scab (also known as “captozeb”).
- f. Equivalent products include Captan 50% W and WP, and Captan and

*Capter 4L. Check the label for rates per 100 gallons per acre. REI restrictions vary from 24 hours to four days; check the label of the product you are using.*

### Insecticide and Acaricide Note

Insecticides should be selected and combined according to their efficacy against individual pests (see Table 4-6).

1. To prevent bud, leaf, and twig injury from oil, be certain that the oil emulsion is stable and use at least 50 gallons of spray per acre with these rates of oil. To a pint of water in a quart jar, add any wettable powder or flowable material first, and emulsifiable concentrates or oils last. Close jar, shake gently, and then observe after 5 to 10 minutes. If materials separate (precipitate, form a gel, foam excessively, or oil droplets appear), they are not physically compatible or the oil emulsion is not stable. Adding a spray adjuvant when testing compatibility of mixes may eliminate separation problems.

### Apples—Tight Cluster to Open Cluster

**Caution about oil fungicide injury:** The tight cluster to open cluster spray should not follow oil for at least five to seven days and until two new leaves unfold when captan or sulfur is used. Both conditions should be met.

**Apple scab.** For effective scab control, apply at least two half-sprays or one complete spray before the first infection period.

**Powdery mildew.** To keep powdery mildew in check, control is needed from tight cluster through first or second cover. The period of most rapid spread is during the active terminal growth period. Where needed, add an effective fungicide to all sprays until terminal shoots stop growing. Standard types of wettable sulfur are not suggested after first cover spray. These fungicides should be tank-mixed with mancozeb up until first cover for better efficacy, especially when also controlling for scab. Refer to Part II for management recommendations.

**Rosy apple aphid.** In orchards where rosy apple aphids have caused problems, an aphicide such as Assail, Sivanto, or Beleaf may be needed. See rosy apple aphid section at ½-inch green for more information on timing and possible impacts on bees.

**Spotted tentiform leafminer.** Synthetic pyrethroids (Asana XL, Battalion, Baythroid, Danitol, Mustang Max, permethrin, Proaxis, and Warrior) or Vydate provide excellent early season control as do most rosy apple aphid sprays prebloom. Exercise caution when using the synthetic pyrethroid insecticides. These products are known to exacerbate mite problems even several weeks and months after their application. Even the tight cluster to open cluster application can affect postbloom mite populations.

**Pesticide recommendations for apples, tight cluster to open cluster.**

FRAC or IRAC Group	Pesticide	Recommended rate per acre
<b>CHOOSE one of the following:</b>		
U12	Syllit FL <sup>a</sup>	1.5 pt
3	Indar 2F <sup>b</sup>	8 fl oz
3	Procure 480SC <sup>b</sup>	12–16 oz
3	Rally 40WSP <sup>b</sup>	10 oz
3	Rhyme <sup>b</sup>	4–6.5 fl oz
3	Topguard <sup>b</sup>	13 fl oz
3	Trionic 4SC <sup>b</sup>	12–16 fl oz
3 + 9	Inspire Super <sup>b</sup>	12 fl oz
M2	Lime sulfur <sup>c</sup>	2.5–3% solution
9	Scala SC <sup>b</sup>	7–10 fl oz
9	Vanguard WG <sup>b</sup>	5 oz
<b>In combination with one of the following:</b>		
M3	Penncozeb 75DF <sup>d</sup>	3 lb
M3	Polyram 80DF	3 lb
M3	Ziram 76DF	3 lb
M4	Captan 80WDG <sup>e,f</sup>	2.5–3 lb
U6	Torino <sup>g</sup>	6.8 oz
<b>OR select one of the following to be applied alone:</b>		
M2	Sulfur	7–10 lb
M3	Ferbam 76WDG	4 lb
M3	Penncozeb 75DF <sup>d</sup>	6 lb
M3	Polyram 80 DF	6 lb
M3	Ziram 76DF	6 lb
M4	Captan 80DF <sup>e,f</sup>	5 lb
<b>PLUS one or more of the following based on the insect pest complex requiring control:</b>		
10A	Apollo 4SC	4 fl oz
3A	Asana XL 0.66 EC	6–10 fl oz
4A	Assail 30SG <sup>1</sup>	2.5–4 oz
3A	Battalion 0.2EC	7–14 fl oz
3A	Baythroid 2E	2.8 fl oz
3A	Danitol 2.4 EC	10.7–21.3 fl oz
7C	Esteem 35WP	4–5 oz
3A	Mustang Max	1.3–4 fl oz
10A	Onager	12–24 fl oz
3A	Permethrin 2EC	8–12 fl oz
3A	Permethrin 3.2EC	4–8 fl oz
3A	Permethrin 25WP	0.5–0.75 lb
3A	Proaxis 0.5EC	2.5–5.1 fl oz
10A	Savey 50WP	3–4 oz
1A	Vydate 2L	3–4 pt
3A	Warrior II	1.3–2.5 fl oz

**Fungicide and Antibiotic Notes**

- If using Syllit, be sure to combine with sulfur or another product that is effective against powdery mildew during this time.
- To improve their efficacy and prevent or delay buildup of resistant strains of the fungus causing apple scab, these fungicides will require a selected use strategy due to concern about resistance development. These fungicides have benefits for early and summer season disease management; however, they should be tank-mixed with a protectant, rotated with another fungicide with a different FRAC code for target disease, and not used in more than two consecutive sprays. Refer to the

label and do not exceed maximum number of applications per season.

- Use on sensitive cultivars (e.g., Delicious apples) may cause injury.
- Some equivalent products include Dithane, Koverall, and Manzate. Check the label for rates.
- Equivalent products include Captan 50% W and WP, and Captan and Captec 4L. Check the label for rates per 100 gallons per acre. REI restrictions vary from 24 hours to four days; check the label of the product you are using.
- Do not use captan within a week either before or after an oil application, or injury may result.
- Torino is labeled only for powdery mildew control only. Only one application is permitted per calendar year.

**Insecticide and Acaricide Note**

Insecticides should be selected and combined according to their efficacy against individual pests (see Table 4-6).

- Do not make insecticide applications when any flowers are open due to bee toxicity.

**Apples—Pink**

**Apple scab.** Peak spore release of primary apple scab spores (ascospores) usually begins about late pink stage in Pennsylvania. Consider using fungicides containing FRAC Group 7 (no more than two applications if using complete sprays, four applications if using ARM) from pink until petal fall, when disease pressure will be greatest for apple scab. If frequent rain events occur between pink and petal fall, complete sprays are highly recommended.

**Cedar-apple rust.** Pink through petal fall is a very critical period to protect against rust in problem orchards. If cedar-apple rust is historically a problem in an orchard, refer to Part II for management recommendations. FRAC Group 3 fungicides work best, and tank-mixing fungicides with mancozeb will help manage rust diseases through first cover. FRAC Group 11 fungicides typically suppress rust infections.

**Powdery mildew.** To keep powdery mildew in check, control is needed from tight cluster through first or second cover. The period of most rapid spread is during the active terminal growth period. Where needed, add an effective fungicide to all sprays until terminal shoots stop growing. Standard types of wettable sulfur are not suggested after first cover spray. These fungicides should be tank-mixed with mancozeb up until first cover for better efficacy, especially when also controlling for scab.

**Mites.** Apollo, Onager, or Savey can be applied at pink, especially if no oil treatment has been applied. If a low rate of oil was applied (1–2 gallons per acre) and overwintering eggs were clearly visible to the unaided eye on the tree bark, then apply Apollo, Onager, or Savey at pink. If a high rate of oil (4 gallons per acre) was used previously, an ovicidal acaricide application is usually not necessary at this time.

**Oriental fruit moth.** An insecticide application at this time will provide some protective control during the bloom period, when egg hatch of the first generation starts. Shoot damage from Oriental fruit moth in apple is minor compared to peach and the larvae are often parasitized or fail to develop, so control is recommended only if heavy damage was seen previously and in blocks adjacent to peach as Oriental fruit moth will move into apple fruit after peach harvest.

**Rosy apple aphid.** In orchards where rosy apple aphids have caused problems, an aphicide such as Assail, Beleaf, Versys may be needed if not used previously. Note: Special care should be taken when using neonicotinoid or similar plant systemic insecticides. Use at 1/2-inch green to minimize any impacts on honey bees or wild bees. These products have been shown to move into the pollen and nectar at low levels. Plant-systemic fungicides have also been found in the nectar and pollen from pink applications with growing evidence that Syllit (dodine) can be toxic to wild bees and should not be used after 1/2-inch green. Contrary to the label, Assail is not recommended at any time during the bloom period. Closer is closely related to the neonicotinoids and is also systemic and very toxic to bees. We do not recommend it prebloom. The neonicotinoid alternative Beleaf is systemic and has been found in the nectar and pollen from pink applications, but it is thought to be safe for bees. It is the one rosy apple aphid insecticide recommended at this time that is thought to be completely safe to honey bees and wild bees, but it should not be used if blossoms have opened. See Table 4-4 for pesticide impacts on bees.

#### **Pesticide recommendations for apples, pink.**

<b>FRAC or IRAC Group</b>	<b>Pesticide</b>	<b>Recommended rate per acre</b>
<b>CHOOSE one of the following:</b>		
3	Indar 2F <sup>a</sup>	8 fl oz
3	Procure 480SC <sup>a</sup>	12–16 oz
3	Rally 40WSP <sup>a</sup>	10 oz
3	Rhyme <sup>a</sup>	4–6.5 fl oz
3	Topguard <sup>a</sup>	13 fl oz
3	Trionic 4SC <sup>a</sup>	12–16 fl oz
3 + 9	Inspire Super <sup>a</sup>	12 fl oz
7	Aprovia <sup>a</sup>	5.5–7 fl oz
7	Fontelis <sup>a</sup>	16–20 fl oz
7	Kenja 400SC <sup>a</sup>	12.5 fl oz
7	Sercadis <sup>a</sup>	3.5–4.5 fl oz
7 + 9	Luna Tranquility <sup>a</sup>	11.2–16 fl oz
7 + 11	Luna Sensation <sup>a</sup>	4–5.8 fl oz
7 + 11	Merivon <sup>a</sup>	4–5.5 fl oz
7 + 11	Pristine <sup>a</sup>	14.5–18.5 oz
9	Scala SC <sup>a</sup>	7–10 fl oz
9	Vangard WG <sup>a</sup>	5 oz
11	Flint Extra <sup>a</sup>	2.9 fl oz
11	Sovran <sup>a</sup>	4–6.4 oz
M2	Lime sulfur <sup>b</sup>	2.5–3% solution
<b>In combination with one of the following:</b>		
M3	Penncozeb 75DF <sup>c</sup>	3 lb
M3	Polyram 80DF	3 lb
M3	Ziram 76DF	3 lb
M4	Captan 80WDG <sup>d,e</sup>	2.5–3 lb
<b>OR select one of the following to be applied alone:</b>		
M2	Sulfur	7–10 lb
M3	Penncozeb 75DF <sup>c</sup>	6 lb
M3	Polyram 80DF	6 lb
M3	Ziram 76DF	6 lb
M4	Captan 80WDG <sup>d,e</sup>	5 lb
<b>PLUS one or more of the following based on the insect pest complex requiring control<sup>1</sup>:</b>		
10A	Apollo 4SC	4 fl oz
4A	Assail 30SG <sup>1</sup>	4 oz
29	Beleaf 50SG	2.8 oz
10A	Onager	12–24 fl oz
10A	Savey 50WP	3–4 oz

#### **Fungicide and Antibiotic Notes**

- To improve their efficacy and prevent or delay buildup of resistant strains of the fungus causing apple scab, these fungicides will require a selected use strategy due to concern about resistance development. These fungicides have benefits for early and summer season disease management; however, they should be tank-mixed with a protectant, rotated with another fungicide with a different FRAC code for target disease, and not used in more than two consecutive sprays. Refer to the label and do not exceed maximum number of applications per season.*
- Use on sensitive cultivars (e.g., Delicious apples) may cause injury.*
- Some equivalent products include Dithane and Manzate. Check the label for rates.*
- Equivalent products include Captan 50% W and WP, and Captan and Captec 4L. Check the label for rates per 100 gallons per acre. REI restrictions vary from 24 hours to four days; check the label of the product you are using.*

- e. Do not use captan within a week either before or after an oil application, or injury may result.

### Insecticide and Acaricide Note

Insecticides should be selected and combined according to their efficacy against individual pests (see Table 4-6).

1. Do not make applications of any insecticides listed above when any flowers are open.

### Apples—Bloom

Boron should be applied in an annual maintenance program. Each year apply a single spray of 1 pound of Solubor per 100 gallons (4 pounds per acre) sometime during the period of full bloom through the first cover spray. In cases of documented deficiency, refer to “Foliar Application of Nutrients” in Part I.

**Apple scab.** Peak release of primary apple scab spores (ascospores) usually occurs around from late pink through petal fall in Pennsylvania. Consider using fungicides containing FRAC Group 7 (no more than two applications if using complete sprays, four applications if using ARM) from pink until petal fall, when disease pressure will be greatest for apple scab. If frequent rain events occur between pink and petal fall, complete sprays are highly recommended.

**Cedar-apple rust.** Pink through petal fall is a very critical period to protect against rust in problem orchards. If cedar-apple rust is historically a problem in an orchard, refer to Part II for management recommendations. FRAC Group 3 fungicides work best, and tank-mixing fungicides with mancozeb will help manage rust diseases through first cover. FRAC Group 11 fungicides typically suppress rust. If frequent rain events occur between pink and petal fall, complete sprays are highly recommended.

**Fire blight.** Conditions favorable for infection include (1) open blossoms or succulent new growth, (2) an average daily temperature of 60°F or higher, plus (3) rainfall or a relative humidity of 60 percent or higher. Apply first streptomycin spray any time after first blossoms open when the above conditions exist or are expected within 24 hours. Use complete sprays when applying control for fire blight. Repeat sprays at five- to seven-day intervals through late bloom. A minimum of two applications is necessary to provide control.

Use streptomycin formulations at label rates plus 1 pint Regulaid in each 100 gallons of spray. Streptomycin formulations are much more effective when applied during slow drying conditions such as at night. Regulaid (or similar adjuvant) is important for uptake and coverage of streptomycin on flower parts; however, the increased uptake of streptomycin can result in injury. Refer to Part II for more information on fire blight management.

**Fruit rots.** Warm, wet conditions favor the fungal fruit infections from bloom through harvest. However, fruit rot symptoms may not manifest until much later in the season.

**Powdery mildew.** To keep powdery mildew in check, control is needed from tight cluster through first or second cover. The period of most rapid spread is during the active terminal growth period. Where needed, add an effective fungicide to all sprays until terminal shoots stop growing. Standard types of wettable sulfur are not suggested after first cover spray. These fungicides should be

tank-mixed with mancozeb up until first cover for better efficacy, especially when also controlling for scab.

**Gypsy moth and obliquebanded leafroller.** For control of both pests during bloom, *Bacillus thuringiensis* (Bt) is effective and safe for bees.

### Apples—Petal Fall

Boron should be applied in an annual maintenance program. Each year apply a single spray of 1 pound of Solubor per 100 gallons (4 pounds per acre) sometime during the period of full bloom through the first cover spray. In cases of documented deficiency, refer to “Foliar Application of Nutrients” in Part I.

**Apple scab.** Peak release of primary apple scab spores continues from late pink through petal fall and environmental conditions need to be monitored. Consider using fungicides containing FRAC Group 7 (no more than two applications if using complete sprays, four applications if using ARM) from pink until petal fall: when disease pressure will be greatest for apple scab. If frequent rain events occur between pink and petal fall, complete sprays are highly recommended.

**Cedar-apple rust.** Pink through petal fall is a very critical period to protect against rust in problem orchards. If cedar-apple rust is historically a problem in an orchard, refer to Part II for management recommendations. FRAC Group 3 fungicides work best, and tank-mixing fungicides with mancozeb will help manage rust diseases through first cover. FRAC Group 11 fungicides typically suppress rust. If frequent rain events occur between pink and petal fall, complete sprays are highly recommended.

**Fire blight.** Prevent late blossom infections at petal fall, when environmental conditions are often favorable for fire blight. Complete sprays are recommended.

**Fruit rots.** Warm, wet conditions favor the fungal fruit infections from petal fall through harvest. However, fruit rot symptoms may not manifest until much later in the season.

**Powdery mildew.** To keep powdery mildew in check, control is needed from tight cluster through first or second cover. The period of most rapid spread is from tight cluster until terminal growth stops. Where needed, add an effective fungicide to all sprays until terminal shoots stop growing. Standard types of wettable sulfur are not suggested after the first cover spray.

**Mites.** If there is a history of European red mite injury, and none of the prebloom miticides or oil have been used, Agri-Mek, Agri-Flex, and Gladiator are very effective at this time with a penetrating surfactant. The predatory mite *T. pyri* has recently been shown to be developing a tolerance to the active ingredient abamectin, so try it on a limited basis if needed in a few blocks until you can gauge its impact on your biological mite control. Exercise caution when using Agri-Flex because of potential impacts on bees since it is a combination product with Actara. Similarly, Gladiator is a combination product of Agri-Mek with a pyrethroid, which can eliminate bees, predatory mites, and other biological control agents.

**Obliquebanded leafroller.** If obliquebanded leafroller larvae are present, use Altacor, Delegate, Exirel, Intrepid, or Proclaim.

**Oriental fruit moth.** In orchards with a history of Oriental fruit moth problems, use Altacor, Assail, Avaunt, Delegate or pheromone mating disruption.

**Plum curculio.** Cool, wet weather may be responsible for extended activity of this pest into first cover as well as reducing pesticide residues. Avaunt and Imidan are the most effective products for use at petal fall. Many orchards may need this application only for the three to four rows that border woods and fencerows. However, plum curculio severity has recently increased in many regions of the state. If injury by this pest occurred in a previous season, spray intervals may need to be shortened and additional applications made into first and second covers.

**Rosy apple aphid.** Not necessary if prebloom applications of most products recommended for rosy apple aphid were used prebloom. If rosy apple aphid is still a problem, use Assail at 6 ounces per acre for increased safety to bees. Note: Special care should be taken when using neonicotinoid insecticides at petal fall because of possible impacts on honey bees and wild bees foraging on later varieties in the same block. Applications should be made after most blossoms have dropped and only with the most bee-safe of these compounds, Assail, Beleaf, Sivanto. See Table 4-4 for pesticide impacts on bees.

**Spotted tentiform leafminer.** Not necessary if prebloom applications of most products recommended for rosy apple aphid were used prebloom. This pest has declined greatly in the last 15 years due to these programs; but, if it is still a problem at this time, Agri-Mek, Assail, Delegate, and Movento are all very effective when applied at petal fall. The addition of a penetrating surfactant to Agri-Mek and Agri-Flex will increase activity toward leafminers.

**White apple leafhopper.** Not necessary if prebloom applications of most products recommended for rosy apple aphid were used prebloom. This pest has declined greatly in the last 10 years due to these programs; but, if it is still a problem at this time, Assail and Sivanto are very effective. Left unchecked, first-brood leafhoppers could be quite injurious at this time.

#### **Pesticide recommendations for apples, petal fall.**

<b>FRAC or IRAC Group</b>	<b>Pesticide</b>	<b>Recommended rate per acre</b>
<b>CHOOSE one of the following:</b>		
3	Indar 2F <sup>a</sup>	8 fl oz
3	Procure 480SC <sup>a</sup>	12–16 oz
3	Rally 40WSP <sup>a</sup>	10 oz
3	Rhyme <sup>a</sup>	4–6.5 fl oz
3	Topguard <sup>a</sup>	13 fl oz
3	Trionic 4SC <sup>a</sup>	12–16 fl oz
3 + 9	Inspire Super <sup>a</sup>	12 fl oz
7	Aprovia <sup>a</sup>	5.5–7 fl oz
7	Fontelis <sup>a</sup>	16–20 fl oz
7	Kenja <sup>a</sup>	12.5 fl oz
7	Sercadis <sup>a</sup>	3.5–4.5 fl oz
7 + 9	Luna Tranquility <sup>a</sup>	11.2–16 fl oz
7 + 11	Luna Sensation <sup>a</sup>	4–5.8 fl oz
7 + 11	Merivon <sup>a</sup>	4–5.5 fl oz
7 + 11	Pristine <sup>a</sup>	14.5–18.5 oz
9	Scala SC <sup>a</sup>	8–16 fl oz
9	Vanguard WG <sup>a</sup>	5 oz
11	Flint Extra <sup>a</sup>	2.9 fl oz
11	Sovran <sup>a</sup>	4–6.4 oz
<b>In combination with one of the following:</b>		
M3	Penncozeb 75DF <sup>b</sup>	3 lb
M3	Polyram 80DF	3 lb
M3	Ziram 76DF	3 lb
M4	Captan 80WDG <sup>c,d</sup>	2.53 lb
<b>OR select one of the following to be applied alone:</b>		
M2	Sulfur	7–10 lb
M3	Penncozeb 75DF <sup>b</sup>	6 lb
M3	Polyram 80DF	6 lb
M3	Ziram 76DF	6 lb
M4	Captan 80WDG <sup>c,d</sup>	5 lb
<b>PLUS one or more of the following based on the insect pest complex requiring control:</b>		
4A and 6	Agri-Flex <sup>1</sup>	8.5 fl oz
6	Agri-Mek 0.15EC <sup>1</sup>	20 fl oz
28	Altacor 35WDG <sup>1</sup>	3 oz
10A	Apollo 4SC	4 fl oz
4A	Assail 30SG <sup>2</sup>	5–8 oz
22A	Avaunt 30WDG	6 oz
5	Delegate 25WG <sup>1</sup>	4.5–6 oz
28	Exirel <sup>3</sup>	14 fl oz
3A and 6	Gladiator 0.25 EW <sup>1</sup>	18 fl oz
1B	Imidan 70WP	3–4 lb
18	Intrepid 2F	16 fl oz
23	Movento	9 fl oz
10A	Onager	24 fl oz
6	Proclaim 5SC <sup>2</sup>	3.2–4.8 fl oz
10A	Savey 50WP	3 oz
4A and 28	Voliam Flexi 40WDG <sup>3</sup>	7 oz
<b>PLUS:</b>		
	Solubor 20.5% B	3 lb

## Fungicide and Antibiotic Notes

- To improve their efficacy and prevent or delay buildup of resistant strains of the fungus causing apple scab, these fungicides will require a selected use strategy due to concern about resistance development. These fungicides have benefits for early and summer season disease management; however, they should be tank-mixed with a protectant, rotated with another fungicide with a different FRAC code for target disease, and not used in more than two consecutive sprays. Refer to the label and do not exceed maximum number of applications per season.
- Some equivalent products include Dithane, Koverall, and Manzate. Check the label for rates.
- Equivalent products include Captan 50% W and WP, and Captan and Captec 4L. Check the label for rates per 100 gallons per acre. REI restrictions vary from 24 hours to four days; check the label of the product you are using.
- Do not use captan within a week either before or after an oil application, or injury may result.

## Insecticide and Acaricide Notes

Insecticides should be selected and combined according to their efficacy against individual pests (see Table 4-6).

- Agri-Flex, Agri-Mek, and Gladiator should be combined with a summer oil for best results; however, other penetrating adjuvants can be used with somewhat less efficacy. The rate for the summer spray oil should be a 0.5 to 1 percent concentration (2 quarts per 100 gallons or a minimum of 1 gallon per acre). For best results, apply Agri-Flex, Agri-Mek, and Gladiator at petal fall or within 10 days of petal fall, and use a minimum of 50 gallons of water per acre (100 gallons per acre is recommended). If foliage is hardening off, apply at petal fall. Agri-Flex and Agri-Mek are not broad-spectrum insecticides and should not be the only insecticide applied at this time.
- Adding 1 to 2 quarts of summer oil per 100 gallons will increase Assail and Proclaim efficacy. Proclaim is highly effective against leafrollers and leafminers, but it only provides suppression for codling moth and Oriental fruit moth.
- Voliam Flexi is very effective against the lepidopterous pests present at petal fall, including the obliquebanded leafroller and Oriental fruit moth, as well as the plum curculio. Because Voliam Flexi belongs to Group 28 (IRAC ryanodine receptor modulators), which also contains the compounds Altacor, Besiege, Exirel, and Minecto Pro, growers should not use any of these products against consecutive generations of any particular pest complex; they should switch to other chemical classes to control the next generation of the targeted pest.

## Apples—First Cover

**Apple scab.** Primary apple scab spores continue and environmental conditions need to be monitored.

**Cedar-apple rust.** If cedar-apple rust is historically a problem, refer to Part II for management recommendations. Tank-mixing fungicides with mancozeb will help manage rust diseases through first cover.

**Cork and bitter pit in fruit.** See Part I.

**Fire blight.** Do not apply streptomycin after petal fall unless there is hail injury. Apply streptomycin within 24 hours of hail injury, especially in orchards where fire blight is a problem. Do not use streptomycin on apple trees within 50 days of harvest.

**Fruit rots.** Warm, wet conditions favor the fungal fruit infections from petal fall through harvest. However, fruit rot symptoms may not manifest until much later in the season.

**Powdery mildew.** If powdery mildew is a problem, refer Part II for management recommendations.

**Codling moth.** If present, codling moth can be controlled with

various products, including either the broad-spectrum insecticides (e.g., Avaunt) applied at 250 and 550 to 600 degree days after biofix, or the more selective insecticides and virus products, including Altacor, Assail, Besiege, Carpovirusine, Cyd-X, Delegate, Exirel, Intrepid, Rimon, or Voliam Flexi. Intrepid and Rimon should be applied at 75 to 100 degree days following biofix and again 14 to 17 days later. Applications of Cyd-X (2 to 6 ounces), Madex HP (1 to 3 fl oz), or Virosoft CP4 (1.6 ounces) should commence at 230 to 240 degree days and be repeated every seven to nine days during the first brood egg hatch period. The virus products are much more effective when used in combination with codling moth pheromone mating disruption (see “Management of Codling Moth with CM Granulovirus” on page XXX).

### Pesticide recommendations for apples, first cover.

FRAC or IRAC Group	Pesticide	Recommended rate per acre
<b>CHOOSE one of the following:</b>		
1	Topsin M WSB <sup>a</sup>	12–16 oz
3	Indar 2F <sup>a</sup>	8 fl oz
3	Procure 480SC <sup>a</sup>	12–16 oz
3	Rally 40WSP <sup>a</sup>	10 oz
3	Rhyme <sup>a</sup>	6.5 fl oz
3	Topguard <sup>a</sup>	13 fl oz
3	Trionic 4SC <sup>a</sup>	12–16 fl oz
3 + 9	Inspire Super <sup>a</sup>	12 fl oz
9	Scala SC <sup>a</sup>	7–10 fl oz
9	Vanguard WG <sup>a</sup>	5 oz
11	Flint Extra <sup>a</sup>	2.9 fl oz
11	Sovran <sup>a</sup>	4–6.4 oz
<b>In combination with one of the following:</b>		
M3	Penncozeb 75DF <sup>b</sup>	3 lb
M3	Polyram 80DF	3 lb
M3	Ziram 76DF	3 lb
M4	Captan 80WDG <sup>c,d</sup>	2.5–3 lb
OR select one of the following to be applied alone:		
M2	Sulfur <sup>e</sup>	7–10 lb
M4	Captan 80WDG <sup>c,d</sup>	5 lb
<b>PLUS one or more of the following based on the insect pest complex requiring control:</b>		
28	Altacor 35WDG <sup>1</sup>	3 oz
4A	Assail 30SG <sup>2</sup>	6–8 oz
22A	Avaunt 30WDG	6 oz
4A	Belay	6 fl oz
4A and 15	Cormoran	20–28 fl oz
31	Cyd-X (CM virus)	2–6 oz
5	Delegate 25WG <sup>1</sup>	4.5 oz
28	Exirel <sup>1</sup>	10–17 fl oz
1B	Imidan 70WP	3–4 lb
18	Intrepid 2F	16 fl oz
31	Madex HP	1–3 fl oz
15	Rimon 0.83EC	20–30 fl oz
31	Virosoft CP4	1.6–3.2 fl oz
4A and 28	Voliam Flexi 40WDG <sup>1</sup>	4–7 oz
<b>PLUS:</b>		
	Calcium chloride (77–80% flake)	2–7.1 lb
	Solubor 20.5%B	3 lb



### Fungicide and Antibiotic Notes

- a. To improve their efficacy and prevent or delay buildup of resistant strains of the fungus causing apple scab, these fungicides will require a selected use strategy due to concern about resistance development. These fungicides have benefits for early and summer season disease management; however, they should be tank-mixed with a protectant, rotated with another fungicide with a different FRAC code for target disease, and not used in more than two consecutive sprays. Refer to the label and do not exceed maximum number of applications per season.
- b. Some equivalent products include Dithane, Koverall, and Manzate. Check the label for rates.
- c. Equivalent products include Captan 50% W and WP, and Captan and Captec 4L. Check the label for rates per 100 gallons per acre. REI restrictions vary from 24 hours to four days; check the label of the product you are using.
- d. Do not use captan within a week either before or after an oil application, or injury may result.
- e. Use on sensitive cultivars (e.g., Delicious) may cause injury. Do not use oil within 14 days of sulfur application. In addition, do not apply sulfur when daytime temperatures will be exceeding 80°F.

### Insecticide and Acaricide Notes

Insecticides should be selected and combined according to their efficacy against individual pests (see Table 4-6).

1. In order to prevent the development of pest resistance to these new chemistries and to practice the most effective resistance management approach, we highly encourage growers to use only one chemical class of products (i.e., mode of action) for a particular generation of a targeted pest and to rotate to another chemical class to control the succeeding generation of the targeted pest. For example, if using Delegate to control the first generation of codling moth, use Altacor, Exirel, or Voliam Flexi to control the second generation, or if using Altacor, Exirel, or Voliam Flexi to control the first generation of codling moth, then switch to Delegate or another chemical class (Assail, etc.) to control the second generation. Altacor, Exirel, and Voliam Flexi belong to the same chemical class (IRAC Group 28) and should not be used for consecutive generations of a targeted pest.
2. Adding 1 to 2 quarts of summer oil per 100 gallons will increase Assail efficacy.

### Apples—Second, Third, and Fourth Covers

*Increasing intervals between sprays:* beginning with the second or third cover, growers often increase the interval between half-sprays. When scab or mildew is present on trees, when shoot growth is rapid, and when rains are frequent, the intervals between half-sprays should not exceed seven days.

**Apple scab.** Dispersal of primary apple scab spores can continue through second cover; environmental conditions need to be monitored during that time. If infections from primary scab are a problem, use the fungicides listed for first cover, being careful to observe label restrictions.

**Cork and bitter pit in fruit.** See Part I.

**Fire blight.** Do not apply streptomycin after petal fall unless there is hail injury. Apply streptomycin within 24 hours of hail injury, especially in orchards where fire blight is a problem. Do not use streptomycin on apple trees within 50 days of harvest.

**Fruit rots.** Warm, wet conditions favor the fungal fruit infections from petal fall through harvest. However, fruit rot symptoms may not manifest until much later in the season.

**Necrotic leaf blotch.** Important for Golden Delicious and cultivars with a Golden Delicious parent. See Part II for mitigation strategies.

**Powdery mildew.** If powdery mildew is a problem, refer to Part II for management recommendations.

**Sooty blotch and flyspeck.** These diseases are likely to be a problem from this time of the growing season through harvest, especially if rainfall is above normal. Refer to Part II.

**Dogwood borer.** Handgun or backpack sprayer applications of Lorsban 4E (1.5 quarts per 100 gallons) or Lorsban Advanced (1.5 quarts per 100 gallons) from the pink stage until mid- to late June or after harvest and directed at burrknot-affected areas are most effective. Do not allow spray to contact foliage or fruit. Do not use a spray volume of more than 100 gallons per acre. Pheromone traps can be used to determine periods of male moth activity. These traps should be hung about 4 feet off the ground near the tree trunk.

**San Jose scale.** Add Centaur at 35 ounces per acre or Movento at 9 fluid ounces with a penetrant. Movento will also give long-residual control of woolly apple aphid and green apple aphid at this timing, but it has not always been consistent in woolly apple aphid control when used on large trees due to penetration problems.

**Tufted apple bud moth and summer obliquebanded leafroller.** Growers having trouble with these leafrollers can use Altacor, Delegate, Intrepid, Rimon, or Voliam Flexi, but their importance as pests has greatly declined over the last 10 years as the newer codling moth materials like Altacor or Delegate also have long residual activity on these pests even though the timings do not overlap very well, especially for summer obliquebanded leafroller. Observe the proper spray intervals and close these intervals at the appropriate times during the egg-hatching period of both broods (approximately second to third and sixth to seventh covers). Use Table 2-9 or 2-10 to properly time sprays. Maximum spray coverage is extremely important. Low-volume sprays (20 to 50 gallons per acre) are often not adequate. Growers should increase water volumes to adequately wet the trees during the critical egg-hatching periods of both broods.

**Woolly apple aphid.** The dormant spray of chlorpyrifos for rosy apple aphid and San Jose scale has been shown to give excellent summer control of woolly apple aphid due to the long residual activity of this product on wood. As resistance to these pests has increased in recent years and fall sprays of pyrethroid sprays for control of brown marmorated stink bug has become more prevalent, this pest has been on the increase in many orchards due to disruption of biological control by syrphid fly larvae and the wasp parasitoid *Aphelinus mali*. The popular move to M9 and other dwarfing rootstocks that are highly susceptible to woolly apple aphid is another reason this pest is increasing in severity. The organophosphate insecticide Diazinon is still the most effective choice for this pest, which is the only use allowed on its label. Movento at the full rate of 9 fluid ounces with a penetrating surfactant or summer oil has been very effective on this pest on smaller trees, but it has sometimes been inconsistent in controlling woolly apple aphid on older, larger trees due to penetration problems for this systemic insecticide. Movento is most cost-effective in orchards that also have San Jose scale problems since it also gives excellent control of that pest at the same time. See Table 1-7 for rootstock susceptibility to woolly apple aphid. In addition to rootstock susceptibility, some varietal scions that are also more susceptible to aerial colonies of woolly apple aphid are Fuji, Ginger Gold, Greening, Rome, and York.

**Pesticide recommendations for apples, second, third, and fourth covers.**

FRAC or IRAC Group	Pesticide	Recommended rate per acre
<b>CHOOSE one of the following:</b>		
1	Topsin M WSB <sup>a</sup>	12–16 oz
3	Indar 2F <sup>a</sup>	6–8 fl oz
3	Rhyme <sup>a</sup>	4–6.5 fl oz
3	Trionic 4SC <sup>a</sup>	12–16 fl oz
11	Flint Extra <sup>a</sup>	2.9 oz
11	Sovran <sup>a</sup>	4–6.4 oz
<b>In combination with one of the following:</b>		
M3	Ziram 76DF <sup>b</sup>	3 lb
M4	Captan 80WDG <sup>b,c</sup>	2.5–3 lb
<b>OR select one of the following to be applied alone:</b>		
M2	Sulfur <sup>d</sup>	7–10 lb
M3	Ziram 76DF <sup>b</sup>	6 lb
M4	Captan 80WDG <sup>b,c</sup>	5 lb
<b>PLUS one or more of the following based on the insect pest complex requiring control:</b>		
28	Altacor 35WDG <sup>1</sup>	3 oz
4A	Assail 30SG <sup>2,3</sup>	4–8 oz
22A	Avaunt 30WDG	6 oz
4A	Belay	6–12 fl oz
16	Centaur	35 oz
31	Cyd-X (CM virus)	2–6 oz
5	Delegate 25WG <sup>1</sup>	4.5 oz
28	Exirel <sup>1</sup>	10–17 fl oz
1B	Imidan 70WP	3–4 lb
18	Intrepid 2F <sup>4</sup>	12–16 fl oz
1A	Lannate 90SP <sup>5</sup>	8–12 oz
1A	Lannate LV <sup>5</sup>	24–36 fl oz
31	Madex HP	1–3 fl oz
N/A	OFM sprayable pheromones	use label rate
6	Proclaim 5SC <sup>3</sup>	3.2–4.8 fl oz
15	Rimon 0.83EC	20–30 fl oz
4A and 28	Voliam Flexi 40WDG <sup>1</sup>	7 oz
<b>PLUS:</b>		
	Calcium chloride (77–80% flake)	2–7.1 lb

**Fungicide and Antibiotic Notes**

- To improve their efficacy and prevent or delay buildup of resistant strains of the fungus causing apple scab, these fungicides will require a selected use strategy due to concern about resistance development. These fungicides have benefits for early and summer season disease management; however, they should be tank-mixed with a protectant, rotated with another fungicide with a different FRAC code for target disease, and not used in more than two consecutive sprays. Refer to the label and do not exceed maximum number of applications per season.
- Equivalent products include Captan 50% W and WP, and Captan and Captec 4L. Check the label for rates per 100 gallons per acre. REI restrictions vary from 24 hours to four days; check the label of the product you are using. At fourth cover, captan and ziram can be combined as a disease management option. Ziram will help mitigate necrotic leaf blotch on susceptible cultivars.
- Do not use captan within a week either before or after an oil application, or injury may result.
- Use on sensitive cultivars (e.g., Delicious) may cause injury. Do not use oil within 14 days of sulfur application. Do not apply sulfur when daytime temperatures are expected to be 80°F or higher.

**Insecticide and Acaricide Notes**

Insecticides should be selected and combined according to their efficacy against individual pests (see Table 4-6).

- In order to prevent the development of pest resistance to these new chemistries and to practice the most effective resistance management approach, we highly encourage growers to use only one chemical class of products (i.e., mode of action) for a particular generation of a targeted pest and to rotate to another chemical class to control the succeeding generation of the targeted pest. For example, if using Delegate to control the first generation of codling moth, use Altacor, Exirel, or Voliam Flexi to control the second generation, or if using either Altacor, Exirel, or Voliam Flexi to control the first generation of codling moth, then switch to Delegate or another chemical class (Assail, etc.) to control the second generation. Altacor, Exirel, and Voliam Flexi belong to the same chemical class (IRAC Group 28) and should not be used for consecutive generations of a targeted pest.
- Use higher rates of Assail when populations of codling moth and Oriental fruit moth are high.
- Adding 1 to 2 quarts of summer oil per 100 gallons will increase Assail and Proclaim efficacy. Proclaim is highly effective against leafrollers and leafminers, but it only provides suppression for codling moth and Oriental fruit moth.
- Use lower rate for TABM control, the higher end of the range for codling moth, Oriental fruit moth, and obliquebanded leafroller control.
- Growers using Lannate should closely watch the interaction between mites and their natural enemies (e.g., Stethorus, predatory mites) since Lannate is moderately to highly toxic to these natural enemies. Outbreaks of mites may occur where Lannate is used. To increase the likelihood of successful biological control by the natural enemies, refrain from using Lannate unless using it for control of brown maromated stink bug. Because of widespread resistance to the organophosphate insecticides by tufted apple bud moth, alternative control measures to use are Altacor, Delegate, Intrepid, Rimon, or Voliam Flexi for first brood control.

**Green apple and spirea aphids and leafhoppers.** The following insecticides should control both green apple and spirea aphids and leafhoppers (potato and white apple) at the same time with summer applications as pressure builds during the summer after second cover. Potato leafhopper injury is quite harmful to small trees and populations may move into a block quickly from an adjacent alfalfa field that has been mowed. Fire blight has also been associated with injury from this pest.

***Pesticide recommendations for control of green apple and spirea aphids and leafhoppers.***

IRAC Group	Pesticide	Recommended rate per acre
<b>CHOOSE one of the following:</b>		
4A	Actara <sup>1</sup>	2–5.5 oz
4A	Admire Pro	2–4 fl oz
4A	Assail 30SG	2.5–4 oz
4A	Belay	3–6 fl oz
29	Beleaf 50SG <sup>2</sup>	2–2.8 oz
4C	Closer 2SC	3 fl oz
4A	Imidacloprid 1.6F	4–6 fl oz
1A	Lannate 90SP <sup>3</sup>	6–8 oz
1A	Lannate LV <sup>3</sup>	18–24 fl oz
23	Movento <sup>4</sup>	6–9 fl oz
1A	Sevin XLR Plus <sup>5</sup>	1 qt
4D	Sivanto	10.5 fl oz

**Insecticide and Acaricide Notes**

Insecticides should be selected and combined according to their efficacy against individual pests (see Table 4-6).

1. Use the lower rate for leafhoppers, the higher rate for aphids.
2. Beleaf is only recommended for aphid and plant bug control.
3. Lannate, while providing good control, will probably adversely affect *Stethorus* and *T. pyri* populations.
4. Movento is only active against aphids (including the woolly apple aphids), not leafhoppers. It is very active against San Jose scale as well. Use a penetrating adjuvant with this product.
5. Sevin XLR Plus can be used for leafhopper control only; however, *Stethorus* and predatory mite populations will probably be adversely affected. Sevin XLR Plus is also a fruit thinning agent.

**Mites.** This is the period when decisions to use a miticide should not be made hastily. Table 2-5 and Figure 2-3 are invaluable for making pest management choices, as they help take the guesswork out of mite control when using predatory mites and/or *Stethorus*. Miticide rates should not be increased above those suggested in the following table if a biological control program is being followed. See Table 4-4 for toxicity ratings of various miticides against the mite predators. If using a miticide in a half-spray application, do not add a miticide to the second half-spray unless it is needed. For growers that routinely get biological mite control from predators, miticide applications have been reduced by up to 90 percent and miticide resistance has not been a problem. The two best miticides for promoting biological mite control have been Envidor and Nealta since they are both safe to predatory mites. For growers that cannot rely on biological mite control for various reasons, a good practice is to rotate miticide types to reduce the probability of resistance. Never use the same

miticide or a miticide in the same chemical class more than once per year in blocks where biological mite control is not effective.

When mite populations are high or increasing rapidly, apply miticides using more water, use full rates of miticides, rotate the use of miticide products, and spray in the evening rather than the morning to prolong residual activity from photodegradation.

***Acaricide recommendations for apples.***

IRAC Group	Acaricide	Recommended rate per acre
<b>CHOOSE one of the following:</b>		
20D	Acramite 50WS <sup>1</sup>	1 lb
10A	Apollo 4SC	4 fl oz
23	Envidor 2SC	18 fl oz
20B	Kanemite 15SC	31 fl oz
25A	Nealta 1.6 F	13.5 fl oz
21A	Nexter 75W <sup>P2</sup>	6.6 oz
10A	Onager	12–24 fl oz
21A	Portal	1–2 pt
10A	Savey 50WP	3–4 oz
1A	Vydate 2L	2–3 pt
10B	Zeal 72WDG	2–3 oz

**Insecticide and Acaricide Notes**

Insecticides should be selected and combined according to their efficacy against individual pests (see Table 4-6).

1. Add a surfactant for improving coverage. It is strongly recommended that water hardness be reduced with ammonium-sulfate-containing water treatment prior to adding the surfactant and Acramite.
2. There have been cases of resistance to Nexter reported in Pennsylvania. If resistance or lack of control is suspected, switch to another product. If using as alternate row middle application, be sure to initiate spraying while the mite populations are low. The amount of water recommended is 100 gallons per acre as every middle spray. For resistance management purposes, only one application of Nexter per season is recommended. If boron-containing products are to be used, the water-soluble bags containing Nexter must be dissolved completely before the boron-containing products are added to the tank. For twospotted spider mite, use Nexter at a rate of 8.8 to 10.67 ounces.

**Apples—Fifth Cover**

**Cork and bitter pit in fruit.** See Part I.

**Fruit rots.** Warm, wet conditions favor the fruit rots during the summer months and at harvest. However, fruit rot symptoms may not manifest until much later in the season.

**Necrotic leaf blotch.** Important for Golden Delicious and cultivars with a Golden Delicious parent. See Part II for mitigation strategies.

**Sooty blotch and flyspeck.** These diseases are likely to be a problem from this time of the growing season through harvest, especially if rainfall is above normal.

**Codling moth.** If present, the second brood of codling moth can be controlled with broad-spectrum or selective insecticides applied at 1,250 to 1,300 and 1,600 to 1,650 degree days after biofix. Choices include Altacor, Assail, Avaunt, Delegate, Exirel, Intrepid, Rimon, and Voliam Flexi. If Intrepid or Rimon is used, start applications at 1,150 to 1,200 degree days and repeat again in 14 to 17 days. Thorough coverage is required to successfully control this brood of codling moth, which lasts 10 to 12 days longer than the first generation. It is recommended that at least 100 gallons per acre be used for the remainder of the season.

#### Pesticide recommendations for apples, fifth cover.

FRAC or IRAC Group	Pesticide	Recommended rate per acre
<b>CHOOSE one of the following*:</b>		
1	Topsin M WSB <sup>a</sup>	12–16 oz
<b>In combination with one of the following:</b>		
M3	Ziram 76DF <sup>b</sup>	3 lb
M4	Captan 80WDG <sup>b,c</sup>	2.5–3 lb
<b>OR select one of the following to be applied alone:</b>		
M2	Sulfur <sup>d</sup>	7–10 lb
M3	Ziram 76DF <sup>b</sup>	6 lb
M4	Captan 80WDG <sup>b,c</sup>	5 lb
<b>PLUS one or more of the following based on the insect pest complex requiring control:</b>		
28	Altacor 35WDG <sup>1</sup>	3 oz
4A	Assail 30SG <sup>2</sup>	4–8 oz
22A	Avaunt 30WDG	6 oz
4A	Belay	6–12 fl oz
11	Bt	use label rate
4A and 15	Cormoran	20–28 fl oz
31	Cyd-X (CM virus)	2–6 oz
5	Delegate 25WG <sup>1</sup>	4.5 oz
28	Exirel	10–17 fl oz
1B	Imidan 70WP	3–4 lb
18	Intrepid 2F	12–16 fl oz
31	Madex HP	1–3 fl oz
N/A	OFM sprayable pheromones	use label rate
15	Rimon 0.83EC	20–30 fl oz
4A and 28	Voliam Flexi <sup>1</sup>	7 oz
<b>PLUS:</b>		
	Calcium chloride (77–80% flake)	2–7.1 lb

\*Alternative options during fifth cover through last cover: preliminary data has indicated products containing polyoxin D salt (Oso, Ph-D) manage sooty blotch and flyspeck. Serenade products have shown fruit rot management when used in rotation in a conventional program. Follow the label for recommended rates.

#### Fungicide and Antibiotic Notes

- To improve their efficacy and prevent or delay buildup of resistant strains of the fungus causing apple scab, these fungicides will require a selected use strategy due to concern about resistance development. These fungicides have benefits for early and summer season disease

management; however, they should be tank-mixed with a protectant, rotated with another fungicide with a different FRAC code for target disease, and not used in more than two consecutive sprays. Refer to the label and do not exceed maximum number of applications per season.

- Equivalent products include Captan 50% W and WP, and Captan and Captac 4L. Check the label for rates per 100 gallons per acre. REI restrictions vary from 24 hours to four days; check the label of the product you are using. At fourth cover, captan and ziram can be combined as a disease management option. Ziram will help mitigate necrotic leaf blotch on susceptible cultivars.
- Do not use captan within a week either before or after an oil application, or injury may result.
- Use on sensitive cultivars (e.g., Delicious) may cause injury. Do not use oil within 14 days of sulfur application. Do not apply sulfur when daytime temperatures are expected to be 80°F or higher.

#### Insecticide and Acaricide Notes

Insecticides should be selected and combined according to their efficacy against individual pests (see Table 4-6).

- In order to prevent the development of pest resistance to these new chemistries and to practice the most effective resistance management approach, we highly encourage growers to use only one chemical class of products (i.e., mode of action) for a particular generation of a targeted pest and to rotate to another chemical class to control the succeeding generation of the targeted pest. For example, if using Delegate to control the first generation of codling moth, use Altacor, Exirel, or Voliam Flexi to control the second generation, or if using Altacor, Exirel, or Voliam Flexi to control the first generation of codling moth, then switch to Delegate or another chemical class (Assail, etc.) to control the second generation. Altacor, Exirel, and Voliam Flexi belong to the same chemical class (IRAC Group 28) and should not be used for consecutive generations of a targeted pest.
- Adding 1 to 2 quarts of summer oil per 100 gallons will increase Assail efficacy. Use higher rates of Assail when populations of codling moth and Oriental fruit moth are high.

#### Apples—Sixth and Seventh Covers

**Cork spot and bitter pit in fruit.** See Part I.

**Fruit rots.** Warm, wet conditions favor the fruit rots during the summer months and at harvest. However, fruit rot symptoms may not manifest until much later in the season or even in storage.

**Sooty blotch and flyspeck.** These diseases are likely to be a problem from this time of the growing season through harvest, especially if rainfall is above normal. New infections can occur as late as September.

**Oriental fruit moth.** If Oriental fruit moth is a problem, thorough coverage (at least 100 gallons per acre) needs to be maintained until at least mid-September. This is the period when adult flight and egg-laying can be continuous, the majority of the fruit injury will occur, and live worms can be present at harvest. Refer to “Oriental fruit moth” in Part II for additional information on proper timing of chemical sprays. Altacor, Assail, Delegate, Rimon, Voliam Flexi, and organophosphate insecticides (unless resistance is suspected) will provide the best protection, but growers should be aware of required preharvest intervals. Sprayable OFM pheromone at 0.75 to 1 fluid ounce per acre has been effective for up to four weeks at this timing and is just as effective if applied as an alternate row middle spray as it is when applied complete.

**Pesticide recommendations for apples, sixth and seventh covers.**

FRAC or IRAC Group	Pesticide	Recommended rate per acre
<b>CHOOSE one of the following*:</b>		
1	Topsin M WSB <sup>a</sup>	12–16 oz
7 + 11	Luna Sensation <sup>a</sup>	4–5.8 fl oz
7 + 11	Merivon 4.18SC <sup>a</sup>	4–5.5 fl oz
7 + 11	Pristine <sup>a</sup>	14.5–18.5 oz
11	Flint Extra <sup>a</sup>	2.9 fl oz
<b>In combination with one of the following:</b>		
M3	Ziram 76DF	3 lb
M4	Captan 80WDG <sup>b,c</sup>	2.5–5 lb
<b>OR select one of the following to be applied alone:</b>		
M3	Ziram 76DF	6 lb
M4	Captan 80WDG <sup>b,c</sup>	5 lb
<b>PLUS one or more of the following based on the insect pest complex requiring control:</b>		
28	Altacor 35WDG <sup>1</sup>	3 oz
4A	Assail 30SG <sup>2,3</sup>	4–8 oz
22A	Avaunt 30WDG	6 oz
4A	Belay	6–12 fl oz
11A	Bt	use label rate
4A and 15	Cormoran	20–28 fl oz
5	Delegate 25WG <sup>1</sup>	4.5–6 oz
28	Exirel	10–17 fl oz
1B	Imidan 70WP	3–4 lb
18	Intrepid 2F	12–16 fl oz
1A	Lannate 90SP <sup>4</sup>	6–10 oz
1A	Lannate LV <sup>4</sup>	24–36 fl oz
N/A	OFM sprayable pheromones	1 fl oz
6	Proclaim 5SC <sup>3</sup>	3.2–4.8 fl oz
15	Rimon 0.83EC	20–30 fl oz
28 and 4A	Voliam Flexi <sup>1</sup>	7 oz
<b>PLUS:</b>		
	Calcium chloride (77–80% flake)	2–7.1 lb

\*Alternative options during fifth cover through last cover: preliminary data has indicated products containing polyoxin D salt (Oso, Ph-D) manage sooty blotch and flyspeck. Serenade products have shown fruit rot management when used in rotation in a conventional program. Follow the label for recommended rates.

**Fungicide and Antibiotic Notes**

- To improve their efficacy and prevent or delay buildup of resistant strains of the fungus causing apple scab, these fungicides will require a selected use strategy due to concern about resistance development. These fungicides have benefits for early and summer season disease management; however, they should be tank-mixed with a protectant, rotated with another fungicide with a different FRAC code for target disease, and not be used in more than two consecutive sprays. Refer to the label and do not exceed maximum number of applications per season. To mitigate fruit rots in storage, it is recommended to save two FRAC Group 11 sprays (and two FRAC Group 7 sprays, if using a premix product) for near harvest.
- Equivalent products include Captan 50% W and WP, and Captan and Captec 4L. Check the label for rates per 100 gallons per acre. REI restrictions vary from 24 hours to four days; check the label of the product you are using.

- Do not use captan within a week either before or after an oil application, or injury may result.

**Insecticide and Acaricide Notes**

Insecticides should be selected and combined according to their efficacy against individual pests (see Table 4-6).

- In order to prevent the development of pest resistance to these new chemistries and to practice the most effective resistance management approach, we highly encourage growers to use only one chemical class of products (i.e., mode of action) for a particular generation of a targeted pest and to rotate to another chemical class to control the succeeding generation of the targeted pest. For example, if using Delegate to control the first generation of codling moth, use Altacor, Besiege, Exirel, or Voliam Flexi to control the second generation, or if using Altacor, Besiege, Exirel, or Voliam Flexi to control the first generation of codling moth, then switch to Delegate or another chemical class (Assail, etc.) to control the second generation. Altacor, Besiege, Exirel, and Voliam Flexi belong to the same chemical class (IRAC Group 28) and should not be used for consecutive generations of a targeted pest.
- Use higher rates of Assail when populations of codling moth and Oriental fruit moth are high.
- Adding 1 to 2 quarts of summer oil per 100 gallons will increase Assail and Proclaim efficacy. Proclaim is highly effective against leafrollers and leafminers, but it only provides suppression for codling moth and Oriental fruit moth.
- Growers using Lannate should closely watch the interaction between mites and their natural enemies (e.g., Stethorus, predatory mites) since Lannate is moderately toxic to these natural enemies. Outbreaks of mites may occur where Lannate is used. To increase the likelihood of successful biological control by the natural enemies, refrain from using Lannate unless using it for control of the brown maromorated stink bug. Because of widespread resistance to the organophosphate insecticides, alternative control measures to use are Altacor, Besiege, Delegate, Intrepid, Minecto Pro, Rimon, or Voliam Flexi for second brood control.

**Apples—Final Cover to Postharvest**

**Postharvest fruit rots.** See “Apples—Sixth and Seventh Covers” and Part VI, Harvest and Postharvest Handling.

## PEAR IPM PROGRAM

### Pears—Dormant to Green Tip

**Fire blight.** Refer to Part II for information on fire blight. Apply copper at a rate of two pounds of metallic copper per acre under good drying conditions and before the ½-inch green stage.

**Insects.** Pear psylla, blister mite, scale.

#### **Pesticide recommendations for pears, dormant to green tip.**

IRAC Group	Pesticide	Recommended rate per acre
N/A	Dormant oil	4–6 gal
<b>PLUS one or more of the following based on the insect pest complex requiring control:</b>		
3A	Asana XL 0.66EC	10–16 fl oz
3A	Baythroid 2E	2.8 fl oz
1B	Chlorpyrifos	1–1.5 qt
3A	Danitol 2.4EC	16–21.3 fl oz
7C	Esteem 35WP <sup>1</sup>	4–5 oz
1B	Lorsban 75WG	1–2 lb
3A	Mustang Max	2–4 fl oz
3A	Permethrin 3.2EC	12 fl oz
3A	Permethrin 25WP	1.2 lb
3A	Proaxis	2.5–5.1 fl oz
N/A	Surround WP	25–50 lb
3A	Warrior II	1.3–2.5 fl oz

#### **Insecticide and Acaricide Note**

Insecticides should be selected and combined according to their efficacy against individual pests (see Table 4-10).

1. Only two applications permitted between swollen bud and petal fall. Thorough coverage is required.

### Pears—Green Cluster Bud

(Separation of flower buds, but before petal show)

**Diseases.** Leaf and fruit spot, scab.

**Insects.** Pear psylla, plant bug, stink bug, pear midge, pear rust mite.

**Pear psylla.** Excellent psylla control has been achieved in the green cluster bud spray when an insecticide was used with oil. If pear psylla is not a problem, reduce the insecticide rate by 25 percent.

#### **Pesticide recommendations for pears, green cluster bud.**

FRAC or IRAC Group	Pesticide	Recommended rate per acre
U12	Syllit FL	3 pt
1	Topsin M WSB	1 lb
<b>PLUS one of the following:</b>		
M3	Ferbam 76 WDG	4 lb
M3	Penncozeb 75DF <sup>a</sup>	3 lb
M3	Ziram 76DF	3 lb
<b>OR one of the following to be applied alone</b>		
M3	Penncozeb 75DF <sup>a</sup>	6 lb
M3	Ziram 76DF	6 lb
N/A	Dormant oil	2–3 gal
<b>PLUS one or more of the following based on the insect pest complex requiring control:</b>		
4A	Actara 25WP <sup>1</sup>	5.5 oz
3A	Asana XL 0.66EC <sup>2</sup>	9–12 fl oz
3A	Baythroid 2E <sup>2</sup>	2.8 fl oz
21A	Bexar	27 fl oz
3A	Danitol 2.4EC <sup>2</sup>	16–21.3 fl oz
3A and 4A	Endigo ZC <sup>2</sup>	6 fl oz
7C	Esteem 35WP <sup>3</sup>	4–5 oz
3A	Mustang Max <sup>2</sup>	2–4 fl oz
3A	Permethrin 2EC <sup>2</sup>	18 fl oz
3A	Permethrin 3.2EC <sup>2</sup>	12 fl oz
3A	Permethrin 25WP <sup>2</sup>	1.2 lb
3A	Proaxis <sup>2</sup>	2.5–5.1 fl oz
N/A	Surround WP	25–50 lb
3A	Warrior II	1.3–2.5 fl oz

#### **Fungicide and Antibiotic Note**

- a. Some equivalent products include Dithane, Koverall and Manzate. Check the label for rates.

#### **Insecticide and Acaricide Notes**

Insecticides should be selected and combined according to their efficacy against individual pests (see Table 4-10).

1. Do not make more than one application prebloom; do not apply after green cluster stage and before complete petal fall. After an Actara application, wait at least five days before placing bee hives in the treated area.
2. Pyrethroid resistance is present in some areas of Pennsylvania. Limit prebloom applications of pyrethroids to two applications.
3. Only two applications permitted between swollen bud and petal fall. Thorough coverage is required.

## Pears—White Bud, Popcorn Stage

**Diseases.** Leaf and fruit spot, scab.

**Insects.** Pear midge, pear psylla, plant bug, stink bug. Avoid killing bees on opening blossoms and cover crops; watch insecticides that are toxic to bees (refer to pesticide label). See Table 1-9 for pesticide impacts on bees.

### Pesticide recommendations for pears, white bud, popcorn stages.

FRAC or IRAC Group	Pesticide	Recommended rate per acre
<b>CHOOSE one of the following:</b>		
U12	Syllit FL <sup>a</sup>	3 pt
1	Topsin M WSB <sup>b</sup>	1 lb
3	Procur 480SC <sup>b</sup>	8–16 oz
3	Rhyme <sup>b</sup>	4–6.5 fl oz
3	Rubigan E.C. <sup>b</sup>	
3	Trionic 4SC <sup>b</sup>	8–16 fl oz
3 + 9	Inspire Super <sup>b</sup>	12 fl oz
7	Aprovia <sup>b</sup>	5.5–7 fl oz
7	Fontelis <sup>b</sup>	14–20 fl oz
7	Kenja <sup>b</sup>	12.5 fl oz
9	Scala SC <sup>b</sup>	7–10 fl oz
9	Vanguard WG <sup>b</sup>	5 oz
11	Flint Extra <sup>b</sup>	2.9 fl oz
11	Sovran <sup>b</sup>	4–6.4 oz
<b>PLUS one of the following:</b>		
M3	Ferbam 76WDG <sup>c</sup>	4 lb
M3	Penncozeb 75DF <sup>d</sup>	3 lb
M3	Ziram 76DF	3 lb
<b>OR one of the following to be applied alone:</b>		
M3	Penncozeb 75DF <sup>d</sup>	6 lb
M3	Ziram 76DF	6 lb
7 + 11	Merivon <sup>b</sup>	4–5.5 fl oz
7 + 11	Luna Sensation <sup>b</sup>	4–5.8 fl oz
7 + 11	Pristine <sup>b</sup>	14.5–18.5 oz
<b>PLUS one or more of the following based on the insect pest complex requiring control:</b>		
3A	Asana XL 0.66EC <sup>1</sup>	12 fl oz
4A	Assail 30SG	8 oz
3A	Baythroid 2E <sup>1</sup>	2.8 fl oz
3A	Danitol 2.4EC <sup>1</sup>	16–21.3 fl oz
7C	Esteem 35WP	4–5 oz
3A	Mustang Max <sup>1</sup>	2–4 fl oz
3A	Permethrin 3.2EC <sup>1</sup>	12 fl oz
3A	Permethrin 25WP <sup>1</sup>	1.2 lb
3A	Proaxis <sup>1</sup>	2.5–5.1 fl oz
1A	Vydate 2L	2–8 pt
3A	Warrior II	1.3–2.5 fl oz

### Fungicide and Antibiotic Notes

- Do not use Syllit FL past white bud stage.
- To improve their efficacy and prevent or delay buildup of resistant

strains of the fungus causing pear scab, these fungicides will require a selected use strategy due to concern about resistance development. These fungicides have benefits for early and summer season disease management; however, they should be tank-mixed with a protectant, rotated with another fungicide with a different FRAC code for target disease, and not be used in more than two consecutive sprays. Refer to the label and do not exceed maximum number of applications per season.

- Late season applications may result in unsightly residues. Do not apply within seven days of harvest.
- Some equivalent products are Dithane, Manzate, and Penncozeb. Check label for rates.

### Insecticide and Acaricide Note

Insecticides should be selected and combined according to their efficacy against individual pests (see Table 4-10).

- Pyrethroid resistance is present in some areas of Pennsylvania. Limit prebloom applications of pyrethroids to two applications.

## Pears—Bloom

For disease control, use the same materials as recommended in white bud, popcorn stages.

**Fire blight.** Conditions favorable for infection include (1) open blossoms or succulent new growth, (2) an average daily temperature of 60°F or higher, plus (3) rainfall or a relative humidity of 60 percent or higher. Apply first streptomycin spray any time after first blossoms open when above conditions exist or are expected within 24 hours. Streptomycin remains effective for three to five days; however, additional blossoms can open during this time period and are vulnerable if not protected and disease conditions are present. Repeat sprays at five- to seven-day intervals through late bloom. A minimum of two applications is necessary to provide control.

Use streptomycin formulations at label rates plus 1 pint of Regulaid in each 100 gallons of spray. Streptomycin formulations are much more effective when applied during slow-drying conditions such as at night. Regulaid (or similar adjuvant) is important for uptake; however, the increased uptake of streptomycin can result in injury. Refer to Part II for more information on fire blight management.

**Leaf spot, fruit spot, and scab.** Do not go over 10 days between fungicide sprays during the bloom period. In wet weather, shorten the period to five days. Use the same fungicides as in the white bud spray.

## Pears—Petal Fall, First through Fifth Covers

**Diseases.** Fruit rots, leaf and fruit spot, scab, sooty blotch.

**Sooty mold.** Control is based on control of aphids and pear psylla. Note: Apply the first cover spray 10 days after petal fall and the remaining cover sprays at 14-day intervals.

**Insects.** Codling moth, leafrollers, mites, Oriental fruit moth, pear psylla, plum curculio, plant bugs.

**Pear psylla.** Where psylla persist or increase, shorten the interval between two successive cover sprays to five to seven days. Imidan and Lannate are not effective in controlling psylla. Note: The insecticide rates suggested below are rates needed for pear psylla control. If psylla is not a problem, reduce rates by 25 percent.

**Pesticide recommendations for pears, petal fall, first through fifth covers.**

FRAC or IRAC Group	Pesticide	Recommended rate per acre
<b>CHOOSE one of the following:</b>		
1	Topsin M WSB <sup>a</sup>	1 lb
3	Procuire 480SC <sup>a</sup>	8–16 oz
3	Rhyme <sup>a</sup>	4–6.5 fl oz
3	Rubigan EC <sup>a</sup>	8–12 fl oz
3	Trionic 4SC <sup>a</sup>	8–16 fl oz
3 + 9	Inspire Super <sup>a</sup>	12 fl oz
7	Aprovia <sup>a</sup>	5.5–7 fl oz
7	Fontelis <sup>a</sup>	16–20 fl oz
7	Kenja 400SC <sup>a</sup>	12.5 fl oz
9	Scala SC <sup>a</sup>	7–10 fl oz
9	Vanguard WG <sup>a</sup>	5 oz
11	Flint Extra <sup>a</sup>	2–2.5 oz
11	Sovran <sup>a</sup>	4–6.4 oz
<b>PLUS one of the following:</b>		
M3	Ferbam 76WDG <sup>b</sup>	6 lb
M3	Penncozeb <sup>c</sup>	3 lb
M3	Ziram 76DF	4 lb
<b>OR one of the following to be applied alone:</b>		
M3	Ziram 76DF	6 lb
7 + 11	Merivon <sup>a</sup>	4–6.7 fl oz
7 + 11	Luna Sensation <sup>a</sup>	4–5.8 fl oz
7 + 11	Pristine <sup>a</sup>	14.5–18.5 oz
<b>PLUS one or more of the following based on the insect pest complex requiring control:</b>		
4A	Actara 25WP <sup>1</sup>	5.5 oz
4A	Admire Pro <sup>2</sup>	7 fl oz
4A and 6	Agri-Flex <sup>3</sup>	8.5 fl oz
6	Agri-Mek 0.15EC <sup>3</sup>	20 fl oz
28	Altacor 35WDG <sup>4</sup>	3 oz
4A	Assail 30SG <sup>2</sup>	5–8 oz
4A	Belay	6–12 fl oz
21A	Bexar	27 fl oz
3A	Brigade 50WSB	6.4–32 oz
16	Centaur <sup>5</sup>	34.5 oz
4A and 15	Cormoran	20–28 fl oz
5	Delegate 25 WG <sup>4,6</sup>	6–7 oz
1B	Diazinon 50W <sup>7</sup>	2–3 lb
7C	Esteem 35WP <sup>8</sup>	4–5 oz
28	Exirel <sup>4</sup>	20.5 fl oz
3A and 6	Gladiator	19 fl oz
4A	Imidacloprid 1.6F <sup>2</sup>	16–20 fl oz
1B	Imidan 70WP	3–4 lb
18	Intrepid 2F	12–16 fl oz
1A	Lannate 90SP	12–16 oz
1A	Lannate LV	36 fl oz
6 and 28	Minecto Pro <sup>4</sup>	10–12 fl oz
23	Movento <sup>9</sup>	6–9 fl oz
21A	Nexter 75WP <sup>10</sup>	10.6 oz
21A	Portal	2 pt
4D	Sivanto 200SL	14 fl oz
UNB	Venerate XC	2–4 qt
4A and 28	Voliam Flexi 40W <sup>4</sup>	4–7 fl oz

**Fungicide and Antibiotic Notes**

- To improve their efficacy and prevent or delay buildup of resistant strains of the fungus causing pear scab, these fungicides will require a selected use strategy due to concern about resistance development. These fungicides have benefits for early and summer season disease management; however, they should be tank-mixed with a protectant, rotated with another fungicide with a different FRAC code for target disease, and not be used in more than two consecutive sprays. Refer to the label and do not exceed maximum number of applications per season.
- Late season applications of ferbam may result in unsightly residues on the fruit.
- Some equivalent products include Dithane, Koverall and Manzate. Check the label for rates.

**Insecticide and Acaricide Notes**

Insecticides should be selected and combined according to their efficacy against individual pests (see Table 4-10).

- Do not apply more than 16.5 ounces per season of Actara or 0.258 pound of active ingredients of thiamethoxam-containing products per season.
- Adding a quart of summer oil per 100 gallons will increase Assail, Admire Pro, and imidacloprid efficacy.
- Agri-Flex and Agri-Mek should be combined with a horticultural spray oil (not a dormant oil) for best results; however, other penetrating adjuvants can be used with somewhat less efficacy. The rate for the horticultural spray oil should be a 0.25 percent concentration (1 quart per 100 gallons or a minimum of 1 gallon per acre). For best results, apply Agri-Flex and Agri-Mek at petal fall or within 10 to 15 days of petal fall and use a minimum of 100 gallons of water per acre. Make a maximum of two applications per season. If foliage is hardening off, do not apply. Agri-Flex and Agri-Mek are not broad-spectrum insecticides and should not be the only insecticide applied at this time.
- In order to prevent the development of pest resistance to these new chemistries and to practice the most effective resistance management approach, we highly encourage growers to use only one chemical class of products (i.e., mode of action) for a particular generation of a targeted pest and to rotate to another chemical class to control the succeeding generation of the targeted pest. For example, if using Delegate to control the first generation of codling moth, use Altacor, Exirel, Minecto Pro, or Voliam Flexi to control the second generation; or if using Altacor, Exirel, Minecto Pro, or Voliam Flexi to control the first generation of codling moth, then switch to Delegate or another chemical class (Assail, etc.) to control the second generation. Altacor, Exirel, Minecto Pro, and Voliam Flexi belong to the same chemical class (IRAC Group 28) and should not be used for consecutive generations of a targeted pest.
- Centaur is highly active against San Jose scale crawlers and effective against pear psylla. Thorough coverage is required. Make only one application per season.
- Control of pear psylla with Delegate can be improved with the addition of an adjuvant (e.g., 2 quarts per 100 gallons of a summer oil).
- Only one application of diazinon is allowed during the season.
- Only two applications allowed between swollen bud and petal fall. Thorough coverage is required.
- For increased effectiveness, add a penetrating adjuvant.
- Nexter is most effective against small nymphs of pear psylla.



**Mites.** Mite injury on pears mimics fire blight injury. Use one of the following for mite control. Several miticide options are given. The miticide chosen and its rate should be based on the size of the mite population, the number of predators present, and the degree of resistance in particular orchard blocks. Miticides should be selected according to their efficacy against individual pests (see Table 4-10).

<b>Acaricide recommendations for pears.</b>		
IRAC Group	Acaricide	Recommended rate per acre
<b>CHOOSE one of the following:</b>		
20D	Acramite 50WS <sup>1</sup>	1 lb
4A and 6	Agri-Flex <sup>2</sup>	5.5–8.5 fl oz
6	Agri-Mek 0.15EC <sup>2</sup>	20 fl oz
10A	Apollo 4SC <sup>3</sup>	4–6 oz
23	Envidor 2SC	18 fl oz
20B	Kanemite 15SC	21–31 fl oz
25A	Nealta	13.7 fl oz
21A	Nexter 75WP <sup>4</sup>	6.6 oz
21A	Portal <sup>5</sup>	2 pt
10A	Savey 50WP <sup>3</sup>	4–6 oz
1A	Vydate 2L	3 pt
10B	Zeal 72WDG	3 oz

#### Acaricide Notes

Acaricides should be selected and combined according to their efficacy against individual pests (see Table 4-10).

1. Add a surfactant for improving coverage. It is strongly recommended that water hardness be reduced with water treatment containing ammonium sulfate prior to adding the surfactant and Acramite.
2. Agri-Flex and Agri-Mek should be combined with a horticultural spray oil (not a dormant oil) for best results; however, other penetrating adjuvants can be used with somewhat less efficacy. The rate for the horticultural spray oil should be a 0.25 percent concentration (1 quart per 100 gallons or a minimum of 1 gallon per acre). For best results, apply Agri-Flex and Agri-Mek at petal fall or within 10 to 15 days of petal fall and use a minimum of 100 gallons of water per acre. Make a maximum of two applications per season. If foliage is hardening off, do not apply.
3. Do not apply Apollo and Savey in the same year.
4. If twospotted spider mites are the intended target of Nexter, use 8.8 to 10.6 ounces per acre.
5. Portal also has activity against pear psylla nymphs.

## Pears—Sixth Cover, Early August

**Diseases.** Sooty blotch, flyspeck, fruit rots.

**Insects.** Codling moth, Oriental fruit moth, leafrollers, pear psylla.

**Sprays before harvest.** Refer to Table 4-15 when selecting sprays during the last month before harvest.

<b>Pesticide recommendations for pears, sixth cover, early August.</b>		
FRAC or IRAC Group	Pesticide	Recommended rate per acre
<b>CHOOSE one of the following:</b>		
1	Topsin M WSB <sup>a</sup>	1 lb
3	Procure 480SC <sup>a</sup>	8–16 oz
11	Flint Extra <sup>a</sup>	2.9 fl oz
<b>PLUS one of the following:</b>		
M3	Ferbam 76WDG <sup>b</sup>	4 lb
M3	Ziram 76DF <sup>b</sup>	4 lb
<b>OR one of the following to be applied alone:</b>		
M3	Ferbam 76WP <sup>b</sup>	4 lb
M3	Ziram 76DF <sup>b</sup>	6 lb
7 + 11	Merivon <sup>a</sup>	4–6.7 fl oz
7 + 11	Luna Sensation <sup>a</sup>	4–5.8 fl oz
7 + 11	Pristine <sup>a</sup>	14.5–18.5 oz
<b>PLUS one or more of the following based on the insect pest complex requiring control:</b>		
4A	Admire Pro <sup>1</sup>	7 fl oz
4A	Assail 30SG <sup>1</sup>	4–8 oz
4A	Belay	6–12 fl oz
5	Delegate 25 WG <sup>2</sup>	6–7 oz
28	Exirel	20.5 fl oz
4A	Imidacloprid 1.6F <sup>1</sup>	16–20 fl oz
23	Movento <sup>3</sup>	6–9 fl oz
N/A	OFM sprayable pheromones	use label rate
4D	Sivanto 200 SL	14 fl oz
UNB	Venerate XC	2–3 qt

#### Fungicide and Antibiotic Notes

- a. These fungicides should be used in combination with another fungicide to improve their efficacy and to prevent or delay buildup of resistant strains of the fungus causing pear scab.
- b. Do not apply ferbam within seven days of harvest, and Ziram within 14 days of harvest; read the label for specific late cover spray.

#### Insecticide and Acaricide Notes

Insecticides should be selected and combined according to their efficacy against individual pests (see Table 4-10).

1. Adding a quart of summer oil per 100 gallons will increase Admire Pro, Assail, and imidacloprid efficacy.
2. Control of pear psylla with Delegate can be improved with the addition of an adjuvant (e.g., 2 quarts per 100 gallons of a summer oil).
3. For increased effectiveness, add a penetrating adjuvant.

## Pears—Final Cover to Postharvest

**Postharvest fruit rots.** See Part VI, Harvest and Postharvest Handling.

## PEACH AND NECTARINE IPM PROGRAM

### Peaches and Nectarines—Dormant, Before Bud Swell

**Brown rot.** Remove all fruit from trees after last picking to prevent brown rot fungus from overwintering in mummies and twig cankers. Disking lightly under the trees no later than first bloom will aid in preventing fruiting of the brown rot fungus on old mummies in contact with the soil. Clean cultivation is not necessary—just disturb the mummy’s contact with the soil. If this is not done, bloom sprays may become more critical. Refer to Part II for additional management strategies..

**Cytospora canker.** Refer to Part II for management.

**Leaf curl, bacterial spot.** The only time to manage peach leaf curl is when all the leaves are off of the tree and before bud swell. If growers choose to apply their dormant spray late winter, be sure to monitor warm spells during February since early cultivars will be most vulnerable to early bud swell during such conditions. It is advised to apply dormant fungicides prior to these events to adequately mitigate peach leaf curl.

**Insects.** Mites, scales.

**Lecanium scale and San Jose scale.** Apply Esteem at 4 to 5 ounces with oil. Use the higher rates of chlorpyrifos, Esteem, and Lorsban under heavy scale pressure.

#### ***Pesticide recommendations for peaches and nectarines, dormant, before bud swell.***

FRAC or IRAC Group	Pesticide	Recommended rate per acre
<b>CHOOSE one of the following:</b>		
M1	Copper	use recommended label rate
M2	Sulfur	15 lb
M3	Ferbam 76WDG	4.5 lb
M3	Thiram Granuflo	3.5 lb
M3	Ziram 76DF	6–8 lb
M5	Bravo Weather Stik	3.1–4 pt
M5	Chlorothalonil 720	3.1–4 pt
U12	Syllit FL	3 pt
<b>PLUS one or more of the following based on the insect pest complex requiring control:</b>		
1B	Chlorpyrifos	2–3 pt
N/A	Dormant oil	4 gal
7C	Esteem 35WP	5 oz
1B	Lorsban 75WG	1–2 lb

### Peaches and Nectarines—Pink to First Open Bloom

**Disease.** Brown rot (blossom blight). Blossom blight typically is not a problem unless temperatures are above 55°F, it is warm and wet, or brown rot has been a problem in the past.

**Insects.** Plant bugs, green peach aphid.

**Oriental fruit moth mating disruption.** If hand-applied mating disruption is used, dispensers should be placed at the pink stage at the recommended label rate. All dispensers should be in place before peach bloom. See Part III for a discussion on mating disruption. If a sprayable pheromone formulation for Oriental fruit moth is used, make first applications before the start of second brood flight. Repeat applications every two to three weeks or as needed. If chemical control is necessary, use degree-day egg hatch model for the best timing of available insecticides. Note: Avoid killing bees on opening blossoms and cover crops; watch insecticides that are toxic to bees (refer to pesticide label). See Table 1-9 for pesticide impacts on bees.

**Plant bugs.** Applying alternate row-middle sprays at reduced intervals should improve control. Plant bug feeding injury results in sunken areas on developing fruit that is not pubescent. Bugs are most persistent in orchards with alfalfa or clover sods. Since peaches are most vulnerable to catfacing injury at pink and petal fall, do not cultivate soil in orchards at those times. Cultivation only serves to destroy many alternate host plants, thus driving the insects up into the peach trees.

**Pesticide recommendations for peaches and nectarines, pink to first open bloom.**

FRAC or IRAC Group	Pesticide	Recommended rate per acre
<b>CHOOSE one of the following:</b>		
M3	Thiram Granuflo	3.5 lb
M3	Ziram 76DF	4.5–8 lb
M4	Captan 80WDG <sup>a</sup>	2.5–5 lb
M5	Bravo Weather Stik	3.1–4 pt
M5	Chlorothalonil 720	3.1–4 pt
1	Topsin M WSB <sup>b</sup>	1–1.5 lb
2	Rovral 4 F <sup>b</sup>	1–2 pt
3	Indar 2F <sup>b</sup>	6–12 fl oz
3	Quash <sup>b</sup>	4 oz
3	Rally 40WSP <sup>b</sup>	6 oz
3	Rhyme <sup>b</sup>	7 fl oz
3 + 7	Luna Experience <sup>b</sup>	6–10 fl oz
7	Fontelis <sup>b</sup>	14–20 fl oz
7	Kenja <sup>b</sup>	12.5 fl oz
7 + 11	Luna Sensation <sup>b</sup>	5–7.6 fl oz
7 + 11	Merivon 4.18SC <sup>b</sup>	4–6.7 fl oz
7 + 11	Pristine <sup>b</sup>	10.5–14.5 oz
9	Scala SC <sup>b</sup>	9–18 oz
9	Vanguard WG <sup>b</sup>	5 oz
11	Flint Extra <sup>b</sup>	2.5–3.8 fl oz

**PLUS one or more of the following based on the insect pest complex requiring control\*:**

3A	Asana XL 0.66EC	4.8–8 fl oz
3A	Baythroid 2E	1.4–2.8 fl oz
3A	Danitol 2.4 EC	10.7–21.3 fl oz
1B	Imidan 70WP	3 lb
3A	Mustang Max	1.3–4 fl oz
3A	Permethrin 3.2EC	6–7.5 fl oz
3A	Permethrin 25W	0.60–0.75 lb
3A	Proaxis	2.5–5.1 fl oz
3A	Warrior II	1.3–2.5 fl oz

\*Insecticides should be selected and combined according to their efficacy against individual pests (see Table 4-12).

**Fungicide and Antibiotic Notes**

- Equivalent products include Captan 50% W and WP, and Captan and Captec 4L. Check the label for rates per 100 gallons per acre. REI restrictions vary from 24 hours to four days; check the label of the product you are using. Some Captan products may be applied up to the day of harvest.
- These fungicides are most effective when applied in combination with captan, Thiram, or Ziram. Refer to the label for specific recommendations.

**Peaches and Nectarines—Bloom**

**Disease.** Brown rot (blossom blight).

**Pesticide recommendations for peaches and nectarines, bloom.**

FRAC Group	Pesticide	Recommended rate per acre
M2	Sulfur	15 lb
M3	Thiram Granuflo	3.5 lb
M3	Ziram 76DF	4.5–8 lb
M4	Captan 80WDG <sup>a</sup>	2.5 lb
M5	Bravo Weather Stik	3.1–4 pt
M5	Chlorothalonil 720	3.1–4 pt
1	Topsin M WSB <sup>b</sup>	1–1.5 lb
2	Rovral 4 F <sup>b</sup>	1–2 pt
3	Indar 2F <sup>b</sup>	6–12 fl oz
3	Quash <sup>b</sup>	4 oz
3	Rally 40WSP <sup>b</sup>	6 oz
3	Rhyme <sup>b</sup>	7 fl oz
3 + 7	Luna Experience <sup>b</sup>	6–10 fl oz
7	Fontelis <sup>b</sup>	14–20 fl oz
7	Kenja <sup>b</sup>	12.5 fl oz
7 + 11	Luna Sensation <sup>b</sup>	5–7.6 fl oz
7 + 11	Merivon <sup>b</sup>	4–6.7 fl oz
7 + 11	Pristine <sup>b</sup>	10.5–14.5 oz
9	Scala SC <sup>b</sup>	9–18 oz
9	Vanguard WG <sup>b</sup>	10 oz
11	Flint Extra <sup>b</sup>	2.5–3.8 fl oz

**Fungicide and Acaricide Notes**

- Equivalent products include Captan 50% W and WP, and Captan and Captec 4L. Check the label for rates per 100 gallons per acre. REI restrictions vary from 24 hours to four days; check the label of the product you are using. Some Captan products may be applied up to the day of harvest.
- These fungicides are most effective when applied in combination with captan, Thiram, or Ziram. Refer to the label for specific recommendations.

**Peaches and Nectarines—Petal Fall**

**Brown rot.** See management recommendations for the bloom timing.

**Peach scab.** Control is needed from petal fall through first cover. Fungicides used to control brown rot will also control for scab.

**Rusty spot.** Control should be included from petal fall through second cover. Spotting on the fruit of some varieties appears to be due to the apple powdery mildew fungus. Jefferson, Jersey Queen, Loring, Redskin, Rio-Oso-Gem, and Washington often are affected. Many of the new peach and nectarine cultivars are also highly susceptible. Luna Experience, Luna Sensation, Merivon, Pristine, Rally, Rhyme, or sulfur may reduce rusty spot incidence. In addition, Quintec and Vivando can be used and are only effective against powdery mildew. Consequently, they must be tank-mixed with another product, such as captan, if needing control for other fungal diseases.

**Insects.** Aphids, Oriental fruit moth, plant bugs, plum curculio.

**Green peach aphid.** If this aphid is present, add Actara, Admire Pro, Assail, Beleaf, imidacloprid, or Movento.

**Plum curculio.** If plum curculio is a problem, shorten spray intervals through the first cover spray. Assail, Avaunt, and Imidan are the best choices for this pest.

**Pesticide recommendations for peaches and nectarines, petal fall.**

FRAC or IRAC Group	Pesticide	Recommended rate per acre
<b>CHOOSE one of the following:</b>		
M2	Sulfur	15 lb
M3	Thiram Granuflo	3.5 lb
M3	Ziram 76DF	4.5–8 lb
M4	Captan 80WDG <sup>a</sup>	2.5 lb
M5	Bravo Weather Stik	3.1–4 pt
M5	Chlorothalonil 720	3.1–4 pt
1	Topsin M WSB <sup>b</sup>	1–1.5 lb
2	Rovral 4 F <sup>b</sup>	1–2 pt
3	Indar 2F <sup>b</sup>	6–12 fl oz
3	Quashb	4 oz
3	Rally 40WSP <sup>b</sup>	6 oz
3	Rhyme <sup>b</sup>	7 fl oz
3 + 7	Luna Experience <sup>b</sup>	6–10 fl oz
7	Fontelis <sup>b</sup>	14–20 fl oz
7 + 11	Luna Sensationb	5–7.6 fl oz
7 + 11	Merivon <sup>b,c</sup>	4–6.7 fl oz
7 + 11	Pristine <sup>b</sup>	10.5–14.5 oz
9	Scala SC <sup>b</sup>	9–18 oz
11	Flint Extra	2.5–3.8 fl oz
13	Quintec <sup>c</sup>	7 fl oz
50	Vivando <sup>c</sup>	15.4 fl oz
<b>PLUS one or more of the following based on the insect pest complex requiring control:</b>		
4A	Actara 25W	5.5 oz
4A	Admire Pro	2.8 fl oz
21A	Apta	27 fl oz
3A	Asana XL 0.66EC	4.8–8 fl oz
3A	Assail 30SG	4–8 oz
22A	Avaunt 30WDG	6 oz
3A	Baythroid 2E	2.8 fl oz
4A	Belay	3–6 fl oz
29	Beleaf 50SG	2.8 oz
3A and 28	Besiege <sup>1</sup>	6–10 fl oz
3A	Danitol 2.4 EC	10.7–21.3 fl oz
5	Delegate 25WG <sup>1</sup>	4.5 oz
3A and 4A	Endigo ZC	5.5 fl oz
28	Exirel <sup>1</sup>	20.5 fl oz
3A and 6	Gladiator	19 fl oz
4A	Imidacloprid 1.6F	4–6 fl oz
1B	Imidan 70WP	3–4 lb
3A and 4A	Leverage 360	2.8 fl oz
6 and 28	Minecto Pro <sup>1</sup>	10–12 fl oz
23	Movento <sup>2</sup>	6–9 fl oz
3A	Mustang Max	1.3–4 fl oz
3A	Permethrin 3.2EC	7.5 fl oz
3A	Permethrin 25WP	0.75 lb
3A	Proaxis	2.5–5.1 fl oz
4A and 28	Voliam Flexi 40 WDG <sup>1</sup>	7 oz
3A	Warrior II	2.5 fl oz

**Fungicide and Antibiotic Notes**

- Equivalent products include Captan 50% W and WP, and Captan and Captec 4L. Check the label for rates per 100 gallons per acre. REI restrictions vary from 24 hours to four days; check the label of the product you are using. Some Captan products may be applied up to the day of harvest.
- These fungicides are most effective when applied in combination with captan, Thiram, and Ziram. Refer to the label for specific recommendations.
- Quintec and Vivando are only effective against powdery mildew and must be tank-mixed with another product if control for other fungal disease is needed.

**Insecticide and Acaricide Notes**

Insecticides should be selected and combined according to their efficacy against individual pests (see Table 4-12).

- In order to prevent the development of pest resistance to these new chemistries and to practice the most effective resistance management approach, we highly encourage growers to use only one chemical class of products (i.e., mode of action) for a particular generation of a targeted pest and to rotate to another chemical class to control the succeeding generation of the targeted pest. For example, if using Delegate to control the first generation of Oriental fruit moth, use Altacor, Besiege, Exirel, Minecto Pro, or Voliam Flexi to control the second generation; or if using Besiege, Exirel, Minecto Pro, or Voliam Flexi to control the first generation of Oriental fruit moth, then switch to Delegate or another chemical class (Assail, etc.) to control the second generation. Altacor, Besiege, Exirel Minecto Pro, and Voliam Flexi belong to the same chemical class (IRAC Group 28) and should not be used for consecutive generations of a targeted pest. The same rotation approach applies to Delegate and all other chemistries.
- For increased effectiveness, add a penetrating adjuvant.

## Peaches and Nectarines—Shuck Split, Shuck Fall

**Bacterial spot.** Rotating multiple products throughout the season is most effective. If disease conditions are favorable, weekly sprays will be needed. During hot, dry weather, intervals can be increased. Begin applications of Mycoshield or FireLine at shuck split on susceptible varieties. Mycoshield and FireLine are applied at a rate of 12 ounces per 100 gallons of water. Sprayer air velocity should not exceed 100 mph. The first three applications are most critical for control. Do not apply within three weeks of harvest. Dilute sprays with Mycoshield or FireLine have provided the best control since complete coverage is essential. Spraying at night under slow-drying conditions is most effective. Fixed coppers have also shown to provide satisfactory disease control. Options also include using 0.5 to 1 ounce of metallic copper per acre (refer to the label for the copper being used); however, be mindful of slow-drying conditions when copper is used since this will increase the phytotoxic nature of copper. Refer to Part III for more information about copper and how to mitigate phytotoxicity. In addition, rotating with a *Bacillus subtilis* product (Double Nickel or Serenade) and/or plant-based products, such as Regalia, with copper has shown efficacy in mitigating bacterial spot on moderately susceptible cultivars in Pennsylvania.

**Brown rot.** From shuck split through covers, broad-spectrum fungicides are adequate for control.

**Peach scab.** Control is needed from petal fall through first cover. Fungicides used to control brown rot will also control for scab. See fungicides recommended for petal fall timing.

**Rusty spot.** Spotting on the fruit of some varieties appears to be due to the apple powdery mildew fungus. Loring, Jefferson, Jersey Queen, Redskin, Rio-Oso-Gem, and Washington are often affected. Many of the new peach and nectarine cultivars are also highly susceptible. Luna Experience, Luna Sensation, Merivon, Pristine, Rally, Rhyme, or sulfur may reduce rusty spot incidence; however, limit the use of these products during this period in order to use them during the preharvest period to limit brown rot. In addition, Quintec and Vivando can be used and are only effective against powdery mildew. Consequently, they must be tank-mixed with another product, such as captan, if needing control for other fungal diseases. Follow label recommendations.

**Insects.** Aphids, Oriental fruit moth, leafrollers, plant bugs, Plum curculio. Assail, Avaunt, and Imidan are our best choices for the control of plum curculio.

**Green peach aphid.** If this aphid is present, add Actara, Admire Pro, Belay, Beleaf, imidacloprid, or Movento.

**Plum curculio.** See petal fall spray recommendations for control.

### Pesticide recommendations for peaches and nectarines, shuck split, shuck fall.

FRAC or IRAC Group	Pesticide	Recommended rate per acre
<b>CHOOSE one of the following:</b>		
M3	Thiram Granuflo	3.5 lb
M3	Ziram 76DF	6–8 lb
M4	Captan 80WDG <sup>a</sup>	2–2.5 lb
<b>PLUS one or more of the following based on the insect pest complex requiring control:</b>		
4A	Actara 25W	5.5 oz
4A	Admire Pro	2.8 fl oz
21A	Apta	27 fl oz
3A	Asana XL 0.66EC <sup>1</sup>	4.8–8 fl oz
4A	Assail 30SG	4–8 oz
22A	Avaunt 30WDG	6 oz
3A	Baythroid 2E <sup>1</sup>	2.8 fl oz
4A	Belay	3–6 fl oz
29	Beleaf 50SG	2.8 oz
3A and 28	Besiege <sup>1,2</sup>	10–12 fl oz
4C	Closer SC	2.75 fl oz
3A	Danitol 2.4 EC <sup>1</sup>	10.7–21.3 fl oz
5	Delegate 25WG <sup>2</sup>	4.5 oz
3A and 4A	Endigo ZC <sup>1</sup>	5.5 fl oz
28	Exirel <sup>2</sup>	20.5 fl oz
3A and 6	Gladiator	19 fl oz
4A	Imidacloprid 1.6F	4–6 fl oz
1B	Imidan 70WP	3–4 lb
N/A	Isomate-PTB Dual <sup>3</sup>	150–250 dispensers per acre
1A	Lannate 90SP	12–16 oz
1A	Lannate LV <sup>5</sup>	36–48 fl oz
3A and 4A	Leverage 360 <sup>1</sup>	2.4–2.8 fl oz
6 and 28	Minecto Pro <sup>2</sup>	10–12 fl oz
23	Movento <sup>4</sup>	6–9 fl oz
3A	Mustang Max	1.3–4 fl oz
N/A	OFM sprayable pheromones	see label rate
3A	Proaxis <sup>1</sup>	2.5–5.1 fl oz
UNB	Venerate XC	2–4 qt
4A and 28	Voliam Flexi 40 WDG <sup>2</sup>	4–7 oz
3A	Warrior II <sup>1</sup>	1.3–2.5 fl oz

### Fungicide and Antibiotic Note

- a. Equivalent products include Captan 50% W and WP, and Captan and Captec 4L. Check the label for rates per 100 gallons per acre. REI restrictions vary from 24 hours to four days; check the label of the product you are using. Some Captan products may be applied up to the day of harvest.

### Insecticide and Acaricide Notes

Insecticides should be selected and combined according to their efficacy against individual pests (see Table 4-12).

1. Use of synthetic pyrethroids after petal fall can cause increases in spider mite populations, and synthetic pyrethroids are quite toxic to all natural enemies.
2. In order to prevent the development of pest resistance to these new

chemistries and to practice the most effective resistance management approach, we highly encourage growers to use only one chemical class of products (i.e., mode of action) for a particular generation of a targeted pest and to rotate to another chemical class to control the succeeding generation of the targeted pest. For example, if using Delegate to control the first generation of Oriental fruit moth, use Altacor, Besiege, Minecto Pro, or Voliam Flexi to control the second generation; or if using Altacor, Besiege, Exirel, Minecto Pro, or Voliam Flexi to control the first generation of Oriental fruit moth, then switch to Delegate or another chemical class (Assail, etc.) to control the second generation. Altacor, Besiege, Exirel, Minecto Pro, and Voliam Flexi belong to the same chemical class (IRAC Group 28) and should not be used for consecutive generations of a targeted pest. The same rotation approach applies to Delegate and all other chemistries.

3. Isomate PTB Dual will control both lesser peachtree borer and peachtree borer and should be placed before first flight of lesser peachtree borer.
4. For increased effectiveness, add a penetrating adjuvant.
5. Lannate LV is not registered for use on nectarines in Pennsylvania.

## Peaches and Nectarines—First, Second, Third Covers

**Bacterial spot.** See shuck split schedule for control. Apply at 10- to 14-day intervals. Reduce interval to seven days in wet weather.

**Brown rot.** Refer to recommendations listed for shuck split timing. Broad-spectrum fungicides are adequate for control.

**Peach scab.** Refer to recommendations listed for petal fall timing. Control through first cover.

**Rusty spot.** Refer to recommendations listed for petal fall and control until pit hardening.

**Insects.** Leafrollers, lesser peachtree borer, mites, Oriental fruit moth, plant bugs, scales.

### Pesticide recommendations for peaches and nectarines, first, second, and third covers.

FRAC or IRAC Group	Pesticide	Recommended rate per acre
<b>CHOOSE one of the following:</b>		
M3	Thiram Granuflo	3.5 lb
M3	Ziram 76DF	6–8 lb
M4	Captan 80WDG <sup>a</sup>	2–2.5 lb
50	Vivando <sup>b</sup>	15.4 fl oz
13	Quintec <sup>b</sup>	7 fl oz
<b>PLUS one or more of the following based on the insect pest complex requiring control:</b>		
4A	Actara 25W	5.5 oz
28	Altacor 35WDG <sup>1</sup>	3 oz
21A	Apta	27 fl oz
3A	Asana XL 0.66EC <sup>2,3</sup>	4.8–8 oz
4A	Assail 30SG	4–8 oz
22A	Avaunt 30WDG	5–6 oz
3A	Baythroid 2E <sup>2,3</sup>	1.4–2.8 fl oz
4A	Belay	3–6 fl oz
3A and 28	Besiege <sup>1,2,3</sup>	10–12 fl oz
16	Centaur	34.5 oz
4C	Closer SC	5.75 fl oz
3A	Danitol 2.4 EC <sup>3</sup>	10.7–21.3 fl oz
5	Delegate 25WG <sup>1</sup>	4.5 oz
1B	Diazinon 50W <sup>4</sup>	2–3 lb
28	Exirel <sup>1</sup>	20.5 fl oz
1B	Imidan 70WP	3–4 lb
1A	Lannate 90SP	12–16 oz
1A	Lannate LV	36–48 fl oz
6 and 28	Minecto Pro <sup>1</sup>	10–12 fl oz
23	Movento <sup>5</sup>	6–9 fl oz
3A	Mustang Max	1.3–4 fl oz
N/A	OFM sprayable pheromones	see label rate
3A	Permethrin 3.2EC <sup>2,3</sup>	4–8 fl oz
3A	Proaxis <sup>2,3</sup>	2.5–5.1 fl oz
UNB	Venerate XC	2–4 qt
4A and 28	Voliam Flexi 40 WDG <sup>1</sup>	4–7 oz
3A	Warrior II <sup>3</sup>	1.3–2.5 fl oz

### Fungicide and Antibiotic Notes

- Equivalent products include Captan 50% W and WP, and Captan and Captec 4L. Check the label for rates per 100 gallons per acre. REI restrictions vary from 24 hours to four days; check the label of the product you are using. Some Captan products may be applied up to the day of harvest.*
- Quintec and Vivando are only effective against powdery mildew and must be tank-mixed with another product if control for other fungal disease is needed.*

### Insecticide and Acaricide Notes

Insecticides should be selected and combined according to their efficacy against individual pests (see Table 4-12).

- In order to prevent the development of pest resistance to these new chemistries and to practice the most effective resistance management approach, we highly encourage growers to use only one chemical class*

of products (i.e., mode of action) for a particular generation of a targeted pest and to rotate to another chemical class to control the succeeding generation of the targeted pest. For example, if using Delegate to control the first generation of Oriental fruit moth, use Altacor, Besiege, Exirel, Minecto Pro, or Voliam Flexi to control the second generation; or if using Altacor, Besiege, Exirel, Minecto Pro, or Voliam Flexi to control the first generation of Oriental fruit moth, then switch to Delegate or another chemical class (Assail) to control the second generation. Altacor, Besiege, Exirel, Minecto Pro, and Voliam Flexi belong to the same chemical class (IRAC Group 28) and should not be used for consecutive generations of a targeted pest. The same rotation approach applies to Delegate and all other chemistries.

- Pyrethroids are very effective against Oriental fruit moth, plant bugs, and stink bugs. They are also effective on lesser peachtree borer when applied by handgun or dilute.
- Use of synthetic pyrethroids after petal fall can cause increases in spider mite populations, and synthetic pyrethroids are quite toxic to all natural enemies.
- Only one application of diazinon is allowed during the season.
- For increased effectiveness, add a penetrating adjuvant.

**Early season lesser peachtree borer.** If there is only a moderate problem (fewer than two borers per tree), wait until late summer to apply controls (see “Postharvest Disorders of Peaches,” below). If there are more than two borers per tree, make an application now and again in late summer. This borer attacks weak or injured trees in winter-damaged orchards and diseased trees, especially those with canker. Adult borers deposit eggs in wounds from May through August. The peak egg-laying period for the first generation is in June. Low-volume sprays are not effective on lesser peachtree borer. Use only high-volume handgun applications. Be sure to cover trunk and scaffold limbs.

#### Lesser peachtree borer recommendations for peaches.

IRAC Group	Pesticide	Dilute rate per 100 gallons
<b>CHOOSE one of the following*:</b>		
3A	Asana XL 0.66EC	2–4 oz
1B	Chlorpyrifos 4E	1.5–2 qt
1B	Lorsban Advanced	1.5–2 qt
3A	Permethrin 3.2EC	1.6 oz

\*Insecticides should be selected according to their efficacy against individual pests (see Table 4-12).

**Mites.** For mite control, use one of the following.

#### Acaricide recommendations for peaches and nectarines.

IRAC Group	Acaricide	Recommended rate per acre
<b>CHOOSE one of the following:</b>		
20D	Acramite <sup>1</sup>	0.75–1 lb
10A	Apollo 4SC	3–6 fl oz
23	Envidor 2SC	14–18 fl oz
21A	Nexter <sup>2</sup>	4.4–10.6 oz
10A	Onager	12–24 fl oz
10A	Savey 50WP	3–6 oz
10B	Zeal	3 oz

#### Insecticide and Acaricide Notes

Insecticides should be selected and combined according to their efficacy against individual pests (see Table 4-12).

- Add a surfactant for improving coverage. It is strongly recommended that water hardness be reduced with a water treatment that contains ammonium sulfate prior to adding the surfactant and Acramite.
- Higher rate of Nexter is necessary for twospotted spider mite control.

#### Peaches and Nectarines—Fourth and Later Covers

**Diseases.** Bacterial spot, brown rot, scab, sooty mold. If peach scab is not a critical issue, using captan only for cover sprays will be adequate for keeping the population of brown rot spores in check. Save the chemicals with a single mode of action for the preharvest intervals of 18 days, 9 days, and one day preharvest. By controlling insects, sooty mold will be controlled.

**Bacterial spot.** See shuck split schedule for control. Apply at 14-day intervals. Reduce spray intervals to 7 to 10 days in wet weather.

**Insects.** Japanese beetle, leafrollers, mites, Oriental fruit moth.

**Western flower thrips.** Lannate SP has been registered for use on nectarines and peaches in Pennsylvania (24c) to control thrips. The label specifies 0.5 to 1 pound per acre. No more than three applications of Lannate can be made within a season. Preharvest intervals are one day for nectarines and four days for peaches. Reentry into treated areas is prohibited for three days unless you wear personal protective clothing and equipment as specified on the Lannate L product label for early reentry. Delegate and Besiege are also registered for flower thrips control. Growers wishing to use Besiege, Delegate, or Lannate for thrips control should carefully check early ripening fruit for the presence of silvering, the damage caused by feeding thrips on the skin of the fruit. It is extremely important that you cover fruit thoroughly with spray since the thrips hide underneath leaves covering the fruit or around the stem end.

**Pesticide recommendations for peaches and nectarines, fourth and later covers.**

FRAC or IRAC Group	Pesticide	Recommended rate per acre
<b>CHOOSE one of the following:</b>		
M2	Sulfur <sup>a</sup>	15 lb
M3	Ziram 76DF	6–8 lb
M4	Captan 80 WDG <sup>b</sup>	3.125–3.75 lb
<b>PLUS one or more of the following based on the insect pest complex requiring control:</b>		
4A	Actara 25W	5.5 oz
28	Altacor 35WDG <sup>1</sup>	3 oz
21A	Apta	27 fl oz
3A	Asana XL 0.66EC <sup>2</sup>	4.8–8 fl oz
4A	Assail 30SG	4–8 oz
22A	Avaunt 30WDG	6 oz
3A	Baythroid 2E <sup>2</sup>	2.8 fl oz
4A	Belay	3–6 fl oz
3A and 28	Besiege <sup>1,2</sup>	6–12 fl oz
16	Centaur	34.5 oz
4C	Closer SC	5.75 fl oz
3A	Danitol 2.4 EC <sup>2</sup>	10.7–21.3 fl oz
5	Delegate 25W <sup>1</sup>	4.5 oz
28	Exirel <sup>1</sup>	20.5 fl oz
1B	Imidan 70WP	3–4 lb
18	Intrepid 2F	12–16 fl oz
1A	Lannate 90SP	12–16 oz
1A	Lannate LV <sup>3</sup>	36–48 fl oz
3A	Mustang Max	1.3–4 fl oz
N/A	OFM sprayable pheromones	see label rate
3A	Proaxis <sup>2</sup>	2.5–5.1 fl oz
UNB	Venerate XC	3 qt
4A and 28	Voliam Flexi 40 WDG <sup>1</sup>	7 oz
3A	Warrior II <sup>2</sup>	2.5 fl oz

**Fungicide and Antibiotic Note**

- Sulfur is adequate for controlling brown rot during fourth and fifth covers.
- Make the last two sprays before the preharvest sprays be captan at no lower than 3.125 lb/A. Equivalent products include Captan 50% W and WP and Captec 4L. Check the label for rates per 100 gallons per acre. REI restrictions vary from 24 hours to four days; check the label of the product you are using.

**Insecticide and Acaricide Notes**

Insecticides should be selected and combined according to their efficacy against individual pests (see Table 4-12).

- In order to prevent the development of pest resistance to these new chemistries and to practice the most effective resistance management approach, we highly encourage growers to use only one chemical class of products (i.e., mode of action) for a particular generation of a targeted pest and to rotate to another chemical class to control the succeeding generation of the targeted pest. For example, if using Delegate to control the first generation of Oriental fruit moth, use Altacor, Besiege, Exirel, or Voliam Flexi to control the second generation; or if using Altacor, Besiege, Exirel, or Voliam Flexi to control the first generation of Oriental fruit moth, then switch to Delegate or another chemical class (Assail) to control the second generation. Altacor, Besiege, Exirel, and Voliam Flexi

belong to the same chemical class (IRAC Group 28) and should not be used for consecutive generations of a targeted pest. The same rotation approach applies to Delegate and all other chemistries.

- Use of synthetic pyrethroids after petal fall can cause increases in spider mite populations, and synthetic pyrethroids are quite toxic to all natural enemies.
- Lannate LV is not registered for use on nectarines in Pennsylvania.

**Peaches and Nectarines—Before Harvest**

**Sprays before harvest to manage brown rot.** Refer to Table 4-15 when selecting sprays during the last month before harvest. To manage brown rot, apply fungicides in different FRAC Groups 18 days, nine days, and one day preharvest. Be mindful of the fungicides used during bloom and petal fall for fungicide resistance management.

**Vapor Gard.** Vapor Gard is an antitranspirant that may improve color and size; apply at a rate of 1 gallon of product in a minimum of 200 gallons of water per acre two weeks before anticipated harvest. Application may hasten maturity by approximately three days. Caution: Do not apply in a spray tank mixture of any insecticide or fungicide.

**Pesticide recommendations for peaches and nectarines, 18 days, 9 days, and one day before harvest**

FRAC Group	Pesticide	Recommended rate per acre
<b>CHOOSE one of the following:</b>		
M4	Captan 80 WDG <sup>a</sup>	2–3 lb
1	Topsin M WSB	1–1.5 lb
3	Indar 2F	12 fl oz
3	Quash	4 oz
3	Rhyme	7 fl oz
3 + 7	Luna Experience	6–10 fl oz
3 + 9	Inspire Super	16 – 20 fl oz
7	Fontelis	14–20 fl oz
7	Kenja	12.5 fl oz
7 + 11	Luna Sensation	5–7.6 fl oz
7 + 11	Merivon	4–6.7 fl oz
7 + 11	Pristine	10.5–14.5 oz
9	Scala SC	10–18 oz
9	Vanguard WG	5 oz
11	Flint Extra	2.5–3.8 fl oz

**Fungicide and Antibiotic Note**

- Equivalent products include Captan 50% W and WP and Captec 4L. Check the label for rates per 100 gallons per acre. REI restrictions vary from 24 hours to four days; check the label of the product you are using. Some Captan products may be applied up to the day of harvest. It is not necessary to tank-mix captan with the listed fungicides since captan residue from the previous covers will be enough to help with fungicide resistance management.



## Peaches and Nectarines—Postharvest Disorders and Diseases

**Postharvest fruit rots.** See Part VI, Harvest and Postharvest Handling. To mitigate Rhizopus rot, which occurs during storage, use a fungicide with FRAC Group 11 in one of the final preharvest sprays.

**Peachtree borer and lesser peachtree borer on bearing and nonbearing trees.** Two borer species may be present at this time of the season: peachtree borer (PTB) and lesser peachtree borer (LPTB). If only PTB is present and it is on a late maturing variety, apply a trunk spray during the first week of August. Use one of the insecticides under Peaches—First, Second, Third Cover, “Early season lesser peachtree borer.” If it is an early maturing variety, make a postharvest application of either chlorpyrifos 4E at 1.5 to 3 quarts per 100 gallons, Lorsban Advanced at 1.5 to 3 quarts per 100 gallons, or Lorsban 75WG at 2 to 4 pounds per 100 gallons, as a coarse, low-pressure handgun application. Apply at least 1 gallon per tree.

If only LPTB is present, either a preharvest spray on late maturing varieties or a postharvest spray may be made as described above.

If both PTB and LPTB are present, use chlorpyrifos 4E, Lorsban Advanced, or Lorsban 75WG within the first two weeks of September (postharvest). Thoroughly wet all bark areas from ground level to scaffold limbs. Do allow the spray to contact fruit and watch preharvest intervals on late maturing peach varieties (chlorpyrifos 4E, Lorsban 4E, Lorsban 75WG; 14-day PHI).

Preplant treatment to control peachtree borer. Chlorpyrifos 4E, Lorsban 4E, Lorsban 75WG, and Lorsban Advanced are effective as a root dip treatment for peach, nectarine, and cherry trees before they are planted. This treatment has given excellent control through the first season only. Use either chlorpyrifos 4E, Lorsban 4E, Lorsban Advanced (all at 3 quarts per 100 gallons), or Lorsban 75WG (1.5 pounds per 40 gallons of water). Mix thoroughly. Dip the trees individually or in bundles so that roots and crowns are wetted well above the graft union.

## Peaches and Nectarines—Fall Leaf Drop

**Cytospora canker.** Studies in Pennsylvania have shown that the fall leaf drop fungicide application is not effective in reducing Cytospora canker. No fungicide spray is recommended after leaf drop for canker control.

**Leaf curl and bacterial spot.** The following spray, when applied in the fall just after the last leaves drop, will control leaf curl. Copper may aid in controlling bacterial spot.

### *Pesticide recommendations for peaches and nectarines, fall leaf drop.*

FRAC Group	Pesticide	Recommended rate per acre
<b>CHOOSE one of the following:</b>		
M1	Copper compounds	use recommended label rate
M2	Sulfur	15 lb
M3	Ferbam 76WDG	4.5 lb
M3	Ziram 76DF	6–8 lb
M5	Bravo Weather Stik	3.1–4 pt
M5	Chlorothalonil 720	3.1–4 pt
U12	Syllit	3 pt

## APRICOT IPM PROGRAM

### Apricots—Dormant

**Canker.** Pruning late in the spring, up to petal fall, followed by a thorough spray before the next rain will reduce new infections.

**Disease.** Bacterial spot. Copper applications are recommended to kill bacteria on the outside of the tree.

**Lecanium scale and San Jose scale:** apply Esteem at 4 to 5 ounces with oil. Use higher rate of Esteem under heavy scale pressure.

### *Pesticide recommendations for apricots where scales are problem.*

FRAC or IRAC Group	Pesticide	Recommended rate per acre
M1	Copper compounds	see label for recommended rates
N/A	Dormant oil	3.5 gal
7C	Esteem 35WP	4–5 oz

### Apricots—Pink to First Open Bloom

**Disease.** Brown rot (blossom blight).

**Insects.** Aphids, plant bugs. Note: Avoid killing bees on opening blossoms and cover crops; watch insecticides that are toxic to bees (refer to pesticide label). See Table 1-9 for pesticide impacts on bees.

**Pesticide recommendations for apricots, pink to first open bloom.**

FRAC or IRAC Group	Pesticide	Recommended rate per acre
<b>CHOOSE one of the following:</b>		
M3	Ziram 76DF	6–8 lb
M4	Captan 80WDG <sup>a</sup>	1–3.5 lb
1	Topsin M WSB <sup>b</sup>	1–1.5 lb
2	Rovral 4 F <sup>b</sup>	1–2 pt
3	Indar 2F <sup>b</sup>	6–12 fl oz
3	Quash <sup>b</sup>	4 oz
3	Rally 4 WSP <sup>b</sup>	2.5–6 oz
3	Rhyme <sup>b</sup>	7 fl oz
3 + 7	Luna Experience <sup>b</sup>	6–10 fl oz
7	Fontelis <sup>b</sup>	14–20 fl oz
7	Kenja <sup>b</sup>	12.5 fl oz
7 + 11	Luna Sensation <sup>b</sup>	5–7.6 fl oz
7 + 11	Merivon <sup>b</sup>	4–6.7 fl oz
7 + 11	Pristine <sup>b</sup>	10.5–14.5 oz
9	Scala SC <sup>b</sup>	10–18 oz
9	Vanguard <sup>b</sup>	5 oz
11	Flint Extra <sup>b</sup>	2.5–3.8 fl oz
<b>PLUS one or more of the following based on the insect pest complex requiring control*:</b>		
3A	Asana XL 0.66EC	4.8–8 fl oz
3A	Baythroid 2E	2.8 fl oz
3A	Danitol 2.4 EC	10.7–21.3 fl oz
1B	Imidan 70WP	3 lb
3A	Mustang Max	1.3–4 fl oz
3A	Proaxis	2.5–5.1 fl oz
3A	Warrior II	1.3–2.5 fl oz

\*Insecticides should be selected and combined according to their efficacy against individual pests.

**Fungicide and Antibiotic Notes**

- Equivalent products include Captan 50% W and WP, and Captan and Captec 4L. Check the label for rates per 100 gallons per acre. REI restrictions vary from 24 hours to four days; check the label of the product you are using. Some Captan products may be applied up to the day of harvest.
- These fungicides are most effective when applied in combination with Ziram or captan. Refer to the label for specific recommendations.

**Apricots—Bloom**

**Disease.** Brown rot (blossom blight).

**Pesticide recommendations for apricots, bloom.**

FRAC Group	Pesticide	Recommended rate per acre
<b>CHOOSE one of the following:</b>		
M3	Ziram 76DF	6–8 lb
M4	Captan 80WDG <sup>a</sup>	1.9–3.5 lb
1	Topsin M WSB <sup>b</sup>	1–1.5 lb
2	Rovral 4 F <sup>b</sup>	1–2 pt
3	Indar 2F <sup>b</sup>	6–12 fl oz
3	Quash <sup>b</sup>	2.5–3.5 oz
3	Rally 40WSP <sup>b</sup>	2.5–6 oz
3	Rhyme <sup>b</sup>	7 fl oz
3 + 7	Luna Experience <sup>b</sup>	6–10 fl oz
7	Fontelis <sup>b</sup>	14–20 fl oz
7 + 11	Luna Sensation <sup>b</sup>	5–7.6 fl oz
7 + 11	Merivon <sup>b</sup>	4–6.7 fl oz
7 + 11	Pristine <sup>b</sup>	10.5–14.5 oz
9	Scala SC <sup>b</sup>	10–18 oz
9	Vanguard <sup>b</sup>	5 oz
11	Flint Extrab	2.5–3.8 fl oz

**Fungicide and Antibiotic Notes**

- Equivalent products include Captan 50% W and WP, and Captan and Captec 4L. Check the label for rates per 100 gallons per acre. REI restrictions vary from 24 hours to four days; check the label of the product you are using. Some Captan products may be applied up to the day of harvest.
- These fungicides are most effective when applied in combination with captan or Ziram. Refer to the label for specific recommendations.

**Apricots—Petal Fall**

**Disease.** Brown rot, powdery mildew/rusty spot, scab.

Use same fungicides as in bloom.

**Apricots—Shuck Split, First, Second Cover to Preharvest**

**Diseases.** Brown rot, scab, powdery mildew/rusty spot.

**Bacterial spot.** Fixed coppers have been shown to provide satisfactory disease control. Oxytetracycline products are not labeled for apricots. Refer to bacterial spot management recommendations in “Peaches and Nectarines—Shuck Split, Shuck Fall.”

**Fruitworms, plum curculio.** Apply first cover 8 to 10 days after shuck split, second cover 8 to 10 days after first cover, other covers at 10- to 14-day intervals, and preharvest spray about one month before harvest. Assail, Avaunt, and Imidan are the best products for the control of plum curculio.

**Pesticide recommendations for apricots, shuck split, first, second cover to preharvest.**

FRAC or IRAC Group	Pesticide	Recommended rate per acre
<b>CHOOSE one of the following:</b>		
M2	Sulfur <sup>a</sup>	see label recommendation
M3	Ziram 76DF	6–8 lb
M4	Captan 80WDG <sup>b</sup>	1.9–3.5 lb
13	Quintec <sup>c</sup>	7 fl oz
50	Vivando <sup>c</sup>	15.4 fl oz
<b>PLUS one or more of the following based on the insect pest complex requiring control:</b>		
4A	Actara 25W	4.5 oz
4A	Admire Pro	2.8 fl oz
28	Altacor 35WDG <sup>1</sup>	3 oz
21A	Apta	14–27 fl oz
3A	Asana XL 0.66EC	4.8–8 fl oz
4A	Assail 30SG	3–8 oz
22A	Avaunt 30WDG	6 oz
3A	Baythroid 2E	2.8 fl oz
29	Beleaf 50SG	2.8 oz
3A and 28	Besiege <sup>1</sup>	6–12 fl oz
4C	Closer SC	2.75–5.75 fl oz
3A	Danitol 2.4 EC	10.7–21.3 fl oz
5	Delegate 25WG <sup>1</sup>	4.5 oz
1B	Diazinon 50W <sup>2</sup>	2 lb
3A and 4A	Endigo ZC	5.5 fl oz
28	Exirel <sup>1</sup>	13.5–20.5 fl oz
3A and 6	Gladiator	19 fl oz
4A	Imidacloprid 1.6F	4–6 fl oz
1B	Imidan 70WP	3 lb
3A and 4A	Leverage 360	2.4–2.8 fl oz
23	Movento <sup>3</sup>	6–9 fl oz
3A	Mustang Max	1.3–4 fl oz
N/A	OFM sprayable pheromones	see label rate
3A	Proaxis	2.5–5.1 fl oz
4A and 28	Voliam Flexi 40W <sup>1</sup>	4–7 oz
3A	Warrior II	1.3–2.5 fl oz

**Fungicide and Antibiotic Notes**

- Various formulations of sulfur are available commercially; these vary in sulfur content. Use labeled amounts of material that are dependent on the formulation.
- Equivalent products include Captan 50% W and WP, and Captan and Captac 4L. Check the label for rates per 100 gallons per acre. REI restrictions vary from 24 hours to four days; check the label of the product you are using. Some captan products may be applied up to the day of harvest.
- Quintec and Vivando are only effective against powdery mildew and must be tank-mixed with another product if control for other fungal disease is needed.

**Insecticide and Acaricide Notes**

Insecticides should be selected and combined according to their efficacy against individual pests.

- In order to prevent the development of pest resistance to these new chemistries and to practice the most effective resistance management approach, we highly encourage growers to use only one chemical class of products (i.e., mode of action) for a particular generation of a targeted pest and to rotate to another chemical class to control the succeeding generation of the targeted pest. For example, if using Delegate to control the first generation of Oriental fruit moth, use Altacor, Besiege, Exirel, or Voliam Flexi to control the second generation; or if using Altacor, Besiege, Exirel, or Voliam Flexi to control the first generation of Oriental fruit moth, then switch to Delegate or another chemical class (Assail) to control the second generation. Altacor, Besiege, Exirel, and Voliam Flexi belong to the same chemical class (IRAC Group 28) and should not be used for consecutive generations of a targeted pest. The same rotation approach applies to Delegate and all other chemistries.
- Only two applications of diazinon are allowed during the season: one at dormant/delayed dormant and one postbloom.
- For increased effectiveness, add a penetrating adjuvant.

**Lesser peachtree borer.** To control, use trunk spray or cover sprays of the following material.

**Lesser peachtree borer recommendation for apricots, shuck split, first, second cover to preharvest.**

IRAC Group	Pesticide	Dilute rate per 100 gal
3A	Asana XL 0.66EC	2–4 fl oz

**Mites.** For control, use the following.

**Acaricide recommendations for apricots.**

IRAC Group	Acaricide	Recommended rate per acre
10A	Apollo 50SC	3–6 fl oz
23	Envidor 2SC	14–18 fl oz
21A	Nextera <sup>a</sup>	4.4–10.6 oz
10A	Onager	12–24 fl oz
10A	Savey 50WP	3–6 oz
10B	Zeal	3 oz

**Acaricide Note**

- Higher rate of Nextera is necessary for twospotted spider mite control.

**Peachtree borer.** Refer to “Peach IPM Program.” Do not use chlorpyrifos or Vydate L for preplant treatments on apricots since these materials are not registered for this purpose on apricots.

**Sprays before harvest.** Refer to Table 4-15 when selecting sprays during the last month before harvest.

<b>Additional applications before apricot harvest.</b>		
FRAC Group	Pesticide	Recommended rate per acre
<b>CHOOSE one of the following:</b>		
M4	Captan 80 WDG <sup>a</sup>	1–3.5 lb
1	Topsin M WSB <sup>a</sup>	1–1.5 lb
3	Indar 2F <sup>a</sup>	6–12 fl oz
3	Quash <sup>a</sup>	4 oz
3	Rally 40WSP <sup>a</sup>	2.5–6 oz
3	Rhyme <sup>a</sup>	7 fl oz
3 + 7	Luna Experience <sup>a</sup>	6–10 fl oz
3 + 9	Inspire Super <sup>a</sup>	16–20 fl oz
7	Fontelis <sup>a</sup>	4–6.7 fl oz
7	Kenja <sup>a</sup>	12.5 fl oz
7 + 11	Luna Sensation <sup>a</sup>	5–7.6 fl oz
7 + 11	Merivon <sup>a</sup>	4–6.7 fl oz
7 + 11	Pristine <sup>a</sup>	10.5–14.5 fl oz
9	Scala SC <sup>a</sup>	10–18 oz
9	Vanguard WG <sup>a</sup>	5 oz
11	Flint Extra <sup>a</sup>	2.5–3.8 fl oz

#### Fungicide and Antibiotic Notes

*b.* Equivalent products include Captan 50% W and WP, and Captan and Captec 4L. Check the label for rates per 100 gallons per acre. REI restrictions vary from 24 hours to four days; check the label of the product you are using. Some captan products may be applied up to the day of harvest. Due to previous captan applications, it is not necessary to tank-mix fungicides with captan during preharvest sprays.

### Apricots—Postharvest Disorders and Diseases

**Postharvest fruit rots.** See Part VI, Harvest and Postharvest Handling, for control suggestions.

**Postharvest orchard disease control.** For brown rot and *Cytospora* canker control, see discussion following the peach dormant spray.

## SWEET CHERRY IPM PROGRAM

### Sweet Cherries—Dormant

**American plum borer, lesser peachtree borer, and peachtree borer.** Pheromone mating disruption has been very effective in controlling the two kinds of peachtree borers, which are closely related. More often in Pennsylvania, control is achieved with trunk spray pesticides applied postharvest. The American plum borer is not related to the other borers and has no pheromone disruption products available for control despite it often being the most destructive of the three pests and having two generations each season instead of one.

**Lecanium scale and San Jose scale.** Apply Esteem at 4 to 5 ounces with oil. Use higher rate of Esteem under heavy scale pressure.

#### Pesticide recommendations for sweet cherries, dormant.

IRAC Group	Pesticide	Recommended rate per acre
<b>CHOOSE one of the following:</b>		
N/A	Dormant oil	4 gal
7C	Esteem 35WP	4–5 oz

### Sweet Cherries—Prebloom

**Diseases.** Brown rot and powdery mildew. Manage powdery mildew from prebloom to two to three weeks after petal fall.

**Black cherry aphid.** If present, add endosulfan (see table for Cherries, Petal Fall). Note: Avoid killing bees on opening blossoms and cover crops; watch insecticides that are toxic to bees (refer to pesticide label). See Table 1-9 for pesticide impacts on bees.

Apply fungicides when first blossoms are open.

#### Pesticide recommendations for sweet cherries, prebloom.

FRAC Group	Pesticide	Recommended rate per acre
<b>CHOOSE one of the following:</b>		
M3	Ziram 76DF	5–8 lb
M4	Captan 80WDG <sup>a</sup>	2.5 lb
M5	Bravo Weather Stik	3.1–4 pt
M5	Chlorothalonil 720	3.1–4 pt
2	Rovral 4 F <sup>b</sup>	1–2 pt
3	Indar 2F <sup>b</sup>	6–12 fl oz
3	Quash <sup>b</sup>	4 oz
3	Rally 40WSP <sup>b</sup>	2.5–6 oz
3	Rhyme <sup>b</sup>	7 fl oz
3 + 7	Luna Experience <sup>b</sup>	6–10 fl oz
7	Fontelis <sup>b</sup>	14–20 fl oz
7	Kenja <sup>b</sup>	12.5 fl oz
7 + 11	Luna Sensation <sup>b</sup>	5–7.6 fl oz
7 + 11	Merivon <sup>b</sup>	4–6.7 fl oz
7 + 11	Pristine <sup>b</sup>	10.5–14.5 oz
11	Cabrio EG <sup>b</sup>	9.5 oz
11	Flint Extra <sup>b</sup>	2.5–3.8 fl oz
13	Quintec <sup>c</sup>	7 fl oz
50	Vivando <sup>c</sup>	15.4 fl oz
U6	Torino <sup>c</sup>	6–8 oz

#### Fungicide and Antibiotic Notes

- Equivalent products include Captan 50% W and WP, and Captan and Captec 4L. Check the label for rates per 100 gallons per acre. REI restrictions vary from 24 hours to four days; check the label of the product you are using. Some captan products may be applied up to the day of harvest.
- These products work best when used in combination with a protectant such as captan or chlorothalonil to reduce resistance pressure.
- Quintec, Vivando, and Torino are only effective against powdery mildew and must be tank-mixed with another product if needing to control for other fungal diseases.

## Sweet Cherries—Bloom

**Diseases.** Brown rot and powdery mildew. For brown rot control, apply when the first blossoms open and again at 70 to 90 percent open blossoms. Follow recommendation in the prebloom schedule. Do not use an insecticide during bloom.

## Sweet Cherries—Petal Fall

**Diseases.** Brown rot, leaf spot.

**Insects.** Aphids, leafrollers, plum curculio. With the loss of azinphos-methyl, Imidan and Avaunt are our best products for controlling plum curculio.

**American plum borer.** American plum borer is increasing, with high populations infesting a number of tart cherry orchards in Pennsylvania. Control of this pest can be achieved at petal fall by applying a dilute application of Gladiator at 4.75 fluid ounces per 100 gallons. Direct spray to the entire trunk area up to the lower scaffold limbs and to all areas cracked and damaged by shaker clamps or other means. Do not apply chlorpyrifos 4E or Lorsban Advanced to sweet cherries, as they are highly phytotoxic to the foliage.

**Black cherry aphid.** If the aphid is present, use Actara or Provado (see following table for rates).

### Pesticide recommendations for sweet cherries, petal fall.

FRAC or IRAC Group	Pesticide	Recommended rate per acre
<b>CHOOSE one of the following:</b>		
M3	Ziram 76DF	5–8 lb
M4	Captan 80WDG <sup>a</sup>	2.5 lb
M5	Bravo Weather Stik	3.1–4 pt
M5	Chlorothalonil 720	3.1–4 pt
1	Topsin M WSB <sup>b</sup>	1–1.5 lb
2	Rovral 4 F <sup>b</sup>	1–2 pt
3	Indar 2F <sup>b</sup>	6–12 fl oz
3	Quash <sup>b</sup>	4 oz
3	Rally 40WSP <sup>b</sup>	2.5–6 oz
3	Rhyme <sup>b</sup>	7 fl oz
3	Trionic <sup>c</sup>	8–16 fl oz
3	Rubigan E.C. <sup>c</sup>	6–12 fl oz
3 + 7	Luna Experience <sup>b</sup>	6–10 fl oz
7	Fontelis <sup>b</sup>	14–20 fl oz
7	Kenja <sup>b</sup>	12.5 fl oz
7 + 11	Luna Sensation <sup>b</sup>	5–7.6 fl oz
7 + 11	Merivon <sup>b</sup>	4–6.7 fl oz
7 + 11	Pristine <sup>b</sup>	10.5–14.5 oz
11	Cabrio EG <sup>b</sup>	9.5 oz
11	Flint Extra <sup>c</sup>	2.5–3.8 fl oz
13	Quintec <sup>c</sup>	7 fl oz
50	Vivando <sup>c</sup>	15.4 fl oz
U6	Torino <sup>c</sup>	6–8 oz
<b>PLUS one or more of the following based on the insect pest complex requiring control:</b>		
4A	Actara <sup>1</sup>	3–4.5 oz
4A	Admire Pro	2.8 fl oz
21A	Apta	17–27 fl oz
3A	Asana XL 0.66EC	6–12 fl oz
4A	Assail 30SG	3–8 oz
22A	Avaunt 30WDG	6 oz
3A	Baythroid 2E	2–2.8 fl oz
29	Beleaf 50SG	2–2.8 oz
3A and 28	Besiege <sup>2</sup>	6–12 fl oz
3A	Danitol 2.4 EC	10.7–21.3 fl oz
5	Delegate 25WG <sup>2</sup>	4.5 oz
3A and 4A	Endigo ZC	5.5 fl oz
28	Exirel <sup>2</sup>	20.5 fl oz
3A and 6	Gladiator	6–19 fl oz
4A	Imidacloprid 1.6F <sup>3</sup>	4–6 fl oz
3A and 4A	Leverage 360	2.8 fl oz
23	Movento <sup>3</sup>	6–9 fl oz
3A	Mustang Max	1.3–4 fl oz
3A	Permethrin 3.2EC	7 oz
3A	Proaxis	2.5–5.1 fl oz
4A and 28	Voliam Flexi 40W <sup>1,2</sup>	7 oz
3A	Warrior II	1.3–2.5 fl oz

### Fungicide and Antibiotic Notes

- Equivalent products include Captan 50% W and WP, and Captan and Captec 4L. Check the label for rates per 100 gallons per acre. REI restrictions vary from 24 hours to four days; check the label of the product you are using. Some Captan products may be applied up to the day of harvest.
- These products work best when used in combination with a protectant such as captan or chlorothalonil to reduce resistance pressure.
- Quintec, Vivando, and Torino are only effective against powdery mildew and must be tank-mixed with another product if needing to control for other fungal diseases.

### Insecticide and Acaricide Notes

Insecticides should be selected and combined according to their efficacy against individual pests.

- Do not apply Actara or Voliam Flexi if bees are active in the orchard or on flowering cover crops.
- In order to prevent the development of pest resistance to these new chemistries and to practice the most effective resistance management approach, we highly encourage growers to use only one chemical class of products (i.e., mode of action) for a particular generation of a targeted pest and to rotate to another chemical class to control the succeeding generation of the targeted pest. For example, if using Delegate to control the first generation of Oriental fruit moth, use Altacor, Besiege, Exirel, or Voliam Flexi to control the second generation; or if using Altacor, Besiege, Exirel, or Voliam Flexi to control the first generation of Oriental fruit moth, then switch to Delegate or another chemical class (Assail, etc.) to control the second generation. Altacor, Besiege, Exirel, and Voliam Flexi belong to the same chemical class (IRAC Group 28) and should not be used for consecutive generations of a targeted pest. The same rotation approach applies to Delegate and all other chemistries.
- For increased effectiveness, add a penetrating adjuvant.

### Sweet Cherries—Shuck Fall, First Cover

**Diseases.** Brown rot, leaf spot.

**Insects.** Leafrollers, plum curculio.

#### Pesticide recommendations for sweet cherries, shuck fall, first cover.

FRAC or IRAC Group	Pesticide	Recommended rate per acre
<b>CHOOSE one of the following:</b>		
M2	Sulfur <sup>a</sup>	see label recommendation
M3	Ziram 76DF	4–8 lb
M4	Captan 80WDG <sup>b</sup>	2.5 lb
1	Topsin M WSB <sup>c</sup>	1–1.5 lb
3	Indar 2F <sup>c</sup>	6–12 fl oz
3	Quash <sup>c</sup>	4 oz
3	Rally 40WSP <sup>c</sup>	2.5–6 oz
3	Rhyme <sup>c</sup>	7 fl oz
3	Rubigan EC <sup>c</sup>	6–12 fl oz
3 + 7	Luna Experience <sup>c</sup>	6–10 fl oz
7	Fontelis <sup>c</sup>	14–20 fl oz
7	Kenja <sup>d</sup>	12.5 fl oz
7 + 11	Luna Sensation <sup>c</sup>	5–5.6 fl oz
7 + 11	Merivon <sup>c</sup>	4–6.7 fl oz
7 + 11	Pristine <sup>c</sup>	10.5–14.5 oz
11	Cabrio EG <sup>c</sup>	9.5 oz
11	Flint Extra	2.5–3.8 fl oz
13	Quintec <sup>d</sup>	7 fl oz
50	Vivando <sup>d</sup>	15.4 fl oz
U6	Torino <sup>d</sup>	6–8 oz
<b>PLUS one or more of the following based on the insect pest complex requiring control:</b>		
4A	Actara 25W	3–4.5 oz
4A	Admire Pro	2.8 fl oz
28	Altacor 35WDG <sup>1</sup>	3 oz
21A	Apta	14–27 fl oz
3A	Asana XL 0.66EC	7–14 fl oz
4A	Assail 30SG	3–8 oz
22A	Avaunt 30WDG	6 oz
3A	Baythroid 2E	2.8 fl oz
29	Beleaf 50SG	2.8 oz
3A and 28	Besiege <sup>1</sup>	6–12 fl oz
4C	Closer	2.75–5.75 fl oz
3A	Danitol 2.4 EC	10.7–21.3 fl oz
5	Delegate 25WG <sup>1</sup>	4.5 oz
1B	Diazinon 50W <sup>2</sup>	2 lb
3A and 4A	Endigo ZC	5–5.5 fl oz
28	Exirel <sup>1</sup>	10–20.5 fl oz
3A and 6	Gladiator	6–19 fl oz
3A and 4A	Leverage 360	2.8 fl oz
23	Movento <sup>3</sup>	6–9 fl oz
3A	Mustang Max	1.3–4 fl oz
3A	Permethrin 3.2EC	7 oz
3A	Proaxis	2.5–5.1 fl oz
4A and 28	Voliam Flexi 40W <sup>1</sup>	7 oz
3A	Warrior II	1.3–2.5 fl oz

### Fungicide and Antibiotic Notes

- Various formulations of sulfur are available commercially; these vary in sulfur content. Use labeled amounts of material that are dependent on the formulation.
- Equivalent products include Captan 50% W and WP, and Captan and Captec 4L. Check the label for rates per 100 gallons per acre. REI restrictions vary from 24 hours to four days; check the label of the product you are using. Some captan products may be applied up to the day of harvest.
- These products work best when used in combination with a protectant such as captan or chlorothalonil to reduce resistance pressure.
- Quintec, Vivando, and Torino are only effective against powdery mildew and must be tank-mixed with another product if control for other fungal disease is needed.

### Insecticide and Acaricide Notes

Insecticides should be selected and combined according to their efficacy against individual pests.

- In order to prevent the development of pest resistance to these new chemistries and to practice the most effective resistance management approach, we highly encourage growers to use only one chemical class of products (i.e., mode of action) for a particular generation of a targeted pest and to rotate to another chemical class to control the succeeding generation of the targeted pest. For example, if using Delegate to control the first generation of Oriental fruit moth, use Altacor, Besiege, Exirel, or Voliam Flexi to control the second generation; or if using Altacor, Besiege, Exirel, or Voliam Flexi to control the first generation of Oriental fruit moth, then switch to Delegate or another chemical class (Assail, etc.) to control the second generation. Altacor, Besiege, Exirel, and Voliam Flexi belong to the same chemical class (IRAC Group 28) and should not be used for consecutive generations of a targeted pest. The same rotation approach applies to Delegate and all other chemistries.
- Only two applications of diazinon are allowed during the season: one at dormant/delayed dormant and once postbloom.
- For increased effectiveness, add a penetrating adjuvant.

### Sweet Cherries—Second Cover

**Diseases.** Brown rot, leaf spot.

**Insects.** Fruit flies, maggots, plum curculio. Assail, Avaunt, and Imidan are our best products for the control of plum curculio. Delegate and Exirel are effective on cherry fruit flies.

**Sprays before harvest.** Refer to Table 4-15 when selecting sprays during the last month before harvest. Note: In southern Pennsylvania, spray about June 1 to 10; in northern areas of the state, spray about June 6 to 16.

### Pesticide recommendations for sweet cherries, second cover.

FRAC or IRAC Group	Pesticide	Recommended rate per acre
<b>CHOOSE one of the following:</b>		
M2	Sulfur <sup>a</sup>	see label recommendation
M3	Ziram 76DF	4–8 lb
M4	Captan 80WDG <sup>b</sup>	2.5 lb
1	Topsin M WSB <sup>c</sup>	1–1.5 lb
3	Indar 2F <sup>c</sup>	6–12 fl oz
3	Quash <sup>c</sup>	4 oz
3	Rally 40WSP <sup>c</sup>	2.5–6 oz
3	Rhyme <sup>c</sup>	7 fl oz
3	Rubigan EC <sup>c</sup>	6–12 fl oz
3 + 7	Luna Experience <sup>c</sup>	6–10 fl oz
7	Fontelis <sup>c</sup>	14–20 fl oz
7	Kenja <sup>c</sup>	12.5 fl oz
7 + 11	Luna Sensation <sup>c</sup>	5–7.6 fl oz
7 + 11	Merivon <sup>c</sup>	4–6.7 fl oz
7 + 11	Pristine <sup>c</sup>	10.5–14.5 oz
11	Cabrio EG <sup>c</sup>	9.5 oz
11	Flint Extra <sup>c</sup>	2.5–3.8 fl oz
13	Quintec <sup>d</sup>	7 fl oz
50	Vivando <sup>d</sup>	15.4 fl oz
U6	Torino <sup>d</sup>	6–8 oz
<b>PLUS one or more of the following based on the insect pest complex requiring control*:</b>		
4A	Actara 25W	4.5 oz
21A	Apta	17–27 fl oz
4A	Assail 30SG	3–8 oz
22A	Avaunt 30WDG	6 oz
3A	Baythroid 2E	2.8 fl oz
29	Beleaf 50SG	2–2.8 oz
4C	Closer	2.75–5.75 fl oz
3A	Danitol 2.4 EC	10.7–21.3 fl oz
5	Delegate 25WG	4.5 oz
1B	diazinon 50W	2 lb
3A and 4A	Endigo ZC	5–5.5 fl oz
28	Exirel	10–20.5 fl oz
3A and 6	Gladiator	6–19 fl oz
3A and 4A	Leverage 360	2.8 fl oz
3A	Mustang Max	1.3–4 fl oz
3A	Permethrin 3.2EC	7 oz
3A	Proaxis	2.5–5.1 fl oz
3A	Warrior II	1.3–2.5 fl oz

\*Insecticides should be selected and combined according to their efficacy against individual pests.

### Fungicide and Antibiotic Notes

- Various formulations of sulfur are available commercially; these vary in sulfur content. Use labeled amounts of material that are dependent on the formulation.

- b. Equivalent products include Captan 50% W and WP, and Captan and Captec 4L. Check the label for rates per 100 gallons per acre. REI restrictions vary from 24 hours to four days; check the label of the product you are using. Some captan products may be applied up to the day of harvest.
- c. These products work best when used in combination with a protectant such as captan or chlorothalonil to reduce resistance pressure.
- d. Quintec, Vivando, and Torino are only effective against powdery mildew and must be tank-mixed with another product if control for other fungal disease is needed.

#### Acaricide recommendations for sweet cherries, second cover.

IRAC Group	Acaricide	Recommended rate per acre
<b>CHOOSE one of the following:</b>		
10A	Apollo 4SC	3–6 fl oz
23	Envirdor 2SC	14–18 fl oz
21A	Nexter <sup>a</sup>	4.4–10.6 oz
10A	Onager	12–24 fl oz
10A	Savey 50WP	3–6 oz
10B	Zeal	3 oz

#### Acaricide Note

- a. Higher rate of Nexter is necessary for twospotted spider mite control.

## Sweet Cherries—Preharvest

**Diseases.** Brown rot, leaf spot.

**Brown rot.** Do not exceed more than three applications of captan on sensitive varieties such as Emperor Francis, Giant, and Schmidt, any time after shuck fall because of possible leaf injury.

**Insects.** Fruit flies, maggots. Delegate and Exirel are very effective on cherry fruit flies. The invasive spotted wing drosophila is best controlled with Delegate or pyrethroids. Neonicotinoid insecticides like Assail are relatively ineffective.

**Sprays before harvest.** Refer to Table 4-15 when selecting sprays during the last month before harvest.

**Vapor Gard.** Apply two to four weeks before anticipated harvest date at a rate of 1 gallon of product in a minimum of 200 gallons of water per acre. This material helps improve fruit size and color and reduces splitting. Caution: Do not apply in spray tank mixtures of any insecticide or fungicide.

#### Pesticide recommendations for sweet cherries, preharvest.

FRAC or IRAC Group	Pesticide	Recommended rate per acre
<b>CHOOSE one of the following:</b>		
M3	Ferbam 76WDG	4.5 lb
M3	Ziram 76DF	4–8 lb
M4	Captan 80WDG <sup>a</sup>	2.5 lb
1	Topsin M WSB <sup>b</sup>	1–1.5 lb
3	Indar 2F <sup>b</sup>	6–12 fl oz
3	Quash <sup>b</sup>	4 oz
3	Rally 40WSP <sup>b</sup>	2.5–6 oz
3	Rhyme <sup>b</sup>	7 fl oz
3	Rubigan EC <sup>b</sup>	6–12 fl oz
3 + 7	Luna Experience <sup>b</sup>	6–10 fl oz
3 + 9	Inspire Super <sup>b</sup>	16–20 fl oz
7	Fontelis <sup>b</sup>	14–20 fl oz
7	Kenja <sup>b</sup>	12.5 fl oz
7 + 11	Luna Sensation <sup>b</sup>	5–7.6 fl oz
7 + 11	Merivon <sup>b</sup>	4–6.7 fl oz
7 + 11	Pristine <sup>b</sup>	10.5–14.5 oz
11	Flint Extra <sup>b</sup>	2.5–3.8 fl oz
11	Cabrio EG <sup>b</sup>	9.5 oz
<b>PLUS one or more of the following based on the insect pest complex requiring control*:</b>		
4A	Actara 25W	4.5 oz
3A	Baythroid 2E	2.8 fl oz
5	Delegate 25WG	4.5 oz
28	Exirel	10–20.5 fl oz
3A	Proaxis	2.5–5.1 fl oz
3A	Warrior II	1.3–2.5 fl oz

\*Insecticides should be selected and combined according to their efficacy against individual pests.

#### Fungicide and Antibiotic Notes

- a. Equivalent products include Captan 50% W and WP, and Captan and Captec 4L. Check the label for rates per 100 gallons per acre. REI restrictions vary from 24 hours to four days; check the label of the product you are using. Some captan products may be applied up to the day of harvest.
- b. These products work best when used in combination with a protectant such as captan or chlorothalonil to reduce resistance pressure.



## Sweet Cherries—Postharvest Disorders and Diseases

**Cherry leaf spot.** This spray program is necessary where leaf spot is active beginning at petal fall and continuing after harvest by applying two postharvest fungicide applications.

### Leaf spot recommendations for sweet cherries.

FRAC Group	Pesticide	Recommended rate per acre
<b>CHOOSE one of the following:</b>		
<i>Petal fall</i>		
M5	Bravo Weather Stik	3.1–4 pt
M5	Chlorothalonil 720	3.1–4 pt
<i>Shuck split through harvest</i>		
U12	Syllit FL	1.5–3 fl oz
3	Elite 45 DF	4–8 oz
3	Quash	4 oz
3	Rhyme	7 fl oz
7	Fontelis 1.67SC	14–20 fl oz
7 + 11	Merivon 4.18SC	4–6.7 fl oz
7 + 11	Pristine	14.5 oz
<i>Postharvest</i>		
M1	Fixed copper (actual)	see label recommendation
M5	Bravo Weather Stik	3.1–4 pt
M5	Chlorothalonil 720	3.1–4 pt
	plus Fresh Spray Lime	3 lb

**American plum borer, lesser peachtree borer, peachtree borer.** See Peach and Nectarine IPM Program. For lesser peachtree borer, apply as a coarse spray to trunk and lower limbs in up to two sprays: June 10 to 20 and August 10 to 25. Do not spray fruit; there is a 14-day preharvest interval for Asana XL and a 14-day preharvest interval for permethrin. Young trees: If peachtree borer damage is present, make two applications, the first around July 15 and the second around August 10. Use Asana XL (4 fluid ounces) or permethrin 3.2EC (1.6 fluid ounces) per 100 gallons of water. If using only one application, apply between July 20 and August 1.

## TART CHERRY IPM PROGRAM

### Tart Cherries—Dormant

**Lecanium scale and San Jose scale.** Apply Esteem at 4 to 5 ounces with oil. Use higher rate of Esteem under heavy scale pressure.

### Pesticide recommendations for tart cherries, dormant.

IRAC Group	Pesticide	Recommended rate per acre
<b>CHOOSE one of the following:</b>		
1B	Chlorpyrifos 4E	1.5–3 pt
N/A	Dormant oil	3.5 gal
7C	Esteem 35WP	4–5 oz
1B	Lorsban Advanced	1.5–3 pt
1B	Lorsban 75WG	1.5–2.5 lb

### Tart Cherries—Prebloom

Apply when first blooms open.

**Diseases.** Brown rot (blossom blight). Brown rot (blossom blight) is only rarely a problem on tart cherries in Pennsylvania. If it is warm (above 55°F) and wet or brown rot has been a problem in the past, follow the recommendations. Note: Avoid killing bees on opening blossoms and cover crops; watch insecticides that are toxic to bees (refer to pesticide label). See Table 1-9 for pesticide impacts on bees.

**American plum borer, lesser peachtree borer and peachtree borer.** Pheromone mating disruption has been very effective in controlling the two kinds of peachtree borers, which are closely related. More often in Pennsylvania, control is achieved with pesticide trunk sprays applied postharvest. The American plum borer is not related to the other borers and has no pheromone disruption products available for control despite it often being the most destructive of the three pests and having two generations each season instead of one. Work at Michigan State and Cornell Universities has shown that a single application of chlorpyrifos at the higher label rates when green tissue first shows will give seasonal control of all three borers due the long residual activity of this product when in contact with wood. This long residual activity can be increased with the addition of a UV light protectant like Vapor Gard or Nu Film 17. Do not apply chlorpyrifos within a week of bloom as the high vapor activity is very toxic to bees. Direct sprays for American plum borer to wounds caused by shaker clamps or other means.

**Pesticide recommendations for tart cherries, prebloom.**

FRAC Group	Pesticide	Recommended rate per acre
<b>CHOOSE one of the following:</b>		
M3	Ziram 76DF	5–8 lb
M4	Captan 80WDG <sup>a</sup>	2.5 lb
M5	Bravo Weather Stik	3.1–4 pt
M5	Chlorothalonil 720	3.1–4 pt
1	Topsin M WSB <sup>b</sup>	1–1.5 lb
2	Rovral 4 F <sup>b</sup>	1–2 pt
3	Indar 2F <sup>b</sup>	6–12 fl oz
3	Quash <sup>b</sup>	4 oz
3	Rally 40WSP <sup>b</sup>	2.5–6 oz
3	Rhyme <sup>b</sup>	7 fl oz
3 + 7	Luna Experience <sup>b</sup>	6–10 fl oz
7	Fontelis <sup>b</sup>	14–20 fl oz
7	Kenja	12.5 fl oz
7 + 11	Luna Sensation <sup>b</sup>	5–7.6 fl oz
7 + 11	Merivon <sup>b</sup>	4–6.7 fl oz
7 + 11	Pristine <sup>b</sup>	10.5–14.5 oz
9	Vanguard <sup>b</sup>	5 oz
11	Cabrio EG <sup>b</sup>	9.5 oz
11	Flint Extra <sup>b</sup>	2.5–3.8 fl oz

**Fungicide and Antibiotic Notes**

- a. Equivalent products include Captan 50% W and WP, and Captan and Captec 4L. Check the label for rates per 100 gallons per acre. REI restrictions vary from 24 hours to four days; check the label of the product you are using. Some captan products may be applied up to the day of harvest.
- b. These products work best when used in combination with a protectant such as captan or chlorothalonil to reduce resistance pressure.

**Tart Cherries—Bloom**

Use the same materials listed at prebloom. Make two applications: when first blossoms open, and again when 70 to 90 percent of blossoms are open.

**Tart Cherries—Petal Fall**

**Diseases.** Brown rot, cherry leaf spot. If a fungicide was not used during bloom, it is important to make the first application at petal fall.

**Insects.** Aphids, leafrollers, plum curculio. With the loss of azinphos-methyl, Calypso and Imidan are our best products for plum curculio.

**American plum borer.** American plum borer has been increasing in tart cherry orchards in Pennsylvania. Control of this pest can be achieved at petal fall by applying a dilute application of chlorpyrifos 4E at 3 quarts per 100 gallons or Lorsban 75WG at 2 to 3 pounds per 100 gallons for seasonal control. Direct spray to the entire trunk area up to the lower scaffold limbs and to all areas cracked and damaged by shaker clamps or other means. Do not apply chlorpyrifos 4E to sweet cherries, as it is highly phytotoxic to the foliage.

**Black cherry aphid.** If the aphid is present, add Actara or Provado.

**Pesticide recommendations for tart cherries, petal fall.**

FRAC or IRAC Group	Pesticide	Recommended rate per acre
<b>CHOOSE one of the following:</b>		
M3	Ziram 76DF	5–8 lb
M4	Captan 80WDG <sup>a</sup>	2.5 lb
M5	Bravo Weather Stik	3.1–4 pt
M5	Chlorothalonil 720	3.1–4 pt
U12	Syllit FL <sup>b</sup>	1.5–3 pt
1	Topsin M WSB <sup>b</sup>	1–1.5 lb
2	Rovral 4 F <sup>b</sup>	1–2 pt
3	Indar 2F <sup>b</sup>	6–12 oz
3	Quash <sup>b</sup>	4 oz
3	Rubigan EC <sup>b</sup>	6–12 oz
3	Rhyme <sup>b</sup>	7 fl oz
3 + 7	Luna Experience <sup>b</sup>	6–10 fl oz
7	Fontelis 1.67SC <sup>b</sup>	14–20 fl oz
7	Kenja	12.5 fl oz
7 + 11	Luna Sensation <sup>b</sup>	5–7.6 fl oz
7 + 11	Merivon <sup>b</sup>	4–6.7 fl oz
7 + 11	Pristine <sup>b</sup>	10.5–14.5 oz
11	Cabrio EG <sup>b</sup>	9.5 oz
11	Flint Extra	2.5–3.8 fl oz
<b>PLUS one or more of the following based on the insect pest complex requiring control:</b>		
4A	Actara <sup>1</sup>	3–4.5 oz
4A	Admire Pro	2.8 fl oz
21A	Apta	17–27 fl oz
3A	Asana XL 0.66EC	7–14 fl oz
4A	Assail 30 SG	3–8 oz
22A	Avaunt 30WDG	6 oz
3A	Baythroid 2E	2–2.8 fl oz
29	Beleaf 50SG	2.8 oz
3A and 28	Besiege <sup>2</sup>	6–12 fl oz
4C	Closer	2.75 fl oz
3A	Danitol 2.4 EC	10.7–21.3 fl oz
5	Delegate 25WG <sup>2</sup>	4.5–6 oz
3A and 4A	Endigo ZC	5.5 fl oz
28	Exirel <sup>2</sup>	10–20.5 fl oz
3A and 6	Gladiator	6–19 fl oz
4A	Imidacloprid 1.6F	5–6 fl oz
1B	Imidan 70WP	3 lb
3A and 4A	Leverage 360	2.4–2.8 fl oz
1B	Lorsban 75WG	1.33–2 lb
23	Movento <sup>3</sup>	6–9 fl oz
3A	Mustang Max	1.3–4 fl oz
3A	Permethrin 3.2EC	7 oz
3A	Proaxis	2.5–5.1 fl oz
4A and 28	Voliam Flexi 40W <sup>1,2</sup>	4–7 oz
3A	Warrior II	1.3–2.5 fl oz

### Fungicide and Antibiotic Notes

- Equivalent products include Captan 50% W and WP, and Captan and Captec 4L. Check the label for rates per 100 gallons per acre. REI restrictions vary from 24 hours to four days; check the label of the product you are using. Some captan products may be applied up to the day of harvest.
- These products work best when used in combination with a protectant such as captan or Ziram to reduce resistance pressure.

### Insecticide and Acaricide Notes

Insecticides should be selected and combined according to their efficacy against individual pests.

- Do not apply Actara or Voliam Flexi if bees are active in the orchard or on flowering cover crops.
- In order to prevent the development of pest resistance to these new chemistries and to practice the most effective resistance management approach, we highly encourage growers to use only one chemical class of products (i.e., mode of action) for a particular generation of a targeted pest and to rotate to another chemical class to control the succeeding generation of the targeted pest. For example, if using Delegate to control the first generation of Oriental fruit moth, use Altacor, Besiege, Exirel, or Voliam Flexi to control the second generation; or if using Altacor, Besiege, Exirel, or Voliam Flexi to control the first generation of Oriental fruit moth, then switch to Delegate or another chemical class (Assail, etc.) to control the second generation. Altacor, Besiege, Exirel, and Voliam Flexi belong to the same chemical class (IRAC Group 28) and should not be used for consecutive generations of a targeted pest. The same rotation approach applies to Delegate and all other chemistries.
- For increased effectiveness, add a penetrating adjuvant.

### Tart Cherries—Shuck Fall

**Diseases.** Fruit rot, leaf spot, powdery mildew.

**Insects.** Aphids, leafrollers, plum curculio. With the loss of azinphos-methyl, Avaunt and Imidan are our best products for plum curculio.

#### Pesticide recommendations for tart cherries, shuck fall.

FRAC or IRAC Group	Pesticide	Recommended rate per acre
<b>CHOOSE one of the following:</b>		
M3	Ziram 76DF	5–8 lb
M4	Captan 80WDG <sup>a</sup>	2.5 lb
U6	Torino <sup>b</sup>	6–6.8 oz
U12	Syllit FL <sup>c</sup>	1.5–3 pt
1	Topsin M WSB <sup>c</sup>	1–1.5 lb
3	Indar 2F <sup>c</sup>	6–12 oz
3	Quash <sup>c</sup>	4 oz
3	Rally 40WSP <sup>c</sup>	2.5–6 oz
3	Rhyme <sup>c</sup>	7 fl oz
3	Rubigan EC <sup>c</sup>	6–12 oz
3 + 7	Luna Experience <sup>c</sup>	6–10 fl oz
7	Fontelis <sup>c</sup>	14–20 fl oz
7	Kenja <sup>c</sup>	12.5 fl oz
7 + 11	Luna Sensation	5–7.6 fl oz
7 + 11	Merivon <sup>c</sup>	4–6.7 fl oz
7 + 11	Pristine <sup>c</sup>	10–14.5 oz
11	Cabrio EG <sup>c</sup>	9.5 oz
11	Flint Extra <sup>c</sup>	2.5–3.8 fl oz
13	Quintec <sup>b</sup>	7 fl oz
50	Vivando <sup>b</sup>	15.4 fl oz
<b>PLUS one or more of the following based on the insect pest complex requiring control:</b>		
4A	Actara 25W	3–4.5 oz
4A	Admire Pro	2.8 fl oz
28	Altacor 35WDG <sup>1</sup>	3 oz
21A	Apta	17–27 fl oz
3A	Asana XL 0.66EC	7–14 fl oz
4A	Assail 30 SG	3–8 oz
22A	Avaunt 30WDG	6 oz
3A	Baythroid 2E	2.8 fl oz
29	Beleaf 50SG	2.8 oz
3A and 28	Besiege <sup>1</sup>	6–12 fl oz
4C	Closer SC	2.75 fl oz
3A	Danitol 2.4 EC	10.7–21.3 fl oz
5	Delegate 25WG <sup>1</sup>	4.5–6 oz
3A and 4A	Endigo ZC	5–5.5 fl oz
28	Exirel <sup>1</sup>	10–20.5 fl oz
3A and 6	Gladiator	6–19 fl oz
4A	imidacloprid 1.6F	4–6 fl oz
1B	Imidan 70WP	3 lb
3A and 4A	Leverage 360	2.8 fl oz
1B	Lorsban 75WG	1.33–2 lb
23	Movento <sup>2</sup>	6–9 fl oz
3A	Mustang Max	1.3–4 fl oz
3A	permethrin 3.2EC	7 oz
3A	Proaxis	2.5–5.1 fl oz
4A and 28	Voliam Flexi 40W <sup>1</sup>	4–7 oz
3A	Warrior II	1.3–2.5 fl oz

### Fungicide and Antibiotic Notes

- a. Equivalent products include Captan 50% W and WP, and Captan and Captec 4L. Check the label for rates per 100 gallons per acre. REI restrictions vary from 24 hours to four days; check the label of the product you are using. Some captan products may be applied up to the day of harvest.
- b. Quintec, Torino, and Vivando are only effective against powdery mildew and must be tank-mixed with another product if control for other fungal disease is needed.
- c. These products work best when used in combination with a protectant such as captan or Ziram to reduce resistance pressure.

### Insecticide and Acaricide Notes

Insecticides should be selected and combined according to their efficacy against individual pests.

1. *In order to prevent the development of pest resistance to these new chemistries and to practice the most effective resistance management approach, we highly encourage growers to use only one chemical class of products (i.e., mode of action) for a particular generation of a targeted pest and to rotate to another chemical class to control the succeeding generation of the targeted pest. For example, if using Delegate to control the first generation of Oriental fruit moth, use Altacor, Besiege, Exirel, or Voliam Flexi to control the second generation; or if using Altacor, Besiege, Exirel, or Voliam Flexi to control the first generation of Oriental fruit moth, then switch to Delegate or another chemical class (e.g., Assail) to control the second generation. Altacor, Besiege, Exirel, and Voliam Flexi belong to the same chemical class (IRAC Group 28) and should not be used for consecutive generations of a targeted pest. The same rotation approach applies to Delegate and all other chemistries.*
2. *For increased effectiveness, add a penetrating adjuvant.*

### Tart Cherries—First, Second (Maggot Spray), Third Covers

**Diseases.** Cherry leaf spot, fruit rot, powdery mildew.

**Insects.** Aphids, cherry maggot, fruit flies, leafrollers, plum curculio. Assail and Avaunt are our best products for the control of plum curculio.

**Cherry fruit flies.** Delegate and Exirel are very effective on cherry fruit flies. Where cherry fruit flies or black cherry fruit flies are a problem or weather conditions are favorable for fruit fly infestation, shorten the interval between sprays.

**Ethephon.** See discussion in Part III, Chemical Management. Apply first cover 10 to 12 days after shuck fall spray; apply the second cover 10 to 12 days after first cover spray; apply the third cover 10 to 14 days after second cover.

**Sprays before harvest.** Refer to Table 4-15 when selecting sprays during the last month before harvest.

### Pesticide recommendations for tart cherries, first, second, and third covers.

FRAC or IRAC Group	Pesticide	Recommended rate per acre
<b>CHOOSE one of the following:</b>		
M3	Ziram 76DF	5–8 lb
M4	Captan 80WDG <sup>a</sup>	2.5 lb
U6	Torino <sup>b</sup>	6–6.8 oz
U12	Syllit FL <sup>c</sup>	1.5–3 pt
1	Topsin M WSB <sup>c</sup>	1–1.5 lb
3	Indar 2F <sup>c</sup>	6–12 oz
3	Quash <sup>c</sup>	4 oz
3	Rally 40WSP <sup>c</sup>	2.5–6 oz
3	Rhyme <sup>c</sup>	7 fl oz
3	Rubigan EC <sup>c</sup>	6–12 oz
3 + 7	Luna Experience <sup>c</sup>	6–10 fl oz
7	Fontelis <sup>c</sup>	14–20 fl oz
7	Kenja <sup>c</sup>	12.5 fl oz
7 + 11	Luna Sensation <sup>c</sup>	5–7.6 fl oz
7 + 11	Merivon <sup>c</sup>	4–6.7 fl oz
7 + 11	Pristine <sup>c</sup>	14.5 oz
11	Cabrio EG <sup>c</sup>	9.5 oz
11	Flint Extra	2.5–3.8 fl oz
13	Quintec <sup>b</sup>	7 fl oz
50	Vivando <sup>b</sup>	15.4 fl oz
<b>PLUS one or more of the following based on the insect pest complex requiring control:</b>		
4A	Actara 25W	4.5 oz
4A	Admire Pro	2.8 fl oz
28	Altacor 35WDG <sup>1</sup>	3 oz
21A	Apta	17–27 fl oz
3A	Asana XL 0.66EC	7–14 fl oz
4A	Assail 30 SG	3–8 oz
22A	Avaunt 30WDG	6 oz
3A	Baythroid 2E	2–2.8 fl oz
29	Beleaf 50SG	2–2.8 oz
3A and 28	Besiege <sup>1</sup>	6–12 fl oz
4C	Closer SC	2.75–5.75 fl oz
3A	Danitol 2.4 EC	10.7–21.3 fl oz
5	Delegate 25WG <sup>1</sup>	4.5 oz
1B	Diazinon 50W <sup>2</sup>	2 lb
3A and 4A	Endigo ZC	5.5 fl oz
28	Exirel <sup>1</sup>	10–20.5 fl oz
3A and 6	Gladiator	6–19 fl oz
4A	Imidacloprid 1.6F	4–6 fl oz
1B	Imidan 70WP	3 lb
3A and 4A	Leverage 360	2.8 fl oz
1B	Lorsban 75WG	1.33–2 lb
23	Movento <sup>3</sup>	6–9 fl oz
3A	Mustang Max	1.3–4 fl oz
3A	Permethrin 3.2EC	7 oz
3A	Proaxis	2.5–5.1 fl oz
4A and 28	Voliam Flexi 40W <sup>1</sup>	4–7 oz
3A	Warrior II	1.3–2.5 fl oz

### Fungicide and Antibiotic Notes

- Equivalent products include Captan 50% W and WP, and Captan and Captec 4L. Check the label for rates per 100 gallons per acre. REI restrictions vary from 24 hours to four days; check the label of the product you are using. Some captan products may be applied up to the day of harvest.
- Quintec, Torino, and Vivando are only effective against powdery mildew and must be tank-mixed with another product if control for other fungal disease is needed.
- These products work best when used in combination with a protectant such as captan or Ziram to reduce resistance pressure.

### Insecticide and Acaricide Notes

Insecticides should be selected and combined according to their efficacy against individual pests.

- In order to prevent the development of pest resistance to these new chemistries and to practice the most effective resistance management approach, we highly encourage growers to use only one chemical class of products (i.e., mode of action) for a particular generation of a targeted pest and to rotate to another chemical class to control the succeeding generation of the targeted pest. For example, if using Delegate to control the first generation of Oriental fruit moth, use Altacor, Besiege, Exirel, or Voliam Flexi to control the second generation; or if using Altacor, Besiege, Exirel, or Voliam Flexi to control the first generation of Oriental fruit moth, then switch to Delegate or another chemical class (Assail, etc.) to control the second generation. Altacor, Besiege, Exirel, and Voliam Flexi belong to the same chemical class (IRAC Group 28) and should not be used for consecutive generations of a targeted pest. The same rotation approach applies to Delegate and all other chemistries.
- Only two applications of diazinon are allowed during the season: one at dormant/delayed dormant and once postbloom.
- For increased effectiveness, add a penetrating adjuvant.

**Mites.** When mites are a problem, use one of the following.

#### Acaricide recommendations for tart cherries.

IRAC Group	Acaricide	Recommended rate per acre
<b>CHOOSE one of the following:</b>		
10A	Apollo 4SC	3–6 fl oz
23	Envidor 2SC	14–18 fl oz
21A	Nexter <sup>a</sup>	4.4–10.5 oz
10A	Onager	12–24 fl oz
10A	Savey 50WP	3–6 oz
10B	Zeal	3 oz

#### Acaricide Note

- Higher rate of Nexter is necessary for twospotted spider mite control.

### Tart Cherries—Preharvest

**Diseases.** Cherry leaf spot, fruit rots, powdery mildew.

**Insects.** Cherry fruit flies. Delegate, Exirel, and Imidan are very effective on cherry fruit flies. The invasive spotted wing drosophila is best controlled with Delegate and pyrethroids; neonicotinoids like Assail are relatively ineffective.

#### Pesticide recommendations for tart cherries, preharvest.

FRAC or IRAC Group	Pesticide	Recommended rate per acre
<b>CHOOSE one of the following:</b>		
M4	Captan 80WDGa	2.5 lb
U6	Torino <sup>b</sup>	6–6.8 oz
U12	Syllit FL <sup>c</sup>	1.5–3 pt
1	Topsin M WSB <sup>c</sup>	1–1.5 lb
3	Indar 2F <sup>c</sup>	6–12 oz
3	Rhyme <sup>c</sup>	7 fl oz
3 + 9	Inspire Super	16–20 fl oz
7	Fontelis <sup>c</sup>	14–20 fl oz
7	Kenja <sup>c</sup>	12.5 fl oz
7 + 11	Luna Sensation <sup>c</sup>	5–7.6 fl oz
7 + 11	Merivon <sup>c</sup>	4–6.7 fl oz
7 + 11	Pristine <sup>c</sup>	14.5 oz
11	Flint Extra	2.5–3.8 fl oz
13	Quintec <sup>b</sup>	7 fl oz
50	Vivando <sup>b</sup>	15.4 fl oz
<b>PLUS one or more of the following based on the insect pest complex requiring control*:</b>		
5	Delegate 25WG	4.5–6 oz
28	Exirel	20.5 fl oz
1B	Imidan 70WP	2–3 lb
3A	Permethrin 3.2EC	7 oz

\*Insecticides should be selected and combined according to their efficacy against individual pests.

### Fungicide and Antibiotic Notes

- Equivalent products include Captan 50% W and WP and Captec 4L. Check the label for rates per 100 gallons per acre. REI restrictions vary from 24 hours to four days; check the label of the product you are using. Some captan products may be applied up to the day of harvest.
- Quintec, Torino, and Vivando are only effective against powdery mildew and must be tank-mixed with another product if control for other fungal disease is needed.
- These products work best when used in combination with a protectant such as captan to reduce resistance pressure.

## Tart Cherries—Postharvest

**Cherry leaf spot.** Two postharvest fungicide applications are necessary to keep cherry leaf spot management. Use recommendations suggested for fungicides in the tart cherries, preharvest table. Ziram and chlorothalonil can be used again during postharvest.

**Peachtree borer and lesser peachtree borer.** For lesser peachtree borer, apply as a coarse spray to trunk and lower limbs in up to two sprays: June 10 to 20 and August 10 to 25. Do not spray fruit; there is a 14-day preharvest interval for Asana XL, a three-day preharvest interval for permethrin, and a 21-day preharvest interval for Lorsban 4E, Lorsban 75WG, and Lorsban Advanced. For peachtree borer, apply as a coarse spray to the trunk only and make two applications, the first around July 15 and the second around August 10. Use Asana XL (4 fluid ounces), Lorsban 4E (1.5 to 3 quarts), Lorsban 75WG (2 to 3 pounds), Lorsban Advanced (1.5 to 3 quarts), or permethrin 3.2EC (1.6 fluid ounces) per 100 gallons of water. If using only one application, apply between July 20 and August 1.

## PLUM AND PRUNE IPM PROGRAM

### Plum and Prune—Dormant

**Bacterial spot.** Dormant copper sprays can be used to help mitigate bacterial spot. Refer to the copper label for rates and to be sure plums are listed. Combining copper and oil during dormancy is acceptable.

**Black knot.** Early season fungicide sprays during rapid growth are most important in controlling black knot. Bravo is one of the more effective fungicides. Cut the branch 6 to 8 inches below the visible swollen portion before bud swell begins. Knots on the trunk and main limbs can usually be removed successfully by cutting off the knot growth beginning in August and throughout the dormant season. All infected material should be removed from the orchard or burned to limit spore dispersal. Remove infected wild cherries from fencerows and nearby wooded areas.

**Brown rot.** Remove any mummified fruit or cankers.

**Lecanium scale and San Jose scale.** Apply Esteem at 4 to 5 ounces with oil. Use higher rate of Esteem under heavy scale pressure. If scales are present, use the following.

#### *Pesticide recommendations for plum and prune, dormant.*

IRAC Group	Pesticide	Recommended rate per acre
<b>CHOOSE one of the following:</b>		
1B	Chlorpyrifos 4E	2.5–3 pt
N/A	Dormant oil	3.5 gal
7C	Esteem 35WP	4–5 oz
1B	Lorsban Advanced	2.5–3 pt

### Plum and Prune—Prebloom

**Diseases.** Brown rot (blossom blight), black knot. Apply when first blossoms open.

#### *Pesticide recommendations for plum and prune, prebloom to opening of first blossom.*

FRAC Group	Pesticide	Recommended rate per acre
<b>CHOOSE one of the following:</b>		
M2	Sulfur <sup>a</sup>	see label recommendation
M4	Captan 80WDG <sup>b</sup>	3.75 lb
M5	Bravo Weather Stik	3.1–4 pt
M5	Chlorothalonil 720	3.1–4 pt
1	Topsin M WSB <sup>c</sup>	1–1.5 lb
2	Rovral 4 F <sup>c</sup>	1–2 pt
3	Quash <sup>c</sup>	4 oz
3	Rhyme <sup>c</sup>	7 fl oz
3 + 7	Luna Experience <sup>c</sup>	6–10 fl oz
7	Fontelis <sup>c</sup>	14–20 fl oz
7	Kenja <sup>c</sup>	12.5 fl oz
7 + 11	Luna Sensation <sup>c</sup>	5–7.6 fl oz
7 + 11	Merivon <sup>c</sup>	4–6.7 fl oz
7 + 11	Pristine <sup>c</sup>	10–14.5 oz
9	Scala SC <sup>c</sup>	10–18 oz
9	Vanguard <sup>c</sup>	5 oz
11	Flint Extra <sup>c</sup>	2.5–3.8 fl oz

#### Fungicide and Antibiotic Notes

- Various formulations of sulfur are available commercially; these vary in sulfur content. Use labeled amounts of material that are dependent on the formulation.
- Do not use captan on Japanese or Stanley plums before July. Check the label for other cultivar restrictions. Equivalent products include Captan 50% W and WP, and Captan and Captec 4L. Check the label for rates per 100 gallons per acre. REI restrictions vary from 24 hours to four days; check the label of the product you are using. Some captan products may be applied up to the day of harvest.
- These products work best when used in combination with a protectant such as captan to reduce resistance pressure.

### Plum and Prune—Bloom

**Brown rot.** Follow the prebloom spray fungicide suggestions. Do not use an insecticide during bloom.

### Plum and Prune—Petal Fall, Shuck Fall, First and Second Covers

**Bacterial spot.** Oxytetracycline is not labeled for plums. Copper, *Bacillus*-based products (Serenade Opti/ASO or Double Nickel), and plant-based products, such as Regalia, can be used in rotation to mitigate bacterial spot. Weekly sprays will be necessary if disease pressure is high. Read the label for the copper being used to make sure it is labeled for plums. Refer to comments under “Peaches and Nectarines—Shuck Split, Shuck Fall.”

**Black knot.** Make a special effort to spray before warm rain periods to control black knot.

**Brown rot.** Follow the prebloom spray fungicide suggestions at petal fall.

**Insects.** Leafrollers, mites, plum curculio. With the loss of azinphos-methyl, Avaunt and Imidan are the best products for plum curculio.

**Aphids.** Apply Actara (3 to 4.5 ounces per acre), Admire Pro (2 to 3 fluid ounces), Movento (6 fluid ounces per acre), or imidacloprid (4 to 6 fluid ounces per acre).

**Mites.** See third cover for miticide suggestions. Apply these sprays at about 10-day intervals.

**Pesticide recommendations for plum and prune, petal fall, shuck fall, first and second covers.**

FRAC or IRAC Group	Pesticide	Recommended rate per acre
<b>CHOOSE one of the following:</b>		
M2	Sulfur <sup>a</sup>	refer to the label for rates and recommendations
M4	Captan 80WDG <sup>b</sup>	3.75 lb
M5	Bravo Weather Stik	3.1–4 pt
M5	Chlorothalonil 720	3.1–4 pt
1	Topsin M WSB <sup>c</sup>	1–1.5 lb
2	Rovral 4 F <sup>c</sup>	1–2 pt
3	Quash <sup>c</sup>	4 oz
3	Rhyme <sup>c</sup>	7 fl oz
3 + 7	Luna Experience <sup>c</sup>	6–10 fl oz
7	Fontellis 1.67SC <sup>c</sup>	14–20 fl oz
7	Kenja <sup>c</sup>	12.5 fl oz
7 + 11	Luna Sensation <sup>c</sup>	5–7.6 fl oz
7 + 11	Merivon 4.18SC <sup>c</sup>	4–6.7 fl oz
7 + 11	Pristine <sup>c</sup>	10.5–14.5 oz
9	Scala SC <sup>c</sup>	10–18 oz
9	Vanguard <sup>c</sup>	5 oz
11	Flint Extra <sup>c</sup>	2.5–3.8 fl oz
<b>PLUS one or more of the following based on the insect pest complex requiring control:</b>		
4A	Actara 25W	3–4.5 oz
4A	Admire Pro	2.8 fl oz
28	Altacor 35WDG <sup>1</sup>	3 oz
21A	Apta	17–27 fl oz
3A	Asana XL 0.66EC	6–12 fl oz
4A	Assail 30SG	3–8 oz
22A	Avaunt 30WDG	6 oz
3A	Baythroid 2E	2–2.8 fl oz
29	Beleaf 50SG	2–2.8 fl oz
3A and 28	Besiege <sup>1</sup>	6–12 fl oz
4C	Closer SC	2.75–5.75 fl oz
3A	Danitol 2.4 EC	10.7–21.3 fl oz
5	Delegate 25WG <sup>1</sup>	4.5 oz
1B	Diazinon 50W <sup>2</sup>	2 lb
3A and 4A	Endigo ZC	5.5 fl oz
28	Exirel <sup>1</sup>	10–20.5 fl oz
3A and 6	Gladiator	6–19 fl oz
4A	Imidacloprid 1.6F	4–6 fl oz
1B	Imidan 70WP	3 lb
18	Intrepid 2F	12–16 oz
3A and 4A	Leverage 360	2.8 fl oz
23	Movento <sup>3</sup>	6 fl oz
3A	Mustang Max	1.3–4 fl oz
3A	Proaxis	2.5–5.1 fl oz
4A and 28	Voliam Flexi 40W <sup>1</sup>	4–7 oz
3A	Warrior II	1.3–2.5 fl oz

### Fungicide and Antibiotic Notes

- Various formulations of sulfur are available commercially; these vary in sulfur content. Use labeled amounts of material that are dependent on the formulation.
- Do not use captan on Japanese or Stanley plums before July. Check the label for other cultivar restrictions. Equivalent products include Captan 50% W and WP, and Captan and Captec 4L. Check the label for rates per 100 gallons per acre. REI restrictions vary from 24 hours to four days; check the label of the product you are using. Some captan products may be applied up to the day of harvest.
- These products work best when used in combination with a protectant such as captan to reduce resistance pressure.

### Insecticide and Acaricide Notes

Insecticides should be selected and combined according to their efficacy against individual pests.

- In order to prevent the development of pest resistance to these new chemistries and to practice the most effective resistance management approach, we highly encourage growers to use only one chemical class of products (i.e., mode of action) for a particular generation of a targeted pest and to rotate to another chemical class to control the succeeding generation of the targeted pest. For example, if using Delegate to control the first generation of Oriental fruit moth, use Altacor, Besiege, Exirel, or Voliam Flexi to control the second generation; or if using Altacor, Besiege, Exirel, or Voliam Flexi to control the first generation of Oriental fruit moth, then switch to Delegate or another chemical class (Assail, etc.) to control the second generation. Altacor, Besiege, Exirel, and Voliam Flexi belong to the same chemical class (IRAC Group 28) and should not be used for consecutive generations of a targeted pest. The same rotation approach applies to Delegate and all other chemistries.
- Only two applications of diazinon are allowed during the season: one at dormant/delayed dormant and once postbloom.
- For increased effectiveness, add a penetrating adjuvant.

## Plum and Prune—Third and Fourth Covers

**Diseases.** Brown rot, leaf spot. See comments under petal fall for bacterial spot recommendations.

**Insects.** Leafrollers, mites, Oriental fruit moth. Apply about mid-June and early July.

### ***Pesticide recommendations for plum and prune, third and fourth covers.***

FRAC or IRAC Group	Pesticide	Recommended rate per acre
<b>CHOOSE one of the following:</b>		
M2	Sulfur <sup>a</sup>	see label recommendation
M4	Captan 80WDG <sup>b</sup>	3.75 lb
1	Topsin M WSB <sup>c</sup>	1–1.5 lb
3	Quash <sup>c</sup>	4 oz
3	Rhyme <sup>c</sup>	6 fl oz
3 + 7	Luna Experience <sup>c</sup>	6–10 fl oz
7	Fontelis 1.67SC <sup>c</sup>	14–20 fl oz
7	Kenja <sup>c</sup>	12.5 fl oz
7 + 11	Luna Sensation <sup>c</sup>	5–7.6 fl oz
7 + 11	Merivon 4.18SC <sup>c</sup>	4–6.7 fl oz
7 + 11	Pristine <sup>c</sup>	10.5–14.5 oz
9	Scala SC <sup>c</sup>	10–18 oz
9	Vanguard <sup>c</sup>	5 oz
11	Flint Extra <sup>c</sup>	2.5–3.8 fl oz
<b>PLUS one or more of the following based on the insect pest complex requiring control:</b>		
4A	Actara 25W	3–4.5 oz
28	Altacor 35WDG <sup>1</sup>	3 oz
21A	Apta	17–27 fl oz
4A	Assail 30SG	3–8 oz
22A	Avaunt 30WG	6 oz
3A	Baythroid 2E	2.8 fl oz
29	Beleaf 50SG	2.8 oz
3A and 28	Besiege <sup>1</sup>	6–12 fl oz
4C	Closer SC	2.75–5.75 fl oz
3A	Danitol 2.4 EC	10.7–21.3 fl oz
5	Delegate 25WG <sup>1</sup>	4.5 oz
28	Exirel <sup>1</sup>	10–20.5 fl oz
3A and 6	Gladiator	6–19 fl oz
1B	Imidan 70WP	3 lb
18	Intrepid 2F	12–16 fl oz
3A and 4A	Leverage 360	2.8 fl oz
3A	Mustang Max	1.3–4 fl oz
3A	Proaxis	2.5–5.1 fl oz
4A and 28	Voliam Flexi 40W <sup>1</sup>	4–7 oz
3A	Warrior II	1.3–2.5 fl oz

### **Fungicide and Antibiotic Notes**

- Various formulations of sulfur are available commercially; these vary in sulfur content. Use labeled amounts of material that are dependent on the formulation.
- Do not use captan on Japanese or Stanley plums before July. Check the label for other cultivar restrictions. Equivalent products include Captan

50% W and WP, and Captan and Captec 4L. Check the label for rates per 100 gallons per acre. REI restrictions vary from 24 hours to four days; check the label of the product you are using. Some captan products may be applied up to the day of harvest.

- These products work best when used in combination with a protectant such as captan to reduce resistance pressure.

### **Insecticide and Acaricide Note**

Insecticides should be selected and combined according to their efficacy against individual pests.

- In order to prevent the development of pest resistance to these new chemistries and to practice the most effective resistance management approach, we highly encourage growers to use only one chemical class of products (i.e., mode of action) for a particular generation of a targeted pest and to rotate to another chemical class to control the succeeding generation of the targeted pest. For example, if using Delegate to control the first generation of Oriental fruit moth, use Altacor, Besiege, Exirel, or Voliam Flexi to control the second generation; or if using Altacor, Besiege, Exirel, or Voliam Flexi to control the first generation of Oriental fruit moth, then switch to Delegate or another chemical class (Assail, etc.) to control the second generation. Altacor, Besiege, Exirel, and Voliam Flexi belong to the same chemical class (IRAC Group 28) and should not be used for consecutive generations of a targeted pest. The same rotation approach applies to Delegate and all other chemistries.

**Mites.** For control, use one of the following.

### ***Acaricide recommendations for plum and prune.***

IRAC Group	Acaricide	Recommended rate per acre
<b>CHOOSE one of the following:</b>		
20D	Acramite 50W <sup>a</sup>	1 lb
6	Agri-Mek 0.15EC	10–20 fl oz
23	Envidor 2SC	14–18 fl oz
21A	Nexter <sup>b</sup>	4.4–10.6 oz
10A	Onager	12–24 fl oz
10A	Savey 50WP	3–6 oz
10B	Zeal	3 oz

### **Acaricide Notes**

- Add a surfactant for improving coverage. It is strongly recommended that water hardness be reduced with a water treatment that contains ammonium sulfate prior to adding the surfactant and Acramite.
- Higher rate of Nexter is necessary for twospotted spider mite control.



## Plum and Prune—Fifth Cover, Preharvest

**Diseases.** Brown rot, leaf spot.

**Brown rot.** Where brown rot is a problem, apply additional fungicide sprays every five to seven days up to harvest. Apply fifth cover in late July; apply preharvest spray about three weeks before harvest.

**Insects.** Leafrollers.

**Sprays before harvest.** Refer to Table 4-15 when selecting sprays during the last month before harvest.

### ***Pesticide recommendations for plum and prune, fifth cover, preharvest.***

FRAC or IRAC Group	Pesticide	Recommended rate per acre
<b>CHOOSE one of the following:</b>		
M2	Sulfur <sup>a</sup>	see label recommendation
M4	Captan 80WDG <sup>b</sup>	3.75 lb
1	Topsin M WSB <sup>c</sup>	1–1.5 lb
3	Rhyme <sup>c</sup>	7 fl oz
3 + 7	Luna Experience <sup>c</sup>	6–10 fl oz
3 + 9	Inspire Super	16–20 fl oz
7	Fontelis <sup>c</sup>	14–20 fl oz
7	Kenja <sup>c</sup>	12.5 fl oz
7 + 11	Luna Sensation <sup>c</sup>	5–7.6 fl oz
7 + 11	Merivon <sup>c</sup>	4–6.7 fl oz
7 + 11	Pristine <sup>c</sup>	10.5–14.5 oz
9	Scala SC <sup>c</sup>	10–18 oz
11	Flint Extra <sup>c</sup>	2.5–3.8 fl oz
<b>PLUS one or more of the following based on the insect pest complex requiring control*:</b>		
4A	Actara 25W	3–4.5 oz
28	Altacor 35WDG	3 oz
21A	Apta	17–27 fl oz
22A	Avaunt 30WDG	6 oz
3A	Baythroid 2E	2.8 fl oz
4C	Closer SC	2.75–5.75 fl oz
3A	Danitol 2.4 EC	10.7–21.3 fl oz
5	Delegate 25WG	4.5 oz
28	Exirel	10–20.5 fl oz
3A and 6	Gladiator	6–19 fl oz
1B	Imidan 70WP	2 lb
18	Intrepid 2F	12–16 fl oz
3A	Proaxis	2.5–5.1 fl oz
3A	Warrior II	1.25–2.5 fl oz

\*Insecticides should be selected and combined according to their efficacy against individual pests.

### **Fungicide and Antibiotic Notes**

- a. Various formulations of sulfur are available commercially; these vary in sulfur content. Use labeled amounts of material that are dependent on the formulation.

- b. Do not use captan on Japanese or Stanley plums before July. Check the label for other cultivar restrictions. Equivalent products include Captan 50% W and WP and Captec 4L. Check the label for rates per 100 gallons per acre. REI restrictions vary from 24 hours to four days; check the label of the product you are using. Some captan products may be applied up to the day of harvest.
- c. These products work best when used in combination with a protectant such as captan to reduce resistance pressure.

## Plum and Prune—Postharvest Disorders and Diseases

**Lesser peachtree borer, peachtree borer.** For lesser peachtree borer, apply as a coarse spray to trunk and lower limbs in up to two sprays: June 10 to 20 and August 10 to 25. Do not spray fruit; there is a 14-day preharvest interval for Asana XL. For peachtree borer, make two applications to the trunk, the first around July 15 and the second at the same time as for lesser peachtree borer (August 10 to 25).

**Postharvest fruit rots.** See Part VI, Harvest and Postharvest Handling.

**Postharvest orchard disease control.** For brown rot and Cytospora canker control, see Part II, Diseases, Disorders, Pests, and Natural Enemies.



**CONTENTS****Determining Fruit Maturity ..... 332**

Apple Maturity Indices ..... 332

Pear Maturity Indices ..... 334

**Harvesting Fruit ..... 334**

Bruising in Fruit ..... 334

Excessive Heat and Worker Safety ..... 335

**Guidelines for Placing Fruit in Storage ..... 336**

1-MCP..... 337

**Controlled Atmosphere Storage  
of Apples and Storage Scald ..... 337**

Storage ..... 337

Storage Scald in Apples and Pears..... 337

Drenching for Scald Control  
and Storage Requirements by Cultivar..... 338**Postharvest Fruit Diseases and Disorders..... 339**

Controlling Postharvest Diseases..... 339

Picture Guide to Apple  
Postharvest Defects and Disorders..... 339

Peach Skin Discoloration..... 339

Peach Chilling Injury ..... 340

Watercore: A Maturity Problem..... 340

**TABLES****Table 6-1.** Atmospheric and temperature  
requirements for controlled-atmosphere storage ..... 337**Table 6-2.** Concentrations of DPA needed to reduce scald.... 338

## DETERMINING FRUIT MATURITY

### Apple Maturity Indices

To allow time to schedule labor, growers must estimate optimum harvest dates well before picking fruit. In addition, there are different optimum maturity levels for the same cultivars, depending on intended use and storage life desired. Harvesting too early results in fruit that is off-flavor or lacking flavor, poorly colored, small, and subject to bitter pit and storage scald. Leaving fruit on the tree too long results in softer fruit, the potential development of watercore, and a shorter storage life.

The obvious first step in marketing a high-quality product is to grow a high-quality product. Early tree training, annual pruning, proper fertilization, and sound pest management can greatly affect tree vigor and, thus, fruit condition. Light crops, crops from extended bloom periods, or crops with high nitrogen levels may differ markedly in maturity date and subsequent storage potential. Each block and cultivar or strain should be evaluated separately for its maturity and storage potential.

Within the list of maturity indices (starch, firmness, juice sugar and acid content, seed color, flesh color, presence of watercore, background color, and internal ethylene concentration [IEC]), there is a priority order for making decisions. Identifying the targeted consumer is the first decision to make. Will the harvested fruit be made available for immediate fresh market consumption, future fresh market consumption following regular or controlled atmosphere storage, or is the fruit destined for the processor? Once the targeted consumer is identified, the relative importance of the specific maturity indicators will be known. With the exception of IEC, which involves the use of a gas chromatograph, all these indicators are relatively easily measured.

Of all the indicators, background color, starch content, and firmness are the most important factors in guiding harvest timing. They are correlated to some extent with sugar content, acidity, flavor, aroma, texture, IEC, and potential storage life. If a fruit lacks the characteristic background color of a specific variety, obviously it will be difficult to sell as a fresh market item. A fruit harvested without desirable color will not change significantly during storage. Fruit lacking characteristic background color is most likely going to be firm, starchy, and immature. The only viable outlet for such fruit is most likely the processing market. However, fruit destined for processing also has minimum maturity standards. Fruit with low starch readings of 1–2 on an index of 1–8 are still immature and will lack flavor and sugar content. They will have a desirable firmness, but the flavor aspect will overshadow this. In general, a combination of the presence of background color, starch conversion of 25–35 percent, and firmness above 15 pounds will qualify for a good storage or processing candidate. For immediate consumer consumption, the presence of background color, starches in the range of 4.5–6.0, sugar content above 13 percent, and firmness readings greater than 13 pounds should meet consumer expectations.

Before doing any measurements, collect a representative sample of fruit. Choose five to eight trees per block per cultivar and rootstock that are typical of the trees in the block, and carefully mark them so that you can collect weekly samples. Trees should have a uniform crop load and be of uniform vigor. Begin sampling approximately four to five weeks before normal harvest

is anticipated. Sample four fruits from the periphery of each tree (recognizing that this represents the most mature fruit on the tree), selecting fruit that is free of any visible insect injury or disease damage. Fruit temperature can affect certain test results; therefore, measurements of the samples' maturity should be performed within two hours of harvest.

### Days after full bloom (DAFB)

DAFB should be used as a general reference to indicate when fruit might mature. There may be a 5- to 20-day spread between the average harvest date and the optimum harvest date for a particular cultivar. Record full bloom by block and cultivar each spring, since full bloom may vary from one site on your farm to another. Estimated days from full bloom to harvest for some cultivars are listed in Table 1-6. These dates should be used as general guides and can vary from year to year.

### Fruit firmness

Fruit firmness can be measured with either an Effigi fruit tester or a Magness-Taylor pressure tester. Both work on the principle that fruit flesh becomes softer as it matures. Many factors, including watercore and fruit size, can affect firmness readings. The presence of watercore will give higher readings that are inaccurate. Therefore, discard firmness measurements of apples that have watercore. Large apples are usually softer than smaller ones, so for firmness measurements try to choose apples of a relatively uniform diameter and that are representative of the fruit in the block.

The most critical feature of firmness testing is the speed with which you apply force to the plunger. The proper speed is about two seconds, and to regulate your speed you might say to yourself, “one, one thousand, two, one thousand” as you insert the plunger into the fruit. Applying pressure too fast is probably the most common way of getting a false reading.

For apples, use the 11-mm tip supplied with the pressure tester and penetrate to a depth of 7.9 mm as marked on the plunger. Test each apple on both the blush side and the nonblush side, then average both readings.

### Percent soluble solids (or sugar levels)

As fruit matures, starch is converted to sugars. To measure the percentage of Brix, or sugar, in a solution, a refractometer can be used. As fruit matures, refractometer readings increase, indicating fruit maturity is progressing.

Fruit from trees with a heavy crop will have lower readings than fruit from trees with a light crop under similar growing conditions. Sugar content will be higher in years of reduced moisture availability, high temperatures, and high sunlight. As with firmness, refractometer readings will also vary by fruit position within the tree and nutritional status. Fruits located in exposed areas, where considerable photosynthesis is taking place, have higher soluble solids. Fruits heavily shaded and located inside the tree or on weak spurs have the lowest soluble level of fruit on that tree.

A refractometer can be purchased for around \$200 from a number of sources. (Refer to the buyer's guide in each July issue of *American Fruit Grower*). Measurements are made by squeezing a small amount of juice from the fruit onto the prism of the

refractometer. A small garlic press works well to produce the juice. Hold the instrument up to the light and read the percentage of soluble solids by looking through the lens. After each sample of juice, rinse the prism face off and wipe with a soft tissue to avoid contamination among samples. One can calibrate refractometers by zeroing with distilled water and at 10 percent with a solution of 10 grams of sucrose dissolved in 90 grams of water. More expensive (~\$600) digital refractometers can be purchased from scientific supply companies such as Fisher, VWR Scientific, or Thomas. Digital refractometers indicate the percent dissolved solids to the nearest 0.1 percent.

### Acidity

As fruit mature, their acid content decreases. Malic acid is the major acid in apple juice, and it plays a major role in the flavor attribute. Table 7-3 categorizes several varieties of apples based on their sugar and acid content. Granny Smith apples have developed a well-known image based on their tart or acidic flavor. Some apple varieties, such as Pink Lady, attain acid values as high as 1.4–1.5 percent in juice. There are no guidelines for maturity based on acid level. The amount of acid present is related to the variety and maturity stage. A drop in acid level is an indicator of advancing maturity. Measuring acidity is somewhat cumbersome and involves the use of common laboratory instruments such as a titrator or a buret. For best use as a maturity indicator, acid level should be recorded over a number of harvests to develop patterns and guidelines.

### Starch levels

Stage of maturity can also be assessed by performing the starch-iodine test to document starch disappearance. Applying an iodine solution to the cut surface of fruit stains the starch a blue black. The iodine solution can be made by dissolving 10 grams of iodine crystals and 25 grams of potassium iodide in 1 liter of water. The pattern of starch disappearance is specific for each variety. Delicious loses its starch in a fairly even ring, while Golden Delicious shows an uneven pattern.

### Preparing a starch-iodine solution

Always use freshly prepared solution at the beginning of every season. The solution is sensitive to light and should be stored in a dark container. A darker colored bottle or glass jar wrapped in aluminum foil will suffice. Chemicals needed for this test are potassium iodide and iodine crystals. Check with your local pharmacist for the iodine. (Note: As part of Homeland Security, iodine can only be purchased in small quantities.) The iodine solution can be made by dissolving 10 grams of iodine crystals and 25 grams of potassium iodide in 1 liter of water. The pattern of starch disappearance is specific for each variety. Delicious loses its starch in a fairly even ring, while Golden Delicious shows an uneven pattern.

**Warning:** Iodine is a very poisonous chemical. The iodine solution should be properly labeled and kept away from children and pets. Apples used in the test should not be fed to any animals or used in composting. In case of ingestion of iodine or iodine-treated apples, induce vomiting and consult the Poison Center Hotline immediately.

Wilson Irrigation Supply in Washington sells starch-iodine solution already made. Visit them online at [www.wilsonirr.com](http://www.wilsonirr.com) or call them at 1-800-232-1174.

Fruit used for firmness testing and soluble solids readings can also be used for the starch-iodine test. Cut the fruit at right angles to the core, approximately halfway from the stem to the calyx end. Apply the iodine solution to the cut surface, drain away any excess, and rate the fruit after two minutes. The reaction of iodine and starch is temperature-dependent. Under cold conditions, the reaction will take longer. An external heating source will speed up the reaction in cold environments. Avoid contact and be cautious when mixing and applying iodine solution. Test a minimum of 10 fruits per block, preferably 20. A commonly used rating system is a scale of 1 to 6, as follows:

- 1 = full starch (all blue-black)
- 2 = clear of stain in seed cavity and halfway to vascular area
- 3 = clear through the area including vascular bundles
- 4 = half of flesh clear
- 5 = starch just under skin
- 6 = free of starch (no stain)

In Washington State, general guidelines have been established for using this scale to rate the long-term storage potential of Delicious and Golden Delicious: a 1.5–2 rating and a 2–3 rating, respectively. Growers should develop scales of their own for their varieties and growing conditions.

Another good reference for starch testing is “Predicting Harvest Date Windows for Apples” by G. D. Blanpied and K. J. Silsby, Information Bulletin 221, Cornell Cooperative Extension (order from Resource Center, Cornell University, 7 Business and Technology Park, Ithaca, NY 14850). This publication contains a Generic Starch-Iodine Index chart that is an excellent picture guide for making starch index determinations. It is also available online at [ecommons.cornell.edu/handle/1813/3299](http://ecommons.cornell.edu/handle/1813/3299).

### Seed color and fruit color

Seed color can also be used in a general way to determine maturity. Cut the fruit in half and rate the seed color on the following scale:

- 1 = clear (no color)
- 2 = trace (tips brown)
- 3 = ¼ color
- 4 = ½ color
- 5 = ¾ color
- 6 = full color

The test probably works best for early maturing varieties.

Flesh color can help determine the amount of chlorophyll still present in the apple. Take a 1/16- to 1/8-inch-thick slice from the middle of the fruit. Hold the slice up to a bright light and observe the extent of green (chlorophyll) in the flesh. Again, a rating of 1 to 6 can be used:

- 1 = flesh all green
- 2 = some loss of green from center of fruit
- 3 = heavy green band ½ inch thick under skin
- 4 = heavy green band ¼ inch thick
- 5 = heavy green band 1/8 inch thick
- 6 = green essentially gone from under skin

### Fruit texture

Texture can be evaluated by a simple taste test. If, as you chew the fruit, the flesh tends to wad up or seem cottony, the apple has not reached an ideal stage for harvest. This is a subjective test and probably no two people will always agree.

New technology is being developed for nondestructive assessment of firmness or texture by companies in Israel (Eshet Eilon), The Netherlands (Aweta), and the United Kingdom (Sinclair). The technologies work on the principle of acoustical vibration, or the amount of elasticity of the fruit following impact by nondestructive tapping of the fruit surface. With acoustics, it has been shown that consumers are able to differentiate fruit based on the acoustical properties as measured by an electronic instrument that taps the fruit and calculates an index based on the fruit's weight and vibration frequency. Bench-top models have been developed. The goal of these companies is to automate the systems for use on packing lines to assess fruit texture at a rate of up to 10 fruit per second.

Remember, harvesting fruit at its optimum maturity requires skill and experience. Do not rely on just one maturity test, but try to use several different tests each year.

### Pear Maturity Indices

Pear maturity indices are not as reliable or consistent as those used for apples. Indices similar to those used for apples historically have not been as consistent for different years or orchards. The exception is firmness and possibly days after full bloom.

A combination of two or more of the following indices will give a better indication of fruit maturity. As with any measurement used to predict fruit maturity, expect variations from year to year, block to block, and by tree and growing conditions. The best method is to select several tests and repeat them every year to develop a track record for your orchard.

#### Days after full bloom (DAFB)

DAFB can give an approximate harvest date or a “ballpark guess.” The major problem with this type of measurement is that there is little consistency from year to year and a wide range in suggested DAFB values. For example, for D’Anjou the range can be 120–150 days; for Bartlett, 110–133; for Bosc, 130–145; and for some of the new Asian pears, 112–150. Firmness in pears can be measured with the same device as apples, but with an 8-mm tip to a depth of 7.9 mm.

#### Firmness

In pears, fruit firmness is probably the most reliable indicator of maturity. Fruit to be sold immediately or held only for a short time can be harvested at a much softer stage than fruit to be stored for a longer time. Firmness is not a good indicator of maturity for Asian pears. These types are best when ripened on the tree where fruit pressures will run 8 to 12 pounds. Color and taste are better indices for the Asian types. The recommended ranges for firmness measured by a pressure tester are as follows: D’Anjou, 13–15 pounds; Bartlett, 15–17 pounds; and Bosc, 14–16 pounds.

#### Fruit appearance

Although it is a subjective evaluation, fruit color and finish can be a valuable maturity indicator. In Bartlett, look for a change

from green to a white green, blotchy appearance at the fruit neck and finally a light yellow. Any pink coloration at the calyx end probably indicates a premature ripening problem in Bartlett. For D’Anjou, look for a change in ground color. Russeted Asian pears change from green to brown to orange or gold. Yellow-fruited varieties change from grass green to light green to yellow green.

Fruit finish is another means of judging maturity. For D’Anjou and Bartlett, look for smooth, waxy skin. As the fruit matures, corking of the lenticels is related to fruit maturity. An immature fruit has white lenticels that become brown and shallow. The brown color in lenticels is a good indicator that the fruit will ripen without shriveling.

#### Other methods

Amount of soluble solids is often not a good indicator of maturity in traditional varieties because of the need to harvest the fruit before it is ripe. A minimum of 11 percent for Bartlett and of 10 percent for all other varieties is recommended, except in Asian pears, where 12 percent is recommended.

Measuring the amount of starch in fruit is a “new” technique that has worked very well for apples but only with limited success for pears. As the fruit matures, starch is converted to sugars. Reports from the Pacific Northwest indicate that the starch iodine test may be a reliable indicator and that fruit should be harvested when 60 percent of the cut fruit surface still contains starch.

## HARVESTING FRUIT

### Bruising in Fruit

Fresh-market fruit growers have long been concerned about bruising. Processing-fruit growers also have grown concerned, because unbruised fruit commands the best prices. The vast majority of bruising in the harvest process falls into two categories: (1) picking bruises associated with rough handling and detrimental impacts, and (2) compression bruises associated with significant vibrations during transport.

Bruising is an ever-present problem. One study showed that bruising of fruit after harvest ranged from 0.6 to 13 percent, with an average of 7.1 percent. A study conducted of packing sheds indicated that bruising caused 8.1 percent of the culls, while another study found bruising to cause only 2.7 percent of the culls. At the retail level in supermarkets, bruising was found to range from 29 to 78 percent, averaging 61 percent.

While bruising is a concern, it must be regarded as a defect that can be controlled through basic management principles. We encourage growers to determine the quality of the product being produced and to determine the dollar value of defects in the product. Good management practices then dictate that production steps be modified if the cost of correcting the problem is less than the cost incurred by defects in the product.

Damage inflicted on fruit is related to the energy available for bruising and the characteristics of the product. The energy available for bruising is in turn related to

1. the suspension characteristics of the vehicle transporting the fruit,
2. the energy input to the system (a function of roughness of the road and vehicle speed), and

3. a third engineering factor involving both the properties and the packaging of fruit.

The damage suffered by fruit is dependent on the number of individual shocks and their severity, and is directly related to the energy absorbed by the fruit.

We may think we cannot change the characteristics of the products we deal with, but this is not entirely so. Packers of Golden Delicious have learned that packing apples directly on removal from storage may produce more bruised fruit than if fruit is packed after being held at a relatively low humidity for a few days to create an outer layer of bruise-resistant cells. Reducing the amount of bruising in fruit appears to be attainable by reducing the amount of energy that fruit receives in handling.

In practical terms, bruising can occur during any of six operations in which fruit is removed from the tree and moved into storage. In several Pennsylvania harvest operations, some of these steps may be combined, but they are discussed here individually to show the complexity of an efficient, high-volume harvest operation. Listed below are seven locations of fruit and the six steps involved in moving the fruit from tree to storage:

Fruit location	Fruit-handling operation	
Fruit on the tree	Step 1	Harvesting
Fruit in the bins	Step 2	Moving bins out of the orchard
Bins at the edge of the orchard	Step 3	Moving bins to loading area
Bins in loading area	Step 4	Loading bins on truck
Bins on truck in loading area	Step 5	Trucking bins to storage
Bins on truck at storage	Step 6	Forklift hauling bins to storage
Bins in storage		

The harvest season is a hectic time of year, but we strongly recommend that growers educate employees in the proper method of performing assigned tasks.

Proper harvesting involves the following:

- Wearing proper clothing and a hat.
- Adjusting the bucket. Picking buckets with rigid sides and of a reasonable size is recommended.
- Checking all ladders before using.
- Carefully setting ladders and setting them at the proper angle.
- Keeping your body centered on the ladder.
- Handling fruit like eggs.
- For apples, using stem-on picking methods.
- Getting your hands in the bucket to prevent bruising.
- Picking a tree from the bottom up.
- Releasing fruit carefully and slowly into the bulk bin.
- Reporting all accidents to the grower.

In Step 1, we suggest that growers offer incentives to pickers who pick properly and that growers give disincentives or penalties to those who cause more bruising than the set limit. Offering both rewards and penalties does more to encourage pickers to harvest fruit properly than if either penalties or rewards are used alone. In addition, we recommend the use of an active supervision system for picking crews.

Major bruise-reducing practices in Washington State include the use of three-legged aluminum stepladders. Growers do not allow pickers to set straight ladders into trees because they find

the resulting damage (bruising and dropped fruits) unacceptable. Another practice is to use bubble liners in bins to absorb energy and vibrations for cultivars such as Golden Delicious and other high-value crops, such as bagged Fuji.

Step 2 involves moving the fruit within the orchard to the end of the rows. This operation is performed by tractors. In Washington State growers prefer the use of low-profile orchard tractors with wide tires. These tires act like springs and can intercept energy to prevent it from transferring to fruit in a bin.

Most Pennsylvania orchard tractors, in contrast, have 12- or 16-inch-wide tires on 24- or 28-inch-diameter rims. These tires are normally inflated to be fairly hard and can therefore transmit more energy to the fruit in a bin as the tractor moves over rough terrain. We recommend using tractors equipped with 18.4 by 16.1 orchard tires.

Step 3 involves moving fruit from the edge of the orchard to a loading area. If the haul distance is short it may be desirable to combine this step with Step 2. Special straddle vehicles or four-bin trailers may be useful. In some areas the trailers are operated in reverse and are attached to the front of the tractors. Using a multibin conveyance system may be more efficient than hauling bins singly on tractors. To lessen bruising, all orchard roads should be as smooth as possible to reduce the energy transferred to fruit during transport. Most loading areas should be smooth and paved, if possible, or at the very least covered with gravel. Muddy loading areas add a significant risk of spreading spores and soil-borne decay organisms. Organic material and dirt caught in bin runners can defeat sanitation procedures used at the warehouse in storing and packing fruit.

Step 4 is loading straight trucks or tractor-trailers for further bin movement. When this operation is performed on paved surfaces, using conventional rubber-tired forklifts may maximize efficiency and may be necessary for handling large volumes of fruit.

Step 5 is trucking the fruit from orchard to storage. Drivers should be instructed to follow the smoothest roads and to travel at reasonable speeds, especially over rough roads. Special trailers with “air-cushioned rides” will absorb more road shock than conventional trailers.

The final step, Step 6, is moving the fruit from the trailer to the storage itself. In this phase, loading areas should be as smooth as possible and shock-absorbing forklifts should be used, especially on rough loading areas.

Bruising may be viewed as a profit-reducing phenomenon and a manageable problem. Bruise-producing operations can be corrected for less money than the reduction in profit caused by the bruising. Remember, bruising is usually caused by only a few procedures. Growers may want to evaluate their present practices in view of the ideas presented here.

### Excessive Heat and Worker Safety

A combination of very high temperatures (significantly above normal) and a higher-than-normal humidity can severely reduce the body’s ability to maintain a proper internal temperature. Prolonged exposure to these conditions can lead to heat cramps, heat exhaustion, and heat stroke. For some, especially the old and infirm, it can lead to death.

The heat index (HI), also referred to as the “apparent temperature,” is a measure of how humidity acts along with high

temperatures to reduce the body's ability to cool itself. The HI is the temperature (in degrees) the body senses, based on normal humidity levels. For example, if the actual temperature is 100°F with 40 percent relative humidity, the effect of these conditions on the body is the same as 110°F with normal humidity (about 20 percent). The basic assumption in computing HI is that the person is in the shade, at sea level, with a wind speed of 6 mph. Exposure to full sunshine can increase the HI about 5 to 15°F. Various wind speeds can also alter the HI but usually have small effect.

The following table shows heat index, or apparent temperature, based on current air temperature and relative humidity.

Air temp. (°F)	Relative humidity (percent)						
	10	20	30	40	50	60	70
105	100	105	113	123	135	149	—
100	95	99	104	110	120	132	144
95	90	93	96	101	107	114	124
90	85	87	90	93	96	100	106
85	80	82	84	86	88	90	93
80	75	77	78	79	81	82	85
75	70	72	73	74	75	76	77
70	65	66	67	68	69	70	70

To use this table find the current air temperature in the lefthand column; follow that row across until you reach the appropriate humidity column. The number you find there is the heat index (HI) or the apparent temperature.

The degree of heat stress may vary with age, health, and body characteristics. Listed below are some heat stress symptoms associated with several apparent temperatures. Symptoms of heat stress include a feeling of weakness, fatigue, giddiness, and nausea. Headaches and cramps are also signs of heat stress. Symptoms of heat stroke include mental confusion, loss of consciousness, convulsions, body temperatures of 106°F or higher, loss of coordination, and hot, dry skin that may be red, mottled, or bluish.

### Preventing heat stroke among farm workers

Employers should take the following steps:

- Learn to spot the signs of heat stroke, which can be fatal.
- Provide frequent rest breaks for the workers.
- Consider a workers' physical condition when assigning work in extreme heat.
- Make available plenty of drinking water (about a quart per hour per worker).
- During extreme heat and humidity, schedule work during the morning and late afternoon hours where possible.
- Provide shade, such as awnings and canopies, if natural shade is not available.

Workers should do the following:

- Get used to the heat for short periods and then follow with longer periods of work.
- Alternate work and rest breaks, with longer rest breaks in cooler areas.

- Wear hats to protect them from the sun.
- Dress in lightweight, loose-fitting, light-colored clothing, such as cotton.
- Drink plenty of water, even if they are not thirsty.
- Do not drink beer and alcohol or take cold medications.
- Take frequent breaks and get out of the sun, if possible.
- Know signs of heat stroke and fatigue and get immediate medical attention.

Apparent temperature (°F)	Danger category	Heat syndrome
80–90	Caution	Fatigue possible with prolonged exposure and physical activity
90–105	Extreme caution	Sunstroke, heat cramps, and heat exhaustion possible with prolonged exposure and physical activity.
105–30	Danger	Sunstroke, heat cramps, or heat exhaustion likely. Heatstroke possible with prolonged exposure and physical activity.
130+	Extreme danger	Heatstroke or sunstroke imminent.

Adjust work schedules to avoid the most stressful parts of the day.

## GUIDELINES FOR PLACING FRUIT IN STORAGE

First, segregate fruit into lots by storage potential. The following types of fruit should not be stored for more than five months because of their potential to break down or develop bitter pit:

- Large fruit from lightly cropped trees
- Fruit from excessively vigorous trees
- Fruit from young trees just coming into bearing
- Fruit from interior portions of trees that are heavily shaded
- Early picked fruit high in starch
- Fruit with a low number of seeds (less than five per fruit)

Second, cool the fruit as rapidly as possible after harvest. Just as workers are at risk from high heat, so too are fruit. Removing bins from direct sunlight under high-temperature conditions is a priority. Exposure to elevated temperature reduces the storage and shelf life of the fruit. The sooner you are able to get fruit into the warehouse and under refrigerated conditions, the better. Balancing the capacity of your refrigeration system to the heat load and volume of your freshly harvested fruit is important. Do not overtax the cooling capacity of your system to the detriment of fruit already in storage. If you plan to use controlled atmosphere (CA) storage, in general the more quickly you cool the fruit and achieve the desired atmosphere, the longer the fruit will store. For best results in CA storage, cool the fruit for two to three days, then achieve the desired atmosphere within seven days or fewer after harvest. Since most CA rooms are not filled in one or two days, CA pulldown can commence shortly after the room is filled during the cooling process. Achieving the target temperature for storage should precede achieving final CA conditions. Some newer varieties, such as Braeburn and Fuji, need to be cooled



thoroughly (40°F for 14 days) prior to applying CA conditions. Typically these varieties are quite dense and do not respond well to elevated levels of carbon dioxide (internal or external).

Third, when placing fruit in storage, leave representative samples of each cultivar and orchard block close to the door, and check the samples periodically to determine fruit quality. Do not “bury” fruit deep in the storage room with no way to check its condition.

Fourth, maintain a high relative humidity in the storage room. Apples are approximately 85 percent water and can quickly lose enough moisture to show signs of skin shrivel if kept at too low a humidity. Shrivel can appear after an apple loses as little as 3 percent of its fresh weight. Abrasions, bruises, and other injuries increase the rate of water loss. A single bruise can increase water loss nearly fourfold. Warm fruit is cooled by giving up moisture. As moisture is removed from the air by the cold refrigeration coils, a deficit gradient is produced that pulls more moisture out of the fruit, which can result in shrivel. Once the fruit has been cooled, the refrigeration coil temperature can be raised to reduce the amount of moisture being removed from the air.

In general, a relative humidity of 90 to 93 percent gives the best results for storing most apple cultivars and is recommended when mixed cultivars are placed in a common storage. Relative humidity is the amount of water that is present in vapor form. The amount of water needed to raise the humidity is actually very little because of the inability of cold air to hold moisture. Free water on the floor of a refrigerated or CA room does little to increase the relative humidity of the room. Fogging systems have been employed to increase the relative humidity in cold rooms. Fogging systems work better than water on the floor because fog is composed of very small droplets whose combined surface area can be a thousand times greater than that available from the area of the floor alone.

### 1-MCP

1-methylcyclopropene, or 1-MCP (Fysium, SmartFresh), provides dramatic benefits to the fruit industry. The mode of action of 1-MCP involves inhibiting the ripening process by attaching the ethylene-binding sites and rendering the fruit insensitive to ethylene exposure. This binding results in fruit that maintain firmness and acidity levels higher than those of untreated fruit. For treatment purposes, 1-MCP is a gas and must be applied in an airtight room or chamber. 1-MCP has been shown to be very active at low concentrations. Its label rate for application will be 1 ppm for a period of 24 hours. Other benefits include inhibition of superficial scald in varieties that are prone to scald occurrence, such as Red Delicious and Granny Smith. Applications of 1-MCP should be made on fruit that is designated for intermediate to long-term storage. Recent work at Cornell indicates that the use of SmartFresh on cultivars that have high levels of volatiles, such as McIntosh and Gala, may have some undesirable effects. 1-MCP will suppress the natural evolution of volatiles that consumers have come to expect. Cultivars that have low levels of natural ethylene during harvest respond best to. However, cultivars that have high levels of ethylene production during harvest do not respond as well. Natural ethylene levels can be stimulated by warmer temperatures or by delaying harvest in an attempt to obtain better color. Blocks treated with ethephon

to hasten maturity also do not respond well to 1-MCP treatment. Delaying treatment of fruit for more than seven days may result in less-than-optimal performance. Fruit should be treated within three to four days after being placed in cold storage.

## CONTROLLED ATMOSPHERE STORAGE OF APPLES AND STORAGE SCALD

### Storage

Controlled atmosphere (CA) storage does not improve fruit quality, but it can slow down the loss of quality after harvest. Successful CA storage begins by harvesting fruit at its proper maturity. Apples should be cooled rapidly and recommended atmospheric conditions achieved shortly after field heat is removed. The longer it takes to adjust carbon dioxide and oxygen levels, the less effective the duration of storage. Guidelines for CA storage regimes are shown in Table 6-1.

Apple cultivars harvested at the same time within seven and ten days of each other can be stored together if they have similar oxygen and carbon dioxide requirements. When storing more than one variety in a room, choose a carbon dioxide level that is not toxic to any of the varieties. For example, Stayman can tolerate 5 percent carbon dioxide, but if it is stored with Delicious, only 2 to 3 percent carbon dioxide should be used.

### Storage Scald in Apples and Pears

Storage scald, also called common scald and superficial scald, affects mainly the skin of fruit and can result in fruit losses. The disorder is believed to be caused by oxidation of a naturally occurring compound in the skin of fruit. Under certain conditions the compound becomes toxic to the cells of the skin.

Scald, evident only after several months of storage, first appears on skin on the green side of fruit as an irregular burned or scalded area. Fruit removed from storage after December may not show symptoms at first, but when allowed to stand at room temperature for 12 to 24 hours may begin to exhibit scald. The

**Table 6-1. Atmospheric and temperature requirements for controlled-atmosphere storage.**

Variety	O <sub>2</sub> (%)	CO <sub>2</sub> (%)	Temperature (°F)
Braeburn	2-3	0.5	34
Cortland	2-3	5 or 2-3	36 or 32
Delicious	1.2	2	31-32
Empire	2-2.5	1.5-2	34-36
Fuji	4	0.5	34
Gala	1.2	2	33
Gold. Delicious	1.1	2	31-32
Granny Smith	1	1	34
Idared	2-3	2-3	31-32
Jonathan	2-3	2-5	36 for 1 mo., 32 thereafter
Macoun	2-3	5	36
McIntosh	3	2-3 for 1 mo., 5 thereafter	36
Northern Spy	2-3	8 or 2-3	38 or 31-32
Rome Beauty	2-3	2-3	31-32
Spartan	2-3	2-3	31-32
Stayman	2-3	2-5	31-32
York	1.8	0.5	32

flesh immediately below the affected area may become soft and discolored if scald is severe. If this happens, the fruit cannot be peeled easily when processed.

Scald severity is influenced by variety, season, cultural practices, and postharvest treatments. Susceptible varieties include Ben Davis, Cortland, Delicious, Granny Smith, Rhode Island Greening, Rome Beauty, Stayman, Winesap, and York Imperial. Less susceptible are Braeburn, Fuji, Gala, Golden Delicious, Jonathan, McIntosh, Northern Spy, Pink Lady, and Spartan. Warm temperatures during the last six weeks before harvest may increase the likelihood of scald. Hot, dry weather increases susceptibility, while cool, damp weather decreases it. Studies in New Jersey with Stayman showed that when fruit experienced 190 hours or more of temperatures below 50°F on the tree during the weeks just prior to harvest, scald did not develop.

Immature fruit is more likely to scald, and there is some indication that fruit high in nitrogen or low in calcium may have a greater tendency to scald. Delays in storage sometimes can reduce scald severity, but they adversely affect the length of storage life. The problem also appears to be worse on fruit stored at high relative humidity.

The best means of controlling scald is to avoid storing immature or overmature fruit. The fruit should be cooled as rapidly as possible, and if placed in CA storage, the desired oxygen level should be achieved quickly.

Treating the fruit with DPA (diphenylamine) or ethoxyquin (labeled for pears only) reduces scald incidence when proper concentrations have been used (see Table 6-2). DPA may retard the loss of green color in the fruit skin. DPA may also cause injury to the fruit if drench solutions accumulate too much dirt. It is recommended that DPA solutions be used at the rate of 30 bins per 100 gallons. Injury from ethoxyquin has occurred when tanks are not properly drained and the material becomes concentrated as the water in the dump tanks evaporates. Ethoxyquin is also very sensitive to sunlight and breaks down rapidly, losing effectiveness. The recommendation is not to exceed 100 bins per 100 gallons of diluted material before changing the solution. Water remaining in the dump tank must not be emptied into residential sewer systems or natural watersheds.

Fruit is normally drenched for 30 seconds in the solution. Longer treatments may result in unacceptably high residue

levels. Fruit treated with ethoxyquin may be washed and waxed as soon as it is dry.

While it is being prepared, agitate the solution to obtain a uniform mixture. Since the active ingredients of DPA and ethoxyquin vary with the manufacturer, it is important to read the label when preparing the solution.

Ethoxyquin coverage can be detected under ultraviolet light, enabling you to assess your effectiveness in covering the fruit. Allow fruits to dry, then view them in a dark room. Do not look directly into the ultraviolet light, because it can damage your eyes.

### Drenching for Scald Control and Storage Requirements by Cultivar (See Tables 6-1 and 6-2)

**Braeburn.** This variety has a low risk of scald development. Diphenylamine (DPA) at 2,000 ppm should alleviate this risk. DPA has also been reported to reduce internal problem in Braeburn. Precondition fruit for 14–17 days at 40°F prior to applying CA regimes. Oxygen concentration should be kept at 2–3 percent and carbon dioxide below 0.5 percent to help avoid Braeburn browning disorder.

**Cortland.** Treat with DPA at 2,000 ppm and store at 2–3 percent oxygen and 5 percent or 2–3 percent carbon dioxide at 36°F or 32°F, respectively.

**Delicious.** Scald can be a problem if fruit is picked too early; therefore, treat fruit with DPA at 2,000 ppm. Store at 1.2 percent oxygen and 2.0 percent carbon dioxide. If carbon dioxide exceeds 3 percent, premature mealiness and cavities can occur.

**Empire.** Treat with DPA at 1,000 ppm. The storage regime for Empire is 2–2.5 percent oxygen and 1.5–2.0 percent carbon dioxide.

**Fuji.** Treat with DPA at 1,000 ppm and store at 4 percent oxygen and 0.5 percent carbon dioxide. Maintain this relatively high level of oxygen as long as significant watercore is present.

**Gala.** No scald treatment is required. The storage regime recommendation is 1.2 percent oxygen and 2 percent carbon dioxide.

**Golden Delicious.** Skin shriveling can be a problem with CA storage. Polyethylene bin liners, sometimes used to raise humidity around apples, may slow the rate of cooling. Polyethylene hoods, if used, should be placed over the bins after field heat has been removed from apples. To help reduce skin shrivel, do not store bins of Golden Delicious on the top tiers. Golden Delicious does not require anti-scald treatment. Storage conditions are 1.1 percent oxygen and 2 percent carbon dioxide.

**Granny Smith.** Granny Smith is very prone to scald and requires 2,220 ppm DPA. Storage conditions are 1 percent oxygen and 1 percent carbon dioxide.

**Idared.** Normally this variety keeps well in regular storage, but because Jonathan is one of Idared's parents, Idared can develop Jonathan spot in regular storage. In CA storage, Jonathan spot usually does not occur. DPA is recommended at 1,500 ppm and storage at 2–3 percent oxygen and 2–3 percent carbon dioxide.

**McIntosh.** More is probably known about this cultivar, based on work done in New York State, than any other. DPA is recommended at 1,500 ppm and storage at 2–3 percent oxygen and 2–3 percent carbon dioxide. Continuous use of 5 percent carbon dioxide may cause injury on skins of less mature fruit. Thus, the

**Table 6-2. Concentrations of DPA needed to reduce scald.**

Variety	DPA (ppm)
Cortland	2,000
Delicious	2,000
Golden Delicious	NR <sup>a</sup>
Granny Smith	2,200
Fuji	1,000
Idared	1,500
McIntosh	1,500
Mutsu	2,000 <sup>b</sup>
Rome Beauty	2,000
Stayman	2,000
Pears	NR

Adapted in part from Blanpied, G. D., and R. M. Smock. Storage of Fresh Market Apples. *Information Bulletin 191*. Cornell University.

a. NR = not recommended.

b. For early picked Mutsu.

carbon dioxide level should be varied, beginning at 2–3 percent the first month and being raised to 5 percent thereafter. Fruit will be firmer if stored at temperatures below 36°F, but various disorders may appear at lower temperatures.

**Northern Spy.** No scald control is recommended. Storage regimes include oxygen at 2–3 percent and carbon dioxide at 8 percent and 2–3 percent when stored at 38°F or 31°F, respectively. Although two possible CA combinations are listed (Table 6-2), a temperature of 32°F maintains fruit firmness better.

**Rome Beauty.** This cultivar has moderate risk of scald and should be treated with 2,000 ppm DPA. A storage regime of 2–3 percent oxygen and 2–3 percent carbon dioxide should be employed.

**Stayman.** Scald control for this variety is 2,000 ppm DPA. This variety is stored at 2–3 percent oxygen and can withstand up to 5 percent carbon dioxide, but because it is frequently stored with other varieties, 2–3 percent is generally used.

**York Imperial.** Scald control for this variety is of less concern, given its emphasis in the processing market. A storage regime of 1–2 percent oxygen and 0.5 percent carbon dioxide at 32°F is recommended.

**Other varieties.** Experiments in New York State with Jonamac, Mutsu, Jonagold, and Spigold indicate that 31 to 32°F with 2 to 3 percent carbon dioxide and oxygen is satisfactory.

## POSTHARVEST FRUIT DISEASES AND DISORDERS

### Controlling Postharvest Diseases

Blue and gray molds are the most important postharvest diseases for apples (see Part II, Diseases, Disorders, Pests, and Natural Enemies). Additional diseases that can be a problem in storage are bitter, white, and black rots, all of which can begin in the field. For peaches, brown rot and Rhizopus rot are important postharvest diseases (refer to Part II, Diseases, Disorders, Pests, and Natural Enemies). To reduce the risk of postharvest diseases, it is important to follow certain preharvest management techniques. While harvesting, handle fruit carefully when picking and transferring fruit from bag to bin to avoid bruising or wounding since bruised or wounded fruit are susceptible to blue and gray molds. Harvesting fruit at proper maturity is important due to more mature fruit being susceptible to storage diseases. Use clean bins and minimize the amount of soil and plant debris brought in on bins. Such debris is an inoculum source for rot pathogens causing disease in storage (if already not on the fruit). Keep fruit cool after harvest by keeping bins in the shade since warm temperatures encourage pathogens to grow. If delivering to a packing house, minimize time between harvest and delivery of fruit. Preharvest chemical controls, such as Luna Sensation, Merivon, and Pristine (see Part III, Chemical Management), control rots, as well as blue and gray molds. Pristine and Merivon have a zero-day PHI, whereas Luna Sensation has a 14-day PHI. In addition, it is important to monitor weather conditions throughout the harvest season, particularly for late season cultivars, making sure they have adequate protection for fruit rot prevention, especially while in storage. Fungicides can be washed off with 1 to 2 inches of

rain; September through early November often has rain events that produce this much rain.

When preparing fruit for storage, follow several management techniques to minimize disease incidence. Working surfaces and fruit in the packing house are quickly contaminated by pathogens brought into the packing house by bins containing soil and plant debris. Disease-causing organisms will remain viable for months on surfaces such as tank walls, grading belts, and brushes. Fruit-handling equipment needs to be washed daily to remove dirt and decayed fruit, and disinfected with a strong chlorine solution on a regular schedule. It is important to keep the packing house and the immediate vicinity clear of any overripe or rotting fruit by removing culls from the packing house and its vicinity immediately. Once rot pathogens begin to sporulate on the fruit, the spores will become airborne. Pathogens present in the air will infect produce under suitable circumstances. The best defense against airborne pathogens is sanitation, consistent chlorination, proper handling, and quick and thorough cooling. A chlorine concentration of about 55 to 70 ppm at a pH of 7.0 is recommended for sanitizing most fruits and vegetables; in actual practice, concentrations of up to 150 ppm of free chlorine have been recommended. Chlorine is a contact fungicide and will reduce the number of spores in the water by killing them; however, chlorine does not penetrate and has no residual activity. Four fungicides are registered specifically for postharvest disease control (Academy, Mertect, Penbotec, and Scholar; see Part III, Chemical Management).

### Picture Guide to Apple Postharvest Defects and Disorders

Washington State Tree Fruit Research and Extension Center has developed a picture card set to aid in identifying common defects found on the packing line. The series of laminated four-by-six-inch cards can be carried in a pocket. They can be ordered from the Good Fruit Grower at 105 South 18th Street, Suite 217, Yakima, WA 98902 or by calling 1800-487-9946. Indicate you want a set of the “Quick Identification Guide to Apple Postharvest Defects and Disorders Card Set.” The cost is \$25.00 plus shipping and tax. You can also view the Postharvest Defects and Disorders cards online at [entomology.tfrec.wsu.edu/Cullage\\_Site/Physiol.html](http://entomology.tfrec.wsu.edu/Cullage_Site/Physiol.html). The Postharvest Disease cards are available at [entomology.tfrec.wsu.edu/Cullage\\_Site/Diseases.html](http://entomology.tfrec.wsu.edu/Cullage_Site/Diseases.html).

### Peach Skin Discoloration

Skin discoloration, also known as inking, is a disorder of peaches that has been a problem for 20 years. A symptom of inking is the development of burgundy-colored areas within the red flesh of the peach, that eventually turn purplish black or ink color. Research at Clemson University, University of California, and Rutgers University has demonstrated that any operation causing peaches to rub, roll, or physically abrade against one another can result in discoloration. Discoloration can also be triggered by iron levels in excess of 10 ppm in the hydrocooler and dump tank, leachate from latex-rubber drying rollers, ammonia, and fungicide sprays.

Four major factors influence the development of inking: the cultivar, dump tank water, contaminants, and abrasions to the skin of the fruit.

**Cultivar.** Early maturing cultivars seem to be more susceptible. Cultivars that have dark red or purplish over color can show the disorder more regularly. Fruit left on the tree too long in an attempt to achieve greater skin color may be more prone to inking. White-fleshed, low-acid cultivars seem to be more prone to discoloration. There are no recommendations as to susceptibility by cultivar, and the susceptibility may vary by the year.

**Dump tank water.** The water used in hydrocoolers and the dump tank should be monitored to keep it at or near a pH of 7.0. Water that is high in iron, copper, or aluminum also tends to increase inking problems. Inspect your hydrocoolers and dump tanks to make sure they are not rusty and allowing additional metals to enter into the water. Change the water regularly to prevent the buildup of metal residues. If your water source is naturally high in iron, consider switching your source or install a filtration system. Inking has also been observed to be more prevalent when fruit are harvested in the rain.

**Contaminants.** Research in California has shown that contaminants can increase the likelihood of inking. Make sure your harvest crew uses good sanitation when picking. Harvest bags, crates, and bins should be clean. Minimize exposure of the fruit to dust. Ensure that hydrocoolers and grading machines are clean. Closely read labels of foliar fertilizers, insecticides, miticides, and fungicides during the final swell period of fruit development and avoid the use of foliar applications of materials that have heavy metals, such as iron (Fe), copper (Cu), and aluminum (Al).

**Skin abrasions.** Minimize rough handling of the fruit during harvest. Consider smoothing orchard roads to avoid excessive jostling of the fruit in transit to the packing house. Brushing to remove the “fuzz” can lead to a greater occurrence of inking. Inspect your packing line for places where excessive abrasion can occur.

To help control the problem:

- Avoid any operation that causes excessive vibration, rubbing, or rolling.
- Check water used for spraying for heavy metal contamination.
- Avoid spraying foliar nutrients that contain heavy metals while fruit is on trees.
- Cool fruit as soon as possible after picking. Hydrocooling is preferred to storing in a cold room. Before hydrocooling, keep field bins in a shaded area out of direct sunlight.
- Keep hydrocoolers and dump tanks as clean as possible by draining and refilling with fresh water on a regular basis.
- Monitor iron levels and water pH in the hydrocoolers and dump tanks. Excessive iron in tanks can cause discoloration. Water pH should be maintained between 6.5 and 7.0. Water at a pH of 4.0 to 6.0 has caused problems with discoloration and iron levels.
- Wash drying rollers, especially new ones, in detergent and rinse well before installing. Polyurethane drying rollers have proven superior to latex rollers for maintaining fruit quality.
- If using ammonia refrigerant, make sure there are no leaks. Peaches can be adversely affected by ammonia levels under 1 ppm although humans cannot detect concentrations that low.

## Peach Chilling Injury

Peaches should be cooled upon harvesting, but cold storage should avoid temperatures in the range of 36–46°F. Peaches can develop a disorder called wooliness if stored within this temperature range.

## Watercore: A Maturity Problem

Watercore is a physiological disorder associated with advancing maturity in apples. It varies greatly from year to year and has been shown to be somewhat related to fruit calcium levels. However, calcium sprays do not control watercore. Unusually high amounts of sunshine and a lack of cloudy, rainy days can aggravate the disorder. It is more prevalent in highly colored or larger fruit.

Watercore develops when the spaces between the cells in apples become filled with a sugar solution. This changes the look of the flesh, giving it a water-soaked, glassy appearance. In unaffected fruit the spaces between the cells are filled with air, giving the flesh a normal appearance. The sugar solution builds up in the fruit because as the apples mature, their carbohydrate metabolism changes and the interconversions between sugars and starch change.

Slight watercore does little harm to apples and, in fact, some consumers like the added sweetness. Slight to moderate watercore usually disappears in storage and no harm is done to the fruit. More serious watercore may retard the gas-exchange properties of fruit to the extent that internal breakdown develops in the cells of the affected parts.

Controlling economic losses from watercore rests with the grower’s management skills. The extent of watercore is only one factor to be included in harvest management decisions. Orchard blocks with a history of watercore should be harvested before other blocks. Special marketing arrangements for watercored apples may be required.

There is no easy solution to sorting watercore. Agricultural engineers from Washington State University have developed a system of sparging air into water flumes that transport fruit. Sparging changes the specific gravity of the water. Since watercored fruit have a higher specific gravity and do not float like normal apples, a shunt or horizontal partition in the flume can be used to separate watercored fruit as they flow through the flume system.

# VII

## CIDER PRODUCTION

### CONTENTS

<b>Identity Standards and Regulations .....</b>	<b>342</b>
<b>Quality and Composition of Cider .....</b>	<b>342</b>
<b>Preservation and Shelf Life .....</b>	<b>342</b>
Microbiology of Cider .....	342
<b>Maximizing Shelf Life .....</b>	<b>343</b>
<b>Production Operations and Practices</b>	
<b>Affecting Cost, Yield, and Quality .....</b>	<b>344</b>
Selecting and Blending Apples .....	344
Sorting, Trimming, and Washing Operations.....	345
Chopping or Milling Equipment.....	345
Press Aids.....	345
Pressing Systems .....	345
Screening/Filtering.....	346
Chilling and Cold Storage .....	346
<b>Labeling Requirements and Options.....</b>	<b>346</b>
Required Labeling Information.....	346
Optional Labeling Information .....	347

### TABLES

<b>Table 7-1.</b> General composition of cider .....	342
<b>Table 7-2.</b> Relative initial quality and shelf life of cider .....	343
<b>Table 7-3.</b> Primary flavor characteristics of Pennsylvania apple cultivars.....	345
<b>Table 7-4.</b> Possible cider blends and their flavor characteristics .....	345
<b>Table 7-5.</b> Composition and nutritional data for apple juice .....	347

### FIGURES

<b>Figure 7-1.</b> Ideal system of operations for making cider....	344
<b>Figure 7-2.</b> A sample of a simple nutritional label for gallon containers of cider.....	347

This section describes the process for making high-quality apple cider. Cider makers who do not pasteurize their product should be aware of the risks associated with consuming fresh juices, especially if they serve it to children, the elderly, or individuals with impaired immune systems. Procedures for minimizing food safety risks associated with unpasteurized cider are provided in Part VIII, Maintaining the Safety of Pennsylvania Apples and Apple Products.

## IDENTITY STANDARDS AND REGULATIONS

In Pennsylvania, apple cider is defined as an amber golden, opaque, unfermented, entirely nonalcoholic juice squeezed from apples. Apples used for cider must be inspected, and decayed or rotten fruit, twigs, and any debris collected with mechanical harvesters removed. Freshly squeezed cider may be filtered, partially clarified, and pasteurized. Ascorbic acid (vitamin C), flavors, and preservatives may be added, but the juice must not be diluted with water or another beverage. Natural or artificial flavors or colors generally recognized as safe may be added if their presence is declared on the label by the use of the word “Imitation” in type at least one-half the size of the type used to declare the flavor.

Fermented cider is known as “hard” cider. “Apple jack” is a term some use to describe an alcoholic beverage produced by distillation of hard apple cider. Neither product may be sold in Pennsylvania without a license from the Liquor Control Board (LCB). Anyone making or interested in making and selling fermented cider should contact the LCB at 717-783-7637 or visit their website at [www.lcb.state.pa.us](http://www.lcb.state.pa.us).

## QUALITY AND COMPOSITION OF CIDER

The traditional aroma, flavor, texture, and color of fresh unpasteurized cider are the result of (1) the type and concentration of aromatic and flavor compounds, the amount and proportion of soluble sugars and acids, and the type and concentration of pectic compounds in the fresh apples, combined with (2) the amount of insoluble carbohydrate, gum, protein, and cell fragments left in the cider and the subsequent development of oxidized flavor and tannin compounds. Some components of apple cider are shown in Table 7-1.

The total amount of sediment formed in unclarified cider would offend many consumers, yet they expect a reasonable amount of sediment. Therefore, insoluble components responsible for the sediment in freshly squeezed juice are partially removed in making cider. If all of the insoluble components are removed quickly from freshly pressed juice, it will resemble canned apple juice in aroma, color, texture, and flavor.

The amount of sugars and acids in fresh apples can vary as much as threefold. Significant variations exist among cultivars, production regions, seasons, and maturity of apples. When the same apple cultivar is grown in the Northeast and the Southeast regions of Pennsylvania, acidity is lower in those apples grown in the Southeast. Apples from orchards located at a higher elevation or in a cooler or cloudier region generally are higher in acidity, which decreases as apples ripen before or during storage. For

example, 33 to 50 percent of acidity is lost by the time a hard mature apple reaches soft-ripe maturity.

The native aroma and flavor compounds in apples are numerous (more than 80), complex, and volatile. Many of these compounds are lost in making a clarified, preserved juice (canned or frozen) from freshly squeezed apples. Tannins (more than 0.05 percent) are responsible for the astringency, while pectins (0.25 to 0.75 percent) are mostly responsible for the body or viscosity of cider.

Apples contain two primary enzymes: polyphenol oxidase and peroxidase. If these enzymes are not quickly heat-inactivated in freshly extracted apple juice, they become very active and accelerate the oxidation of tannins and natural flavors. The discoloration and stronger oxidized flavors in unpasteurized cider are partly due to these oxidized compounds. Some consumers may prefer unpasteurized cider because of these flavors.

## PRESERVATION AND SHELF LIFE

### Microbiology of Cider

The types and numbers of microorganisms (bacteria, yeast, and mold) that contaminate freshly packaged cider come from (1) the surface of apples, especially if they are rotten, slightly decayed, or damaged, and (2) the facility, equipment, air, water, or people involved in making cider.

High-quality unpasteurized cider will keep 12 to 14 days if the cider is cooled quickly and stored at 32 to 36°F. Shelf life is the range of time (expressed in days, months, or years) that any food product can be stored at a specific temperature before any of the following quality characteristics degrade: aroma, flavor, texture, color, safety, and nutritional quality.

Uncontrolled microbial growth is the main cause of shortened shelf life in cider. Native acids in apples limit the growth of many bacterial species, but their presence favors the rapid growth of the aciduric bacteria, yeast, and mold species. Usually harmless yeast and bacteria cells grow and multiply many times, producing alcohol and eventually some acetic acid, as in vinegar. Normal populations of these microorganisms range from 1,000 to 100,000 cells per gram, or about 30,000 to 3 million cells per ounce of unpasteurized cider. The shelf life of unpasteurized, refrigerated

**Table 7-1. General composition of cider.**

Chemical composition <sup>a</sup>
water (86–88%)
carbohydrates (11–12%)
fat (0.25%)
protein (0.25%)
fiber (0.5%)
ascorbic acid or vitamin C (3–30 mg/100 gm)
Natural sugars
fructose (4.5–8.5%)
sucrose (1.5–4.5%)
glucose (1.2–2%)
Acid composition
malic acid (0.15–1.1%)
citric acid (trace amounts)

a. Expressed as a range or an average.

cider is shortened by higher counts of these microorganisms. Aciduric cells grow most rapidly at temperatures ranging from 70 to 80°F. Growth is reduced as the temperature of cider is lowered, but some species continue to grow slowly even at 32 to 36°F. As the cells grow, they use mainly sugars in the cider and produce many by-products. Most consumers perceive that cider loses its shelf life or “spoils” about the same time as its aciduric cell population increases to 1 to 10 million per gram or 30 to 300 million per ounce of cider.

Aciduric cells also grow in juice residue and on apple pieces that accumulate on and in the equipment used in processing. These cells also grow in pools of juice on the floor and in pomace. In addition to practices recommended for controlling those species that pose a public health concern, the following manufacturing recommendations will help to maximize shelf life by minimizing the initial population of aciduric cells and by preventing or reducing their growth rate in freshly pressed cider.

Unpasteurized cider is unsafe to drink if it becomes contaminated with pathogens. The most effective way to ensure the safety of cider is to pasteurize it. The potential for contamination to occur is reduced by following the Good Management Practices and HACCP plan development procedures provided in Part VIII, Maintaining the Safety of Pennsylvania Apples and Apple Products. Cider can additionally become unsafe to drink if mold growth occurs. Discard any cider that, by flavor or visual observation, contains mold.

## MAXIMIZING SHELF LIFE

The shelf life of unpasteurized cider can be greatly increased by quickly chilling freshly pressed cider to a temperature of 35°F and adding either potassium sorbate or sodium benzoate. Maximum concentrations of chemical preservatives allowed in Pennsylvania cider are 0.1 percent of sodium benzoate or benzoic acid (1 ounce per 8 gallons) and 0.05 percent sorbic acid (½ ounce per 8 gallons). If the initial microbial cell count in cider is low and the cider is stored consistently at 32 to 36°F, a preservative concentration as low as 0.05 percent may be adequate.

Potassium sorbate is relatively tasteless, but it is more costly than sodium benzoate. Some consumers prefer potassium sorbate because they dislike the slightly bitter taste and presence of sodium in sodium benzoate. If a preservative is used, it should be added immediately after pressing the cider. For a 0.1 percent concentration of potassium sorbate, add 1 gallon of a 25 percent stock solution to each tank of 250 gallons, or ½ ounce per gallon of cider. Because it is only slightly soluble, the sorbate solution should be added slowly and stirred vigorously in cider. For a 0.1 percent concentration of sodium benzoate, add 1 ounce of a concentrated solution to 8 gallons (or 1 quart to 250 gallons) of cider.

The shelf life of cider may be increased by heat-pasteurization. However, unless the cider is heated rapidly and held for 10 to 15 seconds at 160°F, then cooled rapidly to 35°F, the cider will have a slightly cooked flavor. Among the various systems for pasteurizing cider, a continuous plate, temperature, and flow-controlled pasteurizer (similar to those used for pasteurizing milk) is the most efficient, easily controlled system and results in the best-quality cider. Canning is accomplished by heating cider to 195°F in the same type of pasteurizing system, then filling and sealing containers immediately and waiting five minutes before cooling the metal or glass containers. Fresh-pressed cider preserved by freezing and stored at 0°F retains the most natural aroma and flavor. In fact, frozen cider retains its high quality for several years if packaged and stored properly. The relative quality and shelf life of unpasteurized versus preserved cider stored at several temperatures are compared in Table 7-2.

Shorter shelf life should be expected when:

- lower-quality fresh apples are used
- fresh apples are not properly sorted or washed
- cider is in contact with wood or metals other than stainless steel
- freshly pressed cider is not cooled rapidly
- equipment and facilities are not properly cleaned and sanitized daily when in use
- the temperature of refrigerated cider is allowed to fluctuate by more than 5°F

**Table 7-2. Relative initial quality and shelf life of cider.**

Initial flavor quality when not preserved and when preserved by various methods

Unpasteurized/no preservatives	0.1% potassium sorbate added	0.1% sodium benzoate added	Heated until pasteurized	Heated until sterile/canned	Frozen/stored at 0°F
Very high	High	Good <sup>a</sup>	Good <sup>b</sup>	Fair <sup>c</sup>	Very high
Relative shelf life as influenced by preservation method and storage temperature					
Stored 2–3 days at 46–50°F	Stored 1–2 wks at 46–50°F	Stored 1–2 wks at 46–50°F	Stored 1–2 mos at 46–50°F	Stored 1–3 yrs at room temp.	Stored 2–3 yrs at 0°F
Stored 12–14 days at 32–36°F	Stored 2–3 mos at 32–36°F	Stored 2–3 mos at 32–36°F	Stored 3–6 mos at 32–36°F		

a. Cider may have a slightly bitter flavor.

b. Cider may have a slightly cooked flavor.

c. Cider will have a detectable cooked flavor.

## PRODUCTION OPERATIONS AND PRACTICES AFFECTING COST, YIELD, AND QUALITY

Total costs for fruit and production operations are a major concern. They vary with the source of apples and with certain characteristics of the operations. Use of fresh, unstored, and ungraded smaller apples generally reduces the cost of making cider. Depending on yearly supply and demand, it may be more economical to purchase cider-grade apples from other orchards.

Systems capable of making 150 gallons or more of cider per hour, or at least 1,000 gallons per day and at least 60,000 to 80,000 gallons per year, are most cost-effective. The cost per gallon for making less cider may increase by 10 to 40 percent. This cost difference is attributed to (1) savings per gallon in costs associated with depreciation of equipment and facility; (2) savings in production and cleanup operations; (3) sales; and (4) taxes, insurance, and interest on investment.

The flow diagram (Figure 7-1) shows an ideal system of operations for efficiently producing safe, high-quality cider. The yield of cider made from 100 pounds of fresh apples may vary from 70 to 83 percent by weight, or from 7.2 to 8.5 gallons. Yields per bushel of apples range from 3.2 to 3.6 gallons.

Cider yield may be lower when:

- apples are allowed to reach, or ripen beyond, a soft-ripe maturity before pressing
- pressing firm-ripe apples ground larger than a  $\frac{3}{8}$ -inch particle size
- press aids are not added before pressing ground pulp
- the depth of chopped apples filled into each “cheese” of a rack and frame press exceeds 2 inches
- using a press that is defective or managed improperly

Besides those factors affecting the microbial safety and quality of cider, sensory quality (aroma, color, texture, and flavor of cider) is affected by:

- apple cultivar or blend of cultivars being pressed
- maturity and condition of apples being pressed
- type of press used
- other practices in making cider

### Selecting and Blending Apples

An apple that is ready to fall from a tree generally is at or close to firm-ripe maturity. Apples are best for making cider when they are near their peak of juiciness, acidity, and sweetness. Cider made with immature apples will be lower in aroma and sugars and higher in starch, acids, and a bitter or astringent (green apple) flavor. Cider made with overly mature apples will have lower yields and a sweeter, but flatter flavor.

After harvest and during storage, apples gradually ripen, soften, and lose some acidity and juiciness. Apples from a single cultivar or apples stored three or more months may yield cider with a flatter aroma and flavor as well as an imbalance in acidity, sweetness, and astringency. While some consumers prefer cider made with a specific apple variety, such as McIntosh, better cider is made with a blend of apples from three or more cultivars. Table 7-3 shows the primary aroma and flavor characteristics of important apple cultivars.

The blending guidelines provided in Table 7-4 will help you to make a preferred blend of cider by selecting cultivars and controlling their proportions.

- |   |  |                      |                                 |
|---|--|----------------------|---------------------------------|
| 1. Apple dump bin and conveyer                      | 6. Conveyor/elevator                   | 11. Press            | 16. Pump                        |
| 2. Trash eliminator                                 | 7. Accumulator bin                     | 12. Pomace discharge | 17. Heat pasteurizer (optional) |
| 3. Inspection, sorting, and trimming conveyor table | 8. Press aid bin and feeder (optional) | 13. Juice collector  | 18. Cold storage tank(s)        |
| 4. Washer/scrubber                                  | 9. Chopper/mixer                       | 14. Pump             | 19. Pump                        |
| 5. Fresh water rinsing system                       | 10. Accumulator bin                    | 15. Screen           | 20. Filter                      |
|   |  |                      | 21. Bottler                     |

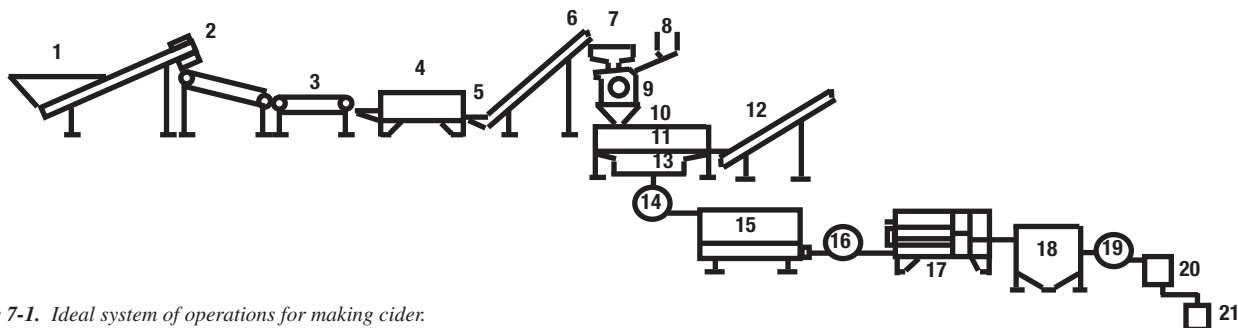

Figure 7-1. Ideal system of operations for making cider.



**Table 7-3. Primary flavor characteristics of Pennsylvania apple cultivars.**

Group I Relatively acid or tart (S/A <20) <sup>a</sup>	Group II Balanced flavor, sweet and tart (S/A 20 to 40)	Group III Relatively sweet (S/A >40)	Group IV Very aromatic	Group V Very astringent; high in tannins
Granny Smith	Baldwin	Red Delicious	Cortland	Crabapples
Idared	Cortland	Grimes Golden	Golden Delicious	Immature apples
Jonathan	Golden Delicious	Fuji	Empire	
Northern Spy	Empire	Gala	Gravenstein	
R.I. Greening	Gravenstein		Jonagold	
Stayman Wealthy	Mutsu		Macoun	
Winesap	McIntosh		McIntosh	
	Rome Beauty		Wealthy	
	Spartan		Winter Banana	
	York Imperial			
	Braeburn			

a. Ratio of sugar to acid (S/A) is less than 20 (<20).

**Table 7-4. Possible cider blends and their flavor characteristics.**

	Possible blends	Apples (%) from groups in Table 7-3 needed for blends					Dominant flavor characteristics
		Group I	Group II	Group III	Group IV	Group V	
Using freshly harvested firm to ripe apples	A	15	45–50	15	20	0–5	Balanced
	B	10	40	10	40	0	Very aromatic
	C	30–35	45–50	0	20	0	Very acid or tart
	D	0	45–50	30–35	20	0	Very sweet
Using firm to ripe apples stored 2 to 4 months	A	15	45–50	15	20	0–5	Flat but sweet
	E	25–30	35–45	0	30	0–5	Balanced
	F	45–50	15–25	0	30	0–5	Tart

### Sorting, Trimming, and Washing Operations

Storage crates, bins, or bulk loads of apples used in making a preferred blend of cider should be emptied into a dump bin. Apples are fed onto a link bar conveyor moving at a speed of 15 to 25 feet per minute. The links of the conveyor belt should have a 1- to 1½-inch square opening, and the belt should be wide enough for the apples to flow in a single layer, allowing debris (leaves, twigs, etc.) to drop through the openings. As an alternative, a smaller mesh belt can be used to move a single layer of apples under a vacuuming cleaner system. This system removes light debris through a narrow vacuum chute mounted over the full width of the belt. Regardless of the system used, apples should then flow onto a 6- to 8-foot roller conveyor table operated at the same speed. If necessary, an inspector can remove and trim partially decayed apples and discard rotten apples. Acceptable apples then flow into a tank or rotating drum washer where they are washed and brushed with cold, recirculated water, then rinsed with fresh cold water as they leave the washer. Excess water should drip from the apples as they move to the chopping equipment.

### Chopping or Milling Equipment

The equipment used to chop the apples to the size needed for pressing is a grater, chopper, or mill. It should be made of stainless steel and be designed with interchangeable screens needed to reduce whole apples to a particle size of ¼ to ¾ inch. The chopper also should have at least 10 percent more capacity than the pressing equipment. If a batch press is used, the chopper should be equipped with a stainless steel bin large enough to store the

volume of chopped apples needed for a single filling cycle of a batch pressing system.

### Press Aids

Using a press aid may increase the yield of cider from some presses by 10 percent or more. Usually, the value of the additional cider more than offsets the added cost of using a press aid. Approved press aids include sterilized wood pulp and rice hulls, normally used at a rate of 2 to 6 percent by weight, or bleached kraft fiber used at a rate of 1 to 3 percent. The press aid should be added at a uniform rate with a vibrating feeder into the chopper, where the aid is mixed as apples are chopped.

### Pressing Systems

The juice in apples is contained in fleshy cells. In making traditional cider, a system with hydraulic, roller, or pneumatic pressure is used to rupture and compress the cells until the recoverable juice is separated from cellular solids called pomace. Available pressing systems for making cider include a vertical hydraulic rack, frame, and cloth press; a horizontal hydraulic rack and cloth-bag press; a continuous belt press; and a pneumatic press.

The least expensive pressing system is a hydraulic rack, frame, and cloth press. Available models have pressing capacities ranging from 30 to 300 gallons per hour. The press is designed with a hydraulic ram for pressing a vertical stack of folded mesh cloths separated with racks. Each cloth is first placed over a standard-size frame and uniformly filled with ground apples to a depth of 2 to 3 inches. The cloth is folded to enclose the pulp. The frame

is removed, and a slotted plastic rack is placed over the folded cloth. Each filled cloth is sometimes called a cheese. This process is repeated until a full vertical stack of cheeses is ready for pressing. The stack is then positioned over the ram and pressed hydraulically in two stages for 20 to 30 minutes. The first lower pressure stage of the pressing cycle ruptures the cells and produce free-run juice. By gradually increasing the pressure, most of the remaining juice is obtained. During the first pressing stage, the extracted juice flows through a continuous web of tiny channels to the surface of the pomace. However, unless a press aid is used with mature apples, these natural channels may collapse during the second stage and reduce the potential cider yield by the portion of juice trapped within the pomace.

Press aids are fibrous materials designed to maintain the flow of juice to the surface of pomace throughout the pressing cycle. Compared to other presses, the batch-operated rack, frame, and cloth press is inefficient and has the highest labor cost for operating, cleaning, and maintaining the press. Yields may be similar to those from other presses if the particle size, use of a press aid, and fill of the cheeses are managed optimally. In terms of quality, the difficulty of cleaning and sanitizing an older press with wood surfaces increases the risk that the cider will have a higher initial microbial population and a shorter shelf life. Usually, the flavor is best from pressing systems that produce a low yield of juice. However, only the last 3 to 5 percent of the juice squeezed with a high-yielding press system is lower in flavor quality when tasted separately.

A popular semiautomatic rack and bag horizontal press offers improved operational efficiency. Available models have pressing capacities of 150 to 1,000 gallons per hour. This horizontal hydraulic press has two accordion-like sets of easy-to-use racks and filter bags held in a vertical position. A slurry of fresh apple pulp, without a press aid, is pumped from a grater hopper to fill the opened bags. One set of filled bags is compressed to remove juice while a second set of bags is alternately unloaded and refilled with fresh pulp. The press may be operated by a single person. Because the juice produced is low in suspended solids, the need for filtering is minimized. This press is very efficient to operate, and both juice quality and yield are high.

All current belt presses used to extract juice from fruits are continuous, labor efficient, and known to produce a very good yield of juice. Belt systems have pressing capacities of 40 to more than 1,000 gallons of cider per hour. With or without a press aid, pulp is fed continuously onto a mesh belt, which is then sealed by a converging belt moving at the same speed. The sandwiched pair of belts move through a wedge zone and then revolve around one or more solid or perforated drums, where a series of stainless steel rollers apply progressively higher pressures. Expressed juice flows through the mesh belt and is channeled into a collection tank. After the pressing is completed, the twin belts are continuously separated to discharge the pomace and then are refilled with prepared pulp. Both pressure and speed are adjustable. The system is simple to operate, offers good yields, and requires minimal labor.

The batch-operated pneumatic press is designed as a horizontal cylinder with a strong inflatable rubber bag in the center. The strong stainless steel exterior surface of the cylinder is perforated to serve as a screen. A slurry of freshly chopped pulp with press

aid is pumped through a door in the screen until the internal space between the bag and screen is filled. The door is closed and the cylinder is rotated while the bag is inflated with compressed air. Juice squeezed from the pulp passes through the screen and is collected in a tray under the cylinder. After a few minutes, the rotation is stopped while the bag is deflated to allow repositioning of the pomace and more efficient extraction of the remaining juice. The process of rotating, inflating for a time, then releasing the pressure to reposition the pulp is repeated three or four times, or until the volume of juice obtained is insignificant. The entire pressing cycle may be programmed to operate automatically, making this a very labor-efficient press. Both juice quality and yield are very good.

### Screening/Filtering

Depending on the press used, freshly extracted juice may contain some undesirable large particles of pulp. To remove these, the collected juice is passed through a screening system. A screen may be a simple drum covered with a stainless mesh cloth and mounted in a horizontal, but slightly inclined, position. The drum is revolved slowly (2 to 5 rpm) as freshly pressed cider continuously and gently flows onto the inside surface of the upper end of the drum. The juice passes through the 80- to 150-mesh cloth, while the undesirable particulates are continuously discharged at the lower end of the drum. Screened cider is collected in a tray under the drum. As an alternative, freshly pressed juice may be bag filtered, bottled, and marketed. An electromagnetically vibrated screen separator may not be as effective in removing undesirable particulates. The juice is then chilled 12 to 24 hours before being bag filtered, bottled, and marketed.

### Chilling and Cold Storage

To maximize the quality and shelf life of unpasteurized cider, chill screened juice as quickly as possible to a 32 to 36°F temperature and hold in a refrigerated storage tank at that temperature for 12 or more hours. During this period, additional large particles of insolubles will develop and settle to the bottom of the tank. Clear cider may then be drawn by gravity or pumped from the tank at a location above the sediment, bag filtered, bottled, and marketed.

## LABELING REQUIREMENTS AND OPTIONS

Product labels used for cider must provide information in a standardized format.

### Required Labeling Information

#### 1. Food name

Cider may be used as the product name on the label only if the product is made solely from apples. If the cider is made from two or more fruits, its food name must identify which fruits were used in order of their dominance by weight. For example, if the product is made of 60 percent fresh apple juice and 40 percent pear juice, the name would be Apple Pear Cider. If the juice is made solely of pears, the name would be Pear Cider. If the cider does not contain a preservative or is not pasteurized, the product would be labeled Fresh Cider, but if it was heat pasteurized, it must be labeled Pasteurized Cider.

## 2. Net quantity or content

Quantity or content may be stated in English or metric units, but must be listed within the lower third of the panel. The value(s) listed must exclude the container weight. Cider may be listed in fluid ounces, pints, quarts, or gallons along with the equivalent metric units. Rounded conversions may include:

1 fl oz = 29.6 ml

1 qt = 32 fl oz = 946 ml

1 gallon = 128 fl oz = 3.8 l

## 3. Ingredients

Ingredients must be listed in descending order of their dominance. If a preservative is added to cider, the specific name of the preservative must be listed. Any added flavor or vitamin C also must be listed.

## 4. Company name

The identity of the firm (manufacturer/packer or distributor) responsible for marketing the cider and the firm's city, state, and zip code must be listed. Telephone and street numbers are not required.

## 5. Product dates

Pack, open, pull, freshness, or expiration dates may be used singly or in combination. Pack and freshness dates are the most meaningful. A pack date identifies when the cider was made, while the freshness date shows how long the cider should be of optimal quality. The label might have a freshness date that reads, "Best if used by Oct. 14, 2005."

## 6. Warning notice

The Food and Drug Administration (FDA) issued a final ruling on labeling of fresh fruit juices that have not received an effective pasteurization treatment. See the section on food safety regulations in Part VIII for details.

<b>Nutrition Facts</b>	
Serving Size: 8 ounces (240 g)	
Servings Per Gallon: 16	
<b>Amount Per Serving</b>	
<b>Calories 110</b>	
	<b>% Daily Value*</b>
<b>Total Fat</b> 0 g	0
<b>Sodium</b> 15 mg	1
<b>Total Carbohydrates</b> 28 g	9
Dietary Fiber 1 g	4
Sugars 26 g	
<b>Protein</b> 0 g	
Vitamin C	4
Iron	2

\*Percent daily values are based on a 2,000 calorie diet. Your daily values may be higher or lower depending on your calorie needs.

Figure 7-2. A sample of a simple nutritional label for gallon containers of cider.

## Optional Labeling Information

### 1. Nutritional labeling

The U.S. Apple Association (USAA) recently developed the first nutritional database and generic labels for cider. The database is the result of analyzing numerous samples collected from sources in the United States. Members may access the database. Anyone wishing to declare any variation of the USAA labeling information should obtain assistance from a qualified person with a reputable agency or analytical laboratory. Sodium values will be significantly higher if either sodium benzoate (a preservative) or sodium ascorbate is added to increase vitamin C content.

### 2. Exemptions and options

Small cider producers are exempt from nutritional labeling requirements for any 12-month period, provided no nutritional claim is made and the producer claiming the exemption employs fewer than an average of 100 full-time employees and has annual food sales of less than \$50,000. This exemption does not apply to the warning statement required for unpasteurized cider.

Nutritional facts such as those listed in Table 7-5 and Figure 7-2 may be displayed at the point of purchase or provided in leaflet form to interested consumers. In either case, a simple format may be used but must minimally include the following facts per serving:

- total calories
- total fats, carbohydrates, and protein in grams (g)
- total sodium in milligrams (mg)

Table 7-5. Composition and nutritional data for apple juice.

Compositional factor	Per 8 fl oz serving <sup>a</sup>	Percentage of RDA <sup>b</sup>
Weight	240 g	—
Calories	120 cal	—
Water	215 g	—
Carbohydrates	—	—
Sugars (before inversion)	27.2 g	9
Fructose	14.2 g	—
Glucose	5.1 g	—
Sucrose	6.6 g	—
Sorbitol	1.2 g	—
Acids as malic	0.5%	—
Fiber	1.2 g	5
Pectin	1.2 g	—
Total protein	0.6 g	0.1
Total fats (lipids)	0.6 g	0.9
Saturated fats	0.05 g	0.05
Cholesterol	0 mg	0.0
Ascorbic acid (Vit C)	2.5 mg	4
Iron	0.4 mg	2.0
Sodium	0.25 mg	0.0001
Potassium	282 mg	8.1

Note: These values are for apple juice since values for cider are not available.

- From Composition of Foods: Fruits and Fruit Juices, Raw • Processed • Prepared. USDA Agricultural Handbook No. 8-9 (1982).
- These recommended daily allowances (RDAs) are based on the 1994 daily values used in developing a food label for a daily 2,000-calorie intake. Some daily values are maximums, as with 65 grams or less of fat; others are minimums, as with 300 grams or more of carbohydrates.

The values listed in Table 7-5 are averages of the compositional and nutritional data published by researchers and USDA's Human Nutrition Information Service. The values listed for an 8-ounce serving and the percent daily values in Figure 7-2 were computed from these average values for the 1994 labeling requirements. For more information on labeling regulations, contact the Food and Drug Administration at 1-888-463-6332 or visit their website at [www.fda.gov](http://www.fda.gov).

### 3. Product codes

Lot coding is a commonly used system of coding (by serial number or other method) each lot of cider that you make. Each lot may differ in one or more quality characteristics because different sources of apples or different blends of cultivars are used. Cider quality also may vary when made by different operators or at different times during the season. Records kept for each lot should show the source and blend of apples and where, when, and by whom the lot was made and sold. This lot coding system and accompanying records make it easier to address a possible consumer concern or regulatory question.

Universal Product Code (UPC) is a 10-digit set of numbers and bars used with computerized scanners and checkout systems and with inventory programs. If cider is to be sold through food stores, an assigned UPC may be obtained for a fee from the Uniform Code Council, Inc. For more information, visit their website at [www.gs1us.org](http://www.gs1us.org) or telephone 937-435-3870.

### 4. Handling instructions

Handling instructions encourage handlers and consumers to store the cider at less than 40°F for maximum shelf life and quality and to consume the cider before the freshness date expires.

### 5. Health claims

Certain health claims regarding the relationship between fat and cancer (21 CFR 101.73[e]), saturated fat and cholesterol and coronary heart disease (21 CFR 101.75[e]), and sodium and hypertension (21 CFR 101.74[e]) are allowed on an apple juice or cider label. If a nutrient or health claim is made, nutrition information must appear on the package regardless of eligibility for small-business exemptions. For details, visit [pennsylvaniaapples.org/apples](http://pennsylvaniaapples.org/apples).



---

# MAINTAINING THE SAFETY OF PENNSYLVANIA APPLES AND APPLE PRODUCTS

---

**CONTENTS**

**Foodborne Illness in the U.S. .... 350**  
Fresh Produce..... 350  
Juice and Cider..... 350

**Good Management Practices for Safe Apple  
Growing, Packing, and Cider Production ..... 350**  
Orchard Operations ..... 351  
Packing Operations ..... 352  
Cider Processing ..... 355

**Recommended Resources..... 361**  
Penn State Extension Workshops and Short Courses ..... 361

## FOODBORNE ILLNESS IN THE U.S.

### Fresh Produce

Pennsylvania apple growers are justifiably proud of their record for producing wholesome and nutritious apples, and there have been no reported cases of foodborne illness associated with their consumption. However, several highly publicized outbreaks of foodborne illness involving red meats, poultry, seafood, juice, and some fresh fruits and vegetables have caused consumers and government regulators to question the safety of the food we eat.

The U.S. Centers for Disease Control and Prevention estimates that, in the United States, 48 million illnesses, 128,000 hospitalizations, and 3,000 deaths occur each year due to consumption of food contaminated with pathogenic microorganisms. Particularly susceptible to foodborne illness are the very young, the elderly, and individuals with existing diseases or who are receiving medical treatments that suppress their immune systems. In addition to the human toll, outbreaks of foodborne illness have caused severe economic losses to food companies in the form of lost reputation, declining sales, and government sanctions.

The proportion of total foodborne illnesses traced to vegetables and fruits, in particular those that are eaten raw, has increased steadily in the last few decades. In the 1990s produce-related cases increased twelvefold. Between 1997 and 2005 the frequency with which produce has been identified as causing illness outbreaks has more than doubled. Outbreaks or recalls have been attributed to contamination of tomatoes, cantaloupes, and alfalfa sprouts with *Salmonella* spp., whole cantaloupes and diced celery with *Listeria monocytogenes*, imported raspberries with *Cyclospora*, and Mexican strawberries with Hepatitis A virus and *E. coli* O157:H7.

Tree fruit has long been assumed to present fewer food safety risks compared to fruits and vegetables that grow closer to the ground. However, in recent years, there has been an increased number of recalls and outbreaks traced to orchard-grown fruit and related processed products. These include recalls and, in some cases, illnesses from California-grown whole peaches, nectarines, plums, and pluots; Michigan-grown apples used to prepare fresh-cut products; and fruit salad products in Texas containing sliced apples. In 2015, thirty-five people in twelve states were infected and seven died after eating caramel apples that were contaminated with *Listeria monocytogenes*. A follow-up investigation showed that infiltration of caramel sugars into the apple during the puncturing process, combined with long-term unrefrigerated storage during shipping and retail display, created conditions that allowed *Listeria* to grow to disease-causing levels.

Tree fruit growers need to be constantly vigilant for potential sources of contamination. Human pathogens such as *Listeria monocytogenes*, *Clostridium botulinum*, and *Bacillus cereus* are naturally present in soils and therefore can be transmitted to fresh produce, especially those types that grow close to or contact the ground. *Listeria* grows well in cool, damp environments commonly found in packing houses and thrives on improperly cleaned and sanitized floors, walls, and equipment surfaces. *Salmonella* spp., *E. coli* O157:H7, *Campylobacter jejuni*, and many parasites and viruses have their origin in the intestines of animals and humans. These microorganisms can

contaminate fresh produce through the use of raw or inadequately composted manure, contaminated irrigation water, untreated wash water, or harvesters and handlers who do not follow good personal hygiene practices. *E. coli* O157:H7 is one of several relatively new variants of this usually harmless species of bacteria found in the human gut, and it is of particular concern because only a few cells are required to make someone seriously ill.

### Juice and Cider

Several highly publicized outbreaks involving fruit juice and cider have been attributed to the presence of *Salmonella* spp., *E. coli* O157:H7, and *Cryptosporidium* in unpasteurized juice. In a 1996 outbreak, unpasteurized apple juice produced by Odwalla, Inc., became contaminated with *E. coli* O157:H7. Sixty-six cases of illness were confirmed and one child died. The cause of the outbreak was thought to be the use of low-quality, partially decayed apples in the product. Because of this and several other outbreaks that followed, consumers and wholesale buyers of apples are now demanding new assurances that fresh fruits and fruit juices are grown, packed, and processed in a safe manner.

The number of reported outbreaks and product recalls of fresh fruits and vegetables and unpasteurized juices may increase in the coming years as produce consumption increases, the proportion of susceptible individuals in the general population increases, and microbial detection methods become more sensitive. Growers, packers, and processors, therefore, are well advised to follow the guidelines and regulations described in this chapter to prevent contamination before it occurs.

## GOOD MANAGEMENT PRACTICES FOR SAFE APPLE GROWING, PACKING, AND CIDER PRODUCTION

This section offers guidelines for recognizing potential food safety hazards in apple growing, packing, and juice production operations. Apples and apple products can become contaminated at any point in the growing, packing, and processing continuum. By taking steps to identify and prevent potential hazards, the Pennsylvania apple industry will continue to maintain consumer confidence in apples and apple products.

“Good Management Practices for Safe Apple Growing, Packing, and Cider Production” is intended to identify a broad range of potential microbial, chemical, and physical hazards that may occur during growing, packing, and distribution of fresh apple products. The scientific basis for identification and prevention of these hazards is not complete. However, the guidelines in this publication are based on established sanitation and hygiene principles for use in food processing and agricultural packing environments. Food safety control measures presented here were drawn from the following documents:

- “Current Good Manufacturing Practice in Manufacturing, Packing, or Holding Human Food (CFR 21 Part 110),” U.S. Code of Federal Regulations
- “Guidance for Industry—Guide to Minimize Microbial Food Safety Hazards for Fresh Fruits and Vegetables,” U.S. Food and Drug Administration

- “Codex Alimentarius Food Hygiene—Basic Texts,” World Health Organization/U.N. Food and Agricultural Organization

Potential hazards and control measures are divided into three sections:

- Orchard operations
- Packing operations
- Cider processing

In each section, the purpose for the guidelines that follow, potential hazards, and preventative or corrective measures are provided. Potential hazards and control methods identified here may not apply to all situations. Individual growers, packers, and distributors, therefore, should seek to identify additional potential hazards and control measures in their own operations as a complement to the broad principles presented in this guide.

## Orchard Operations

### Purpose

To ensure that apples are grown and harvested under conditions that minimize the risk of contamination with human pathogens.

### Potential hazards

Apples can become contaminated with human pathogens during preharvest and harvest activities as a result of contact with water, soils, wild or domestic animals, manure, workers, and harvesting equipment.

### Preventive or corrective measures

#### I. Water quality

WATER USED FOR IRRIGATION OR FOR APPLICATION OF FERTILIZERS, PESTICIDES, AND GROWTH REGULATORS SHOULD BE OF ACCEPTABLE MICROBIOLOGICAL QUALITY.

Because apples intended for the fresh market and for use in cider are not treated to kill all microorganisms, growers should be aware of the microbial quality of the water that may contact apples. Practices that might expose apples to direct contact with contaminated water, such as irrigation and fertilization or application of pesticides or growth regulators, may increase microbial food safety risks, especially when applied close to harvest. The microbial quality of water can be confirmed by laboratory testing of samples; however, the quality of surface water such as rivers, ponds, reservoirs, and lakes is often unpredictable and can vary over a short time period. Growers should, therefore, be aware of water sources and distribution and check for wastewater discharge or runoff from upstream livestock operations. Groundwater is less likely to be a source of contamination. However, wells should be properly constructed and protected from surface runoff.

Where water quality is unknown or cannot be controlled, growers may want to consider irrigation practices that minimize contact between water and apples. Low-volume sprays or drip, furrow, or underground irrigation are options that should be considered. If fertilizer, pesticide, and growth regulators are applied close to harvest, only potable water should be used to prepare solutions. If water is not safe for human consumption, it should be treated with an approved disinfectant.

## II. Cultivation

DOMESTIC ANIMALS SHOULD BE EXCLUDED FROM ORCHARDS DURING THE GROWING SEASON.

Animal manure may be contaminated with human pathogens such as *Salmonella* or *E. coli* O157:H7. Livestock, therefore, should be prevented from entering orchards by physical barriers such as fences.

ANIMAL WASTE FROM ADJACENT LIVESTOCK OPERATIONS OR WASTE STORAGE FACILITIES SHOULD NOT BE ALLOWED TO CONTAMINATE THE ORCHARD.

If surrounding fields and farms are used for animal production, growers should ensure that animal waste does not enter the orchard or areas where wells are located during heavy rains. This can be accomplished by the use of physical barriers such as ditches, mounds, grass/sod waterways, diversion berms, and vegetative buffer areas.

WILDLIFE SUCH AS DEER OR WATERFOWL SHOULD BE DISCOURAGED FROM ENTERING THE ORCHARD.

Control of wild animal populations such as deer or waterfowl in nearby wooded areas, meadows, and waterways is difficult. However, to the extent possible, where high concentrations of wildlife are a concern, growers should discourage these animals from entering the orchard. Visual, auditory, or physical means may be used. Buffer crops that will not be used for fresh market products may be planted between orchards and wild areas to discourage entry of animals.

APPLES INTENDED FOR FRESH MARKET OR CIDER PRODUCTION MUST NOT BE PRODUCED IN ORCHARDS FERTILIZED WITH RAW HUMAN OR ANIMAL WASTES.

Because there is a high probability that raw manure contains human pathogens, it may contaminate apples when it is applied. Once the manure is on the ground, pathogens may survive through the season and contaminate apples during heavy rains, by dust carried on the wind, or by workers during harvesting.

COMPOSTED MANURE SHOULD NOT BE APPLIED DURING THE GROWING SEASON.

Maximum temperatures achieved during proper composting are sufficient to kill most human pathogens; however, in practice, the effectiveness of composting in eliminating the risk of microbial contamination in orchards is not well understood. Therefore, if growers use composted manure, it should be applied well before the growing season to allow additional time for pathogen levels to decrease.

To ensure that composting operations are not a source of contamination, keep manure storage and composting sites as far as possible from orchards. Piles should be kept covered to prevent the spread of microorganisms by birds or winds, and runoff during heavy rains should be prevented from reaching the orchard.

## III. Harvesting

DO NOT HARVEST DROPPED APPLES.

Apples that have dropped onto the ground may have become contaminated with animal manure and should not be used for the fresh market or cider production. Apples attached to lower branches that have contacted the ground under their own weight also should not be used. Training and supervision of harvesters is necessary to ensure that only tree-picked apples are used.

**USE ONLY CLEAN, WHOLESOME APPLES.**

Only apples that meet the minimum quality standards for “U.S. Cider Grade,” that is, “free from decay, wormholes, and internal breakdown,” should be used. Heavily bruised, punctured, or decaying apples, or fruit that is obviously contaminated with bird feces, should not be used for fresh market or cider apple production.

**KEEP HARVEST CONTAINERS CLEAN TO PREVENT CROSS-CONTAMINATION OF APPLES**

Harvest containers used repeatedly during a harvest should be routinely cleaned after each load is delivered and before reuse. Removing mud from containers when fields are muddy may not be practical. At such times, adhering mud should be removed at the packing facility prior to sorting, grading, and packing.

Whenever possible, use containers made from cleanable materials. Wooden containers are more difficult to clean and sanitize and, therefore, should be avoided. Discard damaged containers that are no longer cleanable.

Containers should be stored in a clean area free from pests such as rodents, birds, and insects. If the containers are stored outside, they should be cleaned and, as necessary, sanitized before being used to haul apples.

**MOVE THE APPLES RAPIDLY FROM THE FIELD TO STORAGE.**

Do not let the fruit sit out in the orchard where it is exposed to pests and high temperatures. If apples are to be stored for an extended period of time, quickly cool them to 45°F or lower.

**CLEAN HARVEST STORAGE FACILITIES BEFORE USE.**

Facilities used to store apples should be cleaned and, as necessary, sanitized before harvest. These facilities also should be inspected for evidence of pests such as rodents, birds, and insects.

**USE HARVESTING AND PACKING EQUIPMENT APPROPRIATELY AND KEEP IT AS CLEAN AS PRACTICAL.**

Any equipment used to haul garbage, manure, or other debris should not be used to haul apples or be allowed to contact containers or pallets that are used to haul apples without first being carefully cleaned and sanitized.

**IV. Sanitary Facilities and Worker Hygiene****WORKERS SHOULD BE PROVIDED READY ACCESS TO CLEAN TOILET AND HANDWASHING FACILITIES.**

Sufficient toilet facilities must be provided as regulated by federal occupational safety and health standards for agricultural workers. Each toilet facility should have a handwashing station adequately supplied with soap and disposable towels. Supervisors must insist that workers use toilet facilities.

**WORKERS SHOULD USE GOOD HYGIENIC PRACTICES.**

To prevent contamination during harvesting, workers should maintain a high degree of cleanliness while on duty by thoroughly washing their hands before starting work and each time after using the toilet. Clean, warm water with soap should be used. Common or shared towels should be not be used.

**CLEAN DRINKING WATER THAT IS FREE OF HARMFUL MICROORGANISMS SHOULD BE MADE AVAILABLE TO WORKERS.**

Contaminated drinking water may infect workers, who may then contaminate apples during harvesting and handling.

**ANY WORKER WHO HAS DIARRHEA, OR WHO IS A CARRIER OF A COMMUNICABLE DISEASE THAT CAN BE TRANSMITTED BY FOOD, SHOULD NOT BE ALLOWED TO HARVEST OR HANDLE APPLES.**

Supervisors and workers should be aware of the presence of symptoms of infectious diseases or of skin boils, sores, or infected wounds so that if symptoms are evident, the supervisor can remove or reassign the worker.

**V. Transportation****INSPECT TRUCKS AND TRANSPORT CONTAINERS FOR CLEANLINESS, ODORS, AND OBVIOUS DIRT OR DEBRIS BEFORE BEGINNING THE LOADING PROCESS.**

Growers should be aware of previous loads carried in transport vehicles and take this information into consideration when determining vehicle use. Trucks that were recently used to transport animals or animal products, for example, would increase the risk of contaminating apples if the trucks were not thoroughly cleaned and sanitized before loading.

**LOAD APPLES INTO TRUCKS OR TRANSPORT CARTONS IN A MANNER THAT WILL MINIMIZE DAMAGE.**

Heavily bruised, punctured, or decaying apples may provide a better growth environment for microorganisms and may be more difficult to wash.

**MAINTAIN PROPER TEMPERATURES TO HELP ENSURE BOTH THE QUALITY AND SAFETY OF APPLES.**

Do not let apples sit in unrefrigerated trucks for excessively long periods of time. Refrigerated trucks should be precooled before apples are loaded. Containers of apples should be loaded in a way that ensures proper refrigerated air circulation.

**VI. Product Traceback****MAINTAIN ADEQUATE PRODUCTION RECORDS.**

When good management practices are used to produce apples for fresh market and cider apples, the probability of a foodborne disease incident is reduced. However, if a foodborne disease outbreak occurs, identification of the source of contamination can help to prevent the further occurrence of food safety problems and also may be useful in identifying and eliminating a hazardous pathway.

Documentation should include the name and location of the orchard and cultivar, the date of harvest, and the name and address of the buyer. Any records that document corrective actions taken to minimize food safety hazards, including water quality testing results, should be included. The records should be legible, permanent, accurate, and signed and dated by the responsible individual.

**Packing Operations****Purpose**

To ensure that apples received from the orchard are packed, stored, and transported under conditions that minimize the risk of microbial contamination.



## Potential hazards

Because fresh market and cider apples do not receive a heat treatment that would eliminate harmful bacteria, Good Management Practices are necessary to minimize microbial contamination. Poor sanitation procedures can significantly increase the risk that apples will become contaminated with microorganisms. Pathogens may be found on the floors and in the drains in the packing facility and on the surfaces of sorting, grading, and packing equipment. Without good sanitary practices, any of these surfaces that come in contact with apples could be a potential source of microbial contamination. Workers who do not follow good hygiene practices may infect other workers and contaminate apples. Packers should develop good sanitation and hygiene standards and maintain them throughout the packing operation.

## Preventive or corrective measures

### I. Water Quality

**ALL AREAS IN THE PACKING FACILITY MUST HAVE A SOURCE OF HOT AND COLD POTABLE RUNNING WATER WITH SUFFICIENT PRESSURE FOR ALL REQUIRED WASHING OF FRUIT AND EQUIPMENT AND DAILY FLOOR WASHING.**

If nonmunicipal water is used, it must meet minimum federal standards for drinking water. In Pennsylvania, a private water source must be tested by a certified laboratory each year between August 15 and September 15.

All modifications to the plumbing system should be completed by a licensed plumbing contractor and inspected for conformance with local building codes. All hoses inside and outside the plant should have anti-siphoning devices installed.

Surface water or other water of uncertain microbiological quality should not be used for cooling, drenching, or washing operations or in dump tanks, unless it has been treated with an approved disinfectant.

Water used to sanitize food contact surfaces may be treated with sodium hypochlorite or other approved chemicals to prevent accumulation of harmful microorganisms. The concentration of residual chlorine should be maintained at 50–100 ppm by monitoring regularly with a chlorine test kit.

The temperature of dump tank water should be kept at least 10°F warmer than the apples. This is important because when the water temperature is colder than the apples, a slight vacuum forms within the fruit. Water and any contaminants it might contain can then be drawn inside the apple through calyx and stem areas, lenticels, punctures, and cracks. This is generally not a problem if the dump tank water contains a disinfectant and if apples are cooled before packing.

**CLEAN DRINKING WATER SHOULD BE MADE AVAILABLE TO WORKERS.**

Contaminated drinking water may infect workers, who may then contaminate apples during harvesting and handling.

### II. Grounds and Buildings

**GROUND AND BUILDINGS SHOULD BE FREE OF CONDITIONS THAT MAY RESULT IN PRODUCT CONTAMINATION.**

Grounds in the immediate vicinity of all packing areas should be kept clear of waste, litter, and improperly stored garbage. Remove weeds and keep all grasses cut to discourage the breeding, harboring, and feeding of pests.

Walls and ceilings should be impervious, and the floors must be continuous concrete and have sufficient drains. Walls and ceilings should be light in color for easier cleaning and to provide better lighting on work surfaces. Condensate from fixtures, ducts, and pipes should not contaminate food or food contact surfaces. Drainage areas may contribute to contamination of food by seepage, cross-contamination from shoes and boots, or by providing a breeding place for pests.

Remove any unnecessary articles, including old and inoperative equipment that is no longer used, to eliminate areas that harbor rodents and insects. Minimize the availability of food and water to pests, and eliminate potential nesting or hiding places for pests. Bins should not be stored immediately adjacent to the packing house.

**BLOCK ACCESS OF PESTS INTO ENCLOSED FACILITIES.**

Prevent entry of pests into packing areas by screening or blocking vents and holes in walls, doors, flooring, etc. All windows, doors, and openings around the packing operation should be screened to prevent insect and rodent entry. Entrances to storage areas by forklifts should be covered with plastic curtains.

**ADEQUATE LIGHTING MUST BE PROVIDED IN THE WORK AREAS.**

Well-lit areas are more easily monitored for cleanliness. Interior lights must be shielded to prevent pieces of glass from getting onto the product in the event of bulb or tube breakage.

**REFRIGERATION FACILITIES SUFFICIENT TO KEEP APPLES STORED AT 32 to 38°F (AS CLOSE TO 32°F AS POSSIBLE) SHOULD BE AVAILABLE.**

This will prevent growth of human pathogens as well as extend the product's shelf life.

### III. Product Receiving and Storage

**ACCEPT ONLY CLEAN, WHOLESOME APPLES THAT MEET THE MINIMUM QUALITY STANDARDS FOR "U.S. CIDER GRADE"; THAT IS, "FREE FROM DECAY, WORMHOLES, AND INTERNAL BREAKDOWN."**

Heavily bruised, punctured, or decaying apples or fruits that are obviously contaminated with soil or bird feces should be discarded. Packers should insist that apples are grown in accordance with the Good Management Practices for orchard operations detailed in the previous section.

Additional care should be taken to protect fresh field-packed apples from possible contamination from exposure to manure and animal fecal material in the soil. Operators of open packing facilities also should be aware of potential contamination from airborne contaminants from any nearby livestock or poultry areas or manure storage or treatment facilities.

**INSPECT CONTAINERS UPON RECEIPT FOR CLEANLINESS OR DAMAGE.**

Bins or crates may become a source of contamination if they are soiled when they enter a dump tank. As much adhering dirt as practical should be removed with clean running water.

Damaged container surfaces may cause damage to the surface of apples and make them more difficult to wash. Moreover, smooth container surfaces are desirable because they have fewer protective places for bacteria to survive and accumulate.

**STORE APPLES IN A COOL AREA, FREE FROM PESTS.**

Clean apples cannot remain clean in dirty surroundings. If apples have been contaminated in the orchard, pathogens will grow quickly at warm temperatures. If apples are to be stored for an extended period of time, quickly cool and store them at 45°F or lower.

**IV. Facility and Equipment Sanitation****FACILITIES IN AND AROUND PACKING OPERATIONS SHOULD ALWAYS BE MAINTAINED IN A CLEAN CONDITION.**

Discarded apples attract pests, which may spread harmful microorganisms. Clean and sanitize the dump tank and the washing, grading, and sorting areas daily to reduce the potential for microbial contamination.

Clean product storage areas regularly. Remove, as much as practical, all visible debris, soil, dirt, and unnecessary items from product storage areas on a regularly scheduled and “as needed” basis. Sanitize facilities as necessary.

Floors, walls, and ceilings should be kept clean and be free of peeling paint, rust, dirt, or any evidence of microbial growth. Do not allow standing water to accumulate in packing and storage areas; it provides an ideal environment for growth of harmful microorganisms such as *Listeria*.

**CLEAN EQUIPMENT OR MACHINERY THAT CONTACTS APPLES ON A DAILY BASIS.**

Because contact with apples may serve as a vehicle for spreading microbial contamination, equipment used in transporting, washing, sorting, and grading apples should be of such material and workmanship as to be adequately cleanable. Proper design, construction, use, and cleaning of equipment can help reduce the risk of cross-contamination.

Remove mud and debris from equipment daily. Equipment such as knives, saws, blades, boots, gloves, smocks, and aprons should be cleaned on a regular basis and replaced as needed. Sanitize cleaned equipment and other food contact surfaces daily with an appropriate sanitizing solution.

**FOOD CONTACT SURFACES THAT HAVE BEEN CLEANED SHOULD BE SANITIZED ON A DAILY BASIS DURING THE PEAK SEASON AND AS NEEDED AT OTHER TIMES.**

Sanitizing surfaces not only prevents pathogens from accumulating, but also minimizes the presence of spoilage organisms that can decrease product shelf life. *After food contact surfaces are thoroughly cleaned*, they should be sanitized with an EPA-approved sanitizer. A sanitizing solution can be prepared by mixing  $\frac{3}{4}$  to  $2\frac{1}{2}$  ounces of 5.25 percent available chlorine bleach (commercial liquid chlorine bleach) to 5 gallons of clean water. The sanitizing solution must be 50–200 ppm—do not exceed the recommended strength. Chlorine test papers must be used on each batch of sanitizing solution to ensure a proper concentration of chlorine. Good ventilation is required when working with chlorine.

Toxic cleaning compounds and sanitizing agents should be properly labeled and stored in a manner that protects against contamination of food, food contact surfaces, or food packaging materials.

**USE REGULAR INSPECTION TO MAINTAIN THE QUALITY OF BRUSHES USED TO WASH APPLES.**

Washing efficiency is reduced when brushes are worn or not working correctly. Inspect, clean, and sanitize the brushes daily with an approved disinfectant to prevent accumulation of harmful microorganisms.

**MAINTAIN THE COOLING SYSTEM TO ENSURE PROPER FUNCTIONING OF THE EQUIPMENT.**

Condensate dripping from cooling systems has been identified as a possible source of *Listeria* in a number of food processing operations. Therefore, it is essential that drainage from air-handlers and condensers is piped directly into the drains and not on the floor. Inspect all cooling equipment daily, remove all debris, and clean as necessary when in use.

**V. Pest Control****ESTABLISH A PEST CONTROL SYSTEM.**

Animals, including mammals, birds, and insects, are potential sources of contamination in packing environments because they harbor or could spread pathogens. Apple packers should, therefore, have a pest control program in place that requires regular inspections and treatment of the packing facility by a trained pesticide applicator. The program should include regular and frequent monitoring of affected and treated areas to accurately assess the program’s effectiveness.

Maintain a pest control log that includes dates of inspection, inspection report, and steps taken to eliminate any problems. Establish frequent monitoring of affected and treated areas to determine the effectiveness of the treatment applied.

**USE OF PESTICIDES IS PERMITTED ONLY UNDER PRECAUTIONS AND RESTRICTIONS THAT WILL PREVENT THE CONTAMINATION OF FOOD OR PACKAGING MATERIALS WITH ILLEGAL RESIDUES.**

All applicators must be trained and licensed. If a pesticide is applied within packing areas, precautions must be taken to protect raw ingredients and packaging materials. All food contact surfaces must be thoroughly cleaned and sanitized between pesticide spraying and the beginning of packing operations.

Pesticide chemicals should be labeled and stored in a manner that protects against contamination of food, food contact surfaces, or food packaging materials.

Pesticide regulations are constantly changing, and you must know the current status of regulations pertaining to the pesticides you use in and around your operation. For further information on insecticides and rodenticides, contact the Pennsylvania Department of Agriculture or your county Penn State Cooperative Extension office.

**VI. Sanitation Facilities and Worker Hygiene****WORKERS SHOULD USE GOOD HYGIENIC PRACTICES.**

To prevent contamination during packing operations, workers should maintain a high degree of cleanliness while on duty by thoroughly washing their hands before starting work, after breaks, and each time after using the toilet. Clean, warm water with soap should be used. Hands should be dried with hot air or disposable towels. Common or shared towels should not be used.

Establish a training program to teach workers good hygiene practices. All new workers should understand the importance of proper hand washing practices and general sanitation concerns.

ANY WORKER WHO HAS DIARRHEA, OR IS A CARRIER OF A COMMUNICABLE DISEASE THAT CAN BE TRANSMITTED BY FOOD, SHOULD NOT BE ALLOWED TO HANDLE APPLES.

Supervisors and workers should be aware of the presence of symptoms of infectious diseases or of skin boils, sores, or infected wounds so that if symptoms are evident, the supervisor can remove or reassign the worker.

ALL WASTEWATER MUST BE DRAINED PROPERLY INTO THE SEWER OR A SEPTIC SYSTEM SEPARATE FROM THE TOILET SYSTEM.

Consult your local or state health department about the proper disposal facility to be used.

### **VII. Transportation**

INSPECT TRUCKS AND TRANSPORT CONTAINERS FOR CLEANLINESS, ODORS, AND OBVIOUS DIRT OR DEBRIS BEFORE BEGINNING THE LOADING PROCESS.

When receiving apples from an orchard, packers should be aware of previous loads carried in a transport vehicle. Trucks that were recently used to transport animals or animal products, for example, would increase the risk of contaminating apples if the trucks were not cleaned and sanitized before loading.

MAINTAIN PROPER TEMPERATURES TO HELP ENSURE BOTH THE QUALITY AND SAFETY OF APPLES.

Do not let apples sit in unrefrigerated trucks for excessively long periods of time. Refrigerated trucks should be precooled before apples are loaded. Containers of apples should be loaded in a manner that permits refrigerated air to circulate properly.

### **VIII. Product Traceback**

DEVELOP A RECALL SYSTEM THAT ALLOWS TRACEBACK OF APPLES TO THE GROWER.

When apples are grown and packed in accordance with Good Manufacturing Practices for orchard and packing operations, the probability of a foodborne disease incident is low. In the event of an outbreak, however, it is in the packer's best interest to be able to trace apples back to a specific grower. The ability to identify the source of a product can help to prevent the occurrence of food safety problems and also may be useful in identifying and eliminating a hazardous pathway.

A recall system should include methods to identify, locate, and control the recalled product. Records should be kept that will identify a product by name, size, and lot number, which then should indicate the name and location of the grower and the amount and location of product produced, in inventory, and distributed. Records also should be kept concerning control measures taken to ensure product safety, including standard operating procedures, washing and sanitizing methods, and monitoring records of refrigerated storage rooms. Records should be legible, permanent, accurate, and signed and dated by the responsible individual.

## **Cider Processing**

### **Purpose**

Because unpasteurized apple cider is not treated to eliminate harmful bacteria, Good Management Practices are necessary to minimize contamination during processing. Microbial contamination of apples during preharvest and harvest activities may result from contact with water, soils, fertilizers, manure, harvesting equipment, and workers who handle apples. Packing operations with poor sanitation procedures can significantly increase the risk of contaminating apples used for cider.

**Important:** Cider makers should determine if they are subject to a Food and Drug Administration (FDA) ruling that mandates specific procedures for application of Current Good Manufacturing Practices and development of Hazard Analysis Critical Control Point plans. Details are provided in this chapter under "Food Safety Regulations." In any case, cider makers are considered by the FDA to be food processors, and as such they should carefully read and follow Current Good Manufacturing Practice in Manufacturing, Packing, or Holding Human Food (21CFR 110). The guidelines in "Good Management Practices for Cider Processing" are offered to complement and emphasize the FDA requirements.

### **Potential hazards**

Pathogenic microorganisms may be found on the floors and in the drains in the processing facility and on the surfaces of processing equipment. Without good sanitary practices, any of these surfaces that come in contact with apples or cider could be a potential source of microbial contamination. Workers who do not follow good hygiene practices may infect other workers and contaminate apples.

Apples intended for cider production may come from a variety of sources. Cider processors may have grown and packed the apples themselves or purchased them from outside growers or packers. Despite all sanitation measures during processing, cider may contain harmful levels of pathogens if contaminated apples are used. Cider processors must, therefore, be certain that apples were grown in accordance with Good Management Practices for Orchard Operations and handled in accordance with Good Management Practices for Packing Operations. By doing so, they maintain control throughout the growing, distribution, and processing system and minimize the risk of producing a contaminated product.

Since cider processors often use the same procedures used by apple packers (receiving, storing, dumping, washing, etc.) cider processors should follow Good Management Practices for Packing Operations as appropriate.

### **Preventive or corrective measures**

#### **I. Water Quality**

ALL PROCESSING AREAS MUST HAVE A SOURCE OF HOT AND COLD POTABLE RUNNING WATER WITH SUFFICIENT PRESSURE FOR ALL REQUIRED WASHING OF FRUIT AND EQUIPMENT AND DAILY FLOOR WASHING.

Municipal water is recommended. If nonmunicipal water is used, it must meet federal health standards for drinking water. In Pennsylvania, a private water source must be tested each year between August 15 and September 15 by a certified laboratory.

Commercial, state, or local government laboratories should test water of unknown quality.

All modifications to the plumbing system should be completed by a licensed plumbing contractor and inspected for conformance with local building codes. All hoses inside and outside the plant should have anti-siphoning devices installed.

## **II. Building and Grounds**

**CIDER PROCESSING OPERATIONS MUST BE LOCATED IN A SEPARATE, ENCLOSED ROOM OR BUILDING.**

The walls and ceiling of the processing room must be impervious, and the floors must be continuous concrete and have sufficient drains. Walls and ceilings should be light in color for easier cleaning and to provide better lighting on work surfaces. Drip or condensate from fixtures, ducts, and pipes should not be allowed to contaminate food or food contact surfaces.

**GROUND AND BUILDINGS SURROUNDING THE CIDER OPERATION SHOULD BE FREE OF CONDITIONS THAT MAY RESULT IN PRODUCT CONTAMINATION.**

Properly store unused equipment and hazardous chemicals and remove litter and waste. Tall grass and weeds may harbor rodents and other pests and should be cut regularly.

**THE PROCESSING FACILITY SHOULD BE PROTECTED FROM INSECT AND RODENT ENTRY BY SCREENING OR OTHER PHYSICAL BARRIERS.**

All windows, doors, and openings around the cider operation should be screened. Plastic curtains may be installed where forklifts enter storage areas. Temporary screened panels with a walkthrough can be used to frame in garage doors during cider season and can be removed in the off-season. Construct these temporary walls so that the garage door can be closed and opened as desired.

**ADEQUATE LIGHTING MUST BE PROVIDED IN WORK AREAS.**

Lighting should be sufficient for the work environment and to detect pests. Any interior lights must be shielded to prevent pieces of glass from getting into the product in the event of bulb or tube breakage.

**REFRIGERATION FACILITIES SUFFICIENT TO KEEP CIDER STORED AT 32–38°F (AS CLOSE TO 32°F AS POSSIBLE) SHOULD BE AVAILABLE.**

This will prevent growth of human pathogens as well as extend the product's shelf life.

## **III. Facilities and Equipment Sanitation**

**FACILITIES IN AND AROUND CIDER PROCESSING OPERATIONS ALWAYS SHOULD BE MAINTAINED IN A CLEAN CONDITION.**

Discarded apples attract pests, which may spread harmful microorganisms. Clean floors and walls around processing operations daily to reduce the potential for microbial contamination. Clean product storage areas regularly and sanitize facilities as necessary. Do not allow standing water to accumulate in processing and storage areas.

**ALL FOOD CONTACT EQUIPMENT MUST BE MADE OF FOOD-GRADE MATERIALS.**

Use only stainless steel, food-grade plastic, or wood that is safe, durable, corrosion-resistant, nonabsorbent, and can be cleaned and sanitized easily. As soon as possible, phase out all non-hardwood porous woods and wood in poor condition that contacts the product. The design, construction, use, and general cleanliness of equipment can help reduce the risk of cross-contamination. Copper and copper alloys should not be used in contact with apple cider.

**USE ONLY CLEAN AND SANITIZED EQUIPMENT AND CONTAINERS FOR PROCESSING AND STORAGE OF CIDER.**

Clean and sanitize food contact surfaces daily with appropriate cleaning and sanitizing solutions. Thoroughly inspect containers before using and sanitize them thoroughly as necessary. After food contact surfaces are thoroughly cleaned, they should be sanitized with an FDA-approved sanitizer. A sanitizing solution can be prepared by mixing  $\frac{3}{4}$  to 2½ ounces of 5.25 percent available chlorine bleach (commercial liquid chlorine bleach) to 5 gallons of clean water. The sanitizing solution must be 50–200 ppm—do not exceed the recommended strength. Chlorine test papers must be used on each batch of sanitizing solution to ensure a proper concentration of chlorine. Good ventilation is required when working with chlorine.

**STORE HAZARDOUS CHEMICALS IN A SAFE AND SECURE LOCATION.**

Cleaners, sanitizers, and other hazardous chemicals should be properly labeled and stored in a manner that protects against contamination of food, food contact surfaces, or food packaging materials.

**USE PRESS RACKS MADE ONLY OF FOOD-GRADE PLASTIC OR HARDWOOD PROPERLY COATED WITH PARAFFIN OR FOOD-APPROVED COATING.**

Poorly maintained equipment is difficult to clean. Press racks must be kept off the floor at all times. As with the press cloths, the racks must be washed, sanitized, and dried in a well-ventilated, screened-off area at the end of each day's operation.

**USE ONLY FILTER CLOTHS SPECIFICALLY DESIGNED FOR CIDER PRESSING, MADE OF DURABLE MATERIAL, AND REPLACED FREQUENTLY.**

Sanitary handling of the cloths includes hanging them over a clean line or placing in a clean container between runs. Press cloths must be washed, rinsed, dipped in a sanitizing solution, and dried by hanging on a clean line in a well-ventilated, screened area free from flies and vermin. This should be done at the end of each day's operation. Use only detergents that have been approved for use with food processing equipment.

**TUBING USED IN THE CIDER OPERATION MUST BE APPROVED FOR FOOD USE, AND ANY PLASTIC TUBING MUST BE TRANSPARENT.**

Tubing should never be placed on the floor. Tubing must be easily replaced and be protected from abrasion and breakage. Any tubing that passes through spaces that are not readily accessible must be of one piece and easily cleaned. As much as possible, keep the tubing continuous with as few couplings as possible. All

tubing, clamps, couplings, and connections periodically must be disassembled, cleaned, and sanitized (tubing must be sanitized after each day's run). Position the tubing so that no pockets of liquid remain after rinsing.

**EQUIPMENT AND SUPPLIES MUST BE STORED OFF THE FLOOR IN A CLEAN, DRY, INSECT- AND VERMIN-FREE AREA.**

Cider containers must be stored in the original closed plastic bags and inverted with the open tops down to avoid environmental contamination. Thoroughly inspect equipment and containers before using and sanitize them thoroughly as necessary.

**AFTER EACH DAY'S OPERATION, THOROUGHLY CLEAN ALL EQUIPMENT WITH CLEAN POTABLE WATER WITH ADEQUATE PRESSURE AND VOLUME TO REMOVE PARTICLES OF FRUIT AND FILM FROM ALL SURFACES.**

Use of a suitable high-pressure washer is recommended for this purpose. Following this wash, dismantle all equipment as far as possible and clean and sanitize. Do not rinse after sanitizing. Air-dry the equipment on racks or in a well ventilated, screened area.

**PROPERLY DISPOSE OF PRESSED POMACE IMMEDIATELY.**

Prompt removal of pomace will help control insects and rodents that may spread human pathogens. Check with local authorities on the proper disposal of these materials. Do not leave pomace residue in processing areas overnight.

**DURING THE OFF-SEASON, PRESS RACKS AND CLOTHS MUST BE STORED SO THAT BIRDS, ANIMALS, INSECTS, AND OTHER PESTS ARE UNABLE TO COME IN CONTACT WITH THEM.**

Before storage, thoroughly clean, sanitize, dry, and wrap all racks and cloths. At no time should equipment, utensils, or chemicals (supplies) not used in cider processing be stored in the cider-processing or storage areas.

#### ***IV. Pest Control***

**ESTABLISH A PEST CONTROL SYSTEM.**

Pests are potential sources of contamination in processing environments because they harbor or could spread a variety of pathogens. Cider processors should, therefore, have a pest control program in place that requires regular inspections and treatment of the processing facility by a trained pesticide applicator. The program should include regular and frequent monitoring of affected and treated areas to accurately assess the program's effectiveness.

Maintain a pest control log that includes dates of inspection, inspection report, and steps taken to eliminate any problems. Establish frequent monitoring of affected and treated areas to determine the effectiveness of the treatment applied.

**USE OF PESTICIDES IS PERMITTED ONLY UNDER PRECAUTIONS AND RESTRICTIONS THAT WILL PREVENT THE CONTAMINATION OF FOOD OR PACKAGING MATERIALS WITH ILLEGAL RESIDUES.**

All applicators must be trained and licensed. If pesticide application takes place within the processing area, precautions must be taken to protect all raw ingredients and packaging materials. All food contact surfaces must be thoroughly cleaned and sani-

tized between pesticide spraying and commencement of food processing operations.

**PESTICIDES SHOULD BE PROPERLY LABELED AND STORED IN A MANNER THAT PROTECTS AGAINST CONTAMINATION OF FOOD, FOOD CONTACT SURFACES, OR FOOD PACKAGING MATERIALS.**

Pesticide regulations are constantly changing, and you must know the current status of regulations pertaining to the pesticides you use in and around your operation. For further information on insecticides and rodenticides, contact the Pennsylvania Department of Agriculture or your county Penn State Cooperative Extension office.

#### ***V. Sanitary Facilities and Worker Hygiene***

**WORKERS SHOULD USE GOOD HYGIENIC PRACTICES.**

To prevent contamination during cider processing, workers should maintain a high degree of cleanliness appropriate for a food processing operation.

Establish a training program to teach workers good hygiene practices. All new workers should understand the importance of proper handwashing practices and general sanitation concerns.

All persons working in the processing area must wear clean outer garments while on duty. Hands must be thoroughly washed with clean, warm water and soap before starting work, after each absence from the working area, between operations, and at any other times the hands have become soiled. Common or shared towels should be not be used.

All jewelry, except wedding bands, should be removed. Hair restraints (hairnets, headbands, caps, etc.) must be worn. If gloves are used, they must be designed for food handling operations. The use of gloves does not exempt workers from using good hygiene practices. Whenever an individual moves from a food-contact or cleaning operation to a nonfood-contact operation, the person must replace gloves or thoroughly wash hands before resuming food-contact operations.

Tobacco use of any kind is prohibited in rooms where food or food ingredients are processed, handled, or stored.

**SUPERVISORS AND WORKERS SHOULD BE AWARE OF THE PRESENCE OF SYMPTOMS OF INFECTIOUS DISEASES OR OF SKIN BOILS, SORES, INFECTED WOUNDS, OR OTHER ABNORMAL SOURCES OF MICROBIAL CONTAMINATION SO THAT IF SYMPTOMS ARE EVIDENT, THE SUPERVISOR CAN TAKE APPROPRIATE STEPS.**

Any worker who has diarrhea or is a carrier of a communicable disease that can be transmitted by food should not be allowed to work in cider processing areas.

**EACH CIDER PROCESSOR SHOULD PROVIDE ITS EMPLOYEES WITH ADEQUATE, READILY ACCESSIBLE TOILET FACILITIES.**

Toilet facilities should be completely enclosed and conveniently located near the work area. Hot and cold running water and soap must be provided in the lavatory for hand washing. Disposable towels and covered trash containers also must be provided. A sign reminding employees to wash their hands before returning to work should be posted in the lavatory.

ALL WASTEWATER MUST BE DRAINED PROPERLY INTO THE SEWER OR A SEPTIC SYSTEM SEPARATE FROM THE TOILET SYSTEM.

Consult your local or state health department about the proper disposal facility to be used.

### **VI. Transportation**

INSPECT TRUCKS AND TRANSPORT CONTAINERS FOR CLEANLINESS, ODORS, AND OBVIOUS DIRT OR DEBRIS BEFORE BEGINNING THE LOADING PROCESS.

Processors should be aware of previous loads carried in a transport vehicle and take this information into consideration when determining the use of a vehicle. Trucks that were recently used to transport animals or animal products, for example, would increase the risk of contaminating containers of cider if the trucks were not cleaned before loading.

MAINTAIN PROPER TEMPERATURES TO HELP ENSURE BOTH THE QUALITY AND SAFETY OF CIDER.

Do not let cider sit in unrefrigerated trucks for excessively long periods of time. Refrigerated trucks should be precooled before containers of cider are loaded. Containers should be loaded on the truck in a manner that permits adequate circulation of refrigerated air.

### **VII. Product Traceback**

DEVELOP A RECALL SYSTEM THAT ALLOWS TRACEBACK OF CIDER FROM CONSUMPTION TO GROWER.

Following Good Management Practices will only minimize the probability of a foodborne disease outbreak. In the event of an outbreak, it is in the cider processor's best interests to have a system in place that will allow traceback of cider from the point of consumption to the processor, packer, and grower. The ability to identify the source of a product can help to prevent the occurrence of food safety problems and also may be useful in identifying and eliminating a hazardous pathway.

A recall system should include methods to identify, locate, and control recalled product. Records should be kept that will identify a product by name, size, and lot number, which then should indicate the amount and location of product produced, in inventory, and distributed. Records should include the control measures that were taken to ensure product safety, including sanitation, standard operating procedures, and monitoring records of refrigerated storage rooms.

The records should be legible, permanent, accurate, and signed and dated by the responsible individual.

### **Laboratory Testing**

Laboratory testing of cider samples will not guarantee a safe product. Cider makers who follow Good Management Practices and apply HACCP principles in their operations (see next section) will have the best chance of producing a safe product. However, if you are going to test for microbes before making and marketing fresh, unpasteurized cider, *Escherichia coli* bacteria is a good indicator for the presence of pathogens. Take two or more of the worst samples from each orchard supplying freshly harvested apples. The samples must include individual apples normally discarded or trimmed free of disease or damage lesions. If these apples harbor *E. coli*, they probably have

contaminated some sound apples that they may have touched after harvest. Whether you market unpasteurized or pasteurized cider, additional *E. coli* tests should be made to ensure that operators use hygienic practices and that the operational controls and daily cleanup practices maintain product safety.

Other microbial testing can be used to monitor populations of aerobic acidic bacteria, yeasts, and molds in the facility's environment (air, equipment, surfaces, etc.) and in the cider. Test results should first be used to develop proper operational and cleanup practices and later to confirm that the cider being made is safe and will have a good shelf life.

To develop proper operational practices, samples to be tested should be taken at startup, right after pressing the juice, just after cooling but before bottling, at two or more intervals of time from a single lot of cider stored at your site, and whenever uncertainty exists. Normal aerobic populations in freshly pressed, unpasteurized cider may have from 10,000 to 100,000 bacterial colonies per gram of cider. Normal yeast and mold populations range from 1,000 to 10,000 per gram. Potato dextrose agar acidified to a pH of 3.5 should be used in testing for aerobic populations of aciduric bacteria. Recently, test kits have become available to test *E. coli* in finished cider. For information, contact your county Penn State Extension office.

### **Food Safety Regulations**

The following sections describe federal and state regulations that are designed to ensure the safety of apples and apple products.

#### **a. Food Safety Modernization Act (FSMA) of 2011**

On November 12, 2015, the U.S. Food and Drug Administration (FDA) published "Standards for the Growing, Harvesting, Packing, and Holding of Produce for Human Consumption" in the Federal Register. The regulation establishes mandatory practices that certain farmers must take to prevent microbial contamination of fresh produce. This regulation applies only to farms with total produce sales over \$25,000 that grow fruits, vegetables, sprouts, and mushrooms that are intended or likely to be eaten raw. The sales cut-off is in 2011 dollars and adjusted annually for inflation. For more details on coverage and certain exemptions, visit the Penn State Extension FSMA website at [extension.psu.edu/fsma](http://extension.psu.edu/fsma).

The following are highlights of the FDA produce safety standards.

#### **Training Requirements**

All personnel (including temporary, part time, seasonal, and contracted personnel) who handle produce or food-contact surfaces, or who supervise others, must receive health and hygiene food safety training at least once annually. At least one person responsible for operations must have successfully completed a farm food safety course approved by FDA. Growers are required to show proof of training by keeping written records.

#### **Worker Health and Hygiene**

Farm and packing house workers who harvest or handle fresh produce must maintain good health and follow proper personnel hygiene practices. Toilet facilities have must be readily accessible, kept reasonably clean, and supplied with toilet paper. Hand-washing stations must be close to toilet facilities and supplied with potable running water, hand soap, and clean single-use towels.

### *Agricultural Water*

Growers must be able to demonstrate that the water they use for irrigation, pesticide preparation, cooling and washing, etc., is safe for its intended use. A maximum allowable three-year rolling geometric mean of 126 cells of *E. coli* per 100 milliliters of water has been established for preharvest crop contact water used for irrigation, cooling, or preparation of chemical sprays. Test results may be adjusted downward to account for microbial die at a rate of 0.5 log values per day between application of water to the crop and harvest. Additionally, at least 90 percent of the samples must be shown, through testing, to be below that value. Testing schedules are based on the source of water; surface water will require more frequent testing than well water. Water used for postharvest operations, such as washing, cooling, cleaning and sanitizing, and hand washing face more stringent standards; no detectable levels of *E. coli* are allowed.

### *Biological Soil Amendments*

FDA requires at least a 3-month interval (120 days) between application of raw animal manure to produce fields and harvesting if there is a possibility that the manure may contact the produce. Processes for composting animal manures must be established through scientific studies as adequate to eliminate human pathogens. No human waste is allowed on fields except in the case of sewage sludge bio-solids that are treated according to already existing regulations.

### *Domesticated and Wild Animals*

Growers are required to take all measures reasonably necessary to prevent contamination of produce from grazing and working animals or wildlife. Working animals, such as mules and horses, are allowed in produce fields as long as growers can demonstrate that they have taken adequate measures to prevent contamination. FDA recognizes that it is impossible to keep all wild animals away from produce fields and farms are not required to exclude animals from outdoor growing areas, destroy animal habitat, or clear borders around growing or drainage areas. However, regular visual examination of the growing area and produce should be conducted to assure that no contamination can occur. If the situation is out of control and there is a reasonable probability that wild animals can contaminate produce, growers are required to monitor their fields for signs of animals and take preventative measures to keep them out or discourage them from entering.

### *Equipment, Tools, and Buildings*

Equipment and tools need to be kept reasonably clean. Sanitation standards for packing buildings require good water drainage, control of dripping condensate, a pest control program, regular cleanup of trash and food waste, and periodic cleaning and sanitizing of food-contact surfaces as appropriate. Partially enclosed packing buildings are acceptable if precautions are taken to prevent birds and other pests from becoming established in the buildings.

Here are some important points that need to be made about the produce safety rule:

- Not all farms that grow fresh produce are required to comply with the rule.
- Farms with gross produce sales under \$25,000 (2011 dollars) are not covered by the regulation.

- Farms with total food sales of between \$25,000 and \$500,000 (2011 dollars) may or may not receive exemptions, depending on what kind of marketing channels are used.
- For instance, if a grower sells more than half of their crop directly to consumers, such as at a farmers market, farm stand, or a CSA, or if the grower delivers it directly to a grocery store or restaurant where it is sold or served to consumers, the grower is eligible for an exemption from some parts of the regulation as long as the buyers are in the same state as the farm, or if out of state, no farther than 275 miles from the farm.
- If a crop is mostly sold through wholesale outlets where it is resold, such as through distributors, warehouses, or fresh-cut processors, the farm is not exempt and must comply with all parts of the regulation.
- Exemptions can be canceled if FDA determines that the farm has become a source of contaminated produce.
- Keep in mind that growers of any size who sell at least some of their crop through wholesale marketing channels, even if technically not covered by the federal regulation, have been facing and will to continue to face commercial standards at least as stringent as anything in the final FDA regulations.
- Those who pack or hold fruit at a location where more than half of the produce has been grown on farm not owned by the packer need to be aware that another FSMA regulation, “Current Good Manufacturing Practices, Hazard Analysis, and Preventive Controls” (21 CFR Part 117), may apply. Packers and growers are advised to keep up to date on FSMA developments by visiting the Penn State Extension Food Safety Modernization Act website at [extension.psu.edu/fsma](http://extension.psu.edu/fsma).

### ***b. Food Labeling: Warning and Notice Statement; Labeling of Juice Products (21 CFR Part 101)***

In 1998, the Food and Drug Administration (FDA) required that all fresh fruit juices that have not received a pasteurization treatment equivalent to a 5-log (1/100,000) reduction in harmful bacteria have a separate label that warns of the potential for product contamination. Since the ruling took effect in September 1999, all juice and cider processors have had to place the following statement on their product:

**WARNING: This product has not been pasteurized and, therefore, may contain harmful bacteria that can cause serious illness in children, the elderly, and persons with weakened immune systems.**

The label must have the word WARNING set in bold capitalized letters and a type size no less than 1/16 inch in height. The warning label must be set off in a “hairline” box from the rest of the label information.

If untreated juice products are sold in package form, they are required to bear the warning statement. However, untreated juice products sold in retail establishments (restaurants, delis, some grocery stores, and roadside stands) that are intended for immediate consumption and are not pre-packaged do not require warning statements. Although the FDA’s jurisdiction is technically limited to interstate commerce, the regulation is being broadly enforced by local authorities to include intrastate distribution as well.

### c. Hazard Analysis and Critical Control Point (HACCP); Procedures for the Safe and Sanitary Processing and Importing of Juice (21 CFR Part 120)

#### The Ruling

On January 19, 2001, the Food and Drug Administration issued a final ruling that requires juice processors, including some cider makers, to develop and implement a Hazard Analysis and Critical Control Point (HACCP) plan that includes control measures equivalent to that which would achieve a 5-log (99.999 percent) reduction in harmful pathogens. As of January 2004, all processors of fruit or vegetable juices (including apple cider), purees, or their concentrated products must comply, regardless of size. The regulation applies to juice products in both interstate and intrastate commerce.

In general, federal regulations require cider processors to develop a HACCP plan and pasteurize or UV-treat their product if they:

- Press and sell cider to other business entities (retail stores or wholesale distributors)
- Press and sell cider to other individuals who then resell it (custom press)

Cider makers are exempt from this federal regulation if they:

- Sell all the cider they press directly to consumers at their own farm stand or food-service operation
- Sell at an off-site farmers market and sell the same product at the same location it was pressed

People who sell unpasteurized cider directly to customers at their own retail operation (e.g., roadside stands or farmers markets) are exempt from the regulation. However, in Pennsylvania, cider makers must register their operation with the Pennsylvania Department of Agriculture and must adhere to Good Manufacturing Practices and label their product with the warning statement described above.

#### HACCP Principles

A Hazard Analysis Critical Control Point (HACCP) plan is a systematic evaluation of the potential hazards that may occur in a food operation and identification of control methods to prevent those hazards from occurring. The concept was introduced in the 1960s by NASA as a means to prevent astronauts from contracting a foodborne illness while in outer space. Today, HACCP is widely recognized as the most effective way to prevent food contamination from occurring in a product. Meat, poultry, and seafood processors, and now juice processors, are required to develop HACCP plans.

In any HACCP plan, the following seven procedures must be applied:

1. A hazard analysis is conducted that describes all potential hazards that may occur and methods for their control. Potential hazards in juice products may include microbiological contamination, unlawful pesticide residues, natural toxins, unapproved use of food or color additives, presence of metal or glass fragments, and undeclared ingredients that may be allergens. The FDA has ruled that control measures for juice processing must include a treatment that ensures a 5-log reduction in harmful bacteria.

2. Critical control points (CCPs) are established for each of the identified food hazards that are reasonably likely to occur before, during, and after harvest and during processing. Typical CCPs in a cider making operation might include receipt of raw materials, pasteurization, and foreign matter detection.
3. Critical limits are then established that must be met at each of the critical control points; i.e., target levels and allowable tolerances that ensure the CCP is under control.
4. Procedures and the frequency with which they are to be performed are developed that will be used to monitor each of the critical control points to ensure compliance within the critical limits.
5. Corrective action plans are set in place that are to be followed when monitoring indicates that a particular CCP is not under control.
6. Procedures for verification that the HACCP system is working effectively are developed; and
7. A record-keeping system that documents the monitoring and verification of the critical control points is established.

Precise times and temperatures depend on the type of juice you make and the process you use. The Food and Drug Administration recommends that processors consult the scientific literature for information on effective pasteurization treatments. FDA specifically recommends that processors refer to the study “Thermal Inactivation of Stationary-Phase and Acid-Adapted *Escherichia coli* O157:H7, *Salmonella*, and *Listeria monocytogenes* in Fruit Juices,” by Alejandro S. Mazzotta (*Journal of Food Protection*, 1998, Vol. 64, No. 3, 2001, pages 315–320). Consult with an extension specialist in food science for assistance in determining an effective process for your product.

On November 29, 2000, FDA announced that it has approved the use of ultraviolet (UV) radiation to pasteurize juice and cider products (21 CFR 179.39). The ruling has specific requirements for the light source and the characteristics of the juice flowing through it.

For any type of pasteurization or equivalent nonthermal treatment used, juice processors must show evidence, as part of their HACCP plan, that it is effective in achieving a 5-log reduction and that they are operating their equipment correctly.

#### HACCP Prerequisites

For a HACCP plan to be effective, a strong foundation of safety-related prerequisite programs must be developed. Such programs are not specific to a single product, as is the case with CCPs. Instead, they serve to control the environment in which processing occurs. Prerequisite programs include implementation of Good Manufacturing Practices (21 CFR Part 110) as Sanitation Standard Operating Procedures (SSOP), recall programs, employee hygiene and training, product labeling and coding, facilities design, equipment maintenance, and equipment calibration. As part of a total food safety plan, they are documented and regularly verified for appropriateness and accuracy. The recommendations provided in this chapter as Good Management Practices for Cider Operations include the key features of the federally enforced GMP document. Nevertheless, cider processors are advised to obtain a copy of this regulation and make sure they comply with each point.



In their HACCP ruling, FDA has sought to emphasize the importance of Good Manufacturing practices by specifically requiring Sanitation Standard Operating Procedures (SSOPs) in several key sanitation areas, namely:

1. Safety of the water that comes into contact with food or food contact surfaces
2. Condition and cleanliness of food contact surfaces, including utensils, gloves, and outer garments
3. Prevention of cross-contamination from unsanitary objects to food, food packaging material, and other food contact surfaces, including utensils, gloves, and outer garments, and from raw product to processed product
4. Maintenance of hand washing, hand sanitizing, and toilet facilities
5. Protection of food, food packaging material, and food contact surfaces from adulteration with lubricants, fuel, pesticides, cleaning compounds, sanitizing agents, condensate, and other chemical, physical, and biological contaminants
6. Proper labeling, storage, and use of toxic compounds
7. Control of employee health conditions that could result in the microbiological contamination of food, food packaging materials, and food contact surfaces
8. Exclusion of pests from the food plant.

Developing a HACCP plan can be a challenging without assistance from experienced individuals. For this reason, the FDA requires that plans be developed by individuals who have successfully completed training in the application of HACCP principles to juice processing. Juice and cider makers, therefore, should contact their extension office to learn where to obtain information on upcoming training opportunities.

## RECOMMENDED RESOURCES

### FDA Juice HACCP Website

<https://fda.gov/Food/GuidanceRegulation/HACCP/ucm2006803.htm>

Information on the juice HACCP and labeling regulations

### Pennsylvania Department of Agriculture (PDA) Bureau of Food Safety and Laboratory Services

[https://www.agriculture.pa.gov/consumer\\_protection/Food-Safety/Eggs-Fruit-Vegetables](https://www.agriculture.pa.gov/consumer_protection/Food-Safety/Eggs-Fruit-Vegetables)

Information on the PDA voluntary GAP/GHP audit program

### Penn State Extension Food Safety Modernization Website

[extension.psu.edu/fsma](https://extension.psu.edu/fsma)

Information on farm food safety standards established under FSMA, the USDA GAP audit program, and upcoming training opportunities

### Penn State Extension Workshops and Short Courses

Penn State Extension offers regular food safety outreach courses on topics that include GMPs and sanitation practices, FMSA certification course for the produce safety rule and the preventive controls rule, food microbiology, food defense, and more. Workshops on controlling *Listeria monocytogenes* in produce packing houses are also periodically offered. Visit [foodscience.psu.edu/workshops](https://foodscience.psu.edu/workshops) for a complete list or contact Dr. Luke LaBorde at 814-863-2298 or [llf5@psu.edu](mailto:llf5@psu.edu) for more information.



**CONTENTS**

<b>Tree Fruit Production Budgets .....</b>	<b>364</b>
Protecting Your Investment with Crop Insurance .....	364
<b>State and Federal Laws</b>	
<b>That Apply to Farm Labor .....</b>	<b>373</b>
Is a Worker an Employee or an Independent Contractor? ...	373
Pennsylvania's New Hire Reporting Program .....	374
Immigration Reform and Control Act of 1986 .....	376
Child Labor Laws .....	377
Wage and Hour Laws: Minimum Wage and Hours Worked "Agriculture" defined .....	378
Federal and State Minimum Wage Provisions .....	379
Withholding Income, Social Security, and Medicare Taxes...	380
Unemployment Compensation: Federal .....	381
Unemployment Compensation: State .....	381
Workers' Compensation Insurance .....	381
Occupational Safety and Health Act.....	382
Pennsylvania Worker and Community Right-to-Know Act.....	383
Superfund Amendments and Reauthorization Act (SARA) .....	384
Americans with Disabilities Act .....	384
Pennsylvania Seasonal Farm Labor Act.....	385
Federal Migrant and Seasonal Agricultural Workers Protection Act (MSPA).....	386
Migrant Labor Housing—Federal Regulations .....	388
Migrant Labor Housing—Pennsylvania Regulations .....	388
Family and Medical Leave Act of 1993 (FMLA .....	389
Affordable Care Act.....	390

**TABLES**

<b>Table 9-1.</b> Land preparation budget, tree fruit, Pennsylvania, 2020. Summary of estimated costs per acre. ..	365
<b>Table 9-2.</b> Apple orchard planting budgets, medium- and high-density orchards, Pennsylvania, 2020. Summary of estimated costs per acre.....	366
<b>Table 9-3.</b> Peach orchard planting budget, 155 trees per acre, Pennsylvania, 2020. Summary of estimated costs per acre.....	367

<b>Table 9-4.</b> Fresh-market apple production budgets, 907 trees per acre, with and without mating disruption, Pennsylvania, 2020. Summary of estimated costs per acre. ....	368
<b>Table 9-5.</b> Processing apple production budget, 272 trees per acre, Pennsylvania, 2020. Summary of estimated costs per acre. ....	369
<b>Table 9-6.</b> Mature fresh-market peach orchard budget, 155 trees per acre, Pennsylvania, 2020. Summary of estimated costs per acre.....	370
<b>Table 9-7.</b> Mature tart cherry orchard budget, 121 trees per acre, Pennsylvania, 2020. Summary of estimated costs per acre. ....	371
<b>Table 9-8.</b> Mature dwarf sweet cherry orchard budget, 580 trees per acre, Pennsylvania, 2020. Summary of estimated costs per acre.....	372

## TREE FRUIT PRODUCTION BUDGETS

This section presents sample tree fruit budgets based on projected costs, technology, and management for the 2020 crop year.\* Enterprise budgets represent estimates of the costs and returns associated with the production of specified agricultural products. Budgets are used to:

- Estimate profitability
- Project cash flows
- Provide a basis for obtaining financing
- Assist in business planning

To be most effective, a budget should be prepared with a specific objective in mind. The budgets in this section were prepared to provide general information for a broad range of users and do not apply to individual orchards. They should be used, with appropriate modifications, as guides for preparing budgets for your individual situation.

Eight types of tree fruit production budgets are included in this section. The first is a budget for land preparation (Table 9-1) and can be used for any fruit crop. The second is for apple planting (Table 9-2) for both medium (staked trees) and high-density (trellised trees) orchards. The third budget (Table 9-3) is for peach planting but could be used for any stone fruit. The remainder are mature orchard production budgets for fresh-market apples (Table 9-4, with and without mating disruption), processing apples (Table 9-5), fresh-market peaches (Table 9-6), tart cherries (Table 9-7), and dwarf sweet cherries (Table 9-8). Nonbearing and intermediate production years are examples of other budgets that you could develop.

The budgets were developed based on a tree spacing of 6 feet by 8 feet (907 trees per acre; four-wire trellis with drip irrigation) for fresh-market apples, 10 feet by 16 feet (272 trees per acre; staked trees) for processing apples, 14 feet by 20 feet (155 trees per acre) for peaches, 18 feet by 20 feet (121 trees per acre) for tart cherries, and 5 feet by 15 feet (580 trees per acre) for dwarf sweet cherries. In calculating returns above specified costs, harvest costs of \$1.60 per bushel for fresh-market apples, \$1.20 per bushel for processing apples, \$2.65 per bushel for peaches, \$0.15 per pound for tart cherries, and \$0.50 per pound for sweet cherries were used. The pesticides used in the budget estimates reflect recommended integrated pest management practices; see Part III, Chemical Management, for a complete listing of recommended materials.

These sample budgets should help you ensure that all costs and receipts are included in your budget. Costs are often difficult to estimate in budget preparation because they are numerous and variable. Therefore, you should think of these budgets as a first approximation and then make appropriate adjustments using the “your estimate” column to add, delete, and adjust items to reflect your specific resource situation.

The sample budgets were developed using a computerized budget generator. Input data reflect current production practices and prices. Major subheadings in the budgets are receipts, variable costs, fixed costs, and total specified costs. They are defined as follows:

- Receipts are the gross returns (price times quantity) from production. For tree fruit, receipts may be zero for the first

few years. Because yields, grades, and prices are so variable, you should use representative values for your operation.

- Variable costs are costs that vary depending on the level of production for such inputs as fertilizer, herbicides, insecticides, fungicides, and labor. Other terms used to describe variable costs include cash costs (or expenses), direct costs, and out-of-pocket costs.
- Fixed costs are costs that do not vary by level of production and are incurred by virtue of owning assets such as machinery and land. Depreciation, insurance, and taxes are examples of fixed costs. Sometimes a management fee is included as a fixed cost. These costs are considered “fixed” because they generally remain the same within a production period and do not vary with the level of output. Indirect, noncash, and overhead costs are other terms used to describe fixed costs.
- Total specified costs are the sum of variable and fixed costs. A land charge of \$200 per acre has been included in the budgets, but this will vary greatly from location to location. If you own the land you could include your principal, interest payments, and property taxes as a fixed cost. If you lease the land, then the annual rental cost could be included as a variable cost.

When you subtract receipts from total specified costs you get an estimate of your return to risk and management. This is the estimated profit attributable to your acceptance of risk and your contribution of management expertise. Cash flows over the entire life of the investment should be accounted for when assessing the overall profitability of the enterprise.

Changing crop prices and input costs (in particular, fuel, pesticides, and fertilizer) make it particularly important for you to keep up with market trends and monitor your cost of production. These budgets are a good starting point for developing your own estimates, but changing economic conditions and governmental policies can alter the marketplace and affect your profitability very quickly. For a more detailed discussion of the use of budgets to improve crop decision making, see the farm management publication “Agricultural Alternatives: Budgeting for Agricultural Decision Making,” available from your local Penn State Extension office or online at [extension.psu.edu/budgeting-for-agricultural-decision-making](http://extension.psu.edu/budgeting-for-agricultural-decision-making).

### Protecting Your Investment with Crop Insurance

Tree fruit production involves large initial investments and can be very risky; weather-related crop losses are common and crop prices can be highly variable. Use of individual crop insurance policies for apples, peaches, and pears, and/or a whole-farm revenue protection policy can help you reduce these risks. Coverage for individual crops is based on your Actual Production History (APH); you can select between 50 and 75 percent of your APH yield to protect. You have the option to protect your apple crop as fresh market (as long as you meet certain marketing requirements) or processing. If you can insure your apples as fresh market, you also have the option to use three additional varietal options (varietal groups, A, B, and C). For peaches you can insure your crop as either fresh market or processing. Whole Farm Revenue Protection (WFRP) provides a risk management safety net for all commodities on your farm under one insurance policy. You can buy WFRP alone or with other buy up level (ad-

**Table 9-1. Land preparation budget, tree fruit, Pennsylvania, 2020. Summary of estimated costs per acre.**

Item	Unit	Price (\$)	Quantity	Amount (\$)	Your estimate*
<b>VARIABLE COSTS</b>					
Lime and spreading	ton	28.00	2.00	56.00	_____
<b>Fertilizers/soil amendments</b>					
N	pound	0.45	40.00	18.00	_____
K	pound	0.37	75.00	27.75	_____
Labor, seasonal	hour	15.00	15.00	225.00	_____
Labor, operator	hour	17.00	2.61	44.36	_____
Hard fescue seed	pound	3.00	30.00	90.00	_____
Diesel fuel	gallon	2.80	8.90	24.91	_____
Other _____	_____	_____	_____	_____	_____
_____	_____	_____	_____	_____	_____
_____	_____	_____	_____	_____	_____
_____	_____	_____	_____	_____	_____
_____	_____	_____	_____	_____	_____
<b>Repairs and maintenance</b>					
Tractors	acre		1.00	7.62	_____
Equipment	acre		1.00	10.20	_____
Interest on operating capital	acre		1.00	11.73	_____
Total variable costs				515.57	_____
<b>FIXED COSTS</b>					
Tractors	acre		1.00	15.98	_____
Equipment	acre		1.00	19.39	_____
Land charge	acre		1.00	200.00	_____
Total fixed costs				235.37	_____
Total specified costs				750.94	_____

<b>Other potential costs:</b>	<b>Per acre</b>
Tree removal	\$750–2,000
Root and stump removal	\$500–1,000
Bulldozing, grading	\$500–1,000
Fumigation	\$1,000–2,000
Rapeseed cover crop	\$100–150

\*These budgets are examples only; use the "your estimate" column to adjust figures for your operation. Budget estimates are based on data available in August 2019.

**Table 9-2. Apple orchard planting budgets, medium- and high-density orchards, Pennsylvania, 2020. Summary of estimated costs per acre.**

Item		Price (\$)	Medium density (272 TPA)		High density (908 TPA)		Your estimate <sup>1</sup>
			Quantity	Amount (\$)	Quantity	Amount (\$)	
<b>VARIABLE COSTS</b>							
Apple trees	each	7.95/8.50	272.00	2,162.40	908.00	7,718.00	_____
<b>Fertilizer</b>							
N	pound	0.45	17.00	7.65	57.00	25.65	_____
<b>Pesticides</b>							
Herbicides <sup>2</sup>	acre		1.00	137.83	1.00	137.83	_____
Fungicides <sup>2</sup>	acre		1.00	86.45	1.00	86.45	_____
Insecticides <sup>2</sup>	acre		1.00	10.74	1.00	10.74	_____
<b>Labor</b>							
Seasonal	hour	15.00	21.50	322.50	73.38	1,100.63	_____
Operator	hour	17.00	3.57	60.76	12.57	213.76	_____
<b>Other</b>							
Deer repellent	each	0.80	136.00	108.80	908.00	726.40	_____
Tree guards	each	0.70	272.00	190.40	908.00	635.60	_____
Rodenticide	pound	1.35	10.00	13.50	10.00	13.50	_____
Drip tape	foot	0.02	—	—	10,890.00	217.80	_____
Diesel fuel	gallon	2.80	16.17	45.26	60.04	168.11	_____
<b>Trellis/support system</b>							
Gripple tool	each	24.00	—	—	1.00	24.00	_____
Posts	each	24.69	—	—	160.00	3,950.40	_____
Wire	1,000 feet	15.60	—	—	20.00	312.00	_____
Gripples	each	1.15	—	—	96.00	110.40	_____
Staples	each	0.04	—	—	640.00	25.60	_____
Tree stakes	each	2.21	272.00	601.12	—	—	_____
Tree ties	each	0.08	544.00	43.52	—	—	_____
Tree clips	each	0.13	—	—	3,632.00	472.16	_____
Splicing tool	each	16.00	—	—	1.00	16.00	_____
<b>Repairs and maintenance</b>							
Tractors	acre		1.00	10.98	1.00	41.14	_____
Equipment	acre		1.00	27.79	1.00	98.72	_____
Interest on operating capital	acre		1.00	163.71	1.00	663.53	_____
Total variable costs				3,993.42		16,768.42	_____
<b>FIXED COSTS</b>							
Tractors	acre		1.00	25.53	1.00	86.00	_____
Equipment <sup>3</sup>	acre		1.00	62.43	1.00	208.14	_____
Land charge	acre		1.00	200.00	1.00	200.00	_____
Total fixed costs				287.96		494.14	_____
Total specified costs				4,281.38		17,262.56	_____

1. These budgets are examples only; use the “your estimate” column to adjust figures for your operation. Budget estimates are based on data available in August 2019.

2. Cost estimates based on a typical mix of pesticides used in conjunction with integrated pest management practices.

3. Includes irrigation system.

**Table 9-3. Peach orchard planting budget, 155 trees per acre, Pennsylvania, 2020. Summary of estimated costs per acre.**

Item	Unit	Price (\$)	Quantity	Amount (\$)	Your estimate <sup>1</sup>
<b>VARIABLE COSTS</b>					
Peach trees	each	7.75	155.00	1,201.25	_____
<b>Fertilizer</b>					
N	pound	0.45	14.00	6.30	_____
<b>Pesticides</b>					
Herbicides <sup>2</sup>	acre		1.00	109.44	_____
Fungicides <sup>2</sup>	acre		1.00	22.72	_____
Insecticides <sup>2</sup>	acre		1.00	10.74	_____
<b>Labor</b>					
Seasonal	hour	15.00	11.88	178.13	_____
Operator	hour	17.00	3.57	60.76	_____
<b>Other</b>					
Drip tape	feet	0.02	10,890	217.80	_____
Deer repellent	each	0.80	155.00	124.00	_____
Latex paint	gallon	15.00	0.50	7.50	_____
Rodenticide	pound	1.35	10.00	13.50	_____
Diesel fuel	gallon	2.80	20.29	56.81	_____
<b>Repairs and maintenance</b>					
Tractors	acre		1.00	13.38	_____
Equipment <sup>3</sup>	acre		1.00	31.39	_____
Interest on operating capital	acre		1.00	80.06	_____
Total variable costs				2,133.79	_____
<b>FIXED COSTS</b>					
Tractors	acre		1.00	30.11	_____
Equipment <sup>3</sup>	acre		1.00	71.03	_____
Land charge	acre		1.00	200.00	_____
Total fixed costs				301.14	_____
Total specified costs				2,434.93	_____

1. These budgets are examples only; use the "your estimate" column to adjust figures for your operation. Budget estimates are based on data available in August 2019.
2. Cost estimates based on a typical mix of pesticides used in conjunction with integrated pest management practices.
3. Includes irrigation system.

**Table 9-4. Fresh-market apple production budgets, 907 trees per acre, with and without mating disruption, Pennsylvania, 2020. Summary of estimated costs per acre.**

Item	Unit	Price (\$)	Without mating disruption		With mating disruption		Your estimate <sup>1</sup>
			Quantity	Amount (\$)	Quantity	Amount (\$)	
<b>RECEIPTS</b>							
	bushel						
<b>VARIABLE COSTS</b>							
Lime	ton	28.00	0.50	14.00	0.50	14.00	
<b>Fertilizer</b>							
N	pound	0.45	40.00	18.00	40.00	18.00	
K	pound	0.37	100.00	37.00	100.00	37.00	
Urea (spray additive)	pound	0.21	21.00	4.41	21.00	4.41	
Calcium chloride	pound	0.48	47.50	22.80	47.50	22.80	
Solubor	pound	1.92	6.00	11.52	6.00	11.52	
<b>Pesticides</b>							
Herbicides <sup>2</sup>	acre		1.00	138.96	1.00	138.96	
Fungicides <sup>2</sup>	acre		1.00	575.80	1.00	575.80	
Insecticides <sup>2,3</sup>	acre		1.00	365.03	1.00	321.64	
Mating disruption	acre		—	—	1.00	324.00	
Plant growth regulators <sup>4</sup>	acre		1.00	57.61	1.00	57.61	
<b>Labor</b>							
Trellis maintenance	acre		1.00	90.00	1.00	90.00	
Pest scouting	acre		1.00	40.00	1.00	40.00	
Thinning and misc. <sup>5</sup>	hour	15.00	21.38	320.63	22.38	335.63	
Operator	hour	17.00	5.47	93.02	5.47	93.02	
Pruning	tree	0.55	908.00	499.40	908.00	499.40	
Harvesting	bushel	1.50	1,000.00	1,500.00	1,000.00	1,500.00	
<b>Other</b>							
Bee rental	acre	125.00	1.00	125.00	1.00	125.00	
Insect traps	acre	40.00	1.00	40.00	1.00	40.00	
Rodenticide	pound	1.35	10.00	13.50	10.00	13.50	
Spray additive	gallon	17.00	0.13	2.21	0.13	2.21	
Crop insurance (APH) <sup>6</sup>	acre	293.00	1.00	293.00	1.00	293.00	
Crop insurance (SCO) <sup>6</sup>	acre	36.00	1.00	36.00	1.00	36.00	
Diesel fuel	gallon	2.80	35.36	98.98	35.36	98.98	
<b>Repairs and maintenance</b>							
Tractors	acre		1.00	18.16	1.00	18.16	
Equipment	acre		1.00	59.62	1.00	59.62	
Interest on operating capital	acre		1.00	116.00	1.00	123.66	
Total variable costs				4,590.75		4,893.92	
<b>FIXED COSTS</b>							
Tractors	acre		1.00	37.57	1.00	37.57	
Equipment <sup>7</sup>	acre		1.00	121.20	1.00	121.20	
Land charge	acre		1.00	200.00	1.00	200.00	
Total fixed costs				358.77		358.77	
Total specified costs				4,949.52		5,252.69	

1. These budgets are examples only; use the “your estimate” column to adjust figures for your operation. Budget estimates are based on data available in August 2019.
2. Cost estimates based on a typical mix of pesticides used in conjunction with integrated pest management practices.
3. Additional insecticide sprays may be required for control of brown marmorated stink bug. Insecticides such as Actara, Assail, Belay, and Danitol provide control for a cost of approximately \$12 to \$32 per acre for each additional spray (plus application cost if not tank-mixed with a fungicide). Other insecticides may be available for use on brown marmorated stink bug under Section 18 emergency exemptions.
4. See Tables 1-15 and 1-18 for alternative plant growth regulators used in apples. Depending on the thinning, growth control, and harvest management program used, plant growth regulator costs could vary from \$0 to over \$500 per acre.
5. Assuming chemical thinning in addition to hand-thinning.
6. Hypothetical cost of crop insurance coverage in Adams County (APH, actual production history and SCO, supplemental coverage option) at the 50 percent coverage level for 100 percent of the standard \$12.15 per bushel fresh-market price election and an APH yield of 1,000 bushels per acre. Contact your crop insurance agent for a quote based on your county, government program participation, yields, and pricing preferences. Assumes no participation in Agricultural Risk Coverage (ARC) from the USDA Farm Service Agency.
7. Includes irrigation system.



**Table 9-5. Processing apple production budget, 272 trees per acre, Pennsylvania, 2020 Summary of estimated costs per acre.**

Item	Unit	Price (\$)	Quantity	Amount (\$)	Your estimate <sup>1</sup>
RECEIPTS	cwt				
<b>VARIABLE COSTS</b>					
Lime	ton	28.00	0.50	14.00	
<b>Fertilizer</b>					
N	pound	0.45	40.00	18.00	
K	pound	0.37	80.00	29.60	
Urea (spray additive)	pound	0.21	21.00	4.41	
Solubor	pound	1.92	6.00	11.52	
Calcium chloride	pound	0.48	50.00	24.00	
<b>Pesticides</b>					
Herbicides <sup>2</sup>	acre		1.00	138.96	
Fungicides <sup>2</sup>	acre		1.00	566.23	
Insecticides <sup>2,3</sup>	acre		1.00	350.07	
Plant growth regulators <sup>4</sup>	acre		1.00	27.75	
<b>Labor</b>					
Pest scouting	acre	40.00	1.00	40.00	
Operator	hour	17.00	5.75	97.75	
Pruning	tree	2.30	272.00	625.60	
Misc. seasonal	hour	15.00	1.00	15.00	
Harvesting	bushel	1.25	750.00	937.50	
<b>Other</b>					
Bee rental	acre	125.00	1.00	125.00	
Insect traps	acre	40.00	1.00	40.00	
Rodenticide	pound	1.35	10.00	13.50	
Spray additive	gallon	17.00	0.13	2.21	
Crop insurance (APH) <sup>5</sup>	acre	52.00	1.00	52.00	
Crop insurance (SCO) <sup>5</sup>	acre	7.00	1.00	7.00	
Diesel fuel	gallon	2.80	30.55	85.50	
<b>Repairs and maintenance</b>					
Tractors	acre		1.00	15.78	
Equipment	acre		1.00	54.51	
Interest on operating capital	acre		1.00	100.72	
Total variable costs				3,396.64	
<b>FIXED COSTS</b>					
Tractors	acre		1.00	33.04	
Equipment	acre		1.00	108.81	
Land charge	acre		1.00	200.00	
Total fixed costs				341.85	
Total specified costs				3,738.49	

1. These budgets are examples only; use the "your estimate" column to adjust figures for your operation. Budget estimates are based on data available in August 2019.
2. Cost estimates based on a typical mix of pesticides used in conjunction with integrated pest management practices.
3. Additional insecticide sprays may be required for control of brown marmorated stink bug. Insecticides such as Actara, Assail, Belay, and Danitol provide control for a cost of approximately \$12 to \$41 per acre for each additional spray (plus application cost if not tank-mixed with a fungicide). Other insecticides may be available for use on brown marmorated stink bug under Section 18 emergency exemptions.
4. See Tables 1-15 and 1-18 for alternative growth regulators used in apples. It is assumed in this budget that all fruit thinning will be done with plant growth regulators. Depending on the thinning, growth control, and harvest management program used, plant growth regulator costs could vary from \$0 to over \$500 per acre.
5. Hypothetical cost of crop insurance coverage in Adams County (APH, actual production history and SCO, supplemental coverage option) at the 50 percent coverage level for 100 percent of the standard \$4.35 per bushel processing price election and an APH yield of 750 bushels per acre. Contact your crop insurance agent for a quote based on your county, government program participation, yields, and pricing preferences. Assumes no participation in Agricultural Risk Coverage (ARC) from the USDA Farm Service Agency.

**Table 9-6. Mature fresh-market peach orchard budget, 155 trees per acre, Pennsylvania, 2020. Summary of estimated costs per acre.**

Item	Unit	Price (\$)	Quantity	Amount (\$)	Your estimate <sup>1</sup>
RECEIPTS	bushel				
<b>VARIABLE COSTS</b>					
Lime	ton	28.00	0.50	14.00	
<b>Fertilizer</b>					
N	pound	0.45	50.00	22.50	
K	pound	0.37	60.00	22.20	
<b>Pesticides</b>					
Herbicides <sup>2</sup>	acre		1.00	103.96	
Fungicides <sup>2</sup>	acre		1.00	305.88	
Insecticides <sup>2,3</sup>	acre		1.00	160.45	
Mating disruption	acre		1.00	87.00	
<b>Labor</b>					
Pruning	tree	4.65	155.00	720.75	
Pest scouting	acre	40.00	1.00	40.00	
Hand thinning <sup>4</sup>	tree	3.10	155.00	480.50	
Misc. seasonal	hour	15.00	1.88	28.13	
Operator	hour	17.00	6.30	107.06	
Harvesting	bushel	2.65	300.00	795.00	
<b>Other</b>					
Insect traps	acre		1.00	40.00	
Rodenticide	pound	1.35	10.00	13.50	
Crop insurance (APH) <sup>5</sup>	acre		1.00	105.00	
Crop insurance (SCO) <sup>5</sup>	acre		1.00	50.00	
Diesel fuel	gallon	2.80	33.27	93.11	
<b>Repairs and maintenance</b>					
Tractors	acre		1.00	18.20	
Equipment	acre		1.00	63.10	
Interest on operating capital	acre		1.00	97.08	
Total variable costs				3,367.43	
<b>FIXED COSTS</b>					
Tractors	acre		1.00	37.68	
Equipment <sup>6</sup>	acre		1.00	124.35	
Land charge	acre		1.00	200.00	
Total fixed costs				362.03	
Total specified costs				3,729.46	

1. These budgets are examples only; use the “your estimate” column to adjust figures for your operation. Budget estimates are based on data available in August 2019.
2. Cost estimates based on a typical mix of pesticides used in conjunction with integrated pest management practices.
3. Additional insecticide sprays may be required for control of brown marmorated stink bug. Insecticides such as Actara, Assail, Belay, and Danitol provide control for a cost of approximately \$12 to \$32 per acre for each additional spray (plus application cost if not tank-mixed with a fungicide). Other insecticides may be available for use on brown marmorated stink bug under Section 18 emergency exemptions.
4. Fruit thinning is assumed to be done with a combination of string thinning and hand thinning.
5. Hypothetical cost of crop insurance coverage in Adams County (APH, actual production history and SCO, supplemental coverage option) at the 50 percent coverage level for 100 percent of the standard \$24 per bushel fresh-market price election and an APH yield of 300 bushels per acre. Contact your crop insurance agent for a quote based on your county, government program participation, yields, and pricing preferences. Assumes no participation in Agricultural Risk Coverage (ARC) from the USDA Farm Service Agency.
6. Includes irrigation system.

**Table 9-7. Mature tart cherry orchard budget, 121 trees per acre, Pennsylvania, 2020. Summary of estimated costs per acre.**

Item	Unit	Price (\$)	Quantity	Amount (\$)	Your estimate <sup>1</sup>
RECEIPTS	pound				
<b>VARIABLE COSTS</b>					
Lime	ton	28.00	0.50	14.00	
<b>Fertilizer</b>					
N	pound	0.45	60.00	27.00	
K	pound	0.37	30.00	11.10	
Solubor	pound	1.92	3.00	5.76	
<b>Pesticides</b>					
Herbicides <sup>2</sup>	acre		1.00	125.92	
Fungicides <sup>2</sup>	acre		1.00	177.54	
Insecticides <sup>2</sup>	acre		1.00	99.12	
<b>Labor</b>					
Pest scouting	acre	40.00	1.00	40.00	
Misc. seasonal	hour	15.00	0.80	12.00	
Operator	hour	17.00	5.21	88.46	
<b>Other</b>					
Ethephon 2E	gallon	14.47	0.13	1.81	
Shaking	pound	0.10	8,000.00	800.00	
Rodenticide	pound	1.35	10.00	13.50	
Diesel fuel	gallon	2.80	23.68	66.28	
<b>Repairs and maintenance</b>					
Tractors	acre		1.00	12.58	
Equipment	acre		1.00	39.10	
Interest on operating capital	acre		1.00	42.44	
Total variable costs				1,576.72	
<b>FIXED COSTS</b>					
Tractors	acre		1.00	26.36	
Implements	acre		1.00	79.66	
Land charge	acre		1.00	200.00	
Total fixed costs				306.02	
Total specified costs				1,882.74	

1. These budgets are examples only; use the "your estimate" column to adjust figures for your operation. Budget estimates are based on data available in August 2019.
2. Cost estimates based on a typical mix of pesticides used in conjunction with integrated pest management practices.

**Table 9-8. Mature dwarf sweet cherry orchard budget, 580 trees per acre, Pennsylvania, 2020. Summary of estimated costs per acre.**

Item	Unit	Price (\$)	Quantity	Amount (\$)	Your estimate <sup>1</sup>
RECEIPTS	pound				
<b>VARIABLE COSTS</b>					
Lime	ton	28.00	0.50	14.00	
<b>Fertilizer</b>					
N	pound	0.45	60.00	27.00	
K	pound	0.37	30.00	11.10	
<b>Pesticides</b>					
Herbicides <sup>2</sup>	acre		1.00	125.92	
Fungicides <sup>2</sup>	acre		1.00	258.52	
Insecticides <sup>2</sup>	acre		1.00	107.51	
<b>Labor</b>					
Operator	hour	17.00	4.98	84.60	
Misc. seasonal	hour	15.00	0.80	12.00	
Pest scouting	acre	40.00	1.00	40.00	
Pruning	tree	1.05	580.00	609.00	
Hand harvest	pound	0.50	6,000.00	3,000.00	
<b>Other</b>					
Diesel fuel	gallon	2.80	21.98	61.51	
Bird repellent	acre	50.00	1.00	50.00	
Rodenticide	pound	1.35	10.00	13.50	
<b>Repairs and maintenance</b>					
Tractors	acre		1.00	11.84	
Equipment	acre		1.00	36.10	
Interest on operating capital	acre		1.00	139.54	
Total variable costs				4,602.20	
<b>FIXED COSTS</b>					
Tractors	acre		1.00	29.39	
Equipment <sup>3</sup>	acre		1.00	81.66	
Land charge	acre		1.00	200.00	
Total fixed costs				311.05	
Total specified costs				4,913.25	

1. These budgets are examples only; use the “your estimate” column to adjust figures for your operation. Budget estimates are based on data available in August 2019.

2. Cost estimates based on a typical mix of pesticides used in conjunction with integrated pest management practices.

3. Includes irrigation system.

ditional) federal crop insurance policies. Coverage levels range from 50 to 85 percent of your expected revenue or whole-farm historic average revenue (based on your 1040-F information), whichever is lower.

The Supplemental Coverage Option (SCO) is a new crop insurance option that provides additional coverage for a portion of your underlying crop insurance policy deductible. The amount of SCO coverage you can purchase is based on the level of protection in your APH policy. SCO coverage begins to pay when county average yield for the crop falls below 86 percent of its expected yield. The full amount of the SCO coverage is paid out when the county average yield falls to the coverage level of your underlying APH policy. If you elected to participate in the Agriculture Risk Coverage (ARC) program through the USDA Farm Service Agency, you are not eligible for SCO coverage.

Crop insurance costs are included in the apple and peach budgets. These costs are for purchase of APH and SCO protection at the 50 percent coverage level and are based on the production assumptions in each budget (see footnotes on each budget for more details). These estimates are for illustration only; check with a crop insurance agent for product availability in your county and to explore other options and coverage levels that may better suit your risk management needs. You may also want to consider the use of a separate hail insurance policy to better protect against this type of often very localized damage.

\*Thanks to Greg Krawczyk, Kari Peter, Jim Schupp, and Rob Crassweller for their assistance in updating and improving these budgets.

## STATE AND FEDERAL LAWS THAT APPLY TO FARM LABOR

This section is intended to provide accurate and timely information on some, but not all, of the issues regarding farm labor. As time passes, some of this information may no longer be accurate, and the reader is cautioned to be aware of that. Portions of this section have been drawn directly from statutes and regulations to provide a comprehensive and clear overview of the laws applying to farm labor. The beginning and ending of each excerpted portion will be noted within the content of this section.

The material is not intended to provide legal, accounting, or other professional advice and should not be relied upon as such or as a substitute for such advice. Growers who desire such advice should seek independent professional counsel before acting on any information contained in this section.

### Is a Worker an Employee or an Independent Contractor?

An important determination employers must make is whether or not a worker is an employee or an independent contractor. This distinction is significant, because "...an employer must withhold income taxes and pay Social Security, Medicare taxes and unemployment tax on wages paid to an employee" (IRS fact sheet "Understanding Employee vs. Contractor Designation," July 10, 2017). Such withholdings and payments are not required for independent contractors.

A worker who performs services for an employer is generally considered to be an employee if the employer has the right

to control the work that will be done and how it will be done. This is true even if the employee is given freedom of action. The significant factor is that the employer has the right to control details of how the services are performed.

The following introduction and subsequent "right to control" test is drawn directly from IRS Publication 15-A, *Employer's Supplemental Tax Guide* (Supplement to Pub. 15, *Employer's Tax Guide*), for use in 2019:

To determine whether an individual is an employee or an independent contractor under the common-law, the relationship of the worker and the business must be examined. In any employee-independent contractor determination, all information that provides evidence of the degree of control and the degree of independence must be considered. Facts that provide evidence of the degree of control and independence fall into three categories: behavioral control, financial control, and the type of relationship of the parties. These facts are discussed next.

#### Behavioral control

Facts that show whether the business has a right to direct and control how the worker does the task for which the worker is hired include the type and degree of the following:

- *Instructions the business gives to the worker.* An employee is generally subject to the business's instructions about when, where, and how to work. All of the following are examples of types of instructions about how to do work:
  - When and where to do the work?
  - What tools or equipment to use?
  - What workers to hire or to assist with the work?
  - Where to purchase supplies and services?
  - What work must be performed by a specified individual?
  - What order or sequence to follow?

The amount of instruction needed varies among different jobs. Even if no instructions are given, sufficient behavioral control may exist if the employer has the right to control how the work results are achieved. A business may lack the knowledge to instruct some highly specialized professionals; in other cases, the task may require little or no instruction. The key consideration is whether the business has retained the right to control the details of a worker's performance or instead has given up that right.

- *Training the business gives to the worker.* An employee may be trained to perform services in a particular manner. Independent contractors ordinarily use their own methods.

#### Financial control

Facts that show whether the business has a right to control the business aspects of the worker's job include:

- *The extent to which the worker has unreimbursed business expenses.* Independent contractors are more likely to have unreimbursed expenses than are employees. Fixed ongoing costs that are incurred regardless of whether work is currently being performed are especially important. However, employees may also incur unreimbursed expenses in connection with the services that they perform for their employer.

- *The extent of the worker’s investment.* An independent contractor often has a significant investment in the facilities or tools he or she uses in performing services for someone else. However, a significant investment is not necessary for independent contractor status.
- *The extent to which the worker makes his or her services available to the relevant market.* An independent contractor is generally free to seek out business opportunities. Independent contractors often advertise, maintain a visible business location, and are available to work in the relevant market.
- *How the business pays the worker.* An employee is generally guaranteed a regular wage amount for an hourly, weekly, or other period of time. This usually indicates that a worker is an employee, even when the wage or salary is supplemented by a commission. An independent contractor is often paid a flat fee or based on time and materials for the job. However, it is common in some professions, such as law, to pay independent contractors hourly.
- *The extent to which the worker can realize a profit or loss.* An independent contractor can make a profit or loss.

### Type of relationship

Facts that show the parties’ type of relationship include:

- *Written contracts describing the relationship the parties intended to create.*
- *Whether or not the business provides the worker with employee-type benefits, such as insurance, a pension plan, vacation pay, or sick pay.*
- *The permanency of the relationship.* If you engage a worker with the expectation that the relationship will continue indefinitely, rather than for a specific project or period, this is generally considered evidence that your intent was to create an employer-employee relationship.
- *The extent to which services performed by the worker are a key aspect of the regular business of the company.* If a worker provides services that are a key aspect of your regular business activity, it is more likely that you will have the right to direct and control his or her activities. For example, if a law firm hires an attorney, it is likely that it will present the attorney’s work as its own and would have the right to control or direct that work. This would indicate an employer-employee relationship.

End of information drawn directly from IRS Publication 15-A, Employer’s Supplemental Tax Guide (Supplement to Pub. 15, Employer’s Tax Guide) for use in 2019. Note: This publication also contains real world examples which may help employers understand how to apply the right to control test.

### IRS help

An employer can receive IRS assistance in determining whether a worker is an employee. The employer may file Form SS-8, Determination of Worker Status for Purposes of Federal Employment Taxes and Income Tax Withholding, with the IRS. Once the IRS receives Form SS-8, it may take up to six months for a decision. This may seem like it is a lengthy amount of time to wait, but if there are multiple workers in an identical work position, it would be beneficial for an employer to be certain of those workers’ tax status.

The following information is drawn directly from IRS Publication 15 (Circular E), *Employer’s Tax Guide*, for use in 2019:

If an employer-employee relationship exists, it doesn’t matter what it is called. The employee may be called an agent or independent contractor. It also doesn’t matter how payments are measured or paid, what they’re called, or if the employee works full or part time.

*Statutory employees.* If someone who works for you isn’t an employee under the common law rules discussed earlier, don’t withhold federal income tax from his or her pay, unless backup withholding applies. Although the following persons may not be common law employees, they’re considered employees by statute for social security and Medicare tax purposes under certain conditions:

- An agent or commission driver who delivers meat, vegetable, fruit, or bakery products; beverages (other than milk); laundry; or dry cleaning for someone else.
- A full-time life insurance salesperson who sells primarily for one company.
- A homemaker who works at home or off premises according to guidelines of the person for whom the work is done, with materials or goods furnished by and returned to that person or to someone that person designates.
- A traveling or city salesperson (other than an agent or commission driver) who works full time (except for sideline sales activities) for one firm or person getting orders from customers. The orders must be for merchandise for resale or supplies for use in the customer’s business. The customers must be retailers, wholesalers, contractors, or operators of hotels, restaurants, or other businesses dealing with food or lodging.
- For FUTA tax, an agent or commission driver and a traveling or city salesperson are considered statutory employees; however, a full-time life insurance salesperson and a homemaker aren’t considered statutory employees.
- [End of information drawn directly from IRS Publication 15 (Circular E), *Employer’s Tax Guide*, for use in 2019.]

NOTE: The IRS does not consider H-2A agricultural workers to be statutory employees. As a result, such employers should not check box 13 (Statutory employee) on Form W-2 of H-2A workers.

### For more information

For more information regarding worker classification, see IRS’s website at <https://www.irs.gov/newsroom/understanding-employee-vs-contractor-designation>.

### Pennsylvania’s New Hire Reporting Program

All Pennsylvania employers, including agricultural employers, are required to comply with the state’s New Hire Reporting program. The purpose of the New Hire Reporting program is to assist enforcement activities aimed at collecting child support payments by providing a registry of all employed persons within the state. The statute creating this program and its requirements can be found in Pennsylvania Consolidated Statutes Title 23, *Domestic Relations*, § 4391-96.

**Who is an “employer” that must comply?**

All employers, regardless of size or type of business, must comply with the New Hire Reporting Program. Agricultural employers are included, even if they are exempt from other labor requirements.

**Who is an “employee” for purposes of the program?**

Under the New Hire Reporting program, an “employee” is any person working for an employer, regardless of the person’s age, hours worked, or wages earned. Officers of a corporation are included. An independent contractor is not considered to be an “employee” under the program. For new hire reporting purposes, a person is an employee and not an independent contractor if the employer:

- Must require a W-4 form under applicable law
- Must provide a W-2 form under applicable law
- Must pay Pennsylvania Unemployment Compensation Tax under applicable law
- Must pay Pennsylvania Workers’ Compensation under applicable law

**Required information**

To comply with the program, an employer is required to report within 20 days of hire the following information regarding each employee hired on or after January 1, 1998:

- Full legal name
- Home address
- Social Security number
- Date of hire
- Date of birth (optional)
- State of hire (required for all multi-state employer submissions)

Information must be filed not only for new employees, but also for rehired employees who were terminated, laid off, furloughed, separated, or granted leave without pay for more than 30 days. For these rehired employees, the date of hire is the date of the latest rehire.

The report must also include the following information about the employer:

- Name
- Address
- Federal Employer Identification Number (FEIN, the identifying number assigned to the employer for federal tax purposes)
- Name of employer contact person
- Telephone number of employer contact person

If you submitting as a multi-state employer, you must also include that on your electronic submission.

**Methods of reporting**

“The information may be submitted on a form provided by the Department of Labor and Industry or by attaching the date of hire and name and telephone number of an employer contact to the W-4 form submitted for the newly hired employee. The information may be transmitted by first class mail, magnetically, electronically or by another method authorized

by the directory of new hires” (23 Pa. Cons. Stat. § 4392[b]). All employers (including third-party payroll companies) are encouraged to report electronically to the Pennsylvania New Hire Reporting Program via the Pennsylvania CareerLink website at [www.cwds.pa.gov](http://www.cwds.pa.gov). Paper records may also be sent via fax. Detailed instructions on all methods are available from the New Hire Reporting Program, and employers should consult these instructions before making a report using their chosen method.

Regardless of the reporting method chosen by the employer, an employee’s information must be submitted within 20 days of the date of hire, as stated above. If an employer chooses any non-paper method, that employer should submit two monthly reports that are between 12 and 16 days apart.

**Multistate employers**

If an employer has employees in more than one state, the employer has two options available on how to submit a new hire report. First, an employer can decide to send a report to the state in which each new employee is working. This option can result in more work because the employer is submitting reports to more than one state. This means having knowledge of more than one new hire reporting policies and separate state record keeping and submission. The second option allows an employer to submit all new hire reports to one state. This option minimizes workload because knowledge of only one state reporting system is necessary and a single report filing system. For example, if an employer has some employees that work in Pennsylvania and some that work in Maryland, the new hire report can be sent to the new hire program in Maryland or in Pennsylvania, but will not be sent to both. The employer must report the information of all employees and multistate reports can only be made through electronic filing.

A multistate employer who chooses to file a new hire report in one state must notify the U.S. Department of Health and Human Services in writing as to which state the new hire information is being sent. A copy of the notification letter must be sent to the Pennsylvania New Hire Reporting Program, regardless of which state will receive the reports. An employer may notify the Department of Health and Human Services in one of two ways: (1) filling out the Office of Child Support Enforcement Multi-State Employer Notification Form, or (2) writing a notification letter which must include all of the following:

- Employer’s name
- Employer’s FEIN
- Employer’s Address
- Employer’s phone number
- State selected for receipt of reports
- All states where the employer has employees
- Employer contact name
- Employer contact phone number

Regardless of which option an employer chooses, the employer must submit the form or notification letter by fax or email to:

Department of Health and Human Services  
Administration for Children and Families  
Office of Child Support Enforcement  
Multistate Employer Notification  
PO Box 509  
Randallstown, MD 21133  
Fax: 410-277-9325

The notification requirement is to maintain the National Directory of New Hires in accordance with the Federal Welfare Reform Act of 1997.

### Authorized uses of the information

The primary use of the new hire information will be to facilitate the enforcement of child support obligations under the Federal Welfare Reform Act of 1997. The information will also be used to administer the workers' compensation and unemployment compensation programs of the Pennsylvania Department of Labor and Industry. Any further use of the information by government employees or agencies is prohibited.

### Penalties

If an employer fails to report or falsely reports the required information, the employer will be subject to the following penalties:

- For the first violation, a written warning.
- For the second and each subsequent violation, a civil penalty up to \$25.
- "If the failure to report or the submission of a false report is the result of a conspiracy between the employer and employee, the employer shall be subject to a civil penalty up to \$500" (23 Pa. Cons. Stat. § 4396).

### Reporting resources

Any questions employers may have can be answered by contacting the Pennsylvania New Hire Reporting Program by phone at 1-888-PAHIRES (1-888-724-4737).

## Immigration Reform and Control Act of 1986

### Who must comply?

Employers who have one or more employees are subject to this act. Immigration Reform and Control Act (IRCA) prohibits employers from hiring unauthorized aliens for employment in the United States (8 U.S.C. § 1324[a]). An employer who hires, recruits, or refers for a fee someone known to be an unauthorized alien violates the act. An employer can also violate the act by failing to comply with the employment-verification provisions required by the act.

IRCA holds employers responsible for verifying an employee's identity and eligibility to work in the United States. Agricultural associations and farm labor contractors are also required to verify identities for any individuals they hire, recruit, or refer (8 U.S.C. § 1324[a]). An employer's failure to verify identity and eligibility is a violation of the act, even if the employee hired is not an illegal alien. If an employer can establish he or she complied in good faith with the requirement to verify an employee's identity and eligibility to work in the United States, the employer has an affirmative defense to claims the employer knowingly hired an unauthorized alien.

### What are employers required to do?

An employer subject to the act must follow these steps for compliance with IRCA:

1. Have the employee complete part 1 of the Employment Eligibility Verification form, known as Form I-9. "Employees may voluntarily provide their Social Security numbers on Form I-9 unless you participate in the E-Verify program. Employees must provide E-Verify employers with their Social Security numbers. . . . You may not ask an employee to provide you a specific document with their Social Security number on it. To do so may constitute unlawful discrimination" (U.S. Citizenship and Immigration Services, *Handbook for Employers* M-274, Section 3.0). Keep in mind the employer is responsible for checking the employee properly completes this section of the Form I-9.
2. Check documents submitted by the employee which establish the employee's identity and eligibility to work in the United States for authenticity. An employee demonstrates their citizenship status by way of these documents. All documents presented must be originals. The individual checking the documents must decide if they are genuine and represent the individual presenting them. An employer is not required to make photocopies of the documents but is permitted to do so because copies can be used to prove compliance with IRCA. Accepted documents are listed on the last page of Form I-9 and are broken into three categories: (1) documents establishing both identity and employment authorization (e.g., U.S. passport), (2) documents establishing identity (e.g., driver's license), (3) documents that establish employment authorization (e.g., social security account number card). Note: An employer cannot prefer and request one form of documentation over another.
3. The employee who examined the documents in step 2 must then complete and sign the employer portion of Form I-9.
4. Retain the completed form for at least three years after the employee has been hired or one year after the employment relationship has been terminated, whichever is longer.
5. Form I-9s are not filed with an agency but must be presented to an inspecting officer of the Department of Labor, the Immigration and Naturalization Service, or the Civil Rights Divisions Immigration and Employee Rights Section. These agencies will give employers three days' notice or more before inspection to compile all forms.

Remember, if an employer has chosen to participate in e-verify, they will need an employee's social security number. Participation in e-verify is voluntary and free. E-verify allows employers to electronically confirm an employee's eligibility to work in the United States. For more information about e-verify and to sign up, please go to [e-verify.gov](http://e-verify.gov).

Employers must complete Form I-9 within three business days of the date of hire. Date of hire should be considered as the date an employee actually begins working. If an employee is hired for less than three days, the Form I-9 must be completed at the time of hire.

If an employer rehires an employee for whom a Form I-9 was completed within three years of the date of rehire, the employer



can reverify the information on the first Form I-9 to determine if the employee is still eligible to work in the United States. After the information is verified, the employer must update the Form I-9 to reflect the date of rehire. If the employer's inspection of the Form I-9 determines that the individual's employment authorization has expired, the employer must reverify the employee's eligibility to work in the United States. If the employee cannot establish eligibility, the employee cannot be hired.

### Antidiscrimination

IRCA contains specific antidiscrimination provisions aimed at businesses who have four or more employees. These provisions prohibit employers from discriminating against any employee when hiring, firing, recruiting, or referring for a fee because of the employee's national origin, citizenship, or intended citizenship status. In this context, discrimination means an employer treats some potential employees differently than others for reasons prohibited by law. While the act prohibits discrimination, such as an employer refusing to consider a job applicant because the applicant is a foreign citizen, it requires employers to refuse employment to an applicant who is not authorized to work in the United States. Discrimination also includes unfair documentary requests such as: asking for "more or different documents than are required by Form I-9 to establish the individual's identity and employment authorization; requesting . . . a particular document; rejecting documents that reasonably appear to be genuine and relate to the individuals presenting them; and treating groups of individuals differently when verifying employment eligibility" (U.S. Citizenship and Immigration Services, *Handbook for Employers* M-274, Section 11.2.1). These IRCA provisions are in addition to all other federal laws addressing discrimination based on sex, race, religion, and age.

### For more information

For more information regarding I-9 employment verification, see the U.S. Citizen and Immigration Services website at [www.uscis.gov/i-9](http://www.uscis.gov/i-9). A great source of information for employers can be found at [www.uscis.gov/i-9-central/handbook-employers-m-274](http://www.uscis.gov/i-9-central/handbook-employers-m-274).

### Child Labor Laws

#### Who is an "agricultural employer"?

For purposes of this section, "an agricultural employer means any person who owns or operates a farm, ranch, processing establishment, cannery, gin, packing shed, or nursery, or who produces or conditions seed and who either recruits, solicits, hires, employs, furnishes, or transports any migrant or seasonal agricultural worker" (29 U.S.C. § 1802).

### Fair Labor Standards Act (FLSA)

The FLSA sets wage, hour, and employment standards that apply to most workers in the United States, including young workers. Standards for young workers vary depending on the workers' age group and whether the workers are employed on a farm. In addition, the Pennsylvania Child Labor Law and Seasonal Farm Labor Act have various provisions that affect employment of children in agricultural roles. When these standards are more stringent than FLSA, the more stringent standard will apply.

### Restrictions for farm work

Children employed by their parents or who are at least 16 years of age, under FLSA, may work any time and perform any farm job, even those deemed as hazardous agricultural occupations. If the minor is 14 or 15 years old, they may work outside of school hours in any farm job except those designated as hazardous agricultural occupations. These hazardous occupations can be found in the Code of Federal Regulations Title 29, § 570.71. The following list is directly drawn from that source:

1. Operating a tractor of over 20 PTO horsepower, or connecting or disconnecting an implement or any of its parts to or from such a tractor.
2. Operating or assisting to operate . . . any of the following machines: (i) Corn picker, cotton picker, grain combine, hay mower, forage harvester, hay baler, potato digger, or mobile pea viner; (ii) Feed grinder, crop dryer, forage blower, auger conveyor, or the unloading mechanism of a nongravity-type self-unloading wagon or trailer; or (iii) Power post-hole digger, power post driver, or nonwalking type rotary tiller.
3. Operating or assisting to operate . . . any of the following machines: (i) Trencher or earthmoving equipment; (ii) Fork lift; (iii) Potato combine; or (iv) Power-driven circular, band, or chain saw. Operating or having any contact with trenching equipment, a fork lift, or power-driven saws.
4. Working on a farm in a yard, pen, or stall occupied by a: (i) Bull, boar, or stud horse maintained for breeding purposes; or (ii) Sow with suckling pigs, or cow with newborn calf (with umbilical cord present).
5. Felling, bucking, skidding, loading, or unloading timber with butt diameter of more than 6 inches.
6. Working from a ladder or scaffold (painting, repairing, or building structures, pruning trees, picking fruit, etc.) at a height of over 20 feet.
7. Driving a bus, truck, or automobile when transporting passengers, or riding on a tractor as a passenger or helper.
8. Working inside: (i) A fruit, forage, or grain storage designed to retain an oxygen deficient or toxic atmosphere; (ii) An upright silo within 2 weeks after silage has been added or when a top unloading device is in operating position; (iii) A manure pit; or (iv) A horizontal silo while operating a tractor for packing purposes.
9. Handling or applying . . . agricultural chemicals classified . . . as Category I of toxicity, identified by the word "poison" and the "skull and crossbones" on the label; or Category II of toxicity, identified by the word "warning" on the label; Having any contact with agricultural chemicals of Class I toxicity . . . or Class II toxicity.
10. Handling or using a blasting agent . . . or
11. Transporting, transferring, or applying anhydrous ammonia.

For the unabridged list of hazardous agricultural occupations, see 29 C.F.R. § 570.71.

Minors who are 14 or 15 years old with specialized training may be able to obtain approval to engage in some of the preceding farm occupations. For more details, a vocational agriculture instructor or 4-H leader can be contacted for assistance.

If the employee is 12 or 13 years old, he or she may work outside school hours in nonhazardous farm jobs with his or her parents' written consent or may work on a farm where the parents are employed.

If the employee is younger than 12 years old, he or she may work with parents' written consent and outside school hours in nonhazardous tasks on farms whose employees do not have to be paid minimum wage.

On farms subject to minimum wage, local minors 10 and 11 years old may work for no more than eight weeks between June 1 and October 15, with approval from the Secretary of Labor. This work must be confined to hand harvesting short-season crops outside school hours, under very limited and specified circumstances as prescribed by the Secretary of Labor.

### Minimum wage for youth

If the employee works in a job covered by FLSA, whether agricultural or nonagricultural, he or she must be paid the same minimum wage and overtime pay as adult workers, unless a specific exemption applies.

### For more information

For more information regarding federal child labor laws, see the U.S. Department of Labor website at [www.dol.gov/whd/childlabor.htm](http://www.dol.gov/whd/childlabor.htm).

**Pennsylvania Child Labor Act and Seasonal Farm Labor Act**  
Pennsylvania's Child Labor Act and Seasonal Farm Labor Act contains provisions applicable to employment of youth. A "minor" under Pennsylvania's Child Labor Act is defined as "an individual under 18 years of age" (43 Pa. Cons. Stat. § 40.2). The following list describes some of these additional restrictions and limitations:

No child under **18 years of age** shall be employed to work in any establishment or in any occupation for more than six consecutive days in any one week, or more than 44 hours in any one week, or more than eight hours in any one day.

No child under **18 years of age** shall be "employed for more than five hours continuously [in any establishment] without an interval of at least 30 minutes for a rest break. No period of less than 30 minutes shall be deemed to interrupt a continuous period of work" (43 Pa. Cons. Stat. § 40.3[a]).

No child under **18 years of age**, who is enrolled in regular day school and working outside school hours, shall be employed to work for more than 28 hours during a school week (43 Pa. Cons. Stat. § 40.3[f][1][i]).

No child under **18 years of age** shall be employed or permitted to work in any establishment between the hours of 12:00 a.m. and 6:00 a.m. if such minor is enrolled in regular day school. Children who are 16 and 17 years of age may be employed until, but not after, 1:00 a.m. on Fridays and Saturdays, and on days preceding a school vacation occurring during the school year, excepting the last day of such vacation period (43 Pa. Cons. Stat. § 40.3[f][1][iii]).

No child under **16 years of age** shall be employed to work in any occupation before 7:00 a.m. or after 7:00 p.m. of any day except during school vacation period from June to Labor Day, when such minor may work between the hours of 7:00 a.m.

and 10:00 p.m. No child who is enrolled in school and working outside school hours can be employed or permitted to work in any occupation more than three hours on a school day, or more than eight hours on any other day, or more than 18 hours during a school week (43 Pa. Cons. Stat. § 40.3[d][1]-[4]).

A child under **16 years of age** employed on a farm by a person other than the farmer in the hatching, raising, or harvesting of poultry may be employed or permitted to work until 10:00 p.m. as long as the minor is not working in an agricultural occupation declared hazardous by the United States Secretary of Labor (43 Pa. Cons. Stat. § 40.3[e][1]).

Students **14 years of age** [and over] "whose employment is part of a recognized school-work program supervised by a recognized school authority may be employed for hours which, combined with the hours spent in school, do not exceed eight a day" (43 Pa. Cons. Stat. § 3[e][3]).

No child from **14 to 17 years of age** inclusive who is employed or permitted to work as a seasonal farm worker can be employed "between the hours of seven o'clock in the morning and one hour following the end of the school day or any regular school day of the school district wherein he is then a resident, whether or not such minor is registered as a pupil in such school district" (43 Pa. Cons. Stat. § 1301.203[b]).

"No minor under **14 years of age** shall be required to work, or penalized for failure to work, as a seasonal farm worker, except that this subsection shall not apply to any member of an employer's immediate family" (43 Pa. Cons. Stat. § 1301.203[a]).

At any age, a child may work in any farm job on a farm that his or her parents own or operate.

### Work permits

In Pennsylvania, it is unlawful for anyone under 18 to be employed without a work permit. Each school district is responsible for issuing work permits to all minors who reside in the district, including minors who attend nonpublic schools, cyber charter schools, or are in a home-school program. Additionally, a minor who is a high school graduate must obtain a work permit from the school district where the employer is located or at the college or trade school they are attending.

Every Pennsylvania employer is required to obtain work permits from each minor employee and to keep copies of all work permits on file. An important exception is that minors do not need to have a work permit to work on a farm unless they are considered a seasonal farm worker. See the Pennsylvania Seasonal Farm Labor Act section for the definition of seasonal farm worker.

### For more information

For more information regarding the Pennsylvania Child Labor Act, see the Pennsylvania Department of Education website at <https://www.education.pa.gov/Pages/Codes%20and%20Regulations/Child-Labor-Law.aspx>.

### Wage and Hour Laws: Minimum Wage and Hours Worked

#### "Agriculture" defined

An employee is employed in agriculture if the employee's duties falls within either the primary or secondary meaning of agricul-

ture. Under the primary meaning, “Agriculture includes farming in all its branches and among other things includes the cultivation and tillage of the soil, dairying, the production, cultivation, growing, and harvesting of any agricultural or horticultural commodities . . . the raising of livestock, bees, fur-bearing animals, or poultry” (29 U.S.C. § 203[f]).

The secondary meaning of agriculture is broader than the primary meaning. It includes “any practices (including any forestry or lumbering operations) performed by a farmer or on a farm as an incident to or in conjunction with such farming operations, including preparation for market, delivery to storage or to market or to carriers for transportation to market” (29 U.S.C. § 203[f]). Persons who are not employed in farming, by a farmer, or on a farm are not considered to be employed in farming. Questions to consider when determining what qualifies under the secondary meaning of agriculture include the following:

- Is the activity an established part of agriculture?
- Is the activity subordinate to the farming operation involved?
- Is the activity an independent business?
- Is the activity ordinarily performed by farmers incidentally to their farming operations?
- Do most farmers that produce the commodity engage in the activity (e.g., among all dairy farmers, how many also engage in the activity of processing milk into yogurt)?

For a comprehensive understanding of both primary and secondary agriculture, review 29 C.F.R. § 780.100-780.159. These sections offer broken down definitions of primary and secondary agriculture. Examples include what is considered “raising livestock,” “meaning of a ‘farm,’” and what is “preparation for market.”

### Who must comply?

Agriculture is exempt from federal and Pennsylvania overtime requirements. Labor on a farm is exempt from Pennsylvania’s minimum-wage laws. Seasonal farm workers, however, are to be paid at least the statutory minimum wage or a piece rate equivalent to it.

Under the FLSA, agricultural employers that do not utilize more than 500 “man days” of agricultural labor in any calendar quarter of the preceding calendar year are exempt from federal minimum wage provisions. A “man day” is any day that an employee performs agricultural work for at least one hour. For example, an employer who employs seven people to work at least one hour per day for five days in a given week has generated 35 man days for that week. If these seven workers work five days a week for the full 13-week calendar quarter, then the employer has generated 455 man days during the calendar quarter. Employers who hire many workers to work only short periods should note there are many ways to generate more than 500 man days in a calendar quarter. For example, 50 workers employed to work at least one hour a day for 12 days will generate 600 man days in the calendar quarter when the work is performed. Additionally, federal minimum wage laws do not apply to the following agricultural workers:

- Immediate family members of the agricultural employer

- Workers who are principally engaged in the production of livestock
- Local hand harvest laborers who commute daily from their permanent residence, are paid on a piece rate basis, and were engaged in agriculture fewer than 13 weeks during the preceding calendar year
- Non-local minors who are 16 years of age or younger, are hand harvesters, paid on a piece rate basis, employed on the same farm as their parents, and are paid the same piece rate as those over 16 years of age

For the unedited list of exempt agricultural workers see 29 U.S.C. § 213(6)(A)-(E).

If a farm retail outlet only sells ‘produce grown on the farm, the retail outlet falls within the definition of agriculture and the above minimum-wage test and the overtime exemption would apply.

### Donning, Doffing, and Sanitization

The Pennsylvania Superior Court has interpreted regulations defining “hours worked” to include time that employees are required to spend donning, doffing, and sanitizing their protective gear under the Pennsylvania Minimum Wage Act of 1968 (*Lugo v. Farmers Pride, Inc.*, 967 A.2d 963 [Pa. Super. Ct. 2009]).

The definition provides the following: “Hours worked—The term includes time during which an employee is required by the employer to be on the premises of the employer, to be on duty or to be at the prescribed work place, time spent in traveling as part of the duties of the employee during normal working hours and time during which an employee is employed or permitted to work; provided, however, that time allowed for meals shall be excluded unless the employee is required or permitted to work during that time, and provided further, that time spent on the premises of the employer for the convenience of the employee shall be excluded” (43 Pa. Code § 231.1[b]).

### Federal and State Minimum Wage Provisions

#### Federal Minimum Wage Rates in General

The federal minimum wage for covered nonexempt employees is \$7.25 per hour, effective July 24, 2009. Where an employee is subject to both the state and federal minimum wage laws, the employee is entitled to the higher minimum wage rate.

#### Limited Federal Wage Rates for Employees under Age 20

A federal minimum wage of not less than \$4.25 may be paid to employees under the age of 20 for their first 90 consecutive calendar days of employment with any employer as long as their work does not displace other workers. After 90 consecutive days of employment, or when the worker reaches age 20 (whichever comes first), the worker must receive at least the federal minimum wage.

#### Pennsylvania Minimum Wage Rates in General

The Pennsylvania minimum wage is \$7.25 per hour, equal to the federal minimum wage, effective July 24, 2009.

**For more information**

For more information regarding federal minimum wage requirements, see the United States Department of Labor Wage and Hour Division website at <https://www.dol.gov/whd/minimumwage.htm>. For more information regarding Pennsylvania minimum wage requirements, see the Pennsylvania Department of Labor and Industry website at [www.dli.pa.gov/Individuals/Labor-Management-Relations/llc/minimum-wage/Pages/default.aspx](http://www.dli.pa.gov/Individuals/Labor-Management-Relations/llc/minimum-wage/Pages/default.aspx).

**Pennsylvania Wage Payment and Collection Law**

Caution: Employers should note that several provisions of the Wage Payment and Collection Law are superseded by other laws, particularly the Pennsylvania Seasonal Farm Labor Act. Before making important decisions or taking other action, employers should carefully review both acts.

**Who is covered?**

Every person, firm, partnership, association, corporation, or receiver and any agent of any of the previously mentioned classes who employs any person in the Commonwealth.

**What is meant by “wages”?**

“Wages” includes all earnings of an employee, regardless of whether determined on time, task, piece, commission, or other method of calculation. The term ‘wages’ also includes fringe benefits or wage supplements, whether payable by the employer from his or her funds or from amounts withheld from the employee’s pay by the employer” (43 Pa. Cons. Stat. § 260.2a).

**What does the act require?**

- Every employer is required to pay all wages on regular paydays designated in advance by the employer. If this period is not designated in a written contract of employment, the pay period should reflect the standard period that is customary in the trade or be every 15 days. Every employer is required to “notify his employees at the time of hiring of the time and place of payment and the rate of pay and the amount of any fringe benefits or wage supplements to be paid to the employee, a third party or a fund for the benefit of the employee” (43 Pa. Cons. Stat. § 260.4). The employer must notify employees before any changes in payments are put into effect. This requirement can be met by posting the required information in a conspicuous place at the employer’s place of business.
- Wages are to be paid in cash or check.
- When an employee separates, quits, or resigns, wages or compensation earned are due and payable at the next regular payday. If requested by the employee, this payment must be made by certified mail.

All employers must make their payroll records and other employment records available for inspection by the Pennsylvania Department of Labor and Industry.

**Who enforces the act?**

The Secretary of Labor and Industry has the duty to enforce this act and investigate complaints of violations. The secretary’s right is not exclusive, and employees, labor organizations, or parties to

whom the wages are payable may initiate legal actions to enforce the terms of this law.

**Penalties or sanctions an employer faces for violating the act**

An employer who violates this law may be liable for a penalty of 10 percent of the unpaid wages or compensation found to be due to an employee. A court may also award the cost of reasonable attorney’s fee to the parties who brought the action.

**For more information**

For more information regarding Pennsylvania’s Wage Payment and Collection Law, see the Pennsylvania Department of Labor and Industry Payment of Wages to Employees website at [www.dli.pa.gov/Individuals/Labor-Management-Relations/llc/Pages/Wage-Payment.aspx](http://www.dli.pa.gov/Individuals/Labor-Management-Relations/llc/Pages/Wage-Payment.aspx).

**Withholding Income, Social Security, and Medicare Taxes****Who must comply?**

Farmers whose total payment for agricultural labor provided by all employees is more than \$2,500, or who pay an individual employee more than \$150 in cash wages during the year, must withhold income, social security, and Medicare taxes. Only cash wages paid to farm workers are subject to social security and Medicare taxes. Cash wages include checks, money orders, and any kind of money or cash. Only cash wages subject to social security and Medicare taxes are credited to employees for social security benefit purposes. Non-cash wages include food, lodging, clothing, transportation passes, and other goods and services. Non-cash wages paid to farm workers, including commodity wages, are not subject to social security and Medicare taxes. However, they are subject to these taxes if the substance of the transaction is a cash payment.

Wages paid to a child aged 18 to 21 years by a parent-employer and wages paid to a spouse by his or her spouse-employer, are considered wages for Social Security purposes.

Wages paid to employees are exempt from income and social security withholding if the employee meets all of the following requirements:

- Earns less than \$150 from an agricultural employer
- Is employed as a hand-harvest laborer
- Is paid on a piece-rate basis
- Commutes daily from his or her permanent residence
- Is employed in agriculture less than 13 weeks during the preceding calendar year

Wages paid to employees meeting these requirements are still counted toward the \$2,500 amount by which coverage is determined for other employees who do not qualify for this exemption.

Employers should give each new employee a Form W-4 as soon as they hire the employee. For Spanish-speaking employees, employers may use the Spanish translated Form W-4, Formulario W-4(SP). The employee should complete and return the form to the employer before the first payday. If the employee does not return the completed form, the employer must withhold federal income tax as if the employee is single and claims no withholding allowances.

**For more information**

For more information regarding Withholding Income, Social Security, and Medicare Taxes, see IRS Publication 51 (Circular A), *Agricultural Employer's Tax Guide*, for use in 2019 at <https://www.irs.gov/forms-pubs/about-publication-51>.

**Cost to the employer**

Employers who are required to withhold income taxes from their employees should refer to the tax withholding tables found in Circular E, the Employer's Tax Guide, published by the Internal Revenue Service (IRS). These tables will enable the employer to calculate the correct tax amount to be withheld.

For 2019, the total Social Security tax rate is 12.4 percent (6.2 percent withheld from both the employee and the employer). The maximum amount of wages to which the Social Security withholding and employer tax rates applied is \$132,900 in 2019. This amount, known as the wage base, is subject to change as average wage levels change. In addition, in 2019, a Medicare tax of 1.45 percent of an employee's gross wages is imposed on both an employee and employer (for a total tax of 2.9 percent). This tax is applied to the full amount of an employee's wages.

**For more information**

See IRS Publication 15 (Circular E), *Employer's Tax Guide*, for use in 2019 at [www.irs.gov/uac/about-publication-15](http://www.irs.gov/uac/about-publication-15).

**Unemployment Compensation: Federal  
Who must comply?**

Agricultural employers are subject to the Federal Unemployment Tax Act (FUTA), if they meet either of two tests:

1. Total cash wages paid were \$20,000 or more in any calendar quarter during the current or preceding year.
2. Ten or more farm workers were employed at least part of one day during 20 different calendar weeks of the current or preceding year.

For example, if an employer had 10 people employed for one hour on any single day, that week would be counted as one of the 20 weeks. Family members and children under the age of 21 are not included in the wage determination or in counting the number of farm workers. Wages paid to alien workers are not subject to FUTA tax but are included in the wage test.

**Cost to Employer**

According to IRS Publication 15 (Circular E), *Employer's Tax Guide*, for use in 2019: "Only the employer pays FUTA tax; it isn't withheld from the employee's wages . . . for 2019, the FUTA tax rate is 6.0%. The tax applies to the first \$7,000 you pay to each employee as wages during the year. The \$7,000 is the federal wage base. Your state wage base may be different."

**Tax deposits and forms**

According to IRS *Publication 15 (Circular E)*, *Employer's Tax Guide*, for use in 2019:

"For deposit purposes, figure FUTA tax quarterly. Determine your FUTA tax liability by multiplying the amount of taxable wages paid during the quarter by 0.6 percent. Stop depositing FUTA tax on an employee's wages when he or

she reaches \$7,000 in taxable wages for the calendar year.

If your FUTA tax liability for any calendar quarter is \$500 or less, you do not have to deposit the tax. Instead, you may carry it forward and add it to the liability figured in the next quarter to see if you must make a deposit. If your FUTA tax liability for any calendar quarter is over \$500 (including any FUTA tax carried forward from an earlier quarter), you must deposit the tax by EFT (electronic funds transfer). See section 11 for more information on EFT."

An annual return, Form 940 or Form 940-EC Employer's Annual Federal Unemployment Tax Return, must be filed by January 31 following the close of a calendar year. Any tax due is payable with the form. If no tax is due, forms must be filed by February 11. Form 940 must be filed on a calendar-year basis even if your farm operates on a fiscal-year basis.

**For more information**

For more information regarding FUTA, see IRS Publication 15 (Circular E), *Employer's Tax Guide*, for use in 2019 at [www.irs.gov/uac/about-publication-15](http://www.irs.gov/uac/about-publication-15).

**Unemployment Compensation: State  
Who must comply?**

Employer eligibility rules for Pennsylvania Unemployment Compensation are the same as for FUTA, except for two differences. FUTA exempts the wages of children under the age of 21 while Pennsylvania rules lower the exemption age to children under the age of 18. This can create a situation where an employer is subject to Pennsylvania Unemployment Compensation but exempt from FUTA. The wage base for Pennsylvania Unemployment Compensation is \$10,000 for 2018 and thereafter, which is higher than FUTA's \$7,000 wage base.

**Tax deposits and forms**

Form UC-2 and 2a is filed quarterly on or before the last day of the month following the close of the calendar quarter. If an employer's unemployment contributions during a payment period exceed \$5,000, effective since January 1, 2017, that employer is required to make the payment electronically. If an employer meets this requirement once, all other quarterly payments must be made electronically, even if the amounts in the subsequent periods do not exceed \$5,000.

**For more information**

For more information regarding unemployment compensation, see the Pennsylvania Department of Labor and Industry's Unemployment Compensation webpage at [www.uc.pa.gov/Pages/default.aspx](http://www.uc.pa.gov/Pages/default.aspx).

**Workers' Compensation Insurance  
Who must comply?**

Any agricultural employer is required to provide workmen's compensation coverage for all employees, if during the calendar year such employer either pays wages to one employee for agricultural

labor totaling \$1,200 or more, or furnishes employment to one employee of agricultural labor on 30 or more days.

The term “employee” includes “all natural persons who perform services for another for [pay or] a valuable consideration. [The term does not include] persons whose employment is casual in character and not in the regular course of the business of the employer, and exclusive of persons to whom articles or materials are given out to be made up, cleaned, washed, altered, ornamented, finished or repaired, or adapted for sale in the worker’s own home, or on other premises, not under the control or management of the employer” (77 Pa. Cons. Stat. § 104). Casual employment is described as employment for a temporary or limited purpose that is performed on an occasional basis with long intervals between periods of such employment.

An employed spouse or child who is under 18 years of age is not considered to be an employee unless the services provided are within an express written contract of employment filed with the Pennsylvania Department of Labor and Industry.

### Cost to the employer

The cost of coverage varies, depending on the general type of farm activity and the cost that the insurance industry has experienced in settling claims in that type of farm activity.

Farmers who hire very limited quantities of labor should be aware that their insurance company will make a minimum charge for coverage.

### Compensation coverage

This coverage is available from private insurance agencies or from the State Workmen’s Insurance Fund.

### For more information

See the Pennsylvania Department of Labor and Industry Worker’s Compensation website at [www.dli.pa.gov/Businesses/Compensation/WC/Pages/default.aspx](http://www.dli.pa.gov/Businesses/Compensation/WC/Pages/default.aspx) or contact:

Bureau of Workers’ Compensation  
Department of Labor and Industry  
1171 S. Cameron Street, Room 324  
Harrisburg, PA 17104  
Phone: 717-783-5421 or 717-772-3702

## Occupational Safety and Health Act

### Who must comply?

All employers have a general duty to provide a place of employment that is free from recognized hazards that are causing or are likely to cause death or serious physical harm to employees.

### Duties of employers

- To remove, guard against, or warn employees of potential hazards
- To report to the nearest Occupational Safety and Health Administration (OSHA) area office all work-related fatalities within 8 hours. All work-related losses of an eye, amputations, and inpatient hospitalizations must be reported to OSHA within 24 hours.

- Post in the workplace the OSHA poster informing employees of their rights and responsibilities
- To comply with standards for:
  1. Slow-moving vehicle signs
  2. Logging and pulpwood operations
  3. Storing and handling anhydrous ammonia
  4. Rollover protection devices on certain tractors (see complete description below)
  5. Temporary labor camps
  6. Safety guards on agricultural equipment
  7. Hazard communication

### Rollover Protection Structure (ROPS) Regulations

Every employee who operates an agricultural tractor over 20 horsepower is to be informed of the following practices or any other practices dictated by the work environment found in 29 C.F.R. § 1928, Appendix A to Subpart C of 1928 “Employee Operating Instructions”:

- Securely fasten your seatbelt if the tractor has a ROPS.
- Where possible, avoid operating the tractor near ditches, embankments, and holes.
- Reduce speed when turning, crossing slopes, and on rough, slick, or muddy surfaces.
- Stay off slopes too steep for safe operation.
- Watch where you are going, especially at row ends, on roads, and around trees.
- Do not permit others to ride.
- Operate the tractor smoothly—no jerky turns, starts, or stops.
- Hitch only to the drawbar and hitch points recommended by tractor manufacturers.
- When tractor is stopped, set brakes securely and use park lock if available.

This information is to be provided to employees when they first begin using a tractor and, at a minimum, annually thereafter.

According to 29 C.F.R. § 1928.51, where ROPS are required an employer must also: “(1) ensure each tractor has a seatbelt, (2) ensure the seatbelt is used by employees while the tractor is in motion, and (3) ensure the employee has tightened the seatbelt well enough to keep the employee in the area that is protected by the ROPS.”

Exempt uses for ROPS and seatbelt requirements include:

- Low-profile tractors while they are used in orchards, vineyards, hop yards inside farm buildings or greenhouses and while their use is incidental to the work performed therein
- Tractors with mounting equipment that is incompatible with ROPS such as corn pickers, cotton strippers, vegetable pickers, and fruit harvesters

For more information on ROPS, see 29 C.F.R. § 1928, “Occupational Safety and Health Standards for Agriculture,” Subpart C.

## Field Sanitation

Employers with 11 or more employees must provide toilets, hand-washing facilities, and drinking water for employees engaged in hand-labor operations. Employees who perform field work for three hours or less during the day, including transportation time to and from the field, are exempt from toilet and hand-washing regulations. Other employees groups that are exempt are those engaged in logging operations, caring for livestock, or working in a permanent structure.

According to 29 C.F.R., § 1928.110, “Field Sanitation,” employers must follow these requirements:

1. “Potable water shall be provided and placed in locations readily accessible to all employees. The water shall be suitably cool and in sufficient amounts, taking into account the air temperature, humidity and the nature of the work performed, to meet the needs of all employees. The water shall be dispensed in single-use drinking cups or by fountains. The use of common drinking cups or dippers is prohibited.” 29 C.F.R. § 1928.110(c)(1)(i)-(iii).
2. “One toilet facility and one handwashing facility shall be provided for each (20) employees. Toilet facilities shall be adequately ventilated, appropriately screened, have self-closing doors that can be closed and latched from the inside and shall be constructed to insure privacy . . . shall be accessibly located an in close proximity to each other. The facilities shall be located within a one-quarter-mile walk of each hand laborer’s place of work in the field. Where due to terrain it is not feasible to locate facilities as required above, the facilities shall be located at the point closest vehicular access” (29 C.F.R. § 1928.110[c][2][i]-[iv]). All facilities must be kept clean and sanitary.
3. Inform employees of the importance of good hygiene practices to minimize exposure in the field to heat, communicable disease, retention of urine, and agrichemical residues. Employers must instruct employees to:
  - Use the water and facilities provided for drinking, handwashing and elimination
  - Drink water frequently and especially on hot days
  - Urinate as frequently as necessary
  - Wash hands both before and after using toilet
  - Wash hands before eating or smoking (29 C.F.R. § 1928.110[c][4][i]-[v])

## Exemptions

OSHA’s provisions do not apply to family members employed on a farm by a member of the immediate family.

## OSHA Hazard Communication Standard

The Hazard Communication Standard was created to ensure that hazardous chemicals are categorized as such and that this information is given to employees. This standard involves multiple directives that help ensure the employee receives the necessary knowledge about all hazardous chemicals in the workplace. This standard is concerned only with the question of an employer’s obligation to employees. The standard does not address the rights of the public to request information about hazardous material from employers.

To comply with obligations owed by an employer to an employee, as defined by the standard, the employer has to do five things:

1. Determine which materials in the workplace are hazardous.
2. Obtain and file safety data sheets (SDSs) for each identified hazardous material.
3. Develop and implement a written hazard communication program for the employer’s workplace.
4. Ensure that labels and other forms of warning used on containers of hazardous materials meet the standard’s requirements.
5. Provide each employee “exposed” to hazardous material information and training.

Since 1988, the OSHA Hazard Communication Standard has applied to manufacturing and nonmanufacturing employers, including those in production agriculture. If the OSHA standard applies to an employer, it will preempt any inconsistent state law, such as Pennsylvania’s Right-to-Know Act provisions that also affect an employer’s obligation to employees. Since OSHA does not apply to the general public, Pennsylvania law continues to apply to those issues affecting an employer’s obligation to the general public.

## For more information

See the United States Department of Labor Occupational Safety and Health Administration website at [www.osha.gov](http://www.osha.gov).

## Pennsylvania Worker and Community Right-to-Know Act

This act is intended to be a comprehensive program for handling the risks and hazards faced by workers in their jobs and by public citizens who live or work in Pennsylvania. The Act took effect in 1986 and requires employers to observe their workplace and determine if any materials are identified by the act as hazards, special hazards, or environmental hazards. If the employer discovers the workplace has hazardous materials, the employer is required to make that information available upon request to any employee who could be exposed to the materials.

## Who must comply?

The Community Right-to-Know Act applies to all employers in Pennsylvania. The term “employers” includes “... [a]ny individual, partnership, corporation or association doing business in the Commonwealth, including the Commonwealth, its political subdivisions, including school districts, and any officer, board, commission, agency, authority or other instrumentality thereof.” 35 Pa. Cons. Stat. § 7302. As explained above, the Occupational Safety and Health Administration (OSHA) issues its Hazard Communication Standard. If an employer is subject to the OSHA standard, the standard will prevent the application of the Pennsylvania Right-to-Know Act provisions that relate to an employer’s obligations to an employee. Since the OSHA standard does not apply to an employer’s obligation to disclose information to the general public, the Pennsylvania Right-to-Know rules will continue to apply to all employers.

Considering the OSHA Hazard Communication Standard’s application to production agriculture and agribusiness, provisions of the Pennsylvania Right-to-Know Act regarding the public’s right to this information require the following steps to be taken to comply with the act.

1. Survey the workplace to identify hazards and complete the hazardous substance survey form (HSSF) annually by April 1.
2. File the survey form for future reference.
3. Update the form during the year, as needed.
4. Make the form available if requested by the Department of Labor and Industry.

Requests for this information are made directly to the Department of Labor and Industry, which will then contact the employer. Requests by local police, fire, or emergency response agencies may be made directly to the employer concerned.

#### **For more information**

See the Pennsylvania Department of Labor and Industry Mandatory Postings for Pennsylvania Employers webpage at [www.dli.pa.gov/pages/mandatory-postings.aspx](http://www.dli.pa.gov/pages/mandatory-postings.aspx).

### **Superfund Amendments and Reauthorization Act (SARA)**

This act continues the superfund program that is targeted at cleaning up the environment. In 1986, new amendments were added, entitled “Emergency Planning and Community Right to Know.” The agency tasked with administering SARA is the Environmental Protection Agency (EPA).

#### **What does the act require?**

The act created four major responsibilities for employers:

1. The first is to report the presence of hazardous materials at a facility to the state emergency response commission and the local emergency planning committee. The obligation to file this report is tied to the presence of the hazardous material in a quantity that exceeds the threshold amount set by EPA. Once this report is filed, the person having the material appoints an individual to be involved in local planning committee activities. State and county offices of the Farm Service Agency can assist in identifying hazardous materials and threshold amounts.
2. The second major responsibility under this act is to report the release of any of these hazardous materials. In this case the duty to file the report is triggered by the release of hazardous material in an amount exceeding that set by EPA in its regulations. Under this section, pesticides registered under federal law that are used in accordance with their intended purpose and the normal application of fertilizers are exempt from the release-reporting requirement.
3. The third major responsibility applies to employers subject to the OSHA Hazard Communication Standard. It requires those employers to make information available to the general public and emergency response agencies. This provision becomes particularly important in light of the decision to expand coverage of the OSHA standard. Chemicals used in

routine agricultural operations and household products are not subject to this reporting requirement.

4. The fourth major responsibility applies to manufacturing employers with 10 or more full-time employees who use specified toxic chemicals. If these toxic chemicals are released into the environment, the employer must report the release in the manner required by the act.

Since this act involves the federal government and its agencies as well as the rights of the public regarding hazardous materials, the question of the relationship between state and federal law arises. The SARA amendments are not intended to preempt any state or local law, as in the case of the OSHA Hazard Communication Standard. State and federal laws could both apply to these situations.

#### **For more information**

For more information regarding SARA, see EPA’s SARA overview webpage at [www.epa.gov/superfund/superfund-amendments-and-reauthorization-act-sara](http://www.epa.gov/superfund/superfund-amendments-and-reauthorization-act-sara).

### **Americans with Disabilities Act Purpose**

The Americans with Disabilities Act (ADA) prohibits discrimination against “qualified individuals with disabilities” in employment, public services, transportation, public accommodation, and telecommunication services.

#### **Key terms and what they mean**

A “qualified individual with a disability” is a person who, with or without reasonable accommodation, can perform the essential functions of a job, as taken from the job description of a particular position.

A “disability” is “a physical or mental impairment that substantially limits one or more major life activities of such individual; a record of such impairment; or being regarded as having such an impairment” (42 U.S.C. § 12102[1][A]-[C]). “Disability” is given broad interpretation, with the law favoring the term to be more inclusive than not.

A “substantial” impairment is an inability to perform a “major life activity” or a significant restriction as to the condition, manner, or duration under which that activity can be performed. This determination is made without considering devices or medications which could mitigate this impairment, with the exception of glasses and contacts.

“Major life activities . . . include, but are not limited to, caring for oneself, performing manual tasks, seeing, hearing, eating, sleeping, walking, standing, lifting, bending, speaking, breathing, learning, reading, concentrating, thinking, communicating, and working” 42 U.S.C. § 12102[2][A]). They are activities that the average person in the general population can perform with little or no difficulty.

#### **Who must comply?**

Employer provisions of the ADA covers employers who have 15 or more employees. For purposes of the act, an employee is a person who works each day in each of 20 or more calendar weeks in the current or preceding calendar year.



**What does the act require?**

Employers must post in a conspicuous place where notices to employees are customarily posted a description of the applicable provisions of this act.

**What is prohibited?**

1. Discrimination is prohibited regarding “job application procedures, the hiring, advancement, or discharge of employees, employee compensation, job training, and other terms, conditions, and privileges of employment” (42 U.S.C. § 12112[a]). Forms of discrimination include, among other things:

- Acts that adversely affect opportunities for disabled persons
- Failure to make a reasonable accommodation to known physical or mental limitations

An example of a reasonable accommodation would be making existing facilities accessible and usable for a handicapped employee. Accommodations can vary with each individual employee. Structures, schedules, assignments, equipment, materials, and policies must accommodate people with disabilities.

Employers are exempt from creating reasonable accommodations if making such an accommodation would result in an undue hardship. In determining if undue hardship exists, considerations taken into account are: the nature of the accommodation, the facility’s financial resources, the number of employees, the impact on expenses and resources, the characteristics of the employer, the location of the facility, and the composition and function of the work force are considered.

- Using tests, standards, and criteria that are not job related and that screen out disabled persons.
- Inquiries about the disability or the severity of a disability. An exception exists if the inquiry relates to interviewees or employee’s ability to perform certain job duties.

Preemployment physicals may be required if the physicals are job related, are consistent with business necessity, and are performed after an offer of employment is made to the applicant. Offers of employment can be conditioned on the results of the physicals only if all employees in the same job category are subject to examination and the information obtained from the physical is kept confidential in separate medical files.

- Discrimination against recovering alcoholics and drug addicts who have been in a rehabilitation program and are not using drugs or alcohol.
  - Employers may prohibit the use of illegal drugs and alcohol in the workplace and may require employees to come to work sober and drug free.
2. An employer may not enter into a contractual or other arrangement or relationship with an entity, such as an employment or referral agency, that would have the effect of discriminating against a qualified applicant or employee with a disability.

Although farm labor contractors are not specifically mentioned, it is possible this provision would prohibit a farmer or grower from entering a relationship with a farm labor contractor that discriminates based on disability.

**For more information**

For more information regarding the Americans with Disabilities Act, go to [www.ada.gov](http://www.ada.gov).

**Pennsylvania Seasonal Farm Labor Act****Purpose**

The Seasonal Farm Labor Act was passed by the Pennsylvania legislature to improve the conditions of seasonal farm workers. The act establishes standards for wages, hours, working conditions, housing, food facilities, fire protection, and safety.

**Who must comply?**

Farm labor contractors must comply with this act.

A “farm labor contractor” is “any person who, for payment, wages, salary, fees or other consideration, either for himself or on behalf of another person, recruits, solicits, hires, furnishes or transports five or more seasonal farm workers (excluding members of his immediate family) in any calendar year for employment in agriculture or in agriculture-related industry. In any case in which a firm, partnership, association, corporation or organization engages in such activities for the purpose of supplying seasonal farm workers solely for its own operation, the term ‘farm labor contractor’ means that officer, official, supervisor or employee most directly responsible for such activity.” 43 Pa. Cons. Stat. § 1301.103.

A “seasonal farm worker” is “[a]n individual employed in raising, cultivating, fertilizing, seeding, planting, pruning, harvesting, gathering, washing, sorting, weighing or handling, drying, packing, packaging, grading, storing or delivering to market or to storage or to a carrier for transportation to market in its unmanufactured state, any agricultural commodity . . . on a seasonal or other temporary basis; includes every individual, irrespective of his primary employment, while he performs agricultural labor on a seasonal or other temporary basis, except any person who commutes daily from his permanent residence to the work site unless transportation is provided such a person by a farm labor contractor; and, other provisions of this act to the contrary notwithstanding, includes any person residing in living quarters owned, leased or operated by an employer or a farm labor contractor and occupied by four or more unrelated persons.” The unedited definition can be found at 43 Pa. Cons. Stat. § 1301.103.

The following list is drawn directly from 43 Pa. Con. Stat. § 1301.103. The term “farm labor contractor” does not include:

- any person, firm, partnership, association or corporation which is the holder of a valid and current license pursuant to . . . the “Employment Agency Law”;
- any nonprofit charitable organization, public or nonprofit private educational institution, or similar organization;
- an individual farmer . . . who engages in such activity for the purpose of supplying seasonal farm workers solely for his own operation, except that an employee of an individual farmer who engages in such activity on such a farmer’s behalf shall

be considered a “farm labor contractor” for the purposes of this act;

- “Farm labor employer” includes every individual, firm, partnership, association, trust, corporation, receiver, or . . . any person or group of persons acting directly or indirectly in the interest of an employer in relation to an employee, employing or permitting to work any seasonal farm worker in this Commonwealth, and includes every farmer, grower, nurseryman or landowner who employs, or on whose premises or in whose interest is employed, any seasonal farm worker.
- any person who engages in such activity for the purpose of obtaining seasonal farm workers of any foreign nation for employment in the United States if the employment is subject to: (i) an agreement between the United States and such foreign nation; or (ii) an arrangement with the government of any foreign nation under which written contracts for the employment of such workers are provided for through the United States by an instrumentality of such foreign nation.

For the unedited list of excluded entities and individuals, visit [dli.pa.gov/Documents/Regulations/llc/a-93.pdf](http://dli.pa.gov/Documents/Regulations/llc/a-93.pdf).

#### For more information

For more information regarding Pennsylvania’s Seasonal Farm Labor Act, see the Pennsylvania Department of Labor’s Seasonal Farm Labor Law webpage at [www.dli.pa.gov/Individuals/Labor-Management-Relations/llc/Pages/Seasonal-Farm-Labor-Law.aspx](http://www.dli.pa.gov/Individuals/Labor-Management-Relations/llc/Pages/Seasonal-Farm-Labor-Law.aspx).

### Federal Migrant and Seasonal Agricultural Workers Protection Act (MSPA)

#### Purpose

The MSPA is intended to supplement state law and assist in protecting migrant and seasonal agricultural workers. Compliance with MSPA does not excuse any person from complying with appropriate state law and regulation.

#### Who must comply?

- *Agricultural employers.* An “agricultural employer” is “any person who owns or operates a farm, ranch, processing establishment, cannery, gin, packing shed, or nursery, or who produces or conditions seed, and who either recruits, solicits, hires, employs, furnishes, or transports any migrant or seasonal agricultural worker (defined below)” (29 U.S.C. § 1802[2]).
- *Farm labor contractors.* A “farm labor contractor” is any person, other than an agricultural employer, an agricultural association, or an employee of an agricultural employer or agricultural association, who, for money or other valuable consideration paid or promised to be paid, performs any farm labor contracting activity . . . [such as] recruiting, soliciting, hiring, employing, furnishing, or transporting any migrant or seasonal agricultural worker” (29 U.S.C. § 1802[2]).

NOTE: Agricultural employers and farm labor contractors may be jointly responsible for the requirements of this act. In other words, if the farm labor contractor does not

comply with the Act’s requirements, the agricultural employer is responsible, regardless of whether the farm labor contractor qualifies as an independent contractor. Consider the following factors to determine whether an employer is jointly responsible with the farm labor contractor:

1. Whether the agricultural employer has the power, either alone or through control of the farm labor contractor, to direct, control, or supervise the worker(s) or the work performed;
2. Whether the agricultural employer has the power, either alone or in addition to another employer, directly or indirectly, to hire or fire, modify the employment conditions, or determine the pay rates [or the methods of wage payment] for the worker(s);
3. The degree of permanency and duration of the relationship of the parties, in the context of the agricultural activity at issue;
4. The extent to which the services rendered by the worker(s) are repetitive, rote tasks requiring skills that are acquired with relatively little training;
5. Whether the activities performed by the worker(s) are an integral part of the overall business operation of the agricultural employer/association;
6. Whether the agricultural employer/association’s premises, rather than on premises owned or controlled by another business entity, and
7. Whether the agricultural employer/association undertakes responsibilities in relation to the worker(s) which are commonly performed by employer, such as preparing and/or making payroll records, preparing and/or issuing pay checks, paying FICA taxes, providing workers’ compensation insurance, providing field sanitation facilities, housing or transportation, or providing tools and equipment or materials required for the job (taking into account the amount of the investment).

This list was drawn directly from the U.S. Department of Labor Wage and Hour Division’s Fact Sheet #35: “Joint Employment and Independent Contractors Under the Migrant and Seasonal Agricultural Worker Protection Act.”

#### Key terms and what they mean

A “migrant agricultural worker” is an individual employed in agriculture on a seasonal or other temporary basis, and who is required to be absent overnight from his or her permanent place of residence. NOTE: This term does not include members of the immediate family of a farm labor contractor or an agricultural employer, or temporary nonimmigrant H-2A alien workers.

A “seasonal agricultural worker” is “an individual who is employed in agricultural employment of a seasonal or other temporary nature and is not required to be absent overnight from his permanent place of residence – (i) when employed on a farm or ranch performing field work related to planting, cultivating, or harvesting operations; or (ii) when employed in canning, packing, ginning, seed conditioning or related research, or processing operations, and transported, or caused to be transported, to or from the place of employment by means of a day-haul operation

[pick-up and return on the same day]” (29 U.S.C. § 1802[10][A][i]-[ii]). NOTE: This term “does not include any migrant agricultural worker; any immediate family member of an agricultural employer or farm labor contractor” or temporary nonimmigrant agricultural H-2A alien workers (29 U.S.C. § 1802[B][i]-[iii]).

### Who is exempt?

- Family businesses. The act is not applicable to an individual who engages in farm labor contracting activities on behalf of a farm owned or operated by that person or an immediate family member, if the activities are performed only for such operation and exclusively by such individual or an immediate family member.
- Small businesses. The act is not applicable to an employer who employs fewer than 500 “man days” of agricultural labor in any calendar quarter of the preceding calendar year. This is the same standard as the Fair Labor Standards Act exemption from federal minimum wage requirements.
- A person whose labor-contracting activities are conducted within a 25-mile radius of the person’s permanent residence and for not more than 13 weeks per year.
- Common carriers whose only connection with agriculture is the transport of migrant or seasonal agricultural workers.
- Nonprofit charitable organizations and public and private educational institutions.
- Custom combining, hay-harvesting, or sheep-shearing operations.
- Custom poultry harvesting, breeding, debeaking, desexing, or health service operations.
- Some students serving apprenticeships and some employees of seed and tobacco producers.

For the complete list, see 29 U.S.C. § 1803(a)(1)-(3).

### What does the act require?

- Farm labor contractors must have a certificate of registration.
- Agricultural employers must confirm that the farm labor contractor is registered.
- Farm labor contractors, agricultural employers, and agricultural associations that recruit migrant and/or seasonal agricultural workers must disclose in writing the following information to such workers:
  1. Place of employment
  2. Wage rates to be paid
  3. Crops and kinds of work activity on which worker may be employed
  4. Period of employment
  5. Transportation, housing, and any other employee benefits to be provided, if any, and costs to be charged for each of them
  6. Existence of any strike or other concerted work stoppage, slowdown, or interruption of operations by employees at the place of employment

7. Any arrangements with any owner or agent of any establishment in the area of employment under which the farm labor contractor, the agricultural employer, or the agricultural association is to receive a commission or any other benefit resulting from any sales by such establishment to the workers
8. Whether state workers’ compensation insurance is provided, and, if so, the name of the State workers’ compensation insurance carrier, the name of the policyholder of such insurance, the name and the telephone number of each person who must be notified of an injury or death, and the time period within which such notice must be given

The list above was drawn directly from 29 U.S.C. § 1821(a)(1)-(8).

Compliance with number eight on the list may be met if the worker is given a photocopy of any notice regarding workers’ compensation insurance required by law of the state in which the worker is employed. The worker must be given the disclosure at the time of recruitment or, if sufficient information is unavailable at that time, at the earliest practicable time, but no later than the commencement of work.

- Farm labor contractors, agricultural employers, and agricultural associations that recruit migrant agricultural workers must post the above information in English, Spanish, or another language common to the workers.
- Those that own or control facilities used to house migrant workers are responsible for having these facilities meet federal and state safety and health standards.
- For further details, see “Migrant Labor Housing” (below).
- Each farm labor contractor, agricultural employer, or agricultural association that recruits migrant agricultural workers must maintain for three years those records dealing with:
  1. The basis for wages paid
  2. Piece work units earned
  3. Sums withheld and purpose of withholding
  4. Number of hours worked
  5. Total pay period earnings
  6. Net pay
- Provide to each such worker for each pay period, an itemized written statement of the information.
 

The list above was drawn from 29 U.S.C. § 1821(d)(1)-(2).
- When using any vehicle to provide transportation, each farm labor contractor, agricultural employer, and agricultural association that recruits migrant workers must ensure:
  1. The vehicle conforms to federal and state safety standards
  2. Drivers are validly licensed
  3. An insurance policy or liability bond in the minimum amount of \$100,000 per seat in the vehicle (the total amount required is not more than \$5,000,000) is in force to cover property damage and personal injury

For more information on transportation, see 29 U.S.C. § 1841(a)-(d).

Use of machinery and equipment while actually engaged in planting, harvesting, etc., is exempt from this requirement.

NOTE: The required level of insurance is that required of a common carrier under federal law, but if a contractor, employer, or association maintains workers' compensation coverage for its workers and this coverage includes transporting workers, then no additional insurance is necessary and the workers' compensation policy may meet the insurance requirement. This decision requires a thorough review of the existing policy with an insurance adviser.

#### For more information

For more information regarding the Federal Migrant and Seasonal Agricultural Workers Protection Act, see the United States Department of Labor's Migrant and Seasonal Agricultural Worker Protection Act (MSPA) webpage at [www.dol.gov/whd/mspa](http://www.dol.gov/whd/mspa).

### Migrant Labor Housing—Federal Regulations

#### Who must comply?

Any individual or entity who supplies housing to migrant workers are subject to federal housing standards. There are exemptions for small employers and camp operators who provide the same housing to the general public on a commercial basis. These regulations will not apply if a person "in the ordinary course of that person's business, regularly provides housing on a commercial basis to the general public and who provides housing to migrant agricultural workers of the same character and on the same or comparable terms and conditions as is provided to the general public" (29 U.S.C. 1823[c]).

#### What do the regulations require?

1. Before migrant labor housing can be occupied, a state or local health authority or other appropriate agency must certify that the facility meets all applicable safety and health standards, including federal and state regulations. A copy of the certification must be posted at the site. Certification prior to occupancy will not prevent the housing provider from being assessed penalties for violations that occur after occupancy has begun.

NOTE: "If a request for an inspection of a facility or real property is made to the appropriate State, local or Federal agency at least forty-five (45) days prior to the date on which it is to be occupied by a migrant agricultural worker but the agency has not conducted an inspection by such date, the facility or property may be occupied by migrant agricultural workers" (29 C.F.R § 500.135[c]).

2. Migrant labor housing owned by growers and crew leaders subject to the Migrant and Seasonal Agricultural Workers Protection Act (see previous section) must be registered, inspected, and approved by the Wage and Hour Division of the U.S. Department of Labor. Specific requirements have been set by the Occupational Safety and Health Administration (OSHA) and requirement areas include:

- Housing sites
- Shelter and housing
- Water supply
- Toilet facilities
- Sewage disposal
- Laundry, handwashing, and bathing facilities
- Electrical lighting
- Refuse and garbage disposal
- Cooling and eating facilities
- Screening, insect, and rodent control
- Fire safety and first-aid facilities
- Reporting of communicable diseases

NOTE: There are two applicable housing regulations depending on when the housing was built. If the housing construction "was begun on or after April 3, 1980, and which was not under a contract for construction as of March 4, 1980, [owner or operator] shall comply with the substantive Federal safety and health standards promulgated by OSHA at 29 CFR 1910.142" (29 C.F.R. § 500.132[a][1]). If the housing was "completed or under construction prior to April 3, 1980, or which was under a contract for construction prior to March 4, 1980, [owner or operator] may elect to comply with either the substantive Federal safety and health standards promulgated by OSHA at 29 CFR 1910.142 or the standards promulgated by ETA at 20 CFR 654.404 et seq" (29 C.F.R. § 500.132[a][2]).

3. The Employment Training Administration of the U.S. Department of Labor must approve migrant labor housing before it will supply workers to the operation.
4. OSHA has the authority to inspect any farm labor housing facility in response to a complaint, a report of an injury or accident, or on a random basis. No registration is required under OSHA regulations.

#### Penalties

Employers and migrant farm labor camp owners are subject to fines if found in violation of housing standards. In certain cases, violations may cause the inspecting agency to close the camp and revoke the employer's certification, which could result in an employer losing the employees who are needed to pick a crop.

### Migrant Labor Housing—Pennsylvania Regulations

#### Purpose

With authority drawn from the Seasonal Farm Labor Act, regulations for seasonal farm labor camps set standards for permits, plans, sites, and camp housing. Under housing requirements, regulations cover:

- Occupancy
- Sleeping room contents
- Cleanliness

- Water supply
- Plumbing
- Toilet facilities
- Sewage disposal
- Laundry, handwashing, and bathing facilities
- Lighting and electrical
- Refuse
- Food service
- Insect and rodent control
- First-aid and fire prevention
- Exits and entrances

Other sections deal with occupants' concurrent responsibilities and obligations of owners and operators. These regulations can be found in the Pennsylvania Code, Volume 7, Chapter 82, and contains detailed standards for each category listed above. This link is for the complete Chapter 82 "Seasonal Farm Labor Camps": [https://www.pacode.com/secure/data/007/chapter82/007\\_0082.pdf](https://www.pacode.com/secure/data/007/chapter82/007_0082.pdf).

#### Who must comply?

All employers of migrant and seasonal farm labor in Pennsylvania that provide living quarters for four or more unrelated farm workers are subject to the regulations. If an employee has been employed for less than one year, the employee is presumed to be a seasonal one, unless the employer can prove otherwise.

#### What do the regulations require?

1. Plans for the construction, remodeling, or alteration of farm labor camps must be approved by the governing agency before work on the changes may begin.
2. All seasonal farm labor camps must have a permit from the governing agency. A permit is valid for one year. Initial applications for new camps must be submitted 60 days prior to occupancy. Currently operating farm labor camps will receive a renewal application 60 days prior to the expiration of their current permit.
3. All camps must be ready for inspection by the governing agency at least 45 days prior to occupancy. Violations may cause the camp to be reinspected before a permit is issued. Continued noncompliance with regulations may cause the agency to levy fines or revoke the operating permit.
4. Upon receipt of a permit, the camp owner or operator must post the permit at a prominent location that is readily accessible.

#### For more information

For information regarding Migrant Labor Housing, see the Pennsylvania Department of Agriculture's Seasonal Farm Labor Camps webpage at [https://www.agriculture.pa.gov/Business\\_Industry/Farm%20Labor%20Camp%20Housing/Pages/default.aspx](https://www.agriculture.pa.gov/Business_Industry/Farm%20Labor%20Camp%20Housing/Pages/default.aspx).

### Family and Medical Leave Act of 1993 (FMLA) Purpose

The Family and Medical Leave Act (FMLA) is intended to provide a means for employees to balance their work and family responsibilities by taking unpaid leave for certain reasons. The act is intended to promote the stability and economic security of families as well as the nation's interest in preserving the integrity of families.

#### Who is covered?

The FMLA applies to any employer in the private sector who engages in commerce, or in any industry or activity affecting commerce, and which has 50 or more employees each working day during at least 20 calendar weeks (which do not need to be consecutive) in the current or preceding calendar year.

The law covers all public agencies (state and local governments) and local education agencies (schools, whether public or private). These employers do not need to meet the "50 employee" test. Title II of FMLA covers most federal employees, who are subject to regulations issued by the Office of Personnel Management.

To be eligible for FMLA leave, an individual must (1) be employed by a covered employer and work at a worksite within 75 miles of which that employer employs at least 50 people; (2) have worked at least 12 months (which do not have to be consecutive) for the employer; and (3) have worked at least 1,250 hours during the 12 months immediately before the date FMLA leave begins.

#### Basic provisions/requirements

FMLA provides an entitlement of up to 12 work weeks of job-protected, unpaid leave during any 12-month period for the following reasons:

- Birth and care of the employee's child, or placement for adoption or foster care of a child with the employee
- Care of an employee's spouse, child, or parent with a serious health condition
- Care of the employee's own serious health condition rendering them incapable of performing job duties
- Exigent circumstances arising from the fact that the employee's spouse, son, daughter, or parent is a covered military member on "covered active duty"

FMLA also provides an entitlement of up to 26 work weeks of job-protected, unpaid leave during any 12-month period for care of a covered service member with a serious injury or illness if the employee is the service member's spouse, son, daughter, parent, or next of kin.

If an employee was receiving group health benefits when leave began, an employer must maintain them at the same level and in the same manner during periods of FMLA leave as if the employee had continued to work. Usually, an employee may elect (or the employer may require) the use of any accrued paid leave (vacation, sick, personal, etc.) for periods of unpaid FMLA leave.

Employees may take FMLA leave in blocks of time less than the full 12 weeks on an intermittent or reduced leave basis when medically necessary. Taking intermittent leave for the placement,

adoption, or foster care of a child is subject to the employer's approval. Intermittent leave taken for the birth and care of a child is also subject to the employer's approval except for pregnancy-related leave that would be leave for a serious health condition.

When the need for leave is foreseeable, an employee must give the employer at least 30 days' notice, or as much notice as is practicable. When the leave is not foreseeable, the employee must provide such notice as soon as possible.

An employer may require medical certification of a serious health condition from the employee's health care provider. An employer may also require periodic reports during the period of leave of the employee's status and intent to return to work, as well as "fitness for duty" certification upon return to work in appropriate situations.

An employee who returns from FMLA leave is entitled to be restored to the same or an equivalent job (defined as one with equivalent pay, benefits, responsibilities, etc.). The employee is not entitled to accrue benefits during periods of unpaid FMLA leave, but the employer must return him or her to employment with the same benefits at the same levels as existed when leave began.

Employers are required to post a notice for employees outlining the basic provisions of FMLA and are subject to a \$166 civil money penalty per offense for willfully failing to post such notice. If a substantial portion of employees cannot read English, the notice must be posted in a language the employees can read. Employers are prohibited from discriminating against or interfering with employees who take FMLA leave.

### Employee rights

FMLA provides that eligible employees of covered employers have a right to take up to 12 weeks of job-protected leave in any 12-month period for qualifying events without interference or restraint from their employers. FMLA gives employees the right to file a complaint with the Wage and Hour Division of the Department of Labor's Employment Standards Administration, file a private lawsuit under the act (or cause a complaint or lawsuit to be filed), and testify or cooperate in other ways with an investigation or lawsuit without being fired or discriminated against in any other manner.

### Compliance assistance available

The Wage and Hour Division of the Employment Standards Administration administers FMLA. More detailed information, including copies of explanatory brochures, may be obtained by contacting your local Wage and Hour Division office. The Wage and Hour Division has developed the "elaws" Family and Medical Leave Act Advisor, an interactive online resource designed to answer commonly asked questions about FMLA, including employee eligibility, valid reasons for leave, notification responsibilities of employers and employees, and rights and benefits of employees. Compliance assistance information is also available from the Wage and Hour Division's website at [www.dol.gov/whd](http://www.dol.gov/whd). For additional assistance, contact the Wage and Hour Division at 1-866-4USWAGE.

### Penalties/sanctions

Employees and other persons may file complaints with the Employment Standards Administration (usually through the nearest office of the Wage and Hour Division: [www.dol.gov/whd](http://www.dol.gov/whd)). The Department of Labor may file suit to ensure compliance and recover damages if a complaint cannot be resolved administratively. Employees also have private rights of action, without involvement of the Department of Labor, to correct violations and recover damages through the courts.

### Relation to state, local, and other federal laws

Several states have family leave statutes. Nothing in FMLA supersedes a provision of state law that is more beneficial to the employee, and employers must comply with the more beneficial provision. Under some circumstances, an employee with a disability may have rights under the Americans with Disabilities Act.

For more information For more information regarding the FMLA, see [www.dol.gov/whd/fmla](http://www.dol.gov/whd/fmla).

### Affordable Care Act

The Affordable Care Act (ACA) determines benefits and requirements based on whether an employer is considered to be an "applicable large employer" (ALE). Under ACA, an employer is considered to be ALE if it employs 50 or more full-time employees. Nevertheless, the ACA does provide employers with a seasonal worker exception. According to ACA, "An Employer shall not be considered to employ more than 50 full-time employees if (I) the employer's workforce exceeds 50 full-time employees for 120 days or fewer during the calendar year, and (II) the employees in excess of 50 employed during such 120-day period were seasonal workers. (ii) Definition of seasonal workers: The term 'seasonal worker' means a worker who performs labor or services on a seasonal basis as defined by the Secretary of Labor" (26 U.S.C. § 4982H[c][B][i]-[ii]). According to the IRS, "Employers may apply a reasonable, good faith interpretation of the term 'seasonal worker' and a reasonable, good faith interpretation of the Department of Labor's definition of seasonal worker. . . . These exceptions apply solely for purposes of determining whether an employer is an ALE" (IRS, ALE Info Center, "Questions and Answers on Employer Shared Responsibility Provisions Under the Affordable Care Act").

### For more information

For more information regarding the Affordable Care Act, see [www.irs.gov/affordable-care-act/employers/aca-and-employers-how-seasonal-workers-affect-your-ale-status](http://www.irs.gov/affordable-care-act/employers/aca-and-employers-how-seasonal-workers-affect-your-ale-status).

# X

# MARKETING

## CONTENTS

<b>Your Customers</b> .....	<b>392</b>
Conducting Consumer Research.....	392
Segmenting Consumers .....	393
<b>Your Products</b> .....	<b>395</b>
Value-Added Products .....	396
Specialty Foods .....	396
Snacks .....	396
Customizing Your Product Offering.....	397
Assessing Consumer Response.....	398
<b>Your Retail Outlet</b> .....	<b>398</b>
Transition Zone .....	399
Prime Selling Area .....	399
Product Display Height.....	399
Rotating Displays.....	400
Anchor Goods .....	400
“Grab-and-Go” Items.....	400
Cross-Merchandising .....	400
Floor Plan Layout .....	400
Wall Color .....	401
Flooring Material .....	401
Ceilings .....	402
Music.....	402
After-Hours or Nonpeak Use .....	402
Mobile Payment Systems.....	402
<b>Promotions</b> .....	<b>404</b>
Pretesting Your Promotion .....	405
In-Store Promotions .....	405
Cause Marketing .....	406
Loyalty Programs .....	407
Evaluating the Success of Your Promotion .....	410
Other Ways to Increase Consumer Loyalty .....	410
<b>Cross-Promotion</b> .....	<b>414</b>
Offering Space in Your Retail Outlet .....	414
Newsletters and Blogs.....	414
Your Website, Facebook, and Twitter .....	415
Costs.....	415
<b>Communicating with Customers</b> .....	<b>415</b>
Email .....	415
Social Media .....	416
<b>Online Reputation Management</b> .....	<b>421</b>
Third-Party Websites for Online Monitoring .....	422
Responding to Customer Reviews .....	422

Providing a Place for Consumers to Post Reviews .....	422
Quantifying Visits to Your Website .....	423

## FIGURES

<b>Figure 10-1.</b> If you provide value-added light options, don’t forget to offer tie-in items. For example, if you provide a recipe and assemble ingredients to make three-berry jam, consider adding canning items to your product mix. This strategy could also increase sales .....	396
<b>Figure 10-2.</b> Some consumers might only think of one use for this item, but tomato soup can be thickened to make a sauce, thinned to make salad dressing, added to casseroles, and be an ingredient in several types of chicken stew. They just need ideas, and you can provide them .....	397
<b>Figure 10-3.</b> Diagram showing an example of a retail outlet. The prime selling area is located just past the transition zone .....	399
<b>Figure 10-4.</b> An example of a free-flow layout .....	401
<b>Figure 10-5.</b> Signage describing the item’s flavor, how it could be used, and how to prepare it.....	406
<b>Figure 10-6.</b> Sampling helps reduce consumer risk .....	406
<b>Figure 10-7.</b> Vendors should offer samples for visitors to taste, with some of the proceeds benefiting the cause ....	411
<b>Figure 10-8.</b> Live music can also keep tasting room visitors on the property longer. Survey customers about the local band they enjoy listening to and invite them to perform.....	411
<b>Figure 10-9.</b> Food samples that complement your wine and demonstrations that correspond to an upcoming season or celebration are great ways to attract attendees and keep them in the tasting room longer .....	412
<b>Figure 10-10.</b> Sales and attendee numbers are just a couple of items you should monitor during the event. Assign an employee or two to observe your guests during the event. What vendors tend to attract visitors? Are visitors sampling food items and wine? If so, are they merely sampling but not purchasing? Are there any areas on the grounds where customers tend to gather and other areas where customers do not seem to walk to or through?...	413
<b>Figure 10-11.</b> Data collection .....	414
<b>Figure 10-12.</b> An example HootSuite dashboard with five tabs, each of which is associated with a different social network .....	419
<b>Figure 10-13.</b> Dashboards allow users to create one message and post to multiple accounts. Users can also include links to online content, attach digital images, and schedule posts to be published at specific times .....	420
<b>Figure 10-14.</b> How the HootSuite dashboard stream appears on the screen of an iPhone 4 .....	421
<b>Figure 10-15.</b> How a Facebook newsfeed appears in the HootSuite app .....	421

The attraction of owning and operating a retail outlet may evolve from the need or want to interact directly with consumers or to acquire a greater amount of profit by “cutting out the middleman.” Whatever the reason, retail presents an entirely different list of issues from selling product wholesale or to restaurants and institutions. This is not to say that growers who provide their products to a restaurant or wholesale operation are free from the responsibility of promoting their produce, but retailers must consider how and where they will advertise their businesses, the impact of cause marketing on the community’s perception of their business, and whether or not a loyalty program will provide them with a competitive advantage. Retailers also need to think about store layout, design, and merchandising, as well as labor needs, such as scheduling during times of high foot traffic or other events.

If you are contemplating a new retail business or even a change in how you currently conduct business, you will need to investigate:

- The potential demand for your product(s)
- Direct and indirect competitors and your point of differentiation
- How to best inform and remind consumers about your products and persuade them to purchase from your business

Certainly, this is not an exhaustive list of what business owners must determine, but these questions are paramount for building a strong marketing plan. Statistics indicate that business owners who take the time and effort to develop a plan before starting a new business or making major changes are more likely to be successful. Take the time now, before you implement any changes, to learn more about your customers’ needs and wants and what you can offer that will be superior to what your competitors offer. This chapter is designed to help you think about your business and consider whether you are fully utilizing your retail outlet, offering the right products to the right consumers, and using the right promotional strategy.

## YOUR CUSTOMERS

If you operate an on-farm market, seasonal market, or permanent retail location, you are probably well aware that being “customer centric” and truly catering to those who purchase your goods and services has advantages. Rather than striving to “be all things to all people,” retailers should determine which groups of consumers they can serve successfully based on consumer demand for their products and their ability to provide these products and the experiences their customers desire.

Customers are an asset to your business that you cannot ignore. They are just as vital to a successful operation as the best-looking and most unique product offering, the most knowledgeable sales staff, and a convenient and desirable location. After all, profits, market share, revenue, and salaries are generated from your relationship with your customers and the ability to sell them the products they desire. Nurture your relationship with consumers who enter your store, and turn them into loyal customers who return for a fifth and fiftieth time. Learning about your customers’ needs and wants will enable you to make informed decisions on what products and services are in the greatest demand.

Consumers who visit retailer outlets or search their websites

are looking for products that will provide solutions to their problems. As a retailer, knowing what to stock and sell can be a daunting task. One option is to select products based on your preferences. This may work if your needs and wants, as the retailer, are similar to those of your customers. However, if you do not know what the customer wants or you ignore requests, your clientele may lose interest over time and choose to shop elsewhere. Instead, learn about “who” your customers are and then learn about their interests. This information can provide the basis for an attractive and appealing product mix. To do this, you will need to segment consumers, or divide them into groups, based on common characteristics.

Though consumers use unique sets of criteria to make judgments about products they purchase, the practice of classifying consumers by characteristics based on their demographics, interests, and other factors into manageable groups, or market segments, is a common marketing practice. Offering products that appeal to each and every consumer who visits the store or website would be difficult for any retailer. Hence, successful retailers tend to focus on those consumers who are most likely going to find their products appealing and purchase them.

## Conducting Consumer Research

A first step to learning about your current and potential clientele is to do some marketing and consumer research. Being aware of consumer trends and realizing that it is possible to provide consumers with goods and services to meet their specific needs is not at all unreasonable for a retailer to understand. Changing and emerging consumer trends are often reported and analyzed in newspapers, business journals, and industry websites, as well as broadcasted on local new shows and cable television programs. Sources such as the Center for Media and Social Impact ([www.cmsimpact.org](http://www.cmsimpact.org)) provide information about which methods of advertising are used by various demographic groups. Certain demographic segments of interest still read newspapers, while other demographic groups read the newspaper less often. If you’re interested in reaching younger generations, create an Instagram business page and develop an informative and interactive website.

Doing some investigation to determine what to offer each group of consumers is the vital next step. Observe other industries and retailers, taking note of how they successfully cater to various consumers. This information is truly useful, but what provides even more value is collecting information directly from customers who currently purchase products from you or from consumers you currently don’t serve but could. To collect information from consumers, begin by developing a survey that asks questions such as:

- If we offered hardy kiwi, would you be interested in purchasing it? Why or why not?
- When you serve the fruit to family and friends, what other food items or beverages do you serve?
- How many adults and children live in your household? Of these household members, how many eat produce you purchase?

Post questions on your website and on your Facebook business page, and involve all consumers who enter your store and who are willing to participate in your research. Not only could you learn about what new products consumers want, but you



may also discover any potential problems with your employees or determine where you should focus future efforts. Ask your customers what they think of your retail operation. Why do they shop at your store? Why do they shop at your store rather than at your competitors' stores? What attracts them? How often do they shop at your store? If active customers have become inactive, send them a survey along with a "shop with us again" coupon, and ask why they are no longer purchasing or purchasing less frequently from you.

You could also choose to conduct an online survey. Several online survey programs with limited functions are available for free (the full versions can also be purchased on an annual basis). Tools such as **SurveyMonkey.com** and **SurveyGizmo.com** allow users to:

- Create surveys
- Send links to the survey in emails or incorporate the link into a webpage
- Download data in either report form or as an Excel document

Similarly, explore Google Forms within Google Docs. These can be designed to look like a survey and embedded into an email you can send to potential participants. Once received, recipients can respond to the questions and click the "submit" button when finished. You will then have access to a spreadsheet where responses are organized by survey participant.

### Segmenting Consumers

Take a look at your customers as one large group. Most likely, you will find that they have different interests in your products—for example, certain customers may be interested in purchasing fresh fruit to use in recipes, while others might be more interested in purchasing premade and processed products that require little work to heat and serve. You might also find that consumers enjoy shopping at your store to purchase kitchen gadgets or gift items rather than fresh fruit or food products.

Divide individuals into segments, again creating groups of consumers with similar characteristics or needs and wants based on their responses to the questions above. For example, segments could consist of consumers who:

- Are interested in purchasing hardy kiwi
- Serve wine when they serve fresh fruit to family and friends
- Live in households where only adults consume fresh fruit purchased from the retail outlet

Also consider asking your customers how much they spend on the types of products you sell in a month, brands they purchase that you could also sell, if they use social media and what networks they actively subscribe to, and even questions about them such as household income and city and state where they reside for a majority of the year. Though consumers may not feel comfortable providing personal information, especially if you ask them to list their name or email address, it never hurts to ask. Instead of asking consumers to state their exact age or income, you may consider having ranges (for example, annual household income less than \$25,000, \$25,000 to \$45,000, and so on).

After analyzing survey responses, you may find that several different segments of consumers purchase from you—for example, based on frequency with which they visit your store, types of products they purchase, such as ethnic produce, or even that

they only visit when you host an event. Next, consider the value of each segment and determine which one(s) might provide the highest return on investment. Most likely, you can form a large number of segments, and sorting through the responses may be overwhelming at first; however, savvy business owners will recognize that the process is designed to make their customer pool more manageable. Be aware that even though one segment may be larger in number of potential customers, other segments may include customers with a higher level of income who actually purchase more from you on each shopping occasion. If it is apparent that several segments purchase from you, but one or more segments spend significantly more money than others, those segments would be referred to as "core" customers, whom you would then "target" with advertising and related promotions.

Established businesses may be tempted to seek new customers with higher income levels or greater purchasing potential than existing customers. If you make significant changes that shift the focus from your current customers, you may spend more resources, time, and money trying to interest those consumers who are not familiar with your business compared to what you might spend to please those customers who purchase from you regularly. Work on furthering relationships you already have that are stable rather than on creating unpredictable new relationships. Remember, all customers who enter your store are important, but retaining active customers should always be on your list of priorities. Once you have fully engaged your loyal customers, encourage others who shop with you to do so more frequently and become active customers. New retailers that are still in the planning stages may not have an accurate understanding of their core customers. However, learning about consumers and product trends is a must.

In both cases, retailers that learn about who will shop at their stores are better able to create an appropriate product mix that appeals to these consumers. Once this strategy is in place and consumers are responding, the next step is to consider what else to offer that is unique and captures visitors' attention, and then differentiate the business from a competitor's. The challenge is to always think about the future and investigate new ideas for your retail outlet and approaches for conducting businesses, followed by evaluating customer response.

All of these factors are interdependent and require more work than what you might first expect, but if done correctly, the payoff should be worth the investment. As with other duties associated with small-business ownership, you need to review ideas and strategies, assess success, and continually make changes to meet your business's goals and objectives. The mission that certain growers have, including their need to provide consumers with fresh, healthy, and flavorful fruit and associated products, should outweigh any concern about procedures and processes. As with any other past venture, your passion and perseverance will help you succeed. A strong marketing plan will provide you with the roadmap to meeting your goals and objectives.

As mention above, you can segment your customers in a variety of ways, such as by personality or attitude or beliefs, behavior, frequency, and intensity of product use, and even demographic status (e.g., age, sex, income level). The sections below will help guide you through the process of thinking about your consumers in a bit more detail than just as people who buy stuff from you.

Demographics describe who we are as individuals—for ex-

ample, our ethnicity, age/generation, sex, income, marital status, education, and homeownership. These and other characteristics categorize us without describing our personalities. Many of these demographic characteristics are directly related to our physical being and cannot be changed. Below are some ways we can segment consumers in an effort to learn about them and better serve their needs.

### Generation

Terms such “Gen X,” which is a category that includes U.S. consumers born between 1965 and 1980, “Generation Jones,” those born between 1955 and 1964, and “Baby Boomers,” born between 1946 and 1954, were created as a way of classifying people of the same approximate age and with similar ideas, wants, needs, problems, etc., into groups. Producers or manufacturers can develop products that specifically appeal to a majority of members of each generation, as the general needs and wants of consumers within each group are assumed to be similar. If you sell wine, for example, you may be interested in learning about consumers described as “Generation Y” (born between 1981 and 1996) since they are recognized as being important to wine producers and retailers. Our next youngest generation, “Generation Z” (born between 1997 and 2012), is expected to have a significant impact on the produce industry. These children have a greater influence on what food is purchased for the household than Generation Y had when they were children. Generation Z, it has been reported, is greatly persuaded by foods that are labeled as “fresh,” “natural,” “local,” “hormone-free,” “authentic,” and “farm-raised.” Agricultural industries should consider how they can benefit from this information and then offer goods and services that could appeal to members of select generations.

### Ethnicity

Data available on the U.S. Census website ([www.census.gov](http://www.census.gov)) describes the ethnicities and races, among other demographic characteristics, of consumers who live in the United States and Puerto Rico. For the past several years, the population of certain race and ethnic groups has increased, particularly those of Asian and Hispanic or Latino descent, which presents a number of opportunities. Hispanic and Asian ethnicities are not homogeneous groups. Each subgroup (e.g., Korean, Japanese, Chinese) celebrates different holidays, has different customers, and uses different ingredients in meals they prepare.

- In the United States in 2015, the predominant Hispanic group was Mexican, accounting for 63.9 percent of the Hispanic population, followed by Puerto Rican at 9.5 percent. In Pennsylvania, consumers of Puerto Rican ancestry accounted for 50.9 percent of the Hispanic population, followed by consumers with a Mexican heritage (18 percent) and Dominican heritage (8.7 percent).
- Consumers with a Chinese ancestry accounted for 23.7 percent of Asian consumers, followed by Asian Indian (20.4 percent) and Filipino (16.7 percent). Again, in Pennsylvania these percentages differed from those on a national level. The subgroups with the highest population percentages in the Commonwealth were Asian Indian (29.3 percent), Chinese (26.2 percent), Vietnamese (10.9 percent), and Korean (10.1 percent).

As these U.S. Census Bureau statistics from 2015 demonstrate, the ethnic and racial population in the Commonwealth differs from that of the nation as a whole.

Consider the following questions to learn more about audiences you could serve:

- Are certain products in greater demand during specific periods such as holidays, seasons, or for festivals and special occasions, such as Chinese New Year?
- Is there a preference for a particular variety, size, condition, type of package, or partially/fully processed product?
- Would there be demand for stored, frozen, or canned produce?

It is in your best interest to learn about food trends associated with ethnic foods in the general marketplace. Younger generations are more racially and ethnically diverse than older generations. Based on 2018 population estimates, 38 percent of Generation Z and the following generation, yet to be named, were Hispanic, compared to 13 percent of Gen X, 10 percent of Baby Boomers, and 3 percent of the Silent and Greatest generations. Pertaining to race, 53 percent of Generation Z and younger consumers are of two or more races.

### Income

Disposable income, essentially net income, is the amount of money that an individual has available to pay for expenses minus taxes and deductions. Discretionary income is the amount of money that remains after consumers pay for “needs” that are required to sustain a reasonable livelihood (food, rent/mortgage, insurance, etc.). It would be expected that the higher the level of net income minus monthly expenses, the greater the amount of discretionary income available for a consumer to purchase “wants,” or items not necessary to maintain life.

Everyone has a level of price sensitivity, which has a direct impact on how they respond to prices and how their purchasing decisions change based on an increase and decrease in price. Price sensitivity is influenced by the need for the product, amount of discretionary income available to purchase the product, purchaser-perceived value for the price charged, and availability of other products that could substitute for the product the consumer might feel is overpriced.

In general, small businesses may have trouble competing with discounters or mass merchandisers based on price; however, there is one exception. If you offer items that mass merchandisers also offer, then you may need to charge the same price as your competitor. Why? Some consumers may be very aware of what the product costs at the mass merchandiser. If the price you charge for the identical item is higher than that of the competitor, these consumers may feel that all your products are overpriced based solely on this one comparison. In addition, consumers are comparing prices in stores using their smartphones and websites and by looking through newspaper circulars and other advertisements.

If your core customers have limited income, then goods and services marketed to them should be affordable. Products marketed to more affluent consumers, however, could be manufactured, packaged, and promoted in a manner that would reflect their level of prestige, and they should be priced accordingly.

## Sex

Men and women shop differently and learn about products from different resources. For example, women are three times more likely than men to learn about a product from others. How they respond to color also differs—for example, men between the ages of 19 to 24 have an aversion for purple, while the least favorite color for women in this age range is orange. When designing the color scheme for your business or even choosing the predominant wall color, be aware of these preferences and avoid those that would offend your target audience.

Now, researchers are finding that men and women also respond differently to email and social media strategies. Sixty-seven percent of women, compared to 57 percent of men, are likely to sign up for emails to obtain deals and promotions. Pertaining to social media networks, women who have a Facebook account are more likely to use this tool than men age 35 and older. The percentages of women and men who use Snapchat, Instagram, Yelp, YouTube, etc., also differ. These differences become more pronounced when sex is further segmented by age. Eighty-three percent of men between the ages of 18 and 34 are YouTube users, while slightly fewer women in the same age range (66 percent) used YouTube during the same period.

## Geography

The location where consumers live (the Southeast versus the Northwest United States and/or in a metropolitan area versus a rural environment) can greatly influence their needs, wants, and access to goods and services. Cultural “tastes” and traditions can affect food preparation, ingredients commonly used, and availability of specialty cuisine. Consumers residing along the Atlantic Ocean may include seafood as a staple in their diets, while consumers living in the Southwest may frequently use chili peppers. Also, as a greater number of consumers travel and experiment with new cuisines, they may desire to re-create the dish in their own kitchens upon returning home. Be sure to inform consumers that you have ingredients they can use to create these meals in their own homes, and consider making gift baskets that include these foods that customers can use themselves or give as gifts.

## Psychography and Behavior

You can also segment consumers by how strong of a need or interest they have for products you sell, whether they only shop at your retail outlet when you offer discounts or sales, and so forth. In addition to the demographic characteristics that customers share, it is also essential to learn about their personalities, values, and lifestyles (psychographics), and how they actually spend their time and money, what goods and services they actually purchase, and how often they use or purchase these products (behaviors).

Understanding these “external” characteristics also greatly assists business owners with choosing an appropriate product mix. Consumers might purchase goods and services based on their culture, generation, or sex, but they may also have interests in products that correspond to life experiences, personal preferences, and their hobbies and interests. It is important to understand that just because people fit particular demographic profiles, they might not necessarily think, act, or have interests that are identical to others with the same profile. Though it is possible, do not assume that consumers with similar psychographics and behaviors have similar demographics and vice versa. Choosing

new product offerings with broad appeal would certainly be easier if core customers did have similar demographics, psychographics, and behaviors.

Asking consumers questions about their environmental views could indicate an interest in “green” and organic products. Learning about how much consumers entertain, travel, and socialize could also lead to a broader offering of goods such as wines, unique collectibles, authentic ethnic products, and outdoor living furniture. Since consumers may frequently purchase some of these items, helping them live a life that provides them with enjoyment by offering desirable goods and services can certainly be a strategic business decision.

## YOUR PRODUCTS

The options for products you sell can be immense, and if you choose to not restrict what you sell to produce, offering non-traditional (niche) products increases the number and type of products that you could sell. Consider other industries that have incorporated items that at first glance may not “fit” what you would expect a traditional retailer to sell, for example:

- Florists who offer wine tastings and wines for sale
- Wineries that offer bath and body products and jewelry
- Garden centers that offer value-added processed food products and items, such as dog food, birdseed, and specialty coffee, that require them to return to the retailer to replenish their supply

A fruit market could consider selling cutting boards, peelers and paring knives, potholders, or similar goods that tie into the business of being a retail farm market. Other business owners may find that, based on either their loyal or frequent customer base or lack of a competitor in the immediate area, it would be a good strategy to sell home furnishings, gift items, and other goods that complement fresh fruits and value-added products. In some instances, it will be necessary to develop a vignette or place goods on furniture or fixtures that correspond with how to use the good—for example, a display area that looks like a bath or spa to stock the lotions, bath gels, and related goods.

Don’t just guess at what might work; instead, ask customers to share more information about themselves—for example, what activities they engage in during their leisure time, such as gardening and entertaining—to help you make these decisions. Additionally, ask how involved they are in the hobby (e.g., do they have fruit trees, and how often and whom do they entertain in their home), how much money they spend on the hobby, how often they purchase supplies for their garden, what brands of goods they prefer, and whether there are any goods they are not able to find locally but that they would like to purchase. Based on survey responses, including number of participants who participate in a particular hobby—for example, number of participants who have a dog—you can decide whether or not stocking and selling pet products would be a good fit.

Few businesses can remain economically sustainable by offering only one or a limited assortment of goods. Consider selling products that complement your “core” products—those serving as the basis of your business—and display and promote them along with these primary items. Remember that products

can certainly help you differentiate your business from competitors' businesses, so take care in selecting products not available at other local stores. Do a little shopping yourself. If you are considering adding kitchen gadgets to your product mix, what brand could you sell that "fits" your business's persona and that customers cannot get elsewhere in the local community? Or, when you travel, check out a few progressive retailers and evaluate the nontraditional goods they carry. As you look around, watch customers interact with the products. Do they notice the products, pick them up, and purchase them? Develop some criteria that you will use to determine what niche products to sell.

### Value-Added Products

Have you ever sat down and really looked at all you do in a day? Many consumers are "time stressed" and have difficulty finding the energy and time to do even the simplest tasks, such as eating. From the moment they wake up, some consumers are "on the go" and would value goods and services that reduce the amount of preparation or responsibility they must assume to complete tasks. Value-added products are processed products that provide consumers with benefits ranging from saving them time when preparing a meal to presenting them with a product they may not feel comfortable preparing themselves (Figure 10-1).

### Specialty Foods

Some consumers are looking for food products that are unique in some way, which, in turn, command a higher retail price. This price premium is justified based on one or more factors, such as ingredients that are highly sought after or only available in limited



**Figure 10-1.** If you provide value-added light options, don't forget to offer tie-in items. For example, if you provide a recipe and assemble ingredients to make three-berry jam, consider adding canning items to your product mix. This strategy could also increase sales.

quantity, quality, or origin; packaging and brand; and how the product is distributed and manufactured. There is not one single definition of what a specialty food is; however, examples include balsamic vinegar and BBQ sauce with fruit flavors, apple cider with additional fruit flavors, baked goods with nontraditional fruit or flavorings, and even fresh fruit newly introduced to the country or region. Depending on the consumers you serve, you may find that specialty foods are a welcome addition to your product assortment. It is important that you clearly convey to your customers why the food item is worth the price you charge.

Consumer interest in certain specialty food items is on the rise. According to *Specialty Food Magazine*, nearly every category of specialty foods grew in sales between 2010 and 2012, with a dollar volume increase of 22.1 percent. Many consumers seek specialty food items and ingredients that make their meals unique. Consumers often learn about specialty foods through television cooking shows, related magazines, and restaurant meals, as well as from experiences they have with meals when traveling. Be aware of the top two or three trends and determine whether they would be a good fit for your retail outlet.

### Snacks

Selling snack items could be a great opportunity for your business. According to a January 2019 report from Mintel, 95 percent of consumers in the United States snack at least once a daily, and 70 percent snack two or more times a day. There is now a segment of consumers called "super snackers" who snack four or more times per day. Consumers snack for a variety of reasons, including the grab-and-go lifestyle as well as interest in products that help them control portion size. Numerous products meet consumer demand for midmeal or meal-replacement products.

According to a webinar conducted by the Hartman Group ([www.hartman-group.com](http://www.hartman-group.com)), consumers have an interest in snacks made with authentic "global" or "ethnic" flavors. Current popular snack flavors that were the focus of a presentation delivered at the 2019 Sweets & Snacks Expo included:

- Tropical fruit flavors
- Regional barbecues
- Botanical and fermented flavors

Certainly, several other snack food trends need to be considered, including:

- "Natural" snacks
- Gluten-free options
- Low-calorie foods

Deciding on the best snack for your business hinges on a few factors:

- Snacks that complement your current offering (e.g., seasoned popcorn, nuts, or other crunch snacks)
- Your core products and what snacks make sense for your business (e.g., if you are known for local fruits, consider offering your own brand of dried apple slices)
- Flavors or cuisine you currently focus on (e.g., incorporating products with Asian spices)
- Your customer base (e.g., tap into a local ethnic community to which new snack offerings may appeal)

- Equipment needed to process or manufacture and stock new snack items (e.g., freezers or coolers for perishables)

### Customizing Your Product Offering

One way to take the concept of offering unique products even further is to implement mass customization, a way of allowing customers to select from a limited number of components to create a product that is their own. An easy way to think of mass customization is to visualize a food gift basket—individual items (e.g., candy, food products, cooking utensils) are bundled together in a container and then wrapped or decorated to match the theme. However, instead of you or your employees developing the idea/theme/look for the gift basket, let your customers make the decisions, but help them through the process by not overwhelming them with unlimited choices of what to put in the basket, how to decorate the basket, and so forth.

Several retailers have done well with the concept. Perhaps you have even been involved in mass customization yourself.

- Have you ever created a colorful blend of M&M's? If so, then you had a mass-customization experience. There are 24 colors to choose from. Not every imaginable color is available, but Mars (the manufacturer of M&M's) is probably pretty certain that most customers will find a mix of colors that appeals to them.
- Are you a devoted Converse sneaker customer—one that has a pair in almost every color or style? Now you can design your own. Again, you have 24 colors and 24 prints to choose from for the outside of the sneaker and the same options for the inside, heel stripe, tongue, lining, and other sneaker parts.
- Have you ever created a “My American Girl” doll for a young child? You can select the hair color (10 options for blond hair), eye color (10 eye colors available for blond-haired dolls), and hairstyle (7 straight and 3 curly/wavy options for blonds).

Limiting the number of options (e.g., colors, types of items) that consumers can select from is the key to mass customization for small businesses. If you offer too many choices, customers may be overwhelmed. For example, if all components of creating an American Girl doll were available (49 hair colors, 3 skin tones, 40 eye colors, and 40 hairstyles), customers would have several thousand different combinations to choose from. Most likely, the colors/prints/options available for mass customization are those that have been popular in the past. By narrowing the options to a more manageable number, the process is much easier for both customer and retailer, which is why it's called “mass” customization.

If you explore these or other examples of mass customization, you may notice that the price point for the completed product is higher than off-the-shelf (not customized) products or the total price for all individual pieces used to make the final product. This is done to account for the costs associated with offering customers convenience, such as coming up with the concept, gathering the components, and assembling the final product.

In addition to allowing customers to build their own gift baskets in your store, also think about letting them build their baskets online. Consider a customer who wants to buy a thank-you gift for a friend who is passionate about coffee. The gift giver starts the process by first selecting the container (limited number of

options available). Each container holds a certain number of items based on the size of the container and each item, which helps the customer determine how big the final gift will be and not overstuff the basket. Wrapping and decorating then finish the product's look.

Look through your inventory and think about how you could combine items and create examples that you can display in your store and share on your website and through social media networks. Remember, the goal is to allow customers to create a unique product, but you must limit the number of choices, so develop a list of which products and how many would be appropriate for each basket and/or price range.

### Encouraging Purchases

Your customers probably have a pretty good idea of how to use most of your products. Fresh fruit are eaten without any preparation or they can be used as an ingredient in more common dishes; the same with vegetables (Figure 10-2). The value-added products that you offer, such as jams and chutneys, can be spread on toast or crackers.

There is at least a primary and a secondary food use for everything you sell. But there are probably many more ways that your products could be used, and the more ways that customers can use your products, the more products they might purchase.

You might have noticed this strategy on packages of products you buy for your own household or in magazine advertisements. For example:

- A well-known brand of an instant coffee drink suggests using the powder as a creamer in other drinks.
- “Gourmet” jars of peanut butter suggest uses that go well beyond sandwiches. Peanut butter is a perfect ingredient for Thai food, African peanut stew, and other ethnic foods.
- Cereals are no longer just from breakfast; they can be used in casseroles, as breading for meats, and so much more.
- Maybe your soy sauce bottle has been in your pantry or fridge for quite a while and only gets used to flavor rice? A more prominent soy sauce company developed magazines and



**Figure 10-2.** Some consumers might only think of one use for this item, but tomato soup can be thickened to make a sauce, thinned to make salad dressing, added to casseroles, and be an ingredient in several types of chicken stew. They just need ideas, and you can provide them.

online ads with Thanksgiving meal recipes that listed their product as one of the ingredients.

Of course, some of these ideas are not new and novel; and consumers probably have a similar recipe already saved. But, many times, consumers need to be reminded about the multiple uses that a product can provide. To develop a list of ways consumers can use fresh produce and value-added products you sell, search on recipe websites; look at more traditional recipes and substitute one or two of the ingredients listed with unique products to change the flavor, texture, or other attribute; or just brainstorm to come up with new ideas.

### Providing Convenience and Added Service

To complete what you sell, consider some of the services you could offer. Think about some of your own experiences. You probably have purchased a piece of furniture or accessory for your home only to find that the directions were nearly impossible to understand. Projects that retailers predict are going to be easy to accomplish sometimes turn out to be the most difficult for consumers to actually complete. Do you offer a product that your staff could easily assemble for an added charge? Perhaps some consumers would be willing to pay an additional fee to purchase a grill or garden bench that is completely assembled so they don't have to worry about putting fittings together or making sure they are tight enough to prevent propane leakage.

Delivery may be another service that makes sense for you to offer. (For example, then customers would not have to worry about transporting that grill home.) Suggest purchasing other bulky items that can be delivered at the same time, such as briquettes. This can result in reasonable add-on sales.

### Assessing Consumer Response

Once you have your list of potential niche products, your next step is to pretest your ideas with a group of customers. If you'd like to sell lamps, display a few in a prominent location where customers will notice them. Show the lamps in use by creating a small seating area where customers can take a break from shopping. In advertising, whether in print or online, use visuals, too. Often times, consumers need to see how the product is used in situations before they can envision how they will use it themselves.

Do customers notice the lamps and other products you decided to carry? It may take some trial and error, and you certainly don't want to make the decision to delete a new product based on a few reactions. Develop a promotional strategy where the lamps are positioned as a nice addition to what you already sell. Don't forget that if you carry new and unusual products, you need to let the community know. As you work through the seasons and focus on your niche product, keep track of the outcomes of all your efforts. Have you seen an increase in foot traffic (consumers who visit your store) because of the specific ad you created featuring the lamps? Once at the store, do customers purchase the lamps? These are some of the metrics you need to use to judge whether your strategy was a success and whether you should add more lamp options or choose to go another path with niche goods.

So, what will "fit" your store, what could you provide that would differentiate your business from others in the area, and how are you going to proceed after the new product is a success? Or, if your customers would value a different service, could you

offer it? Would you be able to justify costs? Will your customers still shop at your store if you raise prices to cover costs? Do you have customers who are price sensitive? The product-selection process could surprise you and alert you of products that you would never have considered but appeal to customers.

## YOUR RETAIL OUTLET

Consumers may be searching for specific products as they enter your retail outlet and walk down aisles and through various departments. Both consumers familiar with your store and first-time visitors may only walk through a portion of your retail space or not notice all that you stock and sell. Though a majority of U.S. consumers are familiar with the uniform layout of goods sold in grocery stores and supermarkets, smaller agricultural retailers may carry a variety of goods, and merchandise placement will vary from retailer to retailer. By using concepts that are common within the retail industry and other elements that draw attention to displays and categories of merchandise, there is a greater chance that consumers will shop more of the store and notice more items.

Providing shoppers with an area where they can sit and rest is necessary. Why? First, consider "who" will be shopping with a female customer. Will she have a female, male, or child in tow? The situation that will benefit your business the most is if she brings a female companion. She will probably shop the longest (in terms of minutes) when shopping with a friend, and possibly spend more. How much of an effort would it be for you to clear some space near the entrance and create a waiting area for reluctant shopping companions? The issue becomes trickier when your female customer is shopping with young children, which could require you to provide babysitting services, but for an older child or adult companion, placing comfortable chairs, a television, and magazines near the entrance could be the perfect place for the female shopper to "park" her companion. Make sure the space surrounding the seating area has goods for sale and that these items are situated in direct sight of people occupying the chair or bench. If seating is traditionally sold in the retail outlet, be sure to use this as seating throughout the space. Some larger agricultural retailers may have a café on the premises; if so, the seating area should equally be decorated with accessories and merchandise sold in the store.

Though certain consumers prefer to shop online, many consumers still prefer to purchase from an actual retail store. Certain consumer segments truly desire a retail experience, which is much more than just a store with shelving and goods for sale. Consider implementing elements and strategies described in this chapter, and analyze resulting sales. You may still need to make minor changes to further increase sales. Keep the following in mind when considering changes to your product line:

- If retailing is a play, then the outlet is the stage and goods stocked are the props.
- As with any production, consider all elements, making sure they correspond with the overall theme and are presented in the best way.
- The final effect should communicate to the audience, the customers, that the effort was well executed.

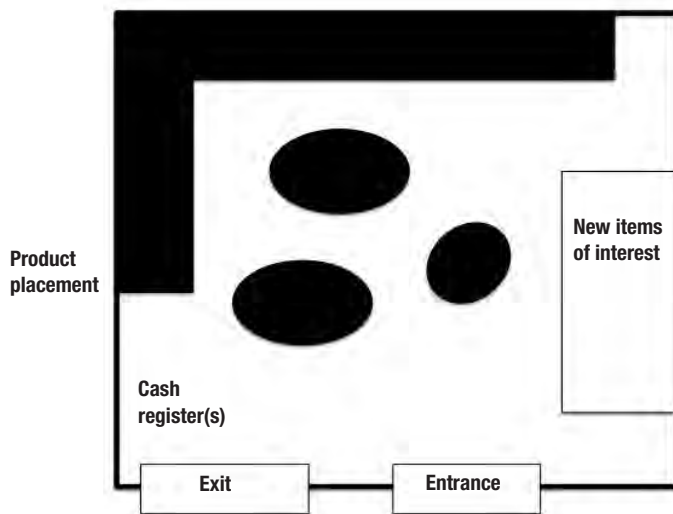

**Figure 10-3.** Diagram showing an example of a retail outlet. The prime selling area is located just past the transition zone.

Whether your business is seasonal or year-round, near a large population center or a “destination location,” considered small or large in terms of sales or retail space, it is necessary to incorporate key layout and design elements that encourage consumers to shop the entire store. Incorporating ideas during the planning stages is easy; however, if the space is already being used, incorporating changes while keeping the shop open for business is still possible. Making changes over time is also a good strategy when budgetary constraints are an issue. Remember, your purpose is to meet consumer needs and wants, so creating a space that is inviting and visually appealing is truly necessary for your business to survive and thrive.

When designing the overall feel of a retail outlet, consider the “feeling” that customers should experience when in the store. For example, if your retail outlet is a small produce store within the center of a city, try to develop an atmosphere that makes consumers feel as if they are choosing freshly harvested produce, or if your store serves an ethnic community, include elements reminiscent of foods’ countries of origin.

Your initial step is to decide on a concept and select building components that support the idea, including materials used to construct the floors, walls, and ceilings of the outlet, as well as wall and display colors, fixtures to place goods on, and lighting to highlight merchandise and focus consumer attention.

So, with such valuable information available, what can you do to turn shopping into an exceptional retail experience? Take a look around your parking lot. Would containers with flowering plants add visual appeal to your outdoor space? What else could you consider adding to make the space inviting? Consumers find the sound of running water to be soothing, so is there space to add a fountain or water feature? Is your entrance clearly marked? Could you guide the consumer to the door by using signage and additional plant material?

### Transition Zone

Within a store there are many “zones” to be aware of that are universal in retail design. After consumers pass through the front

doors of a retail outlet, they enter a space called the “transition” or “decompression” zone, an area described as the first 10 to 15 feet where consumers adjust to the interior environment by removing coats or changing their eyeglasses, preparing children for the shopping trip, organizing lists, or grabbing carts. In smaller stores, the amount of floor space devoted to this function is greatly reduced. Merchandise should be kept to a minimum within this area for two reasons:

1. Customers likely will not notice items placed here because their attention will be on making adjustments.
2. Ample space is needed for these adjustments, and goods placed there would be in the way or could get damaged.

Some retailers will place a small display in this zone to create an “imprint” that customers may remember later in their shopping trip.

### Prime Selling Area

Just past the transition zone is the prime selling area, which is the first one-third of the retail space (Figure 10-3). Within the prime retail area, use the space on the right side to display key items of interest and items that correspond to an upcoming holiday or nonholiday occasion. Change displays in this area frequently. A good rule to follow is that display items should be changed at intervals corresponding with the frequency at which loyal customers visit. For example, if loyal or frequent customers visit an average of every two to three weeks, displays should be changed based on this schedule. At the least, change displays within the prime retail area once a month.

With the number of holiday and nonholiday occasions celebrated in the United States, most agricultural retailers offer some selection of edible and nonedible goods that coordinate with these celebrations. As seasons and occasions pass, remove merchandise from this area and incorporate it with goods displayed in the remainder of the retail outlet, and then introduce merchandise appropriate for the next holiday or occasion into this prime selling area. Use of color becomes even more important beyond the prime selling area. Use accent colors, signage, and visual displays to draw customers down aisles and encourage them to walk throughout the remainder of the sales floor.

### Product Display Height

There are some general rules to follow when displaying goods in a retail outlet. Goods placed at eye level will garner more attention than goods placed below waist level. Use benches, shelves, and other display materials to move items from the floor to waist level or higher. Moving items from the floor to a table top makes them more noticeable and prevents customers, especially those who might have physical limitations, from bending over to pick up items.

Goods can be placed too high as well as too low. Avoid placing items on shelves or fixtures that consumers will have to reach for. This can be an annoyance for consumers and a liability for you, the retailer, should the item fall. Though using this space to store excess goods or to create displays and promote ideas is reasonable, keep additional quantities nearby so customers can see and select from them rather than reach above their heads. If necessary, place small signs around these elevated displays to let consumers know where they can find the items for purchase.

## Rotating Displays

Most retailers decorate for the winter holidays, or at least will do so after Thanksgiving. Nevertheless, all retailers should understand the importance of changing the “look” of their outlets on a regular basis, whether it is a display, a window, or how customers will walk the floor: If you keep products displayed in the same location or do not rotate merchandise in key sales areas, it is likely that repeat customers, who are accustomed to purchasing one or two items and then leaving the premises, will never notice items other than what is on their list. By moving “anchor goods” (items purchased often and that “draw” consumers to visit the retailer) to other locations or mixing seasonal goods in with more commonly stocked items (so that customers looking for holiday decorations will notice other products), customers will certainly notice items that they may not have considered or even realized were stocked and sold.

Aside from rotating merchandise, another way to periodically change the look of a display or draw attention to a particular area is to set up temporary and portable backdrops that complement products placed in front. One way to achieve the goal of easily and cost-effectively changing a backdrop is to hang fabric. Along with being relatively easy to store, fabric is available in many colors and textures, providing a realistic solution for retailers who may not have a large floor space and are limited in how they can rearrange merchandise.

Again, completely rotating or redesigning the entire retail space at this frequency is not necessary; rather, find something you can change easily that customers will notice.

Retail layout and design is certainly a combination of science and art—key elements work to create a smooth flow and transition for most retail outlets, while other components depend on an overall theme for the space. The main idea is to design the space so that all aspects work together toward the goal of creating a space that is visually appealing. You will need to continually update the space and make significant changes to wall color and fixtures as trends change and the space needs to be refreshed. To fit within a more modest budget, institute changes from the front of the store toward the back, as one region is finished another is started. Be careful, consumers are likely to make decisions about objects you sell or the environment you’ve created in less than two minutes, making display and layout as important as the products you offer.

## Anchor Goods

Another strategy to encourage consumers to walk throughout your retail space is to identify the goods that attract the most consumer attention and are purchased frequently. These goods are referred to as “anchor goods.” Draw up a list of anchor goods, and then disperse these pieces throughout your retail outlet. Just as milk and bread are placed in the back, corners, or sides of the grocery store, anchor goods sold by an agricultural retail outlet should be used in same way. Anchor goods may change throughout the seasons, so analyze sales and use these data to decide which 6 to 12 goods are anchor goods and how to best place and manage them within your retail space.

## “Grab-and-Go” Items

It would be ideal if consumers had the time to leisurely walk through your retail store; however, for those days when they

truly have more on their to-do lists than time available, think of ways you can arrange merchandise within the store to provide convenience to these “grab-and-go” customers. In most supermarkets, food staples such as milk and eggs are placed along the back wall. In more progressive stores, however, a cooler placed by the checkout is stocked with some of these same goods. Instead of maneuvering through the produce department and cereal aisle, customers can just grab the milk and go, thus saving time.

Consider the three or five goods your customers are likely to buy from you when they’re stressed for time. If your business is a full-service market, milk might be one of these items. Other goods might include seasonal items that would change this display throughout the year. To determine what items to include, figure out which items are purchased most frequently, and then evaluate how customers react to the display and their resulting purchases.

## Cross-Merchandising

If you walk through a typical supermarket, you are bound to find some ideas that you can adapt to your retail outlet. Have you ever noticed how supermarkets cross-merchandise their goods so the pasta, marinara sauce, cheese, mushrooms, and recipe cards are placed in the meat department next to hamburger? This common location makes it very easy for those who want to prepare a spaghetti dinner but don’t have the time to walk throughout the supermarket to gather all the ingredients. You can do the same in your agricultural retail outlet.

Perhaps you sell not only tree fruit products but also gardening goods, such as tools, fertilizer, plants. If so, cross-merchandise goods that complement your apples, pears, and apple sauces as well as use complementary items to build displays that include containers, potting media, a selection of coordinating plants, whimsical plant tags, container accessories, watering cans, and planting instructions and suggestions for color combinations. Though you are not doing all the work for your customers, you are taking the guesswork out of the equation. Grouping these items together can relieve shoppers from spending too much time hunting for all the necessary “ingredients.” In addition, they become aware of tie-ins, such as ceramic plant tags, small flags, embellishments, and clay “pot feet,” that they may not have seen in other sections of the store.

## Floor Plan Layout

There are several issues to consider when designing the layout of the retail space and building the floor plan.

- Position shelving, display cases, and signage to encourage customers to walk throughout as much of the store as possible.
- Make sure aisles are at least nine feet wide so two shopping carts or strollers can pass each other from opposite directions. If shopping carts are not used, two customers should be able to walk past each other without bumping.
- Lay out aisles to promote a counterclockwise walking pattern that customers are comfortable with when moving throughout the store.

When deciding how much of the floor to allocate to merchandise display, a good rule to follow is that 40 percent of the floor space should be used for displaying goods while the remainder



should be used for aisle ways and to encourage browsing without crowding. Though several layouts can be used in a small to mid-sized retail outlet, almost any layout can be altered to fit within a confined space.

- A grid-style layout has a “crisscross” pattern with two main aisles that bisect each other and usually creates four equal-sized coordinates.
- A loop layout creates a traffic flow where customers enter the retail space on the right, are lead though the outlet in a “racetrack” fashion, and then exit the space on the left where the checkout is positioned.
- A free-flow layout is more unstructured and relies on a variety of colors, wall textures, heights and shapes of fixtures, and signage to draw customers throughout the space (Figure 10-4). This layout is used frequently in boutique stores. It is important to use display cases and tables that do not block customers view of the back of the store. Instead, displays should gradually increase in height as customers move toward the back of the store.

Even after giving a good deal of consideration to the layout, the following scenario is likely to happen: customers will walk down the main aisles, see the merchandise they desire, walk to the merchandise and place it in their basket, and then return back to the position from which they started—they are “boomeranging” back to their starting location without further exploring the rest of the department they just visited. Use color (to attract shoppers) and signage (to direct them to other departments) to encourage customers to continue walking throughout the store rather than adhering to this boomerang effect.

As with color, a part of the decision regarding the layout will have to do with the concept for the retail outlet. An upscale retailer might consider a free-flow layout, while a retailer who sells multiple quantities of smaller items, such as groceries, and needs to stock these items on more uniform and structured shelving and display units may consider using a grid-style layout. Finally, a combination of layouts can be used—for example, you can position a free-flow layout at the front of the store to display accessories and use a grid-style layout in the back to display items in multiple quantities.



Figure 10-4. An example of a free-flow layout.

## Wall Color

Color is a critical factor in retail design; it can be used alone or in combination with other surfaces such as exposed brick or paneling. According to some sources, consumers make a subconscious decision about a person, object, or environment within 90 seconds, with color accounting for 60 percent of this decision, favorable or otherwise.

Several strategies are available for consideration when deciding on a color for the walls. The first is to use a color that builds off the main theme for the outlet. For example, walls in a retail outlet where ethnic food is sold or where a certain ethnic group shops could be painted in a color palate that is important to this ethnicity. Overall, the color preference among the major ethnic groups in the United States is blue, with secondary preference being purple for African Americans and Hispanic Americans, red and pink for Asian Americans, and green for European Americans. A second strategy is to consult resources such as the Color Marketing Group ([colormarketing.org](http://colormarketing.org)) or Pantone ([pantone.com](http://pantone.com)). Both groups predict colors that will be important to the fashion and interior design industries. An additional strategy would be to paint the walls with a neutral color and use more vibrant, monochromatic colors on select walls that will serve as focal points. For example, the walls or backdrop for a space where new merchandise will be displayed could be painted a shade of yellow or red—colors that in some instances have proved to attract consumer attention—to make the space distinctive.

Whatever method you choose, you need to consider the color of the goods that you will place in front of the colored wall or backdrop. Items that are clear, white, or cream work well with almost any color, while red packaging may not look visually appealing if placed in front of a blue background or other contrasting color. Using drapes and colored fabrics to provide color and depth to a space will allow you to easily change the color of the display area throughout the year.

## Flooring Material

A number of flooring materials are available for use in a retail space. When making the final selection, consider how the look of the floor will complement, but not overpower, the rest of the design components. Consider whether or not the floor will become wet at any time during the day, if shopping carts will be pushed along the floor, if the floor will be exposed to excessive sunlight, and what amount of upkeep will be needed. Wood flooring, even distressed flooring with scratches and minor imperfections, can help turn a space into a cozy atmosphere. The sound of footsteps on wood flooring is very distinctive and the material itself is easy to sweep clean. Tiles can also be used and installed in many different patterns.

Carpeting or small area rugs can be used as the foundation for small vignettes or to create designated spaces. Not only does flooring help create the overall atmosphere within a retail space, but a change of flooring can actually moderate customers’ walking pace. Many times, when consumers walk onto a carpeted space from a wood floor, they will actually slow their pace. Consider using this strategy if you want to plan areas where you would like shoppers to stop and linger. A less permanent option is to install one type of flooring and then place rugs in strategic locations and move them as needed.

## Ceilings

Though not the primary surface in a retail outlet, the ceiling should not be ignored. Changing the surface of existing ceilings that are not visually appealing may not be feasible; however, you can attach fabric to the ceiling to mask discolored or cracked ceiling tiles. If ceilings are too high and seem to detract from the overall feel of a space, you can also use fabric to “lower” the height of the ceiling. Fabrics can be changed frequently and colors can be coordinated with displays, seasons of the year, and holidays that are being celebrated. Aside from fabric, consider other options such as hanging accessories that are meant to be hung in homes or gardens.

## Music

Give some consideration to the music you play in your retail outlet. Research suggests that music should be played and that the beat of the music can influence the pace at which consumers walk. In addition, the type of music that is played can also give the impression that products are either expensive or inexpensive. Other sources suggest that retailers choose “light jazz” since it promotes a moderate walking pace and appeals to a broad spectrum of consumers. Be aware that associations such as the American Society of Composers, Authors, and Publishers, as well as radio and television stations, require retailers to purchase licenses in order to play recorded music or programming.

## After-Hours or Nonpeak Use

As a retailer, one of your goals is probably to use your retail space to the fullest. You may have a site that is large enough and appropriate for weddings and receptions, but how else can retailers “sell” your space, or at least areas away from the general public, during nonretail hours? You’ll have to consider whether or not you have the staff willing and available to work after hours, and if the after-hours or the nonsale peak time you have available would appeal to groups or organizations. Also, do you have ample parking, restrooms, and tables, chairs, etc., that groups might need for their event?

You may have considered ideas for using your space that include hosting parties, allowing clubs to rent out an area for meetings, holding a local wine judging event, or even staging engagement, maternity, or family portraits. Your space may also be appealing to those who are seeking a unique location for engagement parties and rehearsal dinners. If you do not have a restaurant on the premises, be sure to develop a list of caterers that you approve of to make the host’s job easier. Think of what other services might be necessary for a successful event and create a list of them, too.

## Mobile Payment Systems

It is becoming more common, but certainly not the rule, to shop at a store or visit a restaurant where the salesperson or server takes your order on a mobile device and/or uses a device to process your payment and even authorize the transaction by having you use your finger to provide your signature, and then asks if you would like receipt emailed to you instead of handing you a printed copy. Such transactions may or may not be much faster than a traditional transaction, but some customers may find them

more convenient since they do not have to wait for the receipt to print (or wait for the server to add a new roll of paper to the receipt printer) or search for a pen or use an electronic stylus that is often tethered to credit card terminals.

Recent statistics indicate that 85 percent of U.S. adults own a smartphone with capabilities that allow users to download apps, such as those used to make mobile payments. We also know from reports that the most popular activities conducted on smartphones are messaging and social media. The following data describe purchasing using smartphones and tablets:

- In 2018, 36 percent of tablet and 45 percent of smartphone owners used their devices to shop online.
- Almost a third, 31 percent, used their smartphone for mobile payments.
- An even greater percentage of smartphone owners used their devices in a store to search for product or service reviews (69 percent), compare products or services (58 percent), learn about product specifications (55 percent), and search for deals or discounts that can be applied to the product they are considering purchasing (53 percent).

## Benefits

An advantage of using a mobile payment system is that businesses can process payments in remote locations. Consider situations where you have been in the process of selling your goods or services and credit card users were not able to make a purchase because you only had cash available to make transactions. Below are some situations in which a mobile payment option may be useful:

- While delivering products to customers’ homes or to other businesses, you can collect the payment immediately instead of waiting for them to mail a check or call to make a credit card payment.
- You can provide more payment options at a farmers market or food tradeshow.
- You sell trees out of a far corner of your farm; instead of having customers drive to your store to make a payment, you can process the payment right in the tree lot.

Aside from flexibility these systems provide for your customers, your business may also benefit:

- These systems capture a fair amount of customer information, which can help businesses create (or take the place of existing) loyalty programs.
- Funds are transferred to the business more quickly, reducing the transaction time from days to hours.
- Most mobile payment companies do not charge a setup fee or a monthly fee to use their system.
- There may be little or no requirement to purchase equipment (if you already own the required smartphones/tablets).
- Though percentage processing fees, ranging from 1.74 to 3.7 percent, are applied to each transaction, some companies have eliminated the per-transaction charge, which can range from \$0.10 to \$0.30.

## Equipment

You will need at least one of the following for most basic operations:

- Smartphone
- iPod touch
- Tablets (e.g., iPad and Android)

Other systems allow business owners to expand their functionality when they use additional devices. Square, for example, provides a card reader for “anywhere” payments but also turns iPads into a Square Register with an additional app ([squareup.com/register](http://squareup.com/register)). Thoroughly investigate each reader you are considering. Some are compatible with Android phones and/or Blackberry, while others are not.

## Readers for Swiping Credit Cards

With credit card terminals already using card swipe readers to process payments, many businesses may feel most comfortable investing in a mobile payment system that uses a similar type of tool. The most common type of reader for swiping cards is a “dongle” that plugs into either the headphone jack on a mobile device (e.g., Square). Google Pay is a mobile payment app that first requires users to link their account with a credit card or debit card. When at the store, customers “tap” their phone against a near field communication (NFC) reader/credit card terminal. Apple Pay is a similar payment system iPhone users can use in retail stores.

## Comparison of Costs

Transaction fees and other costs are likely to change as this technology becomes more widely used and as more competitors enter the marketplace. You will need to consider the costs for processing each type of credit card you honor, as well as whether there is a per-transaction charge. Consider using websites such as [squareup.com](http://squareup.com) that allow users to enter an expected monthly revenue and select whether credit cards are processed by swiping or being keyed in for several different brands of mobile reader companies.

What other costs should you consider? Based on your average customer transaction size, how much will it cost you to use each system, and will knowing this cost help you make the decision between two or more systems? An example from [Valuepenguin.com](http://Valuepenguin.com) shows how transaction fees impact sales. For example, Square, which the source suggests is best for mobile processing, charges \$0.28 for a \$10 transaction, while Stipe, which is suggested for on-line merchants, charges \$0.59, nearly twice the amount of Square’s fees. For a \$200 transaction, Square would charge a fee of \$5.50, while Stripe’s fees would be \$6.10, a difference of \$0.60. Make this comparison for yourself based on common sales transactions you process. With several variables to consider, including how you would prefer customers pay for purchases, take the time to investigate several systems to find the best one for your business.

## Security Considerations

### What is at stake?

Many businesses have been able to process credit cards with mobile payment systems without experiencing any problems. However, there is always the possibility that you could experience a security breach (though not restricted to using a mobile device to collect payments but applicable to every method you use to collect cardholder data) with consequences that include:

- Cost of reissuing new payment cards
- Fines
- Termination of ability to accept payment cards
- “Going out of business” ([bit.ly/1iwnFUd](http://bit.ly/1iwnFUd))

As you can imagine, and maybe it has happened to you, it is easier to misplace a smartphone or other mobile device compared to a register or computer that is either tethered to something or too heavy or bulky to just carry off without anyone noticing. A safeguard that is suggested includes securely storing the device—in a safe, for example—when not in use or fastening the device to a heavy, bulky item (such as a desk or counter) with a combination lock and cable, much as you would a laptop or desktop. Concern is further based on “traditional security controls such as [anti-virus], firewalls, and encryption [not having] reached the level of maturity needed in the mobile space” ([bit.ly/1ftLIm3](http://bit.ly/1ftLIm3)).

## Protecting consumer data

If you are not already familiar with the PCI (Payment Card Industry) Security Standards Council, they work “to educated stakeholders (merchants, processors, financial institutes, and similar) about the PCI Security Standards . . . and promotes the awareness of the need for payment data security to the public” ([www.pcisecuritystandards.org](http://www.pcisecuritystandards.org)), in essence “keeping your customer’s payment card data secure” ([bit.ly/1ix8PN3](http://bit.ly/1ix8PN3)). Retailers that accept credit cards are required to be compliant with the standards.

The PCI also has resources for small businesses, which they consider to be more vulnerable to security breaches than large companies, and several short videos to further demonstrate how retailers can protect consumer data ([bit.ly/1rZWa5e](http://bit.ly/1rZWa5e)).

The PCI strongly discourages what is referred to as BYOD (bring your own device), which involves employees using their own mobile devices to process consumer credit card payments. Instead, the device should be owned by the business, regardless of whether it is used solely for “payment and acceptance for transaction processing” or for both business and personal tasks ([bit.ly/1hayiqv](http://bit.ly/1hayiqv)).

Some companies buy corporate-owned personally enabled (COPE) devices that they distribute to managers and other employees who process payments at remote locations. In such instances, these businesses permit employees to use the device for both business and personal use. This allows the business to install and update software that might not necessarily be appropriate for an employee-owned device ([bit.ly/1iCHYyj](http://bit.ly/1iCHYyj)). Updates can be pushed to devices and the business can seize the device when needed. This particular arrangement is not unreasonable as employees are often provided with desktops, laptops, and tablets to use in their homes and when traveling.

In addition to informing employees about how to handle, use, and store mobile devices, it may be prudent to include background checks during the applicant screening and hiring process ([bit.ly/1ftpQaA](http://bit.ly/1ftpQaA)), if you do not already. Some prehire background checks include requesting credit and criminal records ([1.usa.gov/1uvVxV9](http://1.usa.gov/1uvVxV9)). Businesses that ask employees to handle payments, regardless of whether or not they are mobile device based, have the right to require such background checks ([1.usa.gov/1o36hbK](http://1.usa.gov/1o36hbK)).

### Basic mobile device security policies

The following are some of the more recognized security policies that you should implement:

- Don't store any sensitive cardholder data on the mobile device—or on any electronic equipment for that matter. If you are using the smartphone or tablet and/or a mobile app to save customers' addresses, birthdates, etc., for the purpose of keeping track of purchases (i.e., loyalty program) take steps to encrypt the data and only collect and store what is absolutely necessary.
- Be selective about what apps you download to the device and question why apps might need access to contacts, calendars, location services, etc., on the device.
- Require each employee who needs to have access to mobile devices to have a unique username and password.
- Employees should be trained on how to properly use the device and owners should educate them on how to maintain device security.
- Don't "jailbreak" or "root" your devices (iPhone, iPad, iPod Touch, Android phone or tablets). Jailbreaking or rooting a device allows the owner to download "additional applications, extensions, and themes" not available at the Apple App Store ([bit.ly/1luD6Mb](http://bit.ly/1luD6Mb)); however, Apple states on its website that doing could shorten battery life, allow for security vulnerabilities, cause apps to crash, prevent future software updates, and so forth ([bit.ly/1iDCiEq](http://bit.ly/1iDCiEq)).
- Update your operating software. Often you will get a notification, but check the setting on each device often in case a push notification doesn't go through.
- Keep apps up-to-date, too.
- Beware of phishing emails (emails from individuals posing as legitimate companies with links to malicious software) and SMS texts. Don't click on any hyperlinks or URLs that look suspicious.

All these procedures and other applicable best practices should be included in your employee handbook and operations manual. Just as you would expect your employees to adhere to a code of conduct when dealing with customers, you should expect the same for those who have access to business-owned mobile devices.

### What cyber liability insurance can offer

You may already have a comprehensive insurance policy or riders that protect your business in case of theft, fire, disaster, and even when essential employees are unable to perform their duties. As mobile payment systems and threats to these systems have evolved, so has the insurance industry. Cyber liability insurance is one such addition that "is designed to protect businesses" from:

- Lawsuit damages
- Lawsuit defense costs
- Breach notice costs
- Data restoration costs
- Breach extortion costs ([bit.ly/1iUntyb](http://bit.ly/1iUntyb))

The following site includes a list of questions that can help you assess your level of risk and issues that should be discussed

with an insurance agent ([bit.ly/1rZK0sX](http://bit.ly/1rZK0sX)). Just a few of those listed include the following:

- What security controls can you put into place that will reduce the premium?
- What is expected of you to reduce or limit the risks?
- What and how big [of] a difference to your future premiums will a claim make?
- Do all portable media/computing devices need to be encrypted?
- Are malicious acts by employees covered?"

This source further suggests asking potential insurers if you, the small business owner, will have to participate in post-claim tasks (e.g., alerting customers about the breach) or if they provide "a point of contact" to oversee all processes after a claim is initiated.

### What might cyber liability insurance cost?

Of course, costs vary by type of business, geographical market, and factors that impact your general policy (e.g., number of policies held, number of claims within a certain period), but according to one source, "A cyber add-on to an existing liability policy might cost \$300 a year while a separate policy could cost \$1,000 or several multiples of that" ([bit.ly/Sxrgqv](http://bit.ly/Sxrgqv)). Other sources state that policy premiums can be much higher ([bit.ly/1sher7Q](http://bit.ly/1sher7Q)). Having cyber liability insurance may "pay off" even if a claim is never filled. According to one source, "Cyber insurance also can help boost your business by giving customers and business partners more confidence in you" ([bit.ly/Sxrgqv](http://bit.ly/Sxrgqv)).

### After a breach is detected

So, what do you do when you experience a security breach? Insurers and IT security experts stress notifying the authorities and your insurance company as soon as a breach is expected. Also, finding and repairing the breach quickly is crucial, as well as keeping records of all procedures that were followed after the incident, in addition to having a good record keeping system to begin with ([bit.ly/1uwoAb3](http://bit.ly/1uwoAb3)).

Though no one ever wants to experience this type of disaster, taking precautions, being diligent in your practices, and staying prepared is a must. As our use and dependence on technology grows, and with all the associated benefits and advantages such systems provide, business owners will need to be aware of the possible security situations they could face.

## PROMOTIONS

Using what you know about your customers' attitudes and behaviors, you should be able to create or enhance your promotional strategy, which encompasses paid advertising, in-store promotions and loyalty programs, and social media.

Consider investing in your relationship with your customers by offering them an incentive to purchase your products. Develop your own frequent-buyer program. Send coupons on promotions that reward your active customers, thanking them for their business. If some of your active customers reside in a certain neighborhood, target households in that area. Send out

a flyer advertising your weekly specials and the merchandise you wish to push. Enclose a “first-time buyer” certificate with a survey form on the back to ask these potential customers about their preferences.

Every time consumers hear your name or see it in print, whether you pay for the exposure or others are spreading the word, each effort results in an impression. Overall, these impressions help promote your business by informing and reminding consumers about the solutions you can provide them and persuading them to shop at your retail outlet. Promotion can include several different strategies:

- Purchasing advertising
- Developing a social media presence
- Sending direct mail or email messages to current customers or those with a similar demographic profile
- Creating in-store promotions that highlight product features and benefits
- Hosting events to drive foot traffic to your retail outlet

Whatever approach you choose, be sure to assess whether the efforts you exert—both the time and the money you spend—result in a beneficial outcome for your business.

### Pretesting Your Promotion

Involving consumers in the process of developing and evaluating any promotion, either informally or formally, is an essential step in the planning process. One option is to conduct a focus group session. Focus groups are simply in-depth conversations among small groups of consumers (usually eight to twelve) about a particular set of topics. You will probably get each person’s input by including only a limited number of participants. But, this data should not be the only source you use for making business decisions. Rather, think of focus groups as a starting point for selecting products, making future business decisions, and choosing questions to include in additional surveys. For example:

- If you are using an image in a print publication or on the Internet to promote an event, does the image appeal or detract from the message you are trying to convey?
- If you are developing a new loyalty program and a piece to promote it, do your customers understand the purpose of the program, its benefits, and how to get these benefits? Does the loyalty program truly entice customers to visit your outlet or webpage to make a purchase?
- Perhaps you are planning on carrying and promoting a new seasonal item. How far in advance would consumers like to see the advertisements so they consider buying the item?
- How would consumers prefer to learn about new products (e.g., through social media and/or when visiting your store)? If your customers prefer social media, are you using the social media networks to which your customers subscribe?

You can conduct focus group sessions online using tools such as Google Groups ([groups.google.com](http://groups.google.com)) or Yahoo! Groups ([groups.yahoo.com](http://groups.yahoo.com)) or create a group on your Facebook business page. These can be used to create a group and invite others to join and read and post messages. Additional features for both tools allow users to read and post messages online or view and respond to messages that are sent to their email addresses.

Assembling one group of customers who are loyal and another with customers who purchase less frequently will provide input from a cross-section of those who shop at your outlet. Prepare for the session by developing a list of questions and providing a sample product available that you’d like to discuss, and ask your consumers to express their views, opinions, and thoughts. The outcome of the session may help reveal potential problems or issues.

### In-Store Promotions

If you offer a food item that is new to your region or with which your customers are only slightly familiar, they may be slightly, if not completely, resistant to purchasing the item. For example, an item like jackfruit may cause shoppers to take a second look, but consumers may not find this product visually appealing and choose not to buy it based solely on how it looks. Educate consumers about new products so your introduction of these new goods does not fail. The more information a retailer provides, the more consumers will rely on them to meet their needs, thus developing the relationship between retailer and consumer.

Consider implementing one of the following to inform consumers about the new item:

- Signage that describes the item’s flavor, how it could be used, and how easy it is to prepare (Figure 10-5). Try not to overload the customer by making the sign too busy with words; rather, pick three brief yet informative points to include on the sign.
- Make the new product the “item of the week.” Add extra signs throughout the store to alert customers of the new addition, either with or without an introductory discount.
- Keep the featured product near other like or complementary items, but also position smaller batches for sale and other items consumers tend to purchase frequently near the register.
- Customers will need your ideas on how to use the product. Provide consumers with some inspiration by developing a recipe that uses the featured product and placing it near or attaching it to the featured product. If you use newsletters to reach customers, be certain to include the recipe(s) to encourage repeat purchases.

Consider using the item as a component of something that can be referred to as “value-added light.” Select a recipe that lists the featured product as an ingredient along with a few other products you offer. Assemble the ingredients you sell in quantities appropriate for the recipe, package them together, include a recipe, and showcase it in a prominent place in your outlet. Also include a shopping list with items or ingredients needed for the meal but that you don’t stock or sell. This way you haven’t taken away all the work for consumers, just the guesswork of what they will need to complete their meal. Can you gather the ingredients you sell, including the jackfruit, and promote it with a corresponding recipe? Most likely, several recipes are available for you to use as the basis of “value-added light” products.

Perhaps you have the space and labor available to provide consumers with samples of new products. If so, why not allow them to try the item before they buy it? Samples reduce customer risk and buyer’s remorse and may increase customer satisfaction with your retail outlet (Figure 10-6). Though “unmanaged” sampling—placing the product on tables alone and having consum-

ers serve themselves—is an easy option, having an employee handout samples and recipes, guide customers to the shelf where the product is stocked, and provide additional information on how to use the featured product may significantly increase sales.

Sampling can also be an effective option to promote nonedible items like lotions or soaps. Having testers that customers can freely use on the sales floor, in restrooms, and near the cash register is appropriate and encourages them to try the product, thereby lowering the risk of buying a fragrance or formulation they may find offensive.

Visit a few retail outlets that appeal to your target customers and see how they are using signage and product placement. What works for them might just work for you. Whatever strategy you choose, be sure to evaluate your return on investment (both monetarily and in terms of labor). Did placing more signs that highlighted uses and benefits pertaining to the product throughout the retail outlet increase sales? Did developing and publishing recipes or creating “value-added light” packages have a positive impact? You can also develop related questions for sampling and other promotions. Keep in mind that strategies that work for one product may not work for another and that you may need to expend more energy to encourage sales of “unique” items compared to items with which consumers are already familiar.

### Cause Marketing

Although profits should not be the primary reason for building a cause marketing program into your promotional plan, it is suggested that consumers “feel good” about spending their money on goods that support a cause. According to the 2017 Cone Communications Social Impact Study ([bit.ly/2eWv4OU](http://bit.ly/2eWv4OU)):

- A majority (87 percent) of U.S. consumers “said they’d purchase a product because that company advocated for an issue they cared about.”
- Compared to those who responded to the survey in 2013, a greater percentage of 2017 survey participants had “a more positive image” of “companies that support social and environmental issues” (92 percent versus 85 percent), while a greater percentage of 2017 participants were “more likely to trust” such companies (87 percent) than those who responded



**Figure 10-5.** Signage describing the item’s flavor, how it could be used, and how to prepare it.

to the question in 1998 (66 percent). Slightly fewer 2017 participants (88 percent) responded that they were “more loyal” to “companies that support social and environmental issues” than those who participated in 2013 (90 percent).

### What to Consider When Developing a Cause Marketing Program

With so many local, national, and international causes already being supported by your customers’ generosity, how can you compete with them and the businesses that sponsor them? Consider the following, which could help bolster your cause-marketing program:

- Make sure that the donation process is transparent. For each dollar that you collect, you need to show how and where these funds were distributed. Consumers who do not see any progress associated with the money they donated may very well choose not to donate anymore. Be sure to indicate on your website, in your promotional activities, and in-store that money collected helps to do great things.
- Consider a cause that has a natural connection with your business. Perhaps a member of the business has suffered from a disease and could benefit from a donation. If this is the case, ask him or her to be the “face” of the effort. Often consumers are more likely to donate to a cause if “presented with a personal case of an identifiable victim” through pictures and stories, “something that purely engages the emotional system” ([whr.tn/1uosBjl](http://whr.tn/1uosBjl)). Another aspect with a connection to your business could be an environmental issue that greatly impacts your city, state, or region.
- Promote that you are also accepting donations. In addition to selling a product or two where the proceeds go directly to support the cause, let customers know that they can also donate funds to the cause. You, as the business owner, may assume that consumers would automatically understand that there is more than one way to support a cause; however, it may not occur to consumers that they can make a donation in place of making a purchase.



**Figure 10-6.** Sampling helps reduce consumer risk.

- Involve customers in selecting the cause. Two separate strategies can be used to involve consumers in selecting the cause:
  1. Ask consumers to nominate a cause and ask consumers to select (by vote) the one that will receive all the donations.
  2. Allow consumers to determine which cause receives the profits from the bottles or other merchandise they purchase. This technique is what ONEHOPE Wine has embraced ([www.onehopewine.com](http://www.onehopewine.com)). The brand donates half of all profits to a list of causes, including Cure Alzheimer's Disease, Support Our Veterans, Save Our Planet, and several others. Each wine is associated with a specific cause. For example, half of the profits for the 2012 ONEHOPE California Merlot go to support END7, which "raises awareness and funding necessary to control and eliminate the seven most commonly neglected tropical diseases (NTDs) by 2020" ([bit.ly/1v7yJgv](http://bit.ly/1v7yJgv)), while half of the profits for 2012 ONEHOPE California Cabernet Sauvignon support children with autism.
- Involve employees. Finally, employees should be asked to do more than just collect donations or indicate what purchases support the cause. Involve them in the process of selecting the cause and associated administration needed to support events or activities. The more employees support the effort, the more likely they are to alert customers that your business is involved in collecting donations to help those in difficult situations.

## Loyalty Programs

### What Should a Loyalty Program do for Your Business?

Your loyalty program should help increase your tasting room's profit. A white paper written by Sports Loyalty International, Inc., outlines some of the general benefits of creating a loyalty program ([bit.ly/1GV7R5M](http://bit.ly/1GV7R5M)). By enrolling in the program, members:

- May be less likely to "defect" and purchase from another winery
- Could increase their spending over time
- Could be more responsive to promotions, which could reduce your marketing costs since you will have information about their preferences and habits, allowing for a more targeted promotional effort
- May shift spending to "higher margin products"
- Could refer your program to friends and family based on their positive experience

### Developing an Outline for Your Loyalty Program

The great thing about offering a loyalty program is that customers understand their basic function, as they most likely belong to other programs. Regardless of the type of program you offer, consider these key concepts:

- Your overall goal: what do you hope to achieve
- If you will charge customers to join the program, limit the number of members, or if enrollment will be free
- How customer purchases will be recorded
- Questions to ask members that will help enhance the program and their experience

- What purchases will "count" toward loyalty program benefits, what can members redeem points on, and if a program co-developed with a complementary business could be perceived as being even more attractive
- How you will determine that loyalty has really been established
- How and when you might need to end the program and steps for doing so

### Your Overall Loyalty Program Goal

Each loyalty program that you participate in was (hopefully) designed based on a goal that the business felt would help boost profits. As with the other goals and objectives that you develop for your business, you will also need to think about what you hope your loyalty program will achieve. Though not an exhaustive list, which of the following might be the most appropriate for your business?

- Incremental rewards. Your program might give all members a particular reward, but once consumers spend a certain amount they would be entitled to more attractive and significant awards. You may even consider an "elite" tier that offers even greater rewards when "X" dollars are spent, either on an annual basis or over the lifetime of the program.
- Upsell. A program that falls within this category would allow members to apply a 10 percent discount (for example) when they purchase at least \$50 of wine and a greater discount when they spend even more.
- Encourage repeat purchases within a certain period of time. As with one very popular coffee shop program, members earn rewards not on the dollar amount that they spend but the number of times they frequent the business and make a purchase. A basic membership, where participants only need to visit the shop once in a 12-month period, yields a single reward. If the customer visits "X" number of times in a year they get an even more appealing reward, regardless of the total dollar amount that is spent.

Each of these loyalty program goals could very well encourage customers to spend more. If you choose to focus on a program that provides incremental rewards, you could send an email at the beginning of each season that includes a tabulation of purchases to date and indicate the amount needed to achieve the next level. This could encourage some "basic" members to move up in the ranks and eventually become "elite." The same could be done if your goal is to encourage repeat purchases.

Though it is suggested that members are fully aware of the rewards they receive based on their spending/visits, it is also suggested that you acknowledge members with "surprise and delight," a special reward when they spend a certain amount, visit "X" number of times, or have been a member for a certain period of time. These surprises do not need to be extravagant, but thoughtful and of value to the customer.

### Gamification

There has been a bit of discussion as to whether loyalty programs based on discounts awarded for purchases actually generate loyalty, or if customers purchase from retailers only when merchandise is on sale. Though not a new concept, gamification, according

to Bunchball (<https://www.bunchball.com/gamification>), is “the process of taking something that already exists—a website, an enterprise application, an online community—and integrating game mechanics into it to motivate participation, engagement, and loyalty.” An example includes McDonald’s Monopoly game that provides customers with game pieces based on food purchases. Like the Monopoly game, when a certain number of properties (in this case, game pieces that represent each property) are “obtained,” they can be traded in for the associated prize.

The following are a few game mechanics that gamify.com and Diana Garcia (2018) suggest motivate and engage users:

- Leaderboards that show rankings, how many points/amount of virtual currency, accomplishments, etc., that a participant has earned
- Badges/icons that denote when a participant has completed a particular task, reached a certain level, or acted in some way on a particular day (e.g., made a purchase on a typically slower sales day, completed a level on a certain holiday)
- Challenges that require participants to use their knowledge or skill to master
- Loss aversion, which is a strategy that keeps participants engaged for fear of losing their status, points, etc., if they do not check in after a period of time

Additionally, a strategy that includes small, frequent rewards or achievements, in addition to occasional substantial benefits, will prompt customers to continue with the program (<http://bit.ly/2WrwtBy>). Sometimes it can seem that it takes too many points or other efforts to earn a reward. Benefits that are smaller and easier to achieve can motivate participants to continue on the trajectory toward earning larger discounts.

Gamification (1) delivers results by learning what truly motivates customers to interact with a business; (2) collects data about customers (e.g., how often they visit a tasting room’s website or social media page, make a purchase, attitudes about a product, buying behavior) and makes decisions about how to connect with customers based on those data; and (3) uses these analyses to create “innovate technologies” to encourage positive consumer behavior.

### **Will Your Loyalty Program be Free or Will You Charge a Fee?**

Regarding whether you will charge members to join your program, there are quite a few things to consider:

- If the program is free, will there be an overabundance of customers applying for discounts such that the program isn’t deemed “special” or “exclusive?”
- If you charge a fee, how will you determine how much to charge, will it be a one-time fee or yearly, and will charging a fee deter some customers from joining?
- If you charge a fee, will you apply all or a portion of the fee toward the customer’s future purchases?
- Would a limited-edition program fit your needs? If you choose to offer this type of program, you probably will need to “reopen” the membership after a certain period of time. This may be necessary if you noticed that fewer members are participating in the program and/or several years have passed since the program began.

### **Recording Purchases**

One of the most important components of the loyalty program is keeping track of purchases. The use and value of a program can deteriorate quickly if program participants feel that their purchases are not being recorded correctly.

To reduce costs associated with administering the program, you may decide to make customers accountable for keeping track of award accumulations. In this case, you do not record or tally purchases; rather, customers are responsible for the safe keeping of their loyalty cards. When signing up for membership, customers should be told that they need to keep track of their purchases and that if they lose or damage their loyalty cards, coins, tokens, or receipts, then they, unfortunately, lose any accumulated benefits.

Better yet, with all the advantages that a mobile payment system offers (see the Mobile Payments section), why not use these systems to help manage your loyalty program? The software tied to these systems can record purchases and customers need only tell you their phone number, name, or other identifier for you to find them in the system.

Regardless of whether you use a “punch card,” point-of-sale system, or mobile payment system, the key issue is to learn about your customers’ purchasing habits: what they purchase from you, how often, quantities they purchase at a time, and what promotion (if applicable) prompted their purchase.

### **Learn about Club Members’ Consumption and Purchasing Behaviors and Preferences**

Your loyalty program can provide an incredibly rich source of customer data; you just need to ask the questions. If you are concerned about what potential customers will feel and think when providing personal information, consider the following:

- Only ask for information that will help enhance the program and provide the best experience possible.
- Customers can always choose not to provide responses to questions.
- You should stress that questions are asked so that you can make sure that they only receive emails, mail, and other communication pieces that appeal to them.
- Give customers a privacy statement that indicates you will not share or use their information other than the purpose for what is intended.

You should collect data when the customers sign up for the program. You should also consider asking additional questions when they renew their membership and when they attend events and pick up their products.

### **You could ask questions to gather information, such as:**

- **Name address, email, preferred method for communication, how often they want to hear from you** (every email, once a month, only when related to the wine club, other based on your current email schedule). If there appears to be a concentrated group of members who live in a particular city/zip code, you could use this information to develop targeted promotions.
- **If they would like to receive a reminder email to follow you on Twitter, Facebook, Instagram, etc.** This could help



in cases where the customer has the intention to follow or like you but forgets to do so after leaving your store.

- **Hobbies and leisure activities that they enjoy.** This could help you plan special events that you hold on your property. If a fair number of members like bluegrass music, for example, then it might be worth investigating the possibility of hosting an event.

You have probably filled out a number of surveys and wondered why the business needs certain personal information (e.g., when you fill out a warranty register form for your new vacuum), especially when they do not provide a reason for asking the questions. You may find that more members will provide responses if you indicate how the information will be used and that it will not be shared with any other businesses and individuals not associated with your business.

### Will You Impose Earning and Redeeming Restrictions?

No matter how you structure your program, it will not be successful unless its benefits appeal to members and if it is convenient for customers to redeem their rewards. Have you ever participated in a program that either makes it difficult to redeem rewards (e.g., limited time period) or the “rewards” just did not appeal to you?

A loyalty program that consists of a bunch of inactive members does you no good. In fact, it may indicate a greater problem: your program is not providing customers with desirable benefits. For example, the membership policy could state that members are alerted when their membership has been inactive for two years and then informed that their membership will be canceled and they will lose any unredeemed rewards and points.

### Would a Loyalty Program that Provided Benefits Including Complementary Goods or Involved Other Businesses be Appealing?

What if you learned that a rather large group of loyalty program members are also “foodies”? Could you offer a club option that includes a selection of complementary specialty foods, such as flavored oil oils, crackers and biscuits, sauces and mustards, olives and other pickled products? If you do not offer many specialty foods, it may be worth approaching other local businesses that offer these products and developing a joint program or a club option that includes items from both businesses.

You could also consider partnering with restaurants, lodging, or entertainment providers. A discount offered by a hotel associated with your loyalty club could very well pursue customers to stay the night at the establishment. Perhaps the restaurant that offers discounts to your club members could highlight your produce and value-added products on their menu.

### Have You Achieved Loyalty?

Merely offering a loyalty program and investing little else into your tasting room may produce positive responses for only a short period of time. When you do not improve the tasting room experience beyond offering select discounts, you cannot win loyalty and your customers can become trained to only shop when you offer sales or promotions. You will need to make certain that customer service, product availability and selection, and other experiential factors (e.g., aesthetics and educational opportunities) meet (hopefully, exceed) customer expectations and persuade them to return again and again.

Though you will find lists that describe rather involved calculations to help you determine the success of your loyalty program, Customer Think ([bit.ly/1uhKnSC](http://bit.ly/1uhKnSC)) provides a list of points to evaluate that is easy to understand:

- **Customer Retention Rate:** “measurement of how long customers stay with you. . . . Measuring the difference [in months, years, etc.] in customer retention between program members and non-program members is one of the best ways to determine if your loyalty program is effective.”
- **Customer Effort Score:** “measures your business’ customer service based on actual experiences customers have had with your company.” If a group of loyalty program customers have indicated a need or want for a certain program option or benefit, have you fulfilled this request? Or, if they have alerted you to a problem, have you provided a solution and fixed the issue?
- **Negative Churn:** “Churn is the measurement of how many customers leave your business overtime. Thus, negative churn is the measurement of customers who instead of leaving, upgrade their membership and purchase added services.” You should be able to review your members’ purchases and, based on your overall goal, calculate the percentage of members whose purchases have increased (in number, individual price point, total dollar amount), remained the same, or declined (including those who have not made any purchases) for a particular period of time. Of course, you will need a point-of-sale or mobile payment system to capture these statistics.
- **Net Promoter Score:** a measure of customer satisfaction that can be obtained by asking the following question: on a scale of 1 to 7 (1 = very unlikely, 4 = neither unlikely nor likely, 7 = very likely), how likely are you to (a) continue your membership based on current benefits and (b) recommend our products to friends and family. These are just a couple questions that you could ask members to learn about their level of satisfaction and dissatisfaction. Consider asking “open-ended” questions that allow customers to write responses and provided even more insight.

### Changing or Ending a Loyalty Program

Consider all program aspects and ask employees for their input before introducing the program. Ask your employees to review loyalty programs to which they belong and incorporate features they like and believe their customers will value. To avoid confusion and frustration, do not make significant changes once you have implemented a program. Customers may be discouraged from buying from you if they believe that the program isn’t delivering what was promised.

If you must discontinue a loyalty program, make every effort to contact customers about changes or cancellation and announce the information in the store, in newsletters, and so forth. Be sure to inform members several weeks or months in advance and offer compensation comparable to the benefits or discounts they can no longer redeem. Offer a coupon with an open-ended expiration date so customers understand you are sincere in efforts to help them adjust to the change. Compensatory coupons could be based on several factors, such as:

- An actual discount based on past amount purchased

- An award amount that is slightly greater than the actual amount owed (a good faith effort)
- An entirely new type of reward system you are interested in implementing

Whatever option you choose, it is imperative that customers find value in the program and that redeeming the reward is worth a visit to the store.

### Evaluating the Success of Your Promotion

Two indicators you should evaluate both during and after the promotional period are foot and/or web traffic and sales, and whether either increased compared to the previous year. Interacting with those who visit your retail outlet or who make a purchase online is also a must. Designing the promotion, implementing it, and feeling good about what you have produced is not enough. Additionally, you must talk with your customers, specifically asking them:

- Which promotion or advertisement prompted your visit?
- Are you a new customer? If not, how often have you visited the retail outlet or website?
- If this is your first visit, did you choose to visit because of the promotion?
- Did you make a purchase using a discount that was offered? Were you planning on purchasing the item anyway, even if a discount wasn't offered?

Not all of your efforts will be highly successful and you need to use your resources wisely, so determine what promotional endeavors you should implement again and which ones you shouldn't. Whether asking customers for input when they are at the cash register, on your website, on your Facebook business page, leaving the store, or more formally, the energy you spend to fine-tune the promotion and to assess the final impact, the more likely your intended audience will receive your message and act on it.

### Other Ways to Increase Consumer Loyalty

Merely offering a loyalty program and investing little else into the business may produce positive responses for only a short period of time. When you do not improve the shopping experience beyond offering select discounts, you cannot win loyalty and your customers can become trained to only shop when you offer sales or promotions. Retailers need to make certain that customer service, product availability and selection, and other experiential factors (e.g., aesthetics and educational opportunities) meet customer expectations and persuade them to return again and again.

The bottom line is that a loyalty program alone does not guarantee repeat purchases; rather, it is only one component that successful retailers implement. You must assure your customers that you value their patronage. The resulting outcome can be a lasting relationship that is beneficial for both parties. A continued series of positive experiences further encourages customers to shop there; hence, customers truly become loyal.

### Events and Festivals

Many consumers can remember a time or two when they and their families visited apple orchards for donuts and cider or a

local farmer's field to pick a pumpkin for the fall. Certainly, this fun-filled day helped create a positive impression during the initial outing and may have prompted a return trip. Research indicates that consumers desire opportunities where they and their families can have an enjoyable day together, support a local business owner, and "get back to nature." By inviting community members to help celebrate a grand opening, mementoes anniversary, season, holiday, or other occasion, you are also developing relationships—ones you hope will last well after the event is over.

An opportunity to develop and host an event is only restricted by your creativity and rationale for offering the event. Some potential bases for an event include:

- During periods when sales are typically slow
- Holiday open houses
- Store openings and anniversaries
- Recognition of customers who spend the most at the business on an annual basis
- Targeting your primary customers for a "night out"
- To raise more for a cause

With the amount of time and energy that developing and implementing a successful event can take, consider holding the event for more than one day. Of course, the number of days that you hold an event depends on the type of event as well as how established the business is and how many customers could potentially visit. More established businesses with larger customer bases that are located in more populated areas may need to host a multiday event to accommodate the number of visitors expected. Though having enough employees available to complete all the prep work and on-site activities can be difficult, consider the potential benefits, including:

- Increased likelihood that busy families could attend at least one of the days
- Flexibility in arranging times for vendors, demonstrations, and specialty guests
- Reduced parking congestion and crowding

Before you start planning, take stock of the amount of property or interior retail space available to accommodate larger-than-average crowds. Additionally, determine whether you will need an overflow-parking site. Do you have an open field, or can you use another business's parking lot? If so, can attendees walk from this parking area to the event, or will you need to hire buses to transport them? Hire extra staff to use these spaces most efficiently and alleviate stress for all involved. Extra staff may also be necessary to enforce food and child safety, as well as to help prevent vendors and guests from being victims of theft.

Even with significant space available to accommodate a crowd, several components of creating a comfortable space still need to be considered, such as:

- Appropriate number of bathrooms and wash stations
- Variety of refreshments available for visitors to purchase, especially if temperatures are unseasonably warm
- Shelter, such as a tent, in case of inclement weather

Also consider offering tents or other outbuildings to food vendors who will be cooking and selling snacks and meals. Tents for cooking must be up to code and need to be placed a

specific distance from permanent buildings in case of fire in the tent. Consult your local township, borough, or city for more information and a list of restrictions.

If you don't already have a list of caterers who could handle a crowd, consider visiting a local farmers' market and connect with food vendors. If they have been selling goods at the market for a while they probably have a following and they could easily promote the event at their farmers' market stall, via social media, etc. Having another artisan from the community can further enhance the "local" aspect of your business and that you do your best to support other small businesses (Figure 10-7).

The ultimate goal of the event is to generate income while offering your visitors an experience. Hence, you'll likely need to devote resources beyond what you allocate for regularly scheduled promotions. When both planning and evaluating the event, develop a list of questions that can guide you through the process and help you determine what to change for future years. The following are some questions worth considering:

- Is the idea unique? An event can help business owners differentiate themselves from their competitors. The uniqueness, and subsequent consumer appeal, of an event can be a key marketing factor that customers associate with the business. Certainly, there is a difference between a unique idea that is engaging and inviting and a unique idea that is over the top and intimidates visitors. To be effective, as well as interesting, some tie-in needs to be established between the business and the focus of the event. For example, if you hire a local artist to design labels for your products, consider a "meet the artist" night during the event.
- Will the event be memorable? A family that visits may be looking for a family-oriented day that offers something for all age-groups and won't disappoint. To achieve this, businesses should ensure that the perception (what actually happens) of the event is greater than what visitors expect, and that the outcome ultimately "wows" attendees. Another way to think about this is to deliver more than what is promised, and the visitor will not be disappointed. The reward may be realized both during the event and when the family makes return visits.
- Is the event important enough to justify the amount of time



**Figure 10-7.** Vendors should offer samples for visitors to taste, with some of the proceeds benefiting the cause.

and expense invested? As can be expected with creating an event that is both unique and memorable, resources need to be allocated to the effort. Sales and foot traffic, discussed below, are two indicators you should track and analyze. Keep in mind that it may take more than one attempt at offering the event to actually obtain the desired level of profitability.

While a free event might draw a reasonable crowd, selling tickets could help defray the costs of the event or provide a significant amount that could be donated to a cause. Also, if tickets are sold in advance, it will be much easier to plan the event and ensure that enough food and drink is available. Ask artists to donate some of the proceeds from goods sold, provide items for a silent auction, or pay for their vendor space. Even though attendees will pay admission and bid on items, set up several sites where they can donate money. Asking vendors to have a "donation jar" in their booths is one way to collect spare change and dollars.

Once attendees have arrived, involve them in an experience that engages each of their senses.

- Sight: Create displays for local artists to display their products.
- Sound: Set up a stage and invite local artists to perform or play a selection of music from CDs you offer for purchase (Figure 10-8).
- Touch: Allow attendees to walk through the orchard, see the trees up close, and pick fruit right from the trees.
- Smell and taste: Offer samples and teach customers how to truly enjoy a glass of wine by taking note of the aroma and the flavor. Invite a local bakery to sell specialty breads, pastries, and cheese, all complementing your wine.

Research has shown that the longer consumers spend looking at merchandise in a store, the more likely they are to make a purchase. An on-farm business can prolong the visit by offering tours that show customers what a cluster of grapes looks like when growing on a vine or how apples are pressed and the juice made into cider. Businesses can also offer short seminars for free or all-day educational sessions for a fee on topics such as growing fruit at home or how to can vegetables and make jams and jellies.

Though one business may develop the vision for an event, the



**Figure 10-8.** Live music can also keep tasting room visitors on the property longer. Survey customers about the local band they enjoy listening to and invite them to perform..

responsibility of coordinating and implementing it doesn't need to be restricted to just that business. Complementary businesses should consider the advantages that two or more establishments can both provide and gain by working together. For example, invite a business that sells complementary items, such as dairy products and cheeses, and a florist to co-host. During the event, staff from all three businesses could offer demonstrations, such as meal preparation using the food items and choosing a flower arrangement for the table. Each business could also provide goods that can be included in gift baskets for sale or that could be ordered at the event (Figure 10-9).

Consumers who attend the event may appreciate being able to interact with more than one business and purchase goods and services provided by each. Combining forces could be more economical for all businesses involved, compared to each business hosting its own, smaller event. Primarily, the arrangement could result in having a greater number of employees available to staff the event, along with pooling funds to cover advertising and event-related expenses. Along with agreeing on a unified theme that makes sense for all businesses involved, deciding on where to host the event will have to be discussed. Additional decisions to make include giving each business equal consideration when assigning duties and distributing profits from either admission or activity fees, as well as how the visiting businesses compensate the host business for utility and land use.

Aside from your business hosting an event, another option would be to make your land or retail outlet available for other businesses to use when hosting their events. Some attractive points might be:

- An appropriate amount of space
- Aesthetically appealing facilities
- Employees to assist with planning and implementing the event

Potential clientele could be other businesses, businesses without a physical store, or businesses with a smaller parcel of land or store space that isn't suitable for hosting an event. In addition, your retail outlet could serve as the location for asso-

ciations or organizations to host their events or fundraisers. Just as some wineries make their vineyards and tasting rooms available for weddings, receptions, and other celebrations, orchards and on-farm markets with aesthetically appealing space could also advertise that they can accommodate garden club meetings, showers, or other celebrations.

Offer a small gift, such as a wine glass etched with your company's logo and name, to commemorate the event and further promote your business. Gifts or incentives you offer your customers have the potential to remind them of the goods and services you provide and encourage them to visit your business again.

When it comes to using social media to promote the event, make sure that you:

- "Like" the business you co-host with on Facebook and follow them on Instagram.
- Alert followers when you add co-hosts' products to your displays or when new partners and vendors agree to be involved in the event.
- Post images before, during, and after the event. Consider assigning that duty to a specific staff member; most likely if this role isn't assigned, the number of images collected and items posted will be less than desired.
- Both original tweets and your retweets should mention your co-hosts.
- Develop a Pinterest page that all businesses co-manage and pin pictures to related to the event, provide links to recipes for foods served during the event, etc.
- Develop a #hashtag specifically for the event and use it in all your postings. Also ask visitors to use the #hashtag in their postings so that you can search for their images and repost on social media sites, websites, and tweet. You could encourage attendees to help document the event by announcing that you will hold a contest and select (at random or by vote) one or two visitors who post and use the #hashtag.

### Evaluating the Event

As with every promotional or business-related activity, it is necessary to properly plan events, have clear objectives of what you hope to accomplish (or the benefits you desire), and measure the outcome. This information will be essential to determine whether



**Figure 10-9.** Food samples that complement your wine and demonstrations that correspond to an upcoming season or celebration are great ways to attract attendees and keep them in the tasting room longer.

or not the energy needed to promote and implement the event justified the time and money spent.

Pay attention to how attendees are reacting during the event and note whether what you are offering them meets, if not exceeds, expectations. Be sure to keep track of certain indicators that determine if the event provided a return on investment and whether or not it should be offered again or changed. Specifically, record the number of visitors, amount in sales, and other related information.

### Gross Sales

How did gross sales compare to the same period during the previous year, regardless of whether or not you hosted a similar event? Did they increase, stay the same, or decrease? Gross sales that are either the same or decrease could indicate, excluding any other major changes to the business or factors such as poor weather conditions, that the focus of the event, structure of the activities, or other components need to be altered. An increase in gross sales is certainly a very positive measure; however, it is still necessary to review notes taken during the event and determine if any changes could be made to make the event even more successful.

### Net Sales

Especially during the first few years, an event probably will require more inputs than other promotional activities, depending on:

- How many activities are offered during the event and for which a fee is charged
- If other vendors are invited to be a part of the event and whether they are required to pay for booth space
- Number and expense of additional advertisements to purchase
- Whether merchandise will be discounted during the event
- Number of duties the staff may be asked to perform above those required on a day-to-day basis

The event could be a success in terms of attracting new and existing consumers, yet not be profitable. If the primary goal of

the event was to be a major income generator, but the cost of hosting the event exceeded revenue, then it may be necessary to revise aspects of the event before offering it again. If the primary goal of the event was mainly to alert consumers that the business exists and no significant sales were expected, sales generated during the first year could be viewed as an additional benefit to the business. In both situations, a return on investment should become an objective and aspects of the event be designed to fulfill this purpose.

Sales during the event are key, but consumers may not always make purchases, or make their entire purchase, during the event. Rather, they may return at a later date when there is less of a crowd, or they may need to give greater consideration to the goods and services offered and their need for them. If the conversion rate (number of purchasers compared to number of visitors) is low or less than an average business day's conversion rate, then further investigation is warranted (Figure 10-10).

### Foot Traffic

Being able to document the number of consumers or families that visit the business during the actual event and weeks that follow should be of interest to business owners and operators. Though an event's ultimate measure of success—profitability—is of great interest, it is also important to understand:

- How responsive consumers are to the type of event offered
  - How the event was promoted
  - Goods and services visitors purchased during the event
- Measuring foot traffic can be accomplished by:
- Distributing invitations that attendees bring to the event to be admitted or requiring attendees to RSVP
  - Counting attendees as they arrive at the event by either assigning an employee to manually count customers or installing an electronic sensor that tabulates the number of customers who pass through a particular doorway
  - Providing customers with the opportunity to sign up for a mailing list or to become loyalty program members



**Figure 10-10.** Sales and attendee numbers are just a couple of items you should monitor during the event. Assign an employee or two to observe your guests during the event. What vendors tend to attract visitors? Are visitors sampling food items and wine? If so, are they merely sampling but not purchasing? Are there any areas on the grounds where customers tend to gather and other areas where customers do not seem to walk to or through?

Each system has its advantages and disadvantages—for example, not all customers will sign up for your mailing list or loyalty program, or they may already be members. Customer counts can help you better estimate whether or not enough additional customers visited the event and made a purchase.

It may also be of great benefit to count the number of customers who visit based on the date and time they visit. Such measurements can help with providing appropriate staffing to assist customers. Basing foot traffic counts on a per-hour basis or for a several-hour block of time can be used to adjust the hours that the event could be held in future years. Additionally, if you invite other vendors to showcase their goods and services or a special entertainer to perform, try to schedule their appearances when foot traffic is at a level that will be rewarding for all involved.

Record not only foot traffic at the farm or retail outlet but also the number of visitors who access your website during and after the event to help you develop a more detailed and user-friendly webpage that describes the event. Have customers participate in an online survey that asks if they are interested in attending the event, what additional vendors or attractions they would be like to see, and how they heard about the website and if they were aware of the event before visiting the site (Figure 10-11).

Once the event is over, the work is not done. Though it may be difficult, key personnel should meet immediately after the event to talk about their perceptions of how well the event was received, any components that need to be reconfigured, and what the economic reward was. A final task would be to develop or redefine a list of objectives for the next time you plan to offer the event. Most likely, employees' memories of the event will become less accurate as they become involved in other business activities.

## CROSS-PROMOTION

You likely have relationships with similar or complementary businesses in your area and have thought about how you could benefit from efforts in which you are both involved. Cross-promotion does just that. It is the process of joining forces with one or more other businesses and working together for a common benefit. Just as you might host an event on your own or support a particular cause, you could do both with another business. Whether you team up for a promotion or to support a particular cause, event, or other reason, efforts coordinated with a complementary business could provide the following benefits:

- Expanding your customer base
- Greater reach with promotions and advertising
- Reduced marketing costs
- Increased profits

Every retailer should strive to make shopping easier for their customers by providing all the ingredients or equipment necessary to create a perfect meal, or if you do not offer all that is needed for this experience, by at least directing them to other businesses that sell the complementary goods. You may not produce your own wine, cheese, or other edible products, but you could develop gift baskets using what you do produce along with what other local edible and nonedible products that would be a good fit. Signage placed near items for sale could include a full list of the complementary business's offerings or directions to the retail outlet.

### Offering Space in Your Retail Outlet

Displaying items produced or sold by complementary businesses is one cross-promotion strategy. You may already have relationships with business owners who produce or sell items that would complement what you offer. If you do not, think about what goods and services could appeal to your customer based on their demographics, behaviors, and interests. If you do not already sell items like bath and body products, jewelry, specialty foods, place settings, or the like, search for businesses that do. Once you have assembled a list, learn about clientele they serve, search for reviews customers post online about their shopping experiences, and investigate as much as you can about their business practices before requesting to meet. Just as you put thought into developing a relationship with a new vendor, the same amount of consideration is required when selecting a business to cross-promote products.

For example, you can simply provide space for a local artist to display ceramic planters, statuary, and so forth. Rather than housing items on a shelf, use the artist's piece as intended (e.g., display a one-of-a-kind sundial sculpture or Tuscan fountain in a garden setting). Customers may be encouraged to purchase more than one item if they are able to see an example of how the good is used in an outdoor setting, and if you sell them, surrounded by bedding plants. Offer a discount if customers purchase the sundial along with a selection of your products. By doing so, you may encourage clientele to purchase multiple items and increase transaction size.

Signage placed next to items should include a description of the product as well as information about the artist (e.g., business history, other available products, contact information) and an explanation as to why the product is so unique that you decided to display it in your store. Don't forget to ask the artist to reciprocate by incorporating select products you offer into his/her displays. Or, if this is not possible, provide materials for the artist to make available to consumers in his/her showroom in order to further advertise your business.

### Newsletters and Blogs

Whatever methods you use to inform and remind customers about your business or persuade them to buy your products, there is at least one way to cross-promote each other's products and expertise. One or two small businesses you may interact with

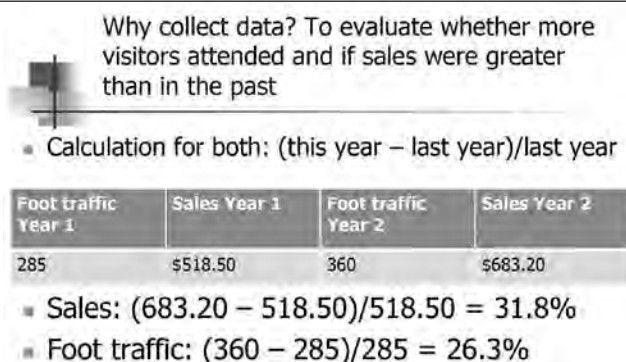

Figure 10-11. Data collection.

has to have a blog, newsletter, or other publication and either has content prepared that you can repost on your own blog or newsletter or would be willing to write about a topic that you think your followers would be interested in reading.

These short pieces not only assist you with disseminating information on a frequent basis but also can alert readers about that business or a new product they are offering. Feature articles can describe how customers can use products from both businesses together or describe an upcoming event that both businesses are sponsoring. Regardless of the type of communication, don't forget to include the complementary business's logo, links to their website, and contact information in your Facebook post, newsletter, or other communication you publish.

### Your Website, Facebook, and Twitter

Your website is an ideal outlet for cross-promotional activities. Use space on your website to inform readers about complementary businesses and provide space for them to advertise. If customers sign up for your newsletter online, provide an option for them to sign up for other businesses' newsletters or add a link that will take them to the other businesses' online form.

When it comes to Facebook, make sure that you "like" the business you cross-promote with, post images of events and activities both businesses implement, include links to articles, and mention each other in postings. Tweets you publish on Twitter should also mention your cross-promotional partners. Include these businesses in your #followfriday (#ff) tweets (a strategy used on Fridays to suggest to your Twitter followers whom they should also follow), retweet (forwarding another Twitter users' tweets to your followers) appropriate messages, and publish tweets when you add their products to your displays. Inform your customers about joint activities while reminding them about your business.

### Costs

Cross-promotion cannot be implemented without certain "costs," including:

- How much complementary product should be used in displays
- Whether to provide the shelf or floor space for free or charge a fee
- What discounts to apply if customers buy a combination of products offered by both businesses
- How both business will share advertising and promotional cost
- How many times during a season or year each business will agree to provide information for blogs, newsletters, etc., and the number of feature articles each business will write
- How each business will allocate staff for events and activities (e.g., if one business provides space for the event, what will the other business offer in compensation)

Additionally, educate staff about the complementary products, how to use the item, benefits for customers, and related information so they can answer basic questions about why the businesses are cross-promoting each other's products and provide customers with at least an introduction on how to use the products.

These are just a few possibilities for cross-promotion and obtaining access to new customers. Your decision will ultimately

depend on the amount of time you and your staff have available, your budget, business goals, and facilities available. While there are tradeoffs to consider, working together can provide benefits for your business and the customers you serve.

## COMMUNICATING WITH CUSTOMERS

Though a variety of outlets exist for retailers to promote their goods and services, you will need to consider your target audience's preferred media method for learning about new goods and services.

The types of promotions you use should be contingent on consumer response. If you placed an advertisement in the newspaper or local shopping paper, ask customers if they saw the advertisement. If you included a coupon in an email newsletter, then be sure to collect the coupon—preferably with the customer's name and address or email to build a customer list—to compare the number of coupons redeemed to the number printed. Collecting this information will also help you determine whether the amount of the promotional budget spent on the advertisement resulted in the desired return on investment, as well as whether in-store promotions or public relations efforts effectively informed customers about the business.

### Email

Email is a way to communicate directly with consumers who are interested in what you sell. Building a list of interested individuals, along with what information recipients want to receive via email and how often they want to receive emails from you, is key. Deleting or ignoring emails is quite easy, so create an email that will encourage your customers to read the message and visit your store, webpage, and/or social media site. Consider one or more of the following strategies to capture your list members' attention:

- Make sure what you write in the subject line is short and to the point. If you want the goal of the email to be an informative piece educating the consumer about something, an example subject line could be "Best ever apple recipe" or "Ever wonder how to properly store peaches?" If you want the recipient to respond to a call to action, where they act based on what you include in the email such as a sale or discount, consider a subject line like "Our cookbook sale starts tomorrow" or "Just three days left to purchase discounted festival tickets."
- You probably have received a number of impersonal emails that are not addressed directly to you; rather, the message includes little or no text that would appear welcoming. Now, consider receiving the same email with a greeting that either includes your first name, "Hello, Kathy," or your email address. Might you feel the sender wanted his/her message to appear to be a bit more inviting? Of course, you'll realize that the message was sent not only to you, but the person sending it took a bit of time and found an email-marketing program that allows him/her to customize or personalize the greeting.
- Consider inserting a link to a webpage with a discount code to drive sales and providing summaries of information rather than full articles, encouraging recipients to read the entire piece by clicking through a link that you provided for them. Insert images (be sure to follow copyright rules) to break up text and provide

something that is pleasing to look at. Also encourage recipients to forward the email to others who might be interested.

Begin figuring out how often to send emails and newsletters by developing a monthly or biweekly email newsletter and evaluating responses. Ask your list members if they would like to hear from you more or less frequently. This is important because a potential outcome of sending emails too frequently is that recipients may ask to be removed from the list; however, sending emails at a more frequent rate around holiday and nonholiday occasions, such as Mother's Day, is acceptable. For a seasonal business, sending out emails when the business is not operating may not be necessary. Instead, focus on sending emails during the months the business is operating, and send an email during the month prior to your seasonal reopening. Encourage all who visit your business or its website or who read your blog to sign up for your newsletter, and add an email newsletter signup app to your Facebook business page.

## Social Media

It is fairly easy to find statistics about social media and which tools consumers are gravitating toward. According to a report on **Retail-Week.com** that investigated the effectiveness of Facebook, Pinterest, and Twitter in “driving traffic to retail sites,” consumers who access “retail sites from Facebook and Twitter purchase more often, Pinterest users spend dramatically more.” Statistics about social media use based on demographics—for example, the percentage of women using Pinterest or Facebook compared to males—are also readily available from a number of online sources. These data provide great insight for those who are less, or not at all, familiar with the various social media tools available. The next step is to investigate each tool, try them for yourself, and learn directly from your customers which tools they actively use and which tools they would like to use to connect with your business.

Do not make the mistake of thinking of these tools as just another way to provide discounts. A business can offer all the discounts and deals their budget allows, but what keeps consumers engaged and following or “liking” your business long after that promotion has expired or they have “unlocked” the “newbie special”? Retailers that rely on social media primarily to increase sales might be sorely disappointed by initial response rates and customer retention.

Use social media as a way to provide customer service. According to one report, 67 percent of consumers have used social media to communicate with a company to get answers to questions or help with a problem. Business owners should know that customers expect an immediate or near immediate response after they submit a question, concern, complaint, etc., on social media. Several sources indicate that a response is expected within an hour, and that if the customer is not happy with the response time, they will may not use the company again and/or will tell others about their experience. Savvy business owners realize that social media is a useful customer relationship tool that requires them to make an effort to engage followers.

## Facebook

Available to the public since 2006, Facebook may be one of the most, if not the most, recognized social networking site. Facebook

has developed quite a bit since its creation. Facebook business pages allow administrators to indicate hours of operation, type of parking available near the business, and directions, as well as announce events. Consider these fan pages as more of an advertising and promotional tool where content is not restricted to only those who choose to “like” the page; rather, these pages are public and can be accessed by anyone, even those who don't have a Facebook account.

A key to engagement on Facebook is to personalize the business page with images, videos, and other content that will encourage visits or like, share, comment, and ultimately make purchases. Not only is it ideal for the business to post content, but if employees, visitors, etc., post content, then their Facebook friends will see evidence of this engagement in their own Facebook feeds. Additionally, encourage those who like your page to suggest the page to their friends.

Facebook has quite a bit of utility for business owners, allowing them to:

- Create ads to target consumers
- Develop offers that can be redeemed online or in a retail outlet
- Download apps to create event announcements
- Develop forms for visitors to sign up for email lists or loyalty programs
- Create a survey
- Provide another outlet for Twitter feeds, blog postings, and YouTube videos
- Allow visitors to purchase products without leaving Facebook
- Host contests
- Create groups that can be used to discuss new product introductions, get feedback on potential promotions, etc.

As with your website, you need to keep your page up-to-date and provide visitors with a reason to return to your page again and again. Stagnant pages will likely see the numbers of visitors decrease over time. Simply adding a news item, a set of pictures, and other information on a regular basis will encourage repeat visits.

## Twitter

Twitter is a simple tool that helps connect businesses more meaningfully with the right audience at the right time. It can be used to quickly share information with people interested in your company, gather real-time market intelligence and feedback, and build relationships with customers, partners, and other people who care about your business. Customers can use Twitter to tell a company (or anyone else) that they've had a great, or disappointing, experience with your business, offer product ideas, and be notified of events or discounts.

As with the other social networking sites, you must register for a Twitter account to both publish and read messages, called “tweets,” that others post. Users can then tweet their own updates and post images, links to websites, and other electronic documents. One type of useful tool to use with Twitter, specifically, is a URL shortener. URL shorteners, such as **goo.gl**, **tinyurl.com**, and **bitly.com**, can greatly reduce the length of long URLs, which is important since these characters count toward the 280-character limit.

Within Twitter, you'll notice an “@” sign placed directly



in front of your user name as it appears on your homepage on **twitter.com** and when others refer to you in their tweets and/or when they “retweet” (reposting what another twitter user initially tweeted) what you originally posted. For example, someone who tweets with the user name **kmk17psu** will be referred to as **@kmk17psu**. Additionally, other Twitter users can type **twitter.com/kmk17psu** into the search field on their web browser to locate the user’s Twitter homepage, where they can find:

- A button they can click to follow you.
- “Lists” of select users you follow. Lists are created by Twitter users and many times are based on a topic, keyword, industry, etc. For example, a list called “PSU” could contain select Penn State Extension personnel who tweet, and only their tweets will appear in that particular Twitter feed. This allows the user to stay current with what these and a few other Twitter users are posting and reduces the need to scroll through the main Twitter feed to find individual updates.
- Number of Twitter users you follow and who follow you, number of tweets you have posted, and lists that other users have placed you in.

This additional information can be used to help users decide whether or not the content you post is meaningful or of interest to them and who else to follow, based on whom you have chosen to follow and who follows you since these types of lists are public. Like Facebook, Twitter users can:

- Create a profile and upload a profile image
- Choose a user name
- Publish their name and business location
- Add a URL for a website
- Create a short bio
- Choose a background theme for their home page (where all the tweets they receive appear)
- Receive an email when others “follow” them, send them a direct message (a private tweet that the user sends to another Twitter user), retweet their tweet, and so forth
- Update followers about the progress of an event, such as hour-by-hour activities at an open house
- Implement privacy settings that allow only approved users to see their tweets in their newsfeed

Twitter allows businesses to interact with consumers who choose to follow them, which is an indication that the followers have some interest in what they are tweeting about. The number of tweets that users can post is not limited, unlike the number of characters allowed for each post; however, as with every other method of communication you use to reach consumers, be sure that what you are tweeting about has merit and corresponds with your purpose for tweeting.

### Instagram

Instagram is an excellent tool for sharing photos of events held at a retail outlet, products, spaces and outdoor areas consumers can rent, and visitors enjoying their experience at festivals and events held at the farm, winery, etc. Users who create a business Instagram account, link it with their Facebook business page, and have a Facebook catalog of their products can create a storefront

on Instagram. This social media tool, in addition to Facebook and YouTube, is highly effective when trying to reach younger millennials and Generation Y, as 64 percent of 18- to 29-year-old U.S. consumers use Instagram.

It is common for businesses to host contests on Instagram. Participants post photos, based on specific criteria, and include a specified #hashtag that organizers can use to identify entries. Then either the contest organizers or Instagram followers can choose the winner. Instagram stories have increased in popularity over the past few years. Stories can include photos and videos and are available to Instagram followers for 24 hours, after which they disappear, but they can be archived so that the creator can use them again. Stories appear at the top of the follower’s feed, which, along with only being available for 24 hours, encourages users to click on and view stories posted by those who they follow. Like Facebook, Instagram has a live video feature with a comment box that allows viewers to ask questions and use emojis to show their emotional response to the segment.

### Pinterest

Pinterest can be best described as an electronic bulletin board on which users “pin” electronic images or video they upload or find on the Internet based on keywords of their choosing (e.g., retail layout ideas, outdoor sign suggestions, apple pie recipes). Other Pinterest users can then “like” the image, “repin” it to their own Pinterest board, or comment on the image or video. Like Facebook, Pinterest allows users to create a business account. A Pinterest business account enables the business owner to create “rich pins” that highlight a pin’s details and may increase users’ “experience and increase engagement” with the business.

Images and video that are pinned from the Internet are often tied to a URL. Consider how this could benefit your business. Pinterest users pin an image you have on your website to one of their boards. When Pinterest members click on the picture, they will be taken to your business’s website, where they can learn more about your products and services. If you upload an image to your Pinterest board that is not tied to a URL—for example, you take a picture with your phone using the Pinterest app and pin it to a board—make sure to add the URL to your website when you label the image and add a description. Again, this will direct interested Pinterest users to where they can learn more.

Also consider using Pinterest to host contests. Several small businesses as well as national and international businesses are using the site for this purpose. One example of a Pinterest contest involves asking customers to submit a picture of a recipe they created using apples, pears, peaches, etc., and then invite other Pinterest users to vote on their favorite image by liking it. The contest winner would then win a fall-themed container garden or similar prize. Search for “contest” or “contest ideas” on Pinterest to see several examples you can use as inspiration.

### YouTube

YouTube is a website (**youtube.com**) where viewers can watch programming such as movie trailers, clips, and full episodes of news programs, special interest shows, and videos that amateur videographers create. Videos can vary from less than a minute to over an hour in length. Since many people are “visual,” this tool may better help convey benefits and features of your goods and services compared to “still” images that are just two dimensional.

Viewers can find videos by:

- Looking through videos arranged by predetermined categories (e.g., how-to and style)
- Entering keywords into the search box (e.g., gardening, grilling vegetables)
- Clicking on links for related videos

Viewers can also create a YouTube account and “subscribe” to “channels” that are specific to the source/person who posts the video (e.g., Garden Girl TV) or topic (e.g., how to make apple pie). By subscribing, viewers receive weekly emails that alert them when a new video is posted to their account. Subscribers will also find a list of recommended videos based on their subscriptions when they log into YouTube. For example, someone interested in learning how to cook produce might subscribe to Cooking.com and by doing so, similar programming may appear under the “Recommended for You” heading on the home page.

As with other social networking sites, it is necessary to post frequently, though the number of videos produced may increase and/or decrease based on the seasonality of the business. To tie in with other social networking tools you may be using, consider posting a video based on content posted in a blog or on Facebook, Twitter, or other social network. Don’t forget to let consumers know when a new video is available by sending them emails, placing an announcement on your website, putting a sign in your retail outlet, and posting on your other social networks.

YouTube can serve as a marketing and customer relationship tool for retail businesses. Since many people respond to visuals and absorb more information through their eyes than their ears, it has been suggested that “video is much more engaging than text,” and it is possible that consumers will remain on a website for a longer period of time if video is available for them to watch ([www.youtube.com/youtubeonyoursite](http://www.youtube.com/youtubeonyoursite)). Whether videos are created to promote a business, new products for the season, helpful tips, or how-tos, posting videos on YouTube is just another creative way to reach current and potential customers and inform, remind, and persuade them to purchase your goods and services. Allowing consumers to view videos you produce adds another dimension to your website or emails.

YouTube allows viewers to email links to others as well as post links to their Facebook page and even send Twitter messages with the link, all from the page where the video is located. It is not merely enough to have the video available for view; it is essential to encourage viewers to send the link to others who might be interested in the content. For example, a retailer could post a video about how to select and store peaches, and at the end of the video, as well as within the written description that accompanies it, mention that the information is applicable to everyone and that the viewer should do their friends and family a favor by forwarding the video link to them. It has been well documented that word-of-mouth and the willingness of consumers to tell others about businesses and products, good or bad, can greatly benefit, or negatively impact, a business.

Those who are more familiar with the impact of online videos suggest that the experience for viewers is not complete until they react or respond to what they have seen on their monitor. Here are some examples of reactions and responses:

- Consumers view your video and either visit your website or retail outlet and/or make a purchase.

- They forward the link to your video to others.
- Viewers actually post comments in the “Respond to this video” comment box and/or click on the “I like this” or “I dislike this” button to express their views.

Not only can the person who posted the video comment on a viewer’s post, but other viewers can type in comments as well. Hence, it is possible to engage viewers in a dialogue and even build a relationship with them as they may come to rely on your expertise and information for their personal use. Responding to unfavorable or negative comments is just as necessary as responding to favorable or positive comments on YouTube. As with other social networking sites, you need to monitor what consumers, vendors, and competitors are saying about your business and respond and/or correct the situation as soon as possible.

Retailers can post video to YouTube and create a channel to which viewers can subscribe to find out when new video has been uploaded. Businesses can:

- Customize their channel with a descriptive profile, include links to the business’s website and other social media accounts, and change the background colors and images to reflect the business’s brand
- Encourage viewers to post comments, like videos, and share the link to the video with others through email or social networks

Posting a video on YouTube may be intimidating at first, so consult the YouTube help pages to find videos and directions on numerous topics ranging from capturing sound to compressing video. Other online resources can be found through keyword searches. Once you develop a process, the number of videos and their content are limited only by your imagination.

### Social Media as a Customer Engagement Tool

Much of traditional advertising (television, print, and radio) is used primarily as a one-way approach to communicating with customers. Retailers then expect customer response in the form

### What are your goals?



- Build relationships and brand loyalty
- Drive traffic to websites
- To distribute information
- Higher visibility



- News and public relations
- Consumers tend to engage and interact more on Twitter



- Ideal for retail, art, food, entertainment, and beauty businesses
- Higher engagement and relationship building
- Younger audience



- “How to,” brand awareness, and ideal for service businesses



- “Scrapbooking,” ideal for clothing, art, and food businesses
- Drives traffic to websites

of foot traffic and sales, not necessarily comments or likes that their friends and family see digitally. Social media, however, is great for reaching consumers, by tweeting about which fruits are in season, posting YouTube videos about how to determine if a fruit is ripe, or sharing Pinterest images of engagement or wedding photos couples took at your orchard, all of which help you build available relationships with your customers.

The graphic below illustrates some of the goals that each of the social media tools discussed above.

You may feel that you are posting great and timely content, but what is happening after you post? Are followers “liking” your posts, responding to offers only available to followers, or clicking on links to your website where you have posted additional information?

Experiment with what you post and evaluate follower response. Do you get more of a reaction when you post images of new products or recipes? Do you see more followers sharing or retweeting posts that announce upcoming events or links to videos about next year’s food trends? Are images posted on Pinterest generating a response, or do you see more activity when you tweet discounts?

Another issue that many businesses experience is knowing whether they have the right kind of follower. Having several hundred Facebook followers is exciting and can be useful because you use numbers to evaluate many aspects of your business, but how many of your Facebook fans are truly likely buyers? Do they have an interest in the goods and services you sell, or are they serial Facebook likers who like tons of pages, or are they likes generated by spambots, malware, or fake account users?

Most social networks offer some type of statistics, though they vary from network to network. Facebook business pages offer analytics (discussed below) that are pretty comprehensive and can help you understand your fans. Analytics can indicate who likes your page and their sex, age, and where they live, and if they liked your page via a mobile device or by accessing the Facebook website on their computers. If you notice that a number of those who like your page are in the same age range and/or are of the same sex as your core customer segment, you could use this information to determine what you post.

It takes a lot of effort to create appropriate and useful content, so you need to have an audience that finds posts about,

for example, selecting the best apple variety to eat fresh, which one(s) work well in pies, and what new brands of value-added and specialty foods you carry both informative and worth their time to read. It would not be a good strategy to ignore those followers who fall outside your target audience, but you need to make sure that you listen to the needs and desires of those who would likely purchase from your business.

### Social Media as a Learning Tool

You could just use social media to post and tweet about events or special promotions, but there is a great deal of power in using social media to learn what other retailers are doing to appeal to consumers. Retailers could:

- Follow other businesses on Facebook and/or Twitter or subscribe to their blog to gain access to other ideas, strategies, and even learn consumer reaction to posts
- See images posted by:
  1. Industry magazines, along with links to corresponding articles
  2. On-farm markets, including their seasonal displays and how they designed their outlet
  3. Consumers and commentary they provide about goods that appeal to them

To find images for inspiration, enter “orchard” in the search box on Flickr or Pinterest or enter the hashtag “#orchard” into the search field into your smartphone Instagram app (like Twitter and Facebook, Instagram encourages account holders to use hashtags so that others can access all posts that contain the particular search word). Using the name of a specific orchard or farm market will pull up even more images.

### Evaluation and Analytics

Depending on the social media tool you choose to use, you may find that the analytics—statistics about who follows you and/or what posts were the most popular or seen by the most number of followers—are quite sophisticated.

- Facebook provides “insights,” which are graphic representations of a business’s reach (how many Facebook users saw a post, the business’s Facebook ad, etc., within a seven-day period).

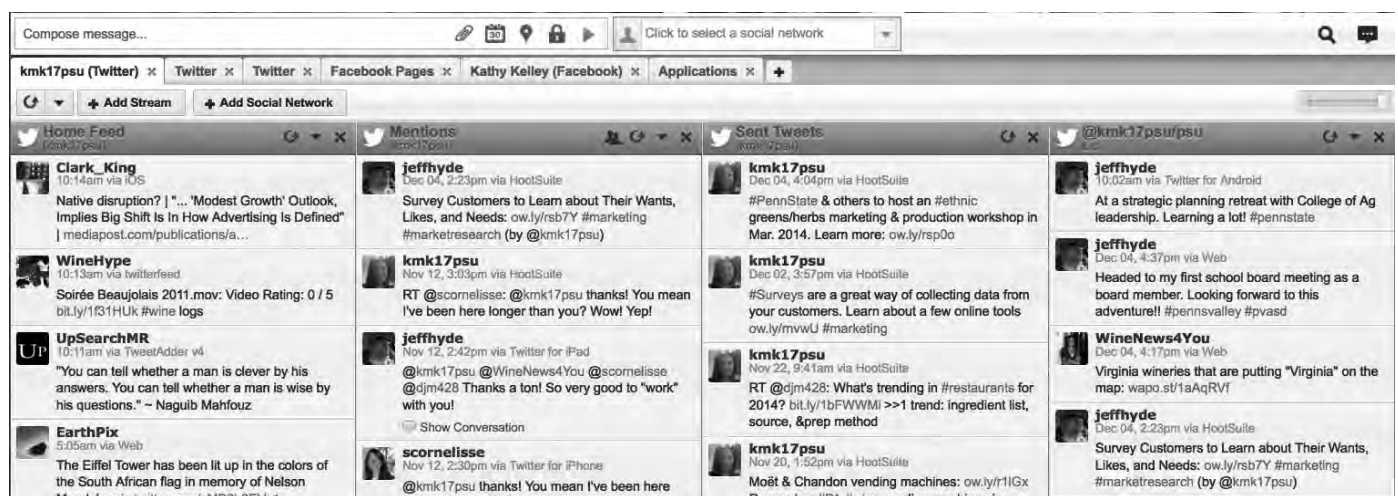

Figure 10-12. An example HootSuite dashboard with five tabs, each of which is associated with a different social network.

- Twitter and Pinterest may not provide direct access to analytics; however, you can receive email alerts when someone begins to follow you on Twitter and when a Pinterest user follows your boards, likes, repins, or comments on your pins.

A number of third-party applications that provide more in-depth analytics are also available.

Understandably, with the number of social media tools available, it can be overwhelming almost to the point that you may decide to avoid investigating new networks or completely reject all of the tools available. The only way to truly get comfortable with social media is to create a personal account, log on, follow/like/network with others, and see how they are using the tool. You will certainly find a number of businesses inside and outside the industry that can provide plenty of ideas and inspirations.

### Dashboards

Novice and experienced social media users alike may find it difficult to keep track of who retweets their tweets, which customers or followers “like” or place comments on their Facebook business page, etc. This is especially true for business owners who are often away from their computers. It is possible to check all these accounts on a desktop by accessing each individual website or downloading separate Twitter, Facebook, etc., apps, but being able to manage multiple accounts by accessing just one program can provide convenience, allow for posting to multiple accounts, and save time by reducing the number of logins necessary to read all postings and updates.

Several different dashboards are available (e.g., TweetDeck, HootSuite, and Sprout Social), each with different advantages and disadvantages, but one that is mentioned frequently and used to demonstrate features in this chapter is HootSuite. In Figure 10-12 you will see five tabs, each associated with a different social network (within the red rectangle, from left to right: three Twitter accounts, a personal Facebook account, and the Penn State Extension Ag Entrepreneurship Team Facebook page).

A dashboard not only allows users to check these accounts simultaneously, it enables them to add streams to each account. For example, while the home feed column (left column in Figure 10-12) allows the user to read all the tweets posted by those they follow on Twitter, they can also see:

- Tweets that mention their Twitter handle (e.g., @kmk17psu) grouped together (second column from the left)
- Tweets they have posted (third column)
- Lists they created

Again, a list is simply a way of grouping those you follow on Twitter by criteria you choose—for example, topics they tweet about or the type of business they operate. The example list you

see below (in the right column) aggregates tweets posted by select Penn State Extension personnel (@kmk17psu/psu).

Alternatively, users can add streams that show results for tweets that contain a particular hashtag (searchable keywords or phrases that follow the “#” symbol, such as “#appleorchard”); for example, a series of tweets containing the #winechat hashtag. #Winechat is an event hosted on Twitter each Wednesday night during which wine professionals and those who just like to drink wine discuss a topic and each person who posts a tweet related to the discussion includes #winechat so that the tweets are grouped together and easier to search for on Twitter.

You may find that you do not want as many streams or that you would like more to be visible. What is nice about most dashboards is that you do have the ability to customize certain aspects, such as the number of accounts and streams that are visible. In fact, this might be one of your criteria for selecting a dashboard to use. Certainly, you can check all these streams by going directly to Twitter.com, but you may like the ease of clicking on another tab and viewing other accounts, such as your Facebook page. Also, like the streams set up in the Twitter tab, you can have multiple streams on a Facebook tab (e.g., wall post stream and event stream).

Dashboards also give users the ability to post one message to more than one social media account. For example, you may have posted a message to Twitter and thought that the message would be equally valuable to your Facebook followers. If this is true for you, then you may find dashboards useful. As you can see in Figure 10-13, with a dashboard you can type the message (remember that Twitter posts are limited to 140 characters) and then select to which accounts you want to post the message.

Or, perhaps you have a goal of posting to your accounts at least once a day during the week, but travel prevents you from doing so “live.” Dashboards allow users to program tweets to post on a scheduled basis. You have the option of typing a message and then selecting the day and time you would like the message to post. One word of caution, though, if you are scheduling tweets that may be associated with good weather or another factor that could impact the usefulness of the tweet, make sure you can cancel the intended tweet—just so your followers are not confused by the perplexing message.

Another benefit is that a few of the available dashboards also provide analytics, including:

- Number of Twitter users who click on a link that you included in your tweet
- Daily Facebook activity
- Bounce rate by connecting your dashboard account with your Google Analytics account

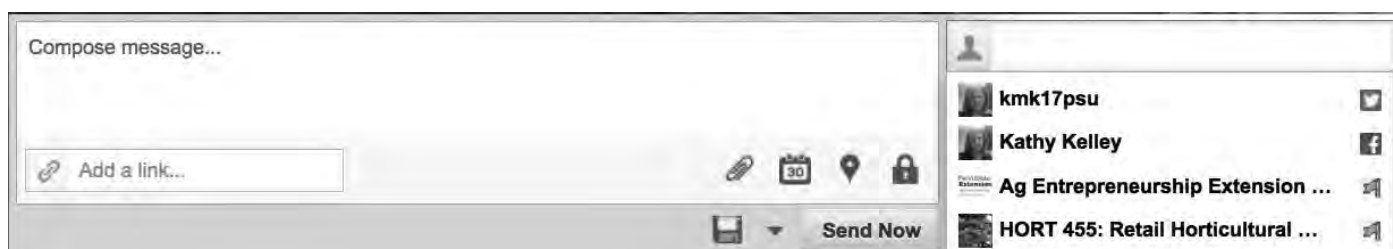

**Figure 10-13.** Dashboards allow users to create one message and post to multiple accounts. Users can also include links to online content, attach digital images, and schedule posts to be published at specific times.



Figure 10-14. How the HootSuite dashboard stream appears on the screen of an iPhone 4.

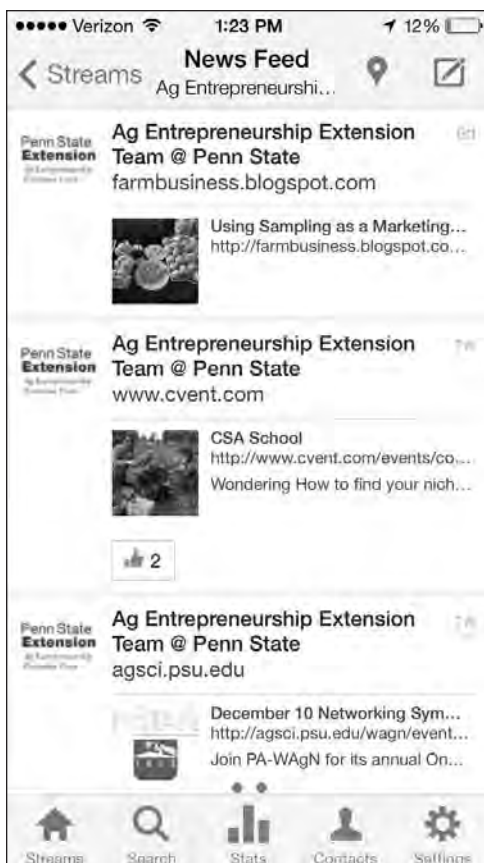

Figure 10-15. How a Facebook newsfeed appears in the HootSuite app.

If you have a schedule that keeps you away from your desk, you might find social media dashboard apps for your tablet or smartphone to be quite useful. Just like desktop dashboards, apps allow the user to:

- Monitor several social media accounts
- Create streams with lists and hashtags (Figure 10-14)
- Schedule when tweets should post
- Easily attach photos to tweets
- Shrink links
- And add locations (latitude and longitude) pertaining to the message

To help you understand what dashboard apps (e.g., TweetDeck, HootSuite, or Yoono), images of various social media networks as they appear on an iPhone are provided in Figure 10-14. These apps will have a similar appearance and functionality on Android phones.

If you have a Facebook page and personal Facebook account, you will be able to access both using a dashboard app. If you have more than one Facebook account that you would like to monitor on your mobile device, your applicable dashboard choice will be limited. Not all dashboards allow users to access both a personal Facebook page and a business page. For comparison, Figure 10-15 shows an image of a Facebook page as it appears in the HootSuite app.

These are just a few features of social media dashboard apps. Each app has benefits as well as limitations; therefore, it is possible that the dashboard app you prefer to use on a desktop may not be the one you prefer to use on a mobile device.

## ONLINE REPUTATION MANAGEMENT

The number of forums, bulletin and message boards, and social networking sites that allow consumers to comment, rant, or rave about a business is continuing to grow. Retailers that have been the subject of consumer expression, good or bad, soon come to understand the power of just one poster's voice. Posts not only impact the business, but others who read the reviews may be swayed by the information they glean from "real people." According to data published in 2016 ([bit.ly/2eYfrXg](http://bit.ly/2eYfrXg)), "more than half of US internet users have stopped doing business with a general retail company due to poor customer service," and an unhappy customer is likely to tell 15 others, on average, about the experience ([amex.co/2eXujWd](http://amex.co/2eXujWd)). Posting and reading reviews will not likely diminish anytime soon. According to research conducted by Forrester Research, consumers who shop on the Internet "rank reviews as the most desired feature of a Web Site."

Taking the necessary steps to monitor what others are saying online about your business is an essential component of building and protecting your business's reputation. Keep in mind that consumers are not the only group that can post about your business. Former vendors, competitors, partners, or others who have ill feelings toward your business may also use this avenue to negatively affect your business.

You can, however, take action to address messages, good or bad, if you are able to monitor what consumers are saying about your business on the web. Fortunately, tools are available to make

this task less daunting. Consider using third-party websites to monitor messages and posts that include your business's name, and correctly acknowledging and addressing both favorable and unfavorable reviews.

### Third-Party Websites for Online Monitoring

The number of tools available for monitoring what is posted about your business, either for free or for a fee, increases frequently. An overview of the types of tools available is presented below. Just as you would research a new piece of equipment or software accounting package, you should do the same for third-party websites. Regardless of which tools you use, it is important to use them weekly, if not daily, to learn what is being posted and read about your business. Keywords you may want to use in your search include “social media monitoring” and “online media monitoring.”

By using a website like **socialmention.com**, you can type keywords or phrases into the search box and access a list of previously published entries. The site uses your keywords to search through blogs, microblogs (such as Twitter), networks, images, video, Q&A, and other information posted online. Because results may be from social networking tools such as Facebook, you may need an active social media account to view that complaint.

Another option is Google Alerts (**google.com/alerts**). This tool is similar to socialmentions.com, but without a Twitter alert search feature. In addition, Google Alerts allows Gmail users to sign up for email alerts based on a keyword of their choosing and determine how often alerts should be sent (e.g., weekly or “as-it-happens”).

To receive alerts for Twitter, consider a tool such as **TweetBeep.com**, which alerts users to “@replies” and “@mentions” posted on Twitter that contain keywords/phrases. Similarly, users can create an account on **IceRocket.com** and search blog postings and subscribe to RSS feeds to receive alerts when new blogs containing keyword/phrases are posted.

These tools can be useful well beyond the purpose of alerting business owners when information is posted on the Internet about their businesses. They can also assist retailers with topics consumers are blogging, tweeting, and posting about, including trends, hobbies, and interests in new products and services. By entering keywords/phrases into search boxes on these sites, you may see common themes among those who are posting online, and you may even discover new merchandise that would be a good fit for your current product offering. Google Trends (**google.com/trends**) and Alexa (**alexa.com**) provide lists of keywords, topics, and/or webpages that consumers are searching for online. An extensive list of third-party websites can be found at **wiki.kenburbary.com**.

### Responding to Customer Reviews

Consumers like to tell others about problems and issues they have had with a product or business. According to a 2017 article on **business.com**, 87 percent of “consumers say they check e-commerce reviews for both online and brick-and-mortar purchases” (**bit.ly/2eX9KZT**), while another source reports that “consumers are likely to spend 31% more on products/services from businesses that have excellent reviews” (**bit.ly/2eXg9UK**).

Whether posted on your website or through third-party web-

site, it is your duty as a business owner to respond to what has been published online. A quarter (26 percent) “of consumers say it’s important that a local business responds to its reviews” (**bit.ly/2y9so9a**). If a consumer contacts a company by email, they may expect a response in a “few hours, or a day or so.” However, if a customer posts a comment or question online, 32 percent (of those who were surveyed) expect a “response within 30 minutes” (**bit.ly/2eY93zq**).

While you should always respond or acknowledge all online reviews, your response to negative posts can help reverse some of the ill feelings that the poster and others reading might have toward your business. If the customer has a valid issue that needs to be addressed, you need to do the following:

- Post a reply to the negative comment as soon as you read the post or receive an alert that something has been posted about your business.
- Acknowledge that there was a problem and that it will be corrected.
- Provide an explanation for the problem.
- Apologize for the problem.
- Thank the customer for informing you about the issue.

To respond to negative reviews on Twitter when you only have 140 characters:

- Respond quickly in one or two tweets.
- Continue the conversation offline.
- If the situation becomes worse and you are harassed or feel the tweet was purposely published to interrupt your business, contact Twitter for assistance.

Chances are that if you reply and correct the situation, your customer may delete the initial negative review or post a new positive one indicating satisfaction with how he/she has been appeased.

Consider responding to positive reviews as well. Thanking customers for publishing these positive views, feelings, and experiences is a way to give your business a personality and increases your presence on the Internet. A simple thank-you is all that is necessary. From **Yelp.com**: “While a gift or invitation sounds like a nice idea, it can also be misinterpreted as a bribe or payment for the review. Remember, this customer already likes your business—just use this opportunity to thank them and introduce yourself.” Responding to favorable reviews demonstrates to your fans that you care about what they have to say. Having any positive conversation with your customers (online, on the telephone, or in your store) is such a great opportunity to learn why they purchase from you and what else you could do to serve their needs.

### Providing a Place for Consumers to Post Reviews

Consumers like to tell others about problems and issues that they have, both good and bad. If consumers are likely to post reviews and critiques online, what better place than on your business's website? A variety of tools are available for you to add a review and comment section to your website. Consider enlisting a service that sends emails to customers who have made online purchases and that invites them to provide a review. Or, include an option where consumers can provide ratings and reviews directly on your

website. PowerReviews ([powerreviews.com](http://powerreviews.com)) and Bazaarvoice ([bazaarvoice.com](http://bazaarvoice.com)) are two such companies that provide a mix of tools for capturing customer input.

Suggestions for soliciting reviews include posting a link on every product page for customers to write a review, sending customers thank-you emails with links to review/comment pages, and offering customers an incentive, such as a free item or discounts/points applied toward a future purchase, for providing reviews.

As you work through the process of asking for and posting reviews on your website, you will certainly find some reviews with spelling errors, grammatical issues, and missing or incorrect product details. You may correct spelling, capitalization, and/or punctuation, but avoid editing much more of the review.

Most likely, as an agricultural business owner, you chose to become involved in your industry out of passion for a particular aspect of agriculture, so that you can live your life a certain way, or because of another personal reason. You probably never anticipated having to spend so much time protecting your business's reputation. As consumers find new ways to communicate with one another, businesses must be aware and participate in these exchanges. By monitoring what is posted online about your business—both the good, which can be used to bolster your reputation, and the bad, which you can take steps to defuse—you are completing some of the tasks necessary to maintain and increase your business's economical sustainability and profitability.

### Quantifying Visits to Your Website

While monitoring what customers post about your business online is an important task, you'll also need to monitor other aspects of your business online:

- Number of visitors who access your website and how this foot traffic changes throughout the day or week
- Effectiveness of an email, online newsletter, or other communication that encourages customers to visit your website
- How long visitors stay on your website
- If certain webpages appear to be more appealing to visitors than others

Just as a variety of tools are available for monitoring what consumers post about your business, there is also an array of third-party websites that can help you gather information to strengthen your online presence. Google Analytics ([google.com/analytics](http://google.com/analytics)) is a free program that can be used to collect the following, among other metrics:

- How visitors “find” your site, whether they type in the URL or are directed from another site
- Your “bounce rate,” which is the percent of visitors who visit your landing page and then leave your website
- How long visitors remain on your site, how many pages they access during their visit, and if they are led to a certain page on your site because they clicked on an ad you posted elsewhere online
- Number of new visitors who have accessed your site, number of times a certain product was purchased, and revenue per click

Implementing Google Analytics requires signing up for a Google account, entering the URL for your website, and adding the Google Analytics Tracking Code to your site. Once the system is in place, your business can benefit from knowing who is visiting the site and when, and where they navigate to—all important statistics when monitoring the effectiveness of your website.





## CONTENTS

### **Drip Irrigation and Sensor-Based Precision Irrigation ..... 426**

Introduction.....	426
Drip Irrigation Systems for Tree Fruit Orchards.....	426
Irrigation Application Rate Calculation.....	426
Terms and Principles for Soil Water Status.....	427
Soil Texture Differences.....	427
Soil Water Status.....	428
Irrigation Scheduling Strategies.....	428
Soil-Moisture-Based Irrigation System.....	429
Automated Irrigation System.....	430

### **Collecting Weather Information in Orchards ..... 431**

Personal Weather Systems.....	431
NEWA Weather System.....	431
Pennsylvania Environmental Monitoring Network (PEMN).....	431
Which System Is the Right Choice?.....	431
Weather Summary Information.....	432
E-Weather Systems.....	432
Weather Stations and Accessories.....	432

### **Frost Protection for Tree Fruit..... 432**

Selecting the Right Site.....	432
Heating.....	432
Sprinkling.....	432
Pulsing.....	433
Undertree.....	433
Wind Machines.....	433

### **Critical Temperatures for Various Fruits ..... 433**

## TABLE

<b>Table 11-1.</b> Critical temperatures for various fruits.....	434
--	-----

## FIGURES

<b>Figure 11-1.</b> A simplified drip irrigation system schematic diagram.....	426
<b>Figure 11-2.</b> The components of soil water reservoir and important terms.....	427
<b>Figure 11-3.</b> Soil moisture conditions for various soil textures.....	427
<b>Figure 11-4.</b> Soil water content (a) and potential change (b) during an irrigation event at hourly intervals.....	430

## DRIP IRRIGATION AND SENSOR-BASED PRECISION IRRIGATION

### Introduction

Irrigation is the application of controlled amounts of water to plants at needed intervals. Irrigation helps grow agricultural crops, maintain landscapes, and revegetate disturbed soils in dry areas and during periods of inadequate rainfall. Precipitation in Pennsylvania averages about 37 inches each year. About 13 inches of this precipitation runs off land into streams, while 24 inches infiltrates into the soil, where it can be used by crops. While uneven precipitation can cause plant stress during critical growth periods, which will affect both crop productivity and produce quality, most horticultural crops require supplemental irrigation to minimize plant stress. Proper timing of water applications during appropriate periods can increase the yield and quality of most horticultural crops in Pennsylvania in most years. Critical periods for the irrigation of apples are during flower formation, early fruit set, and during final fruit swell (Penn State Extension 2017).

For high-density apple orchards, water relations are even more important. Irrigation is essential for ensuring optimum growth of newly planted and young apple orchards and to obtain desired fruit size. For high-density orchards, the economic success really depends on obtaining significant yields in the third, fourth, and fifth years to repay the establishment costs. To obtain the expected high yields requires excellent tree growth during the first three years after planting. However, one of the biggest problems we see with new high-density orchards is inadequate tree growth during the first three years. It is estimated that when poor tree growth in the early years delays cropping of a new orchard, peak investment is delayed by 20 percent and the total profits are reduced by 66 percent over the 20-year life of the orchard (Robinson et al. 2013). Much of the problem of poor tree growth can be traced to inadequate water supply during the first three years. Therefore, it is very important to have a precision irrigation system for high-density apple orchards.

### Drip Irrigation Systems for Tree Fruit Orchards

Typically, there are three major irrigation systems in tree fruit orchards: drip irrigation, undertree sprinkler, and overhead sprin-

kler. In humid-climate regions, drip irrigation is primarily used. Drip irrigation is a type of micro-irrigation system that has the potential to save water and nutrients by allowing water to drip slowly to the roots of the plants, either above the soil surface or buried below the surface. Drip is the most efficient way to irrigate. It is usually about 90 percent efficient, compared to about 70 percent for sprinkler and often 50 percent for surface irrigation. Besides high water-use efficiency (90–95 percent), drip irrigation also reduces the risk of plant diseases that thrive in wet conditions. A typical drip irrigation system includes a water source (e.g., well water, river water), a pump, a pressure regulating system, valves, pipeline, emitters, and other accessories. Figure 11-1 illustrates a simplified drip irrigation schematic diagram. Drip irrigation is suitable to all soil types because of its extremely slow application rate and high degree of control over timing and amounts (Peters 2015). For details of drip system components, installation, and operation, refer to the *Drip Irrigation Handbook* at <https://www.netafim.com/499749/globalassets/products/drippers-and-dripperlines/drip-irrigation-system-handbook.pdf>.

### Irrigation Application Rate Calculation

As described in Peters (2015), water movement capability varies in different soil types, e.g., sandy soil (1-to-1.5-foot radius); loam soil (1.5-to-2.5-foot radius); and clay soil (2.5-to-3.5-foot radius). These are important for setting lateral distance between the emitters. Meanwhile, a smaller root zone is more sensitive to water and nutrient stress because crop roots have no motivation to and will not grow into dry soil. Therefore, a larger root zone can be encouraged by running the drip system for longer amounts of time. In order to calculate the application rate of the drip irrigation system, the emitter flow rate, the emitter spacing among the tubing, and the distance between drip lines must be known. The equation is as follows:

$$ApRt = 231.1 \times [(EmitterFlow \times Eff) / (RowSpc \times EmitterSpc)]$$

Where ApRt is the application rate in inches per hour, EmitterFlow is the emitter flow rate in gallons per hour, Eff is the irrigation efficiency (use 0.95 for drip irrigation), RowSpc is the spacing between rows in inches, and EmitterSpc is the spacing between emitters in inches.

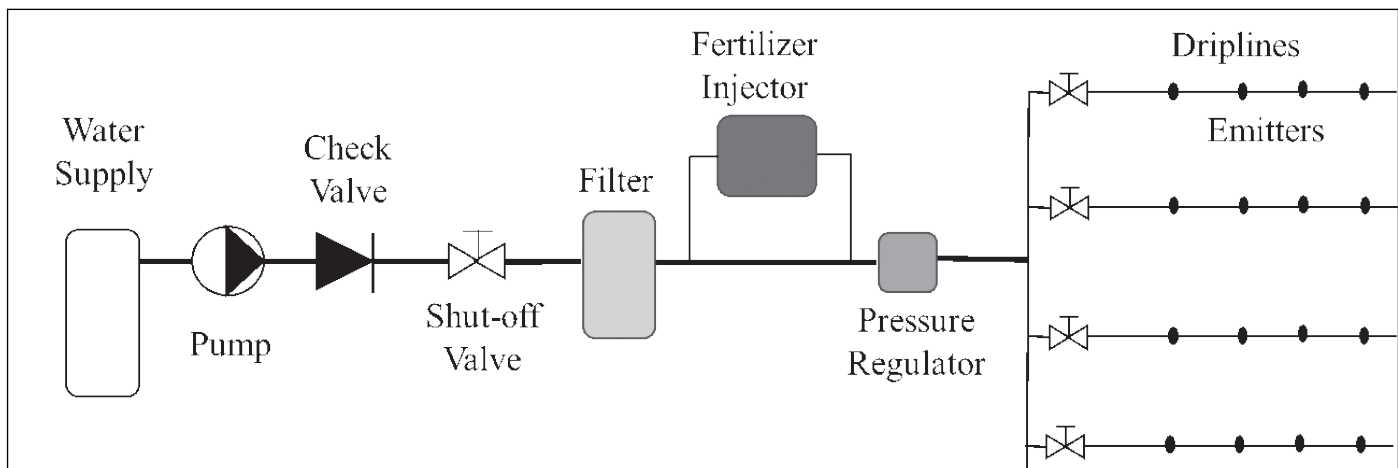

Figure 11-1. A simplified drip irrigation system schematic diagram.

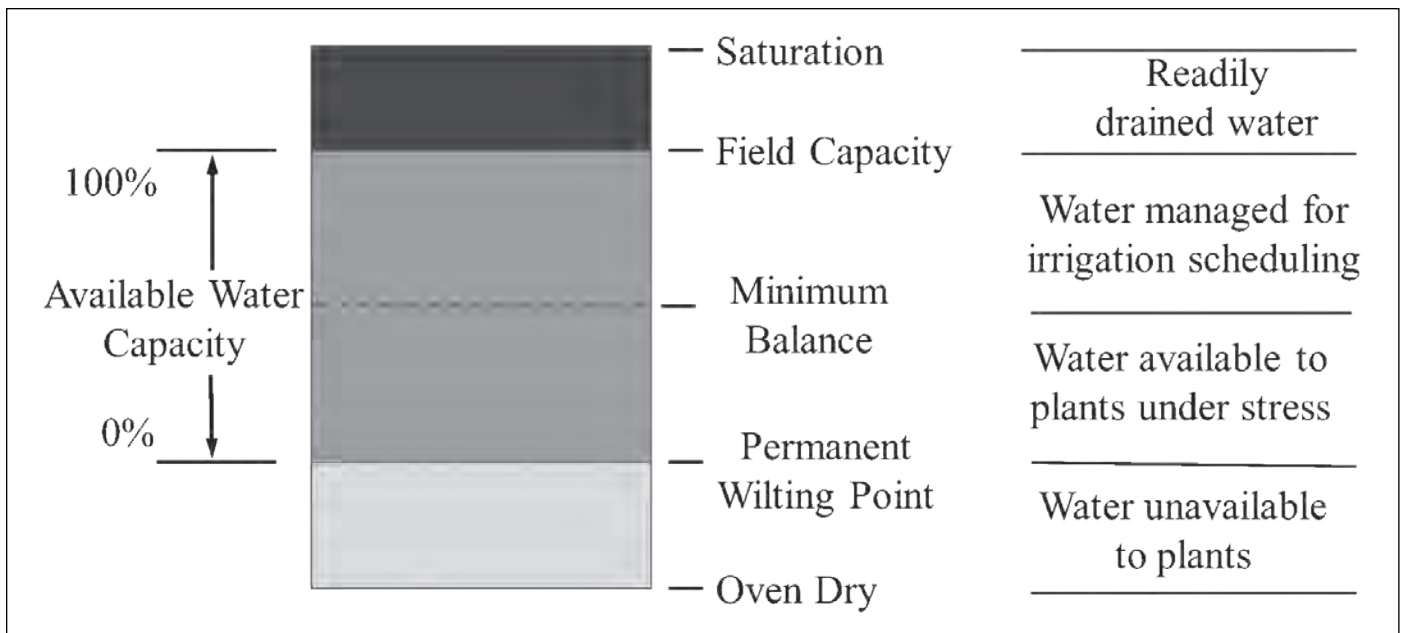

Figure 11-2. The components of soil water reservoir and important terms.

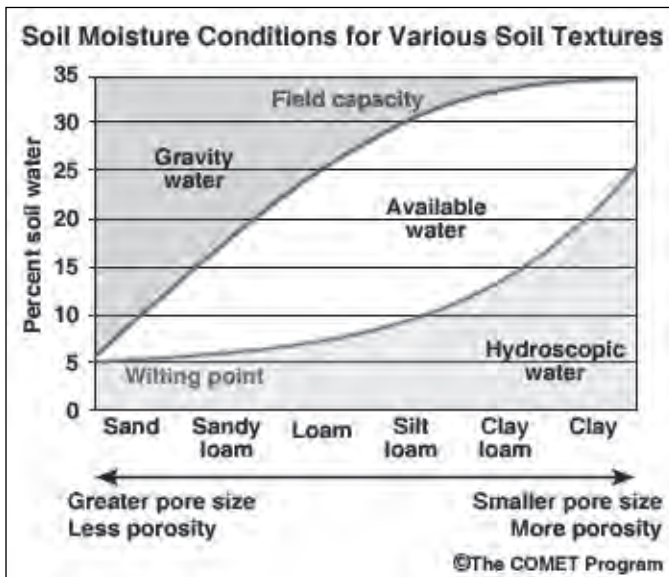

Figure 11-3. Soil moisture conditions for various soil textures. Source: The COMET Program, University Corporation of Atmospheric Research.

The calculation of application rate is for covering the entire field. When considering the root zone of the fruit trees (if only root zone is expected to be watered), the application rate could be lower based on the size of the root zone.

### Terms and Principles for Soil Water Status

Here are definitions for some core terms from the University of Minnesota Extension's "Soil-Water Basics for Irrigation Scheduling" (2019):

**Available water holding capacity (AWC):** amount of water that soil can store to be extracted by the plant. It is the water held between field capacity and permanent wilting point.

**Field capacity:** amount of water that remains in the soil after all the excess water at saturation has been drained out. When the soil

is allowed to drain for approximately 24 hours after saturation, field capacity is reached. Field capacity is viewed as the optimal condition for plant growth and microbial activity.

**Minimum allowable balance (MAB):** the soil water content where crops begin to experience water stress. Usually, most crops do not experience water stress before 40–60 percent of AWC has been removed.

**Permanent wilting point:** when plants uptake all the available water for a given soil, soil dries to a point that it cannot supply any water to keep plants from dying.

**Saturation:** water that readily percolates or drains out from the root zone by gravitational force; also called gravitational water.

**Soil water deficit:** amount of water removed from active rooting depth by comparing to the water level at the field capacity. Soil water deficit can be monitored directly by using soil moisture sensors or indirectly by estimating crop water use (evapotranspiration) with using water-balance equation.

**Soil water:** water contained within or flowing through the soil profile. Surface water must infiltrate the soil profile to become soil water. Groundwater is subsurface water in sufficient quantity that wells or springs can use it.

Figure 11-2 illustrates the components of soil water reservoir and the corresponding interpretation of water status in the soil. As shown in Figure 11-2, the available water in the soil is between the field capacity and permanent wilting point; however, we should not wait until the available water is gone to start irrigation. Irrigation needs to be started before the water level reaches the minimum balance, which is the threshold for the plant not being stressed.

### Soil Texture Differences

As shown in Figure 11-3, different soil types have different available water content ranges between field capacity and wilting point. Sandy soil has very low field capacity, while clay soil has

very high field capacity. The same as the wilting point, sandy soil also has the lowest value, and clay soil has the highest value. Overall, sandy soil has the least available water. Available water is not the highest for clay soil but rather for silt loam or clay loam.

For example, even though the amount of available water from sandy loam soil is small, the plant can still get water at certain low levels of water content. For the clay soil, even with a relatively higher water content (25 percent) in the soil, the plant has difficulty using water at this water level due to the higher amount of energy required for water movement in the clay soil. For irrigation scheduling, whenever the soil water deficit is equal to or higher than minimum water balance, then irrigation should be triggered. The application rate of irrigation could refill the root zone to the level of field capacity.

### Soil Water Status

The state of water in soil is described in terms of the amount of water and the energy associated with the forces that hold the water in the soil. The amount of water is defined by water content, and the energy state of the water is the water potential. Plant growth, soil temperature, chemical transport, and groundwater recharge are all dependent on the state of water in soil. While there is a unique relationship between water content and water potential for a particular soil type, it is important to understand the distinction when choosing an instrument to measure soil water.

### Soil Water Content

Soil water content is expressed on a gravimetric or volumetric basis. Gravimetric water content is the mass of water per mass of dry soil. It is measured by weighing a soil sample, drying the sample to remove the water, then weighing the dried soil. Volumetric water content is the volume of liquid water per volume of soil. Volume is the ratio of mass to density. Water content indicates how much water is present in the soil. It can be used to estimate the amount of stored water in a profile or how much irrigation is required to reach a desired amount of water. Water content measurement methods include gravimetric, neutron probe, time-domain reflectometry (TDR), and other dielectric permittivity sensitivity devices.

### Soil Water Potential

Soil water potential is an expression of the energy state of water in soil, and it is estimated to describe the water flux in the soil. Water flux is defined as the movement of water occurring within the soil profile, between the soil and plant roots, and between the soil and the atmosphere.

Water potential quantifies the tendency of water to move from one area to another due to osmosis, gravity, mechanical pressure, or matrix effects such as capillary action. The concept of water potential has proved useful in understanding and computing water movement within plants, animals, and soil. If flow is not restricted, water will move from an area of higher water potential to one of lower potential. Soil water moving to the plant is a good example, as it has negative water potential relative to the pure water references.

### Irrigation Scheduling Strategies

The purpose of irrigation scheduling is to determine the exact amount of water to apply to the field and the exact timing for

application. The amount of water applied is determined by using a criterion that determines irrigation need and a strategy to prescribe how much water to apply in any situation. There are a few different methods for scheduling irrigation for tree fruit orchards, such as conventional irrigation, ET-based irrigation, soil moisture-based irrigation, and plant-based irrigation.

### Conventional Irrigation

Conventionally, irrigation is applied based on grower experience and simple observations, or by scheduling a regular time for irrigation, for example, irrigation every day or certain days of the week for certain durations at each time. This may lead to waste from overirrigation or ineffectiveness due to underirrigation. An improper water supply for the crops also may cause nutrient leaking or insufficient nutrient uptake. When correctly employed, appropriate irrigation scheduling methods may reduce water usage and increase profitability and sustainability. Therefore, sensor-based irrigation is essential for precise irrigation in terms of saving water and obtaining maximum production.

### Evapotranspiration-Based Irrigation

Weather-based irrigation is also called evapotranspiration (ET)-based irrigation. The ET rate equals the total loss of water by evaporation from the soil surface, plus the transpiration from plants, over a given area in 24 hours, in inches per day. With ET-based irrigation, the application rate of an irrigation system would be the total ET rate subtracted from the precipitation rate. ET-based irrigation requires a complete set of weather parameters from a nearby weather station to calculate the ET rate. The ET rate can be calculated using the Penman-Monteith equation. Of course, the crop itself and planting situations also affect calculating ET. ET is an estimated value that may not be very accurate. Also, modeling irrigation needs from ET data can be a challenge for an inexperienced grower.

### Soil-Moisture-Based Irrigation

Soil moisture measurement acquired in the field adjacent to the crops being irrigated is one of the best and simplest ways to support water management decisions. Soil water content and soil water potential are two indicators of plant-available water used by soil-based irrigation systems. There are a wide range of measuring instruments for measuring soil moisture, including neutron probes, time-domain reflectometry/transmissivity (TDR) sensors, capacitance sensors, tensiometers, and granular matrix sensors. These devices range from inexpensive gypsum blocks to costly TDR sensors. Variable soil texture and structure, as well as difficulty of accurately locating the root zone, are challenges for soil-moisture-based irrigation technology. Despite these difficulties, soil sensors report conditions directly from the field, and can be polled locally or remotely to control irrigation.

### Plant-Based Irrigation

Canopy temperature has been shown to be an indicator of plant water stress. Plant-based thermal optimum approaches schedule irrigation based on plant infrared thermal response to water status. Crop water stress index (CWSI) can be used to indicate the status of the crop. The index is based on the difference between canopy temperature and air temperature normalized for the vapor

pressure deficit of the air. The index can be used to determine when to irrigate based on the stress level of the plant. Meanwhile, climate data must also be taken into consideration.

Among these irrigation scheduling strategies, soil-moisture-based irrigation is achieved with easy and direct measurement, and has been widely used for crop irrigation system. Therefore, we will focus mainly on the soil-moisture-based method and its associated components and technologies.

### Soil-Moisture-Based Irrigation System

As indicated earlier, there are different types of sensors to measure the soil moisture level. The sensors are produced from a wide range of manufacturers. Here, we will take the sensors from Meter Group, Inc. as an example, with soil water content sensors (Teros 10 or Teros 12) and soil water potential sensor (Teros 21).

### Site Selection

To adequately apply irrigation in an orchard block, it is very important to find a location(s) to install sensors that could be representative to the whole orchard block. A representative location is one where the drainage and retention conditions match the average conditions within the block. There is no single rule for how many sensor stations are required for a certain size of orchard block, and one sensor station may include multiple sensors at different depths. In most cases, site selection depends on the estimation along with the experience. If the orchard has better uniformity in terms of soil type and terrain, then one sensor node could be sufficient to cover a big orchard. Of course, installing more sensor stations will increase the accuracy of irrigation for the whole orchard block. When using more sensor stations, the cost of adopting and maintaining the sensor system would increase accordingly.

Data service availability will also need to be taken into consideration if wireless data communication is expected (i.e., to access the data remotely from a computer, tablet, or phone). Prior to installing the sensors into the ground, make sure the location is capable of the required service (cellular service or in the range of LoRa data acquisition).

### Sensor Installation

Sensor installation begins by digging a hole into which the sensors will be placed and in contact with the soil. To cover the root zone for fruit trees, multiple sensors will typically need to be installed at different depths. Meanwhile, it is very important to accurately sample the soil profile while disturbing the soil as little as possible. For a soil water content sensor, firmly insert the prongs of the sensor into the undisturbed sides of the hole; for soil water potential sensor, cover the head with moist soil prior to being placed into the hole at the required depth. Specific installation requirements for the sensors should follow instructions from the Meter Group, Inc.

### Data Acquisition

Sensor data for the soil moisture information is recorded by a datalogger (ZL6), which can connect up to six sensors. All the sensors are physically connected to the datalogger, and the soil moisture is recorded by the datalogger at a certain frequency (e.g., 10 minutes per reading). With different types of soil

moisture sensors (Teros 12), the soil temperature and electric conductivity (EC) are also measurable.

The data from the datalogger is available to download physically via USB or Bluetooth connection (with Zentra Utility app). To access the data remotely, create an account at Zentra Cloud ([www.zentracloud.com](http://www.zentracloud.com)). Create a profile that links your orchard with each ZL6 datalogger device to the Zentra Cloud service. Follow the step-by-step instructions at <https://www.metergroup.com/environment/articles/why-you-need-zentra-cloud-and-how-to-get-started/#started> to link the sensors in the orchard to your Zentra Cloud account. Data should begin uploading from the logger at the intervals set during the configuration step.

### Data Analysis and Irrigation Scheduling

As discussed above, the water content sensor (Teros 10) reading indicates how much water is in the soil (for example, 0.30 m<sup>3</sup>/m<sup>3</sup> means 30 percent of a block of soil is water at the measured location). The water potential sensor reading indicates the energy required to move the water from soil to the plant, and the value is always negative. The smaller the absolute value, the wetter the soil. For example, -10 kPa indicates very wet soil, while -80 kPa indicates that the soil is possibly a bit dry.

The idea is that irrigation is to keep the soil water content at its field capacity level (too much water causes water/energy loss and nutrient loss, while less water causes plant stress). For different types of soil, the specific values for identifying wet or dry conditions with a soil water content sensor are different. Even at different depths within the same orchard, the values may vary.

Two different methods may be employed to estimate the field capacity. At the beginning of the season prior to heavy demands for water by rapidly growing trees, apply full irrigation (for example, 6–8 hours of drip irrigation). Check the soil water content data after 12–24 hours. This provides an estimated field capacity since excess water will have drained away and it is assumed little is lost to transpiration and evaporation.

A second method to identify the field capacity uses the Teros 21 water potential sensor. Apply full irrigation as above. If the water potential remains at or near -10 kPa for 12–24 hours, then the corresponding measured water content value could be considered at field capacity.

The water potential sensor is less sensitive to the soil type/texture and is more representative of the availability of water to the plants. Normally, if the water potential is about -10 kPa, tree roots could get water from the soil very easily. As the value gets increasingly negative, the difficulty for roots to acquire water increases. For sandy soils or soils with rocks, when the potential drops to -30 kPa, it may be appropriate to consider starting the irrigation system. If the soil contains more clay, then the irrigation threshold could be set to -80 kPa or lower. However, it is also important to take into consideration the root zone of the soil and its depth. If the soil surface area (upper root zone) gets dry while the deeper soil remains wet, fewer irrigation hours may be necessary.

Figure 11-4 shows the changing of the soil water content (a) and soil water potential (b) within an irrigation event. Three soil water content sensors were installed at 1 foot (WC #1), 2 feet (WC #2), and 3 feet (WC #3); two soil water potential sensors were installed at 1.25 feet (WP #1) and 2.5 feet (WP #2). The

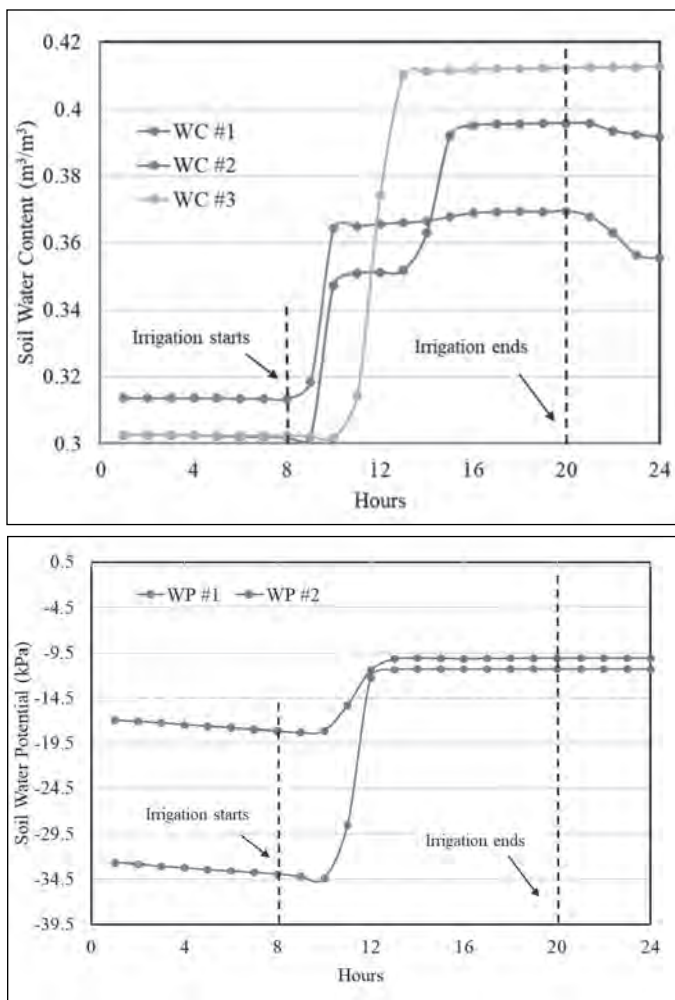

Figure 11-4. Soil water content (a) and potential change (b) during an irrigation event at hourly intervals.

irrigation event started at 8:00 a.m. and ended at 8:00 p.m., for total of 12 hours of irrigation. About 1 inch of water was applied to the soil for apple trees. The soil water content at the top portion of the root zone increased first after the irrigation event started, and then deeper ones followed. After a few hours of irrigation, the soil water contents at different levels were maintained at a consistent level, especially after 1:00 pm. The same trends also occurred for soil water potential measurements. Therefore, it would be reasonable to stop irrigation at an earlier time to save some water. More studies/cases will be conducted to identify an effective irrigation ending time when soil water content sensors are used for irrigation scheduling in apple orchards.

### Automated Irrigation System

An automated irrigation system (1) accesses the soil moisture data remotely, (2) includes decision-making with a predefined irrigation scheduling strategy, and (3) applies irrigation automatically with the solenoid valves.

### Internet of Things

Internet of things (IoT) is a system of interconnection via the internet of computing devices embedded in everyday objects, enabling them to send and receive data. With IoT-based farming, a system is built to monitor the crop field with the help of sensors

and automate the operation systems. Farmers can monitor field conditions from anywhere and even conduct automatic operations. Precision agriculture is one of the most famous applications of IoT in the agriculture sector, and precision irrigation is among them. Here we introduce two types of IoT systems for precision agriculture.

**Cellular-based IoT** is a way of connecting physical things (like sensors) to the internet by having them piggyback on the same mobile networks as smartphones. Take the ZL6 datalogger as an example. Data communication is based on cellular service (AT&T and T-Mobile). The sensors are connected to the datalogger, the sensor data will be recorded at set time intervals (for example, 10 minutes per reading), and the data will be uploaded to the cloud service every hour at selected times. Through end-user devices, such as a phone or computer, the data can be accessed and downloaded by logging into [zentracloud.com](http://zentracloud.com).

**Long-range (LoRa)-technology-based IoT** uses license-free sub-gigahertz radio frequency bands like 433 MHz, 868 MHz (Europe), and 915 MHz (North America). LoRa enables long-range transmissions (more than 5 miles in rural areas) with low power consumption. The technology is presented in two parts: LoRa, the physical layer, and LoRaWAN (long-range wide-area network), the upper layers. LoRa and LoRaWAN permit long-range connectivity for IoT devices in different types of industries.

LoRa devices and technology are making irrigation management systems easy and affordable. Many different manufacturers provide LoRa-based IoT systems for precision irrigation; Vinduino is the one we tested. When using the Vinduino system, a maximum of four soil moisture sensors can be connected to the LoRa-based sensor station, and a LoRa-based controller can be used to control the solenoid valves for automated irrigation.

### Automated Irrigation Control

**Connect the sensors to the internet.** As described earlier, sensors will be installed in the plant root zone and connected to the datalogger. The soil moisture data will be recorded in real time and transmitted to the cloud service through a gateway (internet). Then the irrigation application will be applied according to the soil moisture and irrigation strategy (threshold to apply and stop water).

**Control of solenoid valves.** Once the soil moisture level has reached the dry threshold, then the solenoid valves will be turned on to apply water to the plants. During irrigation, the soil moisture values will change until the wet threshold is reached, and then the control system will turn the solenoid valves off to stop watering the plants. The application could be fully automated using IoT technology. The status of the solenoid valves (on/off) can be shown in an end-user interface, and human interference could be allowed to manually turn the solenoid valves on and off.

**Irrigation scheduling interface.** For the IoT system, an end-user interface for monitoring the sensor status and controlling the irrigation valves is essential. Some sensor/IoT system manufacturers have their own or recommended interfaces. For example, if ZL6 datalogger is used along with soil moisture sensors, then we can use Zentra Cloud to access the data. With using Vinduino system, eOrchard software is recommended to access the data. A fee is typically required for a season pass to use the

cloud services from these companies. A customized interface could be developed from some free-access resources, such as “thethingsnetwork” and “allthingstalk.”

## COLLECTING WEATHER INFORMATION IN ORCHARDS

Collecting weather data is an important step to successful implementation of integrated pest management (IPM) and making orchard cultural management decisions. Weather information aids in monitoring disease infection periods, operating insect degree-day models, monitoring irrigation systems, applying fruit-thinning chemicals, determining application intervals, and operating computer-based orchard management software.

This section describes options for collecting and recording weather data to help make fruit production decisions. The emphasis is on choosing instruments and options, making observations, and modifying local forecasts for specific locations. However, customized weather prediction services that are specific to your farm can also be purchased from private companies. There are numerous weather stations available to growers, and some of them are listed at the end of this section.

Weather can vary over small distances, owing to variations in terrain, vegetative cover, proximity to water bodies, and other factors. Therefore, weather observations taken at one location may not be representative of another location, even within the same county, farm, or orchard. Similarly, weather forecasts for a nearby city or area may not be adjusted for local weather influences (e.g., terrain) within a county or on a farm. Therefore, it is necessary for growers to take weather observations on their own farms in order to make informed decisions. If there are significant differences in the locations of your orchards, you may need to make weather observations at several sites on the farm.

Many weather monitoring systems are available for collecting weather data in orchards. Automated weather stations provide continuous monitoring of weather and the data obtained can be downloaded or sent wirelessly to a computer. Depending on the model and software, some stations are capable of sending the data to a computer where the data can be automatically uploaded and viewed in real time on a website. The cost of weather stations can range anywhere from under \$100 to upward of \$2,500, depending on the hardware options, software options, and the quality of the components.

### Personal Weather Systems

Personal weather systems allow growers to get real-time, on-site weather data. They typically measure temperature, precipitation, and relative humidity. Many also measure barometric pressure and include an anemometer to measure wind speed. These systems typically use a console that connects wirelessly to an outdoor station. Many of these systems now have the ability to access data through a remote computer, tablet, or smartphone with the proper software. Some can also connect to Wi-Fi. More advanced weather systems have ports to which additional sensors can be connected, allowing growers to choose which sensors they want. Some of these include sensors that measure leaf wetness, soil moisture, solar radiation, and other parameters. Most are equipped with solar panels to extend battery life. Weather

data that is collected by some weather stations is stored and can be downloaded on a personal computer. In addition, there are some weather networks, such as Weather Underground, that can upload data from personal weather stations that can be viewed by the public. The types of weather stations these networks can support vary by network.

### NEWA Weather System

Penn State is a member of the NEWA (Network for Environment and Weather Applications) system network, which is operated by Cornell University, initially utilizing the RainWise MKIII SP1 Weather station, and provides onsite predictions of disease and insect problems based on models and weather data. In 2019 a new option for weather station system monitoring with the ONSET HOBO data loggers was added to the NEWA site. There are numerous weather stations in grower orchards across the state. You can log onto [newa.cornell.edu](http://newa.cornell.edu) and select stations located in Pennsylvania near you to monitor weather, pathogen, and insect conditions. Disease models for apple scab, fire blight, sooty blotch, and flyspeck are included in the system. Insect pest models include spotted tentiform leafminer, oriental fruit moth, codling moth, plum curculio, obliquebanded leafminer, apple maggot, and San Jose scale. This system also provides access to two horticultural predictive models. Cornell’s MaluSim model, developed by Dr. Alan Lakso, utilizes sunlight, maximum and minimum temperatures, latitude, and crop phenology to estimate the carbohydrate level of a typical apple tree. This information is then utilized to adjust chemical thinning recommendations. The new Pollen Tube Growth Model was added this past season. It allows growers to predict the appropriate timing for the application of a thinning spray during bloom to prevent fruit set during bloom. The second model utilizes similar information to estimate the water status of an apple tree to assist in determining irrigation needs of the orchard. Other models under the crop management heading include irrigation scheduling, evapotranspiration, apple frost risk, growing degree days, and monthly drought outlook and monitor. For more information on the capabilities and requirements of this system, go to [newa.cornell.edu](http://newa.cornell.edu).

### Pennsylvania Environmental Monitoring Network (PEMN)

A statewide weather and soil condition monitoring network was initiated in 2019. Several stations are being installed throughout the state, and the measured data will be available to the public through the internet. Air temperature, wind speed and direction, solar radiation, soil moisture and temperature at various levels, and precipitation rates and totals will be measured in a standardized format. The data will be transmitted to a centralized location for processing and quality control. The information will be developed into output formats useful for agriculture, emergency management, utilities, and other interested parties. Similar networks have been established in New Jersey and Delaware. A great example of the goals of this project can be found at the Oklahoma Mesonet, [mesonet.org](http://mesonet.org).

### Which System Is the Right Choice?

No single system is the right choice for everyone. The system a grower chooses depends on the needs of the individual grower. The factors that often determine what type a grower utilizes

are cost of the instrument, ease of setup and maintenance, and the type of data that a grower uses. Complete weather stations placed in the orchard have the advantage of very accurately recording the weather at the orchard site, but they will require routine maintenance (replacing batteries, checking rain collector for debris, etc.). There are currently numerous automated weather stations available for growers to collect data for their personal use. The summary below provides an incomplete list of some of the weather stations readily available on the market and a generalized relative price comparison. Contact your local extension educator if you have questions about the selection of a weather monitoring system.

### Weather Summary Information

The Pennsylvania State Climatologist office produces a monthly newsletter titled *The Pennsylvania Observer*. You can subscribe to electronic delivery of the newsletter by going to [climate.met.psu.edu/features/newsletter](http://climate.met.psu.edu/features/newsletter) and supplying them with your email address. The newsletter provides a monthly summary of Pennsylvania weather with extreme conditions in the past month, a featured climate highlight, and a long-range outlook for the coming month.

### E-Weather Systems

Network for Environmental and Weather Applications (NEWA)  
315-787-2207  
[newa.cornell.edu](http://newa.cornell.edu)

### Weather Stations and Accessories

AcuRite  
262-249-3259  
[www.acurite.com](http://www.acurite.com)

Ambient Weather  
480-346-3380  
[www.ambientweather.com](http://www.ambientweather.com)

BloomSky  
855-278-7080  
[www.bloomsky.com](http://www.bloomsky.com)

Davis Instruments  
510-732-7814  
[www.davisinstruments.com](http://www.davisinstruments.com)

La Crosse Technology  
608-785-7939  
[www.lacrossetechnology.com](http://www.lacrossetechnology.com)

Meter Environment  
509-332-2756  
[www.metergroup.com](http://www.metergroup.com)

New Mountain  
860-691-1876  
[www.newmountain.com](http://www.newmountain.com)

ONSET HOBO Data Loggers  
1-800-564-4377  
[www.onsetcomp.com/corporate/partners/newa](http://www.onsetcomp.com/corporate/partners/newa)

Oregon Scientific  
1-800-853-8883  
[oregonscientificstore.com](http://oregonscientificstore.com)

RainWise  
1-800-762-5723  
[www.rainwise.com](http://www.rainwise.com)

## FROST PROTECTION FOR TREE FRUIT

Frost causes the loss of a certain percentage of tree fruit crops almost every year. Susceptibility to frost damage depends on a tree's stage of development, variety, and location, but certain preventive measures can be taken. The goal of all frost protection methods is to maintain the blossom temperature above the critical temperature.

Only a few frost protection methods have been consistently effective over the years. These vary considerably in cost, management time, and effectiveness. It is very important to get a good estimate of actual economic losses caused by frost before deciding whether to implement a frost protection system. A small average annual loss of crop to frost may not be worth the time and money invested in a protection system.

### Selecting the Right Site

When air near the ground cools, it becomes denser. If the ground is sloped, the colder air will flow downhill into a pocket or onto level ground. Therefore, planting the orchard on a hill is the first step in frost protection because there is nothing to trap the cold air as it drains. In some cases, cold air drainage may protect the crop from frost enough that no other method is necessary. However, if a good sloped site is not available or a site already established is experiencing frost damage, other protection measures may be required.

### Heating

Burning combustible materials to protect crops from frost originated thousands of years ago. This is the most effective way to maintain the temperature above the critical level, but it is also the most expensive and environmentally damaging. Stack heaters, still available from selected distributors, burn fuel oil stored in the heater's base or injected through nozzles from a fuel line. The heaters often have a diffuser on the top to spread out the flume. Trees are heated through radiational transfer directly from the heaters or from air warmed by them.

### Sprinkling

Using water to protect blossoms from cold has gained popularity over the last couple decades. Compared to heating, irrigation for frost protection lowers expenses and reduces environmental damage. Irrigation lines can also be used for soil moisture maintenance, chemical injection, and heat suppression. Although water use can protect against frost, it involves greater risks than heating. Overuse of water can saturate soils, increasing the likelihood of



diseases, and build up ice, which may damage trees. Water application rates depend on the desired bud temperature (buds in earlier stages of development are hardier and therefore have lower critical temperatures), air temperature, humidity, and wind speed.

### Overtree

Applying water directly to flower buds allows the heat released from freezing water to maintain a bud temperature near freezing, which is a few degrees above the critical damaging level. As long as the rate of water being applied and the rate of freezing are balanced, bud temperature will remain close to the freezing mark. Insufficient application can do more damage than no protection at all since evaporation may cause flower bud temperature to drop below air temperature.

One problem with overtree sprinkling is not knowing how much water to apply. Application rate models have been developed by modeling the energy balance between heat lost from the buds as a result of environmental conditions and heat gained from freezing of the water. Rates for different conditions have been determined using the sprinkler application rate model FROSTPRO and are shown in the table below. Note that lower humidities will increase the application rate.

<b>Sprinkler application rates (inches per hour) from FROSTPRO.</b>				
Temperature (°F)	Wind speed (mph)			
	1	2	5	10
30	0.05	0.05	0.09	0.12
28	0.07	0.10	0.15	0.16
26	0.10	0.13	0.20	0.24
24	0.12	0.17	0.26	0.32
22	0.14	0.20	0.31	0.40
20	0.17	0.24	0.37	0.47

*Note: Results are based on the assumption that the critical temperature of the bud is 28°F and the relative humidity is 75 percent. Source: Perry (1986).*

### Pulsing

The principle behind pulsing (or cycling) the irrigation system is that the rate by which water is delivered to the orchard can be varied by turning the water on and off in short cycles, e.g., two minutes on and two minutes off. First, determine the fixed rate of the sprinklers. If it is not known, you can determine the application rate by placing buckets in a grid pattern in the orchard and sprinkling for one hour. Measure the depth of water in the buckets, and use the average application rate in inches per hour. For example, if the fixed rate is 0.20 inch per hour, and the recommended rate is 0.10 inch per hour, the cycle would be something like two minutes on and two minutes off. The on time should not be less than the time for a sprinkler head to make a complete rotation, and the off time should not exceed three minutes.

### Undertree

A sprinkling technique common for citrus in Florida is the use of undertree sprinklers to protect trees from frost. How this method works is not completely understood, but it is believed that the heat released as water vapor condenses on leaves and blossoms keeps buds above the critical temperature. This approach uses less water, and there is little or no damage to the tree as a result

of ice buildup; but certain blossoms, especially those at the top and exposed to the sky, may receive inadequate protection.

### Wind Machines

The lowest several hundred feet of the atmosphere become stratified under calm, clear, frost conditions. An inversion condition thus exists, meaning that temperature increases as it rises to the top of the inversion layer. A wind machine mixes the warmer air from the upper portions of the inversion layer with the colder air near the ground, raising air temperatures around the trees by a few degrees.

Wind machines are motor driven and therefore consume fuel, although not nearly as much as stack heaters. There are two types of wind machines: those that have the engine mounted at the top of the fan, and those with the engine located on the ground. Having the type with the engine on the ground makes servicing the machine easier. They work under calm, clear conditions as long as the frost is not too “deep”; that is, temperatures are not more than three or four degrees below the critical temperature. Wind machines do not work under cold, windy conditions because the wind usually mixes the atmosphere enough to prevent an inversion layer from developing.

When using wind machines, it is important that the machines are turned on when the air temperature in the orchard is still above critical temperatures. If air temperature is being monitored in a protected shelter within or outside of the orchard, the machines should be initiated when the air temperature is still above 32°F. It is very possible that bud temperatures may be several degrees below the air temperature due to radiational cooling, and they can experience damage even if the air is still above freezing.

More information about choosing and implementing frost protection systems can be obtained from your county extension educator or commercial dealers that offer frost protection systems and components.

## CRITICAL TEMPERATURES FOR VARIOUS FRUITS

The temperature at which fruit buds are injured depends primarily on their stage of development. As flowers begin to swell and expand into blossoms, they become less resistant to freeze injury.

Not all blossoms on a tree are equally tender. Resistance to freeze injury varies within trees as it does between orchards, cultivars, and crops. Buds that develop slowly tend to be more cold hardy. As a result, some buds are usually killed at higher temperatures, while others are resistant at much lower temperatures. Table 11-1 shows the average temperatures required to kill 10 percent and 90 percent of buds if they are exposed for 30 minutes. Consideration should also be given to weather conditions preceding cold nights. Prolonged cool weather tends to increase bud hardiness during the early stages of bud development.

**Table 11-1. Critical temperatures for various fruits.**

Adapted from 1989 Spray Guide for Tree Fruits in Eastern Washington. Bulletin EBO419. E. H. Beers, coordinator.

<b>Apples*</b>		
<b>Stage of development</b>	<b>10% kill (°F)</b>	<b>90% kill (°F)</b>
Silver tip	15	2
Green tip	18	10
½-inch green	23	15
Tight cluster	27	21
First pink	28	24
Full pink	28	25
First bloom	28	25
Full bloom	28	25
Post bloom	28	25

\*For Red Delicious. Golden Delicious and Winesap are approximately 1 degree hardier. Rome Beauty is 2 degrees hardier, except after petal fall when all cultivars are equally tender.

<b>Peaches</b>		
<b>Stage of development</b>	<b>10% kill (°F)</b>	<b>90% kill (°F)</b>
First swelling	18	1
Calyx green	21	5
Calyx red	23	9
First pink	25	15
First bloom	26	21
Full bloom	27	24
Post bloom	28	25

<b>Pears*</b>		
<b>Stage of development</b>	<b>10% kill (°F)</b>	<b>90% kill (°F)</b>
Scales separating	15	0
Blossom buds exposed	20	6
Tight cluster	24	15
First white	25	19
Full white	26	22
First bloom	27	23
Full bloom	28	24
Post bloom	28	24

\*For Bartlett. D'Anjou is similar but may bloom earlier and therefore may be more tender than Bartlett at the same date.

**Table 11-1. Critical temperatures for various fruits (continued).**

<b>Sweet cherries</b>		
<b>Stage of development</b>	<b>10% kill (°F)</b>	<b>90% kill (°F)</b>
First swelling	17	5
Side green	22	9
Green tip	25	14
Tight cluster	26	17
Open cluster	27	21
First white	27	24
First bloom	28	25
Full bloom	28	25
Post bloom	28	25

<b>Apricots</b>		
<b>Stage of development</b>	<b>10% kill (°F)</b>	<b>90% kill (°F)</b>
First swelling	15	—
Tip separates	20	0
Red calyx	22	9
First white	24	14
First bloom	25	19
Full bloom	27	22
In the shuck	27	24
Green fruit	28	25



---

# APPENDIX: TREE FRUIT ON THE WEB

---

## Bees and Pollination

Eastern Apicultural Society..... [www.easternapiculture.org](http://www.easternapiculture.org)  
Mid-Atlantic Apiculture..... [agdev.anr.udel.edu/maarec](http://agdev.anr.udel.edu/maarec)  
Penn State Center for Pollinator Research..... [.ento.psu.edu/pollinators](http://.ento.psu.edu/pollinators)  
Pennsylvania Beekeepers Association ..... [www.pastatebeekeepers.org](http://www.pastatebeekeepers.org)  
Pollen and Pollination (PollenPro)..... [www.Pollenpro.net](http://www.Pollenpro.net)  
Pollinator Network..... [www.pollinator.cals.cornell.edu](http://www.pollinator.cals.cornell.edu)  
Virtual Beekeeping Gallery..... [www.beekeeping.com/index.html](http://www.beekeeping.com/index.html)

## Fruit—General

Apple Crop Electronic Discussion Group..... [virtualorchard.com/applecrop.html](http://virtualorchard.com/applecrop.html)  
British Columbia Tree Fruit Information..... [www2.gov.bc.ca/gov/content/industry/agriculture-seafood/animals-and-crops/crop-production/tree-fruits](http://www2.gov.bc.ca/gov/content/industry/agriculture-seafood/animals-and-crops/crop-production/tree-fruits)  
Cherry Marketing Institute..... [www.choosecherries.com](http://www.choosecherries.com)  
Cornell Fruit Resources ..... [www.fruit.cornell.edu](http://www.fruit.cornell.edu)  
eXtension Apple Site..... [www.extension.org/apples](http://www.extension.org/apples)  
Fruitipedia..... [www.fruitipedia.com](http://www.fruitipedia.com)  
Horticulture New Zealand..... [www.hortnz.co.nz](http://www.hortnz.co.nz)  
Market Diseases of Apples, Pears, and Quinces ..... [archive.org/details/marketdiseasesof168rose](http://archive.org/details/marketdiseasesof168rose)  
Mid-Atlantic Regional Fruit Loop ..... [www.virginiafruit.ento.vt.edu](http://www.virginiafruit.ento.vt.edu)  
National Agricultural Statistics Service ..... [www.nass.usda.gov](http://www.nass.usda.gov)  
NC140..... [www.nc140.org](http://www.nc140.org)  
Northwest Pear Bureau ..... [www.usapears.com](http://www.usapears.com)  
Ontario Ministry of Agriculture and Rural Affairs  
    Commercial Apple Growers Information ..... [www.omafra.gov.on.ca/english/crops/hort/apples.html](http://www.omafra.gov.on.ca/english/crops/hort/apples.html)  
    Tender Fruit in Ontario ..... [www.omafra.gov.on.ca/english/crops/hort/tender\\_fruit.html](http://www.omafra.gov.on.ca/english/crops/hort/tender_fruit.html)  
Orange Pippin ..... [www.orangepippin.com](http://www.orangepippin.com)  
Organic Apple Production..... [ucanr.edu/sites/placernevadasmallfarms/files/112366.pdf](http://ucanr.edu/sites/placernevadasmallfarms/files/112366.pdf)  
Pennsylvania Apple Program..... [pennsylvaniaapples.org](http://pennsylvaniaapples.org)  
Pollination Information from Summit Tree Sales..... [www.summittreesales.com/resources/pollination-charts](http://www.summittreesales.com/resources/pollination-charts)  
Tree Spacing Template..... [ag.umass.edu/fruit/fact-sheets/apple-scionrootstock-selection-planning](http://ag.umass.edu/fruit/fact-sheets/apple-scionrootstock-selection-planning)  
University of Maryland Extension: Grapes and Fruit..... [extension.umd.edu/smallfruit/tree-fruit](http://extension.umd.edu/smallfruit/tree-fruit)  
University of Georgia Peach Production Information ..... [extension.uga.edu/agriculture/ag-fruits-vegetables/peaches](http://extension.uga.edu/agriculture/ag-fruits-vegetables/peaches)  
USDA-ARS Appalachian Fruit Research Station..... [www.ars.usda.gov/northeast-area/kearneysville-wv/appalachian-fruit-research-laboratory/innovative-fruit-production-improvement-and-protection](http://www.ars.usda.gov/northeast-area/kearneysville-wv/appalachian-fruit-research-laboratory/innovative-fruit-production-improvement-and-protection)  
USDA-ARS Wenatchee Tree Fruit Lab ..... [www.tfrec.wsu.edu](http://www.tfrec.wsu.edu)  
USDA Economics and Statistics Service..... [usda.mannlib.cornell.edu](http://usda.mannlib.cornell.edu)  
Virginia Fruit Website (Virginia Tech)..... [www.virginiafruit.ento.vt.edu](http://www.virginiafruit.ento.vt.edu)  
Virtual Orchard ..... [virtualorchard.com](http://virtualorchard.com)

## Guides/Magazines/Newsletters

Cornell Scaffolds Newsletter ..... [www.scaffolds.entomology.cornell.edu](http://www.scaffolds.entomology.cornell.edu)  
Good Fruit Grower..... [www.goodfruit.com/index.php](http://www.goodfruit.com/index.php)  
New York Fruit Quarterly..... [nyshs.org/fruit-quarterly](http://nyshs.org/fruit-quarterly)  
Ontario Fruit Growing Information ..... [www.omafra.gov.on.ca/english/crops/index.html#fruit](http://www.omafra.gov.on.ca/english/crops/index.html#fruit)  
Penn State Fruit Times Newsletter..... [extension.psu.edu/forage-and-food-crops/fruit](http://extension.psu.edu/forage-and-food-crops/fruit)  
Rutgers Plant and Pest Advisory..... [plant-pest-advisory.rutgers.edu](http://plant-pest-advisory.rutgers.edu)  
UMass Fruit Advisor..... <http://fruitadvisor.info/tfruit/clements/index.html>

**Nurseries**

Adams County Nursery, Aspers, PA .....	www.acnursery.com
Big Horse Creek Farm, Lansing, NC .....	www.bighorsecreekfarm.com
Boyer's Nursery, Biglerville, PA .....	www.boynurseries.com
Brandt's Fruit Trees, Yakima, WA .....	brandtsfruittrees.com
Burchell Nursery Inc., Oakdale, CA .....	www.burchellnursery.com
C & O Nursery, Wenatchee, WA .....	www.c-onursery.com
Cameron Nursery .....	www.cameronnursery.com
CopenHaven Farms Nursery, Gaston, OR .....	www.copenhavenfarms.com
Cummins Nursery, Ithaca, New York .....	www.cumminsnursery.com
Dave Wilson's Nurseries, Hickman, CA .....	www.davewilson.com
Four Mile Nursery, Canby, OR .....	www.fourmile.com
Green Tree Nursery, La Grange, CA .....	greentreenursery.com
Janssen Brothers Nurseries LTD, Netherlands .....	www.janssen-rootstocks.nl
Johnson Nurseries, Ellijay, GA .....	www.johnsonnursery.com
Moser Fruit Tree Sales, Coloma, MI .....	www.moserfruittreesales.com
ProTree Nursery .....	www.protreenursery.com
Sierra Gold Nurseries, Yuba City, CA .....	www.sierragoldtrees.com
Southmeadow Fruit Gardens, Baroda, MI .....	www.southmeadowfruitgardens.com
Stark Bros. Nurseries, Louisiana, MO .....	www.starkbros.com
Summit Tree Sales, Paw Paw, MI .....	www.summittreesales.com
TRECO, Woodburn, OR .....	www.treco.nu
Tree Connection, Dundee, OR .....	www.treeconnect.com
Trees of Antiquity, Paso Robles, CA .....	www.treesofantiquity.com
V. Kraus Nurseries Ltd., Hamilton, ON, Canada .....	www.krausnurseries.com
Van Well Nurseries, Wenatchee, WA .....	www.vanwell.net
Vintage Virginia Apples, North Garden, VA .....	www.vintagevirginiaapples.com
Viveros Requinoa, Santiago, Chile .....	www.viverosrequinoa.cl
Waffler Nurseries, Wolcott, NY .....	www.wafflernursery.com
Willamette Nurseries Inc., Canby, OR .....	www.willamettenurseries.com
Willow Drive Nursery, Ephrata, WA .....	www.willowdrive.com

**Orchard Supply Sources**

Alpha Scents Monitoring Supplies, West Linn, OR .....	www.alphascents.com
Amberg's Nursery, Inc., Stanley, NY .....	www.ambergs.com
Gemplers, Janesville, WI .....	www.gemplers.com
Great Lakes IPM, Vestaburg, MI .....	www.greatlakesipm.com
OESCO, Conway, MA .....	www.oescoinc.com
Orchard Valley Supply, Harrisburg, NC .....	orchardvalleysupply.com
Peach Ridge Orchard Supply, Sparta, MI .....	www.peachridge.com
Wilson Irrigation & Orchard Supply Yakima, WA .....	www.wilsonirr.com

**Penn State Fruit Resources**

College of Agricultural Sciences .....	agsci.psu.edu
Department of Entomology .....	ento.psu.edu
Department of Plant Pathology and Environmental Microbiology .....	plantpath.psu.edu
Department of Plant Science .....	plantscience.psu.edu
Fruit Research and Extension Center, Biglerville .....	agsci.psu.edu/frec
Lake Erie Regional Grape Research and Extension Center .....	agsci.psu.edu/research/extension-centers/erie
Pesticide Education Program .....	extension.psu.edu/insects-pests-and-diseases
Russell E. Larson Agricultural Research Center .....	agsci.psu.edu/research/extension-centers/rock-springs
Weather Links at Penn State .....	www.psu.edu/weather

**Pesticide Information/Labels**

AGRIAN .....	www.agrian.com/home
C & P Green Book of Pesticide Labels .....	www.greenbook.net
CDMS Pesticide and SDS Labels .....	www.cdms.net/Label-Database
Fungicide Resistance Action Committee .....	www.frac.info

Greenbook.....	www.greenbook.net
Herbicide Resistance Action Committee .....	hracglobal.com
Insecticide Resistance Action Committee.....	irac-online.org
National Pesticide Information Center.....	www.npic.orst.edu
National Pesticide Information Retrieval System .....	state.ceris.purdue.edu
PaPlants.....	www.paplants.state.pa.us
Penn State Pesticide Education Program .....	extension.psu.edu/pests-and-diseases/pesticide-applicators
Pennsylvania Department of Agriculture.....	www.agriculture.state.pa.us
PDA Pesticide Registration Site.....	www.paplants.pa.gov/productregFSA/BrandSearch.aspx
Sprayers 101.....	sprayers101.com
U.S. Environmental Protection Agency .....	www.epa.gov/pesticides

### Professional Societies

American Pomological Society.....	americanpomological.org
American Society for Horticultural Science .....	www.ashs.org
International Fruit Tree Association.....	ifruittree.org
International Society for Horticultural Science .....	www.ishs.org
Maryland State Horticultural Society .....	www.mdhortsociety.org
Michigan Apple Committee.....	www.MichiganApples.com
Midwest Apple Improvement Association.....	maiaapples.com
State Horticultural Association of Pennsylvania (SHAP).....	shaponline.org
U.S. Apple Association .....	www.usapple.org
Washington State Tree Fruit Association .....	wstfa.org

### University Resources

Cornell University.....	fruit.cornell.edu
Michigan State Fruit Information .....	www.canr.msu.edu/fruit
Oregon State.....	horticulture.oregonstate.edu/group/tree-fruits-and-nuts
UC Davis Fruit and Nut Information Center .....	fruitsandnuts.ucdavis.edu
University of Massachusetts Fruit Information .....	ag.umass.edu/fruit
Virginia Tech.....	ext.vt.edu/agriculture/commercial-horticulture/tree-fruit.html
Washington State University Tree Fruit Research and Extension Center.....	www.tfrec.wsu.edu
Postharvest Information Network .....	postharvest.tfrec.wsu.edu
Soils and Nutrition .....	soils.tfrec.wsu.edu
Tree Fruit Research and Extension Center.....	www.tfrec.wsu.edu

### USDA-NRCS Conservation Programs

Center for Agricultural Partnerships .....	www.agcenter.org
Michigan State University EQIP IPM Program for Specialty Crops.....	www.ipm.msu.edu
PA IPM.....	extension.psu.edu/integrated-pest-management-for-agriculture
Pennsylvania USDA-NRCS.....	www.pa.nrcs.usda.gov

### Weed Information/Identification

Illinois .....	weeds.cropsci.illinois.edu/weedid.htm
Michigan State .....	www.canr.msu.edu/pestid/resources/plant-and-weed-identification/index
Oregon.....	oregonstate.edu/dept/nursery-weeds
Ontario .....	omaf.gov.on.ca/IPM/english/weeds-herbicides/identification-keys/index.html
Penn State.....	extension.psu.edu/pests-and-diseases/pest-disease-and-weed-identification
Purdue .....	ag.purdue.edu/btny/weedscience/Pages/default.aspx
Rutgers .....	njaes.rutgers.edu/weeds
University of California .....	www.ipm.ucdavis.edu/PMG/weeds_intro.html

### Wildlife Information

Internet Center for Wildlife Damage .....	icwdm.org
Jack H. Berryman Institute .....	www.berrymaninstitute.org
Northeast Wildlife Damage Management Coop.....	wildlifehelp.org/agency/northeast-wildlife-damage-management-cooperative

---

# BIBLIOGRAPHY

---

## Cultural Information, Harvest and Postharvest Handling

- American Society of Heating, Refrigeration and Air-Conditioning Engineers, Inc. (ASHRAE), Refrigeration Application for Foods and Beverages, Technical Committee 10.9. (1998). "Thermal properties of foods." In *Refrigeration* (pp. 8.1-8.30). Atlanta, GA: ASHRAE.
- ASHS Press. 1997. *Brooks and Olmo register of fruit and nut varieties*. 600 Cameron St, Alexandria, VA 22314-2562 Phone: 703-836-4606, Fax: 703-836-2024, e-mail: ashspres@ashs.org
- Barritt, B. H. 1992. Intensive orchard management. *Good Fruit Grower*. 105 S. 18th St., #217, Yakima, WA 98901.
- Baughner, T. A., and S. S. Singha. (eds.) 2003. *Concise Encyclopedia of Temperate Tree Fruit*. The Haworth Press Inc., 10 Alice Street, Binghamton, NY 13904-1580.
- Beckerman, J. 2006. *Disease Susceptibility of Common Apple Cultivars*. Purdue Extension.
- Brown, S. K., R. D. Way, and D. E. Terry. 1989. Sweet and tart cherry varieties. *New York Food and Life Science Bulletin* 127.
- Childers, N. F. 1966. *Fruit nutrition*. Gainesville, FL: Horticultural Publications.
- Childers, N. F., J. R. Morris, and G. S. Sibbett (eds.). 1995. *The peach, world cultivars to marketing*. Gainesville, FL: Horticultural Publications.
- Combrink, J. C. (1996). *Integrated management of post harvest quality*. Stellenbosch, South Africa: Infruitec.
- Durham, R. E., R. E. McNiel, J. R. Hartman, D. A. Potter, and W. M. Fountain. 1999. *The Flowering Crabapple*. University of Kentucky.
- Eskin, N. A. Michael, ed. (1991). *Quality and preservation of fruits*. Boca Raton, FL: CRC Press.
- Evans, K. (ed). 2017. *Achieving sustainable cultivation of apples*. Cambridge: Burleigh Dodds Science Publishing Limited.
- Faust, Miklos. 1989. *Physiology of temperate zone fruit trees*. New York: John Wiley.
- Ferree, D. C. and I. J. Warrington. 2003. *Apples Botany, production and uses*. CAB International, 44 Brattle Street, Cambridge, MA 02138.
- Fidler, J., B. Wilkinson, K. Edney, and R. Sharples. 1973. *The biology of apple and pear storage*. Slough, England: Commonwealth Agricultural Bureaux (Central Sales, Farnham Royal, Slough SL2 3BN, England).
- Forshey, C. G., D. C. Elfving, and R. L. Stebbins. 1992. *Training and pruning apple and pear trees*. American Society for Horticultural Science. 600 Cameron St, Alexandria, VA 22314-2562 Phone: 703-836-4606, Fax: 703-836-2024, e-mail: ashspres@ashs.org
- Hardenburg, R. E., A. E. Watada, and C. Y. Wang. (1986). *The commercial storage of fruits, vegetables, and florist and nursery stocks*, Handbook No. 66. Washington, D.C.: USDA.
- Jackson, D. I., N. E. Looney, M. Morely-Bunker, and G. Thiele, eds. 2011 *Temperate and subtropical fruit production*. 3rd ed. CABI Publishing, 10 E. 40th Street, Suite 3202, New York, New York 10016. Phone: 212-481-7018, Fax: 212-686-7993, e-mail: cabinao@cabi.org
- Kader, A., R. Kasmire, G. Mitchell, M. Reid, N. Sommer, and J. Thompson. (1985). *Postharvest technology of horticultural crops*, Publication 3311. Davis, CA: Univ. of California Cooperative Extension Service, Division of Agriculture and Natural Resources.
- Kays, S. J. (1997). *Postharvest physiology of perishable plant products*. Athens, GA: Exon Press.
- Kitinoja, L. and A. A. Kader. (1995). *Small-Scale Postharvest Handling Practices: A Manual for Horticultural Crops* 3rd Edition. Postharvest Horticultural Series No. 8. Department of Pomology, University of California, Davis, California 95616.
- Landers, A. 2016. *Effective Orchard Spaying: A Practical Guide for Growers*. www.EffectiveSpraying.com.
- LaRue, J. H., and R. S. Johnson. (eds.). 1989. *Peaches, plums and nectarines*. Publications, Division of Agriculture and Natural Resources, University of California, 6701 San Pablo Ave., Oakland, CA 94608-1239.
- Layne, D., and D. Bassi. (eds.). 2008. *The Peach: Botany production and uses*. CAB International, 44 Brattle Street, Cambridge, MA 02138.
- Lespinasse, J. M., and E. Leterme. 2011. *Growing Fruit Trees: Novel Concepts and Practices for Successful Care & Management*. English translation. W. W. Norton Company. 500 Fifth Ave. New York, NY. ISBN: 13:978-0-393-73256-6.
- Little, C. R. and R. J. Holmes. (2000). *Storage technology for apples and pears*. Knoxfield, Victoria, Australia: Department of Natural Resources and Environment.
- Maib, K. M., P. K. Andrews, G. A. Lang and K. Mullinix. (eds.) 1996. *Tree fruit physiology: Growth and development*. Available from *Good Fruit Grower*, Dept. I-O, P.O. Box 9219, Yakima, WA 98909.
- Peterson, A. B and R. G. Stevens (eds.). 1994. *Tree fruit nutrition shortcourse proceedings*. Available from *Good Fruit Grower*, Dept. I-O, P.O.Box 9219, Yakima, WA 98909.
- Rieger, M. 2006. *Introduction to fruit crops*. Haworth Press, 10 Alice Street, Binghamton, NY 13904
- Rom, Roy C., and R. F. Carlson (eds.). 1987. *Rootstocks for fruit crops*. New York: John Wiley.
- Ryugo, K. 1988. *Fruit culture, its science and art*. New York: John Wiley.
- Sansavini, S., G. Costa, R. Gucci, P. Inglese, A. Ramina, C. Xiloyanis, and Y. Desjardins (eds.). 2019. *Principles of modern fruit science*. International Society for Horticultural Science. www.ishs.org/principles-modern-fruit-science.
- Shear, C. B., and M. Faust. 1980. Nutritional ranges in deciduous tree fruits and nuts. *Hort. Reviews*. 2:142-163.
- Stiles, W. C., and W. S. Reid. 1991. *Orchard nutrition management*. Information Bull. 219. Cornell Cooperative Extension. <https://ecommons.cornell.edu/handle/1813/3305>.
- Van der Zwet, T., and N. F. Childers (eds.). 1982. *The pear, cultivars to marketing*. Gainesville, FL: Horticultural Publications.
- Webster, A. D., and N. E. Looney. 1996. *Cherries: Crop physiology, production and uses*. CAB International University Press, Cambridge, United Kingdom
- Westwood, M. N. 1993. *Temperate zone pomology*. Portland, OR: Timber Press.
- Wills, R., W. Glasston, D. Graham, T. Lee, and E. Hall. 1989. *Postharvest, an introduction to the physiology and handling of fruit and vegetables*. New York: Van Nostrand Reinhold.
- Wills, R., B. McGlasson, D. Graham, and D. Joyce. (1998). *Postharvest: An introduction to the physiology and handling of fruit, vegetables and ornamentals*, Fourth edition. Adelaide, South Australia: Hyde Park Press.

## Pesticide Information

- Agrilience Agrisolutions. 2004. *Adjuvant Technical Handbook*. Agrilience Know How. Helena Chemical Company.
- Harvey, Lori T. *A Guide to Agricultural Spray Surfactants used in the United States*. 1992. Thomson Publications, PO Box 9335, Fresno, CA 93791.



- Kalo Technical Product Materials. Kalo Laboratories, Inc., 4550 W. 109th Street, Suite 250, Overlook Park, KS 66211-1311 (800-255-5196).
- Miller specimen labels, Miller Chemical & Fertilizer Corp., PO Box 333, Hanover, PA 17331 (717-633-1434).
- Riverside Adjuvant Tech. Handbook*. 1997. Terra International, Inc., 600 Fourth Street, PO Box 6000, Sioux City, IA 51102-6000 (800-762-3837).
- Setre Chemical Company Product Label Book*. 1995. Setre Chemical Company, 6075 Poplar Ave., Suite 500, Memphis, TN 38119. Contact local Helena Chemical Co. representative.

### Environmental Monitoring

- Fischer, W. C., and C. E. Hardy. 1976. *Fire-weather observers' handbook*. Agriculture handbook no. 494. Washington, DC: Forest Service, U.S. Dept. of Agriculture.
- National Weather Service. 1972. *National weather service observing handbook no. 2, substation observations*. Washington, DC: National Oceanic and Atmospheric Administration, U.S. Dept. of Commerce.
- Truxall, D. L., and J. W. Travis. 1994. Analysis of the accuracy of predicted weather data on the impact of apple disease management. *Phytopathology* 84: 1125.
- World Meteorological Organization. 1971. *Guide to meteorological instruments and observing practices*. WMO no. 8. Geneva, Switzerland: World Meteorological Organization.

### Mammal Control

- Byers, R. E. 1985. Management and control. In R. H. Tamarin (ed.), *Biology of new world microtus*. American Society of Mammalogists 8: 621-646.
- Byers, R. E., and D. H. Carbaugh. 1987. Efficacy of rodenticides for control of orchard voles. *Journal of the American Society for Horticultural Science* 112: 267-272.
- Halls, L. K. (ed.). 1984. *White-tailed deer ecology and management*. Wildlife Management Institute. Harrisburg, PA: Stackpole Books.
- Hygntstrom, S. E., R. M. Timm, and G. E. Larson (eds). 1994. *Prevention and control of wildlife damage*. Univ. Nebraska Cooperative Extension Service.
- Palmer, W. L., R. G. Wingard, and J. L. George. 1983. Evaluation of white-tailed deer repellents. *Wildlife Society Bulletin* 11: 164-166.
- Selders, A. W., and J. B. McAninch. 1987. *High-tensile wire fencing*. NRAES 11. Ithaca, NY: Northeast Regional Agricultural Engineering Service.
- Tobin, M. E., and M. E. Richmond. 1993. Vole management in fruit orchards. U.S. Department of Interior, FWS Biol. Report 5.

### Orchard Spraying, Tree Row Volume

- Landers, A. 2016. *Effective Orchard Spaying: A Practical Guide for Growers*. www.EffectiveSpraying.com.
- Steiner, P. W. 1987. Tree row volume: a concept for improving pesticide dosage control. *Proceedings 128th annual meeting, Pennsylvania State Horticultural Society*.
- Sutton, T. B., and C. R. Unrath. 1984. Evaluation of the tree-row-volume concept with density adjustments in relation to spray deposits in apple orchards. *Plant Disease* 68: 480-484.
- Travis, J. W., Skroch, W. A., and Sutton, T. B. 1987. Effects of travel speed, application volume, and nozzle arrangement on deposition and distribution of pesticides in apple trees. *Plant Disease* 71: 606-612.
- Unrath, C. R., T. B. Sutton, J. D. Obermiller, and K. M. Williams. 1986. *A tree row volume model for determining proper spray rates in apple orchards*. Publication no. 001. Edneyville, NC: North Carolina Apple Growers Association.

### Tree Fruit Diseases

- Biggs, A. R., and W. W. Turecheck, 2014. *Maryblyt™ 7.1: A Predictive Program for Forecasting Fire Blight Disease in Apples and Pears*. University of Maryland, West Virginia University, and USDA-ARS.
- Brunt, A. A., Crabtree, K., Dallwitz, M. J., Gibbs, A. J., Watson, L. and Zurcher, E. J. (eds.) 1999. "Plum Pox Potyvirus." In: *Plant Viruses Online: Descriptions and Lists from the VIDE Database*. Version: 16th January, 1997. (biology.anu.edu.au/Groups/MES/vide/)
- Jones, Alan L., and T. B. Sutton. 1984. *Diseases of tree fruits*. North central regional extension publication no. 34. Michigan State University.
- Ogawa, J. M., E. Zehr, G. W. Bird, D. F. Ritchie, Y. Urrio, J. K. Uyemoto. 1995. *Compendium of stone fruit diseases*. Amer. Phytopath. Soc., St. Paul, Minnesota.
- Lalancette, N. 2015. *Brown Rot Management In a Wet Growing Season: Part I*. Rutgers Plant and Pest Advisory. July 21. plant-pest-advisory.rutgers.edu/brown-rot-management-in-a-wet-growing-season-part-i.
- Lalancette, N. 2015. *Brown Rot Management In a Wet Growing Season: Part II*. Rutgers Plant and Pest Advisory. July 24. plant-pest-advisory.rutgers.edu/brown-rot-management-in-a-wet-growing-season-part-ii.
- Lalancette, N. 2015. *Brown Rot Management In a Wet Growing Season: Part III*. Rutgers Plant and Pest Advisory. July 29. plant-pest-advisory.rutgers.edu/brown-rot-management-in-a-wet-growing-season-part-ii.
- Larson, H. 1999. *Coryneum Blight Fact Sheet 2.914*. Colorado State University, Department of Horticulture and Landscape Architecture. <https://extension.colostate.edu/docs/pubs/crops/02914.pdf>.
- Sutton, T. B., H.S. Aldwinckle, A. M. Agnello, and J. F. Walgenbach, 2014. *Compendium of apple and pear diseases and pests*. Amer. Phytopath. Soc., St. Paul, Minnesota.
- Travis, J. W. 1988. *Cytospora canker of stone fruits*. Extension fact sheet no. 1988. The Pennsylvania State University, Department of Plant Pathology.
- UConn Home and Garden Education Center. 2012. "Pear Trellis Rust." [www.ladybug.uconn.edu/FactSheets/pear-trellis-rust\\_6\\_2329861430.pdf](http://www.ladybug.uconn.edu/FactSheets/pear-trellis-rust_6_2329861430.pdf).
- Zehr, E. I. 1983. Importance and control of blossom blight in the southeastern United States. Pp. 2-4 in T. J. Burr (ed.), *Proceedings, Brown rot of stone fruit workshop*, Ames, Iowa.

### Tree Fruit Pests

- Agnello, A. M., and D. P. Kain. 1996. *Codling moth*. Tree fruit IPM
- Agnello, A. M., and D. P. Kain. 1996. *Codling moth*. Tree fruit IPM insect identification sheet no. 12. New York State Agricultural Experiment Station.
- Agnello, A., J. Kovach, J. Nysop, and H. Reissig. 1990. *Simplified insect management program*. Cornell Cooperative Extension. IPM Number 201A.
- Biddinger, D., J. Tooker, A. Surcica, and G. Krawczyk. "Survey of native biocontrol agents of the brown marmorated stink bug in Pennsylvania fruit orchards and adjacent habitat." *Penn Fruit News* 92, no. (2012): 47-54.
- Biddinger, D., and B. Butler. "Biological control of mites in Pennsylvania and Maryland apple orchards." *Fruit Times*, July 26, 2013. extension.psu.edu/plants/tree-fruit/news/2013/biological-control-of-mites-in-pennsylvania-and-maryland-apple-orchards.
- Beers, E. H. 1997. *Crop production guide for tree fruits in Washington*. Washington State Cooperative Extension Service.
- Beers, E. H. (ed.) 1993. *Orchard pest management: A resource book for the Pacific Northwest*. Washington State University.
- Belding, R. D. (coord.). 1997. *Commercial tree fruit production guide*. Cooperative extension bulletin E002J. Rutgers University.
- Brunner, J. F., and S. C. Hoyt. 1987. *Codling moth control—a new tool for timing sprays*. Extension bulletin 1072. Washington State Cooperative Extension.

- Chaney, D., D. Cooley, G. Krawczyk, T. Leskey and A. Tuttle. 2015. Ecological management of key arthropod pests in Northeast apple orchards. SARE Ag Innovation Series, Technical Bulletin. [www.sare.org/Learning-Center/Fact-Sheets/Ecological-Management-of-Key-Arthropod-Pests-in-Northeast-Apple-Orchards](http://www.sare.org/Learning-Center/Fact-Sheets/Ecological-Management-of-Key-Arthropod-Pests-in-Northeast-Apple-Orchards).
- Demchak, K., D. Biddinger, and B. Butler. 2012. *Spotted Wing Drosophila, Part 1: Overview and Identification*. University Park: Penn State Extension. [pubs.cas.psu.edu/FreePubs/PDFs/ee0042.pdf](http://pubs.cas.psu.edu/FreePubs/PDFs/ee0042.pdf).
- . 2012. *Spotted Wing Drosophila, Part 2: Natural History*. University Park: Penn State Extension. [pubs.cas.psu.edu/FreePubs/PDFs/ee0043.pdf](http://pubs.cas.psu.edu/FreePubs/PDFs/ee0043.pdf).
- . 2012. *Spotted Wing Drosophila, Part 3: Monitoring*. University Park: Penn State Extension. [pubs.cas.psu.edu/FreePubs/PDFs/ee0044.pdf](http://pubs.cas.psu.edu/FreePubs/PDFs/ee0044.pdf).
- . 2012. *Spotted Wing Drosophila, Part 4: Management*. University Park: Penn State Extension. [pubs.cas.psu.edu/FreePubs/PDFs/ee0045.pdf](http://pubs.cas.psu.edu/FreePubs/PDFs/ee0045.pdf).
- Frost, S. W. 1951. *Insects that attack the apple in Pennsylvania*. Bulletin no. 535. Agricultural Experiment Station. The Pennsylvania State College.
- Hogmire, H. W. (ed.). 1995. *Mid-Atlantic orchard monitoring guide*. Ithaca, NY: Northeast Regional Agricultural Engineering Service, Cooperative Extension.
- Howitt, A. J. 1993. *Common tree fruit pests*. Michigan State University Extension, NCR 63.
- Hull, L. A., G. Krawczyk, and D. Biddinger. “Maintaining the integrity of IPM in Pennsylvania while battling the brown marmorated stink bug.” *Pennsylvania Fruit News* 91, no. 4 (2011): 9–10.
- Koehler, G. W. (ed.). 1996. 1996-97 *New England apple pest management guide*. Universities of Connecticut, Maine, Massachusetts, New Hampshire, Rhode Island, and Vermont. Cooperative Extension Service.
- Krawczyk, G., and L. A. Hull. “Management option for the control of brown marmorated stink bug—a Pennsylvania perspective.” *Pennsylvania Fruit News* 91, no. 5 (2011): 15–21.
- Leeper, J. R. 1980. Extension-based tree-fruit insect pest management strategies for apple and pear. *Plant Sciences* No. 85. New York State Agric Exp. Stat. Bull.
- Leeper, J., and J. Tette. 1978. *Pear psylla*. Tree fruit IPM insect identification sheet no. 1. New York State Agricultural Experiment Station.
- Lienk, S. 1980. *Peachtree borer*. Tree fruit IPM insect identification sheet no. 6. New York State Agricultural Experiment Station.
- Lienk, S. 1980. *Plum curculio*. Tree fruit IPM insect identification sheet no. 3. New York State Agricultural Experiment Station.
- Rajotte, E. G., and L. A. Hull. 1987. Managing periodical cicada in Pennsylvania fruit orchards. *Pennsylvania Fruit News* 66 (5).
- Reissig, W. H. 1991. *Apple maggot*. Tree fruit IPM insect identification sheet no. 8. New York State Agricultural Experiment Station.
- Reissig, W. H. 1980. *Green fruitworm*. Tree fruit IPM insect identification sheet no. 4. New York State Agricultural Experiment Station.
- Reissig, W. H. 1980. *Obliquebanded leafroller*. Tree fruit IPM insect identification sheet no. 5. New York State Agricultural Experiment Station.
- Weires, R. 1980. *Predatory phytoseiid mite*. Tree fruit IPM insect identification sheet no. 7. New York State Agricultural Experiment Station.
- Weires, R., and J. Leeper. 1980. *Rosy apple aphid*. Tree fruit IPM insect identification sheet no. 11. New York State Agricultural Experiment Station.
- ## Cider Production
- Anonymous. 1998. “Hazard Analysis and Critical Control Point (HACCP); Procedures for the Safe and Sanitary Processing and Importing of Juice.” *Federal Register*, April 24, 1998, Volume 63, Number 79, pp. 20449-20486. Docket No. 97N-0511. Comment deadline: July 8, 1998
- Anonymous. 1998. “Food Labeling: Warning and Notice Statements; Labeling of Juice Products; Final Rule” *Federal Register*, July 8, 1998, Volume 63, Number 130, pp. 37029-37056. Docket No. 97N-0524.
- Anonymous. Current Good Manufacturing Practice in Manufacturing, Packing, or Holding Human Food, *Code of Federal Regulations* 21 Part 110. ([www-seafood.ucdavis.edu/GUIDELINES/gmps.htm](http://www-seafood.ucdavis.edu/GUIDELINES/gmps.htm))
- Anonymous. 1998. *Guidance for Industry—Guide to Minimize Microbial Food Safety Hazards for Fresh Fruits and Vegetables*, U.S. Department of Health and Human Services, Food and Drug Administration, Center for Food Safety and Applied Nutrition. ([www.foodsafety.gov/~dms/prodguid.html](http://www.foodsafety.gov/~dms/prodguid.html))
- Besser, R. E., M. S. Lett, J. T. Weber, M. P. Doyle, T. J. Barrell, J. G. Wells, and P. M. Griffin. An outbreak of diarrhea and hemolytic uremic syndrome from escherichia coli d157:h7 in fresh pressed apple juice. 1993. *Journal of the American Medical Association* 269: 2217–2220.
- Beuchat, L. R. 1982. Thermal inactivation of yeasts in fruit juices supplemented with food preservatives and sucrose. *Journal of Food Science* 47: 1679–1682.
- Cider Stuff*. 1999. Current public issues related to cider manufacturing. ([www.virtualorchard.net/rce/ciderstuff.html](http://www.virtualorchard.net/rce/ciderstuff.html))
- Downing, D. L. 1989. Apple cider. pp. 169–187 in *Processed apple products*, D.L. Downing, ed. New York: Van Nostrand Reinhold.
- Emerson, F. H. 1983. Apple cider production. *Pennsylvania Fruit News*: 26–35.
- Ferguson, W. E., and W. D. Powrie. 1957. Studies on the preservation of fresh apple juice with sorbic acid. *Applied Microbiology* 5: 41–43.
- Filtration and blending is key to sparkling apple juice at Carolina Products. January 1985. *Food Products Management*: 64–65.
- Focus On Food Labeling. 1993. *FDA Consumer*. May 1993. ([www.fda.gov/fdac/special/foodlabel/food\\_toc.html](http://www.fda.gov/fdac/special/foodlabel/food_toc.html))
- The food label. 1999. *FDA Backgrounder*. BG: 99-5
- Funt, R. C. Sept. 1987. Put the squeeze on cider costs. *Fruit Grower*: 25–27.
- Goverd, K. A., Beech, F. W., Hobbs, H. P., and Shannon, R. 1979. The occurrence and survival of coliforms and salmonellas in apple juice and cider. *Journal of Applied Bacteriology* 46: 521–530.
- HACCP: State-of-the-Art Approach to Food Safety. *FDA Backgrounder* BG: 99-6
- Hager, D. Sept. 1985. The cider appeal. *The Grower*: 25–26.
- Hope, G. W. 1965. Temporary preservation of apple juices by preservation and pH adjustment. *Food Technology* 19: 155–158.
- International Apple Institute. *Apple juice and cider—America’s favorite natural fruit beverage*.
- Jolicoeur, C. 2013. *The New Cider Maker’s Handbook: A Comprehensive Guide for Craft Producers*. Chelsea Green Publishing.
- Johnson, K. M. 1984. Microbiology of apple juice. In *Special report no. 54*, 24–26. Ithaca, N.Y.: Cornell Cooperative Extension.
- Katsuyama, A.M., ed. 1993. *Principles of Food Processing and Sanitation*. Food Processors Institute, National Food Processors Association.
- Kozempel, M. 1998. The cost of pasteurizing apple cider. *Food Technology* 52 (1): 50-52.
- Marriott, N.G. 1999. *Principles of Food Sanitation*. Aspen Publications.
- Mattick, L. R. 1984. Chemical composition of apple juice. In *Special report no. 54*, 2–4. Ithaca, NY: Cornell Cooperative Extension.
- Moyer, J. C. 1984. Apple juice extraction. In *Special report no. 54*, 13–17. Ithaca, NY: Cornell Cooperative Extension.

- Norris, J. G. 1982. Sanitation in the processing and packaging of raw cider. *Dairy and Food Science* 2: 143–144.
- Pennsylvania Department of Agriculture. 1983. Quality cider comes from Pennsylvania. *News Bulletin* 68 (17).
- Pooley, M. and J. Lomax. *Real Cidermaking on a Small Scale*. 1999. Nexus Inc., U.K.
- Proulx, A. and L. Nichols. *Cider Making, Using, and Enjoying—Sweet and Hard Cider*. 1980. Story Communications. Pownal, Vermont.
- Sapers, G. M., J. Abbot, D. Massie, A. Watoda, and E. E. Finney, Jr. 1977. Volatile compositions of McIntosh apple juice as a function of maturity and ripen indices. *Journal of Food Science* 42: 44–47.
- Steele, B.T., N. Murphy, and C. P. Rence. 1982. An outbreak of hemolytic uremic syndrome associated with the ingestion of fresh apple juice. *Journal of Pediatrics*. 101: 963–965.
- Succeeding with cider. August 1984. *Fruit Grower*: 13–14.
- Swanson, K. M. J., S. B. Leasor, and D. L. Downing. 1985. Aciduric and heat resistant microorganisms in apple juice and cider processing operations. *Journal of Food Science* 50: 336–339.
- Swientek, R. J. April 1985. Expression-type belt press delivers high juice yields. *Food Processing*: 110–111.
- Watson, B. *Cider Hard and Sweet—History, Traditions, and Making Your Own*. 1999. The Countryman Press. Woodstock, Vermont.
- Wheeler, J. L., M. A. Harrison, and P. E. Koehler. 1987. Presence and stability of patulin in pasteurized apple cider. *Journal of Food Science* 52: 479–480.
- Zhao, T., M. P. Doyle, and R. E. Besser. 1993. Fate of enterohemorrhagic escherichia coli. D157:h7 in apple cider with and without preservatives. *Applied Environmental Microbiology* 59: 2526–2530.
- ## Marketing
- Agrawal, R. 2012. Groupon is testing a payments offering to compete with Square and PayPal. *Venturebeat.com*, May 24, 2012. [venturebeat.com/2012/05/24/groupon-is-testing-a-payments-offering-to-compete-with-square-and-paypal/](http://venturebeat.com/2012/05/24/groupon-is-testing-a-payments-offering-to-compete-with-square-and-paypal/).
- Barr, A. 2012. Groupon tests payments rival to PayPal, Square. *Reuters.com*, May 25, 2012. [www.reuters.com/article/2012/05/25/groupon-payments-idUSL1E8GP7JN20120525](http://www.reuters.com/article/2012/05/25/groupon-payments-idUSL1E8GP7JN20120525).
- Baer, J. 42 percent of consumers complaining in social media expect 60 minute response time. *Convince and Convert*. <https://www.convinceandconvert.com/social-media-research/42-percent-of-consumers-complaining-in-social-media-expect-60-minute-response-time/>.
- Bedbury, S. 2002. *A Brand New World: Eight Principles for Achieving Brand Leadership in the 21st Century*. New York: Viking Penguin.
- Bell, J., and K. Ternus. 2003. *Silent Selling: Best Practices and Effective Strategies in Visual Merchandising*. New York: Fairchild Publications.
- Bronto Software. 2007. *The Email Marketing Companion: A “Must Have” for All Email Marketers*. [www.bronto.com](http://www.bronto.com).
- Buffer. Instagram Stories: the complete guide to using stories. *Buffer Marketing Library*. <https://buffer.com/library/instagram-stories>.
- Bunchball. 2016. Using gamification for customer loyalty. <http://bit.ly/2Wm1d6S>.
- Cone Communications CSR Study. 2017. [www.conecomm.com/2017-cone-communications-csr-study-pdf](http://www.conecomm.com/2017-cone-communications-csr-study-pdf).
- Curry, J., and A. Curry. 2000. *The Customer Marketing Method*. New York: The Free Press.
- Deloitte. 2018. *Global Mobile Consumer Survey, US Edition: Overview of Results*. <https://www2.deloitte.com/content/dam/Deloitte/us/Documents/technology-media-telecommunications/us-tmt-global-mobile-consumer-survey-extended-deck-2018.pdf>.
- Dimock, M. 2019. Defining generations: Where Millennials end and Generation Z begins. *Pew Research Center*. <https://www.pewresearch.org/fact-tank/2019/01/17/where-millennials-end-and-generation-z-begins/>.
- Dooley, R. 2011. Replies can change customer minds. *Neuromarketing*, March 17, 2011. [www.neurosciencemarketing.com/blog/articles/change-minds.htm](http://www.neurosciencemarketing.com/blog/articles/change-minds.htm).
- eMarketer.com. 2012. Majority of U.S. smartphone owners use devices to aid shopping. April 12, 2012. [www.emarketer.com/Article/Majority-of-US-Smartphone-Owners-Use-Devices-Aid-Shopping/1008971](http://www.emarketer.com/Article/Majority-of-US-Smartphone-Owners-Use-Devices-Aid-Shopping/1008971).
- eMarketer.com. 2010. Mixed reactions to product recommendations: Online retailers’ suggestions are hit or miss. February 4, 2010. [www.emarketer.com/Article.aspx?R=1007497](http://www.emarketer.com/Article.aspx?R=1007497).
- EventBrite.com. 2012. Introducing the At The Door Card Reader and Eventbrite’s Mobile Box Office. March 20, 2012. [blog.eventbrite.com/introducing-the-at-the-door-card-reader/](http://blog.eventbrite.com/introducing-the-at-the-door-card-reader/).
- Facebook Business. How to set up Instagram shopping. <https://www.facebook.com/business/instagram/shopping/guide>.
- Fusion, J. 2013. Marketing to men vs. women. *Chron.com*. [smallbusiness.chron.com/marketing-men-vs-women-1011.html](http://smallbusiness.chron.com/marketing-men-vs-women-1011.html).
- Galinsky, E., J. T. Bond, S. S. Kim, L. Backon, E. Brownfield, and K. Sakai. 2005. *Overwork In America: When The Way We Work Becomes Too Much. Executive Summary*. New York: Families and Work Institute. [familiesandwork.org/summary/overwork2005.pdf](http://familiesandwork.org/summary/overwork2005.pdf).
- Garcia, D. 2018. “Gamification in marketing: 16 gamification gurus share their favorite examples & insights.” *SurveyAnyplace.com*. <http://bit.ly/2HvERtv>.
- Godin, S. 1999. *Permission Marketing: Turning Strangers In To Friends, And Friends Into Customers*. New York: Simon and Schuster Trade.
- Hobbs, F., and N. Stoops. 2002. *U.S. Census Bureau, Census 2000 Special Reports, Series CENSR-4, Demographic Trends in the 20th Century*. [www.census.gov/prod/2002pubs/censr-4.pdf](http://www.census.gov/prod/2002pubs/censr-4.pdf).
- Humes, K. R., N. A. Jones, and R. R. Ramirez. 2011. *Overview of Race and Hispanic Origin: 2010: 2010 Census Briefs*. Washington, D.C.: U.S. Department of Commerce, Economics and Statistics Administration, U.S. Census Bureau. [www.census.gov/prod/cen2010/briefs/c2010br-02.pdf](http://www.census.gov/prod/cen2010/briefs/c2010br-02.pdf).
- Jamieson, A. 2009. Silent majority risk worse customer service as companies monitor Twitter, Facebook. *Telegraph*, December 13, 2009. [www.telegraph.co.uk/finance/newsbysector/retailandconsumer/6802019/Silent-majority-risk-worse-customer-service-as-companies-monitor-Twitter-Facebook.html](http://www.telegraph.co.uk/finance/newsbysector/retailandconsumer/6802019/Silent-majority-risk-worse-customer-service-as-companies-monitor-Twitter-Facebook.html).
- J.D. Power. 2013. Poor social media practices can negatively impact a businesses’ bottom line and brand image. <https://www.jdpower.com/business/press-releases/2013-social-media-benchmark-study>.
- Keiningham, T. L., T. G. Vavra, L. Aksoy, and H. Wallard. 2005. *Loyalty Myths*. Hoboken, N.J.: John Wiley & Sons.
- Kelley, C. L., and T. K. Kowalczyk. 2003. Cause marketing: Opportunities for assisting exempt organizations and sponsors. *The CPA Journal* 73(2): 15.
- Kelley, K. 2011. Cross promotion: Partnering with other businesses to better serve your customers. *OFA Bulletin* 930 (January/February 2011): 1, 9, 10.
- . 2007. Implementing a customer loyalty program. *OFA Bulletin* 905 (November/December 2007): 1, 12–14.
- . 2008. Layout and design for retail horticulture businesses. *OFA Bulletin* 910 (September/October 2008): 4–5.
- . 2012. Social media strategies for horticultural businesses. *OFA Bulletin* 936 (November/December 2012): 10–12.
- Koch, L. 2019. Two-thirds of shoppers check phones in-store for product information, skipping store associates. <https://www.emarketer.com/content/two-thirds-of-internet-users-check-phones-in-store-for-product-information-skipping-store-associates>.
- Koetsier, J. 2012. Social media demographics 2012: 24 sites including Twitter, Facebook, and LinkedIn. *Venturebeat.com*, August 22, 2012. [venturebeat.com/2012/08/22/social-media-demographics-stats-2012/](http://venturebeat.com/2012/08/22/social-media-demographics-stats-2012/).

- Kohler, C. 2004. Got color? *Floral Management* 21(5): 20–22, 24, 26, 28, 31.
- Kotler, P. 2003. *Marketing Insights From A to Z: 80 Concepts Every Manager Needs to Know*. Hoboken, N.J.: Wiley.
- Lempert, P. 2009. In the hot seat online? Better respond. SupermarketGuru.com, October 13, 2009. [www.supermarketguru.com/articles/in-the-hot-seat-online-better-respond.html](http://www.supermarketguru.com/articles/in-the-hot-seat-online-better-respond.html).
- Levine, M., and S. Pownall. 2004. *Wine Industry Outlook: Consumption Demographics, Market Segmentation, Trends and Opportunities*. 2004 Wine Industry Outlook Conference, Darling Harbour, Sydney, Australia. Melbourne, Australia: Roy Morgan Research Pty.
- M2W E-ssentials. 2010. Women more likely to subscribe to email marketing messages. July 6, 2010. [m2wessentials.wordpress.com/2010/07/06/women-more-likely-to-subscribe-to-email-marketing-messages](http://m2wessentials.wordpress.com/2010/07/06/women-more-likely-to-subscribe-to-email-marketing-messages).
- McClain, A. 2004. Supers can do better. RetailWire. [www.retailwire.com/Discussions/Sngl\\_Discussion.cfm/9707](http://www.retailwire.com/Discussions/Sngl_Discussion.cfm/9707).
- Mitchell, S. 2000. *American Generations: Who They Are, How They Live, What They Think*. Ithaca, N.Y.: New Strategist Publications.
- Monhollon, T. 2011. How to: Respond to a negative Twitter reply or complaint. ReachCast Blog. [blog.getreachcast.com/208364/2011/08/19/how-to-respond-to-a-negative-twitter-reply-or-complaint.html](http://blog.getreachcast.com/208364/2011/08/19/how-to-respond-to-a-negative-twitter-reply-or-complaint.html).
- Nearly half of U.S. smartphone owners report shopping on their device. 2018. <https://www.npd.com/wps/portal/npd/us/news/press-releases/2018/nearly-half-of-u-s-smartphone-owners-report-shopping-on-their-device/>.
- Olga. What is the cost of poor customer service? Provide Support Blog. <http://www.providesupport.com/blog/cost-poor-customer-service/>.
- Paul, P. 2002. Color by numbers: Research data concerning color, demographic trends. *American Demographics* 24(2): 30–35
- Pinterest. How to easily enable rich pins on Pinterest. <http://bit.ly/2SOUkJv>.
- Pinterest Developers. Getting started. <https://developers.pinterest.com/docs/rich-pins/overview/>.
- Prakash, N. 2012. Facebook weeds out fake “likes,” improves brand integrity. Mashable.com, September 1, 2012. [mashable.com/2012/09/01/facebook-removes-fake-likes/](http://mashable.com/2012/09/01/facebook-removes-fake-likes/).
- Retail-Week.com. 2012. Which social networks increase sales for retailers? September 17, 2012. [www.retail-week.com/technology/social-media/infographic-which-social-networks-increase-sales-for-retailers/5040776.article?blocktitle=Latest-News-and-Insight&contentID=5963](http://www.retail-week.com/technology/social-media/infographic-which-social-networks-increase-sales-for-retailers/5040776.article?blocktitle=Latest-News-and-Insight&contentID=5963).
- Salesforce Blog. 2018. What are consumers doing on their smartphones, anyway? <https://www.salesforce.com/blog/2018/02/consumer-smartphone-use.html>.
- Salkever, A. 2012. Will mobile payment companies expand into SMB marketing? *Street Fight*, May 9, 2012. [streetfightmag.com/2012/05/09/will-mobile-payment-companies-expand-into-smb-marketing/](http://streetfightmag.com/2012/05/09/will-mobile-payment-companies-expand-into-smb-marketing/).
- Schaeffer, K. 2019. The most common age among whites in U.S. is 58—more than double that of racial and ethnic minorities. Pew Research Center. <https://www.pewresearch.org/fact-tank/2019/07/30/most-common-age-among-us-racial-ethnic-groups/>.
- Scott Design, Inc. 2012. What’s your favorite color? February 8, 2012. [www.hotdesign.com/marketing/whats-your-favorite-color](http://www.hotdesign.com/marketing/whats-your-favorite-color).
- Sebastian, R. S., C. W. Enns, and J. D. Goldman. 2011. MyPyramid intakes and snacking patterns of U.S. adults: What we eat in America, NHANES 2007-2008. Food Surveys Research Group Dietary Data Brief No. 5 (June 2011). Beltsville, Md.: USDA Agricultural Research Service. [ars.usda.gov/Services/docs.htm?docid=19476](http://ars.usda.gov/Services/docs.htm?docid=19476).
- Sewell, C., and P. B. Brown. 1998. *Customers for Life*. New York: Pocket Books.
- ShapePartners. 2006. Nearly 90% of Internet users share content via e-mail. February 9, 2006.
- Shuteyev, P. 2012. Social media statistics 2011-2012—by age, gender, purpose and time spent. April 23, 2012. [www.massmailsoftware.com/blog/2012/04/social-media-statistics-2011-2012-by-age-gender-purpose-and-time-spent](http://www.massmailsoftware.com/blog/2012/04/social-media-statistics-2011-2012-by-age-gender-purpose-and-time-spent).
- silverPOP. 2006. Email creative that works. [www.silverpop.com](http://www.silverpop.com).
- Smith, A., and Anderson, M. 2018. Social media use in 2018. Pew Research Center. <https://www.pewinternet.org/2018/03/01/social-media-use-in-2018/>.
- Snacking Motivations and Attitudes - US - January 2019. <https://store.mintel.com/snacking-motivations-and-attitudes-us-january-2019>.
- Stanley, J. 2002. *The Complete Guide to Garden Center Management*. Batavia, Ill.: Ball Publishing
- Starkov, M., and M. Mechoso. 2008. Best practices on monitoring hotel review sites: An action plan for monitoring and responding to Internet chatter about your hotel. Hospitality Net, August 18, 2008. [www.hospitalitynet.org/news/4037310.html](http://www.hospitalitynet.org/news/4037310.html).
- Sykes, C. 2003. What women want: Are you marketing to the majority? *Garden Center Merchandising & Management* 9(9): 57–58.
- Tanner, R. 2013. The state of the specialty food industry 2013. *Specialty Food Magazine* 43(3): 32–48.
- Temple, A. 2003. You sell what? *Floral Management* 20(1): 20–23, 26–27.
- Tilton, L. 2000. Restaurant taste at supermarket prices. *Produce Business* 16(4): 50, 52.
- The Packer. 2017. Tune into Generation Z’s growing appetites. [www.thepacker.com/article/corrected-tune-generation-z-aetums-growing-appetites](http://www.thepacker.com/article/corrected-tune-generation-z-aetums-growing-appetites).
- Underhill, P. 2000. *Why We Buy*. New York: Simon & Schuster.
- Underwood, R. 2008. Dear customer... Managing e-mail campaigns. *Inc. Magazine*: 58–59.
- U.S. Census. 2015. <https://factfinder.census.gov/faces/nav/jsf/pages/index.xhtml>.
- ValuePenguin. Best credit card processing 2019. <https://www.valuepenguin.com/credit-card-processing/best-credit-card-processing>
- Walsh, Mark. 2012. Nielsen: Half of cell users have smartphones. *MediaPost News*, March 29, 2012. [www.mediapost.com/publications/article/171334/nielsen-half-of-cell-users-have-smartphones.html?edition=45129#ixzz1xgsxDrzu](http://www.mediapost.com/publications/article/171334/nielsen-half-of-cell-users-have-smartphones.html?edition=45129#ixzz1xgsxDrzu).
- Watrous, M. 2019. Trending flavors in the snack aisle. Food Business News. <https://www.foodbusinessnews.net/articles/13826-trending-flavors-in-the-snack-aisle>.
- White, B. 2004. Situational displays. *Lawn & Garden Retailer* 3(6): 82.
- The Wise Marketer. 2007. 7 steps to win back unresponsive e-mail contacts. [www.thewisemarketer.com](http://www.thewisemarketer.com).
- Yalch, R., and E. Spangenberg. 1990. Effect of store music on shopping behavior. *Journal of Services Marketing* 4(1): 31–39.

## Precision Agriculture

- Lamont, W., et al. 2017. “Irrigation for Fruit and Vegetable Production.” Penn State Extension. <https://extension.psu.edu/irrigation-for-fruit-and-vegetable-production>.
- Peters, R. T. 2015. “Drip Irrigation for Agricultural Producers.” Washington State University Extension.
- Robinson, T., et al. 2013. “Precision Irrigation Management in Apples.” Cornell University.

# TABLES

<b>Table 1-1.</b> Number of trees per acre at various tree spacings.....	6	<b>Table 1-22.</b> Commercially grown and promising peach and nectarine cultivars for Pennsylvania.....	83
<b>Table 1-2.</b> Nutritional ranges used to interpret leaf analysis values for apples, peaches, nectarines, pears, and cherries.....	15	<b>Table 1-23.</b> Growth regulators for stone fruit.....	91
<b>Table 1-3.</b> Recommended leaf nitrogen levels for apple cultivars by bearing habit.....	16	<b>Table 1-24.</b> Sweet cherry pollination guide .....	93
<b>Table 1-4.</b> Foliar applications for special nutritional problems...	17	<b>Table 1-25.</b> Critical temperatures for various fruits.....	95
<b>Table 1-5.</b> General indices for judging nitrogen status of fruit trees .....	17	<b>Table 1-26.</b> Management practices for apples and stone fruits...97	
<b>Table 1-6.</b> Apple cultivars .....	20	<b>Table 2-1.</b> Calculating apple scab infection periods using the Revised Mills Table .....	107
<b>Table 1-6B.</b> Parentage of common and new apple cultivars. ....	22	<b>Table 2-2.</b> Susceptibility of apple rootstocks and scions to apple union necrosis and decline disease .....	108
<b>Table 1-7.</b> Comparisons of apple rootstock characteristics.....	39	<b>Table 2-3.</b> Using temperature and wetness hours to determine cedar-apple rust infection periods .....	128
<b>Table 1-8.</b> Increase in tree density made possible using beds. ....	40	<b>Table 2-4.</b> Degree-day look-up table for codling moth (lower threshold 50°F, upper threshold 88°F, horizontal cut off, using sine-wave curve).....	136
<b>Table 1-9.</b> Toxicity of insecticides, miticides, fungicides, and blossom- and fruit-thinning agents to bees, and suggested timing of application .....	48	<b>Table 2-5.</b> European red mite densities predicted from the percentage of mite-infested leaves.....	139
<b>Table 1-10.</b> Sources of nitrogen, nitrogen content, and application rates .....	59	<b>Table 2-6.</b> Relationship between number of European red mites per leaf at their peak and accumulated number of mite days per leaf.....	139
<b>Table 1-11.</b> Poor soil conditions that may result in low-calcium fruit disorders, their modes of action, and corrective measures ..	61	<b>Table 2-7.</b> Timing of insecticide applications on apples and peaches to control the Oriental fruit moth based on crop stage or degree days from biofix .....	145
<b>Table 1-12.</b> Nutritional imbalances that may interfere with production of high-calcium apples, their modes of action, and corrective measures.....	61	<b>Table 2-8.</b> Emergence of different broods of periodical cicada in Pennsylvania counties by year.....	148
<b>Table 1-13.</b> Causes of excessive vegetative growth that may compete for available calcium, their modes of action, and corrective measures .....	62	<b>Table 2-9.</b> Counts of sap-feeding spotted tentiform leafminer mines to determine infestation status and the necessity for treatment .....	154
<b>Table 1-14.</b> Factors that may result in a small crop of large fruit, their modes of action, and corrective measures .....	62	<b>Table 2-10.</b> Relation between percentage of egg hatch and degree-day accumulations from the first pheromone trap capture of adult tufted apple bud moth.....	157
<b>Table 1-15A.</b> Growth regulators for apples and pears .....	67	<b>Table 2-11.</b> Recommended spray timing for conventional pesticides (e.g., Altacor, Delegate, Intrepid) based on degree-day accumulations for tufted apple bud moth depending on application method .....	157
<b>Table 1-15B.</b> 6BA conversion chart for fluid ounces per 100 gallons of water.....	69	<b>Table 2-12.</b> Recommended spray timing for products containing <i>Bacillus thuringiensis</i> (Bt) based on degree-day accumulations for tufted apple bud moth depending on application method. Use only complete sprays.....	157
<b>Table 1-16.</b> Tree and weather conditions affecting fruit thinning with chemicals .....	74	<b>Table 2-13.</b> Degree-day look-up table for tufted apple bud moth (lower threshold 45°F, upper threshold 91°F) and Oriental fruit moth (45–90°F) (horizontal cut off, using sine-wave curve) .....	158
<b>Table 1-17.</b> Suggested apple thinning recommendations.....	75		
<b>Table 1-18.</b> A quick comparison of compounds registered as stop drops .....	76		
<b>Table 1-19.</b> Fluid ounces of Fruitone L or PoMaxa or ounces of Fruitone N or Refine 3.5 WSG to apply per acre in enough water to thoroughly wet the foliage at a given ppm....	80		
<b>Table 1-20.</b> Concentration of NAA (ppm) applied based on amount of PoMaxa, Fruitone L, Fruitone N, or Refine 3.5 WSG desired per acre (from Table 1-19) and gallons of water to be applied per acre .....	80		
<b>Table 1-21.</b> Parts per million (ppm) of NAA in tank based on amount of Amid-Thin W added to tank of (x) size.....	80		

<b>Table 2-14.</b> Orchard weeds identified as reservoirs of tomato ringspot virus.....	168
<b>Table 2-15.</b> Plant-parasitic nematodes and their treatment guidelines .....	169
<b>Table 2-16.</b> Efficacy of various insecticides against BMSB adults during direct contact laboratory bioassay.....	176
<b>Table 2-17.</b> Suggested timings and product options for the control of brown marmorated stink bug in fruit orchards....	176
<b>Table 3-1.</b> EPA numbers and Worker Protection Standard reentry and personal protective equipment guidelines.....	199
<b>Table 3-2.</b> Total gallons per minute sprayed (both sides) for various row spacings and gallons-per-acre rates, when sprayer moves at 1.5, 2, and 2.5 mph.....	206
<b>Table 3-3.</b> Nozzle flow (gal/min) of various cone tips at various pressures .....	206
<b>Table 3-4.</b> Converting dilute spray rate to concentrate rate of pesticide materials.....	208
<b>Table 3-5.</b> Calculating tree row volume.....	209
<b>Table 3-6.</b> Simplified tree row volume table.....	210
<b>Table 3-7.</b> Comparison of insecticide modes of action based on Insecticide Resistance Action Committee (IRAC) classification (issued July 2017).....	214
<b>Table 3-8.</b> Comparison of fungicide modes of action based on Fungicide Resistance Action Committee (FRAC) classification (issued February 2019).....	215
<b>Table 3-9.</b> Herbicide Resistance Committee (HRAC) classification of herbicides according to mode of action (issued 2015).....	218
<b>Table 3-10.</b> Copper formulations for fruit crops.....	227
<b>Table 3-11.</b> Adjuvants available for use on tree fruit.....	252
<b>Table 3-12.</b> Target pH ranges and half-lives of selected orchard insecticides and miticides .....	263
<b>Table 3-13.</b> Target pH ranges and half-lives of selected orchard fungicides .....	263
<b>Table 3-14.</b> Target pH ranges and half-lives of common herbicides.....	263
<b>Table 4-1.</b> Tree fruit herbicide registration by crop .....	267
<b>Table 4-2.</b> Herbicides labeled for use in orchards.....	270
<b>Table 4-3.</b> Soil fumigants and nematicides .....	271
<b>Table 4-4.</b> Toxicity of pesticides to mite and aphid predators, at rates recommended in Part V .....	272
<b>Table 4-5.</b> Apples: insecticide and miticide timing .....	274
<b>Table 4-6.</b> Apples: insecticide and miticide efficacy .....	275
<b>Table 4-7.</b> Apples: fungicide timing.....	277
<b>Table 4-8.</b> Apples: fungicide and antibiotic efficacy .....	278
<b>Table 4-9.</b> Pears: insecticide and miticide timing .....	279
<b>Table 4-10.</b> Pears insecticide and miticide efficacy.....	279
<b>Table 4-11.</b> Stone fruit: insecticide and miticide timing.....	280
<b>Table 4-12.</b> Stone fruit: insecticide and miticide efficacy .....	281
<b>Table 4-13.</b> Stone fruit: fungicide and antibiotic timing.....	282
<b>Table 4-14.</b> Stone fruit: fungicide and antibiotic efficacy .....	283
<b>Table 4-15.</b> Reentry (REI) and preharvest (PHI) or spray-to-harvest intervals.....	284
<b>Table 6-1.</b> Atmospheric and temperature requirements for controlled-atmosphere storage.....	337
<b>Table 6-2.</b> Concentrations of DPA needed to reduce scald.....	338
<b>Table 7-1.</b> General composition of cider.....	342
<b>Table 7-2.</b> Relative initial quality and shelf life of cider.....	343
<b>Table 7-3.</b> Primary flavor characteristics of Pennsylvania apple cultivars .....	345
<b>Table 7-4.</b> Possible cider blends and their flavor characteristics .....	345
<b>Table 7-5.</b> Composition and nutritional data for apple juice.....	347
<b>Table 9-1.</b> Land preparation budget, tree fruit, Pennsylvania, 2020. Summary of estimated costs per acre .....	365
<b>Table 9-2.</b> Apple orchard planting budgets, medium- and high-density orchards, Pennsylvania, 2020. Summary of estimated costs per acre .....	366
<b>Table 9-3.</b> Peach orchard planting budget, 155 trees per acre, Pennsylvania, 2020. Summary of estimated costs per acre .....	367
<b>Table 9-4.</b> Fresh-market apple production budgets, 907 trees per acre, with and without mating disruption, Pennsylvania, 2020. Summary of estimated costs per acre .....	368
<b>Table 9-5.</b> Processing apple production budget, 272 trees per acre, Pennsylvania, 2020 Summary of estimated costs per acre.....	369
<b>Table 9-6.</b> Mature fresh-market peach orchard budget, 155 trees per acre, Pennsylvania, 2020. Summary of estimated costs per acre .....	370
<b>Table 9-7.</b> Mature tart cherry orchard budget, 121 trees per acre, Pennsylvania, 2020. Summary of estimated costs per acre.....	371
<b>Table 9-8.</b> Mature dwarf sweet cherry orchard budget, 580 trees per acre, Pennsylvania, 2020. Summary of estimated costs per acre .....	372
<b>Table 11-1.</b> Critical temperatures for various fruits.....	434