

Canada
PFRC
Inform. rept.
BC-X-331
c. 1



**Proceedings of the first meeting of
IUFRO Working Party S2.07-09
(Diseases and Insects in Forest Nurseries)**

Edited by

J.R. Sutherland and S.G. Glover

Pacific and Yukon Region • Information Report BC-X-331

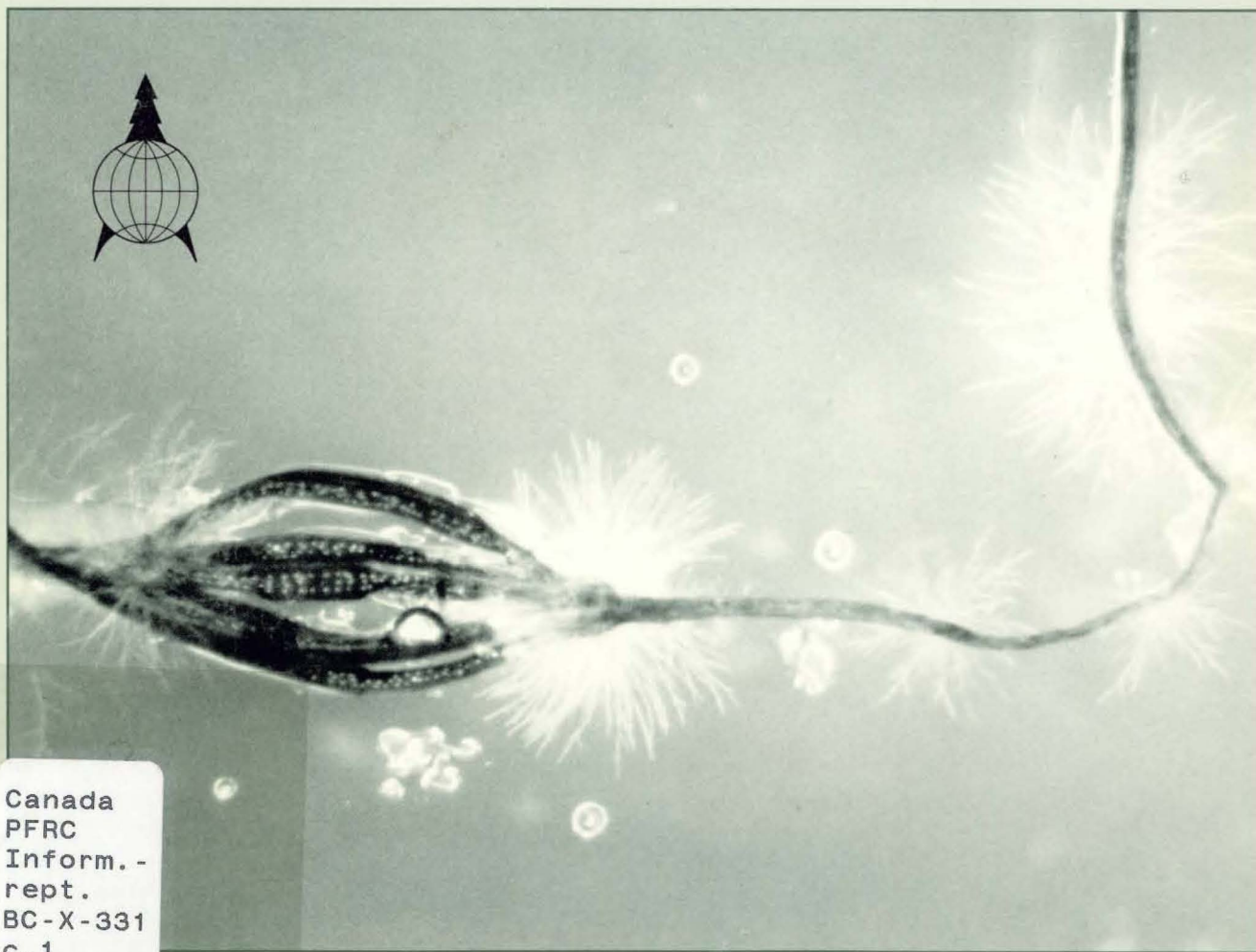

Canada
PFRC
Inform. -
rept.
BC-X-331
c. 1

Industry Forêts
Canada Canada

Canada

PL 23

01

**Proceedings of the first meeting of IUFRO
Working Party S2.07-09
(Diseases and Insects in Forest Nurseries)**

**Victoria, British Columbia, Canada
August 23-30, 1990**

LIBRARY

JUN 17 1992

FORESTRY CANADA
PACIFIC & YUKON REGION
505 W. BERRIDGE RD.
VICTORIA, B.C. V8Z 1M5 CANADA

Edited by
Jack R. Sutherland
and
S.G. Glover

Forestry Canada
Pacific and Yukon Region
Pacific Forestry Centre

BC-X-331

1991



The Pacific Forestry Centre is one of six regional and two national establishments of Forestry Canada. Situated in Victoria with a district office in Prince George, the Pacific Forestry Centre cooperates with other government agencies, the forestry industry, and educational institutions to promote the wise management of the forest resources of British Columbia and the Yukon.

The Pacific Forestry Centre undertakes research in response to the needs of the various managers of the forest resource. The results of this research are distributed in the form of scientific and technical reports and other publications.

Forestry Canada
Pacific and Yukon Region
Pacific Forestry Centre
506 West Burnside Road
Victoria, British Columbia, Canada
V8Z 1M5

Phone (604) 363-0600

© Minister of Supply and Services Canada, 1991
Catalogue No. Fo46-17/331E
ISBN 0-662-19277-X

Microfiches of this publication may be purchased from:

MicroMedia Inc.
Place du Portage
165, Hôtel-de-Ville
Hull, Quebec
J3X 3X2

Printed in Canada

Canadian Cataloguing in Publication Data

International Union of Forestry Research Organizations. Working Party S2.07-09
(Diseases and Insects in Forest Nurseries)

Proceedings of the first meeting of IUFRO Working Party S2.07-09
(Diseases and Insects in Forest Nurseries): Victoria, British Columbia, Canada, August 32-30, 1990

(Information report, ISSN 0830-0453; BC-X-331)

Includes abstracts in French.

ISBN 0-662-19277-X

DSS cat. No. Fo46-17/331E

1. Trees—Diseases and pests—Congresses,
2. Forest nurseries—Congresses. I. Sutherland, Jack R. II. Glover, S.G. (Stephen Gerard), 1954-
III. Title. IV. Title: Diseases and insects in forest nurseries. V. Series:
Information report (Pacific Forestry Centre); BC-X-331.

SB727.157 1991

634.9'6

C92-099523-3

Acknowledgments

Special thanks are due Fiona Ring, John Dennis, and Dan Hall of the Pacific Forestry Centre, and staff at the University of Victoria for their splendid help in making the arrangements that ensured an enjoyable and productive meeting. Staff at the Mesachie Lake Research Centre of the British Columbia Ministry of Forests were excellent hosts while we toured their nursery and provided the excellent meal facilities. We also want to thank staff at Canadian Pacific Forest Products and Koksilah nurseries for allowing us to tour their facilities, and again for being such gracious hosts.

Thanks are also due to the staff of the publications section at the Pacific Forestry Centre, particularly to Heather Matson for typing the manuscripts and to Dan Dunaway for typesetting and graphic design.

We especially thank Daphyne Lowe of the Pacific Forestry Centre for proofreading the proceedings.

The papers in this report have not been subjected to peer review. The findings and recommendations are those of the authors of the individual papers, and they do not necessarily represent the views of Forestry Canada or the Government of Canada.

Mention in this publication of specific commercial products or services does not constitute endorsement of such by Forestry Canada or the Government of Canada.

This report contains accounts of research involving pesticides. Pesticides must be handled and applied properly according to directions and regulations. Pesticides must be approved by federal and provincial authorities before use. Always read the label.

This Forestry Canada publication contains
recycled or recyclable paper.



Contents

NURSERY DISEASES AND INSECTS AROUND THE WORLD

DISEASES AND PESTS OF AUSTRALIAN FOREST NURSERIES: PAST AND PRESENT <i>B.N. BROWN AND F.R. WYLIE</i>	3
DISEASES OF FOREST NURSERIES IN BRAZIL <i>FRANCISCO ALVES FERREIRA AND JAMES J. MUCHOVEJ</i>	17
DISEASES AND INSECTS IN FOREST NURSERIES IN CANADA <i>JACK R. SUTHERLAND, SYLVIA GREIFENHAGEN, JENNIFER JUZWIK AND C. DAVIS</i>	25
CONTROL OF THREE SPECIES OF INSECTS AFFECTING ROOTS OF FOREST NURSERY SEEDLINGS IN NORTHEAST CHINA <i>YAO GUO QUAN, LIU DE CHENG, WANG YAN SHENG</i>	33
DISEASES IN CZECHOSLOVAK FOREST NURSERIES <i>ZDENKA PROCHÁZKOVÁ AND JANCARÍK VLASTISLAV</i>	37
IMPORTANT NURSERY INSECTS AND DISEASES IN HAITI AND THEIR MANAGEMENT <i>SCOTT J. JOSIAH AND DEBRA ALLEN-REID</i>	51
DISEASES AND INSECTS IN FOREST NURSERIES IN INDIA AND THEIR MANAGEMENT <i>J.K. SHARMA AND GEORGE MATHEW</i>	61
DISEASES AND INSECT PESTS IN FOREST NURSERIES IN ITALY <i>P. RADDI, P. CAPRETTI AND R. TIBERI-IST</i>	69
FOREST NURSERY DISEASES AND INSECTS AND THEIR CONTROL IN SHIMANE PREFECTURE, JAPAN <i>YASUO SUTO AND JIRO INOUE</i>	79
NURSERY DISEASE AND INSECT PROBLEMS IN NEW ZEALAND <i>J.W. RAY</i>	85
DISEASES AND INSECTS IN NORWEGIAN FOREST NURSERIES <i>DAGMAR BØRJA AND ØYSTEIN AUSTARA</i>	91
FOREST NURSERY DISEASES IN PAPUA NEW GUINEA <i>FRANS ARENTZ</i>	97
FOREST NURSERY DISEASES AND INSECTS IN THE PHILIPPINES <i>ENRIQUITO D. DE GUZMAN, ERNESTO P. MILITANTE AND REY LUCERO</i>	101
DISEASES OF CONTAINER-GROWN CONIFER NURSERY SEEDLINGS IN SWEDEN <i>TORNGY UNESTAM AND LISELOTTE BEYER-ERICSON</i>	105
DISEASES AND INSECTS IN UNITED STATES FOREST NURSERIES <i>JOHN D. STEIN AND RICHARD S. SMITH, JR.</i>	109
DISEASES AND INSECTS IN WESTERN EUROPEAN FOREST NURSERIES <i>ROBERT PERRIN AND ANTONIO NOTARIO GOMEZ</i>	117

INVITED PAPERS

BIOLOGICAL CONTROL OF PLANT PATHOGENS: PRINCIPLES AND STRATEGIES <i>PAIGE E. AXELROOD</i>	127
NURSERY HYGIENE IN CONCEPT AND PRACTICE <i>B.N. BROWN AND A.G.M. BAXTER</i>	133
PRESENT STATUS OF NURSERY DISEASES IN SICHUAN PROVINCE, CHINA <i>CHEN SHOU CHANG</i>	141
IDENTIFICATION, MANAGEMENT, AND APPLICATION OF ECTOMYCORRHIZAL FUNGI IN FOREST TREE NURSERIES <i>CHARLES E. CORDELL, DANIEL W. OMDAL AND DONALD H. MARX</i>	143

USING A VAX 8650 COMPUTER TO ORGANIZE DISEASE EXTENSION REPORTS <i>JOHN J. DENNIS AND DOUG M. SAY</i>	157
MONOCLONAL ANTIBODIES AND THEIR APPLICATION IN FORESTRY <i>ABUL K.M. EKRAMODDOULLAH</i>	161
THE ISOLATION AND IDENTIFICATION OF <i>PHYTOPHTHORA</i> SPECIES CAUSING DAMAGE IN BARE-ROOT CONIFER NURSERIES <i>P.B. HAMM AND E.M. HANSEN</i>	169
<i>FUSARIUM</i> DISEASES OF CONIFER SEEDLINGS <i>R.L. JAMES, R.K. DUMROESE AND D.L. WENNY</i>	181
SOIL FUMIGATION IN BAREROT TREE NURSERIES <i>THOMAS D. LANDIS AND SALLY J. CAMPBELL</i>	191
INSECTS IN BRITISH COLUMBIA FOREST NURSERIES <i>G.M. SHRIMPTON</i>	207
LYGUS BUGS: A WORLDWIDE PROBLEM IN CONIFER NURSERIES <i>DAVID B. SOUTH</i>	215
EXPERT SYSTEMS FOR DIAGNOSING NURSERY INSECT, DISEASE AND ENVIRONMENTAL PROBLEMS <i>A.J. THOMSON, J.R. SUTHERLAND, M.E. BLACHE AND J. DENNIS</i>	223

CONTRIBUTED PAPERS

SOILBORNE PATHOGENS: OCCURRENCE AND CONTROL IN AN ITALIAN BARE-ROOT NURSERY <i>T. ANNESI, M. CASELLA, E. MOTTA</i>	229
DEVELOPING A CONTROL SYSTEM FOR FUNGAL DISEASES IN FOREST NURSERY SEEDBEDS <i>BERNT ARVIDSSON</i>	235
MYCORRHIZAL PROTECTION OF <i>PINUS SYLVESTRIS</i> SEEDLING ROOTS AGAINST <i>RHIZOCTONIA</i> <i>EVA DAMM AND TORGNY UNESTAM</i>	239
BIOTESTS FOR DETERMINING FUNGICIDE EFFICACY AGAINST COIDIA AND MYCELIUM OF <i>CYLINDROCLADIUM</i> <i>SCOPARIUM</i> AND <i>RHIZOCTONIA SOLANI</i> <i>F A FERREIRA, J J MUCHOVEJ, N L DEMUNER AND A C ALFENAS</i>	243
SEX PHEROMONE FOR THE BLACK CUTWORM, <i>AGROTIS YPSILON</i> ROTTEMBERG <i>JIAXI ZHOU, XUEYAN YANG, AND XIAOBING ZHOU</i>	249
USING SEX PHEROMONE TO PREDICT <i>PARANTHRENE TABANIFORMIS</i> ROTT DAMAGE <i>JIAXI ZHOU, XUEYAN YANG, AND XIAOBING ZHOU</i>	251
ASSAYING FOR SEED-BORNE FUNGI OF DOUGLAS-FIR AND TRUE FIR SPECIES <i>WILLIS R. LITTKE AND JOHN E. BROWNING</i>	253
EFFECTS OF ETHEPHON AND DROUGHT ON CONTAINER-GROWN <i>PINUS RESINOSA</i> SEEDLINGS <i>SANDRA F. MAYNARD AND WILLIAM H. LIVINGSTON</i>	259
THE CURRENT STATUS OF <i>EUCALYPTUS</i> FOREST NURSERY FERTILIZATION PRACTICES AND SEEDLING DISEASES IN BUENOS AIRES PROVINCE, ARGENTINA <i>MARÍA ISABEL SALERNO</i>	269
BIOLOGY OF A WHITE FIR APHID NURSERY PEST: BIOTYPE OR NEW SPECIES [ABSTRACT] <i>JOHN D. STEIN</i>	273
EXPERIENCE WITH INSECTICIDES FOR CONTROL OF <i>MINDARUS VICTORIA</i> : A NEW APHID PEST OF WHITE FIR NURSERY SEEDLINGS <i>JOHN D. STEIN AND MICHAEL I. HAVERTY</i>	275

INFLUENCE OF INOCULATION CONDITIONS ON SEVERITY OF DISEASE CAUSED BY <i>PESTALOTIOPSIS GLANDICOLA</i> ON <i>CHAMAECYPARIS OBTUSA</i> SEEDLINGS YASUO SUTO	283
SPECIES OF PINE SEEDLINGS AFFECTED BY <i>FUSARIUM</i> YANG JUN XIU AND ZHAO JUNXIA	287
ECTOMYCORRHIZAL FUNGI AS HYPERPARASITES OF <i>RHIZOCTONIA SOLANI</i> ZHAO ZHI-PENG AND KUO SHIU-CHIEN	291
APPENDIX: MEMBERS OF IUFRO WORKING PARTY S2.07-09 (DISEASES AND INSECTS IN FOREST NURSERIES)	295

Preface

Forty nine members from thirteen countries attended the first meeting of working party S2.07-09 (Diseases and Insects in Forest Nurseries) of the International Union of Forestry Research Organizations (IUFRO) at Victoria, British Columbia, Canada, August 22 to 30, 1990. Jack Sutherland, founder of the working party and organizer of the meeting, and Dr. T. John Drew, Director General of Forestry Canada's Pacific and Yukon region, welcomed attendees to Canada.

In the first session, entitled "Forest Nursery Diseases and Insects Around the World," papers were presented to give participants an overview of problems encountered by their colleagues around the world. Subsequent sessions updated participants on a wide range of topics such as the principles of pest management and identification, use of monoclonal antibodies, biological control of pathogens, and use of expert systems for identifying diseases and insects. Two workshops were held. The first, led by Phil Hamm, was on isolation and identification of *Pythium* and *Phytophthora*. The second, led by Bob James, covered *Fusarium* isolation and identification. The final paper session consisted of fourteen papers dealing with numerous subjects including the protective effects of mycorrhizae against root pathogens, fungicide bioassay tests for seedling pathogens, and insects affecting seedling roots in Northeast China. Two field trips allowed participants to view nursery and pest management practices at Vancouver Island nurseries.

Not all of our time was spent at work; attendees enjoyed activities such as an evening meal and some vigorously contested volleyball at the British Columbia Ministry of Forests' Mesachie Lake Research Centre, and a Saturday afternoon of salmon fishing near Victoria.

When the Victoria meeting was over, ten participants went on a post-meeting tour of nurseries in the interior of British Columbia. Without a doubt all of us came away from the meeting with lots of new knowledge and friends. The success of this meeting also confirmed the interest in and the need for this new (1988) working party, which by mid-winter of 1990 had 105 members from 22 countries. At the conclusion of the meeting, Bruce Brown (Australia) and Dagmar Børja (Norway) became leader and co-leader of the working party, and we accepted Bruce's offer to host our next meeting in Australia.

NURSERY DISEASES AND INSECTS AROUND THE WORLD

Digitized by Google



Diseases and pests of Australian forest nurseries: past and present

B. N. BROWN AND F. R. WYLIE,
*Queensland Forest Service, Department of Primary Industries,
Indooroopilly, Queensland.*

*Presented at the first meeting of IUFRO Working Party S2.07-09
(Diseases and Insects in Forest Nurseries), Victoria, British Columbia, Canada, August 22-30, 1990.*

Abstract

Plantation forestry commenced in Australia over a century ago to meet timber needs in areas where natural forest supplies were scarce. There are now over 900 000 ha of forest plantation in Australia, more than two thirds of which is government owned. Most of the Australian forest plantation area is planted with exotic *Pinus* spp., largely the one species, *P. radiata*. Only in the tropical and sub-tropical areas of Queensland is radiata pine not the dominant species. In that state, *P. elliotii*, *P. caribaea* and the native conifer *Araucaria cunninghamii* predominate.

This report is an overview of the diseases, insect pests and nematodes that have been recorded from the nurseries that produce the planting stock used to establish the Australian forest plantations. The information has been obtained from published reports and from personal contributions from a number of forest pathologists and entomologists who have worked in these fields. Some brief notes on vertebrate pests of Queensland forest nurseries have also been included. The genera *Pinus*, *Araucaria* and *Eucalyptus* constitute over 97 % of the Australian forest plantation estate and this report is limited to host species of those three genera.

Resume

En Australie, la technique des plantations forestières a fait son apparition il y a plus d'un siècle pour répondre aux besoins des régions australiennes mal pourvues en peuplements forestiers. L'Australie compte à l'heure actuelle plus de 900 000 hectares de plantations forestières, dont plus du tiers appartiennent à l'État. Ces peuplements sont composés en majeure partie d'espèces du genre *Pinus* exotiques, le plus souvent *P. radiata*. Les régions tropicale et subtropicale du Queensland sont les seules où *P. radiata* ne soit pas l'espèce dominante. Dans cet état, on trouve surtout des *P. elliotii*; des *P. caribaea* et l'espèce indigène *Araucaria cunninghamii*.

S'inspirant des travaux de nombreux pathologistes et entomologistes des forêts, les auteurs font un survol des types de maladies, d'insectes nuisibles et de nématodes qui sont observés dans les pépinières cultivant les stocks destinés aux plantations forestières australiennes. Le compte rendu, dans lequel on trouve quelques notes sur les vertébrés nuisibles des pépinières forestières du Queensland, fait état de ce que les trois genres *Pinus*, *Araucaria* et *Eucalyptus* constituent plus de 97 % du stock de plantations forestières australiennes et porte exclusivement sur les espèces hôtes des genres en question.

Introduction

Australia comprises a land area of 7 682 300 square kilometres located between 10° 41' and 43° 39' south latitude (Castles 1989). The continent of Australia is relatively dry: nearly 80 % of the area has a median rainfall of less than 600 mm per year and about 50 % has less than 300 mm (Castles 1989). The first government plantations in Australia were established in South Australia, an area largely devoid of natural forests, in 1876 (Anon. 1989). In 1987 there were 905 174 ha of forest plantation in Australia (Anon. 1989), most (69 %) belonging to government agencies (the New South Wales, Queensland and Victorian State Governments between them owning 40 %).

Nearly 90 % of the Australian forest plantations are planted with *Pinus* species, with *P. radiata* D. Don, at

almost 69 % of total plantations, occupying the largest area. Most of the *P. radiata* plantings are in temperate, southern parts of Australia with the only other significant conifer in those areas being *Pinus pinaster* Aiton in South Australia and Western Australia (3.5 % of Australian total). In Queensland and northern New South Wales, where the climate is tropical (in the north of Queensland) to sub-tropical, the species composition of the plantations is greatly different from that elsewhere. In 1987 the predominant species were *Pinus elliotii* Engelm. var. *elliotii* (10.6 % of Australian total), *Pinus caribaea* Mor. (5 %) and *Araucaria cunninghamii* Aiton ex D. Don (hoop pine; a species native to eastern regions of Queensland and northern New South Wales - 5 %). *P. caribaea* is now the favored exotic species in Queensland. The Australian *Eucalyptus* plantations

total 42 010 ha without the inclusion of some old *Eucalyptus* plantings which are managed as native forest, or enrichment plantings in native forests (Anon. 1989). The rate of *Eucalyptus* planting in 1987 was about 4 000 ha per annum but was expected to increase considerably (Anon. 1989). Between 1980 and 1987 the average annual rate of plantation establishment in Australia was 32 544 ha; about two thirds of this total was established by Government agencies. With time, more of the forest plantings are second rotation following final crop harvest.

There is little published information on Australian forest nursery diseases and pests. Newhook (1964), in presenting an overview of the forest disease situation in Australia and New Zealand, included a section on seedling (mainly nursery) diseases and reported that the general pattern of seedling disease for Australia was very similar to that in most parts of the world. Waterhouse and Came (1964) presented an overview of forest entomology in Australia, Papua-New Guinea and the British Solomon Islands but made no mention of nursery insect problems. However, Anon. (1964) mentioned that cutworms of the family Noctuidae had destroyed young nursery stock of exotic *Pinus* in New South Wales. Neumann and Marks (1976) presented a synopsis of the important pests and diseases in Australian forests and forest nurseries in which they listed a number of nursery pathogens but only two insect pests of forest nursery stock.

The present report is the first specific coverage of Australian forest nursery diseases and pests and is based on published reports and information supplied from workers throughout Australia. The coverage will be restricted to hosts of the genera *Pinus*, *Araucaria* and *Eucalyptus* because they account for more than 97% of the Australian forest plantation area. It will include discussion on diseases (primarily fungal), and insect, nematode and vertebrate pests. The last category is a late inclusion to the report and will be limited to Queensland, where vertebrate animals have posed short-term intermittent, rather than persistent, problems in forest nurseries. However, there have been instances when vertebrate damage in exotic and hoop pine nurseries has threatened that year's productivity.

Pinus species

For many years in Australia nursery production of most of the *Pinus* spp. has been largely as bare-root seedling plants. These come from open beds and are grown over a period of about 9 months for planting during winter. Although much of the current nursery output of *Pinus* in Australia remains seedling plants, the use of cuttings is becoming more important and, for special needs, container stock is also produced.

Diseases of *Pinus*

Damping-off

Pre- and post-emergence damping-off has long been recognized as a significant problem in *Pinus* nurseries in Australia causing serious losses of seed and seedlings. It is probable that damping-off has caused more losses of *Pinus* nursery seedlings than any other disease. Whilst the causal agents were often not determined, a number of species of *Pythium* have been shown to be important causal agents of damping-off, as has *Rhizoctonia solani* Kuhn. Fungi such as *Phytophthora cinnamomi* Rands, *Botrytis cinerea* Pers. ex Pers., *Cylindrocladium scoparium* Morgan, and *Macrophomina phaseolina* (Tassi) Goid. are also known to be involved. The role of various *Fusarium* spp. has often been questioned, but it has been proved that species such as *F. oxysporum* Schlecht. emen. Snyder & Hansen and *F. solani* (Mart.) Sacc. can cause damping-off of *Pinus* seedlings. Many of the damping-off pathogens have also been associated with diseases of older seedlings in the nursery.

Unsatisfactory nursery practices, such as continuous cropping, have undoubtedly played a major role in development of damping-off and other soil-borne diseases in *Pinus* nurseries of Australia in the past. Seasonal effects are known to play a part; for example, in Queensland the heaviest damping-off losses of *Pinus* species in seed-beds used to be in sowings made during the summer wet season. Host differences may also play a role; e.g., Oxenham and Winks (1963b) reported that *P. radiata* was more susceptible to damping-off caused by a number of fungi than was *P. elliotii*. Observations over a number of years in Queensland forest nurseries indicated that *P. patula* Schiedeet Deppe and *P. caribaea* var *hondurensis* Barr. & Golf. are more susceptible to damping-off than is *P. elliotii*.

Australian workers have successfully investigated means of reducing losses of *Pinus* seedlings caused by damping-off. The measures have ranged from solar-heating to soil fumigation, seed-dressings and seed-bed drenches. In some places routine seed-dressings and/or soil drench applications are currently employed. However, Queensland (Brown and Baxter 1990) and Tasmanian experience indicates that good nursery practices, even if they do not control damping-off, do at least minimize the problem; soil drenches have only been used occasionally in hygiene nurseries in both states.

Phytophthora cinnamomi and other *Phytophthora* species

Phytophthora cinnamomi is one of the damping-off fungi which causes root rot of older *Pinus* seedlings. Host species reported from Queensland are *P. elliotii*,

P. radiata, *P. taeda* L., *P. caribaea* var *hondurensis* and *P. clausa* Vasey (Brown 1985). *Phytophthora cinnamomi* root rot of *Pinus* has been reported from forest nurseries in most Australian states and the Australian Capital Territory, the one exception being South Australia. In Western Australia *P. citricola* Sawada and *P. cryptogea* Pethyb. & Lafferty have also been recovered from *Pinus* nurseries.

As discussed by Oxenham and Winks (1963a), severe nursery root rot due to *P. cinnamomi* causes direct loss of trees in the nursery and increased transplant loss when diseased plants are planted in the field and may result in spread of this potentially dangerous pathogen into new areas. The use of infected planting stock undoubtedly resulted in the transfer of *P. cinnamomi* to parts of Queensland otherwise free of the pathogen. The probable introduction of *P. cinnamomi* into new Queensland nurseries with needle litter (duff) for mycorrhizal inoculation has been discussed (Brown 1985). Boughton and Crane (1984) assessed the *Phytophthora* (*P. cinnamomi* and *P. cryptogea*) disease risk at a major *Pinus* nursery in Western Australia. They recognized the risk of apparently healthy plants as carriers of infection and warned that incoming pine duff should be checked for *Phytophthora* before introduction to the nursery.

For a number of years soil fumigation was used to control *P. cinnamomi* root rot in Queensland *Pinus* nurseries but most of the infested nurseries were subsequently abandoned and replaced by *P. cinnamomi*-free nurseries operated under a strict hygiene system (Brown 1985; Brown and Baxter 1990). A number of the other Australian states have abandoned nurseries because of *P. cinnamomi* problems and some have adopted the hygiene concept. Metalaxyl has been used for control of *P. cinnamomi* in several Australian states, and fumigants such as methyl bromide, chloropicrin and Di-Trapex (methyl isothiocyanate) have also been used. Although studies have shown that solar-heating of soil could control the fungus, this practice does not appear to have been used in routine operations.

Severe *P. cinnamomi* root rot in a large *P. radiata* nursery at Benalla in Victoria has been linked to herbicide usage for weed control. It has been reported that propazine, used on a regular basis, predisposed pine seedlings to root rot, but when it was replaced with chlorthal dimethyl, the disease disappeared rapidly (Neumann and Marks 1989). Chlorthal dimethyl has been shown to reduce radial growth, sporangial production and inoculum potential of *P. cinnamomi* (Kassaby and Hepworth 1987). On the other hand, propazine, whilst being mildly phytotoxic to the fungus, stimulated sporangial production and inoculum potential. Marks and Cerra (1990) reported that propazine increased

sensitivity of *P. radiata* to *P. cinnamomi* and also that it increased numbers of spore-forming bacteria stimulatory to sporangial formation by *P. cinnamomi*, whilst chlorthal dimethyl greatly reduced numbers of bacteria, including the spore formers, in treated soil. By contrast with the Benalla experience with propazine, severe root rot of *Pinus* spp., including *P. radiata*, occurred in a number of Queensland nurseries during the late 1950s and early 1960s (Oxenham and Winks 1963a; Brown 1985). At that stage white spirit was used for weed control; the broad scale use of a chlorthal dimethyl/propazine mixture only commenced in 1973 (Bacon 1979). Of particular interest in Queensland, should *P. cinnamomi* become a problem again, is the possible interaction of propazine and chlorthal dimethyl on both the soil microflora and *P. cinnamomi*.

Macrophomina phaseolina and other root-rot pathogens

Another root rot pathogen of *Pinus* that is also associated with damping disease is *Macrophomina phaseolina* (sometimes reported as *Sclerotium bataticola* Taub.) which has been reported from a number of localities. Although overseas experience suggests that this fungus alone, or in combination with other fungi (as charcoal root rot), could be a serious nursery problem in drier areas of Australia, this has not happened. In an earlier paper (Brown 1985), the potential role of leguminous cover crops and *M. phaseolina* on *P. caribaea* var. *hondurensis* in tropical Queensland was queried; no problem has yet resulted. Hosts in the genus *Pinus* from Australian forest nurseries include *P. caribaea* var. *hondurensis*, *P. elliotii*, *P. patula*, *P. pinaster*, *P. radiata* and *P. taeda*. This is one of the soil-borne pathogens shown to be controlled by solar-heating of soil but no control measures are currently in use against this disease in Australia.

Other fungi associated with root rot of nursery *Pinus* plants in Australia include a number of *Pythium*, *Fusarium*, and *Cylindrocarpon* species, *Thielaviopsis basicola* (Berk. & Br.) Ferraris, *Rhizoctonia solani*, and other species of *Rhizoctonia*. Most of these are associated with damping-off of young seedlings as well as later root rot disease.

Colletotrichum acutatum

Terminal crook disease of *Pinus* spp. is caused by the fungus *Colletotrichum acutatum* Simmonds. This fungus attacks the growing shoot of seedling pines and results in partial death of the bud. Continuation of growth of the bud results in distorted growth, even to the extent of the shoot growing through a bend of 180°. It

appears that the hormone balance of the growing shoot is affected as diseased seedlings do not produce secondary branches during the remainder of the nursery stage. Thus, although not lethal, terminal crook disease renders affected plants unsuitable for use.

Terminal crook for a number of years appeared sporadically in scattered *Pinus* nurseries in Queensland but, in recent years, it has appeared regularly in two nurseries. It has also been recorded on *Pinus* in north-eastern New South Wales. The disease has been recorded on *P. caribaea* var. *hondurensis*, *P. elliotii* and *P. radiata*. Losses are generally low, but on one occasion in a bed of 270 000 *P. elliotii* seedlings, 18% were affected with some patches of up to 90% were attacked, but, in other beds, only about 2.5% of 460 000 plants showed infection. Following New Zealand experience, the first control measure adopted in Queensland was captan plus white oil but currently dichlofluanid plus white oil is employed.

Sphaeropsis sapinea

Sphaeropsis sapinea (Fr.) Dyko & Sutton causes a shoot dieback of nursery stock, particularly of *P. radiata* and, although not uncommon, is usually not serious. Stahl (1966) included *S. sapinea* (as *Diplodia pinea* (Desm.) Kickx) as one of the causes of damping-off. Shoot infection in the nursery often follows mechanical damage such as hail or strong winds but, on occasion, soft succulent stock in fumigated nursery beds have been infected without any significant signs of physical damage. Most problems in New South Wales arise from the practice of reducing the size of nursery stock by topping. In Western Australia, damage to rooted cuttings of both *P. radiata* and *P. pinaster* is generally low but on one recent occasion over 20% of a batch of *P. radiata* were lost. In that state, benomyl every 3 weeks is used for control.

Dothistroma septospora

The pine needle blight fungus *Dothistroma septospora* (Dorog.) Morelet was first discovered in Australia in 1975 (Edwards and Walker 1978) and by 1987 it had been found in the Australian Capital Territory, Queensland, Victoria and Tasmania (Eldridge and Simpson 1987). In Victoria, *D. septospora* has been recorded on *P. radiata* on cutting stool plants at one nursery and restrictions have been placed on transfer of the resultant cuttings; such plants are only used within *D. septospora* infested zones. Although *D. septospora* may not have occurred in other forest nurseries, several states have for some years placed restrictions on the transfer of seedlings from nurseries within infested areas to prevent spread of needle blight disease.

Tasmania recently ceased the processing of *P. radiata* cones (for seed extraction) at a site adjacent to one nursery in order to avoid accidental infection of nursery stock with *D. septospora*.

Nursery mycorrhizae

It has been long recognized that the *Pinus* spp., exotic to Australia, require infection by mycorrhizal fungi for satisfactory growth. In Queensland, as in other areas, it had been the practice for a long time to introduce mycorrhizal inoculum from the lower layer of the needle litter under pine stands into new nurseries. This is done regularly in Western Australia, but in Queensland a single inoculation has been sufficient.

The use of needle litter is obviously a potential means of introduction of pathogenic fungi which may occur under the source stands. In Western Australia, sources must be free of *Phytophthora* spp. before such inoculum can be used. In Queensland it has been shown that inoculation is not necessary for nurseries adjacent to pine stands, but nurseries remote from plantations do require inoculation (Brown and Baxter 1990). *Rhizopogon* spores have been used for seed inoculation prior to sowing of new beds in New South Wales. In Tasmania this procedure was used prior to sowing beds after 5 years fallow but seedling growth in some uninoculated beds revealed that it was not necessary.

There appear to be no studies on the effect of soil fungicide or fumigant usage on mycorrhizal development on nursery crops of *Pinus* spp. However, observations in a number of nurseries over some years of soil fumigation in Queensland showed that mycorrhizal fungi readily re-invaded the seed beds adjacent to *Pinus* plantations. Marks and Becker (1990) reported studies on the effect of commonly used nursery weedicides on mycorrhizae of *Pinus* and showed that both propazine and chlorthal dimethyl produced changes in mycorrhizal type, numbers and ratios of one type to another.

Insect pests of Pinus

Lepidoptera

Cutworms. These insects are among the most commonly occurring pests in forest nurseries in Australia and have been reported from all states. Larvae damage bark on roots and stems near ground level and may cause death of seedlings (Moore 1962; Neumann and Marks 1976, 1989). Principal pest species are the common cutworm, *Agrotis infusa* (Boisduval) (Noctuidae), and the brown cutworm, *A. munda* Walker. During a severe outbreak at Toolara, Queensland in 1979, larvae of *A. munda* seemed to preferentially attack seedlings of *P. caribaea* var. *hondurensis* rather than those of *P. elliotii* var. *elliotii*. The infestation is

thought to have originated in weed growth on fallow blocks within the nursery.

Budworms. Larvae of the native budworm, *Heliothis punctigera* Wallengren (Noctuidae), have caused occasional severe damage to needles, shoots and terminal buds of *P. radiata* and *P. taeda* in Queensland and of *P. radiata* in South Australia. Another species of *Heliothis*, the tobacco budworm, *H. armigera* (Hubner), also damages *P. radiata* in South Australia.

Armyworms. Larvae of the southern armyworm, *Persectania ewingii* (Westwood) (Noctuidae), and of species of another noctuid genus, *Pseudaletia*, cause occasional severe defoliation of *P. radiata* nursery stock in South Australia.

Leaf or tip webbing caterpillars. The most important of this group is the light brown apple moth, *Epiphyas postvittana* (Walker) (Tortricidae), whose larvae damage needles, shoots and terminal buds of *P. radiata* in Victoria, New South Wales and South Australia (Moore 1962; Neumann and Marks 1976, 1989). Another tortricid, *Merophyas divulsana* (Walker), has damaged *Pinus halepensis* Miller in South Australia while the geometrid, *Ectropis exsuperata* (Walker), is a pest of *P. radiata* in Tasmania.

Case moths. The leaf case moth, *Hyalarcta huebneri* (Westwood) (Lepidoptera: Psychidae), has occasionally defoliated seedlings of *P. radiata* in Queensland.

Other Lepidoptera. Larvae of the painted apple moth, *Teia anartoides* Walker (Lymantriidae), cause occasional severe defoliation of *P. radiata* in New South Wales and Victoria (Neumann and Marks 1989). Unidentified species of looper caterpillars, (Geometridae), have been reported attacking *Pinus* spp. in New South Wales.

Coleoptera

Scarab beetle larvae and adults. These are an important pest group in nurseries in most states. Soil-dwelling scarab larvae or white grubs attack underground portions of plants, sometimes ringbarking or severing the main stem. Adults generally attack aerial parts of seedlings, damaging needles or bark. In South Australia, white grubs have been particularly devastating in new nurseries developed from old pastures, the principal pest species being the redheaded pasture cockchafer, *Adoryphorus couloni* (Burmeister) (Scarabaeidae). In Western Australia, larvae of *Heteronyx* spp. have damaged *P. pinaster*, and white grub attack has also been reported

on seedlings of *P. radiata* in New South Wales. Adult *Heteronyx* spp. have caused damage to *Pinus* spp. in Tasmania and South Australia, and adult *Diphucephala* spp. and *Liparetrus* have caused damage to *Pinus* spp. in South Australia. Swarms of African black beetle, *Heteronychus arator* (Fabricius), caused considerable losses among *P. elliotii* var. *elliotii* seedlings at Toolara, Queensland in 1978. Adults damaged not only the aerial parts of these plants but also tunneled in the soft, sandy soil and girdled stems at and below the collar. The outbreak is thought to have originated, in part, from fallow nursery beds sown to Gatton panic, a cultivar of *Panicum maximum* Jacq., and from the grassy surrounds of the nursery.

Weevils. The whitefringed weevil, *Graphognathus leucoloma* (Boheman) (Curculionidae), is a common pest of *Pinus* spp. in New South Wales and South Australia, and the apple weevil, *Otiorynchus scribicollis* Gyllenhal, is also a pest of *Pinus* spp. in the latter State.

Bark beetles. Larvae and adults of the black pine bark beetle, *Hylastes ater* (Paykull) (Scolytidae), and the goldenhaired bark beetle, *Hylurgus ligniperda* (Fabricius), another scolytid, damage cambium, roots and bark of *P. radiata* seedlings in Victoria and South Australia, sometimes causing death of these seedlings (Neumann and Marks 1989). Both of these species of bark beetle are introduced pests from Europe (Neumann 1987).

Grasshoppers and mole crickets

Nymphs of the Australian plague locust, *Chortoicetes terminifera* (Walker) (Orthoptera: Acrididae), have caused death of *P. radiata* seedlings in Victoria. Neumann and Marks (1989) note that severe attack may occur on nursery stock near grassy sites during prolonged dry weather. In South Australia, the yellow-winged locust, *Gastrimargus musicus* (Fabricius) (Orthoptera: Acrididae), and wingless grasshoppers, *Phaulacridium* spp., cause problems each year in *Pinus* spp. nursery stock, particularly in the south-east region of the state. Attack is usually associated with outbreaks of these insects in pastures up to several kilometres away from the nurseries.

Mole crickets, *Gryllotalpa* spp. (Orthoptera: Gryllotalpidae), are occasional pests of *Pinus* spp. in South Australia, Western Australia and Queensland.

Mealybugs

Nymphs and adults of mealybugs, *Pseudococcinae* (Hemiptera: Pseudococcidae), have been recorded as pests of *P. radiata* in Victoria. They feed by piercing

plant tissue and ingesting sap. Neumann and Marks (1989) note that they may attack callus growth of fresh cuttings in nurseries, and by inducing resin flows prevent root formation.

Other non-vertebrate pests

The European earwig, *Forficula auricularia* Linnaeus (Dermaptera: Forficulidae), reportedly causes damage to *P. radiata* in South Australia, usually in spring. Thrips are a common pest of *Pinus* spp. in New South Wales nurseries. White snails (*Helicella* sp.), slugs and millipedes cause occasional severe damage to *P. radiata* in South Australia, usually in new nurseries.

Nematodes of Pinus

Vaartaja and Bumbieris (1967) suggested that nematodes from several genera (*Longidorus*, *Xiphinema* and *Pratylenchus*) may have been involved in occasional serious losses in conifer (*P. radiata*) nurseries in South Australia. A survey for nematodes in exotic pine nurseries in Queensland in 1972 showed population levels which might affect growth and development of host species (Anon. 1973). The nematodes detected from *Pinus* seedlings included *Paratrichodorus minor* (Colbran) Siddiqi (reported as *Trichodorus minor* Colbran) on *P. elliotii*, and *P. minor*, *Trichodorus* sp. and *Pratylenchus* n. sp. on *P. caribaea*. Although no control measures were applied, no adverse effects were noted in subsequent *Pinus* crops at the nurseries even though nematodes were detected at Beerburum and Toolara, two of Queensland's hygiene nurseries (Brown and Baxter 1990), in the early stages of their operation. On one occasion *P. minor* caused problems in a forage *Sorghum* cover crop at Toolara without having any noticeable impact on subsequent pine crops (Brown and Baxter 1990). Magor (1979) reported a survey of five *P. radiata* nurseries in New South Wales; no evidence of symptoms was found and all but one single specimen were nematodes common in most soils.

Winoto-Suatmadji and Marks (1983) reported the detection of high numbers of the root lesion nematode *Pratylenchus penetrans* (Cobb) Chitwood and Oteifa from roots of diseased *P. radiata* from Rennick nursery in western Victoria. Large disease patches appeared in bays where *radiata* pine had been successively cropped and disease was less in bays where a crop rotation, which included legumes and grasses with pine every third year, had been used. Winoto-Suatmadji and Marks (1984) demonstrated the pathogenicity of *P. penetrans* to *P. radiata* and concluded that the nematode was the likely cause of the disease at the Rennick nursery. That disease, its effects and control have been reviewed by Marks *et al.* (1985 and 1987). Nematicides

(fenamiphos, aldicarb and ethoprophos) control the disease. Fenamiphos applied before sowing or to young (14 days after emergence) or older (20 weeks old) plants, controlled the nematodes but best plant growth response resulted from the pre-sowing treatment. Studies on the seedlings growing in bays that had received the pre-sowing treatment also showed greater development of mycorrhizae than plants in an untreated area. Winoto-Suatmadji *et al.* (1985) reported that the fungicide metalaxyl suppressed root lesion nematodes on *P. radiata* but not to the same extent as did fenamiphos.

More recently, following effective control of *P. penetrans* at Rennick, further patches of chlorotic, stunted and dead seedlings were observed (Winoto-Suatmadji and Marks 1989). There were few *P. penetrans* associated with the disease but large numbers of another plant pathogenic nematode, *Rotylenchus robustus* (de Man) Filipjev, were detected. The *R. robustus* problem is increasing in spite of the use of fenamiphos; crop rotation is seen as the answer. Earlier this year, large numbers of *R. robustus* and smaller numbers of *P. penetrans* were detected in a nursery in South Australia. This nursery is on similar soils to, and only a few kilometres from Rennick, in Victoria.

Vertebrate pests of Pinus

Birds are the major cause of damage in exotic pine nurseries. In the case of *P. caribaea*, both the newly sown seeds and the retained seed coat on recent germinants are the target of birds. The Torresian Crow, *Corvus orru*, is the major problem species. In addition, flocks of native ducks occasionally cause a serious, though brief problem by browsing on the seed coats of germinants. Gas powered "scare guns" are routinely employed against any birds which create problems in nurseries, but with limited success. Greater success has been achieved against crows by attracting them away from the nursery during the critical seed planting and germination phases by conducting fuel reduction burns in nearby forest. The crows apparently find the insects flushed by the fire more attractive than the pine seed. Another method of control is to attract birds away from the nursery by spreading grain seed along plantation roads close to the nursery from a week before sowing until the germination is complete. Parrots, mainly Crimson Rosellas, *Platycercus elegans*, cause some problems in *P. radiata* nurseries. Limited trials with seed treated with chemical anti-feedants have been conducted with inconclusive results. Black rats, *Rattus rattus*, and house mice, *Mus musculus*, can also create problems where newly sown seed beds are adjacent to areas of cover crop or pine seedlings. Control is with coumatetralyl, if mice populations appear high, this is commenced prior to sowing.

Araucaria species

The only native conifer of any significance in the Australian plantation program is *A. cunninghamii* (hoop pine) which is planted mainly in Queensland and to a lesser extent in New South Wales.

Although recent developments have resulted in 12-month, container planting stock after direct sowing, most of the hoop pine still planted results from a nursery operation of over 2 years duration. Hoop pine seed is sown into prepared beds under about 50 % shade in spring (August-September), the seedlings are root wrenched about the end of the second February in the beds, lifted and side tubed into metal tubes during the next winter and are then planted out during early summer (November-December) (Hawkins and Muir 1968). Because of high capital cost of the permanent timber nursery shade system that was used in Queensland, beds were frequently cropped continuously with only short periods between lifting of one crop and bed preparation for another. More recently, using removable shade cloth material, less expensive structures have allowed better rotational systems with fallow between crops.

Seedling hoop pine are particularly sensitive to insolation effects, either through direct losses or because of heat-girdling. Heat-girdling, just above ground level, occurs sporadically; often it is not detected until some months after the damage when the affected plants show drought symptoms. At that stage, the plants have a pronounced swelling of the stem above the girdled area where the cambium was killed by high temperatures.

Diseases of *Araucaria*

Damping-off

Severe damping-off in *A. cunninghamii* seed beds was just one of the adverse consequences of the repeated cropping practiced in Queensland for many years. Even with the lower plant densities resulting from severe damping-off, size of the nursery produce also declined markedly. In some Queensland nurseries soil was sometimes added to hoop pine seed beds to improve production and occasionally the bed soil was removed and replaced with fresh rainforest soil to overcome the long-term effects of continuous cropping.

Heavy pre-emergence losses have been recorded in Queensland. Those losses invariably occurred in nurseries with a history of substantial post-emergence losses. Post-emergence losses in some nurseries commonly exceeded 25 % of total emergents. *Pythium* and *Rhizoctonia* species have usually been associated with damping-off of hoop pine.

A seed-dressing with captan was adopted in Queensland hoop pine nurseries in 1965 for pre-emer-

gence damping-off control. Where comparisons were available from experiments or from routine sowings with and without captan, seed dressing usually increased germination, often by over 20 %, except on those occasions when germination was high without the seed-dressing. On some, but not all occasions, the seed dressing also gave control of post-emergence damping-off. Captan and thiotox were used for many years in hoop pine for control of post-emergence damping-off, but as yet, no alternative has been found for captan since its de-registration in Australia several years ago.

Rhizoctonia crocorum root-rot

The second most serious hoop pine nursery disease is a rootrot of advanced nursery stock caused by the mycelial state of the basidiomycete *Helicobasidium compactum* Boedijn (Young 1948). The mycelial state is similar to the *Rhizoctonia crocorum* Fr. state of *H. purpureum* Pat. and this has apparently lead to incorrect records, such as that of Browne (1968), of *H. purpureum* on *A. cunninghamii* from Queensland.

The disease occurs sporadically; it has only occurred several times over the past 25 years. The outbreaks appear to result from introduction of fresh rainforest soil into nursery beds, but the disease has been spread between nurseries on infected nursery stock. *Rhizoctonia* root rot is characterised by rot of outer root tissue with superficial brown strands and hyphae of the fungus and also infection cushions and black sclerotia on the surface (Young 1948). Hoop pine seedlings may have advanced rot of the roots without showing foliage symptoms.

Young (1948) reported that Cheshunt mixture controlled the disease. Soil fumigation with chloropicrin has been used to eradicate the disease without adverse effects to subsequent *Araucaria* sowings. Methyl bromide, even at low rates, adversely affects the vesicular arbuscular mycorrhizae, essential for hoop pine growth, but chloropicrin has no such effect.

Other hoop pine nursery diseases

One of the more virulent of the diseases occasionally recorded in Queensland hoop pine sowings has been collar rot caused by *Sclerotium rolfsii* Sacc. (Anon. 1963). This causes losses in patches of seed bed but has been readily controlled with quintozene.

Other diseases recorded in hoop pine nursery crops include a sore-shin disease of advanced seedlings caused by a *Rhizoctonia* sp., a seed and seedling stem rot caused by *Lasiodiplodia theobromae* (Pat.) Griff. & Maubl. (Simmonds 1966 as *Botryodiplodia theobromae* Pat.), a seedling blight caused by *Dothiorella pinea* (Pass.) Petrak & Sydow (Simmonds 1966), and a stem

canker believed to be due to *Botryosphaeria ribis* Grossenbacher & Duggar.

Insect pests of Araucaria

Lepidoptera

Cutworms. Damage by cutworm larvae, *Agrotis* spp. (Noctuidae), to *A. cunninghamii* has usually been confined to germinating seedlings. As described in Anon. (1963), first the cotyledon and seedling shoot are eaten then the hypocotyl. At this stage the damage resembles that caused by grasshoppers or by crickets. Grubs usually shelter at the base of the seedling where their presence can be detected from a slightly raised area of soil about 2cm in diameter. At a later stage the larvae may cut the plant and pull it downwards, leaving the cotyledons resting on the soil surface. Control is by application of a soil insecticide when the damage is first noticed.

Loopers. Larvae of the castor oil looper, *Achaeajana* (Linnaeus) (Noctuidae), occasionally cause severe damage to *A. cunninghamii* seedlings, consuming the leaves and above-ground stem of plants (De Baar 1983). Larvae of *Cleora* sp. (Geometridae) also occasionally defoliate hoop pine seedlings.

Coleoptera

White grubs. Larvae of *Rhopaea* spp. (Scarabaeidae) have long been one of the most important nursery pests of hoop pine. Until recently, treatment of nursery beds with persistent chemical insecticides prior to sowing was routine practice against these pests. Present practice is to apply a soil insecticide only when attack has been noticed.

Weevils. The pine bark weevil, *Aesiotes notabilis* Pascoe (Curculionidae), sometimes attacks tubed *A. cunninghamii* seedlings. Larvae tunnel in the main roots, chewing away woody tissue as well as bark, and finally form cocoons for pupation at or near ground level. Their activities can result in girdling of the main stem and seedling death (Brimblecombe 1945; Yllie and Yule 1978).

Mealybugs

The golden mealybug *Nipaecoccus aurilanatus*, (Maskell) (Hemiptera: Pseudococcidae), is an important pest of *A. cunninghamii* and *A. bidwillii* Hook. in Queensland nurseries. Attacks are usually brought under control naturally by the mealybug ladybird, *Cryptolaemus montrouzieri* Mulsant (Coccinellidae), but sometimes spraying with a chemical insecticide is necessary.

Mole crickets

Mole crickets, *Gryllotalpanitidula* Seville (Orthoptera: Gryllotalpidae), are occasional pests of *A. cunninghamii* nursery stock.

Nematodes of Araucaria

In 1972 surveys were made for nematodes from a number of hoop pine nurseries in Queensland. Among the nematodes detected, one (*Tylenchus emarginatus*) was present in numbers likely to be a problem (Anon. 1973). However, there have been no indications that nematodes have caused nursery problems in hoop pine.

Vertebrate pests of Araucaria

Because seed beds are enclosed in shade cloth, hoop pine nurseries do not suffer from bird damage. However, the black rat, *Rattus rattus*, has caused problems by taking recently planted seed. The problem is associated with untidy nursery surrounds and can be corrected with arat control program and a general tidy-up. Occasionally, the short-nosed bandicoot, *Isoodon macrourus*, a small omnivorous marsupial, uproots seedlings while searching for white-grubs in seed beds. Damage can be quite extensive but is readily avoided by adequately fencing the nursery.

Eucalyptus species

In Australia much of the nursery production of *Eucalyptus* has been in some form of container system, although bare root production is becoming more common. Depending on the location, container production ranges from 3 months to 4-5 months and in open beds, bare root seedlings are produced over a 9-month period.

Diseases of Eucalyptus

Grey mould

One of the most important nursery diseases of *Eucalyptus* spp. in Australian forest nurseries is grey mould caused by *Botrytis cinerea*, the anamorph of *Sclerotinia fuckeliana* (de Bary) Fuckel. The disease affects a wide range of *Eucalyptus* spp. and can be particularly severe in containerized plants. Grey mould disease has been recorded throughout Australia and as well as foliage death causes a stem lesion which usually results in stem collapse. The fungus also causes damping-off of eucalypt seedlings (Palzer 1980).

The disease can build up to epidemic levels in a very short time, particularly at the end of the growing season in autumn when plants are densely spaced and when suppressed plants and dead tissue are present. Heavy nitrogenous fertilization, resulting in lush, soft growth,

favors epidemic disease. Disease may be severe following frost damage of *Eucalyptus* seedlings.

Cultural practices are seen as important in reducing grey mould problems. These include removal of dead material to reduce potential infection foci, improvement of ventilation by both increased plant spacing and lifting plants off the ground, control of amount and time of watering to minimize leaf wetness periods and adjusting fertilizer levels to avoid succulent growth. Regular fungicidal sprays with copper-based material are used in Victoria (Marks et al. 1982) whilst in Western Australia a rotating schedule of glycofenox, vinclozolin, benomyl and chlorothalonil is used in autumn. In Tasmania, alternate fortnightly spraying of benomyl and glycofenox is commenced when plants reach a size where air circulation is restricted.

Damping-off

As with the other forest tree nursery crops, damping-off has been a problem with *Eucalyptus* spp. in Australia although there is little reference to it in published work. Pathogens involved are species of *Pythium* and *Rhizoctonia solani*.

Holmes and Floyd (1969) reported that damping-off could be a major problem in raising *E. pilularis* Smith seedlings. They reported that captan seed dressing increased germination (possibly by controlling pre-emergence damping-off) and advised regular captan sprays against damping-off. Palzer (1980) reported that filtration of a nursery water supply, for seed germination, propagation and glasshouse work, had substantially decreased damping-off of *Eucalyptus* spp. Kassaby (1985) reported that both steaming and solar-heating of a sandy-loam potting mixture reduced damping-off of *E. obliqua* L'Her. He also showed that damping-off was greater when nursery water from a contaminated source (*P. cinnamomi*, *P. cryptogea* and three species of *Pythium*) was used on steamed or untreated potting mixture but not when it was used on solar-heated mixture. Damping-off losses are now avoided by the use of composted potting mixtures or the use of sterilized soil in germination trays, with the use of hygiene systems and by altering the time of sowing.

Phytophthora and Pythium stem and root rots

Wardlaw and Palzer (1985) reported a stem disease of nursery seedlings of *Eucalyptus* spp. and other plants caused by *Phytophthora cactorum* (Leb. & Cohn) Schroet., *P. citricola* and *Pythium anandrum* Drechsler. The stem rot originated in the leaf axils and extended predominantly up the main stem and along leaf midribs, killing tissue distal to the stem infection. Wardlaw and Palzer reported good control of this disease with thiotox

or metalaxyl. The primary source of inoculum was believed to be the river water used for nursery irrigation. On a small scale, filtration of nursery water supply controlled this disease on non-eucalypt hosts. The subsequent use of a chlorination system has given good control on a larger scale, except for one instance when re-occurrence of the disease was probably due to inactivation of the chlorination by heavy silt loads in the water as result of flooding.

Although *Phytophthora cinnamomi* has been associated with disease of many species of *Eucalyptus* in Australia, most of the records are from natural forest, plantations, or experimentally inoculated plants. That work has shown that seedlings of many species of eucalypt are susceptible, often highly so, and thus *Phytophthora* root rot could be expected to be a nursery problem. However, there are very few actual reports of *P. cinnamomi* causing nursery problems with the eucalypts. In Queensland, *P. cinnamomi* caused deaths of container *E. pilularis* and was subsequently transferred to the field on diseased plants. Weste (1980) also reported the transfer of *P. cinnamomi* to the field by eucalypt plants infected in the nursery.

Cylindrocladium blights

Keirle (1981) reported the occurrence of *Cylindrocladium scoparium* in New South Wales forest nurseries on a number of *Eucalyptus* spp. Onset of the disease coincided with high relative humidities, temperature and rainfall. Although it appeared that the pathogen had been transferred to plantation areas, there was no evidence of widespread plantation deaths. Blight caused by *C. scoparium*, *C. floridanum* Sobers & Seymour and *C. clavatum* Hodges & May continues to be a serious problem on eucalypt nursery stock in New South Wales. According to Rossman (1983), *C. floridanum* is synonymous with *C. scoparium*.

Cylindrocladium quinqueseptatum Boedijn & Reitsma was reported on a number of eucalypts from the tropics at Darwin in the Northern Territory (Pitkethley 1976). The fungus was associated with leaf spots, leaf blight and seedling blight. Rossman (1983) placed this species into *C. ilicicola* (Hawley) Boedijn & Reitsma. Over several years, *C. ilicicola* caused severe losses in one nursery in tropical Queensland. On the other hand, although it was associated with severe disease in plantations of *Eucalyptus* spp. in another area of tropical Queensland in 1989, it caused little disease on *Eucalyptus* spp. in a forest nursery only 25 km away.

Powdery mildew

Powdery mildew caused by *Oidium* sp. is not unusual in *Eucalyptus* nursery stock. Although infection rarely

kills seedlings, it can cause severe distortion and reduction in growth. In Tasmania, on the most heavily infected species, *E. nitens* (Deane & Maiden) Maiden, heavy infection occurs in the glasshouse or under 50 % shade but under 34 % shade it is less serious and is undetectable in open beds. Infection rarely persists once plants are transferred to the field.

In Victoria, control of powdery mildew on *Eucalyptus* is achieved with colloidal sulphur fungicides (Marks et al. 1982). Triadimefon but not benomyl has given good control in Tasmania and recently prochloraz also gave good control of powdery mildew (Wardlaw and Phillips 1990). Triadimefon is also used in New South Wales.

Integrated control of powdery mildew and grey mould of E. nitens

Wardlaw and Phillips (1990) discuss the problems of control of *Oidium* spp. and *Botrytis cinerea* on *E. nitens*, an important crop species. In the past, control of both diseases has meant separate applications of triadimefon for powdery mildew and alternating sprays of benomyl and glycophene for grey mould. Recent trials have suggested that triadimefon can be mixed with either benomyl or glycophene without phytotoxic effects thus allowing for a single application of those fungicide mixtures. Wardlaw and Phillips indicated that trials showing the control of powdery mildew with prochloraz suggest that this chemical has promise for the control of both diseases.

Other shoot and foliage diseases

There are a number of *Mycosphaerella* known to affect juvenile leaves of eucalypts. In Victoria, two species (*M. cryptica* (Cooke) Hansf. and *M. nubilosa* (Cooke) Hansf.) are serious nursery problems. *Mycosphaerella* infect young expanding leaves during warm wet weather and symptoms occur 1 to 2 months later (Marks et al. 1982). They suggest that prophylactic sprays early in the growing season would be more effective than attempts at control of diseased plants.

Phaeoseptoria eucalypti Hansf. emen. J. Walker. is another fungus frequently associated with nursery disease of eucalypts. Although Walker (1962) reported that it had caused severe seedling damage in a New South Wales nursery, the fungus appears to be of no real significance to current nursery production.

Walker and Bertus (1971) described *Ramularia pitereka* Walker & Bertus from nursery stock of *E. maculata* Hook and other species from New South Wales. The fungus had been observed for a number of years causing shoot blight of seedlings over 3 months old. According to Walker and Bertus, if not controlled

by spraying, *Ramularia* blight could kill or severely damage seedlings. This disease continues to be a problem in nurseries in New South Wales. In Queensland, however, the fungus has only been recorded from plants in the field, never from the nursery.

Colletotrichum gloeosporioides (Penz.) Sacc., the anamorph of *Glomerella cingulata* (Stonem.) Spaulding & Schrenk, can cause a serious blight of seedling eucalypts, particularly during wet, showery weather. In southern Queensland, similar conditions during autumn are associated with a severe leaf spot, particularly of *E. pilularis* and *E. cloeziana* F. Muell. The causal agent, yet to be confirmed, is believed to be a bacterium of the genus *Xanthomonas*.

Insect pests of Eucalyptus

Lepidoptera

Cutworms, armyworms and budworms. In South Australia, the same species of *Agrotis*, *Persectania*, *Pseudaletia* and *Heliothis* mentioned previously as pests of *Pinus* also attack *Eucalyptus* species in forest nurseries.

Leaf or tip webbing caterpillars. Larvae of the autumn gum moth, *Mnesampela privata* (Guenee) (Geometridae), are pests of *E. globulus* Labill. and *E. nitens* in Tasmanian nurseries and have also been reported attacking *Eucalyptus* spp. in nurseries in New South Wales. The tortricids, *E. postvittana* and *M. divulsana*, mentioned previously as pests of *Pinus* in South Australia, also attack *Eucalyptus* spp. in that state. Larvae of *Epiphyas xyloides* (Meyrick) (Tortricidae) attack a wide range of eucalypt species in Tasmania.

Cup moths. Larvae of *Doratifera* spp. (Limacodidae) are occasional pests of *Eucalyptus* spp. in New South Wales.

Coleoptera

Scarab beetle larvae and adults. Insects belonging to this group are common pests of *Eucalyptus* spp. in nurseries in most states. In South Australia, larvae of *Adoryphorus couloni* and adults of *Diphucephala*, *Heteronyx* and *Liparetrus* are known as pests, while in Queensland adult *Liparetrus* sp. have seriously defoliated seedlings of *E. microcorys* F. Muell. Larvae of the opaline cockchafer, *Anoplognathus porosus* (Dalman), have caused damage to advanced *Eucalyptus* spp. stock in New South Wales nurseries.

Weevils. The eucalyptus weevil, *Goniapterus scutellatus* (Gyllenhal) (Curculionidae), is a common but minor

pest of *Eucalyptus* spp. seedlings in Tasmania (Elliott and deLittle 1984). In South Australia, the weevils *G. leucoloma* and *O. cribicollis* attack *Eucalyptus* spp. as well as *Pinus*.

Chrysomelid leaf beetles. Adults of *Paropsis porosa* Erichson (Chrysomelidae) occasionally defoliate *Eucalyptus* spp. in Tasmania. Adult *Rhyparida* spp. cause similar damage in South Australia.

Grasshoppers and mole crickets

In South Australia, the grasshoppers *G. musicus* and *Phaulacridium* spp. and mole crickets, *Gryllotalpa* spp., damage *Eucalyptus* spp. in addition to *Pinus*.

Psyllids

The blue gum psyllid, *Ctenarytaina eucalypti* (Maskell) (Hemiptera: Psyllidae), is a pest of *E. globulus* and other glaucous *Eucalyptus* spp. in Tasmania and South Australia (Morgan 1984). Species of *Eucalyptolyma* also damage *Eucalyptus* spp. in South Australia.

Other insects

The cotton aphid, *Aphis gossypii* Glover (Hemiptera: Aphididae), infests *Eucalyptus* spp. in Queensland and

South Australia. In New South Wales, larvae of the steelblue sawfly, *Perga affinis affinis* Kirby (Hymenoptera: Pergidae), occasionally defoliate *Eucalyptus* spp. seedlings while species of *Apiomorpha* (Hemiptera: Eriococcidae), including *A. munita* (Schrader), cause galls on stem, twigs and leaves.

Acknowledgements

The Queensland contributions in this paper result from part of the research and operational work programs of the Queensland Forest Service. We record our appreciation for the work of many Forestry staff in nurseries and laboratories for their assistance. We also wish to thank J. Kehl and J. Porter for their contribution on the vertebrate pests of Queensland forest nurseries.

This overview of the Australian forest nursery disease and pest problems would not have been possible without the valued assistance of interstate forest pathologists and entomologists. The following have contributed in this way: pathology, J.A. Simpson (N.S.W.), G.C. Marks (Vic.), T. Wardlaw (Tas.), E. Scott with assistance from R. Boardman and W. Ateo (S.A.) and E.M. Davison (W.A.); entomology, R. H. Eldridge (N.S.W.), F. G. Neumann (Vic.), R. Bashford and H. J. Elliott (Tas.), F.D. Morgan (S.A.) and I. Abbott (W.A.).

References

- Anon. 1963. Technique for the establishment and maintenance of plantations of hoop pine (*Araucaria cunninghamii*). Forestry Department, Brisbane.
- Anon. 1964. Forest insect situation in New South Wales. in Documents presented to the FAO/IUFRO Symposium on Internationally Dangerous Forest Diseases and Insects. Oxford, 20-30 July 1964, Meeting No. II/III, ii + 7 p.
- Anon. 1973. Annual Report 1972-1973. Department of Forestry, Brisbane, Queensland.
- Anon. 1989. Australian Forest Resources: Present areas and estimates of future availability of wood. Prepared by Forest Resources Committee for the Standing Committee of the Australian Forestry Council, Canberra, February 1989.
- Bacon, G. 1979. An effective pre-emergence weedicide mix for use in *Pinus* nurseries. South African Forestry Journal 109:3-6.
- Boughton, T. J.; Crane, C. E. 1984 Assessment of *Phytophthora* disease risk at the Nannup nursery. Forests Department of Western Australia, Research Paper 77, 7 p.
- Brimblecombe, A. R. 1945. The biology, economic importance and control of the pine bark weevil *Aesiotus notabilis* Pasc. Queensland Journal of Agricultural Science 2: 1-88.
- Brown, B. N. 1985. *Phytophthora cinnamomi* root rot in *Pinus* nurseries: soil fumigation and disease prevention by hygiene. Pages 507-514 in D. B. South, editor. Proceedings of the International Symposium on Nursery Management Practices for the Southern Pines, Montgomery, Alabama, August 4-9, 1985. School of Forestry, Alabama Agricultural Experiment Station, Auburn University and International Union of Forestry Research Organization Subject Group S3.202-03 "Nursery Operations".
- Brown B. N.; Baxter, A. G. M. 1990. Nursery hygiene in concept and in practice. Pages 133-140 in J.R. Sutherland and S.G. Glover, editors. Proceedings of the first meeting of IUFRO Working Party S2.07-09 (Diseases and Insects in Forest Nurseries), Victoria, British Columbia, Canada. August 22-30, 1990. Forestry Canada, Pacific Forestry Centre, Information Report BC-X-331, Victoria B.C. 298 p.
- Browne, F. G. 1968. Pests and diseases of forest plantation trees Clarendon Press, Oxford. vi + 1330 p.
- Castles, I. 1989. Year Book Australia 1989. Number 72. Australian Bureau of Statistics, Canberra, xvii + 863 p.
- De Baar, M. 1983. The castor oil looper. Queensland Department of Forestry, Leaflet No. 20.2 p.
- Edwards, S. W.; Walker, J. 1978. *Dothistroma* needle blight in Australia. Australian Forest Research 8:125-137.

- Eldridge, R. H.; Simpson, J. A. 1987. Development of contingency plans for use against exotic pests and diseases of trees and timber. 3. Histories of control measures against some introduced pests and diseases of forests and forest products in Australia. *Australian Forestry* 50(1):24-36.
- Elliott, H. J.; deLittle, D. W. 1984. *Insect Pests of Trees and Timber in Tasmania*. Forestry Commission, Tasmania. 90 p.
- Hawkins, P. J.; Muir, J. D. 1968. *Aspects of management of plantations in tropical and sub-tropical Queensland*. Department of Forestry, Queensland, Australia. 34 p.
- Holmes, D. A.; Floyd, A. G. 1969. Nursery techniques for raising eucalypts in jiffy pots in the N.S.W. North Coast Forestry Commission of New South Wales, Research Note No. 22. 15 p.
- Kassaby, F. Y. 1985. Solar-heating soil for control of damping-off diseases. *Soil Biology and Biochemistry* 17(4):429-434.
- Kassaby, F. Y.; Hepworth, G. 1987. *Phytophthora cinnamomi*: Effects of herbicides on radial growth, sporangial production, inoculum potential and root disease in *Pinus radiata*. *Soil Biology and Biochemistry* 19(4):437-441.
- Keirle, R. M. 1981. *Cylindrocladium scoparium* Morgan associated with diseased *Eucalyptus* spp. in New South Wales. *Australasian Plant Pathology* 10(2):34-36.
- Magor, V. E. 1979. Survey of nematodes in New South Wales *Pinus radiata* nurseries. *Australasian Plant Pathology* 8(4):53.
- Marks, G. C.; Becker, S. L. 1990. Influence of propazine and chlorthal dimethyl on mycorrhizal development in *Pinus radiata* seedlings. *Australian Journal of Botany* (in press).
- Marks, G. C.; Cerra, R. 1990. Effects of propazine and chlorthal dimethyl on *Phytophthora cinnamomi* root disease of *Pinus radiata* seedlings and associated soil microflora. *Soil Biology and Biochemistry* (in press).
- Marks, G. C.; Fuhrer, B. A.; Walters, E. M. 1982. *Tree diseases in Victoria*. Handbook No. 1, Forests Commission, Victoria.
- Marks, G. C.; Winoto-Suatmadji, R.; Christie, I. D. 1985. *Pratylenchus penetrans* (root lesion nematode) - cause of patch chlorosis of *Pinus radiata* seedlings. *Australian Forestry* 48(2):109-115.
- Marks, G. C.; Winoto-Suatmadji, R.; Smith, I. W. 1987. Effects of nematode control on shoot, root and mycorrhizal development of *Pinus radiata* seedlings growing in a nursery soil infested with *Pratylenchus penetrans*. *Australian Forest Research* 17:1-10.
- Moore, K. M. 1962. Insect attack on *Pinus* spp. Forestry Commission of New South Wales, Research Note No. 12. 14 p.
- Morgan, F. D. 1984. *Psyloidea of South Australia*. Government Printer, South Australia. 136 p.
- Neumann, F. G. 1987. Introduced bark beetles on exotic trees in Australia with special reference to infestation of *Ips grandicollis* in pine plantations. *Australian Forestry* 50:166-178.
- Neumann, F. G.; Marks, G. C. 1976. A synopsis of important pests and diseases in Australian forests and forest nurseries. *Australian Forestry* 39(2):83-102.
- Neumann, F. G.; Marks, G. C. 1989. Insect pests and diseases in native forests, pine plantations and forest nurseries. Department of Conservation, Forests and Lands, Victoria, Research Report No. 340. 64 p.
- Newhook, F. J. 1964. Forest disease situation, Australasia. In Documents presented to the FAO/IUFRO Symposium on Internationally Dangerous Forest Diseases and Insects. Oxford, 20-30 July 1964, Meeting No. VI, iii + 12 p.
- Oxenham, B. L.; Winks, B. L. 1963a. *Phytophthora* root rot of *Pinus* in Queensland. *Queensland Journal of Agricultural Science* 20(3):355-366.
- Oxenham, B. L.; Winks, B. L. 1963b. *Pinus* damping-off investigations in Queensland. *Queensland Journal of Agricultural Science* 20(4):455-461.
- Palzer, C. 1980. Water-borne pathogens and their simple control. *Australasian Plant Pathology* 9(1):11-12.
- Pitkethley, R. N. 1976. *Cylindrocladium quinqueseptatum* on myrtaceous tree seedlings. *Australian Plant Pathology Society Newsletter* 5(4):57.
- Rossman, A. Y. 1983. The phragmosporous species of *Nectria* and related genera. *Mycological Papers* No. 150, Commonwealth Mycological Institute, Kew, Surrey, England. 164 p.
- Simmonds, J. H. 1966. *Host Index of Plant Diseases in Queensland*. Queensland Department of Primary Industries, Brisbane, Queensland, ii + 111 p.
- Stahl, W. 1966. The use of Trapex as a soil sterilant in a forest nursery. *Australian Forest Research* 2(2):35-42.
- Vaartaja, O.; Bumbiens, M. 1967. Organisms associated with root rots of conifers in South Australian nurseries. *Plant Disease Reporter* 51(6):473-476.
- Walker, J. 1962. Notes on plant parasitic fungi. I. Proceedings of the Linnean Society of New South Wales 87(2):162-176.
- Walker, J.; Bertus, A. L. 1971. Shoot blight of *Eucalyptus* spp. caused by an undescribed species of *Ramularia*. Proceedings of the Linnean Society of New South Wales 96(2):108-115.
- Wardlaw, T.; Palzer, C. 1985. Stem diseases in nursery seedlings caused by *Phytophthora cactorum*, *P. citricola* and *Pythium anandrum*. *Australasian Plant Pathology* 14(3):57-59.
- Wardlaw, T.; Phillips, T. 1990. Nursery diseases and their management at the Forestry Commission Nursery, Perth. *Tasforests* 2(1):21-26.
- Waterhouse, D. F.; Carne, P. B. 1964. Forest entomology in Australia, Papua-New Guinea and the British Solomon Islands. In Documents presented to the FAO/IUFRO Symposium on Internationally Dangerous Forest Diseases and Insects. Oxford, 20-30 July 1964, Meeting No. II/III, ii + 3 p.
- Weste, G. 1980. Vegetation changes as a result of invasion of forest on krasnozem by *Phytophthora cinnamomi*. *Australian Journal of Botany* 28:139-150.

-
- Winoto-Suatmadji, R.; Marks, G. C. 1983. *Pratylenchus penetrans* in *Pinus radiata* in Victoria. Australasian Plant Pathology 12(2):29-31.
- Winoto-Suatmadji, R.; Marks, G. C. 1984. Pathogenicity of *Pratylenchus penetrans* to *Pinus radiata* seedlings. Australasian Plant Pathology 13(1):5-6.
- Winoto-Suatmadji, R.; Marks, G. C. 1989. *Rotylenchus robustus* in a *Pinus radiata* nursery in Victoria. Australasian Plant Pathology 18(2):38.
- Winoto-Suatmadji, R.; Marks, G. C.; Kassaby, F. Y. 1985. Suppressive effect of ridomil and nemacur on root-lesion nematodes in radiata pine seedlings, 1983. Fungicide and Nematicide Tests 40:108.
- Wylie, F. R.; Yule, R. A. 1978. Pine bark weevil. Queensland Dept. For. Advisory Leaflet No. 1. 3 p.
- Young, H. E. 1948. *Rhizoctonia* root rot of hoop pine. Queensland Journal of Agricultural Science 5:13-16.



Diseases of forest nurseries in Brazil

FRANCISCO ALVES FERREIRA AND JAMES J. MUCHOVEJ

Departamento de Fitopatologia
Universidade Federal de Vicosa
36570 Vicosa, MG, Brazil

Presented at the first meeting of IUFRO Working Party S2.07-09
(Diseases and Insects in Forest Nurseries), Victoria, British Columbia, Canada, August 22-30, 1990.

Abstract

The important diseases of *Eucalyptus*, *Hevea* rubber, *Pinus*, *Ipê*, and diseases which are not host-specific, are described for Brazilian forest nurseries. Chemical and cultural practices currently being used against these diseases are also described.

Growing seedlings (on benches to prevent contact with the soil) in containers with a small volume of sterilized growing medium allows production of seedlings that are free of soil-borne pathogens. This is especially important for *Eucalyptus* and *Pinus*. These practices and use of sanitation measures results in minimal disease losses. They also prevent soil-borne pathogens being introduced into new areas on ornamental and fruit trees seedlings. Another advantage is that fungicide useage is reduced. Fungicides are only used for air-borne pathogens which become evident during the growing season. Development of seedlings that are genetically resistant to disease is not practical as such resistance is best used against diseases in the field.

Resume

Le présent article comprend une description des principales maladies touchant les genres *Eucalyptus*, *Pinus*, certains *Hevea* et *Ips* ainsi que de certaines maladies non spécifiques de l'hôte dans des pépinières forestières du Brésil. Des méthodes de protection chimiques et culturelles actuellement utilisées contre ces maladies sont également décrites.

La culture de semis en récipients (disposés sur des banquettes pour éviter le contact avec le sol) contenant un petit volume de milieu de croissance stérile assure la production de semis qui sont exempts de pathogènes du sol. Cette pratique est particulièrement importante dans le cas des genres *Eucalyptus* et *Pinus*. Elle permet, conjointement avec l'application de mesures sanitaires, de réduire le plus possible les pertes causées par les maladies. Elle permet également d'éviter que des pathogènes du sol soient introduits dans de nouvelles zones où se trouvent des semis d'arbres ornementaux ou fruitiers. Autre avantage, elle réduit l'utilisation des fongicides. Ces derniers ne sont appliqués que pour détruire les pathogènes présents dans l'air qui se manifestent au cours de la saison de croissance. Il n'est pas pratique de sélectionner des semis génétiquement résistants aux maladies en pépinière, car la résistance est plus utile contre des maladies rencontrées sur le terrain.

Introduction

About 8 511 900 km² of Brazil are tropical or subtropical. Plantation forests cover slightly more than 7 million ha, with about 5 million ha in *Eucalyptus*. Only maize and soybeans occupy more land than forest plantations.

The purpose of this paper is to briefly discuss the principal diseases in Brazilian forest nurseries and their control.

Eucalyptus diseases

Damping-off (1, 2, 5, 6, 7, 10, 11, 13)

Four seedling growth stages need to be considered when studying the etiology, epidemiology and control

of damping-off (i) the pre-emergence stage; (ii) the pre-thinning stage which begins with seedling emergence and continues through seedling thinning or transplanting; (iii) the post-thinning or post-transplant stage which begins with the thinning or transplanting of seedlings and continues until seedling canopy closure - when plant crowding occurs; and (iv) the closure stage which begins with canopy closure and lasts until seedlings are lifted for outplanting (Figures 1 and 2) (Ferreira 1989). Under normal conditions stages ii-iv occur 40, 60, and 120 days from germinant emergence. The pathogens involved are mostly *Rhizoctonia solani*, *Cylindrocladium scoparium*, and *C. clavatum* in the pre-emergence stage, *R. solani* and both *Cylindrocladium* in the post-thinning stage (Figure 2)

although disease seldom occurs during this stage (Figure 3), and *Botrytis cinerea* and *C. scoparium* in the closure stage.

Girdling lesions and stem wilting are found only in the pre-thinning stage. Symptoms in the other stages consist of a girdling lesion anywhere on the stem, especially above the lower, lignified portion of the stem. Seedlings then wilt without drooping. *Botrytis* is the only pathogen which affects branches, leaves, and apical meristems and causes blight or basal stem lesions immediately above the lignified tissues (Figure 2).

Until 1970, damping-off was very common and severe in Brazilian nurseries. More recently, its prevalence has decreased with the introduction of direct seeding into plastic bags rather than into seedbeds. Direct seeding reduced damping-off because (i) planting density is lower, (ii) less organic material is present, (iii) seedbeds are drier, (iv) thinning causes less damage to residual seedlings, and (v) there is less dispersal of pathogens since the growing containers restrict root contact and water dispersal of inoculum among containers (Figure 1).

About 1984, seedlings began to be produced in tubettes in Brazil. Tubettes are conical or pyramidal (3 x 20 cm) plastic containers which contain only about 20% as much growing medium as plastic bag containers. The growing medium contains vermiculite to make it lighter. Ninety-six or more tubettes can be placed in a Styrofoam rack (or other holder) and suspended above

the soil, a practice that allows soil moisture to be controlled. Both from an economic and practical viewpoint, use of tubettes allows seedlings to be grown in a pathogen-free medium (fumigated or sterilized) without the containers contacting the ground and becoming contaminated with soil-borne microorganisms. Moreover, contamination of the growing medium by pathogen-contaminated rain or irrigation water is prevented. The light weight of the growing medium favors sanitation practices such as culling diseased seedlings. These

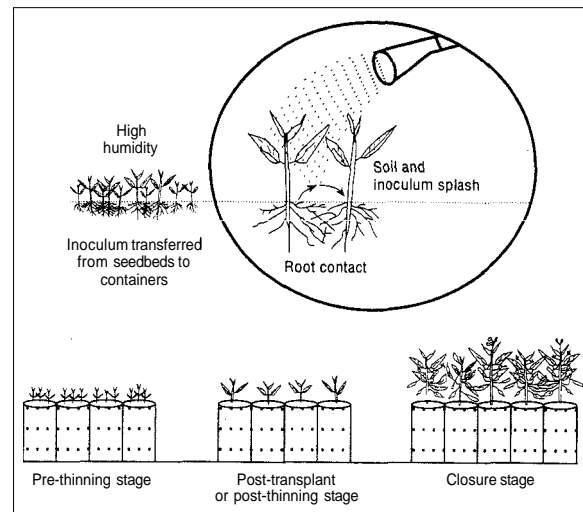

Figure 1. Systems of nursery management using soil seedbeds (above) and direct seeding to containers (below).

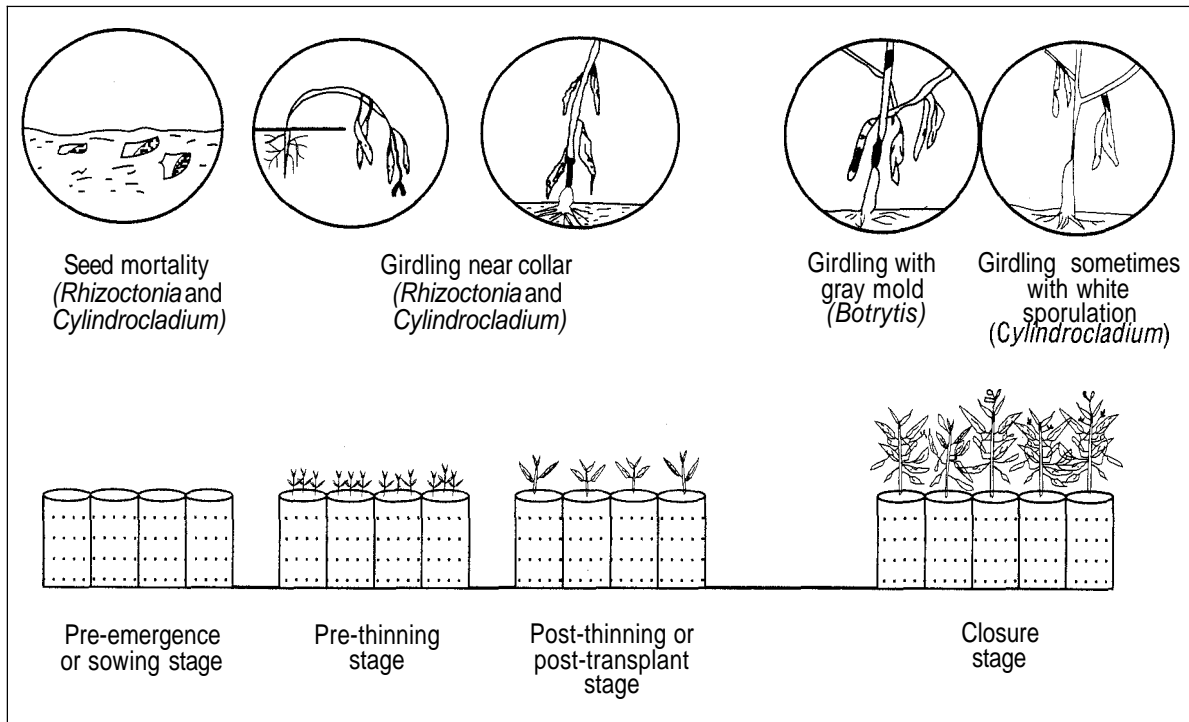

Figure 2. Stages of seedling production and damping-off pathogens.

practices, mostly done with older seedlings, include removal of containers with dead or underdeveloped seedlings and removal of leaves which have fallen on the surface of the growing medium. After canopy closure, damping-off can start on weakened seedlings, then affect healthy seedlings. *Botrytis cinerea* is prevalent at this stage of seedling growth, and it sporulates readily on fallen leaves and weakened seedlings. Rouging of diseased and under-height seedlings reduces *B. cinerea* inoculum. Fertility levels can also be adjusted to benefit smaller seedlings so that more uniform seedlings are available for outplanting (Figure 3).

Thus, control of damping-off of *Eucalyptus* is achieved by several nursery practices which include (i) sowing pathogen-free seed, (ii) use of pathogen-free racks and tubettes, (iii) direct seeding into containers (tubettes, if possible) containing a pathogen-free growing medium, (iv) thinning seedling densities as soon as possible (before the seedlings reach 7 cm height), (v) irrigation with pathogen-free water, and (vi) culling seedlings for uniform height at least twice after canopy closure. During culling, diseased or dead seedlings are discarded and their tubettes are removed along with senescent or fallen leaves. With these practices, disease is rarely found in the pre-thinning and post-thinning stages. When disease occurs after canopy closure, it is easily controlled by rouging. However, in large nurseries, long periods of rainy weather and the large size of some nurseries can reduce the effectiveness of cultural

controls. In such cases fungicides are used. Fungicide applications should be made every 14 days or more frequently, and culling of small and diseased seedlings should continue (Figure 3).

When disease is observed, *Rhizoctonia* can be diagnosed in less than 24 hours (Ferreira 1989). *Botrytis* can be identified by presence of conidia and conidiophores which normally form on diseased seedlings. Absence of *Rhizoctonia* and *Botrytis* suggests *Cylindrocladium*. Once the pathogen is identified, fungicides can be sprayed twice a week for the first 2 weeks after disease initiation. A sequence of fungicides are used against *Cylindrocladium* and *Botrytis*, i.e., 35 g of benomyl + 150 g of thiram or 35 g of benomyl + 100 g of captan (a.i. per 100 L). For *Rhizoctonia* control the recommendation is 120g of thiabendazole + 150g of thiram (a.i. per 100 L). When the pathogen is unknown, alternate applications of 35 g of thiabendazole + 100 g captan + 35 g of benomyl + 100 g thiram (a.i. per 100L) can be used on seedlings in the pre-thinning and post-thinning stages. Fungicides recommended for *Cylindrocladium* and *Botrytis* are applied after seedling canopy closure (Figure 3).

Genetic resistance is best used to combat diseases of outplanted stock as under field conditions, chemical and cultural measures are impractical. Nursery disease problems can be solved using cultural and chemical controls.

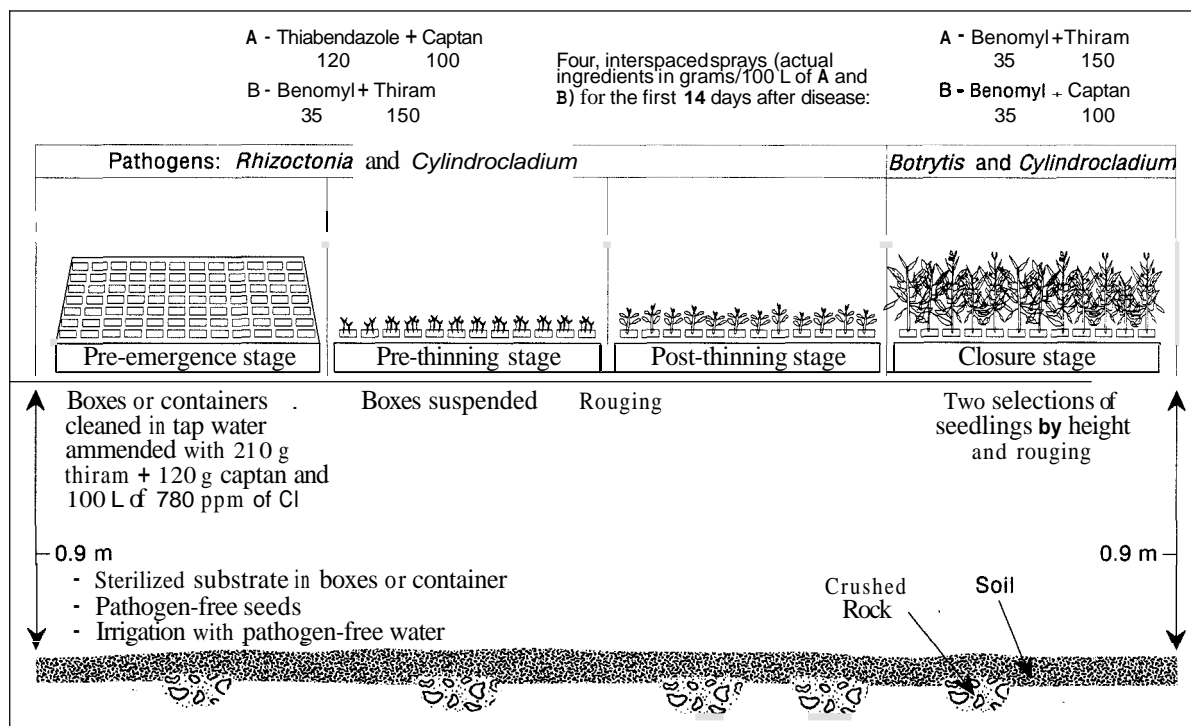

Figure 3. Integrated control of damping-off of eucalypts in Brazil.

Rots of cuttings (1, 3, 4, 5)

Cylindrocladium spp., *R. solani* and *Fusarium* spp. decrease rooting of cuttings in greenhouses. Lesions caused by these fungi are most common at the soil line, but sometimes form elsewhere on seedlings. Inoculum comes either from field soil which accompanies the cuttings or from greenhouse soil. Rain or irrigation water appears to be the main method by which inoculum is spread. Control is based primarily on keeping sterilized growing containers off the ground, and immersing the cuttings in 250 ppm chlorine for 1 minute. Fungicide sprays are applied twice each week with alternate sprays of 35 g benomyl + 150g thiram and 35 g benomyl + 100 g captan (a.i. per 100L) being used. All diseased cuttings are rouged and every 40 days all cuttings are removed from the greenhouse and a new crop is brought in. The greenhouse should be filled in one operation. All growing containers are washed in running water and then treated with 210 g thiram + 120 g captan per 100L of aqueous 780 ppm active chlorine. After 1 or 2 crops have been grown (40 to 80 days), greenhouse soil should also be treated with this suspension.

Eucalyptus rust (5, 14)

Under nursery conditions this disease is restricted to highly susceptible hosts, i.e., *Eucalyptus cloeziana*, *E. grandis* (South African provenance), and *E. phaeotricha*. The provenance of *E. grandis* which has been extensively planted in Brazil is no longer used as it is extremely susceptible to this disease. In 1974, one nursery lost 400 000 *Eucalyptus* seedlings to rust. *Eucalyptus phaeotricha* has been planted in experiments, but so far shows no promise as a forest tree. However, *E. cloeziana* is an excellent species for some regions and especially for charcoal production. In plantations, rust severely affects this species at the rebudding stage.

In *E. cloeziana* nurseries, *Peridermium psidii* produces abundant yellow urediniospore pustules on the tender stems and twigs, resulting in seedling death. Beginning about 14 days after disease onset, tender parts of diseased seedlings become necrotic and then dry. Weekly sprays of 160 to 200 g of copper oxichloride or mancozeb or 70 ml of triadimenol or 28 ml of triforome (a.i. per 100L) are recommended to control rust on *E. cloeziana*.

Minor diseases

Powdery mildew (5)

Species of *Oidium* cause brooming and foliar deformation of *E. citriodora* seedlings, but seedlings of other species normally suffer little damage. Weekly sprays of wettable sulfur (250 g/100 L) or benomyl (35 g/100 L) twice a month are recommended.

Phaeoseptoria leaf blight (5)

In Brazilian nurseries, *Phaeoseptoria eucalypti* affects only seedlings that are more than 4 months old. Normally, seedlings are 3 months old when outplanted; thus, this disease is not a problem if seedlings are outplanted on time. The pathogen occurs on mature (old) leaves and can cause defoliation, especially in *E. camaldulensis*, *E. teretricornia*, *E. citriodora*, and *E. urophylla*. Twice monthly sprays of benomyl (35 g/100 L) or carbendazim (50 g/100 L) also control the disease.

Alternaria leaf spot (5)

Alternaria tenuissima causes leaf spots of older, chlorotic (nutrient-deficient) seedlings of *E. grandis*. The spots are irregular, less than 10 mm in diameter, with a light yellow center and a yellow-brown halo. Seedlings that are kept too long in the nursery are particularly susceptible, especially if not fertilized adequately. Weekly sprays of 200 g mancozeb per 100 L are recommended when the disease first appears.

Nursery diseases of *Hevea* rubber trees

Diseases of *Hevea* rubber nursery seedlings which occur on new leaflets merit control. These controls are listed in Table 1.

South American leaf blight (5, 8, 9)

South American leaf blight caused by *Microcyclus ulei* is the only disease which has received much attention in Brazil. This disease causes severe defoliation. Symptoms occur only on new leaves and include curling and deformation caused by small, irregular lesions on the leaf undersurface. Lesions may be covered by dry grayish green or brownish green spores of the imperfect stage of the fungus. In mature leaves, dark stroma form either at random or in circles. These constitute the "sand paper" stage of the disease and pycnidia and perithecia form within these stroma.

Ring spot (5, 9)

Ring spot is caused by *Thanatephorus cucumeris*. One of the first indicators of the disease is small drops of latex exuded on the underside of leaves. These drops oxidize, becoming dark. Lesions then spread, forming broad yellow to brown arcs which may be irregular and discontinuous or spiral and concentric.

Anthracnose (5, 9)

This disease, caused by *Colletotrichum gloeosporioides*, is characterized by many small lesions which are often surrounded by chlorotic halos. When these occur on leaf veins, a severe leaf curl can be produced.

Table 1. Chemical controls recommended for *Hevea* rubber nurseries and for clonal gardens seedlings.

Disease and pathogen	Fungicide	(a.i./100 L)	Comments
South American leaf blight (<i>Microcyclusulei</i>)	benomyl	50	Weekly sprays in the rainy season and twice monthly during the dry season
	methyl thiophanate	100	
	carbendazim	90	
	mancozeb	320	
	triforine	28.5	
	propiconazol	7.5	
	chlorothalonil	315	
	mancozeb	1.6kg/ha	
	triforine	0.228 kg/ha	
	propiconazol	0.075 kg/ha	
	chlorothalonil	0.9 kg/ha	
Blight (<i>Phytophthora</i> spp.)	metalaxyl-copper oxide	70	Weekly sprays in the rainy season and twice monthly during the dry season
	metalaxyl-mancozeb	58	
	dodine	71.5	
	metalaxyl-copper oxide	0.56 kgha	
	dodine	0.5 kgha	
	cymoxanil-maneb-zinc	1.24kg/ha	
	copper oxichloride	2 kg/ha	
	cupric oxide	2 kg/ha	
	metalaxyl-mancozeb †	0.193 kg/ha †	
	dodine	0.325 kgha	
	cymoxanil-mancozeb †	0.408 kgha †	
	dodine	0.325 kgha	
	Ring spot (<i>Thanatephoruscucumeris</i>)	triadimefom	
copper oxichloride		150	
cupric oxide		150	
Anthracnose (<i>Colletotrichum gloeosporioides</i>)	copper oxichloride	150	Weekly sprays after grafting
	cupric oxide	150	
	chlorothalonil	150	
Corynespora leaf spot (<i>Corynespora cassiicola</i>)	benomyl	35	Weekly sprays

Other diseases of *Hevea* rubber which sometimes occur in nurseries include *Phytophthora* blight and leaf spots caused by *Alternaria* sp., *Corynespora cassiicola* and *Periconia manihoticola*.

Nursery Diseases of Pine (5,12)

In Brazil, pine is seldom affected by disease either in nurseries or in the field. In the nursery, the only disease which has received attention is damping-off (*R. solani*, *Cylindrocladium* spp., *Fusarium* spp., and *Pythium* spp.). Preventive alternate sprays of 35 g benomyl + 130 g captan and 35 g benomyl + 150 g thiram (per 100L) are recommended. These sprays may also be applied if the disease appears late in the growing season. Also, cultural controls given in the section on *Eucalyptus* may be applied.

Nursery Diseases of Ipê (5)

Besides producing a high quality wood, trees of the genus *Tabebuia* produce exquisite flowers and so the trees are also used as ornamentals. *Tabebuia serratifolia*, *T. rosea*, and *T. odontodiscus* are the three most common species planted in Brazil. *Tabebuia serratifolia* is the Brazilian national tree.

The most important disease of Ipê in nurseries is a rust (*Prospodium bicolor*) which occurs only in south-eastern Brazil on *T. serratifolia*. Basidiospore infection results in gall formation which severely deforms young seedlings, making them worthless. This fungus is autoecial and long-cycled and is an excellent teaching model for tropical forest rusts. The galls are initially light green in the pycnial stage and become covered with brown powdery spores during the aecial stage. Spraying every 15 days with 40 mL triadimenol + 120 g mancozeb per 100L are recommended for seedlings up to 6 months of age. For older seedlings, controls include removal of old leaves, stimulation of uniform flushes of leaves through fertilization, and spraying with the aforementioned fungicides at 15, 30 and 45 days after fertilization.

Two other diseases which produce leaf spots are caused by *Corynespora cassiicola* and *Asteromidium*

tabebuia. Occasionally *Corynespora* leaf spot can severely defoliate seedlings of any of the three *Tabebuia* species. The spots are dark and irregularly circular with a central white dot. *Asteromidium* leaf spot occurs in hot humid tropical areas. Spots are reddish brown and round (up to 2 cm in diameter). Normally, many spots occur on each leaf. Both diseases can be controlled by weekly sprays of 200 to 300 g of mancozeb per 100L, or twice monthly sprays of 35 g benomyl per 100L.

Seedlings of *Tabebuia* are frequently attacked by the nematode *Meloidogyne javanica*. To avoid this problem, growing media must be sterilized and kept off the ground. Preventing infection avoids dissemination of this pathogen on diseased seedlings.

Non-host-specific diseases

Basal rot

Basal rot (*Sclerotium rolfsii*) can affect virtually all species of nursery seedlings, e.g., known hosts occur in the genera *Tabebuia*, *Joanesia*, *Cesalpineia*, and *Araucaria* planted in non-sterile soil from bean (*Phaseolus*) fields. Control measures include sterilization of the soil or growing medium plus spraying with 300 to 400 g quintozene per 100L every 3 days once the disease has occurred.

Hypocotyl girdling

A disease of seedlings of a native legume (*Cesalpineia peltoporoides*) caused by *Rhizoctonia solani* has the potential to attack other native species, especially when seeds are collected from the ground. In nursery beds fumigated with methyl bromide cotyledons are affected by a seed-borne fungus from the attached seed coat. The fungus then moves onto the stem. Recommended controls include seed treatment with 120g thiabendazole + 160 g thiram per 100 kg seeds, use of sterilized growing media and spraying twice weekly with alternating sprays of 120g thiabendazole and 35 g benomyl until the seedlings have lost their cotyledons.

References

1. Alfenas, A.C.; Demuner, N.L.; Silva, A.R. 1987. Resistência de *Cylindrocladium scoparium*, agente etiológico de podridão em estacas de *Eucalyptus*, a benomil. *Fitopatologia Brasileira*, 12:158. (Abstract).
2. Bedendo, I.P. 1986. Persistência de benomil em mudas de *Eucalyptus cloeziana* e *E. grandis* aplicado em tratamento de solo e pulverização foliar. ESALQ, Piracicaba, SP. M.S. Thesis. 47 p.
3. Demuner, N.L.; Ferreira, F.A.; Alfenas, A.C.; Rezende, D.V. 1988. Análise técnica da prática de imersão de base de estacas em suspensão de benomil para prevenção do apodrecimento de estacas de eucalipto para enraizamento. *Fitopatologia Brasileira* 13:127. (Abstract).

-
4. Demuner, N.L.; Ferreira, F.A.; Alfenas, A.C.; Demuner, A.J. 1988. Erradicação “in vitro” de conídios e micélio de *Cylindrocladium scoparium* com benomil, captan, thiram e hipoclorito de sódio. *Fitopatologia Brasileira* 13(2):127. (Abstract).
 5. Ferreira, F.A. 1989. Patologia florestal - Principais doenças no Brasil. UFV, SIF, 570 p.
 6. Ferreira, F.A. 1987. Metodologia simples para constataçãorápida do *Rhizoctonia* na enfermidade tombamento de mudas de eucalipto. *Fitopatologia Brasileira* 12:124. (Abstract).
 7. Ferreira, F.A.; Demuner, N.L.; Alfenas, A.C. 1988. Erradicação de *Cylindrocladium scoparium* no solo com fumigação de brometo de metila e irrigação de fungicidas. *Fitopatologia Brasileira* 13:149. (Abstract).
 8. Gasparotto, L. 1988. Epidemiologia do mal das folhas (*Microcyclus ulei* (P. Henn.) v. Arx.) da seringueira (*Hevea* spp.). Viçosa, MG, UFV, D.S. Thesis. 124 p.
 9. Gasparotto, L.; Trindade, D.R.; Silva, H.M. 1984. Doenças de seringueira. EMBRAPA/CNPDS. Circular Técnica no 4, 71 p.
 10. Ghini, R.; Krugner, T.L. 1987. Ocorrência de *Botrytis cinerea* resistente a benomil em viveiro de *Eucalyptus viminalis* em Três Barras, SC. *Summa Phytopathologica* 13:36. (Abstract)
 11. Krugner, T.L. 1980. Doenças do eucalipto - *Eucalyptus* spp. Pages 275-296 in F. Galli (ed.). *Manual de Fitopatologia*. São Paulo, Editora Agronômica Ceres, vol. 2.
 12. Krugner, T.L. 1980. Doenças do pinus - *Pinus* spp. Pages 404-417 in F. Galli (ed.). *Manual de Fitopatologia*. São Paulo, Ed. Agronômica Ceres, vol. 2.
 13. Leite, I.C.A. 1986. Seleção de fungicidas sistêmicos e protetores com atuação erradicante no solo para *Cylindrocladium scoparium* Morgan, agente etiológico do tombamento de mudas de eucalipto. Viçosa, MG, UFV, M.S. Thesis, 54 p.
 14. Ruiz, R.A.R. 1988. Epidemiologia e controle da ferrugem (*Pucciniaipsidii* Winter) do eucalipto. Viçosa, MG, UFV, M.S. Thesis. 108 p.

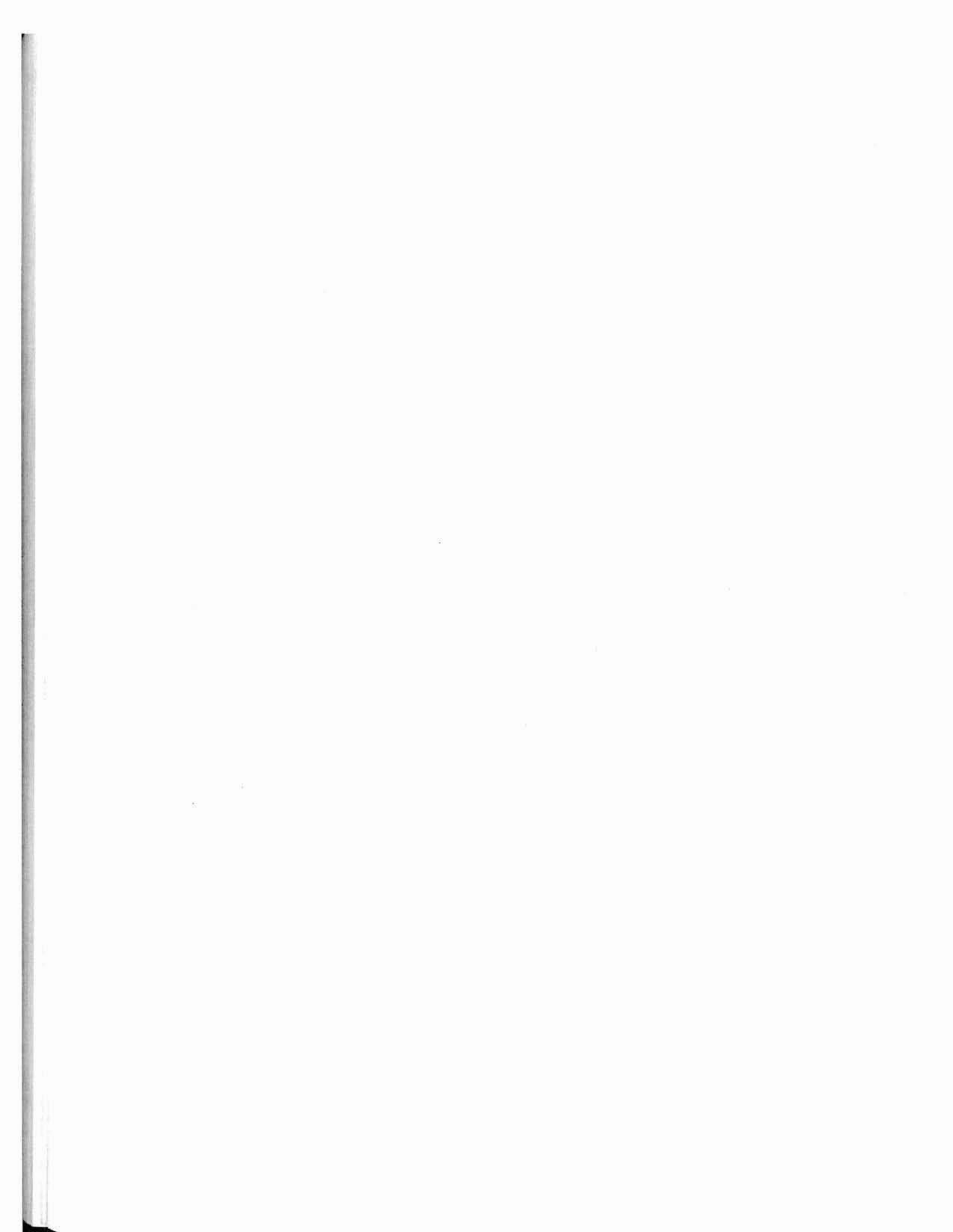

Diseases and insects in forest nurseries in Canada

JACK R. SUTHERLAND

*Forestry Canada, Pacific Forestry Centre
506 West Burnside Road, Victoria, British Columbia*

SYLVIA GREIFENHAGEN AND JENNIFER JUZWIK

*Forest Health and Protection Branch
Ontario Ministry of Natural Resources
Sault Ste. Marie, Ontario*

AND

C. DAVIS

*Forestry Canada, Great Lakes Forestry Centre
Sault Ste Marie, Ontario*

*Presented at the first meeting of IUFRO Working Party S2.07-09
(Diseases and Insects in Forest Nurseries), Victoria, British Columbia, Canada, August 22-30, 1990.*

Abstract

This paper reviews the damage and hosts, disease or life cycles and management practices for the major diseases and insects affecting forest nursery seedlings in Canada.

Resume

Cette Etude passe en revue les dégâts, les hôtes, les cycles de vie et les moyens de gestion des principales maladies et des principaux insectes attaquant les semis des pépinières forestières au Canada.

Introduction

Since the late 1960s, an ever increasing number of seedlings produced in Canada have been grown in containers. In 1984 (Glerum 1990) there were 144 forest nurseries in Canada of which 70% (101) were producing container-grown seedlings while the remaining 30% were bareroot facilities. This trend of growing seedlings in containers has continued; in 1989 over 75% of Canada's annual production of 904 million seedlings were container-grown (Glerum 1990). This technological change of growing seedlings in containers rather than in bareroot beds has had a major impact on the abundance and importance of particular nursery diseases and insects across the country. For example, soil-borne diseases such as damping-off which are important in bareroot nurseries are much less severe in container facilities where the growing medium (mainly peat) is normally pathogen-free. Conversely, shoot diseases and in particular gray mold (caused by *Botrytis cinerea* Pers.), which seldom affects bareroot seedlings, are major impediments to container seedling production. Seed-borne pathogens including species of *Fusarium* and *Sirococcus strobilinus* Preuss are an-

other group of pathogens whose importance has increased with the increased emphasis on container-grown seedlings. Similarly, the importance of certain insects has changed as exemplified by the decreasing importance of white grubs [(e.g. *Polyphylla decemlineata* (Say))] which damage bareroot seedlings while the importance of fungus gnats (most commonly *Bradysia* species) has paralleled the increased production of seedlings in containers. Another recent change is in the way nursery diseases and insects are managed. Recent environmental concerns about use of pesticides have given added importance to nursery pests; not only do they cause direct losses, but their occurrence may necessitate use of fungicides or insecticides. Because of these concerns, today's nursery managers and workers, and tree planters, are becoming more interested in the use of cultural and biological controls for nursery diseases and insects.

The purpose here is to review the major disease and insect problems currently affecting forest nursery seedlings in Canada. Topics covered include types of damage and hosts, disease and life cycles, and present day management practices. Because most research

(and unpublished information) on nursery diseases and insects in Canada has been done in British Columbia, Ontario and Quebec, the majority of our examples are from those provinces. More detailed information on many of the topics is available in Sutherland *et al.* (1989). Because of space limitations, we have not covered diseases and insects of minor importance.

Major diseases

Damping-off

Both pre-emergence and post-emergence damping-off affect a wide range of seedling species (both coniferous and broadleaf) in nurseries across Canada. Since most damping-off fungi are soil-borne, losses are much more serious in bareroot than in container nurseries. In container nurseries, seed and seedling losses are often traced to contaminated growing media, especially peat, or to pathogens introduced on seeds (e.g. *Fusarium*) or in irrigation water. In bareroot nurseries the same pathogens cause damping-off and many root rots, and mostly include species of *Pythium*, and occasionally *Phytophthora*, *Fusarium*, *Rhizoctonia* and *Cylindrocladium* while *Pythium* and *Fusarium* most commonly affect seeds and seedlings in container-nurseries. *Caloscypha fulgens* (Pers.) Boudier (the seed or cold fungus) causes pre-emergence failure of spruce seeds and nonserotinus pines in both container and bareroot nurseries. Whereas damping-off tends to be sporadic in containers, the disease is endemic in most bareroot nurseries with annual losses of 5 to 20% of the seeds and seedlings. In years when weather, soil and other factors favor damping-off, losses of 60 to 80% of the crop are not uncommon. Besides the direct losses from killing seeds and seedlings, damping-off frequently kills adjacent seedlings or patches of seedlings, thereby affecting stand uniformity and resulting in uneven-sized stock at lifting.

The general biology and disease cycle of most damping-off pathogens is similar and although they are soil-borne they are usually poor competitors in soil. Instead they survive by colonizing pieces of organic matter including old root pieces and sawdust (often used for mulching) from which they grow to attack nearby seeds or germinants (pre-emergence damping-off) or succulent stems about groundline (post-emergence damping-off). Thus, infection occurs via vegetative mycelium whereas asexual conidiospores serve mainly in pathogen dispersal. Many damping-off fungi form sclerotia, oospores or chlamydospores for overwintering or survival of other adverse conditions. Sexual spores are, overall, rare. Damping-off ceases to be a problem once seedling stems become woody.

Measures used to control damping-off vary across Canada and especially among nurseries: the intensity of individual efforts is largely related to the severity of damping-off experienced in the past at a particular nursery. Nurseries where the disease has been habitually severe may rely on soil fumigation (e.g., dazomet), particularly when weeds or insects are also problems. Where damping-off is less damaging or only sporadic, the nursery may rely solely on one or a combination of cultural practices. Such cultural practices include sowing stratified seeds in the spring, sowing seeds after soil temperatures are warm enough to promote germination, maintaining soil pH at 4.5-5.5, using damping-off prone areas for transplants, and withholding nitrogenous fertilizers until seedling stems are woody. All too often, the most important remedy for managing damping-off is overlooked in selecting the nursery site: nurseries with light, sandy, well drained soils suffer less damping-off than those on heavy, poorly drained, clay soils. Not only do nurseries with heavy soils have more damping-off, but management practices such as soil fumigation and fallowing are consistently less effective on these soils.

Cylindrocladium root rot

Cylindrocladium species cause an important root rot of conifers and hardwoods in eastern Canadian (especially Ontario and Quebec) forest nurseries. *Cylindrocladium floridanum* Sobers & Seymour was first detected in both Quebec and Ontario nurseries in the late 1960s and early 1970s. By 1988, the fungus had been detected in all 10 provincial bareroot nurseries in Ontario. All conifer species grown in Ontario and Quebec bareroot nurseries are susceptible to the fungus, except perhaps eastern white cedar (*Thuja occidentalis* L.). In both Ontario and Quebec, black (*Picea mariana* (Mill.) B.S.P.) and red (*P. rubens* Sarg.) spruce transplants are the most susceptible conifers grown. Several nursery-grown hardwoods, particularly black walnut (*Juglans nigra* L.) and yellow poplar (*Liriodendron tulipifera* L.), are also susceptible.

In 1986 and 1987, 430 000 spruce seedlings were culled due to *Cylindrocladium* root rot in five Ontario nurseries. Assessments in 1988 and 1989 revealed incidence levels of 1 to 40% within individual fields in various Ontario nurseries.

Although *Cylindrocladium* can cause damping-off, foliage and shoot blight, stem cankers, and root rots, it usually causes root and root collar rot. The fungus overwinters as thick-walled microsclerotia in the soil or in infected plant material. Microsclerotia can survive in fallow nursery soil for at least 15 years. Favorable environmental conditions stimulate germination of

microsclerotia and the fungus infects seedling roots. Disease symptoms first become evident from mid-summer to early fall. Foliage of root-rotted seedlings becomes chlorotic or yellow, lateral shoots may droop, and finally foliage becomes reddish brown. Cortical cells of infected roots are first water-soaked and then discolored and finally, in advanced stages, roots are necrotic.

Recent efforts at disease management include restricting movement of infested soil and infected stock, root raking of infested soil to remove plant material following seedling lifting, and fumigation with dazomet. Nursery machinery is washed to remove soil after leaving fields with a high disease incidence. Cover crops are commonly used in nurseries to prevent soil erosion during non-crop years; this builds up soil organic matter and retains or increases soil nutrients. The "Green Leaf" variety of sorghum-sudangrass which was previously used in southern Ontario nurseries failed to reduce fungus populations and disease incidence. Alfalfa and other leguminous species should not be used on nursery fields where *Cylindrocladium* occurs. Soil solarization significantly reduced levels of fungus microsclerotia in soil in experiments in southern Ontario in 1987 and 1988, but solarization has not been tried operationally. Repeated cultivation of fallow fields during hot summer months did not reduce levels of the fungus in Ontario nursery soils. Moreover, the practice adversely affected survival and growth of spruce transplants.

Other root problems

Other root diseases less devastating than *Cylindrocladium* root rot damage both broadleaf and conifer seedlings throughout Canada. The main fungi implicated are species of *Pythium*, *Fusarium* and *Cylindrocarpon*; unfortunately, not much is known about their biology or pathology in Canadian nurseries. The soil-borne nature of these fungi almost certainly implies that they are indigenous in most bareroot nursery soils. Their origin is far from clear in containers, but they could be introduced by wind, on growing media peat, with irrigation water (*Pythium* in particular), or on seeds (as in the case of *Fusarium*). Damage varies from severe to inconspicuous; in the latter case the term "root thief" (Unestam and Beyer-Ericson 1991) is appropriate. Disease occurrence and intensity, as shown in Sweden (Unestam *et al.* 1989), is undoubtedly related to stress resulting from such cultural practices as using drought to restrict seedling shoot height. Hopefully, research initiated recently in British Columbia by P. Axelrood, J. Sutherland and H. Kope will clarify the biology and pathology of these root problems and allow

biological and cultural controls to be used for their management.

Nematodes

Several genera of soil inhabiting nematodes (Phylum Nematoda) have been recorded from Canadian bareroot nurseries. These include (genera in parentheses) root lesion nematodes (*Pratylenchus*), pin nematodes (*Paratylenchus*), and the stubby root nematode *Paratrichodorus pachydermus* (Seinhorst) Siddiqi which damages bareroot eastern white pine (*Pinus strobus* L.) seedlings in southern Ontario. However, *Xiphinema bakeri* Williams, the cause of corky root disease, is the only nematode which so far has been documented as causing serious damage. In the 1960s, corky root resulted in several million seedlings (mainly Douglas-fir, *Pseudotsuga menziesii* (Mirb.) Franco) being culled in coastal British Columbia bareroot nurseries. The nematode, indigenous to coastal forests, is found in coastal nurseries recently established on such sites, especially those with very sandy soils. Besides being sandier and with many more *X. bakeri* nematodes than disease-free soils, soils conducive to corky root are also less fertile. *Xiphinema bakeri* can also be brought into disease-free nurseries on *X. bakeri*-infested soils used to "lighten up" heavier soils. Although Douglas-fir is most susceptible, *X. bakeri* damages all species of seedlings grown in coastal nurseries including spruces and western hemlock (*Tsuga heterophylla* (Raf.) Sarg.). Western hemlock is now grown exclusively in containers. Symptoms appear in mid to late summer of the first growing season; diseased root systems lack laterals and have a dark, swollen, often club-tipped tap root. Affected seedlings have chlorotic, stunted shoots. Initially, symptoms appear on individual seedlings, and as the disease progresses patches of diseased seedlings appear. These may coalesce to form larger patches up to 1 ha in size. The disease intensifies during the second growing season so that corky root seedlings are discarded at lifting. The life cycle of *X. bakeri* consists of the egg stage, four pre-adult stages, and the adult stage; males are rare. Sutherland *et al.* (1989) give a detailed account of the biology and pathology of *X. bakeri*.

Corky root can be controlled with broad spectrum soil fumigants or nematicides, but in British Columbia bare fallowing between crops accompanied by frequent cultivation during the summer are used to reduce nematode numbers to non-damaging levels.

Gray mold

Gray mold caused by the fungus *Botrytis cinerea* is the most serious disease of container-grown seedlings in Canada. Although both cultural and fungicidal controls

are available, significant losses are still experienced in some nurseries. *Botrytis cinerea* occurs throughout the world, and has a host range of up to 235 species. The disease, which is seldom a problem in bareroot nurseries, is a classic example of how a technological change can result in a pathogen increasing in importance. The container nursery environment is ideal for the disease as large numbers of highly fertilized, succulent seedlings are grown under crowded conditions. Another factor which favors this disease is overhead irrigation in container nurseries. This results in long periods during which the foliage is wet or in which humidity is very high within the seedling canopy. Crowding of seedlings provides an abundance of senescent or dead needles which allows the fungus to become established as a saprophyte before moving onto green needles as a parasite.

Most forest tree species are susceptible to gray mold, although conifers are the most seriously affected. In eastern Canada, jack pine (*Pinus banksiana* Lamb.), white spruce (*Picea glauca* (Moench) Voss) and especially black spruce seedlings are affected; in western Canada, spruces, western hemlock and Douglas-fir suffer the most damage. In eastern Canada, losses to *Botrytis* have also been observed in Norway spruce (*Picea abies* (L.) Karst.) cuttings.

Signs of the disease include the presence of gray mycelium and spores and black sclerotia on the senescent lower needles and stems of affected seedlings. Visible clouds of spores are released when severely affected seedlings are handled. Brownish, water-soaked lesions can be found on stems, and seedlings may be girdled. Damage varies among nurseries and from year to year. Gray mold destroyed 1% of the container-grown seedlings in Ontario in 1988 and 1989. Variation in damage levels is caused by local weather conditions and varying nursery cultural practices.

Botrytis cinerea lives as a saprophyte on organic material within and around the nursery where it produces large numbers of air-borne spores. These spores are introduced into the nursery by wind and are drawn into greenhouses by ventilating fans where in early summer they are thought to infect senescent or dead needles in the lowest portion of the seedling crown. After infection, the fungus is thought to remain latent until late summer or early fall, when environmental conditions (high relative humidity and moderate temperatures) become favorable. The disease first becomes evident as cottony, gray-brown mycelium and spores on the lower needles of seedling shoots. If favorable conditions persist, the disease spreads upward and laterally, killing foliage and sometimes the seedling stem and lateral branches. Sclerotia form on infected tissue,

allowing the fungus to overwinter and survive other unfavorable conditions.

Gray mold requires specific environmental conditions to cause severe damage; therefore it is a disease which can be controlled largely by altering cultural practices. Humidity can be lowered by reducing irrigation and by spacing containers to increase air circulation among seedlings. Using ventilation fans to increase ventilation through the greenhouse also helps. Controlling seedling height reduces the amount of senescence of the lower needles and results in lower humidity within the seedling canopy. Maintaining healthy, vigorous stock also decreases senescence of lower needles. One of the main cultural practices used against gray mold in British Columbia is to remove greenhouse covers (plastic sheeting) during the frost-free portion of the growing season. This results in shorter, stockier seedlings which are less susceptible to gray mold. Preventing abiotic damage such as fertilizer-burns on foliage also aids in control of gray mold, as damaged seedlings allow the fungus to become established before moving onto healthy foliage. In Ontario, container seedlings are usually overwintered outside in cold frames. Crops "flattened" by winter snow, particularly excessively tall spruce seedlings, often develop gray mold in the spring. Containers of such seedlings are spaced to allow them to dry out as soon as possible. Such seedlings should be outplanted quickly to prevent further losses. In Ontario the appropriate use of blackout curtains to initiate bud formation in container-grown spruce results in a uniform crop of shorter, hardier seedlings that are less susceptible to gray mold.

Fungicides are used regularly as a preventative measure at many container nurseries in Ontario and Quebec. A schedule in which benomyl, chlorothalonil and iprodione applications are alternated is recommended, as *Botrytis* may become resistant to a fungicide if it is used continuously. In western Canada, fungicides are applied as needed to control *Botrytis* outbreaks and sprays are also applied just before canopy closure and before seedling lifting and storage.

Snow blight

Snow blight of various conifer species may be caused by several fungi including *Phacidium abietis* (Deam.) Reid & Cain, *Lophophacidium hyperboreum* Lagerb., *Sarcotrochila piniperda* (Rehm) Korf, *S. balsameae* (J.J. Davis) Korf, and *Hemiphacidium planum* (Davis) Korf. In Ontario nurseries, eastern white cedar, jack pine, and black and white spruce are the species most affected by snow blight. Damage occurs in patches where snowmelt is delayed. Disease severity ranges from only the foliage below the snowline being killed to

seedling death. The greatest damage in northern Ontario nurseries has occurred following winters with heavy snowfall and prolonged snowmelt in the spring. About 120 000 black spruce transplants were killed or had to be culled in an Ontario bareroot nursery in 1989. Although the disease has occurred in other Ontario and Quebec bareroot nurseries, recent losses have been insignificant. Recently, gray mold damage has increased significantly under snow on overwintered, container-grown black spruce seedlings.

Spores of the pathogens are released and disseminated by wind during late summer and fall. Spores germinate on snow-covered foliage. The fungus grows under a snow cover during late winter and early spring. Implementation and regular use of cultural and chemical controls have greatly reduced losses, although significant losses sometimes occur. Snow blight is controlled by a late fall fungicide application (with a sticker added) to spruces and balsam fir. Snow fences can also be erected to prevent snow drifting over low areas in fields.

Storage molds

Although molding of stored stock is one of the most important diseases of forest nursery seedlings in Canada (it harms the nursery managers final product), the problem has received little attention. The disease is in fact two diseases: in container-grown seedlings it is invariably gray mold (*Botrytis cinerea*) which becomes established on the seedlings in the nursery and continues to develop further in storage; in bareroot seedlings, molds may include a variety of ubiquitous fungi such as species of *Penicillium*, *Aspergillus*, *Mucor*, and *Botrytis*. Such molds are likely part of the seedling's natural microflora or are acquired as contaminants from soil that accumulate on seedling shoots during lifting.

The biology of storage molding of both container and bareroot stock is poorly understood: however, incidence and severity of molding of container-grown stock almost certainly relates to incipient or developed *B. cinerea* on the seedlings prior to storage, and to storage conditions. Host seedlings affected are the same as for gray mold in the nursery. To date, no relationship has been established between storage mold severity and survival of outplanted (container-grown) stock, but logic dictates that severely damaged stock, particularly if the stem has been killed, would not survive as well as healthy stock. The best strategies against storage mold on container-grown seedlings are to prevent mold from becoming established in the nursery and, where possible, to store seedlings at -1 or -2°C to reduce *B. cinerea* growth.

Initial evidence of molding of bareroot stock is often a cottony mold on the lowermost needles of seedlings

stored in bundles. As the disease develops, the mold spreads upward on the shoots of the seedlings. Depending upon the fungi involved (normally several) the molding varies in color (e.g. orange, pink or white) and frequently seedlings have a moldy odor. Sometimes clouds of spores are emitted when boxes of moldy seedlings are opened. With advanced molding, part or all of the stem and branches have water-soaked lesions from which the bark can easily be stripped to reveal the dead, butterscotch-colored, cambium. All seedling species are affected but, at least on the west coast, pines seem to be less susceptible than other conifers. Transplants are very susceptible to storage molding.

Since severity of molding increases with storage time and above-freezing temperatures, losses can be reduced by storing stock at -1 or -2°C for as short a time as possible. Other helpful measures include frequent inspection of stored stock and then outplanting stock soon after molding starts.

Sirococcus blight

This disease, caused by *Sirococcus strobilinus* Preuss, affects forest trees, particularly regeneration, and both bareroot and container-grown nursery seedlings. On container-grown seedlings the disease is often seed-borne. In the nursery, *Sirococcus* blight occurs on all species of spruce and pines across Canada and sometimes on Douglas-fir in British Columbia. In the bareroot nursery, wind-borne and rain-borne inoculum comes from affected trees and cones adjacent to nurseries; while such inoculum can infect seedlings in container nurseries, inoculum there is more often seed-borne. Thus, in containers the disease primarily affects young germinants and seedlings, whereas on bareroot seedlings it occurs later in the growing season, sometimes being confused with early frost damage. In containers, germinants and young seedlings are killed with needles dying from the base upward. A similar pattern of needle killing may occur on shoots of bareroot seedlings where killing of the shoot results in a lateral branch turning upward as the leader. Since the disease is seed-borne in container nurseries, blight occurrence there often occurs in specific seedlots. There is evidence that lodgepole pine (*Pinus contorta* Dougl.) provenances (Illingworth 1973) vary in their susceptibility to *S. strobilinus*. Another distinguishing feature of the disease is that it is most likely to prevail in nurseries with cool, rainy, overcast weather. Besides being ideal for fungus infection and spread, seedlings grown in such nurseries may be light stressed, further favoring the disease (Wall and Magasi 1976). In both containers and bareroot production, *Sirococcus* can affect up to 60% of the seedlings within a provenance or seedlot. Besides

direct seedling losses, an additional cost factor is that of control where several fungicide applications may be needed to control blight on young, fast growing container seedlings.

For the most part, *Sirococcus* shoot blight is still managed with fungicides. However, early detection of seed-borne inoculum by conventional techniques (Sutherland 1987) or monoclonal antibodies (Mitchell 1988) can be used to forewarn managers of infested seedlots. Knowing the incidence of seed-borne inoculum, nursery managers can, where practical, reduce irrigation or increase greenhouse temperatures slightly, or they can apply protective fungicides to reduce spread of the disease.

Insects and mites

Spruce spider mite

The spruce spider mite, *Oligonychus ununguis* (Jacobi), is an important pest of conifers in nurseries throughout the north temperate zone. In Ontario and Quebec the mite was first observed in the mid-1920s. In nurseries in these provinces the mite damages white spruce, black spruce, Norway spruce, eastern white cedar, and larch; spruce is the preferred host. The mites feed by inserting their stylet-like mouthparts into needles and tender twigs and sucking out the juices, thus causing a mottled discoloration and subsequent drying of tissue. Feeding usually begins on the lower branches and progresses upward. Mites are most destructive during hot, dry weather; heavy rainfall tends to wash many mites off seedlings. Both immature and adult mites produce a fine webbing around twigs and between the needles, which protects them from enemies and from being dislodged. Webbing is usually more noticeable on the underside of branches.

The mite develops through five stages: egg, larva, two nymphal stages, and adult. Adults are barely visible to the naked eye. Overwintering occurs as eggs which initially are pale yellow and gradually become reddish-brown. Overwintered eggs hatch in May and newly hatched larvae are mottled pink, and become needle-green to dark green after feeding. Larvae have three pairs of legs and nymphs and adults four. Development of larvae and nymphs each requires 3 to 6 days. Nymphs become adults by early June and under favorable conditions can live up to 30 days. Mature females lay 40 to 50 eggs which after 13 to 16 days incubation result in a second generation by late June. This cycle is repeated up to six times during the remaining summer. Overwintering eggs are laid from late September to the onset of severe frost.

All active forms of the spruce spider mite occur on needles and to some extent on tender twigs. Larvae and

first-stage nymphs do little wandering and feed on the basal parts of needles while second-stage nymphs and adults move about freely, feeding on needles.

Because of the high reproductive capacity and short life cycle of this pest, populations can build up very rapidly, especially during long dry periods. Adults are carried on the wind to adjacent trees and spread longer distances on infested outplanted stock. Pressure washing infested trees at weekly intervals during the spring and summer dislodges adults and breaks up webbing. Heavy infestations may require use of miticides which should be applied at a high pressure to ensure adequate coverage. Several applications at 10-day intervals are usually required as eggs survive treatment.

Root weevils

Both the strawberry root weevil, *Otiiorhynchus ovatus* (Linnaeus) and black vine weevil, *O. sulcatus* (Fabricius), seriously damage both bareroot and container-grown seedlings across Canada. Of the two, *O. ovatus* is usually the most serious. Several other weevils are also common in Canadian nurseries, but they rarely cause serious damage. The strawberry root weevil has caused varying amounts of damage to container-grown white and black spruce in Ontario, while losses to black, white and Norway spruce, larch, and red and jack pine have been reported in Quebec bareroot nurseries. In British Columbia, hosts include spruces, western red cedar, western hemlock, western larch (*Larix orridentalis* Nutt.), *Abies* spp., and pines.

Adult weevils primarily affect 1+0 seedlings by girdling a 1-cm band of the fleshy, uppermost part of the hypocotyl. Feeding damage occurs primarily in early June or July before stems become woody. Adult weevils feed all summer. They are primarily nocturnal feeders and hide in debris during the day. Larvae of the strawberry root weevil damage roots of older 2+0 conifers. Larvae normally occur in groups in the top 2.5 cm of soil around the roots of the host plant. They feed on fibrous roots, strip most laterals, and girdle stems at the root collar. Often damage by adults or larvae is not noticed until trees are lifted or until they suddenly wilt.

Root weevils overwinter as adults in debris or more commonly as larvae in the soil. Overwintered larvae and adults become active in spring and continue feeding. Larvae, which are slightly curved and creamy white with brown heads, pupate in cells as deep as 20 cm below the soil surface in mid-spring. Adults emerge in late spring and immediately begin feeding. The parthenogenic, wingless adults are dark brown, gray or black with a short snout and elbowed antennae. Both overwintered and emerging adults oviposit for about 7 weeks, ceasing in late summer to early fall. Eggs have

an incubation period of 10 to 20 days. After hatching, larvae begin feeding on seedling roots. Most damage is done by larvae in the fall.

Root weevil larvae are hard to kill; therefore, control measures are aimed at adults. Various detection methods, such as flat sticky traps or surveying for fresh girdling on conifer seedlings in early summer can be used to determine adult populations in the nursery. When control is justified, insecticides should be applied in late spring or as soon as adults become active. A second application is desirable about a month later to control late-emerging adults. It is also useful to remove weeds (alternative food supplies) from seedbeds and beneath nearby trees.

Lygus bug

The lygus bug, *Lygus lineolaris* (Palisot de Beauvois), and other species of *Lygus*, damage bareroot and container-grown seedlings in British Columbia and recent evidence in Ontario points to similar damage in bareroot pines and container-grown spruce. So far, in British Columbia, damage has been mainly on 1+0 bareroot and container-grown lodgepole pine, but western larch, Douglas-fir and 1- and 2-year-old spruce (all species) are also damaged. Adults and nymphs feed on terminal shoots, resulting in seedlings with multiple leaders. An elongated scar often forms on one side of damaged terminals, which have thick, short, twisted needles. The terminal of such shoots usually assumes a crozier shape. At both bareroot and container facilities, damage is most prevalent around the periphery of the nursery where the insects fly in from adjacent areas (e.g., alfalfa fields).

Lygus bugs overwinter as adults which are shield-shaped and yellowish-green to reddish-brown. In spring they feed on young shoots, mate, and the females oviposit into numerous host plants. Nymphs, similar in appearance to adults, emerge about 10 days later and molt five times as they develop. In British Columbia, the life cycle is completed in 3 to 4 weeks and there are two or three lygus bug generations per growing season.

In British Columbia, where lygus bug populations may reach damaging levels, seedlings are protected by insecticide sprays during the first quarter of June, July, and August. Keeping the nursery and nearby areas free of weeds and other host plants also helps reduce lygus damage.

Cutworms

Cutworms, larvae of moths in the order Lepidoptera (family Noctuidae) damage very young bareroot and container-grown seedlings all across Canada. Some damage occurs in most nurseries each year and some-

times damage is heavy. One of the most damaging cutworms is *Peridroma saucia* (Hubner), the variegated cutworm. Cutworms damage many plants including most species of conifers.

Damage is mainly restricted to very young seedlings (before stems become woody): cutworms eat foliage and cut off stems just above soil line, leaving a stump. Feeding occurs mostly at night and the cutworms hide in loose sand and soil during the day. Adults (moths) are robust, large, buff-colored, and fly mainly at night. The larvae, which damage seedlings, are large, soft, dull-colored caterpillars with hairless bodies and shiny heads. They characteristically curl into a circular shape when disturbed.

The life cycle consists of eggs, larvae, pupae and adults; depending on the location and cutworm species, there can be one to three generations each year. Most cutworms overwinter as eggs or pupae, although some species overwinter as larvae. The first generation is normally the most harmful as it occurs when seedlings are young and succulent.

Bareroot fields and container facilities should be kept free of weeds which may attract egg-laying females. Adults can be caught in light traps and greenhouses can be insect-proofed to exclude moths. When populations are small, cutworms can be hand-picked and destroyed. Poison baits can be used against larvae, but insecticides must be used when populations are large. Insecticides are most effective when applied late in the day when cutworms are active, especially when temperatures are warm.

Aphids

Many species of aphids (Order Homoptera) affect forest nursery seedlings in Canada. Needle and stem feeding aphids such as giant conifer aphids (*Cinara* spp.) and woolly aphids (*Adelges* and *Pineus* spp.) are quite common on bareroot seedlings. Root feeding aphids such as those of the genus *Pachypappa* are especially prevalent on roots of container-grown conifers. Damage is seldom severe although species of *Adelges* often cause twisting, distortion and chlorosis of seedling needles, particularly in Douglas-fir. In coastal British Columbia, the green spruce aphid, *Elatobium abietinum* (Walker), may cause year-old needles of spruce seedlings to fall off. Because the life cycle of aphids varies with factors such as host alternation, parthenogenesis, viviparity, and geographic locality, it is not possible to outline a life cycle for all aphids. It is common for most aphids to pass through several generations per year and for populations to fluctuate widely and quickly. Except for size, adults and juveniles are generally similar in appearance. Most aphids overwinter as eggs.

The mere presence of aphids may not justify their control as large populations are often necessary before seedlings are damaged. In fact, there is no evidence that many aphids, including those that feed on seedling roots, do sufficient harm to warrant control. Rarely are

insecticide sprays appropriate, but even then insecticidal soaps are usually quite effective. For aphids that complete their life cycle on two or more hosts, it is worthwhile to remove alternate hosts (e.g., hedges) from within or adjacent to the nursery.

Literature cited

- Glerum, C. 1990. Stock production research in Canada: a historical perspective. *For. Chron.* 66: 103-111.
- Illingworth, K. 1973. Variation in susceptibility of lodgepole pine provenances to *Sirococcus* shoot blight. *Can. J. For. Res.* 3: 585-589.
- Mitchell, L.A. 1988. A sensitive dot immunoassay employing monoclonal antibodies for detection of *Sirococcus strobilinus* in spruce seed. *Plant Dis.* 72: 664-667.
- Sutherland, J.R. 1987. *Sirococcus* blight. In J.R. Sutherland, T. Miller and R.S. Quinard editors, *Cone and Seed Diseases of North American Conifers*, North Amer. For. Comm. Publ. No. 1, pp. 34-41.
- Sutherland, J.R.; Shrimpton, G.M.; Sturrock, R.N. 1989. Diseases and insects in British Columbia forest seedling nurseries. FRDA Rep. 065, Forestry Canada / British Columbia Ministry of Forests, Victoria, 85 p.
- Unestam, T.; Beyer-Ericson, L. 1991. Diseases of container-grown conifer nursery seedlings in Sweden. Pages 105-108 in J.R. Sutherland and S.G. Glover, editors. *Proceedings of the first meeting of IUFRO Working Party S2.07-09 (Diseases and Insects in Forest Nurseries)*. Victoria, British Columbia, Canada. August 23-30, 1990. *For. Can. Pac. For. Cent. Inf. Rep. BC-X-331*. Victoria, B.C. 298 p.
- Unestam, T.; Beyer-Ericson, L.; Strand, M. 1989. Involvement of *Cylindrocarpon destructans* in root death of Scots pine seedlings: pathogenic behavior and predisposing factors. *Scand. J. For. Res.* 4: 521-535.
- Wall, R.E.; Magasi, L.P. 1976. Environmental factors affecting *Sirococcus* shoot blight of black spruce. *Can. J. For. Res.* 6: 448-452.

Control of three species of insects affecting roots of forest nursery seedlings in northeast China

YAO GUO QUAN, LIU DE CHENG, WANG YAN SHENG

General Bureau of Forest Industry
Heilongjiang province, 26 Wen Chang St.
Nan Gang District, Harbin
The People's Republic of China

Presented at the first meeting of IUFRO Working Party S2.07-09
(Diseases and Insects in Forest Nurseries), Victoria, British Columbia, Canada, August 22-30, 1990.

Abstract

In recent years, the large black chafer, *Holotrichia diomphalia* Bates, the African mole cricket, *Grylotalpa africana* Palisot et Beauvois, and the black cutworm, *Agrotis ipsilon* Rott, have seriously affected the quality and quantity of forest nursery seedlings in northeastern China. Up to 10% of the seedlings in Song Huajiang Region have been damaged. This paper reports the hosts, damage, and management practices for these insects.

Resume

Au cours des demikres années, le scarabte (*Holotrichia diomphalia* Bates), la courtilikre (*Grylotalpa africana* Palisot et Beauvois) et le ver-gris noir (*Agrotis ipsilon* Rott.) ont gravement réduit la quantité de semis et leur qualitt dans des pépinières forestikres du nord-est de la Chine. Dans la rtgion de Song Huajiang, jusqu'a 10 % des semis ont été endommagts. Le prtsept article porte sur ces insectes, leurs hôtes, les dommages qu'ils causent et les méthodes de lutte utilisées.

The large black chafer, *Holotrichia diomphalia* Bates

Larvae of *H. diomphalia* attack seedlings of *Larix gmelini* (Rupr.), *Pinus sylvestris* L. var. *mongolica* (Litv.), *P. koraiensis* Sieb. et Zucc., *Picea koraiensis* Naki, and species of *Populus*, *Salix*, and *Syringa*. Second-instar larvae cut and eat the tap and fibrous roots or the bark of seedling roots. Damage is severe and seedlings die quickly.

Two or three years are required for *H. diomphalia* to complete its life cycle. Older larvae pupate at a depth of 25 to 30 cm in the soil in July in the same year. Pupation requires 22 to 33 days. Pupal eclosion occurs after mid-March. As temperatures decrease, larvae migrate deeper into the soil to overwinter. Adults emerge from the soil from May 20 to June 10 the next year. They live 350 to 380 days. Starting with the last 10 days of June, females lay, over the next 3 to 4 months, an average of 115 eggs each. Eggs hatch about 19 days after oviposition. By late autumn larvae can develop to either first, second, or sometimes third instars. Both larvae and adults overwinter 60 to 80 cm deep in the soil, moving upward to damage seedlings when spring soil temperatures reach 10°C at a depth of 10 cm. Feeding damage occurs from the end of June through the first 10 days of July, when

larvae and adults are most abundant and the weather is warm and bright following rains. Numbers of adults increase rapidly. Adults are negative phototactic, spending the day in the soil around shrubs or clumps of weeds. At night, especially about 21:00, adults are active and mate. Adults feed on numerous plants, especially soybean.

In Heilongjiang province, phorate (also known as 3911) has given excellent control in five of seven forestry bureaus where it has been used. Phorate is effective either as a contact or a stomach poison, or as a fumigant, and it has systemic activity. It remains effective for 3 months. We use 3911 before nursery seedbeds are formed at the beginning of May. It is applied 10 to 20 cm deep in the soil or on the seedbed surface, or it can also be broadcast onto seedbeds of growing stock and then watered in. This is best done on bright days. Table 1 gives results obtained with 3911 at the Weihe forest nursery. Although distribution of *H. diomphalia* was not uniform, overall numbers of the insect were reduced by the 3911 treatment. After using 3911, numbers of recoverable seedlings increased by 7% and there was an 81.8% population reduction of the target insect.

Three percent granular carbofuran, 5% granular 2% fenthion, and 50% phoxim oil emulsion were also evaluated. These insecticides had no residual phytotoxicity. Their efficacy lasts 70 to 90 days, so they need to be used only once a year. The results of using these materials are given in Table 2. The granular pesticide can be used instead of spraying and dusting and it has the additional advantage of not being blown away by wind. Moreover, it is harmless to beneficial insects and the environment.

A unique approach to biocontrol of *H. diomphalia*, and one which is not harmful to birds, involves sticking the abdomens of female insects onto glass slides to attract males. These slides are suspended over water, which traps the males.

African mole cricket, *Gryllotalpa africana* Palisot et Beauvois

Gryllotalpa africana occurs throughout China. It is especially damaging in the north. Larvae and adults attack roots and buds causing death of many coniferous and broadleaved seedlings, e.g., *Larix gmelini*, *Pinus koraiensis*, and *P. sylvestris* var. *mongolica*. The insect also tunnels through seedbeds, causing seedling wilt and death.

Two years are required for *G. africana* to complete its life cycle. There are six larval stages. From September to March, larvae and adults occur in the soil at depths of 1 to 1.5m. During April and May they move upward. Maturation feeding occurs on seedling roots prior to mating and egg laying. From about June 10 to late

Table 1. Results of using 3911 to control *Holotrichia diomphalia* on *Larix gmelini* nursery seedlings

Sample number	Sample depth (cm) in soil and insect counts before and after treatment											
	0-20		20-40		40-60		60-80		80-100		Total	
	Before	After	Before	After	Before	After	Before	After	Before	After	Before	After
1	10	1	23	1	0	2	0	3	0	7	33	14
2	7	2	16	0	21	9	15	7	2	0	61	18
3	28	3	4	7	3	4	0	2	0	1	35	17
4	33	0	11	0	1	0	2	0	0	0	47	0
5	27	0	18	0	15	3	21	1	7	0	88	4
6	4	0	15	0	11	0	7	1	0	1	37	2
7	1	1	20	3	18	0	8	4	10	3	63	11
Total:	110	7	107	11	69	18	53	18	19	12	364	66

Table 2. Effectiveness of insecticides for control of *Holotrichia diomphalia* on *Larix gmelini* seedlings

Treatment	Dose g/m	Treatment date			
		July 6	July 14	July 22	July 30
		----- % seedlings damaged' -----			
3% Carbofuran, granular	10	4.70	2.58	2.50	0.02
3% Carbofuran, granular	20	0.02	0.08	0	0.04
2% Fenthion, granular	25	7.08	3.33	4.58	1.50
50% Phoxim oil emulsion	1.4	6.92	4.83	4.50	0
Control	0	23.67	9.42	12.50	7.00

^u Based on 1200 seedlings.

August, larvae aestivate in soil (30 to 40 cm depth) and females lay 30 to 60 eggs. During September larvae and young adults feed voraciously prior to overwintering.

There are several control methods for *G. africana*. For example, in the Suiling Forestry Bureau we have used soybean oil. This method is easy to use, labor saving, economical, and produces good results. The technique involves applying 2 or 3 drops of soybean oil to recently constructed tunnels that the insect constructs in the soil. Water is then poured into the hole and after 12 to 14 hours the adults emerge and die. How soybean oil kills the insects is not known, but the technique is not harmful to seedlings or man, and it is effective. Poisonous baits can also be used. They are made of Chinese sorghum or maize seeds, or other seeds, which are boiled in water, mashed and then DDVP (10:0.5 by weight) is added. Such baits are broadcast onto seedbeds and kill insects that eat them. Another bait consists of soaking seeds in lead arsenate (100:11 by weight). These are then broadcast onto seedbeds for ingestion. Black lamp traps are also effective against *G. africana* adults.

The black cutworm, *Agrotis ypsilon* Rott

Agrotis ypsilon is widely distributed in China. Only larvae damage seedlings. Third instar or older larvae emerge from the soil and cut off seedling roots, and pull them into their hole for consumption. Mortality, or decreased growth resulting from root damage, occurs in patches. Larvae are polyphagous.

Two or three generations of *A. ypsilon* occur each year with older larvae or pupae being the overwintering stages. Adults occur in May through August. Adults are nocturnal, being especially active at night (19:00-22:00). *Agrotis ypsilon* is attracted to both fluorescent light (rather than incandescent light) and sweet substances such as molasses. After mating, a female lays 800 to 1000 eggs. Eggs hatch about 7 days later and the young larvae feed (during night and day) on groups of adjacent needles on a seedling. Third instar and older larvae are negatively phototactic and burrow 2 to 6 cm into the soil

during the day, emerging to feed at night. Larvae pupate in the soil (at a depth of about 5 cm).

Several procedures can be used to manage *A. ypsilon*. For example, intensive cultivation of nursery fields to eliminate weeds deprives young larvae of food. Adults can be trapped with a mixture of molasses, sugar, vinegar, alcohol and water (6:3:1:10 by volume) containing 6% BHC. Tender weeds poisoned with 16% BHC can be broadcast, at dusk, onto the ground to kill third instar or older larvae. Young larvae, third instar and younger, can be controlled by spraying DDP emulsion (1 mL 25% DDP emulsion:200 to 250 mL water) or BHC wettable dust (1:200 by weight). Larvae can also be caught by hand and destroyed by digging around damaged roots of seedlings where larvae hide. Sexual attractants can also be used against *A. ypsilon*. The procedure involves extracting the attractant by placing abdomens of females in dichloromethane for 15 hours. The crude extract is then stored in a refrigerator. For use it is smeared onto strips of 6 x 17 cm² paper and dried under cool temperatures. The paper strips are then rolled and placed 1 cm above a water (containing washing powder) surface. At dusk, such traps (75 to 150 per ha) are placed around the nursery. Trapped moths are removed as needed and new traps are put out every 3 days.

Conclusions

We have described the damage, hosts and controls for three major insect pests of forest nursery seedlings in northeast China. The occurrence of these insects, type of damage, and management is not related to nursery environment (locality, crops grown before the seedlings, fertilizer regime, or soil type). The methods outlined for managing these insects conform to nursery management policies. When warranted, i.e., when the insects are abundant, we use an integrated approach to control. This prevents spread of these pests and provides good protection of nursery seedlings in northeast China.

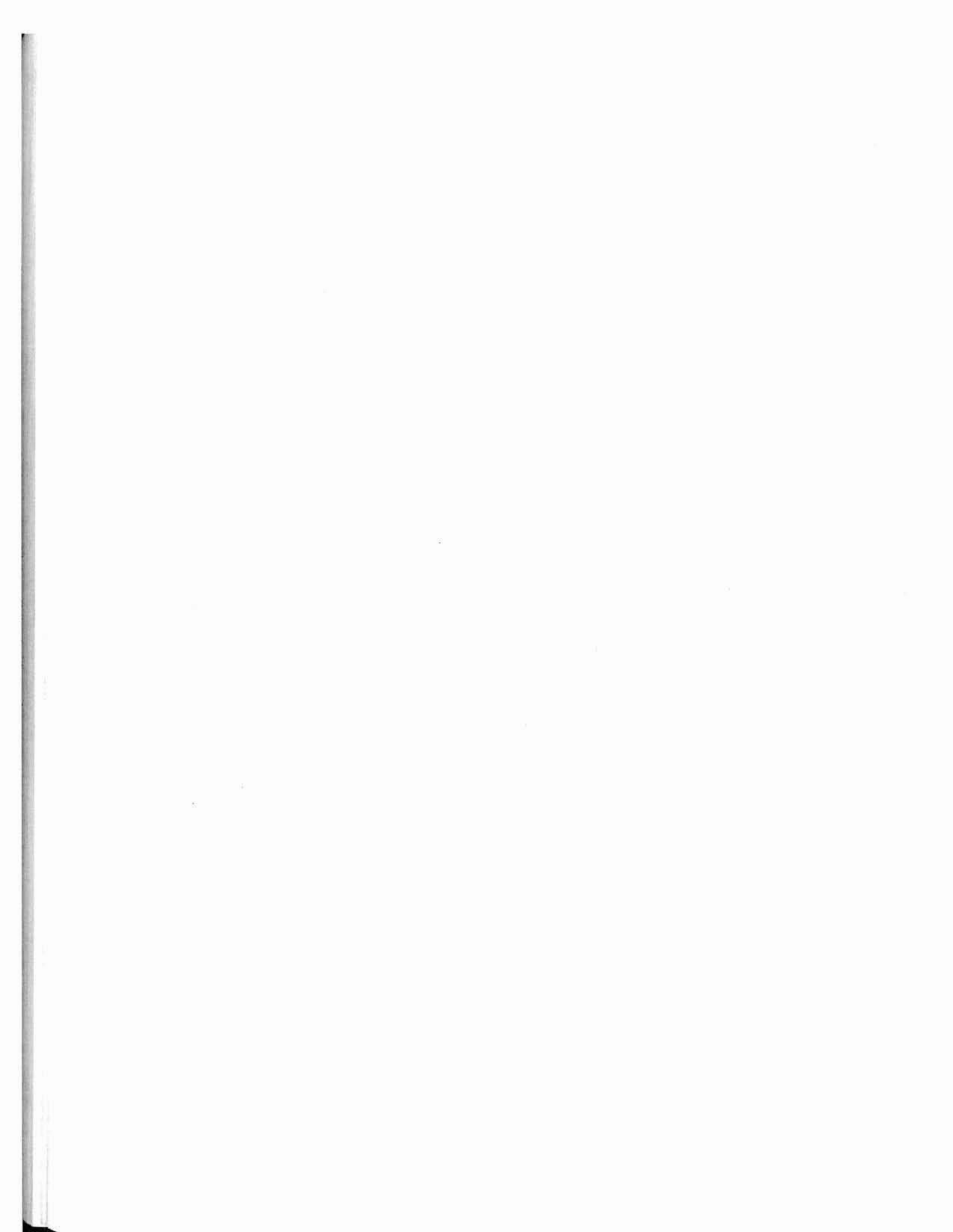

Diseases in Czechoslovak forest nurseries

ZDENKA PROCHÁZKOVÁ AND JANČARÍK VLASTISLAV

Research Institute of Forestry and Game Management, Czechoslovakia

Presented at the first meeting of IUFRO Working Party S2.07-09

(Diseases and Insects in Forest Nurseries), Victoria, British Columbia, Canada, August 22-30, 1990.

Abstract

Seed-borne diseases and other seedling diseases that occur in Czechoslovakian forest nurseries are discussed. The information is based on more than 30 years of disease research in forest nurseries by members of the Research Institute of Forestry and Game Management.

Résumé

Cette étude porte sur les maladies transmises par la semence et autres maladies de semis affectant les pépinières forestières de Tchécoslovaquie. L'information qu'elle contient est fondée sur plus de trente années de recherches pathologiques menées par l'Institut de recherches sur la forêt et la faune dans les pépinières forestières de Tchécoslovaquie.

In this paper we present information about plant diseases in Czechoslovak forest nurseries, especially in Bohemia and Moravia. First we deal with seed-borne pathogens of forest trees and then we discuss some of the more important or frequently encountered fungus pathogens in nurseries. Seed-borne fungi not only influence seed quality (e.g., germination and viability) but they are also important in the spread of pathogenic fungi within and among forest nurseries.

In Bohemia and Moravia nearly all seeds, mostly conifers, are extracted, processed, and stored (short-term and long-term storage) in a central seed facility in Tynište nad Orlicí. Seed quality is determined in a laboratory accredited by ISTA at the Research Institute of Forestry and Game Management. Tests are made for purity and germination, and biochemical assays for viability, moisture content, seed weight, and seed health are conducted. However, we have not yet devised protocols for health testing of forest seeds. Research on developing such protocols began in 1956, and they are now in draft form. The results that we present here are based on 4 years of research on seed-borne mycoflora. From 1986 to 1989, seed-borne fungi were identified and their frequency determined (using the standard moist-blotter test, i.e. on a Jacobsen germination apparatus and in Petri dishes with filter paper) in 5595 seed samples of five genera (35 species) of forest tree seeds (Table 1). Malt-agar, potato-dextrose agar, Czapek-Dox agar, and water and soil agar were used to evaluate incidence of internal fungi of beechnuts and acorns.

Eighty-five fungi were isolated (Tables 1, 2, and 3). This number is approximate because certain fungi are not detected by the wet chamber technique. Most of the

fungi isolated (number of fungus species in parentheses) were from seeds of hardwoods: ash, *Fraxinus excelsior* L. (45), beech, *Fagus sylvatica* L. (44), maple, *Acer* spp., mainly *Acer pseudoplatanus* L. (39) and lime, *Tilia* species, especially *T. cordata* Mill. and *T. platyphyllos* Scop. (37). Isolations from conifer seeds showed that seeds of European larch, *Larix decidua* Mill., were the most heavily contaminated (40 fungal species), followed by seeds of spruce, mainly *Picea abies* (L.) Karst., which yielded 38 species of fungi. Most of the seed-borne fungi on both the conifer and hardwood tree seeds were saprophytes or weak (facultative) pathogens.

The most abundant fungi on conifer seeds (mainly Norway spruce, European larch and Scots pine, *Pinus sylvestris* L.) were *Penicillium* Link ex Fr., *Penicillium expansum* (Link) Thom, *Trichothecium roseum* Link, *Aspergillus* Micheli sp. div. (*Aspergillus niger* van Tieghem, *Aspergillus glaucus* agg., *Aspergillus flavus* agg.), and in some years *Botrytis gemella* Bonord. and *Oedocephalum glomerulosum* (Bull. ex Fr.) Sacc. Larch seeds were often contaminated with *Alternaria alternata* (Fr.) Keissler and a species of *Phomopsis* Sacc. Depending upon year of collection, 72 to 90% of the larch seedlots contained *Phomopsis*. In 1988, 90% of 660 seed samples contained this pathogen; the amount of diseased seeds in seedlots ranged from 0 to 45%, and on average 8.4% of the seeds per sample were contaminated. Radiographs of non-viable, contaminated seeds at the end of a 21-day germination test showed only empty seeds. Some *Phomopsis* species such as *Phomopsis occulta* Traverso and *P. lokoyae* Hahn are serious pathogens in U.S. and Canadian forest nurseries.

ies. Presence of this fungus on European larch seeds is an important source of inoculum for forest nurseries in Czechoslovakia.

Besides *Penicillium* spp. and *Trichothecium roseum*, other fungi which were frequently isolated from hardwood seeds were *Alternaria alternata*, *Cladosporium herbarum* Link ex Fr. (mainly on seeds of lime, maple, ash, and horn-beam, *Carpinus betulus* L.) and *Verticillium tenerum* (Nees ex Fr.) Link and *Sordaria fimicola* (Rob.) Ces. et de Not. on ash seeds.

Although beechnuts often yielded *Trichothecium roseum*, *Alternaria alternata*, *Penicillium* spp., and *Rhizopus stolonifer* (Ehrenb. ex Fr.) Vuill., these fungi seldom occurred on beechnuts with viability above 90%. Abundance of saprophytic fungi increased as beechnut viability increased. Most samples were classified as second-class infection (6 to 25% infected seeds per sample). Besides the fungi mentioned above, lower viability beechnuts sometimes yielded *Acremonia atra* Sacc., *Acremonium strictum* Gams, *Cladosporium herbarum*, *Doratomyces stemonitis* (Pers. ex Fr.) Morton et Smith, and a species of *Graphium* Corda. Similar results were obtained with Norway spruce and Scots pine seeds.

Even though the viability was high (50 to 100% contaminated seeds in a sample) ash, maple, lime, and horn-beam seeds frequently yielded saprophytic fungi (*Penicillium* spp., *Trichothecium roseum*, *Alternaria alternata* and *Cladosporium herbarum*).

Parasitic fungi were very rarely found in seed samples. The genus *Ciboria* contains several fungi which cause seed black rot and mortality. *Ciboria alni* (Maul. ex Rostr.) Whetz. was identified from three alder, *Alnus glutinosa* (L.) Gaertn., seed samples and *Ciboria betulae* (Nawaschin) White was identified from one birch *Betula verrucosa* Ehrh. sample. Because of the enormous quantity of seed which was collected, these two fungi are not a serious problem. However, in acorns (*Quercus* spp.) *Ciboria batschiana* (Zopf) Buchwald is a very significant pathogen which destroys stored acorns. This fungus was isolated from 38% of the seedlots and up to 25% of the acorns were affected.

Botrytis cinerea Pers. ex Fr. was more abundant in seeds of alder, birch, elm, *Ulmus glabra* Huds., and horn-beam than in seeds of other species. At present this fungus is also becoming more prevalent in greenhouses and nurseries. In 1988, gray mold damaged or killed 1.15 million seedlings in Bohemia and Moravia. Damage also occurred on cold-stored seedlings as well as on grafts and root stocks. The sexual state, *Botryotinia fuckeliana* (de Bary) Whetz, seldom occurs in nurseries.

Numerous *Fusarium* Link ex Fr. species such as *Fusarium acuminatum* Ellis et Everhart, *F. avenaceum* (Corda ex Fr.) Sacc., *F. flocciferum* Corda, *F.*

graminearum Schwabe, *F. oxysporum* Schlecht., *F. poae* (Peck) Wollenw., *F. proliferatum* (Matsushima) Nirenberg, and *F. solani* (Mart.) Sacc. were isolated from several samples of conifer seeds, but those fungi were more abundant on seeds of maple, ash, horn-beam, and on acorns and beechnuts. In 1987 in east Slovakia, species of *Fusarium* were isolated from 43% of the beechnut lots, but within infested lots affected beechnuts did not exceed 5%.

Fungi such as *Fusarium* Link ex Fr., *Cylindrocarpon* Wollenw., *Rhizoctonia solani* Kuhn (found only in three beechnuts samples), *Alternaria alternata*, *Verticillium* Nees ex Link, *Botrytis cinerea*, *Trichothecium roseum*, *Cladosporium herbarum*, and *Trichoderma viride* Pers. ex Fr. cause post-emergence damping-off in forest nurseries. Damping-off losses in 1985 in southern Moravia exceeded 1 million seedlings. Although seed-borne fungi are often the source of inoculum, seed health testing shows that the main source of pathogens is from the nursery soil. Other factors contributing to losses include late sowing of seeds, unsuitable soil structure, and abiotic factors such as poor drainage. Seedlings are very sensitive to chemicals during the first 6 to 8 weeks of their development.

Phytophthora cactorum (Leb. et Cohn) Schroet; beech-blight, is an important cause of beech seedling mortality in our nurseries. This fungus was suspected of being seed-borne, but it was not isolated from 421 seedlots of beechnuts (freshly collected or in long-term storage) from Bohemia, Moravia, and east Slovakia. The isolation techniques used could have allowed the fungus to go undetected on beechnuts. With the increasing amount of beech sowings, however, losses from *Phytophthora cactorum* continue to increase. In Slovakia in 1985, production of beech seedlings was endangered and in 1988 more than 1.5 million beech seedlings were killed in Bohemian and Moravian nurseries. Isolation of *Phytophthora cactorum* was successful only from stratified beechnuts or from diseased seedlings. The fungus forms dark brown, circular, spreading lesions on cotyledons. When the stem is affected, the seedling dies. The disease spreads most rapidly in wet, warm weather in poorly drained soils. Danger from this disease disappears with sunny, dry weather.

At present, tracheomycosis is the most important disease of both seeds and seedlings. Fungi of the genus *Ophiostoma* Syd. cause bluestain of conifers and tracheomycosis of various hardwoods including elm and oak. Besides *Ophiostoma*, some fungi such as species of *Phomopsis*, *Coniothyrium* Corda, *Cylindrocarpon*, *Fusarium*, *Verticillium*, and *Graphium* can cause the diseases, but species of *Ophiostoma* are the most important. Seed health tests showed that *Ophiostoma* spp. was present in 29% of all acorn

samples; however, *Ophiostoma* was rare in seeds of other species of forest trees. All imported acorns are tested for tracheomycotic fungi; when they are found, importation is prohibited. *Ophiostoma* species produce black, irregular lesions on cotyledons of acorns. These lesions increase in size until the entire cotyledon becomes black and soft. When the embryo is not invaded, acorns germinate and the disease occurs on seedling shoots, forming annular lesions around the stem which grow larger and kill the shoot. Frequently, new shoots grow and are killed so that several dead black shoots are present - a characteristic sign of the disease. Gradually the roots are attacked too, killing the seedling. In our nurseries, *Ophiostoma* species attack both oak and beech seedlings, and sometimes other species of seedlings. Perithecia of *Ophiostoma* are present on seeds, stems, roots or seedling leaves. Besides causing mortality and damage to seeds and seedlings, tracheomycosis can be transferred to older stands via diseased stock.

Lophodermium needle cast of Scots pine, caused by the fungus *Lophodermium pinastri* (Schrad.) Chev., is one of the most serious and dangerous diseases in our forest nurseries. There are three species of *Lophodermium* in Czechoslovakia (*L. pinastri*, *L. seditiosum* Minter, Staley et Millar, and *L. conigenum* Hiltzer); *L. pinastri* is the most widespread. *Lophodermium conigenum* is less important because it is found only in the original Hiltzer's area in the Bohemian Forest in southern Bohemia. *Lophodermium seditiosum* is spreading gradually. Previously, the biology of *Lophodermium pinastri* was studied in detail and methods for needle cast control were determined. Because of our weather conditions, three sprays of fungicide (mainly mancozeb) are applied: the first from July 10 to 15, followed by another two applications every 2 weeks. The timing of the first spray is critical because neglect or delay can result in intensive needle damage. In years with high rainfall, *Lophodermium* needle cast affects even primary needles of pine seedlings which, thanks to their wax cover, are usually relatively resistant. In some years, *L. pinastri* fruiting bodies occur on soft, young stems. The amount of needle infection in 2-year-old Scots pine is the chief criterion for determining if the seedlings can be used for planting. Seedlings with more than 66% of the crown needles destroyed cannot be used for reforestation. From 1986 to 1988, *Lophodermium* needle cast destroyed 1.5, 2.0, and 9.0 million Scots pine seedlings, respectively. *Lophodermium* needle cast attacks pines other than Scots pine, but damage is less serious.

Other species of needle-damaging fungi occur on pines in forest nurseries but they are less important in nurseries than in older stands. For example, *Sclerophoma pithyophila* (Corda) Hohn. sometimes causes insignifi-

cant damage in nurseries. Another fungus, *Naemacyclus niveus* Pers., causes needle cast of Austrian pine, *Pinus nigra* Arnold, but the disease is rare. Needle cast disease is also very rare on Norway spruce seedlings. Larch needle cast, *Meria laricis* Vuill., which was very damaging in the 1950s both in nurseries and in forest stands, is now rare. *Rhabdocline pseudotsugae* Syd., which occurs in North American nurseries and which has occurred in Czechoslovakian forests since 1939, has not yet been found in our nurseries.

Oak mildew, *Microsphaera alphitoides* Griff. et Maubl., regularly occurs on oak seedlings, but severity varies from year to year. The disease often goes undetected and damage is underestimated. An introduced fungus, *M. alphitoides* is very well adapted to our climate, appearing in early spring. Severe mildew results in poor shoot growth and insufficient shoot dormancy, thereby increasing frost damage. *Microsphaera alphitoides* overwinters in buds of seedlings; thus, there is the danger of affected seedlings carrying the disease into the forest. Powdery mildew can be controlled with sulfur-based fungicides.

Uncinula aceris (D.C.) Sacc., powdery mildew on maple leaves, is relatively rare, especially in forest nurseries. In the early 1980s an outbreak occurred on sycamore, *Acer pseudoplatanus* L., seedlings and some disease was also recorded on Norway maple, *Acer platanoides* L. The fungus *Phyllactinia guttata* (Will.) Lév. occurs on leaves of beech and certain other trees. It is often overlooked due to its inconspicuous nature on the underside of leaves. This fungus is rare in forest nurseries.

Many species of rusts are currently spreading in Czechoslovakia, the most damaging of which is *Melampsora pinitorqua* Rostr. Although it can be serious on 2-year-old Scots pine nursery seedlings, damage is highest in young forests. Aeciospores (in yellow-orange pustules) are produced in spring on stems of affected pine seedlings, causing twisting of affected stems. When disease is severe, stems dry out and die above the affected area. When less severe, shoots can overcome the disease and wounds become covered with resin. In the older seedlings, branch terminals are invaded and usually killed. Severe infection causes high mortality of the 1-year-old and 2-year-old seedlings. The alternate hosts of this fungus are aspen and some species of poplars (Leuce). Removing these trees from the immediate vicinity of conifer nurseries and young plantations provides adequate control, as do fungicide applications.

Occurrence of pine needle rust, caused by species of *Coleosporium*, has increased in the last 10 years. This disease occurs in nurseries and is spreading into young forest stands. Several herbaceous plants serve as alter-

nate hosts. Owing to the morphological similarity of *Coleosporium* species, recognition of the different species is based on their alternate hosts. Some authors group these "species" into biological races (varieties) of *Coleosporium tussilaginis* (Pers.) Lév. Other authors distinguish them as separate species.

White pine blister rust, *Cronartium ribicola* Fischer, which attacks only eastern white pine, *Pinus strobus* L., is increasing in intensity. Its occurrence on nursery stock indicates a high potential for spread to forest stands. This disease is most abundant in plantations originating from planted stock. Several rusts cause spots and mortality on leaves of hardwoods. The most important of these rusts is *Melampsora* sp. on poplars, *Populus* sp., and willows, *Salix* spp., with numerous herbaceous plants and some forest tree and shrubs, e.g., species of *Larix*, *Euonymus* and *Ribes* serving as alternate hosts. *Melampsoridium betulinum* (Pers.) Kleb. is relatively abundant on leaves of birch seedlings in nurseries; when severe, it can kill seedlings.

Root pathogens are also very important. *Rosellinia quercina* Hartig is a very serious pathogen in heavy poorly drained soils. *Helicobasidium purpureum* Pat. (conidial state *Rhizoctonia violacea* Tul. = *R. crocorum* Fr.) forms striking violet mycelial cushions at the base of stems of diseased seedlings. It frequently occurs as an unimportant epiphyte, but sometimes it becomes very aggressive and kills many seedlings. The striking color of the mycelium allows easy identification of this pathogen. The very dangerous pathogen *Armillaria mellea* (Vahl) Karst. *sensu lato* has occurred more frequently in nurseries in the last few years, attacking seedlings of Norway spruce and Scots pine up to 5 years old. Sometimes the smothering fungus, *Thelephora laciniata* (Pers.) Fr., can severely affect nursery seedlings. This mycorrhizal fungus, associated with many coniferous species, develops large fruiting bodies around the lower stem of seedlings, killing them by smothering.

Fungi that cause leaf spots of hardwood trees often go unnoticed because they seldom cause much damage.

Losses occur only when leaves become heavily infected early in the growing season as this may retard onset of dormancy and thus increase susceptibility of the seedlings to frost. Several fungi that affect leaves, such as *Mycosphaerella tulasnei* (Jancz.) Lindau, occur on leaves of several tree species, while other fungi affect leaves of only one host; some examples of fungi that affect the leaves of only one host are *Rhytisma acerinum* (Pers.) Fr. on maple, *Guignardia aesculi* (Peck) Stew. on horse chestnut, *Aesculus hippocastanum* L., *Apiognomonium tiliae* Hohn. and *Mycosphaerella microsora* Syd. on lime, and *Apiognomonium errabunda* (Rob.) Hohn. on beech.

The fungus *Drepanopeziza punctiformis* Gremmen, better known by its conidial stage *Marssonina brunnea* (Ellis et Everh.) Magn., causes *Marssonina* blight of poplars. In the past this pathogen was rarely observed in Czechoslovakia. Species of *Taphrina* Fr. which cause leaf deformation of poplar, aspen and birch seldom occur in our nurseries. Species of *Venturia* (conidial state *Fusicladium* Bon., *Pollaccia* Bald et Cif.), the cause of black spot disease of poplar and aspen leaves, can often damage young shoots, especially on aspen seedlings. Leaf spots are common on other tree species, and though damage is usually insignificant they can result in early fall of heavily infected leaves.

Although stem and branch diseases are more serious in forests, they sometimes cause damage in nurseries. The most serious of these pathogens is *Brunchorstia pinea* (Karst.) Hohn. Its sexual state, *Ascocalyx abietina* (Lagerb.) Schlapfer (= *Scleroderris lagerbergii* Gremmen or *Gremmeniella abietina* (Lagerb.) Morelet), has not been recorded in Czechoslovakia. *Brunchorstia pinea* has been found in some nurseries. Damage was greatest on the 3-year-old Scots pine in western Bohemia. Previously, for unknown reasons, damage decreased, but interest in the pathogen has recently increased as populations have again increased.

Background reading

- Hesko, J.; Leontovyc, R. 1963. Zdravotny stav bukvic zo sberu roku 1958 v oblasti SLPR Zilina. Lesnický časopis. 9: 921-930.
- Král, V. 1957. Fytopatologická kontrola v lesnom semenárstve. Les. 13: 231-236.
- Ondrusovd, V. 1958. Zdravotni kontrola semen a plodú lesnich drevin. Zprávy VULHM. 4: 155-156.
- Procházková, Z. 1988. Zdravotni kontrola lesního osiva. Zprávy lesnického vyzkumu. 33: 16-19.
- Sutherland, J.R.; Shrimpton, G.M.; Sturrock, R.N. 1989. Diseases and insects in British Columbia forest seedling nurseries. 2nd edition. FRDA Rep. 065. Forestry Canada/British Columbia Ministry of Forests. Victoria. 85 p.
- Urosevic, B. 1983. Trycheomycotic diseases in oak. Comuniones Instituti Forestalis Cechosloveniae. 13: 85-100.

List of tree species whose seeds were examined

- Abies* spp. **A.** *alba* Mill., **+A.** *concolor* Hoopes, *+A. grandis* Lindl.
Acer spp. *A. pseudoplatanus* L., *A. platanoides* L., *+A. saccharinum* L., **+A.** *negundo* L.
Alnus spp. *A. glutinosa* (L.) Gaertn., *+A. viridis* DC.
Betula verrucosa Ehrh.
Carpinus betulus L.
Fagus sylvatica L.
Fraxinus spp. *F. excelsior* L., *+F. americana* L., *+F. angustifolia* Wahlenb.
Quercus spp. *Q. robur* L., *Q. petraea* (Mattuschka) Liebl.
Larix decidua Mill.
Picea spp. *P. abies* (L.) Karst., *+P. glauca* Voss, *+P. omorika* Purk., *+P. pungens* Engelm., *+P. sitchensis* Carr.
Pinus spp. *P. sylvestris* L., *+P. nigra* **Am.**, *+P. strobus* L., *+P. mugo* var. *mughus* Fenaroli, *+P. mugo* var. *uncinata* Fenaroli,
+P. cembra L., *+P. contorta* Dougl.
Pseudotsuga menziesii (Mirb.) Franco
Sorbus aucuparia L.
Tilia spp. *T. cordata* Mill., *T. platyphyllos* Scop.
Ulmus glabra Huds.
† several samples

Table 1. Occurrence of fungi on conifer seeds (1986-1989)

Genus from which seeds originated

Fungi	<i>Abies</i>		<i>Pseudotsuga</i>		<i>Picea</i>		<i>Pinus</i>		<i>Larix</i>	
	Number of samples	%	Number of samples	%	Number of samples	%	Number of samples	%	Number of samples	%
ZYGOMYCETES										
<i>Rhizopus stolonifer</i> (Ehrenb. ex Fr.) Vuill.	59	85	3	12	664	34	422	26	442	23
Mucoraceae	50	72	2	8	324	16	119	7	191	10
ASCOMYCETES										
<i>Chaetomium</i> spp.	-	-	1	4	145	7	186	11	489	26
<i>Melanospora samiae</i> Corda	-	-	-	-	-	-	-	-	1	+
<i>Ophiostoma</i> spp.	-	-	-	-	1	+	-	-	36	2
<i>Phialea</i> sp.	-	-	-	-	-	-	-	-	1	+
<i>Sordariafimicola</i> (Rob.) Ces. et de Not.	-	-	-	-	2	+	-	-	12	1
DEUTEROMYCETES										
<i>Acremonia atra</i> Sacc.	9	13	-	-	12	1	-	-	110	6
<i>Acremonium strictum</i> Gams	17	25	-	-	1	+	4	+	30	2
<i>Alternaria alternata</i> (Fr.) Keissler	22	32	3	12	64	3	56	3	1,075	56
<i>Arthrobotrys superba</i> Corda	-	-	-	-	25	1	3	+	42	2
<i>Aspergillus</i> spp.	30	43	-	-	1,472	75	603	37	1,059	55
<i>Botrytis cinerea</i> Pers. ex Fr.	10	14	-	-	18	1	2	+	128	7
<i>Botrytis gemella</i> Bonord.	-	-	-	-	473	24	530	33	887	46
<i>Cladosporium herbarum</i> Link ex Fr.	1	1	15	60	7	+	8	+	31	2
<i>Doratomyces stemonitis</i> (Pers. ex Fr.) Morton & Smith	-	-	1	4	7	+	-	-	-	-
<i>Drechslera siccans</i> (Drechs.) Shoem.	-	-	-	-	-	-	1	+	-	-
<i>Epicoccum nigrum</i> Link	-	-	2	8	37	2	12	1	8	+
<i>Fusarium</i> spp.	3	4	-	-	12	1	10	1	404	21
<i>Gliocladium roseum</i> Bain.	2	3	4	+	4	+	5	+	51	3
<i>Graphium</i> sp.	-	-	6	+	6	+	6	+	8	+
<i>Chlamydomyces palmarum</i> (Cooke) Mason	1	1	-	-	-	-	-	-	7	+
<i>Chrysosporium pannorum</i> (Link) Hughes	-	-	-	-	10	+	-	-	2	+
<i>Myrothecium roridum</i> Tode ex Fr.	-	-	-	-	-	-	-	-	1	+
<i>Oedocephalum glomerulosum</i> (Bull. ex Fr.) Sacc.	-	-	5	20	321	16	529	33	679	35

Table 1. (continued)

Genus from which seeds originated

Fungi	<i>Abies</i>		<i>Pseudotsuga</i>		<i>Picea</i>		<i>Pinus</i>		<i>Larix</i>	
	Number of samples	%	Number of samples	%	Number of samples	%	Number of samples	%	Number of samples	%
<i>Papulaspora</i> spp.	28	41			5	+	3	+	103	5
<i>Penicillium</i> spp.	61	88	7	28	1.894	96	1.340	83	1.318	69
<i>Phomopsis</i> spp.					18	1	1	+	1.550	81
<i>Stuchybotrys atra</i> Corda					3	+	6	+	1	+
<i>Stenphylium botryosum</i> Wallr.					1	+			3	+
<i>Trichocladium asperum</i> Hars									1	+
<i>Trichoderma viride</i> Pers. ex Fr.	48	70	11	44	250	13	172	11	822	43
<i>Trichothecium roseum</i> Link	29	42	11	44	1.373	70	949	59	1.266	66
<i>Verticillium tenerum</i> (Nees ex Fr.) Link					1	+				
<i>Verticillium</i> spp.					3	+	1	+	3	+
Sphaeropsidales							3	+	209	11
Total samples	69	100	25	100	1974	100	1617	100	1910	100
Total fungi	18		14		38		31		40	

Table 2. (continued)

Genus from which seeds originated

Fungi	<i>Alnus</i>		<i>Betula</i>		<i>Fagus</i>		<i>Tilia</i>		<i>Fraxinus</i>	
	Number of samples	%	Number of samples	%	Number of samples	%	Number of samples	%	Number of samples	%
<i>Doratomyces stemonitis</i> (Pers. ex Fr.) Morton & Smith			3	2	7	+	5	4		
<i>Doratomyces purpureofuscus</i> (Fr.) Morton & Smith			1	1	-	-	3	3	1	1
<i>Drechslera siccans</i> (Drechs.) Shoem.	22	19	48	29	1	+	36	37	27	33
<i>Epicoccum nigrum</i> Link	12	10	6	4	49	12	10	10	42	51
<i>Fusarium</i> spp.									1	+
<i>Geotrichum candidum</i> Link	2	2	3	2	31	7	-	-	2	2
<i>Gliocladium roseum</i> Bain.	-	-	-	-	1	+	-	-	-	-
<i>Gliocladium viride</i> Matr.							40	41	32	38
<i>Gonatobotrys</i> sp.	4	3	2	1	9	2	6	2	2	1
<i>Graphium</i> sp.					1	+	3	3	-	-
<i>Chlamydomyces palmarum</i> (Cooke) Maspn	8	7	1	1	1	+	3	3		
<i>Oedocephalum glomerulosum</i> (Bull. ex Fr.) Sacc.	5	4			53	13	37	38	5	6
<i>Papulaspora</i> spp.	101	83	80	48	321	76	61	63	28	29
<i>Penicillium</i> spp.										
<i>Pestalotia</i> sp.	-	-	-	-	-	-	-	-	-	-
<i>Phomopsis quercella</i> (Sacc. et Roum) Died.	-	-	-	-	-	-	-	-	14	17
<i>Phomopsis samararum</i> (Desm.) Hohnel	4	3			3	+	2	2		
<i>Phomopsis</i> spp.									1	+
<i>Pleurage anserina</i>					3	+				
<i>Rhizoctonia solani</i> Kuhn	-	-	-	-	18	4	3	3	9	11
<i>Stachybotrys atra</i> Corda	1	1	2	1	6	1	1	1	2	2
<i>Stemphylium botryosum</i> Wallr.					8	+	1	1		
<i>Trichocladium asperum</i> Harz	44	38	5	3	82	19	29	30	8	8
<i>Trichoderma viride</i> Pers. ex Fr.	78	68	161	97	342	81	69	71	41	49
<i>Trichothecium roseum</i> Link										
<i>Ulocladium</i> sp.			1	+			-	-	-	-

Table 2. (continued)

Fungi	Genus from which seeds originated											
	<i>Alnus</i>	<i>Betula</i>	<i>Fagus</i>	<i>Tilia</i>	<i>Fraxinus</i>	<i>Alnus</i>	<i>Betula</i>	<i>Fagus</i>	<i>Tilia</i>	<i>Fraxinus</i>	<i>Alnus</i>	<i>Betula</i>
	Number of samples	%	Number of samples	%	Number of samples	%	Number of samples	%	Number of samples	%	Number of samples	%
<i>Verticillium lecanii</i> (Zimm.) Viegas			1	+								
<i>Verticillium tenerum</i> (Nees ex Fr.) Link			3	+	1	1	3	+	1	1	29	35
<i>Verticillium</i> spp.	1	1	5	3	15	15	3	+	5	5	11	13
Melanconiales											13	16
Sphaeropsidales	3	3			5	5			2	2	2	2
BASIDIOMYCETES												
Total samples	115	100	166	100	421	100	100	100	97	100	83	100
Total fungi	27		30		44		44		37		45	

Table 3. Occurrence of fungi on hardwood tree seeds (1986-1989)

Fungi	Genus from which seeds originated											
	<i>Acer</i>		<i>Sorbus</i>		<i>Carpinus</i>		<i>Quercus</i>		<i>Ulmus</i>			
	Number of samples	%	Number of samples	%	Number of samples	%	Number of samples	%	Number of samples	%		
MYXOMYCETES												
<i>Badhamia macrocarpa</i> (Ces.) Rost.	2	2	-	-	-	-	-	-	-	-	-	-
ZYGOMYCETES												
<i>Rhizopus stolonifer</i> (Ehrenb. ex Fr.) Vuill.	24	30	39	95	37	60	11	34				
Mucoraceae	13	16	12	29	13	20	4	12	1			+
ASCOMYCETES												
<i>Ciboria alni</i> (Maul. ex Rost.) Whetz.	-	-	-	-	-	-	-	-	-	-	-	-
<i>Ciboria batschiana</i> (Zoff) Buchwald	-	-	-	-	-	-	-	-	-	-	-	-
<i>Ciboria hetulae</i> (Nawaschin) White	10	10	2	5	2	3						
<i>Chaetomium</i> spp.	1	1			2	3						
<i>Melanospora samiae</i> Corda	2	2			2	3						
<i>Ophiostoma</i> spp.	11	14			2	3	9	29				
<i>Pleospora herbarum</i> (Pers. ex Fr.) Rabenh.	34	42			34	52			1			+
<i>Sordariafinicola</i> (Rob.) Ces. et de Not.	4	5			9	14	2	6				
DEUTEROMYCETES												
<i>Acremonium strictum</i> Gams	1	1										
<i>Acrospira levis</i> Wiltshire	65	80	5	12	52	80	4	12	4			+
<i>Alternaria alternata</i> (Fr.) Keissler	1	+										
<i>Arthrinium</i> sp.	5	6			2	3						-
<i>Arthrobotrys superba</i> Corda	23	28	28	44	24	37	6	19				
<i>Aspergillus</i> spp.	18	22			42	65	4	12	4			+
<i>Botrytis cinerea</i> Pers. ex Fr.					5	8						
<i>Botrytis gemella</i> Bonord.	44	54	1	2	47	72			2			+
<i>Cladosporium herbarum</i> Link ex Fr.	-	-	-	-	-	-	-	-	-	-	-	-
<i>Cylindrocarpon magnusianum</i> (Sacc.) Woll.	-	-	-	-	-	-	4	12				
<i>Cytospora</i> spp.												

10.1111/j.1365-3113.2011.00501.x
 © 2011 British Ecological Society, *Journal of Applied Ecology*, 48, 43–50

Table 3. (continued)

Genus from which seeds originated

Fungi	Acer		Sorbus		Carpinus		Quercus		Ulmus	
	Number of samples	%	Number of samples	%	Number of samples	%	Number of samples	%	Number of samples	%
<i>Verticillium tenerum</i> (Nees ex Fr.) Link	1	1	1	1	-	-	-	-	-	-
<i>Verticillium</i> spp.					1	3				
Melanconiales					-	-				
Sphaeropsidales	20	25	31	48	-	-			1	+
BASIDIOMYCETES										
Total samples	110	100	41	100	65	100	2	00	4	00
Total fungi	39		11		19		27		12	

bioRxiv preprint doi: <https://doi.org/10.1101/2023.08.15.554444>; this version posted August 15, 2023. The copyright holder for this preprint (which was not certified by peer review) is the author/funder, who has granted bioRxiv a license to display the preprint in perpetuity. It is made available under aCC-BY 4.0 International license.

Important nursery insects and diseases in Haiti and their management

SCOTT J. JOSIAH

*Assistant Director for Agroforestry
Pan American Development Foundation/Pwojè Pyebwa
Port-au-Prince, Haiti*

AND

DEBRA ALLEN-REID

*Consulting Entomologist
Port-au-Prince, Haiti*

*Presented at the first meeting of IUFRO Working Party S2.07-09
(Diseases and Insects in Forest Nurseries), Victoria, British Columbia, Canada, August 22-30, 1990.*

Abstract

Management of insects and diseases poses one of the greatest challenges to consistent, predictable production of high quality tropical hardwood nursery stock grown in Haiti. Nursery systems, insect and disease incidence and identification, and integrated pest management strategies developed during the nine-year tenure of the USAID-funded Agroforestry Outreach Project and subsequent Agroforestry II Project are discussed.

Resume

La lutte contre les insectes et les pathologies est l'un des plus grands défis auquel les pépinières d'Haïti doivent faire face dans la production d'essences de bois feuillus tropicales de haute qualité. Le document traite des méthodes de culture en pépinière, de l'incidence et de la nature des insectes et des maladies sur les cultures, de même que des stratégies rationnelles de lutte contre les espèces nuisibles qui ont été mises au point au cours des neuf années que ont duré le projet d'action directe d'USAID en agroforesterie et son projet subséquent, Agroforesterie II.

Introduction

Haiti, a small Caribbean nation occupying the mountainous western third of the island of Hispaniola, once was covered almost entirely by forest. However, years of natural resource mismanagement, including extensive deforestation, have led to severe soil erosion and widespread environmental degradation. Increased demand for agricultural land and continued dependence on trees for firewood, charcoal production, and as a fuel source for commercial dry cleaners, bakeries and small distilleries have all contributed to deforestation. Nearly all of the original forest cover has been removed, leaving only one upland pine forest (*Pinus occidentalis*) of approximately 10 000 hectares (M. Ashley, forest management consultant, The World Bank, personal communication 1989) and scattered small forest remnants elsewhere. Most of Haiti's lands are now vegetated either with sparse brush or grass or are barren and rocky. Haiti has one of the lowest gross national products per capita (\$300) in the western hemisphere (Population Reference Bureau 1988), and one of the highest ratios of rural population density to arable land (700 persons per arable hectare) (USAID 1984). Popu-

lation pressures and declining land productivity have forced peasants to cultivate marginal sites on steep slopes, exacerbating soil erosion and perpetuating the vicious downward spiral of reduced agricultural production, destabilized watersheds, and intensified rural poverty.

In an effort to reverse these trends, the United States Agency for International Development (USAID) funded the Agroforestry Outreach Project in 1981 to promote the planting of trees as a cash crop. Based on a socio-cultural analysis of Haitian peasant needs and attitudes regarding the planting and use of trees, the project aims to motivate farmers to plant and protect trees in their fields (Murray 1981; Smucker 1981). Project activities are implemented through non-governmental organizations (NGOs), such as religious missions and grassroots development groups. The Pan American Development Foundation (PADF) and CARE, selected by USAID as lead NGOs, direct project activities. PADF provides the smaller collaborating organizations with technical, logistical, material and credit support. CARE, lacking adequate numbers of collaborators in its zone of responsibility, operates its own nurseries and works directly

with farmers. Tree seedlings are produced and distributed to farmers free of charge by the collaborators, encouraging the practice of cropping trees on private holdings to increase farmers' incomes and land productivity.

Over the past 9 years the Agroforestry Outreach Project has developed an efficient, appropriate system for the mass production of containerized tree seedlings in a country of marginal resources and infrastructure. The 50 participating regional nurseries produce and distribute nearly 10 million trees per year to participating farmers. The project's achievements have been buttressed in part by basic applied research conducted by the project's research component (currently contracted to the Southeast Consortium for International Development (SECID) in conjunction with Auburn University).

Most programs attempting to modernize nursery production of tropical hardwoods are essentially starting from scratch. Much of what has been learned from decades of research conducted on temperate species or for tropical/subtropical pines is usually not applicable for hardwoods in the tropical, developing country context. Management of insects and disease in these nurseries poses one of the most important challenges to consistent, predictable production of high-quality tropical hardwood nursery stock. This paper summarizes the experience gained in the Agroforestry Outreach Project and the current Agroforestry II Project in tropical insect and disease management in forest nurseries in Haiti.

The Nursery System

The project encompasses a network of 50 regional nurseries operated either directly by CARE, or by smaller collaborating organizations receiving technical assistance from PADF. Since 1981, these regional nurseries have utilized rigid-wall plastic containers, either the Roottrainer system, produced by Spencer-Lemaire of Canada, or the Winstrip system, of Winstrip International, Asheville, N.C. Both container systems have produced tens of millions of high-quality tree seedlings of over 40 tropical species.

Seedlings are grown in a variety of soil media. An imported commercial soil medium composed of peat moss, vermiculite and perlite, is the predominant soil mix used in the project. There has been a recent move toward the utilization of local mixes prepared in Haiti from decomposed plant materials and animal manures. Some nurseries compost their own materials and make their own soil medium.

The regional nurseries are managed by people selected by the collaborator and trained by PADF or CARE. These nursery managers are peasant farmers

who show aptitude for working with plants and for managing people. They are usually marginally literate rural dwellers, not accustomed to the highly organized and structured activities and approaches required for predictable production of high quality nursery stock.

In an effort to establish sustainable nursery production at the farm level, the project recently began to encourage farmers to produce forest tree seedlings in small nurseries (100-5000 trees/nursery) at their homes. To avoid the high initial costs and to reduce the complexity of the system, plastic sacks are utilized as containers in these home nurseries.

Since their inception a little over a year ago, home nurseries have provided some interesting pest management insights. Yard nurseries appear to have more insect problems but fewer disease problems than the larger regional nurseries. The less structured nursery environment, significantly lower level of management, and the lack of sanitation all contribute to the insect problem. Sacks usually rest on the ground where ants, crickets and cutworms have easy access. A lower incidence of disease, especially foliar types, appears to be related to lower densities of seedlings of the same tree species, better spacing and ventilation, and less tendency to over-water and over-shade, leading to less seedling stress.

Insects in containerized nurseries

Entomological pests in general and specifically nursery pests have not been well studied in Haiti. In the case of the Agroforestry Outreach Project, investigations of nursery insect pests have thus far been of lower priority than the evaluation of nursery methods and species performance; this is most likely due to the lack of serious pest problems or catastrophic losses. The availability and efficacy of multispectrum insecticides have minimized damage and therefore interest in insect study. The need for a comprehensive entomological survey in Haiti has been recognized by USAID in recent years, but budget restraints and shifting priorities have left that task unfunded.

Published entomological literature specific to Haiti is sparse, as evidenced by a computer search at Auburn University and visits to institutional libraries in Port-au-Prince. Locally, there appears to be only one relevant work available, an excellent though dated treatment by Wolcott (1927) in French. To bridge this gap, USAID periodically engages consultants under short-term contracts to investigate specific problems. While the ensuing reports may be of considerable scientific value, the information is rarely published and may be difficult to access.

To determine the nature and extent of nursery insect problems, personnel from CARE, PADF, Operation Double Harvest (formerly a project participant), and Auburn University were interviewed and project consultancy reports were reviewed. Nurseries were visited and specimens submitted by nursery personnel were examined. Because nurseries were often completely clean of specimens (an observation also made by Tourigny (1987) who suspected insecticide overuse), some species which were collected from recently outplanted stock are included in the discussion below. Beneficial species always suffer from chemical control measures but regional project staff report the presence of lacewings, walkingsticks, preying mantids, polistine wasps and an unidentified predatory bug which feeds on aphids on guava.

Lepidoptera

Because of their size and obvious feeding damage, caterpillars are the most readily recognized of nursery pests. Even when the larva is not found, most defoliating types of feeding are attributed to members of this order. Reports of armyworm and cutworm (Noctuidae) incidence indicate that these species may occasionally move in from adjacent grassy areas. Some damping-off damage may also be incorrectly reported as cutworm damage. Because of the common practice of growing crops adjacent to nurseries, most lepidopterous pests appear to move opportunistically from their preferred crop hosts under population pressure onto nursery stock (Tourigny 1987). This appears to be the case for at least one species of leaf-tying pyralid which attacks *Catalpa longissima*. An unidentified, uncollected caterpillar reportedly attacks *Swietenia mahogoni* but its incidence appears sporadic. Although never observed in the one nursery that produces pine (*Pinus occidentalis*), a very serious defoliator of this species which could threaten outplantings has been identified as a Saturniid in the subfamily Citheroniinae (P.M. Estes, Auburn University, Auburn, Alabama. Personal communication). Control of Lepidoptera in the nursery is generally accomplished by the spraying of a synthetic insecticide (usually carbaryl), but a naturally derived neem extract (discussed in more detail later) or manual removal are also used.

Hymenoptera

A number of ant species (Formicidae) which frequent the nurseries have thus far been classified only by their behavior. These include leaf-cutters which attack *Casuarina siamea*, aphid tenders which stave off predators on *Citrus* spp., seed-stealing ants which remove sown seed of *Eucalyptus camaldulensis* and *Casuarina glauca*,

and container colonizers which burrow around seedling roots leaving very little soil to accompany the seedling when it is outplanted. Current treatments include the application of a synthetic insecticide, treating the seed chemically before planting, spraying the lower portion of the rack holding the seedlings, and seeking the ant nest and chemically treating it.

Homoptera

This order contains perhaps the most widespread and frequently-found pests. Aphids have been reported on *Citrus* spp., *Gliricidia sepium*, and *Catalpa longissima* and may also vector a virus on *Colubrina arborescens* (Tourigny 1987). Psyllids feed on both indigenous and introduced *Leucaena* spp. and *Albizia saman*. Tourigny (1987) believes this psyllid may be the same species (*Heterospylla cubana* Crawford) causing large-scale defoliation of *Leucaena leucocephala* in Asia. Scale insects, including the cottony cushion scale (*Icerya purchasi* Maskell), the citrus snow scale (*Unaspis citri* Comstock), and unidentified mealybugs, have been observed on *Citrus* spp. An unidentified scale insect has also been collected on 1-year-old outplanted *Azadirachta indica*, but has not yet been found in the nursery. Leafhoppers occur but are not considered very important except as disease vectors. When needed, control of Homoptera is by natural insecticides for less serious infestations and by synthetic chemical sprays in severe cases.

Diptera

A seed maggot which attacks *Albizia saman* was tentatively identified by Tourigny (1987) as the corn seed maggot, *Hylemya platura* (Meig). This pest formerly caused serious losses but now is largely controlled by either seed dressings with synthetic pesticides or the application of fine netting over the soil surface immediately after sowing.

Orthoptera

Crickets (Gryllidae) are not usually a serious problem but may attack *Casuarina glauca*, *Acacia auriculiformis*, *Eucalyptus* spp., and *Colubrina arborescens*. These nocturnal feeders may clip seedlings just above the root collar or defoliate them. They are more common in home nurseries where they have easy access to seedlings resting directly on the ground. Nursery managers reduce cricket damage by removing vegetation and trash from the nursery, eliminating locations which shelter crickets, and elevating seedlings. Direct control measures include spraying synthetic insecticides in areas frequented by crickets and building a fire at night to attract and kill them.

Coleoptera

A species of tortoise beetle (Chrysomelidae, subfamily Cassidinae) is a fairly common pest on *Catalpa longissima*. It most likely moves into the nursery from weedy areas or adjacent crops. Manual removal is usually adequate for the numbers involved but spraying for other pests may be keeping this species in check.

Diseases in containerized nurseries

Diseases remain the biggest obstacle to consistent production of tropical hardwood seedlings in Haiti. Soil-borne diseases attacking the seed prior to or during germination account for large initial losses. Constant high temperatures and relative humidities create excellent conditions for the growth and spread of foliar disease pathogens. Early diagnosis followed by appropriate action is required to avoid large losses. Diseases found in containerized nurseries in Haiti have been well summarized in project consultancy reports (Runion *et al.* 1990; Runion and Kelly 1990). The pathogens listed in the Appendix have not been determined as the causal agents but rather were identified as existing on the plants at the time of collection.

An unusually virulent leaf spot complex (*Cercospora*, *Alternaria*, *Curvularia*, *Fusarium*, *Fusoma*, etc.) occurring on *Cassia siamea* is clearly the most important disease in project nurseries. *Cassia siamea*, due to its excellent performance on poor, degraded sites, is one of the most popular species distributed by the project. If not recognized early and controlled (usually by a combination of cultural and chemical treatments), this disease complex will kill nearly all *C. siamea* in the nursery. Because *C. siamea* seedlings under nutrient or water stress seem especially vulnerable to attack, they must be maintained in a vigorous condition throughout their nursery period. The susceptibility of *C. siamea* to this disease may be related to it being exotic to Haiti. These foliar pathogens also attack many other species of trees (Appendix).

Another important foliar disease which attacks *Cassia siamea*, *Acacia auriculiformis*, *Casuarina equisetifolia*, *Carica papaya*, and *Eucalyptus* spp. is powdery mildew (*Oidium* spp.). Although less serious than the leaf spots, powdery mildew can also cause significant losses when not recognized and promptly treated by the nursery manager.

Anthraxnose is especially severe on mango (*Mangifera indica*) seedlings when grown in areas of high relative humidity. It is difficult to control culturally in these areas; thus, chemical control is preferred.

Sooty molds, which grow on the honeydew exudates of sap-sucking insects (aphids, mealybugs, scales, psyllids), have been observed on *Citrus* spp. and

Leucaena spp. If heavy enough, these molds may inhibit photosynthesis but are usually more important as insect infestation indicators. Scab (*Sphaceloma* spp.) is also found on *Citrus* spp., causing reduced vigor and occasional mortality.

Damping-off complexes are widespread, especially in newer nurseries where the nursery managers are less experienced and where the tendency to overwater is greater. *Fusarium*, *Rhizoctonia*, and *Phytophthora*, among others, have all been implicated in causing damping-off in Haiti nurseries (Tourigny 1987; Runion *et al.* 1990). Both pre-emergent and post-emergent damping-off is commonly observed in containers exposed to excessive water and it declines in severity when watering frequency is reduced. Occasionally, heavy rains over a period of days or weeks create optimal conditions for the growth and spread of these soil-borne pathogens, which subsequently require chemical control. In areas with high rainfall and high humidity, nursery managers routinely spray the newly sown containers with captan to slow the growth of damping-off fungi.

Locally produced soil mixes are not sterile, yet nurseries using local mixes do not for the most part experience serious problems with soil-borne pathogens. Surprisingly, the commercial imported medium has more serious problems with soil-borne pathogens causing severe damping-off than do the local mixes. Some studies have indicated that sterilized soil mixes are essentially biological vacuums which can be quickly colonized by locally aggressive, pioneering pathogenic microorganisms (Schneider 1982; James 1989). Non-sterile local soil mixes with more balanced microbial populations than commercial media and fewer available niches may resist rapid population increases of opportunistic pathogenic microorganisms (Schneider 1982). Additionally, local mixes may be a source of endomycorrhizal inoculant which can significantly contribute to seedling growth and vigor.

Nematodes occasionally attack *Citrus* spp., *Swietenia macrophylla*, *Colubrina arborescens*, and *Leucaena leucocephala* (Tourigny 1987; Runion *et al.* 1990). Root decay, stunted growth and general unthriftiness characterize affected plants. Nematodes are a problem in some nurseries where unsterilized soil media are used, especially soil mixes using very old, decomposed sugarcane bagasse. Utilization of organic materials other than bagasse is the best way to avoid nematodes.

Viruses are also fairly common in the nurseries, attacking *Carica papaya*, *Cedrella odorata*, *Colubrina arborescens*, *Catalpa longissima*, *Azadirachta indica*, and *Albizia saman* (Tourigny 1987; Runion *et al.* 1990; Runion and Kelley 1990). Micronutrient deficiency

symptoms may occasionally resemble symptoms of viral infection. Individual viruses have not yet been thoroughly studied or identified in Haiti. Stunted seedlings, “carrot top” leaf distortions, mottled leaves and seedling mortality are the usual symptoms associated with viral infections. Some viruses are vectored by the citrus aphid, *Toxoptera aurantii*, as well as other Homoptera and mites, some of which have been positively identified in project nurseries (Tourigny 1987). Nursery managers or farmers occasionally plant gardens in the immediate proximity of the nursery, growing cucurbits or papaya which often show signs of viral infection. The project discourages this practice, especially with these virus-prone garden species, in order to reduce the chance of the virus being vectored to the nursery seedlings.

Integrated pest management strategies

Since nursery managers in Haiti are faced with an array of fungal pathogens and insect pests, they must be aware of prevention and control methodologies available. Nurserypersons are trained in integrated pest management strategies in formal seminars and during monthly visits to each nursery. Training sessions and materials emphasize prevention of insect and disease problems and the use of cultural techniques. Chemicals are presented as a last resort approach. To aid in identification of insect, disease, and cultural problems, an illustrated nursery manual written in Haitian Créole with color photos of the most common nursery management problems and their prevention or treatment (Josiah 1989) is used.

Chemical Control

Because pesticides are not regulated in Haiti, chemical importation, distribution, sales and application of chemicals are uncontrolled. Thus, many pesticides restricted or banned in other countries are easily obtained. Pesticides are often repackaged in inappropriate, unlabeled containers for distribution or sale. Marginal literacy among purchasers and applicators adds to improper or unsafe pesticide usage. To reduce the danger of exposure to dangerous pesticides, relatively safe and unsafe chemicals are identified during the training sessions, and only the safer ones are recommended for use. Pesticide labels are re-written in Haitian Créole to further encourage safe use.

All nursery managers receive extensive training in pesticide safety. In the regional nurseries, only pesticides approved by the U.S. Environmental Protection Agency may be distributed, due to USAID requirements. Of those insecticides approved for use, carbaryl is by far the most popular. Synthetic pesticides are

probably used more often than is desirable, especially for the more visible insect pests, because of their effectiveness and ease of use.

Chemical controls are usually limited to the use of a few insecticides (i.e., carbaryl, malathion, trichlorophen). A fatty acid insecticidal soap has been recently introduced and shows promise in controlling insect pests such as scales, aphids, and mealybugs. Control of fungal pathogens is usually achieved by using captan, mancozeb or benomyl. Foliar diseases, especially the leaf spot complex, must be controlled in the early stages of infection by benomyl.

Natural Pesticides

While the preparation and use of natural insecticides is included in training materials and seminars, the practices are often not well accepted among managers of the larger regional nurseries. It is simply easier and faster to purchase a synthetic pesticide than it is to collect and process the materials necessary to make a natural pesticide. CARE has made its own investigations into the use of neem (*Azadirachta indica*) and sees great potential for this locally available alternative to synthetic pesticides (Peter Welle, Program Co-ordinator, FARM Project, CARE International, Port-au-Prince, Haiti, personal communication, February 1990). Seeds or leaves of the neem tree are crushed and soaked in water from several hours to a day, and the solution is then sprayed on the infected seedlings. Azadirachtin has been shown to have antifeedant, insecticidal and growth regulatory properties for a variety of insect pests (Jacobsen *et al.* 1985). Unfortunately, synthetic pesticide use is generally viewed by farmers in developing countries as a “modern” remedy, used by “progressive” farmers (Schwab 1988). Natural pesticides are considered by at least some nursery managers in Haiti as being less effective, possibly due to their slower mode of action than the synthetics. In spite of these perceived drawbacks, a limited number of regional nursery managers are beginning to use natural insecticides such as neem to control their insect pests.

Farmers producing trees in their own home nurseries are more likely than the regional nursery manager to use natural pesticides. These farmers operate independently, without subsidized chemicals or intensive technical assistance. Because they cannot afford to spend any money on their seedlings, a low-cost alternative pesticide which they can prepare themselves is attractive. Home nurseries use a strategy encompassing prevention, natural enemies and natural pesticides to keep pest populations to a minimum. Other potential, locally available botanicals include chili pepper (*Capiscum frutescens*), sweetsop (*Annona squamosa*), sour-

sop (*Annona muricata*), and tobacco (*Nicotiana tabacum*).

Prevention

Prevention of nursery insect and disease problems is preferred in all nurseries. This is best accomplished by promoting good sanitation procedures, removing leaf litter and trash, grasses and weeds, and eliminating standing water from the nursery area. Seedling containers in regional nurseries are washed after each season in a solution of chlorine bleach and water. Seedlings are fertilized throughout their 4 months in the nursery with a balanced soluble fertilizer (20-20-20 plus micronutrients) to maintain a vigorous and resistant condition. Nursery personnel are advised to avoid overfertilization or excessive shade as the succulent foliar growth is attractive to insects, especially Homoptera.

Light, Moisture and Humidity Control

Nursery personnel are encouraged to provide good air circulation by supporting the seedlings at least 40 cm above the ground, and cutting any trees and bushes in the area that inhibit aeration. The planting of border or adjacent shade trees of the same species as grown in the nursery is discouraged in order to avoid providing habitat for insects or pathogens.

While shade cloth-covered shadehouses have better air circulation and lower air temperatures than those using plastic films, plastic has been found to be superior in reducing disease occurrence. Plastic permits nursery personnel to completely control soil moisture in the containers, even during periods of prolonged precipitation, greatly reducing the incidence of soil-borne pathogen (*Fusarium*, *Rhizoctonia*, *Phytophthora*, etc.) attacks. Shade cloth eliminates this control over soil moisture and forces the manager to rely heavily on fungicides to control soil-borne pathogens.

Control of moisture is critical to the management of insects and especially diseases in Haiti's nurseries. Proper watering procedures are insisted upon. Nursery managers are trained to irrigate when needed, rather than on a fixed schedule. This encourages the nursery personnel to maintain a presence in the nursery, to check the seedlings twice daily and to water accordingly. Water is drawn from many different sources (deep and shallow wells, rivers and streams) depending upon the water resources near the nursery site, availability of electricity, etc. Serious disease problems are often linked to pathogen-contaminated surface water used for nursery irrigation. To reduce these problems, nursery managers are encouraged to store surface water in drums, allowing impurities and suspended sediments to settle. The water is also treated with chlorine bleach to

reduce pathogen populations (especially motile zoospores of damping-off and root-rot pathogens). These actions are only somewhat effective in reducing disease incidence.

When foliar diseases do occur, some cultural options are available to help control the pathogen. *Oidium* can be controlled by placing the infected plants in direct sunlight for an extended period. Plants infected with other leaf spots or blights also seem to improve with increased light intensity, though not as markedly as plants infected with *Oidium*.

Mechanical control /beneficial organisms

Nursery managers often use mechanical control procedures (swatting, hand picking) to reduce the numbers and impact of insect pests. They are trained to recognize useful natural enemies of insect pests, both insects and animals (i.e., ladybird beetles, lacewings, syrphids, lizards, toads, snakes, birds, etc.) and to protect and encourage their numbers. However, worker aversion to snakes and frogs makes it unlikely that these animals would survive in sufficient numbers in a nursery to reduce insect pests. Use of *Bacillus thuringiensis* would be a desirable option but it is currently too expensive.

Microsymbionts

Nitrogen-fixing trees account for 25% of all trees produced in the Agricultural Outreach Project; the majority are leguminous. All nitrogen-fixers are inoculated with the appropriate strain of *Rhizobium*, produced in a Haitian laboratory from NifTAL (Nitrogen Fixation by Tropical Agricultural Legumes, Paia, Hawaii) cultures, or with crude inoculant produced from locally obtained crushed *Frankia* nodules (for *Casuarina* and *Alnus* species). In addition, pines are inoculated with imported *Pisolithus tinctorius* or a locally collected ectomycorrhizae. Trees inoculated with the proper microsymbiont are more vigorous and have far fewer diseases or nutrient deficiency problems.

Resistance to pest damage

Natural resistance to disease and insect feeding damage is an important consideration in an integrated management system. Determination of within-species variation in susceptibility to attack is required before such traits can be exploited. The seed and germplasm improvement group of the project's research team has thus far limited its investigation of genetic variation to biomass production and form. Systematic evaluation of variation in pest resistance could be incorporated into these studies, replacing informal observations of insect

and disease incidence. Current approaches to minimize future pest problems include the matching of tree species to site and the use of indigenous species. The diversity of species produced and distributed by the nurseries further reduces the chance for widespread epidemics which are common to monocultures.

Conclusion

Successful management of insects and diseases is necessary for the production of healthy tropical nursery stock capable of surviving the harsh conditions commonly found on degraded land in the Haitian countryside. Challenges to be met include the training of marginally literate nursery managers in integrated pest management methods, adapting conventional nursery technology to the lower-input systems appropriate for developing countries, and working with pest/host relationships which have been little studied.

It is possible, however, to effectively mass-produce tens of millions of tree seedlings of a variety of species in the tropics, as evidenced by the success of the Haiti Agroforestry Outreach Project, and many other successful projects worldwide. Small home nurseries are providing new insights into nursery pest management strategies; lower disease incidence than found in the larger regional nurseries makes closer examination of these systems desirable. Greater biological diversity within and adjacent to the home nursery and fewer, better-spaced seedlings may account for the reduced disease incidence.

Minimizing losses to insects and diseases depends on the ability of the nursery manager or farmer to correctly identify and respond to the problem at hand. The nursery personnel must also understand the underlying causes of the problem and manage the nursery environment by supporting natural regulatory mechanisms to reduce the numbers of injurious organisms.

Literature cited

- Ehrlich, M.; Conway, F.; Adrien, N.; LeBeau, F.; Lewis, L.; Lauwerysen, H.; Lowenthal, I.; Mayda, Y.; Paryski, P.; Smucker, G.; Talbot, J.; Wilcox, E. 1985. Country environmental profile of Haiti. U.S. Agency for International Development, Washington, D. C. 120 p.
- Jacobson, M.; Stokes, J.B.; Warthen, J. D. Jr.; Redfem, R.E.; Reed, D. K.; Webb, R.E.; Telek, L. 1985. Neem research in the U.S. Department of Agriculture: An Update. Pages 31-42 in H. Schmutterere and K. R. S. Ascher, editors. Proceedings of the 2nd International Neem Conference, Rauischholzhausen, Federal Republic of Germany, 25-28 May, 1983. Dt. Ges. für Techn. Zusammenarbeit (GTZ) GmbH, Rosdorf: TZ-Verlagsgesellschaft.
- James, R. L. 1989. Effects of fumigation on soil pathogens and beneficial microorganisms. Pages 29-34 in T. D. Landis, Tech. Coordinator. Proceedings of the Intermountain Forest Nursery Association. Bismarck, North Dakota, August 14-18, 1989. USDA Forest Service General Technical Report RM-184. Rocky Mountain Forest and Range Experiment Station, Fort Collins, Colorado.
- Josiah, S. J. 1989. *Gid Pepinyèris* (Nursery Manual). Pan American Development Foundation. Le Natal, Port-au-Prince, Haiti. 224 p.
- Murray, G. F. 1981. Peasant tree planting in Haiti: a social soundness analysis. Unpublished document. USAID Contract # 521-000-C-00-1036-00. Port-au-Prince, Haiti. 30 p.
- Population Reference Bureau, Inc. 1988. World population data sheet. Fourteenth Street, N.W. Suite 8800, Washington, D.C. 2 p.
- Runion, G. B.; Reid, R. K.; Kelley, W. D. 1990. Pathology of nursery seedlings in Haiti: their etiology and control. SECID/Auburn Agroforestry Report No. 12, Haiti Agroforestry Research Project. SECID/Auburn University. USAID Contract # 521-0122-C-00-7104-00. 29 p.
- Runion, G. B.; Kelley, W. D. 1990. Biological, physiological and environmental factors affecting the health of trees important to Haiti. SECID/Auburn Agroforestry Report No. 19, Haiti Agroforestry Research Project. SECID/Auburn University. USAID Contract # 521-0122-C-00-7104-00. 101 p.
- Schneider, R. W., Ed. 1982. *Suppressive soils and plant disease*. American Phytopathological Society. 88 p.
- Schwab, A. 1988. *Fighting pests the natural way*. Pesticides Action Network (PAN-Europe), Brussels, Belgium. 46 p.
- Smucker, G.R. 1981. *Trees and charcoal in the Haitian peasant economy*. A feasibility study of reforestation. Unpublished document. USAID, Haiti. 81 p.
- Tourigny, G. 1987. *Pest survey and management options in Haiti's agroforestry tree nurseries*. A consultancy report prepared for the USAID Agroforestry Outreach Project, Port-au-Prince, Haiti. 82 p.
- USAID. 1984. *November fact sheet on Haiti*. United States Agency for International Development, Port-au-Prince, Haiti. 2 p.
- Wolcott, G. N. 1927. *Entomologie D'Haiti*. Republique D'Haiti, Port-au-Prince. 440 p.

Appendix

Table 1. Diseases observed on seedlings in Haitian nurseries, with associated pathogenic organisms (from Runion *et al.* 1990)

Tree species	Disease type	Pathogen genus
<i>Acacia auriculiformis</i>	Damping-off Leafspot Powdery Mildew	<i>Fusarium</i> , <i>Rhizoctonia</i> , Nematodes, <i>Pestalotia</i> <i>Oidium</i>
<i>Azadirachta indica</i>	Damping-off Leafspot “Carrot-top” “Yellowing”	<i>Fusarium</i> , <i>Rhizoctonia</i> , Nematodes <i>Cercospora</i> , <i>Phyllosticta</i> unidentified unidentified
<i>Cassia siamea</i>	Damping-off Leafspot Anthracnose Stem Blight / Vascular Wilt	<i>Alternaria</i> , <i>Cercospora</i> , <i>Diaporthe</i> , <i>Fusarium</i> , <i>Macrophomina</i> , <i>Myrothecium</i> , <i>Rhizoctonia</i> , Nematodes <i>Alternaria</i> , <i>Cercospora</i> , <i>Curvularia</i> , <i>Fusarium</i> <i>Fusoma</i> , <i>Macrophoma</i> , <i>Pestalotia</i> , <i>Rhizoctonia</i> <i>Colletotrichum</i> unidentified
<i>Catalpa longissima</i>	Leafspot Anthracnose	<i>Alternaria</i> , <i>Botrytis</i> , <i>Cercospora</i> <i>Colletotrichum</i>
<i>Casuarina equisetifolia</i>	Needle Blight Powdery Mildew	<i>Alternaria</i> , <i>Cercospora</i> <i>Oidium</i>
<i>Cedrella odorata</i>	Leafspot, Stem Blight / Vascular Wilt	<i>Cercospora</i> unidentified
<i>Citrus</i> spp.	Scab Blight / Canker Leafspot Anthracnose Root Rot	<i>Sphaceloma</i> <i>Fusarium</i> , <i>Phytophthora</i> <i>Alternaria</i> , <i>Fusarium</i> , <i>Phoma</i> <i>Colletotrichum</i> unidentified
<i>Coffea arabica</i>	Damping-off Leafspot Anthracnose Stem Blight / Vascular Wilt	<i>Rhizoctonia</i> <i>Alternaria</i> , <i>Cephalosporium</i> , <i>Cercospora</i> , <i>Mycena</i> , <i>Pestalotia</i> , <i>Phyllosticta</i> <i>Colletotrichum</i> unidentified
<i>Colubrina arborescens</i>	Stem Blight / Damping-off Stem Blight / Anthracnose Stem Blight / Vascular Wilt Leafspot	<i>Alternaria</i> , <i>Fusarium</i> <i>Colletotrichum</i> <i>Fusarium</i> <i>Alternaria</i> , <i>Cercospora</i> , <i>Myrothecium</i>

Tree species	Disease type	Pathogen genus
<i>Eucalyptus</i> spp.	Damping-off	<i>Fusarium, Phomopsis, Phytophthora</i>
	Anthracnose	<i>Myrothecium, Scolecotrichum</i>
	Stem Canker	<i>Colletotrichum</i>
<i>Eucalyptus</i> spp.	Leafspot	<i>Phomopsis</i>
	Powdery Mildew	<i>Alternaria, Cercospora, Curvularia, Myrothecium, Phytophthora, Sphaeropsis</i>
<i>Hibiscus elatus</i>	Powdery Mildew	<i>Oidium</i>
	Stem Blight	<i>Alternaria</i>
<i>Hibiscus elatus</i>	Damping-off	<i>Fusarium</i>
<i>Leucaena</i> spp.	Damping-off	<i>Alternaria, Fusarium, Myrothecium, Rhizoctonia</i>
	Stem Blight / Vascular Wilt	unidentified
<i>Mangifera indica</i>	Powdery Mildew	<i>Oidium</i>
	Leafspot	unidentified
<i>Persea americana</i>	Leafspot	unidentified
<i>Pinus occidentalis</i>	Needle Blight	unidentified
	Damping-off	unidentified
<i>Albizia saman</i>	Sooty Mold “Carrot-top”	<i>Capnodium</i> unidentified
<i>Simarouba glauca</i>	Stem Blight / Damping-off	<i>Fusarium</i>
<i>Swietenia mahogoni</i>	Stem Blight / Damping-off	<i>Fusarium, Macrophoma</i>
	Stem Blight / Anthracnose	<i>Colletotrichum</i>
	Stem Blight / Vascular Wilt	<i>Fusarium</i>
	Leafspot	<i>Alternaria</i>
	Leaf Blister	<i>Taphrina</i>

Diseases and insects in forest nurseries in India and their management

J.K. SHARMA (DIVISION OF PLANT PATHOLOGY)

AND

GEORGE MATHEW (DIVISION OF ENTOMOLOGY)

Kerala Forest Research Institute, Peechi 680 653
Kerala, India.

*Presented at the first meeting of IUFRO Working Party S2.07-09
(Diseases and Insects in Forest Nurseries), Victoria, British Columbia, Canada, August 22-30, 1990.*

Abstract

India's climate ranges from temperate in the northern Himalayas to tropical in the southern peninsula. Consequently, incidence and severity of seedling diseases also show tremendous variation, since they chiefly depend upon the prevailing climatic conditions and host species. Damping-off, which occurs throughout India, is the most serious disease of young seedlings. In temperate and drier regions, *Pythium*, *Fusarium*, and *Macrophomina* are the main nursery pathogens, whereas, in tropical humid regions, ubiquitous facultative parasites, *Rhizoctonia*, *Sclerotium*, and *Cylindrocladium* are the major pathogens causing a wide variety of serious diseases. Caterpillars (Order Lepidoptera) that defoliate seedlings are the most damaging insects in Indian forest nurseries. Root feeding insects such as termites and white grubs are also economically important in many forestry crops.

Though millions of seedlings of tree species are raised in forest nurseries every year throughout India, and pests and diseases take a heavy toll in some areas, their management is conventional and depends chiefly on chemicals. Control measures are attempted only when the diseases or pests have already appeared and have caused damage; prophylactic treatments are usually arbitrary and without any scientific basis. This paper describes some of the major seedling diseases and pests of important forest tree species in India, and highlights some of the lacunae which have to be remedied if scientifically sound practices for management of forest nursery pests in India are to be developed.

Resume

L'Inde se caractérise par la grande variété de ses climats régionaux, depuis la zone tempérée des régions septentrionales (Himalayas) jusqu'à la zone tropicale de la péninsule méridionale, d'où l'hétérogénéité des courbes d'incidence et de gravité des maladies affectant les semis. La fonte, présente dans toutes les régions du subcontinent indien, est la maladie la plus grave affectant les semis. Dans les régions tempérées et sèches, le *Pythium*, le *Fusarium* et le *Macrophomina* sont les principaux pathogènes des pépinières, tandis que dans les régions tropicales humides, les parasites hétéroxyènes ubiquistes *Rhizoctonia*, *Sclerotium* et *Cylindrocladium* sont les principaux pathogènes à l'origine d'une grande variété de maladies graves. Les chenilles de l'ordre des lépidoptères, qui défolient les semis, sont les insectes les plus nuisibles aux pépinières forestières indiennes. Les insectes rhizophages tels les termites et les hannetons ont également une incidence économique importante dans de nombreuses cultures forestières.

Bien que des millions de semis arboricoles soient cultivés chaque année dans les pépinières forestières de l'Inde et que les insectes nuisibles et les maladies causent beaucoup de ravages dans certaines régions, les méthodes employées pour lutter contre eux sont généralement de type conventionnel et à base de produits chimiques. Les moyens de lutte sont mis en oeuvre seulement après l'apparition de la maladie ou de l'insecte et de dégâts; et les thérapies prophylactiques sont habituellement arbitraires et ne procèdent d'aucune démarche scientifique véritable. Cette étude décrit quelques-unes des principales maladies et des principaux insectes qui ravagent les semis des plus importantes espèces arboricoles indiennes et met en lumière certaines des lacunes qui devront être redressées pour que l'Inde puisse élaborer des pratiques de gestion scientifiques des maladies et des insectes nuisibles qui ravagent ses pépinières forestières.

Introduction

With the increasing demand for wood in India, forestry has gained importance in recent years. A need for augmenting the productivity of the existing plantations by intensive management is being felt. However, as forest management becomes more intensive, more pests and diseases appear. This apparent increase is partially the result of high seedling densities (to accomplish increased production of seedlings), improper nursery practices, closer observations, and a greater concern about insect pests and diseases. The availability of healthy seedlings for planting is important to forest management. To meet this need, it is imperative to minimize or control pest insects and diseases, depending upon their seriousness and economic importance. In India, climatic conditions range from temperate in the northern Himalayas to tropical humid-warm in the southern peninsula, so incidence and severity of insect pests and diseases of seedlings also shows tremendous variation; these variations depend chiefly on the prevailing climatic conditions and the host species.

We do not intend to describe in this paper various types of nursery diseases or pests of different tree species and factors responsible for their development; they are already well known. Rather, we will provide information on some of the serious nursery diseases and insect pests of important plantation species in India and their control measures. As well, we will highlight the lacunae in the management of the nursery diseases and pests.

Status of diseases in forest nurseries

Under conducive conditions, seedlings of any tree species, whether hardwood or softwood or exotic or indigenous, may suffer from one or more diseases in the nursery. Every year millions of seedlings of different tree species are raised in forest nurseries throughout India, and diseases take a heavy toll, at least in some parts of the country. Close surveillance in nurseries for the occurrence of diseases is warranted so that proper control measures can be adopted before losses become evident. Proper control is possible only when the identity of a disease and its pathogen are known. Unfortunately, there exists a large gap in information on nursery diseases of various tree species in different parts of India; even available information is scattered in the literature. Except in Kerala state, where during the past decade systematic disease surveys have been conducted by Sharma and co-workers to identify nursery diseases of various tree species and to establish control measures of serious diseases, no such studies have been carried out in other parts of India. Bakshi *et al.* (1972) surveyed forest diseases in India; unfortunately, the survey was

not exhaustive and an urgent need for a systematic and intensive forest disease survey in all the states of India still remains. Lately, preservation of the natural forests has become the focus of considerable attention. Since we do not have much information on diseases of seedlings in natural forests, which may be very useful in restocking the degraded areas or gaps in natural forests, the Kerala Forest Research Institute has initiated detailed investigations on seedling diseases of indigenous tree species, including bamboos, reeds, and canes in natural forests as well as nurseries.

Nursery diseases and their management

In a tropical country like India, numerous nursery diseases are encountered. Each seedling species suffers from many diseases causing mortality at different growth stages. In Kerala, surveys conducted by Sharma *et al.* (1985) and Sharma and Sankaran (1987) recorded 35 seedling diseases on seven host species (*Ailanthus triphysa* (Dennst.) Alston, *Albizzia falcataria* L. Fosberg., *Bombax ceiba* Linn., *Dalbergia latifolia* Roxb., *Gmelina arborea* Roxb., *Eucalyptus*, and *Tectona grandis* L.) with which 49 pathogens were associated; eight diseases were identified as serious and six others were found to be potentially serious. Clearly the management of the large array of seedling diseases found in the tropics becomes complex; often, management practices adopted in the nursery fail to prevent diseases so chemicals are important in disease management.

Among the microbes, fungal pathogens cause heavy losses in forest nurseries. Damping-off of newly emerged seedlings, which occurs throughout India, is the most prevalent disease which can cause extensive mortality of seedlings. Other diseases such as various root rots, wilts, and leaf blights become important and cause further loss of older seedlings. The incidence and severity of a seedling disease is directly influenced by the level of susceptibility of the host seedlings in a particular environment; hence, most of the diseases have a spatial distribution. Since it is not possible to provide details of all the nursery diseases recorded on seedlings of all forest trees grown in India, details of only some of the major diseases that have a significant impact on plantation forestry are included here. For convenience, the seedling diseases are described separately for each host species rather than grouping them according to their symptoms.

Ailanthus triphysa

Ailanthus triphysa, which occurs naturally in southeast Asia, was introduced to India during early 1960s for its softwood used in the match industry. The tree suffers from many diseases in the nursery: damping-off and

collar rot are the most important diseases causing serious seedling mortality. Other diseases that affect this species are seedling blight (*Colletotrichum dematium*), stem infection (*Botryodiplodia theobromae*), shot-hole (*Colletotrichum* state of *Glomerella cingulata*), sooty mold (*Meliola ailanthi*), and bacterial leaf spot (*Pseudomonas solanacearum*) (Sharma *et al.* 1985).

Damping-off: The disease occurs within 2 weeks of seed germination when the first pair of leaves emerges out of the soil. It causes 50 to 60% mortality of seedlings under the dense shade provided over the seedbeds and if there has been excess watering. The disease can be controlled effectively by two soil drenches of Dithane M-45 (mancozeb) (0.05% a.i. and 0.02% a.i.) applied at weekly intervals.

Collar rot: This is the most widespread and serious disease among all the nursery diseases of *A. triphysa*. The disease usually appears when the seedlings are 1 month old and it often continues to affect seedlings for 3 to 4 months; it can result in 30 to 60% mortality. Collar rot is effectively controlled by two soil drenches of MEMC (Emisan-6) (0.005% a.i.) at an interval of 10 to 15 days, depending upon the age of the seedlings.

Albizia falcataria

Albizia falcataria, one of the fast growing species suited for humid tropics, is a native of Moluccas, New Guinea and the Solomon Islands. It was introduced into India as part of an afforestation program. Two serious nursery diseases (web blight caused by *Rhizoctonia solani* state of *Thanatephorus cucumeris* and *Fusarium* wilt by *F. solani*) have been recorded in Kerala by Sharma and Sankaran (1987); web blight has also been recorded in Assam (Agnihotrudu 1962).

Web blight: Seedling mortality from web blight varies by locality depending upon seedling age and density. This disease can be controlled by applying a prophylactic soil drench of Bavistin (carbendazim) (0.05% a.i.) a week before sowing the seeds. After appearance of the disease, however, at least two applications of Bavistin (0.1% a.i.) at weekly intervals are necessary.

Fusarium wilt: This disease, recorded in 1- to 3-month-old seedlings, may cause up to 75% mortality. The rapid increase of the disease incidence is partially controlled by regulating the watering frequency. Complete control of wilt is achieved by drenching the seedbeds with Dithane M-45 (0.03% a.i.) or Bavistin (0.02% a.i.).

Casuarina equisetifolia

In India, *Casuarina equisetifolia* Forst. was introduced along the east and west coast in the latter half of the last century, primarily to meet the growing fuelwood demand. Damping-off, seedling blight, stem canker, and root rot are common diseases caused by *Rhizoctonia solani*, all of which cause significant losses (Mohan and Sharma 1990). Of these, only the first two are serious enough to warrant discussion here.

Damping-off: Damping-off is most prevalent in over-watered, shaded seedbeds. To alleviate disease losses, watering should be temporarily suspended and lighting improved. The disease is controlled by Vitavax (carboxin) (0.01% a.i.).

Seedling blight: Seedling blight is most common on 2- to 3-month-old seedlings. Vitavax (0.01% a.i.) is a very effective control.

Eucalyptus spp.

Eucalyptus grandis Hill ex Maid and *E. tereticornis* Sm. have become the most widely planted exotic species in India because of their fast growth, adaptability, and high value for pulp and paper. Diseases are especially damaging in high rainfall (>1500mm) areas and as many as 14 nursery diseases have been recorded on these species in India. Damping-off, web blight, seedling blight, and leaf blight appear almost in a succession and form a disease complex. Some of these diseases may result in almost 100% seedling mortality in certain areas. Other diseases are *Cylindrocladium* cotyledon spot (*C. quinqueseptatum*), seedling wilt (*Sclerotium rolfsii*), stem infections (*C. quinqueseptatum*, *C. ilicicola*, and *C. clavatum*), leaf spots (*Bipolaris spicifera*, *Phaeoseptoria eucalypti*, and *Exserohilum rostratum*), root rots (*C. curvatum*, *Sclerotium rolfsii*, and *Rhizoctonia solani*), and charcoal root rot (*Macrophomina phaseolina* and its anamorph *Rhizoctonia bataticola*) (Sharma *et al.* 1985; Soni *et al.* 1985).

Damping-off: Numerous pathogens such as *Rhizoctonia solani*, *Pythium deliense*, *P. myriotylum*, *P. spinosum*, *Cylindrocladium quinqueseptatum*, *C. floridanum*, *C. parvum*, and *Fusarium oxysporum* have been isolated from damped-off eucalypt seedlings. Post-emergence damping-off occurs more commonly than pre-emergence damping-off. The disease spreads rapidly under high soil moisture and high seedling density. This disease is effectively controlled by treating seedbeds with Bavistin, Dithane M-45, and MEMC (Sharma and Mohan 1990) separately with an interval of 4 hours between treatments. After appearance of the disease,

watering is reduced to a bare minimum until application of fungicides.

Webblight: Web blight of eucalypts, recorded in humid areas of the country, is caused by *Rhizoctonia solani*, anamorph of *Thanatephorus cucumeris* (Sharma *et al.* 1985). Young seedlings (4 to 8 weeks old) are killed outright, but older seedlings (more than 10 weeks old) remain alive for some time before dying. MEMC applied as a soil drench is very effective in web blight control. After the appearance of web blight, reduction in watering of seedbeds is recommended to check spread of the disease.

Seedling blight: Seedling blight, affecting 1- to 2-month-old seedlings, may result in heavy mortality (up to 75%) of seedlings. The disease is caused by *Cylindrocladium quinquesepatum*, *C. ilicicola*, *C. parvum*, *C. clavatum*, *C. camelliae*, and *C. scoparium*. Seedling blight is controlled effectively by Bavistin (carbendazim) (0.01 to 0.02% a.i.) applied as foliar and soil drenches (Sharma and Mohanan 1990). A second application of the fungicide may be necessary if the disease persists as the result of favorable weather.

Cylindrocladium leaf blight: Leaf blight caused by species of *Cylindrocladium* (*C. quinquesepatum*, *C. ilicicola*, *C. clavatum*, *C. scoparium*, and *C. colhounii*) is one of the most important and widespread diseases in eucalypts throughout India (Sharma *et al.* 1984; Nair and Jayasree 1986); severe losses occur in high rainfall areas. If remedial measures are not taken immediately after the appearance of this disease, high mortality (up to 100%) may result within 1 month. Bavistin (0.01 or 0.02% a.i., depending upon the disease severity) applied as a foliar drench is highly effective in controlling the leaf blight. In the case of severe outbreaks, a second application may be necessary.

Since a single pathogen can cause many diseases of eucalypts and a single disease can be caused by many pathogens, control of the disease complex poses special problems. To manage this disease complex, Sharma and Mohanan (1990) have standardized nursery practices and integrated control measures; they recommend proper management (with adequate shade, an optimum soil moisture regime, appropriate seedling density, etc.) in concert with prophylactic fungicidal treatment.

Pinus spp.

Many species of indigenous and exotic hard pines are raised in India to meet the increasing demand for pulp and paper. Since in India these pines are grown both in temperate and tropical conditions, depending upon the

species, many different diseases such as damping-off, seedling wilt, charcoal root rot, needle blight, and rusts are encountered (Bakshi *et al.* 1972; Reddy and Pandey 1973; Jamaluddin *et al.* 1981; Sujan Singh *et al.* 1982, 1983); details of some of the important diseases are provided below.

Damping-off: This is the most widespread and serious disease in pine nurseries. Up to 100% mortality can occur in exotic pines such as *Pinus elliottii* Engelm., *P. occidentalis* Sw., *P. oocarpa* Schiede., and *P. kesiya* Royle ex Gord. *Rhizoctonia solani* is usually the main damping-off pathogen; *Pythium* and *Fusarium* are less common. In North Bengal and Andhra Pradesh nurseries, damping-off is controlled by sterilization of nursery soil with formalin at least 10 to 12 days before seed sowing. In Madhya Pradesh, damping-off losses have been controlled by treating the soil with copper oxychloride.

Seedling wilt: Seedling wilt caused by *Fusarium solani* is also common in pine nurseries, especially on *P. caribaea* Morelet, *P. elliottii*, and *P. patula* Schlecht. & Cham. in Uttar Pradesh and North Bengal. Seedling mortality is very severe (80%) up to 6 months after pricking the seedlings into containers. No effective controls are known.

Cercoseptoria needle blight: This disease, also known as "brown needle disease", is caused by *Mycosphaerella gibsonii* (conidioma *Cercosepteria pini-densiflorae*; spermogonia *Asteromella* sp.). The pathogen, inadvertently introduced into India, continues to seriously damage pine nursery seedlings in Uttar Pradesh and Andhra Pradesh, where the disease incidence is as high as 100% on some pines. The disease is serious in hard pines (*P. clausa*, *P. caribaea*, and *P. patula*) raised on unsuitable sites, such as those with a high soil pH. Dithane M-45 and Cuman LC, applied immediately after the first rains, effectively control the disease.

Populus spp.

Besides *Populus Ciliata*, an indigenous poplar occurring in the Himalayas from Kashmir to Bhutan, other exotic poplar species such as *P. deltoides* Bartr., *P. alba* L., and *P. xeuramericana* (Dode) Guinier are raised in plantations in northern India. Besides the diseases described below, *Alternaria* tip blight (*Alternaria* stage of *Pleospora infectoria*) and *Melampsora* rust (*M. Ciliata*) also occur in poplar nurseries in northern India (Sujan Singh *et al.* 1983).

Cladosporium leaf spot: This disease, caused by *Cladosporium humile*, affects *Populus ciliata* Wall. ex Royle and *P. albainn* nurseries in Uttar Pradesh, Himachal Pradesh, and Jammu and Kashmir (Sujan Singh et al. 1983). The disease causes extensive premature defoliation, consequently it affects seedling growth. Dithane M-45 is very effective in controlling leaf spot.

Ganoderma root rot: In Punjab state different species of *Populus* suffer from a root rot caused by *Ganoderma lucidum* (Bakshi et al. 1972). The disease causes up to 100% mortality of nursery seedlings.

Botryodiplodia set rot: A severe rot of cuttings of *P. yunnanensis* Dode, *P. deltoides*, and *P. ciliata* is prevalent in the states of Himachal Pradesh and Uttar Pradesh. This rot, caused by *Botryodiplodia palmarum*, kills the new shoots within 4 to 6 weeks of sprouting; in severe cases cuttings do not sprout at all.

Tectona grandis

Tectona grandis (teak), indigenous to India and other southeast Asian countries, is the major plantation species. The most common diseases are a rust followed by bacterial collar rot, *Rhizoctonia* collar rot, and mildew.

Rust: Rust, caused by *Olivea tectonae*, is widespread in nurseries of Andhra Pradesh, Madhya Pradesh, and Kerala, especially in dry areas. Rust severity varies greatly by locality and year depending upon weather conditions (chiefly rainfall). Severe outbreaks cause premature defoliation, which may affect seedling growth. The rust is controlled by foliar sprays of sulphur-based fungicides (Khan 1951) and Plantvax (Sharma et al. 1985).

Bacterial collar rot: This disease, caused by *Pseudomonas solanacearum*, usually affects young (4 to 5 months old) teak seedlings (Sharma et al. 1985); about 5 to 10% of seedlings are killed in patches, and seedling mortality increases when soil moisture is high. The disease is successfully controlled by an application of Plantamycin (0.01% a.i.) as a soil drench. Collar rot can also be effectively managed by adopting appropriate cultural and nursery management practices.

Rhizoctonia collar rot: A serious collar rot disease caused by *Rhizoctonia solani* (anamorph of *Thanatephorus cucumeris*) affects young seedlings (40 to 45 days old). Disease incidence varies from 5 to 25%; high humidity and high seedling density are predisposing factors. Several fungicides such as carbendazim, thiophanate methyl, carboxin, and MEMC are effective against this disease (Mohamed Ali and Florence 1990).

Powdery mildew: Powdery mildew of teak caused by *Uncinula tectonae* affects mature teak seedlings (1 year and older). In the nurseries of Kerala, Andhra Pradesh, and Madhya Pradesh (Bakshi et al. 1972; Sharma et al. 1985), triadimeno, quinomethionate, and tridemorph (Kulkarni and Siddaramaiah 1979) effectively control this disease.

Insect pest problems in forest nurseries

Very little information is available on the insect pests of forest nurseries in India. However, based on the information available in the literature (Beeson 1941; Mathew 1986; Mathew and Nair 1985; Singh and Ahmad 1989; Thakur 1989; Varma 1984; Singhet al. 1982) five types of major pest problems (damage by white grubs, termites, cut worms, defoliators, and sap-sucking insects) that are recognized in the forest nurseries in India are described below.

White grubs

White grubs are polyphagous pests that make their appearance during the rainy season. Many scarabaeid root grubs damage seedlings in nurseries or in young plantings. Of these, two species belonging to the genus *Holotrichia* (*H. consanguinea* and *H. longipennis*) are the most widely distributed in India and they attack several tropical species. *Hilyotrogus holosericea*, *Granida albosparsa*, *Brahmina* spp., *Hoplia advena*, and *Melolontha fuscicauda* are associated with coniferous trees, mostly pines, in the temperate zones at high elevations of 1500 to 3000 m (Beeson 1941). Most of these insects have a prolonged life cycle which takes 1 to 2 years for completion. In nursery beds, damage by root grubs results in patch mortality of seedlings.

Management of white grubs using insecticides such as Phorate, Carbofuran, Aldicarb, Heptachlor, and Aldrin has been suggested, but success depends on the time of application. Usually the insecticides are applied after the first rains (in April or May) and again after the monsoon (September).

Termites

Termite attack is very common in both nurseries and young plantations. Usually the tap root, which is characteristically taper-shaped, is attacked. The first aboveground symptom of termite attack is the drooping of tender leaves and wilting; this is followed by seedling mortality. *Eucalyptus* spp. are the most susceptible, although attack has been noticed in several species including *Casuarina equisetifolia*, *Tectona grandis*, and *Shorea robusta* (Beeson 1941). In India, the important termites causing damage are *Odontotermes microdentatus*, *O. obesus*, and *Microtermes obesi*

(Thakur 1989). Treatment of the nursery bed or container seedlings with organochlorine insecticides like Heptachlor or Aldrin is recommended (Nair and Varma 1981).

Cutworms

Cutworms are well known pests in agriculture and forestry. They generally attack seedlings in nurseries and young plantations, cutting-off tender shoots at ground level and removing buds and leaves which may be eaten or dragged to the insect's hiding place. Consequently, the cut portion of the seedling is usually not visible. In India, the noctuid *Agrotis ipsilon* is the most widely distributed cutworm affecting numerous host plants including *Cedrus deodara*. Eggs are laid in small groups on the ground and the larvae hide in the soil during the day and emerge to feed at night. Pupation occurs in the soil. The life cycle is completed in about 2 months. Soil application of granular pesticides as well as foliar spray of systemic insecticides are recommended controls.

Defoliators

Besides cutworms, several leaf-feeding insects often cause serious damage in forest nurseries. Caterpillars, beetles, and grasshoppers belong to this category. Of these, caterpillars can cause serious damage by building up in large numbers within a short period. These insects occur in numerous habits and include concealed feeders like *Adoxophyes moderata* (on *Albizia falcataria*) *Archips micaceanus* (on *A. falcataria* and *Eucalyptus* spp.) which roll the leaves and feed from the inside, as well as surface feeders like *Eurema blanda* (on *Albizia falcataria*), *Ophiusa janata*, *Prodenia litura*, and *Lymantria* spp. (on *Eucalyptus* spp., *Shorea robusta* Gaertn. f. and *Populus* spp.) as well as the defoliator *Hyblaea puera* (on teak). Incidence of leaf-feeding beetles and orthopterous insects (*Brachytrypes portentosus*, *Gymnogryllus erythrocephalus*, and *G. humeralis* attacking *Casuarina equisetifolia* and *Caloptenopsis* sp., *Chrotogonus* sp., and *Catantops indicus*) attacking pines have also frequently damaged forest nursery seedlings. Control strategies involve applying organophosphorus insecticides like Dimethoate, Malathion, Phosphamidon, and Quinalphos.

Sap-sucking insects

Occasional build-up of sap-sucking thrips (Thysanoptera) and insects in the hemipteran families Aleyrodidae, Aphididae, Membracidae, Coccidae, Psyllidae, and Miridae also occur in forest nurseries. Their attacks result in the crinkling of leaves, shoot dieback, or even seedling death. Instances of shoot

dieback as the result of the membracid *Oxyrachis tarandus* is common in *Albizia falcataria* nurseries and plantations. The coccid *Pulvinaria maxima* attacks tender shoots of *Azadirachta indica* A. Juss. causing dieback. Usually these insects are associated with certain ants, which often play a role in their distribution. Attack by thrips results in the crinkling of the leaves and very often detection of the causal organisms is difficult. Since the incidence rate of sap-sucking insects in forest nurseries is very low as compared to the root or leaf feeding insects, very few studies have been made on their control.

Conclusion

Management of a nursery is a specialized forestry activity. Some disease and insect problems associated with forest plantations are directly affected by nursery management practices, since affected nursery stock may contribute to the distribution and spread of pathogens and insect pests, as occurred in the case of *Cylindrocladium* leaf blight of eucalypts in Kerala (Sharma 1986). Consequently, it is important to control insects and diseases in the nursery.

Since insect pests vary with plant species and also with ecoclimatic region, detailed studies are necessary to identify potential foliage pests (e.g. leaf feeding beetles, grass hoppers, and crickets) and root pests (termites and white grubs). Among the foliage pests, caterpillars belonging to order Lepidoptera are the most damaging in forest nurseries. Among the root pests, several species of termites and white grubs are equally important. Once the most serious nursery pests in different regions are identified, detailed studies need to be undertaken on their management. Although, at present, standard recommendations using insecticides are already available for the management of several pests, ecological information such as pest occurrence and importance, natural incidence of various bio-control agents, and the impact of pesticides on other organisms is not available. Such information is essential to develop a scientifically sound management strategy against nursery pests.

In any disease control strategy, the recognition of the disease and its etiology are essential since diseases like damping-off can be caused by many organisms, as is the case in eucalypts. Secondly, the relationship of epidemiology of seedling diseases and nursery practices, which has implications in disease control strategies, has been studied much less than disease etiology or ecology. For integrated control, therefore, epidemiology of some of the serious diseases needs to be related to management practices. Furthermore, though the results of nursery trials are always useful in judging the

effectiveness of a fungicide under various climatic and soil conditions, preliminary laboratory screenings should always be made to eliminate ineffective fungicides. Unfortunately, many chemical control studies are initiated in forest nurseries rather than in the laboratory, assuming that a fungicide effective against a particular pathogen on one host will also be effective against the same pathogen on another host; the host origin of the pathogen and the possibility of dealing with a different biotype or strain (which may behave differentially to fungicide) are ignored, and this may result in partial control or no control of the disease. More importantly, the screening method should be appropriate to the type of pathogen. For example, for a pathogen like *R. solani* producing microsclerotia, the soil-fungi screening method is more appropriate than the poisoned-food method. If the effective fungicides are selected on the basis of the poisoned-food method, it is likely that the disease will be successfully controlled.

Rhizoctonia solani is one of the most widespread nursery pathogens in tropical India, where it can cause several destructive diseases. Surveys by Sharma and his coworkers in Kerala indicate that *R. solani* affects numerous hosts; of 22 hosts surveyed, 10 are affected.

Rhizoctonia solani is a ubiquitous and opportunistic pathogen that should not be ignored.

For the control of most of the seedling diseases and insect pests in India, there is an emphasis on chemicals. This occurs because when forest departments establish nurseries, their top priority is to raise seedlings – no importance is given to imminent disease or insect problems which can be avoided by following appropriate cultural and nursery management practices. And when disease or insect problems occur and cause damage, immediate control measures are sought to save the stock. In this situation, the only remedial measures possible involve the use of chemicals. In the absence of forest pathologists in each state, advice for controlling diseases is taken in most cases from local agricultural plant pathologists who are unaware of the disease control strategies appropriate to forest nurseries. To overcome these difficulties it is essential to publish nursery manuals and extension bulletins on a regional basis. These publications should include details of standardized nursery and cultural practices for a particular seedling crop, its insect and diseases problems, and strategies for their management. This requires the concerted effort of foresters, forest pathologists, and entomologists.

References

- Agnihotrudu, V. 1962. Outbreaks and records. Two species of *Pellicularia* parasitic on *Albizia falcata* in Assam. *FAO Plant Prot. Bull.* 10:143-145.
- Bakshi, B.K.; Reddy, M.A.R.; Puri, Y.M.; Sujan Singh. 1972. Forest disease survey (Final Technical Report) Forest Research Institute & Colleges, Dehra Dun, India. 117 p.
- Beeson, C.F.C. 1941. The ecology and control of forest insects of India and the neighbouring countries. Vasant Press, Dehra Dun. 1007 p.
- Jamaluddin; Dadwal, V.S.; Soni, K.K. 1981. Studies on charcoal root rot of *Pinus caribaea*. *Indian For.* 108:618-622.
- Khan, A.H. 1951. Some diseases observed in teak plantations of the Punjab. *Pakist. J. Sci. Res.* 7:92-99.
- Kulkarni, S.; Siddaramaih, A.L. 1979. Chemical control of powdery mildew of teak. *Current Research* 8:192-193.
- Mathew, G. 1986. Insects associated with forest plantations of *Gmelina arborea* Roxb. in Kerala, India. *Indian J. For.* 9:308-311.
- Mathew, G.; Nair, K.S.S. 1985. Insects associated with forest plantations of *Paraserianthes falcataria* in Kerala, India. *Malaysian Forester* 48:200-205.
- Mohamed Ali, M.I.; Florence, E.J.M. 1990. Studies on collar rot of teak seedlings. *Indian For.* (In Press).
- Mohan, C.; Sharma, J.K. 1990. Occurrence of new diseases of *Casuarina equisetifolia* in India. *Indian For.* 115:33-37.
- Nair, J. Madhavan; Jayasree, M.C. 1986. Occurrence of *Cylindrocladium colhounii* Peirally on eucalypts in Kerala. *Curr. Sci.* 55:799-800.
- Nair, K.S.S.; Varma, R.V. 1981. Termite control in eucalypt plantations. *Kerala For. Res. Inst. Res. Rep.* 6, 48 pp.
- Reddy, M.A.R.; Pandey, P.C. 1973. *Cercospora* needle blight of *Radiata* pine in India. *Indian For.* 99:308-309.
- Sharma, J.K. 1986. Potential threat of native pathogens on exotic eucalypts in Kerala. Pages 367-376 in J.K. Sharma, C.T.S. Nair, S. Kedhamath and S. Kondas, Editors. *Eucalypts in India: past, present and future*. Proceedings of the national seminar on eucalypts in Indian forestry - Past, present and future, Kerala, Jan. 30-31, 1984. *Forest Res. Inst., Peechi, Kerala, India.*
- Sharma, J.K.; Mohanan, C. 1990. Epidemiology and control of nursery diseases of *Eucalyptus* caused by *Cylindrocladium* spp. in Kerala. *Kerala For. Res. Inst. Res. Rep.*, 165 p (Draft).
- Sharma, J.K.; Sankaran, K.V. 1987. Diseases of *Albizia falcataria* in Kerala and their possible control measures. *Kerala For. Res. Inst. Res. Rep. No. 47*, 50 p.
- Sharma, J.K.; Mohanan, C.; Florence, E.J.M. 1984. Nursery diseases of *Eucalyptus* in Kerala, India. *Eur. J. For. Pathol.* 19:77-87.

-
- Sharma, J.K.; Mohanan, C.; Florence, E.J.M. 1985. Disease survey in nurseries and plantations of forest tree species grown in Kerala. Kerala For. Res. Inst. Res. Rep., No. 36, 268 p.
- Singh, P.; Ahmed, M. 1989. Insect fauna of *Casuarina equisetifolia*. Proceedings of Third Forestry Conference, Forest Res. Institute, Dehra Dun, 1989.
- Singh, P.; Mararrat Fasih; Prasad, Ganga. 1982. Insect pests of exotic pines in India. Indian For. 108:93-107.
- Soni, K.K.; Dadwal, V.S. and Jamaluddin. 1985. Charcoal root rot and stem rot of *Eucalyptus*. Eur. J. For. Path, 15:397-401.
- Sujan Singh; Khan, S.M.; Misra, B.M. 1983. Some new and noteworthy diseases of poplars in India. Indian For. 109:636-644.
- Sujan Singh; Khan, S.M.; Misra, B.M.; Uniyal Kamla. 1982. Some important diseases of hard pines in India. Indian For. 108:86-82.
- Thakur, M.L. 1989. Insect pest problems in experimental forest nurseries at New Forest, Dehra Dun (U.P) and their control. Third Forestry Conference, Forest Research Institute, Dehra Dun, India, 1989.
- Varma, R.V. 1984. New records of insects damaging *Eucalyptus* in the nurseries in Kerala, India. Indian J. For. 7:160-161.

Diseases and insect pests in forest nurseries in Italy

P. RADDI

C.S. Patologia specie legnose montane, C.N.R.

P. CAPRETTI AND R. TIBERI-IST

Patologia e zoologia forestale e agraria, Universita, Florence, Italy.

Presented at the first meeting of IUFRO Working Party S2.07-09

(Diseases and Insects in Forest Nurseries), Victoria, British Columbia, Canada, August 22-30, 1990.

Abstract

This paper reviews the main disease and insect problems in Italian forest nurseries. Also included is information on management of these pests. Some of the major diseases that are covered include cypress canker, pine twist rust, diseases of chestnut seedlings, and powdery mildew of *oak*. Besides the narrative on nursery insects, a table is presented that summarizes host plants affected, when damage occurs, and the severity of damage.

Resume

Ce document passe en revue les principales difficultés liées aux maladies et aux insectes rencontrées dans les pépinières forestières de l'Italie. Il comprend également de l'information sur la gestion de ces ravageurs. Parmi les principales maladies dont il est question figurent le chancre du cyprès, la rouille du pin, les maladies des semis de châtaignier et l'oïdium du chêne. A l'exposé narratif sur les insectes des pépinières s'ajoute un tableau qui résume des informations sur les plantes hôtes, le moment où surviennent les dommages et la gravité de ces dommages.

Introduction

In Italy there are about 300 forest seedling nurseries with a total area of 800 hectares. In 1987 these nurseries produced some 30 million conifer and 25 million broadleaved seedlings (including 5 million rooted poplar cuttings). Italian nurseries are run by the "Regioni" (regions or regional governments) which in the last few years have closed down many nurseries because they were too small, or badly sited (e.g. with respect to their soil) or because it was not possible to mechanize the cultural practices. In spite of this re-organization, many nurseries are still too small to be economically viable or are located on unsuitable terrain. Nursery personnel also often lack adequate professional training. These deficiencies affect both the quantity and quality of the seedlings produced, and this has a negative impact on forest production. Also, there are very few researchers who specialized in the diseases and pests of forest nursery seedlings. This can result in infected stock being outplanted or the introduction of pests into pest-free areas, or both. In this paper we concentrate on diseases and insects in central and south Italian nurseries. Pests of northern Italian nurseries tend to be ones that are already fully described in the standard manuals of plant pathology and entomology.

The climate of the area we are concerned with is characterized by long dry summers (longer in the south),

mild rainy winters, and variable springs. The summer affects the life cycle of pathogenic fungi and reduces the incidence of foliar diseases while the mild winters and variable springs result in premature early growth and possible damage from late frosts. The major diseases are described below with notes on their distribution, their hosts, damage caused, disease progression, and the methods used to control them. Limited coverage of some diseases and pests indicates that in-depth information about them is still unavailable, and that more research is needed. Information about diseases in nurseries in Italy is summarized in Table 1.

Cypress canker

Cypress canker, caused by *Seiridium cardinale*, is one of the most important diseases in central Italian nurseries. The pathogen was first reported in California in 1928 and since then it has spread and become common in Europe (especially Italy, France and Greece), Israel, New Zealand, Australia, Africa and South America. Cypress canker causes serious losses in seedling stock. The movement of diseased stock resulted in the disease being spread rapidly throughout Italy and other Mediterranean basin countries. Significant losses have been suffered by nurseries in the Pistoia area, where Italian cypress clones, for ornamental purposes, are produced by grafting.

Table 1. Nursery seedling diseases and references to studies that have been done on them in Italy

Host(s)	Type of damage and causes	Pathogen	References
Broadleaf			
<i>Populus</i> spp.	Root rot in plantations with fluctuating water tables	<i>Rosellinia necatrix</i>	6-25
<i>Acer</i> spp.	Foliar necrosis, premature defoliation	<i>Rhytisma acerinum</i> <i>Uncinula aceris</i>	4
<i>Castanea sativa</i>	Leaf chlorosis and necrosis	<i>Mycosphaerella maculijormis</i>	31
<i>Eucalyptus</i> spp.	Premature defoliation of young trees	<i>Oidium</i>	6-15
<i>Juglans regia</i>	Leaf chlorosis, necrosis and black lesions on petiole	<i>Xanthomonas campestris</i> pv. <i>Juglandis</i>	6-22
<i>Populus</i> spp.	Premature defoliation, reduced growth	<i>Marssonina brunnea</i>	6,7
<i>Quercus</i> spp.	Premature defoliation, stunted growth	<i>Microsphaera alphitoides</i>	1-6
<i>Q. ilex</i>	Dieback	<i>Phyllosticta</i>	6
<i>Pinus nigra</i>	Dieback of 1 and 2-year old needles and seedlings	<i>Lophodermium seditiosum</i>	22
<i>P. sylvestris</i>			
<i>Eucalyptus bicostata</i>	Stem and branch dieback associated with cold winds	<i>Botrytis cinerea</i> <i>Cercospora</i> sp.	6-25 6-18
<i>E. maidenii</i>			
<i>E. globulus</i>			
<i>Populus</i> spp.	Bark necrosis on stems - branches of seedlings under weather stress, bronze lesions	<i>Dothichiza populea</i> <i>Phomopsis polloide</i> <i>P. tyrrenica</i> <i>Cytospora chrisosperma</i>	6 6 6 6
<i>Q. ilex</i>	Stem - branch dieback	<i>Diplodia</i> sp.	23
Conifer			
<i>Cupressus</i> spp.	Stem-branch dieback	<i>Pestalotia</i> sp. <i>Phomopsis</i> sp. <i>Seiridium cardinale</i>	22 22 22
<i>Larix decidua</i>	Dieback of the shoots and small cankers on stems	<i>Lachnellula willkommii</i>	22
<i>Picea excelsa</i>	Branches and shoot dieback	<i>Herpotrichia juniperi</i>	24
<i>P. pungens</i>			
<i>Pinus nigra</i>	Dieback of stems and seedlings	<i>Cronartium flaccidum</i>	22
<i>P. pinea</i>			
<i>P. pinaster</i>		<i>Melampsora pinitorqua</i>	22
<i>P. pinea</i>	Shoot dieback on seedlings under water stress	<i>Sphaeropsis sapinea</i> (<i>Diplodiapinea</i>)	6
<i>P. radiata</i>			
<i>P. nigra</i>	Lateral shoot dieback	<i>Sclerophoma pithyophila</i>	
<i>P. sylvestris</i>			
<i>P. pinea</i>	Lateral shoot dieback	<i>Brunchorstia pinea</i>	2
<i>P. sylvestris</i>			

The species of cypress most susceptible to the disease are *Cupressus macrocarpa*, *C. pygmaea*, *C. abramsiana*, *C. goveniana*, the common or Italian cypress (*C. sempervirens*) and *C. arizonica*. The most resistant species are the smooth cypresses (*C. glabra*), *C. funebris*, *C. torulosa* and *C. bakeri*. Other ornamental Cupressaceae which have become infected in the nursery with varying amounts of damage include *Thuja orientalis*, *T. orientalis* 'pyramidalis aurea', *Cupressocyparis leylandii*, *Juniperus communis*, and *J. communis* 'Hibemica'.

Cankers may occur anywhere on the stem or branches. A characteristic symptom is resin flow from the affected area. Subsequently this area becomes sunken and tends to spread lengthwise along the stem or branch. As the bark dies it becomes bronze-colored and the canker forms. Under favorable conditions conidia-containing pustules (acervuli) form. Dissemination of the fungus is through dispersal of the conidia by rain, wind, the insect vector *Phloeosinus aubei*, and birds.

When detected early enough, control can be achieved by sanitizing infected nursery seedlings and large trees growing in the area around the nursery. Chemical control is economically feasible and consists in spraying with benomyl (100 g/100 L) and methyl thiophanate (120 g/100 L), twice in the spring and once in autumn. In 1975, a resistance breeding program against cypress canker was started at our establishment. The program was financed by the national research council of Italy and the European Economic Community. The results have been very good and five resistant clones suitable for ornamental plantings have already been patented and made commercially available. We are continuing work on identifying individuals with high general combining ability (GCA) that can be used to establish clonal seed orchards for seedling production for afforestation.

Diseases of pine seedlings

Pine twist rust

Pine twist rust, caused by *Melampsora pinitorqua*, sometimes occurs on pine seedlings. This fungus attacks young 2-needle pines growing near trembling aspen (*Populus tremula*). This disease reaches epidemic levels when conditions are favorable, as during cold wet springs. Uredial and telial stages of the rust occur on *Populus alba* and *Populus canescens*, in summer and autumn, and the following spring the pycnial-aecial stages are produced which lead to infection of pine shoots at flushing. The first sign of disease appears on the new shoots in May or June as yellowish-orange spots which break open, liberating masses of powdery aecioconidia. The disease is most damaging when it occurs during the first growing season, in which case

seedling mortality is certain. Seedlings attacked after the first year of growth are not usually killed but growing shoots are badly deformed, i.e., they are bent into an S-shape, or dieback of the smaller branches may occur. The latter delays seedling growth. The rust is most prominent in nurseries near natural stands of trembling aspen (in the Appennine regions, Tuscany, and Liguria). There the most susceptible pines are *P. sylvestris*, *P. pinaster*, *P. pinea* and *P. halepensis*. *Pinus nigra* var. *austriaca* and *P. nigra* var. *calabrica* are only susceptible as very young seedlings.

Removing diseased trembling aspen, by cutting or with silvicides, before telia form reduces overwintering inoculum so infection of pine seedlings does not occur the following spring. This practice must be repeated each year for the first 4-5 years of seedling growth (when seedlings are particularly susceptible) until they reach a height of 2 m. Spraying in April or May with 2-3% captan or with Bayleton also controls the disease.

Blister rust of 2-needle pines

This disease, *Cronartium jilacidum*, is especially prevalent in central and southern Europe. The rust is heteroecious with stages 0 and I on *Pinus sylvestris*, *P. nigricans*, *P. laricio*, *P. montana*, *P. pinaster*, *P. pinea*, *P. halepensis*, and stages II and III on various herbaceous perennials such as white swallow wort (*Vincetoxicum*), *Peonia*, or *Gentiana*. In Italy, the most common species of *Cronartium* is *C. jilacidum* f. sp., whose alternate host is *V. hirundinaria*. Telia form on the abaxial surface of alternate host leaves during summer and autumn. Teliocidia germinate soon after formation, and the basidiospores result in infection of young pine needles. Mycelium of the fungus penetrates needle tissues and then moves into the bark and the wood, developing especially along the parenchymatic rays and concentrating in the phloem. One or often 2 years after penetration, pycnidia develop under the periderm of the infected twig, which has become slightly thickened. Pycnidia produce characteristic drops of viscous translucent liquid containing the spermatia. The following spring, several conspicuously yellow aecial blisters erupt. At maturity these blisters break open along their margins, releasing clouds of conidia which infect *Vincetoxicum*.

In the nursery damage from this rust is considerable even though the disease occurs in cycles. Hosts (in decreasing order of damage) are: *P. pinea*, *P. pinaster*, *P. laricio*, *P. halepensis*, *P. nigricans* and *P. sylvestris*. The disease is most prevalent in nurseries where *Vincetoxicum hirundinaria* thrives nearby, especially in sandy sea shore habitats with calcareous soils.

Seedlings become more resistant to blister rust with age. Since it is difficult to recognize infected 1-0 and 2-0 seedlings, there is the risk of disseminating the disease to new areas on infected stock.

Control is achieved by eradicating *Vincetoxicum* around the nursery and by culling diseased seedlings. Work on the genetic improvement of this tree has revealed that, for the populations tested, *P. pinea* does not vary in its susceptibility; however, since resistance exists in *P. pinaster*, it has been possible to select and breed resistant individuals with mechanisms of resistance in the needles and in the stems.

Diseases of chestnut seedlings

Root rot can affect seedlings of several broadleaf species, causing them to wilt and die. Here we describe the symptomatology of *Phytophthora cambivora* and *P. cinnamomi* on chestnut. These fungi can attack seedlings at any age. Initial damage usually occurs at or just below the groundline, but also on fine roots. The fungus then ramifies throughout the root tissues, killing them. Infection is favored by wet soil, and *P. cambivora* and *P. cinnamomi* oospores can survive for up to 10 years in wet soil. While *P. cambivora* attacks only chestnut and walnut, the host range of *P. cinnamomi* includes numerous conifers and broadleaves, including agriculturally important hosts.

Prevention is the only control measure and consists of not growing chestnut in poorly drained soils. Spraying with Fosetyl and Furoxyl, which is effective against *Phytophthora cactorum* on garden and ornamental trees, does not protect chestnut seedlings against *P. cambivora* or *P. cinnamomi*.

After seedlings are a few years old, shoot pathogens may appear. One such fungus is *Mycosphaerella maculiformis* which damages chestnut seedlings. *Mycosphaerella maculiformis* causes numerous necrotic spots on the leaves but it can also affect shoots, leaf petioles, and flower peduncles. Infection becomes most evident at the end of the growing season, though the first signs can be clearly seen in spring. In rainy summers the disease spreads rapidly, resulting in premature defoliation. *Mycosphaerella maculiformis* is effectively controlled with fungicides.

Powdery mildew of oak

Powdery mildew, *Microspheera alphitoides*, is an important disease of nursery-grown oaks. This pathogen, which probably originated in America, was first reported in Italy in 1908 (Marchetti and D'Aurelio 1980). Powdery mildew occurs in spring and summer, especially during rainy, wet weather. Affected leaves which are covered with white mycelium become deformed

with various amounts of dieback. Premature defoliation and reduced growth characterize the disease on seedlings both in the nursery and after transplanting. The disease is common in nurseries in central and northern Italy where it particularly affects *Quercus robur*, *Q. petraea*, and *Q. pubescens* and in more southerly nurseries it occurs on *Q. pubescens*, *Q. cerris*, and *Q. suber*.

Microspheera alphitoides can be controlled with sprays containing colloidal or wettable sulphur or with dinocap or benomyl. Most sterol biosynthesis inhibitors, i.e. fusilazone triadimenol and mycobutanil, applied three times a week, provide effective protection of seedlings (Anselmi and Nicolotti 1990).

Marssonina foliar blight of poplar

This disease, *Marssonina brunnea*, has become widespread in Italy since 1963 where it causes an economically important leaf blight of poplar (Cellerino 1972; Cellerino *et al.* 1987). On the most susceptible poplar clones, *Marssonina brunnea* results in serious defoliation, starting in the lowermost crown and progressing upward. However, the first symptoms, in spring, are necrotic spots on the leaves. These spots become progressively larger until the leaf dies and falls off. Seedling growth is reduced. During the growing season the pathogen fruits around the necrotic areas on the leaves. The disease is fairly common in the Po Valley and it also occurs in inland valleys in the Italian peninsula, in south Italy, and in Sardinia. Long hot summers hinder disease spread.

Spraying with Maneb or Mancozeb at the first sign of infection early in the growing season effectively controls the disease. Very good results have been obtained in the Italian genetic improvement program for poplar.

Other diseases

In southern Italian nurseries, damping-off affects containerized seedlings of *Pinus halepensis*, *P. pinaster*, *Cupressus macrocarpa*, and *Thuja orientalis*. The fungi most frequently isolated from the seedlings were *Fusarium solani*, *Rhizoctonia solani*, and *Cylindrocarpon destructans* (Frisullo *et al.* 1984). *Pythium* spp. and *Rhizoctonia* cause severe damage on seedlings of *P. nigra* and *Fusarium* spp. (mostly *F. oxysporum*) damage *P. radiata*, *P. brutia*, *P. canariensis*, and *Cedrus* spp. (Magnani 1972, 1975). *Pythium*-caused losses occur in soils with a pH greater than 6, and *Rhizoctonia*-caused diseases are present in areas where the temperature exceeds 24°C, pH is below 6, and the relative humidity is 30-50%. Control of damping-off is based mainly on physical and chemical soil treatments.

Some attempt has been made to use biological control (Turchetti 1979).

Pinus pinea and *P. radiata* growing in the Mediterranean region sometimes suffer terminal bud die-back (*Sphaeropsissapinea* = *Diplodiapinea*). The disease is especially common if spring drought occurs before and during shoot growth. Usually only lateral buds are affected and affected seedlings survive but affected seedlings must be culled and cannot be outplanted in plantations.

Regarding broadleaves, eucalyptus (which is of some economic importance) sometimes becomes infected in the nursery with certain weak parasites such as *Cercospora eucalypti* and *Botrytis cinerea*; these parasites can cause losses when seedlings are under weather-related stress (e.g. cold winds). During wet weather or in the greenhouse, eucalyptus seedlings are sometimes attacked by *Oidium*, which causes extensive defoliation.

Recently, water and nutrient deficiencies, both chronic and acute, have occurred as the result of natural and man-made toxins.

Insect pests in Italian forest nurseries

There are numerous harmful insects in Italian seedling nurseries (Table 2) and they vary both taxonomically and with respect to their hosts. These insects can be divided into three groups: (i) insects that live, reproduce and die in the nursery, (ii) insects that frequent the nursery only at certain periods in their life cycle (usually because they are attracted by the abundant supply of food), and (iii) insects that visit the nursery only irregularly and fortuitously. Animals (including insects) are a potential problem in the nursery from the time of seed sowing, while insects in the orders Hymenoptera and Formicidae (typical seed-eaters) and vertebrates such as birds and rodents can cause significant losses. Both

Table 2. Insect pests of Italian forest nurseries.

INSECT ORDER Family Species	Nature and location of damage	Insect stage producing damage	Time of damage	Damage rating	Refer- ences
ORTHOPTERA Gryllotalpidae <i>Gryllotalpa gryllotalpa</i> L.	Browses on roots of various herbaceous plants and trees. Prefers light, cultivated, deep soils with a rich humus layer.	Larvae and adults 1 day-1 year	Spring- autumn	***	
RHYNCHOTA (Suborder HOMOPTERA) Cercopidae <i>Haematoloma dorsatum</i> (Arh.)	Puncture-feeding on needles, causes deformation and wilting, defoliation often follows. On Pinaceae and Cupressaceae, especially in nurseries near uncultivated land with grasses.	Adult 1 day-1 year	Spring - early summer	**	10
Telaxidae <i>Mindarus abietinus</i> Koch	Puncture-feeding on needles, which bend upwards; frequently wilting of shoot. Prevalent in nurseries near adult trees. Holocyclic on fir.	various stages	Spring	*	
Callaphididae <i>Phyllaphisfagi</i> L.	Colonies on leaves, particularly the underside. Whitish waxy secretions cover the leaves. This sucking insect causes leaf roll, leaf shedding, and shoot wilting. Damage also caused by the abundant honey-dew. Holocyclic on beech.	Various stages	Spring- early summer	**	5

Table 2. continued

INSECT ORDER Family Species	Nature and location of damage	Insect stage producing damage	Time of damage	Damage rating	Refer- ences
<i>Diphillaphis mordwilkoii</i> (Arbg.)	Colonies on lower leaves; leaves covered with whitish waxy secretions. Leaves become yellow and wither. The damage begins with spots, these enlarge until entire leaf surface is covered. Holocyclic on <i>oak</i> .	various stages	Summer-early autumn	*	3
Adelgidae <i>Eopineus strobilus</i> (Htg.)	Colonies along stem and branches. Anholocyclic on <i>P. strobilus</i>	various stages	Spring-summer	**	9
<i>Pinus pini</i> (Macq.)	Colonies on shoots and twigs and along stem. Anholocyclic on pines.	Various stages	Spring	**	9
<i>Gyllettella coweni</i> (Gill.)	Attacks needles. Recognized by the white waxy filaments with which individual insects progressively cover themselves during development. The sucking insects cause yellowing followed by leaf fall, plus shoot decline. Anholocyclic on Douglasia.	Various stages	Spring-summer	***	8
<i>Sacchiphantes viridis</i> (Ratz.)	Gall formation on buds on the lateral and main shoots of Norway spruce seedlings. <i>S. viridis</i> alternates between spruce and larch while <i>S. abietis</i> is anholocyclic on spruce.	Fondatrix and Fondatrigeniae	Spring	**	9
<i>Sacchiphantes abietis</i> L.		Pseudofondatrix	Spring-summer	***	9
LEPIDOPTERA					
Tortricidae					
<i>Rhyacionia buoliana</i> (Den. et Schiff.)	Tunnels in buds and shoots resulting in visible deformation of the branches and main stem of pine seedlings	Larva 1 day-1 year	Summer-autumn and spring	**	29-32
<i>Argyrotaenia pulchellana</i> (Hw.)	Browses on leaves which are webbed together with silk from larvae. Polyphagous on forest and agricultural broadleaves.	Larva 1-3 days- 1 year	Spring-autumn	*	5
Noctuidae					
<i>Agrotis segetum</i> (Den. et Schiff.)	Young larvae browse on leaves; then browsing on the stalk and stem and in the root collar and upper root system area. Polyphagous.	Larva 1-3 days- 1 year	Spring-autumn	**	
DIPTERA					
Bibionidae					
<i>Bibio</i> spp.	Attacks <i>roots</i> , rhizomes and tubers. Damage may become serious in rich organic soils. Polyphagous.	Larva	Spring 1 day-1 year	*	12

Table 2. continued

INSECT ORDER Family Species	Nature and location of damage	Insect stage producing damage	Time of damage	Damage rating	Refer- ences
Tipulidae <i>Tipula</i> spp.	Browses on the roots and root collar; occasionally on the leaves. Common in humid, rich organic soils. Polyphagous.	Larva 1-2 days- 1 year	Spring- early autumn	**	
COLEOPTERA Scarabeidae <i>Melolontha melolontha</i> L	Browses on the roots at various levels. Prefers humid rich organic soils.	Larva and adult,	Spring- autumn	***	
<i>Melolontha hippocastani</i> F.	Browses also on buds and leaves. Polyphagous on conifers and broadleaves.	1 day-3 years.		**	
<i>Polyphylla fullo</i> L.	Attacks roots of various trees and needles of pine. Common in nurseries located near pine woods, especially those growing near sandy soils.	Larva and adult	Spring- autumn	**	
Elateridae <i>Agriotes</i> spp.	Attacks roots and root collar of herbaceous plants and many young trees.	Larva 1 day-3-4 years.	Spring- autumn	***	
Curculionidae <i>Otiorrhynchus</i> spp.	Browses on roots of many conifers and broadleaves. Also attacks leaves.	Larva and adult, 1 day-1 year.	Spring- summer	***	5
<i>Phyllobius</i>	Damages roots and foliar browsing that is more or less regular in shape on many plants.	Larva and adult, 1 day-1 year.	Spring- summer	*	
<i>Polydrosus</i>	Same as above more frequent in nurseries in forest areas. Polyphagous.	Larva and adult, 1 day-1 year.	Spring- summer	*	
<i>Strophosomus melanogrammus</i> Forst	Browses on buds, leaves and green bark of shoots or stems. Polyphagous.	Adult 1 day-1 year	Spring and autumn	**	5
<i>Cleonus alternans</i> Hbst.	Browses especially on conifer roots. Does not damage broadleaves.	Adult 1 day-1 year.	Spring- summer	*	
<i>Pissodes notatus</i> F.	Rounded browsing marks on earliest bark of the stem and branches of pine.	Adult 1 day-1 year.	Spring and autumn	*	27
<i>Hylobius abietis</i> L.	Irregular rounded browsing marks on the green bark of young conifer and also broadleaf seedlings. Especially threatens nurseries located near old spruce and pine woods, where the larvae colonize the stumps.	Adult 1 day-1 year	Summer- autumn and spring	**	27
HYMENOPTERA Cynipidae	Gall formation on leaves, buds, etc., especially on <i>oaks</i> .	Larva	Summer and autumn	*	

young and older seedlings suffer from these pests (Magini 1979; Santini 1983; Del Favero and Masutti 1974).

The nurseryman must know the particular feeding habits and life cycles of insect pests if his control measures are to succeed. Special attention has been paid to insects that attack seedlings below or near the groundline.

Some of the species listed in Table 2 are harmful mainly at certain stages of their life cycle, others cause damage at all stages both below and at ground level. Nursery stock must therefore be carefully protected, using all appropriate methods (e.g., cultural, mechanical, physical, chemical, biotechnical, and biological) either singly or, if need be, in combination. In this way seedlings will be free of insects and less likely to have problems with disease once they are transplanted to forests or to ornamental or recreational plantings. This is very important because when such problems appear at that time they are often much more difficult and sometimes impossible to solve.

Before describing ways of managing insect pests, some words are in order about prevention, which is

always important. Prevention means following appropriate cultural practices, carefully monitoring seedlings and seedling health, and culling all seedlings that lack vigor or that are deficient. Seedlings should also be covered with nets to keep away rodents and birds and repellents can be used when appropriate (Magnini 1979; Santini 1983).

When Formicidae infestations occur, the nests should be destroyed (Suss 1984). Measures to combat insects are often justified. Such measures are directed against either the early or adult stages of the insect, or both. Organic chlorine-based insecticides and many fumigants are no longer used because of their undesirable side-effects. For treatment of seedling shoots these materials have been replaced by organic phosphate and carbamate sprays. Moreover, it is best to always use the least persistent and most specific spray that is effective. Because of environmental concerns, control of nursery and other insects depends increasingly upon biological and microbiological controls, entomophagous insects, and nematodes and fungi (Lozzia 1983, Deseo *et al.* 1985).

References

1. Anselmi N.; Nicolotti G. 1990. Prove di lotta contro il mal bianco della quercia. Atti Giomate fitopatologiche, Pisa, 79-88.
2. Barbacovi, A.; Capretti, P.; Moriondo, F. 1979. Diffusione e danni da *Brunchorstia pinea* (Karst.) Hohn. su popolamenti naturali e artificiali di conifere in Italia. AM. Accad. Ital. Sc. For. 28:123-161.
3. Binazzi A.; Roversi, P.F. 1988. Il *Diphyllaphis mordwillkoi* (Aizenberg) in Toscana (*Homoptera Aphidoidea Callaphididae*). Redia, LXXI (1): 201-211.
4. Biraghi, A. 1963. Rassegna dei casi fitopatologici forestali. Ann. Accad. Ital. Sc. For. 12:33-109.
5. Cecconi, G. 1924. Manuale di entomologia forestale. Tip. Seminario, Padova, XIX, 630. p.
6. Cellerino, G.P. 1972. La lotta contro le principali malattie delle piante forestali del bacino del mediterraneo. Compte rendus des Troisièmes Jour. de Phytatrie et de Phytopharmacie circum-méditerranéennes. Sassari, 20-24 sept. 1971, pp. 403-419.
7. Cellerino, G.P.; Anselmi, N.; Belisario, A. 1987. On the main infections disease of the Poplar, Willow and Eucalyptus and on control strategies in the mediterranean area. Pages 176-189 in Simposio sobre Silvilcoltura y Mejoramiento Genético de Especies Forestales. Buenos Aires, Argentina, 6-10 Apr. 1987.
8. Covassi, M. 1971. Prove di lotta chimica in vivaio contro *Gylletella coweni* (Gill.) (Homoptera, Adelgidae). Ann. Ist. Sper. Zool. Agr. II 1-9.
9. Covassi, M.; Binazzi, A. 1981. Contributi alla conoscenza degli afidi delle conifere. IV. Note su alcune specie di Adelgidi reperite in Italia (Homoptera, Adelgidae). Redia LXIV: 303-329.
10. Covassi, M.; Roversi, P.F.; Toccafondi, P. 1989. Danni da *Haematoloma dorsatum* (Ahrens) su Conifere (Homoptera, Cercopidae). I. Alterazioni macroscopiche degli apparati fogliari. Redia LXXII(1): 259-275.
11. Del Favero, M.; Masutti, L. 1974. Animali e strobili di abete rosso in alcuni boschi delle Alpi orientali. Monti e Boschi, 25, 5:3-16.
12. Della Beffa G. 1961. Gli insetti dannosi all'agricoltura e i moderni metodi e mezzi di lotta. Ed. Hoepli. Milano XX + 1106 p.
13. Deseo, K.V.; Kovaks, A.; Lercari, G.; Costanzi, M. 1985. Possibilità di applicazione di nematodi entomoparassiti contro gli insetti dannosi nella floricoltura. Inf. tore fitopat., 35(11): 37-42.
14. Frisullo, S.; Ciccarese, F.; Cirulli, M. 1984. Osservazioni sulle morie dei semenzali in Puglia e Basilicata. L'informatore Agrario, XL, 30:49-51.
15. Grasso, V. 1948. L'oidio dell'eucalitto, Nuovo G. bot. ital., n.s., 55:581-584.
16. Lozzia, G.C. 1983. *Otiorrhynchus sulcatus* nelle coltivazioni floricole del Lago Maggiore. Inf. tore fitopatol 33(7/8): 15-19.
17. Magini, E. 1979. Appunti di vivaistica forestale (semi e piante forestali). CLUSF. Coop. ed. Univ., Firenze. cfr. pp. 139-141.

-
18. Magnani, G. 1965. Alterazioni su foglie e rametti di eucalitto causate da *Cercospora eucalypti* Cook et Masee, *Phytopath. mediterr.*, 4(1):6-11.
 19. Magnani, G. 1972. Morie di semenzali di Pino radiata causate da parassiti fungini. *Pubbl. Centro Sper. Agr. For.* 11:135-144.
 20. Magnani, G. 1975. Sulla suscettibilità di alcune specie di conifere alle morie in semenzaio. *Pubbl. Centro Sper. Agr. For.* 10: 19-25.
 21. Marchetti, L.; Zecchini D'Aurelio, A. 1980. L'oidio della quercia. *Inf. tore fitopat.* 9:23-24.
 22. Moriondo, F. 1989. *Introduzione alla patologia forestale*. UTET. Torino.
 23. Petri, L. 1933. Rassegna dei casi fitopatologici osservati nel 1932. *Bollettino della Regia stazione di Patologia vegetale*. Anno XIII N.S. n. 1, p. 51.
 24. Ragazzi, A. 1983. Presenza di *Herpotrichia juniperi* (Duby) Petrak su *Picea excelsa* Link e *Picea pungens* Engelm. *Inf. tore fitopat.* 9:37-39.
 25. Salemo, M. 1957. Un parassita fogliare di *Eucalyptus* spp. (*Cercospora eucalypti* Cooke et Masee) nuovo per l'Italia. *Ital For. mont.*, 12(3):3-5.
 26. Santini, L. 1983. I roditori italiani di interesse agrario e forestale. C.N.R. AQ/1/232, Padova, VII, 168p.
 27. Servadei, A.; Zangheri, S.; Masutti, L. 1972. *Entomologia generale ed applicata* Ed. CEDAM Padova, XVI + 733 p.
 28. Suss, L. 1985. Insetti "striscianti": blatte, formiche e termiti. In: *Convegno di Entomologia urbana per la qualità della vita*. Milano, 17-18 Maggio, 1984. Tip. Coppini Firenze. 183-192.
 29. Tiberi, R.; Covassi, M.; Roversi, P.F. 1988. La tecnica della confusione control *Rhyacionia buoliana* (Den. et Schiff.) in giovani pinete dell'Italia centrale (Lepidoptera, Tortricidae). *Redia* LXXI, (2):355-368.
 30. Turchetti, T. 1979. Prospettive di lotta biologica in alcune malattie di piante forestali. *Inf. tore fitopat.* 8:7-15.
 31. Turchetti, T. 1986. Alcuni aspetti delle principali malattie del castagno.
 32. Zocchi, R. 1961. La difesa delle piante forestali dagli animali nocivi. *Economia Trentina, C.C.I.A.A., Trento*, 1-2:3-16.

Forest nursery diseases and insects and their control in Shimane Prefecture, Japan

YASUO SUTO AND JIRO INOUE
Shimane Prefecture Forest Research Centre
Shinji-cho, Yatsuka-gun, Shimane 699-04, Japan

Presented at the first meeting of IUFRO Working Party S2.07-09
(Diseases and Insects in Forest Nurseries), Victoria, British Columbia, Canada, August 22-30, 1990.

Abstract

Several diseases and insects damage forest nursery seedlings in Shimane Prefecture, Japan. Soil-borne diseases such as damping-off, root-rot of transplanted seedlings, charcoal rot, webblight, and nematode diseases are serious problems. Needle diseases such as *Cercospora* needle blight of *Pinus* and *Cryptomeria* and *Pestalotia* needle blight of *Chamaecyparis* are also prevalent. White grubs and the false melon beetle are the main insect pests in nurseries. The first step in the control of these diseases and insects is to improve the environmental conditions in the nursery and remove the source of inoculum or insects. Application of various chemicals provides effective control.

Resume

Plusieurs maladies et insectes attaquent les semis des pépinières forestières situées dans la préfecture de Shimane, au Japon. Les maladies d'origine pédologique, notamment la fonte et le pourridié, la pourriture noire et les maladies causées par les nematodes, sont des pathologies graves. Les maladies des aiguilles, notamment le *Cercospora* des genres *Pinus* et *Cryptomeria* et la brûlure des aiguilles *Pestalotia* de *Chamaecyparis*, sont aussi très répandues. Les scarabées et les fausses scolytes du melon sont les principaux insectes nuisibles des pépinières. La première étape d'un programme de lutte contre ces maladies et ces insectes est l'amélioration des conditions ambiantes et l'élimination des inoculats ou insectes en cause. L'utilisation de divers produits chimiques est un moyen de lutte efficace.

Introduction

Shimane Prefecture is in the northwestern part of the mainland of the Japanese Archipelago, and the long northern boundary faces the Japan Sea. The prefecture contains 663 000 ha and 80% of it is covered with forests. Four species of conifers, *Pinus densiflora* Sieb. et Zucc., *P. thunbergii* Parl., *Cryptomeria japonica* D. Don, and *Chamaecyparis obtusa* Endl., are the important forest species and as such they are grown in nurseries and used for reforestation.

In 1988, 250 nurseries produced seedlings and cultivated cuttings. The total area of nurseries was 40 ha, and 7 700 000 seedlings and cultivated cuttings were produced for reforestation. Seventy percent of the seedlings were *Chamaecyparis* seedlings and 30% were *Cryptomeria* seedlings and cultivated cuttings. Until 15 years ago, *Pinus* was the main tree species for reforestation. Since then, however, pines have not been planted because of the risk of pine wilt disease caused by the pinewood nematode, *Bursaphelenchus xylophilus* (Stein et Buhr.) Nick., resulting in a drastic reduction of *Pinus* seedling production.

Various kinds of diseases and insects have been recorded in nurseries in Shimane Prefecture. Some of them are a major impediment to the production of nursery stock (Suto 1974, 1984). This paper describes the main diseases and insects in nurseries and practical measures for their control.

Forest nursery diseases and their control

Several soil-borne diseases, damping-off, root rot of transplanted seedlings, charcoal rot, webblight, and nematode diseases, are serious problems of various tree species. Needle diseases also occur extensively, the main ones being *Cercospora* needle blight of *Pinus*, and *Cryptomeria*, and *Pestalotia* needle blight of *Chamaecyparis*.

Damping-off

Damping-off is a common problem in seedbeds of all the conifers. Pre-emergence damping-off decreases emergence while post-emergence damping-off causes high mortality of seedlings during May and June. Root rot affects seedlings after June, and occasionally kills

them. The roots frequently rot partially, and the shoots are stunted and needles become yellow or purple. Top rot and foot rot are seldom observed.

Six species of fungi have been isolated from the affected seedlings: *Rhizoctonia solani* Kiihn, *Fusarium oxysporum* Schlechtendahl, *F. roseum* Link, *F. solani* (Martius) Appel et Wollenweber, *Cylindrocladium scoparium* Morgan and *Cylindrocarpon* sp. Among them, *Rhizoctonia solani* Kühn and *Fusarium* spp. (*F. oxysporum* Schlecht., *F. roseum* Link, and *F. solani* (Mart.) App. et Woll.) are the main pathogens. *Rhizoctonia solani* affects seedlings in May and June if bed soils are excessively wet. *Fusarium* spp. affect seedlings throughout the growing season whether soils are wet or dry.

The first step in the control of this disease is to improve nursery conditions. Some practical measures are: (1) adjust the pH of the nursery soil to 5.0 to 5.5; (2) sow seeds in mid-April, which is the best time for germination; (3) remove rice straw (the covering material over the seedbeds) gradually after seedling emergence; (4) thin seedlings to avoid overcrowding; and (5) apply sufficient phosphorus and potassium fertilizer and avoid excessive nitrogenous fertilization.

Thiram and a mixture of thiram and thiophanate-methyl are used as seed disinfectants. Seeds are either dusted or immersed in an emulsion of the fungicide. Metam-ammonium, a dithiocarbamate soil fumigant, is an effective disinfectant of soil in seedbeds. The efficacy of the fumigant has been demonstrated not only on fungi, but also on nematodes, soil insects, and weed seeds and roots. Accordingly, soil fumigation is recommended as an economical practice for seedbeds. Drenching the soil with hydroxyisoxazol, a soil disinfectant that is specific against *Fusarium*, effectively controls disease after seedling emergence. This chemical should be applied at the initial stage of post-emergence damping-off.

Root rot of transplants

Root rot of transplanted 2- and 3-year-old seedlings becomes more severe if 1- and 2-year-old seedlings slightly affected by the same disease are transplanted. Seedling growth is greatly suppressed, and shoots become yellow or purple. Occasionally the entire seedling wilts and dies. These symptoms are indicative of a root problem. Affected roots become dark, and the bark can be stripped away easily. *Fusarium* spp. are the main root rot pathogens.

It is important to prevent root rot of 1-year-old seedlings in seedbeds. Seedlings with heavily rotted roots should not be transplanted, even if the shoots appear healthy.

Charcoal rot

Charcoal rot, caused by *Macrophomina phaseolina* (Tassi) Goid. occurs in dry, hot summers. It frequently is fatal to nursery stock. Two- and three-year-old seedlings of *Cryptomeria* and *Chamaecyparis* are severely affected; damage is less severe on 1-year-old seedlings, because nurseries routinely shade the seedbeds. *Cryptomeria* cuttings are also severely affected. Pine is affected only in the seedbeds, which are generally not shaded.

Nursery seedlings were damaged severely by this disease in August of 1964, 1967, 1969, 1973, 1975, and 1984. In July and August of these years, prolonged dry conditions and high temperatures accelerated the occurrence of this disease. The disease occurred not only in nurseries with sandy soil but also in those with clay loam.

To control charcoal rot, nursery seedbeds should be heavily watered, and shaded to prevent drought and high temperature stress. Excessive applications of nitrogenous fertilizer should be avoided, as this results in succulent tissues which are more susceptible to the disease. Soil fumigation with metam-ammonium is recommended to control charcoal rot in nurseries where it occurs every year.

Webb blight

Webb blight caused by *Thanatephorus cucumeris* (Frank) Donk mainly occurs in overcrowded seedbeds where there are more than 800 seedlings per m². *Chamaecyparis* seedlings are most severely affected, but all coniferous seedlings are affected to some degree.

The disease breaks out in the rainy season, "Tsuyu", during mid-June and mid-July. The problem occurs in patches which are roughly circular, and occasionally spreads to all the seedlings in the seedbeds. Almost all affected seedlings are killed.

An outbreak of this disease was recorded in many nurseries in July of 1965, and in late July to early August of 1975. The disease suddenly spread when temperature increased immediately after continuous and excessive rainfall. The disease mainly occurred in seedbeds with a clay loam soil.

To prevent excessively wet conditions in nurseries, seedbed shades are taken off in the rainy season, and the ditches between beds are made deeper. Seedlings should be thinned to a density of 500 to 700 per m². Baridamycin, an antibiotic fungicide, is recommended as a treatment for seedlings and for the soil surface of the seedbed when the disease begins to spread. Regular applications of copper fungicides are also effective in preventing infection.

Nematode diseases

The following 12 species of plant parasitic nematodes were obtained from soil or seedling roots in a survey of forest nurseries (Yamada and Suto 1966; Suto 1977; Suto *et al.* 1983): *Pratylenchus penetrans* (Cobb) Chitwood & Oteifa, *Tylenchorhynchus claytoni* Steiner, *T. sp.*, *Trichodorus cedrus* Yokoo, *T. sp.*, *Helicotylenchus dihystra* (Cobb) Sher, *H. sp.*, *Rotylenchus pini* Mamiya, *Xiphinema americanum* Cobb, and one species each of *Criconemoides*, *Paratylenchus*, and *Hirshmanniella*. Among them, *Pratylenchus penetrans* (Cobb) Chit. and Otei., the root lesion nematode, and *Tylenchorhynchus claytoni* Stein, the stunt nematode, were the main pathogenic nematodes; they were distributed widely, occurred at high levels in soil or roots, and caused definite symptoms.

The following combinations of pathogenic nematodes and hosts normally occur in seedbeds. Large numbers of *P. penetrans* occur in roots of *Cryptomeria* and *Chamaecyparis* seedlings, and *T. claytoni* severely affects *P. densiflora* as well as *Cryptomeria* and *Chamaecyparis*. The nematodes feed on the newly developing roots resulting in a root system that is stunted and forked.

Shoot growth is severely affected, and needles turn yellow or purple. Seedlings affected by nematodes are also attacked by *Fusarium* and occasionally die.

Crop rotation is recommended for control of nematode diseases, but it is actually impractical, because nursery area is limited and the present level of seedling production must be maintained. Nonetheless, nurseries severely affected by these diseases should not be used for seedling production. Soil fumigation with metammonium results in excellent nematode control. It is important to reduce the nematode populations when the seedlings are young, particularly until early August (Suto 1973).

Cercospora needle blight of pines

Cercospora needle blight of *Pinus* caused by *Cercospora pini-densiflora* Hori et Nambu became a serious problem in the 1960s and 1970s, when many pine seedlings were grown in nurseries. This disease spread to the coastal regions of the prefecture and affected seedlings of *P. thunbergii* and, to a lesser degree, seedlings of *P. densiflora*. Usually, 1- and 2-year-old nursery seedlings are infected, but this disease does not occur in forests. *Cercospora* needle blight causes significant needle blight and occasionally kills seedlings.

The causal fungus overwinters as hyphae within diseased needles and as latent infection within apparently healthy needles. New conidia form on the lesions from late April and are the source of the primary

inoculum. Conidia production continues until early December. The optimum dispersal periods for production of conidia is middle to late June through early July, and again in early August and late October. Rain is important in conidia dispersal (Suto 1982).

Diseased 1-year-old seedlings should not be transplanted, even if the disease is minor. Copper fungicides are recommended for control of the disease on pine seedlings. However, the fungicide occasionally damages *P. densiflora* seedlings. Disease control experiments showed that maneb and benomyl were as effective as copper fungicides. Both of these fungicides should be applied fortnightly, i.e., 10 times during the growing season. The amount of maneb in the spray can be reduced by adding stickers (polyvinyl alcohol or Paraffin). Using maneb with the stickers at monthly intervals, or about five times during the growing season, is as effective as spraying more often with a wettable spreader (Suto 1982).

Cercospora needle blight of *Cryptomeria*

Cercospora needle blight of *C. japonica* caused by *Cercospora sequoiae* Ell. et Ev. is widely distributed in the prefecture. In the 1980s the importance of the disease decreased dramatically. There are two reasons for this decline. Firstly, cultivated cuttings which are resistant to the pathogen have increased in popularity over seedlings which are more susceptible. Also, chemical control has been effective in most nurseries. This disease causes severe blight of seedlings in nurseries where no chemical control is practiced. Needles, lateral branches, and main stems are affected. Stem lesions enlarge gradually each year and develop perennial cankers on the bole of mature trees. Thus, even slightly affected seedlings cannot be used for outplanting.

The pathogen overwinters within lesions as hyphae. Conidia form on lesions from early April onward and serve as the source of the primary infection. Conidia continue to be produced through early December. The optimum periods for conidia dispersal are late July and late October. Conidia are released from the fruiting bodies when raindrops hit them (Suto 1975).

Affected seedlings (including those that are only slightly affected) should be rogued and burned rather than transplanted. The disease can be largely prevented by spraying Bordeaux mixture or maneb about 10 times at 2-week intervals. As in the case of *Cercospora* needle blight of pine, the frequency of spraying can be reduced to about five times per growing season by adding polyvinyl alcohol to a dilute emulsion of maneb (Suto 1976).

Pestalotia needle blight of Chamaecyparis

Although *Pestalotia* needle blight occurs on seedlings of all coniferous species, *Chamaecyparis* are most severely affected. Since the early 1980s production of *Chamaecyparis* seedlings has increased and this disease has become a serious problem in nurseries. Affected seedlings cannot be used for outplanting, and 1-year-old seedlings are occasionally killed.

Three species of *Pestalotiopsis*, i.e., *P. microspora* Speg., *P. foedans* (Sacc. et Ell.) Stey., and *P. glandicola* (Cast.) Stey., are the causal fungi. Inoculation experiments showed that wounds are necessary for disease development. Field observations indicate that the disease starts on seedlings wounded by strong wind or during transport, or in seedlings injured by insects. Severe damage by this disease was recorded in *Chamaecyparis* and *Cryptomeria* nurseries in various regions after two typhoons occurred in August of 1971.

Copper fungicides such as Bordeaux mixture are used to prevent this disease; control experiments revealed that they were not effective. Benomyl and thiophanate-methyl, both systemic fungicides, were quite effective, even if sprayed a few days after inoculation, and they showed a good curative effect (Suto and Kanamori 1988). Nurserymen should apply these fungicides immediately after seedlings are wounded.

Forest nursery insects and their control

White grubs are the most serious insect pests in forest nurseries. Also, *Chamaecyparis* seedlings are heavily damaged by the feeding of the false melon beetle.

White grubs

Anomala rufocuprea Mot. is the most common and destructive white grub (root feeder) in nursery beds. *Anomala cuprea* Hope is also a serious problem. Both insects feed on the bark of roots and rootlets, suppressing shoot growth. Affected seedlings occasionally wilt and die. Although the insects attack all species of coniferous seedlings, mortality of *Chamaecyparis* seedlings is high because the injured roots of this species do not regenerate well.

Anomala rufocuprea completes one generation per year (Figure 1). Larvae overwinter in the soil at a depth of more than 30 cm. The following spring they move upward and attack seedling roots through mid-July. Pupation occurs from mid-June. Adults emerge from the soil from late June and feed on leaves of broadleaf trees such as *Quercus acutissima* Carr. and *Castanea crenata* Sieb. et Zucc., and lianas such as Kuzu vine, *Pueria lobata* (Willd.) Ohwi. They then oviposit in the soil beginning in July, and the resulting larvae attack seedling roots from mid-July through late October. The

life cycle of *A. cuprea* is similar to that of *A. rufocuprea*.

June beetles (adults of white grubs) are attracted to decaying organic material where they oviposit. To prevent such attraction, only completely decomposed farmyard manure should be applied to nursery beds.

Chemical control of white grubs is an essential practice at every nursery. There are two recommended times for applying the chemical to seedbed soil. The first is when the beds are made. At this time chemicals are applied to kill overwintered larvae. Dust or microgranules of Diazinon, granules of Fenthion, or microgranules of Prothiophos are worked into the seedbeds. Metam-ammonium and chloropicrin are the recommended fumigants. Chemicals can also be applied during July and August to kill young larvae. The seedbed soil is drenched with a dilute emulsion of Fenthion. Granules of Fenthion or microgranules of Prothiophos are also worked into the soil between seedlings in transplant beds (Inoue *et al.* 1988).

The false melon beetle

Previously, the false melon beetle, *Atrachys menetriesi* Fald., was not a pest in forest nurseries. Recently, however, *Chamaecyparis* seedlings in the prefecture have been damaged by this insect. Although the false melon beetle is polyphagous, adults feed on needles and branches of *Chamaecyparis* seedlings, suppressing their growth. Seedlings attacked by adults are occasionally attacked by a *Pestalotiopsis* fungus which enters the host through the insect feeding wound.

Atrachys menetriesi completes one life cycle per year (Figure 2) and overwinters in the soil as eggs. The

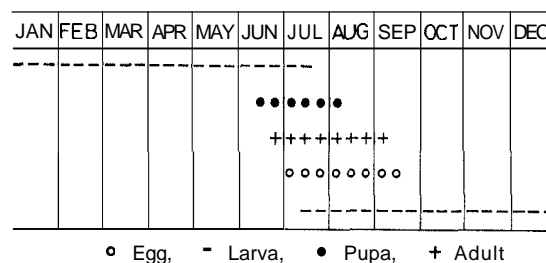

Figure 1. Life cycle of *Anomala rufocuprea* in Shimane Prefecture.

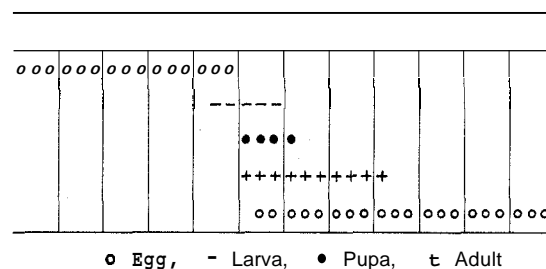

Figure 2. Life cycle of *Atrachys menetriesi* in Shimane Prefecture.

eggs hatch from mid-May and larvae emerge from the soil to feed on weeds and tree leaves. They then return to the soil and pupate from early June. Adults emerge from the soil about early June and feed on plants including *Chamaecyparis* seedlings through early September. Eggs are oviposited in the soil from mid-June.

Larvae have not been observed feeding on *Chamaecyparis* seedlings. The adults are thought to invade nurseries from nearby farmland.

Spraying once or twice with a dilute emulsion of Fenitrothion at the initial stage of the feeding by adults is recommended.

References

- Inoue, J.; Kanamori, H.; Suto, Y. 1988. Mycological and chemical control of root feeders in the nursery. Bull. Shimane Pref. For. Res. Cent. 35:25-32*.
- Suto, Y. 1973. Chemical control of root rot of seedlings. Bull. Shimane Pref. For. Exp. Stn. 23:1-50**.
- Suto, Y. 1974. Researches on tree diseases in Shimane Prefecture in 1963-1972. Bull. Shimane Pref. For. Exp. Stn. 24:1-40**.
- Suto, Y. 1975. Conidial production and dispersal of *Cercospora sequoiae*. Bull. Shimane Pref. For. Exp. Stn. 25:27-38**.
- Suto, Y. 1976. Chemical control of *Cercospora* needle blight of *Cryptomeria japonica*. Bull. Shimane Pref. For. Exp. Stn. 26:16-25*.
- Suto, Y. 1977. Plant parasitic nematodes associated with coniferous seedlings in forest nurseries in Shimane Prefecture (II). Bull. Shimane Pref. For. Exp. Stn. 27:1-10*.
- Suto, Y. 1982. Fundamental studies on control of the needle blight in pines caused by *Cercospora pini-densiflorae* Hori et Nambu. Bull. Shimane Pref. For. Exp. Stn. 32:1-102*.
- Suto, Y. 1984. Researches on tree diseases in Shimane Prefecture (II) In 1973-1982. Bull. Shimane Pref. For. Res. Cent. 35:17-26*.
- Suto, Y.; Inoue, J.; Hara, I. 1983. Plant parasitic nematodes associated with coniferous seedlings in forest nurseries in Shimane Prefecture (III). Bull. Aso. Plant Prot. Shimane Pref. 9:7-11**.
- Suto, Y.; Kanamori, H. 1988. Chemical control of *Pestalotia* needle blight of coniferous seedlings. Bull. Shimane Pref. For. Res. Cent. 39:13-23*.
- Yamada, E.; Suto, Y. 1966. Plant parasitic nematodes associated with coniferous seedlings in forest nurseries in Shimane prefecture. Bull. Shimane Pref. For. Exp. Stn. 14:1-27**.

* In Japanese with an English summary

** Only in Japanese

Nursery disease and insect problems in New Zealand

J.W. RAY

Ministry of Forestry
Forest Research Institute
Rotorua

Presented at the first meeting of IUFRO Working Party S2.07-09
(Diseases and Insects in Forest Nurseries), Victoria, British Columbia, Canada, August 22-30, 1990.

Abstract

New Zealand's forest nurseries produce almost 50 million seedlings annually, approximately 94% of which are *Pinus radiata*. Of the diseases described only terminal crook disease (*Colletotrichum acutatum*), limited in distribution to the northern half of the North Island, has the potential to decimate nursery stock. Root diseases are limited to those nurseries with poor soil drainage. Many insects are found in nurseries, but only the onion thrip (*Thrips tabaci*) and tortricid caterpillars are regularly controlled by spraying.

Resume

Les pépinières forestières de Nouvelle-Zélande produisent près de 50 millions de semis par année, dont environ 94 % sont constitués de *Pinus radiata*. De toutes les maladies décrites dans cette étude, seule la courbure de la pousse terminale (*Colletotrichum acutatum*), circonscrite à la moitié septentrionale de l'île Nord, serait capable de décimer le stock produit dans les pépinières. Les maladies des racines sont circonscrites aux pépinières mal drainées. Ces pépinières abritent de nombreux insectes, mais seul le thrips de l'oignon (*Thrips tabaci*) et les tortricidés font l'objet de programmes de pulvérisation systématiques.

Introduction

New Zealand has approximately one million hectares of exotic forest under cultivation, of which the dominant species is *Pinus radiata*. Some 3% of the forest is in *Pseudotsuga menziesii* and 2% in *Eucalyptus* spp. and there is a small percentage in a number of other species. At present, forest nurseries annually grow approximately 45 million *P. radiata*, 2.5 to 3 million *Eucalyptus* spp., and also seedlings of a variety of other minor species. The majority of the seedlings are bare rooted, but one of the large private forestry companies is currently producing almost half a million plants annually using tissue culture methods. Increasing numbers of plants are being produced vegetatively, about 3.5 million, but once rooted they are treated as bare rooted stock. The nurseries vary in size from a few to 50 ha and are spread over the length and breadth of New Zealand. Cultivation methods vary depending on the types of soil but all nurseries are advised to deep rip periodically to avoid the formation of a "plough-pan" which could impede drainage. Most nurseries use a New Zealand-produced precision seed sower for the *P. radiata* whilst the other species are generally sown using a Stanhay drill. Precision sowing reduces problems caused by overcrowding. Weeds are controlled by pre-emergent

and post-emergent applications of herbicides; fertility is maintained by the use of artificial fertilizers. Soil sterilization is not routinely used by any forest nursery in New Zealand for either weed or disease control. The seedlings are conditioned for outplanting by undercutting, wrenching, and lateral pruning. In the warmer areas some stock is topped if it becomes too large for the planters to handle. In most nurseries the stock is lifted by hand as 1/0 plants.

Diseases in forest nurseries

Dothistroma needle blight: Dothistroma pini Hulbary.

This disease was first identified by Gilmour (1966) in the center of the North Island and is now present throughout the country, with the exception of the northern tip of the North Island. The disease occurs on a wide range of pine species and can also infect *Larix decidua*, *Picea sitchensis*, and *Pseudotsuga menziesii*. The fungus attacks needles, ultimately causing their death. The disease is first found on the lower needles on a seedling; the early sign of infection is the presence of a red band. Small, irregularly shaped, black fruiting bodies appear in the red bands. The spores are spread in water droplets

and infection, which can take place at any time after seedling emergence, is favored by warm wet spells. Spores landing on the needle surface germinate and penetrate the needle via a stoma. Once in the needle, the hyphae grow a short distance through the tissue, liberating a red toxin called dothistromin. It is the toxin which kills the tissue. Fruiting bodies are produced soon after the appearance of the red band. The time interval between infection and the production of fruiting bodies depends on climatic conditions and can vary between 2 weeks and 6 months. Infected needles eventually die and ultimately drop off. The most common source of infection is older trees adjacent to the nursery, although needle fragments can also perform this role. If seedlings are retained in the nursery for a second year, disease levels often become very high if the seedlings are not sprayed regularly. Disease control is achieved by monthly applications of copper oxychloride (Jancarik 1969) which, together with the practice of good hygiene in the nursery and the removal of the sources of disease inoculum from the vicinity of the nursery, result in an extremely low incidence of the disease. Severely infected seedlings can become chlorotic and die, but the main purpose in controlling the disease in the nursery is to retard its build-up in the plantation.

Terminal crook disease: *Colletotrichum acutatum* *Simmonds f. sp. pinea* *Dingley & Gilmour*.

The causal agent was first identified by Dingley and Gilmour (1972) in a forest nursery near Auckland. The disease has spread and now infects *P. radiata* seedlings grown in most nurseries in the North Island but has never been found in planted stock. As well as *Pinus radiata*, *P. contorta*, *P. elliotii*, *P. muricata*, *P. nigra*, and *P. pinaster* are all susceptible.

The fungus attacks young needles in the terminal rosette and its development and spread are favored by periods of warm wet weather. The spore landing on the needle germinates and penetrates, and the hyphae grow in the needle towards the stem, killing a narrow strip of the stele. The dead tissue, because it is unable to expand, causes the growing point to bend over giving rise to the typical crozier-shaped malformation from which the disease gets its name. Under severe infection pressure, the disease can cause the death of the needles in the terminal, giving rise to a terminal blight. The disease is characterized, apart from the striking malformation, by the presence in the terminal of one or more straw-colored needles with a water soaked appearance and often a pink tinge to the needles and the stem. Soon after becoming infected, the stem of the seedling becomes markedly stiffer. Infected seedlings are shorter

than uninfected ones. Although the disease does not kill the seedling, growth is retarded, continuing only when a lateral bud develops. Seedlings that have been infected by terminal crook disease usually fail to reach a suitable size for outplanting in 1 year.

The spores are produced on infected plant debris and are spread by water splash. Infection is very rapid under favorable conditions and fresh spores are produced in a few days. If left uncontrolled, under favorable climatic conditions the disease will spread rapidly, rendering infected seedlings unplantable. Control is currently achieved by weekly spraying with dichlofluanid and an emulsifiable oil (Ray 1975; Vanner and Ray 1977), but in a recent trial Vanner (1990) has shown that unless disease pressure is very high control can be achieved by fortnightly applications of prochloraz. For nurseries not infected, it is important they practice good hygiene in order to prevent infected debris from being carried in on machinery or in planting boxes.

Bacterial dieback: *Pseudomonas syringae p.v. syringae van Hall*

This is the first record of a pine seedling disease caused by bacteria (Langridge and Dye 1982). Although the bacteria are ubiquitous in New Zealand, the disease has been recorded only in nurseries in the South Island and in the lower half of the North Island. The disease has been recorded on *Pinus muricata*, *P. patula*, and *P. radiata*. This list should not be regarded as complete. Infection normally occurs near the growing point, although it can occur low down on the stem. Wilting and death occur above the point of infection with the stem often turning purple. The infected portion eventually dries out and becomes brittle.

The disease first appears in the autumn before the seedlings become fully hardened. Infection is initiated by frost followed by several wet days. Infected seedlings survive and continue to grow after the development of a lateral bud. As a result of dieback, height is lost, often rendering the seedling too small for planting. The disease is of limited importance; infected seedlings occur in isolated patches in a nursery. A 40% reduction in disease levels has been achieved in a trial with an application of a low rate of copper oxychloride combined with Agrimycin at weekly intervals during the months of April and May (late autumn).

Grey mold: *Botrytis cinerea* *Persoon ex Fries*

The disease is widespread and common in New Zealand but it seldom causes significant losses. The host range includes a wide range of both broadleaved trees and conifers (Gilmour 1966). Given optimum conditions for infection it is likely that all species raised in the

nursery are susceptible. The disease can invade healthy tissue but is normally regarded as a wound parasite. It becomes established on the dead tissue and then spreads to adjacent soft tissue. High humidity and warm temperatures favor infection and under these conditions the infected parts rapidly become covered in a webbing of grey mold - the aerial mycelium and spore bearing structures of the fungus. The spores are dispersed by air currents and quickly germinate on contact with susceptible host tissue. When necessary the disease can be controlled by high volume applications of thiram, captan, benomyl, or dichlofluanid.

Diplodia dieback: Diplodia pinea (Desmazieres) Kickx

The disease is widespread in New Zealand. It is most frequently recorded on *Pinus radiata* and has also been recorded on *P. muricata* and *Pseudotsuga menziesii* but it is highly likely that all pine species grown in nurseries are susceptible (Gilmour 1966). *Diplodia* is usually considered to be a wound parasite with infection occurring on tissue that has begun to wilt because of drought or wrenching in dry weather, but it may infect tissue that has been damaged either mechanically or by chemicals. The spores are spread by rain splash and infection occurs when they land on susceptible tissue. The spread of the fungus in the tissue is often limited in extent, with only the soft tissue just below the terminal becoming infected. The stem shows a purplish color at the point of infection, whilst the upper portion of the stem turns brown and bends over. Small black fruiting bodies are frequently seen on the dead tissue. Seedlings rarely die, the chief effect being a loss of height growth. No attempts have been made to control the disease.

Damping-off

This is associated with a complex of soil-inhabiting fungi of which the following are considered to be the most important: *Cylindrocladium scoparium* Morgan, species of *Fusarium* and *Phytophthora*, and *Rhizoctonia solani* Kuhn (Bassett 1961). All the young tissues of very young seedlings are susceptible to infection, but the disease is more common in moist soils during periods of wet weather. The disease manifests itself in two ways - pre-emergence damping-off where the seedling is killed before it emerges leaving a sparse crop, and post-emergent damping-off in which the seedling emerges but is killed shortly afterwards. In this latter case collapsed and withering seedlings are seen lying on the soil surface. The former condition is more difficult to recognize as low seed viability and mouse and bird predation produce the same end result and

losses from these causes are often attributed to damping-off.

Of the fungi listed, *Phytophthora* and *Pythium* species are regarded as the most damaging. Sound nursery practices such as good hygiene, maintenance of soil structure and drainage, the use of good seed and stratification to ensure rapid growth all contribute to the production of healthy seedlings with the minimum of losses. Seed treatment with thiram also reduces losses, as does the incorporation of metalaxyl prior to bed formation.

Root and collar rot

The same fungi responsible for damping-off cause root-rot. The distinction between the two conditions is that damping-off is a term used to describe the death of only very small seedlings. No species appear to be immune from attack by this group of fungi. Often seedlings will survive the attack with a loss in height gain. However, if they are also subjected to stress they will die. Root regeneration occurs provided the seedlings are not subjected to either drought or water-logging. The fungi all survive between crops on plant debris, so reducing the amount of residue left after lifting will reduce the incidence of disease as will the maintenance of a good soil structure combined with good drainage. Stem scorch or abrasion due to soil blow predisposes the seedling to attack in the region of the root collar. Control options are limited to pre-sowing treatments using etridiazole or a soil fumigant or the application of metalaxyl before or after sowing.

Smotherfungus: Thelephora terrestris Ehrhart ex Fries

This fungus is widespread and can, as the name suggests, kill very small seedlings by growing over them and smothering them. It is not parasitic and merely uses other plants to support its dark brown, velvety fruiting bodies. Fast-growing seedlings will outgrow the fungus. *Thelephora terrestris* may act as a beneficial mycorrhizal fungus. No control has ever been attempted.

Mycosphaerella leaf-blotch: Mycosphaerella cryptica (Cooke) Hansford

This fungus is limited to the northern half of the South Island and all but the northernmost part of the North Island (Dick 1982). The disease is found on the leaves and stem of *Eucalyptus delegatensis*, *E. fastigata*, and *E. regnans*. It is of significance only on *E. delegatensis* where leaf infection causes loss of growth and twig infection leading to dieback and multi-leading. The inoculum usually comes from an older infected stand

growing adjacent to the nursery. Sanitation felling will control the disease in this situation. The fungus produces asexual spores, which are spread by rain splashing, only in the summer; sexual spores, which are dispersed by wind, are produced all the year round. Chemical control is achieved by fortnightly applications of chlorothalonil plus a surfactant.

Cypress canker: *Monochaetia unicornis* (Cooke & Ellis) Saccardo (= *Seiridium unicorne* (Cooke and Ellis) Sutton) and *Coryneum cardinale* Wagnener = *Seiridium cardinale* (Wagnener) Sutton and Gibson

The disease is unusual because identical symptoms are caused by two different fungi. Both are found in New Zealand, but *Monochaetia unicornis* is the most common (van der Werff 1984). Seedlings of *Chamaecyparis lawsoniana*, x *Cupressocyparis leylandii*, *Cupressus macrocarpa*, and *Thuja plicata* are attacked by both these fungi, usually via a wound or at the base of a branchlet. Large amounts of resin are produced and the tissue turns brown. The infection girdles the affected branch; if the infection is on the main stem it can result in the death of the seedling. The spores are produced in pustules that appear on the surface of the dead tissue. The disease is of little economic importance. Usually the source of infection is an old tree in the vicinity of the nursery. Sanitation felling is the only option. Infected seedlings should be burnt. If infected seedlings are planted out they will develop large cankers. No chemicals are used in the nursery to control the disease.

Minor diseases

The following diseases have been found periodically from forest nurseries but are not considered to be of economic significance. *Cercospora* leaf-spot and *Hendersonia* leaf-spot caused by *Cercospora eucalypti* Cooke & Masee and *Hendersonia* spp., respectively, both occur on *Eucalyptus* spp. (Dick 1982). *Meria* needle-cast caused by *Meria laricis* Vuillemin occurs on larch causing needle loss (Gilmour 1966). Swiss needle-cast, *Phaeocryptopus gaeumannii* (Rohde) Petrak, may cause casting of 1-year-old needles of *Pseudotsuga menziesii* (Dick and Vanner 1986). *Phomopsis* dieback, *Phomopsis juniperovora* Hahn, causes dieback on *Cupressus macrocarpa* (Dick and Vanner 1986).

Insect problems in forest nurseries

Insects attacking the root and root-collar

Victoria weevil: *Desiantha diversipes lineata* Pascoe. This Australian insect was first recorded in New Zealand

in 1930. The larvae of this weevil feed on the roots of many plants including tree seedlings (Clark 1932). Damage to tree seedlings often occurs to the tap root leading to loss of growth and, in extreme cases, death. In forest nurseries, the insect, when prevalent, is more commonly found in beds of *Pseudotsuga menziesii*. The insect has an annual life cycle with adults emerging in October and November. The adults also damage seedlings, feeding at the root-collar. Problems with this weevil in nurseries were always associated with the presence of the weed *Rumex acetosella*; elimination of this weed with modern herbicides has cured the problem.

White-fringed weevil: *Graphognathus leucoloma Boheman*. The larvae feed on the roots of various plants but tree seedlings appear unaffected until they become stressed (Bain 1977). This South American insect is present in the North Island and in the northern half of the South Island. Only females have been found and they reproduce parthenogenetically with a 2-year life cycle. The insect rarely causes significant damage. With the withdrawal of the organochlorine insecticides, the only option, if required, is to control the adults, which are present from early December to April and whose numbers peak in January and February, with contact insecticides.

Grass grubs: *Odontria sylvatica* White and *Costelytra zealandica* White. These insects are melolonthine beetles (chafers), the larvae of which feed on plant roots. *Odontria sylvatica* and *C. zealandica* are two examples from this extensive group present in New Zealand, and are most commonly found affecting seedlings in nurseries (Bain 1980). With the improvements in weed control, few problems now occur as the adults do not readily oviposit in bare or sparsely vegetated ground.

Australian soldier-fly: *Ionopus rubriceps* Mcquart. The distribution of this introduced fly is limited to the northern half of the North Island. Normally it is a pasture pest but will attack tomatoes and cucurbits. It was found attached to *P. radiata* roots in a nursery newly established from pasture. Serious growth loss occurred. Again, the adult does not lay on bare ground, but could be a problem in areas of nurseries which have been fallowed under grass. Cultivation is the only control option available to the nurseryman.

Insects attacking stems and foliage

Tortrix caterpillars: *Ctenopseustis obliquana* (Walker), *Planotortrix excessana* (Walker), *Epiphyas postvittana* (Walker), and *Strepsicrates macropetana* Meyrick. The

above are the most commonly found in forest nurseries, and are characterized by the larvae webbing together the needles or leaves of seedlings. With the exception of *S. macropetanu*, which is restricted to eucalypts (Nuttall 1983a), many species of tree seedling are attacked by these tortricids (Kay 1979; Nuttall 1983b). Some loss of growth can be expected, but the most serious effect occurs when the caterpillars attack the terminal bud causing the seedling to become multi-leadered. A variety of insecticides have been used to control tortricids when the numbers become high. Low rates of deltamethrin give good control.

Cut-worms: *Agrotis ipsilon aneituma Walker*. The larvae of this noctuid moth, which is distributed throughout the country, occur from time to time in forest nurseries where they can devastate emerging seedlings, chewing them off just above ground-level. All species are attacked. The larvae, which feed at night, live in the ground, often pulling seedlings into their burrows. The adults are also nocturnal, and the female lays up to 1000 eggs into cracks in the ground. When this insect is present, as indicated by short cut-off seedling stalks, control is necessary. This is best achieved by the application of a contact insecticide in the late evening.

Eucalyptus leaf mining sawfly: *Phylacteophaga froggatti Riek*. This is a recently introduced Australian sawfly (Nuttall 1985), whose larvae feed by mining inside the leaves of the host plant. The structure of the lower leaf

surface remains intact, leaving a paper thin cuticle covering the mine. Growth is adversely affected owing to the loss of photosynthetic capacity caused by the mining. The insect is at present confined to the North Island. Dimethoate is applied to control the insect in nurseries; sprays have to be repeated because both the egg and the pupal stages are unaffected. A parasitic wasp, *Bracon phylacteophagus* Austin, has been successfully established and is depressing sawfly numbers to very low levels.

Onion Thrips: *Thrips tabaci Lindeman*. *Pinus radiata* seedlings show a graded response to the number of thrips present on the seedling. At very low levels, instead of being straight, a few needles develop sharp bends or kinks somewhere along their length. As the number of thrips increases, the incidence of this type of damage increases, and the needles shorten and become glaucous. Seedling growth is reduced. In some seedlings, the terminal bud aborts and the plant eventually becomes multi-leadered. Although multi-leadered seedlings perform well when outplanted and one of the lateral shoots becomes dominant, these seedlings are not readily accepted by establishment foresters and are culled unnecessarily. Onion thrips are cosmopolitan and attack a very extensive range of host plants. The incidence of attack is highest in the drier nurseries. Thrips can be controlled by fortnightly applications of deltamethrin (Ray and Vanner 1988).

References

- Bain, J. 1977. *Graphognathus leucoloma* Boheman. N. Z. For. Serv. For. Res. Inst. Forest and timber insects in New Zealand. No. 13.
- Bain, J. 1980. Melolonthine beetles in forests. N. Z. For. Serv. For. Res. Inst. Forest and timber insects in New Zealand. No. 43.
- Bassett, C. 1961. Some soil-borne fungi in forest nurseries. N. Z. Sci. Rev. 19:24.
- Clark, A.F. 1932. Insects infesting *Pinus radiata* in New Zealand. N. Z. J. Sci. Technol. 13:235-243.
- Dick, M. 1982. Leaf-inhabiting fungi of eucalypts in New Zealand. N. Z. J. For. Sci. 12:525-537.
- Dick, M.; Vanner, A.L. 1986. Nursery diseases. N. Z. For. Serv. For. Res. Inst. Forest Pathology in New Zealand. No. 16.
- Dingley, J.M.; Gilmour, J.W. 1972. *Colletotrichum acutatum* Simms. f. sp. *pineae* associated with "terminal crook" disease of *Pinus* spp. N. Z. J. For. Sci. 2:192-201.
- Gilmour, J.W. 1966. The pathology of forest trees in New Zealand. N. Z. For. Serv. For. Res. Inst., Tech. Pap. No. 48.
- Jancarik, V. 1969. Control of *Dothistroma pini* in forest nurseries. N. Z. For. Serv., For. Res. Inst., Res. Leaflet. No. 24.
- Kay, M.K. 1979. *Ctenopseustis obliquana* (Walker). N. Z. For. Serv., For. Res. Inst., Forest and timber insects in New Zealand. No. 40.
- Langridge, Y.N.; Dye, D.W. 1982. A bacterial disease of *Pinus radiata* seedlings caused by *Pseudomonas syringae*. N. Z. J. Agric. Res. 25:273-276.
- Nuttall, M.J. 1983a. *Strepsicrates macropetanu* Meyrick. N. Z. For. Serv., For. Res. Inst., Forest and timber insects in New Zealand. No. 57.
- Nuttall, M.J. 1983b. *Planotortrix excessana* (Walker), *Planotortrix notophaea* (Turner), *Epiphyas postvittana* (Walker). N. Z. For. Serv., For. Res. Inst., Forest and timber insects in New Zealand. No. 58.
- Nuttall, M.J. 1985. New insect pest attacks eucalypts. New Zealand Farmer 106:124-125.
- Ray, J.W. 1975. "Terminal Crook" disease in pine nurseries. N. Z. For. Serv., For. Res. Inst., What's New in Forest Research No. 25.

-
- Ray, J.W.; Vanner, A.L. 1988. Reducing the frequency of seedling malformations in *Pinus radiata* nurseries by the application of insecticides. N. Z. J. For. Sci. 18:280-286.
- van der Werff, H. 1984. Cypress canker. N. Z. For. Serv., For. Res. Inst. Forest pathology in New Zealand. No. 8.
- Vanner, A.L.; Ray, J.W. 1977. Control of the disease "terminal crook" in pine seedlings. Fungicide and Nematicide Tests **32**, Report No. 275.
- Vanner, A.L. 1990. Control of terminal crook disease in radiata pine seedlings. Pages 187-190 in A.J. Popay, editor. Proceedings of the 43rd New Zealand weed and pest control conference. Dunedin, August 14-16, 1990. New Zealand Weed and Pest Control Society, Palmerston North.

Diseases and insects in Norwegian forest nurseries

DAGMAR BØRJA AND ØYSTEIN AUSTARA

Norwegian Forest Research Institute
P. O. Box 61, 1432 Ås-NLH, Norway

Presented at the first meeting of IUFRO Working Party S2.07-09
(Diseases and Insects in Forest Nurseries), Victoria, British Columbia, Canada, August 22-30, 1990.

Abstract

The introduction of container seedling production in the early 1970s markedly affected both the kinds and occurrence of diseases and insects in Norwegian forest nurseries. Pathogens common to bareroot nurseries such as *Lophodermium seeditiosum*, *Sirococcus strobilinus*, *Gremmeniella abietina*, *Melampsora pinitorqua*, *Phacidium infestans*, and *Herpotrichia*-like mycelia occur less frequently on container-grown stock. Also, insects and mites such as *Oligonychus ununguis*, *Melolontha hippocastani*, *Amphimallon solstitialis*, *Phyllopertha horticola*, *Serica brunnea*, *Bracyderes incanus*, and species of *Agrotis* that damage bareroot seedlings have not yet been recorded in containers. Recently the most serious problem has been root dieback in several nurseries. Abiotic factors such as flooding, old contaminated sand beds, or poor sanitation of used containers have contributed to the problem. These predisposing factors have provided suitable conditions for pathogens such as *Pythium* and *Rhizoctonia* to severely damage seedling roots. Frequently, physiological disorders or infection by *Botrytis cinerea* damage shoots of container-grown seedlings. To date, insect damage has been confined to root and vine weevils (*Otiorhynchus* spp.).

Resume

L'introduction de la production de semis en contenant au début des années 70 a profondément influé aussi bien le type que sur la fréquence des maladies et des insectes dans les pépinières forestières de la Norvège. Les agents pathogènes que l'on rencontre couramment dans les pépinières à racines nues, comme *Lophodermium seeditiosum*, *Sirococcus strobilinus*, *Gremmeniella abietina*, *Melampsora pinitorqua*, *Phacidium infestans* et les mycéliums apparentés à *Herpotrichia*, sont moins fréquents dans les pépinières où l'on pratique la culture en contenant. De plus, des insectes tels *Oligonychus ununguis*, *Melolontha hippocastani*, *Amphimallon solstitialis*, *Phyllopertha horticola*, *Serica brunnea*, *Bracyderes incanus* et les espèces du genre *Agrotis* qui endommagent les semis à racines nues n'ont pas encore été signalés dans les semis en contenant. Récemment, la difficulté la plus sérieuse rencontrée a été le dépérissement des racines dans plusieurs pépinières. Des facteurs abiotiques comme l'inondation, l'utilisation de vieux lits de sable contaminés et le nettoyage insuffisant des contenants réutilisés ont contribué à ce problème. Ces facteurs de prédisposition ont fourni les conditions favorables qui ont permis à des agents pathogènes comme *Pythium* et *Rhizoctonia* de causer de graves dommages aux racines des semis. Souvent, les pousses des semis en contenant subissent des dommages par suite de désordres physiologiques ou d'une infection par *Botrytis cinerea*. Jusqu'à présent, les seuls insectes à avoir causé des ravages sont des charançons (*Otiorhynchus* spp.).

Introduction

In Norway, about 70 million conifer seedlings, mainly *Picea abies* and *Pinus sylvestris*, are produced each year in some 30 nurseries throughout the country (Figure 1). Each nursery produces stock for outplanting locally.

Until the early 1970s seedlings were mainly produced in bareroot nurseries where they were grown 3 to 5 years. Gradually, however, bareroot production has been reduced so that today about 80% of all seedlings are container-grown (Sandvik 1987). Spruce seedlings are grown for one or two growing seasons, while pines are ready for outplanting after one season in the nursery. The technological change from bareroot to container-

ized production has been accompanied by a change in the kinds and abundance of diseases and insects affecting seedlings.

Main pests and diseases in forest nurseries

Fungus-caused diseases of bareroot seedlings

In general, bareroot seedlings are subject to many hazards. Seedlings grown outdoors suffer from a greater variety of diseases and insects than container-grown seedlings in the glasshouse. The most damaging disease of young, succulent seedlings is root rot caused by soil-borne pathogens, mainly species of *Fusarium*, *Rhizoctonia*, *Pythium*, and *Cylindrocarpum*.

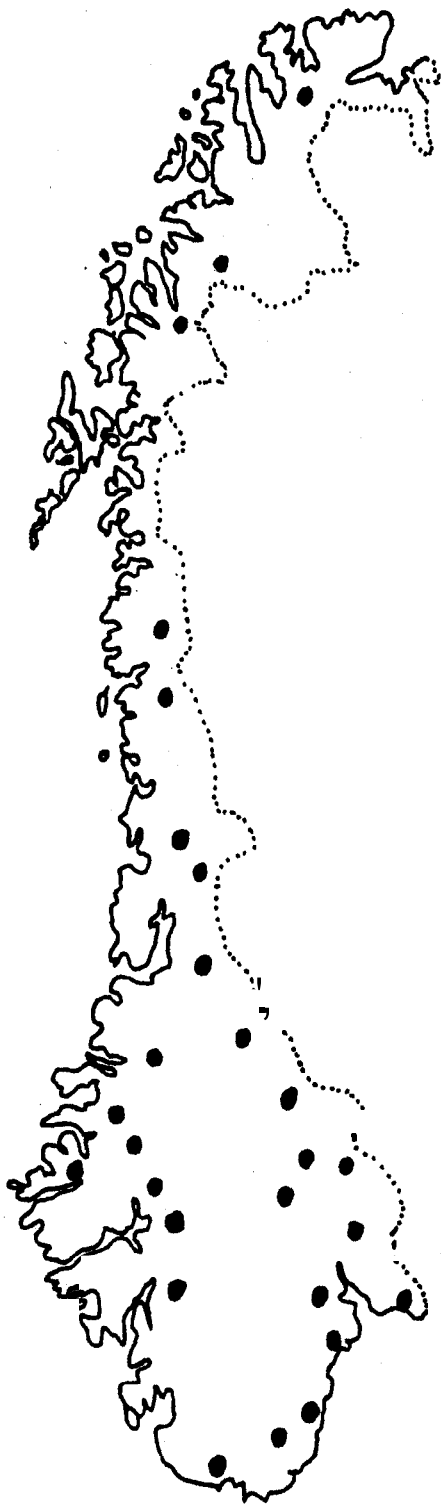

Figure 1. Forest nurseries in Norway.

In 1962, serious damage occurred on roots of 4-year-old spruce seedlings outplanted in autumn at 21 localities in southern Norway (Roll-Hansen and Venn 1966). Typical symptoms were root necrosis and bark death on the lower part of the stem. The causal agents responsible for the disease were not identified. However, the authors discussed the possible influence of abiotic factors and hypothesized that outplanted seedlings may be predisposed to root damage by physiological conditions that occur at certain times in autumn.

Shoots and needles of bareroot pine have been damaged by *Lophodermium seditiosum*, *Sirococcus strobilinus* (also on spruce) or *Gremmeniella abietina*, and sometimes by the rust fungus *Melampsora pinitorqua*. Pine seedlings were often damaged by *Phacidium infestans* in areas where snow cover persists (Roll-Hansen 1968; 1969; Venn 1976).

Overall, spruce seedlings suffer less from diseases than do pine seedlings (Venn 1976). Shoot damage by *Herpotrichia*-like mycelia has been reported sporadically. In the 1960s, however, serious damage occurred on shoots of 4- to 5-year-old spruce in southern Norway. The pathogen was a species of *Rhizoctonia* which appeared to belong to the *Ceratobasidium* genus (Roll-Hansen 1968). The white, sterile mycelium of the fungus grew on the bark and entwined and killed needles on the lower shoot, then spread upwards and laterally to neighboring plants. In dense plantations under moist cool conditions, entire seedlings were covered with the mycelium (Roll-Hansen 1969).

Botrytis cinerea is one of the most common shoot pathogens on pine and spruce seedlings. Moulding of bundles of cold-stored seedlings, caused by *B. cinerea* or sterile *Basidiomycetes* mycelium, is also very common.

Insects and mites affecting bareroot seedlings

Among the Aracnidae, the spider mite *Oligonychus ununquus* has occurred on spruce seedlings (Bakke 1961; Christiansen 1969; Ehnstrom *et al.* 1974), and is usually controlled by acaricides. Insect pests are mainly in the orders Coleoptera and Lepidoptera. Earlier, cockchafers were especially troublesome (Bakke 1961); *Melolontha hippocastani*, *Amphimallon solstitialis*, *Phyllopertha horticola*, and *Serica brunnea* have, to varying degrees, caused serious damage in forest nurseries in various parts of Norway. The latest record of a cockchafer infestation in Norway was a 1973 outbreak of *Melolontha hippocastani* (Loyttyniemi *et al.* 1979). Other troublesome beetles have been the weevils *Otiorhynchus* spp. (Bakke 1961) and *Brachyderes incanus* (Austara *et al.* 1983). Among the moths, *Agrotis* spp. often damaged young seedlings in open beds. The most

recent outbreak occurred in 1976 when *Agrotis segetum* damaged seedlings and young plants in several nurseries. One nursery in particular suffered devastating damage (Löyttyniemi *et al.* 1979).

Cockchafer larvae and cutworms were usually controlled by watering or dusting the soil with lindane. Insects in the families Elateridae and Tipulidae have been of little concern in Norwegian forest nurseries.

Fungus-caused diseases of container-grown seedlings

Many of the pathogens occurring on bareroot stock are also encountered in container nurseries; however, disease occurs less often. Root dieback is common on spruce and pine seedlings. It usually results from a combination of unfavorable abiotic and biotic conditions. *Botrytis cinerea* is the most frequent shoot pathogen.

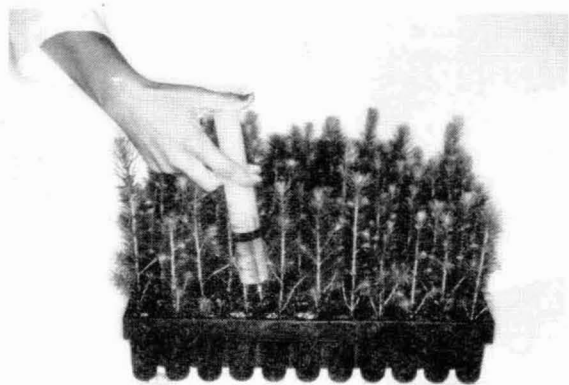

Figure 2. Inoculation of spruce seedlings with pathogenic fungi.



Figure 3. *Rhizoctonia*-inoculated spruce seedlings.

Insects and mites affecting container grown seedlings

Since seedling production has largely shifted to container nurseries, insect problems are mostly confined to *Otiorhynchus* weevils. They invade greenhouses from adjacent grasslands, or occasionally nearby strawberry fields. Several times from 1980-1989 *O. ovatus* and *O. nodosus* have caused extensive damage to container-grown spruce seedlings (Austara *et al.* 1983; Ehnström, B., Annala, E., Austara, Ø., Harding, S. and Ottosen, J.G. Insect pests in forests of the Nordic countries 1982-1986. Unpublished manuscript). Control was achieved by watering with lindane. Cockchafer and cutworms have not yet been a problem on container-grown seedlings.

Recent problems

The most serious and persistent problem since the introduction of container nursery technology has been root dieback which occurred in the mid-1970s. Damage mostly occurred on spruce seedlings at several nurseries. Losses were considerable, reducing seedling production by as much as 4 to 5%. Root dieback losses were carried over from one crop to the next, since at that



Figure 4. *Pythium*-inoculated spruce seedlings.

time growing containers were set on sand beds to obtain proper capillary contact and drainage. Moreover, containers were usually used several times.

Typical diseased symptoms included shoot wilting and chlorosis "droopiness", stunted growth, and varying amounts of root damage. Symptoms occur on young seedlings in their first year or during the second growing season, and sometimes after seedling outplanting. Root damage occurs prior to appearance of shoot symptoms.

Distribution of affected seedlings in containers suggested a fungal pathogen. Subsequent isolations from diseased roots yielded natural rhizoplane fungi, i.e., *Mycelium radicans atrovirens*, *Penicillium* sp., *Phoma herbarum*, and *Varicosporium elodeae* (Venn 1985) plus pathogenic fungi in the genera *Pythium*, *Rhizoctonia*, *Fusarium* and *Cylindrocarpon* (Galaaen and Venn 1979). Pathogenicity tests with isolates of a *Pythium* sp. (later determined to be *P. dimorphum*) and a multinuclear *Rhizoctonia* sp. showed that these fungi were aggressive pathogens, whereas the *Cylindrocarpon* and *Fusarium* isolates were weakly pathogenic (Venn 1985).

Although *P. dimorphum* and the *Rhizoctonia* were repeatedly isolated from diseased roots, these fungi were obviously not the only factor involved in the root dieback. Experiments at several nurseries determined the effects of inoculation with the most pathogenic isolates of *Pythium* and *Rhizoctonia* in combination with various abiotic factors (e.g., growing media, irrigation and container placement) on disease occurrence and severity. Regardless of the growing medium, seedlings grown in containers sitting on old sand beds were inferior to those in containers on racks raised 5 to 10 cm above the ground (Venn *et al.* 1986). This

indicated that the sand layer was a source of pathogen inoculum. Analysis of the sand showed that sand under the containers of diseased seedlings had a very uniform flora, mainly fungi in the family Pythiaceae. The flora beneath containers of healthy seedlings was more variable (Olsen, personal communication).

Seedlings inoculated with either *Rhizoctonia* or *Pythium* (Figure 2) showed typical root dieback symptoms. *Rhizoctonia*-inoculated seedlings had stunted growth and dense, chlorotic leaders (Figure 3), but they were not killed. *Rhizoctonia* was recovered from seedling roots up to four months after inoculation. *Pythium* inoculations showed that the earlier seedlings were inoculated, the more severe the damage. *Pythium*-inoculated seedlings were usually irreversibly damaged (Figure 4); however, it was only possible to recover *Pythium* from seedling roots within 6 weeks of inoculation (Venn *et al.* 1986).

Flooding also predisposed seedlings to root dieback. When seedlings were stressed by flooding, *Pythium* was more harmful than on unstressed seedlings (Venn 1983). Old, contaminated containers were also a source of inoculum (Olsen, personal communication).

Root dieback losses have decreased following (i) removal of sand beds, to improve drainage, (ii) implementation of container sanitization between crops, and (iii) development of appropriate fungicide and irrigation regimes. These practices have eliminated the root dieback problem. However, constant vigilance and monitoring and cooperation between growers and forest pathologists are necessary to ensure that the problem does not return.

References

- Austara, Ø.; Annala, E.; Bejer, B.; Ehnstrom, B. 1983. Insect pests in forests of the Nordic countries 1977-1981. Fauna norv. Ser. B. 31:8-15.
- Bakke, A. 1961. Skogsinsekter. H. Aschehoug & Co. (W. Nygaard). Oslo 1961. 172 p.
- Christiansen, E. 1969. Insect pests in forests of the Nordic countries 1961-1966. Norsk ent. Tidskr. 17:153-158.
- Ehnstrom, B.; Bejer-Petersen, B.; Loyttyniemi, K.; Tvermyr, S. 1974. Insect pests in the forests of the nordic countries 1967-1971. Suomen Hyonteistieteellinen Aikakauskirja 40(1):37-47.
- Galaaen, R.; Venn, K. 1979. *Pythium sylvaticum* Campbell & Hendrix and other fungi associated with root dieback of 2-0 seedlings of *Picea abies* (L.) Karst. in Norway. (Sopper assosiert med rotavdaing pa 2/0 granplanter.) Medd. Nor. inst. skogforsk. 34:265-280.
- Loyttyniemi, K.; Austara, Ø.; Bejer, B.; Ehnstrom, B. 1979. Insect pests in forests of the Nordic countries 1972-1976. Folia Forestalia 395:1-13.
- Roll-Hansen, R. 1968. Soppsykdommer. Produksjon av skogplanter, utgitt av Det norske skogselskap. 6 p.
- Roll-Hansen, F. 1969. Soppsykdommer pa skogtrær. Vollebekk. 173 p.
- Roll-Hansen, F.; Venn, K. 1966. Rotavdaing pa gran etter høstplanting. Norsk Skogbruk 12:90-92.
- Roll-Hansen, H. 1968. Grankingel, en planteskolesykdom som har vekket oppmerksomhet i 1960 arene. Årsskrift for Norske Skogplanteskoler 1968:39-51.
- Roll-Hansen, H. 1969. En *Rhizoctonia*-art som skader granplanter i sør-Norge. Norsk Skogbruk 15:149-152.
- Sandvik, M. 1987. Rotdøden i pluggplanteproduksjonen i norske skogplanteskoler. Aktuelt fra SFFL. Informasjonsmøte skogbruk 1987, nr. 6. 1987:7-16.

-
- Venn, K. 1976. Soppsykdommer i skogplanteskolene. Årsskrift for Norske Skogplanteskoler 1975:77-80.
- Venn, K. 1983. Rotavdøing - Det patogene aspekt. Årsskrift for Norske Skogplanteskoler 1982:51-53.
- Venn, K. 1985. Rotavdøing hos bartreplanter i skogplanteskoler. (Root dieback of coniferous seedlings in forest nurseries.) Rapp. Nor. inst. skogforsk. 3/85:1-11.
- Venn, K.; Sandvik, M.; Langerud, B.R. 1986. Nursery routines, growth media and pathogens affect growth and root dieback in Norway spruce seedlings. Medd. Nor. inst. skogforsk:39:3 14-328.

Forest nursery diseases in Papua New Guinea

FRANS ARENTZ

Department of Forestry, Papua New Guinea University of Technology
Papua New Guinea

Presented at the first meeting of IUFRO Working Party S2.07-09
(Diseases and Insects in Forest Nurseries), Victoria, British Columbia, Canada, August 22-30, 1990.

Abstract

In Papua New Guinea, damping-off may be caused by a number of pathogens, principally *Rhizoctonia* in the lowlands and *Pythium* in the highlands. Several leaf pathogens including *Colletotrichum*, *Cylindrocladium*, and *Harknessia* cause significant defoliation and bud dieback of seedlings. *Phytophthora* root rot has been responsible for seedling mortality in a number of highland nurseries. Adequate disease control is obtained by soil sterilization, maintaining nursery hygiene and the use of appropriate fungicides.

Resume

En Papouasie–Nouvelle-Guinée, la fonte des semis peut être causée par un certain nombre d'agents pathogènes, principalement *Rhizoctonia*, dans les basses terres, et *Pythium*, dans les hautes terres. Certains agents pathogènes agissant sur les feuilles, dont *Colletotrichum*, *Cylindrocladium* et *Harknessia*, entraînent une défoliation et un dépérissement des bourgeons importants chez les plantules. Dans certaines pépinières des hautes terres, des plantules sont mortes du pourridié des racines causé par *Phytophthora*. La stérilisation du sol, le maintien d'une bonne hygiène dans les pépinières et l'utilisation de fongicides appropriés sont des moyens efficaces de lutte contre les maladies.

Introduction

In the last 40 years, forest plantation establishment in Papua New Guinea has been carried out on a relatively small scale, and to date approximately 34 000 ha have been established in a number of localities in both the highlands and lowlands. It is anticipated that, with the increased pace of logging of the natural forests, the rate of plantation establishment will be significantly increased over the next 10 years, and several thousand hectares of plantation will be established every year.

The diversity of habitats in Papua New Guinea has resulted in the need for a wide range of tree species suited for specific habitats. In the lowlands, the main species planted are *Eucalyptus deglupta* Blume, *Terminalia brassii* Exell., *Pinus caribaea* Morelet, *Gmelina arborea* Roxb., *Tectona grandis* L.f., *Acacia mangium* Willd. and *Acacia auriculiformis* Cunn. ex Benth.; in the lower montane sites *Araucaria hunsteinii* Schumann, *A. cunninghamii* Aiton ex D. Don, *Pinus caribaea*, *P. merkusii* Jungh. & de Vries, *P. oocarpa* Schiede and *P. kesiya* Royle ex Gordon are planted; at high altitudes *Pinus patula* Schiede & Deppe is the main species planted although *Casuarina papuana* S. Moore, *Eucalyptus saligna* J.E. Smith and *E. robusta* Smith are also grown.

All species are raised as tubed stock in forest nurseries which are located throughout the country. The incidence of disease of seedlings is variable depending on locality, tree species being planted, and the skill of the nursery workers. The range of nursery pathogens found in any particular locality in Papua New Guinea is predictable and appropriate control measures can be adopted. This paper examines some of the diseases caused by these pathogens and gives details of disease control measures.

Damping-off

Because of conditions of high temperature and humidity, damping-off caused by *Rhizoctonia solani* Kuhn is the major disease problem of germinating seedlings for all tree species grown in the lowlands. The severity is greatest with *Eucalyptus deglupta*; total loss of germinating seedlings of this species has occurred using unsterilized soil. The damping-off can be controlled by heat sterilization of the nursery soil and by ensuring nursery hygiene. Steam sterilization is not done due to a lack of proper equipment. There have been problems with soil toxicity as a result of the over-heating of soil. Also, despite all precautions, damping-off may still occur, often as a result of splash dispersal of *Rhizocto-*

nia during heavy rain, and affected seedlings are often spot-treated with PCNB-based fungicides in these situations. *Cylindrocladium scoparium* Morgan, *C. parvum* Anderson and *C. ilicicola* (Hawley) Boedijn & Reitsma also cause damping-off of *E. deglupta* seedlings in several nurseries.

In the highlands, where conditions are drier and cooler than in the lowlands, damping-off may be caused by a range of pathogens including *Pythium* spp., *Fusarium*, and *Botrytis cinerea* Pers. For example *Pythium butleri* Subram., has caused damping-off of *Pinus kesiya* (Shaw 1984) and *P. patula* has been found to be highly susceptible to an unidentified *Pythium* sp. As a result, seeds are germinated in open beds of sterilized soil before being transplanted into tubes. Because of the susceptibility to damping-off and the need to use sterilized soil, the seedlings have poor mycorrhizal development. To correct this, tubed seedlings are placed around mycorrhizal mother trees grown in the middle of a nursery bed (Evans 1982). Spot outbreaks of damping-off caused by *Pythium* are treated with metalaxyl (Ridomil).

Fusarium has been isolated from wilting seedlings of *Araucaria huntsteinii* (Shaw 1984) and may cause significant levels of mortality in the nursery. Similarly, *B. cinerea* has been associated with serious damping-off of seedlings of the *Eucalyptus globulus* group and of *Casuarina* seedlings. The disease can be controlled by treatment with Benomyl and by soil sterilization.

Diseases of older seedlings

Foliage diseases

A number of root and leaf pathogens have been associated with disease problems in forest nurseries in Papua New Guinea. Only the most significant pathogens will be discussed.

Colletotrichum spp. have been associated with leaf spot and bud blight of a wide range of plant species (Shaw 1984). For example, a *Colletotrichum* sp. causes bud blight of *Araucaria huntsteinii* seedlings. Symptoms include sunken, moist, brown or black lesions on young leaves and shoots, possible death of the apical meristem, and retarded growth. Although the pathogen can be controlled using fungicides, all fungicide formulations tried have been phytotoxic. Instead, disease control involves manipulating the environment by reducing humidity through improved air circulation, by careful watering and by manipulating the amount of overhead shade so as to make conditions less favorable for the pathogen.

Colletotrichum gloeosporioides (Penz.) Penz. & Sacc. causes a conspicuous leaf spot of *Eucalyptus deglupta* in a number of nurseries and plantations.

Variable resistance to *C. gloeosporioides* infection has been observed in different provenances of *E. deglupta* and this could be incorporated into future breeding programs.

Cylindrocladium spp. are widespread in Papua New Guinea, and they cause both root rot and shoot and leaf blights. *Cylindrocladium quinqueseptatum* Boedijn & Reitsma may cause severe defoliation of *E. deglupta*, and although in the laboratory all provenances are susceptible to infection by the pathogen, the severity of defoliation in the field is variable and appears to be related to provenance. *Cylindrocladium parvum* has been isolated from leaf spots on *Eucalyptus tereticornis* and *E. raveretiana* in a number of nurseries. The severity of disease was greatest on seedlings under nutrient or water stress and control was achieved with the application of fungicides to the foliage. Mortality of *Pinus caribaea* seedlings has been recorded following infection of the roots by *Cylindrocladium* sp.

An undescribed species of *Harknessia* has caused significant defoliation of unthrifty seedlings of *E. deglupta*. Symptoms include the appearance of brown irregular necrotic lesions and death of the leaders. Two other undescribed species of *Harknessia* have a widespread distribution on *Eucalyptus robusta* and *E. grandis* in the highlands causing leaf spot; the disease is severe only on seedlings and trees under nutrient stress.

Low levels of shoot blight caused by *Diplodiapineae* (Desm.) Kickx have been recorded on *P. caribaea* seedlings in the highlands. Control is achieved using cultural methods by isolating infected seedlings and by nursery hygiene.

Root diseases

Phytophthora spp. are the most significant root rot pathogens in Papua New Guinea nurseries. A number of species including *P. cryptogea* Pethybridge & Lafferty, *P. nicotianae* van Dreda de Haan var. *nicotianae*, *P. nicotianae* var. *parasitica* (Dastur) Waterhouse, and *P. palmivora* (Butler) Butler have been isolated from nursery soil (Arentz 1986). Only *P. cryptogea* has been consistently associated with mortality of seedlings, especially of *Pinus caribaea*. After the initial recovery of *P. cryptogea* from the roots of dying *Pinus* seedlings it was thought that the pathogen may have been introduced into the country from overseas. A survey of the occurrence and distribution of *Phytophthora* spp. found that a large number of *Phytophthora* spp. were widespread in Papua New Guinea soils (Arentz 1986) and that *P. cryptogea* and the other *Phytophthora* spp. were already present in the soil being used in the nursery.

This was associated with the practice of taking soil from Pinus plantations in order to ensure that the soil contained suitable mycorrhizal inoculum for the seedlings. Symptoms of *Phytophthora* root rot in the nursery included chlorosis of the whole seedling followed by death. Satisfactory disease control has been achieved by using *Phytophthora*-free soil taken from areas outside forest plantations. Although both mating types of *P. cinnamomi* Rands have been isolated from plantations and natural forests (Arentz and Simpson 1986) the pathogen has not been recovered from forest nurseries in Papua New Guinea.

Reduced seedling growth as a result of the presence of nematodes has been observed. However, little work has been done with these organisms. Similarly, little work has been done on the impact of *Fusarium* spp. on seedling health although these pathogens are common in nursery soils. A recent disease outbreak in *Araucaria cunninghamii* seedlings was associated with the presence of *Fusarium* although this was not confirmed.

Discussion

In the last few years almost no monitoring has been done of forest nurseries in Papua New Guinea to check for previously unrecorded nursery pathogens. With the likely increase in the rate of plantation establishment over the next decade, and the use of a wider range of species, the probability of new disease outbreaks is high. The shortage of suitably qualified forest pathologists within Papua New Guinea may mean that many of these outbreaks will remain undetected.

Acknowledgements

I wish to acknowledge the use of unpublished data on leaf pathogens collected by J.A. Simpson, N.S.W. Forestry Commission, while he was working with the Papua New Guinea Department of Forests.

References

- Arentz, F. 1986. A key to *Phytophthora* species found in Papua New Guinea with notes on their distribution and morphology. Papua New Guinea J. Agric. For. Fish. 43:9-18.
- Arentz, F.; Simpson, J.A. 1986. Distribution of *Phytophthora cinnamomi* in Papua New Guinea and notes on its origin. Trans. Brit. Mycol. Soc. 87:289-295.
- Evans, J. 1982. Plantation forestry in the tropics. 1st edition. Oxford University Press, Oxford. 472 p.
- Shaw, D.A. 1984. Microorganisms in Papua New Guinea. Department of Primary Industry, Port Moresby. Res. Bull. No. 33. 344 p.

Forest nursery diseases and insects in the Philippines

ENRIQUITO D. DE GUZMAN, ERNESTO P. MILITANTE AND REY LUCERO
*Department of Forest Biological Sciences, U.P. College of Forestry,
College, Laguna, The Philippines*

*Presented at the first meeting of IUFRO Working Party S2.07-09
(Diseases and Insects in Forest Nurseries), Victoria, British Columbia, Canada, August 22-30, 1990.*

Abstract

Important diseases and insect pests affecting forest nursery seedlings in the Philippines from 1965 to the present are reviewed. Basic information about these problems is lacking due to insufficient research funding. In the future, work on seedling diseases and insect pests should increase to the same level as that for research on pests affecting plantations and wood products.

Resume

Le rapport Etudie les principales maladies et les insectes nuisibles qui affectent les semis des pépinières forestières depuis 1965. Il existe peu de renseignements sur ces problèmes parce que le financement de la recherche est insuffisant. A l'avenir, les travaux sur les maladies des semis et sur les insectes nuisibles devraient augmenter au même niveau que la recherche sur les déprédateurs qui affectent les plantations et les produits du bois.

Introduction

The forests of the Philippines are one of the country's major natural resources. The dipterocarp forest, composed mostly of medium to large trees which can attain a height of 40-65 m and a diameter of 60-150 cm, produces the world renowned "Philippine mahogany." Philippine mahogany is composed of several species which produce either light or dark colored wood which is used for general construction or in making high-quality plywood, furniture, and pulp and paper. About 50 years ago, the Philippines' total land area of some 30 million ha was mostly covered with forests. de Guzman *et al.* (1986) cited 1984 statistics (supplied by the Bureau of Forest Development) as follows: 10.8 million ha total forest lands, 8.1 million ha of productive dipterocarp forest, 1.4 million ha of unproductive or protected dipterocarp forest, 955.73 million m³ of standing trees, 805.20 million m³ of dipterocarp forest, and 6.5 million ha of commercial forest land.

The reduction in the country's forest land has been attributed to rapid population growth, one of the highest in Southeast Asia. This has resulted in increased and uncontrolled shifting cultivation, conversion of forest lands to agriculture, illegal logging, and squatting. Over the years these activities have caused significant environmental degradation such as frequent flooding, soil erosion and siltation of rivers and depletion of plant and animal genetic resources.

As the human population increases the country will likely experience a timber deficit by the year 2000. The

government has therefore developed and implemented several schemes to increase wood productivity and, consequently, improve environmental conditions. The schemes are reforestation by the government, and agroforestry and establishment of industrial plantations by the private sector. Thus far, industrial plantations comprise about 100000 ha and 60000 ha has been reforested by the government. Recently, small-scale agroforestry has been implemented.

Plantation establishment has created conditions conducive to insect and pathogen outbreaks. This paper summarizes the status of these problems as they affect forest nurseries in the Philippines.

Characteristics of tree plantations

Table 1 shows the most common tree species used for reforestation, industrial plantations and agroforestry in the Philippines. Most species are exotic, fast-growing and planted as monoculture on degraded acid clay soils at lower elevations. The extension of these species beyond their natural geographical range subjects them to selection pressure by endemic pests and pathogens.

Important nursery diseases

During a symposium on the status of forest pests and diseases in Southeast Asia held at College, Laguna, Philippines in May, 1985 Quinones and Zamora (1987) gave the status of forest pests and diseases in the Philippines for the previous 20 years. Some of the important nursery diseases noted are described below.

Table 1. Trees used in forestry in the Philippines

Tree species	Government reforestation	Agroforestry	Industrial tree plantation
<i>Acacia auriculaeformis</i>	X		X
<i>A. mungium</i>	X		X
<i>Albizia falcataria</i>		X	X
<i>Aleurites moluccana</i>	X		
<i>A. trisperma</i>	X		
<i>Anacardium occidentale</i>		X	
<i>Anthocephalus chinensis</i>	X		X
<i>Casuarina equisetifolia</i>	X		
<i>Cedrela odorata</i>	X		
<i>Coffea robusta</i>		X	
<i>Eucalyptus camaldulensis</i>	X		
<i>E. deglupta</i>	X		X
<i>E. grandis</i>	X		
<i>E. robusta</i>	X		
<i>Gmelina arborea</i>	X		X
<i>Instsia bijuga</i>	X		
<i>Leucaena leucocephala</i>	X	X	X
<i>Mangifera indica</i>		X	
<i>Pinus kesiya</i>	X		X
<i>P. merkusii</i>	X		
<i>P. caribaea</i>	X		X
<i>Pterocarpus indicus</i>	X		
<i>Samanea saman</i>	X		
<i>Sweitenia macrophylla</i>	X		X
<i>Tectona grandis</i>	X		X

(a) Damping-off and root rot

This disease is caused by species of fungi in the genera *Pythium*, *Phytophthora*, *Fusarium*, *Rhizoctonia* and *Sclerotium*, acting singly or together. Seedling losses of up to 100% have been reported in some nurseries, with almost all seedling species being susceptible. Root rot is caused by either *Botryodiplodia theobromae* Pat. or *Corticium rolfsii* Curzi. The tree species most often affected are *Anacardium occidentale*, *Cryptomeria japonica*, *Pinus kesiya*, *P. caribaea*, and *Sweitenia macrophylla*.

(b) Pink disease

This disease is characterized by needle yellowing, toppling or downward curling of the seedling leader and pinkish discoloration of affected tissue. *Pinus kesiya* is most susceptible species; mortality of up to 40% has been recorded. *Fusarium solani* (Mart.) Sacc. is associated with the disease.

(c) Needle blight

This is a common disease affecting *P. kesiya* and *P. caribaea* seedlings. Typical symptoms are tiny, yellowish spots on the needles followed by browning and stunting of needles as the disease advances. Wilting and death of the upper portion of the stem are also common. Infection of 20-80% of nursery stock has been reported. A species of *Pestalotia* was initially associated with this disease but later studies revealed that it is caused by *Cercospora pini-densiflorae* Hori et Nambu.

In 1988, Kobayashi and De Guzman published a survey of forest tree diseases in the Philippines in 1977, 1981 and 1985. Besides the diseases reported by Quinones and Zamora, their work revealed the presence of other potentially dangerous seedling diseases such as the following.

(a) Charcoal rot

This disease, caused by *Macrophomina phaseolina* (Tassi.) Goid., affects all species of *Pinus*. Symptoms

are similar to those produced by *Rhizoctonia solani* Kuhn and *Fusarium* spp. Small black sclerotia commonly form beneath the bark of diseased seedlings.

(b) Seedling rust

Seedling rust is very common in nurseries and plantations where it affects *Tectona grandis*. The pathogen is *Olivea tectonae* (T.S. et K. Ramakr) Mulder. Seedling rust is most severe on seedlings during their first 2 months and decreases thereafter; it is insignificant on older trees.

(c) Coffee rust

This disease is caused by *Hemileia vastatrix* Berk. et Br. and affects all coffee species grown in plantations and agroforestry. The typical rusty appearance is caused by numerous uredosori produced on the lower leaf surface. Severely affected leaves drop and seedlings can be defoliated if infection is continuous throughout the year.

(d) Powdery mildew

Powdery mildew occurs on seedlings of *Acacia mangium*, *Eucalyptus citriodora*, *Samanea saman* and *Tamarindus indicus*. It is characterized by a powdery appearance of leaves and stems and stunted growth. Although the pathogen has not been identified, it produces a well developed oidial stage.

(e) Anthracnose

Anthracnose (*Glomerellacingulata* (Ston.) Sp. et Schr.) is common on seedlings of *Mangifera indica* and *Leucaena leucocephala*. On *M. indica*, the fungus causes leaf spots and necrosis of young stems. Severe disease causes defoliation and dieback; the latter results in affected seedlings producing numerous shoots. Heavily affected seedlings are culled as they do not survive outplanting. On *L. leucocephala*, the fungus causes top wilting. Pinkish conidial masses are produced on wilted tissue together with pale pink fruit bodies of *F. soluni*.

(f) Tar spot

Tar spot, caused by *Phyllachora pterocarpii* H. et P. Sydow, is common on seedlings and mature trees of *Pterocarpus indicus*. Although seedlings may be heavily diseased, leaves remain attached and the disease does not affect growth significantly.

Recently, several new diseases had been reported affecting some very important tree species.

(a) Gall disease

Generalao *et al.* (1989) reported a severe outbreak of a gall disease on seedlings and mature trees of *Albizia*

falcataria (L.) Back. in Mindanao. The disease is characterized by twisting or girdling of shoots, followed by gall formation. Galls then turn brown and later become rusty in appearance. Affected seedlings usually lose their leaves and become stunted, eventually dying. According to Militante (unpublished data), disease incidence in nurseries is 90-100%. Gall disease was allegedly observed as early as 1983 in a government reforestation project in Mindanao, but since this observation was not confirmed, disease development was not monitored. Eusebio *et al.* (1990), in studying identity of the causal agent, reported the pathogen to be *Uromykladium tepperianum* (Sacc.) McAlpine. Both the pycnial and telial stages of the fungus occur on the same host. Their identification was confirmed by M. Dick, Forest Research Institute, Rotorua, New Zealand.

(b) Root rot of *Gmelina arborea*

About 10000 seedlings of *G. arborea* have been killed in a reforestation project in southern Leyte due to *C. rolfsii*. Symptoms include yellowing, wilting and seedling death. Numerous sclerotia form at the base of the diseased seedlings.

Important seedling insect pests

Although many insects affect forest nursery seedlings in the Philippines, only a few reports have been published on such insects. Quinones and Zamora (1987) found a mole cricket, *Gryllotalpa africana* Pal., infesting *Leucaena* seedling roots, causing seedling wilt and desiccation. Losses up to 30% of the *Leucaena* seedlings occurred at one site. Adult mole crickets are 2-5 cm long, brown, with a velvety appearance. Oviposition takes place in the rainy season and the life cycle is completed over the next year. Adults live 2-3 months, or longer. The above authors also reported an unidentified Lepidopteran damaging newly emerged or developed *Pinus kesiya* seedlings. Losses of 5-10% have been observed in some nurseries, but higher losses can occur if larvae are not controlled. The body of the dark colored adult insects is 5 mm long, while their forewings measure 6 mm. Pupation occurs inside a leaf case molded by insect webbing.

Quinones and Zamora (1987) also cited a report by Weidelt who in 1975 observed the occurrence of teak defoliator (*Hyblaea puera* Cramer) and teak skeletonizer (*Pyrausta machaelis* Walk.). The defoliator cuts out patches of leaf tissue while leaving the coarser veins. Young leaves are usually consumed. The life cycle requires 15-34 days for completion. Moths have a wing span of 30-40 mm. Their forewings are variable grey brown and red with diffused bands of darker color and the hind wing is dark brown with a curved orange

band sometimes broken up into patches. The skeletonizer consumes all the tissues between veins. The life cycle is completed in 23-29 days. Adult deposits eggs (on both upper and lower leaf surfaces) which hatch after 3 days; larvae feed under a protective silk cover. The moth has a wing span of 19-26mm; the forewing is yellowish with zigzag markings of varying colors while the hindwing is pale with a reddish marginal line.

In recent years, a psyllid infestation of *L. leucocephala* has been found worldwide, including in the Philippines, introduced into the country many years ago. *L. leucocephala* became a major source of fuel for cooking and a substitute for posts in rural housing. Because of the high nutritional value of its leaves, the species became a good source of nitrogen in animal feed formulations. Its popularity resulted in the introduction of other, fast-growing varieties. The popularity of these fast-growing varieties resulted in large scale plantings which eventually outnumbered the traditional variety. In 1985, an outbreak of psyllid infestation occurred. Initially, the infestation was confined to plantations, but later even nursery seedlings were attacked. Damage consists of defoliation, distortion of young stems, sooty mold development, and death of affected branches. A multi-disciplinary task force was created to study the problem and devise management strategies. One of us (Rey Lucero) studied the insect's population dynamics. Preliminary results follow: (i) in 1987, individual shoots with five compound leaves contained about 8000 eggs; (ii) egg, nymph and adult populations can reach 10 000 and defoliation begins 1 week after initial infestation; (iii) on heavily infested shoots, honeydew produced by the psyllid enhances sooty mold colonization; (iv) when nymph numbers reach 4000, most first-instar and second-instar nymphs die because of the honeydew's sticky nature; (v) fifth-instar nymphs are usually attacked by a chalcid parasite, e.g. in November, 1989, parasitism of fifth-instar nymphs reached 60% (the population of the psyllid is presently at its lowest level); and (vi) in 1985, only 13 species of natural parasites were observed. Presently, there are more than 100

natural enemies (most are predators while three are parasites).

Discussion and conclusions

A symposium on forest pests and diseases held in Southeast Asia in May, 1985 resulted in the identification of potentially dangerous insect pests and diseases which should be given top priority, outlined gaps in pathology and entomology research and gave a profile of current manpower. Training and equipment requirements for the region for 1986-1990 were also given. For the Philippines, no nursery insects were given a high priority. For diseases, the distribution and control of needle blight was identified as a top priority while the survey and identification of causal agents of leaf spot disease was given a number two priority. Research gaps identified for forest nursery insect pests and diseases were: (i) survey and growth impact, (ii) identification, (iii) biology and population dynamics, and (iv) control. The seemingly low priority given to research on seedling pests and diseases in the Philippines can be attributed to insufficient trained researchers, and lack of facilities and funding. Because pest-caused losses are more obvious in plantations and on wood products and because of the drastic reduction in the quality and serviceability of wood products, research designed to solve these problems has received more support from government and international research organizations.

In the immediate future the Philippines will be depending even more on plantations and agricultural tree crops to meet the increasing demand for wood. Large tracts of land will be converted into monocultural plantations. Under these conditions, many destructive pests and pathogens will affect both the production and utilization aspects of plantation management. Tree crop protection should thus be made an integral part of the management scheme. Research on biological problems affecting nurseries should receive as much attention as those affecting plantations and wood products. Because many important biological problems are common to the region, cooperative research efforts should be encouraged among researchers in Southeast Asia.

References

- De Guzman, E.D.; Umali, R.U.; Sotalbo, E.D. 1986. Dipterocarps/Non Dipterocarps. Guide to Philippine Flora & Fauna. Vol. III. Nat. Res. Manage. Cent., Univ. Phil. 414 p.
- Eusebio, M.A.; Sinohin, V.O.; Dayan, M.P. 1990. Gall rust disease of *Albizia falcataria* (L.). Res. Inf. Ser. Eco. 7 p.
- Generalao, M.L.; Cacanindin, D.C.; Decipulo, M.S. 1989. Gall disease: A threat to *Albizia falcataria* plantations. Pages 6-7 in Eco. Res. Dev. Sec. Res. Dig. Vol. 1(3).
- Kobayashi, T.; de Guzman, E. 1988. Monograph of tree diseases in the Philippines with taxonomic notes on their associated organisms. Bull. For. and For. Prod. Res. Inst. No. 351. 200 p.
- Quinones, S.S.; Zamora, R.A. 1987. Forest pests and diseases in the Philippines. Pages 43-65 in E. de Guzman and T. Nuhmara, editors. Forest Pests and Diseases in Southeast Asia. Biotrop Special Publ. #26.

Diseases of container-grown conifer nursery seedlings in Sweden

TORGNY UNESTAM AND LISELOTTE BEYER-ERICSON

Department of Forest Mycology and Pathology
Swedish University of Agricultural Sciences
Box 7026, 750 07 Uppsala, Sweden

Presented at the first meeting of IUFRO Working Party S2.07-09
(Diseases and Insects in Forest Nurseries), Victoria, British Columbia, Canada, August 22-30, 1990.

Abstract

The biology, distribution and damage of diseases of container-grown conifer seedlings in Sweden are reviewed. Special emphasis is given to the role of the common rhizospheric fungus *Cylindrocarpon destructans* (Zins.) Scholten in root death of *Pinus sylvestris* in Nordic nurseries and plantations.

Resume

L'étude porte sur la phytopathologie des semis de conifères cultivés en récipients dans les pépinières forestières suédoises. On y traite en particulier du rôle du champignon rhizosphérique commun *Cylindrocarpon destructans* (Zins.) Scholten dans la mortification rhizomlienne de *Pinus sylvestris* cultivé dans les pépinières et les plantations nordiques.

Introduction

In Sweden about 600 million seedlings are produced each year (Nystrom 1989), 80% of which are container-grown. Although Scots pine (*Pinus sylvestris*) and Norway spruce (*Picea abies*) are the major species grown, some lodgepole pine (*Pinus contorta*) and birch (*Betula verrucosa*) are also produced. There are from one to four crops each year. The first crop, sown in the greenhouse in March is normally outplanted on clear-cuts in the autumn of that year. Seedlings from subsequent sowings are overwintered outdoors or stored in freezers (-3°C) in waxed cardboard boxes (B. Arvidsson, National Board of Forestry, Jonkoping, Sweden, personal communication). As production of containerized seedlings has increased so have the associated diseases (James 1985). Although shoot diseases are most common, root diseases also cause notable losses.

Biology, Distribution and Damage

Shoot diseases

The most serious shoot diseases of container-grown seedlings in Swedish forest nurseries are grey mould (*Botrytis cinerea* Pers. ex Fr.), *Scleroderris* shoot dieback (*Gremmeniella abietina* (Lagerb.) Morelet), *Sirococcus* blight (*Sirococcus strobilinus* (Desm.) Petrak), *Lophodermium* needle cast (*Lophodermium seditiosum* Minter, Staley & Millar), and snow blight (*Phacidium infestans* Karst.). Among the rusts only

pine twist rust (*Melampsora pinitorqua* Rostr.) causes notable losses.

Over several years we have concluded that intensive plant production often favors pathogen buildup. The greenhouse environment often enhances pathogen development while outside cool, moist conditions and crowded stands with dense foliage may favor pathogens.

Grey-mould (*Botrytis cinerea*)

The fungus *B. cinerea* is the most damaging shoot pathogen in Swedish nurseries, especially on pine seedlings. This facultative parasite colonizes dead material before infecting living tissues. Although *Botrytis* conidia are present in the air at all times of the year, they are most numerous during the summer and autumn (Pawsey 1964). Grey-mould development and spread are favored by cool, moist conditions (Coley-Smith et al. 1980). Infection often follows physical damage, but conditions that weaken seedlings increase susceptibility to *Botrytis* (Pawsey 1964). Whereas Sutherland and Van Eerden (1980) say that *Botrytis* does not harm roots, Galaaen and Venn (1979) found the fungus associated with root collar necrosis of 2-year-old spruce seedlings.

Scleroderris shoot dieback (*Gremmeniella abietina*). This is the second most damaging shoot disease in Swedish nurseries. The fungus attacks *P. sylvestris* and *P. contorta*, but not *P. abies* seedlings. Infection

probably occurs from July through October and is favored by a cool, wet growing season (Petaisto and Repo 1988). Conidia are dispersed during rainy periods (Bergdahl 1983) and the fungus develops in shoots during the winter when it is favored by temperatures around 0°C (Barklund and Unestam 1988). This explains why snow cover creates good conditions for fungal infection (Marosy and Patton 1988). Disease symptoms appear in June, which is a problem as seedlings may have already been outplanted. At that time seedlings often bear ripe pycnidia, whereas pycnidia on trees do not mature until 1 year later. Conversely, cryptoconidia are often present on both seedlings and twigs on trees during summer following infection (Hellgren, unpublished).

Sirococcus blight (*Sirococcus strobilinus*)

In Sweden, damage from *Sirococcus* blight has increased since the early 1980s. Sudden outbreaks have occurred in northern Sweden, especially on *P. contorta*. The fungus primarily affects container-grown *P. contorta* and *P. abies*, but is rare on *P. sylvestris*. The pathogen spreads via spores from late spring until summer. Infection is favored by high humidity, insufficient light and cool temperature (Sutherland 1982).

We have often found infected seedlots of lodgepole pine adjacent to healthy spruce, or vice versa. Peace (1962) suggested that pine and spruce are attacked by different strains of the fungus. There might also be differences in susceptibility among pine and spruce provenances.

Pine needle cast (*Lophodermium seeditiosum*)

Lophodermium needle cast affects Scots pine and lodgepole pine. The disease has caused important damages to nursery seedlings in south and central Sweden (L. Beyer-Ericson, unpublished data). The pathogen occurs frequently in dense, moist seedbeds. Rainy, autumn weather favors infection (Butin 1989).

Lophodermium seeditiosum was long confused with *L. pinastri*. The latter attacks senescent and dead needles, whereas *L. seeditiosum* affects needles of all ages, although the current-year shoots are most severely affected (Minter 1981).

Snow blight (*Phacidium infestans*)

This foliage disease is common in nurseries in northern and central Sweden. The fungus infects *P. sylvestris* and *P. contorta* via spores in late autumn just before seedlings become covered with snow. Disease development and spread are favored by deep (at least 40-60 cm), prolonged snow cover (Mattson-Mårn and Nenzell 1941; Roll-Hansen 1989). Because in northern Sweden

a deep snow cover usually lasts from November through April, losses caused by *P. infestans* pose a serious problem especially where insufficient fungicide has been applied.

Twist rust (*Melampsora pinitorqua*)

This is the only rust causing economically important damage in Swedish nurseries. The fungus produces aecia on *P. sylvestris*, and uredia and telia on aspen (*Populus tremula*), white poplar (*Populus alba*), and grey poplar (*P. canescens*). *Pinus contorta* is not attacked by twist rust (Butin 1989). Infection occurs in spring on elongating pine shoots. When the fungus girdles shoots, they wither and die. Young pine seedlings may die when shoot damage is severe. The disease can be prevented by maintaining a 500-m-wide aspen and poplar-free strip around the nursery (Butin 1989).

Root diseases

Root problems are often neglected or misinterpreted. For example, delayed growth induced by mild disease may be attributed to other causes. Since the early 1980s root dieback on young, containerized conifer seedlings has occasionally caused serious problems in nurseries throughout Scandinavia. To determine the frequency and degree of root damage, 10 nurseries were surveyed in south and central Sweden. The findings were complemented by laboratory and greenhouse experiments.

Root pathogen survey

In the root pathogen survey isolations were made from roots of container-grown, 1- to 4-year-old Scots pine and Norway spruce seedlings with signs of root damage. Typical symptoms of root damage were stunted shoot growth, needle chlorosis, and browning beginning at the needle-tips. Fine roots were dead in most of the damaged root systems. Fungi isolated from surface sterilized tissues of damaged roots included *Pythium* spp., *Cylindrocarpon destructans* (Zins.) Scholten, *Alternaria alternata* (Fr.) Keissler, *Ulocladium atrum* Preuss, and *Botrytis cinerea* Pers. ex Fr., all of which are considered to be stress pathogens.

Pathogenicity and infection

We focused mainly on the effect of the mildly pathogenic but sometimes serious root-thief *Cylindrocarpon destructans*, which appeared in several nurseries where it was clearly associated with certain types of growing media (unpublished data), as well as with watering, shading, and pesticides usage (Unestam *et al.* 1989). The fungus is normally rather harmless, but may "steal" roots without causing symptoms other than delayed

plant growth. The fungus often increased its inoculum potential by growing on dead root pieces left in the growing medium or on the ground, thereby threatening the next crop. *Cylindrocarpon* appeared to inhabit the surface of fine roots where under favorable conditions it produced toxins that killed parts of the root, thereby allowing the fungus to invade. Under nursery conditions most of the root system eventually dies, although initial shoot symptoms may barely be noticeable (Unestam *et al.* 1989; Unestam and Beyer-Ericson 1988).

Stress also predisposes seedlings to *Fusarium*, *Alternaria* and *Pythium* infection. All these fungi produce toxins that weaken root tips, allowing the fungi to enter and kill roots. Spores of *Fusarium* and *Alternaria* may germinate and enter through cutting and grafting wounds. As far as we know, *Botrytis* does not produce a toxin; instead it penetrates roots and shoots of seedlings weakened by flooding, shading or frost (Pawsey 1964).

Stress and disease

In the nursery, infection by most root and shoot diseases is favored by plant stress. Thus, where such diseases are prevalent, it is often assumed that the seedlings are under stress. Many nursery practices can stress seedlings as may outplanting. Thus stress factors must be investigated and minimized. Intensive studies on *Cylindrocarpon* root death (Unestam *et al.* 1989; unpublished results) revealed that excessive rain, overwatering during dry periods, and the use of finely ground peat (which has an extremely high water-holding capacity) can result in oxygen depletion, an important source of stress. Shading (dense stocking), fungicides (some stress the root more than inhibit the pathogen), herbicides (that inhibit photosynthesis), root pruning and transplanting can all cause stress. For some fungi a pH higher than 6 resulting from liming of the peat substrate, or adding vermiculite, among other practices, favored disease (Damm and Unestam 1990; E. Stenstrom, Swedish University of Agricultural Sciences, Uppsala, personal communication).

Protecting microflora

Some soils favor growth of species of *Trichoderma* which may protect plant roots from pathogens. Unfortunately, these beneficial fungi are sometimes more sensitive to fungicides than are pathogens (Unestam *et al.* 1989).

Mycorrhizal fungi may, under certain conditions, protect seedling roots from pathogens (Chakravary and Unestam 1987 and references therein). The mycorrhizal fungi *Laccaria laccata* and *Hebeloma*

crustuliniforme not only protect short roots, but also actively favor formation of new long roots where the old roots had been killed by the pathogen (Damm and Unestam 1990). The photosynthetic capacity of damaged seedlings was partly preserved if their roots were mycorrhizal. Mycorrhiza formation in nurseries may be encouraged by suitable cultivation conditions such as moderate nutrient levels and avoidance of flooding (Stenstrom and Ek 1990; E. Stenstrom, manuscript in preparation "The effects of flooding on the formation of ectomycorrhizae in *Pinus sylvestris* seedlings."). Practical methods for inoculation with mycorrhizae have yet to be developed for Swedish nurseries.

Cold storage problems

In Sweden, most containerized seedlings are cold stored from about October until May. Since seedlings always become contaminated with spores or mycelium of saprophytic fungi during the growing season, storage mould is inevitable. Various fungi can mould cold stored seedlings. *Botrytis cinerea* is the main storage mould in Sweden, with an unidentified basidiomycete (*Basidiomycetes* sp.) being next in importance. Problems with storage mould are usually not detected until the seedlings are removed from the freezer in the spring. Seedlings attacked by *Botrytis* are usually covered with a grey, cottony mycelium, and the upper part of the shoot is often dead. As *Botrytis* can grow and parasitize plants at relatively low temperatures, e.g., -2°C, it is necessary to keep the storage temperature below -3°C. If the temperature temporarily increases during storage, perhaps from power failure or because too many boxes were placed in the freezer simultaneously, the fungus may grow and damage seedlings (Beyer-Ericson 1987). *Botrytis* has caused serious damage on seedlings that were insufficiently winter hardened before storage, or weakened by other fungi. Seedlings lifted from seedbeds during wet weather, and earth-soiled seedlings are especially susceptible to *Botrytis* during storage (Beyer-Ericson 1987).

Basidiomycetes sp. is another low temperature fungus causing mould on container-grown pine and spruce. The fungus forms a light grey mould on roots. If mycelial growth is intensive during storage, the fungus may spread outside the storage box. Because it can deteriorate cellulose, the fungus grows on paper, timber and other organic material near stored seedlings (Venn 1983). The mycelium of *Basidiomycetes* sp. collapses once seedlings are removed from the box to warmer and drier conditions. According to Venn (1983) the fungus is strongly associated with stem necroses. Nevertheless there are no reports from Sweden of affected seedlings dying after outplanting. Perhaps this is due to damage

being discovered and the boxes being opened before the fungus enters and destroys roots.

Fungicides

Although the proper use of fungicides can effectively reduce disease losses in the nursery, we find that routine applications, overdoses, and repeated use of the same compound can exacerbate rather than correct diseases. Knowledge is lacking on both the direct and indirect effects of fungicides on minor pathogens (Unestam *et al.* 1989). We do know, however, that the fungicide vinclozolin has little effect on *Cylindrocarpon*, but may

predispose roots to attack by this usually mild pathogen. Exclusive use of systemic fungicides such as benomyl may lead to serious attacks by *Botrytis cinerea* and species of *Alternaria* and *Fusarium*. Benomyl tolerant strains of *Botrytis* are well known (Coley-Smith *et al.* 1980). Failures in disease control as a result of benomyl tolerance in *Alternaria* occurs in carnation (Manning and Papia 1972) and young pine seedlings (Beyer-Ericson unpubl.). Olvång (1985) showed that *Gerlachia* (*Fusarium*) *nivalis* can be benomyl-tolerant. Although fungicide use is decreasing, more testing and information is needed to improve use of these materials.

References

- Barklund, P.; Unestam, T. 1988. Infection experiments with *Gremmeniella abietina* on seedlings of Norway spruce and Scots pine. *Eur. J. For. Pathol.* 18:409-420.
- Bergdal, D.R. 1983. Dispersal of conidia of *Gremmeniella abietina* related to weather. *Proc. Int. Symp. Scleroderris canker of conifers*, Syracuse, USA. June 21-24, 1983.
- Beyer-Ericson, L. 1987. Skadesvampar i plantskolor. *Plantnytt*, Swedish Univ. Agric. Sci., Garpenberg, Sweden, No. 1, 4 p.
- Beyer-Ericson, L. 1989. Rotdod i skogsplantskolor. *Plantnytt*, Swedish Univ. Agr. Sci., Garpenberg, Sweden, No. 1, 4 p.
- Butin, H. 1989. Krankheiten der Wald- und Parkbaume. Georg Thieme Verlag, Stuttgart, New York. 216 p.
- Chakravarty, P.; Unestam, T. 1987. Mycorrhizal fungi prevent disease in stressed pine seedlings. *J. Phytopathol.* 118:335-340.
- Coley-Smith, J.R.; Verhoff, K.; Jarvis, W.R. 1980. The biology of *Botrytis*. *Acad. Press*, New York, London. 318 p.
- Damm, E.; Unestam, T. 1990. Mycorrhizal protection of *Pinus sylvestris* seedling roots against *Rhizoctonia*. Pages 239-242 in J.R. Sutherland and S.G. Glover, editors. *Proceedings of the first meeting of IUFRO Working Party S2.07-09 (Diseases and Insects in Forest Nurseries)*. Victoria, British Columbia, Canada. August 22-30, 1990. *For. Can. Pac. For. Cent. Inf. Rep. BC-X-331*. Victoria, B.C. 298 p.
- Galaen, R.; Venn, K. 1979. *Pythium sylvaticum* Campbell & Hendrix and other fungi associated with root dieback of 2-0 seedlings of *Picea abies* (L.) Karst. in Norway. *Rep. Norwegian Forest Res. Inst., Ås, Norway* 34: 269-279.
- James, R.L. 1985. Disease associated with containerized seedling soil mixes. *Tree Planters' Notes* 36, 2 p.
- Manning, W.J.; Papia, P.M. 1972. Benomyl soil treatments and natural occurrence of *Alternaria* leaf spot on carnation. *Plant Dis. Rep.* 56:9-11.
- Marosy, M. and Patton, R.F. 1988. The effect of low temperature on the epidemiology of *Scleroderris* shoot blight. *Proc. IUFRO Working Party S2.06.02 Canker Diseases (Scleroderris)* in Ljubljana, Sept. 1986.
- Mattsson-Mårn, L.; Nenzell, G. 1941. Studier over snoskytteangrepp inom tall-foryngningar å Bergvik & Ala Nya Aktiebolags. *Norrlands SkogsvFörb. Tidskr.*, pp. 160-191. *For. Abstr.* 5, 4, p. 278.
- Minter, D.W. 1981. *Lophodermium* on pines. *Comm. Myc. Inst. Mycological Papers*, No 147.
- Nystrom, C. 1989. Svensk plantproduktion 1989. *Plantnytt*, Swedish Univ. Agric. Sci., Garpenberg, Sweden No. 6, 4 p.
- Olvång, H. 1985. Benomyl resistance in *Gerlachianivalis*. II. Investigation of seed lots and performance of carbendazime seed treatment. *J. Plant Dis. Prot.* 92:561-567.
- Pawsey, R.G. 1964. Grey mould in forest nurseries. *Forestry Commission Leaflet* 50.
- Peace, T.R. 1962. *Pathology of trees and shrubs*. Oxford Univ. Press, England. 723 p.
- Petaisto, R.L.; Repo, T. 1988. Stress combinations and the susceptibility of Scots pine to *Ascochyta abietina*. *Proc. IUFRO Working Party S2.06.02 Canker and Shoot Blight of Conifers*, Ljubljana, Sept. 1986.
- Roll-Hansen, F. 1989. *Phacidium infestans*. A literature review. *Eur. J. Forest Path.* 19:237-250.
- Stenstrom, E.; Ek, M. 1990. Field growth of *Pinus sylvestris* following nursery inoculation with mycorrhizal fungi. *Can. J. For. Res.* 20:914-918.
- Sutherland, J.R. 1982. *Sirococcus* blight not seed-borne on serotinous lodgepole pine. *Can. For. Serv., Research Notes* 2:20-21.
- Sutherland, J.R.; Van Eerden, E. 1980. Diseases and insect pests in British Columbia forest nurseries. *Canadian Forestry Service/ British Columbia Ministry of Forests. Joint Report No. 12*.
- Unestam, T.; Beyer-Ericson, L. 1988. Rotskador, fungicider och stress - hanger de ihop? *Skogsfakta, Biologi och Skogssktsel*, Swedish Univ. Agr. Sci., Uppsala, Sweden 53, 4 p.
- Unestam, T.; Beyer-Ericson, L.; Strand, M. 1989. Involvement of *Cylindrocarpon destructans* in root death of Scots pine seedlings: pathogenic behaviour and predisposing factors. *Scand. J. For. Res.* 4:521-535.
- Venn, K. 1983. Winter vigour in *Picea abies* (L.) Karst.: Fungi isolated from mouldy nursery stock held in overwinter cold storage. *Rep. Norwegian Forest Res. Inst., Ås, Norway* 38:1-32.

Diseases and insects in United States forest nurseries¹

JOHN D. STEIN

*Pacific Southwest Research Station
Forest Service, U.S. Department of Agriculture
Berkeley, California 94701 USA*

AND

RICHARD S. SMITH, JR.

*Forest Insect and Disease Research
Forest Service, U.S. Department of Agriculture
Auditors Building, Washington, D.C. 20090-6090 USA*

*Presented at the first meeting of IUFRO Working Party S2.07-09
(Diseases and Insects in Forest Nurseries), Victoria, British Columbia, Canada, August 22-30, 1990.*

Abstract

This paper presents examples of seedling damage resulting from the interaction of available pests, time of year, local environmental conditions, existing silvicultural practices, and tree species. As a general rule, newly germinated seedlings are affected by damping-off and cutworms, whereas established seedlings are prone to damage by cankers, root diseases, and root weevils. White grubs prefer sandy soils, whereas shoot blights and crane flies prefer wet, heavy soils. In the United States, cultural practices such as organic amendments (sawdust, etc.) may influence cutworm populations by providing a more favorable environment, whereas clean cultivation and rotation of seed and transplant beds can help prevent pest damage.

Resume

Cet article renferme des exemples des dommages que subissent les semis en fonction des insectes nuisibles, du temps de l'année, du milieu ambiant, des méthodes de sylviculture et des espèces d'arbre. En règle générale, les semis souffrent de la fonte et du vers-gris peu après la germination, alors que les plants plus avancés peuvent être endommagés par les chancres, les maladies des racines et les charançons des racines. Les hannetons préfèrent les sols sablonneux alors que l'on retrouve les brûlures des pousses et les tipules dans les sols humides et lourds. Aux Etats-Unis, les pratiques de culture telles que les modifications biologiques (sciure, etc.) peuvent faire augmenter les populations de vers-gris en fournissant un milieu plus favorable, tandis que la culture nettoyante et la rotation des planches de semences et de transplantation peuvent aider à prévenir les dommages causés par les insectes nuisibles.

Introduction

Forest nurseries in the United States operate in a wide variety of temperature climates: the arid Southwest, the mild damp Northwest, the warm humid South, and the harsh Northeast. With this wide range of growing conditions one expects to find a large number of nursery pest problems with a great deal of variation from region to region. One also expects the number of pests to change with different tree species and seedling rotations. The pest complex affecting a two-crops-per-year container seedling differs from that of a two-year-old

bareroot seedling. Unique pest problems would also be associated with propagation of endangered species.

A recent Forest Service publication lists and describes some 58 different nursery pest problems from both bareroot and container nurseries (Cordell *et al.* 1989). In the short time allotted we cannot attempt to describe all the major insect and disease problems. Instead we have chosen a variety of problems which we think are important in nursery management and which illustrate how these pests affect forestry in the United States.

¹ Trade names and commercial products and enterprises are mentioned solely for information. No endorsement by the U.S. Department of Agriculture is implied.

Diseases

Root Diseases

The charcoal root disease [*Macrophominaphaseolina* (Maub.) Ashby] affects several hundred plant species including many forest tree seedlings and native weeds. All conifers may be suitable hosts, but the most susceptible are white fir, Douglas-fir, red fir, sugar pine, Jeffrey pine and giant sequoia in the West and slash, loblolly, longleaf, and Virginia pines in the South (McCain and Scharpf 1989; Smith *et al.* 1989). This disease is most often found in the warmer growing zones of the Southeast and Southwest United States including California (Smith 1975).

Charcoal root disease can cause heavy losses in some species if left unchecked. The fungus attacks all portions of the root system of the seedling, killing the root tissues of stressed seedlings during hot weather. Severe infection results in seedling death in the nursery bed. Stunted seedlings will not survive outplanting. The charcoal root fungus forms small black microsclerotia in the cambial zone after the seedling's death. These microsclerotia (overwintering stage) are released in the soil as the root decays. When a growing root contacts a microsclerotium the following year, it will germinate, grow over the root surface, and penetrate between epidermal cells into the cortex. From here the fungus advances through the cortex and inner bark to the taproot. Deterioration of the root system causes the seedling to become stunted, chlorotic and finally die.

The most effective control is soil fumigation with a combination of methyl bromide-chloropicrin. Once found in a nursery with a warm growing season, this root disease builds up high populations in the soil and consistently causes significant seedling mortality (Smith *et al.* 1989). Infected seedlings should be culled.

Several species are responsible for fusarium root disease [*Fusariumoxysporum* (Schl.) emend. Synd. & Hans and *F. solani* (Mart.) Appel. & Wollew. emend. Synd. & Hans]. *Fusarium* attacks the roots of most conifer seedlings, but certain species such as Douglas-fir and pines appear to be the most susceptible (Johnson *et al.* 1989). Fusarium root disease has been reported from many nurseries throughout North America. The range of symptoms includes late damping off resulting from hypocotyl infection, foliage chlorosis, seedling death, stunting, increased culling, reduced survival of outplantings, and wilting and death of 3- to 4-year-old potted sugar pine used as grafting root stock (Hamman and Hansen 1989).

There is still a great deal to learn about fusarium diseases of conifers—the infection process, host specialization, role of stress, and spread of these diseases.

Also, the large number of saprophytic fusaria found on the roots of infected plants makes identification of the causal agent difficult. In most fusarium diseases, the pathogen rests in the soil in the form of a thick walled chlamydospore which germinates in response to contact with root exudates. During warm periods the fungus grows over the root and penetrates into the cortex and xylem, resulting in the death of these tissues.

Soil fumigation with methyl bromide and chloropicrin mixtures before planting has yielded the best and most consistent control of this disease. Fungicides as a rule have not been effective. Stunted and/or chlorotic seedlings growing in fusarium-infested seedbeds should be culled.

Stem and Foliage Diseases

Fusiform rust [*Cronartium quercuum* (Berk.) Miyabe ex Shirai f. sp. *fusiforme* Burds & Snow] is the most serious disease of slash and loblolly pines in the Southeastern United States. No mortality occurs in the nursery, but infected nursery seedlings seldom survive the first year of outplanting and those that do, usually become malformed, and provide the potential to spread the disease to other healthy pines in the plantation. This disease is found from Maryland south to Florida and west to Texas. Thirty-two species of hard pines are susceptible to this disease, and members of the black oak group are the most common alternate hosts (Rowan 1989).

The use of triadimefon (Bayleton) in the forest nursery has greatly reduced infection and spread of this disease via nursery stock. The control of this disease in nurseries has reduced the levels of infection in many plantations in the South. In the past decade, successful breeding programs for rust-resistant slash and loblolly pines have also significantly reduced the adverse effects of this disease.

Fusiform rust exemplifies a disease which can be contracted in the nursery, but the real impact of this disease occurs after outplanting in the forest plantation. Therefore, the nursery manager has an important role in controlling this pest.

Grey mold [*Botrytis cinerea* (Fr.) Pers.] is caused by a fungus which has an extremely large number of hosts including herbaceous plants, trees and shrubs. Nearly all species of trees grown in forest nurseries are susceptible, especially redwood, giant sequoia, and Monterey cypress (Srago and McCain 1989). This disease occurs sporadically when conditions of high humidity occur in and around susceptible tissue. Thus the disease tends to occur in overstocked stands of seedlings, where it starts on the lower senescent foliage and moves up through the plant, killing needles and young shoots. Grey mold

can also infect seedlings in transit and storage when proper conditions are not maintained. It is capable of killing large numbers of seedlings in a short period of time.

Negligence or lack of knowledge usually promotes this disease. In most cases grey mold can be prevented by controlling the cultural conditions under which the seedlings are grown or stored.

Lophodermium needle cast [*Lophodermium seditiosum* Minter, Staley & Millar] usually causes severe damage on Scots and red pine in the Great Plains and the northern half of the United States wherever the hosts are grown. Infection can involve a complex of several *Lophodermium* species but *L. seditiosum* is considered the strongest pathogen.

Spores are introduced into the nursery from diseased trees on adjacent property or infected needles used as mulch. Infection occurs on current-year needles in the summer or fall. Symptoms usually appear the following winter or early spring when severely affected seedlings turn yellow and then a scorched reddish brown. Outplanted seedlings infected with needle cast are focal points in plantations for this disease (Staley and Nicholls 1989). This needle cast is another disease that causes needle loss but seldom kills nursery seedlings.

Needle cast can be controlled by a combination of sanitation, proper watering schedules, and the application of chlorothalonil or maneb. Frequency of chemical applications varies across the northern United States from four applications every 14 days in Michigan to a year-round application every 30 days in the state of Washington (Kanaskie 1990).

Brown-spot needle blight [*Mycosphaerella dearnessii* Barr] (syn. *Scirrhia acicola*) infects seedlings of longleaf, slash, loblolly, and white pines in nurseries from Texas to North Carolina. The grass stage of longleaf pine is particularly susceptible to this disease (Kais 1989; Phelps *et al.* 1978).

This disease is disseminated by two different spore forms. Ascospores are wind borne and conidia are disseminated by water. The conidia are produced in acervuli on ascospore lesions and responsible for the buildup of populations in nursery beds. Infected seedlings have discolored spots on the foliage. When the needle tissue dies between lesions, the seedling has a mottled appearance. Severe infections result in defoliation and reduced survival in new plantations.

Brown-spot needle blight can be controlled by a combination of low seed density, reduction of pH below 6.0 in conjunction with inoculation of *Pisolithus tinctorius*, and root prune seedlings at least 40 days before lifting. Applications of a Bordeaux mixture, maneb, chlorothalonil, or a root-dip of benomyl-kaolin mixture before packing and outplanting improves growth

and survival of severely infected seedlings.

Phoma needle blight [*Phomaeupyrena* Sacc.] is an interesting foliage disease caused by a soil-borne fungus. It affects Douglas-fir, red and white firs, and Engelmann spruce in the Pacific Northwest and Intermountain areas (Srago *et al.* 1989). The disease is most severe on small and stunted seedlings where rain or irrigation causes a buildup of soil cones around the lower stem and foliage of seedlings. This soil-borne fungus spreads from the soil cones into the lower needles and up through the crown, killing the needles (Kliejunas *et al.* 1985). Completely defoliated seedlings usually die when their terminal buds are dead.

This disease is controlled by both cultural and chemical factors. Cultural measures which increase the rate of growth are helpful in reducing disease losses. This may include early planting, inoculating trees with mycorrhizae when their absence is the cause of the stunting, maintaining proper levels of fertilizers, and mulching. Methods which reduce sand splash and the buildup of soil cones will also reduce losses. Chemical sprays with chlorothalonil during the dormant rainy season have been effective.

Phoma blight is an atypical foliage disease in which the pattern is in concentrated spreading patches, more like a root disease. The greatest losses may not be mortality, but in the great variation in seedling size and in number of seedlings that need to be culled or grown for an additional season.

Sirococcus shoot blight [*Sirococcus strobilinus* Preuss] is found in the western and the north central United States. It is severe along the coast of northern California and southern Oregon where the climate is moderate and moist (Smith and Nicholls 1989). On occasion this shoot blight is found farther inland with the occurrence of a warm, wet growing season. It occurs on various pines, spruces, and western hemlock. Jeffrey, Coulter and sugar pine appear to be the most susceptible. Infected seedlings of all ages may be killed or damaged to the point of being culled.

This disease causes a shoot dieback and canker of the current-year's growth. The fungus overwinters in dead needles and shoots and on spruce cones. This disease may also be seed borne. Initial infections in the late spring or early summer are usually scattered throughout the nursery beds. Secondary infection by rain and irrigation splash causes small pockets of infection to build up during the growing season. Warm, moist weather may produce heavy seedling losses.

Sirococcus shoot blight is controlled by the application of chlorothalonil at 3- to 4-week intervals throughout the growing season. It is recommended that very susceptible species be grown in nurseries with an arid growing season. Nurseries with a surrounding forest

and a history of *Sirococcus* may wish to examine the adjacent stands. In northern California, Sitka spruce cones in the stand surrounding Humboldt Nursery were found to be a source of inoculum.

Insects

Root Insects

The cranberry girdler [*Chrysoteuchia topiaria* (Zeller)] is a problem in bareroot nurseries adjacent to pastures and rye grass fields (Triebwasser and Overhulser 1981). Populations are established each year by invasion of migrating adults on 2+0 seedlings of Douglas-fir, Shasta red fir, grand fir, noble fir, larch, and spruce in Idaho, Washington, Oregon, and northern California (Kamm *et al.* 1983; Overhulser and Morgan 1989). Oviposition takes place in June and July with subsequent larval damage in August through October. The lesser corn-stalk borer [*Elasmopalpus lignosellus* (Zeller)] is an agricultural pest which periodically produces girdling damage on at least 10 species of seedlings in southern nurseries. The larvae of both species feed on the bark of the main stem just below the ground surface. Their feeding damage is usually discovered during lifting operations. In the past, nurserymen have attributed girdling damage to strawberry root weevil, cutworms, June beetle larvae, and rodents.

Nursery surveys have identified the cranberry girdler as increasing and causing moderate to severe damage in several nurseries (Sutherland 1984). Three forest industry nurseries in Washington and Oregon have extensive control programs utilizing treatments of Diazinon or Dursban. These nurserymen indicate that without control, seedling damage would range from 5 to 15% or higher of seedlings in beds adjacent to grass fields. A sex pheromone developed for use with the sod webworm in grass seed fields can now be used to monitor adult girdler flights into the nursery (Kamm *et al.* 1983).

Several older nurseries have reported that the cranberry girdler was not a problem in the 1960s. The discontinued use of chlorinated hydrocarbon pesticides in the past 15 years may be the reason why cranberry girdler damage first began to attract attention in the mid 1970s and was considered a significant pest in the early 1980s.

Several species of weevils that belong to the genera *Otiorhynchus*, *Sciopithes*, and *Nemocestes* are large flightless beetles that seem to be most abundant in containerized nurseries adjacent to agricultural land. Larval damage has been reported on true firs. Douglas-fir, spruce, hemlock, and red cedar under nursery conditions (Furniss and Carolin 1977; Dolph 1967; Capizzi 1990).

Root weevil larvae are in the soil year round except in early summer. Adult weevils lay eggs on the soil near host plants during early summer. Larvae hatch within 21 days, feed on small roots during the summer and migrate downward to hibernate in the winter. Established seedlings sustain most of the root damage as the larvae migrate upward in the spring. Damage is usually characterized by wilting of seedlings in the spring.

Damage by root weevils has decreased in bareroot nurseries, but 6 of 13 containerized nurseries in the Northwest reported the presence of weevils. The problem has been reported as being spotty and confined to older facilities with gravel floors or wooden benches.

Larvae of the tenlined June beetle [*Polyphylla decemlineata* (Say)] and the European crane fly [*Tipula paludosa* Meigen] are among several insects which occasionally damage seedling root systems. They are usually classified as being present but a negligible problem by nurserymen. Both insects feed upon a wide variety of seedling species and are almost exclusively restricted to 2+0 bareroot or transplant stock. Tenlined June beetle larvae prefer light, sandy soil, and often cause extensive damage when associated with green cover crops that have been in the field for more than 2 years or in soil converted from sod to nursery beds. The European crane fly, on the other hand, prefers heavier soils that are usually associated with a high water table or poor drainage.

Nematodes are one of the most underrated groups of pests distributed in forest nurseries throughout the United States. In the Western United States alone, 25 nematode species are known to cause damage to 19 western conifer species (Riffle and Smith 1979; Viglierchio 1979). Root-knot nematodes [*Meloidogyne* spp.] are more important in areas with a warm climate, whereas lesion nematodes [*Pratylenchus* spp.] are a more serious problem in the cooler climate of the Northern United States and are rarely found in the South (Ruehle 1975; McElroy 1990). Other damaging forest nursery nematodes are pine cystoid nematodes [*Meloidodera* spp.], lance nematodes [*Hoplolaimus* spp.], stunt nematodes [*Tylenchorhynchus* spp.], stubby-root nematodes [*Trichodorus* spp.], and the dagger nematodes [*Xiphinema* spp.] (Peterson 1962; Ruehle *et al.* 1966; Peterson and Riffle 1986). Cultural practices have a definite influence on the presence of nematodes. Therefore, careful consideration should be given to the interaction between green manure crops and the potential increase in nematode populations (McElroy 1972). Soil fumigation and rotation of nonhost seedlings are generally recommended for control and to alleviate symptoms of reduced growth.

Stem and Foliage Insects

In the early 1980s, *Lygus hesperus* Knight caused shoot deformation and tip die-back on Douglas-fir seedlings in several nurseries in the Willamette Valley of Oregon (Schowalter *et al.* 1986). In 1982, damage to 2+0 seedlings ranged between 20 and 70% at Weyerhaeuser's Co. Forest Nursery at Aurora, Oregon. Damage frequency and height reduction have been associated with seed source (Schowalter and Stein 1987). The tarnished plant bug [*Lygus lineolaris* (Palisot de Beauvois)] frequently becomes a pest on loblolly pine or hybrid poplars in southern nurseries. Damage frequently results in multiple-top seedlings which are culled at the time of lifting.

Emphasis on aphid damage in recent surveys probably resulted from increased awareness of aphids and not on actual increase in damage. However, some aphids are newly introduced pests from foreign countries. A honeysuckle aphid [*Hyadophis tatricae* (Aizenberg)] native to Russia was first reported in Lake County, Illinois, in 1979 and is now found throughout the Midwest and the Great Plains (Herman and Chaput 1989; Boisvert *et al.* 1981). A woolly fir aphid [*Mindarus victoria* Essig] from Victoria, British Columbia, described in 1939 is now a serious pest on white fir nursery seedlings and Christmas tree plantations in central California (Stein and Haverty, 1990).

In the past, aphids were found in bareroot nurseries and rarely on containerized stock. In recent years the trend has been reversed. Both the apple aphid [*Aphis pomi* DeGeer] in Pennsylvania and the leafcurl ash aphid [*Prociphilus fraxinifolii* (Riley)] in Colorado are pests in containerized nurseries.

Several species of the family Noctuidae occur intermittently in forest nurseries. The redbacked cutworm [*Euxoa ochrogaster* (Guenee)], the darksided cutworm [*E. messoria* (Harris)], *E. excellens* Grote, and the variegated cutworm [*Peridroma saucia* (Hubner)] are the most frequently encountered (Sutherland and Van Eerden 1980). Larvae of all these species are similar in habits and attack only 1+0 seedlings. Most damage occurs during the spring and early summer in both bareroot and containerized nurseries. Approximately half of the nurserymen producing container stock in the Pacific Northwest applied control treatments for cutworms. Management practices such as sawdust mulch may influence population levels by providing a more favorable environment in which the larvae hide during daylight hours.

The seedcom maggot [*Delia platura* (Meigen)] causes an occasional loss of seedlings in the Pacific Northwest. Larvae burrow inside the stem near the root collar of coniferous seedlings in early spring soon after germination. Maggot damage is often mistaken for

damping-off or heat scald. Larvae have occasionally infested Douglas-fir and Sitka spruce in Washington and Oregon (Fumiss and Carolin 1977). In the past, 50% of bareroot Douglas-fir and Sitka spruce seedlings have been damaged or killed in a Nisqually, Washington nursery. This insect can be controlled by soil fumigation. Cultural practices such as delayed planting or application of inorganic fertilizers will help reduce populations occurring in nurseries near heavily infested agricultural crops (Keen 1952).

Some insects are opportunistic and feed on nursery crops adjacent to naturally infested forests. Several species of sawflies [*Neodiprion* spp., *Diprion similis* (Hartig), *Anoplonyx occidens* Ross, *Pikonemu alaskensis* (Rohwer)] produce occasional damage to fir, pine, and spruce throughout the United States (Morris and Hoffard 1989). The cottonwood leaf beetle [*Chrysomelascrpta* Fabricius] is a serious defoliator of poplars and willows in the southern nurseries. Stunted growth and reduced cutting yield are often associated with defoliation and twig damage (Oliveria and Solomon 1989). Other sporadic defoliators include the elm leaf beetle [*Pyrrhalta luteola* (Muller)] on elms in Colorado and the gypsy moth [*Lymantria dispar* (Linnaeus)] on oaks in Ohio, when outbreaks occur in the vicinity of the nurseries.

Mites, found on many tree species are characterized by populations that fluctuate widely but seldom warrant control measures. Heavy infestations cause premature yellowing, needle fall, and predisposition to damage by disease. These heavy infestations are usually associated with hot, dry conditions and a frequent insecticide spray schedule which eliminate natural predators.

Ford and Barry (1989) ranked the spruce spider mite [*Oligonychus ununguis* (Jacobi)], the conifer spider mite [*O. coniferarum* (McGregor)], and the southern red mite [*O. ilicis* (McGregor)] as the three most important mite species on nursery seedlings. Recently the honeylocust spider mite [*Platyetranychus multidigitali* (Ewing)] and a rust mite [*Aculops* sp.] were serious pests of containerized honeylocust in the central Rocky Mountains.

Damage from wood borers is most common in the Southeast. Cottonwood and willow are the major hosts for the cottonwood borer [*Plectrodera scalator* (Fabricius)] and the clearwing borer [*Paranthrene dollii* (Neumoegen)]. Infestations produce stunted growth and injured terminals resulting in multiple forked tops and reduced cutting yields (Solomon 1989). Late fall plowing and cover crop rotation will usually reduce borer populations. The Nantucket pine tip moth [*Rhyacionia frustrana* (Comstock)] has been reported as a serious pest on containerized stock of loblolly and other species of pine in North Carolina and Oklahoma nurseries.

Literature cited

- Boisvert, J.; Cloutier, C.; McNeil, J. 1981. *Hyadaphis tartaricae* (Homoptera: Aphididae), a pest of the honeysuckle new to North America. *Can. Entomol.* 113:415-418.
- Capizzi, J. 1990. Root weevils. pages 53-55 in P.B. Ha ^{♦♦}, S.J. Campbell, and E.M. Hansen, eds. Growing healthy seedlings: identification and management of pests in northeastern forest nurseries. Spec. Publ. 19. Forest Research Laboratory, Oregon State University, Corvallis, Oregon. 110p.
- Cordell, C.E.; Anderson, R.L.; Hoffard, W.H.; Landis, T.D.; Smith, R.S., Jr.; Toko, H.V., Tech. Coords. 1989. Forest nursery pests. U.S.D.A. For. Serv., Agric. Handb. 680. 184 p.
- Dolph, R.E. 1967. Forest insect conditions in the United States, 1966, Oregon and Washington. U.S.D.A., For. Serv. 12p.
- Ford, R.P.; Barry, P.J. 1989. Spider mites. Pages 140-141 in E.D. Cordell, R.L. Anderson, W.H. Hoffard, T.D. Landis, R.S. Smith, Jr. and H.V. Toko, Tech. Coords. Forest nursery pests. U.S.D.A. For. Serv., Agric. Handb. 680. 184 p.
- Fumiss, R.L.; Carolin, V.M. 1977. Western forest insects. U.S.D.A., For. Serv., Misc. Publ. 1339. 654 p.
- Ha ^{♦♦}, P.B.; Hansen, E.M. 1989. Fusarium hypocotyl rot. Pages 120-121 in E.D. Cordell, R.L. Anderson, W.H. Hoffard, T.D. Landis, R.S. Smith, Jr. and H.V. Toko, Tech. Coords. Forest nursery pests. U.S.D.A. For. Serv., Agric. Handb. 680. 184 p.
- Herman, D.E.; Chaput, L.J. 1989. Evaluation of Lonicera taxa for honeysuckle aphid susceptibility, winter hardiness, and plant use. Pages 119-126 in T.D. Landis, Tech. Coords. Proceedings of the international forest nursery association meeting. Bismarck, North Dakota, August 14-18, 1989. U.S.D.A. For. Serv., Gen. Tech. Rep. RM-184. 150p.
- Johnson, D.W.; LaMadeleine, L.A.; Bloomberg, W.J. 1989. Fusarium root rot. Pages 40-42 in E.D. Cordell, R.L. Anderson, W.H. Hoffard, T.D. Landis, R.S. Smith, Jr. and H.V. Toko, Tech. Coords. Forestnurserypests. U.S.D.A. For. Serv., Agric. Handb. 680. 184 p.
- Kais, A.G. 1989. Brown spot needle blight. Pages 26-28 in E.D. Cordell, R.L. Anderson, W.H. Hoffard, T.D. Landis, R.S. Smith, Jr. and H.V. Toko, Tech. Coords. Forest nursery pests. U.S.D.A. For. Serv., Agric. Handb. 680. 184 p.
- Kamm, J.A.; Morgan, P.D.; Overhulser, D.L.; McDonough, L.M.; Triebwasser, M.; Kline, L.N. 1983. Management practices for cranberry girdler (Lepidoptera: Pyralidae) in Douglas-fir nursery stock. *J. Econ. Entomol.* 76:923-926.
- Kanaskie, A. 1990. Lophodermium needle cast of Scotch pine. Page 34 in P.B. Ha ^{♦♦}; S.J. Campbell; E.M. Hansen, eds. Growing healthy seedlings: identification and management of pests in northeastern forest nurseries. Spec. Publ. 19. Forest Research Laboratory, Oregon State University, Corvallis, Oregon. 110p.
- Keen, F.P. 1952. Insect enemies of western forests. U.S.D.A., For. Serv., Misc. Publ. 273. 280 p.
- Kliejunas, J.T.; Allison, J.R.; McCain, A.H.; Smith, R.S., Jr. 1985. Phoma blight of fir and Douglas-fir seedlings in a California nursery. *Plant Disease* 69:773-775.
- McCain, A.H.; Scharpf, R.F. 1989. Effect of inoculum density of *Macrophomina phaseolina* on seedling susceptibility of six conifer species. *Eur. J. For. Pathol.* 19:119-123.
- McElroy, F.D. 1972. Studies on the host range of *Ziphinema bakeri* and its pathogenicity to raspberry. *J. Nematology* 4:16-22.
- McElroy, F.D. 1990. Nematodes. Pages 62-65 in P.B. Hamm, S.J. Campbell, and E.M. Hansen, eds. Growing healthy seedlings: identification and management of pests in northeastern forest nurseries. Spec. Publ. 19. Forest Research Laboratory, Oregon State University, Corvallis, Oregon. 110p.
- Morris, C.L.; Hoffard, W.H. 1989. Sawflies. Pages 82-83 in E.D. Cordell, R.L. Anderson, W.H. Hoffard, T.D. Landis, R.S. Smith, Jr. and H.V. Toko, Tech. Coords. Forest nursery pests. U.S.D.A. For. Serv., Agric. Handb. 680. 184p.
- Oliveria, F.L.; Solomon, J.D. 1989. Cottonwood leaf beetle. Pages 109-110 in E.D. Cordell, R.L. Anderson, W.H. Hoffard, T.D. Landis, R.S. Smith, Jr. and H.V. Toko, Tech. Coords. Forest nursery pests. U.S.D.A. For. Serv. Agric. Handb. 680. 184p.
- Overhulser, D.L.; Morgan, P.D. 1989. Cranberry girdler. Page 86 in E.D. Cordell, R.L. Anderson, W.H. Hoffard, T.D. Landis, R.S. Smith, Jr. and H.V. Toko, Tech. Coords. Forest nursery pests. U.S.D.A. For. Serv., Agric. Handb. 680. 184 p.
- Peterson, G.W. 1962. Root lesion nematode infestation and control in a plains forest tree nursery. U.S.D.A., For. Serv., Res. Note RM-75. 2 p.
- Peterson, G.W.; Riffle, J.W. 1986. Root lesion nematodes in junipers and pines. Pages 140-141 in J.W. Riffle and G.W. Peterson, Tech. Coords. Diseases of trees in the Great Plains. U.S.D.A., For. Serv., Gen. Tech. Rep. RM-129. 149 p.
- Phelps, W.R.; Kais, A.G.; Nicholls, T.H. 1978. Brown-spot needle blight of pines. U.S.D.A. For. Serv., For. Insect and Disease Leaflet. 44. 8 p.
- Riffle, J.W.; Smith, R.S., Jr. 1979. Nursery diseases of western conifers. U.S.D.A., For. Insect and Disease Leaflet. 157. 11 p.
- Rowan, S.J. 1989. Fusiform rust. Pages 43-44 in E.D. Cordell, R.L. Anderson, W.H. Hoffard, T.D. Landis, R.S. Smith, Jr. and H.V. Toko, Tech. Coords. Forest nursery pests. U.S.D.A. For. Serv., Agric. Handb. 680. 184 p.
- Ruehle, J.L. 1975. Nematodes. Pages 31-34 in G.W. Peterson and R.S. Smith, Jr., Tech. Coords. Forest nursery diseases in the United States. U.S.D.A., For. Serv., Agric. Handb. 470. 125p.
- Ruehle, J.L.; May, J.T.; Rowan, S.J. 1966. Nursery fumigation trial with vorlex. *Tree Planters' Notes* 76:4-7.
- Schowalter, T.D.; Overhulser, D.L.; Kanaskie, A.; Stein, J.D.; Sexton, J. 1986. *Lygus hesperus* as an agent of apical bud abortion in Douglas-fir nurseries in western Oregon. *New Forests* 1:5-15.

-
- Schwalter, T.D.; Stein, J.D. 1987. Influence of Douglas-fir seedling provenance and proximity to insect population sources on susceptibility to *Lygus hesperus* (Heteroptera: Miridae) in a forest nursery in western Oregon. *Environ. Entomol.* 16: 984-986.
- Smith, R.S., Jr. 1975. Charcoal root disease. Pages 11-13 in G.W. Peterson and R.S. Smith, Jr., Tech. Coords. Forest Nursery diseases in the United States. U.S.D.A. For. Serv., Agric. Handb. 470. 125 p.
- Smith, R.S., Jr.; Hodges, C.S.; Cordell, C.E. 1989. Charcoal root rot and black root rot. Pages 112-113, in E.D. Cordell, R.L. Anderson, W.H. Hoffard, T.D. Landis, R.S. Smith, Jr. and H.V. Toko, Tech. Coords. Forest nursery pests. U.S.D.A. For. Serv., Agric. Handb. 680. 184 p.
- Smith, R.S., Jr.; Nicholls, T.H. 1989. Sirococcus shoot blight. Pages 71-72 in E.D. Cordell, R.L. Anderson, W.H. Hoffard, T.D. Landis, R.S. Smith, Jr. and H.V. Toko, Tech. Coords. Forest nursery pests. U.S.D.A. For. Serv., Agric. Handb. 680. 184 p.
- Solomon, J.D. 1989. Cottonwood borers. Pages 106-108 in E.D. Cordell, R.L. Anderson, W.H. Hoffard, T.D. Landis, R.S. Smith, Jr. and H.V. Toko, Tech. Coords. Forest nursery pests. U.S.D.A. For. Serv., Agric. Handb. 680. 184 p.
- Srago, M.D.; James, R.L.; Kliejunas, J.T. 1989. Phoma blight. Pages 45-46 in E.D. Cordell, R.L. Anderson, W.H. Hoffard, T.D. Landis, R.S. Smith, Jr. and H.V. Toko, Tech. Coords. Forest nursery pests. U.S.D.A. For. Serv., Agric. Handb. 680. 184 p.
- Srago, M.D.; McCain, A.H. 1989. Gray mold. Pages 45-46 in E.D. Cordell, R.L. Anderson, W.H. Hoffard, T.D. Landis, R.S. Smith, Jr. and H.V. Toko, Tech. Coords. Forest nursery pests. U.S.D.A. For. Serv., Agric. Handb. 680. 184 p.
- Staley, J.M.; Nicholls, T.H. 1989. Lophodermium needle cast. Pages 49-51 in E.D. Cordell, R.L. Anderson, W.H. Hoffard, T.D. Landis, R.S. Smith, Jr. and H.V. Toko, Tech. Coords. Forest nursery pests. U.S.D.A. For. Serv., Agric. Handb. 680. 184 p.
- Stein, J.D.; Haverty, M.I. 1990. Insecticides effectively control an aphid pest of white fir seedlings. *Tree Planters' Notes* 41(4):8-12.
- Sutherland, J.R. 1984. Pest management in northwest bareroot nurseries. Pages 203-210 in M.L. Duryea and T.D. Landis, eds. Forest nursery manual: Production of bareroot seedlings. Martinus Nijhoff/Dr. W. Junk Publishers, The Hague/Boston/Lancaster, for Forest Research Laboratory, Oregon State University, Corvallis, Oregon. 386 p.
- Sutherland, J.R.; Van Eerden, E. 1980. Diseases and insect pests in British Columbia forest nurseries. B.C. Ministry of Forests/Can. Forestry Serv., Victoria. Joint Rep. 12. 55 p.
- Triebwasser, M.E.; Overhulser, D.C. 1981. The cranberry girdler in conifer nurseries of western Washington and Oregon. Pages 80-83 in Proc. Intermountain Forest Nurserymen's Assoc. and Western Forest Nursery Assoc. combined meeting. Boise, Idaho. Aug. 12-14, 1980. U.S.D.A., For. Serv., Gen. Tech. Rep. INT-109. 148 p.
- Viglierchio, D.R. 1979. Response of *Pinus ponderosa* seedlings to stylet-bearing nematodes. *J. Nematol.* 11:377-387.
-

Diseases and insects in western European forest nurseries

ROBERT PERRIN

INRA, B.P.1540, 17 rue Sully, 21034 Dijon cedex, France

ANTONIO NOTARIO GOMEZ

ETS de Montes Ciudad universitaria 28040 Madrid, Spain

Presented at the first meeting of IUFRO Working Party S2.07-09

(Diseases and Insects in Forest Nurseries), Victoria, British Columbia, Canada, August 22-30, 1990.

Abstract

Diseases and insects affecting forest nursery seedling production in western Europe are described along with management practices that are being used to reduce losses from these pests. Major diseases covered include seed-borne diseases, soil-borne diseases such as damping-off and *Phytophthora* root rot, and gray mold (*Botrytis cinerea*). The section on nursery insects contains several tables that summarize information such as hosts affected and type of damage.

Resume

On décrit les maladies et les insectes qui ravagent la production de semis dans les pépinières forestières de l'ouest de l'Europe ainsi que les pratiques de gestion mises en oeuvre pour réduire les pertes occasionnées par ces agents nuisibles. Parmi les principales maladies traitées figurent les maladies transmises par les semences, les maladies transmises par le sol comme la fonte des semis et la phytophthora des racines, et la moisissure grise (*Botrytis cinerea*). La partie consacrée aux insectes des pépinières contient plusieurs tableaux dans lesquels on résume l'information connue, comme les hôtes touchés et le type de dommages.

Introduction

The occurrence of diseases and insects is related to numerous factors such as the crop system, site conditions, and cultural practices. In western Europe, most seedlings are produced under a wide variety of conditions in bareroot nurseries, so forest nursery managers have to be aware of the threat of diseases and insects to seedling production. Our purpose here is to give an overview of the main diseases and insects currently affecting seedling growth or causing seedling mortality in western European forest nurseries.

Diseases in forest nurseries

Diseases of seeds

Seeds may carry pathogens that kill the seeds or subsequently damage seedlings, especially conifers. In western Europe, little work has been done in this field, but three categories of seed-borne fungi have been distinguished: (i) fungi of common occurrence such as species of *Penicillium*, *Aspergillus*, *Mucor*, *Rhizopus*, *Cladosporium*, *Alternaria*, *Stemphylium*, *Chaetomium*, *Trichoderma* and *Trichothecium*, which are usually considered as saprophytes, but which can under certain

conditions reduce germination; (ii) pathogenic fungi which are host specific, infecting seeds and seedlings such as *Phomopsis occulta* on *Juniperus virginiana* and *Larix leptolepis*, *Sphaeropsis sapinea*, or *Ciboria batschiana* on acorn, and *Seiridium cardinale* on *Cupressus*; and (iii) pathogenic fungi (usually not host-specific) such as *Fusarium* spp., *Rhizoctonia solani*, *Botrytis cinerea*, and *Phoma* spp. which cause pre-emergence and post-emergence damping-off.

Losses from these fungi can be reduced by dressing or coating seeds with various fungicides, or by special treatments such as thermotherapy for black rot of acorns. Early collection of seeds followed by drying to low moisture content and storing at low temperatures is sometimes recommended. Seed health testing allows detection of seed-borne microorganisms and allows heavily infested seedlots or diseased seeds to be discarded.

Soil-borne diseases: damping-off and rot of seedlings

Pre-emergence and post-emergence damping-off, resulting from the attack of soil-inhabiting fungi, are well

known diseases in coniferous nurseries in Europe. Species of *Pythium* and *Fusarium* and *Rhizoctonia solani*, appear to be the main fungi involved in damping-off. These fungi are commonly present in nursery soils, but occurrence of a particular pathogen and severity of damping-off vary greatly according to the site, climatic conditions, and year. Species of *Pythium* are the main cause of damping-off in cool (15-20°C) alkaline and neutral soils. In contrast, *F. oxysporum* and *F. solani* are more prevalent in acid soils at higher temperatures (25-30°C). *Rhizoctonia solani* is favored also by high temperature but it seems not to be affected by edaphic factors.

Root rot damage such as destruction of lateral roots and stunting is less known and often underestimated because only a few seedlings are killed. First symptoms appear on the shoot and include chlorosis of terminal needles followed by all needles becoming flaccid then brown and sometimes dried out. These shoot symptoms are the result of root damage. Diseased root systems have few laterals and the roots are often dark brown, swollen, and lack white root tips. The root system is usually deformed. Root necrosis is caused by the same fungi involved in damping-off although *Fusarium oxysporum* and *Cylindrocarpon destructans* are the most common pathogens.

Information on susceptibility of tree species to damping-off and root rot is scarce, though most coniferous species are known to be affected to some extent. Species of pine, especially *Pinus nigra* and *P. halepensis*, and larch are more susceptible than Douglas-fir, spruce, and fir. Members of the family Cupressaceae appeared to be resistant. The so-called damping-off or seedling blight of beech, caused by *Phytophthora cactorum*, sometimes occurs in nurseries.

To improve disease diagnosis we developed biotests for determining soil infectivity in the laboratory prior to seed sowing, plus a special method to be carried out in the field by nursery managers. Soil fumigation is the most effective control, but it eliminates mycorrhizal fungi. Fungicide drenches or seed dressings give good control of *Pythium* spp. and *Rhizoctonia solani* but are inefficient against *Fusarium* spp.

***Phytophthora* root rot**

Different species of *Phytophthora* may attack the roots of woody plants in the nurseries of western Europe. The most widespread and harmful species is undoubtedly *P. cinnamomi* which damages *Castanea sativa*, *Fagus sylvatica*, *Quercus rubra*, and various species of Cupressaceae. Crown symptoms are typical of root diseases in general. In broadleaf seedlings, leaves may be abnormally small, yellow, or sparse over part or all

of the crown, finally becoming brown. Fluid may exude from affected bark at the base of the shoot (ink disease). Careful examination reveals symptoms more specific to *Phytophthora* root diseases. Portions of roots closest to the main stem may be dead, whereas more distal parts may be unaffected. Rot may extend up the shoot for a few centimetres. Although these symptoms are indicative of *Phytophthora* root rot, disease confirmation depends upon laboratory isolation of the pathogen from recently infected tissues.

Sanitation is one of the better practices for control of *Phytophthora* root diseases in the nursery, e.g. destroying infected plants, soil disinfection, and regulating diseased planting stock. Use of fungicides such as ethyl phosphonate, etridiazole, and furalaxyl is also helpful.

Shoot and needle diseases

Gray mold

Gray mold, caused by *Botrytis cinerea*, has a very wide host range and occurs both as a saprophyte and parasite on almost every plant species, sometimes causing severe damage. Gray mold occurs in both the nursery and on cold-stored stock. Damage is most severe on container-grown seedlings. Conifer seedlings commonly exhibit a top dieback with a yellowing and later browning of needles. Some needles may fall but many remain hanging on the shoots and the black sclerotia of *B. cinerea* may develop on them. The fungus produces a fine web of gray-brown mold; it colonizes dead plant material and spreads to living plants. Its ability to grow at low temperatures enables the pathogen to damage plants under snow cover and in cold storage. In Europe, attacks by *B. cinerea* are sporadic. All the common conifers are susceptible: spruce, larch, Douglas-fir, Scots pine, and Corsican pine. Most damage occurs during the first year of plant growth. Gray mold outbreaks take place within a narrow range of conditions, including unseasonable freezing weather and high humidities. Dense seedling stands contribute to the problem.

Routine spraying of fungicides may be necessary in nurseries or in crops in which the disease is troublesome. Reducing the density of seedling stands, improving lighting, reducing humidity, and avoiding conditions favorable for gray mold help overcome the disease.

Minor diseases

Numerous other diseases occasionally affect forest nursery seedlings. The most common of these diseases recorded over the past decade are: (i) *Pestalotia* spp. on conifers associated with strangling disease probably

caused by high temperatures at collar level, (ii) seedling blight caused by *Phomopsis occulta* on spruce and pine, (iii) needle cast on pine caused by *Lophodermium* spp. (*L. seditiosum*) and on larch by *Meria laricis*, (iv) needle rust on pines, (v) needle blight caused by *Dothistroma pini* on species of pine, (vi) mildew and powdery mildew on various broadleaved trees such as oak, ash, and maple, (vii) *Dothichiza* bark necrosis and *Cytospora* dieback of *Populus* and (viii) minor leaf pathogens (*Marssonina*, *Gloeosporium*, *Septoria*, *Gnomonia*, and *Sclerotinia*) on various hardwood species.

Disease management

During the last decade forest nursery practices have improved greatly. Consequently, the importance of certain diseases has changed and modified the scope of phytosanitary problems. Soil fumigation, for example, has decreased the incidence of soil-borne diseases, but the importance of seed-borne fungi has increased. On the negative side, new problems related to the lack of mycorrhizae have appeared.

In the future, updating of information on nursery disease identification must be a top priority and we must continuously improve our knowledge to provide nursery managers with recommendations for integrated management. Biological control through mycorrhizal association could soon be important for controlling soil-borne diseases in forest nurseries.

Insects in forest nurseries

In western Europe, few specific studies have been made regarding insects which attack forest nursery seedlings. Instead, efforts have concentrated on pests in established field plantations since most of these pests generally also affect small nursery plants. Consequently, an information gap exists regarding nursery insects, so it is important to increase research on detection, identification, and control of insects affecting nursery seedlings.

In European countries with mainly Mediterranean climates, such as Spain, several insects attack nursery seedlings. Agenjo (1964) and Bachiller et al. (1981) refer to approximately 30 such insects and categorize them according to the plant they attack and the damage they cause (Table 1).

Of the insects in Table 1, the greatest damage is caused by *Dicranura vinula*, *Leucoma salicis*, *Paranthrene tabaniformis*, *Gypsonoma aceriana*, *Cryptorhynchus lapathi*, *Thaumetopoca pityocampa*, *Rhyacionia duplana*, and all insects that destroy roots. In 1982, there was an intense attack by *Otiorhynchus sulcatus* on *Pittosporum* and *Evonymum* ornamental plants at a Madrid nursery (Notario et al. 1983). This

insect has been described in the USA (Schread 1972; USDA 1980) as causing serious damage to species of *Taxus* and *Tsuga* and *Juniperus horizontalis*. There have been occasional attacks by *Apantele megacephala*, *Lithocolletis populifoliella*, *Dioryctria nivaliensis* (on *Pinus insignis* on the island of Tenerife), *Prodenia littoralis* (in eucalyptus nursery in Huelva), and *Plusia gamma* (on *Pinus halepensis* at a nursery on Sierra Espuña, in the province of Murcia).

In 1973, *Cedrobium laportei* was found in Spain (Notario et al. 1984), and in 1978 *Cinara cedri* appeared for the first time in that country (Notario et al. 1978). Both of these insects are causing considerable damage to cedars (all ages), thus seriously affecting the nurseries in which these conifers are grown. For unknown reasons, in the 1980s, newly reforested areas, established pine plantations, and sometimes nurseries in certain regions of Spain suffered severe damage from species of the Lachnidae family (Binazzi et al. 1983). Notario (not published) detected *Cinara maritima* infesting small plants in Madrid and Jaen.

In England, with its Atlantic climate, Bevan (1987) gives data on those insects damaging nursery seedlings. He lists 19 species of insects and categorizes them according to the age and part of the plant that they attack (Table 2).

Bevan also refers to species of insects that damage trees of all ages (including nursery seedlings). The most damaging are listed in Table 3.

Nef (1982, 1983), in Belgium, refers to the Coleoptera *Otiorhynchus sulcatus* and *Strophosoma* spp. as damaging potted plants and to the chrysomalid Coleoptera *Zeugophora flavicollis* and to the Lepidoptera *Leucoma salicis*, *Stigmella trimaculella*, *Gypsonoma aceriana*, and *Phyllocnistis suffusella* as causing considerable damage to nursery-grown poplars. Nef considers *Phyllocnistis suffusella*, a leaf-mining insect, to currently be the most harmful of these insects. He is attempting to find an effective control for this insect.

The above gives an overview of the insects which commonly affect forest nursery seedlings throughout western Europe. However, it is not possible to make general statements which are applicable to all European countries. With certain exceptions (such as in the case of *Otiorhynchus* and certain others), occurrence of such insects depends upon numerous factors including climate and presence of host species. However, throughout the area very few species of insects are host-specific to nursery plants. Also, new pests are constantly being detected, such as plant lice and *Phyllocnistis suffusella*.

Table 1. Host(s), type of damage and insects.

	Insect order			
	Lepidoptera	Coleoptera	Orthoptera	Diptera
<i>Populus</i> spp.				
Defoliation				
<i>Dicranura vinula</i> L.	X			
<i>Apantele megacephala</i> Schiff.	X			
<i>Leucoma salicis</i> L.	X			
<i>Smerinthus ocellata</i> L.	X			
Trunk borer				
<i>Paranthrene tabaniformis</i> Rott.	X			
<i>Aegeria apiformis</i> Cl.	X			
<i>Gypsonoma aceriana</i> Dup.	X			
<i>Cryptorhynchus lapathi</i> L.		X		
Leaf mining				
<i>Lithocolletis populifoliella</i> Tr.	X			
<i>Pinus</i> spp.				
Defoliation				
<i>Thaumetopoea pityocampa</i> Schiff.	X			
Shoot and stem borer				
<i>Rhyacionia buoliana</i> Schiff.	X			
<i>R. duplana</i> Schiff.	X			
<i>Petrova resinella</i> L.	X			
<i>Dioryctria nivaliensis</i> Rbl.	X			
Root feeder				
<i>Prodenia littoralis</i> B	X			
<i>Eucalyptus</i> spp.				
Defoliation				
<i>Plusia gamma</i> L.	X			
<i>Populus</i> and <i>Pinus</i> spp.				
Root feeder				
<i>Gryllotalpa grylloptarpa</i> L.			X	
<i>Melolontha melolontha</i> L.		X		
<i>M. hippocastani</i> F.		X		
<i>Anoxia villosa</i> F.		X		
<i>Polyphylla fullo</i> F.		X		
<i>Amphimallus pini</i> O1		X		
<i>Rhizotrogus</i> spp.		X		
<i>Agriotes</i> spp.		X		
<i>Melanotus</i> spp.		X		
<i>Otiorhynchus</i> spp.		X		
<i>Tipula</i> spp.				X

Table 2. Insects damaging nursery seedlings in England.

Plant part affected and insect	Damaging stage	Insect order
Needles		
<i>Argyrotaenia pulchellana</i> Haw.	Larva	Lepidoptera
<i>Strophosoma melanogramma</i>	Adult	Coleoptera
<i>Otiorhynchus singularis</i> L.	Adult	Coleoptera
Leaves and shoots		
<i>Phyllaphisfagi</i> L.	Adult & Nymph	Hemiptera
<i>Myzus cerasi</i> F.	Adult & Nymph	Hemiptera
<i>Neoterus quercusbaccarum</i>	Larva	Hymenoptera
<i>Strophosomus melanogrammus</i>	Adult	Coleoptera
<i>Otiorhynchus singularis</i> L.	Adult	Coleoptera
Roots		
<i>Agrotis segetum</i> Schiff.	Larva	Lepidoptera
<i>A. exclamationis</i> L.	Larva	Lepidoptera
<i>Noctua pronuba</i> L.	Larva	Lepidoptera
<i>Hepialus humuli</i> L.	Larva	Lepidoptera
<i>Barypeithes araneiformis</i> Schr.	Adult	Coleoptera
<i>B. pellucidus</i>	Adult	Coleoptera
<i>Melolontha melolontha</i> L.	Larva	Coleoptera
<i>Serica brunnea</i>	Larva	Coleoptera
<i>Phylloptha horticola</i>	Larva	Coleoptera
<i>Otiorhynchus ovatus</i> L.	Larva	Coleoptera
<i>Bibio</i> spp.	Larva	Diptera

Table 3. Insects damaging trees of all ages (including nursery seedlings) in England.

Hosts (genus), damage and insects	Damaging stage	Insect order
Alnus		
Leaf mining		
<i>Nematus pavidus</i>	Larva	Hymenoptera
<i>Hemichroa crocea</i>	Larva	Hymenoptera
Betula		
Leaf mining		
<i>Alnetoidea alneti</i> Dahlb.	Nymphs and adults	Hemiptera
<i>Nematus melanaspis</i>	Larvae	Hymenoptera
<i>Hemichroa crocea</i>	Larvae	Hymenoptera
<i>Operophterafagata</i> Scharf.	Larvae	Lepidoptera
<i>O. brumata</i> L.	Larvae	Lepidoptera
<i>Phyllobius</i> spp.	Adults	Coleoptera
<i>Lochmaea capreae</i> L.	Larvae and adults	Coleoptera

Table 3 (cont'd).

Hosts (genus), damage and insects	Damaging stage	Insect order
<i>Fagus</i>		
Leaf mining		
<i>Phyllaphisfagi</i> L.	Nymphs and adults	Hemiptera
<i>Rhynchaenusfagi</i> L.	Larvae and adults	Coleoptera
<i>Populus</i>		
Leaf mining		
<i>Alnetoida alneti</i> Dahlb.	Nymphs and adults	Hemiptera
<i>Nematus melanapsis</i>	Larvae	Hymenoptera
<i>N. pavidus</i>	Larvae	Hymenoptera
<i>N. salicis</i>	Larvae	Hymenoptera
<i>Trichiocampus viminalis</i> L.	Larvae	Hymenoptera
Leaf and shoot mining		
<i>Phyllosecta vitellinae</i> L.	Larvae and adults	Coleoptera
<i>P. vulgatissima</i>	Larvae and adults	Coleoptera
<i>Chrysomela populi</i> L.	Larvae and adults	Coleoptera
Wood boring		
<i>Cryptorhynchus lapathi</i> L.	Larvae	Coleoptera
<i>Saperda populnea</i> L.	Larvae	Coleoptera
Leaf mining		
<i>Cerura vinula</i> L.	Larvae	Lepidoptera
<i>Salix</i>		
Leaf mining		
<i>Alnetoidia alneti</i> Dahlb.	Nymphs and adults	Hemiptera
<i>Nematus melanapsis</i>	Larvae	Hymenoptera
<i>Trichiocampus viminalis</i> L.	Larvae	Hymenoptera
<i>Lochmaea capreae</i> L.	Larvae and adults	Coleoptera
Leaf and shoot mining		
<i>Galerucella lineola</i> F.	Larvae and adults	Coleoptera
<i>Plagioderma versicolora</i> Laich	Larvae and adults	Coleoptera
Wood boring		
<i>Saperda populnea</i> L.	Larvae	Coleoptera
<i>Cryptorrhynchus lapathi</i> L.	Larvae	Coleoptera
<i>Sorbus</i>		
<i>Dysaphis aucupariae</i>	Nymphs and adults	Hemiptera
<i>Abies</i>		
Needle feeding		
<i>Adelges nordmannianae</i> Eck.	Nymphs and adults	Hemiptera
Needle and shoot feeding		
<i>A. piceae</i> Ratzb.	Nymphs and adults	Hemiptera
<i>Cedrus</i>		
Shoot mining		
<i>Cedrobium laportei</i> Rem.	Nymphs and adults	Hemiptera

Table 3 (cont'd).

Hosts (genus), damage and insects	Damaging stage	Insect order
<i>Juniperus</i>		
Needle mining <i>Dichomeris marginella</i> F.	Larvae	Lepidoptera
<i>Larix</i>		
Needle feeding <i>Adelges laricis</i> Vall.	Nymphs and adults	Hemiptera
Needle and shoot mining <i>Zeiraphera diniana</i> Guen.	Larvae	Lepidoptera
<i>Picea</i>		
Needle feeding <i>Elatobium abietinum</i> Walk.	Nymphs and adults	Hemiptera
Shoot feeding <i>Adelges abietis</i> L.	Nymphs	Hemiptera
<i>Cinara pilicornis</i>	Nymphs and adults	Hemiptera
Needle mining <i>Epinotia manana</i>	Larvae	Lepidoptera
<i>E. tedella</i> Cl.	Larvae	Lepidoptera
<i>Orgyia antiqua</i> L.	Larvae	Lepidoptera
Needle and shoot mining <i>Zeiraphera diniana</i> Guen	Larvae	Lepidoptera
<i>Pinus</i>		
Needle mining <i>Cinara pini</i>	Nymphs and adults	Hemiptera
Root mining <i>Stagona pini</i>	Nymphs and adults	Hemiptera
Needle and shoot mining <i>Zeiraphera diniana</i> Guen.	Larvae	Lepidoptera
Needle mining <i>Orgyia antiqua</i> L.	Larvae	Lepidoptera
<i>Thecodiplosis brachyntera</i> Schwaegr.	Larvae	Diptera
Shoot and stem mining <i>Tomicus piniperda</i> L.	Larvae and adults	Coleoptera
Stem mining <i>Dendroctonus ponderosae</i> Hopk.	Larvae	Coleoptera
<i>Pseudotsuga</i>		
Needle feeding <i>Adelges cooleyi</i> Gill.	Nymphs and adults	Hemiptera

References

- Agenjo, R. 1964. Lepidópteros españoles perjudiciales a los viveros forestales y a las plantaciones jóvenes. Bol. Serv. Plag. Forest. 13:38-42.
- Bachiller, P. *et al.* 1981. Plagas de insectos en las masas forestales españolas. Ministerio de Agricultura, Pesca y Alimentación, Madrid.
- Bevan, D. 1987. Forest Insects. U.K. Forestry Commission, Farnham, England.
- Binazzi, A.; Notario, A.; Baragallo, J.; Castresana, L.; Montoya, R. 1983. Algunos pulgones que atacan a repoblados de pinos en la Sierra de Baza (Granada). Bol. Est. Centr. Ecol. 10:35-48.
- Nef, L. 1982. Relationship between population density of *Phyllocnistis suffusella* and environmental characteristics of poplars. V. Int. Sympos. Insect-Plant relationship. Wageningen, The Netherlands.
- Nef, L. 1983. Les principaux insectes minant les feuilles du peuplier. Agriccontact, No. 1434 pp.
- Notario, A.; Cadierno, D.; Mijares, A. 1978. Presencia en Hoyo de Manzanares (Madrid) de un pulgón que ataca a los cedros, *Cinara cedri* Mimeur. AM. INIA Ser. Prot. Veg., 8:59-64.
- Notario, A.; Baragallo, J.; Castresana, L. 1983. El *O. sulcatus* amenaza a las plantas ornamentales. TRIA, 397:74-75.
- Notario, A.; Binazzi, A.; Castresana, L.; Baragallo, J.; Montoya, R. 1984. Los pulgones del cedro: *Cinara cedri* Mimeur y *Cedrobium laportei* Remaudiere. Monografías ICONA, No. 33.
- Schread, J.C. 1972. The black vine weevil. Circular Connecticut Agric. Exp. Sta., No. 211.
- U.S.D.A. 1980. Black vine weevil (*Otiorynchussulcatus*) - Kansas - new state record. Coop. Plant. Pest. Rep. 5:660.

INVITED PAPERS

Biological control of plant pathogens: principles and strategies

PAIGE E. AXELROOD
*British Columbia Research Corporation
Forest Biotechnology Centre
3650 Wesbrook Mall, Vancouver, British Columbia*

*Presented at the first meeting of IUFRO Working Party S2.07-09
(Diseases and Insects in Forest Nurseries), Victoria, British Columbia, Canada, August 22-30, 1990.*

Abstract

The development of integrated approaches to disease management that incorporate biological control methods will hopefully decrease the reliance on chemical usage in the environment. Appropriate cultural practices that maintain or encourage disease suppressive microbial populations can be integrated into plant production systems. Furthermore, the selection and assessment of microorganisms for disease control, utilizing sensible isolation protocols and effective *in planta* screening assays can result in the development of microbial inoculants. Protection of the infection court and/or the reduction of pathogen inoculum can slow down disease progression and these situations have been observed in many biological control systems. Mechanisms which are active in biological control may include competition for space or nutrients, antibiosis, siderophore production, parasitism or predation, and induced host resistance or hypovirulence. The major concepts and principles of biological control of plant pathogens are highlighted in this review as well as strategies to develop a biological control research program. Examples emphasize the biological control of pathogens of woody plants, including conifer seedlings.

Résumé

La laboration de méthodes rationnelles de gestion des phytopathologies faisant appel aux biopesticides permettra éventuellement de réduire notre dépendance à l'égard des produits chimiques. Les systèmes de phytoproduction pourraient intégrer des pratiques de culture faisant intervenir des biopesticides dans la lutte contre les maladies des plantes. En outre, la sélection et l'évaluation de micro-organismes pour la lutte contre les maladies, dans la mesure où elle fait intervenir des protocoles d'isolation rationnels et des épreuves sélectives *in planta*, pourrait conduire à l'élaboration de vecteurs d'inoculation microbiens. Comme on a pu l'observer dans nombre de systèmes de lutte biologique, la protection du foyer d'infection et la réduction de l'inoculum pathogène peuvent ralentir la propagation de la maladie. Parmi les phénomènes intervenant dans la lutte biologique, citons la lutte pour l'espace et les nutriments, l'antibiose, la production de sidérophores, le parasitisme ou la prédation et l'immunologie induite ou l'hypovirulence. L'auteur fait une revue des grands principes de la lutte biologique antiphytopathogène et des stratégies de développement d'un programme de recherche sur les biopesticides. L'étude est étayée d'exemples de lutte biologique appliquée aux maladies des plantes ligneuses, notamment des semis de conifères.

Introduction

Biological control of plant pathogens, insect pests and weeds has gained considerable attention over the last 20 years. Much of this interest stems from the desire to decrease the use of pesticides in agricultural, forest and urban environments. The development of integrated approaches to disease and pest management that incorporate biological control methods will hopefully assist in safeguarding the environment while maintaining plant productivity. This symposium paper will focus on the biological control of plant pathogens. Major concepts and principles of biological control will be high-

lighted (Baker and Cook 1974; Papavizas and Lumsden 1980; Schroth and Hancock 1981; Cook and Baker 1983; Baker 1987; Weller 1988) as well as possible strategies to develop a biological control research program (Baker and Cook 1974; Cook, 1982; Cook and Baker 1983; Linderman *et al.* 1983). Examples will emphasize the biological control of pathogens of woody plants including conifer seedlings.

Biological control can be defined as the reduction of the amount of inoculum or the disease producing activity of the pathogen accomplished through one or more organisms other than man (Cook and Baker 1983).

Early historical observations indicated that the biological balance in soil could be altered to favor biological disease control by making changes to the soil such as altering the soil organic matter, by adding a disease suppressive soil to a conducive soil, or by introducing selected antagonistic microorganisms into soil (Cook and Baker 1983). One of the earliest examples of the influence of altering the microbial balance in soil on subsequent disease development was made by Hartley (1921) while studying damping-off of pine seedlings (*Pinus banksiana*, *P. ponderosa*) caused by *Pythium debaryanum*. The incidence of damping-off when *Pythium* was added to non-treated nursery soil was 35.8% compared to 100% damping-off when *P. debaryanum* was added to autoclaved nursery soil. Hartley hypothesized that the native microflora in nursery soil may have inhibited disease development by *Pythium* and the incidence of disease increased when this microbial component was eliminated by sterilization. Disease was also decreased when autoclaved soil was amended with *Pythium* plus additional saprophytes (*Phoma*, *Chaetomium*, *Rhizopus*, *Trichothecium*, *Trichoderma*, *Aspergillus*, *Rosellinia* and *Penicillium*, one unidentified bacterium and three unidentified fungi). Hartley concluded that the competition of saprophytes with *Pythium* may provide some disease protection for pine seedlings planted in heat disinfected soil. Subsequent examples in this review will substantiate the involvement of antagonistic microorganisms in biological control.

Biological control mechanisms

The reduction of plant disease through biological means can result from 1) reduction of pathogen inoculum, 2) protection of the infection court, 3) reduction of infection of the host, or 4) a reduction of disease progression or severity (Cook 1982; Cook and Baker 1983). A major mechanism which plays a role in many biological control situations is the competition for nutrients as well as space; this can result in niche exclusion of the pathogen. An example of a specialized form of nutrient competition which has offered disease protection in some plant/pathogen systems involves the production of siderophores (Leong 1986; Loper 1988). Siderophores are iron-chelating compounds which are produced by some biological control microorganisms and can cause iron deprivation of the pathogen. Additional mechanisms which may be involved in biological control include antibiosis (Fravel 1988; Thomashaw and Weller 1988), parasitism or predation (Papavizas and Lumsden 1980), induced host resistance or cross protection (Kuc 1982; Palukaitis and Zaitlin 1984) and hypovirulence (Van Alfen and Hansen 1984; Fulbright 1990). It is very important to keep in mind that several mechanisms may

operate jointly to reduce disease through biological control and it is difficult to determine the mechanisms which are most influential. Furthermore, microbial communities are complex and several members of the community are most likely active in decreasing disease development or progression.

Several of the above mechanisms can be illustrated using examples of biological control of diseases affecting woody plants. One of the classic examples of biological control deals with the control of crown gall disease caused by *Agrobacterium tumefaciens* (Kerr 1980; Cooksey and Moore 1982). This soilborne bacterial pathogen invades the plant through wounds such as those created by root pruning or when bareroot nursery stock is dug. This disease affects a wide range of woody and herbaceous plants. The biological control organism *Agrobacterium radiobacter* K84 has been used effectively for disease control by inoculating plant wounds prior to transplanting. *Agrobacterium radiobacter* K84 produces a bacteriocin which inhibits the growth of *A. tumefaciens* and bacteriocin production is thought to play a role in biological control. Equally important is protection of the infection court by *A. radiobacter* K84. *Agrobacterium tumefaciens* and *A. radiobacter* K84 are closely related organisms and occupy common niches during saprophytic growth in the soil. These factors may assist *A. radiobacter* K84 in being better able to compete with *A. tumefaciens* on plant surfaces. Commercial inoculants containing *A. radiobacter* K84 are available in the United States and Australia.

Another example of biological protection of an infection court involves inoculating freshly cut tree stumps with *Peniophora gigantea* which inhibits colonization of the stump by the root rot pathogen *Heterobasidion annosum* (Rishbeth 1963). *Heterobasidion annosum* can cause extensive root rot problems in managed forest stands and infects conifers such as Douglas-fir (*Pseudotsuga menziesii* [Mirb.] Franco), lodgepole pine (*Pinus contorta* var. *latifolia* Engelm.), Sitka spruce (*Picea sitchensis* [Bong.] Carr.) and western hemlock (*Tsuga heterophylla* [Raf.] Sarg.) (Morrison *et al.* 1986). The pathogen infects tree stumps, colonizes the roots, and can thereby spread through root contact with adjacent trees. The biological control agent is a weak pathogen that is unable to infect living trees but is an efficient saprophytic colonist of tree stumps. *Peniophora gigantea* is thought to inhibit *H. annosum* through protection of the infection court and possibly by hyphal interference (Cook and Baker 1983). This biological control agent has been used commercially in England, Finland and the United States (Cook and Baker 1983).

The final example that will be reviewed is the biological control of chestnut blight caused by the

fungal pathogen *Endothia parasitica* (Van Alfen *et al.* 1975; Van Alfen 1982; Anagnostakis 1982; Fulbright 1990). This pathogen causes cankers in chestnut trees (*Castanea sativa*, Mill.) and has resulted in extensive damage and death of trees in Europe and the United States. Biological control of this disease is fascinating because of the natural occurrence and spread of hypovirulent strains of *E. parasitica* which have been effective in reducing the impact of chestnut blight. Hypovirulent strains (strains with reduced virulence) contain RNA mycoviruses which can be transmitted to virulent *E. parasitica* strains thereby making strains receiving the RNA particles hypovirulent. Transfer usually occurs between strains from the same compatibility group. Fewer compatibility groups are present in Italy and France compared with the United States and therefore biological control of chestnut blight has been most successful in Europe. The biological control of chestnut blight exemplifies an attempt to eradicate the pathogen by decreasing virulence whereas the biological control of *Agrobacterium tumefaciens* and *Heterobasidion annosum* are examples of protection of the infection court.

The three examples described previously illustrate several mechanisms which are involved in biological control including competition, antibiosis, antagonism and hypovirulence. Microbial competition is a very important factor which is usually active in combination with other mechanisms. It is important to keep in mind that any introduced biological control agent must compete within microbial communities which may include multiple pathogens as well as the resident associative microorganisms. These biological components as well as abiotic factors are influential in disease development and ultimately disease control. Abiotic factors such as temperature, soil pH, soil structure, and soil moisture can all be major determinants in the effectiveness of an introduced biological control agent.

Biological control strategies

The biological control of plant diseases can include many approaches such as the protection of the infection court or the eradication of a virulent pathogen as previously discussed. Most current research emphasizes protective approaches to biological disease control; therefore, this will be the focus for the remainder of the paper. It is very important to gain an understanding of the disease of interest prior to developing a biological control research program. Primary sources of inoculum should be known as well as the epidemiology of the disease, the disease cycle, and when disease protection is most critical. Diseases which require a short window of protection, such as damping-off diseases, are easier to control biologically than a disease such as *Phellinus*

root rot of Douglas-fir which requires a very long window of protection. Damping-off diseases cause pre-emergence or post-emergence damage and affect seed or young seedlings. A small window of protection is required during the first month of seedling growth and the biological control organism can be applied directly onto the seed. The success of disease control is enhanced by introducing the biological control agent in the infection court. Requirements of plant tissue colonization are minimized since the microorganism is only required locally to protect against infection of the seed, seedling stem, or root. Disease control may also be more readily achieved since extensive root colonization throughout the growing season is not required nor is survival for long periods of time.

Biological disease control is much more challenging for a pathogen such as *Phellinus weirii* which causes root rot of Douglas-fir (Wallis 1976). Disease occurs most frequently in young forest stands but can also affect young seedlings on regenerating forest lands. The inoculum can survive in tree stumps or root debris in forest soils for up to 100 years and the disease is spread by root-to-root contact. This disease is much more difficult to control biologically since a suitable inoculum delivery system would need to be developed, extensive root colonization is required to allow for contact between the biological control agent and the pathogen, and long-term survival of the introduced microorganism is required. A more useful approach for control of *Phellinus* may involve looking for a transmissible agent to decrease virulence rather than trying to protect the host from infection.

Desirable attributes of biological control microorganisms

There are several desirable attributes of biological control microorganisms for successful control of soilborne diseases (Baker and Cook 1974; Cook and Baker 1983; Weller 1988). These include the colonization of plant surfaces, competition with the native microflora, maintenance of adequate populations throughout the period of disease expression, and survival through adverse environmental conditions. The importance of these factors may vary depending upon the disease as well as the mechanisms which are involved in disease control. Additional requirements may also exist such as the production of inhibitory metabolites, the induction of host resistance, or other factors specific to the mechanism, or mechanisms, of action.

Two main approaches to biological disease control are the cultural management of resident antagonists and the introduction of a biological control agent.

Cultural management of resident antagonists

Resident antagonists have been favored by managing cropping practices such as monoculture, tillage, cover cropping, incorporating green manure plant debris into soil, or altering soil conditions such as pH or moisture (Baker and Cook 1974; Cook and Baker 1983). These practices may act to reduce the survival of pathogen inoculum or enhance the populations of resident antagonists. These cultural practices exhibit specificity and are not strategies which can be used for generalized disease control. For example, monoculture has resulted in take-all decline of wheat but may enhance disease in other plant/pathogen systems. Each disease must be explored on an individual basis.

Establishment of a microbial culture collection

The development of screening programs to identify candidate biological control strains and the introduction of these strains into agricultural systems has gained considerable attention in recent years. Less emphasis has been placed on the biological control of diseases of woody plants. Biological control strains known to offer effective disease control can be screened against other related pathogens to expand the use of the strain. Alternatively, a culture collection can be established for disease control of a specific pathogen of interest. Microbial culture collections can be derived from isolating microorganisms from the plant tissues requiring disease protection or by developing baiting systems for isolating antagonists, parasites or predators.

Microorganisms should be isolated from healthy plants on which disease does not occur, develops slowly, or declines after a period of time (Baker 1987). A focus should be placed on situations where a susceptible host is grown and environmental conditions are conducive for disease development but the pathogen is unable to incite disease. Therefore, one is looking for microorganisms that proliferate in a potential infection court and are present due to the absence of disease. Logic rules that greater success may be achieved if isolations are made from the plant species which requires disease protection and from plant tissues requiring protection from pathogen infection. For example, if the disease of interest is *Fusarium* root rot of Douglas-fir, isolations should be made from the rhizosphere of healthy Douglas-fir seedlings growing in environments where the disease does not occur despite the presence of the pathogen.

Several isolation methods and general or selective media can be used to optimize the isolation of diverse rhizosphere microorganisms and cultural conditions can be designed to favor specific requirements of the

biological control strain. For example, if protection is required against a damping-off pathogen that causes disease in cool soils, rhizosphere dilution plates could be incubated at the cooler temperature to isolate microorganisms which are metabolically active under those environmental conditions. Unique colony types are selected from dilution plates and purified.

An alternate approach utilizes baiting or enrichment methods to isolate microorganisms that readily colonize pathogen propagules such as sclerotia, spores, or mycelium (Cook and Baker 1983; Linderman *et al.* 1983). The aim is to isolate antagonistic microorganisms or organisms which may be parasites or predators. Baiting methods can be optimized by using soils exhibiting disease suppression. Baiting methods were successfully used to isolate antagonists for the control of onion white rot caused by *Sclerotium cepivorum* (Utkhede and Rahe 1980). Sclerotia were isolated from soil and microorganisms which colonized the sclerotia were isolated and tested for antagonism and disease control. Several isolates were identified which offered biological control in field trials.

Care must be taken to store microbial strains using methods that ensure their viability and stability. Bacteria are often stored at -70°C as cell suspensions containing either 15% glycerol or 7% DMSO (Davis *et al.* 1980). Alternatively, cells can be lyophilized. Fungal strains can be stored in a variety of ways such as in liquid nitrogen, by lyophilization, or in sterile soil. Candidate strains should be stored using two separate methods if there is any doubt in maintaining strain viability and stability. If the appropriate equipment is unavailable for some of the methods listed above, it would be prudent to contact an established culture collection such as the American Type Culture Collection and request recommendations for alternate forms of culture storage.

Biological control screening programs

Although many biological control agents produce antibiotics *in vitro*, it has not been clearly established whether or not screening for this attribute helps to identify candidate beneficial strains (Fravel 1988; Weller 1988). Therefore, it may be more prudent to screen strains initially in plant bioassays in the growth chamber or greenhouse. However, if *in vitro* antibiosis screening is of interest, it is important to screen strains on several media and against several pathogen isolates since inhibitory compounds may only be detected under certain conditions. Inhibition may result from a decrease in the pH of the test media or from nutrient competition, and these factors should be kept in mind.

The development of a plant bioassay screen is of utmost importance and should closely resemble condi-

tions where disease protection is needed. Natural soils that contain the pathogen can be used or soil can be infested with a representative pathogen at an inoculum level which yields reproducible levels of disease. The environmental and cultural conditions should reflect the conditions of the disease situation. The disease of interest may require a long incubation period prior to symptom development and it may be necessary to use an alternate screening assay which has a shorter incubation time. For example, *Fusarium* can cause a root rot of conifer seedlings and disease may not appear in container nurseries until the end of the growing season (Sutherland *et al.* 1989; Landis *et al.* 1990). *Fusarium* is also able to cause seedling damping-off and hypocotyl rot under some conditions. The development of a conifer seedling bioassay targeting on damping-off and hypocotyl rot would result in a screening assay with a

much shorter incubation period. The final step in any screening assay is confirmation testing of candidate beneficial strains in field trials. Although most screening programs focus on the use of individual beneficial strains, greater success may be achieved if multiple beneficial strains are combined into an inoculant.

The development and utilization of microbial inoculants for biological disease control is highly challenging. Numerous reports in the literature indicate variation in the effectiveness of biological control strains under different environmental conditions and among different trials. The introduced microorganism must be competitive and able to proliferate and survive. The identification of the "super bug" is highly unlikely and a more practical approach may be integrated disease management which includes biological disease control strategies to enhance plant health.

References

- Anagnostakis, S.L. 1982. Biological control of chestnut blight. *Science* 215:466-471.
- Baker, K.F. 1987. Evolving concepts of biological control of plant pathogens. *Ann. Rev. Phytopathol.* 25:67-85.
- Baker, K.F.; Cook, R.J. 1974. Biological control of plant pathogens. W.H. Freeman and Company, U.S.A. 433 p.
- Cook, R.J. 1981. Biological control of plant pathogens: Overview. *In* Biological control in crop production. Beltsville Symposia in Agricultural Research Ser., 5. Allanheld Pub, 474 p.
- Cook, R.J.; Baker, K.F. 1983. The nature and practice of biological control of plant pathogens. Amer. Phytopathol. Soc., St. Paul, Minnesota. 539 p.
- Cooksey, D.A.; Moore, L.W. 1982. Biological control of crown gall with an agrocin mutant of *Agrobacterium radiobacter*. *Phytopathology* 72: 919-921.
- Davis, R.W.; Botstein, D.; Roth, J.R. 1980. A manual for genetic engineering: Advanced bacterial genetics. Cold Spring Harbor Laboratory, Cold Spring Harbor, New York. 254 p.
- Fravel, D.R. 1988. Role of antibiosis in the biocontrol of plant diseases. *Ann. Rev. Phytopathol.* 26:75-91.
- Fulbright, D.W. 1990. Molecular basis for hypovirulence and its ecological relationships: New directions in biological control. Pages 693-702 *in* R.R. Baker and P.E. Dunn, editors. Alternatives for suppressing agricultural pests and diseases. U.C.L.A. Symposium. Alan R. Liss, Inc. New York.
- Hartley, C. 1921. Damping-off in forest nurseries. U.S. Dept. Agric. Bull. 934:1-99.
- Kerr, A. 1980. Biological control of crown gall through the production of agrocin 84. *Plant Dis.* 64:25-30.
- Kuc, J. 1982. Plant immunization-mechanisms and practical implications. Pages 157-178 *in* R.K.S. Wood, editor. Active defense mechanisms in plants. Plenum Press, New York.
- Landis, T.D.; Tinus, R.W.; MacDonald S.E.; Bamett J.P. 1990. The container tree nursery manual (Vol. 5). The biological component: Nursery pests and mycorrhizae. USDA For. Serv. Agric. Handbk. 674. Washington, D.C.
- Leong, J. 1986. Siderophones: their biochemistry and possible role in the biocontrol of plant pathogens. *Ann. Rev. Phytopathol.* 24: 187-209.
- Linderman, R.G.; Moore, L.W.; Baker, K.F.; Cooksey, D.A. 1983. Strategies for detecting and characterizing systems for biological control of soilborne plant pathogens. *Plant Dis.* 67: 1058-1064.
- Loper, J.E. 1988. Role of fluorescent siderophore production in biological control of *Pythium ultimum* by a *Pseudomonas fluorescens* strain. *Phytopathol.* 78: 166-72.
- Morrison, D.J.; Larock, M.D.; Waters, A.J. 1986. Stump infection by *Fomes annosus* in spaced stands in the Prince Rupert Forest Region of British Columbia. Can. For. Serv. Pac. For. Cent. Inf. Rep. BC-X-285. Victoria, B.C. 12p.
- Palukaitis, P.; Zaitlin, M. 1984. A model to explain the "cross-protection" phenomenon shown by plant viruses and viroids. *In* T. Kosuge and E.W. Nester, editors. Plant-microbe interactions, molecular and genetic perspectives. Vol. 1. MacMillan Publishing Company, New York. 444 p.
- Papavizas, G.C.; Lumsden, R.D. 1980. Biological control of soilborne fungal propagules. *Ann. Rev. Phytopathol.* 18:389-413.
- Rishbeth, J. 1963. Stump protection against *Fomes annosus* III. Inoculation with *Peniophora gigantea*. *Ann. Appl. Biol.* 52:63-77.
- Schroth, M.N.; Hancock, J.G. 1981. Selected topics in biological control. *Ann. Rev. Microbiol.* 35:453-476.
- Sutherland, J.R.; Shrimpton, G.M.; Sturrock, R.N. 1989. Diseases and insects in British Columbia forest seedling nurseries. For. Can., Victoria; Brit. Columbia Minist. For., Victoria. FRDA report 065.

-
- Thomashow, L.S.; Weller, D.M. 1988. Role of phenazine antibiotic from *Pseudomonas fluorescens* in biological control of *Gaeumannomyces graminis* var. *tritici*. J. Bacteriol. 170:3499-3508.
- Utkhede, R.S.; Rahe, J.E. 1980. Biological control of onion white rot. Soil Biol. Biochem. 12:101-104.
- Van Alfen, N.K. 1982. Biology and potential for disease control of hypovirulence of *Endothia parasitica*. Ann. Rev. Phytopathol. 20:349-362.
- Van Alfen, N.K.; Jaynes, R.A.; Anagnostakis, S.L.; Day, P.R. 1975. Chestnut blight: Biological control by transmissible hypovirulence in *Endothia parasitica*. Science 189:890-891.
- Van Alfen, N.K.; Hansen, D.R. 1984. Hypovirulence. in T. Kosuge and E.W. Nester, editors. Plant-microbe interactions, molecular and genetic perspectives. Vol. 1. MacMillian Publishing Company, New York. 444 p
- Wallis, G.W. 1976. *Phellinus (Poria) weirii* root rot detection and management proposals in Douglas-fir stands. Environ. Can., Can. For. Serv., For. Tech. Rep. 12. Victoria, B.C. 16p.
- Weller, D.M. 1988. Biological control of soilborne plant pathogens in the rhizosphere with bacteria. Ann. Rev. Phytopathol. 26:379-407.

Nursery hygiene in concept and practice

B. N. BROWN AND A. G. M. BAXTER

Queensland Forest Service, Department of Primary Industries
Indooroopilly and Toolara respectively, Queensland, Australia

Presented at the first meeting of IUFRO Working Party S2.07-09
(Diseases and Insects in Forest Nurseries), Victoria, British Columbia, Canada, August 22-30, 1990.

Abstract

Over 20 years ago, the Queensland Department of Forestry adopted a strict nursery hygiene scheme to avoid the need for soil fumigation for the control of *Phytophthora cinnamomi* root rot in nurseries producing bare-root *Pinus* planting stock. This system has been used successfully for many years in three important forest nurseries in Queensland, one of these being among the larger forest nurseries in Australia. The concept behind the hygiene system and some practical aspects of its operation are described.

Resume

Il y a plus de 20 ans, le département de foresterie du Queensland adoptait un plan rigoureux d'hygiène des cultures en pininbre afin d'éviter l'emploi de produits de lutte contre la phytophtorose des racines dans les pininbres cultivant des plants de *Pinus* à racines nues. Cette méthode a été utilisée avec succès pendant de nombreuses années dans trois grandes pépinières du Queensland, dont l'une compte parmi les plus importantes pininbres forestières d'Australie. Les auteurs décrivent le principe qui sous-tend le plan d'hygiène en question et certains aspects pratiques de sa mise en oeuvre.

Introduction

A serious root rot problem in bare-root *Pinus* nurseries in Queensland caused by the fungus *Phytophthora cinnamomi* Rands, was first recognized in 1958 (Oxenham and Winks 1963); and by 1963, the Queensland Department of Forestry (now the Queensland Forest Service) had introduced soil fumigation as an operational control measure (Brown 1985). Initial fumigations utilized methyl bromide released under raised plastic sheeting, but following experimental studies a 50:50 mixture of methyl bromide:chloropicrin injected at 25 - 30 cm depth, with plastic surface cover, became the favored fumigant (Brown 1985).

Severe losses due to *P. cinnamomi* in one of the first areas fumigated experimentally raised an awareness of the problem of re-contamination. To prevent re-contamination occurring in fumigated beds, a strict regime was developed for the Queensland *Pinus* nurseries. In essence this was:

1. use of simple wooden kerbing (on uphill sides, if not all around the fumigated area) and simple fencing at the perimeter of the treated area,
2. drainage to prevent water flow into the treated area,
3. an unsown strip left inside the fenced area (45 to 60 cm wide) - i.e., an area larger than the required bed space prepared and fumigated,

4. exclusion of all but necessary entry of personnel to the fenced fumigated area, and
5. use of 5% formalin to clean equipment to be taken into the area and the boots of the personnel who have to enter.

For many years, nursery personnel have been under strict instructions to adhere to this regime where fumigation has been used for *Pinus* sowings. It is believed that the procedures are effective as records of *P. cinnamomi* in fumigated areas have been rare: some of those records were undoubtedly due to problems at fumigation, e.g., fumigation with soil temperatures too low. Fumigation is still used in one small *Pinus radiata* D. Don nursery in Queensland.

It has been the long-term aim of the Queensland Forest Service to produce *P. cinnamomi*-free *Pinus* planting stock rather than just to reduce nursery losses. Soil fumigation has been and still is regarded as an effective, if costly, means of achieving control of *P. cinnamomi* in bare-root nursery production of *Pinus* species for Queensland conditions. However, in the tropical to sub-tropical conditions under which the Queensland Forest Service produces bare-root *Pinus* planting stock, fumigation led to the growth of large succulent seedlings under nursery regimes which did not include a mechanical root-wrenching schedule. Such a schedule was introduced in the mid-1970s (Ward and Simpson 1985; Bacon 1985) but has not been

Table 1. Details of the three bare-root nurseries operated by the Queensland Forest Service using the hygiene system

Nursery	Major crop ⁽¹⁾	First sown	Gross area ⁽²⁾	Net area	Potential production ⁽³⁾
Beerbur	PCH/PEE	1968	3.9	3.6	900 000
Toolara	PCH/PEE	1971	20.6	17.1	4500000
Ingham	PCH	1981	6.5	4.6	1080000

(1) PCH = *P. caribaea* var. *hondurensis*
 PEE = *P. elliotii* var. *elliottii*

(2) hectares

(3) Production potential for PCH, that for PEE is 1.3 times higher

routinely used on *Pinus* seedlings growing in fumigated seedbeds. However, on one occasion during development of the conditioning schedule, there were problems in restraining growth of seedling pines in a fumigated area, even with frequent root-wrenching (Bacon, personal communication).

During the mid- 1970s the Queensland Department of Forestry also became interested in greater mechanization of nursery activities, particularly at and following sowing. At the time, intensive mechanization such as bed-forming and sowing, inter-row cultivation, root-wrenching and tractor-mounted boom sprays for weedicide or pesticide application were not seen to be compatible with fumigation of bed areas (even if large); broad-area fumigation would have been necessary for disease control if mechanical operations were to follow.

An alternative to continued use of nurseries known to be infested by *P. cinnamomi* was to select new nursery sites and operate them under a strict hygiene system. That course was followed, and this paper discusses the history of establishment of the system, the conceptual principles that were used in its development, and some of the practical aspects and difficulties involved.

The history of hygiene nurseries in Queensland

The hygiene nursery system, now employed by the Queensland Forest Service, was developed from the basic hygiene measures that have been used to avoid recontamination of fumigated nursery beds. The hygiene system was first designed in the late 1960s, prior to its first use at Beerbur in southeastern Queensland where a new nursery was first sown in 1968. Over the years there have been some refinements, but the basic system remains the same. Three such nurseries have been operated in Queensland (Table 1). Because of

changes in preferred species, and a greater need for container rather than bare-root stock for second rotation plantings, there have been changes in these nurseries in recent years; however, two of the hygiene nurseries remain fully operational. The Beerbur nursery, where the last bare-root crop was lifted in 1989, has been retained in an inactive state but with hygiene being maintained. It will be available in the future should crop needs alter.

The Beerbur nursery operated successfully, without any evidence of *P. cinnamomi* disease activity, for over 20 years. This was despite the known occurrence of the fungus in the general area and despite the detection of *P. cinnamomi* in an adjacent area used for expansion and in container stock in another area beside the hygiene nursery. The expansion area has been kept isolated from the main section; how this was achieved is described later in the paper. The present nursery site is on the same ridge system, has similar soils, and is only about 0.5 km from the first Beerbur nursery which was closed because of severe root rot which developed within 10 years of its being opened in 1949. The Toolara hygiene nursery is also in a plantation area where *P. cinnamomi* is known to be widespread and it replaced another nursery with severe root rot. It has now been used for nearly 20 years without any indication of contamination by *P. cinnamomi*.

The hygiene nursery concept

The hygiene nursery system, as developed by the Queensland Forest Service, was intended for use in permanent open-bed nurseries where capital costs of development and the special structures required to maintain hygiene can be amortized over many years. The system is also suitable for permanent nurseries producing container stock.

The essential start to the system is a culturally suitable site free from major soil-borne pathogens, *P. cinnamomi* being considered the most important for Pinus crops in Queensland. Once an acceptable pathogen-free site has been selected, the biggest risk is seen to be the introduction of such pathogens from outside the site. Another essential component of the system is the use of acceptable cultural practices rather than overcropping the nursery beds, as had been the practice in Queensland. Thus, the hygiene system was developed as an integrated package involving not only exclusion (quarantine) provisions but also cultural practices such as crop rotation and regular deep ripping.

The components of the hygiene system are:

1. Site selection,
2. Initial clearing and construction,
3. Perimeter fencing,
4. Access points,
5. Water supply,
6. Nursery bed additives and other nursery supplies,
7. Introduction of mycorrhizal inoculum,
8. Nursery extensions (beds and/or buildings),
9. Crop rotation, and
10. Deep ripping.

1. Site selection

Obviously a potential nursery site must meet certain criteria with regard to soil conditions, slope, water supply, and other cultural requirements. Subject to the potential site meeting such criteria, the following hygiene criteria should be applied:

- a. The site should be tested for, and be free of, major potential pathogens - in Queensland this applies to *P. cinnamomi*;
- b. Because soil-borne pathogens can be spread by water flow, there should not be any drainage from outside areas; a raised site which drains outwards in all directions is obviously preferable, but external drainage could be constructed.

2. Initial clearing and construction

Even during the early stages, restrictions should be placed on access to the site. Machinery and vehicles which are essential should be free of soil, having been cleaned down off-site if necessary.

3. Perimeter fencing

The entire nursery site, including headlands and vehicle access tracks to be used within the nursery must be enclosed by adequate fencing. Nursery sheds and other building facilities can be located on the perimeter as part

of the external enclosure or located within the fenced area. In Queensland the fencing is designed to exclude machines, vehicles, men and large animals (dogs, kangaroos, etc.) but not smaller animals.

4. Access points

Access to the nursery must only be via approved sites which incorporate fungicidal baths; this must apply equally to personnel, machinery and vehicles. Equipment and vehicles which are to be taken into the nursery must be cleaned down, especially underneath, with a high pressure hose and then taken through the bath.

5. Water supply

One major potential source of pathogens is the water supply used within the nursery. Thus, it is important to ensure that irrigation and other nursery water supplies are free of pathogenic fungi.

There are several options available for sterilizing a nursery water supply. A reticulated domestic water supply, which is filtered and chlorinated, is quite suitable. Where this source of water is not available, possible options are filtration or the use of ultra violet light (Palzer 1980; Grech *et al.* 1989) or chlorination (Smith 1979). All three forms of sterilization have advantages and disadvantages which should be assessed in light of the local situation.

To avoid the risk of phytotoxicity to growing seedlings, consideration should be given to aeration of chlorinated water before nursery use.

6. Nursery bed additives and other nursery supplies

Special attention should be given to ensuring that there is no chance of *P. cinnamomi* (or other target pathogens) being introduced with materials being taken into the nursery. These materials must be clean and free of soil. If not, then they must be washed and sterilized. Soil and similar materials must be sterilized in some way.

7. Introduction of mycorrhizal inoculum

It seems probable that the widespread occurrence of *P. cinnamomi* in Pinus nurseries in Queensland resulted from the use of Pinus litter from under plantation areas to introduce mycorrhizal fungi into those nurseries. Thus, special consideration needs to be given to the requirements for inoculation of the new nurseries and, if inoculation is required, what form of inoculum would be suitable with regard to the hygiene requirements.

8. Nursery extensions (beds and/or buildings)

Extensions to a nursery or the modification of facilities, including buildings, water supply or drainage, pose problems for the maintenance of hygiene. The disease-free status of the original nursery site should be maintained at all costs.

9. Crop rotation

The Queensland Forest Service hygiene system is intended primarily for use in open-bed nurseries to be operated over a long period of time, preferably without the need to introduce soil or bulk organic material. Hence, a crop rotation system including green manure crops is an important part of the system. The role of the cover crop is seen more as a source of organic matter than as having a role in weed and erosion control. These are aspects that cannot, however, be overlooked.

Selection of species for the cover crop, and its cultivation, should take into account the potential for organic-matter production, the risk of large remnants which do not decompose readily, and the potential disease or pest problems which may follow its use.

10. Deep ripping

One of the factors that was believed to lead to the development of severe *Phytophthora* root rot in Queensland's forest nurseries was the formation of a hardpan below the cultivated zone of the bed through regular cultivation with tractor-mounted rotary hoes. Although the lower cultural activity associated with crop rotation practices and reduced use of rotary hoes were expected to lessen hard pan development, regular deep ripping was included in the schedule to ensure good vertical drainage.

The hygiene nursery in practice and the problems

1. Site selection

One of the major problems associated with the testing of potential nursery sites is the availability of reliable pathogen screening systems. At the time that the Beerburum and Toolara sites were being considered, isolations for *P. cinnamomi* were carried out by direct root isolations from volunteer *Pinus* seedlings that were scattered across the sites and by soil baiting into green apples. By the time that investigations were in progress for expansion of the Beerburum site, and for the Ingham site, a double-baiting modification of the Chee and Newhook (1965) New Zealand blue lupin isolation method allowed for systematic surveying.

At one small, somewhat isolated *Pinus* plantation center in central Queensland, several potential nursery

sites were tested for the presence of *P. cinnamomi* and it was present at all. As a result, plans to replace the old infested nursery were abandoned and stock production continued for some years using soil fumigation, but current planting-stock needs for the area are met from the large Toolara nursery using refrigerated transport.

2. Initial clearing and construction

There are certainly problems associated with maintaining hygiene during the early construction stages, before vehicle and machinery wash-down facilities have been built. During those stages, there is often need for heavy machinery for site clearing and levelling, for installation of water supplies and drainage as well as construction of the nursery sheds and water storage tanks. It was the practice to restrict site access at all times, and prohibit access during wet weather, when soil would have been readily carried on machinery. Machinery to be used on the proposed nursery was free of soil, having been cleaned down away from the site.

Where one of the nursery sites (Ingham) needed substantial levelling, soil from within the hygiene boundaries was used, rather than use imported soil with the inherent risk of pathogen introduction.

3. Perimeter fencing

Construction of the perimeter fencing with associated access points was treated as a high priority. Once in place, the fence became a major factor in maintaining site integrity. Design of the perimeter barrier included location of access points and the incorporation of buildings.

4. Access points

Special consideration has been given to the chemical to be used in the foot and vehicle baths through which access to the nursery is permitted. Following laboratory studies conducted some years ago, the Queensland Forest Service continues to use formalin (0.75% formaldehyde) for this purpose.

Tractors and other equipment, used only in the nursery, are kept inside the enclosed area. When not in use, they are stored in sheds which have access only into the controlled area. When a vehicle or machine is to be taken into the nursery, careful attention is given to the cleaning, even in the cabin, and an inspection is carried out before it is allowed to pass through the bath.

The greatest problems with vehicle access and control occur at lifting of the stock, when large numbers of seedlings have to be transported away from the beds. This has been solved in two ways depending on the nature of lifting operations: where plants are packed and, if necessary, graded on the bed near the lifting

front, they are packed into trailers on site. Those trailers have already been washed down outside the site and are towed into and out of the nursery by a clean tractor through the formalin bath; or with the provision of grading and packing facilities on the nursery perimeter, plants are transported from the lifting front to those facilities on pallets, and, after grading/packing, are loaded onto transport through the shed to the outside of the hygiene area.

5. Water supply

It is Queensland Forest Service policy to use chlorinated water supplies within hygiene nurseries. This is seen as the most practical and least expensive means of killing plant-pathogenic fungi which may be present in creek water supplies. To avoid the risk of phytotoxicity to growing seedlings, chlorinated water is aerated in large storage tanks from which it can be pumped for nursery use.

The Toolara nursery irrigation system uses 60 000 L per hour when in full operation. Treatment is with gaseous chlorine injected into the water to give 2 ppm of free chlorine at the outlet into the storage tanks. The use of aeration and holding tanks requires a pump with an associated treatment system, operating on demand, to maintain water storage. A second pump then provides the output and pressure to run the irrigation system from the holding tanks, as required.

6. Nursery bed additives and other nursery supplies

No plants, except for cuttings, are allowed into the nursery and then only if they are clean and free of soil. Although not now used, soil and organic matter such as farmyard manure or filter press (a high organic by-product of cane-sugar processing) were fumigated before being taken onto the seed-beds. In container production, sand and some other potting materials are fumigated or heat-treated before being taken into the nursery. Inorganic fertilizers and vermiculite are not treated but care is taken to ensure that there is no soil on the outside of the bags. Kiln-drying of the clay that was used for root-puddling was considered adequate treatment.

New pots and plant trays are considered safe but such items being returned to the nursery from planting fronts must be cleaned and sterilized. One area of concern is what chemicals are suitable for use as sterilants for cleaning pots, polystyrene containers, benches and concrete areas and also for use in foot and vehicle baths. To be acceptable, a chemical should be fungicidal (not merely fungistatic) at a reasonably short exposure time. Various chemicals have been recommended in Australia for use as disinfectants in nurseries. Sutton (1980), for example, reported that Biogram

(a substituted phenol) at 1% was suitable. Sutton listed disinfectants used in Victorian ornamentals nurseries as Biogram (1%), Dettol (1%), formalin (2%) and sodium hypochlorite (0.5%). Noske and Shearer (1985) reported that a number of quaternary ammonium compounds inhibited the growth of mycelium of *P. cinnamomi* quite dramatically, especially at concentrations over 1.2%, and that they were more effective than Biogram. However, their results show that even after exposure for 2 minutes to quaternary ammonium compounds at concentrations of 10% a.i., *P. cinnamomi* retained its viability.

Recently, further studies were conducted by the Queensland Forest Service to test for an alternative sterilant to formaldehyde for use on pots and containers. A range of locally available materials, particularly some of the newer chemicals, were tested. Mycelium of *P. cinnamomi* was exposed to the test chemicals for varying periods. Initial screening showed major differences between a number of quaternary ammonium compounds, even some based on benzalchonium chloride, with one local quaternary ammonium preparation (Safa) and another sterilant (Dettol); both prevented growth of *P. cinnamomi* after exposure for 15 minutes (Table 2).

In a further test, Safa and Dettol were compared with formaldehyde for exposure periods of up to 10 minutes (Table 3). Exposure to Dettol for 2 minutes and to Safa for 5 minutes prevented growth of *P. cinnamomi*, but for formaldehyde, 10 seconds exposure time was effective. It will be more difficult to kill *P. cinnamomi* in soil or plant debris so, for the present, formalin remains the recommended sterilant for use in the Queensland hygiene nursery system.

7. Introduction of mycorrhizal inoculum

Experience following a number of fumigations at a number of centers indicated that, in nurseries adjacent to existing plantations, mycorrhizal re-infection occurred readily. Thus, there was no attempt to introduce mycorrhizal inoculum at either the Beerburrum or Toolara nurseries because both were within 50 m of well-established stands. Natural development of mycorrhizae occurred at both centers. However, the Ingham nursery was developed on a site some distance from established plantations. It was decided that, at Ingham, inoculation should be carried out in each seed-bed area at its first sowing.

Basidiomes of *Rhizopogon* and *Suillus* were collected from Beerwah in southeastern Queensland, and, after washing and surface sterilizing with sodium hypochlorite, they were homogenized in sterile water. For most of the bed areas, the homogenate slurry was mixed

Table 2. The growth of *Phytophthora cinnamomi* after exposure of macerated mycelium to a number of sterilants. Each preparation was used at the rate recommended for use for dirty conditions

Treatment	Chemical(s)	% a.i.	Exposure time	
			15 min	30 min
Control			+++	+++
Dettol	Chloroxylenol	0.24		
	+ Ethanol	0.79	—	—
Safa	Benzalchonium chloride	0.15	—	—
Quatrasan	Benzalchonium chloride	0.67		
	+ Giguanine hydrochloride	0.0013	+++	+++
Refresh	Benzalchonium chloride	0.042	+++	+++
Savlon	Centrimide	0.5		
	+ Chlorohexidine gluconate	0.05	+++	+t+

+++ very good growth — no growth

with *Pinus* seed which was sun-dried before being drill-sown into seed-beds. That procedure gave good results, in contrast to the one occasion when inoculation was initially overlooked. Attempts were made to inoculate the beds by adding homogenized basidiome to established but mycorrhizal-deficient seedlings in the seed-beds; this procedure gave very patchy results, but the mycorrhizal fungi did spread with time.

8. Nursery extensions (beds and/or buildings)

Beerburum is the only one of the Forest Service's hygiene nurseries that has been enlarged. Surveys detected *P. cinnamomi* in the proposed extension. More detailed sampling was used to establish the distribution of the fungus, and then the affected area, along with an extensive buffer zone, was treated with metalaxyl. The original nursery fencing was left in place and the extension was operated as a separate unit. Only one-way access was permitted from the original section to the extension and from there to the outside and back into the original nursery via the perimeter baths.

During construction of additional perimeter facilities it had been necessary to remove part of the fencing. At that stage, measures were taken to ensure that there was no access from the outside onto the hygiene area by personnel or equipment. Equipment was well washed down for use during the work. At the end of construction, any new areas incorporated into the hygiene area have been fumigated (soil), or treated with formalin (paths and gravel areas).

9. Crop rotation

Continued productivity of the hygiene nursery system is based on replacement of nutrient losses with inorganic

fertilizers and maintenance of soil physical and biological properties by rotational cropping and use of cover crops (Simpson 1985). Current Queensland nursery design allows for one *Pinus* (10 month) crop and two ley years incorporating the cover crop and a period for organic matter breakdown.

Long-term monitoring of the Beerburum and Toolara nurseries has shown a consistent decline in soil pH with time (presumably due in part, at least, to the use of inorganic fertilizers) and of concern, a gradual decline in organic carbon levels (Simpson 1985). The pH

Table 3. Effect of exposure of mycelial mats of *Phytophthora cinnamomi* to three sterilants (formalin 1.85 percent a.i.) for periods of up to 10 minutes

Exposure time	Dettol	Safa	Formalin
0 sec	+++	+++	+++
10 sec	+++	+++	—
20 sec	+++	+++	—
30 sec	+++	++t	—
40 sec	+++	+++	—
50 sec	++	+++	—
1 min	+	+++	—
2 min	—	+++	—
5 min	—	—	—
10 min	—	—	—

+++ very good growth

++ good growth

+ slight growth

— no growth

decline at Toolara was corrected last year by the addition of 2 tonnes ha⁻¹ of lime. Despite increased production of organic matter with improved cultural practices for the cover crop, the organic matter levels are still causing some concern.

The concern that leguminous cover crops at Ingham may lead to a charcoal root rot problem (*Macrophomina phaseolina* (Tassi) Goid.) (Brown 1985) has not eventuated. However, at Toolara, on one occasion the grass cover crop resulted in severe activity by African black beetles (*Heteronychus arator* (Fabricius) (Coleoptera: Scarabaeidae)) on adjacent *Pinus* crops. Although not evident in subsequent *Pinus* crops, one planting of a forage sorghum cover crop suffered damage by stubby-root nematode, *Paratrichodorus minor* (Colbran) Siddiqi.

10. Deep ripping

In Queensland, beds are deep ripped to at least 50 cm at no more than 85 cm spacing during bed preparation for each *Pinus* crop, and for the intervening cover crop. It is important, in designing and developing the nursery site, that services such as water and drainage are installed in areas never to be ploughed (internal tracks or headlands), or that they are located at depths below any possible cultivation effects.

Conclusion

Operation of a hygiene-style nursery poses management problems and imposes a financial cost, regarded as minor, on the nursery operation. However, those costs must be balanced against the possible losses from major nursery pathogens, the availability and cost of chemical control should those pathogens occur within a nursery crop, the adverse effects of using infected stock in a planting program or the risks of spreading pathogens to new areas.

In Queensland, Forestry was faced with a severe root rot problem caused by *P. cinnamomi* in a number of nurseries producing bare-root *Pinus* stock. This stock was primarily intended to meet the needs of a significant planting program (Queensland Forest Service's *Pinus* plantations currently comprise about 12% of the total Australian forest plantation area). Root rot disease caused nursery losses, led to heavy culling of planting stock, and was sometimes associated with heavy outplanting losses at a time when there were no effective methods of controlling *P. cinnamomi* root rot on any crop species. There is also evidence of the spread of *P. cinnamomi* to new localities with diseased planting stock.

The intention of the Queensland Forestry Department was to produce disease-free planting stock, not

merely to avoid losses in the nursery. The alternatives, which would allow this, were seen to be regular soil fumigation (at high cost and with associated problems of large succulent plants under subtropical growing conditions) or to develop new nurseries on virgin, pathogen-free sites and to operate them in such a manner as to prevent accidental introduction of serious pathogens. Hence, the Queensland Forest Service hygiene nursery system was developed.

One such nursery was operated for over 20 years whilst another (Toolara, which is the largest in the State with a site area of over 20 ha) has now produced 19 successive annual crops of *Pinus* species. This year Toolara nursery produced 4 200 000 bare root plants, mainly *P. caribaea* Mor. var *hondurensis* Barr. et Golf. and hybrids between it and *P. elliottii* Engelm. var. *elliottii*. The hygiene nurseries certainly have not been disease free, the main problems having been terminal crook caused by *Colletotrichum acutatum* Simmonds and some minor damping-off. However, during the two decades of operation of the system, there have never been any signs of root rot caused by *P. cinnamomi*, the major threat to *Pinus* nursery production in Queensland. *Phytophthora* root rot in the past had resulted in the closure of earlier nurseries at both centers.

After more than 20 years, it is not unreasonable to claim that the hygiene nursery system operated by the Queensland Forest Service, the second largest grower of *Pinus* plantations in Australia, has been a success. The hygiene nursery at Toolara is one of the largest forest nurseries in Australia.

Acknowledgements

The work reported here includes parts of the forest research and operational nursery activities of the Queensland Forest Service. We wish to sincerely thank Mrs. S. Winnington-Martin for conducting the trials with sterilants. We also record our appreciation to the many forestry personnel who, over the years, have assisted in development and maintenance of the hygiene nursery system.

References

- Bacon, G. J. 1985. A physiological interpretation of nursery stock conditioning through intensive root wrenching. Pages 342-350 in D. B. South, editor. Proceedings of the International Symposium on Nursery Management Practices for the Southern Pines, Montgomery, Alabama, August 4-9, 1985. School of Forestry, Alabama Agricultural Experiment Station, Auburn University and International Union of Forestry Research Organization Subject Group S3.202-03 "Nursery Operations".
- Brown, B. N., 1985. *Phytophthora cinnamomi* root rot in *Pinus* nurseries: soil fumigation and disease prevention by hygiene. Pages 507-514 in D. B. South, editor. Proceedings of the International Symposium on Nursery Management Practices for the Southern Pines, Montgomery, Alabama, August 4-9, 1985. School of Forestry, Alabama Agricultural Experiment Station, Auburn University and International Union of Forestry Research Organization Subject Group S3.202-03 "Nursery Operations".
- Chee, K. H.; Newhook, F. J. 1965. Improved methods for use in studies on *Phytophthora cinnamomi* Rands and other *Phytophthora* species. New Zealand Journal of Agricultural Research 8:88-95.
- Grech, N. M.; Frean, R. T.; Williams, G. 1989. Ultraviolet irradiation and filtration of irrigation water in citrus and subtropical fruit nurseries. Phytophylactica 21:247-249.
- Noske, G. L.; Shearer, B. L. 1985. Quaternary ammonium compounds were more effective than a phenolic compound or sodium hypochlorite in inhibiting growth of *Phytophthora cinnamomi* Rands. Australasian Plant Pathology 14(2):37-40.
- Oxenham, B. L.; Winks, B. L. 1963. *Phytophthora* root rot of *Pinus* in Queensland. Queensland Journal of Agricultural Science 20(3):355-366.
- Palzer, C. 1980. Water-borne pathogens and their simple control. Australasian Plant Pathology 9(1):11-12.
- Simpson, J. A. 1985. Use of inorganic fertilizers and cover crops in exotic pine nurseries in southern Queensland. Pages 203-212 in D. B. South, editor. Proceedings of the International Symposium on Nursery Management Practices for the Southern Pines, Montgomery, Alabama, August 4-9, 1985. School of Forestry, Alabama Agricultural Experiment Station, Auburn University and International Union of Forestry Research Organization Subject Group S3.202-03 "Nursery Operations".
- Smith, P. M. 1979. A study of the effects of fungitoxic compounds on *Phytophthora cinnamomi* in water. Annals of Applied Biology 93:149-157.
- Sutton, J. 1980. Studies in disinfectants for the nursery. Pages 3.5-1 to 3.5-10 in Nursery trends and developments '80. Proceedings of the short course presented at Burnley Horticultural College, Department of Agriculture, Victoria, Note Series No. 66.
- Ward, D.; Simpson, J. A. 1985. Bare-root exotic pine nursery practice on the coastal lowlands of Queensland: A historical perspective. Pages 48-57 in D. B. South, editor. Proceedings of the International Symposium on Nursery Management Practices for the Southern Pines, Montgomery, Alabama, August 4-9, 1985. School of Forestry, Alabama Agricultural Experiment Station, Auburn University and International Union of Forestry Research Organization Subject Group S3.202-03 "Nursery Operations".

Present status of nursery diseases in Sichuan Province, China

CHEN SHOU CHANG

Sichuan Academy of Forestry, Chengdu,
The People's Republic of China

Presented at the first meeting of IUFRO Working Party S2.07-09
(Diseases and Insects in Forest Nurseries), Victoria, British Columbia, Canada, August 22-30, 1990.

Abstract

Nursery diseases cause serious losses in Sichuan province, China. This paper reviews the important nursery diseases of forest tree species such as damping-off, *Paulownia* damping-off, *Cryptomeria* stem rot, *Uromyces* gall rust, needle cast, *Pestalotia* needle blight, *Glomerella* black spot, *Marssonina* leaf blight and *Aecidium* leaf rust. Diseases of seedlings of non-forest tree species such as *Sclerotium* root rot, *Macrophomina* stem rot, *Xanthomonas* leaf blight, and *Microsphaera* powdery mildew are also covered.

Résumé

Les maladies sévissant dans les pépinières forestières ont causé des pertes importantes dans la province du Sichuan, en Chine. Le présent article porte sur les principales maladies rencontrées dans des pépinières d'espèces forestières comme la fonte des semis, la fonte des semis (*Paulownia*), la carie du tronc (*Cryptomeria*), la rouille-tumeur (*Uromyces*), le rouge des aiguilles, la brûlure des aiguilles (*Pestalotia*), la tache noire (*Glomerella*), la brûlure des feuilles (*Marssonina*) et la rouille des feuilles (*Aecidium*). Il est également question de maladies affectant les semis d'espèces non forestières comme le pourridié (*Sclerotium*), la carie du tronc (*Macrophomina*), la brûlure des feuilles (*Xanthomonas*) et le blanc (*Microsphaera*).

Introduction

The climate of Sichuan province is subtropical and its topography and climate are extremely variable and range from very cold to tropical.

The well known Sichuan basin is in eastern Sichuan. Pine, fir, and cypress forests predominate there. Western Sichuan is a magnificent plateau with subalpine conifers. With such a diversity of climate and tree species, the importance of specific diseases varies from nursery to nursery. Recently, several of these diseases have become increasingly serious.

Seedling diseases of important forest tree species

Damping-off

This disease is one of the first to appear in newly sown seedbeds. It is widespread in nurseries throughout eastern and western Sichuan. Most conifer species such as *Cunninghamia lanceolata* (Lamb.) Hook., *Pinus massoniana* Lamb., and *Larix potaninii* Batal. are susceptible. *Cupressus* species are seldom if ever affected.

Many fungi cause damping-off, but the most common are species of *Pythium*, *Fusarium*, and *Rhizoctonia solani* Kuehn. Four types of symptoms occur: seed rot, damping-off, root rot, and tip rot.

Damping-off of *Paulownia fortunei* (Seem.) Hems., caused by *Rhizoctonia microsclerotia* Matz and *Pythium aphanidermatum* (Edson) Fitzp., is another disease that has become important recently. Symptoms vary depending on when infection occurs. Early attacks affect seeds before they emerge from the soil. Losses from such pre-emergence damping-off is often attributed to poor seed. Post-emergence infection characteristically occurs at or just below groundline and results in a necrotic area on the stem or root rot. The disease usually is most severe from mid-May to the first 10 days of June, particularly during periods of high relative humidity.

Stem diseases

Stem rot due to the fungus *Valsa cryptomeriae* Kitajima frequently causes cankers of *Cryptomeria japonica* (L.f) D. Don. The perfect stage is usually on the distal portion of the killed twig.

Gall rust, *Uromyces truncicola* P. Henn. & Shir., often occurs on seedlings of *Sophora japonica* L. where it causes globose galls at the site of infection and may kill twigs on the seedling.

Foliage diseases

Needle blight is the most serious disease of nursery-grown *Pinus massoniana* Lamb., but *Pinus elliotii*

Engelm. may also be affected. The pathogen is *Cercospora pini-densiflorae* Hori & Nambu. First evidence of needle infection is a small yellow band which later becomes gray-brown or dark brown and affects the entire needle. Symptoms appear most commonly from June to September.

Needle cast, *Lophodermium pinastri* (Schrad. ex Hook.) Chev., has a wide host range and attacks numerous pines. Damage is most serious on *Pinus massoniana* Lamb. and *P. yunnanensis* Franchet, but other pines are also damaged. The symptoms of these diseases are brown-black spots on infected needles which become greenish brown bands in late summer through fall.

In *Cupressus funebris* Endl. nurseries, red blight, caused by species of *Pestalotia* and *Phoma*, is a serious problem. The fungi attack 1- and 2-year-old seedlings. When seedlings are 1 to 2 months old, yellow spot lesions may develop on the lowermost needles on the shoot. The symptoms gradually reach the tips of needles over the entire seedling. Infected needles may curl inward. Seedling mortality can exceed 95% in seedbeds.

Black spot of *Cinnamomum camphora* (L.) Nees & Eberm. is another destructive disease. It is caused by the fungus *Glomerella cinnamomi* Yosh. This disease may quickly reach epidemic proportions during July through August. Leaves, twigs, and stems appear abnormal or have round spots.

The fungus *Marssonina populi* (Lib.) Magn. damages species of *Populus* in all nurseries. Maximum damage occurs from June to August when the weather is very hot and rainy.

Paulownia anthracnose is caused by *Gloeosporium* spp. Leaves and shoots of the current season's growth are attacked. Tiny dark brown or black, circular to irregularly circular spots appear on infected leaves. Afterward, diseased leaves fall off.

Leafrust, *Aecidium klugkistianum* Diet., sometimes attacks *Ligustrum lucidum* Ait., producing abundant acidium.

Diseases of non-forest tree seedlings

Root diseases,

Roots of Oiltea, *Camellia oleifera* Abel, may be infected by the fungus *Sclerotium rolfsii* Sacc. White mycelium covers the surface of diseased roots which subsequently turn yellow, and the seedling eventually dies. The causal fungus overwinters in infected roots as thick-walled resting bodies (sclerotia).

Stem diseases

A stem disease of *Ginkgo biloba* L., caused by *Macrophomina phaseolina* (Tassi) Goidanich, is both prevalent and troublesome. Field observations show that the fungus is a weak parasite, inciting the disease only under certain environmental conditions. The disease is especially favored by hot, dry weather. Growth of the pathogen is optimum above 32°C. Non-lignified tissues of seedlings, injured by high soil temperature during hot, dry weather, serve as infection courts.

Foliage diseases

The bacterium *Xanthomonas juglandis* (Pierce) Dowson causes irregular-angled or circular spots on leaves of *Juglans regia* L. Initially the lesions are dark brown, and later they coalesce to form large spots. Premature defoliation then occurs. This disease is favored by high rainfall, and epidemics follow periods of high rainfall.

Powdery mildew is the most damaging disease of *Castanea mollissima* Bl. Two fungi, species of *Microsphaera* and *Phyllactinia*, are involved. The pathogen overwinters and produces perithecia and ascospores on fallen leaves. Mature ascospores are discharged during periods of heavy rain or dew.

Selected references

- Chen Shou Chang. 1964. Important seedling diseases in Sichuan. Sichuan Forest Research Institute, 1-13.
Chen Shou Chang. 1974. Development types of damping-off of *Cunninghamia lanceolata*, resistance and its control measure. Sichuan Forest Research Techn. 1:20-22.
Chen Shou Chang. 1978. Forest disease and pest control in Sichuan. Sichuan People's Publication.
Chen Shou Chang. 1983. Integrated control of seedling damping-off. Forest Pest and Disease 4:38-39.

Identification, management, and application of ectomycorrhizal fungi in forest tree nurseries

CHARLES E. CORDELL AND DANIEL W. OMDAL

*Forest Pest Management Region
USDA Forest Service, Asheville
North Carolina 28802*

AND

DONALD H. MARX

*Institute of Tree Root Biology
USDA Forest Service
Athens, Georgia 30602*

*Presented at the first meeting of IUFRO Working Party S2.07-09
(Diseases and Insects in Forest Nurseries), Victoria, British Columbia, Canada, August 22-30, 1990*

Abstract

Techniques and procedures are presented to facilitate the identification, management, and application of ectomycorrhizal fungi in forest tree nurseries. Ectomycorrhizal fungi are identified by fruiting bodies and morphological characteristics. Ectomycorrhizae quantity and quality are significantly affected by nursery soil properties, environmental factors, and nursery cultural management practices. The technology, equipment, and alternative inoculum types are presently available for operational application of several species of ectomycorrhizal fungi in bareroot and container nurseries. Nursery inoculation with specific ectomycorrhizal fungi, such as *Pisolithus tinctorius*, have significantly increased the quality of nursery seedlings and tree survival and growth in field plantings. Cost of seedling inoculations with ectomycorrhizal fungi is considered to be justified for a variety of customized forestation projects and is 5% or less of the total forestation expense.

Resume

Cette étude fait état de plusieurs techniques et méthodes utilisées pour faciliter l'identification, la gestion et l'inoculation de champignons ectomycorhiziens dans les pépinières forestières. Les champignons ectomycorhiziens sont identifiés par leurs fructifications et leurs caractéristiques morphologiques. Le nombre et la qualité des champignons ectomycorhiziens dépendent fortement des propriétés du sol, des conditions ambiantes et des pratiques de gestion des cultures des pépinières. Il existe maintenant des technologies, des matériels et de nouveaux types d'inoculats pour la production de plusieurs espèces de champignons ectomycorhiziens à racines nues ou en récipients. L'inoculation de certains champignons ectomycorhiziens, par exemple *Pisolithus tinctorius*, a sensiblement augmenté la qualité des semis produits en pépinière et le taux de survie et de croissance des arbres en site forestier. Le coût de l'inoculation des semis avec des champignons ectomycorhiziens est considéré comme étant justifié dans de nombreux projets de reboisement. Il représente moins de 5% du coût total du reboisement.

Introduction

Seedling quality and field performance are largely governed by processes occurring in and around the root zone of seedlings. Absorption of water and nutrients is a function of the amount and quality of growing root tips or feeder roots. The feeder roots of most tree species are infected by specialized fungi that form beneficial associations called mycorrhizae (fungus-roots). The most widespread symbiotic association on plant roots is mycorrhizae. These structures greatly increase root

absorption efficiency and are vital to the survival and growth of both the host tree and the fungus. Compared to nonmycorrhizal roots, those roots infected by mycorrhizal fungi have increased absorptive capacity, nutrient fixation, resistance to soil pathogens, and longevity. As the main interface between seedling and soil, mycorrhizae are a key measure of root system quality and are a vital component of integrated nursery management.

Mycorrhizae are of two biological types: endomycorrhizae (which penetrate host cells) and

ectomycorrhizae (which grow between the root cells and cover the root surface with a mantle of fungus hyphae), Endomycorrhiza is the most widespread type and comprises three groups –ericaceous, orchidaceous, and vesicular-arbuscular mycorrhizae. The vesicular-arbuscular mycorrhizae are found on more plant species than all other types of mycorrhizae combined; they have been observed in roots of over 1000 genera of plants representing some 200 families. Over 90% of the 300 000 species of vascular plants in the world form vesicular-arbuscular mycorrhizae. Ectomycorrhizae occur on about 10% percent of the world flora. Trees belonging to the Pinaceae, Fagaceae, Betulaceae, Salicaceae, Juglandaceae, Myrtaceae, Ericaceae, and a few others form ectomycorrhizae. Some tree genera such as *Alnus*, *Eucalyptus*, *Casuarina*, *Cupressus*, *Juniperus*, *Tilia*, *Ulmus*, and *Arbutus* form both ectomycorrhizae and vesicular-arbuscular mycorrhizae, depending on soil conditions and tree age. Some species, such as *Casuarina* and *Alnus*, form symbiotic nitrogen-fixing nodules as well.

Numerous fungi form ectomycorrhizae. In North America alone, at least 2100 species of fungi form ectomycorrhizae with forest trees. Worldwide, there are over 5000 species of fungi that can form ectomycorrhizae on some 2000 species of woody plants.

There appear to be distinct early-stage and late-stage fungi in ectomycorrhizal fungus successions in forests (Marx *et al.* 1991). In a septic culture (i.e., without competition and other stresses) early-stage and late-stage fungi form ectomycorrhizae on seedlings equally well. However, only the early-stage fungi are able to rapidly colonize seedlings in natural, nonsterile soil that harbors competitors and other environmental stresses. Increases in fungal species diversity are associated with ectomycorrhizal fungus succession as forest stands age and numbers of host species increase (Marx *et al.* 1991).

For several years, the USDA Forest Service, in cooperation with several state and private forestry agencies, has been supporting research on mycorrhizae and their applications in forest tree nurseries, forest plantings, and plantings on reclaimed mineland. The primary objective has been the practical use of one ectomycorrhizal fungus, *Pisolithus tinctorius*, in forest land management. This fungus was selected because of its availability, ease of manipulation, wide geographic and host range, and demonstrated benefits to a wide variety of host trees. *Pisolithus tinctorius* is especially tolerant of extreme soil conditions, including low pH, high temperatures, and drought, that frequently kill other ectomycorrhizal fungi and their host trees (Marx *et al.* 1984).

The research and development program on *Pisolithus tinctorius* has evolved from controlled nursery-plot

research to relatively large-scale operational applications in both bareroot and container seedling nurseries. Mycorrhizal culture is rapidly expanding to include additional fungi and tree hosts for a variety of forestation and mineland reclamation applications in several North American, South American, European, South African, and Asian countries. Effective ectomycorrhizal fungus inoculum, along with the necessary equipment and technology for successful operational applications in bareroot and container nurseries, is now available to nursery personnel (Cordell *et al.* 1991).

Ectomycorrhizae – identification and quantification

Estimates of seedling quality can be improved by learning to recognize and quantify the dominant mycorrhizal types occurring on seedlings. Ectomycorrhizal fungi are most easily identified by their fruiting bodies—the numerous puffballs or mushrooms that develop some time after seedlings have been colonized. The fungi can also be recognized on the basis of distinct morphology of ectomycorrhizal feeder roots. Although over 2000 ectomycorrhizal fungi are known, only a few (one to three) species usually are found in a nursery. On western fir, spruce, and pine seedlings, gilled mushrooms of *Laccaria* (Figure 1a) and *Hebeloma* (Figure 1b) species, pored mushrooms of *Suillus* species (Figure 1c), and puffballs of *Rhizopogon* species (Figure 1d) are common. On or near pine seedlings in the South, puffballs of *Pisolithus tinctorius* (Figure 1e) and the papery thin, funnel-shaped mushrooms of *Thelephora terrestris* (Figure 1f) frequently occur. Puffballs of *Rhizopogon* species, which have white, homogeneous centers, can easily be distinguished from those of *Pisolithus tinctorius* by their lack of peridioles or small sacs of spores within the context. Recognizing and separating ectomycorrhizal species on the basis of root morphology requires a trained eye, but the different colors and shapes of ectomycorrhizae can be distinguished with practice. Whereas nonmycorrhizal feeder roots are generally thin, with texture and color similar to the larger roots, ectomycorrhizae usually are swollen, forked or many-branched, and differently textured and colored from the rest of the root system (Cordell *et al.* 1987).

During quantitative and qualitative seedling evaluations, a relative measure of the amount of mycorrhizal occurrence is more useful than identification of the ectomycorrhizal fungi on a sample of seedlings. Sampling techniques have been developed to estimate the proportion of a seedling's feeder roots that are ectomycorrhizal. In measured lengths of lateral roots, numbers of feeder roots with and without

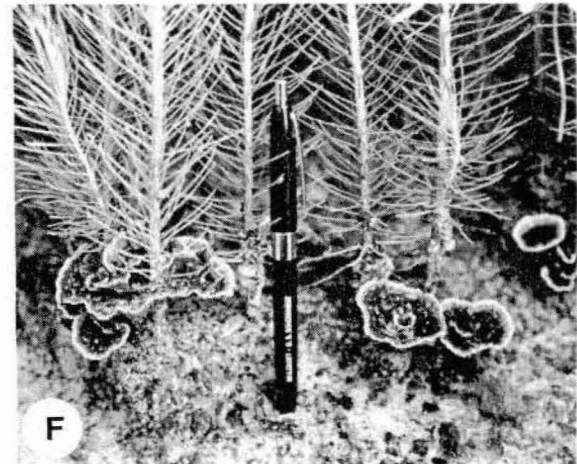
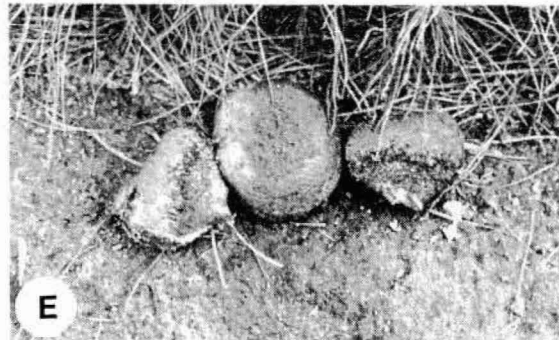
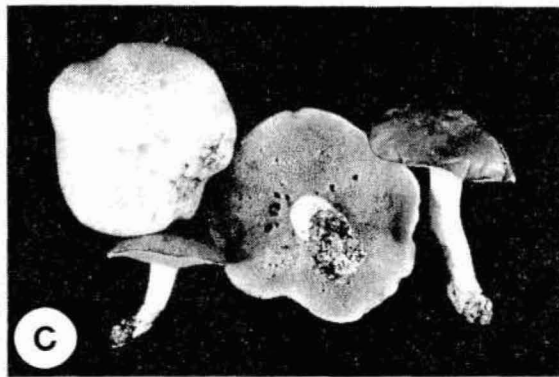
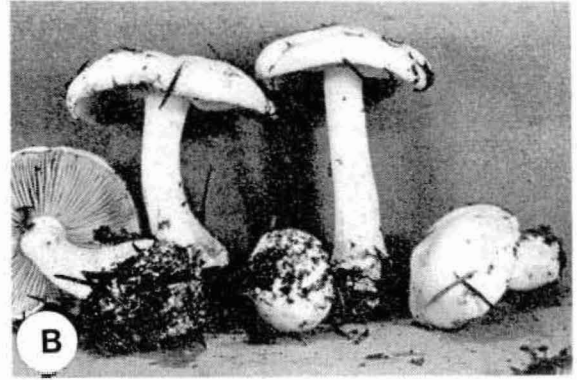

Figure 1. Characteristic ectomycorrhizal fungus fruiting bodies of (a) *Laccaria* sp., (b) *Hebeloma* sp., (c) *Suillus* sp., (d) *Rhizopogon* sp., (e) *Pisolithus tinctorius*, and (f) *Thelephora terrestris*.

ectomycorrhizae are counted (Anderson and Cordell 1979). Such laborious examinations may be required for research studies, but they are impractical for estimates of large quantities of operational seedlings. A reliable estimate can be determined by visual examination of seedling root systems that have been rinsed clean in water. An estimated percentage of ectomycorrhizal feeder roots is assayed for each seedling and averaged for the whole seedling sample. With experience, an individual can evaluate a seedling in a matter of seconds. These estimates provide values that can be compared among samples, inventory dates, or even

different crop years. As nursery management practices are refined, it becomes possible to monitor the mycorrhizal component of seedling quality. More valid quantitative estimates are made by use of an ectomycorrhizal fungus index. The ectomycorrhizal fungus index is derived from the formula $a \times (b/c)$ where a is the percentage of seedlings with selected ectomycorrhizae, b is the average percentage of feeder roots with selected ectomycorrhizae, and c is the average percentage of feeder roots with all types or total ectomycorrhizae.

Mycorrhizae nursery management

Ectomycorrhizae in nurseries can be increased by modifying nursery management practices, as well as by artificial mycorrhizal inoculation. Guidelines for mycorrhizal nursery management pertain more to maintaining healthy seedling root systems than to the requirements of a particular species of mycorrhizal fungus. Enhancement of mycorrhizal fungi is inseparable from increased seedling quality. Management for increased mycorrhizal development is not limited solely to establishing the symbiotic structures on roots. One must consider development and retention of seedling feeder roots and mycorrhizae from seed sowing to seedling lifting in the nursery and to planting the trees in the field. Nurserymen, field foresters, and tree planters must be made aware of the two symbiotic living organisms they are handling—the tree seedling and its complement of mycorrhizal fungi.

Mycorrhizae require generally the same moisture, fertility, and pH as their host tree seedlings, but tolerance for extreme or adverse conditions does vary. Soil and cultural factors that significantly affect mycorrhizae include pH, drainage and moisture, fertility, fumigation, pesticides, cover crops, shading and root pruning. Soil and water pH values are two of the most limiting factors in the development of ectomycorrhizae in both bareroot and container nurseries. In addition, seedling lifting, storing, and planting practices have significant effects on seedling feeder root and ectomycorrhizae retention, quality, and subsequent field survival and growth. Special care must be taken during all stages of seedling handling to maintain sufficient root systems and ectomycorrhizae. Ectomycorrhizae are delicate structures that can be ripped off during lifting, desiccated in storage, or cut off prior to field planting. To sustain seedling quality, lifting and handling techniques must be modified to minimize damage to feeder roots and ectomycorrhizae. Stripping of roots severely impairs seedling field performance (Marx and Hatchell 1986). Full-bed seedling harvesters are less destructive than single-row or double-row lifters. Condition of the root systems should be checked throughout the lifting process; even slight reductions in tractor speed can greatly reduce damage to roots and ectomycorrhizae as seedlings are lifted. During transfer of the seedlings from the field to the packing room and at all other times when the seedlings are being handled, special care is required to avoid drying of the roots by exposure to wind and sun.

The procedure by which seedlings are packed influences their ability to endure storage and survive field planting. If extended storage is required, Kraft paper bags with polyethylene seals will maintain seedling

moisture better than seedling bales. Cold storage is vital to slow seedling respiration. Seedling survival is better when peat moss, clay, or inert super-absorbents are used rather than hydromulch (Cordell *et al.* 1984). Best results are obtained when all root systems are coated or at least in contact with the packing material. Numerous studies have documented the effects of storage time on seedling quality. For most tree species and their ectomycorrhizae, storage for 2 to 6 weeks is not harmful.

Improper transportation to the planting site or rough handling during planting can severely reduce seedling vigor. Tree planters should understand proper planting methods and the reasons for them. Where possible, seedlings should be transported under refrigeration. If that is not possible, they should be covered and stacked with spacers to avoid high temperature buildup inside the seedling containers. For machine or hand planting, root pruning at the planting site should be avoided because it eliminates carefully nurtured feeder roots and mycorrhizae. High temperatures, high winds, and low humidity desiccate and kill feeder roots and mycorrhizae very rapidly. The first priority in planting should always be to maintain seedling viability and vigor. The rate at which seedlings are planted is of no consequence if the seedlings do not survive (Cordell *et al.* 1991).

Benefits

Most conifer species, including all pines, cannot grow without ectomycorrhizae. This obligate dependency of trees on their fungal symbionts has been thoroughly substantiated through extensive laboratory and field research, and through unsuccessful attempts to introduce tree species into areas where their symbiotic fungi were not present. After the ectomycorrhizal fungi were introduced, trees were successfully established (Marx 1980). Trees with abundant ectomycorrhizae have a much larger, physiologically active, root-fungus area for nutrient and water absorption than trees with few or no ectomycorrhizae. This increase in surface area comes both from the multi-branching habit of most ectomycorrhizae and from the extensive vegetative growth of hyphae of the fungal symbionts into the soil. These extramatrical hyphae increase nutrient and water capture from the soil by the host. Ectomycorrhizal roots are able to absorb and accumulate nitrogen, phosphorus, potassium, and calcium in the fungus mantles more rapidly and for longer periods of time than nonmycorrhizal feeder roots. Ectomycorrhizae also appear to increase the tolerance of trees to drought, high soil temperatures, soil toxins (organic and inorganic), and extremes of soil acidity caused by high levels of sulfur or aluminum. Ectomycorrhizae deter infection of

feeder roots by root pathogens, such as species of *Pythium* or *Phytophthora* (Marx and Krupa 1978). Hormone relationships induced by fungal symbionts cause ectomycorrhizal roots to have greater longevity (length of physiological activity) than nonmycorrhizal roots (Slankis 1973). Ectomycorrhizae are apparently the first line of biological defense against stress in trees. Not all species of fungi form ectomycorrhizae that have equal benefit to their hosts (Marx *et al.* 1991).

Recently, Castellano (1991) compiled a listing of outplanting performance of seedlings inoculated with ectomycorrhizal fungi from the world literature. Sixty-six species of ectomycorrhizal fungi have been used experimentally to form ectomycorrhizae on 49 tree species. Over 40% of the publications dealt with *Pisolithus tinctorius* on 29 different tree species. *Cenococcum geophilum*, *Hebeloma crustuliniforme*, *Laccaria bicolor*, *L. laccata*, *Suillus granulatus*, *S. luteus*, and *Thelephora terrestris* have been evaluated to a lesser extent on six or more tree species.

In forest tree nurseries in the United States, there is seldom a total absence of ectomycorrhizal fungi. Seedlings form ectomycorrhizal associations with naturally occurring fungi that originate from wind-blown spores produced by fruiting bodies in adjacent windbreaks, seedling beds, or forest stands. In nurseries where cultural practices or new field conditions have reduced ectomycorrhizal fungus populations, seedlings grow poorly and do not respond to increased fertilization. Pockets of seedlings that do have ectomycorrhizae or even those on which ectomycorrhizae have become established earlier in the season have increased stem caliper and height, improved foliage color, and a more balanced shoot:root ratio than adjacent stunted seed-

lings which are deficient in ectomycorrhizae (Cordell *et al.* 1987).

The ectomycorrhizal fungi that occur most commonly in bareroot nurseries, such as *Thelephora terrestris* (Tt), are ecologically adapted to the favorable growing conditions in nursery soils. However, these fungi are poorly adapted to the adverse conditions of many reforestation and reclamation sites.

Consequently, ectomycorrhizal research and development by the USDA Forest Service has initially focused on one particular ectomycorrhizal fungus, *P. tinctorius*, with its observed tolerances to environmental stresses along with other positive attributes (Marx *et al.* 1984). Many conifer and some hardwood species on a variety of nursery sites have been artificially inoculated with *P. tinctorius* by treating seedling containers and pre-fumigated nursery seedbeds (Figure 1e). Effective *P. tinctorius* vegetative inoculum has consistently improved the quality of nursery seedlings (Figure 2). National container and bareroot nursery evaluations have demonstrated the effectiveness of different formulations of *P. tinctorius* inoculum on selected conifer seedling species (Marx *et al.* 1981; Marx *et al.* 1984). During the past 13 years, more than 100 bareroot nursery tests have been conducted in 38 states. Results obtained from 34 nursery tests showed that *P. tinctorius* inoculation increased fresh weight of southern pine seedlings by 17%, increased ectomycorrhizal development by 21%, and decreased the percentage of cull seedlings at lifting time by 27% (Fig. 3-a). Results have sometimes been negative, but failures of this kind have been positively correlated with such factors as ineffective *P. tinctorius* inoculum, high soil pH (above 6.5), adverse environment, detrimental cultural practices, and pesticide toxicity (Cordell 1985).

Inoculated seedlings have been planted on a variety of routine forestation sites, strip-mined areas, kaolin wastes and Christmas tree farms in locations throughout the United States. Over 100 *P. tinctorius* outplantings involving 12 species of conifers are being monitored in 20 states on a variety of forestation, mineland reclamation, and Christmas tree sites. Preliminary analyses show significant increases in tree survival and growth in over half of these field studies. Loblolly pines (*Pinus taeda* L.) inoculated with *P. tinctorius* continue to show significant increases in tree volume growth (Figure 3-b) in four southern states when compared with uninoculated check trees after 6 to 10 years in the field. Longleaf pines (*P. palustris* Mill.) inoculated with *P. tinctorius* had a significantly improved survival after 3 years in the field in four southern states (Figure 3-c). Extensive reclamation research has been conducted on seedlings custom grown with *P. tinctorius* ectomycorrhizae and outplanted on adverse sites in the eastern U.S. In

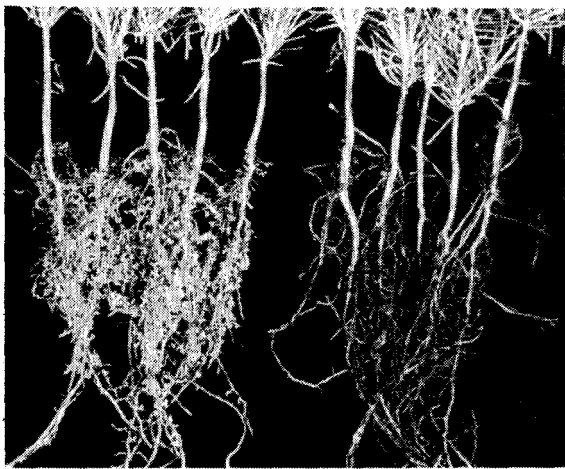

Figure 2. 1-0 Loblolly pine seedlings with *Pisolithus tinctorius* ectomycorrhizae (left) and with only naturally occurring ectomycorrhizae (right).

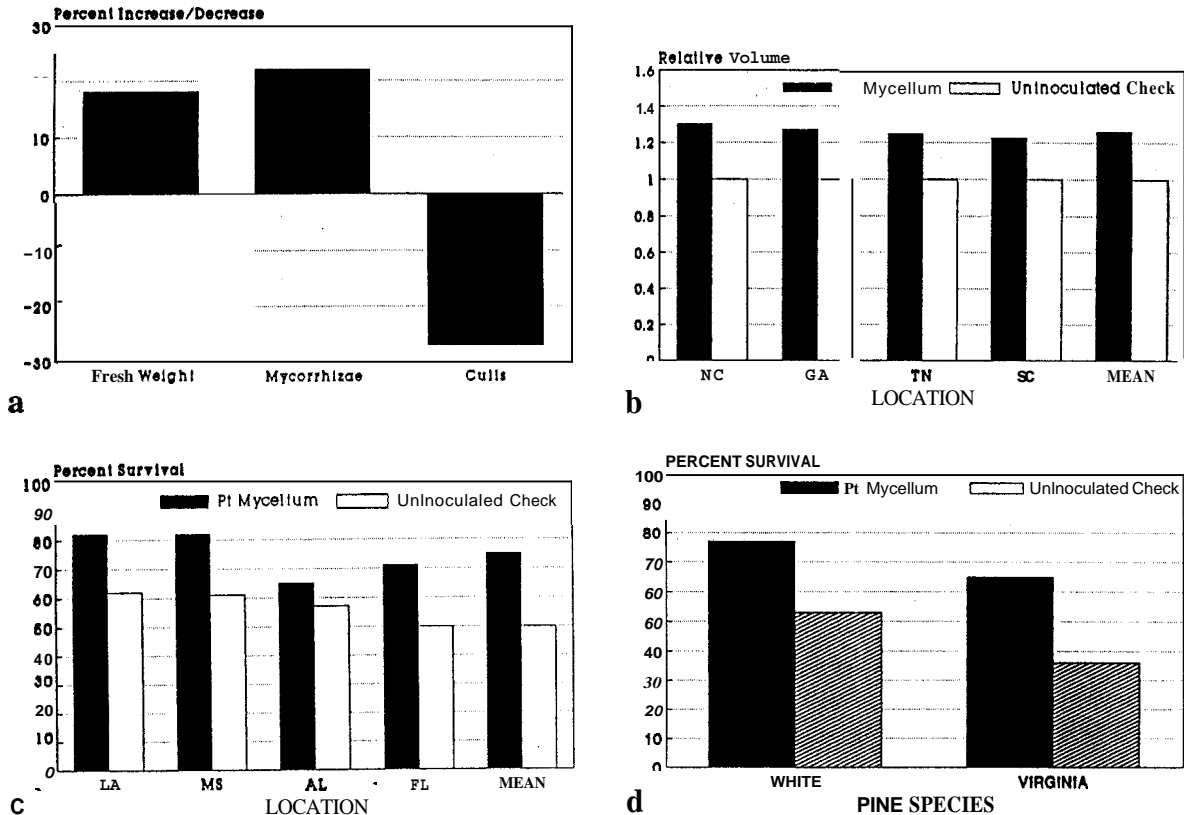

Figure 3. Effects of inoculation with *Pisolithus tinctorius* vegetative mycelium on (a) southern pine seedlings in 34 bareroot nurseries, (b) growth of loblolly pine after 6 to 10 years in the field, (c) survival of longleaf pine after 3 years in the field, and (d) survival of two pine species on mine reclamation sites in Ohio.

numerous field tests on coal spoils, annual tree root evaluations have confirmed the ecological adaptation of *P. tinctorius* to these disturbed sites. Without exception, seedlings with *P. tinctorius* ectomycorrhizae developed new roots very rapidly, and these roots were quickly colonized by the fungus. Root growth was also routinely followed by the prolific production of *P. tinctorius* fruiting bodies in the vicinity of trees with *P. tinctorius* ectomycorrhizae on their root systems. In outplantings established by the Ohio Division of Mineland Reclamation in southern Ohio during the past 9 years, Virginia, eastern white, and loblolly x pitch hybrid pines and northern red oak (*Quercus rubra* L.) seedlings inoculated with *P. tinctorius* have consistently higher survival and growth than routine nursery seedlings. Increased survival of white and Virginia pine is shown in Figure 3-d (Cordell *et al.* 1988).

Positive field responses are correlated with successful *P. tinctorius* nursery inoculations (Pt index greater than 50), with mineland reclamation conditions, and with periodic moisture stress on normal forestation sites. Results from outplanting studies in southern Georgia suggest that seedlings with abundant *P. tinctorius* ectomycorrhizae at the planting date are

better able to withstand some site or environmental stresses than seedlings without *P. tinctorius* ectomycorrhizae. Rainfall deficiencies have been frequently associated with large growth differences. Results from two studies (Marx *et al.* 1988) on routine reforestation sites support the theory of greater drought tolerance of seedlings with *P. tinctorius* ectomycorrhizae. After 8 years on a good-quality, formerly forested site in south Georgia (site index of 80 ft. at age 25), trees with only naturally occurring *Thelephoru terrestris* ectomycorrhizae grew less during years of low rainfall than trees treated with *P. tinctorius*. During years with moisture stress, *P. tinctorius* ectomycorrhizae markedly improved diameter growth. The apparent effectiveness of *P. tinctorius* in tolerating moisture stress on routine southern pine forestation sites is highly significant and should greatly expand the economic practicality of the *P. tinctorius* program in forest land management in this region of the United States where wood fiber production is so important (Cordell *et al.* 1990). In an unprecedented cooperative project, the USDA Forest Service, the U.S. Department of Energy, and the South Carolina Commission of Forestry are producing 1.0 million longleaf and 1.4

million loblolly pine with *P. tinctorius* ectomycorrhizae annually as part of a 5-year, customized reforestation program at the Savannah River Site near Aiken, South Carolina. State-of-the-art cultural, biological, and chemical practices are being utilized in bareroot nurseries to produce seedlings of the highest quality. In operational loblolly and longleaf plantings at the Savannah River Site, tree survival has averaged over 90% and 85%, respectively, after 2 years. Two-year-old longleaf pines have over 90% emergence from the "grass" stage. Previous operational plantings with nursery seedlings have resulted in 50 to 60% survival of longleaf pine, 70 to 80% survival of loblolly pine and less than 50% emergence of longleaf pine from the "grass" stage after 2 years.

The USDA Forest Service in the Pacific Northwest has developed a very successful spore inoculation program in container and bareroot nurseries. Basidiospores of several species of hypogeous, truffle-like ectomycorrhizal fungi have been applied to four conifer species. *Rhizopogon vinicolor* and *R. colossus* form abundant ectomycorrhizae on Douglas-fir following this spore inoculation method. Two years after outplanting, Douglas-fir seedlings with *R. vinicolor* ectomycorrhizae had significantly greater survival, stem height, root collar diameter, and biomass than noninoculated seedlings (Castellano and Trappe 1985).

In France, inoculation with ectomycorrhizal fungi has two purposes: to improve field performance of seedlings in reforestation programs, and to enhance production of edible fungi (LeTacon *et al.* 1988). During the last decade in France, much progress has been made in understanding ectomycorrhizal fungal species associated with a range of forest trees. *Laccaria laccata*, *L. bicolor*, and *Hebeloma crustuliniforme* form abundant ectomycorrhizae with Douglas-fir, Norway spruce, and Scots pine seedlings following successful nursery inoculation with vegetative inocula. Instead of the normal 3 to 4 years, plantable Douglas-fir seedlings can be produced in fumigated soil after 2 years following inoculation with *L. laccata*. Many examples are found in which ectomycorrhizal inoculation is highly beneficial to reforestation. Best results were achieved in experiments with conifers, especially Douglas-fir, outplanted on sites such as old fields containing low resident inoculum of other ectomycorrhizal fungi. The most effective ectomycorrhizae on such sites were those formed by strains of *L. laccata* from the United States and by local French strains of *L. bicolor*. Two-fold to threefold increases in aboveground tree weights and volumes of Douglas-fir after 4 to 6 years are attributable to *Laccaria* ectomycorrhizae. Outplanting experiments with *Suillus granulatus* and *Boletus edulis* ectomycorrhizae are also underway.

Since 1973, *Quercus* spp. artificially inoculated with *Tuber melanosporum* or *T. uncinatum* have been commercially produced in France for truffle production. Truffle fruit bodies can be obtained 3 to 5 years after transplanting the seedlings on proper sites. More recently, *Pinus pinaster* seedlings with *Suillus granulatus* ectomycorrhizae have been produced and outplanted to produce edible fruit bodies of the fungus (Marx *et al.* 1991).

A review of ectomycorrhizal inoculation in Canada shows most work is still in the experimental or developmental stage (Langlois and Gagnon 1988). The following points emerge from this container-grown seedling research: (i) using a mixture of fungi in solid inoculum results in only one fungus colonizing the seedlings roots; (ii) fertility of substrate and nutritional regimes influence ectomycorrhizal formation; (iii) liquid inoculum entrapped in calcium alginate beads, or liquid inoculum can be used with success at sowing; and (iv) liquid inoculum injected in container cavities of 6-week-old and 10-week-old seedlings produces abundant ectomycorrhizae. In British Columbia, Douglas-fir, lodgepole pine, and various spruces have been inoculated with *Amphinema byssoides*, the E-strain fungus, and various *Rhizopogon* and *Suillus* species. Inoculated seedlings are planted on cold soils with short growing seasons in the northern spruce and pine habitats or in the southern Douglas-fir and pine habitats subject to long summer drought. Early work with *Laccaria laccata* and *Hebeloma crustuliniforme* ectomycorrhizae showed no improvement in field performance. The other aforementioned fungal symbionts, however, have improved diameter growth of seedlings of fir, pine, and spruce and research is continuing (Marx *et al.* 1991).

Ectomycorrhizal research in the Philippines during the last 15 years has concentrated on developing mass inoculant production and inoculation techniques to replace the traditional mycorrhizal soil inoculation technique. The traditional techniques faced problems of high transport cost and destructive effects of soil-borne pathogens. One significant technology development is ectomycorrhizal fungal tablets made from compressed mixtures of basidiospores of *P. tinctorius* and *Scleroderma cepa*. These fungi grow abundantly in plantations in the Philippines. Mycorrhizal seedlings of *Pinus* and *Eucalyptus* species can be obtained in 2 months following tablet inoculations in container nurseries. Height and diameter growth of these species are increased by 30 to 70% in the nursery. In the field, height growth of inoculated seedlings increased by as much as 45 to 60%, diameter growth by 40 to 95%, and volume growth by more than 200% relative to uninoculated plants. These positive responses were

observed even after 3 years in the field. In addition, mycorrhizal tablet inoculation was able to replace from 60 to 85% of the inorganic fertilizers required for the growth of pines and eucalyptus in the field (Marx *et al.* 1991).

Inoculations

Ectomycorrhizal fungi have been introduced into deficient soils throughout the world in various inocula to provide seedlings with adequate ectomycorrhizae to create man-made forests. Research on inoculation with ectomycorrhizal fungi has been based on two premises. First, any ectomycorrhiza on tree seedlings is far better than none. Success in correcting deficiencies has contributed greatly to our understanding of the importance of ectomycorrhiza to trees. Second, some species of ectomycorrhizal fungi on certain sites are more beneficial to trees than other fungal species that may naturally occur on such sites. Much work in recent years with a few fungal species has been aimed at selecting, propagating, manipulating, and managing the more desirable fungal species to improve tree survival and growth. This subject has been reviewed many times (Bowen 1965; Mikola 1973; Trappe 1977; Marx 1980; Marx and Cordell 1989).

The first and most important step in any inoculation program of tree seedlings is the selection of fungi. Physiological and ecological differences among ectomycorrhizal fungi are great and these differences can be used as criteria for selection. The candidate fungus should exhibit the physiological capacity to form abundant ectomycorrhizae on seedlings of the desired hosts and the more hosts the better. This suggests use of early-stage fungi. Several isolates from different tree hosts and geographic regions should be tested, at least initially, to determine the amount of variation that exists between isolates (Moser 1958; Marx 1981). The selected fungus must have the ability to grow rapidly in pure culture and withstand physical, chemical, and biological manipulation (Marx *et al.* 1984). The fungus inoculum must also be able to survive in soil a minimum of 4 to 6 weeks between nursery soil inoculation and seed sowing, germination, and the production of short roots by the seedlings. Ideally, the fungus should also be able to survive several weeks of storage between inoculum production and use. A very important criterion is the ecological adaptation of the selected fungus to the major type of site on which the seedlings are to be planted. The ecological adaptability of an ectomycorrhizal fungus hinges on the metabolic pathways it has evolved to contend with environmental variation (Trappe 1977). The selected fungus must adapt to many kinds of environmental

variations, including extremes of soil and climate, antagonism from other soil organisms including other ectomycorrhizal fungi, pesticide application, physical disruption of mycelium by nursery cultural practices (undercutting and root pruning), and the abrupt physiological adjustment from a well fertilized and irrigated nursery soil to an uncultivated low-fertility planting site with all its natural stresses. Another desired trait is the production of hyphal strands or sclerotia to enhance nutrient and water absorption during moisture stress conditions and to enhance survival potential of the fungus. All of the above criteria are meaningless unless the candidate fungus is aggressive and can form abundant ectomycorrhizae on seedlings as soon as short roots are produced. This is another characteristic common among early-stage fungi. The fungus should be able to maintain superiority over naturally occurring fungi, such as *Thelephora* spp., on seedling roots in the nursery. Even though the effect of a fungus on seedlings may only be temporary and it is supplanted years later by other fungi in the outplanting site, this advantage can make the difference between survival or death of newly planted seedlings and can greatly improve their early growth performance (Marx *et al.* 1991).

Most reports on inoculation techniques with ectomycorrhizal fungi involve basidiomycetes on pines, oaks, and eucalyptus. Techniques were developed mainly out of the necessity to grow tree species that require ectomycorrhizae in areas of the tropics where ectomycorrhizal fungi are absent. Several types of natural and laboratory-produced inocula and several methods of application have been used through the years. Many of the techniques have proven successful; others have not. The most widely used natural inoculum, especially in developing countries, is soil or humus collected from established pine plantations (Mikola 1973; Marx 1980). In most instances, the original soil inoculum came from mature pine plantations on other continents. Major drawbacks with soil inoculum are the lack of control of species of ectomycorrhizal fungi in the inoculum and the harmful microorganisms and noxious weeds that it may contain. Soil inoculum, however, is better than none.

Spores of various fungi such as *P. tinctorius*, *Rhizopogon vinicolor*, and *R. colossus* have been used as inoculum to form specific ectomycorrhizae on tree seedlings in the United States and several other countries. The major advantages are that spores require no extended growth phase under aseptic conditions and they usually maintain viability in storage from one season to the next. However, spore inoculum has several disadvantages: spores of many ectomycorrhizal fungi have not been germinated in the laboratory to determine spore viability; formation of ectomycorrhizae

by basidiospores usually takes 3 to 4 weeks longer than vegetative inoculum of the same fungus (Theodorou and Bowen 1970; Marx and Cordell 1990); and there is a lack of information on their genetic definition. Genetic diversity in basidiospores can be enormous, particularly if spores are collected from many geographic areas and from different tree hosts and combined into a single inoculum.

Mycelial or vegetative inoculum of ectomycorrhizal fungi has been repeatedly recommended as the most biologically sound material for inoculation. Several researchers in various parts of the world have developed cultural procedures for producing vegetative inoculum of a variety of fungi for research purposes.

The vegetative form of *P. tinctorius* inoculum has been used in fumigated nursery soil and other growing media to form ectomycorrhizae on numerous species of *Abies*, *Carya*, *Picea*, *Pinus*, *Pseudotsuga*, and *Quercus* seedlings in bareroot and container seedling nurseries throughout the United States and on various *Pinus* spp. in Brazil, Canada, Congo, France, Ghana, Liberia, Nigeria, Mexico, South Korea, and Thailand (Marx and Bryan 1975; Marx 1980; Alvarez and Trappe 1983; Marx *et al.* 1984). Many other tree species, including *Eucalyptus*, *Castanea*, *Fagus*, and *Salix* have been inoculated with this inoculum and formed abundant ectomycorrhizae in various tests. It is very possible that *P. tinctorius*, under the proper test conditions, will form ectomycorrhizae on all tree species that form ectomycorrhizae under natural field conditions (Marx *et al.* 1991).

Until recently, artificial inoculation of *P. tinctorius* or any other ectomycorrhizal fungus species was limited because procedures, commercial fungus inoculum, and necessary equipment were not readily available to nurserymen. The USDA Forest Service has been cooperating with several private companies to develop different types of commercial ectomycorrhizal inoculum, along with equipment and procedures needed for inoculating bareroot and container-grown seedlings. In addition to *P. tinctorius* ectomycorrhizal inoculum, strains of *Hebeloma* sp., *Laccaria* sp., and *Scleroderma* sp. are currently available. The types of *P. tinctorius* inoculum that are available are vegetative inoculum and bulk spores (Mycorr Tech, Worthington, Pennsylvania), and spore pellets, spore-encapsulated seeds, and bulk spores (from either International Forest Tree Seed Co., Odenville, Alabama, or SouthPine, Inc., Birmingham, Alabama). A nursery seedbed applicator has been developed to accurately place *P. tinctorius* vegetative inoculum in seedbeds prior to sowing in bareroot nurseries. Inoculum is applied in bands under seed rows at desired depths. Use of the applicator has reduced the amount of vegetative inoculum needed by 75% and

reduced the time and labor requirements when compared to broadcast application. A vegetative inoculum applicator has also been developed for side-banding inoculum between rows of established seedlings. Both applicators are commercially available from R.A. Whitfield Manufacturing Co., Mableton (Atlanta), Georgia (Cordell *et al.* 1987; Cordell *et al.* 1991).

Operational procedures vary among different commercial *P. tinctorius* inoculum types, but with any inoculum, the biological requirements of a second living organism are added to those of the seedling. Special precautions are necessary for shipping, storing, and handling the *P. tinctorius* inoculum, as well as for lifting, handling, and field planting of seedlings. For successful *P. tinctorius* inoculation in bareroot seedbeds, populations of pathogenic and saprophytic fungi and native ectomycorrhizal fungi that may already be established in the soil must be reduced by soil fumigation, preferably in the spring, with fumigants comparable in effectiveness to the methyl bromide-chloropicrin formulations. Prior to spring sowing, vegetative inoculum can be broadcast on the soil surface and incorporated into the fumigated seedbeds or it can be applied by machine with greater effectiveness and efficiency. For container-grown seedlings, vegetative inoculum can be incorporated into the growing medium before filling the containers or the inoculum can be placed at selected depths in the growing medium in the container. Bulk spores can be sprayed, drenched, or dusted onto growing medium for containerized seedlings and onto seedbeds in bareroot nurseries. Spore pellets can either be incorporated into the growing medium or seedbed soil, or they can be broadcast on the soil surface, lightly covered, and irrigated. Spore pellets have been applied at several nurseries with a standard fertilizer spreader. Spore-encapsulated seeds can be sown by conventional methods. A major disadvantage of the *P. tinctorius* spore inoculum is the absence of a reliable means of determining or controlling spore viability. Consequently, *P. tinctorius* ectomycorrhizal development has been considerably less consistent and effective with spore inoculum than with vegetative inoculum (Cordell *et al.* 1987).

Research has shown that to obtain maximum growth on reforestation sites of southern pine seedlings inoculated with *P. tinctorius*, a threshold level of at least half of all ectomycorrhizae must be those of *P. tinctorius* at the time of planting (Pt index 50) (Marx *et al.* 1991). Additional novel types of ectomycorrhizal fungus inoculum that are being used effectively include macerated sporocarp suspensions in the Pacific Northwest of the United States (Castellano and Molina 1989), calcium alginate bead vegetative mycelium inoculum in

France (LeTacon *et al.* 1988), and ectomycorrhizal fungus tablets in the Philippines (Marx *et al.* 1991).

Operational applications

For the past two decades cooperative research, development, and technology transfer activities have been done by the USDA Forest Service Institute for Mycorrhizal Research and Development, (now the Institute of Tree Root Biology) and Forest Pest Management, Region-8 in the United States for the operational application of specific ectomycorrhizae (primary *P. tinctorius*) to forest tree nurseries, forestation, mineland reclamation, and Christmas tree plantings. The demand for seedlings inoculated with specific ectomycorrhizal fungi continues to increase. In 1989, 6.5 million seedlings at 12 bareroot and container nurseries in the eastern United States were inoculated with *P. tinctorius*. In 1990, the total rose to about 8.0 million seedlings, comprising eight conifer species and one hardwood species (Figure 4). A 5-year reforestation plan at the Savannah River Site near Aiken, South Carolina involves the annual production of 1.0 million longleaf and 1.25 million loblolly pine seedlings inoculated with *P. tinctorius*. Bareroot nursery inoculations involve 3600 L of *P. tinctorius* vegetative inoculum applied in 36 000 linear feet (6.8 miles) of seedbed. This is the largest single artificial ectomycorrhizal bareroot nursery inoculation to date (Cordell *et al.* 1991).

Interest in the use of *P. tinctorius* ectomycorrhizae in mineland reclamation has increased steadily over the past 10 years. Since its inception in 1981, the Ohio Abandoned Mineland Reforestation Program has planted approximately 1.4 million seedlings inoculated with *P. tinctorius* on 810 acres of abandoned strip mines in southern Ohio (Cordell *et al.* 1987). This program has expanded annually, and in 1990-91, the Ohio Division of Reclamation planted approximately 0.3 million seedlings inoculated with *P. tinctorius* on 200 acres. Estimates for tree planting in Ohio through 1995 indicate requirements for an additional 2.0 million seedlings inoculated with *P. tinctorius* for plantings on 1350 acres of abandoned mineland.

National forests, state forestry agencies, and a number of private companies have shown considerable interest in the use of *P. tinctorius* ectomycorrhizae on selected forestation sites in the United States. National forests in Ohio and South Carolina have scheduled the annual production of bareroot seedlings inoculated with *P. tinctorius* for selected reclamation and forestation sites. During 1990, seedlings inoculated with *P. tinctorius* are being produced for six state forestry agencies, three national forests, the Savannah River Site, and five forest products companies. The demand

for seedlings inoculated with *P. tinctorius* is expected to substantially increase during the next 5 years due to the increased emphasis on reforestation and mineland reclamation and forestation. The potential is great in several regions around the world. For example, in the southern United States, tree nurseries annually produce over 1.5 billion seedlings for reforestation. Another recent expansion of the *P. tinctorius* program has been into the Christmas tree industry with approximately 0.5 million conifer seedlings inoculated with *P. tinctorius* being grown in six southern nurseries exclusively for Christmas tree plantings in 1990.

In a customized technology transfer program, the USDA Forest Service continues to provide mycorrhizae technology to forest tree nurserymen, field foresters, mineland reclamation specialists, and other concerned land managers throughout the United States and several foreign countries (Cordell and Webb 1980; Cordell 1985). Initially, this program emphasized the use of *P. tinctorius* on selected forestation sites and in mineland reclamation programs. However, the program has been expanded to a wider range of forestation sites, mycorrhizal fungi, and tree hosts over a broader geographic area. The expanded ectomycorrhizal technology transfer program now has national emphasis with international scope; 17 thirdworld countries are adopting this technology (Marx *et al.* 1991). Successful operational applications with several species of ectomycorrhizal fungi have been obtained in the northwestern United States along with several other countries. Recently, Castellano and Molina (1989) described in detail the status of ectomycorrhizae in Pacific Northwest nurseries, source of inoculum, inoculation techniques, and evaluation of inoculation success. In 1990, nearly 18 million Douglas-fir and pine seedlings were inoculated with spores of ectomycorrhizal fungi in

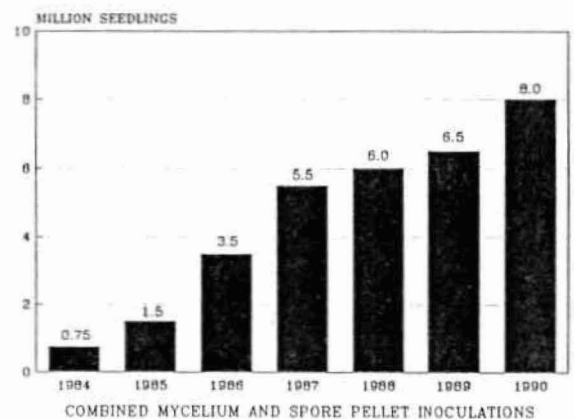

Figure 4. Operational *Pisolithus tinctorius* custom seedling production using vegetative and spore inoculum in bareroot and container nurseries in the eastern United States, 1984-1990.

container (85%) and bareroot (15%) nurseries in the Pacific Northwest. Forest Mycorrhizal Applications in Grants Pass, Oregon, is commercially producing spore suspensions of various *Rhizopogon* and *Suillus* species for nurserymen in the Pacific Northwest. Industrial fermentation and entrapment in calcium alginate beads have been successfully employed to produce pure culture inoculum in France (LeTacon *et al.* 1988). In Canada, vegetative inoculum of several ectomycorrhizal fungus species has been successfully produced in industrial fermentors for operational applications in container and bareroot nurseries (Marx *et al.* 1991). In Quebec, Canada, there are plans to field test planting stock inoculated with commercially produced liquid ectomycorrhizal fungus vegetative inoculum (Rhizotec Laboratories, Inc., Laval University, Quebec, Canada). Mycorrhizal tablets are now commercially available in the Philippines from the National Institutes of Biotechnology and Applied Microbiology (BIOTECH) (Marx *et al.* 1991).

cost

There is a wide range in the cost of commercial *P. tinctorius* inoculum (Table 1). Cost of each inoculum type also varies with such factors as nursery seedling density, seed size for spore-encapsulated seeds, and field planting spacing. Recently, cost of vegetative inoculum of *P. tinctorius* for bareroot nurseries per unit of forest product were reduced 25% by increasing nursery seedbed inoculation efficiency, improving effectiveness of inoculum, and decreasing application rates. The vegetative mycelium is sold on a volume (liter) basis, while the spore inocula are all sold on a weight (pound) basis (Cordell *et al.* 1987). The cost of

the most expensive vegetative mycelium inoculum (\$7.50 per 1000 seedlings or \$13.45 per planted hectare) is 5% or less of the total plantation establishment costs.

Conclusions

Many methods have been developed to establish ectomycorrhizae on forest tree seedlings. Pure vegetative inoculum has the greatest biological advantage. Pure cultures of certain fungi can be used to improve survival and growth of tree seedlings on a variety of sites. A few fungi are being used in practical reforestation and reclamation programs in the United States today. However, these results represent only the beginning of a much-needed widespread practical program. Millions of hectares of potential exotic forests must be established on former treeless sites in the Third World, and millions of hectares of deforested lands await artificial regeneration throughout the world. For these purposes and for normal reforestation efforts, the need for ectomycorrhizal technology is paramount. The technology still is very young. A tremendous amount of basic and practical information must be revealed if these fungi are to be fully utilized and integrated into existing forestry programs (Marx *et al.* 1991). Symbiotic relationships between tree seedlings and mycorrhizal fungi are the rule in nature. Most conifer and some hardwood species require ectomycorrhizae for survival. The quality of ectomycorrhizae for a planting site depends on the combination of host tree and fungus species; optimum combinations can be produced by inoculating seedlings for specific applications, such as mineland reclamation. Custom production of mycorrhizal seedlings has been incorporated into bareroot and container nursery operations. The quality of mycorrhizae and their seedling

Table 1. Commercial *Pisolithus tinctorius* inoculum costs (\$) - 1989

<i>Pisolithus tinctorius</i> inoculum type	Inoculum costs (\$) per ¹		
	1000 seedlings	Hectare	Acre
Vegetative mycelium	7.50	13.45	5.45
Spore encapsulated seed	2.22	3.98	1.61
spore pellets	2.75	4.93	2.00
Double-sifted bulk spores ²	0.43	0.77	0.31

¹Cost estimates are for loblolly and slash pine bareroot nurseries (269 seedlings/m² - 25 seedlings/sq. ft.) and forestation plantings (1.8 x 3.0 m - 6 x 10 ft. spacing; 1794 trees/ha. - 726 trees/ac.) in the southern U.S. Costs for longleaf pine bare-root seedlings (129 seedlings/m² - 12 seedlings/sq. ft.) is \$15.63/1000 seedlings, \$28.02/ha of plantation, and \$11.35/ac. of plantation.

²Double sifting is required for even flow through spray nozzles; standard spores are only sifted once.

hosts can also be improved through careful management of existing ectomycorrhizae. The symbiotic relationship between the tree seedling and the mycorrhizal fungus is an integral component of nursery seedling production. Any estimates of seedling quality that exclude quantitative and qualitative mycorrhizal assessments are incomplete and unrealistic.

Artificial container and bareroot nursery inoculations are expected to increase in the near future. Additional technological developments will be accompanied by ectomycorrhizae application expansions involving broader geographic areas, tree hosts, ectomycorrhizal fungi, and forest-related products.

Literature cited

- Alvarez, I.F.; Trappe, J.M. 1983. Effects of application rate and cold soaking pretreatment of *Pisolithus* spores on effectiveness as nursery inoculum on western conifers. *Can. J. For. Res.* 13:533-537.
- Anderson, R.L.; Cordell, C.E. 1979. How to recognize and quantify ectomycorrhizae on conifers. USDA Forestry Bulletin SA-FB/P8. 9 P. State and Private Forestry, Atlanta, Georgia.
- Bowen, G.D. 1965. Mycorrhiza inoculations in forestry practice. *Austral. For.* 29:231-237.
- Castellano, M.A. 1991. Outplanting performance of mycorrhizal inoculated seedlings: a review. *New For.* In press.
- Castellano, M.A.; Molina, R. 1989. Mycorrhizae. Pages 101-167 in T.D. Landis, R.W. Tinus, S.E. McDonald, and J.P. Bamett, editors. The container tree nursery manual, volume 5. USDA For. Serv. Agric. Handb. 674. Washington, DC.
- Castellano, M.A.; Trappe, J.M. 1985. Ectomycorrhizal formation and plantation performance of Douglas-fir nursery stock inoculated with *Rhizopogon* spores. *Can. J. For. Res.* 15:613-617.
- Cordell, C.E. 1985. The application of *Pisolithus tinctorius* ectomycorrhizae in forest land management. Pages 69-72 in R. Molina, editor. Proceedings of the 6th North American conference on mycorrhizae. Bend, Oregon, June 25-29, 1984. Forest Research Laboratory, University of Oregon, Corvallis.
- Cordell, C.E.; Webb, D.M. 1980. "Pt" ...A beneficial fungus that gives your trees a better start in life. Southeastern Area, State and Private Forestry, USDA For. Serv., Gen. Rep. SA-GR-8. 16p. Atlanta, GA.
- Cordell, C.E.; Marx, D.H.; Omdal, D.W. 1991. Pt ectomycorrhizal fungus operational inoculations and management in forest tree nurseries - 1990. In O. Ross, editor. Proceedings of the Southern Forest Tree Nursery Association Conference. Biloxi, Mississippi. July 24-26, 1990. Miss. For. Comm., Jackson. In Press.
- Cordell, C.E.; Owen, J.H.; Marx, D.H. 1987. Mycorrhizae nursery management for improved seedling quality and field performance. Pages 105-115 in Meeting the challenge of the nineties: Proceedings of a meeting of the Intermountain Forest Nursery Association. Oklahoma City, August 10-14, 1987. Rocky Mtn. For. Range Exp. Stn., USDA For. Serv., Gen. Tech. Rep. RM-151. Fort Collins, Colorado.
- Cordell, C.E.; Caldwell, C.; Marx, D.H.; Farley M.E. 1988. Operational production and utilization of ectomycorrhizal - inoculated tree seedlings for mineland reclamation. Pages 229-235 in D.H. Graves, editor. Proceedings of a 1988 symposium on mining, hydrology, sedimentology and reclamation. University of Kentucky, Lexington, and Reno, Nevada, December 5-9, 1988. Univ. Kentucky, Lexington.
- Cordell, C.E.; Kais, A.G.; Affeltranger, C.E. 1984. Effects of benomyl root storage treatments on longleaf pine seedling survival and brown-spot disease incidence. Pages 24-28 in Proceedings of the 1984 southern nursery conference (eastern session), Asheville, North Carolina, July 24-27, 1984. USDA For. Serv. Atlanta, Georgia.
- Langlois, C.G.; Gagnon, J. 1988. The production of mycorrhizal conifer seedlings in Quebec: The progression of the project. Pages 9-13 in M. Lalonde, Y. Piche, editors. Proceedings of the Canadian Workshop on Mycorrhizae in Forestry. Ste. Foy, Quebec, May 1-4, 1988. Centre de Recherche en Biologie Forestière, Faculté de Foresterie et de Géodesie, Université Laval, Ste-Foy, Quebec.
- LeTacon, F.; Garbaye, J.; Bouchard, D.; Chevalier, G.; Oliver, J.M.; Guimberteau, J.; Poitou, N.; Frochot, H. 1988. Field results from ectomycorrhizal inoculation in France. Pages 51-74 in M. Lalonde, and Y. Piche, editors, Canadian workshop on mycorrhizae in forestry. Ste. Foy, Quebec, May 1-4, 1988. Centre de Recherche en Biologie Forestière, Faculté de Foresterie et de Géodesie, Université Laval, Ste-Foy, Quebec.
- Marx, D.H. 1980. Ectomycorrhizal fungus inoculations: A tool for improving forestation practices. Pages 13-71 in P. Mikola, editor. Tropical mycorrhiza research. Clarendon Press, Oxford.
- Marx, D.H. 1981. Variability in ectomycorrhizal development and growth among isolates of *Pisolithus tinctorius* as affected by source, age, and reisolation. *Can. J. For. Res.* 11:168-174.
- Marx, D.H.; Bryan, W.C. 1975. Growth and ectomycorrhizal development of loblolly pine seedlings in fumigated soil infested with the fungal symbiont *Pisolithus tinctorius*. *For. Sci.* 21:245-254.
- Marx, D.H.; Cordell, C.E. 1989. The use of specific ectomycorrhizas to improve artificial forestation practices. Pages 1-25 in J.M. Whipps, and R.D. Lumsden, editors. Biotechnology of fungi for improving plant growth. British Mycological Society, Cambridge University Press, Cambridge.
- Marx, D.H.; Cordell, C.E. 1990. Development of *Pisolithus tinctorius* ectomycorrhizae on loblolly pine seedlings from spores

-
- sprayed at different times and rates. USDA For. Serv. Res. Note SE-356. Southeastern For. Exp. Stn., Asheville, North Carolina.
- Marx, D.H.; Hatchell, G.E. 1986. Root stripping of ectomycorrhizae decreases field performance of loblolly and longleaf pine seedlings. *South. J. Appl. For.* 10:173-179.
- Marx, D.H.; Krupa, S.V. 1978. Mycorrhizae. A. Ectomycorrhizae. Pages 373-400 in Y.R. Domergues and S.V. Krupa, editors. *Interactions between nonpathogenic soil microorganisms and plants*, Elsevier Scientific, Amsterdam.
- Marx, D.H.; Cordell, C.E.; Clark, A. III. 1988. Eight-year performance of loblolly pine with *Pisolithus* ectomycorrhizae on a good-quality forest site. *South. J. Appl. For.* 12:275-280.
- Marx, D.H.; Maul, S.B.; Cordell, C.E. 1991. Chapter 7 - Application of specific ectomycorrhizal fungi in world forestry. *In Proceedings of a meeting of the American Mycological Society*. Madison, Wisconsin. June 25-29, 1990. Science Tech. Publishers, Madison, Wisconsin. In press.
- Marx, D.H.; Cordell, C.E.; Kenney, D.S.; Mexal, J.G.; Artman, J.D.; Riffle, J.W.; Molina, R.J. 1984. Commercial vegetative inoculum of *Pisolithus tinctorius* and inoculation techniques for development of ectomycorrhizae on bare-root tree seedlings. *For. Serv. Monogr. No. 25*. 101 p.
- Marx, D.H.; Ruehle, J.L.; Kenney, D.S.; Cordell, C.E.; Riffle, J.W.; Molina, R.J.; Pawuk, N.S.; Tinus, R.W.; Goodwin, O.C. 1981. Commercial vegetative inoculum of *Pisolithus tinctorius* and inoculation techniques for development of ectomycorrhizae on container grown seedlings. *For. Sci.* 28(2):373-400.
- Mikola, P. 1973. Application of mycorrhizal symbiosis in forestry practice. Pages 383-411 in G.C. Marks, and T.T. Kozlowski, editors. *Ectomycorrhizae: their ecology and physiology*. Academic Press, New York.
- Moser, M. 1958. Die kunstliche Mykorrhizaimpfung an Forstpflanzen. I. Erfahrungen bei der Reinkultur von Mykorrhizapilzen. *Forstwissenschaftliches Centralblatt* 77:32-40.
- Slankis, V. 1973. Hormonal relationships in mycorrhizal development. Pages 231-298 in G.C. Marks and T.T. Kozlowski, editors. *Ectomycorrhizae: their ecology and physiology*. Academic Press, New York.
- Theodorou, C.; Bowen, G.D. 1970. Mycorrhizal responses of radiata pine in experiments with different fungi. *Austral. For.* 34:183-191.
- Trappe, J.M. 1977. Selection of fungi for ectomycorrhizal inoculation in nurseries. *Ann. Rev. Phytopathol.* 15:203-222.

Using a VAX 8650 computer to organize disease extension reports

JOHN J. DENNIS AND DOUG M. SAY

Forestry Canada, Pacific Forestry Centre
506 West Burnside Road, Victoria, British Columbia
Canada V8Z 1M5

*Presented at the first meeting of IUFRO Working Party S2.07-09
(Diseases and Insects in Forest Nurseries), Victoria, British Columbia, Canada, August 22-30, 1990.*

Abstract

The Pacific Forestry Centre provides forest nurseries with a pest diagnostic service. Organization and operation of the diagnostic pest service is done with a software package called "Nursery". The software runs on the Digital VAX 8650 at the Pacific Forestry Centre. An example of the information included in a record and a letter produced by this pest diagnostic service is given.

Resume

Le Centre forestier du Pacifique offre un service de diagnostic des parasites. L'organisation et le fonctionnement de ce service reposent sur un logiciel appelé "Nursery"; le programme est exécuté sur un ordinateur Digital VAX 8650, au Centre forestier du Pacifique. Le compte rendu comprend un exemple des renseignements inclus dans un dossier et d'une lettre émanant du service de diagnostic des parasites.

The Pacific Forestry Centre has provided forest nurseries in British Columbia with a pest diagnostic service since the early 1970s. At that time, the Pacific Forestry Centre had a protection research program that studied disease problems relating to both forests and forest nurseries. The need for the nursery service developed because rapidly changing techniques for growing forest seedlings created new problems that required immediate identification to prevent substantial loss in stock production.

As nursery production increased, so did the volume of material sent to the Pacific Forestry Center for identification. In 1985, it became necessary to process these identification requests more efficiently. Entering data directly into a computer organized the information, made it more uniform, and reduced errors. Information regarding a particular sample became readily accessible. Annual summaries could be prepared quickly, and current trends were more easily recognized and compared with past trends in the expanding data base.

Nursery production in British Columbia has been coordinated by the British Columbia Ministry of Forests which needed to be kept informed of problems generated at the nurseries. The pest clinic at the Pacific Forestry Centre sent letters to personnel at the British Columbia Ministry of Forests regarding pest diagnoses. The computer system is designed to generate these letters faster, thereby enabling personnel at the provincial ministry to make cultural recommendations based on results from the pest clinic.

The software package is called "Nursery". Development of the package was undertaken by the software development section at the Pacific Forestry Centre in response to a request from the seedling pathology section. Discussions between the computing and pathology sections indicated that a system that paralleled but automated the existing paper system was required.

Because portability was not required, the project was carried out taking advantage of computing tools available at the Pacific Forestry Centre. When the package was created in 1985, reports and summaries were prepared on an *ad hoc* basis, so a package that could only generate fixed reports would be of little value. Instead, a connection to a local database product was provided that enabled the user to construct queries in such a way as to produce the desired report. The package was completed in June, 1985.

Currently, Nursery is written in VAX fortran using a screen management tool, FMS. It runs on the VAX 8650 at the Pacific Forestry Centre. An illustration of the data accepted by the database is given below and an example of a letter produced by this software is given in Figure 1.

Table 1 is an example of the information collected by the "Nursery" program. The information collected includes details that are not required to produce responses to client inquiries but which allows periodic summaries to be made. Summaries made on specified topics discloses trends and helps forecast client demand. This particular information is from Report #94-123.

Table 1. Examples of Information collected in the “Nursery” Program

REQUEST #: 123
REQUESTED BY: John Doe
ENTERED BY: JJD
BUSINESS: Pacific Regen. Tech. Inc. Chilliwack Nursery
P.O. Box 242
Vedder Crossing
VOX 1Z0

16-4-94

MATERIAL	TYPE OF MATERIAL	AGE	DAMAGE LOCATION
western red cedar	container	2+0	foliage
white spruce	bareroot	2+0	shoot tip
Douglas-fir	container	1+0	roots
peat	container		

SAMPLE A

ADDITIONAL INFORMATION:

Western red cedar 2+0 with foliage damage. Please determine if it is a disease or whether it is a cultural or environmental damage.

OBSERVATION:

Foliage damage has large apothecia of *DIDYMASCELLA THUJINA*. Lower foliage only. Average on 15 plants is 30% of the lower foliage necrotic. Plug seedlings were grown in 21 1 styroblock containers and are too tall and overcrowded.

INCUBATION:

CULTURES:

DIAGNOSIS:

DZDYMASCELLA THUJINA (Keithia blight) found on western red cedar at Chilliwack River Nursery. Fortunately it is a small crop of 500,000 seedlings and will be going onto a fairly dry site.

SAMPLE B

ADDITIONAL INFORMATION:

White spruce, bareroot 2+0 with shoot tip necrosis. Please assess for disease, cultural or environmental causes.

OBSERVATION:

Terminal shoots collapsed and mushy. Young *pycnidia* forming but no spores as yet. Roots look healthy and lower stems are normal.

INCUBATION:

16/4. 4 shoot tips. 18/4 - confirmed *SIROCOCCUS STROBILINUS*.

CULTURES:

16/4. 21/4 early results look like *SZROCOCCUS* on from all stem pieces cultured.

DIAGNOSIS:

SIROCOCCUS STROBILINUS causing shoot tip blight on white spruce from Chilliwack.

Table 1. (continued)

SAMPLE C

ADDITIONAL INFORMATION:

Coastal Douglas-fir, container, 1+0 with root necrosis. Please check for disease.

OBSERVATION:

Shoots are wilted but lower stems are healthy. Roots are black, thickened, lack root hairs, and short roots. Definitely root rot.

INCUBATION:

CULTURES:

16/4. Soil mix assay: PPA = 400 propagules per gram *PYTHIUM*, KM = 0 ppg *FUSARIUM*.

16/4 Root assay: 27/50 root pieces with *PYTHIUM*. 5/50 pieces with *FUSARIUM*. lots of *TRICHODERMA* & *PENICILLIUM*, *CLADOSPORIUM*.

DIAGNOSIS:

PYTHIUM root disease on Coastal Douglas-fir from Chilliwack River Nursery.

SAMPLE D

ADDITIONAL INFORMATION:

Peat sample (Premier Manitoba) for pathogen assay. This quality grade peat is being used for a 1 million seedling crop of lodgepole pine. Please assess for pathogens.

OBSERVATION:

Peat is a light brown, coarse fibred material. No apparent lumps or clumps. Odour is "normal" with no musty or mouldy smell.

INCUBATION:

CULTURES:

Soil mix assay: PPA = 0 *PYTHIUM*, KM = 0 *FUSARIUM*

DIAGNOSIS:

No pathogens were found in the peat sample sent in from Chilliwack River.

COMMENTS:

As I mentioned on the phone, the western red cedar you sent is infected with Keitha blight (*DIDYMASCELLA THUJINA*). Approximately 30% of the foliage from all seedlings is infected. Considering the site these trees are to be planted in soon is a dry site, the trees should be able to outgrow the disease. The cool, wet summer and overcrowding has contributed to the problem. The white spruce tips are infected with *SIROCOCCUS STROBILINUS*. Again, the weather has contributed to the high disease levels. Roguing the affected seedlings should reduce the spread. Also, the reduced nitrogen fertilizer will lignify the shoot tissues increasing resistance to infection. The Douglas-fir you sent had *PYTHIUM* root rot. This is caused by having a saturated soil mix. Roguing, again, will reduce the spread and improved water management should prevent further losses. The peat sample you sent has been assayed and no *PYTHIUM* or *FUSARIUM* was found. As you are aware, the sample is very small and it cannot be inferred that there are no pathogens in the rest of the truck load. If you would like, we can test more samples to build confidence that this is standard for the whole load.

PC5720

Pacific Forestry Centre
506 West Burnside Rd.
Victoria, B.C. V8Z 1M5
Phone: (604) 363-0600

July 26, 1990

John Doe
Pacific Regen. Tech. Inc. Chilliwack Nursery
P.O. Box 242
Vedder Crossing, B.C.
VOX 1Z0

Dear John: Re: Pest Clinic Report #94-123

As I mentioned on the phone, the western red cedar you sent is infected with Keith blight (*DIDYMASCELLA THUJINA*). Approximately 30% of the foliage from all seedlings is infected. Considering the site these trees are to be planted in soon is a dry site, the trees should be able to outgrow the disease. The cool, wet summer and overcrowding has contributed to the problem. The white spruce tips are infected with *SIROCOCCUS STROBILINUS*. Again, the weather has contributed to the high disease levels. Roguing the affected seedlings should reduce the spread. Also, the reduced nitrogen fertilizer will lignify the shoot tissues increasing resistance to infection. The Douglas-fir you sent had *PYTHIUM* root rot. This is caused by having a saturated soil mix. Roguing, again, will reduce the spread and improved water management should prevent further losses. The peat sample you sent has been assayed and no *PYTHIUM* or *FUSARIUM* was found. As you are aware, the sample is very small and it cannot be inferred that there are no pathogens in the rest of the truck load. If you would like, we can test more samples to build confidence that this is standard for the whole load.

Yours truly,

John Dennis
Reforestation Disease Technician

Figure 1. Example of a letter prepared by the "Nursery" software package.

Monoclonal antibodies and their application in forestry

ABUL K. M. EKRAMODDOULLAH

Forestry Canada, Pacific Forestry Centre,
506 West Burnside Road, Victoria, British Columbia,
Canada, V8Z 1M5

Presented at the first meeting of IUFRO Working Party S2.07-09
(Diseases and Insects in Forest Nurseries), Victoria, British Columbia, Canada, August 22-30, 1990.

Abstract

In this paper, a few basic concepts of immunology are introduced. These concepts are (i) antibody structure, (ii) functional fragments of antibody molecules, (iii) antigen-antibody interactions, (iv) antibody specificity and antibody affinity, (v) antigen cross-reactivity, (vi) cells involved in the antibody response, (vii) clonal selection, (viii) hybridoma technology, (ix) immunological techniques to screen hybridoma supernatant for antibody activity. The application of monoclonal antibodies was discussed in terms of their use in (a) affinity chromatography to isolate a specific antigen, (b) establishing structure-function relationships, (c) detection of seed-borne pathogens and (d) the study of host-pathogen interactions. Possible applications of these techniques in forestry are discussed.

Résumé

Cet exposé porte sur plusieurs concepts de base dans le domaine de l'immunologie: i) structure des anticorps; ii) fragments fonctionnels des molécules d'anticorps; iii) interactions antigène-anticorps; iv) spécificité et affinité des anticorps; v) réactivité croisée des anticorps; vi) cellules participant à la réaction immunitaire; vii) sélection clonale; viii) technologie des hybridomes; ix) techniques d'immunologie utilisées pour examiner l'activité des anticorps dans le surnageant hybridome. On y traite également de l'application des anticorps monoclonaux dans: a) la chromatographie d'affinité pour isoler un antigène spécifique; b) l'établissement de relations structure-fonction; c) la détection des agents pathogènes transmis par la semence; d) l'étude des interactions hôte-agent pathogène. Enfin, l'auteur examine les possibilités d'application de ces techniques en foresterie.

Introduction

Since the first successful production of monoclonal antibodies by Kohler and Milstein more than a decade ago, there has been a tremendous stride forward in various diagnostic procedures in medicine. In addition to applications in diagnostics, monoclonal antibodies are used to enhance our basic understanding of disease processes. For their effort, Kohler and Milstein were awarded the Nobel prize. This paper will describe some applications of monoclonal antibodies and discuss how these immortal magic molecules can be applied in forestry. First, I will review a few basic concepts of immunology as they relate to antibodies.

Antibody structure

Antibodies, also known as immunoglobulins, are a group of glycoproteins present in the serum and tissue fluids of all mammals. Their production is induced when the host comes in contact with antigens foreign to the host. Antibodies bind specifically to the antigen which induced their formation in the first place. The basic structure of an antibody molecule is shown in Figure 1.

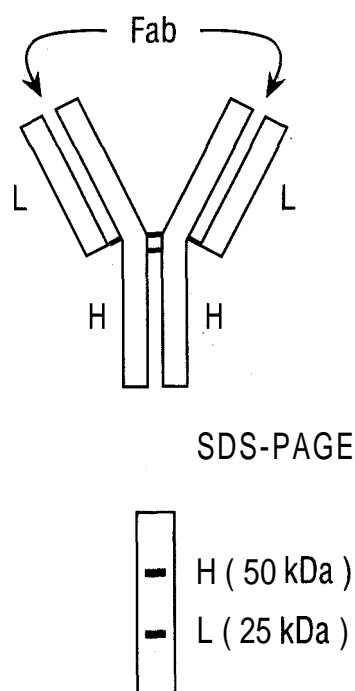

Figure 1. General structure of an IgG antibody

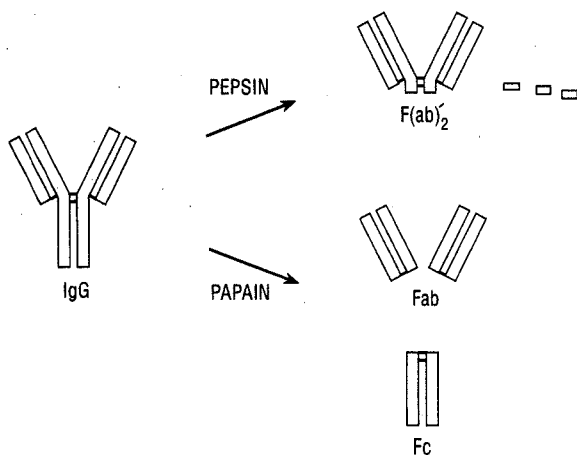

Figure 2. Enzymatic cleavage of IgG antibody into fragments

The molecule consists of four polypeptide chains. Two identical heavy chains are linked together by disulfide bonds, and the two light chains are also linked to the heavy chains by a disulfide bond. The light chain has a molecular weight of 25 000, and the molecular weight of the heavy chain is 50 000. The molecular weight of the entire molecule is thus 150 000. On reduction and alkylation, these polypeptide chains can be dissociated. With a technique called SDS polyacrylamide gel electrophoresis (SDS-PAGE), the dissociation mixture can be resolved into two bands corresponding to the heavy and light chains.

Functional fragments of antibody molecules

The antibody molecule has two binding sites which are formed between the heavy and light chains. The separated chains, therefore, are unable to bind to antigens. However, the molecule can be cleaved enzymatically into functional fragments as shown in Figure 2. Papain, a plant proteolytic enzyme, can cleave the molecule at the hinge region into three fragments: two monomeric fragments (Fab) retaining the antigen binding site, and a third fragment (Fc) which is a part of two heavy chains. The enzyme pepsin cleaves the antibody molecule at two points in the heavy chain resulting in a major fragment called $F(ab)_2$ (which retains both antigenic binding sites) and a few fragments of low molecular weight. Although these fragments were initially generated by Porter and Edelman to establish structure-function relationships of antibody molecules, for which work they received the Nobel prize, the importance of these fragments stems from their extensive use in the development of reagents and methodology used in research or diagnostics. For example, to produce specific antibodies in rabbits to a mouse immunoglobulin molecule which in this case will be an

antigen, the Fc fragment rather than the whole molecule will be used to immunize the rabbits, since most of the antigenic characteristic of the immunoglobulin molecule resides in this fragment. On the other hand, if one employs immunocytochemical techniques to localize cell surface molecules putatively involved in plant-pathogen interactions, one would prepare an antibody molecule of interest, then prepare a $F(ab)_2$ fragment of the molecule, and then label these fragments with gold for electron microscopy or with a fluorescent compound for light microscopy. The reason the entire molecule is not used is that the Fc fragment is sticky and may give rise to non-specific binding. Moreover, the Fab fragment is smaller than the whole molecule, and so it has easy access to the target molecule and can interact with it more easily.

Antigen-antibody interactions

What forces are involved in the interaction between an antigen and antibody? The interaction between the antigen and antibody is governed by the law of mass action; the equilibrium constant K (which in this case is known as the affinity constant) is given by the formula in Figure 3 and can be experimentally measured by determining the concentration of the antigen-antibody complex and the concentration of their free forms. The forces that keep the complex together are mainly electrostatic, hydrogen bonding, and van der Waals forces. This complex can be dissociated by altering the pH of the reaction mixture. To a given antigenic site one could generate different types antibodies which would differ in affinities. A high affinity antibody would have a perfect fit for the antigenic site while a low affinity antibody would have a poor fit (Figure 3). In hybridoma technology (the technology used to produce mono-

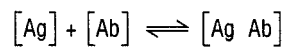

$$\text{Affinity, } K = \frac{[Ag Ab]}{[Ag][Ab]}$$

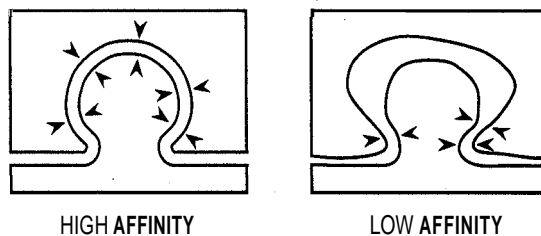

Figure 3. Antigen antibody interactions: a high-affinity antibody (left) will have a virtually perfect fit to the antigenic site; a low affinity antibody (right) will have a poor fit.

clonal antibodies) antibodies of different affinities can be selected. Thus, if the purpose of producing monoclonal antibody is the detection of a plant pathogen which may be present in very small amounts, then one would select the high-affinity antibody. However, if the purpose is to isolate a specific protein such as disease resistance protein or a virulent factor derived from a pathogen, one would use the low-affinity antibody, since it will be necessary in this application to dissociate the antibody-antigen complex.

Antibody specificity and antigen cross-reactivity

An important characteristic of antigen-antibody reactions is their high level of specificity. Thus, if one produces antibodies to an antigen *A* which has three different antigenic sites *x*, *y* and *z*, polyclonal antibodies are produced which have these three specificities; these antibodies will react specifically with the immunizing antigen and will fail to recognize antigen *C* which lacks these three antigenic sites (Figure 4). On the other hand, if the antigenic site *y* is also present in a related antigen *B* then a part of the antibody population will also bind to antigen *B* and these antigens are regarded as cross-reactive, having a common antigenic site *y*. To render

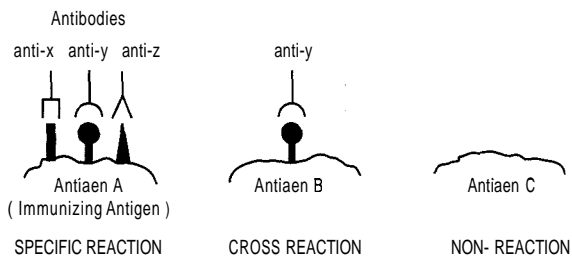

Figure 4. Antigen cross reactivity

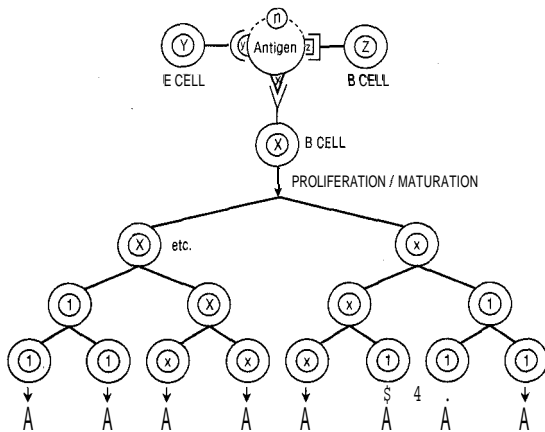

Figure 6. Clonal selection

these polyclonal antibodies specific for antigen *A*, the traditional method is to deplete the anti-*y* antibody population by extensively absorbing them with antigen *B*. In hybridoma technology, one can produce and select monoclonal antibodies which will recognize either antigenic site *x* or *z*, and these antibodies will be truly specific for antigen *A*.

Cell co-operation in antibody response

What types of cells are involved in the antibody response? When an antigen is encountered by the host immune system, the antigen is processed by a group of cells known as antigen presenting cells (Figure 5). The antigen is picked up by the antigen presenting cell, degraded, processed, and the fragments are expressed on its cell surface. The antigen presenting cells present the processed antigen to two types of lymphocyte cells, T helper cells (T_H) and B cells. The receptor on B cells

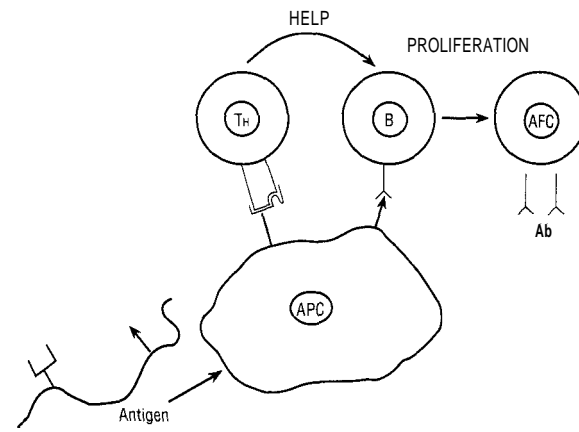

Figure 5. Cell cooperation in antibody response. APC = antigen presenting cell; TH = T helper cell; B = B cells; AFC = antibody forming cells.

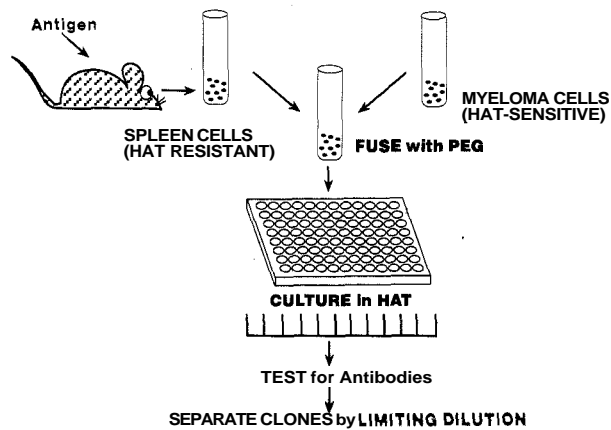

Figure 7. Cell fusion to produce monoclonal antibodies

is the immunoglobulin itself and it binds the antigenic site. On the other hand, *T* helper cells binds to the different part of the antigen molecule which is expressed on the cell surface of the antigen presenting cells in association with an Iamolecule characteristic of the antigen presenting cell. On interaction with antibody presenting cells, and receiving a help signal from *T* cells, the *B* cells differentiate into antibody producing cells which proliferate and mature to provide antibodies in the circulation. Of passing interest, it is the *T* helper cells that get knocked out when an individual is infected with the HIV virus that leads to the development of AIDS.

Clonal selection

Each *B* cell is programmed to make one type of antibody which is placed on its surface as receptors (Figure 6). If a *B* cell having the specificity of X proliferates and matures into antibody producing cells, all such cells will produce antibodies exactly of the same specificity and the resulting antibodies will be monoclonal. However, *in vivo*, a number of *B* cells with different specificities would proliferate and mature, and the resulting antibodies would be polyclonal. In hybridoma technology, there is a way of separating these polyclonal *B* cells of different specificities into monoclonal cell populations which in turn produce monoclonal antibodies.

Hybridoma technology

The principle of hybridoma technology is illustrated in Figure 7. Animals such as mice are immunized with the antigen. Once the animals are making antibodies, they are killed, and the spleen - a primary organ of the immune system - is removed. The immune spleen contains the antibody forming cells with many different specificities. Single cell suspensions of these cells are then prepared, mixed with a single cell suspension of a tumor (myeloma) cell line. Polyethylene glycol (PEG) is added to initiate the fusion of these two different types of cells. The resulting hybrid cell will produce antibodies, like the immune spleen cells, and will grow indefinitely, like the tumor cells. These hybrid cells are immortal, and are a source of unlimited amounts of antibodies. Following the addition of PEG, the cells are pelleted by centrifugation to remove excess PEG, and then washed and cultured in a medium containing HAT. (H stands for hypoxanthine, A stands for aminopterin and T stands for thymidine). The parental myeloma cell line is sensitive to this media because aminopterin blocks its *de novo* DNA synthesis, and these cells do not have an alternate route of synthesizing DNA. However, the hybrid cells inherit an alternate route from the parental immune spleen cells, and so both hybrid cells

and immune spleen cells are resistant to the HAT medium. On the other hand, the immune spleen cells do not grow for long in cultures.

When cells are grown in a 96-well plate for 14 days in this medium, only the hybrid cells survive. Cell supernatants are withdrawn at this stage and wells containing antibody activity are identified. The number of positive wells is a measure of successful fusion. At this stage, the hybrid cells produce polyclonal antibodies. The next step is to obtain a monoclonal cell line, and this is accomplished by the limiting dilution technique. Cells from each of the wells in which antibody activity was detected are diluted until there is only one hybridoma cell per well. These cells are grown, and their supernatant is tested for antibody activity. Cloning is repeated to ensure a stable cell line. Once subcloned, some of the cells are frozen for storage; other cells are grown in flasks to produce large amounts of antibodies, either by expanding the cell culture *in vitro* or growing them as tumors *in vivo*. In my laboratory, I prefer to produce monoclonal antibodies in ascites. Once subcloned, hybridoma cells are injected intraperitoneally into mice. After 7-10 days, depending on the type of hybridoma cells, the abdominal cavity is filled with ascites containing antibodies. Antibodies are then isolated from these ascites by biochemical methods.

One of the critical areas in hybridoma technology is the selection of clones secreting antibodies of the desired specificity. I have used two immunochemical techniques for selecting specific clones. These are (i) enzyme-linked immunoassay (ELISA) and (ii) Western immunoblot. In ELISA (Figure 8), a 96-well plate is coated with antigen which gets adsorbed onto the plate. Areas on the plate surface on which the antigen was not adsorbed are then blocked with gelatin to prevent non-specific adsorption of the test antibody. After washing, the cell supernatant from hybridoma cells is added. The test antibody will bind to the antigen, and a second antibody labelled with an enzyme is then added. The second antibody is usually developed against the Fc portion of the test antibody. One can also use *Streptococcus aureus* protein A, which also binds the Fc portion of the immunoglobulin. After the unbound portion of the second antibody is removed by washing,

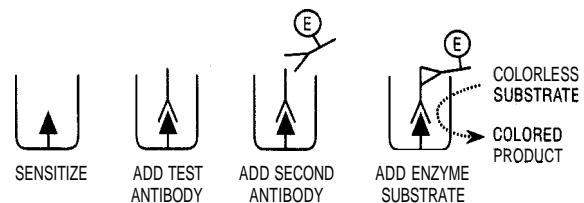

Figure 8. Enzyme-linked immunosorbent assay (ELISA)

a colorless enzyme substrate is added, which is converted into a colored product in the presence of the enzyme bound to the second antibody. The color intensity is measured spectrophotometrically and the amount of antibody is quantitated. The whole procedure can be automated. At this stage one can also use differential screening. In this method, another cross-reactive antigen is used in parallel to coat the antigen, wells showing positive antibody activity to both antigens are discarded, wells showing positive antibody activity only to the test antigen are kept for further expansion.

The second method we used is the Western immunoblot (Figure 9). This method is useful if the immunizing antigen is actually a mixture of antigens. A complex mixture of antigens is first electrophoretically separated on a polyacrylamide gel by electrophoresis. A nitrocellulose membrane is then placed on top of the gel, followed by a filter paper. The whole sandwich assembly is then put in an electrophoresis cell, and antigens separated on the gel are transferred to the membrane when current is applied. The membrane is processed for immunodetection as illustrated for the ELISA technique. Figure 10 shows the application of the Western immunoblot technique in establishing the specificity of a monoclonal antibody which we produced (Ekramoddoullah *et al.* 1986a; Kisil *et al.* 1980). The immunizing antigen was a mixture of grass pollen proteins, which were separated by polyacrylamide gel electrophoresis. These proteins were transferred onto the nitrocellulose membrane shown on the right lane. This Western blot was developed with a monoclonal antibody which only reacted with one component, indicating that this monoclonal antibody is specific for this component. We now have a battery of monoclonal antibodies which recognize a majority of these components separately. During our screening we found a large number of monoclonal antibodies that would recognize a majority of these components collectively; on further examination, these monoclonal antibodies were shown to recognize a common carbohydrate structure present on these pollen proteins (2). The point I want to stress here is that one does not need a purified preparation of immunizing antigen to obtain monoclonal antibodies - what is needed is a suitable screening procedure.

Genetically engineered monoclonal antibody

Technology to produce genetically engineered antibody has emerged within the past year (Sastry *et al.* 1989; Huse *et al.* 1989). Genes coding for heavy chains and light chains reside on different chromosomes on B cells. The mRNA for both heavy and light chains is transcribed in the antibody forming cells (Figure 11), which could be either immune spleen cells or hybri-

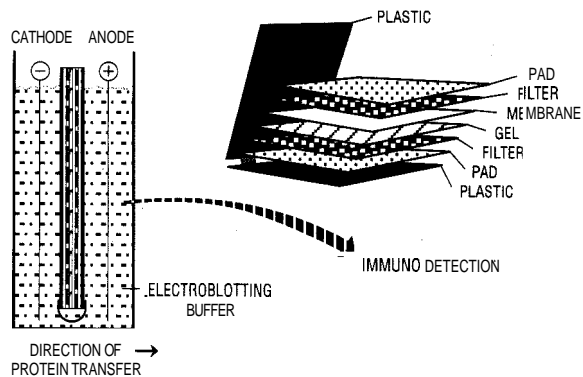

Figure 9. Western immunoblot

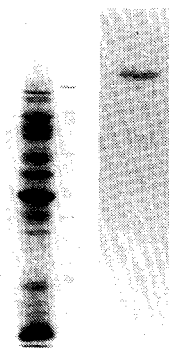

Figure 10. Western immunoblot. The left lane is a rye grass pollen extract separated by SDS-PAGE. The right lane is the corresponding Western immunoblot: note that only one of the many components was stained by the antibody.

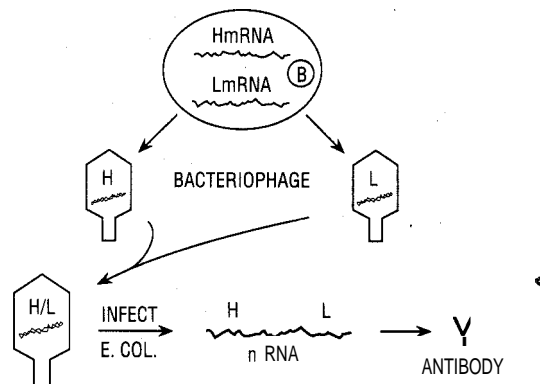

Figure 11. Production of monoclonal antibodies by genetic engineering.

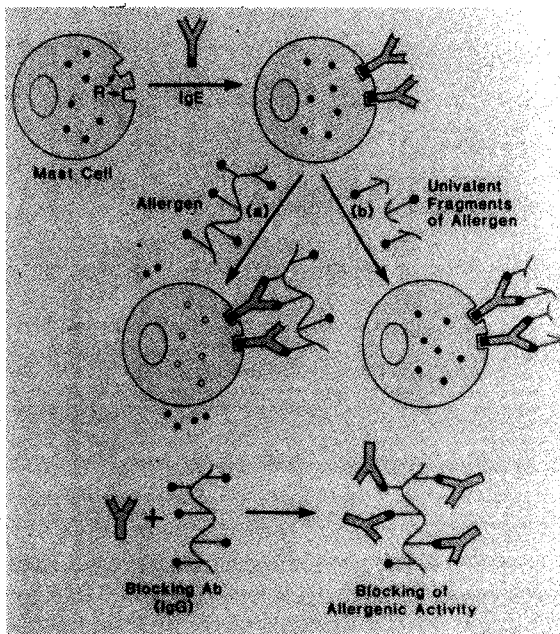

Figure 12. Schematic diagram of a typical allergic reaction triggered by an allergen. Path A represents allergic reaction, and path B represents inhibition of the allergic reaction by univalent allergen fragments.

doma cells. mRNA is isolated, amplified by polymerized chain reaction technology and a cDNA library is constructed separately for both chains in the virus (bacteriophage). DNA is extracted, spliced, ligated and re-expressed such that both heavy and light chains are transcribed on one mRNA strand and expressed ultimately as the antibody molecule.

Applications of monoclonal antibodies

Affinity chromatography

We made use of these monoclonal antibodies by preparing reversed immunosorbents to purify various antigens in a single-step process (Lin et al. 1988; Ekramoddoullah et al. 1986b).

Structure-function relationships

Monoclonal antibodies have also been used to study structure-function relationships of biologically active molecules. I will draw an example from a medical field (allergy) for the simple reason that I am more familiar with that field; however, the same principles can be easily adapted to study host-pathogen interactions in forestry. Individuals who suffer from hayfever, such as grass pollen allergy, produce a harmful antibody called IgE (Figure 12). This antibody has the same structural features as other antibodies which were discussed earlier. However, they are different in that the molecule

has an extra domain in Fc region which allows the molecule to bind to mast cells or basophils; we all have these granulated cells under the skin, lining the mucous membrane, and in the circulation system. In a typical allergic reaction, the multivalent allergen combines with the cell-bound IgE antibodies causing these molecules to cross link. Once cross-linked, the cells degranulate, releasing histamine that is present in the granules, and this causes the allergic reaction. However, if the allergen is fragmented into univalent units, the fragments will bind cell-bound IgE, but because of their univalency they cannot cross-link IgE molecules and so cannot trigger allergic reactions. Then, since the IgE molecules are occupied by these univalent fragments, the multivalent allergen is unable to elicit the allergic reaction. By virtue of their ability to inhibit allergic reactions, these fragments have therapeutic potential. We have used monoclonal antibodies to identify these allergenic sites. The approach was to produce a battery of monoclonal antibodies to many sites of a given allergen. In an *in-vitro* assay we screened the monoclonal antibodies for their ability to bind the allergenic site so that it blocks the binding of IgE antibodies to the same site, leading to the inhibition of allergic reactions.

A typical example (Ekramoddoullah et al. 1987) is shown in Figure 13. This is a solid phase radio-immunossay measuring the level of harmful antibodies

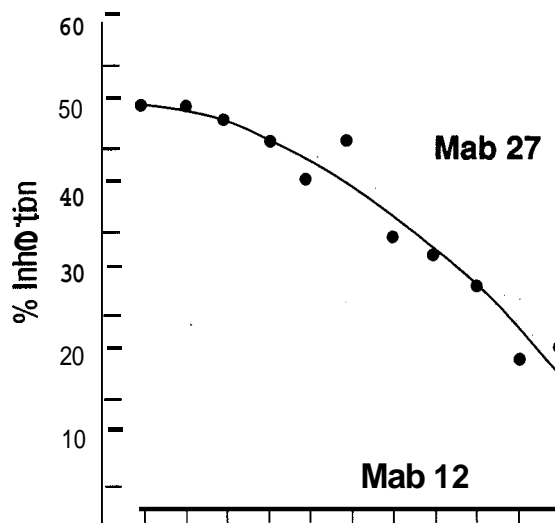

Figure 13. Inhibition of the binding of human IgE antibodies by monoclonal antibodies: Mab 27 is specific to this allergen, and Mab 12 is not specific to this allergen.

present in the sera of patients allergic to grass pollen. Figure 13 illustrates the effect of two monoclonal antibodies, Mab 27 and Mab 12. Mab 27 is specific for the particular allergen which elicited the IgE antibodies being measured. As the concentration of the Mab 27 monoclonal antibody was increased, there was a dramatic inhibition of the binding of IgE to the allergen. This inhibition is specific; the other monoclonal antibody which binds to a different allergen did not inhibit the binding of IgE to the allergen. Thus, a major allergenic site on this particular allergen was identified.

Detection of seed-borne pathogens

Monoclonal antibodies have been used (Mitchell and Sutherland 1986; Mitchell 1988) to detect the seed-borne pathogen *Sirococcus strobilinus*. *Sirococcus* blight is a sporadic but serious problem in container nurseries where it causes mortality of Sitka and white spruce and of lodgepole and ponderosa pine seedlings. Current methods for detecting seed-borne pathogens such as *S. strobilinus* involve plating surface-sterilized seeds onto nutrient media and identifying the emerging fungi on the basis of general morphology and production of distinctive spores. These pathogens were detected by two immunological assays based on monoclonal antibodies which were produced to the mycelial proteins of these pathogens. These methods were compared with plate assay. A total of 12 seedlots were examined. There were three healthy seed lots included, and the pathogen could not be detected in these by either technique. Of the remaining nine, the pathogen could be positively detected in only three seed lots with the plate assay technique. However, the pathogen was detected in all nine seedlots using the dot immunossay, demonstrating the sensitivity of immunological methods.

Host-pathogen interactions

One of the major applications of monoclonal antibodies in forestry would be in the study of host-pathogen interactions. Recently, Hardham (1989) from Australia has used monoclonal antibodies to localize and characterize molecules involved in the infection caused by the

fungus *Phytophthora cinnamomi*. This fungus attacks a wide variety of fruit, ornamental, and forest trees. Zoospores, the major infective agent of the fungus, may be transported downhill over a long distances in water moving within or on the surface of the soil. When they contact the surface of a root, they encyst; this process is characterized by a change in cell shape from ovoid to spherical, loss of flagella, secretion of material which appears to have adhesive properties, and formation of a microfibrillar cell wall. Following encystment, the fungus firmly attaches to the host surface, cysts germinate, and the fungal hyphae colonize adjacent tissues. Hardham produced monoclonal antibodies to this fungus and examined surface components by immunofluorescence microscopy. A total of 35 monoclonal antibodies, each of which recognized different surface areas of the fungus, were examined; nine different patterns were apparent. Some of the monoclonal antibodies were also shown to discriminate various isolates of the fungus; thus, monoclonal antibodies are a useful tool in taxonomy as well as in diagnostics.

Hardham also used these monoclonal antibodies to study the induction of encystment, and the storage and secretion of adhesive material during encystment. The monoclonal antibody that labels only the surface of the flagella was shown to trigger encystment, indicating that the molecules involved in this process reside on the flagella surface. The author also found that one monoclonal antibody stained the contents of the large vesicles; this was demonstrated by attaching gold particles to the monoclonal antibodies and observing their distribution by electron microscopy. The contents of smaller vesicles stained a different group of monoclonal antibodies. A time course study revealed that the contents of the small vesicles are secreted during encystment, and that the contents of the large vesicles were not secreted. This suggests that the contents of the small vesicles are involved in encystment.

Acknowledgement

I wish to thank Mr. S. Glover for critical comments on an earlier version of this manuscript.

References

- Ekramoddoullah, A.K.M.; Kasil, F.T.; Sehon, A.H. 1986a. Partial characterization of an antigenic site of HMBA, a Rye grass pollen allergen, using a monoclonal antibody. *Molecular Immunology*. 23: 111-117.
- Ekramoddoullah, A.K.M.; Kasil, F.T.; Sehon, A.H. 1986b. Isolation of a Kentucky Bluegrass pollen allergen using a murine monoclonal antibody immunosorbent. *Int. Archs. Allergy and Appl. Immunol.* 80: 100-106.
- Ekramoddoullah, A.K.M.; Kasil, F.T.; Cook, R.T.; Sehon, A.H. 1987. Recognition of a site of a Kentucky Bluegrass pollen allergen by antibodies in the sera of allergic and non-atopic humans and a murine monoclonal antibody. *J. Immunol.* 138: 1739-1743.

-
- Hardham, A.R. **1989**. Lectin and antibody labelling of surface components of spores of *Phytophthora cinnamomi*. *Aust. J. Plant Physiol.* **16**:19-32.
- Huse, W.D.; Sastry, L.; Iverson, S.A.; Kang, A.S.; Alting-Mees, M.; Burton, D.R.; Benkovic, S.J.; Lemer, R.A. **1989**. Generation of a large combinatorial library of the immunoglobulin repertoire in phage lambda. *Science*. **246**:1275-1281.
- Kisil, F.T.; Ekramoddoullah, A.K.M.; Bundesen, P.G.; Kelly, K.; Rector, E.S.; Chakrabarty, S.; Dzuba, J.M.M.; Schon, A.H. **1980**. Murine hybridoma antibodies to antigens of Kentucky Blue Grass (KBG) pollen (Abstract). *Fedn Proc.* **39**:3479.
- Lin, Z.; Ekramoddoullah, A.K.M.; Kisil, F.T.; Hebert, J.; Mourad, W. **1988**. Isolation and characterization of Poa p.I. allergens of Kentucky Bluegrass pollen with a murine monoclonal anti-Lo1 p. I. antibody. *Int. Archs. Allergy Appl. Immunol.* **87**:294-300.
- Mitchell, L.A. **1988**. A sensitive dot immunoassay employing monoclonal antibodies for detection of *Sirococcus strobilinus* in spruce seed. *Plant Dis.* **72**:664-667.
- Mitchell, L.A.; Sutherland, J.R. **1986**. Detection of seed-borne *Sirococcus strobilinus* with monoclonal antibodies in an enzyme-linked immunosorbent assay (ELISA). *Can. J. For. Res.* **16**:945-948.
- Sastry, L.; Alting-Mees, M.; Huse, W.D.; Short, J.M.; Sorge, J.A.; Hay, B.N.; Janda, K.D.; Benkovic, S.J.; Lemer, R.A. **1989**. Cloning of the immunological repertoire in *Escherichia coli* for generation of monoclonal catalytic antibodies: Construction of a heavy chain variable region-specific cDNA library. *Proc. Natl. Acad. Sci. USA.* **86**:5728-5732.

The isolation and identification of *Phytophthora* species causing damage in bare-root conifer nurseries

P.B. HAMM

Hermiston Agriculture Research and Extension Center
Oregon State University, Box 105
Hermiston, OR 97838

E.M. HANSEN

Department of Botany and Plant Pathology
Oregon State University
Corvallis, OR 97331-2902 U.S.A.

Presented at the first meeting of IUFRO Working Party S2.07-09
(Diseases and Insects in Forest Nurseries), Victoria, British Columbia, Canada, August 22-30, 1990.

Abstract

Of the more than 50 *Phytophthora* species described worldwide, only 10 are associated with root rot of bare-root conifer seedlings primarily used for reforestation. These species are sometimes difficult to isolate and even more difficult to identify. A general review of isolation methods to improve recovery is presented. Physiological and morphological characteristics of these species are described which are particularly useful when identifying isolates from bare-root conifer seedlings. Methods for observing the fungi are provided along with a key to simplify species identification. The geographical range and conifer hosts attacked are identified.

Resume

Parmi plus de 50 espèces de *Phytophthora* décrites dans le monde, on n'en compte que 10 qui causent le pourridié chez les semis de conifères à racines nues principalement utilisés dans le reboisement. Ces espèces sont parfois difficiles à isoler et encore plus difficiles à reconnaître. On passe en revue les méthodes d'isolement servant à améliorer la détection des champignons. On décrit les caractéristiques physiologiques et morphologiques de ces espèces qui sont particulièrement utiles pour identifier les isolats provenant de semis de conifères à racines nues. L'article comporte des méthodes d'observation de ces champignons ainsi qu'une clé facilitant l'identification des espèces. On précise la distribution géographique des champignons ainsi que les espèces de conifères hôtes.

Introduction

Phytophthora species cause losses to bare-root conifer seedlings in forest nurseries in many locations throughout the world. *Phytophthora cinnamomi* Rands is the most widespread species; it is reported to cause damage in The Netherlands (Slavekoorde 1978), United Kingdom (Aldhous 1972), New Zealand (Basset and Will 1964; Newhook 1970), South Africa (Broembsen 1981; Donald and Broembsen 1977), and Australia (Kassaby and Hepworth 1987; Oxenham and Winks 1963a, 1963b). In the United States, *P. cinnamomi* has been reported throughout the East and from the southeastern states (Bruck and Kenerley 1983; Crandall *et al.* 1945; Jackson and Crandall 1935; Kenerley and Bruck 1981; Kuhlman and Smith 1975), and in the Pacific Northwest (Pratt *et al.* 1976). Other species of *Phytophthora* that

have been reported in forest nurseries included the following: *P. citricola* Sawada in Australia (Davison and Bumbieris 1973) and the United States in Michigan (Adams and Bielenin 1988) and North Carolina (Shew and Benson 1981); *P. cryptogea* Pethy. and Laff. in Australia (Davison and Bumbieris 1973), and northwest North America including British Columbia (Hamm *et al.* 1985; Pratt *et al.* 1976); *P. cactorum* (Leb. and Cohn) Schr. in Sweden (Molin *et al.* 1961), United Kingdom (Aldhous 1972), and the United States in Michigan (Adams and Bielenin 1988) and the Pacific Northwest (Hamm and Hansen 1982a); *P. cambivora* (Petri) Buisman in northwest North America (P.B. Hamm, unpublished data); *P. drechsleri* in British Columbia (Hamm *et al.* 1985) and the United States (Benson *et al.* 1976; Hamm and Hansen 1982a; Pratt *et al.*

al. 1976); *P. gonapodyides* (Peterson) Buisman in north-west North America (Brasier *et al.* 1989); two distinguishable groups of *P. megasperma* Drech. in the United States in Oregon and Washington (Hansen and Haas 1983), and a single group in Australia (Davison and Bumbieris 1973); *P. parasitica* Dastur in Australia (Davison and Bumbieris 1973) and the United States in Florida (Barnard *et al.* 1985); and *P. pseudotsugae* in the United States in Oregon and Washington (Hamm and Hansen 1982a, 1983, 1987; Hansen *et al.* 1979; Pratt *et al.* 1976).

Two additional fungi deserve mention, although they have not yet been associated with root rot in bare-root nurseries. *Phytophthora lateralis* is an aggressive pathogen of *Chamaecyparis lawsoniana* in forests, ornamental plantings, and ornamental container nurseries in northwestern North America. It is a serious threat wherever Port Orford cedar is grown. *Phytophthora undulatum*, much better known as *Pythium undulatum*, has been found in the United Kingdom (Pitts and Calhoun 1984) and in streams from remote forested areas of North America (Hamm *et al.* 1988). It releases zoospores like a *Phytophthora* (Dick 1989) but has growth and pathogenicity more like a *Pythium*. These two species are easily separated from the *Phytophthora* species described here by following the information provided elsewhere (Hamm and Hansen 1987; Hamm *et al.* 1988).

Phytophthora has been overlooked as a cause of tree mortality in the past because of difficulties in isolation, recognition, and identification of the pathogen. Recent advances in chemical control (Bruck and Kenerley 1983; Haas *et al.* 1984) and information on host preferences of these fungi (Campbell and Hamm 1989; Hamm and Hansen 1982a) can be utilized in disease management (Cooley *et al.* 1985) only after proper isolation and identification of the pathogens. This paper has a dual purpose: (1) to review general isolation procedures to provide aid in recovering *Phytophthora*, and (2) to present a simplified key to identify species found on bare-root conifer seedlings primarily grown for reforestation.

More than 50 species of *Phytophthora* are described worldwide, but only 10 taxa have been reported from bare-root conifer seedlings. One of these 10, *P. parasitica*, will not be dealt with in detail because isolation and damage has been infrequent and minor. Focusing on the nine remaining species simplifies the problem of identification. Keep in mind, however, that isolates of a species may be variable. In addition, one may recover a species not previously reported. For these reasons, this key should be used in conjunction with other comprehensive works (Ho 1981; Newhook

1970; Waterhouse 1963, 1970; Waterhouse and Blackwell 1954) to confirm your identification.

While the central theme is the isolation and identification of *Phytophthora*, a related genus, *Pythium*, is commonly found in the same environments and is therefore frequently recovered when isolating *Phytophthora*. For this reason, information has been included to aid in distinguishing *Phytophthora* from *Pythium*.

Isolation of *Phytophthora*

Isolation of *Phytophthora* can be difficult due to a number of factors such as (1) the species of *Phytophthora* involved, (2) the presence of fast-growing contaminants, and (3) the condition of the material from which isolations are attempted. A variety of selective techniques, however, are available, each with advantages and disadvantages for particular situations. Direct isolation from recently infected tissue is generally the most reliable and straightforward method. Combining direct isolation with plugging infected roots into apples can improve recovery from seedlings (Hansen *et al.* 1979). Baiting methods are generally best to recover *Phytophthora* from soil or water, especially if populations are low. *Pythium* sp. can be easily isolated by the same methods except where hymexazol (see later discussion) is used.

Direct isolation

Placing portions of diseased tissue directly on selective medium is the most straightforward approach to isolation. This method works best where active margins of infection can be identified. Collect samples that are fading or recently killed, and do not let the roots or stem dry out. Always place samples in a cooler after collecting in the field during warm months. Direct isolation is usually difficult from old dead or dried material, or from material that was poorly stored after collecting. Once in the laboratory, the sample should be thoroughly washed and then carefully examined by lightly scraping the cortex to identify the reddish brown discoloration of diseased phloem. Small (2 to 4 mm) cross-sectioned pieces of root from the advancing margin are then removed. Frequency of isolation is often higher from smaller (lateral) versus larger (tap) roots exhibiting this symptom. These pieces are surface sterilized on a minute in 1% sodium hypochlorite (laundry bleach mixed 1:4 with distilled water); smaller sections are sterilized for less time. Never allow root pieces to dry prior to plating. Sections are then rinsed in two changes of sterile distilled water, blotted dry, and plated on corn meal agar containing pimarin, ampicillin, and rifamycin [CMP+A+R (the recipe for this and other media is

found at the end of this paper)]. Isolation plates are placed inverted, in the dark, at room temperature. Put no more than seven well-spaced pieces per plate. Within 24 to 36 hours, *Pythium* sp. will begin growing from the diseased pieces and will be clearly visible. These should be subcultured, if wanted, then the wood segment plus the entire growing *Pythium* colony should be cut out to prevent the overgrowth of other wood fragments. *Phytophthora* colonies should be visible within 36 to 48 hours.

Isolation from water

Phytophthora is commonly spread via zoospores in water, whether from an irrigation canal, a pond, a drainage ditch, or a forest stream. Zoospores follow a chemical gradient and can be trapped, or baited, from water with an attractive substrate.

Fruit baits. Unripe fruits (apples, pears, lemons, avocados, etc.) are widely used to bait *Phytophthora* from water. Overripe fruit can be infected by a wide range of organisms, but intact green fruit, floating in water, is reasonably selective for fungi with motile zoospores. Some *Phytophthora* spp. will not decay particular fruits, however, so negative results must be interpreted with care. Apples (cultivars that remain green and hard are especially useful) and pears have been widely used.

Fruit baits are suspended in the water source for five or six days in a loosely woven bag held in place with a wire flag. Fruits are then incubated at room temperature for up to a week. Infections will appear as dark patches, similar to bruises, after one or more days at 20°C. Areas of firm, brown decay may indicate *Phytophthora* infection; soft or juicy decay is probably caused by other organisms. *Phytophthora* is recovered by aseptically splitting the fruit from healthy to infected areas and transferring 1-mm² portions from the margins of areas of firm decay to CMP+A+R.

Seedling baits. Intact seedlings suspended in water as baits can be highly specific for recovering *Phytophthora* species. Port Orford cedar seedlings have been used in this manner to monitor *P. lateralis* in forest streams and roadside drainages (Dr. L.F. Roth, personal communication). Seedlings are grown in plastic tubes until their roots emerge from the bottom. They are then placed in shallow water and held by wire flags, or in deeper water on floats. After a convenient trapping period (7 to 10 days) seedlings are returned to the greenhouse for incubation (2 to 6 weeks). They should be checked at weekly intervals for crown symptoms. Direct isolations from diseased roots or stems of symptomatic seedlings confirm the presence of *Phytophthora*.

From soil

Phytophthora can be recovered from soil by baiting or by dilution plating. The former allows sampling a much larger volume of soil, but the latter allows easier quantitative population estimates. The challenge is to separate the target fungus from the many other organisms in the soil that might mask or inhibit its growth and detection. Modern selective media greatly aid this process, but recovery of slow-growing *Phytophthora* species is still difficult at best in most soils. Each of the techniques described below is selective against some *Phytophthora* spp. Always test your technique against the target organism.

Stuffed apples. Unripe apples can be stuffed with moist soil, roots, or both and incubated to allow the characteristic firm, brown *Phytophthora* decay to develop on the fruit's exterior. A cork borer (9 to 12 mm diameter) works well to remove a plug from the apple. The hole is then refilled immediately with the soil sample, or roots, then sealed with tape. Water can be added to the soil prior to stuffing, making a thick paste. Root segments can be poked directly into the apple without a cork borer hole. Apples are incubated at room temperature (or cooler if your target fungus has a lower optimum temperature). Apple baits are split open, cutting from the non-bruised to bruised areas. Samples are then removed from margin areas, and placed onto CMP+A+R. *P. pseudotsugae* grows slowly or not at all in apples and cannot be isolated by this technique.

Flouting foliage baits. Water can act as a selective medium to separate zoospore fungi from those without motile spores. The double-cup technique of Linderman and Zeitoun (1977) has been adopted to recover *P. lateralis* and *P. cinnamomi* from soils (Hamm and Hansen 1984). Separating the organic matter (by flotation and wet sieving) from the mineral soil fraction concentrates *Phytophthora* propagules. This technique, developed by Ostrofsky *et al.* (1977), increases both the volume of soil sampled and recovery rates. This technique could be used when isolating other *Phytophthoras* by simply changing the bait used.

The double cup is prepared from two nested styrofoam drinking cups, one bottomless. Cheesecloth held by the bottomless cup separates the sample below from floating baits above. Five 3-cm lengths of succulent cedar foliage with small branchlets removed are used for recovering *P. lateralis* and *P. cinnamomi*, but lupine seedlings or eucalyptus leaf discs are also widely used for recovering *Phytophthora*. Baits can be floated on distilled water or on distilled water with 20 µg/mL hymexazol added, which helps to inhibit contamination

by *Pythium* spp. (Hamm and Hansen 1984). After six days the baits are removed and blotted on sterile filter paper, then transferred to CMP+A+R containing only 10 g of cornmeal agar per litre. This medium allows baits to be easily pushed into the agar. Other baiting methods have been developed for isolating *Phytophthora* from soil. Check Jeffers and Aldwinckle (1987) for a more complete list.

Dilution plating. *Phytophthora* can be isolated directly from some soils on selective media. One method, well cited in the literature, was developed by Tsao and Ocana (1969). Using a medium containing pimaricin, vancomycin and PCNB (P₁₀VP), *Phytophthora* can be isolated successfully by traditional soil dilution methods, or by adding soil directly to the surface of the medium. Jeffers and Martin (1986) reported an improvement over P₁₀VP by changing the antibacterial agents and adding hymexazol (see CMP+A+R preparation). The amount of the dilution or soil added varies with each soil and needs to be determined through preliminary trials. Usually, a dilution of 10⁻³ to 10⁻⁴ is a good starting point. Plates should be incubated in the dark at approximately 20°C and *Phytophthora* colonies observed after two days and three to four days. Colonies are recognized by macroscopic characteristics, microscopic examination, or by subculturing on fresh medium to allow more complete observations. Faster growing species (e.g., *P. cinnamomi* or *P. cryptogeu*) are usually more reliably isolated by this method.

Identification of *Phytophthora*

Water molds (Oomycetes) versus other fungi

The taxonomic distinctions between the Phycomycetes and the Ascomycetes or Basidiomycetes are very basic, often quite technical, and not very helpful when faced with a hundred isolation plates. *Phytophthora* and *Pythium* colonies are white, and grow at a slow to fast rate (generally, *Phytophthora* spp. grow at a slow to moderate rate and *Pythium* spp. grow at a moderate to fast rate), without conidia or any multicellular fruiting bodies. One of the most useful characteristics is the ability of *Phytophthora* and *Pythium* to grow on agar amended with the antibiotic pimaricin [also called Natamycin and Delvocid (Eckert and Tsao 1962)]. Most other fungi are inhibited.

Pimaricin is light sensitive, and should be stored in a dark, cool (5°C) place. The selective effect is gradually lost when plates are incubated or stored in the light, or held for a week or more. However, with proper care, pimaricin-amended medium provides an effective means for isolating and the best first screen for identifying *Phytophthora* and *Pythium*.

Phytophthora versus *Pythium*

Pythium species are widespread in the same habitats as *Phytophthora*, are often abundant, and are usually fast-growing. Not only are they superficially similar to *Phytophthora*, but they are likely to overgrow any *Phytophthora* present. *Pythium* species can be pathogens in their own right, but with very different behavior, and with different consequences for the seedling or tree. It is essential to distinguish accurately between the two. A reliable selective medium does not exist to differentiate these two genera in every instance. However, at least one antibiotic has been shown to be effective in some applications (Hamm and Hansen 1984; Hansen *et al.* 1979; Massago *et al.* 1977). Fortunately, the technical distinction between these genera is easily observed in most cases.

With experience, growth rate and hyphal characteristics can be used to recognize most *Phytophthora* and *Pythium* isolates. Generally, *Pythium* colonies are fast-growing, and less dense, often with strongly radiating hyphae. Less subjective characters exhibited by some isolates, but not all, include round non-papillate sporangia, hyphae with a smaller diameter, and small oogonia often with multiple antheridia or with multiple oospores. These features are not generally found in *Phytophthora*. The ultimate distinction, however, is based on differences in indirect germination (the formation of zoospores) of sporangia between the two genera. In *Phytophthora*, cytoplasm differentiates into zoospores within the sporangium. At germination, the active zoospores are released, sometimes momentarily into a transparent vesicle, then they burst free and swim away. The vesicle is usually not visible at all. *Pythium* zoospores, on the other hand, differentiate from cytoplasm in the vesicle, not in the sporangium. The vesicle may not always be visible but the cluster of developing zoospores will be easily seen distal to the tip of the sporangium. They remain in the vesicle for minutes or even hours as they differentiate from the cytoplasm. The formation of a persistent (long lasting) vesicle does not always indicate a *Pythium* sp. At least one *Phytophthora*, *P. undulatum*, reportedly differentiates cytoplasm into zoospores both in sporangia and vesicles (Dick 1989).

Methods for inducing sporangia are described below. Growth characters in pea broth (PB) during sporangial induction should give clues to identity even before the formation of sporangia. *Pythium* colonies will be thin and fast-growing; they do not stick to the bottom of the plastic Petri plate. *Phytophthora* colonies are dense, relatively slow growing, and adhere to the Petri plates.

The species of *Phytophthora* found in bare-root forest nurseries

Methods for identification

The species of *Phytophthora* present on seedlings can be identified, with experience, by their characteristics on one of two growth media: carrot agar [CA (Brasier 1972)] or clarified V-8 agar [clar V-8A (Hamm and Hansen 1987)]. Information on colony morphology, sexuality, oogonial characteristics, growth rate, chlamydospores, and sometimes sporangia can be obtained on either one of these media.

Oogonia and Oospores. Oospores are formed as a result of the sexual fusion of single-celled antheridia and oogonia. These “male” and “female” structures may be formed by a single strain of a homothallic species or during mating of two different strains of a heterothallic species. Oospores are distinguished from chlamydospores by the presence of two walls, the external oogonium wall and an internal, thicker wall around the oospore itself. Mature oogonia will also have an antheridium attached. Antheridia attach either around the oogonial stalk (amphigynous) or elsewhere on the oogonium, often adjacent to the stalk (paragynous).

Most homothallic species found in bare-root conifer forest nurseries will form oogonia readily on carrot agar or clar V-8A after 1 to 3 weeks in the dark at room temperature. If oogonia have not formed in four weeks, repeat the procedure on fresh agar. Failure to form oogonia after repeated efforts suggests a heterothallic fungus. Original cultures should come from single zoospore isolates or be subcultured from hyphal tipped colonies to prevent a mixed culture that could incorrectly indicate a homothallic condition.

Isolates suspected to be heterothallic, because they failed to produce oogonia in single culture, should then be paired with one or more known heterothallic species, using both A¹ and A² mating types. If moderate to large numbers of oogonia consistently form with pairings to the same mating type, then the isolate is likely heterothallic. However, the production of oogonia does not necessarily mean the two isolates belong to the same species. Oogonial formation is hormonally regulated and can be induced when two different species are paired (Ko 1980). The resulting oogonia are nearly always the result of selfing and are not the result of interspecific crosses (Boccas 1981).

A good technique to help recognize when selfing has occurred in interspecific pairings is using a known species with distinctive oogonial characteristics, such as *P. cambivora*. This species produces oogonial walls with clearly seen projections. When paired with an unlike species of the opposite mating type, two oogonial

types can be seen in the pairing - one with ornate oogonia belonging to *P. cambivora*, and the other smooth walled, belonging to the other isolate. Size differences and other characteristics can also be distinctive in other species and can be used similarly.

Chlamydospores. In *Phytophthora*, these resting structures are spherical to ovoid, single-celled, and either intercalary or terminal on the hyphae. They are delimited from subtending hyphae by septations. Chlamydospores, if produced, will usually form on either CA or clar V-8A.

Sporangia. The asexual zoospores of *Phytophthora* are formed in sporangia, usually in water. Sporangia are either non-papillate (without terminal protrusion), semi-papillate, or papillate. Sporangial shape and size vary with age and growth conditions. It is important to use standard practices for identification. Characteristics should be observed on the first-formed sporangia. A listing of the different factors influencing sporangial production can be found elsewhere (Ribeiro 1978). Sporangia can be produced in a number of ways. One good and reliable method is to grow isolates in pea broth (PB) in the dark, at room temperature, for three to five days or until the colonies are 1 to 2.5 cm in diameter. Colonies are then carefully and thoroughly rinsed with distilled water, flooded with soil extract water [SEW (directions for preparation are at the end of this paper)], and placed in the dark for 12 to 16 hours to induce sporangia.

Some species of *Phytophthora* will form sporangia and release zoospores above solid media flooded with distilled water. Use young colonies (3 to 5 days old) on clar V-8A or lima bean agar (LBA), flood and rinse repeatedly with sterile water over 6 to 8 hours to leach out excess nutrients, then flood again and incubate for an additional 6 to 8 hours. Sporangia will usually form. A related method uses agar discs containing *Phytophthora*. When placed in SEW as above, sporangia will be induced within 12 to 16 hours. This is a quick method but generally the number of sporangia produced is less than either method already mentioned. Zoospore release can sometimes be stimulated by replacing SEW with distilled water and chilling for 15 to 30 minutes.

To determine whether sporangia are deciduous, vigorously swirl flooded colonies containing sporangia. Deciduous (caducous) sporangia will float free.

Key to selected *Phytophthora* species

- A Zoospores always differentiated outside the sporangium in a vesicle *Pythium* spp.
- A, Zoospores liberated directly from sporangium. *Phytophthora* spp. B
- B Oogonia with predominantly (>50%) paragynous antheridia produced in single strain culture on clar V-8A or CA C
- C Oogonia average >46 μm *P. megasperma* (BHR)
- C₁ Oogonia average <44 μm D
- D Sporangia non-papillate and non-deciduous, ovoid or pear-shaped, (length to width ratio usually large 1.4-1.6:1.0) *P. megasperma* (DF)
- D₁ Sporangia moderately to markedly papillate, nearly round (length to width ratio small 1.0-1.2:1.0) E
- E Sporangia deciduous, markedly papillate, oogonia average 28 μm , good growth (1-5 mm/day) occurs on cornmeal agar at 30°C *P. cactorum*
- E, Sporangia non-deciduous, moderately to markedly papillate F
- F₁ Oogonia average 35 μm , hyphal growth intertwined, little (1 mm/day) or no growth occurs at 30°C *P. pseudotsugae*
- F₂ Oogonia average 35 μm , hyphal growth parallel and distinctly patterned on clar V-8A or CA, growth (>1.0 mm/day) occurs at 30°C, sporangia commonly with multiple apices *P. citricola*
- B, Oogonia with predominantly (>50%) amphigynous antheridia produced in single culture. Species not previously recovered from bare-root conifer nurseries.
- B₂ Oogonia rarely or never produced without opposite strain in clar V-8A or CA, moderate to fast growing (4-9 mm/day at 20°C) G
- G Mycelium with numerous small hyphal swellings *P. cinnamomi*
- G₁ Mycelium without numerous swellings H
- H Colony highly aerial with slight or no pattern on clar V-8A or CA, and fast-growing (5-9 mm/day at 20°C) on cornmeal agar, sporangia 37-55 x 23-30 μm ; oogonia smooth-walled in paired culture *P. cryptogea*
- H₁ Colony appressed with dense rosettes of sharp, compact petals on CA or clar V-8A, moderate growth (4-6 mm/day at 20°C) on cornmeal agar *P. gonapodyides*
- H₂ Some rosette pattern, growth at 35°C. *P. drechsleri*
- H₃ Colony moderately aerial, without pattern on clar V-8A or CA, and moderate growth (4-6 mm/day at 15-20°C) on cornmeal agar. Sporangia large (58-73 x 38-45 μm). Oogonia ornamented in paired culture *P. cambivora*

The following descriptions highlight features of each species that are especially helpful in identifying isolates from forest nurseries. Other sources should be consulted for complete information (Newhook *et al.* 1978; Ho 1981; Waterhouse 1963, 1970; Waterhouse and Blackwell 1954).

Phytophthora cactorum

Papillate, deciduous sporangia and oogonia with paragynous antheridia are characteristic of this homothallic species. This species has recently been found to be very uniform worldwide (M. P. Coffey, P. B. Hamm, and E. M. Hansen, unpublished data). *Phytophthora cactorum* most closely resembles isolates of *P. pseudotsugae* and *P. citricola* from bare-root conifer seedlings. *Phytophthora cactorum* is found on a wide range of hosts worldwide, including *Abies*, *Pinus*, and *Pseudotsuga* in the United States (Adams and Bielenin 1988; Hamm and Hansen 1987) and *Pinus sylvestris* in Sweden (Molin *et al.* 1961).

Sporangia (range 36-50 x 28-35 μm); borne sympodially, are markedly papillate, ovoid to obpyriform, deciduous, and often formed in LBA and on other solid media. Abundant mature oogonia (range 25-32 μm) with paragynous antheridia are commonly formed. Chlamydospores are rarely formed. *Phytophthora cactorum* successfully rots apple fruits.

Phytophthora cambivora

This species is heterothallic, moderately fast growing and patternless with aerial mycelium on clar V-8 agar or CA. *Phytophthora cambivora* generally grows more slowly than *P. cryptogea*, and produces larger sporangia, and oogonia. Oogonia are distinctly ornamented and antheridia commonly are two-celled. It lacks the numerous hyphal swellings and chlamydospores of *P. cinnamomi* on clar V-8A or CA or the rosette pattern formed by *P. gonapodyides* or *P. drechsleri*. *Phytophthora cambivora* has been found to cause root rot in the USA in a forest nursery (P.B. Hamm, unpublished data) and in Christmas tree plantations (Chastagner *et al.* 1990).

Sporangia (58-73 x 38-45 μm) are unbranched, ovoid, and non-deciduous. Ornate oogonia (39-51 μm) with amphigynous antheridia form in paired culture with opposite mating types. The fungus rots apples.

Phytophthora cinnamomi

Chlamydospores are readily produced in culture. Of the species found associated with forest seedlings in nurseries, only *P. cinnamomi* produces abundant chlamydospores (*P. drechsleri* produces chlamydospores in some isolates). *Phytophthora cinnamomi* grows much

faster than *P. lateralis* (4-8 versus 1-2 mm/day, respectively, at 20°C) with numerous hyphal swellings, and rots apples. *Phytophthora cinnamomi* has an extensive host and geographic range worldwide. It is reported to cause damage outside of the United States on *Pseudotsuga menziesii* (Aldhous 1972) and *Pinus radiata* (Basset and Will 1964; Donald and Broembsen 1977; Kassaby and Hepworth 1987; Newhook 1970; Oxenham and Winks 1963a, 1963b) and in the United States on *Abies fraseri* (Bruck and Kenerley 1983), *A. balsamea* and *Picea abies* (Kenerley and Bruck 1981), *Pinus resinosa* (Jackson and Crandall 1935), and other conifers (Crandall *et al.* 1945; Kuhlman and Smith 1975) throughout the eastern states and *P. menziesii* in the Pacific Northwest (Pratt *et al.* 1976).

Sporangia (range 27-114 x 20-71 μm) are persistent, non-papillate, ellipsoid to ovoid and formed on unbranched sporangiophores. Oogonia (21-58 μm) form in paired culture and exhibit amphigynous antheridia. Chlamydospores average 41 μm . *Phytophthora cinnamomi* rots apples.

Phytophthora citricola

Sporangia are often distorted in shape or with two apices, or sit askew on the sporangiophore. They are rarely produced in solid media. This species has been reported to damage *Abies fraseri*, *A. balsamea*, *A. concolor*, *A. procera*, and *Pseudotsuga menziesii* in the United States (Adams and Bielenin 1988; Shew and Benson 1981) and was reported from soil in a nursery in Australia (Davison and Bumbieris 1973).

Sporangia (range 21-70 x 15-39 μm) are semi-papillate, non-deciduous, persistent, obpyriform or obovoid, and usually distorted with multiple apices. Oogonia with paragynous antheridia form in single culture (range 27-32 μm). The fungus rots apples.

Phytophthora cryptogea

This species is fast growing, heterothallic, and produces a patternless, aerial colony when observed on clar V-8A or CA. Hyphal swellings and chlamydospores are not produced. Sporangia and oogonia are smaller than those produced by *P. cambivora*. It is reported in the United States (Pratt *et al.* 1976) and British Columbia (Hamm *et al.* 1985) causing root rot of *Pseudotsuga menziesii*, and is also capable of causing root rot on a large number of other conifer species in artificial inoculations (Campbell and Hamm 1989; Hamm and Hansen 1982a).

Sporangia (range 37-55 x 23-30 μm) are non-papillate, persistent, non-deciduous, ovoid, and produced sympodially. Oogonia are small (range 30-38 μm) having amphigynous antheridia when produced in

paired culture. Chlamyospores are not formed. The fungus rots apples.

Phytophthora drechsleri

This species has been confused with *P. cryptogea* in the past and some think these species should be combined. Isolates of *P. drechsleri* from hosts other than conifers appear distinctly different from isolates of *P. cryptogea* from conifers and for that reason they are separated here. Both species are heterothallic and generally produce oogonia and sporangia of similar size and shape. *Phytophthora drechsleri* forms a slight to distinct rosette pattern in V8A or CA and is lightly to moderately aerial. The production of sporangia with a tapered base is a characteristic that has been used to separate isolates of *P. drechsleri* from *P. cryptogea*. Distinction of these two species most often centers around whether the isolate can grow or not at 35°C. Those which grow are identified as *P. drechsleri*.

Sporangia (range 35-50 x 26-30 μm) are non-papillate, persistent, non-deciduous and generally obpyriform. Oogonia are small (ave. 36 μm) with amphigynous antheridia when produced in paired culture. The fungus rots apples.

Phytophthora gonapodyides

This species occasionally produces sporangia in solid media, particularly in isolation plates, a characteristic similar to *P. cactorum*. Chlamyospores are formed infrequently compared to the abundant production of these spores by *P. cinnamomi*. Colony pattern (strongly radiating) on clar V-8A or CA is distinctive. In the Pacific Northwest this species was originally identified as *P. drechsleri* (Hamm and Hansen 1982a; Hamm *et al.* 1984, 1985; Hansen *et al.* 1979, 1980, 1988; Pratt *et al.* 1976). These isolates were recently found to be identical with *P. gonapodyides* from the United Kingdom (Brasier *et al.* 1989). *Phytophthora gonapodyides*, reported as *P. drechsleri*, causes damage to a large number of conifer seedlings in the United States (Campbell and Hamm 1989; Hamm and Hansen 1982; Pratt *et al.* 1976). *Phytophthora gonapodyides* is found commonly in rivers and streams in remote and semi-remote areas of northwestern North America (E.M. Hansen and others, unpublished data, 1988), and in the United Kingdom (Pitts and Calhoun 1984).

Sporangia are non-papillate, persistent and elongated (range 36-70 x 26-40 μm), and produced on sympodially branched sporangiophores. Oogonia do not form, or, if they are formed, are the result of selfing. Chlamyospores are formed infrequently. It rots apples.

Phytophthora megasperma DF

Two distinct forms of *P. megasperma* are found in conifer nurseries. Oogonia of isolates belonging to *P. megasperma* DF are not as pigmented on clar V-8A or CA as is *P. megasperma* BHR, and are generally produced in large numbers. Optimum growth occurs at 27°C, but isolates also grow well at 35°C (1 to 2 mm/day). Isolates of *P. megasperma* DF are inhibited (80% growth reduction) by metalaxyl at 1 $\mu\text{g}/\text{mL}$ (Hansen and Hamm 1983; Hunger *et al.* 1982). Either group of *P. megasperma* can be separated from the other homothallic species by their production of non-papillate sporangia and generally larger oogonia. Isolates of the group have been infrequently isolated from conifer seedlings in northwestern North America and from non-conifer hosts in the eastern United States and Japan (Hansen *et al.* 1986). Isolates of *P. megasperma* DF are more aggressive than *P. megasperma* BHR in pathogenicity studies and are capable of causing root rot on a large number of conifer hosts but not alfalfa or clover (Hansen and Hansen 1981, 1982a).

Sporangia (average 53 x 35 μm) are persistent, non-papillate, mostly ovoid, and are produced on unbranched sporangiophores. Oogonia (average less than 44 μm) with predominantly paragynous antheridia are produced in single strain culture. Chlamyospores are not formed. The fungus rots apples.

Phytophthora megasperma BHR

Large oogonia produced in single-strain culture are characteristic. Oogonia are usually distinctly pigmented light brown or yellow brown and generally form in moderate quantities on clar V-8A or CA. Optimum growth temperature is 22°C. The fungus will not grow at 35°C. Growth inhibition (*in vitro*) by metalaxyl at 1 $\mu\text{g}/\text{mL}$ is 45% (Hansen and Hamm 1983; Hunger *et al.* 1982). *Phytophthora megasperma* BHR can be separated from the other homothallic species by the production of large oogonia with non-papillate sporangia. This species is present in nurseries of northwestern North America on *P. menziesii* and *Abies* sp. (Hamm and Hansen 1981, 1982a; Hansen *et al.* 1979; Hansen and Hamm 1983; Pratt *et al.* 1976) and is possibly found in Australia (Davison and Bumbieris 1973). It is not as aggressive as *P. megasperma* DF during pathogenicity studies but has a wider host range (Hansen and Hansen 1981, 1982).

Sporangial characteristics are similar to those listed under *P. megasperma* DF. Large oogonia (average more than 46 μm) are produced in single-strain culture with predominantly paragynous antheridia. *Phytophthora megasperma* BHR also rots apples.

Phytophthora pseudotsugae

This species most closely resembles *P. cactorum*, but differs by producing larger oogonia, oospores that often abort (appearing empty to granular within the oogonium), and persistent sporangia; it has a lower optimum temperature for growth than *P. cactorum* (20-25 vs 25-27°C). Sporangia are rarely formed on solid media and are frequent in liquid culture. *Phytophthora pseudotsugae* does not form pigment on casein hydrolysate-tyrosine medium, is sensitive to malachite green (Ho 1981), and does not decay apple fruits (Hamm and Hansen 1983) in contrast to *P. cactorum*. *Phytophthora pseudotsugae* rarely forms hyphal swellings, does not form chlamydospores, and nearly always has paragynous antheridia. *Phytophthora pseudotsugae* has been found only in bare-root conifer nurseries in northwestern North America, attacking *Pseudotsuga menziesii* and *Abies* sp.

Sporangia (average 39 x 32 µm) are persistent and papillate. Oogonia (average 32 µm) are produced in single-strain cultures with paragynous antheridia. *Phytophthora pseudotsugae* rarely forms hyphal swellings and does not form chlamydospores.

Media for isolation and identification of *Phytophthora*

The following is a list of media, their preparation, and uses for isolation and identifying *Phytophthora* species. Additional information can be obtained elsewhere (Ribeiro 1978).

Corn meal agar with pimaricin (CMP)

Seventeen grams of cornmeal is added to 1000 mL distilled water, plus 20 µg/mL Pimaricin (concentration of active ingredient) and autoclaved for 15 minutes at 15 PSI.

When preparing CMP, always add Pimaricin (also called Delvocat, available from Gist-Brocades, 2200 Renaissance Blvd., Suite 150, King of Persia, PA 19406, 1-800-662-4478) before autoclaving. This material comes as a 50% wettable powder. Keep Pimaricin refrigerated in powdered form in an amber bottle and out of direct light. Never use Pimaricin from stock solutions. Always use freshly prepared plates. Older plates can be used for maintaining pure cultures.

CMP is a general selective isolation medium where bacteria are not a special problem, or for determining growth rate or long-term (12 months or longer for some species) storage of isolates in slants at 5°C.

CMP + Ampicillin + Rifamycin (CMP+A+R)

Add 17 g cornmeal agar and 20 µg/mL Pimaricin to 1000 mL distilled water. Autoclave for 15 minutes at 15

PSI. After the medium has cooled to 45°C, add 250 mg/mL Ampicillin and 10 µg/mL Rifamycin from stock solutions. Stock solutions should be prepared using sterile water (Ampicillin) or a 50% ethanol solution (Rifamycin) and stored at 5°C.

Rifamycin and Ampicillin inhibit bacteria without slowing *Phytophthora* or *Pythium* growth. This is a good all-purpose medium for isolating from plant material and is very helpful for removing bacteria from contaminated colonies. This recipe is modified after Jeffers and Martin (1986) who also added PCNB (100 µg/mL). They reported good success in isolating both *Pythium* and *Phytophthora* from soil or plant material. When plating baits, a softer agar is helpful and more successful since baits can be pushed into the agar (Hamm and Hansen 1984). Follow the recipe above but use 10 g/L cornmeal agar for this purpose.

Clarified V-8 Agar (clar V-8A)

To 200 mL of V-8 juice add 1.5 g calcium carbonate. Heat in an autoclave at standard pressure for 5 minutes. This solution is then centrifuged at 2000 RPM for 15 minutes and the supernatant collected. To each 200 mL of supernatant, add 800 mL of distilled water. Agar (15 g/L) is then added to prepare clar V-8A or omitted for clar V-8 Broth, and is autoclaved for 15 minutes (Pratt and Mitchell 1973).

Clar V-8A is particularly useful to observe oogonia and chlamydospore characteristics and can be used to obtain colony morphology information. Clar V-8B is useful for obtaining spores free of medium for inoculum.

Carrot Agar (CA).

Wash and chop 200 g of carrots (in blender), add water, and bring to a boil. Simmer for 45 minutes, then strain through cheese cloth. Add supernatant to water to make 1000 mL. Add agar (15 g/L) and autoclave for 15 minutes (Brasier 1972).

Lima Bean Agar (LBA)

Prepare as per bottle instructions. *Phytophthora cactorum* commonly forms large numbers of sporangia in this medium.

Pea Broth (PB)

In an autoclave, 150 g of split peas is heated in 1 L of distilled water for 3 minutes. The solution is then poured through a double layer of cheese cloth, bottled, and autoclaved for 15 minutes at 15 PSI (Trione 1974). Colonies grown in PB can be stimulated to produce sporangia by using SEW (see below). Chlamydospores

are also produced in large numbers in this medium by *P. cinnamomi*.

P₁₀ VP.

Add pimaricin (10 mg/mL) to 17 g of cornmeal agar before autoclaving. Vancomycin (200 µg/mL) and PCNB are added after cooling to 45 to 48°C. The medium is useful in isolating some *Phytophthora* species from soil (Tsao and Ocana 1969).

Soil Extract Water (SEW)

Add equal amounts of soil and water, stir, and leave overnight at room temperature. Filter through qualitative filter paper (Zentmeyer and Marchall 1959). Soil extract water is used to stimulate sporangia formation, particularly in colonies grown in pea broth. Wash colonies with distilled or tap water carefully and thoroughly prior to the addition of this material. Colonies are then placed in the dark for 12 to 16 hours.

References

- Adams, G.C., Jr.; Bielenin, B. 1988. First report of *Phytophthora cactorum* and *P. citricola* causing crown rot of fir species in Michigan. *Plant Dis.* 72:79.
- Aldhous, J.R. 1972. Nursery Practice, Forestry Commission Bulletin, No. 43, 184 p.
- Barnard, E.L.; Blakeslee, G.M.; English, J.T.; Oak, S.W.; Anderson, R.L. 1985. Pathogenic fungi associated with sand pine root disease in Florida. *Plant Dis.* 69:196-199.
- Basset, C.; Will, G.M. 1964. Soil sterilization trials in two forest nurseries. *N. Z. J. For.* 9:50-58.
- Benson, D.M.; Grand, L.F.; Suggs, E.G. 1976. Root rot of Fraser fir caused by *Phytophthora drechsleri*. *Plant Dis. Rep.* 60:238-240.
- Boccas, B.R. 1981. Interspecific crosses between closely related heterothallic *Phytophthora* species. *Phytopathology* 71:60-65.
- Brasier, C.M. 1972. Observations on the sexual mechanism in *Phytophthora palmivora* and related species. *Trans. Br. Mycol. Soc.* 87:557-573.
- Brasier, C.M.; Ha ** , P.B.; Hansen, E.M. 1989. *Phytophthora* diseases: status of *P. gonapodyides*, *P. drechsleri* and *P. cryptogea*. Pages 45-46 in Report on Forest Research. HMSO, London.
- Broembsen, S.L. von. 1981. Control of *Phytophthora* root rot and other soil-borne diseases of forest nurseries. *South Afr. For. J.* 117:37-40.
- Bruck, R.I.; Kenerley, C.M. 1983. Effects of metalaxyl on *Phytophthora cinnamomi* root rot of *Abies fraseri*. *Plant Dis.* 67:688-690.
- Campbell, S.J.; Hamm, P.B. 1989. Susceptibility of Pacific Northwest conifers to *Phytophthora* root rot. *Tree Planters' Notes* 40:15-18.
- Chastagner, G.A.; Hamm, P.B.; Byther, R.S. 1990. Symptomology of *Phytophthora* root and stem canker disease of Noble fir in the Pacific Northwest. *Phytopathology* 80:887 (Abstract).
- Cooley, S.J.; Hamm, P.B.; Hansen, E.M. 1985. Management guide to *Phytophthora* root rot in bare root conifer nurseries of the Pacific Northwest. USDA Forest Service, Pacific Northwest Region. 13p.
- Crandall, B.S.; Gravatt, G.F.; Ryan, M.M. 1945. Root disease of *Castanea* species and some coniferous and broadleaf nursery stocks caused by *Phytophthora cinnamomi*. *Phytopathology* 35:162-180.
- Davison, E.M.; Bumbieris, M. 1973. *Phytophthora* and *Pythium* from pine plantations in South Australia. *Aust. J. Biol. Sci.* 26:163-169.
- Dick, M.W. 1989. *Phytophthora undulata*, comb. nov. *Mycotaxon* 35:449-453.
- Donald, D.G.M.; Broembsen, S.L. von. 1977. The control of *Phytophthora cinnamomi* Rands in a South African Forest Nursery. *South Afr. For. J.* 100:50-55.
- Eckert, J.W.; Tsao, H. 1962. A selective antibiotic medium for isolation of *Phytophthora* and *Pythium* from plant roots. *Phytopathology* 52:771-777.
- Hamm, P.B.; Hansen, E.M. 1981. Host specificity of *Phytophthora megasperma* from Douglas-fir, soybean, and alfalfa. *Phytopathology* 71:65-68.
- Hamm, P.B.; Hansen, E.M. 1982a. Pathogenicity of *Phytophthora* spp. to Northwest conifers. *Eur. J. For. Pathol.* 12:167-174.
- Ha ** , P.B.; Hansen, E.M. 1982b. Single-spore isolate variation: the effect on varietal designation in *Phytophthora megasperma*. *Can. J. Bot.* 60:2931-2938.
- Ha ** , P.B.; Hansen, E.M. 1983. *Phytophthora pseudotsugae*, a new species causing root rot of Douglas-fir. *Can. J. Bot.* 61:2626-2631.
- Hamm, P.B.; Hansen, E.M. 1984. Improved method for isolating *Phytophthora lateralis* from soil. *Plant Dis.* 68:517-519.
- Hamm, P.B.; Hansen, E.M. 1987. Identification of *Phytophthora* spp. associated with conifers in Northwest North America. *Northw. Sci.* 61:103-109.
- Hamm, P.B.; Cooley, S.J.; Hansen, E.M. 1984. Response of *Phytophthora* spp. to metalaxyl in forest tree nurseries in the Pacific Northwest. *Plant Dis.* 68:671-673.
- Hamm, P.B.; Hansen, E.M.; Hennon, P.E.; Shaw, C.G. III. 1988. *Pythium* species from forest and muskeg areas of southeast Alaska. *Trans. Br. Mycol. Soc.* 91:385-388.

- Hamm, P.B.; Hansen, E.M.; Sutherland, J.R. 1985. *Phytophthora cryptogea* and *P. drechsleri* associated with root rotted Douglas-fir seedlings in British Columbia. *Plant Dis.* 69:361.
- Hansen, E.M.; Hamm, P.B. 1983. Morphological differentiation of host specialized groups of *Phytophthora megasperma*. *Phytopathology* 73:129-134.
- Hansen, E.M.; Brasier, C.M.; Shaw, D.S.; Hamm, P.B. 1986. The taxonomic structure of *Phytophthora megasperma*: Evidence for emerging biological species groups. *Trans. Br. Mycol. Soc.* 87:557-573.
- Hansen, E.M.; Hamm, P.B.; Julis, A.J.; Roth, L.F. 1979. Isolation, incidence, and management of *Phytophthora* in forest tree nurseries in the Pacific Northwest. *Plant Dis. Rep.* 63:607-611.
- Hansen, E.M.; Hamm, P.B.; Shaw, C.G. III; Hennon, P.E. 1988. *Phytophthora drechsleri* in remote areas of southeast Alaska. *Trans. Br. Mycol. Soc.* 91:379-384.
- Hansen, E.M.; Roth, L.F.; Hamm, P.B.; Julis, A.J. 1980. Survival, spread, and pathogenicity of *Phytophthora* spp. on Douglas-fir trees planted on forest sites. *Phytopathology* 70:422-425.
- Ho, H.H. 1981. Synoptic keys to the species of *Phytophthora*. *Mycologia* 73:705-714.
- Hunger, R.M.; Hamm, P.B.; Homer, C.E.; Hansen, E.M. 1982. Tolerance of *Phytophthora megasperma* isolates to metalaxyl. *Plant Dis.* 66:645-649.
- Jackson, L.W.R.; Crandall, B.S. 1935. A *Phytophthora* root and collar rot of *Pinus resinosa* seedlings. *Phytopathology* 25:22. (Abstr.).
- Jeffers, S.N.; Aldwinckle, H.S. 1987. Enhancing detection of *Phytophthora cactorum* in naturally infested soil. *Phytopathology* 77:1475-1482.
- Jeffers, S.N.; Martin, S.B. 1986. Comparison of two media selective for *Phytophthora* and *Pythium* species. *Plant Dis.* 70:1038-1043.
- Kassaby, F.Y.; Hepworth, G. 1987. *Phytophthora cinnamomi*: Effects of herbicides on radial growth, sporangial production, inoculum potential and root disease in *Pinus radiata*. *Soil Biol. Biochem.* 19:437-441.
- Kenerley, C.M.; Bruck, R.I. 1981. *Phytophthora* root rot of balsam fir and Norway spruce in North Carolina. *Plant Dis.* 65:614-615.
- Ko, W.H. 1980. Hormonal regulation of sexual reproduction in *Phytophthora*. *J. Gen. Microbiol.* 116:459-463.
- Kuhlman, E.G.; Smith, R.S., Jr. 1975. *Phytophthora* root rot. Pages 17-18 in: Forest nursery diseases in the United States. G.W. Peterson and R.S. Smith, technical coordinators. U.S. Dept. Agric., Agric. Handb. 470, 125 p.
- Linderman, R.G.; Zeitoun, F. 1977. *Phytophthora cinnamomi* causing root rot and wilt of nursery-grown native western azalea and salal. *Plant Dis. Rep.* 61:1045-1048.
- Massago, H.; Yoshikawa, M.; Fukada, M.; Nakanishi, N. 1977. Selective inhibition of *Pythium* spp. on medium for direct isolation of *Phytophthora* spp. from soils and plants. *Phytopathology* 67:425-428.
- Molin, N.; Persson, M.; Persson, S. 1961. Root parasites on forest tree seedlings. *Medd. Skogsforskn. Inst., Stockh.* 49:1-17.
- Newhook, F.J. 1970. *Phytophthora cinnamomi* in New Zealand. Pages 173-176 in T.A. Toussoun, R.V. Bega, and P.E. Nelson, editors. *Root diseases and soil-borne pathogens*. Univ. Calif. Press, Berkeley. 252 p.
- Newhook, F.J.; Waterhouse, G.M.; Stamps, D.J. 1971. Tabular key to the species of *Phytophthora* de Bary. *Commonw. Mycol. Pap. No.* 143.
- Ostrofsky, W.D.; Pratt, R.G.; Roth, L.F. 1977. Detection of *Phytophthora lateralis* in soil organic matter and factors that affect its survival. *Phytopathology* 67:79-84.
- Oxenham, B.L.; Winks, B.L. 1963a. *Phytophthora* root rot of *Pinus* in Queensland. *Qd. J. Agric. Sci.* 20:355-366.
- Oxenham, B.L.; Winks, B.L. 1963b. *Pinus* damping-off investigations in southern Queensland. *Qd. J. Agric. Sci.* 20:445-461.
- Pitts, J.E.; Calhoun, J. 1984. Isolation and identification of Pythiaceae fungi from irrigation water and their pathogenicity to *Antirrhinum*, tomato and *Chamaecyparis lawsoniana*. *Phytopathol. Z.* 110:301-318.
- Pratt, R.G.; Mitchell, J.E. 1973. A new species of *Pythium* from Wisconsin and Florida isolated from carrots. *Can. J. Bot.* 51:333-339.
- Pratt, R.G.; Roth, L.F.; Hansen, E.M.; Ostrofsky, W.D. 1976. Identity and pathogenicity of species of *Phytophthora* causing root rot of Douglas-fir in the Pacific Northwest. *Phytopathology* 66:710-714.
- Ribeiro, O.K. 1978. A source book of the genus *Phytophthora*. J. Cramer. 417 p.
- Shew, N.D.; Benson, D.M. 1981. Fraser fir root rot induced by *Phytophthora citricola*. *Plant Dis.* 65:688-689.
- Slavekooorde, S.M. 1978. Wenkenvoor de bestrijding van *Phytophthora cinnamomi* in de boom kwekerij. *Bedrijfsontwikkeling* 9:487-488.
- Trione, E.J. 1974. Sporulation and germination of *Phytophthora lateralis*. *Phytopathology* 64:1531-1533.
- Tsao, P.H.; Ocana, G. 1969. Selective isolation of species of *Phytophthora* from natural soils on an improved antibiotic medium. *Nature* 223:636-638.
- Waterhouse, G.M.; Blackwell, E.M. 1954. Key to the species of *Phytophthora* recorded in the British Islands. *Commonw. Mycol. Inst. Mycol. Pap. No.* 57.
- Waterhouse, G. M. 1963. Key to the species of *Phytophthora* de Bary. *Commonw. Mycol. Inst. Mycol. Pap. No.* 92.
- Waterhouse, G. M. 1970. The genus *Phytophthora* de Bary. *Commonw. Mycol. Inst. Mycol. Pap. No.* 122.
- Zentmyer, G.A.; Marchall, L.A. 1959. Factors affecting sporangial production by *Phytophthora cinnamomi*. *Phytopathology* 49:556 (Abstr.).

Fusarium diseases of conifer seedlings

R.L. JAMES

USDA Forest Service, Coeur d'Alene, Idaho

R.K. DUMROESE AND D.L. WENNY

University of Idaho Research Nursery, Moscow, Idaho

Presented at the first meeting of IUFRO Working Party S2.07-09
(Diseases and Insects in Forest Nurseries), Victoria, British Columbia, Canada, August 22-30, 1990.

Abstract

Diseases caused by *Fusarium* spp. are important factors reducing conifer seedling production, particularly in western North America. These diseases are especially damaging to container-grown seedlings. Although most conifer species are affected, these diseases are particularly damaging to Douglas-fir, western larch, true fir, and spruce. Several *Fusarium* spp. are involved, the most common being *F. oxysporum* and *F. acuminatum*. Preventing high infection levels through integrated pest management approaches is the most effective way of reducing losses from *Fusarium* diseases. Consistently placing isolates in proper taxa makes it difficult to work with *Fusarium*.

Resume

Les maladies causées par *Fusarium* spp. contribuent énormément à réduire la production de semis de conifères, notamment dans l'ouest de l'Amérique du Nord. Ces maladies affectent tout particulièrement les semis en récipients. Bien qu'elles infectent la plupart des essences de conifères, elles ravagent tout particulièrement le douglas taxifolié, le mélèze occidental, le sapin et l'épinette. Plusieurs *Fusarium* différents causent des dégâts, les plus répandus étant *F. oxysporum* et *F. acuminatum*. La façon la plus efficace de réduire les pertes causées par *Fusarium* est d'empêcher l'apparition de taux élevés d'infection grâce à l'utilisation de méthodes de lutte intégrée. Il est difficile de travailler avec *Fusarium* car il faut constamment classer les isolats dans le taxon approprié.

Introduction

Many early reports of diseases of conifer seedlings grown in nurseries described damping-off and root diseases. *Fusarium* spp. were consistently isolated from diseased seedlings and shown capable of eliciting disease in controlled pathogenicity tests (Gifford 1911; Hartley and Merrill 1914; Hartley and Pierce 1917). Most control attempts involved using agricultural fungicides and fumigants to reduce disease losses (Hartley and Merrill 1914). Many early studies were designed to determine which environmental factors in the nursery were conducive or restrictive to disease (Rathbun 1922; Tint 1945a, 1945b).

Although environmental effects were studied, epidemiology of the disease on conifer seedlings was unclear until a series of reports by Bloomberg (1971; 1973; 1976) detailed the biology of root disease caused by *F. oxysporum* Schlecht. on bareroot Douglas-fir seedlings in British Columbia. This work provided the basis for understanding the epidemiology of *F. oxysporum*; a model outlining infection processes and disease development was formulated (Bloomberg 1979). This model helped nursery growers develop more effec-

tive strategies for combating disease in bareroot nurseries. Unfortunately, not all of this information is applicable to container operations, which are increasing in importance in the western United States and Canada. *Fusarium*-associated diseases are extremely damaging in some container facilities (James 1986a). Efforts to control these diseases using common fungicides have often failed (James *et al.* 1988c; Williams 1989). To formulate more effective ways of reducing damage, investigations were initiated in the early 1980s to understand the biology of *Fusarium* spp. in container operations. Results of some of this work are briefly summarized in this paper.

Types of diseases

Fusarium spp. cause several different diseases on conifer seedlings. These fungi decay seed, thus preventing germination (Bloomberg 1981; Huang and Kuhlman 1990; Matuo and Chiba 1966). They also induce damping-off either before (pre) or after (post) seedling emergence (Bloomberg 1981; Hartley *et al.* 1914; Lock 1973). Damped-off seedlings are usually attacked at the radicle or main stem when tissues are succulent

(Spaulding 1914). Once seedling stems lignify a few weeks after emergence, they are no longer susceptible to damping-off (Rathbun-Gravatt 1925; Spaulding 1914). *Fusarium* spp. also cause root disease during the first growing season, but seldom cause disease on bareroot stock during the second growing season (Enebak *et al.* 1990; Sinclair *et al.* 1975). Several *Fusarium* spp. are capable of causing stem cankers above or just below the groundline (Brownell and Schneider 1985; Cooley 1983; Hansen and Hamm 1988); these cankers may expand and eventually girdle seedlings. Some *Fusarium* spp. also cause top blight, resulting in apical dieback of seedlings (Bloomberg 1981; Hartley *et al.* 1914; Matuo and Chiba 1966). *Fusarium* canker and top blight diseases may be associated with other pathogenic organisms (Hansen and Hamm 1988).

A major problem in dealing with *Fusarium* diseases is seedling infection without disease symptoms being produced (Bloomberg 1971, 1973; Hartley *et al.* 1914; James *et al.* 1987). Surveys indicate that many seedlings may be infected although disease symptoms are lacking (James and Gilligan 1988d), especially on container-grown seedlings (James and Gilligan 1985, 1988a; James *et al.* 1987).

Hosts affected

Most conifer species are susceptible to infection by *Fusarium* spp. (Bloomberg 1981). However, in western North America, most damage occurs on Douglas-fir, western larch, true fir, and Engelmann spruce (Bloomberg 1971; Hansen and Hamm 1988; James 1985c; James and Gilligan 1985; James *et al.* 1987). Sugar pine is also severely damaged in southern Oregon and northern California (Cooley 1983). Although commonly infected, ponderosa pine rarely displays disease symptoms (James 1985c; James and Gilligan 1988a).

Associated *Fusarium* spp.

Work with bareroot conifer seedlings identified *F. oxysporum* as the major pathogen (Bloomberg 1971, 1973, 1976, 1979; Brownell and Schneider 1985; Cooley 1983; Tint 1945a). This species is also common on container-grown seedlings, but other species frequently isolated include *F. acuminatum* Ell. & Ev., *F. avenaceum* (Fr.) Sacc., *F. solani* (Mart.) Appel & Wollenw., *F. sambucinum* Fuckel, and *F. tricinctum* (Corda) Sacc. (James *et al.* 1989b). Isolates of *F. oxysporum* and *F. acuminatum* can cause severe disease of container-grown seedlings (James and Gilligan 1984; James *et al.* 1986, 1989a). Other fusaria occasionally isolated from container-grown conifer seedlings include *F. poae* (Peck) Wollenw., *F. equiseti* (Corda) Sacc., *F. lateritium* Nees., *F. moniliforme* Sheldon, *F. proliferatum* (Matsushima)

Nirenberg, *F. subglutinans* (Wollenw. & Reinking) Nelson, Toussoun & Marasas, and *F. sporotrichioides* Sherb. (James 1986a; James and Gilligan 1985; James *et al.* 1988c). Under certain environmental conditions, some of these species may be pathogenic to conifer seedlings (Bloomberg 1981; Rathbun-Gravatt 1925).

Epidemiology in container-grown seedlings

Conifer seed assayed prior to or just after sowing is often contaminated with *Fusarium* spp. (James 1986b, 1987b). These fungi are isolated most frequently from seedcoats, with much lower levels found internally on seed embryos (James 1987b). Extent of seed contamination seems related to seedlot, i.e., greater disease occurs within specific seedlots. Disease levels are often higher in seedlots obtained from squirrel caches than those collected directly from trees (James 1987b), although some specific lots gathered from trees may be extensively colonized with *Fusarium* (James 1985b). Investigations to locate sources of seed contamination during cone collection, transport, and processing have been lacking. However, *Fusarium* spp. may spread throughout seedlots during stratification (W.R. Littke, Weyerhaeuser Forestry Research Center, Centralia, WA., personal communication) and are often introduced into container operations on contaminated seed (James 1986a, 1987b).

Another important source of *Fusarium* inoculum in container operations is contaminated containers reused to grow several crops of seedlings. *Fusarium* spp. often colonize the inner walls of both styroblock and pine cell containers (James and Gilligan 1988b; 1988c; James *et al.* 1988a). Other possible inoculum sources include organic debris on greenhouse benches, walls, and floors and weeds growing within or adjacent to greenhouses (James *et al.* 1987). Weeds may harbor *Fusarium* spp. similar to those that attack conifer seedlings (James *et al.* 1987), although their pathogenicity to seedlings has yet to be evaluated. Investigations have shown that *Fusarium* spp. produce spores usually disseminated by water splash (Ingold 1960; Snyder 1981). However, spores of some fusaria are dispersed by air currents, particularly within greenhouses (Horst *et al.* 1970; Lukezic and Kaiser 1966; Rowe *et al.* 1977), and may be introduced through various openings. Importance of airborne inoculum in container conifer seedling production has yet to be determined.

Fusarium inoculum remains viable for long periods of time as chlamyospores (Park 1959; Price 1984). Under the right conditions of temperature, moisture, nutrients, and presence of a suitable host, i.e., exudation production by host roots, these spores will germinate and may infect seedling roots (Elad and Baker 1985;

Oritsejafor and Adeniji 1990; Price 1984). When environmental conditions are conducive, parasitic *Fusarium* species are rapid colonizers of host roots via rapid spore germination and penetration of host epidermal and cortical cells (Bloomberg 1973; Bloomberg and Trelawny 1970; Katan 1971). Pathogenic strains of *Fusarium* may be poor competitors with other soil organisms (Mitchell and Alexander 1961; Palmer and Kommedahl 1969; Sivan and Chet 1989). They are adapted to remain dormant until a suitable host is available (Gordon *et al.* 1989; Palmer and Kommedahl 1969).

Once host penetration occurs, *Fusarium* extensively colonizes cortical tissues (Bloomberg 1976), although penetration into root endodermis tissues and subsequent attack on the vascular system may be delayed (Gerik and Huisman 1985). Infections may remain quiescent in cortical tissues throughout much of the seedling growth cycle. Although present, *Fusarium* spp. may not necessarily initiate below or above-ground disease symptoms (James *et al.* 1987). Symptom production may be due to virulence characteristics of the colonizing *Fusarium* strains (Bloomberg 1971) and environmental stresses that reduce host resistance or enhance pathogen activity. Interactions of many inter-related factors probably influence disease severity (Fisher and Toussoun 1983). Unfortunately, in container-grown seedlings, root infection is an inaccurate predictor of disease levels (James *et al.* 1987). More research is needed to quantify environmental influences on disease symptom expression in conifer seedlings.

Once disease symptoms appear on host plants, *Fusarium* has extensively colonized the root system (Harling *et al.* 1988; James *et al.* 1987). For conifer seedlings, symptoms include general wilting (including twisting of needles) and needle-tip dieback followed by foliar chlorosis and necrosis (James 1985c; James and Gilligan 1985; James *et al.* 1987). Many diseased seedlings are also stunted (James *et al.* 1987). When seedlings die, orange-colored sporodochia sometimes appear on the main stem just above the groundline (James 1986a; Landis 1976). Only some *Fusarium* spp. are capable of producing sporodochia (Nelson *et al.* 1983), but seedlings infected with these species may still lack these structures (James *et al.* 1987). Disease symptoms of container-grown seedlings are most apparent for about 2-3 weeks after seedling emergence and more severe toward the end of the growth cycle when seedlings are water and nutrient stressed during bud initiation and hardening-off (James 1986a; James and Gilligan 1985; James *et al.* 1987).

Seedlings transplanted within nurseries or outplanted in forests may be stressed until they become estab-

lished. Seedlings infected with *Fusarium* may become diseased as a result of this stress. This has been verified when infected seedlings are transplanted elsewhere in the nursery (James, unpublished), but may or may not be important once seedlings are outplanted in forest soils. Previous investigation (Smith 1967) showed that *Fusarium* spp. are often replaced by other microorganisms on roots once seedlings are outplanted in forest soils. *Fusarium* spp. are insignificant inhabitants of most temperate forest soils (Meyer 1967; Park 1963) and may be unable to successfully compete with other microorganisms (Mitchell and Alexander 1961; Sivan and Chet 1989). Therefore, planting infected seedlings in forest soils may not necessarily result in high disease losses.

Control options

Fusarium diseases in some bareroot nurseries have effectively been controlled with soil fumigation using standard biocides like methyl bromide and chloropicrin (Sinclair *et al.* 1975). Fungicide drenches are also periodically used to control disease in seedbeds (Bloomberg and Orchard 1969). However, fungicide treatments are usually less effective than fumigation.

Unfortunately, control of *Fusarium* diseases of container-grown seedlings has proven more difficult. An integrated program to reduce host infection levels has been the best approach (James *et al.* 1988c). Reducing levels of *Fusarium* inoculum to which seedlings are exposed is important in limiting infection. Prevention is much more effective than trying to "cure" disease once symptoms are noticed (James *et al.* 1988c; Williams 1989).

It is important to reduce inoculum carried on seed. Treating seeds with chemical pesticides has produced mixed results. Surface sterilants such as hydrogen peroxide and sodium hypochlorite (standard bleach) have been effective in reducing amounts of seedborne *Fusarium* (Bamett 1976; Dumroese *et al.* 1988; James and Genz 1981). Unfortunately, these chemicals are sometimes toxic and may adversely affect seed germination or damage young germinants (Edwards and Sutherland 1979; James 1983). Fungicides have also been tested as seed treatments, but problems with reduced germination and phytotoxicity have precluded their widespread use (Cooley 1983; Lock *et al.* 1975). Subjecting seed to running water rinses for at least 48 h. is effective in reducing amounts of *Fusarium* and other fungi colonizing seedcoats while preconditioning seed for germination (James 1987a; James and Genz 1981). Running water rinses are more effective in reducing fungal inoculum than standing water. Treating seeds with water heated with microwaves was also effective

in reducing amounts of seedborne *Fusarium* (James *et al.* 1988b).

Another potential source of *Fusarium* inoculum is the peat:vermiculite growing medium for container seedlings (James 1985a). Growing media can be fumigated or steam treated to reduce potential pathogen populations (Baker and Olson 1959). However, commercially prepared media are usually pathogen-free and may contain fairly large populations of antagonistic organisms (James 1985a). Therefore, media is not usually treated unless severe disease problems occur (James and Gilligan 1984).

One major source of *Fusarium* inoculum in container operations is reused styroblock and plastic cell containers (James *et al.* 1988a). *Fusarium* propagules, which increase with repeated use, are usually found at highest levels near the bottom of containers (James 1989). High-pressure steam, commonly used at many nurseries to clean containers, is usually inadequate at removing these propagules (James *et al.* 1988a). However, recent work (James and Woollen 1989) indicates that immersion of containers in hot water may effectively kill pathogens, particularly if water temperatures are above 68°C and containers are immersed for at least 3-5 min. A little detergent or surfactant added to the hot water improves contact with container surfaces. Several chemicals including sodium metabisulfite, standard bleach, and other common sterilants have been used to clean containers (Sturrock and Dennis 1988). Although some of these successfully reduce *Fusarium*, there may be problems with worker exposure to and disposal of toxic chemicals. For these reasons, many growers are implementing hot water immersion methods for cleaning containers.

When growing seedlings in greenhouses, sanitation before and during each crop is very important. Interior surfaces of greenhouses, including benches, walls, ceilings, and floors, should be washed thoroughly between crops with sterilants such as bleach. Weeds within and adjacent to greenhouses should be removed periodically, since they may harbor *Fusarium* spp. that attack nursery seedlings (James *et al.* 1987). During the crop cycle, diseased seedlings should be removed to help prevent fungal spread within greenhouses.

Unfortunately, fungicides are only partially effective in controlling *Fusarium* diseases (James *et al.* 1988c; Williams 1989). They are usually effective against damping-off, but often inadequately control root disease of older seedlings (James and Gilligan 1984; James *et al.* 1988c). This is probably because much inoculum and root infection occurs near the bottom of plugs (James 1989) and chemicals seldom reach most infection sites in sufficient concentrations to

be toxic. Also, by the time above-ground symptoms become apparent, seedling root systems are thoroughly colonized and most fungicides are unable to "cure" infected plants. Another problem with repeated chemical use is potential development of fungicide resistance by *Fusarium* (Dekker 1976). When exposed to the same fungicides for a long time, selection pressure on fungi may be high enough to induce resistance. By using the lowest effective dosages and rotating several different fungicides, chances for development of resistance in resident pathogen populations may be minimized (Delp 1980).

Several environmental factors significantly affect severity of *Fusarium* diseases of container-grown conifer seedlings. Nitrogen fertilizers often stimulate succulent growth of seedlings making them more susceptible to damping-off (Sinclair *et al.* 1975; Tint 1945a). Ammonia nitrogen sources are usually more conducive to disease than nitrate nitrogen (Maurer and Baker 1965). Potassium amendments may improve host resistance to disease, at least in young seedlings (McClellan and Stuart 1947; Sinclair *et al.* 1975). Saturated conditions due to overwatering reduce oxygen interchange of roots and may help promote infection by pathogenic fungi (Hargreaves and Fox 1978). Also, too little water stresses plants and promotes infection and increased disease severity (Cook 1981). Another important factor affecting disease severity by *Fusarium* spp. is temperature (Bloomberg 1973). Several *Fusarium* spp. are considered "warm weather" fungi, growing best and inciting more severe disease at high temperatures (above 24°C) (Bloomberg 1973; Booth 1971; Nelson *et al.* 1983; Tint 1945b). By properly controlling temperature, moisture, and fertilizers, impact of *Fusarium* diseases can be reduced.

Under natural conditions, many *Fusarium* spp. are restricted by a wide range of competitive and antagonistic microorganisms. Several potential biological control organisms have been developed commercially for control of different pathogens, including *Fusarium* (Harman and Taylor 1988; Stasz *et al.* 1988). These include fungi of *Trichoderma* and *Gliocladium*, and several types of bacteria (Baker and Cook 1974; Papavizas 1985). Biological control organisms exert direct antibiosis against pathogens, compete for space, nutrients, and colonization sites, and may parasitize pathogens (Baker and Cook 1974). Biological control agents may be applied during sowing as a topical dressing or incorporated into the growing medium; they may also be applied as seed dressings. Although biological control has proven effective in many agricultural systems, adequate testing on conifer seedlings is lacking. An integrated approach using cultural, biologi-

cal, and chemical treatments is needed to effectively control *Fusarium* diseases of container-grown seedlings.

Working with *Fusarium*

One of the greatest difficulties plant pathologists have when working with *Fusarium* diseases is taxonomy (Price 1984). Isolation of organisms from diseased seedlings is fairly easy and confirming pathogenicity is usually simple. However, placing isolated fusaria into the proper taxa on a consistent basis may be quite difficult. This problem is compounded by the fact that there are several different "accepted" taxonomic treatments of *Fusarium*. Taxonomic problems make it difficult to compare findings reported in the literature because of possible isolate misidentification.

Isolation of associated *Fusarium* spp.

Standard procedures for *Fusarium* isolation include washing of plant surfaces to remove pieces of soil or organic debris. Washed specimens are surface sterilized to eliminate contaminating organisms. This is especially important for roots where rhizosphere organisms may be confused with root-infecting organisms (Parkinson 1967). After surface sterilization, tissues are rinsed with sterile water to remove residual sterilant. For quantification of root colonization, selecting root tips or randomly selecting root pieces from dissected root systems has proven useful (James 1985c; James and Gilligan 1985). Some investigators determine extent of root colonization by calculating number of *Fusarium* colonies per unit length of root (Bloomberg 1973). Several different selective media have been developed for preferentially isolating *Fusarium* spp. while keeping soil saprophytes and other microorganisms at a minimum. Most of these contain antibiotics and fungicides, such as PCNB, which restrict growth of common soil fungi and bacteria. Nash and Snyder (1962) developed their selective medium specifically for *F. soluni*, but it is effective for isolating most fusaria. Komada (1975) developed another medium specifically for *F. oxysporum* and closely related species, but some *Fusarium* spp. grow poorly on this medium and may be overlooked (Nelson *et al.* 1983). However, this medium has proven very useful in isolating *Fusarium* spp. associated with conifer seedling diseases (James *et al.* 1989b).

Plates should be incubated under light to induce sporulation necessary for identification. Diurnal cycles of cool, fluorescent light are usually successful (Komada 1975). Black light also induces sporulation of fusaria (Nirenberg 1981). Plates are incubated at about 24°C (22-26°C) for 7 to 10 days to allow fungi to grow from

the sample and over the agar surface. When colonies are confirmed as *Fusarium*, portions should be transferred to potato dextrose agar (PDA) or other media necessary for identification.

Identification of associated *Fusarium* spp.

Because of their importance as plant pathogens, *Fusarium* spp. have been studied extensively. Several taxonomic treatments of this genus have been formulated, each with slightly different emphasis on characteristics thought to be consistent for specific taxa. Taxonomy of the genus has been based on morphology, physiology, genetics, and molecular biology. Most practicing plant pathologists are limited by expertise or facilities to using morphological characteristics which can consistently differentiate taxa. Most taxonomic systems based on morphological characteristics use presence of microconidia and chlamydospores, morphology of macroconidia, and types of conidiogenous cells as major criteria. Less important characteristics include colony morphology and pigmentation, growth rates at specific temperatures, and production of sporodochia and sclerotia. Several of these latter characteristics vary widely among different isolates of the same taxon and mutations may occur over time. It is important that the taxonomic system used by plant pathologists emphasizes consistent characters easily determined and without excessive subjective judgment on the part of the observer.

Experience during the past several years indicates that the taxonomic system of Nelson *et al.* (1983) is relatively easy to use and provides consistent identifications of *Fusarium* spp. isolated from conifer seedlings. Another useful taxonomic system is by Gerlach and Nirenberg (1982). Both systems were developed from the original taxonomic work on the genus by Wollenweber and Reinking (1935). The Nelson system has proven more practical for identification of commonly encountered fusaria than descriptions by Snyder and Hansen (1940) or Booth (1971). Snyder and Hansen's system lumps all fusaria into only nine species. Our experience is that many isolates classified as the same species by their system are clearly different and should be separated. Booth's system seems too cumbersome and has too many individual taxa delimiting organisms with only slight variations. However, the system of Nelson *et al.* (1983) seems a reasonable compromise. Important characteristics of the Nelson system include using standard growing conditions, media, and transfer procedures. For this system, all isolates to be identified should be grown on carnation leaf agar to induce sporodochia and uniform (size and shape) production of macroconidia and microconidia

(Fisher *et al.* 1982). Plates should be incubated under diurnal cycles of cool, fluorescent light to enhance spore formation and uniform growth. Single-spore transfers should be made to reduce potential for mutation, particularly when isolates remain on agar media high in carbohydrates (such as PDA) for extended periods of time. For colony morphology, pigment production, and growth rate, potato dextrose agar is recommended. Growth on water agar amended with KCl promotes microconidial chains for isolates in the group *Liseola*. Several of these fungi produce microconidia in both false heads and chains, but the characteristic chains are usually absent unless grown on a medium with low water potential, such as water agar amended with KCl. Another useful technique is growth on a low nutrient medium (SNA) with exposure to continuous black light. This induces sporodochia and microconidial chain formation (Nirenberg 1981).

Several *Fusarium* spp. are notorious for mutating in culture. These mutants usually proceed from more natural sporodochial types (Waite and Stover 1960; Wellman and Blaisdell 1941). Mutants may either be mycelial, which form abundant aerial mycelium but few macroconidia, or pionnotal types, which produce little or no aerial mycelium but abundant macroconidia (Nelson *et al.* 1983). Mycelial mutant types frequently lack sclerotia, sporodochia and pigmentation; pionnotal mutant types have a slimy, wet appearance (Waite and Stover 1960). In pathogenic isolates, mutants frequently exhibit a loss in virulence and toxin production. Mutation can be minimized by single-sporing cultures, hyphal tipping (instead of mass transferring cultures), avoidance of carbon-rich media (such as PDA), and keeping subculturing to a minimum (Nelson *et al.* 1983; Wellman and Blaisdell 1941). Long-term storage of cultures is best in either liquid nitrogen or by lyophilization (Nelson *et al.* 1983).

Pathogenicity testing

Some *Fusarium* isolates commonly obtained from conifer seedlings with disease symptoms are not pathogenic (James and Gilligan 1984; James *et al.* 1989a). Non-pathogenic fungi often reside in the rhizosphere or superficially colonize roots (Parkinson 1967). In order to confirm pathogenicity, suspected isolates must be subjected to Koch's postulates (Agrios 1969). If done properly, isolates that fulfill the criteria defined by

Koch's postulates can be classified as pathogens. However, care must be taken to ensure that inoculum concentrations are not excessive and that tests are not contaminated with other *Fusarium* isolates (James *et al.* 1989a).

Different inoculum types have been used for evaluating pathogenicity of *Fusarium*. Some investigators used spore suspensions, either dipping test seedlings in solutions (Walker and Foster 1946) or pouring solutions next to seedlings (Walker and Hooker 1945). Stem inoculations have also proven useful for quick screening of large numbers of isolates (Hansen and H a •• 1988). One common technique used for conifer seedlings is introduction of test isolates on young germinants in sterile test tubes (James *et al.* 1986; Vaartaja and Bumbieris 1967). Although such tests may seem quite artificial, they can provide useful information for a large number of isolates in a short period of time.

One very successful method for inoculating conifer seedlings uses inoculum composed of a cornmeal-perlite substrate colonized by *Fusarium*. This inoculum is incorporated into growing media in which seedlings are transplanted (James and Gilligan 1984; James *et al.* 1989a). This method is a variation of that described by Miles and Wilcoxson (1984) and closely mimics behavior of chlamydospores in a natural environment, i.e., the perlite substrate provides a source of fungal material which can infect roots as a response to root exudates. If refrigerated, cornmeal-perlite inoculum remains viable for a year or more.

When properly conducted, pathogenicity tests can give useful information regarding fusaria encountered when investigating conifer seedling diseases. However, such tests are time-consuming and expensive. Valuable but less costly alternatives include protein analysis (Partridge *et al.* 1984), vegetative compatibility (Puhalla 1985), and genetic tests comparing nucleic acids (Kuninaga and Yokosawa 1989). Comparisons with known pathogenic isolates could be made rather quickly, thus precluding the need for elaborate pathogenicity tests. Unfortunately, these techniques require a certain amount of expertise and equipment often unavailable to many plant pathologists. Nevertheless, these and other new techniques should be evaluated when possible to improve our understanding about *Fusarium* isolates associated with conifer seedling diseases.

References

- Agrios, G.N. 1969. Plant pathology. Academic Press, New York. 629 p.
Baker, K.F.; Cook, R.J. 1974. Biological control of plant pathogens. W.H. Freeman & Co., San Francisco, CA. 433 p.
Baker, K.F.; Olson, S.M. 1959. Soil steaming. Calif. State Florist Assoc. Bull 8(9): 1-10.
Barnett, J.P. 1976. Sterilizing southern pine seeds with hydrogen peroxide. Tree Planters' Notes 27(3): 17-19.

-
- Bloomberg, W.J. 1971. Diseases of Douglas-fir seedlings caused by *Fusarium oxysporum*. *Phytopathology* 61: 467-470.
- Bloomberg, W.J. 1973. *Fusarium* root rot of Douglas-fir seedlings. *Phytopathology* 63: 337-341.
- Bloomberg, W.J. 1976. Distribution and pathogenicity of *Fusarium oxysporum* in a forest nursery soil. *Phytopathology* 66: 1090-1092.
- Bloomberg, W.J. 1979. Model simulations of infection of Douglas-fir seedlings by *Fusarium oxysporum*. *Phytopathology* 69: 1071-1077.
- Bloomberg, W.J. 1981. Disease caused by *Fusarium* in forest nurseries. Pages 178-187 in P.E. Nelson, T.A. Toussoun and R.J. Cook, editors. *Fusarium: diseases, biology, and taxonomy*. The Pennsylvania State University Press, University Park.
- Bloomberg, W.J.; Orchard, W.R. 1969. Chemical control of root disease of Douglas-fir seedlings in relation to fungus and nematode populations. *Ann. Appl. Biol.* 64: 239-244.
- Bloomberg, W.J.; Trelawny, J. 1970. Effect of thiram on germination of Douglas-fir seed. *Phytopathology* 60: 1111-1116.
- Booth, C. 1971. The genus *Fusarium*. The Commonwealth Mycological Institute, Kew, Surrey, England. 237 p.
- Brownell, K.H.; Schneider, R.W. 1985. Delimitation of lesions of *Fusarium* hypocotyl rot of pine by soil microsite environmental determinants. *Phytopathology* 75: 58-60.
- Cook, R.J. 1981. Water relations in the biology of *Fusarium*. Pages 236-244 in P.E. Nelson, T.A. Toussoun and R.J. Cook, editors. *Fusarium: diseases, biology, and taxonomy*. The Pennsylvania State University Press, University Park.
- Cooley, S.J. 1983. Seed and soil treatments to reduce seed decay and *Fusarium* root rot of sugar pine. U.S.D.A. For. Serv., Pacific Northwest Region. *Forest Pest Mgt.* 8 p.
- Dekker, J. 1976. Acquired resistance to fungicides. *Ann. Rev. Phytopathol.* 14: 405-428.
- Delp, C. 1980. Coping with resistance to plant disease control agents. *Plant Dis.* 64: 652-657.
- Dumroese, R.K.; James R.L.; Wenny, D.L.; Gilligan, C.J. 1988. Douglas-fir seed treatments: effects on seed germination and seedborne organisms. Pages 155-160 in T.D. Landis, Tech. Coord. Proceedings of the combined meeting of the Western Forest Nursery Associations. Vemon, British Columbia, August 8-11, 1988. U.S.D.A. For. Serv., Gen. Tech. Rep. RM-167.
- Edwards, D.G.W.; Sutherland, J.R. 1979. Hydrogen peroxide treatment of *Abies* seed. *Can. For. Serv., Bi-Monthly Res. Notes* 35: 3-4.
- Elad, Y.; Baker, R. 1985. The role of competition for iron and carbon in suppression of chlamydospore germination of *Fusarium* spp. by *Pseudomonas* spp. *Phytopathology* 75: 1053-1059.
- Enebak, S.A.; Palmer, M.A.; Blanchette, R.A. 1990. Managing soilborne pathogens of white pine in a forest nursery. *Plant Disease* 74: 195-198.
- Fisher, N.L.; Burgess, L.W.; Toussoun, T.A.; Nelson, P.E. 1982. Carnation leaves as a substrate and for preserving cultures of *Fusarium* species. *Phytopathology* 72: 151-153.
- Fisher, N.L.; Toussoun, T.A. 1983. Symptom response and colonization as measures of resistance in chrysanthemum cultivars inoculated with *Fusarium oxysporum* f. sp. *chrysanthemi*. *Plant Dis.* 67: 376-378.
- Gerik, J.S.; Huisman, O.C. 1985. Mode of colonization of roots by *Verticillium* and *Fusarium*. Pages 80-83 in C.A. Parker, editor. *Ecology and management of soilborne plant pathogens*. American Phytopathological Society, St. Paul, MN.
- Gerlach, W.; Nirenberg, H. 1982. The genus *Fusarium* - a pictorial atlas. Paul Parey, Berlin. 406 p.
- Gifford, C.M. 1911. The damping-off of coniferous seedlings. *Vermont Agric. Exp. Stn. Bull.* 157: 140-171.
- Gordon, T.R.; Okamoto, D.; Jacobson, D.J. 1989. Colonization of musk-melon and nonsusceptible crops of *Fusarium oxysporum* f. sp. *melonis* and other species of *Fusarium*. *Phytopathology* 79: 1095-1100.
- Hansen, E.M.; Hamm, P.B. 1988. Canker diseases of Douglas-fir seedlings in Oregon and Washington bareroot nurseries. *Can. J. For. Res.* 18: 1053-1058.
- Harman, G.E.; Taylor, A.G. 1988. Improved seedling performance by integration of biological control agents at favorable pH levels with solid matrix priming. *Phytopathology* 78: 520-525.
- Hargreaves, A.J.; Fox, R.A. 1978. Some factors affecting survival of *Fusarium avenaceum* in soil. *Trans. Brit. Mycol. Soc.* 70: 209-212.
- Harling, R.; Taylor, G.S.; Matthews, P.; Arthur, A.E. 1988. The effect of temperature on symptom expression and colonization in resistant and susceptible carnation cultivars infected with *Fusarium oxysporum* f. sp. *dianthi*. *J. Phytopathol.* 121: 103-117.
- Hartley, C.; Merrill, T.C. 1914. Preliminary test of disinfectants in controlling damping-off in various nursery soils. *Phytopathology* 4: 89-92.
- Hartley, C.; Merrill, T.C.; Rhoads, A.S. 1914. Seedling diseases of conifers. *J. Agric. Res.* 15: 521-558.
- Hartley, C.; Pierce, R.G. 1917. The control of damping-off of coniferous seedlings. U.S.D.A. Agricultural Bulletin 453. 32 p.
- Horst, R.K.; Nelson, P.E.; Toussoun, T.A. 1970. Aerobiology of *Fusarium* spp. associated with stem rot of *Dianthus caryophyllus*. *Phytopathology* 60: 1296.
- Huang, J.W.; Kuhlman, E.G. 1990. Fungi associated with damping-off of slash pine seedlings in Georgia. *Plant Disease* 74: 27-30.
- Ingold, C.T. 1960. Dispersal by air and water - the take off. Pages 137-168 in J.G. Horsfall and A.E. Dimond, editors. *Plant Pathology*, Vol. 3. Academic Press, New York.
-

-
- James, R.L. 1983. *Fusarium* root disease of containerized seedlings at the Montana State Nursery, Missoula. U.S.D.A., For. Serv., Northern Region. Timber, Cooperative Forestry and Pest Manage. Nursery Disease Notes 5. 9 p.
- James, R.L. 1985a. Diseases associated with containerized seedling soil mixes. Tree Planters' Notes 36(2): 3-5.
- James, R.L. 1985b. Pathogenic *Fusarium* on spruce seed from the Towner Nursery, North Dakota. U.S.D.A. For. Serv., Northern Region. Timber, Cooperative Forestry and Pest Manage. Rep. 85-23. 9 p.
- James, R.L. 1985c. Studies of *Fusarium* associated with containerized conifer seedling diseases: (2). Diseases of western larch, Douglas-fir, grand fir, subalpine fir, and ponderosa pine seedlings at the USDA Forest Service Nursery, Coeur d'Alene, Idaho. U.S.D.A. For. Serv., Northern Region. Timber, Cooperative Forestry and Pest Manage. Rep. 85-12. 7 p.
- James, R.L. 1986a. Diseases of conifer seedlings caused by seed-borne *Fusarium* species. Pages 267-271 in R.C. Shearer, compiler. Proceedings of the symposium on conifer tree seed in the inland mountain West. Missoula, Montana, Aug. 5-6, 1985. U.S.D.A., For. Serv., Gen. Tech. Rep. INT-203.
- James, R.L. 1986b. Occurrence of *Fusarium* on Douglas-fir seed and containerized seedlings at the Plum Creek Nursery, Pablo, Montana. U.S.D.A. For. Serv., Northern Region. Timber, Cooperative Forestry and Pest Manage. Rep. 86-4. 10 p.
- James, R.L. 1987a. Effects of water rinse treatments on occurrence of fungi on spruce seed from the Towner Nursery, North Dakota. U.S.D.A. For. Serv., Northern Region. Timber, Cooperative Forestry and Pest Manage. Rep. 87-5. 4 p.
- James, R.L. 1987b. Occurrence of *Fusarium* on conifer tree seed from Northern Rocky Mountain nurseries. Pages 109-114 in T.D. Landis, tech. coord. Proceedings of the combined Western Forest Nursery Council and Intermountain Nursery Association meeting. Tumwater, Washington, Aug. 12-15, 1986. U.S.D.A. For. Serv., Gen. Tech. Rep. RM-137.
- James, R.L. 1989. Spatial distribution of fungi colonizing Leach pine cell containers - USDA Forest Service Nursery, Coeur d'Alene, Idaho. U.S.D.A. For. Serv., Northern Region. Timber, Cooperative Forestry and Pest Manage. Rep. 90-3. 7 p.
- James, R.L.; Dumroese, R.K.; Gilligan, C.J.; Wenny, D.L. 1989a. Pathogenicity of *Fusarium* isolates from Douglas-fir seed and container-grown seedlings. Idaho Forest, Wildlife and Range Exp. Stn. Bull. No. 52. 10 p.
- James, R.L.; Dumroese, R.K.; Wenny, D.L. 1988a. Occurrence and persistence of *Fusarium* within styroblock and Ray Leach containers. Pages 145-148 in T.D. Landis, Tech. Coord. Proceedings of the combined meeting of the Western Forest Nursery Associations. Vernon, British Columbia, August 8-11, 1988. U.S.D.A. For. Serv., Gen. Tech. Rep. RM-167.
- James, R.L.; Dumroese, R.K.; Wenny, D.L. 1989b. Occurrence, characteristics, and descriptions of *Fusarium* isolates from Douglas-fir seed and seedlings. U.S.D.A. For. Serv., Northern Region. Timber, Cooperative Forestry and Pest Manage. Rep. 90-4. 23 p.
- James, R.L.; Dumroese, R.K.; Wenny, D.L.; Myers, J.L.; Gilligan, C.J. 1987. Epidemiology of *Fusarium* on containerized Douglas-fir seedlings. 1. Seed and seedling infection, symptom production, and disease progression. U.S.D.A. For. Serv., Northern Region. Timber, Cooperative Forestry and Pest Manage. Rep. 87-13. 22 p.
- James, R.L.; Genz, D. 1981. Ponderosa pine seed treatments: effects on seed germination and disease incidence. U.S.D.A. For. Serv., Northern Region. Timber, Cooperative Forestry and Pest Manage. Rep. 81-16. 13 p.
- James, R.L.; Gilligan, C.J. 1984. Studies of *Fusarium* associated with containerized conifer seedling diseases: pathogenicity tests of isolates from the Alpine Nursery, Kalispell, Montana. U.S.D.A. For. Serv., Northern Region. Timber, Cooperative Forestry and Pest Manage. Rep. 84-14. 29 p.
- James, R.L.; Gilligan, C.J. 1985. Containerized Engelmann spruce seedling diseases at the USDA Forest Service Nursery, Coeur d'Alene, Idaho. U.S.D.A. For. Serv., Northern Region. Timber, Cooperative Forestry and Pest Manage. Rep. 85-17. 15 p.
- James, R.L.; Gilligan, C.J. 1988a. Association of *Fusarium* with nondiseased containerized ponderosa pine seedlings at the USDA Forest Service Nursery, Coeur d'Alene, Idaho. U.S.D.A. For. Serv., Northern Region. Timber, Cooperative Forestry and Pest Manage. Rep. 88-5. 10 p.
- James, R.L.; Gilligan, C.J. 1988b. Fungal colonization of styroblock containers - Plum Creek Nursery, Pablo, Montana. U.S.D.A. For. Serv., Northern Region. Timber, Cooperative Forestry and Pest Manage. Rep. 88-10. 9 p.
- James, R.L.; Gilligan, C.J. 1988c. Occurrence of *Fusarium* on Leach pine cells from the USDA Forest Service Nursery, Coeur d'Alene, Idaho. U.S.D.A. For. Serv., Northern Region. Timber, Cooperative Forestry and Pest Manage. Rep. 88-8. 10 p.
- James, R.L.; Gilligan, C.J. 1988d. Occurrence of *Fusarium* on the roots of non-diseased bareroot Douglas-fir seedlings - USDA Forest Service Nursery, Coeur d'Alene, Idaho. U.S.D.A. For. Serv., Northern Region. Timber, Cooperative Forestry and Pest Manage. Rep. 88-12.4 p.
- James, R.L.; Gilligan, C.J.; Dumroese, R.K.; Wenny, D.L. 1988b. Microwave treatments to eradicate seedborne fungi on Douglas-fir seed. U.S.D.A. For. Serv., Northern Region. Timber, Cooperative Forestry and Pest Manage. Rep. 88-7. 8 p.
- James, R.L.; Gilligan, C.J.; Reedy, V. 1988c. Evaluation of root diseases of containerized conifer seedlings at the Champion Timberlands Nursery, Plains, Montana. U.S.D.A. For. Serv., Northern Region. Timber, Cooperative Forestry and Pest Manage. Rep. 88-11. 21 p.
- James, R.L.; Militante, E.P.; Woo, J.Y.; Gilligan, C.J. 1986. Pathogenicity of *Fusarium* from forest seedling nurseries on Douglas-fir and ponderosa pine seedlings. U.S.D.A. For. Serv., Northern Region. Timber, Cooperative Forestry and Pest Manage. Rep. 86-8. 12 p.
-

- James, R.L.; Woollen, R.L. 1989. An evaluation of the efficacy of hot water-chemical treatments to clean styroblock containers -Champion Timberlands Nursery, Plains, Montana. U.S.D.A. For. Serv., Northern Region. Timber, Cooperative Forestry and Pest Manage. Rep. 89-5. 8 p.
- Katan, J. 1971. Symptomless carriers of the tomato *Fusarium* wilt pathogen. *Phytopathology* 61: 1213-1217.
- Komada, H. 1975. Development of a selective medium for quantitative isolation of *Fusarium oxysporum* from natural soil. *Rev. Plant Prot. Res. (Japan)* 8: 114-125.
- Kuninaga, S.; Yokosawa, R. 1989. Genetic relatedness 'within and between formae speciales of *Fusarium oxysporum* as measured by DNA-DNA reassociation kinetics. *Ann. Phytopathol. Soc. Japan.* 55: 216-223.
- Landis, T.D. 1976. *Fusarium* root disease of containerized tree seedlings. U.S.D.A. For. Serv., Rocky Mountain Region. Forest Pest Manage. Rep. R2-76-16. 6 p.
- Lock, W. 1973. *Fusarium* root rot of Douglas-fir nursery seedlings. *Can. For. Serv., For. Pest Leaflet.* 61. 7 p.
- Lock, W.; Sutherland, J.R.; Sluggett, L.J. 1975. Fungicide treatment of seeds for damping-off control in British Columbia forest nurseries. *Tree Planters' Notes* 26(3): 16-18.
- Lukezic, F.L.; Kaiser, W.J. 1966. Aerobiology of *Fusarium roseum* "Gibbosum" associated with crown rot of boxed bananas. *Phytopathology* 56: 545-548.
- Matuo, T.; Chiba, O. 1966. Species and formae speciales of *Fusaria* causing damping-off and root-rot of coniferous seedlings in Japan. *Ann. Phytopathol. Soc. Japan.* 32: 14-22.
- Maurer, D.L.; Baker, R. 1965. Ecology of plant pathogens in soil. II. Influence of glucose, cellulose, and inorganic nitrogen amendments on development of bean root rot. *Phytopathology* 55: 69-72.
- McClellan, W.D.; Stuart, N.W. 1947. The influence of nutrition on *Fusarium* basal rot of *Narcissus* and on *Fusarium* yellows of *Gladiolus*. *Am. J. Bot.* 34: 88-93.
- Meyer, J.A. 1967. Recherches sur les Fusarioses. II. Ecologie et pathogenie due *Fusarium oxysporum*. *Ann. Epiphyties* 18: 241-247.
- Miles, M.R.; Wilcoxson, R.D. 1984. Production of fungal inoculum using a substrate of perlite, commeal, and potato dextrose agar. *Plant Disease* 68: 310.
- Mitchell, R.; Alexander, M. 1961. The mycolytic phenomenon and biological control of *Fusarium* in soil. *Nature* 190: 109-110.
- Nash, S.M.; Snyder, W.C. 1962. Quantitative estimations by plate counts of propagules of the bean root rot *Fusarium* in field soils. *Phytopathology* 52: 567-572.
- Nelson, P.E.; Toussoun, T.A.; Marasas, W.F.O. 1983. *Fusarium* species: an illustrated manual for identification. The Pennsylvania State University Press, University Park. 193 p.
- Nirenberg, H.I. 1981. A simplified method for identifying *Fusarium* spp. occurring on wheat. *Can. J. Bot.* 59: 1599-1609.
- Oritsejafor, J.J.; Adeniji, M.O. 1990. Influence of host and non-host rhizospheres and organic amendments on survival of *Fusarium oxysporum* f. sp. *elaedis*. *Mycol. Res.* 94: 57-63.
- Palmer, L.T.; Kommedahl, T. 1969. Root-infecting *Fusarium* species in relation to rootworm infestations in corn. *Phytopathology* 59: 1613-1617.
- Papavizas, G.C. 1985. *Trichoderma* and *Gliocladium*: biology, ecology, and potential for biocontrol. *Ann. Rev. Phytopathol.* 23: 23-54.
- Park, D. 1959. Some aspects of the biology of *Fusarium oxysporum* Schl. in soil. *Ann. Bot.* 23: 35-49.
- Park, D. 1963. The presence of *Fusarium oxysporum* in soils. *Trans. Brit. Mycol. Soc.* 46: 444-448.
- Parkinson, D. 1967. Soil microorganisms and plant roots. Pages 449-478 in A. Burges and F. Rein, editors. *Soil biology*. Academic Press, London.
- Partridge, J.E.; Nelson, P.E.; Toussoun, T.A. 1984. Ribosomal proteins of the genus *Fusarium*. *Mycologia* 76: 533-544.
- Price, D. 1984. *Fusarium* and plant pathology: the reservoir of infection. Pages 71-93 in M.O. Moss and J.E. Smith, editors. *The applied mycology of Fusarium*. Cambridge University Press, Cambridge.
- Puhalla, J.E. 1985. Classification of strains of *Fusarium oxysporum* on the basis on vegetative compatibility. *Can. J. Bot.* 63: 179-183.
- Rathbun, A.E. 1922. Root rot of pine seedlings. *Phytopathology* 12: 213-220.
- Rathbun-Gravatt, A. 1925. Direct inoculation of coniferous stems with damping-off fungi. *J. Agric. Res.* 30: 327-339.
- Rowe, R.C.; Farley, J.D.; Coplin, D.L. 1977. Airborne spore dispersal and recolonization of steamed soil by *Fusarium oxysporum* in tomato greenhouses. *Phytopathology* 67: 1513-1517.
- Sinclair, W.A.; Cowles, D.P.; Hee, S.M. 1975. *Fusarium* root rot of Douglas-fir seedlings: suppression by soil fumigation, fertility management and inoculation with spores of the fungal symbiont *Laccaria laccata*. *For. Sci.* 21: 390-398.
- Sivan, A.; Chet, I. 1989. The possible role of competition between *Trichoderma harzianum* and *Fusarium oxysporum* on rhizosphere colonization. *Phytopathology* 79: 198-203.
- Smith, R.S., Jr. 1967. Decline of *Fusarium oxysporum* in the roots of *Pinus lambertiana* seedlings transplanted into forest soils. *Phytopathology* 57: 1265.
- Snyder, W.C. 1981. Introduction. Pages 3-8 in P.E. Nelson, T.A. Toussoun, and R.J. Cook, editors. *Fusarium: diseases, biology, and taxonomy*. The Pennsylvania State University Press, University Park.

-
- Snyder, W.C.; Hansen, H.N. 1940. The species concept in *Fusarium*. *Am. J. Bot.* 27: 64-67.
- Spaulding, P. 1914. The damping-off of coniferous seedlings. *Phytopathology* 4: 73-88.
- Stasz, T.E.; Harman, G.E.; Welden, N.F. 1988. Protoplast preparation and fusion in two biocontrol strains of *Trichoderma harzianum*. *Mycologia* 80: 141-150.
- Sturrock, R.N.; Dennis, J.J. 1988. Styroblock sanitization: results of laboratory assays from trials at several British Columbia forest nurseries. Pages 149-154 in T.D. Landis, Tech. Coord. Proceedings of the combined meeting of the Western Forest Nursery Associations. Vemon, British Columbia, August 8-11, 1988. U.S.D.A. For. Serv., Gen. Tech. Rep. RM-167.
- Tint, H. 1945a. Studies in the *Fusarium* damping-off of conifers. II. Relation of age of host, pH, and some nutritional factors to the pathogenicity of *Fusarium*. *Phytopathology* 35: 440-457.
- Tint, H. 1945b. Studies in the *Fusarium* damping-off of conifers. III. Relation of temperature and sunlight to the pathogenicity of *Fusarium*. *Phytopathology* 35: 498-510.
- Vaartaja, O.; Bumbieris, M. 1967. Organisms associated with root rots of conifers in South Australian nurseries. *Plant Dis. Repr.* 51: 473-476.
- Waite, B.H.; Stover, R.H. 1960. Studies on *Fusarium* wilt of bananas. VI. Variability and the cultivar concept in *Fusarium oxysporum* f. *cubense*. *Can. J. Bot.* 38: 985-994.
- Walker, J.C.; Foster, R.E. 1946. Plant nutrition in relation to disease development. III. *Fusarium* wilt of tomato. *Am. J. Bot.* 33: 259-264.
- Walker, J.C.; Hooker, W.J. 1945. Plant nutrition in relation to disease development. I. Cabbage yellows. *Am. J. Bot.* 32: 314-320.
- Wellman, F.L.; Blaisdell, D.J. 1941. Pathogenic and cultural variation among single-spore isolates from strains of tomato-wilt *Fusarium*. *Phytopathology* 31: 103-120.
- Williams, F. 1989. Benomyl drenches do not control *Fusarium* or *Cylindrocarpon* caused root rots. *Seed and Seedling Extension Topics*. British Columbia Minist. of Forests 2(1): 11-12.
- Woltenweber, H.W.; Reinking, O.A. 1935. Die Fusarien, ihre Beschreibung, Schadwirkung und Bekämpfung. Paul Parey, Berlin. 355 p.

Soil fumigation in bareroot tree nurseries¹

THOMAS D. LANDIS AND SALLY J. CAMPBELL
USDA Forest Service, Portland, Oregon

Presented at the first meeting of IUFRO Working Party S2.07-09
(Diseases and Insects in Forest Nurseries), Victoria, British Columbia, Canada, August 22-30, 1990.

Abstract

This paper gives a general overview of fumigation in bareroot tree nurseries in the United States. Application methods, biological activity, behavior in the environment, risks to human health, and economics are discussed. Information is presented for the more commonly used fumigants: methyl bromide, chloropicrin, dazomet, metam-sodium, and vorlex.

Resume

Ce document traite de façon générale de la fumigation dans les pépinières d'arbres à racines nues aux Etats-Unis. On y examine les techniques d'application, l'activité biologique, ce qui se passe dans l'environnement, les dangers pour la santé humaine et les aspects économiques. Les renseignements présentés portent sur les fumigants les plus courants, soit le bromure de méthyle, la chloropicrine, le dazomet, le mtam-sodium et le vorlex.

Introduction

Chemical fumigants have been used in forest nurseries since the early 1900s when formalin, an aqueous solution of formaldehyde gas, was recommended for control of fungal damping-off (Tillotson 1917). Other chemical fumigants were tested in forest tree nurseries in the late 1940s. Methyl bromide was initially used for weed control, but was also found to control damping-off fungi (Niner 1951), whitegrubs, and nematodes (Clifford 1951). Ethylene dibromide was found to be both effective and economical in controlling root rot at a southern nursery, costing less than \$50 per acre (\$123 per ha) (Henry 1951). Methyl bromide fumigation was considerably more expensive at over \$600 per acre (\$1482 per ha) (Clifford 1951).

In the years since those early trials, chemical fumigation of seedbeds has become an accepted pest control practice in forest tree nurseries. A survey of nursery soil fumigation practices in 1981 reported that over 90% of southern and western nurseries used fumigants to control a broad spectrum of nursery pests but was primarily used for weed and disease control. Around 90% percent of all soil fumigation was done with methyl bromide and methyl bromide/chloropicrin, with telone, vorlex, and vapam used occasionally (J.L. Ruehle USDA Forest Service, Athens, Georgia, Personal Communication, 1986). A more recent survey of federal nurseries in Washington and Oregon revealed that fumigants still account for 93% of annual pesticide use, with methyl

bromide/chloropicrin and dazomet the most popular chemicals (Table 1).

Soil fumigation is an interesting topic for several different reasons. It is one of the most *expensive* cultural operations in a nursery, presently costing around \$1000 per acre (\$2470 per ha) or more. Because of this high cost, chemical fumigation can only be economically justified on the most valuable agricultural crops such as seed tobacco, strawberries, and ornamentals. Soil fumigation is also *effective* - it works. As previously mentioned, fumigation is the most effective pest control practice used in forest nurseries today, and nursery managers consider pre-sowing fumigation to be a normal part of the cultural sequence. But soil fumigation has become controversial in recent years because of concern about the safety of these biocides, both at the nursery and in the surrounding area. Other concerns include disposal of fumigation tarps, possible groundwater pollution, and adverse effects on beneficial soil microorganisms. These issues have forced nursery managers to take another look at the soil fumigants that they are currently using and reevaluate other pest management options.

Physical and chemical properties of common nursery fumigants

Four chemicals have commonly been used for soil fumigation in forest nurseries in the United States and Canada in recent years (Table 2).

¹ This paper was previously presented at the Intermountain Forest Nursery Association Meeting, Bismarck, North Dakota, August 14-18, 1989.

Methyl bromide/chloropicrin (MBC) is available in two common formulations: one containing 2% chloropicrin (MBC-2), and another containing 33% chloropicrin (MBC-33). The chloropicrin in MBC-33 is an active fumigant, whereas that in MBC-2 is only added as a tracer to the methyl bromide, which has no detectable odor. MBC is available from several different manufacturers under a number of different trade names (Table 2). MBC is applied as a pressurized liquid that changes into a gas when injected into the soil. This pervasive fumigant is always covered with a one-mil or two-mil (0.001 to 0.002 in.; 0.025 to 0.051 mm) thick plastic tarp, which is impermeable to the fumigant gases.

Table 1. Average annual pesticide use in federal forest nurseries in Oregon and Washington

Pesticide	Pounds of active ingredient	Percent of total
Fumigants		
MB-C	33 250	66
Dazomet	13 461	27
Subtotal	46 711	93
Herbicides		
Bifenox	1425	3
DCPA	420	1
Dicamba	25	<1
Diphenamid	585	1
Glyphosate	44	<1
Oxyfluorfen	320	1
Subtotal	2819	6
Fungicides		
Benomyl	102	<1
Captan	60	<1
Chlorothalonil	414	1
DCNA	60	<1
Metalaxyl	58	<1
Subtotal	694	<1
Insecticides		
Acephate	3	<1
Carbaryl	3	<1
Chloropyrifos	50	<1
Fenvalerate	15	<1
Malathion	6	<1
Subtotal	77	<1
Total	50 491	100

Source: USDA Forest Service (1989)

Two tarping techniques have been used for covering injected fumigants. Continuous tarping is an operation in which each strip of plastic tarp is glued to the previous one, resulting in the entire field being covered with a solid sheet (Figure 1). Another alternative technique is strip fumigation where the fumigant is applied under separate sections of tarp that are covered on both sides with soil (Figure 2). After the prescribed treatment period has passed, the untreated strips of soil must be fumigated to provide complete coverage. Under either system, the tarp must remain intact during the entire fumigant exposure period. If the integrity of the fumigation tarp is broken before the end of the treatment period (Figure 3), then these areas must be retreated.

Dazomet, also known as Basimid Granular[®], is a unique formulation for a fumigant because it is applied as a very fine granule that converts into a gas when it encounters water in the soil. These "micro-granules" are normally applied through drop-type spreaders (Figure 4), immediately incorporated into the soil (Figure 5), and physically contained with a roller or water-sealed with sprinkler irrigation. The fumigant activity



Figure 1. Continuous tarp fumigation consists of glued, overlapping sheets of fumigation tarp which form a solid cover.

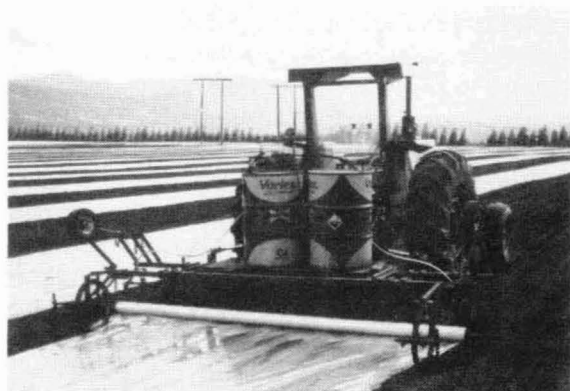

Figure 2. Strip fumigation consists of treating separate strips of the field, and then returning to fumigate the untreated sections.

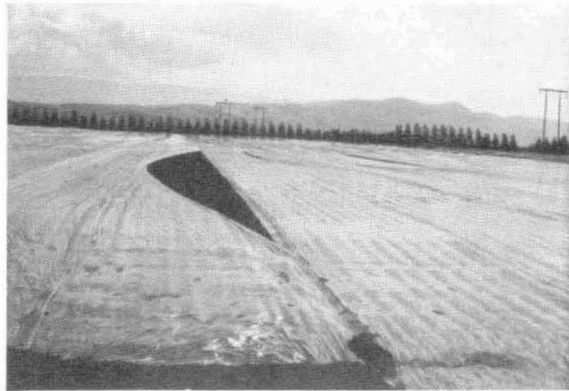

Figure 3. Wind can break the glue seal between adjacent strips of fumigation tarp before the exposure period is completed, requiring the area to be retreated.

results from the interaction of a mixture of different gases, the most common being methyl isothiocyanate (Table 2).

Metam-sodium (Vapam[®]) is a liquid fumigant that also converts to methyl isothiocyanate gas in the soil (Table 2). It can be either injected into the irrigation system and applied through sprinklers, or directly injected into the soil. Although this fumigant can be water-sealed like dazomet, the label recommends that it can be covered with plastic tarp "for better results."

Vorlex is a liquid fumigant that volatilizes into a mixture of different fumigant gases: dichloropropane, dichloropropene, and methyl isothiocyanate (Table 2). This fumigant is soil-injected, and may or may not be covered with a plastic tarp (Figure 2).

Biological activity of major fumigants

Although fumigants are commonly thought to be biocides that kill all organisms, there are differences in effectiveness between the different chemicals. The

Table 2. Physical and chemical properties of common soil fumigants and their application in forest nurseries

Chemical name	Trade name(s)	Active ingredients/ (Breakdown products)	Formulation/activity	Application methods
Methyl bromide + chloropicrin	Brom-O-Gas [®] MBC-33 [®] Meta-Brom 98 [®] Namco Pathofume BR Pic-Brom 33 [®] Terr-O-Gas 67 [®]	Two formulations: 98% methyl bromide + 2% chloropicrin and 67% methyl bromide + 33% chloropicrin	Liquified gas, bottled under pressure. Volatilizes at ambient pressure and temperature.	Injected into the soil, and covered with plastic tarp.
Dazomet	Basamid-Granular [®]	Tetrahydro-3,5-dimethyl-2H-1,3,5-thiadiazine-2-thione (Methyl isothiocyanate)* (Formaldehyde) (Hydrogen sulfide) (Monomethylamine)	Fine crystalline solid. Volatilizes after contacting soil moisture.	Incorporated into the soil, and sealed with roller and/or water.
Metam-sodium	Vapam [®] Metam [®] Soil-Prep [®] Nemasol [®]	Sodium N-methyldithiocarbamate (Methyl isothiocyanate)	Liquid. Volatilizes after application to soil.	Injected into irrigation system, or into soil.
Vorlex	Vorlex [®]	80% Dichloropropene/ dichloropropane 20% Methyl isothiocyanate	Liquid. Volatilizes after application to soil.	Injected into soil; may or may not be tarped.

* Parentheses indicate the breakdown product and active fumigant gas
Source: modified from Thomson (1988)

common nursery fumigants are not equally effective against the four major groups of nursery pests: fungi, insects, nematodes, and weeds (Table 3). The concept of a "target pest" is important when choosing a control method. Fumigation should never be used as an all-purpose pest control treatment; instead, target pests should be identified and all control options analyzed before a fumigant is used.

Fungi

All fumigants do a reasonably good job on the common soil pathogenic fungi, especially at the higher application rates (James 1989). The MBC-33 formulation is the only one that can control the more resistant fungal pathogens such as *Cylindrocladium* spp. and *Macrophomina phaseolina* [(Maub.)Ashby] that form resistant resting stages called sclerotia. Luckily, these persistent pathogens are not found in nurseries in cooler environments. Cordell and Wortendyke (1972) provide a good review of the older literature on the relative effectiveness of the methyl bromide formulations compared to other fumigants.

Based on many early trials, MBC-33 became the standard fumigant for forest nurseries in the United States. Dazomet, however, is becoming increasingly popular as an alternative to methyl bromide fumigation in recent years. McElroy (1986) tested MBC-33, dazomet, metam-sodium, and vorlex at several Pacific Northwest nurseries and found that all gave good control of *Fusarium* spp. and *Pythium* spp., the principal soil pathogens in that area. Tanaka *et al.* (1986) also did fumigation trials at two nurseries in this region, comparing dazomet to MBC-33 at two application rates [the standard 360 lb/ac (404 kg/ha), and a 2X rate]. They also monitored soil populations of *Pythium* and *Fusarium* and found that dazomet was nearly as effective as the standard rate of MBC-33, and that the 2X rate of MBC-

33 was not justified. Campbell and Kelpsas (1988) report that fall fumigation with MBC-33 was more effective than dazomet or metam sodium in reducing soil populations of *Pythium* and *Fusarium* through the spring sowing period. James (1989) reported that, while dazomet and MBC-33 both lower populations of pathogenic fungi, MBC-33 provides a longer period of control.

The relationship of soil pathogen population levels to seedling disease and growth is unclear, however. Tanaka *et al.* (1986) found that MBC-33 gave better control of *Fusarium* root rot infections and produced significantly larger Douglas-fir [*Pseudotsugamenziesii* (Mirb.)Franco] seedlings than dazomet. On the contrary, Campbell and Kelpsas (1988) found that dazomet produced significantly larger ponderosa pine (*Pinus ponderosa* Laws.) seedlings than MBC-33; seedlings treated with metam-sodium were also larger, although the differences were not statistically significant.

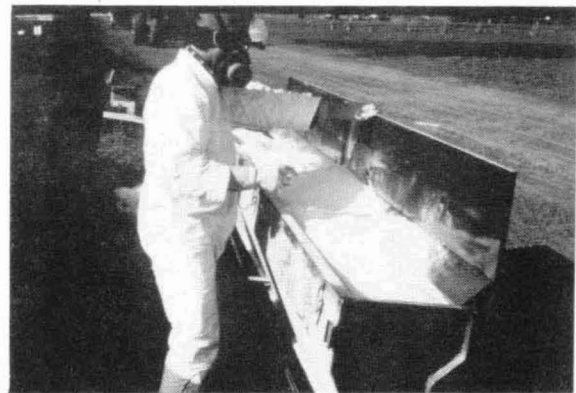

Figure 4. The fumigant dazomet is a fine "microgranule", which is applied with drop-type fertilizer spreaders. Photo courtesy of Bruce Kelpsas, NW Chemical Co.



Figure 5. After application, the dazomet granules are incorporated into the soil and sealed with a roller or water seal. Photo courtesy of Bruce Kelpsas, NW Chemical Co.

Table 3. Relative pest control effectiveness of common nursery fumigants

	Fungi	Insects	Nema- todes	Weeds
MBC-33*	Yes	Yes	Yes	Most
MBC-2	Most	Yes	Yes	Most
Dazomet	Most	Yes	Yes	Most
Metam- sodium	Most	Yes	Yes	Most
Vorlex	Most	Yes	Yes	Most

* Methyl bromide/chloropicrin comes in two major formulations: 67%:33% and 98%:2%

Insects and nematodes

All of the fumigants do a reasonably good job of controlling soil insects and nematodes (Table 3). Insect damage is rarely severe enough to justify fumigation on its own, but nematodes have been the main target pests for fumigation in forest nurseries. MBC fumigants provide excellent control of nematodes in forest nurseries (Ruehle 1975), and the MBC-2 formulation is generally recommended. Both MBC-33 and dazomet at the 350 lb/ac (393 kg/ha) rate controlled populations of the root lesion nematode (*Pratylenchus penetrans* Cobb), although a less rate of dazomet (150 lb/ac = 168 kg/ha) had less effect (McElroy 1986). Peterson and Riffle (1986) caution that, while fumigation greatly reduces the nematode populations in soil, it does not completely eradicate them.

Weeds

Weeds are sometimes the primary target pest for fumigation (Grierson 1989), but none of the fumigants control all species of weeds (Table 3). MBC-33 is not as effective for controlling weeds as MBC-2 at standard application rates, but is a good herbicide at a 400 lb/ac (449 kg/ha) rate (J.L. Ruehle USDA Forest Service, Athens, Georgia, Personal Communication, 1986). Methyl bromide also tends to scarify the seed coat of hard-seeded weed species such as many legumes, and actually stimulate germination immediately after fumigation. This may be beneficial in the case of fall fumigation because the recently germinated weeds are soon killed by frost. Vorlex was found to give less weed control than the other fumigants in a Pacific Northwest nursery (McElroy 1986). Since little data have been reported on which weed species are resistant to which fumigants, it would be wise to contact chemical company representatives and other nursery managers before selecting a fumigation chemical.

Microbial re-invasion of fumigated soil

Because nature abhors a vacuum, fumigated soil will eventually become recolonized by a full complement of endemic microorganisms, both beneficial and pathogenic. Even the most effective soil fumigation can be ruined if the target pest is able to rapidly re-invade the treated soil.

The most common source of re-invading microorganisms is from adjacent untreated soil, but they can also move up from soil strata underneath the fumigated layer. Re-invasion studies with the pathogenic fungus *Fusarium oxysporum* f. sp. *melonis* Snyder and Hans. have shown that, although the fungus could not be isolated from fumigated soil after 6 days, by 32 days the

pathogen was isolated consistently from the outer edges of the treated area. There was also evidence that the fungus was re-invading from lower untreated soil layers because after 10 weeks there was a distinct population density gradient from below the fumigated layer to the soil surface (Marois *et al.* 1983). Vaartaja (1967) studied the development of several soil microorganisms after fumigation and found that re-invasion by fungi occurred in several ways: rain splash, irrigation water, blowing dust, and soil carried on boots. Another probable source of contamination is nursery tillage equipment that carries soil from untreated to treated fields.

Rapid re-invasion with beneficial microorganisms is desirable. Many fungal species that form mycorrhizae produce air-borne spores that can blow into fumigated soils within a few months after fumigation. The fungi that form endomycorrhizae, however, are slower recolonizers because their spores are not carried by air and must be reintroduced on soil particles (Marx *et al.* 1989). Actually, beneficial microorganisms may be the first to reestablish in fumigated soil. Fungi of the genus *Trichoderma* spp. and bacteria are among the earliest colonizers (Vaartaja 1967), and *Trichoderma* may be responsible for the positive seedling growth response often observed in fumigated soils (Ingestad and Nilsson 1964).

To slow the rate of re-invasion by soil-borne pathogens, nursery managers should reduce obvious sources of recontamination such as transported soil and surface water runoff. Nursery implements should be cleaned before being used in fumigated soil; some nurseries use portable steam cleaners to both clean and sterilize their equipment. Fumigated fields should be physically isolated by a ditch or other type of drainage system to intercept surface runoff which can carry contaminated soil particles or motile spores of water mold fungi. Because re-invasion will eventually occur, nurseries should schedule fumigation as close to the date of sowing as is practically possible. Obviously, fall-fumigated fields are more liable to recontamination than spring-fumigated ones; in many bareroot nurseries, however, fall fumigation is the only option because spring soil temperatures are too low to allow early fumigation. Re-invasion is usually slower in soils which have had pathogen populations reduced to near zero (e.g. after MBC fumigation), as compared to soils where a low residual population of pathogens remain after treatment (e.g. after dazomet fumigation).

Application considerations for soil fumigation

Relative safety of application

The primary consideration when selecting a fumigant should be worker safety. All the common fumigants are

hazardous chemicals, but the MBC formulations and vorlex are “restricted use pesticides,” which means that they can only be applied by specially trained, certified applicators. Because of their concerns about nursery worker safety, many nursery managers choose to contract their MBC soil fumigation. Dazomet and metam-sodium are relatively less hazardous to apply, and so most nurseries do their own fumigation with these chemicals.

Soil properties

Soil temperature is critical to the effectiveness of all fumigants because the vapor pressure of any gas is a function of temperature. The temperature will, therefore, determine how quickly the fumigant gases pervade the soil particles and also define their persistence in the soil. In the case of the granular dazomet, temperature controls the speed of conversion of the solid particles to a gas (Neumann *et al.* 1984). Warm soil temperatures, in the presence of moisture, also increase the metabolism of nursery pests and make them more susceptible to the fumigants (Boone 1988).

Although some soil fumigants are reported to be effective at colder temperatures, the lower temperature limit for all fumigants should be 50°F (10°C) at a soil depth of 6 inches (15 cm). Because soil temperatures take too long to warm in the spring, most northern nurseries fall fumigate while soils are still warm. Dazomet should not be applied if soil temperatures are too warm, however; Thomson (1988) recommends an upper limit of 90°F (32°C). Soil temperatures can also affect the fumigation technique; tarping is recommended for vorlex if the temperature exceeds 75°F (24°C) (Thomson 1988).

Fumigation effectiveness is also a function of soil moisture content, which should usually be in the range

of 50 to 75% of field capacity (Boone 1988). Moist soil promotes good tilth which leads to good fumigant penetration. Again, soil moisture stimulates nursery pests to their most susceptible state (germinating weed seeds, fungi in the mycelial state, and emerging nematodes). For the granular dazomet, a soil moisture content of 60 to 70% is necessary for rapid conversion to a gas (Neumann and others 1984). The soil seal that is recommended for dazomet, and possibly other similar fumigants, should be maintained by periodic light irrigations for 3 to 5 days after application (Thomson 1988). Soil can also be too wet for effective fumigation, however. Overly wet soil can form large clods when tilled and also has a high percentage of pores filled with water, both of which restrict fumigant penetration.

The physical condition of a soil is also important for effective fumigation. Soil should be tilled to a moderate-sized crumb structure if possible to generate a large proportion of macropores to carry the fumigant gases. The high surface-to-volume ratio of large clods inhibits fumigant penetration, whereas the numerous small particles that are produced in an overworked soil create micropores that slow movement of fumigant gases.

Soil organic matter content should also be considered. Undecomposed organic matter may inactivate the fumigants (Boone 1988). In the case of dazomet, the effective gases may be bound by the organic matter itself or by the ammonia created as the organic matter breaks down (BASF 1984). Green manure or cover crops should be turned under and organic amendments applied long enough before fumigation to allow complete breakdown. Organic matter may also delay dissipation of the fumigant gases; it is recommended that crops not be sown until at least 30 days after fumigating high organic soils with metam-sodium (Thomson 1988).

Table 4. The effect of soil temperature on fumigation waiting periods

	Methyl bromide/ Chloropicrin	Dazomet
		<i>Fumigant applied and soil sealed</i>
Exposure period (gas activity)	1 to 3 days	4 to 25 days
		<i>Tarp removed or soil seal broken</i>
Aeration Period (gas escapes)	2 to 14 days	2 to 20 days
		<i>Test for residual fumes</i>
Germination testing	5 days	5 days
		<i>Sow Crop</i>
Total waiting period	8 to 22 days	11 to 50 days

Source: BASF (1984)

Exposure and aeration periods

The mandatory waiting period between fumigation and sowing the seedling crop consists of two different intervals: the exposure period, in which the fumigant gas is active, and the aeration period, when the gas is allowed to dissipate from the treated area. The aeration period is normally followed by a germination test (Table 4). This consists of sowing seeds from a rapidly germinating species, such as radish or lettuce, in a small sample of soil from the fumigated area. A non-fumigated control soil sample should also be taken at the same time for comparison. Both soil samples should be placed in lidded glass jars and watered. At the end of about 5 days, the seedlings should have emerged and be developing normally (Figure 6); poor germination or distorted growth means that some fumigant fumes still persist in the soil.

The recommended number of days for the two fumigation waiting periods depends on soil temperature and weather conditions, but the total period can range from 8 to 50 days for MBC or dazomet (table 4). Dazomet typically requires a longer period under normal nursery fumigation conditions, however; because MBC is immediately converted into a gas, it becomes active more rapidly than the granular dazomet. At a typical soil temperature of 50°F (10°C), the exposure period for dazomet will take 12 days, compared to 3 days for MBC. Wet weather can cause problems with fumigant dissipation, particularly with the granular dazomet. McElroy (1986) reported that 1 inch (2.5 cm) of rain after dazomet fumigation moved the fumigant deeper into the soil; this delayed the escape of the fumigant, resulting in phytotoxicity to the crop seedlings. Similar consequences have been observed with

the chloropicrin component of MBC (F.D. McElroy, Peninsulab, Kinston, Washington, personal communication).

Economics of soil fumigation in forest tree nurseries

Because fumigation is such an expensive cultural practice, it is necessary for nursery managers to provide economic justification. In a successful nursery operation, economic realities mandate that the costs of fumigation be offset by the benefits of the practice.

Fumigation costs

The cost of fumigation can be prohibitive in smaller nursery operations, where cash flow problems make it difficult to come up with the money for fumigation so early in the crop cycle. Fumigation is also less expensive for larger nurseries because many fumigation con-



Figure 6. At the end of the aeration period, a germination test should be performed on the fumigated soil to make certain that it is safe to plant the crop. Photo courtesy of Bruce Kelpsas, NW Chemical Co.

Table 5. Soil fumigation costs for USDA Forest Service nurseries in 1989

	Contract application	Nursery application
Methyl bromide/chloropicrin		
Number of nurseries	5	1
Average	\$1137	\$902
Range	\$942 to \$1280	N/A
Dazomet		
Number of nurseries	0	4
Average	N/A	\$1032
Range	N/A	\$938 to \$1 173

tractors have the same set-up charge regardless of the amount of acres to be treated. Nurseries in remote locations are also at an economic disadvantage because contractors must reflect travel costs in their fees. One way to save money on fumigation contracts is to coordinate the timing of fumigation with other nurseries in the general area so that the contractor can visit each operation on an efficient travel circuit.

Soil fumigation costs can vary between chemicals. Campbell and Kelpsas (1988) reported that the per-unit chemical cost of applying MBC-33 was similar to that of dazomet, while the metam-sodium chemical costs were less. The 1989 soil fumigation costs for the 10 USDA Forest Service nurseries averaged around \$1200/ac (\$2964/ha) for MBC contracts, and around \$1000/ac (\$2470/ha) for nursery-applied dazomet (Table 5). These figures reflect chemical and application costs, as well as the cost of tarp removal in the case of MBC.

Benefits from fumigation

The benefit side of the economic scale can be subjective, and figures are often outdated because the comparisons were only done when fumigation was first implemented. One easy way to determine fumigation benefits is to leave one or more small "check" or untreated areas in the seedbed so that seedling yield information can be compared to fumigated areas. Growth information, such as seedling height, caliper, biomass, and root growth, should be collected at intervals during the growing season because the benefits are sometimes

only visible at one time during the rotation. The true test of fumigation benefits, however, is to harvest seedlings from each area and have them graded; this will generate actual "shippable seedling" data that can be converted back into dollars and compared to fumigation costs.

Behavior of fumigants in the environment

Because fumigants are highly toxic pesticides, there is widespread concern that they or their breakdown products may contaminate the water, air, or soil in the nursery or in adjacent areas. The physical properties of fumigants determine how readily they move or persist in the environment after application; environmental factors, such as soil characteristics and amount of rainfall, also influence contamination potential and persistence. Several physical characteristics for MBC and dazomet determine their pollution potential in the environment (Table 6).

Water quality

Both surface and groundwater can become contaminated with pesticides from surface water runoff or leaching through the soil profile. The likelihood that a particular fumigant will contaminate water is dependent on a number of factors, including soil characteristics, pesticide characteristics, the local climate, amount of precipitation and/or irrigation, number of applications of the pesticide, rate at which the pesticide is applied, surface and groundwater hydrology of the site,

Table 6. Effect of physical properties of methyl bromide/chloropicrin and dazomet on water, soil, and air pollution

Pollution site	Methyl bromide/ chloropicrin	Dazomet
Water		
Solubility in water ¹	Moderate	High
Leaching potential	Low	Negligible
Soil		
Persistence in soil ²	Low	Low
Decomposition mode	Biological and chemical	Chemical
Air		
Volatility ³	High	High

¹ Solubility is rated as high (> 100 ppm), moderate (1-100 ppm), and low (< 1 ppm).

² Persistence is rated in half-lives: high (> 180 days), moderate (30-180 days), and low (< 30 days).

³ Volatility is rated in vapor pressure units: high (> 1.00 mm Hg), moderate (0.001 - 1.00 mm Hg), and low (< 0.001 mm Hg).

Source: USDA Forest Service (1989).

drainage system at the site, and cultivation practices used at the site to increase infiltration (USDA Forest Service 1989).

The most significant factors affecting water pollution by pesticides are solubility in water and leaching potential (Table 6). Pesticides must first dissolve in the soil water before they can leach downward. The situation concerning the solubility of fumigants in water is confusing because the solubility of a gas in water is usually measured under greater atmospheric pressure than that normally encountered in nursery soil (Chemical Fate Testing Guidelines 1983). Even though MBC is given a "moderate" solubility rating in water (Table 6), it is estimated that only about 0.1% of the applied MBC would ever leach from the nursery soil (USDA Forest Service 1989). Even though dazomet has a "high" water solubility rating, the leaching potential for its principal active ingredient (methyl isothiocyanate) is negligible due to its rapid degradation in the soil and its high volatility (Table 6). In fact, no groundwater contamination by methyl bromide, metam-sodium, or methyl isothiocyanate has yet been detected in the United States (Parsons and Witt 1988), although traces of MBC were identified in groundwater in Holland (Rattink 1984).

Groundwater contamination by 1,2-dichloropropane and 1,3-dichloropropene, two components of the fumigant vorlex, has been detected in a number of states (Parsons and Witt 1988). However, it has not been determined that these occurrences were due to vorlex contamination because these two chemicals are found in other fumigants, such as D-D, and are also used for other non-agricultural purposes.

Surface water run-off can occur when rainfall or irrigation exceed the infiltration capacity and water flows over the soil surface or when water moves laterally through the soil profile into a surface water source such as a stream or drainage ditch. Surface water can become polluted either directly with soluble pesticides or when non-soluble pesticides are adsorbed onto soil particles and carried along with surface water flow. The surface water run-off potential for MBC is considered negligible (USDA Forest Service 1989); the situation for dazomet, vorlex, or metam-sodium is unclear but should not be significant.

Soil quality

Two physical characteristics of fumigants that affect the soil pollution potential are persistence in soil and the type and rate of decomposition. The soil persistence of MBC is rated low (Table 6) because MBC is rapidly broken down by both biological and chemical means (USDA Forest Service 1989). MBC and inorganic

bromide residues are absorbed by plants and animals; MBC is metabolized and the inorganic residues are relatively non-persistent. There is very little information about the environmental fate of chloropicrin, including its persistence in the soil (USDA Forest Service 1986).

Following incorporation, dazomet is also relatively non-persistent in soil (Table 6). This fumigant chemically breaks down into many different products, all of which are lost from the soil within a few days through further degradation and volatilization, which are dependent on soil moisture and temperature. Soil type and pH also influence the effectiveness of the fumigant and its rate of breakdown. Soils with high clay or organic matter content can bind methyl isothiocyanate, thus reducing its effective concentration (BASF 1984) and intermediate pH values (around 6.5) maximize degradation. (USDA Forest Service 1987). There is little information on metam-sodium, but, since methyl isothiocyanate is the primary breakdown product, its behavior in soil should be similar to that of dazomet.

Persistence of 1,3-dichloropropene (a component of vorlex) in the soil is considerably higher; the half-life of 1,3-dichloropropene is 14 to 180 days, depending on environmental conditions. This compound disappears through degradation (biological and non-biological hydrolysis), dispersion through the soil, volatilization into the air, and irreversible binding to soil particles. Temperature and soil moisture influence the rate of these processes (USDA Forest Service 1987).

Air quality

Since fumigants are gases or volatilize after application, there is potential for drift into adjacent areas (Table 6). The labels on all four fumigants direct the applicator to seal the soil surface in some fashion (water seal, rolling, or plastic seal) after application. If properly applied, damaging aerial concentrations of a fumigant should occur rarely, due to the restrictive seal, rapid degradation of the fumigant, and the large volume of air into which it can disperse if it escapes through the seal. However, if the seal is poor or weather conditions prevent rapid dispersion (for example, an inversion layer), toxic fumigant concentrations may build up and injure adjacent plants, animals, or people. Myers (J. Myers, USDA Forest Service, Coeur d'Alene, Idaho, Personal Communication) reports that, following MBC fumigation at a forest nursery, an air inversion caused a local accumulation of MBC gases; they had apparently escaped through the tarp and caused minor health effects to residents living near the nursery. Forest nursery managers have reported fumigant damage to adjacent seedlings for both MBC and dazomet. White pines

seem to be particularly susceptible to dazomet fumes (Scholtes 1989), whereas Douglas-fir is sensitive to MBC (J. Myers, Personal communication, 1989).

Effects of fumigants on human health

All pesticides are poisons, and fumigants are among the most acutely toxic pesticides used in bareroot forest nurseries. It should be remembered, however, that the actual hazard of any chemical is a function of both toxicity and exposure. If fumigants are applied by

trained, certified applicators and according to label instructions, the potential health hazards can be reduced to acceptable levels.

All chemicals, including pesticides, can be ranked according to the dose of the chemical required to kill half of a population of test animals; this dose is known as the LD₅₀ (table 7). Although oral exposures are most frequently used to determine LD₅₀, other types of chemical exposure are more relevant for fumigants. With all fumigants, there is a risk of inhalation exposure due to

Table 7. Toxicity of common nursery fumigants in relation to other chemicals

Toxicity category	Pesticide label signal words	Pesticides and other chemicals	Acute toxicity ¹ Oral LD ₅₀	Other
I-Severe	Danger-Poison		0-50 mg/kg	
		Chloropicrin	38	Dermal = 100 mg/kg Inhalation = 0.178 to 150 mg/l
		Nicotine	50	
II-Moderate	Warning		50-500 mg/kg	
		DDT	100	
		Caffeine	200	
		Methyl bromide	214	Inhalation = 4.5 mg/l
		Dazomet	363	Dermal = 200 to 10 400 mg/kg Inhalation = 302 to 60 000 mg/l
		Vorlex	538	Dermal = 470 to 961 mg/kg Inhalation = 11 mg/l
III-Slight	Caution		500-5000 mg/kg	
		Metam-sodium	820	
		Aspirin	1700	
		Table Salt	3750	
		Glyphosate	4320	
IV-Very Slight	Caution		5000-50 000 mg/kg	
		Oxyfluorfen	5000	
		Captan	9000	
		Ethyl alcohol	13 700	

¹ Oral and dermal ratings are measured in lethal doses (LD₅₀), and inhalation ratings in lethal concentrations (LC₅₀) - the amount of pesticide per unit of body weight that is required to kill 50% of the test animals. These values are only examples of some study results - published values may vary considerably.

Sources: USDA Forest Service (1989); USDA Forest Service (1987); Bohmont (1983); Great Lakes Chemical Company (1989); Thomson (1988).

their gaseous nature at the time of application or shortly after. Because dazomet is applied as a fine granule, inhalation of granules could be significant as well. There is a dermal exposure hazard with both MBC if skin comes into contact with the pressurized liquid, and dazomet if granules contact the skin.

The common nursery fumigants vary considerably in their toxicity, ranging from the severe to the slight category (Table 7).

MBC is the most toxic fumigant used in forest nurseries because chloropicrin ranks in the severe category and methyl bromide is in the moderate category (Table 7). Chloropicrin, also known as “tear gas”, is extremely irritating to eyes and skin (Table 8). Concen-

trations as low as 2 ppm can be lethal if inhaled for as little as 1 minute, and concentrations of 0.1 ppm can be injurious over longer periods (Thomson 1988). Pure methyl bromide is relatively less toxic than chloropicrin and is rated in the moderate toxicity category (Table 7). This fumigant is particularly dangerous to use because it is colorless and odorless. Chronic exposure to methyl bromide causes severe health hazards (Table 8); exposure to 2000 ppm of methyl bromide for 1 hour may be lethal (Thomson 1988). In formulations containing a mixture of methyl bromide and chloropicrin, exposure time to excessive amounts is usually very short; this is due to the extremely irritating nature of the chloropicrin which compels the person being exposed to quickly

Table 8. Potential health hazards of common nursery fumigants

Fumigant	Known health hazards
Methyl bromide	<p>Exposure symptoms - Although it has no odor, methyl bromide causes severe chemical skin burns, swelling of bronchial membranes, and kidney damage. Small amounts will cause nausea and vomiting, and may lead to mental confusion, double vision, tremors, lack of coordination, and slurred speech. Continued exposure leads to coma and death.</p> <p>Cancer - Variable information.</p> <p>Reproductive/developmental - Organ weight variation in offspring of rats; fetal and maternal toxicity.</p>
Chloropicrin	<p>Exposure symptoms - Chloropicrin has an obnoxious odor and was used as a chemical warfare agent in World War I. It is extremely irritating—causing tearing, swelling of bronchial membranes, gasping, and vomiting. Severe exposure may result in irregular heartbeat and asthma.</p> <p>Cancer - Insufficient information.</p> <p>Reproductive/developmental - No information.</p>
Dazomet	<p>Exposure symptoms - Dazomet is irritating to skin and eyes.</p> <p>Cancer - None observed in animal studies.</p> <p>Reproductive/developmental - No information on dazomet, but methyl isothiocyanate causes maternal toxicity and fetal death in animals.</p>
Vorlex	<p>Exposure symptoms - Highly irritating to eyes, skin, and lungs.</p> <p>Cancer - Methyl isothiocyanate is not carcinogenic in animals, but 1,3-dichloropropene appears to be.</p> <p>Reproductive/developmental - No information on vorlex, but xylene, one of the ingredients, causes birth defects in animals.</p>

Sources: USDA Forest Service (1989); USDA Forest Service (1987); Bohmont (1983); Thomson (1988); Great Lakes Chemical Company (1989).

move from the area. Information about the cancer-causing ability of methyl bromide and chloropicrin is varied. For chloropicrin, there is no information regarding carcinogenicity. For methyl bromide, some carcinogenic effects are reported (Great Lakes Chemical Co. 1989) although very recent reports indicate no cancer effects (J. Sargent, Great Lakes Chemical Co., West Lafayette, Indiana. Personal communication, 1989).

Dazomet and vorlex share a common active ingredient (methyl isothiocyanate), and rank in the moderate toxicity category (Table 7). Dazomet does not break down into a gas until it contacts soil moisture; because of this, it is easier to control than an injected gas. The micro-granule formulation of dazomet can be irritating to skin and eyes (Thomson 1988). Although dazomet has not caused cancer in animal studies, other health effects have been observed (Table 8).

Metam-sodium also breaks down into methyl isothiocyanate, but is slightly less toxic than dazomet or vorlex, which places it in the slight toxicity category (Table 7). Metam-sodium can be irritating to skin, eyes, and mucous membranes (Thomson 1988), but the risk of cancer from exposure to methyl isothiocyanate is apparently low (Table 8).

Quality of fumigant exposure data

The quality of information on the effects of fumigants on human health is marginal or inadequate in some areas (Tables 8 and 9). The published information can be categorized by six types of toxicity: systemic, carcinogenic, reproductive and developmental, mutagenic-

ity, neurotoxicity, and immunotoxicity (Table 9). Very little work is done on humans; human data are usually derived from accidents or from operational exposure. Therefore, most tests have been done on animals, such as rats or rabbits, and much of the available information is difficult to interpret and compare because different units were used and results were variable. Table 9, however, categorizes the general state of data (adequate, sufficient, marginal, or inadequate) from available published animal studies.

Human health risks

When determining the danger of a particular pesticide, both the toxicity of the material, as well as the probability of exposure, are important. The nursery workers at greatest risk for exposure to fumigants are those involved in applying them: tractor drivers, shovelers, and tarp lifters (Table 10). Other nursery workers, such as weeders or inventory crew, will have almost negligible risk since they are in the fields after the fumigant has long since dissipated. For the general public, including residences adjacent to the nursery, there is more potential risk of exposure to fumigants than other pesticides due to the gaseous nature of the fumigants allowing them to diffuse and be carried away from the site of application and onto neighboring property.

The probability that detrimental health effects will occur has been estimated, based on Threshold Limit Values (TLVs), for the various workers involved in fumigant application and for the general public (Table 10). A TLV is the estimated maximum concentration

Table 9. Quality of nursery pesticide database for each toxicity category

Fumigant	Systemic	Carcinogenic	Reproductive/ Developmental	Mutagen- icity	Neuro- toxicity	Immuno- toxicity
Methyl bromide	Adequate	Sufficient: new studies could change conclusions	Marginal: variable results	Adequate	Adequate	Inadequate
Chloropicrin	Adequate	Marginal: variable results	Inadequate	Marginal: variable results	Inadequate	Inadequate
Dazomet	Sufficient: new studies could change conclusions	Adequate	Sufficient: new studies could change conclusions	Marginal: variable results	Sufficient: new studies could change conclusions	Marginal: variable results

Source: USDA Forest Service (1989).

for an 8-hour workday exposure that will not result in any adverse effects. Workers using MBC-33 are at the highest risk because their estimated doses for chloropicrin exceed the TLV. Workers applying dazomet are at a lower risk because their estimated doses are less than the TLV (Table 10). Risks associated with dazomet application should be further reduced by the lag time between application and formation of toxic compounds in the soil. Gases from both MBC and dazomet can drift for some time after application and may cause workers and neighbors to experience some degree of minor irritation. Although there are not documented cases of serious injury to these people, fumigant drift under certain weather conditions has caused concern (J. Myers, Personal Communication).

Future availability of fumigants

For the past few years, nursery managers have expressed concern about the possibility that the use of some fumigants, particularly MBC, will be severely restricted or banned. This is a legitimate concern because other fumigants have been banned after they were detected in groundwater in agricultural areas. A soil fumigant (DBCP) is the most widespread pesticide contaminant of groundwater in the United States, and its use was suspended in 1979. Since then, other fumigants have also been detected in groundwater and subsequently removed from the market: D-D, a nematicide, along with EDB, a close chemical relative of MBC (Russell and others 1987). Because of this "guilt by association," groundwater is being tested across the country for MBC, but it has not been detected as of this date (Parsons and Witt 1988). It is considered unlikely that MBC would ever be detected, however, because it rapidly dissociates into inorganic bromide and a methyl-containing substance before reaching groundwater supplies (Bentson and Lavy 1989).

Another concern about the future of soil fumigants is the possible link to cancer. MBC is particularly

suspect because it is considered a possible mutagen in humans (USDA Forest Service 1989), and the closely related EDB has already been shown to be a potent carcinogen in animals (Russell *et al.* 1987). Although further cancer testing is underway for both methyl bromide and chloropicrin, the results are inconclusive so far (USDA Forest Service 1989).

At the present time, however, none of the four currently used fumigants (MBC, dazomet, metam-sodium, or vorlex) are in any danger of losing their pesticide registration in the United States. We specifically inquired about the re-registration status of the MBC fumigants and company representatives and Environmental Protection Agency scientists informed us that they will continue to be available to the agricultural community (J. Andersen, U.S. Environmental Protection Agency, Washington, D.C. Personal communication, 1989).

Conclusions and recommendations

Although fumigants are extremely toxic pesticides, they are relatively not persistent in the environment, they have immediate severe health risks, but long-term risks are not much more severe than other pesticides. If properly applied with adequate precautions, they can continue to be a major weapon in the chemical arsenal.

Fumigation and integrated pest management

Soil fumigation, along with other cultural activities and pesticides, should always be viewed in the larger context of an overall nursery pest management plan. Progressive nurseries have begun to define their pest management activities in the context of integrated pest management. Integrated pest management in forest nurseries can be defined thus:

"Integrated nursery pest management is the maintenance of seedling pests at tolerable levels by the planned use of a variety of preventive, suppressive, or regulatory methods (including no action) that are consistent with

Table 10. Probability of health hazards for public and workers exposed to common soil fumigants

Fumigant	Fumigation Applicators ¹			
	Public	Driver	Shoveler	Tarp lifter
Methyl bromide	Low	Moderate	Moderate	High
Chloropicrin	Moderate	High	I ²	I
Dazomet	Low	Moderate	N/A ²	N/A

¹ Average exposures per workday, based on historical data of workers not wearing protective clothing.

² I = Insufficient information; N/A = Not applicable.

Source: USDA Forest Service (1989).

nursery management goals. It is implicit that the actions taken are the end-result of a decision-making process where pest populations and their impact on hosts are considered and control methods are analyzed for their effectiveness as well as their impact on economics, human health and the environment” (USDA Forest Service 1989).

Use of afumigant, like any other pest control method, must be analyzed for the entire range of nursery effects, including control of the target pest, impact on seedling growth and survival, cost of application, effect on the environment, and hazard to worker health and public safety.

Analyze Fumigation in an IPM Context example: Soil Disease

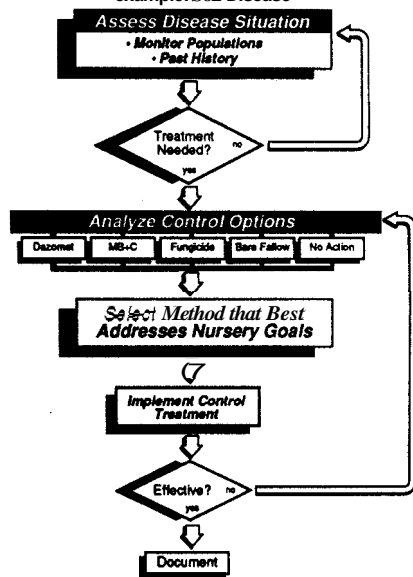

Figure 7. A flow chart can help nursery managers think through the sequential steps in an integrated pest management (IPM) program. This example shows the sequence of events for managing a soilborne disease problem.

Selection of a pest control method to control a specific target pest will depend on the priorities and resources of the nursery. Pesticides are no longer applied based solely on their ability to control a pest or because they are considered to be more cost-effective than other methods. Other issues, such as risk to human health, may drive the decision to use or not use a particular pest control method.

The decision-making process for managing soil-borne pests in a forest nursery can be illustrated with a flow chart which shows both the steps and the order in which they are taken (Figure 7). In this flow chart, there are several key steps:

1. Determining whether or not there is a pest problem in need of treatment
2. Deciding which pest control methods are available to reduce or prevent crop damage
3. Analyzing the benefits and drawbacks of each method
4. Selecting the best pest management method in accordance with the goals and priorities of the nursery
5. Implementing pest treatment
6. Evaluating the treatment for effectiveness

Documentation is an important yet often neglected part of an integrated pest management program. Adequate documentation includes figures on pest population trends, type of control treatment (what was used, rates, dates of application, etc.), and treatment effectiveness, but there should also be some documentation of the analysis and rationale used for selecting the treatment to aid in future decisions.

If fumigants are analyzed and applied in a comprehensive integrated pest management context, nursery managers can be assured that they are acting in a logical, environmentally sound manner and will continue to be able to use these effective pesticides.

Acknowledgements

Appreciation is expressed to Fred McElroy, Peninsulab, Bruce Kelpsas, Northwest Chemical Corp., and Jim Sargent, Great Lakes Chemical Co. for their review of this paper.

Literature cited

- BASF. 1984. Basamid Granular. BASF, Agricultural Research Stn. Limburgerhof, Germany, 91 p.
- Bentson, K.P.; Lavy, T.L. 1989. A study plan for deep leaching of pesticides at USDA Forest Service nurseries. USDA Forest Service, Pacific Northwest Forest and Range Experiment Station. Corvallis, OR 26 p.
- Bohmont, B.L. 1983. The new pesticide user's guide. Reston Publishing, Reston, VA. 452 p.
- Boone, A.J. 1988. Soil fumigation in forest tree nurseries. Pages 33-38 in Proceedings, Southern Forest Nursery Association. July 25-28, 1988 Charleston, SC. South Carolina Forestry Commission Columbia, SC.
- Campbell, S.J.; Kelpsas, B.R. 1988. Comparison of three soil fumigants in a bareroot conifer nursery. Tree Planters' Notes 39(4):16-22.
- Clifford, E.D. 1951. Methyl bromide to control weeds in conifer seedbeds. Tree Planters' Notes 7:17-18.
- Cordell, C.E.; Wortendyke, J.T. 1972. Background document for methyl bromide. Internal Report. USDA Forest Service, Forest Pest Management Asheville, NC. 70 p.

-
- Great Lakes Chemical Co. 1989. Material safety data sheet, Ten-0-Gas 67. West Lafayette, Indiana
- Grierson, D. 1989. Methyl bromide fumigation at the Lone Peak State Forest Nursery, Utah. Pages 38-39 *in* T.D. Landis, technical coordinator. Proceedings of a meeting of the Intermountain Forest Nursery Association. Bismarck, North Dakota, August 14-18, 1989. U.S.D.A. For. Serv. Gen. Tech. Rep. RM-184. Fort Collins, CO.
- Henry, B.W. 1951. Ethylene dibromide controls a root rot at the W.W. Ashe Nursery. Tree Planters' Notes 7:2-4.
- Ingestad, T.; Nilsson, H. 1964. The effects of soil fumigation, sucrose application, and inoculation of sugar fungi on the growth of forest tree seedlings.
- James, R.L. 1989. Effects of fumigation on soil pathogens and beneficial microorganisms. Pages 29-34 *in* T.D. Landis, technical coordinator. Proceedings of a meeting of the Intermountain Forest Nursery Association. Bismarck, North Dakota, August 14-18, 1989. U.S.D.A. For. Serv. Gen. Tech. Rep. RM-184. Fort Collins, CO.
- Marois, J.J.; Dunn, M.T.; Papavizas, G.C. 1983. Reinvasion of fumigated soil by *Fusarium oxysporum* f.sp. *melonis*. Phytopathology 73(5):680-684.
- Marx, D.H.; Cordell, C.E.; Kormanik, P. [In press]. Mycorrhizae: benefits and practical application in forest tree nurseries. *in* C.E. Cordell, R.L. Anderson, W.H. Hoffard, T.D. Landis, R.S. Smith and T.V. Toko, technical coordinators. Forest Nursery Pests. Agriculture Handbook. USDA Forest Service, Forest Pest Management, Washington, DC.
- McElroy, F.D. 1986. Use of metam-sodium and dazomet fumigants. Pages 139-146 *in* T.D. Landis, technical coordinator. Proceedings: Combined Western Forest Nursery Council and Intermountain Nursery Association meeting, August 12-15, 1986, Tumwater, WA. USDA For. Serv. Gen. Tech. Rep. RM-137. Rocky Mountain Forest and Range Experiment Station, Fort Collins, CO.
- Neumann, U.; Will, H.; Groner, H. 1984. Soil fumigation with basimid granular, including new experimental results. Acta Horticulturae 152:171-178.
- Niner, G.C. 1951. Control of weeds with Dowfume MC-2 in woody stock production at the Albuquerque SCS nursery. Tree Planters' Notes 4:9-10.
- Parsons, D.W.; Witt, J.M. 1988. Pesticides in groundwater in the United States of America. Report No. EM-8406. Oregon State University, Extension Service, Corvallis, OR 18p.
- Peterson, G.W.; Riffle, J.W. 1986. Root lesion nematodes in junipers and pines. Pages 140-141 *in* G.W. Peterson and J.W. Riffle, technical coordinators. Diseases of trees in the Great Plains. USDA For. Serv. Gen. Tech. Rep. RM-129. Rocky Mountain Forest and Range Experiment Station, Ft. Collins, CO.
- Rattink, H. 1984. Introduction to soil fumigation and specific problems with a special reference to the effect of low dosages of methyl bromide on some fungi and nematodes. Acta Horticulturae 152: 163-170.
- Ruehle, J.L. 1975. Nematodes. Pages 31-34 *in* G.W. Peterson and R.S. Smith, Jr. technical coordinators. Forest Nursery Diseases in the United States. USDA For. Serv. Agric. Handbk. 470. Washington, DC.
- Russell, H.H.; Jackson, R.J.; Spath, D.P.; Book, S.A. 1987. Chemical contamination of California drinking water. West. J. Med. 147(5): 615-622.
- Scholtes, J.R. 1989. Soil fumigation at J. Herbert Stone Nursery. Pages 35-37 *in* T.D. Landis, technical coordinator. Proceedings of a meeting of the Intermountain Forest Nursery Association. Bismarck, North Dakota, August 14-18, 1989. U.S.D.A. For. Serv. Gen. Tech. Rep. RM-184. Fort Collins, CO.
- Tanaka, Y.; Russell, K.W.; Linderman, R.G. 1986. Fumigation effect on soilborne pathogens, mycorrhizae, and growth of Douglas-fir seedlings. Pages 147-152 *in* T.D. Landis, technical coordinator. Proceedings of the Combined Western Forest Nursery Council and Intermountain Nursery Association meeting, August 12-15, 1986 Tumwater, WA. USDA For. Serv., Gen. Tech. Rep. RM-137. Rocky Mountain Forest and Range Experiment Station, Fort Collins, CO.
- Thomson, W.T. 1988. Agricultural chemicals III: Fumigants, growth regulators, repellents, and rodenticides. Thomson Publications, Fresno, CA 210 p.
- Tillotson, C.R. 1917. Nursery practice on the National Forests. USDA Bulletin No. 479, Government Printing Office, Washington, D.C. 86 p.
- USDA Forest Service. 1986. Pesticide background statement, Volume II. Fungicides and Fumigants. Agric. Handbk. No. 661.
- USDA Forest Service. 1987. Pesticide background statement, Volume III. Nursery Pesticides. Agric. Handbk. No. 670.
- USDA Forest Service. 1989. Nursery pest management. Environmental Impact Statement. Pacific Northwest Region, Portland, OR.
- US Environmental Protection Agency. 1988. Pesticides in ground water data base. Interim Report. Office of Pesticide Programs, Environmental Fate and Effects Division, Environmental Fate and Ground Water Branch.
- Vaartaja, O. 1967. Reinfestation of sterilized nursery seedbeds by fungi. Can. J. Microbiol. 13:771-776.
-

Insects in British Columbia forest nurseries

G.M. SHRIMPTON

*British Columbia Ministry of Forests
3605-192nd Street, Surrey, V3S 4N8*

*Presented at the first meeting of IUFRO Working Party S2.07-09
(Diseases and Insects in Forest Nurseries), Victoria, British Columbia, Canada, August 22-30, 1990.*

Abstract

The damage, hosts, biology and management of the major insects affecting forest nursery seedlings in British Columbia, Canada are discussed. An appendix contains similar information for nursery insects of minor importance in the province.

Resume

Cette étude décrit les dommages, les organismes hôtes, les caractéristiques biologiques et le mode de gestion des principaux insectes (avec un tableau portant sur les insectes d'importance moindre) attaquant les semis arboricoles cultivés en pépinière en Colombie-Britannique.

Introduction

Conifer seedling nurseries have a unique complex of insect pests because young and succulent seedlings can be hosts to several insects that would not normally feed on mature trees. Many of these insects are general feeders and often attack agricultural crops. They directly affect the quantity and quality of seedlings produced. Monetary losses include the cost of producing dead or culled seedlings, plus the cost of control procedures. There is also an increasing resistance to the use of insecticides due to human health and environmental concerns. Complications arise when planting sites have been prepared in the field and the seedlings are not available. This can delay reforestation for 1 or more years, and if weeds become established the site will have to be prepared again. In addition, infested stock can disseminate pests to new areas, reducing the survival of the stock.

The Appendix describes nursery insect pests and their damage, and outlines recommended control procedures. The insects are grouped by feeding habits: chewing, sucking, girdling, and root feeding.

Foliage feeders

Most insect pests in conifer nurseries feed on the needles and shoots of seedlings. General feeders will readily attack young seedlings before the stems become woody and the needles become resinous. These insects are the most easily detected and controlled because pests or damage can be seen on inspection. In small infestations, the insects can be removed by hand and destroyed. In large infestations, or when damage is severe, foliar applications of insecticides may be necessary.

Root collar feeders

Conifer seedlings can sustain girdling damage from several insects. Although the damage from different insects often looks similar, type of stock, time of damage, and some characteristics of the girdle can help to distinguish the culprits.

Girdling damage or presence of the insects is not easily detected. Most of these pests are soil or surface dwelling; some are nocturnal. Often their presence is not noted until major feeding damage to the root collar has caused the shoot to turn chlorotic. If the damage occurs before the seedlings have become dormant for the winter, callous tissue may develop along the edges of the feeding injury and adventitious roots may develop. Seedlings girdled after they are dormant will not turn chlorotic and damage may still appear fresh when the seedlings are lifted.

Partial girdling probably does reduce seedling vigor, especially when seedlings are planted in reforestation sites. However, under current grading standards, all such seedlings are automatically culled.

Root feeders

Soil-dwelling insects that feed on the roots of conifer seedlings are the most difficult to detect and control. Unless the seedlings are lifted during routine surveys, infestations are not noticed until the supply of water and mineral nutrients to the seedling shoot is reduced, resulting in foliar symptoms. By this time, damage is usually too severe to save the seedling.

Root feeders cause further problems by opening infection courts for soil-borne pathogens. Pesticides must be applied as a soil drench, and contacting all pests

can be difficult. As well, the chemical used must be carefully chosen because many compounds are inactivated in the soil. Often control programs for larval stages are aimed at preventing the mobile adults from ovipositing on the conifer seedlings.

Control considerations

Insect control in nurseries is practised at all phases of production and begins with the selection of the nursery site. Factors to be considered include the incidence of pests in the surrounding areas and presence of plants that could serve as alternative hosts, and the existence of established quarantine zones for insects. General year-round maintenance of the site is crucial for reducing and controlling many insect populations. For example, grasses in and around the nursery can serve as alternate hosts for both the cranberry girdler and the European marsh crane fly. Removal of weeds in general can help reduce endemic populations of cutworms, lygus bugs, and root weevils. Populations of fungus gnats can build up in pools of standing water, so greenhouse facilities should have adequate drainage. The build-up of algae, moss, and liverworts in container culture can also encourage fungus gnats and springtails.

Monitoring programs have been developed for several nursery insect pests. Pheromones are used to trap the spruce budworm, European pine shoot moth, and cranberry girdler moth. Yellow-colored sticky traps are used to monitor fungus gnats, and board traps are used for root weevils. Light traps are occasionally used to reduce and monitor populations of moths in greenhouses.

Current control procedures rely less on pesticides. Many insect pests such as cutworms and tussock moth larvae are hand-picked and destroyed. Some pests are physically excluded from greenhouses for part of the season by closing the doors and placing screens over the fans. Several biological control agents have also been tested. Nematodes have been used against root weevil larvae, viruses against rusty tussock moth larvae, and *Bacillus thuringiensis* against cutworms.

Pest management in British Columbia conifer seedling nurseries is a relatively new field. As nurseries are becoming established in new areas and as stock types change, new insects are becoming pests. When discovered, the pests are identified, their biology is investigated, and management programs are developed. An active program to gain new registrations for safer and more effective pesticides has also been established in the province.

Literature Cited

- Doidge, D.F.; Marshall, V.G. 1971. Spruce spider mite in British Columbia. Dep. Fish. For., For. Res. Lab., For. Pest Leaflet No. 33.
- Furniss, R.L.; Carolin, V.M. 1977. Western forest insects. U.S. Dep. Agric. For. Serv., Washington, D.C. Misc. Publ. No. 1339.
- Gerber, H.S.; Tonks, N.V.; Ross, D.A. 1974. The recognition and life history of the major insect and mite pests of ornamental shrubs and shade trees of British Columbia. B.C. Dep. Agric., Victoria, B.C. Bull. 74-13. 47 p.
- Kamm, J.A.; Morgan, P.D.; Overhulser, D.L.; McDonough, L.M.; Triebwasser, M.E.; Kline, L.M. 1983. Management practices for cranberry girdler (Lepidoptera: Pyralidae) in Douglas-fir nursery stock. J. Econ. Entomol. 76(4):923-926.
- Koot, H.P. 1983. Spruce aphid in British Columbia. Environ. Can., Can. For. Serv., Pac. For. Res. Cent., Victoria, B.C. For. Pest Leaflet No. 16.
- Lindquist, R.K. 1983. Fungus gnats becoming a pest. Greenhouse Manager 2:66-71.
- Marshall, V.G.; Ilnytzky, S. 1976. Evaluation of chemically controlling the collembolan *Bourletiella hortensis* on germinating Sitka spruce and western hemlock in the nursery. Can. J. For. Res. 6:467-474.
- Nielsen, D.G.; Dunlap, M.J.; Boggs, J.F. 1978. Controlling black vine weevils. Am. Nurseryman 147:12, 13, 89-92.
- Palmer, M.; Nichols, T. 1981. How to identify and control cutworm damage on conifer seedlings. U.S. Dep. Agric. For. Serv., N. Central For. Exp. Stn., Leaflet No. 767-160.
- Schowalter, T.D.; Hargrave, W.W.; Crossley, D.A., Jr. 1986. Herbivory in forested ecosystems. Ann. Rev. Entomol. 31:171-196.
- Shrimpton, G.M. 1985. Four insect pests of conifer nurseries in British Columbia. Western Forest Nursery Council - Intermountain Nurseryman's Assoc., U.S. Dep. Agric. For. Serv., Gen. Tech. Rep. INT-185.
- Unger, L.S. 1986. Spruce budworms in British Columbia. Environ. Can., Can. For. Serv., Pac. For. Cent., Victoria, B.C. For. Pest Leaflet No. 31.
- Wilkinson, A.T.S.; Gerber, H.S. 1983. Description, life history, and control of leatherjackets. B.C. Minist. Agric. Food, Victoria, B.C.
- Wood, C. 1977. Cooley spruce gall aphid. Can. Dep. Fish. Environ., Pac. For. Res. Cent., Victoria, B.C. For. Pest Leaflet No. 6.

Appendix. Common insect pests of conifer nurseries in British Columbia

Chewing insects

Cutworms, especially variegated cutworm *Peridroma saucia* (Palmer and Nichols 1981)

Species affected - All species of conifers in both bareroot and container culture

Potential for damage - Greatest losses occur in 1+0 stock; several seedlings can be destroyed by a single larva each night. Larvae shelter in 2+0 stock in open compounds, causing minimal damage, but may then also accompany stock to planting sites. There are probably populations at all nurseries in every growing season, but the severity of the infestation varies greatly.

Signs and symptoms - During growing season, larvae grow up to 4 cm long; caterpillars are large, soft, and fat, with hairless bodies and shiny heads, and they feed on foliage. Symptoms that may indicate presence of cutworms are stems without needles, depressed areas on stems that look like fungal lesions, stems cut off below the soil so it appears that the seedling did not germinate, or stems cut off at ground level.

Adult cutworm moths are thick-bodied, dull-colored, mostly nocturnal, and about 18 mm long. They fold their wings in a tent fashion when at rest.

Management - Permethrin is effective when applied under warm, moist conditions in the evening when activity is highest. Adult moth populations can be reduced by the use of light traps, closed doors, and screens placed over fans in greenhouses. Keeping nursery sites weed-free reduces cutworm populations because many moths are attracted to certain weeds when ovipositing. Applications of bait reduce cutworms in 2+0 stock.

Needle tiers *Choristoneura rosaceana* and *Archips rosanus* (Fumiss and Carolin 1977)

Species affected - Infestations often occur in spruce, but most species of seedlings have been attacked

Potential for damage - Distribution is spotty throughout the crop, and usually solitary; most infestations are incidental.

Signs and symptoms - Larvae web the top needles of the seedlings together early in the season when the seedlings are about 5-8 cm tall.

Management - Can be controlled physically by the removal of caterpillars. Applications of insecticides are seldom necessary. Larvae are green with black heads.

Spruce budworm *Choristoneura occidentalis* (Unger 1986)

Species affected - Douglas-fir and spruce seedlings. Do not feed significantly on pine.

Potential for damage - Larvae are voracious feeders and cause severe damage to small seedlings. Adult moths may oviposit on nursery seedlings. Resulting larvae can accompany stock from the nursery to reforestation sites.

Signs and symptoms - In spring, nursery stock can become infested by larvae that have overwintered in small, silken cocoons in mature trees in and around the nursery site. The larvae spin long silken threads which get caught in the wind and carry the larvae into nursery stock. Full-grown larvae are 30 mm long, with brownish heads and bodies and prominent ivory-colored spots.

Management - Applications of sevin are often necessary to protect seedlings from larvae in the spring. Pheromone traps are used to monitor adult moths. If warranted, diazinon sprays will discourage oviposition on the seedlings.

Spruce spider mite *Oligonychus ununguis* (Doidge and Marshall 1971)

Species affected - Douglas-fir, true firs, hemlock, larch, spruce, and pine

Potentialfor damage - These are sporadic pests at some nurseries, particularly in the interior of **B.C.**, but infestations are usually not severe.

Low host vigor, host crowding, and the absence of natural enemies will enhance outbreaks; damage usually occurs near the end of the growing season when seedlings are being stressed for water and nutrients to induce bud set.

Signs and symptoms - The mites feed on needles, causing them to become *dry*, mottled, and bleached. First there is a chlorotic stippling of the foliage; later a fine silk webbing develops which eventually covers the foliage. Severely affected foliage turns dingy yellow to dull rusty brown and the needles drop off.

Management - A proper miticide must be used; applications must often be repeated because the eggs are resistant to pesticides, and several different life stages are usually present simultaneously.

Sucking insects

Giant conifer aphids *Cinara* spp. (Fumiss and Carolin 1977)

Species affected - All species of seedlings can be hosts for at least one species of *Cinara*

Potentialfor damage - Giant conifer aphids usually do not cause damage until they have reached high numbers, but population build-up is fast and erratic. They are a particular problem on stock grafted for seed orchards.

Signs and symptoms - Aphids are 3-5 mm long, **dark-** colored and long-legged. They feed gregariously, usually on the stem of the seedlings. Heavy infestations severely reduce growth and vigor of seedlings and may cause foliage chlorosis. Often *Cinara* infestations are detected by the presence of wasps or ants. Eggs, the overwintering stage in the aphid life cycle, are about 1 mm long, black, and oval; there is usually one per needle.

Management - Wasps feed on the honeydew the aphids produce, as well as on the aphids themselves, and can be used to control small populations. Larger infestations may require an insecticide. At the end of the growing season, aphids may lay overwintering eggs on the seedlings. Once present, eggs are hard to control and stock will leave the nursery infested with aphids.

Cooley spruce gall aphid *Adelges cooleyi* 1st life stage Woolly stage (Wood 1977)

Species affected - Douglas-fir, white, Engelmann, or Sitka spruce seedlings

Potentialfor damage - The woolly stage can be a serious pest on nursery stock, since it is present all year round. The white, woolly covering makes them harder to control.

Signs and symptoms - Aphids appear as little white balls of fluff about 1 mm long on the lower surface of needles and shoots. Feeding on the needles causes them to be mottled or twisted and severe infestations can cause stunting or needle drop.

Management - Small infestations can be successfully treated with Safer's soap; large infestations can be treated with diazinon.

Mature spruce trees host the alternate stage of the life cycle and should be removed from the nursery site.

2nd life stage gall stage

Species affected - Spruce transplant or grafting stock that is at least 3 years old

Potential for damage - Seedlings are seldom killed, but heavy infestations can reduce growth and vigor and cause deformation in small trees.

Signs and symptoms - Cone-shaped galls form on spruce.

Management - Galls may be clipped off and destroyed. Removing Douglas-fir, the alternate host, will help to reduce populations.

Green spruce aphid *Elatobium abietinum* (Koot 1983)

Species affected - Most spruce species, particularly Sitka spruce, may occur on pine and Douglasfir.

Potential for damage - Initial feeding results in mottled needles, followed by chlorosis and needle drop. Severe infestations can lead to complete defoliation and seedling death.

Signs and symptoms - Aphids are 1 mm long and dark green with long cornicles. They are usually found on lower shaded needles rather than on the leaders or growing tips.

Management - Populations overwinter as adults on foliage and, under mild conditions, will continue to reproduce and feed. Nursery personnel must be aware of populations throughout the year.

Control is often necessary.

Woolly aphid *Mindarus obliquus*

Species affected - Spruce

Potential for damage - Has been a problem at several nurseries across the province. It is capable of killing the terminal of the seedling and causing deformation.

Signs and symptoms - Aphids appear as a white woolly mass at the tip of the seedling.

Management - Widespread infestations may require treatment with an insecticide.

Tarnished plant bug *Lygus lineolaris* (Schowalter et al. 1986)

Species affected - This insect has a preference for 1+0 stock. Most damage has occurred on pine and spruce; Douglas-fir, cedar, and larch have also been attacked. Up to 50% of some stock types can be attacked.

Potential for damage - Lygus bug damage has been found at almost every nursery. Lygus populations invade the nurseries throughout the growing season from mid May to late September.

Signs and symptoms - Adults are mottled yellowish or reddish brown, 7 x 3.5 cm, with flat, oval bodies. The five nymphal instars are greenish and resemble aphids. Feeding on the apical meristem

causes an initial distinctive terminal distortion. Needles are thicker, shorter, and twisted; adult foliage may develop in pine. An elongate scar may appear on the stem; later, a multiple leader develops.

Management - One application of Cymbush during the first week of June, July, and August has reduced damage significantly.

Girdling insects

Cranberry girdler *Chrysoteuchia topiaria* (Kamm et al. 1983)

Species affected - Most damage has occurred on bareroot 2+0 Douglas-fir and true firs; 2+0 spruce and Douglas-fir container stock have been attacked

Potential for damage - In severe infestations, losses can exceed 25% of the seedlings in a bed; damage generally occurs in scattered patches where almost all seedlings are injured.

Signs and symptoms - Larvae are up to 1.5 cm long and dirty white, with tan head capsules. They feed on stock from late August to mid-November. Larvae eat the bark and chew into the wood. The area about 2.5 cm above and below the soil line is attacked; major damage to the root collar will cause the seedling to turn chlorotic. Adults are 1-2 cm long moths with a protruding snout. They have pale forewings with touches of brown, silver, and black. Hindwings are gray.

Management - Pheromone traps are used to monitor moth populations and diazinon spray is applied to protect the crop, acting as an insecticide and repellent. Reducing the amount of grass also works by limiting the alternate host.

Adult weevils *Otiorhynchus rugosostriatus*, *Otiorhynchus ovatus*, *Otiorhynchus sulcatus*. Suspect-*Trachyphloeus bifoveolatus*; Suspect-*Strophosoma melanogrammus* (Gerber et al. 1974)

Species affected - These weevils attack container seedlings 8-15 cm in height. Spruce is preferred but cedar, larch, fir, and pine are also attacked.

Potential for damage - Seedlings at the edges of greenhouses and on the outsides of styroblocks are most frequently attacked. Usually one seedling is girdled at one time.

Signs and symptoms - Damage consists of a uniform 1-cm-wide ring below the point at which foliage begins in the fleshiest part of the stem. Damage usually occurs in June and July.

Management - Belmark is applied as a foliar spray during the second week of May followed by a second application 3 weeks later.

European marsh crane fly (leather jackets) *Tipula paludosa* (Wilkinson and Gerber 1983)

Species affected - Any stock present in the nursery in early spring may be attacked

Potential for damage - Damage is limited to coastal areas. Crane flies have been chronic pests at several coastal nurseries for the past 10 years, and are common and damaging pests of lawn and turf.

Signs and symptoms - Adults resemble large mosquitoes, are 2.5 cm long, and have 2-cm wings and long spindly legs. Legless larvae are a grayish color, and have tough leather-like skin. They are 4 cm long in older instars. Damage occurs in the spring and consists of a uniform ring 3 cm wide at

the soil line; only the bark is consumed. Damage is spotty, and one to seven seedlings are attacked by one larva.

Management - Best control is achieved by drenching for larvae with insecticides in October.

Springtails *Bourletiella hortensis* (Marshall and Ilnytsky 1976)

Species affected - Conifer seedlings in bareroot nurseries

Potential for damage - Most feed on decaying material but if in large numbers they will also feed on conifer seedlings.

Signs and symptoms - Springtails are small (less than 6 mm long), often gray-colored insects, with an appendage-like structure on the abdomen that allows them to jump. They attack the hypocotyle area between the needles and the roots after seedling emergence for about 3 weeks, producing small lesions which may result in deformation or mortality of seedlings.

Management - Once the seedling stems become woody, springtails are no longer a problem. Routine pre-emergence applications of the herbicide A W K reduce numbers. If large populations persist, Diazinon may be applied.

Root feeding insects

Black vine weevil *Otiorhynchus sulcatus* (Nielsen et al. 1978)

Species affected - Conifer seedlings in container culture, Douglas-fir and hemlock

Potential for damage - Larvae can cause considerable damage to container stock, especially at coastal nurseries enhanced by 2+0 container rotation. They are also a serious problem in grafting houses.

Signs and symptoms - Adults are 9 mm long and brownish black, with patches of yellow hair on the abdomen. Larvae are white, C-shaped, and legless, with brown-headed capsules. They consume roots and girdle the stem below the ground line throughout the fall and winter. Adults girdle seedlings from late May to July.

Management - These pests can be physically excluded by placing Stickem on table legs or placing each table leg in a bucket of soapy water. Applications of Belmark for recurring infestations are recommended; it should be applied after adult emergence but before egg-laying begins.

Strawberry root weevil *O. ovatus* (Shrimpton 1985)

Species affected - Predominantly 2+0 bareroot stock

Potential for damage - Strawberry root weevil damages conifer seedlings in the Pacific Northwest, but has only been a serious problem in one Lower Mainland nursery. Damage usually occurs in patches because weevils are somewhat gregarious.

Signs and symptoms - Adults are dark brown to black, 6 mm long, and egg-shaped. Larvae are white, C-shaped, and legless, with brown-headed capsules, smaller than those of black vine weevil larvae.

Larvae eat roots of seedlings, stripping most laterals. In heavy concentrations, they may girdle root collar. Seedlings may become chlorotic in the fall, indicating root damage.

Management - Populations are monitored using board traps to determine the length of the adult emergence period, the distribution of weevils throughout the nursery, and the effectiveness of control programs.

Surface application of Orthene or Belmark is recommended. First spray should be applied 2 weeks after the adult population starts to emerge in the spring; later applications may be necessary.

Fungus gnats family *Sciariidae* (Lindquist 1983)

Species affected - Container seedlings, all species

Potential for damage - Larvae normally feed on soil fungi and organic matter but will be attracted to seedlings if they have been predisposed by stress. Infestations often accompany infections of root pathogens.

Signs and symptoms - Adults are small, 2.5 mm, dark-colored, mosquito-like flies, with clear wings, long legs, and segmented antennae. Larvae are legless, semi-transparent, milky-white worms with black heads; they range up to 0.5 cm in length. Larvae consume root hairs and small rootlets, but in heavy concentrations will strip main roots and sometimes girdle the stem just below and at soil line. Symptoms include wilting and loss of vigor.

Management - Management techniques include general greenhouse sanitation, removing moss and algae, and ensuring good drainage to remove puddles of water. After stock has been lifted, styroblocks should be washed and greenhouses cleaned. If larvae become established and damage is evident, drenching with diazinon may be necessary. Populations of adult flies can be monitored with the use of yellow-colored sticky traps.

Conifer root aphid *Pachypappa tremulae* (Shrimpton 1985)

Species affected - Container spruce, spruce potted for grafting stock; also pine, larch, and Douglas-fir

Potential for damage - Conifer root aphids have infested stock at several nurseries, particularly in the Prince George area. Those that have been infested report no damage. Damage will be minimal if seedlings are growing in ideal conditions with ample nutrients.

Signs and symptoms - Aphids are detected by secretions of white, waxy filaments, and infestations are usually on the surface of the plug between the roots and the container wall. An alternative life cycle occurs on the leaves of *Populus tremuloides*, where aphids form leaf nest structures.

Management - No control measures are recommended to date.

***Lygus* bugs: A worldwide problem in conifer nurseries**

DAVID B. SOUTH

Auburn University, Southern Forest Nursery Management Cooperative, School of Forestry
and Alabama Agricultural Experiment Station, Auburn University, Alabama 36849-5418, USA

Presented at the first meeting of IUFRO Working Party S2.07-09
(Diseases and Insects in Forest Nurseries), Victoria, British Columbia, Canada, August 22-30, 1990.

Abstract

Lygus lineolaris (Palisot de Beauvois), *L. hesperus* (Knight) and *L. rugulipennis* (Poppius) can cause multiple leaders to form on conifer seedlings. Injury due to *Lygus* bugs has increased during the last two decades to the point where these bugs are now considered the worst insect pest at many conifer nurseries. At several nurseries, *Lygus* bugs have injured 30% or more of the seedlings. Substantial injury has occurred in the United States, Canada, Europe, and the United Kingdom. Similar injury in other regions of the world (i.e. New Zealand) might also be attributed to *Lygus* or related species. It is hypothesized that the rise in injury results from a cessation in the use of mineral spirits (also known as white spirits or mineral oils) that were frequently applied to control weeds in seedbeds.

Resume

Lygus lineolaris (Palisot de Beauvois), *L. hesperus* (Knight) et *L. rugulipennis* (Poppius) peuvent entrainer la formation de pousses apicales multiples sur les semis de conifères. Les dégâts causés par *Lygus* ont tellement augmenté au cours des deux dernières décennies que ces punaises sont maintenant considérées comme le pire ravageur dans de nombreuses pépinières de conifères. Différentes espèces de *Lygus* ont endommagé plus de 30% des semis dans plusieurs pépinières. Des dommages importants ont été signalés aux Etats-Unis, au Canada, en Europe et au Royaume-Uni. Des dégâts similaires observés dans d'autres régions du monde (comme en Nouvelle-Zélande) pourraient également être attribuables à *Lygus* ou à des espèces apparentées. On présume que cette augmentation des dommages est attribuable à l'abandon des essences minérales (également appelées solvants blancs) qui étaient souvent appliquées sur les planches de semis pour lutter contre les mauvaises herbes.

Introduction

Insects in the *Lygus* complex¹ occur throughout the world and can be found in North and South America, the United Kingdom, Europe, Africa, India, Russia, China, Japan, Hawaii, Australia, Fiji, and New Zealand (Graham *et al.* 1984; Wise 1977). It has been known for many years that various insects in this group can injure tree seedlings (Haseman 1918; Graham 1929; Forsslund 1936; Francke-Grosman 1962). Members of the *Lygus* genus can injure both hardwoods (Haseman 1918; Sapiot *et al.* 1982) and conifers. Several species of *Lygus* occur in Europe and Asia and more than 30 species can be found in North America (Kelton 1975).

When *Lygus* injures conifer seedlings, there is usually a distinctive growth distortion at the terminal.

Feeding at the terminal leads usually results in a loss of apical dominance. This leads to the formation of multiple leaders (sometimes referred to as "bushy-tops" in the United Kingdom and United States, "cabbage heading" in Canada, and "brooming" in Czechoslovakia). Within a week of injury, growth of newly emerging needles is distorted: they are shorter, thicker, and appear to be affected by a chemical or growth hormone. On some seedlings (ca. 20%), a brown lesion forms on the main stem just below the dead terminal. Overhulser and Kanaskie (1989) have provided color photographs of the insect and associated damage to *Pseudotsuga menziesii* (Mirb.) Franco. However, reports of injury in conifer nurseries were not common until after the 1970s (Table 1). Either the injury was often misdiagnosed, or the frequency of injury has increased for some reason.

¹For many years, the genus *Lygus* (family Miridae) contained a number of subgenera (i.e. *Orthops*, *Lygocoris*, *Agnocoris*, *Stechus*, *Neolygus*, *Apolygus*, and *Taylorilygus*) (Kelton 1975). However, since 1940, many of the subgenera have been raised to generic status. As a result, the number of species in *Lygus* has been greatly reduced. For the purposes of this paper, the term "*Lygus*" refers to species in the current genus and the term "*Lygus* complex" refers to all genera that were at one time classified as *Lygus*.

Misdiagnosis

Correct identification of the pest is the first vital step in a nursery pest management program (Sutherland and van Eerden 1980). However, due to the habits of these insects, injury from *Lygus* bugs is often misdiagnosed. Since these insects are very mobile, they are seldom found on the seedlings when the symptoms appear. During dry spells, they are apparently attracted by the presence of succulent plants that have been fertilized and irrigated (Adkisson 1957). Within a few days, they can move onto nursery beds, feed, and exit onto adjacent areas that contain alternate hosts. When present in the seedbeds, they seem to be most active during the early morning and can be difficult to find during the afternoon. Since it is difficult to associate the injury with the presence of *Lygus* bugs, the injury is often blamed on other agents.

Explanations for the cause of the multiple-leadering have ranged from herbicide injury, frosts, viruses, genetics, disease, air pollution, "juvenile instability," nutrient deficiencies, and other insects. In the southern United States, use of the herbicide oxyfluorfen was suspected to cause injury (even though the same herbicide was used at nurseries where no injury was noted). Some thought that multiple leaders were the result of boron deficiencies (Ray and Vanner 1988; Raitio 1983). In Finland, a virus was thought to be involved (Soikkeli 1985).

In more northern climates, injury from frost damage was suggested as the major reason for multiple leaders (Raitio 1985; Hofstra *et al.* 1988). However, Holopainen (1990a) demonstrated that low temperature alone would not cause an increase in multiple leaders of *Pinus sylvestris* L. In the United States, multiple-leaders occur on 1-0 seedlings prior to any frost damage.

Some thought the injury was due to insects that could be readily found in the seedbeds. Springtails (*Bourletiella hortensis*) were common and were thought to cause multiple-leadered seedlings in the United Kingdom (Bevan 1965; Aldhous 1972) and Canada. However, after conducting several studies, it was concluded that springtails do not cause multiple leaders in Canada (Marshall and Ilnytzky 1976; Sutherland and van Eerden 1980; Webb and Reese 1984). In the southern United States, several species of thrips (*Frankliniella tritici*, *F. fusca*, *Sericothrips variabilis*, and *Anophothrips obscurus*) were suspected to cause injury since they were 300 to 500 times more abundant than *Lygus lineolaris* (Oak *et al.* 1987a). However, these species of thrips failed to produce multiple leadering in caging studies (Oak *et al.* 1987b). Thrips (*Thrips tabaci*

Lindeman) are also suspected of causing multiple leadering of *Pinus radiata* D. Don in New Zealand and Chile (Ray and Vanner 1988). When the cause of multiple leadering is not known, it is understandable that most guesses as to the causal agent will be wrong.

Increased frequency of injury

There has been a simultaneous increase in multiple leadering in forest nurseries throughout the world. The percentage of seedlings with multiple leaders can often be quite high (Table 2). It is possible that the increase in injury is a result of natural cycles or adaptation by the *Lygus* bugs. However, the increase is more likely due to a major change in the way weeds are controlled in conifer nurseries.

During the 1950s, managers throughout the world began to control weeds in conifer nurseries by applying mineral spirits (a petroleum oil also known as white spirits and sold under various trade names such as Varsol²; Stoddard solvent; Shell AWK). Although used as a herbicide, mineral spirits also have insecticidal properties (Marshall and Ilnytzky 1976). Application to conifers was a common practice in Canada, the United Kingdom, the United States, South Africa, Australia, and New Zealand. However, during the 1970s, the price of oil greatly increased and as a result the use of mineral spirits declined. In 1975, almost all nurseries in the southern United States were still using mineral spirits, but most had ceased using it by 1984 (South 1987). It was during the 1970s and 1980s when the reports of multiple leadering increased. At one nursery in New Zealand, the incidence of multiple-leadered seedlings was said to decrease when use of mineral spirits was resumed (Ray and Vanner 1988).

The herbicidal activity of mineral spirits depends on its aromatic content; most brands used by nursery managers had an aromatic content of 10 to 25%. Therefore, mineral spirits may have reduced insect injury by acting as an insect repellent. Although petroleum oils can be used as insecticides, it is likely that any direct contact activity of mineral spirits on insects would be ephemeral (Marshall and Ilnytzky 1976). However, the smell from treated seedlings lasts for several days and could have kept *Lygus* bugs away from the nursery beds. If this were the case, then weekly applications would have provided better protection than monthly applications. Of course, if treatment with mineral spirits started after the injury had occurred on newly germinated seedlings, even weekly applications would not prevent multiple leadering.

²Use of trade or corporation names is for the reader's information and convenience. Such use does not constitute official endorsement by Auburn University of any product or service to the exclusion of others that may be suitable.

Table 1. Conifer species affected by *Lygus* spp.

Species	Reference
<i>Larix occidentalis</i> Nutt.	personal observation, G. Shrimpton
<i>Picea engelmannii</i> (Parry) Engelm.	personal observation, G. Shrimpton
<i>Picea glauca</i> (Moench) Voss	Shrimpton 1985
<i>Picea sitchensis</i> (Bong.) Carr.	personal observation, D.B. South
<i>Pinus elliottii</i> Engelm.	personal observation, D.B. South
<i>Pinus clausa</i> (Chapm.) Vasey	personal observation, D.B. South
<i>Pinus contorta</i> Dougl.	Shrimpton 1985
<i>Pinus palustris</i> Mill.	personal observation, D.B. South
<i>Pinus ponderosa</i> Laws.	personal observation, G. Shrimpton
<i>Pinus sylvestris</i> L.	Holopainen 1986
<i>Pinus taeda</i> L.	South 1986, Bryan 1989
<i>Pinus virginiana</i> Mill.	personal observation, D.B. South
<i>Pseudotsuga menziesii</i> (Mirb.) Franco	Shrimpton 1985, Schowalter <i>et al.</i> 1986
<i>Thuja plicata</i> Donn	personal observation, G. Shrimpton

Table 2. Examples of the percentage of conifer seedlings with multiple leaders

Nursery	Location	Year	Injury (%)	Reference
?	United Kingdom	1959-60	35	Bevan 1965
Coosa	Alabama	1982	4	personal observation
Surrey	British Columbia	1982	11	Hofstra <i>et al.</i> 1988
Midhurst	Ontario	1982	30	Hofstra <i>et al.</i> 1988
Prince Albert	Saskatchewan	1982	29	Hofstra <i>et al.</i> 1988
Aurora	Oregon	1983	14	Overhulser <i>et al.</i> 1986
New Kent	Virginia	1984	10	personal observation
Suonenjoki	Finland	1984	65	Holopainen 1986
Phipps	Oregon	1984	33	Overhulser <i>et al.</i> 1986
Piedmont	South Carolina	1984	40	Cantrell 1989
New Kent	Virginia	1984	10	personal observation
Rotorua	New Zealand	1985	23	Ray and Vanner 1988
Phipps	Oregon	1985	62	Overhulser <i>et al.</i> 1986
Carters	Georgia	1986	17	Bryan 1989

Table 3. Insecticides that have reduced the occurrence of multiple leadering of conifer seedlings

Insecticide	Species	Reference
acephate	<i>Pseudotsuga menziesii</i>	Overhulser <i>et al.</i> 1986
cyperrmethrin	<i>Pinus sylvestris</i>	Holopainen 1989b
deltamethrin	<i>Pinus radiata</i>	Ray and Vanner 1988
dimethoate	<i>Pinus taeda</i>	Bryan 1989
endosulfan	<i>Pseudotsuga menziesii</i>	Overhulser <i>et al.</i> 1986
fenitrothion	<i>Pinus radiata</i>	Ray and Vanner 1988
fenvalerate	<i>Pseudotsuga menziesii</i>	Overhulser <i>et al.</i> 1986
oxydemethon-methyl	<i>Pinus sylvestris</i>	Holopainen 1989b

Observations from the southern United States

Multiple leadering of pines was not considered a problem in southern nurseries prior to 1982 (Wakeley 1954; South 1986). In 1982, Bill Rayfield at the Coosa Nursery in Alabama reported 4% multiple leadering (mineral spirits were last used at this nursery in 1978). Similar symptoms were recognized at other nurseries in 1983. However, it took several years before the cause of the injury was determined. Numerous guesses as to the causal agent were made. Finally, a report from Canada (Shrimpton 1985) indicated that *Lygus lineolaris* could cause multiple leadering of pines. Although this species could easily be found on adjacent fields in southern pine nurseries, initial searches failed to find them on the seedlings. Finally, on June 20, 1985, both nymphs and adults were observed by Rick Brooks and Dr. Charles Davey on young *Pinus taeda* L. germinants at the Hopewell Nursery in Virginia. These reports along with caging studies (South 1986) convinced the author that *Lygus lineolaris* was the causal agent.

In 1987, the Auburn University Southern Forest Nursery Management Cooperative installed monitoring studies at five nurseries to determine (1) if *Lygus* bugs could be trapped in *Pinus taeda* seedbeds, and (2) if there was a relationship between injury and the occurrence of *Lygus* bugs. Nurseries selected were the Stauffer Nursery and Coosa Nursery in Alabama, the Carters Nursery in Georgia, the Piedmont Nursery in South Carolina, and the New Kent Nursery in Virginia (all five nurseries had ceased use of mineral spirits between 1977 and 1982).

Twelve white traps (Rebell®) were placed throughout each nursery (each location was usually more than 15 m from the end of the nursery bed and at least 15 m

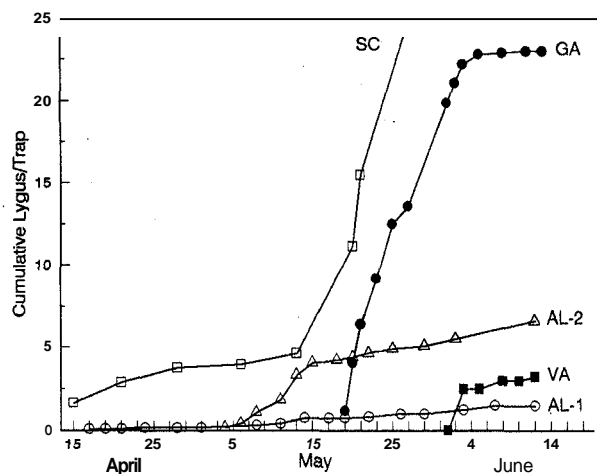

Figure 1. Recorded trapping of *Lygus* at five southern pine nurseries during the spring of 1987 (AL-1 = Stauffer Nursery; AL-2 = Coosa Nursery; GA = Carters Nursery; SC = Piedmont Nursery; VA = New Kent Nursery).

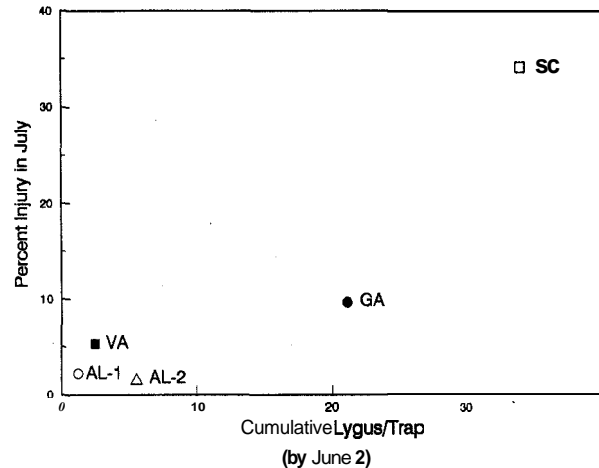

Figure 2. The relationship between number of *Lygus* trapped by June 2 and the percent of seedlings exhibiting injury in July of 1987.

from an adjacent cover-crop or fallow field). Each trap was positioned in a seedbed and was hung from a bent piece of rebar so the bottom of the trap would be about 30 cm from the ground. The number of *Lygus* bugs was usually recorded on Monday, Wednesday and Friday. Once a week, the traps were cleaned with mineral spirits and retreated with Tangletrap®. The cumulative number of *Lygus* bugs caught per trap was determined for each nursery (Figure 1). Seedling injury at all five nurseries began to appear at the end of May and the first week of June.

The cumulative number of bugs trapped by the first week of June was plotted against the amount of seedling injury present in July. The Piedmont nursery trapped the most insects (34 *Lygus*/trap) and had the highest injury (Figure 2).

Although trapping may appear to be useful in determining when to begin spraying, it has a major limitation. For example, at the New Kent nursery, no *Lygus* were trapped up to and including May 31; during the next two-day period, an average of 2.5 *Lygus*/trap were caught. A spraying program initiated after scouting on June 2 would only have protected the crop from future injuries. A substantial amount of damage would already have been caused. If only 4% of a crop of 30 million seedlings were culled due to multiple-leaders, a loss of \$36,000 could result. Therefore, most managers of nurseries that have experienced injury from *Lygus* bugs usually spray prophylactically with an insecticide (e.g. fenvalerate).

Instead of installing traps, some managers may choose to monitor preferred weed hosts each morning for the presence of *Lygus* bugs. At nurseries with a high percentage of multiple leadering, a spraying program should begin if just one *Lygus* bug is found during crop germination. The host plants to monitor will vary with

season and region. In the southern United States, cutleaf evening-primrose (*Oenothera laciniata* Hill) is suggested while common groundsel (*Senecio vulgaris* L.) might be used at more northerly nurseries (Holopainen 1989a).

Thus far, *Pinus taeda* nurseries with substantial *Lygus* injury have been east of the Mississippi River. Although nurseries west of the river use the same management practices, the percentage of multiple-leadered seedlings is usually less than 0.1%. Even though the western nurseries are within the range of *Lygus lineolaris*, the population levels are apparently not as high as in the east.

Observations from Oregon

After nursery managers in the Willamette Valley ceased applying mineral spirits in the 1970s, they began to notice an increase in deformed terminal growth during the 1-0 year. Seedlings with multiple leaders formed during the 2-0 year. Several studies were initiated during 1983 and 1984 to determine if an insect was causing the problem. Tests were conducted in three conifer nurseries (Weyerhaeuser's Aurora Nursery, the United States Forest Service Nursery at Medford, and the D.L. Phipps Nursery at Elkton). These studies found that *Lygus hesperus* was causing apical bud abortion in 1-0 and 2-0 *Pseudotsuga menziesii* seedlings (Schowalter *et al.* 1986; Overhulser *et al.* 1986). Detailed reports on the habits of this pest in Oregon nurseries have been made (Schowalter 1987; Schowalter and Stein 1987).

Observations from Canada

Multiple leadering of conifer seedlings occurs throughout Canada (Hofstra *et al.* 1988) and was recorded in Ontario nurseries as early as 1957. In some cases, the percentage of seedlings with multiple leaders has exceeded 50%. Therefore, numerous studies have been conducted on the multiple leadering problem (Vaartaja *et al.* 1964; Gross 1982, 1983, 1985; Webb and Reese 1984). Apparently, two types of injury can result in multiple leaders: (1) damage from frost or over-winter desiccation of buds; and (2) abnormal development of the apical bud (Webb and Reese 1984; Hofstra *et al.* 1988). The terms "Reese syndrome" and "cabbage heading" were coined to describe injury of the second type (Vaartaja *et al.* 1964; Webb and Reese 1984). Although the initial studies by Gross concluded that springtails were not the problem, they did not eliminate *Lygus* as the causal agent.

In 1983, notable damage from *Lygus lineolaris* occurred at several nurseries in British Columbia (Shrimpton 1985). However, this species is found from Alaska to Mexico, and from the Queen Charlotte Is-

lands to Newfoundland (Kelton 1975). Therefore, it is likely that much of the abnormal bud development observed in other Canadian nurseries (Hofstra *et al.* 1988) is also caused by this species.

Observations from Scandinavia

Lygus bugs have injured conifers in Finland (Holopainen 1990b), Sweden (Bemt Arvidsson, personal communication, National Board of Forestry, Jonkoping), and Iceland (Liseolotte Beyer-Ericson, Swedish University of Agricultural Sciences, Uppsala, personal communication). In Finland, abnormal bud development of conifer seedlings is very important since Section 13 of the Forest Regeneration Material Trade Act (No. 684/1979) states that seedlings with multiple leaders do not meet quality standards and therefore cannot be sold (Puttonen 1986). This results in a great economic loss since in 1984 a high percentage of *Pinus sylvestris* seedlings had to be culled because of multiple leaders. At one nursery, over 80% of the 2+1 seedlings had damaged buds (Holopainen and Rikala 1990).

Initially, it was suggested that nutrient deficiencies, frost damage and viruses were causing the problem (Raitio 1983, 1985; Soikkeli 1985). However, it was determined that *Lygus rugulipennis* was the causal agent (Holopainen 1986). Another species (*Lygus punctatus* Zett.) was also collected from conifer seedlings but it was present in much lower numbers.

Several studies in Finland suggest that much of the multiple-leader damage on pine seedlings could be due to *Lygus* feeding rather than to frost injury (Rikala and Rpon 1987; Holopainen 1988, 1990a, 1990b). Although multiple leadering might result from growth hormones present in the saliva (see numerous citations in Graham *et al.* 1984), it has been suggested that the effect is simply due to the mechanical damage caused by the bug's stylet (Holopainen 1986; 1990a). Using netting to cover the seedbeds has become a routine practice (Holopainen 1990b). The percentage of multiple leadering can be reduced from 50 to 90% in uncovered seedbeds to 10 to 30% in covered seedbeds (Poteri *et al.* 1987).

Observations from the United Kingdom

Although a common insect, there is no current literature from the United Kingdom regarding injury to conifers from *Lygus rugulipennis*. However, on a visit in September of 1988, the author observed *Lygus rugulipennis* on conifer seedlings at three nurseries (Tilhill Nursery at Tilford; EFG Nursery in Whitchurch; and the Forestry Commission's Nursery at Newton). In June of 1989, *Lygus* was also noted at the Forestry Commission's

Research Nursery at Roslin. The symptoms appeared identical to injury caused by the same species in Finland (Holopainen 1986). Although "bushy-top" seedlings in the United Kingdom are assumed to be the result of springtail injury (Bevan 1965; Aldhous 1972), this author is confident that caging studies will prove the injury results from *Lygus rugulipennis*.

Observations from New Zealand

Multiple leaders have been observed on *Pinus radiata* seedlings in the nursery (Burdon and Bannister 1973; Ray and Vanner 1988). In some nurseries, as much as 23% of the seedlings had multiple leaders. Like other regions of the world, injury was initially thought to be related to other factors such as nutrient deficiencies. Since no single factor was easily found, Burdon and Bannister (1973) attributed the formation of multiple leaders to "unstable" juvenile growth. However, it is now realized that the occurrence of multiple leaders can be reduced with frequent applications of insecticides (Ray and Vanner 1988).

Although thrips (*Thrips tabaci*) can cause needle crinkling of *Pinus radiata* seedlings, it was assumed they were also the cause of multiple leaders (Ray and Vanner 1988). Since three members of the *Lygus* complex (*Lygus buchmanii* Poppius, *Lygus maoricus* (Walker), and *Lygus plebejus* Reuter) occur in New Zealand (Wise 1977), it is possible multiple leaders were caused by one of these species at the same time that thrips were causing needle crinkling. Therefore, caging studies could determine if multiple leaders of *Pinus radiata* are caused by thrips or by a member of the *Lygus* complex.

Insecticides

Numerous insecticides have been tested against *Lygus* bugs in agronomic crops (Graham *et al.* 1984). Some of the more promising ones have been used in conifer seedbeds in hopes of reducing the occurrence of multiple leadering (Table 3). Although a number of insecticides may be used on pine seedlings (Bacon and South 1989), the synthetic pyrethroids (fenvalerate and cypermethrin) have proven effective if applied at the correct time. It has been suggested that these insecticides may repel *Lygus* (Holopainen 1989b). Multiple insecticide applications are recommended, not only

because *Lygus* bugs have several generations per year, but because it is important to apply the insecticide before the insects have an opportunity to cause damage. The frequency of insecticide application is directly related to the reduction in damage (Overhulser *et al.* 1986). Although trapping can be used to monitor population levels in the nursery, its usefulness as an aid in determining when to begin spraying is limited. This is because these insects need only a short time to enter an unprotected nursery and cause a substantial amount of injury. Therefore, to minimize the occurrence of multiple leaders, prophylactic applications on a weekly (Bryan 1989) or bi-weekly (Overhulser *et al.* 1986; Ray and Vanner 1988) basis may be required in regions where warm temperatures promote chemical degradation. For best results, applications should be made during the early morning when the insects are the least active.

Field performance

There is general disagreement regarding the long-term growth effects of outplanting seedlings with multiple leaders. Due to governmental regulations, some say that presence of multiple leaders is unacceptable (Holopainen 1986). There is concern (whether justified or not) that height growth of outplanted seedlings would be reduced. Seedlings with single leaders might be better suited to outgrow competing weeds (Rikala 1985; Holopainen 1990b).

On the other hand there are data to show that, independent of differences in initial seedling size, multiple-leadering has no effect on subsequent field growth (Burdon and Bannister 1973; Minko 1974; Gross 1985; Kaunisto and Kinnunen 1985). Apparently, the concern is mostly with visual appearance instead of documented reductions in field performance.

Conclusions

Although *Lygus* bugs have been known to cause injury to tree seedlings for more than 70 years, they were not considered a major pest in conifer nurseries until after the 1980s, when they rose quickly from a level of obscurity to the status of a major pest. The frequency of reported injury has increased greatly since the decline in use of mineral spirits.

Literature cited

- Adkisson, P.L. 1957. Influence of irrigation and fertilizer on populations of three species of Mirids attacking Cotton. *FAO Plant Protection Bull.* 6(3):33-36.
- Aldhous, J.R. 1972. *Nursery Practice*. Her Majesty's Stationery Office, London. Forestry Commission Bull. 43, 184p.
- Bacon, C.G.; South, D.B. 1989. Chemicals for control of common insect and mite pests in southern pine nurseries. *South. J. Appl. For.* 13:112-116.

- Bevan, D. 1965. *Bourletiella signata* (Nicol.) (Collembola) - a pest of conifer seedlings. Pages 666-668 in P. Freeman, editor. Proceedings of the 12th International Congress of Entomology. London.
- Bryan, H. 1989. Control of the tarnished plant bug at Carters Nursery. *Tree Planters' Notes* 40(4):30-33.
- Burdon, R.D.; Bannister, M.H. 1973. The significance of forks and multileaders in nursery stock of *Pinus radiata*. *N.Z.J. For.* 18: 133-140.
- Cantrell, S.W. 1989. "Bushy-top" syndrome on seedlings at Piedmont Nursery. Pages 141-145 in R. Hagwood, editor. Proceedings of the 1988 Southern Forest Nursery Association. Charleston, South Carolina, July 25-28, 1988. Southern Forest Nursery Association.
- Forslund, K.H. 1936. Some dangerous enemies of the seedlings of spruce and pine in Norrland. *Skogen* 5:99-101.
- Francke-Grosmann, H. 1962. [Unusual injuries to buds of Sitka spruce]. *Verhandlungen XI Internationaler Congress fur Entomologie, Wien, 17-25 August, 1960, 2:189-191.*
- Graham, H.M.; Negm, A.A.; Ertle, L.R. 1984. Worldwide literature of the *Lygus* complex (Hemiptera: Miridae) 1900-1980. *U.S. Dept. Agric. Bibliogr. Lit. Agric.* 30:1-205.
- Graham, S.A. 1929. Principles of forest entomology. New York: McGrawHill Book Co. 339 p.
- Gross, H.L. 1982. Character of 2 + 0 white spruce growth in 1979 relative to multi-leadering trends. *Dep. Environ., Can. For. Serv., Sault Ste. Marie, Ont. File Rep.* 18 p.
- Gross, H.L. 1983. Injuries to terminal shoots cause multiple-leadered nursery seedlings. *Can. For. Serv. Great Lakes For. Centre Inf. Rep.* 0-X-347. Sault Ste. Marie, Ont. 12 p.
- Gross, H.L. 1985. Multiple-leadered trees compare favorably with single-leadered trees in field performance tests of nursery stock. *Can. For. Serv. Great Lakes For. Cent., Inf. Rep.* 0-X-363. Sault Ste. Marie, Ont. 10 p.
- Haseman, L. 1918. The tarnished plant-bug and its injury to nursery stock. *Missouri Agricultural Experiment Station Research Bulletin* 29, 26 p.
- Hofstra, G.; McLeod, C.M.; Ensing, J. 1988. Incidence and performance of multiple-leadered seedlings of black and white spruce in Canadian nurseries. *North. J. Appl. For.* 5:99-103.
- Holopainen, J.K. 1986. Damage caused by *Lygus rugulipennis* Popp. (Heteroptera, Miridae) to *Pinus sylvestris* L. seedlings. *Scand. J. For. Res.* 1: 343-349
- Holopainen, J.K. 1988. Cellular responses of Scots pine (*Pinus sylvestris* L.) seedlings to simulated summer frost. *Eur. J. For. Pathol.* 18:207-216.
- Holopainen, J.K. 1989a. Host plant preference of the tarnished plant bug *Lygus rugulipennis* Popp. (Het., Miridae). *J. Appl. Entomol.* 107:78-82.
- Holopainen, J.K. 1989b. The influence of cypermethrin and oxydemeton methyl treatments on *Lygus* damage in young Scots pine seedlings. *Ann. Appl. Biol.* 114:209-216.
- Holopainen, J.K. 1990a. The relationship between multiple leaders and mechanical and frost damage to the apical meristem of Scots pine seedlings. *Can. J. For. Res.* 20:280-284.
- Holopainen, J.K. 1990b. The role of summer frost and *Lygus* feeding in the induction of growth disturbances in Scots pine seedlings. Ph.D. Dissertation. Natural Sciences, Original Reports. Dept. of Environmental Sciences, University of Kuopio. 46 pp.
- Holopainen, J.K.; Rikala, R. 1990. Abundance and control of *Lygus rugulipennis* (Heteroptera: Miridae) on Scots pine (*Pinus sylvestris* L.) nursery stock. *New Forests* 4: 13-25.
- Kaunisto, S.; Kinnunen, K. 1985. Taimilajin ja taimitarhalla todetun kasvuhaion vaikutus mannyntaimien alkukehitykseen maastossa. *Metsantutk. lait. tiedonantoja* 202.
- Kelton, L.A. 1971. Review of *Lygocoris* species found in Canada and Alaska (Heteroptera: Miridae). *Mem. Entomol. Soc. Can.* No 83. 87 p.
- Kelton, L.A. 1975. The *Lygus* Bugs (Genus *Lygus* Hahn) of North America (Heteroptera: Miridae). *Mem. Entomol. Soc. Can.* No 95. 101 p.
- Marshall, V.G.; Ilnytzky, S. 1976. Evaluation of chemically controlling the collembolan *Bourletiella hortensis* on germinating Sitka spruce and western hemlock in the nursery. *Can. J. For. Res.* 6:467-474.
- Minko, G. 1974. Effects of seedling size on growth of field planted *Pinus radiata*. *For. Tech. Pap. For. Comm. Vic.* 21:58-68.
- Oak, S.W.; Knight, J.L.; Boone, A.J. 1987a. Incidence, severity, and causes of multiple tops in loblolly pine seedlings, 1986. USDA Forest Service, Southern Region, Forest Pest Management, Report 87-1-3.
- Oak, S.W.; Semple, S.; Boone, A.J. 1987b. Evaluation of thrips as causal agent of multiple tops in loblolly pine seedlings, 1987. USDA Forest Service, Southern Region, Forest Pest Management, Report 88-1-9.
- Overhulser, D.L.; Kanaskie, A. 1989. *Lygus* Bugs. Pages 146-147 in *Forest Nursery Pests*. USDA For. Serv. Agric. Handbk. No. 680.
- Overhulser, D.L.; Morgan, P.D.; Miller, R. 1986. Control and impact of *Lygus* damage of 1-0 Douglas-fir seedlings. Pages 153-157 in T.D. Landis, editor. Proc. Combined Western Forest Nursery Council and Intermountain Nursery Association Meeting, August 12-15, 1986, Tumwater, Wash. USDA For. Serv. Gen. Tech. Rep. RM 137.
- Poteri, H.; Heikkila, R.; Yuan-Yi, L. 1987. Development of the growth disturbance caused by *Lygus rugulipennis* in one-year-old pine seedlings. *Folia For.* 697:1-14.

-
- Puttonen, P. 1986. Current quality requirements of seedlings in Finland. Pages 557-564 in Proc., International Symposium on Nursery Management Practices for the Southern Pines. Ala. Agric. Exp. Stn., Auburn University, Ala.
- Raitio, H. 1983. Growth disturbances in nursery-grown pine seedlings. *Commun. Inst. For. Fenn.* 116, 1-208, 17-19.
- Raitio, H. 1985. Symptoms and occurrence of a growth disturbance in one-year-old, bare-rooted Scots pine seedlings raised in the open. *Folia For.* 611:17-19.
- Ray, J.W.; Vanner, A.L. 1988. Reducing the frequency of seedling malformations in *Pinus radiata* nurseries by the application of insecticides. *N.Z. J. For. Sci.* 18:280-286.
- Rikala, R. 1985. Monilatvaisten ja silmuhaarioistenmännynntaimien kehitys istutuksenjakkeen. *Kasvinsuojeluseuran mon.* 2:32-39.
- Rikala, R.; Rept, T. 1987. Frost resistance and frost damage in Scots pine (*Pinus sylvestris* L.) seedlings during the shoot elongation. *Scand. J. For. Res.* 2:299-306.
- Sapio, F.J.; Wilson, L.F.; Ostry, M.E. 1982. A split-stem lesion on young hybrid *Populus* trees caused by the tarnished plant bug, *Lygus lineolaris* (Hemiptera [Heteroptera]: Miridae). *Great Lakes Entomol.* 15:237-246.
- Schowalter, T.D. 1987. Abundance and distribution of *Lygus hesperus* (Heteroptera: Miridae) in two conifer nurseries in western Oregon. *Environm. Entomol.* 16:687-690.
- Schowalter, T.D.; Overhulser, D.L.; Kanaski, A.; Stein, J.D.; Sexton, J. 1986. *Lygus hesperus* as an agent of apical bud abortion in Douglas-fir nurseries in western Oregon. *New Forests* 15-15.
- Schowalter, T.D.; Stein, J.D. 1987. Influence of Douglas-fir seedling provenance and proximity to insect population sources on susceptibility to *Lygus hesperus* (Heteroptera: Miridae) in a forest nursery in western Oregon. *Environm. Entomol.* 16:984-986.
- Shrimpton, G. 1985. Four insect pests of conifer nurseries in British Columbia. Pages 119-121 in USDA For. Serv. Gen. Tech. Rep. INT 185.
- Soikkeli, S. 1985. Ultrastructural aberrations referring to viruses in the needles of young growth disturbed pine seedlings. *Eur. J. For. Pathol.* 15:246-253.
- South, D.B. 1986. The tarnished plant bug can cause loblolly pine seedlings to be bushy-topped. Auburn Univ. South. For. Nurs. Manage. Coop. Note #27. 4 p.
- South, D.B. 1987. Herbicides for southern pine seedbeds. *South. J. Appl. For.* 10:152-157.
- Sutherland, J.R.; van Eerden, E. 1980. Diseases and Insect Pests in British Columbia Forest Nurseries. British Columbia Ministry of Forests, Canadian Forestry Service, Joint report No. 12. 55 p.
- Vaartaja, O.; Dance, B.W.; Lynn, D.F. 1964. Cabbaging of white pine seedlings. *Can. Dept. For., Progr. Rep.* 20:3.
- Wakeley, P.C. 1954. Planting the Southern Pines. Government Printing Office, Washington, D.C. USDA Agric. Monogr. No. 18. 233 p.
- Webb, D.P.; Reese, K.H. 1984. Multiple Leadering of Coniferous Nursery Stock. Joint Report - Great Lakes Forest Research Centre, Canadian Forestry Service; No. 3, 8 p.
- Wise, K.A.J. 1977. A synonymic checklist of the Hexapoda of the New Zealand sub-region: the smaller orders. *Bulletin of the Auckland Institute and Museum.* 176p.

Expert systems for diagnosing nursery insect, disease and environmental problems

A.J. THOMSON, J.R. SUTHERLAND, M.E. BLACHE AND J. DENNIS

Forestry Canada
506 West Burnside Road
Victoria, British Columbia
Canada V8Z 1M5

Presented at the first meeting of IUFRO Working Party S2.07-09
(Diseases and Insects in Forest Nurseries), Victoria, British Columbia, Canada, August 22-30, 1990.

Abstract

A prototype expert system for diagnosing nursery disease, insect and environmental problems was described. The system was developed using the rule-based expert system shell EXSYS. The system was demonstrated in relation to the disease *Sirococcus* blight, and lessons learned from the prototyping experience were discussed.

Resume

Cet article décrit un prototype de système expert mis au point pour le diagnostic des maladies, des insectes et des problèmes environnementaux qui se manifestent dans les pépinières. Ce système est basé sur le système essentiel à base de règles EXSYS. Il a été expérimenté avec la brûlure *Sirococcus*, et les leçons tirées de l'expérience de prototypage sont passées en revue.

Introduction

An expert system is a computer program that behaves like an expert in some domain of application. The program can advise on selection among choices, and can explain its reasons for a particular choice. The reasoning should mimic the expert's reasoning process. When information is requested from the user, the system can explain why this information is necessary.

Expert systems are generally composed of three main parts: a knowledge base, an inference mechanism, and a user interface. An expert system shell is a special type of program which facilitates construction of expert systems by providing a domain-independent knowledge base structure, an inference mechanism, and a user interface.

Using an expert system shell, EXSYS (EXSYS Inc., P.O. Box 11247, Albuquerque NM 87192), we have developed a prototype expert system for diagnosing environmental, insect and disease problems in British Columbia nurseries. A prototype is a preliminary version of a system developed to identify the characteristics that an operational system should have to be useful. The system was based primarily on information contained in a manual (Sutherland *et al.* 1989). Features of the system, and of expert systems in general, were illustrated by following through a consultation, giving answers appropriate to *Sirococcus* blight.

The consultation

After working through some initial information screens, the user is presented with a question:

THE LOCATION OF THE NURSERY IS

- 1 COASTAL
- 2 INTERIOR
- 3 TRANSITION

This question reflects the way in which the expert system shell represents knowledge, in the form of if-then-else rules. For example, the first rule in the system is

RULE NUMBER 1:

IF:

The location of the nursery is coastal
and the nursery type is bareroot

THEN:

Colletotrichum blight (*C. acutatum*) - Probability=0/10
and *Colletotrichum* blight (*C. gloeosporioides*) -
Probability=0/10
and Needle dieback (*Pythium* spp.) - Probability=0/10
and Gray mould (*Botrytis cinerea*) - Probability=2/10
and Phoma blight (*Phoma* spp.) - Probability=8/10
etc.

There is no ELSE section to this rule. The IF part of the rule is made up of conditions, which in turn are in two parts. The first part is the qualifier, which is the part of the condition up to the verb, and the second part is one or more values. When the shell, EXSYS, tries to evaluate if a condition in a rule is true, it first checks to see if a value has already been attached to the qualifier, then it checks if the value can be established through application of other rules in the system, and finally, if it cannot obtain the information in any other way, it asks a question in the form of the qualifier verb phrase followed by the possible values which can be attached to that phrase. Each value has a number associated with it and the user can enter one or more of these numbers, as appropriate, to define the conditions of the consultation.

If all the conditions of the rule are found to be true, the THEN part of the rule is implemented. This entails assigning confidence values for some or all of the possible choices considered in the system (diseases, insects, or environmental problems in this case). If one or more conditions in the rule are false, the ELSE part of the rule, if present, would be implemented.

The set of rules in the system forms the knowledge base, the question format provided by the shell is the user interface, and the way in which information is first sought by chaining through other rules, plus the manner in which confidence limits are assigned and processed, is the inference engine. In the EXSYS system, a confidence value (termed probability) of 0/10 excludes that choice, regardless of any other considerations, while a confidence value of 10/10 fixes that choice. The final average score for each choice is used by the system to rank the choices.

Scores depend on whether the system is built from the point of view of the problem or from that of the host trees, the expert, or the nurseryman. The present system was developed from a problem (primarily disease) viewpoint.

The user may enter "WHY" instead of a number to select a value. This is used to determine the reason for the question, and is answered by displaying the rule from which the question is asked. The rule may have additional notes and reference sections to assist the user, as well as other help facilities.

The expert system is set up as if an expert were consulted by phone by a nurseryman with samples in hand. The expert's reasoning is mimicked as far as possible by having a question sequence that reflects that of the expert, who generally starts a consultation by finding out about the nursery setting and host material.

It was assumed that there is a single cause (environmental, disease, or insects) for all observed symptoms, except that some secondary agents are possible after

environmental damage. This situation may be compared with other diagnostic situations with fewer causal agents but where multiple problems may occur at one time (Thomson and Taylor 1990).

The question sequence works through the description of the nursery setting then identifies any insects or mites feeding on the plants. It then evaluates the possibility of environmental damage, based primarily on the pattern of symptoms on the plants and within the nursery, as well as the rate of symptom development. Questions are then asked to evaluate the possibility of consumption by insects not currently on the plant, and finally diseases are diagnosed.

Questions may include the possibility that a value is "unknown", and still be able to rank possibilities based only on the partial information available. The system was also designed to take account of the fact that nurserymen may never answer anything but "good" to questions regarding the quality of various cultural practices.

In the prototype system, rules were often structured in a manner that reflected the expert's concepts and language, but which allowed the information to be encoded rapidly, but which resulted in complex questions. In an operational system, such rules would be modified to infer the complex information from simpler concepts and language more appropriate to nurserymen.

Discussion

The system has performed well in the tests which we have provided, as indicated by the correct diagnosis of *Sirococcus* in the example worked through. The EXSYS shell allowed rapid prototyping, giving accurate diagnosis in tests, but the expert's reasoning and explanation ability were not easily represented to any great extent. It was not easy to generate a list of typical symptoms of the primary hypothesis which were absent, or to determine if any unexpected symptoms were present. Such features were present in an earlier and more complex PROLOG-based system (Thomson and Taylor 1990), which also included advice in the form of a letter written in full by the system (Figure 1).

12/3/1990
Mr. P. Norman,
ForCon Ltd.,
20 Terrace Rd.,
Edinburgh,
EH14 2GD

Dear Mr. Norman :

Processing of the data collected on 23/11/88 from Compartment 120,134 of Torrance Forest at Pennicuik, Lothian has been completed. Our interpretation of the information, and our recommendations regarding treatment, are as follows.

The foliar analysis indicated developing nitrogen deficiency, developing phosphorus deficiency, and developing potassium deficiency. Past fertiliser applications may not have been carried out correctly, as the foliar analysis now indicates a nutrient deficiency earlier than anticipated from applications of this type. The symptoms poor height growth, most needles yellow, and loss of old needles are not the result of N, P or K deficiency.

Nitrogen deficiency on this type of site is caused by a combination of heather competition and low rates of nitrogen mineralisation. Herbicide application to remove heather should result in improved growth, but later applications of nitrogen at 150 kg N/ha will be required to ensure complete canopy closure. Application of potassium at 100 kg K/ha together with phosphate at 60 kg P/ha is also required. Crown closure will probably occur before additional P and K is required. The trees are small enough that fertiliser application by hand is possible. If fertiliser is applied by hand, ensure that it is not placed too close to the boles of the trees, as this may have adverse effects. An on-site visit should be arranged to clarify some aspects of this case. If you have any questions regarding the above interpretation and recommendations, please feel free to contact me.

*Yours sincerely,
Alan J. Thomson*

Figure 1. Example of a letter produced by an expert system for diagnosis and treatment of nutrient deficiencies in response to a hypothetical consultation.

The prototyping experience was valuable in quickly and easily determining the characteristics required for an operational system. A knowledge representation protocol for diseases is necessary to capture the manner in which the temporal progression of signs and symptoms interacts with various indices of severity. A treatment advisory system would be based on whether

a diagnosis was tentative (as from an expert system) or confirmed (as from a diagnostic laboratory). In addition, many problems are more easily prevented than treated. A critiquing system (Miller 1986) could be developed to evaluate nursery plans and advise on combinations of practices that might induce problems.

References

- Miller, P.L. 1986. Expert critiquing systems. Springer-Verlag, New York Inc. 175p.
Thomson, A.J.; Taylor, C.M.A. 1990. An expert system for diagnosis and treatment of nutrient deficiencies of Sitka spruce in Great Britain. *AI Applic. Nat. Resour. Manage.* 4:44-52.
Sutherland, J.R.; Shrimpton, G.M.; Sturrock, R.N. 1989. Diseases and insects in British Columbia forest seedling nurseries. FRDA Rep. 065 Forestry Canada/British Columbia Ministry of Forests. Victoria.

CONTRIBUTED PAPERS

Soilborne pathogens: occurrence and control in an Italian bareroot nursery

T. ANNESI, M. CASELLA, AND E. MOTTA

Instituto Sperimentale per la Patologia Vegetale, Roma-Italia

Presented at the first meeting of IUFRO Working Party S2.07-09

(Diseases and Insects in Forest Nurseries), Victoria, British Columbia, Canada, August 22-30, 1990.

Abstract

Control of *Pythium* spp., *Fusarium oxysporum*, and *Rhizoctonia solani* on bareroot nursery seedlings was studied using a minimum number of chemical applications. The trial included seed dressing with mancozeb or no dressing and a treatment in the post-emergence period with mancozeb, benomyl or mancozeb+metalaxyl. Post-emergence applications were ineffective, whereas seed dressing resulted in efficient control of *F. oxysporum* only; this was sufficient to increase survival of seedlings.

Resume

Cette Etude concerne les méthodes de lutte (à base de certains produits chimiques) contre *Pythium* sp., *Fusarium oxysporum* et *Rhizoctonia solani* des semis de pîpinibres à racines nues. Méthodes étudiées : enrobage avec mancozèbe, aucun enrobage et un traitement de postlevée avec mancozbbbe, benomyl ou mancozbbbe + métalaxyl. Les applications en postlevée se sont révélées inefficaces, mais le traitement par enrobage des semis a donné des résultats concluants dans le cas de *F. oxysporum*, sans pourtant se traduire par une augmentation du taux de survie des semis.

Materials and methods

The research was done at the Pieve S. Stefano nursery. At the end of May 1989, *P. nigra* was sown by distributing 85 g of seed in five rows in plots 1 m wide, according to a two-factor randomized complete block design (four replications) with two seed treatments (dressing and no dressing) and three different chemicals used in one post-emergence application (12 days after the sowing, at germinant emergence) and an untreated control. Active ingredients and application rates of the treatments are given in Table 1. During the study, air temperature was recorded and chemical and physical analyses of seedbed soil were also made.

Inoculum density

To quantify inoculum densities of *Pythium* spp., *Fusarium oxysporum* Schlecht., and *Rhizoctonia solani* Kühn, seven replicate soil samples were collected before sowing, air dried, passed through a 2-mm sieve, then kept cool in unsealed containers.

The methods of Ricci *et al.* (1976) and Komada (1975) were used for inoculum density determinations of *Pythium* spp. and *F. oxysporum*, respectively. In the case of *R. solani*, a method was developed, using the medium proposed by Ko and Hora (1971). For each

Introduction

In Italy, most conifer seedlings are grown in bareroot nurseries; consequently, they may encounter soil-borne pathogens (Bonifacio and Marinari, 1969; Frisullo *et al.* 1984; Magnani 1972). To avoid damage to the natural biological balance in the soil, particularly to mycorrhizal fungi, forest nurseries do not normally use soil sterilants or early chemical treatments. Consequently, damping-off is always severe; this has sometimes been regarded as unavoidable. In order to obtain a sufficient number of surviving seedlings seedbeds have often been oversown. However, this causes damping-off to be more severe (Hartley 1921) and lowers seedling quality (Bloomberg 1985; Foster 1959; Gibson 1979).

In 1988, a preliminary study was started in a 12-ha bareroot, forest nursery in central Italy where several species of conifer seeds are sown in the spring. These preliminary results indicated that *Pinus nigra* Arnold was the most susceptible species to damping-off (Figure 1). Thus, *P. nigra* was used in a trial to determine the best schedule for disease control and with minimum application of chemicals. To understand the etiology and development of damping-off another concurrent study was made on pathogenic mycoflora in seedbeds.

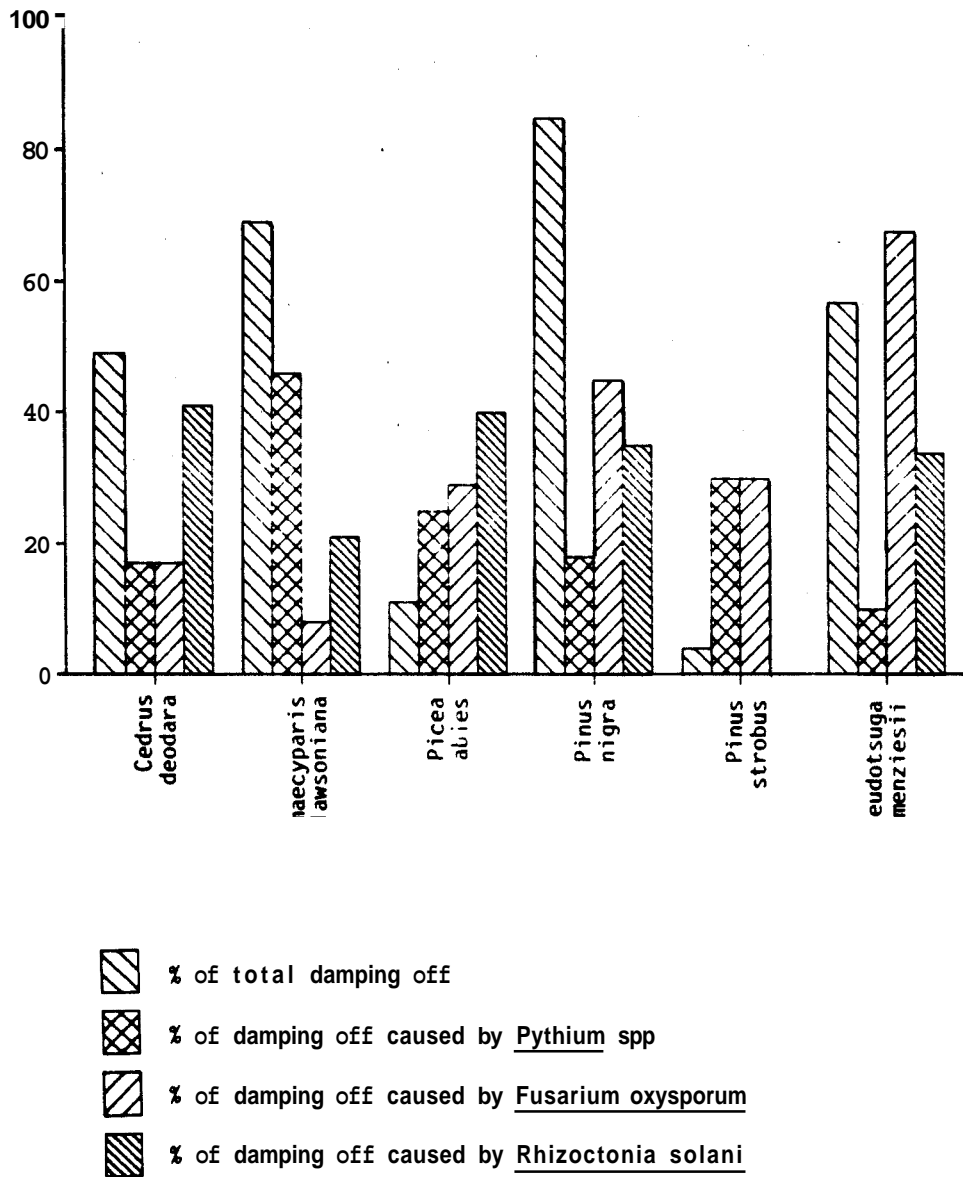

Figure 1. Damping-off of conifers in an Italian nursery (1988).

sample, 10g of soil was analyzed. Two hundred pellets were formed by pressing a corkborer into a solidified mixture of soil and melted, 2% water agar. Ten pellets were placed in each dish of selective medium and incubated 24 hours in the dark at 28°C. *Rhizoctonia solani* mycelium was identified by looking at the margin of the pellets with a light microscope (Figure 2).

Damping-off

To determine the role of each pathogen in damping-off, a month after sowing, two 10-cm long sections of

individual segments of rows of seedlings were chosen at random in each of the 32 plots. Within each section the seedlings were counted and the dead ones were removed. To isolate the pathogens from the dead seedlings, stem tissues near the root collar were disinfected with 30% hydrogen peroxide (10 seconds), rinsed three times in sterile distilled water, and incubated on malt agar (1% + 0.5 g/l citric acid) in the dark at 20°C.

At the end of June, when damping-off had ceased, the percentage of surviving seedlings was assessed by measuring the length (cm) of the rows fully covered by seedlings in each plot.

Table 1. Effectiveness of fungicides for damping-off control caused by *Pythium* spp., *Fusarium oxysporum* and *Rhizoctonia solani*

Seed dressing (mancozeb 4.3 g/kg)	Treatment		Pathogens (%)			Surviving seedlings (%)
	Post-emergence application Active ingredient	Dose (g/ha)	<i>Pythium</i> spp.	<i>Fusarium</i> <i>oxysporum</i>	<i>Rhizoctonia</i> <i>solani</i>	
Yes	Mancozeb	800	9.4 a	12.9 a	50.0 a	52 a
Yes	Benomyl	250	1.2 a	5.2 a	84.8 a	56 a
Yes	Mancozeb +metalaxyl	800+100	0.4 a	4.5 a	87.8 a	57 a
Yes			Oa	6.5 a	90.6 a	58 a
No	Mancozeb	800	1.9 a	22.5 b	74.2 a	35 b
No	Benomyl	250	Oa	32.9 b	77.3 a	34 b
No	Mancozeb +metalaxyl	800+100	2.1 a	22.4 b	71.8 a	38 b
No			3.4 a	25.4 b	73.0 a	38 b

Percentages in the same column followed by the same letter are not significantly different (P=0.01).

Results

The soil at the nursery has a high pH (8.5) and a very large fraction (40%) of soil particles with diameter above 2 mm. Maximum and minimum daily temperatures during germination and emergence are presented in Figure 3.

Inoculum density

The numbers of propagules in a gram of soil were 1430 ± 230 for *F. oxysporum*, 360 ± 60 for *Pythium* spp., and 0.67 ± 0.16 for *R. solani*.

On Komada's medium some other fungi were identified as: *F. solani* (Mart.) Sacc., *F. moniliforme* Sheld. var. *subglutinans* Wollenw. et Reink., *F. culmorum* (W.G. Smith) Sacc., and *Cylindrocarpon* spp.

Identification of *R. solani* was verified as follows: many colonies with typical hyphae grown on selective medium were transferred to potato dextrose agar and water agar and tested for nuclear condition with the Giemsa staining method (Herr 1979) (Figure 4).

Damping-off

Incidence of each pathogen and percentage of surviving plants in the different treatments are shown in Table 1. Among the pathogens obtained from seedlings, *R. solani* was the most prevalent (50.0-90.6%), *F. oxysporum* was also common (4.5-32.9%), and *Pythium* spp. appeared only sporadically (0-9.4%).

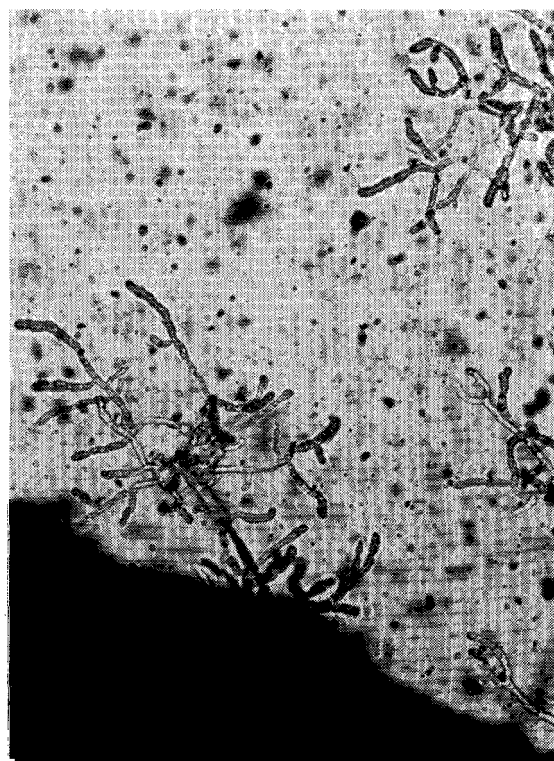

Figure 2. *Rhizoctonia solani* hyphae growing from a soil pellet on a selective medium.

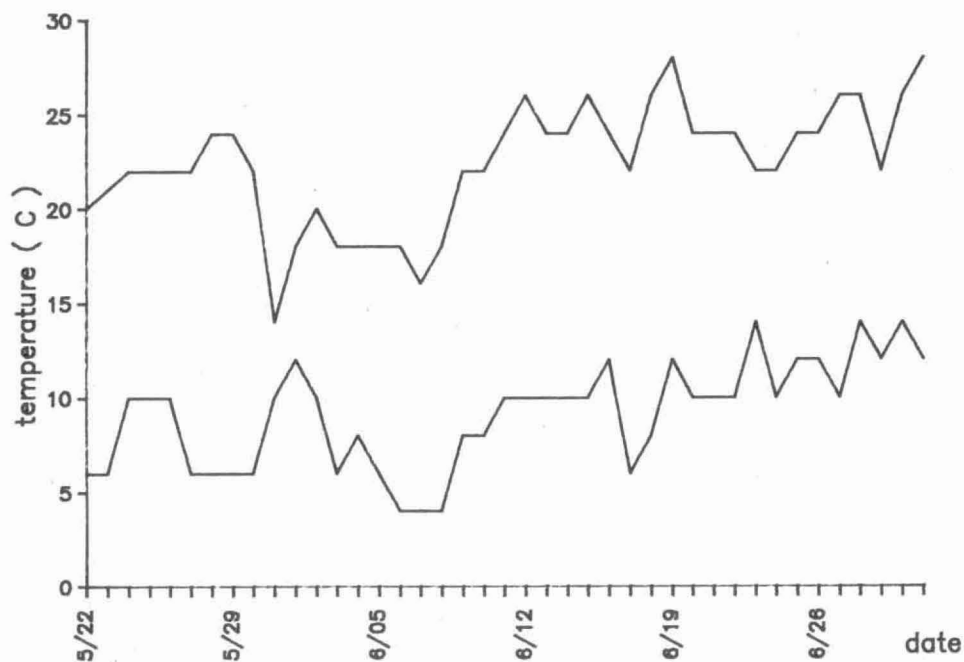

Figure 3. Maximum and minimum air temperatures (°C) during 1989.

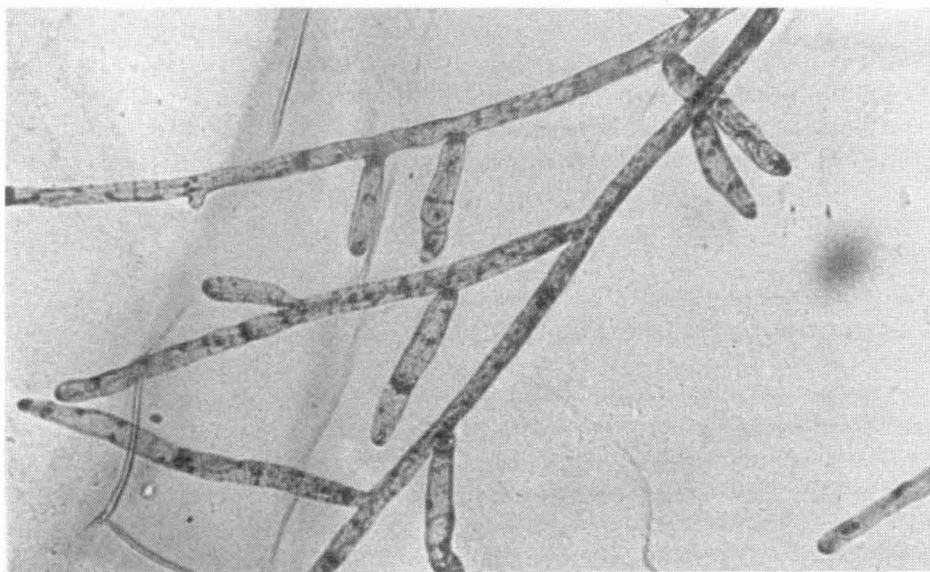

Figure 4. Multinucleate cells of *Rhizoctonia solani* (Giemsa staining method).

The analysis of variance of the randomized block indicated a highly significant ($P=0.01$) difference among seedling survival between plots with dressed seeds (52-58%) and control (34-38%) plots. However, subsequent treatment with mancozeb, benomyl or mancozeb+metalaxyl produced no beneficial effect. Among the pathogens, only *F. oxysporum* was signifi-

cantly controlled by seed treatment (4.5-12.9%) versus 22.4-32.9% incidence in control plots.

Alkaline soils (Weinhold 1977; Pullman *et al.* 1981; Schlub *et al.* 1981) favor *Pythium* spp. and *R. solani* and this could account for the high incidence of these fungi at the Stefano nursery. Conversely, the high pH is likely responsible for the low incidence of *F. oxysporum*.

Discussion and conclusions

The high inoculum densities, the late sowing date caused by the rainy spring, and the consequent high temperatures during germinant emergence (maximum daily temperature was always greater than 22°C) probably accounted for the progression of damping-off in 1989 (Roth and Riker 1943; Perrin and Sampangi 1986). Under such conditions, which are common in central Italy, mancozeb seed dressing was effective against *F. oxysporum*. Control of this pathogen increased seedling survival, even though two other damping-off pathogens (*R. solani* and *Pythium* spp.) were not significantly controlled.

These results suggest a need for further research to obtain complete protection of seedlings. Post-emergence treatments are not needed as they are ineffective. Other fungicides will be tested in order to find the more effective chemicals for use against specific damping-off pathogens in our nurseries.

Acknowledgement

This research was supported by the Italian Ministry of Agriculture and Forestry, Project "Lotta biologica e integrata per la difesa delle colture agrarie e delle piante forestali," Subproject "Piante forestali."

References

- Bloomberg, W.J. 1985. The epidemiology of forest nursery diseases. *Ann. Rev. Phytopathol.* 23: 83-96.
- Bonifacio, A.; Marinari, A. 1969. Osservazioni a proposito del damping off dei semenzali. *Annales de Phytopathologie I (hors-série)*: 141-144.
- Foster, A.A. 1959. Nursery diseases of southern pines. *USDA For. Serv. For. Leaflet*. 32.
- Frisullo, S.; Ciccarese, F.; Cirulli, M. 1984. Osservazioni sulle morie dei semenzali forestali in Puglia e Basilicata. *L'informatore Agrario* 40(30): 49-51.
- Gibson, I.A.S. 1979. Diseases of forest trees widely planted as exotics in the tropics and southern hemisphere. Part II. The Genus *Pinus*. C.M.I., Kew, UK; C.F.I., Oxford, UK.
- Hartley, C. 1921. Damping-off in forest nurseries. *USDA Bulletin* No. 934.
- Herr, L.J. 1979. Practical nuclear staining procedures for Rhizoctonia-like fungi. *Phytopathology* 69: 958-961.
- Ko, W.; Hora, F.K. 1971. A selective medium for quantitative determination of *Rhizoctonia solani* in soil. *Phytopathology* 61: 707-710.
- Komada, H. 1975. Development of selective medium for quantitative isolation of *Fusarium oxysporum* from natural soil. *Rev. Plant Prot. Res.* 8:114-124.
- Magnani, G. 1972. Damping off of *Pinus radiata* seedlings caused by fungal parasites. *Pubblicazioni del Centro Sperimentazione Agricola e Forestale* 11:307-313.
- Perrin, R.; Sampangi, R. 1986. La fonte des semis en pépinière forestière. *Eur. J. For. Pathol.* 16:309-321.
- Pullman, G.S.; De Vay, J.E.; Garber, R.H.; Weinhold, A.R. 1981. Soil solarization: Effects on *Verticillium* wilt of cotton and soilborne populations of *Verticillium dahliae*, *Pythium* spp., *Rhizoctonia solani* and *Thielaviopsis basicola*. *Phytopathology* 71:566-569.
- Ricci, P.; Toribio, J.A.; Messiaen, C.M. 1976. La dynamique des populations de *Pythium* dans les sols maraichers de Guadaloupe. *Annales de Phytopathologie* 8:51-63.
- Roth, L.F.; Riker, A.J. 1943. Influence of temperature, moisture and soil reaction on the damping-off of red pine seedlings by *Pythium* and *Rhizoctonia*. *J. Agric. Res.* 67:273-293.
- Schlub, R.L.; Lockwood, J.L.; Komada, H. 1981. Colonization of soybean seeds of plant tissue by *Fusarium* species in soil. *Phytopathology* 71:693-696.
- Weinhold, A.R. 1977. Population of *Rhizoctonia solani* in agricultural soils determined by a screening procedure. *Phytopathology* 67:566-569.

Developing a control system for fungal diseases in forest nursery seedbeds

BERNT ARVIDSSON

National Board of Forestry, S-551 83 Jonkoping, Sweden

Presented at the first meeting of IUFRO Working Party S2.07-09
(Diseases and Insects in Forest Nurseries), Victoria, British Columbia, Canada, August 22-30, 1990.

Abstract

A new method for controlling seed-borne and soil-borne fungal pathogens in seedbeds of Norway spruce and Scots pine was developed. For toxicological reasons the old seed dressing compound had to be replaced. New fungicides were screened in seed germination assays to determine whether they had any detrimental effects on seed germination. Two fungicides, Aliette (phosethyl aluminium) and Baycor 25 WP (bitertanol), that performed well in the seed germination assays were tested in small-scale field experiments. Baycor 25 WP was then tested in large-scale field experiments.

Resume

Une nouvelle méthode de prévention de la transmission de maladies fongiques par les semences ou par le sol dans les semis d'épinette de Norvège et de pin écossais a été mise au point. Pour des raisons de toxicité, l'ancien produit de désinfection de semences a dû être remplacé. Les nouveaux fungicides proposés ont été soumis à des essais pour vérifier s'ils pouvaient nuire à la germination. Deux des produits proposés, les fungicides Aliette (aluminium phoséthyl) et Baycor 25 WP (bitertanol), ont donné des résultats concluants et ont été mis à l'essai dans des projets expérimentaux à petite échelle, à la suite de quoi le fungicide Baycor 25 WP a été mis à l'essai à grande échelle.

Description of the problem

In Sweden about 100 million bareroot seedlings are produced each year. Most of these seedlings are outplanted in the forest at 3 or 4 years of age. Norway spruce (*Picea abies* (L.) Karst.) and Scots pine (*Pinus sylvestris* L.) are the main species cultivated.

During the first growing season, seeds and seedlings can be affected by fungal diseases, which can considerably reduce the yield (measured as the percentage of the germinable seeds that results in healthy seedlings) and growth (measured as seedling length). This early fungal damage is caused by seed-borne or soil-borne pathogens. Although *Fusarium* is the genus most often causing damage, *Phytophthora*, *Pythium* and *Rhizoctonia* are also isolated occasionally from infected seedlings. All these pathogens can be soil-borne; in addition, *Fusarium* and *Rhizoctonia* can be seed-borne.

The type of damage varies, depending on whether the pathogen is seed-borne or soil-borne and on the developmental stage initially attacked. For a given seedling development stage and infection court, however, symptoms are similar regardless of the fungal genus.

Attack before or during germination leads to a failure in seedling development. Attack by soil-borne pathogens at the cotyledon stage leads to typical symp-

toms of "damping off" (wilting at the root collar), whereas if the pathogen is seed-borne, the attack starts in the cotyledons and proceeds downwards. Infection after the cotyledon stage leads to "root dieback" (root rot).

In Sweden, this pathogen group traditionally has been controlled by dressing the seed with a broad-spectrum fungicide, which also functions as a bird repellent. In addition, a fungicide is sometimes sprayed a few weeks after seeding. The compound "Fusarin", which has been used in recent years, however, was withdrawn from the market during the mid-1980s because it was found to be toxic to nontarget organisms.

Planning the screening program

A screening program was started with the aim of finding alternative compounds to be used primarily for seed dressing and secondarily for spraying. To be chosen for the screening program a compound had to:

- 1) have low human toxicity (supported by comprehensive documentation),
- 2) provide effective protection against the most commonly occurring pathogens, and
- 3) not adversely affect seed germination and seedling development.

A study of both published and unpublished material was made on a large number of compounds to learn as much as possible about their toxicity to humans and about their fungicidal properties. A number of these compounds were then selected to study their effects on seed germination and plant growth. It was assumed that all fungicides repel rodents and birds to some extent. **Also**, compounds with relatively weak repellent effects could be accepted, because treatment of seed with blue dye after dressing with the fungicide would provide some protection against animals (unpublished data).

It was considered important to find out whether the selected compound had any severe side-effects on seed germination and seedling development. In practical and experimental work with seed dressing in agriculture it has been found that fungicidal dressings can reduce seed germinability (Lock et al. 1975). Furthermore, Benlate dressings have reportedly caused low seedling yields in a couple of forest nurseries.

The screening program was conducted as follows:

1. Seven compounds, selected in the literature study, were tested *in vitro* to determine their effects on seed germination.
2. Each compound or combination of compounds that had no adverse effects on seed germination (step 1) was then tested further in carefully controlled field experiments.
3. The compounds or the combination of compounds performing satisfactorily in step 2 was tested at one dosage in large-scale field experiments under practical conditions.

In vitro test

Based on information obtained in the literature study, a number of fungicidal compounds were selected for an *in vitro* test. The compounds were:

Trade name	Active ingredient
Aliette	phosethyl-aluminium 800 g/kg
Antivermin	lime sulphur 270 g total-S/l
Baycor 300 EC	bitertanol 300 g/l
Baycor 25 WP	bitertanol 250 g/kg
Benlate	benomyl 500 g/kg
Carsan	copper oxychloride 880 g/kg
Fusarin	thiram 640 g/kg, oxincopper 100 g/kg, captan 50 g/kg
Sibutol FS	bitertanol 375 g/l, fuberidazole 23 g/l
Tecto Flytande	thiabendazole 450 g/l

Fusarin (the most commonly used seed dressing compound in the past) and Benlate (known to inhibit germination) were included as references.

Germination analyses were made on several seed lots of *Picea abies* and *Pinus sylvestris*. The tests were carried out as assays in 10-cm glass petri dishes, where dressed seeds were placed on 9-cm filter paper moistened with deionized water. For each seed lot tested, three doses of each fungicide and an untreated control were used. The seed (50 per dish) was spread out in the dishes, which were then placed in climate chambers. Germination ratios were determined after 7, 14 and 21 days.

The method turned out to be very sensitive. Germination was inhibited to different degrees by the various compounds, and the degree of inhibition was strongly dose dependent. The mean germination time was also increased, indicating that the dressing treatment adversely affected seed vitality. In most cases germination was reduced at dosages of 4 g fungicide/kg seed. At 30 g/kg inhibition was often very strong (below 15% germination for several compounds), and at 120 g/kg seed, inhibition was even more pronounced (below 5% for two compounds).

Based on an analysis of the results, including all doses and seed lots, it was concluded that Antivermin was the least inhibitory compound, followed, in order of their increasing inhibitory effect, by Baycor 25 WP, Aliette, Carsan, Fusarin, Benlate, Tecto Flytande, Sibutol FS and Baycor 300 EC.

Carsan caused moderate inhibition of germination; however, at the highest doses the germ tips frequently became discoloured. No visible defects were noted on seedlings that developed from seed treated with the other fungicides.

The degree to which germination was inhibited depended partly on the formulation of the compound and partly on the active ingredients present. Formulations with organic solvents or surfactants caused very severe inhibition. For example, the benzimidazole group (benomyl, fuberidazole and thiabendazole) has considerable phytotoxicity (see Galaaen and Venn 1979).

Small-scale field experiments

Based on their performance in the *in vitro* test, Aliette and Baycor 25 WP were selected for further testing in the field experiments. According to the literature data these compounds offer good protection against two important pathogens, namely *Phytophthora* (Aliette) and *Fusarium* (Baycor 25 WP). A combination of these compounds was therefore tested as a dressing at three doses, using untreated seed and Fusarin-treated seed as references. Although Antivermin showed the lowest phytotoxicity, its fungitoxicity is reportedly low; therefore it was not selected for further testing.

In addition, spraying with Baycor 25 WP at doses of 0.5 and 1.0 kg/ha was combined with the seed dressing treatment at each of the dosages using untreated seedlings as control. Spraying was carried out either directly after seeding (as an alternative to seed dressing) or four weeks afterwards.

No negative effects on seed germination or seedling development were observed after seed dressing with a combination of Aliette and Baycor 25 WP in the field experiment. Even at the highest dose (20 + 20 g/kg seed), there was no sign of inhibited germination or development.

Although no signs of visible fungal infection were observed in the field experiment, the seedling yield was somewhat higher in treatments with dressed seed than in treatments with undressed seed. Spraying alone resulted in a slightly higher yield compared with that obtained with untreated seed. Spraying with Baycor 25 WP (0.5kg/ha) in addition to seed dressing gave a better result than seed dressing alone.

Large-scale field experiments

Large-scale field experiments were then made at two nurseries, based on the results described above. Because both nurseries considered *Fusarium* to be the major fungal threat in seedbeds, Baycor was tested for

seed protection, but not Aliette. Dressing with Baycor 25 WP at a rate of 15-21 g/kg seed was compared with the conventional method of seed dressing with Fusarin. In three out of four cases seed dressing with Baycor 25 WP resulted in a better seedling yield in seedbeds than seed dressing with Fusarin.

Discussion

Seed dressing compounds can be effectively ranked with respect to their germination inhibiting properties by testing them *in vitro* in germination analyses. The adverse effect of the fungicides on germination seemed to be less under field conditions than *in vitro*. Strongly inhibiting compounds probably have detrimental effects regardless of seed quality, whereas moderately inhibiting compounds may only pose a problem when weak seed lots are used, especially those with pronounced seed coat damage.

When studying soil-borne pathogens in Swedish nurseries it is very difficult to be sure that the infection pressure is high and evenly distributed. However, information from the literature on the effects of fungicides on pathogens together with data on phytotoxic effects on conifer seedlings appear to provide a good base for the selection of seed dressing compounds.

References

- Lock, W.; Sutherland, J. R.; Sluggett, L. J. 1975. Fungicide treatment of seeds for damping-off control in British Columbia forest nurseries. *Tree Planters Notes* 26.3:16-18, 28.
- Galaaen, R.; Venn, K. 1979. Effects of Benomyl on the germination of seeds of *Picea abies* (L.) Karst. Reports, Norwegian Institute of Forest Research, Aas, Norway 34.9:233-236.

Mycorrhizal protection of *Pinus sylvestris* seedling roots against *Rhizoctonia*

EVA DAMM AND TORGNY UNESTAM
Department of Forest Mycology and Pathology
University of Agricultural Sciences
Box 7026, S-750 07 Uppsala, Sweden

Presented at the first meeting of IUFRO Working Party S2.07-09
(Diseases and Insects in Forest Nurseries), Victoria, British Columbia, Canada, August 22-30, 1990.

Abstract

Ectomycorrhizae (*Laccaria bicolor* and *Hebeloma crustuliniforme*) reduced root damage by *Rhizoctonia* sp. on 10-week-old Scots pine (*Pinus sylvestris*) seedlings. *Suillus bovinus*, which failed to form mycorrhizae, had no protective effect. *Rhizoctonia* caused more damage to long-root tips than to short-root tips, even when mycorrhizae did not form on the latter. *Laccaria bicolor* mycorrhizae partly restored photosynthesis in *Rhizoctonia*-infected seedlings. Disease reduction also occurred when lime was applied to sphagnum peat.

Resume

Les champignons ectomycorhiziens *Laccaria bicolor* et *Hebeloma crustuliniforme* ont réduit les dommages racinaires causés par *Rhizoctonia* sp. à des semis de pin sylvestre (*Pinus sylvestris*). *Suillus bovinus*, qui n'a pas formé de mycorrhize, n'assure pas de protection. *Rhizoctonia* a causé plus de dommages aux extrémités des racines longues qu'aux extrémités des racines courtes, même lorsqu'il ne s'est pas formé de mycorrhizes sur ces dernières. Le mycorrhize *L. bicolor* a rétabli partiellement la photosynthèse dans les semis infectés par *Rhizoctonia*. On a également obtenu une réduction de l'importance de la maladie par l'application de chaux sur de la tourbe de mousse,

Introduction

Fine roots of coniferous seedlings are susceptible to many root-damaging fungi, particularly when roots are stressed (Unestam *et al.* 1989). Besides fungicides, ectomycorrhizal fungi can protect seedlings from root pathogens (e.g., Sampangi *et al.* 1986; Chakravarty and Unestam 1987).

Although the relationship between mycorrhizae and various pathogens have been investigated for many years, few studies have dealt with nonsterile, relatively well defined soil systems. In one such study, Marx (1973) noted that *Phytophthora cinnamomi* did not suppress growth of *Pinus echinata* seedlings with *Pisolithus tinctorius* mycorrhizae. Sinclair *et al.* (1982) showed that *Laccaria laccata* mitigated *Fusarium oxysporum* damage on *Pseudotsuga menziesii* roots. The protective effect of *L. laccata* occurred even before mycorrhizal colonization took place. Mycorrhizal fungi can also counteract the influence of certain factors predisposing seedlings to fungal attack (Chakravarty and Unestam 1987).

Many mechanisms presumably contribute to the ability of mycorrhizae to prevent disease (Marx 1972; Sylvia and Sinclair 1983; Duchesne *et al.* 1989;

Malajczuk 1984). They may function simultaneously, or one or two may dominate, depending on conditions at the time.

Materials and methods

Mycorrhizal inoculum

The mycorrhizal fungi used were *Laccaria bicolor* (isolate S-238a), *Hebeloma crustuliniforme* (isolate siv) and *Suillus bovinus* (isolate 85b). For inoculum production, 100 mL of water-washed, 3-mm-diameter brick pellets were soaked in MMN-medium (Marx 1969) in a 300-mL E-flask for 10 minutes, then the surplus medium was poured off. The pellets were autoclaved for 40 minutes and mycelial suspensions were used for inoculation. The mycorrhizal inoculum was incubated for about 6 weeks at 20°C. Just before use the inoculum was soaked in cold water for 1 h.

Pathogen inoculum

The pathogen used in the experiments was a species of *Rhizoctonia* (isolate 83-111/1N, supplied by Kåre Venn, Ås, Norway). It was inoculated and cultured as for the mycorrhizal fungi, except that the incubation period

was 14 days. Before use, inoculum was soaked in cold tap water for 1 h.

Experimental design

Scots pine (*Pinus sylvestris* L.) seeds were surface sterilized for 15 minutes in 35% H_2O_2 and then washed three times with sterile water. They were germinated on water agar for 6 days to detect seed-borne fungi. Germinants were transplanted into a substrate of 3-mm brick pellets and peat moss (2/1; v/v) in 20x30 cm plastic mini-greenhouses (Stewart Propagator). Each propagator contained 30 germinants. Half of the propagators were inoculated with mycorrhizal fungi at planting. About 1 mL of mycorrhizal inoculum was placed along the rootlets of the small seedlings. The propagators were kept in a growth chamber (18°C, 24 h day light, and ca $200 \mu\text{Em}^{-2}\text{s}^{-1}$) for 10 weeks. At that time 100% of the short roots were colonized by *L. bicolor* and *H. crustuliniforme*, while no roots were colonized by *S. bovinus*.

When the seedlings were 10 weeks old they were replanted into 100-mL pots containing the brick pellet-peat mixture medium (as before) into which a defined amount of *Rhizoctonia* inoculum was mixed. Inoculated seedlings were incubated for 14 days after which healthy (white) and diseased (brown) long- and short-root tips were counted using a dissecting microscope.

In one experiment, protection provided by *S. bovinus*, *H. crustuliniforme* and *L. bicolor* was evaluated. To improve mycorrhizal colonization by *S. bovinus*, seedlings were reinoculated by dipping their roots in a

concentrated mycelial suspension 10 days before the experiments started. Thus, at the start of the experiment, % *bovinus* had colonized 2 to 3% of the uppermost short roots, while at the end of the experiment about 4% of these roots were colonized.

In a second experiment, the photosynthetic capacity of diseased and healthy plants with *L. bicolor* mycorrhiza was compared with that of control seedlings. Photosynthetic measurements were made with a portable IRGA and humidity sensor system (ADC, U.K.). Also, damage caused by *Rhizoctonia* to seedling roots and the degree of mycorrhizal protection were measured in two substrates. The limed sphagnum peat (pH 5.5) normally used in the growing medium was replaced by an unlimed natural sphagnum peat (pH 4.7) to lower the pH of the growing medium.

Results and discussion

Root-tip counts (Figure 1) showed that severity of root damage was positively related to the initial inoculum density of *Rhizoctonia* and that much more injury occurred on vigorously growing long-root tips than on short-roots, regardless of mycorrhiza formation on the latter. The figure also shows that well developed mycorrhizae can protect roots from *Rhizoctonia* sp. This applies to mycorrhizal short roots and, to a lesser extent, to non-mycorrhizal long roots. However, most of the main long roots of seedlings were killed even on mycorrhizal plants, but these had a greater capacity to form new tap roots which remained healthy.

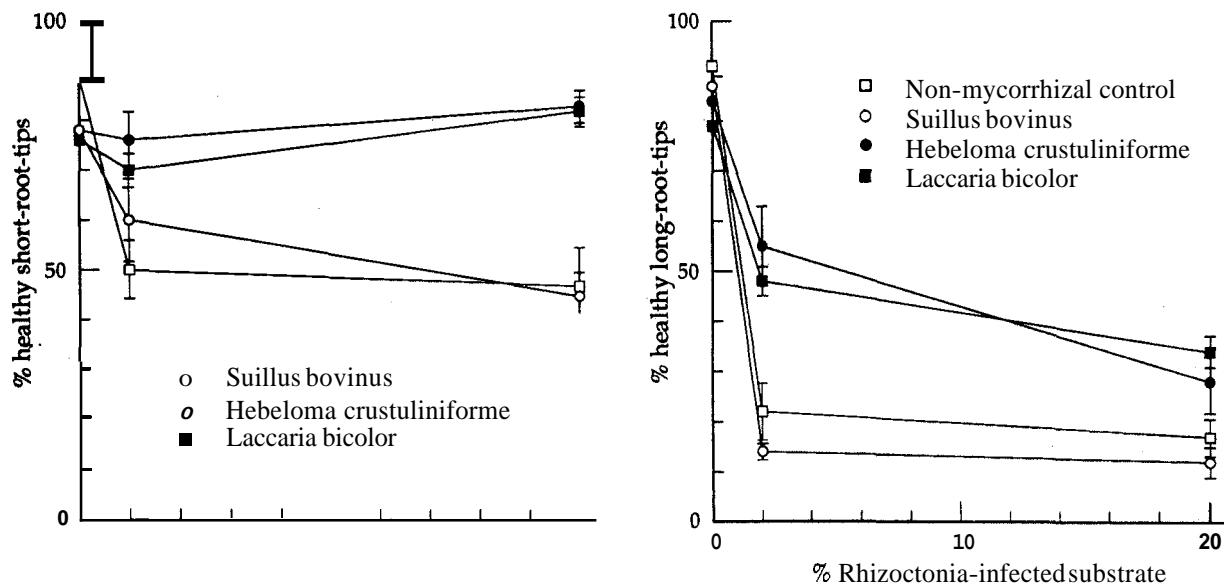

Figure 1. Percentage of healthy long-root and short-root tips of *Pinus sylvestris* seedlings inoculated with one of three mycorrhizal fungi after treatment with one of two concentrations of *Rhizoctonia* inoculum. *Suillus bovinus* failed to form mycorrhizae.

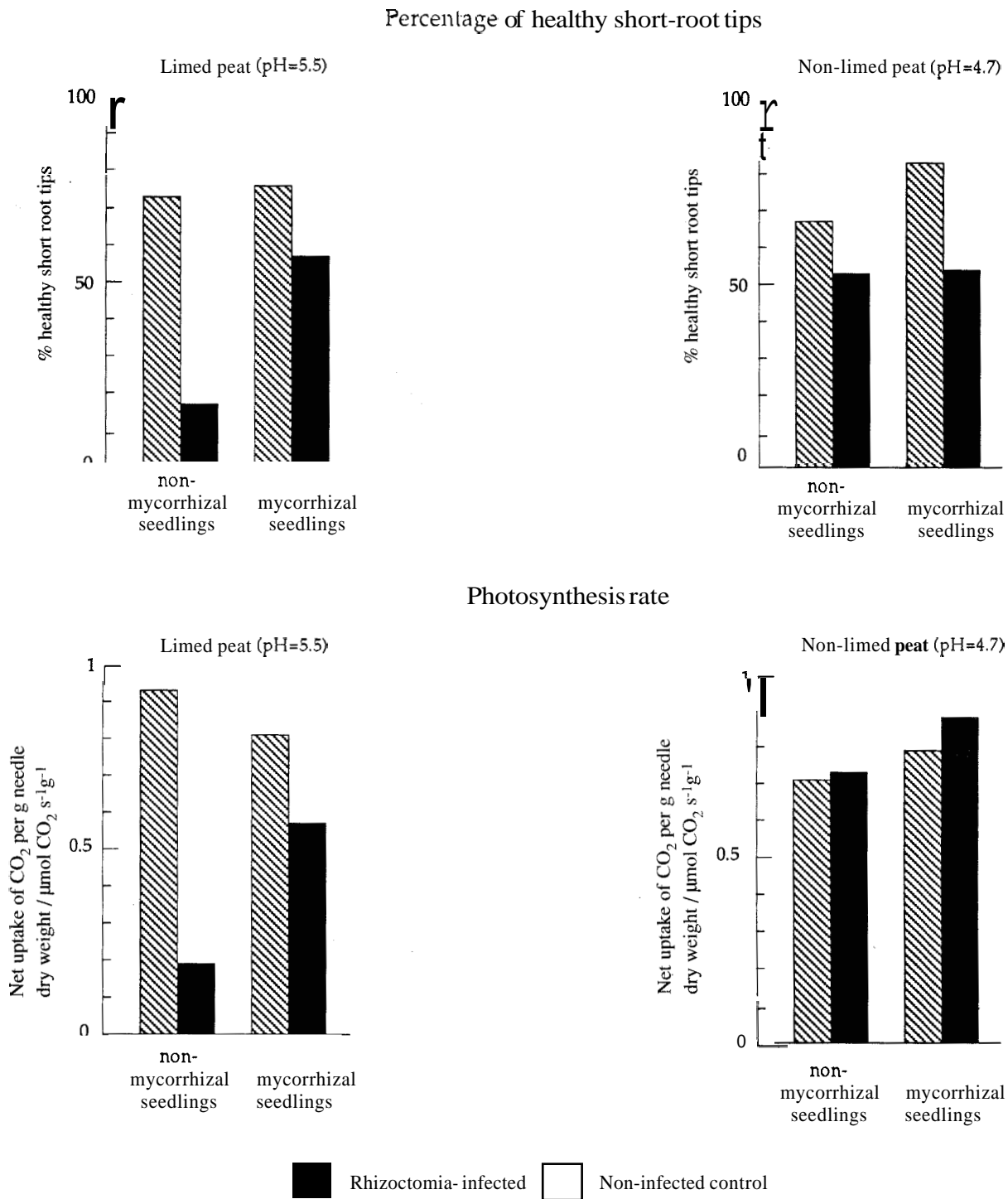

Figure 2. Effect of *Laccaria* mycorrhizae on the proportion of healthy short roots and the photosynthetic rate of *Pinus sylvestris* seedlings infected with *Rhizoctonia* sp. Twenty percent of the root substrate (brick pellets sphagnum peat 3:1 (v:v)) of *Rhizoctonia*-inoculated seedlings consisted of infected brick pellets. Disease severity was evaluated in a limed (pH=5.5) and an unlimed (pH=4.7) sphagnum peat.

Laccaria bicolor and *H. crustuliniforme* were equally effective in protecting roots, whereas roots with *S. bovinus* (a poor mycorrhizal former) were damaged about as much as control roots. The few *S. bovinus*-mycorrhizal short roots were healthy, whereas most non-mycorrhizal roots on the seedlings were as diseased as control roots. Thus, seedlings with *S. bovinus* mycorrhizae appeared not to have developed any immunity even though they had close physical contact with the fungus mycelium shortly before *Rhizoctonia* was added.

The fact that *Rhizoctonia* damage was more severe on long-roots than on short-roots could have been due to the elongation zone on long-roots being much more extended, so that this zone had an incompletely formed endodermis. On roots where the endodermis was complete, the cortex was killed but the stele mostly remained intact. The short elongation zone of the short-roots may also function as an entrance point to the stele by a pathogen, but on mycorrhizal roots no such entrance point exists. Parts of the root system with intact stele easily regained new root growth.

In *in vitro* tests neither *L. bicolor* nor *H. crustuliniforme* mycelium prevented *Cylindrocarpon destructans* spore germination. However, both fungi afforded good protection to roots with mycorrhizae. Although the fungi were not antagonistic *in vitro*, they could be so *in vivo* (Duchesne et al. 1989).

Laccaria bicolor mycorrhizae counteracted the suppression of photosynthetic capacity caused by *Rhizoctonia* (Figure 2). The reduced photosynthesis might have been caused by the reduced capacity of the few surviving roots to take up water, and the most seriously injured seedlings started to wilt 14 days after pathogen inoculation. In turn, the reduced photosynthetic ability of the *Rhizoctonia*-injured seedlings might be crucial for a seedling in which much of the root system has to be regenerated. Seedlings with severe root damage grow very slowly (Marx 1973; Sampangi et al. 1986).

The substitution of the limed sphagnum peat substrate (pH 5.5) for an unlimed one (pH 4.7) reduced root disease severity. Mycorrhizal, *Rhizoctonia*-infected seedlings grown in unlimed peat showed no reduction in photosynthesis.

References

- Chakravarty, P.; Unestam, T. 1987. Mycorrhizal fungi prevent disease in stressed pine seedlings. *J. Phytopathol.* 118:335-340.
- Duchesne, L.C.; Peterson, R.L.; Ellis, B.E. 1988. Pine root exudate stimulates the synthesis of antifungal compounds by the ectomycorrhizal fungus *Paxillus involutus*. *New Phytol.* 108:471-476.
- Duchesne, L.C.; Ellis, B.E.; Peterson, R.L. 1989. Disease suppression by the ectomycorrhizal fungus *Paxillus involutus*: contribution of oxalic acid. *Can. J. Bot.* 67:2726-2730.
- Malajczuk, N. 1984. Perspective on ectomycorrhizal-pathogen interaction. Pages 123-124 in R. Molina, editor. Proc. 6th North Am. Conf. on Mycorrhizae. Bend, Oregon, June 25-29, 1984, USA.
- Marx, D. 1969. The influence of ectotrophic mycorrhizal fungi on the resistance of pine root to pathogenic infection. 1. Antagonism of mycorrhizal fungi to root pathogenic fungi and soil bacteria. *Phytopathology* 59:153-163.
- Marx, D. 1972. Ectomycorrhizae as biological deterrents to pathogenic root infections. *Ann. Rev. Phytopathol.* 10:429-454.
- Marx, D. 1973. Growth of ectomycorrhizal and nonmycorrhizal short leaf pine seedlings in soil with *Phytophthora cinnamomi*. *Phytopathology* 63:18-23.
- Sampangi, R.; Perrin, R.; Le Tacon, F. 1986. Disease suppression and growth promotion of Norway spruce and Douglas-fir seedlings by the ectomycorrhizal fungus *Laccaria laccata* in forest nurseries. *Mycorrhizae: physiology and genetics*. Pages 799-806 in V. Gianinazzi-Pearson and S. Gianinazzi, editors. Proc. 1 Eur. Symp. on Mycorrhizae, Dijon, July 1-5, 1985. INRA, Paris.
- Sinclair, W.A.; Sylvia, D.M.; Larsen, A.O. 1982. Disease suppression and growth promotion in Douglas-fir seedlings by the ectomycorrhizal fungus *Laccaria laccata*. *For. Sci.* 28:191-201.
- Sylvia, D.M.; Sinclair, W.A. 1983. Phenolic compounds and resistance to fungal pathogens induced in primary roots of Douglas-fir seedlings by the ectomycorrhizal fungus *Laccaria laccata*. *Phytopathology* 73:390-397.
- Unestam, T.; Beyer-Ericson, L.; Strand, M. 1989. Involvement of *Cylindrocarpon destructans* in root death of *Pinus sylvestris* seedlings: pathogenic behaviour and predisposing factors. *Scand. J. For. Res.* 4:521-535.

Biotests for determining fungicide efficacy against conidia and mycelium of *Cylindrocladium scoparium* and *Rhizoctonia solani*

F. A. FERREIRA, J. J. MUCHOVEJ, N. L. DEMUNER AND A. C. ALFENAS

Departamento de Fitopatologia
Universidade Federal de Vigosa, 36570, Vigosa
Minas Gerais, Brazil

Presented at the first meeting of IUFRO Working Party S2.07-09
(Diseases and Insects in Forest Nurseries), Victoria, British Columbia, Canada, August 22-30, 1990.

Abstract

Two techniques are described for determining the efficacy of fungicides against spores and mycelium. The test with spores was done by mixing a concentrated spore suspension with an equal volume of double strength fungicide, then 5 μ L of this material was mixed into 12 mL of molten (49°C) potato-dextrose agar (PDA) and plated. In the second technique the test fungus was grown for 2-5 days on a thin film of PDA in a petri plate which was then flooded for various treatment times with a solution of the test fungicide.

After the desired exposure time the cultures were rinsed three times with 10 mL of sterile water per plate after which small disks were cut from the test fungus. These were placed on PDA in petri plates and survival was determined after several days incubation. The technique was tested using spores and mycelium of *Cylindrocladium scoparium* and mycelium of *Rhizoctonia solani*, both of which rot *Eucalyptus* cuttings in Brazil. Spores and mycelium of *Cylindrocladium* were killed by a 3-minute exposure to 780 ppm (wt./vol.) chlorine. *Cylindrocladium* mycelium was killed by 120 ppm benomyl or 2100 ppm thiram after 2 minutes exposure and *R. solani* mycelium was killed after being exposed to 1200 ppm thiabendazole for 3 minutes.

Resume

Les auteurs décrivent deux techniques utilisées pour déterminer l'efficacité des fongicides contre les spores et le mycélium. Dans le cas des spores, l'essai a été effectué, dans un premier temps, en mélangeant un concentré de spores en suspension et un volume égal de fongicide à double concentration; puis, dans un deuxième temps, en ajoutant 5 μ L de cette solution à 12 mL cubes d'agar à base de glucose de pomme de terre (PDA) en fusion (49 °C). Le tout a ensuite été déposé sur une lamelle. La deuxième technique a consisté à faire croître le champignon d'essai pendant 2 à 5 jours sur une mince pellicule de PDA dans une boîte de Pétri qui a ensuite été submergée dans une solution de fongicide d'essai pour des traitements de durées variées.

Après le temps d'exposition voulu, chaque lamelle contenant les cultures a été rincée trois fois dans 10 mL cubes d'eau stérilisée. De petits disques ont ensuite été coupés du champignon d'essai et placés sur le PDA dans des boîtes de Pétri. La survie a été déterminée après plusieurs jours d'incubation. La technique a été expérimentée avec les spores et le mycélium de *Cylindrocladium scoparium* et le mycélium de *Rhizoctonia solani*, lesquels font tous deux pourrir les boutures d'*Eucalyptus* du Brésil. Les spores et le mycélium de *Cylindrocladium* ont été détruits après une exposition de 3 minutes à 780 ppm (poids/vol.) de chlore. Le mycélium de *Cylindrocladium* a été détruit par 120 ppm de benomyl ou 2100 ppm de thirame après 2 minutes d'exposition; le mycélium du *R. solani* a été détruit après avoir été exposé pendant 3 minutes à 1200 ppm de thiabendazole.

Introduction

Most of the *Eucalyptus* species that are planted in Brazil are rooted from young cuttings from lateral shoots of clonal garden plants, potted seedlings, or sprouts from stumps in the field. Various pathogenic fungi are common in the litter and soil from these areas, e.g., *Cylindrocladium scoparium* and *Rhizoctonia solani*. Both pathogens may be disseminated by rain or irriga-

tion water. Consequently, these pathogens are commonly brought into greenhouses with soil or litter that adheres to cuttings. Besides routine procedures that are used to control rotting (e.g. use of pathogen-free soil and irrigation water) cuttings are immersed in sodium hypochlorite or benomyl solutions (Ferreira 1989; Batista *et al.* 1985). Until 1988 the cut ends of cuttings were dipped in these chemicals, but disease control was not

adequate. Since then new methods, fungicides, dosages, and immersion times have been tested for rot control. The purpose of this study was to investigate *in vitro* fungicide assays against conidia and mycelium of *Cylindrocladium scoparium* and *Rhizoctonia solani*, the causal agents of *Eucalyptus* cutting rot in Brazil.

Materials and methods

Experiments with *Cylindrocladium scoparium* spores

Conidia of *C. scoparium* were obtained by placing inoculum plugs (from 12-day-old cultures on PDA) on autoclaved castor bean leaves. Leaves were incubated (5 to 8 days at 25°C, 12-h photoperiod) in petri plate bottoms covered with translucent glass trays. Moist paper towels in the trays maintained a high humidity. Affected leaf pieces were placed in a small amount of sterile water to obtain a concentrated spore suspension.

Fungicide or chlorine solutions were prepared double strength and 0.2 mL of a solution was placed in a cavity of a porcelain spot-plate. The 0.2 mL spore suspension was then added to each fungicide solution and the two mixed. After the desired treatment time, 5 µL of the spores/fungicide mixture was removed and added to 12 mL of molten PDA (about 49°C) in a test tube, diluting the fungicide 2400 X. The contents of the tube were shaken and poured into a petri plate.

The fungicides and chlorine concentrations tested were (i) benomyl at 0, 30, 60, 120, 240 and 480 ppm (wt./vol.) for 0, 0.3, 10 or 30 minutes, (ii) captan at 0, 12, and 120 ppm for 0, 0.3, 10 or 30 minutes or 1200, 1600, 2000 and 2400 ppm for 2 or 10 minutes, (iii) thiram at 0, 21 and 210 ppm for 0, 0.3, 10 or 30 minutes or 2100, 2500, 2900 or 3300 ppm for 2 or 10 minutes, and (iv) chlorine at 0, 130, 260 and 780 ppm for 0, 0.5, 1, and 3 minutes. The chlorine was commercial bleach while the fungicides were commercial formulations. Chlorine concentrations were determined by titration (Adad 1982). There were four replicates of each combination of treatment and exposure time. Cultures were incubated at 25°C in the dark and presence or absence of pathogen growth (the test for chemical efficacy) was determined after 8 days.

Experiments with mycelium

About 5 mL of molten (60 to 70 °C) PDA was poured into a petri plate and then the plate was tilted 20° to allow the medium to solidify. This resulted in a thin film of PDA in the plate with most of the medium in a lump. The medium was allowed to solidify for about 20 minutes before the lump was removed (using a sterilized spatula) leaving a thin, uniform film of agar. To achieve this, the agar should be hot (60 to 70 °C).

Preliminary tests with *C. scoparium* showed that 2-mm-thick agar films gave inconsistent results when tested with benomyl for 1 to 3 minutes while films of 0.5 mm or less gave repeatable results. The requirement for a specific agar thickness means that the petri plate should have a very flat surface, i.e., it should be free of undulations which alter thickness. One to three 5-mm-thick disks were taken from the margin of 8-day-old cultures of *C. scoparium* or *R. solani*, and distributed over the PDA film. Plates were then incubated at 25°C for 48 h in the dark. Next, 10 mL of the fungicide or chlorine solutions were poured over the colony (on PDA) for a pre-determined time. The fungicide was then decanted and the plates washed three times with 10 mL of sterile water. After the last wash, each plate was tilted and drained for about 1 minute and the inoculum disks discarded. With the plate still inclined, five or more disks (fragments) of the colony on the film were removed and plated on PDA in petri plates. The location of each fragment was marked. After 5 days for *C. scoparium* and 2 days for *R. solani*, the fragments or disks which grew were counted.

The fungicide and chlorine concentrations tested (all for exposures of 0.03, 2 or 10 minutes) were: (i) benomyl at 0, 30, 120, and 480 ppm, (ii) captan at 0, 12, 120 or 1200 ppm, (iii) thiram at 0, 21, 210 or 2100 ppm, (iv) chlorine at 0, 130, 260 and 780 ppm, (v) chlorine plus captan at 0+0 and 130+1200 ppm, (vi) chlorine plus thiram at 65+2100 ppm, and (vii) chlorine plus benomyl at 130+480 ppm (v-vii for 0, 0.5, 1, and 3 minutes). The chlorine concentrations were determined as previously and then determined again after being added to the fungicides. When mixed with thiram, the chlorine content dropped about 50%.

Results

Conidia of *C. scoparium* were relatively resistant to the fungicides, especially at lower dosages (Table 1). These lower dosages, even for prolonged exposures, did not affect conidia germination. However, higher dosages, even for short exposures, killed conidia. Chlorine, even at relatively low dosages, was fairly effective against conidia.

Mycelium of *C. scoparium* was much more susceptible than conidia to low dosages and short exposures of fungicides (Table 2). Chlorine was less effective against mycelium. Mixtures of fungicide (except captan) and chlorine were effective against *C. scoparium* mycelium, even after a 0.5-minute exposure.

Mycelium of *R. solani* was much more difficult to kill, with most treatments giving negative results (Table 3). Other fungicides which had been tested previously (i.e. quinterozone, iprodione and thiram, unpublished data) have also given negative results. Only thia-

bendazole significantly affected *R. soluni* mycelium. Benomyl, the fungicide most commonly used in Brazilian nurseries, did not kill *C. scoparium* spores or *R. soluni* mycelium.

Discussion

The two techniques described here allow fungicide efficacy to be measured at various concentrations and exposure times. Knowing the time required for a concentration of a fungicide to kill spores or mycelium is very important in immersion treatments of *Eucalyptus* cuttings because after treatment fungicides are washed away or diluted by frequent irrigation in the greenhouse. Techniques such as ours for *in vitro* fungicide testing are not common (Dhingra and Sinclair

1986; Zehr 1978). In the well known cellophane transfer technique for testing fungicide efficacy, the fungicide continues to affect spores after they are transferred to fungicide-free medium (Neely and Himelick 1966). Tests where an inoculum plug is placed on top of a fungicide-amended medium may give inaccurate results as fungus regrowth often occurs when the inoculum is subsequently placed on a fungicide-free medium. In preliminary tests with our method, a benomyl-sensitive *C. scoparium* isolate did not grow on PDA with 30 ppm benomyl, but a resistant isolate grew at 980 ppm (Alfenas *et al.* 1987). Using our method, mycelium of a benomyl-sensitive *C. scoparium* isolate was not killed by 30 ppm benomyl but was killed after a 2-minute exposure to 120 ppm.

Table 1. Colonies per petri plate of *Cylindrocladium scoparium* that developed after spores were exposed to fungicides or chlorine for various times.

Fungicide and concentration (ppm)	Exposure (minutes)						
	0.03	0.5	1	2	3	10	30
Benomyl							
0	>300					>300	>300
30	>300					>300	>300
60	>300					>300	>300
120	>300					>300	>300
240	>300					>300	>300
480	>300					>300	>300
Captan							
0	>300					>300	>300
12	>300					>300	>300
120	>300					>300	>300
1200				45		2	
1600				15		1	
2000				5		1	
2400				2		0	
Thiram							
0	>300					>300	>300
21	>300					>300	>300
210	>300					>300	>300
2100				80-120		2	
2500				0		0	
2900				0		0	
3300				0		0	
Chlorine							
0		>300	>300			>300	
130		0	0			0	
260		0	0			0	
780		0	0			0	

Table 2. Percent recovery of *Cylindrocladium scoparium* mycelium after exposure to fungicides or chlorine for various times.

Fungicide and concentration (ppm)	Exposure (minutes)					
	0.03	0.5	1	2	3	10
Benomyl						
0	100			100		100
30	100			100		40
120	40			0		0
480	8			0		0
Captan						
0	100			100		100
12	100			100		100
120	100			100		100
1200	44			25		0
Thiram						
0	100			100		100
21	100			100		100
210	100			59		67
2100	9			0		0
Chlorine						
0	100	100	100		100	
130	100	100	100		100	
260	100	100	100		100	
780	100	42	50		0	
Chlorine+captan						
0+0	100	100	100		100	
130+1200	17	25	9		0	
Chlorine+thiram						
65+210034	0	0		0		
Chlorine+benomyl						
130+48025	0	0		0		

Table 3. Percent recovery of *Rhizoctonia solani* mycelium after exposure to fungicides or chlorine for various times.

Fungicide and concentration (ppm)	Exposure (minutes)	
	1	3
Benomyl		
0	100	100
350	100	100
1000	100	100
Thiabendazole		
0		100
1200		0
2400		0
Toclophos (methyl)		
0		100
500		91
Chlorine		
0	100	100
130	100	
260	100	
780		0
Benomyl+Thiram		
350+1500		100
Thiabendazole+Thiram		
1200+1500		0

Literature cited

- Adad, J.M.T. 1982. Controle quimico de qualidade. Ed. Guanabara, Rio de Janeiro, 204 p.
- Alfenas, A.C.; Demuner, N.L.; Silva, A.R. 1987. Resistência de *Cylindrocladium scoparium*, agente etiológico de podridão de estacas de *Eucalyptus* a benomil. Fitopatologia brasileira 12:158 (Abstr)
- Batista, A.M.P.; Caluosa, N.; Dianese, J.C. 1985. Hipoclorito de sódio eno controle da podridão de estacas usadas na multiplicação vegetativa de *Eucalyptus urophylla*. Fitopatologia brasileira 10:363. (Abstr)
- Dhingra, O.D.; Sinclair, J.B. 1986. Basic plant pathology methods. CRC Press, Boca Raton, FL. 365 p.
- Ferreira, F.A. 1989. Patologia Florestal - Principais Doenças Florestais no Brasil. UFV-SIF, Viçosa, Brasil. 570 p.
- Neely, D.; Himelick, E.B. 1966. Simultaneous determination of fungistatic and fungitoxic properties of chemicals. Phytopathology 56:203-209.
- Zehr, E.I. (ed). 1978. Methods for evaluating plant fungicides, nematocides and bactericides. American Phytopathological Society, St. Paul, MN. 141 p.

Sex pheromone for the black cutworm, *Agrotis ypsilon* Rottemberg

JIAXI ZHOU, XUEYAN YANG, AND XIAOBING ZHOU

Northwest Forestry College
Yangling, Xi'an, Shaanxi 712100
The People's Republic of China

Presented at the first meeting of IUFRO Working Party S2.07-09
(Diseases and Insects in Forest Nurseries), Victoria, British Columbia, Canada, August 22-30, 1990.

Abstract

The black cutworm, *Agrotis ypsilon* Rottemberg, is widespread and causes serious damage to nursery seedlings in Shaanxi province, The People's Republic of China. In central Shaanxi it has four generations per year. First-generation larvae are the most damaging. A sex pheromone for adults is used to predict damage.

Resume

Le ver-gris noir (*Agrotis ipsilon* Rottemberg) est une espèce largement répandue qui cause des dégâts importants aux semis des pépinières forestières dans la province du Shaanxi, en République populaire de Chine. Dans la région centrale du Shaanxi, le ver-gris noir compte quatre générations par an. Ce sont les larves de la première génération qui causent les plus grands ravages. On utilise une phéromone sexuelle pour dénombrer les adultes et prévoir les pertes.

Introduction

The black cutworm (also called the ypsilon dart or dark sword grass moth) *Agrotis ypsilon* Rottemberg (Noctuidae) = *A. ipsilon* (Hufnagel), occurs worldwide. It is one of the most widely distributed and abundant (constituting 89-95% of Noctuidae pests in number) and most serious insects in Chinese nurseries.

Agrotis ypsilon affects many kinds of crops including cotton, wheat, corn, sorghum, sweet potato, potato, beans and vegetables, certain grasses, and all species of nursery seedlings. The first generation larvae are the most damaging to seedlings. One- and two-year-old larvae destroy young leaves of seedlings while 3-year-old larvae feed at the base of seedling stems, killing seedlings. Seedling damage generally ranges from 5 to 20% but is sometimes over 80%.

Life history

In western Shaanxi province there are four generations of *A. ypsilon* per year. First-generation larvae appear from about mid-April to late May while adults are present from early to mid-June. Thereafter, until mid-late September, alternating populations of adults (every 6 weeks) and larvae (2 weeks later) occur. The first generation produces the largest populations and does the most harm, especially from mid to late May.

Adults lay eggs 3 to 5 days after emergence; at about 15°C, eggs hatch in approximately 15 days. At about

18.5°C, the first instar lives 6 days, the second 5 days, and the second through fifth instars have a lifespan of 5 to 7 days, while the sixth instar lives 12 days.

Biology and damage

Adults are nocturnal, hiding during the day, and are most active from twilight to midnight, and at dawn. They remain inactive at temperatures below 4°C, but resume activity at 4 to 8°C. They can fly when the temperature is above 10°C. Activity is greatest on warm to hot, humid, calm nights.

Agrotis ypsilon is strongly phototactic, especially toward ultraviolet light, and chemotropic to sweet-sour odors such as those produced by fermentation, wilted poplar leaves, and branches.

Female *A. ypsilon* lay 800 to 2000 eggs each. Two oviposition peaks occur each year; the first lasts from the last 10 days of March to the first 10 days of April. The second peak is from about April 20 to April 30. About 70% of the eggs are dispersed over the surface of the ground, 20% on the dead grass and plant roots and branches, and the remainder are dispersed on nursery seedlings. Initially eggs are white to yellow, then they become silver-red, red-purple, and finally pale black.

The 1- and 2-year-old larvae of *A. ypsilon* live above ground; they feed on the contents of leaves, leaving the epicuticle. Heavy rainfall kills many larvae. Three-year-old and older larvae hide in the soil by day and

emerge at night to damage leaves. In their fourth year, larvae can cut off seedling stems near the groundline. Fifth and sixth stage larvae eat voraciously; they destroy three to five trees each night.

The range in body lengths of the various larval stages is 2.6-3.6, 4.6-5.7, 7.8-11.9, 6.4-20.0, 26.5-33.0, and 39.5-48.7 mm for each of the 6 years, respectively.

Sex pheromone experiment

To obtain a better estimate of the potential damage from black cutworm, the insect's sex pheromone was used to attract adult *A. ypsilon* in Northwest China. The pheromone (made in Jintan Insect Hormone Institute, Jiangsu province) was injected into silicious rubber lure cones. The major components of the sex pheromone are cis-7-dodecenyl acetate and cis-9-tetradecenyl acetate (3:1). Their structural formulas are:

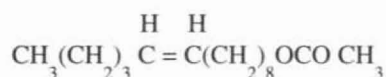
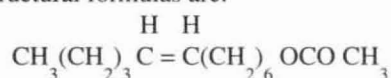

Our research was done in the nurseries of the Northwestern College of Forestry where 12 traps were installed, one of which was placed beneath an ultraviolet lamp. Numbers of trapped insect pests were recorded daily at 22:00. The experiment lasted 12 days, from March 23 to April 3.

Sex pheromone alone attracted about as many insects as pheromone plus light (Table 1). Thus, sex pheromone alone can be used to predict when adults of the black cutworm will appear and also indicate subsequent cutworm numbers and damage. Moreover, pheromone traps can replace ultraviolet light traps.

Perhaps placing traps in the field earlier in the season would have given a better indication of subsequent cutworm numbers as numerous adult moths were already present in the nursery at our first sampling date (Table 1). Our results also showed that rainy weather decreases numbers of trapped adults. We trapped few if any adults during rainy weather.

Table 1. Number of adult *Agrotis ypsilon* trapped with sex pheromone traps and ultraviolet light

Dates	Lure											
	Pheromone alone	Pheromone plus ultraviolet light ^{a/}										
		Trap #										
	1	2	3	4	5	6	7	8	9	10	11	
March												
23	1	3	4	1	4	1	5	3	2	0	7	1
24	0	0	0	0	0	0	0	0	0	0	2	0
25	3	2	0	2	3	6	3	4	2	3	1	3
26	0	0	1	1	3	0	0	0	1	1	0	1
27	3	0	0	3	0	0	0	0	0	0	0	0
28	0	0	0	0	0	0	0	0	0	0	0	0
29	1	1	0	0	0	0	0	0	0	0	0	0
30	0	1	1	1	0	0	0	0	0	0	0	0
31	0	0	0	0	0	0	0	0	0	0	0	0
April												
1	0	0	0	0	0	0	0	0	0	0	0	0
2	0	0	0	0	0	0	0	0	1	0	0	0
3	0	0	0	1	0	0	0	0	0	0	0	0
Total	8	7	6	9	10	7	8	7	6	4	10	5

^{a/} Eleven observations (traps)

Using sex pheromone to predict *Paranthrene tabaniformis* Rott damage

JIAXI ZHOU, XUEYAN YANG, AND XIAOBING ZHOU

Northwest Forestry College
Yangling, Shaanxi
The People's Republic of China

Presented at the first meeting of IUFRO Working Party S2.07-09
(Diseases and Insects in Forest Nurseries), Victoria, British Columbia, Canada, August 22-30, 1990.

Abstract

Paranthrene tabaniformis Rott injures trunks and branches of 1- and 2-year-old poplars. Using sex pheromone to attract adults results in better detection of the insect so that measures can be taken to prevent damage.

Résumé

Paranthrene tabaniformis Rott. attaque le tronc et les branches des peupliers d'un an et de deux ans. L'utilisation d'une phéromone sexuelle pour attirer les adultes améliore la détection de l'insecte, ce qui permet de prendre des mesures préventives.

Introduction

Paranthrene tabaniformis Rott seriously injures trunks and branches of 1- and 2-year-old poplars, especially in nurseries. The insect occurs extensively across China. Adults lay eggs at the base of leaf petioles, on trunks, or on the upper portions of seedling shoots. Larvae enter the bole of the tree or eat small branches or enter and eat the contents of terminal buds. Consequently, affected trees often have multiple leaders. At first, larvae eat both xylem and phloem in the bole; they then penetrate deeper into the xylem. Such mining, plus gall formation on the bole, predisposes affected trees to wind breakage. Previously, insecticides were used against *P. tabaniformis*, but damage often occurred before the insect was detected. On average, 20% of poplars are injured; sometimes damage exceeds 50%.

Our purpose here was to test the efficacy of a sex pheromone to attract adult *P. tabaniformis* and to use those data to predict potential damage. Such information should be useful in preventing such damage. In preliminary experiments, during the period from the beginning of May to mid-August from 1984 to 1987, we used *P. tabaniformis* sex pheromone with good success.

Methods

The *P. tabaniformis* sex pheromone used was made by the Shanghai Organic Chemistry Institute and by Jintan Insect Hormone Institute in Jiangsu province. Its major component is trans-3, cis-13-18-dienol. A lure cone was made by injecting 200 µg of pheromone into a block of silicone rubber. The bottom inside of the triangular-

shaped trap contained a thick paper painted with SHI pattern glue. A lure cone was put at the center of the paper and the trap was hung among the seedlings at the nurseries of the Northwest Forestry College and in the central nursery at Hu County, Shaanxi province.

Results and conclusions

By attracting male *P. tabaniformis* with sex pheromone we were able to determine when the insects first appear and how long populations persist. Results of trapping *P. tabaniformis* with sex pheromone and with caged poplar branches are presented in Table 1. The date when adults were first detected differed for the two trapping techniques. Moths were found in pheromone-baited traps 9 days sooner and 1 month later than in traps with branches. With pheromone-baited traps, adults were found over a 3-month period, i.e. from the first 10 days of May to mid-late August. In poplar branch-baited traps, adults were detected during just 2 months (Table 1). We concluded that traps baited with sex pheromone were more sensitive indicators of the presence of *P. tabaniformis*.

Our sex pheromone trap results show that adults are active from May 15 to June 15. During this period more than 80% of adults emerge. Control measures should be implemented during this time. Traps baited with poplar branches provide misleading data on occurrence of adults, and such misleading data could lead to mistakes in preventing damage. Sex pheromone traps provide better data for predicting when *P. tabaniformis* adults will initially appear.

Use of sex pheromone to prevent *Paranthrene tabaniformis* damage

In 1983 and 1984 several techniques were used to control *P. tabaniformis* at the nursery at the Northwest Forestry College. Results of these trials were evaluated in September of each year. In spite of these efforts, the percentage of trees injured often reached 50%; the average number of insects per tree was 2.93, even though 50% Fenvalerate was used twice at 200 times the recommended rate between July and August, 1983. After using sex pheromone to attract adults in 1984, the percentage of injured trees was reduced to 16.3% and the average number of insects per tree dropped to 0.18.

Surveys at other nurseries, i.e., nurseries other than the one at the Northwest Forestry College, revealed as many as 1.42 *P. tabaniformis* per seedling in September. These high numbers occurred because the traps were blown down by wind in mid-June; these traps contained 34 male insects which had been attracted from mid-May to late June. This compares to the 368 male insects that were trapped before mid-August at the college nursery, where the average number of insects per seedling was 0.18. The damage of *P. tabaniformis* was controlled after successfully attracting and killing the pests in 1985 and 1986. The percentage of trees injured also dropped greatly in experiments at three nurseries (Table 2).

Table 1. Numbers and percentages of male *Paranthrene tabaniformis* caught by pheromone-baited traps versus poplar branch-baited traps.

Trap type	Trapping periods												Total
	May			June			July			August			
	0-10	10-20	20-30	0-10	10-20	20-30	0-10	10-20	20-30	0-10	10-20	20-30	
Pheromone													
Number:	3	60	105	93	41	35	20	4	5	0	2	0	368
Percentage:	0.8	16.3	28.6	25.3	11.1	9.5	5.4	1.1	1.4	0	0.5	0	
Branch-baited													
Number:	0	3	6	38	36	36	9	5	1				134
Percentage:	0	2.2	4.4	28.4	26.9	26.9	6.7	3.7	0.7				

Table 2. Results of using *Paranthrene tabaniformis* sex pheromone to prevent damage at three nurseries in Hu County.

Nursery location	Before pheromone use					After pheromone use				
	Nursery size (ha.)	Trees species ^a	Tree age (yrs)	No. trees examined	Percent damage (%)	No. trees examined	Insects per tree	Percent damage untreated	Percent damage in fields	Percent reduction ^b
Laodian Village	4.0	PE	3	876	44.7	350	0.41	17%	59.2%	71.3%
Centre Nursery	0.2	PT	1	712	19.2	350	0.028	2%	18.4%	89%
Centre Nursery	0.47	PT	4	1,117	12.1	400	0.010	1.3%	5%	75%

a PE = *Populus x euramericana* cv. 'sacrau 79', PT = *Populus x tomentosa* Carr.

b Percent reduction = $\frac{\text{percentage in comparative field (C)} - \text{percentage in experimental field (B)}}{\text{percentage in comparative field (C)}} \times 100\%$

Assaying for seed-borne fungi of Douglas-fir and true fir species

WILLIS R. LITKE AND JOHN E. BROWNING

Weyerhaeuser Forestry Research Center
Centralia, Washington 98531, U.S.A.

Presented at the first meeting of IUFRO Working Party S2.07-09
(Diseases and Insects in Forest Nurseries), Victoria, British Columbia, Canada, August 22-30, 1990.

Abstract

Periodic declines in conifer seed germination potential have been linked to elevated levels of seed-borne mold fungi. Levels of these fungi have been shown to increase on seed following cone storage and seed extraction. Seed-borne fungi such as *Fusarium*, *Cladosporium*, *Penicillium*, and *Trichothecium* may be linked to reduced conifer seed germination vigor and nursery seedling diseases. No standard method for assaying Douglas-fir or true fir conifer seed for seed-borne microorganisms is currently available, but a seed assay technique is presented which could quantify a variety of seed-borne fungi and help identify seedlots which might benefit from seed treatment.

Resume

Un lien a été établi entre le déclin périodique du pouvoir de germination des graines de conifères et la présence d'un nombre élevé de moisissures dans les graines. On a montré que le nombre de champignons dans les graines augmentait après l'entreposage des cônes et l'extraction des graines. Certains champignons portés par les graines, comme *Fusarium*, *Cladosporium*, *Penicillium* et *Trichothecium*, peuvent être liés à une réduction de la vigueur de germination des graines de conifères ainsi qu'à des maladies touchant les semis en pépinière. Il n'existe pas à l'heure actuelle de méthode standard pour détecter la présence de microorganismes dans les graines de douglas taxifolié ou d'*Abies*, mais on présente une méthode d'analyse des graines qui pourrait permettre de quantifier divers champignons portés par les graines et aider à reconnaître les lots de graines qui pourraient tirer profit d'un traitement.

Introduction

A diverse group of seed-borne fungi (Table 1) have been reported to be associated with conifer seed (Anderson 1985; Shea 1957; Fisher 1941; Urosevic 1961; Bloomberg 1966; James 1984). Some seed-borne fungi, such as *Fusarium oxysporum*, are known plant pathogens and may be linked to nursery seedling disease outbreaks (Bloomberg 1969). Levels of seed-borne fungi have been shown to increase following cone storage and seed extraction. Periodic declines in conifer seed germination performance have been linked to elevated levels of these cone fungi (Shea 1957, 1960). Therefore, seed assay methods which quantify seed-borne fungal levels could help identify seedlots which might benefit from seed treatment.

Most seed assay methods rely on isolating and enumerating seed-borne fungi on agar-based media. Some media are highly specific for species such as *Fusarium* (Komada 1969), while others are non-selective. Currently no standard assay for conifer seed-borne fungi is in use. A study was initiated to survey the incidence of seed-borne fungi on a cross section of Douglas-fir and true fir seedlots from various Pacific Northwest seed sources. We chose to use a selective medium (Komada's *Fusarium* medium) to quantify

Fusarium levels, and indirectly to assay for other important seed-borne fungi.

Objectives

This paper will describe our standard method for assaying conifer seedlots. The specific study objectives were:

- (1) To determine seed-borne fungi on Douglas-fir seedlots from various Washington and Oregon seed sources.
- (2) To quantify seed-borne fungal levels before and after cone storage.
- (3) To examine fungal levels on filled and non-filled seed.
- (4) To determine the efficacy of seed coat sterilization.
- (5) To quantify seed-borne fungi levels on true fir seedlots.

Methods

Separate experiments were conducted using a variety of seedlot material of Douglas-fir (*Pseudotsuga*) or true fir (*Abies*). The methodologies employed and seed sources used in each experiment will be described separately. Four "marker" seed-borne fungi, including *Cladosporium* spp., *Fusarium oxysporum*, *Penicillium*

spp., and *Trichothecium roseum*, were selected for comparison studies.

General seed assay method

Seed-borne fungal levels were quantified by plating individual seed directly on to petri dishes containing Komada's *Fusarium* agar medium (KM medium) (Komada 1969). Plates were incubated at 25°C for 10 days, after which they were scored for fungal growth.

Assay of Washington and Oregon seed sources

Nine individual Douglas-fir seedlots from an Oregon seed orchard (Willamette Valley, Oregon) and seven seedlots from a Washington seed orchard (Olympia, Washington) were used in this seed assay experiment. The seed had previously been extracted from cones receiving full operational cone storage (2 to 3 months at ambient conditions). For this assay, 150 seeds from each seedlot were plated on KM medium in groups of 10

seeds per plate with 15 replicate plates per seedlot. The isolation frequency for each "marker" seed-borne fungus was averaged for either the Washington or Oregon seed source.

Seed-borne fungal levels before and after cone storage

Ten cones from nine individual Douglas-fir seedlots were removed from sacks of freshly picked cones. The seed was immediately extracted by hand from these cones and placed in sterile petri dishes. The remaining cones were held in Operational storage bags (burlap) at ambient conditions. After 3 months in storage, the stored seed was extracted and cleaned of cone debris. Seeds extracted before and after cone storage were analyzed for seed-borne fungi as previously described. Each assay was performed on 15 replicates of 10 seeds per seedlot and storage treatment.

Table 1. A list of seed-borne fungi associated with various conifer genera

Fungus	Conifer genera						
	Thuja	Tsuga	Abies	Pseudotsuga	Picea	Pinus	Larix
<i>Alternaria</i>	¹		M	J,K,M	A,K,M	M	
<i>Aspergillus</i>			M	C,D,E,I	M	A,B,M	M
<i>Botrytis</i>			A	-	-	A,M	
<i>Caloscypha</i>				A,N	-	-	
<i>Cephalosporium</i>			I	A	-	-	
<i>Cladosporium</i>			M	L	K,M	A,K,M	
<i>Fusarium</i>			A,M	A,G,H,L,M	J,K,M	A,B,K,M	M
<i>Lirula</i>			A	-	-	-	
<i>Mucor</i>			M	A,F,H,I	K,M	A,B,K,M	M
<i>Penicillium</i>			M	A,C,D,F,H	J,K,M	A,B,K,M	M
<i>Pestalozia</i>	A ²			-	-	M	
<i>Phoma</i>			M	-	-	A	A
<i>Phomopsis</i>				-	-	-	A
<i>Pythium</i>				-	-	A	
<i>Rhizopus</i>			M	A,C,E,F,H,I	K,M	A,K,M	M
<i>Sclerotium</i>			A	-	-	-	
<i>Sirococcus</i>				-	A,O	-	
<i>Trichoderma</i>			M	A,C,D,E,H,I,L	K,M	B,K,M	M
<i>Trichothecium</i>				C,I,L	K,M	A,B,K,M	
<i>Verticillium</i>		A		A	A,M	A,B,M	

¹ Not found in literature

² Literature citations:

(A) Anderson 1985; (B) James and Genz 1981; (C) Shea 1960 (D) Rediske and Shea 1965; (E) Bloomberg 1966; (F) Schubert 1960; (G) Graham and Linderman 1983; (H) James 1984; (I) Bloomberg 1969; (J) Mittal and Wang 1986; (K) Mittal and Wang 1987; (L) Kanaskie *et al.* 1987; (M) Prisyazhnyuk 1960; (N) Paden *et al.* 1978; (O) Mitchell and Sutherland 1986.

Fungal levels on filled and non-filled seed

The seed extracted before storage in the previous experiment (nine seedlots) was also used to quantify the seed-borne fungal levels on filled and non-filled Douglas-fir seed. Seed was examined using a Faxitron seed X-ray device and separated into groups according to seed status (filled or non-filled seed). Five replicates of 15 seed per seed status and seedlot were plated onto KM medium and incubated at 25°C. Plates were examined after 14 days and fungi identified.

Removal of seed-borne inoculum by seed surface sterilization

Ten individual orchard seedlots of Douglas-fir were used to test the efficacy of mild surface sterilization to remove seed-borne fungal inoculum. Non-treated seed was plated directly onto KM media, with five replicate plates each containing ten seeds. The seed treatment involved first soaking seed in a 10% solution of Chlorox bleach (1:10 dilution) for 30 minutes. This treated seed was rinsed several times with sterile distilled water and plated.

Seed-borne fungi on true fir

Seed from noble fir (*Abies procera*), grand fir (*Abies grandis*), and shasta red fir (*Abies magnifica*) was obtained from private seed collection sources. The seed-borne fungal levels from these seedlots were determined by plating ten seeds on four replicate plates per seedlot. The number of colony-forming units per

seed (CFU/seed) from these seedlots was determined by plating a seed slurry (ground seed) on KM medium. Ten seeds from each seedlot were ground for 1 minute at high speed with 30 mL of sterile distilled water in a tissue homogenizer. This seed slurry was serially diluted with sterile distilled water to achieve dilutions of 1:1000 and 1:10 000. One-mL portions were pipetted into three petri plates. Agar medium (KM) was cooled to 35°C in a water bath and poured into the plate containing the seed slurry. Each plate was swirled to mix the media and inoculum.

Results

Seed-borne fungal levels on Douglas-fir from Washington and Oregon seed sources

Cladosporium sp. and *Trichothecium roseum* were the most frequently isolated seed-borne fungi associated with Douglas-fir seed from either the Washington or Oregon seed sources (Figure 1). There was no significant difference ($p=0.05$) between seeds source location and the isolation frequency of either fungus. *Penicillium* sp. was also isolated from a majority of the seed tested. *Fusarium oxysporum* levels were significantly lower ($p=0.05$) than the other three marker fungi.

Seed-borne fungal levels before and after cone storage

The level of seed-borne fungi isolated from Douglas-fir seed was significantly higher after cone storage than before storage (Figure 2). Most notably was the increase

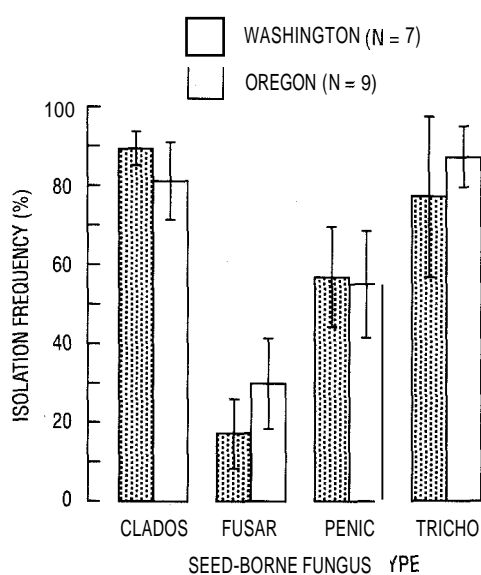

Figure 1. Isolation frequency of marker seed-borne fungi of Douglas-fir seedlots from Washington and Oregon seed sources. Mean of 7 Washington and 9 Oregon seedlots. +/- 95% confidence interval.

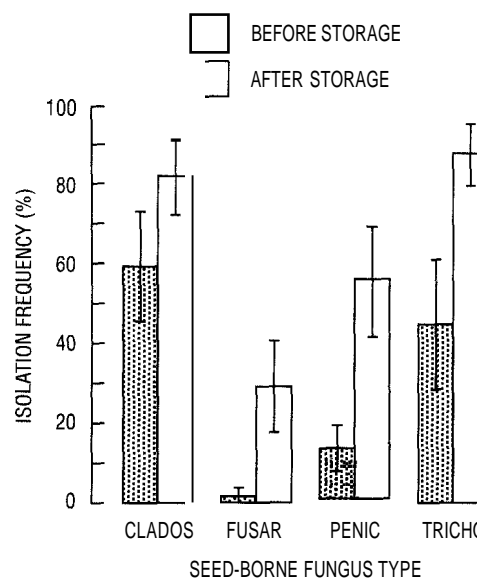

Figure 2. Isolation frequency of various marker seed-borne fungi from Douglas-fir seed prior and after cone storage. Variation shown as +/- 95% confidence interval of the mean.

in the level of *F. oxysporum*. Similar increases occurred with *Penicillium* and *Trichothecium*. This observation suggests that inoculum may be transferred to the seed from cones during storage, cone drying, and seed extraction processes.

Fungal levels on filled and non-filled seed

The status of Douglas-fir seed (filled or non-filled) did not appear to affect the levels of seed-borne fungi associated with that seed (Figure 3). There was no significant difference between the isolation frequency of the four marker fungi and seed status.

Removal of seed-borne inoculum by seed surface sterilization

Surface sterilization of Douglas-fir seed using Chlorox bleach removed a significant amount of the seed-borne fungi present on the seed (Figure 4). This indicates that a major portion of this inoculum is loosely held on the outer seed coat surface. The remainder of the inoculum could not be removed easily and this fraction may have greater significance to disease development.

Seed-borne fungi on true fir

The occurrence of various seed-borne marker fungi on seed of noble fir, grand fir, and shastared fir was highly variable (Figure 5). The grand fir tested showed the highest incidence level of *Cladosporium* of the true fir species tested. *Fusarium oxysporum* and *Trichothecium* levels were also higher on the grand fir. *Penicillium* was

the most frequent seed-borne fungus isolated from noble fir and shastared fir seed. *Trichothecium* was not isolated from the shasta red fir seedlot.

Spore load density (CFU/seed) was similar for the most of the marker fungi of the true fir species tested (Figure 6). The highest inoculum load was observed from *Penicillium* on shastared fir seed (200 CFU/seed).

Discussion

The seed assay method used was designed to meet several minimum objectives: to quantify potential marker seed-borne pathogens, their incidence on seedlots, and location relative to the seed coat. Our results will be discussed in relation to published literature concerning the possible roles these marker fungi play in the seed pathology of conifers.

Cladosporium species are known to infect agricultural and conifer seed (Malone and Musket 1964; Anderson 1985). Anderson (1985) lists its occurrence on *Pinus excelsa*, *P. pinsularis*, *P. ponderosa*, *P. sylvestris*, and *P. taeda*. Mittal and Wang (1987) isolated *Cladosporium* from *Picea glauca* and *P. strobus*, and cited references to its isolation from other conifer species, i.e., *Cedrus deodora*, *C. seprevirens*, *P. caribaea*, *P. roxburghii*, *Abies sibirica*, *Larix sibirica*, and *Picea abies*. Our findings and those of Kanaskie et al. (1987) indicate that *Cladosporium* is a very common fungal isolate associated with Douglas-fir seed in the Pacific Northwest. This fungus can also be isolated from cone bracts and scales. It appears to be equally common on true fir seed as well. Urosevic (1961)

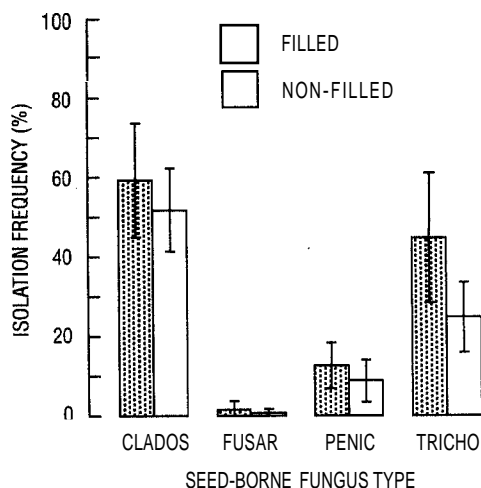

Figure 3. Isolation frequency of marker seed-borne fungi from filled or non-filled Douglas-fir seed.

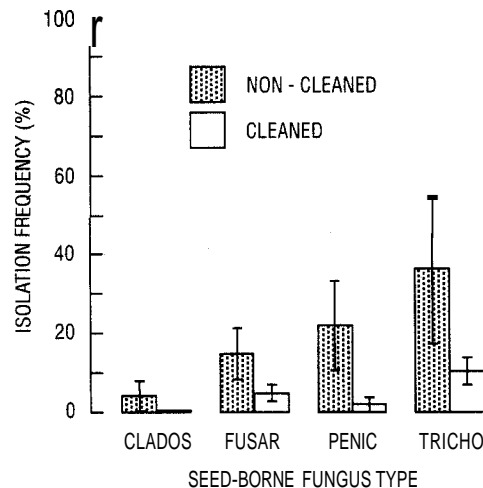

Figure 4. Isolation frequency of marker seed-borne fungi before and after seed sterilization with 10% Chlorox solution.

reports that *Cladosporium* displays weak pathogenic activity, and has been linked to germination declines in conifers.

Seed-borne *Fusarium oxysporum* levels have received much interest possibly because of their importance as disease causing organisms (Malone and Muskett 1964). Our seed testing has found *F. oxysporum* and *Fusarium roseum* on many seedlots of Douglas-fir, grand fir, ponderosa pine, noble fir, and shasta red fir. We consistently isolate *Fusarium* from the outer portions of developing cones, and from seed after cones have opened. Nelson *et al.* (1986) also found that seed-borne *Fusarium* incidence was low on seed prior to cone opening. Transfer of *Fusarium* inoculum (like other marker species) likely occurs from the cone to the seed (Mittal and Wang 1987; Kanaskie *et al.* 1987).

The build-up of *Fusarium* inoculum on seed is especially important because this fungus is a significant pathogen in nursery disease complexes such as damping-off, hypocotyl-rot, and top-blight (Prisyazhnyuk 1960; Bloomberg 1969; Neergaard 1979; Graham and Linderman 1983; James 1984; Mittal and Wang 1986). The contribution of seed-borne *Fusarium* to nursery disease cycles has been difficult to quantify and remains to be fully assessed.

Penicillium species have been isolated from many species of conifers (Anderson 1985; Mittal and Wang 1987). We frequently isolate this fungus from Douglas-fir and true fir seed, where it can be a dominant seed-

borne component. Fisher (1941) observed that *Penicillium* could reduce the germination vigor of ponderosa pine, and it has been linked to seedling emergence failure of other species like *P. glauca* (Mittal and Wang 1986). Some species of *Penicillium* are associated with seed, but are not pathogenic (Malone and Muskett 1964).

Trichothecium roseum has been reported from a variety of conifer species (Anderson 1985; Urosevic 1961). In the Pacific Northwest, *Trichothecium* commonly occurs as a seed-borne fungus of Douglas-fir, grand fir, and ponderosa pine (Kanaskie *et al.* 1987; James and Genz 1982). This fungus has been identified as a seed-rot organism (Mittal and Wang 1987; Malone and Muskett 1964). We have observed that *Trichothecium* can reduce the germination potential of Douglas-fir seed by 15% when inoculated onto seed.

Conclusions

Numerous seed-borne fungi co-exist on or in the seed of Douglas-fir and true fir species in the Pacific Northwest. Many seed-borne fungi are demonstrated plant pathogens linked to germination decline, seed-rot, or disease. Seed fungal inoculum levels build up on seed following cone storage. This seed-borne inoculum may be an important contributor to nursery soil reinfestation following fumigation, and may be a source of disease during crop development, although this remains to be quantified. The specific results demonstrated by this research were the following:

- (1) Seed assay using Komada's media allows for determination of *F. oxysporum* and various other

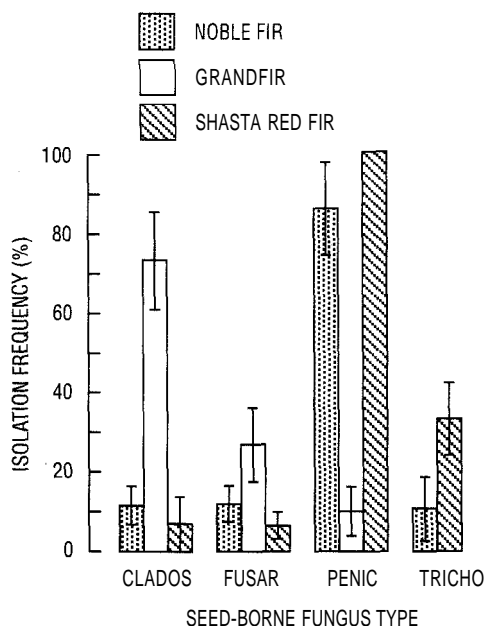

Figure 5. Isolation frequency for marker seed-borne fungi from several true fir (*Abies*) species.

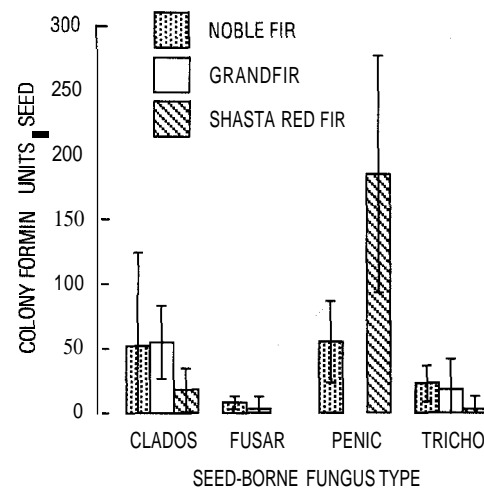

Figure 6. The number of colony forming units (CFU/seed) determined in seed slurry platings for various seed-borne fungi and true fir seedlots.

- seed-rot fungi (*Cladosporium*, *Penicillium* and *Trichothecium*).
- (2) Seed-borne fungal levels can vary with seed source.
 - (3) Seed-borne fungal levels usually increase during and following cone storage and seed extraction.
 - (4) Filled seed contains similar seed-borne fungal levels as non-filled seed.
 - (5) A significant portion of the seed-borne inoculum can be removed by mild surface sterilization.
 - (6) Seed-borne fungi on true fir species show similar differences with regard to seed source.
 - (7) Plating seed slurry yields data on fungal inoculum density.
 - (8) No standard seed fungus testing method is currently in use, and this technique represents one way to detect potential seed-borne problems.

Literature cited

- Anderson, R.L. 1985. Checklist of micro-organisms associated with tree seeds in the world, 1985. USDA Forest Service Southeastern Forest Experiment Station. Gen. Tech. Rep. SE-39. 34 p.
- Bloomberg, W.J. 1969. Disease of Douglas-fir seeds during cone storage. For. Sci. 15:176-181.
- Bloomberg, W.J. 1966. The occurrence of endophytic fungi in Douglas-fir seedlings and seed. Can. J. Bot. 44:413-420.
- Fisher, P.L. 1941. Germination reduction and radicle decay of conifers caused by certain fungi. J. Agric. Res. 62:87-95.
- Graham, J.H.; Linderman, R.G. 1983. Pathogenic seed-borne *Fusarium* from Douglas-fir. Plant Dis. 67:323-325.
- James, R.L. 1984. Fungi colonizing Douglas-fir seed at the Champion Timberlands nursery. USDA For. Serv. Northern Region. Rep. 84-13.3 p.
- James, R.L.; Genz, D. 1981. Ponderosa pine seed treatments: effects on seed germination and disease incidence. USDA For. Serv. Northern Region. For. Pest Manage. Rep. 81-16. 13 p.
- Kanaskie, A.; Cook, A.; Jaeger, R.; Hamm, P. 1987. Effect of cone storage conditions on Douglas-fir seed yield and viability, cone mold, and seed-borne pathogens. Unpublished Report. Oregon State Department of Forestry. 10 p.
- Komada, M. 1969. A new selective medium for isolating *Fusarium* from natural soil. Proc. Amer. Phytopath. Soc. 3:221.
- Malone, J.E.; Muskett, A.E. 1964. Seed-borne fungi. Description of 77 fungus species. Proc. Int. Seed Test. Assoc. 29:179-384.
- Mitchell, L.A.; Sutherland, J.R. 1986. Detection of seed-borne *Sirococcus strobilinus* with monoclonal antibodies in an enzyme-linked immunosorbent assay. Can. J. For. Res. 16:945-948.
- Mittal, R.K.; Wang, B.S.P. 1986. Emergence failure and top decay in white spruce germinants due to three fungi. Can. Plant Dis. Sur. 66:5-7.
- Mittal, R.K.; Wang, B.S.P. 1987. Fungi associated with seeds of eastern white pine and white spruce during cone processing and seed extraction. Can. J. For. Res. 17:1026-1034.
- Neergaard, P. 1979. Seed-borne diseases in tree seed. Dansk Skovforenings Tidsskrift. 54:241-260.
- Nelson, E.E.; Thies, W.G.; Li, C.Y. 1986. Are seed and cone pathogens causing significant losses in Pacific Northwest seed orchards. USDA For. Serv. Pac. Northwest Res. Stn. Res. Note PNW-436. 5 p.
- Paden, J.W.; Sutherland, J.R.; Woods, T.A.D. 1978. *Caloscypha fulgens* (Ascomycetidae, Pezizales): the perfect state of the conifer seed pathogen *Geniculodendron pyriforme* (Deuteromycotina, Hyphomycetes). Can. J. Bot. 56:2375-2379.
- Prisyazhnyuk, A.A. 1960. Fungal diseases of seed and cones of conifers. Lesnoi Zhurnal 3:31-37.
- Rediske, J.R.; Shea, K.R. 1965. Loss of Douglas-fir seed viability during cone storage. For. Sci. 11:463-472.
- Shea, K.R. 1960. Mold fungi on forest tree seed. For. Res. Note 31. Weyerhaeuser Company, Centralia, Washington. 10 p.
- Shea, K.R. 1957. Problem analysis: molds of forest tree seeds. Weyerhaeuser Forestry Research Note: November 1957. Weyerhaeuser Co., Centralia, Washington. 10 p.
- Schubert, G.H. 1960. Fungi associated with viability losses of sugar pine seed in storage. Proc. Soc. Amer. For. Meeting: Nov. 13-16, Washington, D.C. pgs. 18-21.
- Urosevic, B. 1961. The influence of saprophytic and semi-parasitic fungi on the germination of Norway spruce and Scots pine seeds. Proc. Int. Seed Test. Assoc. 26: 537-556.

Effects of ethephon and drought on container-grown *Pinus resinosa* seedlings

SANDRA F. MAYNARD AND WILLIAM H. LIVINGSTON

University of ~~Maine~~, Orono, 04469, USA

Presented at the first meeting of IUFRO Working Party S2.07-09
(Diseases and Insects in Forest Nurseries), Victoria, British Columbia, Canada, August 22-30, 1990.

Abstract

Deflection of lateral roots from the container wall results in a deformed root structure that may persist after outplanting, predisposing the seedling to stress and disease. Ethephon (2-chloroethylphosphonic acid) was used in an effort to control the lateral root growth of container-grown red pine (*Pinus resinosa*) seedlings. A factorial design was used to evaluate the effects of ethephon (0, 25, 75 ppm), an ectomycorrhizal fungus, (*Fusarium subglutinans*), and drought on growth of *P. resinosa* (2-week-old seedlings, 24 treatments, 30 seedlings per treatment). *Fusarium* produced no disease or other effect in the experiment. Ethephon decreased root length and increased the thickness of the roots. Drought resulted in 30% mortality of the controls (ethephon=0 ppm). Ethephon-treated seedlings exhibited no mortality, but did exhibit phosphorus deficiency symptoms. Phosphorus deficiency was corrected by the presence of ectomycorrhizae. Ethephon treatments alter root growth of container-grown red pine resulting in decreased lateral root length and improved drought resistance.

Resume

Les racines secondaires des semis produits en récipients ont tendance à défléchir au contact des parois du récipient. Ce phénomène provoque une déformation du système racinaire, déformation qui peut persister après la transplantation du semis en site forestier et favoriser la prédisposition des semis au stress et aux maladies. Pour inhiber la croissance des racines secondaires des semis de pin rouge (*Pinus resinosa*) produits en récipients, on a procédé à un essai à l'éthéphon (acide chloroéthylphosphonique 2). Un plan d'expérimentation factoriel a été utilisé pour évaluer les effets de l'éthéphon (0, 25, 75 ppm), d'un champignon ectomycorhizien (*Fusarium subglutinans*) et de la sécheresse sur la croissance de *P. resinosa* (semis âgés de deux semaines, 24 traitements, 30 plants par traitement). Au cours de cette expérimentation, on a constaté que le *Fusarium* n'était la cause d'aucune maladie ni d'aucun traumatisme, que l'éthéphon avait contribué à réduire la longueur des racines et à augmenter leur épaisseur et que la sécheresse avait causé la mort de 30 % des sujets témoins (éthéphon=0 ppm). Les semis traités à l'éthéphon n'ont subi aucune diminution de population mais ont donné des signes de carence phosphorique, carence qui a été corrigée par la présence des ectomycorhiziens. Les traitements à l'éthéphon ont pour effet de modifier le processus de croissance du système racinaire des pins rouges produits en récipients, réduisant la longueur des racines secondaires et améliorant leur résistance à la sécheresse.

Introduction

A common problem associated with container production of seedlings is root deformities (Preisig *et al.* 1979; Carlson *et al.* 1980; Livingston 1990). Seedling exhibiting container-induced root deformities have been associated with *Armillaria* root disease after planting (Livingston 1990). Controlling the number and length of lateral roots may lead to better root form. Burdett *et al.* (1983) and Ruehle (1985) used cupric carbonate (CuCO_3) to coat container walls to prevent first-order laterals from growing down the wall. However, the treatment results are variable and are dependent on tree species, container, soil mixture, and development of

second- and third-order laterals (Burdett and Martin 1982).

Ethephon (2-chloroethylphosphonic acid) may be a viable alternative to cupric carbonate for controlling root growth by restricting root elongation (Livingston 1988). After contact with plant tissue, ethephon releases ethylene, a plant growth regulator (de Wilde 1971) which elicits changes in root growth (Graham and Linderman 1981; Wilson and Field 1984; Livingston 1988).

Ethephon treatments for controlling root growth would only be useful if treated seedlings do not become more susceptible to diseases. *Fusarium* disease has

been associated with ethylene-treated seedlings (Graham and Linderman 1981) and *Fusarium* often affects roots of container-grown conifers (James and Gilligan 1984; James 1986).

Because root growth is altered by ethephon treatments, susceptibility to drought stress could be altered. Drought stress to container-grown seedlings can result from insufficient water during transport, storage at holding areas, overwintering, and planting.

While *Fusarium* disease and drought are potentially serious problems for seedlings treated with ethephon, ectomycorrhizal inoculation is a potential treatment for minimizing the effects of these diseases. Inoculating conifer seedlings with ectomycorrhizal fungi reduces losses due to *Fusarium* disease (Sinclair *et al.* 1982; Sylvia and Sinclair 1983; Duchesne *et al.* 1988; Chakravarty and Unestam 1987). Plants infected with ectomycorrhizal fungi have been shown to exhibit improved growth and survival during drought than non-mycorrhizal plants (Mudge *et al.* 1987).

This study attempts to evaluate how ethephon treatments, in conjunction with ectomycorrhizal inoculations, affect growth of red pine and its resistance to drought stress and *Fusarium* disease.

Materials and methods

A factorial design was used to evaluate the effects of ethephon (0, 25, and 75 ppm), an ectomycorrhizal fungus, *Fusarium*, and drought on the growth of red pine seedlings (24 treatments, 30 seedlings per treatment).

Inoculum preparation

The ectomycorrhizal isolate was obtained from a black spruce (*Picea mariana* [Mill.] B.S.P.) seedling growing at a nursery in Millinocket, Maine. The fungus is an isolate of an undescribed *Inocybe* spp. (unpublished data).

To determine if problems due to *Fusarium* disease increase with the use of ethephon, the seedlings were inoculated with a *Fusarium* isolate obtained from a white sporodochium on a symptomatic (wilted) white pine (*Pinus strobus* L.) seedling growing in a greenhouse in Hermon, Maine. The isolate was identified as *F. subglutinans* (Wollenw.) (Reinking) Toussoun and Marasas (Kuhlman *et al.* 1978; Nelson *et al.* 1983) by Dr. Paul Nelson of the *Fusarium* Research Laboratory at The Pennsylvania State University.

Ectomycorrhizal inoculum starter was grown for 2 weeks in 25 x 150 mm Pyrex test tubes, using 18 ml vermiculite, 2 ml sifted peat (#18 mesh), and 12 ml modified Melin-Norkans (MMN) medium (Molina and Palmer 1982). Inoculum for the greenhouse was pro-

duced by emptying one tube of inoculum starter in autoclaved Seal-A-Meal® bags (12 in x 8 in; Dazey Corp. Industrial Airport, KS 66031) containing a mixture of 700 ml vermiculite, 25 ml peat, and 340 ml MMN. Openings of inoculated bags were folded over and incubated in the dark at 25°C for 6 weeks. *Fusarium* inoculum was prepared in the same manner except bags were inoculated with a plug of colonized potato dextrose agar. Sterile control inoculum was prepared in the same manner as the ectomycorrhizal and *Fusarium* inoculum, except no fungi were added to the bags.

Seed germination and planting

Red pine seed (Michigan source) was surface-disinfected with 10% hydrogen peroxide (Molina and Palmer 1982), plated on water agar to detect contaminants, and allowed to grow for 14 days at 25°C. Ray Leach Containers® (Canby, OR) were filled with ca. 195 ml 2:1 graded nonsterile peat/vermiculite soil mixture, pH 5.0, supplemented with slow-release fertilizer (14:14:14 N:P:K, 2.8 L/m³ soil). Half of the treatments received 3 ml of mycorrhizae inoculum and/or 3 ml of *Fusarium* inoculum added to each tube (mycorrhizal inoculum on top). Non-treated controls received sterile inoculum. The filled tubes were leached three times with tap water to remove sugars from the inoculum. Germinated seeds were transplanted to the containers in December 1988.

Seedling management and treatments

The seedlings were grown under two 1000 W high-pressure sodium lamps (153 mmol m⁻² sec⁻¹, 15-hr day) with average day and night temperatures of 30° and 16° C. The seedlings were watered with a mister to keep the soil fully moist and fertilized to point of runoff about every 2 weeks with Peters water soluble fertilizer (20:20:20).

Eight weeks after transplanting, weekly ethephon drenches (0, 25, and 75 ppm) began and continued for 13 weeks. Ethephon (Ethrel®, Rhone-Poulenc, Research Triangle Park, NC) was added to distilled water at the time of treatment. The soil of each tube was saturated with the ethephon solution.

Drought treatments began after bud set (21 weeks after transplanting) to determine the effects of drought on ethephon-treated seedlings. Water was withheld from half of the seedlings until the controls (ethephon = 0 ppm) visibly wilted, a period of 13 days. At this time over 50% of the needles exhibited a horizontal or drooped orientation. Watering and ethephon treatments resumed for 4 weeks, and the seedlings were harvested.

Data Collection and Analysis

Seedling appearance (normal, chlorotic, or dead) was evaluated weekly, and cumulative mortality was calculated at the end of the experiment (27 weeks after transplanting). Growth changes of seedlings were evaluated at the end of the experiment on 10 randomly selected seedlings. Measurements included shoot length, shoot caliper, primary root length, number and length of first-order laterals, root dry weight, shoot dry weight, and nutrient analysis (total nitrogen and phosphorus). On five of these seedlings, the first-order lateral root systems were cut at 25-mm intervals, and the number of root segments within each interval was counted. Twelve of these segments were sampled for measuring the percentage of ectomycorrhizal root tips, average length

of a sampled root segment, and weight per length of root.

Fusarium was re-isolated on Komada's selective medium (Komada 1975) in order to detect *Fusarium* colonization on the seedlings. *Fusarium* re-isolations from live seedlings were performed on 36 seedlings (1-2 seedlings per treatment) at 13 weeks after transplanting and 120 seedlings (5 seedlings per treatment) at 27 weeks after transplanting. Re-isolations from dead seedlings occurred throughout the experiment.

Containers were weighed at the end of the drought period and after saturating the soil with water. The dry weight of the soil, container, and seedling were subtracted from the wet-weight values to yield water content. Values were expressed as a percentage of maximum water content.

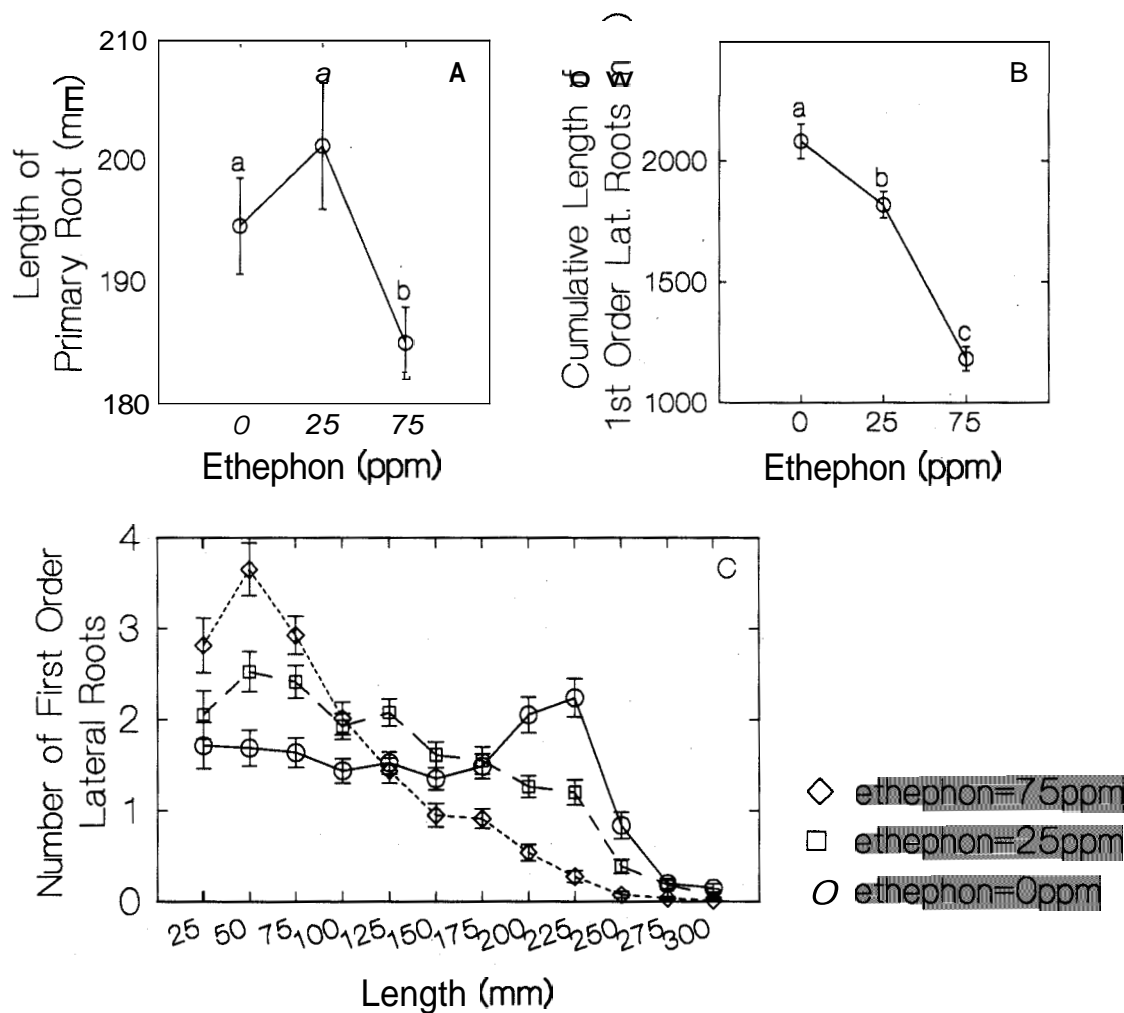

Figure 1. Effect of ethephon on primary and lateral root growth. (A) Primary root length. Seedlings treated with ethephon at 0 ppm and 25 ppm did not differ. Ethephon at 75 ppm reduced primary root length. (B) Cumulative length of first-order lateral roots. Increasing ethephon treatments reduced cumulative length of first-order lateral roots, with the most pronounced effect in seedlings treated with ethephon at 75 ppm. (C) Number of first-order lateral roots by 25-mm size classes. Ethephon treatments decreased the number of roots in higher size classes. Error bars = standard error. Means with different letters are significantly different ($P = 0.01$).

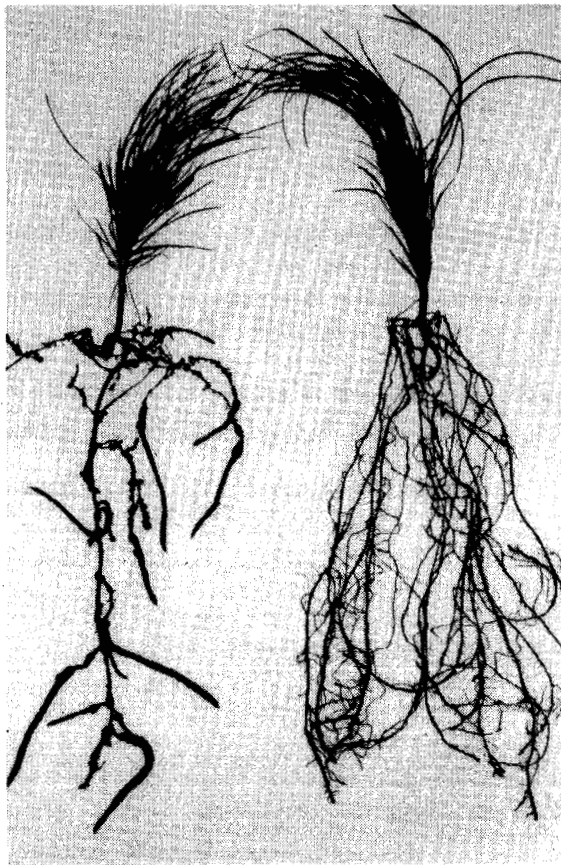

Figure 2. Effect of ethephon on root appearance. Seedlings treated with ethephon at 75 ppm (left) and ethephon at 0 ppm (right). Note decreased root length and increased root diameter.

Results

Data from the experiments did not have similar variances (Bartlett's test for homogeneity, $P < 0.01$; Wilkinson 1989). Nonparametric tests are not available for factorial designs, but Conover (1980) recommends a ranking procedure for these data sets. Therefore, all data (with the exception of mortality data) were ranked and standard ANOVA procedures were used on the ranked data ($P < 0.01$). Actual data (average and standard error) are presented in the figures. Data for average and standard error calculations were pooled for treatment factors which were not significant as a main effect nor part of a significant interaction in the ANOVA. Tukey's procedure for multiple comparisons of means was used. Frequency of mortality was analyzed as cross-classified categorical data using the loglinear model (Fienberg 1977; Wilkinson 1989).

Root measurements and data analysis

Ethephon treatment was the only factor affecting the length of the primary root (Figure 1a). Primary root

length in seedlings treated with ethephon at 75 ppm was reduced by ca. 5% and 8% compared to seedlings treated with 0 ppm and 25 ppm ethephon, respectively.

Ethephon treatment was the only factor to decrease the cumulative length of first-order lateral roots (13% and 43% for 25 and 75 ppm, respectively; Figure 1b). First-order lateral roots were shorter after ethephon treatments than those of nontreated seedlings (Figure 1c, Figure 2). Ethephon treatments did not affect the total number of first-order lateral roots per seedling which averaged 16.4 (SE 0.33). However, drought stress slightly decreased the average number of first-order lateral roots per seedling from 17.0 (SE 0.47) to 15.8 (SE 0.46).

Ectomycorrhizae developed on 92% of the inoculated root tips (SE 1.73); noninoculated seedlings had 2% colonization. Ethephon treatments increased ectomycorrhizal colonization of inoculated seedlings: 0 ppm = 84.8% colonization, SE 4.2; 25 ppm = 96.7%, SE 1.1; 75 ppm = 95.0%, SE 2.2. Ethephon treatments induced ectomycorrhizal-like short root branching in noninoculated red pine.

Ethephon treatments significantly decreased the number of roots (number of root segments counted) as distance from the primary root increased from 25 mm to 300 mm (Figure 3a) (only averages of the 0 ppm and 25 ppm treatments at 275 mm were not significantly different). Treatment with 75 ppm ethephon resulted in the greatest decrease, from 26-97% of the number of roots in untreated seedlings. There was a significant interaction between ectomycorrhizal inoculations and ethephon treatments. Ectomycorrhizae also decreased the number of roots across all ethephon treatments and distances (Figure 3b).

Increasing ethephon concentrations increased weight per length of root segment by 111% and 178% for 25 and 75 ppm, respectively (Figures 2 and 4a). Without ectomycorrhizal inoculations, ethephon increased root dry weight by 23% at 25 ppm, but differences were not significant between the seedlings treated with 0 ppm and 75 ppm ethephon (Figure 4b). Ectomycorrhizal inoculations decreased root dry weight in seedlings treated with 25 ppm ethephon by 21% such that their root dry weight was not different from that of seedlings treated with 0 ppm ethephon with or without ectomycorrhizal inoculation. Drought significantly decreased root dry weight in seedlings treated with 0 and 25 ppm ethephon by 27% and 16%, respectively, but had no effect in seedlings treated with 75 ppm ethephon (Figure 4c).

Ethephon decreased the phosphorus:nitrogen (P:N) ratio of roots (non-mycorrhizal) compared to seedlings treated with 0 ppm ethephon by 4% and 20% for 25 and 75 ppm, respectively (Table 1). Ectomycorrhizae in-

creased the P:N ratio across all ethephon levels from 3-7%.

Shoot growth

Ethephon at 75 ppm decreased shoot dry weight (Figure 4d). Seedlings treated with ethephon at 0 ppm and 25 ppm were not significantly different. Other treatments had no significant effect. Nutrient analysis of the shoots revealed a decreased P:N ratio in ethephon-treated seedlings (Table 2). Ethephon at 25 and 75 ppm decreased the P:N ratio by 4% and 34% compared to the controls. Ectomycorrhizae increased the P:N ratio by 9-46% increase for 75 ppm across all ethephon treatments.

Seedling survival and drought stress

Seedling mortality was minimal before drought stress (0-12%). Wilt symptoms developed on 77% of seedlings not treated with ethephon after 13 days without

watering; such symptoms appeared on 11% of seedlings treated with ethephon at 25 ppm and 75 ppm. Four weeks after resumption of watering, mortality was limited to those seedlings not treated with ethephon. Ectomycorrhizae and *Fusarium* were evaluated for their ability to reduce and induce mortality, respectively, in the seedlings not treated with ethephon. The only interaction term to significantly improve G^2 compared to the independent loglinear model was ectomycorrhizae \times mortality (G^2 of model differences = 6.82, 1 df, $P < 0.01$; G^2 of improved model = 1.43, 4 df, $P > 0.10$). Addition of the *Fusarium* \times mortality interaction did not significantly improve the independence model (G^2 of model differences = 0, 1 df, $P > 0.01$; G^2 of independence model = 8.25, 4 df, $P < 0.10$). Drought caused severe mortality of seedlings not treated with ethephon (42%), but mortality of these seedlings was reduced by half (to 19%) with ectomycorrhizal fungus inoculation.

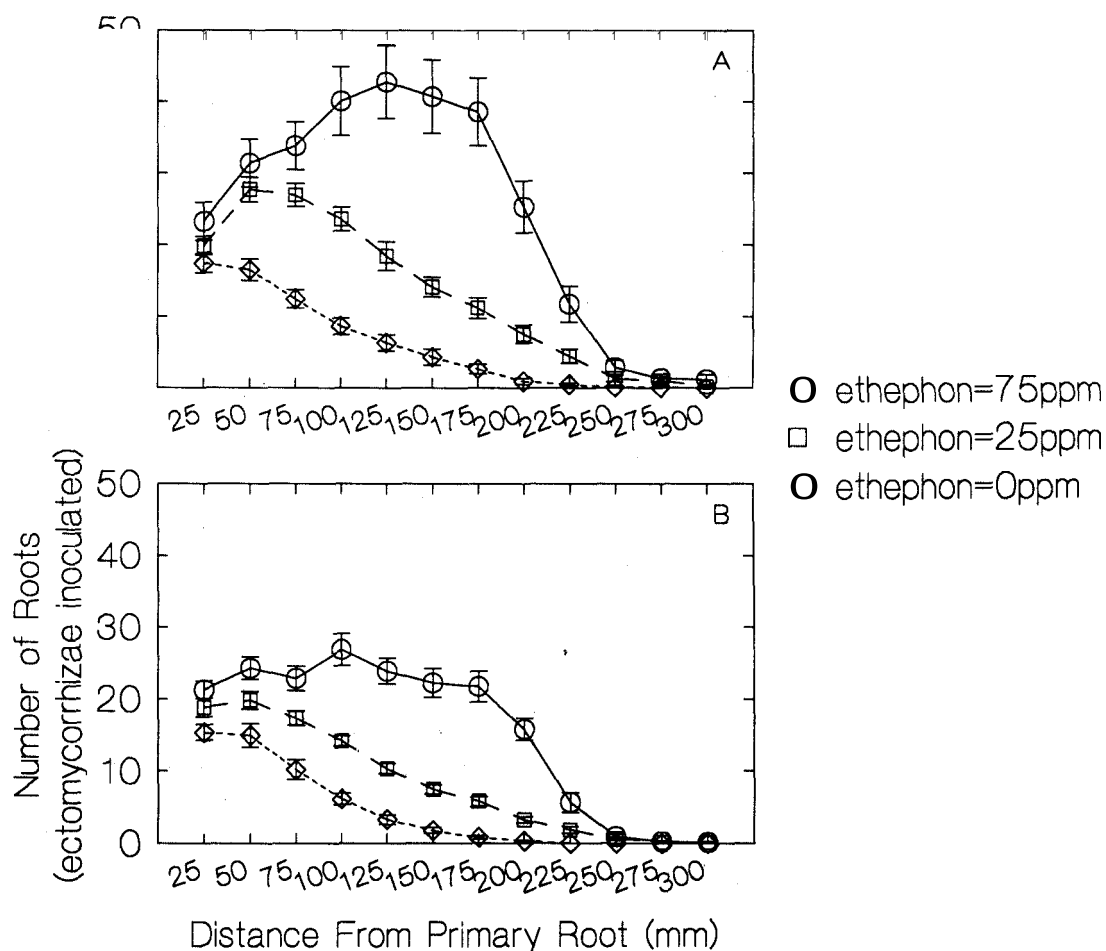

Figure 3. Effect of ethephon on the number of roots. (A) Seedlings not inoculated with an ectomycorrhizal fungus. Increasing ethephon levels decreased the number of roots counted at 25-mm intervals from the primary root. (B) Ectomycorrhizal inoculations decreased the number of roots across all ethephon levels. Error bars = standard error.

Water content of container soil after drought stress shows the largest water loss (88.6%) from seedlings not treated with ethephon (Figure 5).

Ectomycorrhizae increased (up to 19%) the amount of water lost during drought stress. *Fusarium* inoculation had no effect on water loss.

Fusarium re-isolation

Fusarium re-isolation was evaluated by counts of colonized and noncolonized root segments. *Fusarium* was re-isolated from 13 seedlings which died before drought stress (360 seedlings inoculated). No *Fusarium* was isolated from 15 noninoculated seedlings which died prior to drought. After drought, *Fusarium* was re-isolated from root segments of living seedlings in in-

oculated (81%, n = 265 root segments) and noninoculated (23%, n = 284) treatments. Cross-contamination occurred primarily in the live seedlings treated with 75 ppm ethephon (48%, n = 84). Despite its presence on seedlings, *Fusarium* did not produce disease and had no significant effect on growth parameters in the experiment.

Discussion

Ethephon treatments successfully controlled root growth of red pine seedlings. Root numbers and lengths were reduced. Therefore, ethephon treatments reduce the amount of root tissue being deflected along container walls on solid wall containers. On porous wall containers, e.g. the Jiffy® peat-pellet, the treatments should limit root egress and interrooting of plugs. Therefore,

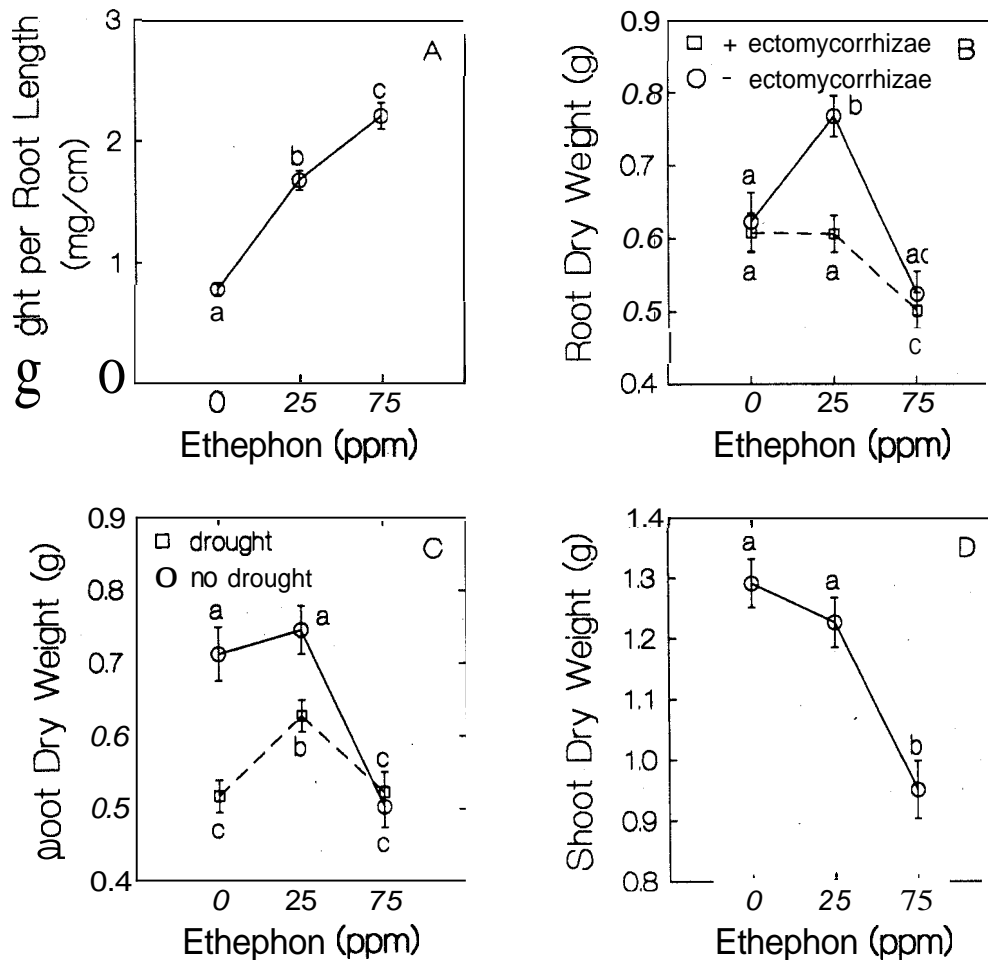

Figure 4. Effect of ethephon on seedling weight. (A) Weight per root length. Increased ethephon levels resulted in increased weight per length of root segments. (B) Ectomycorrhizae and root dry weight. Ethephon at 25 ppm resulted in an increase of root dry weight, but differences were not significant between ethephon at 0 ppm and 25 ppm on seedlings inoculated with an ectomycorrhizal fungus. Ethephon at 75 ppm reduced root dry weight. (C) Drought and root dry weight. Drought reduced dry weight of seedlings treated with ethephon at 0 ppm and 25 ppm, but had no effect on seedlings treated with 75 ppm ethephon. (D) Shoot dry weight. Seedlings treated with Ethephon at 0 ppm and 25 ppm did not differ. Ethephon at 75 ppm reduced shoot dry weight. Errors bars = standard error. Means with different letters are significantly different (P = 0.01).

ethephon treatments should aid in reducing root deformities after planting. Treatments also increased weight per root length. Therefore, reduced root lengths from ethephon treatments did not necessarily result in reduced root dry weights. Ethephon at 25 ppm actually increased root dry weight.

Most observations in this study agree with previous reports of ethephon effects on conifer growth. Decreased lateral root length resulting from ethephon treatments on conifer seedlings also has been reported by Graham and Linderman (1981), Wilson and Field (1984), and Livingston (1988). Similar or increased root dry weight of red pine after ethephon treatment is consistent with Graham and Linderman's study (1981) of ethephon-treated Douglas-fir seedlings, but Weston *et al.* (1980) reported a decrease in root weight of white spruce when ethephon was applied as a foliar spray. Graham and Linderman (1981) found ethylene to have no effect on ectomycorrhizal colonization of conifer roots. However, this study showed increased ectomycorrhizal colonization of red pine roots after ethephon treatments. Ethephon treatments induced ectomycorrhizal-like short root branching in noninoculated red pine as was previously described for other conifers (Rupp and Mudge 1985; Wilson and Field 1984). No changes or decreases in shoot dry weight of conifers after ethephon treatment were ob-

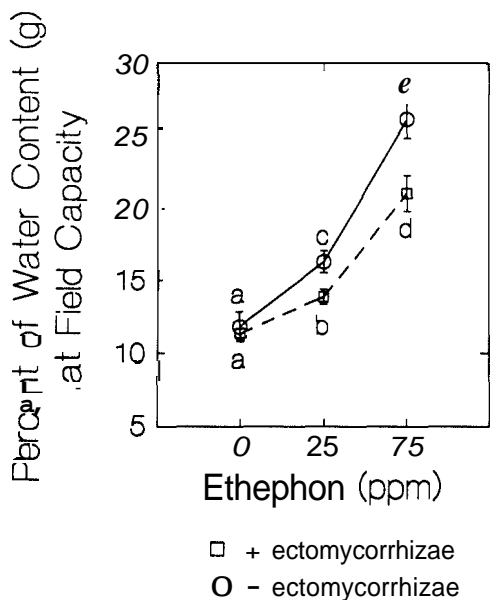

Figure 5. Effect of ethephon and ectomycorrhizae on water content of soil after drought stress. Increased ethephon concentrations resulted in increased water content within the soil after drought stress. Ectomycorrhizae decreased soil water content for ethephon at 25 ppm and 75 ppm. Error bars = standard error. Means with different letters are significantly different ($P = 0.05$).

served in this study or by Graham and Linderman (1981) and Weston *et al.* (1980). No differences were discernable in shoot or terminal growth of red pine seedlings treated with ethephon root drenches, as was reported by Cheung (1975) and Hare (1981) with foliar ethephon application to other conifers. In summary, ethephon has consistently decreased lateral root length, has a variable effect on root weight, and induces ectomycorrhizal-like short root branching on conifers. Ethephon has variable effects on conifer shoot length and dry weight.

This study is the first report of ethephon treatments decreasing seedling susceptibility to drought stress. Reduced drought susceptibility of ethephon-treated seedlings was probably due to growth changes in the root system. Reduced root length resulting from ethephon treatments decreased the amount of root surface in contact with soil water. This probably contributed to decreased water uptake and higher amounts of soil water in containers of ethephon treated seedlings after 13 days

Table 1. Levels (%) of nitrogen (N), phosphorous (P), and ratios (X100) of phosphorus:nitrogen in dried root tissue (10 plants per sample)

Treatment	N	P	P:N
Ethephon 0 ppm	1.28	0.26	20.39
Ethephon 0 ppm + ectomycorrhiza	1.38	0.29	21.01
Ethephon 25 ppm	1.23	0.24	19.59
Ethephon 25 ppm + ectomycorrhiza	1.51	0.31	20.80
Ethephon 75 ppm	1.88	0.31	16.28
Ethephon 75 ppm + ectomycorrhiza	1.99	0.35	17.49

Table 2. Levels (%) of nitrogen (N), phosphorous (P), and ratios (X100) of phosphorus:nitrogen in dried shoot tissue (10 plants per sample)

Treatment	N	P	P:N
Ethephon 0 ppm	1.45	0.25	17.24
Ethephon 0 ppm + ectomycorrhiza	1.48	0.31	20.81
Ethephon 25 ppm	1.32	0.22	16.59
Ethephon 25 ppm + ectomycorrhiza	1.51	0.28	18.21
Ethephon 75 ppm	1.98	0.23	11.47
Ethephon 75 ppm + ectomycorrhiza	1.76	0.30	16.82

without watering. Therefore, due to reduced numbers and lengths of roots, the ethephon-treated seedlings did not undergo as severe drought stress as did the controls.

Increase in average size and number of cortical cells after ethephon treatments resulted in thicker roots on red pine (Maynard 1989). These roots have the capacity to store more water per length of root than nontreated roots and should make them better able to survive longer periods of low soil moisture. This could explain why ectomycorrhizal red pine treated with 25 ppm ethephon were able to survive drought stress despite having soil moisture contents similar to those of the controls (ethephon=0 ppm, with or without ectomycorrhizae) which suffered 30% mortality.

Ectomycorrhizae decreased root numbers and lengths, but still increased water uptake in red pine seedlings. Increased water uptake could be due to the hyphal network of ectomycorrhizal roots which increases the absorptive surface area (Linderman 1988). Although the soil of ectomycorrhizal seedlings lost more water, ectomycorrhizae reduced seedling mortality due to drought by over 50% when compared to nonmycorrhizal seedlings. Mudge *et al.* (1987) presents a review of studies of ectomycorrhizal drought-stressed seedlings, and states mycorrhizal roots may be more resistant to desiccation than nonmycorrhizal roots, thereby retaining a larger functional root system during drought.

Ectomycorrhizae increased but ethephon decreased phosphorus uptake of seedlings as shown by nutrient analysis of the roots and shoots (Tables 1 and 2). The optimum P:N ratio for red pine is 14 (Timmer and Armstrong 1987). With the exception of seedlings treated with 75 ppm ethephon, P:N ratios of the shoots of the seedlings ranged from 16.82 to 20.81. Nonmycorrhizal seedlings treated with 75 ppm ethephon had a P:N ratio of 11.47, below the optimum level; however, the P:N ratio of such seedlings was raised 32% by ectomycorrhizae to 16.82. Ectomycorrhizal inocu-

lations can improve nutrient uptake of P in ethephon-treated seedlings.

The *Fusarium* isolate used in this study produced no disease and had no significant effect on the experiment. *Fusarium subglutinans* has previously been reported as a nursery pathogen (Barnard and Blakeslee 1980; Blakeslee *et al.* 1981; Dwinell 1988). This is the first report of *F. subglutinans* in Maine. The isolate probably induced vascular wilt on the nursery seedling from which it was cultured, but most likely lost pathogenicity when maintained in culture. Duchesne *et al.* (1988) report loss of pathogenicity when *Fusarium* isolates were maintained in culture longer than 3-4 weeks. The *Fusarium* isolate used in this experiment was maintained in culture 8 weeks prior to seedling inoculation. Because the *Fusarium* isolate caused no disease and had no effect on growth parameters, the interaction of the disease with ethephon treatments, ectomycorrhizae, or drought could not be evaluated. The results of this study indicate that *F. subglutinans* need not be pathogenic to colonize root tissue and evade surface sterilization. Previous studies also show *Fusarium* colonization of healthy root systems without symptoms (James and Gilligan 1984).

Ethephon treatments have the potential to be a viable, simple method to control root growth of container-grown pine seedlings. Because ethephon can be easily applied as a root drench through the watering system, the treatments do not require expensive labor-intensive methods or equipment and could be easily incorporated into existing practices at tree nurseries. Outplanting studies of ethephon-treated seedlings are needed to determine the effects, if any, of ethephon on root out-growth into the surrounding soil.

Acknowledgements

The authors thank David H. Lambert and Jody Jellison for review of the manuscript, and William A. Halteman for assistance with statistical analysis.

References

- Bamard, E.L.; Blakeslee, G.M. 1980. Pitch canker of slash pine seedlings: a new disease in forest tree nurseries. *Plant Disease* 64:695-696.
- Blakeslee, G.M.; Miller, T.; Bamard, E.L. 1981. Pitch canker in forest tree nurseries. USDA Forest Service, *Forestry Bulletin* SA-FB/P 22. 1p.
- Burdett, A.N.; Martin, P.A.F. 1982. Chemical root pruning of coniferous seedlings. *HortScience* 17:622-624.
- Burdett, A.N.; Simpson, D.G.; Thompson, C.F. 1983. Root development and plantation establishment success. *Plant Soil* 71:103-110.
- Carlson, W.C.; Preisig, C.L.; Promnitz, L.C. 1980. Comparative root system morphologies of seeded-in-place, bareroot, and container-cultured plug Sitka spruce seedlings after outplanting. *Can. J. For. Res.* 10:250-256.
- Chakravarty, P.; Unestam, T. 1987. Differential influence of ectomycorrhizae on plant growth and disease in *Pinus sylvestris* seedlings. *J. Phytopathol.* 120:104-120.
- Cheung, K. 1975. Induction of dormancy in container-grown western hemlock: effects of growth retardants and inhibitors. British Columbia Forest Service Research Note No. 73. 9p.

- Conover, W.J. 1980. Practical nonparametric statistics. 2nd edition. John Wiley and Sons, New York. 492 p.
- de Wilde, R.C. 1971. Practical applications of (2-chloroethyl)phosphonic acid in agricultural production. *HortScience* 6:12-18.
- Duchesne, L.C.; Peterson, R.L.; Ellis, B.E. 1988. Interaction between the ectomycorrhizal fungus *Paxillus involutus* and *Pinus resinosa* induces resistance to *Fusarium oxysporum*. *Can. J. Bot.* 66:558-562.
- Dwinell, L.D. 1988. Comparative pathology of *Fusarium subglutinans* isolated from Monterey pine in California and southern pines. *Phytopathology* (abstr.) 78:1607.
- Fienberg, S.E. 1977. The analysis of cross-classified categorical data. MIT Press, Cambridge.
- Graham, J.H.; Linderman, R.G. 1981. Effect of ethylene on root growth, ectomycorrhiza formation, and *Fusarium* infection of Douglas-fir. *Can. J. Bot.* 59:149-155.
- Hare, R.C. 1981. Effect of nine growth retardants applied to loblolly and slash pine. *Can. J. For. Res.* 12:112-114.
- James, R.L. 1986. Occurrence of *Fusarium* on Douglas-fir seed and containerized seedlings at the Plum Creek Nursery, Pablo, Montana. USDA Forest Service, Northern Region Report 86-4. 10 p.
- James, R.L.; Gilligan, C.J. 1984. Studies of *Fusarium* associated with containerized conifer seedling diseases: pathogenicity tests of isolates from the Alpine Nursery, Kalispell, Montana. USDA Forest Service, Northern Region Report 84-14. 29 p.
- Komada, H. 1975. Development of a selective medium for quantitative isolation of *Fusarium oxysporum* from natural soil. *Rev. Plant Prot. Res.* 8:114-125.
- Kuhlman, E.G.; Dwinell, L.D.; Nelson, P.E.; Booth, C. 1978. Characterization of the *Fusarium* causing pitch canker of southern pines. *Mycologia* 70:1131-1143.
- Linderman, R.G. 1988. Mycorrhizal interactions with the rhizosphere microflora: the mycorrhizosphere effect. *Phytopathology* 78:366-371.
- Livingston, W.H. 1988. Ethephon and ectomycorrhizal treatments alter root growth of containerized black spruce seedlings. *Phytopathology* (abstr.) 78:1608.
- Livingston, W.H. 1990. *Armillaria ostoyae* in young spruce plantations. *Can. J. For. Res.* (in press).
- Maynard, S.F. 1989. Effect of ethephon and drought on containerized *Pinus resinosa* seedlings. M.S. Thesis, University of Maine, Orono. 87 p.
- Molina, R.; Palmer, J.G. 1982. Isolation, maintenance, and pure culture manipulation of ectomycorrhizal fungi. Pages 115-129 in S. Schenck, editor. *Methods and principles of mycorrhizal research*. American Phytopathological Society, St. Paul, MN. 244 p.
- Mudge, K.W.; Diebolt, K.S.; Whitlow, T.H. 1987. Ectomycorrhizal effect on host plant response to drought stress. *J. Environ. Hort.* 5:183-187.
- Nelson, P.E.; Toussoun, T.A.; Marasas, W.F.O. 1983. *Fusarium* species: an illustrated manual for identification. Pennsylvania State University Press, University Park, PA. 193 p.
- Preisig, C.L.; Carlson, W.C.; Promnitz, L.C. 1979. Comparative root system morphologies of seeded-in-place, bareroot, and containerized Douglas-fir seedlings after outplanting. *Can. J. For. Res.* 9:399-405.
- Ruehle, J.L. 1985. The effect of cupric carbonate on root morphology of containerized mycorrhizal pine seedlings. *Can. J. For. Res.* 15:586-592.
- Rupp, L.A.; Mudge, K.W. 1985. Ethephon and auxin induce mycorrhiza-like changes in the morphology of root organ cultures of Mugo pine. *Physiol. Plant.* 64:316-322.
- Sinclair, W.A.; Sylvia, D.M.; Larsen, A.O. 1982. Disease suppression and growth promotion in Douglas-fir seedlings by the ectomycorrhizal fungus *Laccaria laccata*. *For. Sci.* 28:191-201.
- Sylvia, D.M.; Sinclair, W.A. 1983. Suppressive influence of *Laccaria laccata* on *Fusarium oxysporum* and on Douglas-fir seedlings. *Phytopathology* 73:384-389.
- Timmer, V.R.; Armstrong, G. 1987. Diagnosing nutritional status of containerized tree seedlings: comparative plant analysis. *Soil Sci. Am. J.* 51:1084-1087.
- Weston, G.D.; Carlson, L.W.; Wambold, E.C. 1980. The effect of growth retardants and inhibitors on container-grown *Pinus contorta* and *Picea glauca*. *Can. J. For. Res.* 10:510-516.
- Wilkinson, L. 1989. SYSTAT, the system for statistics. Systat, Inc., Evanston, IL. 822 p.
- Wilson, E.R.L.; Field, R.J. 1984. Dichotomous branching in lateral roots of pine: the effect of 2-chloroethylphosphonic acid on seedlings of *Pinus radiata* D. Don. *New Phytol.* 98:465-473.

The current status of *Eucalyptus* forest nursery fertilization practices and seedling diseases in Buenos Aires province, Argentina

ING. FTAL. MARÍA ISABEL SALERNO

Centro de Investigaciones de Suelos y Aguas de Uso Agropecuario. (Convenio Ministerio de Asuntos Agrarios - Universidad Nacional de La Plata). - calle 3 N° 584 - La Plata 1.900 - Buenos Aires - República Argentina

Presented at the first meeting of IUFRO Working Party S2.07-09
(Diseases and Insects in Forest Nurseries), Victoria, British Columbia, Canada, August 22-30, 1990.

Abstract

This paper reviews the fertilization practices that are used to grow eucalyptus seedlings in Buenos Aires province. Special emphasis is placed on nitrogen and phosphorus fertilization and soil fumigation and how they relate to seedling growth and diseases.

Resume

Dans la présente communication, on passe en revue les pratiques de fertilisation utilisées pour faire pousser les semis d'eucalyptus dans la province de Buenos Aires. L'accent porte principalement sur la fertilisation avec de l'azote et du phosphore et sur la fumigation du sol; on décrit les relations qui existent entre ces traitements d'une part et la croissance des semis et les maladies d'autre part.

Introduction

Successful establishment of commercial forests needs seedlings of the highest quality. The standard method of growing *Eucalyptus* species in the province of Buenos Aires is sowing in nursery beds and pricking out in plastic containers. Eucalypt seeds are usually very small and so have low nutrient reserves in the critical few days after germination. Most authors agree that the purpose of a nursery is to create an environment which is a compromise between the conditions under which the species is known to grow best and those under which it will have to grow when planted in the field. The nursery provides the growing medium required to provide "healthy" hardy and uniform transplants (Waite Research Institute 1972).

The main purpose of this paper is to analyse the current status of the knowledge of *Eucalyptus* spp. nursery practice in our province and to indicate the needs for further research.

Soil type

The supply of soil for the nursery beds and for filling containers is one of the most important factors in seedling production. Most soils of the fertile regions of this province are typical Argiudolls. They are fairly high in organic matter, moderately acid, have a high base status and contain little available phosphorus. This local soil is the one used as substratum in nurseries. Since the volume of topsoil (A horizon) is limited in the

nursery, when this is consumed, subsurface Bt horizon, with high content of clay and lower levels of nutrients is commonly used in containers. Nursery soil should not contain excessive amounts of organic matter. It must not compact into a clod nor must it be so sandy as to lose moisture quickly or disintegrate from around the roots when the transplant is handled. (Waite Research Institute 1972).

Diseases

As pointed out by Cellerino (1987), selecting a well-drained medium for seedling propagation and sowing seeds after temperature of the medium is warm enough to enhance germination helps reduce damping-off. Damping-off is the most common disease problem in nurseries. It is caused by such fungi as *Pythium multimum*, *Fusarium oxysporum*, *Rhizoctonia solani* and *Phytophthora cinnamomi* (Sarasola 1959). Recently, Merlo (personal communication) reported *Alternaria alternata* affecting the early development of the seedlings in relation to temperatures over 27°C and soils with a very high organic matter content.

Foliar diseases such as *Oidium* spp. and *Botrytis cinerea* are sometimes harmful in nurseries. Also, attacks by *Cercospora epicocoides* were reported by the above authors. When warranted, foliage pathogens, can be controlled with appropriate fungicides (captan and benlate).

Soil pathogens can be controlled by fumigation with sterilants such as methyl bromide (Hodges, 1987). This is the standard method used in nurseries in our province to control against weeds, nematodes, insects and pathogenic fungi. The dosage rates commonly used are 504 g per 14 m² (48 hours exposure and 48 hours aeration). Methyl bromide is an extremely toxic gas and it kills a wide range of organisms in the soil including beneficial ones. Donald (1968) found that results of experiments to control damping-off in *Pinus* spp. using methyl bromide and other fumigants were inconclusive and gains were not economically justified.

Fertilization

Inorganic fertilizers for the production of *Eucalyptus* spp. in forest nurseries in the Province of Buenos Aires are not commonly used although their use in many countries has been generally accepted. Barrett (1978) supports the view that the subject of plant nutrition is extremely complicated and that the type and timing of application, raising or lowering of soil pH, risk of fertilizer "burn," and the effect of sterilants have to be considered. It is difficult to obtain adequate soil analyses and bulk density data.

Soil compaction can restrict root development and nutrient uptake, which in turn can frequently reduce plant growth. The excellent studies of Foissner (1989) demonstrate the inhibitory effects on some soil organisms of even slight compaction and the dramatic reduction of life in severely compacted soils. He suggests that such changes probably result from reduced pore space and lower moisture content. Novais (1989) also reported that root growth was strongly reduced as the soil density increased from 1.30 (natural) to 1.70 g per cm³ (compacted). When subsoil is used as the substrate in our nurseries shoot and root growth may be reduced.

With low soils of low N and P content, problems of plant nutrition can occur. Trials to determine suitable levels of P and N for the production of eucalypts were carried out at the nursery of the Ministry of Agriculture. *Eucalyptus camaldulensis* responded well to phosphorous (P) fertilization. Applying fertilizers helps keep plants healthy. Unfortunately such fertilizers are not used regularly. The soils in which plants are pricked out have 1 to 7 ppm available P. Uexkull, cited by Luna Flores (1972), considered that soils for raising seedlings should have P fertilizer added before sowing.

Experiments were also conducted to determine if it was necessary to apply nitrogenous (N) fertilizers before seeds are sown. Addition of N fertilizer is not recommended by Barrett (1978). He suggests that it may promote damping-off fungi or render the seedlings more susceptible to damping-off. N deficiency is

generally indicated by small, chlorotic foliage. Furthermore, reduced growth and insufficient shoot development are typical symptoms of N deficiency (Huttl 1986). Conversely, an over abundance of nitrogen can increase the potential of frost resistance (Friedland cited by Huttl, 1986). Donald (1972) showed that a so-called optimum level of nutrients existed and that plants raised in soils with optimum nutrition grew vigorously in the nursery and survived and grew satisfactorily when field planted.

Studies have been made to determine the appropriate levels of N at the nursery of the School of Agronomy. The nursery soil was analysed for total N and the suitable nutrient for the plants was then estimated. The estimated available nutrient in the soil was supplemented by adding inorganic N fertilizer to bring N levels up to the optimum level. The inorganic fertilizer used was urea (46% N). The amount of urea to be added was then determined. Total N in the nursery soil beds was low. Table 1 shows the chemical composition and soil texture of the two seedbeds where the experiment was made. The amount of N added to the soil before sowing (in a randomized plot with four replications) was: N1 : 5 g/m², N2 : 10 g/m² and T : 0 g/m² (control). The soil had been previously treated with methyl bromide. The methyl bromide dosage rates used were: seedbed 1 (825 g/14 m²); seedbed 2 (504 g/14 m²).

The results showed that (i) seedlings raised in fertilized plots (N1 and N2) in seedbed 1 did not germinate, (ii) seedlings grown with the N1 treatment in seedbed usually germinated well, and (iii) seedlings in the control plots grew normally. This suggested that methyl bromide adversely affected nitrifying bacteria which decompose urea to nitrate (NO₃⁻):

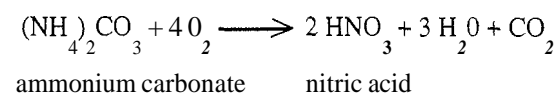
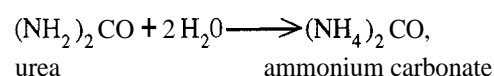

Nitrifying bacteria are required to oxidize ammonium carbonate to nitrate. This process which involves the conversion of urea to ammonium carbonate, then to nitric acid and then to nitrate requires 3 to 4 weeks (Tisdale 1970).

From these observations we suspected that the eucalypt seeds which we sowed were harmed by prolonged concentration of ammonia (NH₃) in the soil. Williams and Hanks, cited by Barrett (1978), reported that "as fumigants tend to inhibit nitrifying bacteria and phosphorous absorption, trouble may be experienced in

achieving a satisfactory level of fertility.” If nitrification is inhibited, nitrites may accumulate in the soil and reach phytotoxic levels. Nitrifying bacteria are rather sensitive to factors such as aeration, temperature, humidity, the C/N ratio and levels of Ca and other nutrients. Also, there is no nitrification in winter and urea is absorbed as such (Malavolta 1987).

A biological experiment was also carried out on the aforementioned nursery soils. Samples were taken 3 months after treatment from the topsoil (0-10 cm) of both treated and untreated seedbeds. Data were collected (under laboratory conditions) to determine the NH_4^+ and NO_2^- in the nursery soils treated with methyl bromide. There was NO_3^- in the untreated soil. The number of microbe species in the treated soil was much less than in the untreated soil. This suggests that microorganisms necessary to oxidize NO_2^- to NO_3^- were affected by partial sterilization. Problems caused by soil sterilization have been reported by several authors and it is obvious that much more research is needed in this area. Barnes, cited by Barrett (1978), found indications of mycorrhizal problems in treated soils. There is a great deal of interest today in mycorrhizal fungi which form symbiotic relationships that are beneficial to plants. Most eucalypt tree species form endomycorrhizae, depending on them for normal growth. Cordell *et al.* (1987) showed that seedlings grow poorly and do not respond to increased fertilization in nurseries where cultural practices such as soil fumigation have reduced ectomycorrhizal fungus populations.

Further experiments were initiated to clarify the connection between the dosage rates of methyl bromide used and the amount of urea added to the soil. One nursery bed was sterilized with 564 g/14 m² and another was left untreated (control). The soils were fertilized with urea at 5, 7.5, 10 and 0 g/m² (control). The results showed that (i) plants grown in sterilized soil at the 5 g N/m² level grew vigorously, (ii) germination failed to

occur in the 10 g N/m² treatment, and (iii) seedlings raised in the untreated soil with nitrogen at 5, 7.5 and 10 g/m² germinated well. However, there were fewer plants in the 5 g N/m² treated soil. These results suggest the effects of methyl bromide. The dosage rates used in this experiment were between those used in the nursery beds in the previous trial. Methyl bromide soil sterilization increased germination and seedling height growth. Whether this is a result of controlling insects and pathogenic fungi is unknown. The nursery failures that occurred in the experiment with the higher dosage of sterilants have been shown to be the result of phytotoxicity.

Russell and Hutchinson, cited by Foissner (1989), suggested that “sick” soils owed their infertility to low bacterial activity and that bacterial activity was inhibited by some factor which was removed by partial sterilization. They thought that this inhibitory factor was the protozoan fauna.

Foissner (1989) highlights the potential importance of soil protozoa as bioindicators. The contribution of protozoa to the productivity of soils around the world suggests that changes occurring in the community structure of protozoa in stressed areas should not be overlooked. The excellent review of this author suggests the importance of protozoa as a potential means of controlling soil-borne diseases. Also, Cordell *et al.* (1987) emphasized and that any estimation of seedling quality that excludes quantitative and qualitative mycorrhizal assessments are incomplete and unrealistic.

Acknowledgements

The helpful comments of Dra Perla Imbellone (National University of La Plata) are acknowledged. Particular thanks are due to Ing. Agr. Jorge Gimenez (National University of La Plata) who constructively criticized the paper.

Table 1. Nursery soil data (school of agronomy)

Seedbed	Available P (ppm)	Total N (%)	O M (%)	pH (paste)	Field capacity (%)	Sand (%)	Silt (%)	Clay (%)
1	24	0.189	4.3	6.4	24.8	38.2	42	19.8
2	15	0.168	3.8	5.6	26.0	36.2	40	23.8

References

- Allen, H.L. 1987. Forest fertilizers, *J. For.* 85(2).
- Alves Ferreira, F. 1986. Enfermedades do eucalipto. Informe Agropecuario N° 141, Belo Horizonte.
- Areso, E. 1961. Técnicas inadecuadas en la producción de plantas forestales y sus consecuencias en la Forestación, Dirección de Investig. Ftales. Bs. As.
- Bamett, R.L. 1978. Forest nursery practice for the Wattle regions in the Republic of South Africa. Waite Research Institute.
- Campinhos Jr. E.; Ikemori, Y.K.; Martins, F.C.G. 1983. Determination of the most adequate growth medium to the production of seedlings of *Eucalyptus* and *Pinus* in rigid plastic containers. Aracruz Florestal S.A. Brasil.
- Cozzo, D. 1976. Tecnología de la Forestación en Argentina y América Latina. Edit. Hemisferio Sur. Bs. As.
- Cordell, C.E.; Owen, J.H.; Marx, D.H. 1987. Mycorrhizal nursery management for improved seedling quality and field performance. Pages 105-115 in Meeting the Challenge of the nineties: Proceedings of a meeting of the Intermountain Forest Nursery Association. Oklahoma City, August 10-14, 1987. Rocky Mtn. For. Range Exp. Stn., USDA For. Serv., Gen. Tech. Rep. RM - 51, Fort Collins, Colorado.
- Dominguez Vivancos, A. 1984. Tratado de Fertilización. Ediciones Mundi.
- Donald, D.G.M. 1965. A study of the history, practice and economics of forest nurseries in South Africa. *Annales Univ. Stellenbosch.* Vol. 40. Serie N° 1.
- Donald, D.G.M. 1972. The use of inorganic fertilizers for the production of pines in the forest nursery. *South African Journal* N° 81.
- Fao, 1981. El eucalipto en la Repoblación Forestal. Roma.
- Foissner, 1989. Soil protozoa. Institute of Zoology, Univ. of Salzburg. Austria.
- Foot Guimaraes, R. 1959. Adubação em "Torrao Paulista" de *Eucalyptus saligna*. Boletín N° 12. Servicio Forestal Brasil.
- Herbert, M.A. 1987. Fertilizer and site interactions on the growth and foliar levels of *Eucalyptus grandis*. Canberra, Australia.
- Huttl, R.F. 1986. Forest fertilization. Greenhill house, London.
- Kamaruzaman, J. 1988. Height and diameter growth of *Acacia* seedlings in compacted soils. Fac. of Forestry. Paper presented at the International Symposium on Forest Tree Physiology. Nancy, France, Sept. 25-30, 1988.
- Luna Flores, C.D. 1972. Efecto del uso de fertilizantes en el crecimiento inicial de *Eucalyptus botryoides*. Actas del VII Congreso Forestal Mundial. Volumen II.
- Malavolta, E. 1975. Deficiencias minerales en Fitopatología. Curso moderno. Tomo IV. Sarasola A.A. Editorial Hemisferio Sur. Bs. As.
- Malavolta, E. 1987. Manual de Calagem e Adubação das Principais culturas. Editorial Agronómica Ceres. Ltda. San Pablo.
- Navarro de Andrade, E. 1954. Instrucciones para el cultivo del eucalipto. Publicación miscelánea N° 384. Ministerio de Agricultura y Ganadería. Bs. As.
- Novais, R.F. 1986. Effect of soil compaction, levels of P and water on the growth of *Eucalyptus* and forms of P in the plants. Soil Science Department. Federal Univ. Vicosa. M.G. Brasil.
- Sarasola, A.; de Sarasola, M.A.R. 1959. Enfermedades del eucalipto en la Argentina. IDIA.
- Simoes, J.W. 1987. Problemática de la Producción de Mudas Forestales. Serie técnica N° 13. IPEF. Piracicaba. Brasil.
- Teuscher, H.; Adler, R. 1965. El suelo y su fertilidad. Compañía Editorial Continental. S.A. Mexico.
- Tisdale, S.L. y W.L., 1970. Fertilidad de los Suelos y Fertilizantes. Montaner y Simón. S.A. Barcelona.
- Wattle Research Institute. 1972. Handbook on Eucalypt growing.

Biology of a white fir aphid nursery pest: biotype or new species

JOHN D. STEIN

Research Entomologist, Pacific Southwest Research Station
Forest Service, U.S. Department of Agriculture
Berkeley, California 94701 USA

Presented at the first meeting of IUFRO Working Party S2.07-09
(Diseases and Insects in Forest Nurseries), Victoria, British Columbia, Canada, August 22-30, 1990.

Abstract

Severe damage from a woolly fir aphid was reported on white fir (*Abies concolor* [Gord. & Glend.] Lind.) and bristlecone fir (*A. bracteata* D. Don) nursery seedlings at Placerville, California in 1987. This aphid was tentatively identified as *Mindarus victoria* Essig (Dr. D. Voegtlin, personal comm. to Dr. L. E. Ehler). This is the first known report of *M. victoria* in California and the first time this species, which has four distinct forms, has been reported on white fir or bristlecone fir nursery stock. The first form is the fundatrix (stem mother), which hatches from overwintering eggs and eventually gives birth to live young (viviparous) without mating (parthenogenesis). The nymph feeds on developing needles and matures into fundatrigenia (viviparous female). This form produces several generations of both apterous (wingless) and alate (winged) aphids from May to August. A few of these parthenogenetic individuals develop into alate sexupara. The sexupara matures in July and August to produce the fourth form or sexuales (males and sexual females). The female mates and lays 1 or 2 overwintering eggs. In the nursery environment, the life cycle of this aphid apparently extends 30 to 60 days beyond the seasonal life cycle of the forms collected by E.O. Essig from Victoria, British Columbia in 1939. This difference in biology may indicate a possible biotype or new species for the Sierra Nevada in central California.

Resume

De graves dégâts causés par un puceron lanigère à des semis de sapin concolore (*Abies concolor* [Gord. & Glend.] Lindl.) et de sapin bractéifère (*Abies bracteata* D. Don) ont été signalés dans des pépinières de Placerville, en Californie, en 1987. Ce puceron a été provisoirement identifié comme étant *Mindarus victoria* Essig (Dr. D. Voegtlin, comm. pers. au Dr. L.E. Ehler). C'est la première fois que *M. victoria* est signalé en Californie et que la présence de cette espèce qui comporte 4 formes distinctes est rapportée sur des semis de sapin concolore et de sapin bractéifère poussant en pépinière. La première forme est celle de la fondatrice (femelle d'origine) qui éclôt des oeufs d'hiver et finit par donner naissance par parthénogénèse (sans accouplement) à des petits vivants. Au stade nymphal, les individus se nourrissent des jeunes aiguilles en cours de développement et deviennent fondatrigenes (femelle vivipare) à maturité. Cette forme produit plusieurs générations d'aphides aptères (sans aile) et ailés de mai à août. Quelques-uns de ces individus parthogénétiques se transforment en sexupares ailés. Ces derniers atteignent la maturité en juillet et août et produisent les deux sexes (individus mâles et femelles), la quatrième et dernière forme. Les femelles s'accouplent et pondent 1 ou 2 oeufs d'hiver. En pépinière, le cycle vital de ce puceron dépasserait de 30 à 60 jours celui des formes recueillies par E.O. Essig de Victoria, en Colombie-Britannique, en 1939. Cette différence au niveau du cycle biologique pourrait révéler la présence d'un biotype particulier ou d'une nouvelle espèce dans la Sierra Nevada, dans le centre de la Californie.

Experience with insecticides for control of *Mindarus victoria*: a new aphid pest of white fir nursery seedlings

JOHN D. STEIN AND MICHAEL I. HAVERTY
*Pacific Southwest Research Station
Forest Service, U.S. Department of Agriculture
Berkeley, California 94701 USA*

*Presented at the first meeting of IUFRO Working Party S2.07-09
(Diseases and Insects in Forest Nurseries), Victoria, British Columbia, Canada, August 22-30, 1990.*

Abstract

Damage by the aphid *Mindarus victoria* Essig was first reported in white fir (*Abies concolor* [Gord. & Glend.] Lindl.) nursery beds at Placerville, California, in 1987. A total of 11 different insecticide formulations were tested for control of this aphid. One early application of acephate, chlorpyrifos, diazinon, dimethoate and fluvalinate significantly reduced aphid infestations for at least 73 days; a second application of each insecticide significantly reduced aphid populations for the entire season in 1988. One remedial application of dimethoate, esfenvalerate, cyfluthrin and fluvalinate significantly reduced aphid populations in 1989. Carbaryl, azadirachtin, and soap were apparently not effective against this aphid in the nursery environment. Two applications of acephate had a negative effect upon seedlings by causing a significant reduction in height growth.

Resume

Les dommages causts par le puceron *Mindarus victoria* Essig ont été signalés pour la première fois dans des lits de semis de sapin concolore (*Abies concolor* [Gord. & Glend.] Lindl.) à Placerville, Californie, en 1987. 11 préparations insecticides différentes ont été testées pour la lutte contre ce puceron. Une application précoce d'acéphate, de chlorpyrifos, de diazinon, de diméthoate et de fluvalinate a réduit considérablement les infestations par ce puceron pendant au moins 73 jours; une deuxième application de chacun de ces insecticides a réduit de la même manière la population pendant toute la saison en 1988. Une application après infestation de diméthoate, d'esfenvalérate, de cyfluthrine et de fluvalinate a beaucoup réduit la population en 1989. Le carbaryl, l'azadirachtine et le savon n'étaient apparemment pas efficaces contre ce puceron dans l'environnement de la pépinière. Une double application d'acéphate a eu un effet négatif sur les semis : on a observé une réduction importante de la croissance en hauteur.

Introduction

In 1987, a woolly fir aphid (*Mindarus* sp.) was first noticed in the USDA Forest Service Nursery at Placerville, California, in the central Sierra Nevada. Initial infestations were on 2-0 seedlings of white fir (*Abies concolor* [Gord. & Glend.] Lindl.), and bristlecone fir (*A. bracteata* D. Don). This particular aphid was initially identified in 1987 as the balsam twig aphid (*Mindarus abietinus* Koch.).

The environment in the Placerville Nursery apparently has extended the life cycle of this aphid from that reported in the literature by at least 30 to 60 days (Ferrell 1989; Nettleton and Hain 1982). Also, the winged or alate stage migrates into 2-0 white fir beds in May and into the 1-0 white fir beds in early August. Due to this atypical life cycle for the balsam twig aphid, several collections from the nursery and white fir plantations

were submitted to Dr. David Voegtlin, Illinois Natural History Survey, for identification. When compared with a description published by Essig (1939), this material was tentatively identified as *Mindarus victoria* Essig (Dr. L. Ehler, personal communication). This is the first known report of *M. victoria* infesting nursery stock, and the first time this species has been reported on bristlecone fir.

In 1987, damage to 1-0 stock resulted in curled needles and an enlarged, club-like apex of current growth, in conjunction with the formation of an abnormal bud rosette. On 2-0 seedlings, *M. victoria* feeds on elongating shoots causing discoloration and curling of new needles and distortion of terminal growth. Retarded bud formation and tip dieback could result in increased mortality or a decrease in root growth capacity during the first year of outplanting.

Effective chemical control has been reported for *Mindarus* in *Abies* Christmas tree plantations in Maine and North Carolina (Bradbury and Osgood 1986; Nettleton and Hain 1982; Osgood 1977; Saunders 1969). However, multiple applications of malathion in 1987, did not appear to reduce damage or control infestations of *M. victoria*, in either 1-0 or 2-0 white fir nursery beds at the Placerville Nursery. In 1987, the cull rate for 2-0 white fir seedlings was 47%. In the past, normal cull rates for white fir grown in this nursery usually range between 20 and 30%. Therefore, we assume that *M. victoria* was probably responsible for an increase in the cull rate and the rejection of 227 000 to 360 000 white fir seedlings.

In 1988 and 1989, we evaluated a total of 11 insecticides for control of *M. victoria* infesting 2-0 white fir seedlings to determine (a) the minimum number of applications of each insecticide needed to adequately reduce initial populations of *M. victoria*, (b) which insecticides were effective on midseason aphid colonies, and (c) phytotoxic effects of each insecticide to the buds and new foliage.

Materials and methods

Study location

This study was conducted at the Placerville Nursery (administered by the Eldorado National Forest), which is located 4.8 km north of Placerville, California. The nursery is surrounded by a mosaic of natural forest, fruit orchards, and Christmas tree plantations.

Many (20% or more) of the white fir seedlings processed in December 1987 were severely damaged by *M. victoria*. Inspection of 1-0 seed beds on 17 February 1988 indicated that a significant portion of 1.6 ha (4.5a) of white fir seedlings (1.8 million) was infested with *M. victoria*, and had sustained damage during the first growing season.

Experimental design

The experiment was conducted as a randomized split-plot design in 1988 and a completely randomized design in 1989. In 1988, one of six treatments (five insecticides and an untreated check) was randomly assigned to each white fir bed. Once the treatments had been assigned, each white fir bed (replicate) was subdivided into three 3x1 m plots, and randomly assigned a number from 1 to 3. The number of each plot determined the number of applications of a specific insecticide. Each of the 15 insecticide treatments (five insecticides times three applications) had 11 replicates, and untreated controls had 30 replicates. In 1989, white fir beds were again subdivided into three 3x1 m plots and numbered consecutively. Each of the nine treatments (eight insecticides and an untreated check) were randomly assigned to the plots. Each treatment was replicated 10 times.

The 11 insecticides and dilutions tested in 1988 and 1989 are listed in Table 1. Insecticides in both years were applied using a pressurized garden sprayer with a single hand-held nozzle. The application rate for each chemical was approximately 153 l/ha (100 gal/a).

Table 1. Insecticides and application rates for tests of efficacy against *Mindarus victoria* infesting 2-0 white fir at the Placerville Nursery

Common name	Formulation	Application rate (kg ai/ha)	Year	
			1988	1989
Acephate	Orthene 75S (75% SC)	0.56	X	
Chlorpyrifos	Dursban 4E (44.4% EC)	0.56a	X	
Diazinon	Diazinon (25% EC)	0.56	X	
Dimethoate	Cygon (23.4% EC)	1.12	X	X
Carbaryl	Sevimol (40% SC)	1.12		X
Carbaryl	Sevin SL (41.2% SC)	1.12		X
Esfenvalerate	Asana XL (8.4% EC)	0.06		X
Cyfluthrin	Tempo 2W (20% WP)	0.06		X
Fluvalinate	Mavrik 2E (25% EC)	0.06	X	X
Azadirachtin	Margosan-0 (0.3% EC)	0.02		X
Soap	Safer Soap (49%)	6.10		X

^a First application of chlorpyrifos was at the rate of 0.56 kg ai/ha, as reported in Nettleton and Hain (1982). The second application was at the labeled rate of 0.28 kg ai/ha.

The white fir beds were examined before the first insecticide application and every week thereafter through September. At each examination, four sample points within each plot were located by a random coordinate system. At each sample point, five seedlings were examined and the proportion infested by *M. victoria* was recorded.

In 1988, insecticides were first applied on 28 March, to precede terminal bud flush and to coincide with the first appearance of aphids in the spring. When the aphid infestation rate in the insecticide-treated plots increased to a threshold of 10%, a second insecticide spray was applied (27 May) to the remaining two-thirds of each treatment plot. After the second treatment, *M. victoria* infestation rates were again monitored to determine whether a third spray would be applied to the remaining one-third of the treatment beds. A natural decline of the *M. victoria* population in late June eliminated the need for a third spray. In 1989, insecticides were applied on 11 July to seedlings with established aphid colonies. A second application of azadirachtin and soap occurred on 18 July.

Growth after treatment

Seedlings were examined in both years for phytotoxic effects to the foliage for two consecutive weeks after each insecticide application. The percentage of discolored needles on both infested and uninfested seedlings was visually estimated 7 and 14 days after treatment. In addition to foliage estimates, two sampling points in each treatment were flagged, and 10 seedlings were selected for measurement. Once every 14 days during shoot elongation, and in conjunction with aphid sampling, height and caliper were monitored. These measurements were taken from June to October 1988, and from bud break until the end of the growing season in

1989. Height measurements were taken from the cotyledon scar to the tip of the visible stem or the nearest tip of the bud. Seedling diameter was measured directly below the cotyledon scar. In November 1988, four randomly selected sample points were established in each treatment bed, and five seedlings were examined for apical bud damage at each sample point.

Analysis

Although the experiment in 1988 was conducted as a split plot design, single and double treatment applications were analyzed separately due to non-homogeneous variances. Differences among insecticides in the proportion of seedling's infested with *M. victoria*, with apical bud damage and differences in height and diameter were evaluated by analysis of variance for all data in 1988 and 1989. Dunnett's multiple comparison procedure was used to make pairwise comparisons of differences between treatment means and the untreated control, at an experiment-wise alpha level of 0.05 (Dunnett 1955).

Results and discussion

Aphid control

A single application of all the tested insecticides in 1988 (acephate, chlorpyrifos, diazinon, dimethoate, and fluvalinate) significantly reduced the percentage of 2-0 white fir seedlings infested with *M. victoria* from 38 through 73 days after spraying (Table 2). The March spray was applied at anticipated egg hatch. Despite the 29-day lapse between the first spray application and initial aphid migration into the 2-0 white fir beds, insecticide residues on the foliage apparently were sufficient to decrease the survival of arriving aphids and reduce the number of resulting *M. victoria* colonies.

Table 2. Percentage of 2-0 white fir seedlings infested with *Mindarus victoria* after a single application of insecticide on 28 March 1988

Treatment	N	Prespray	16 days	38 days	51 days	59 days	73 days
Acephate	11	0.0	0.0	0.0	7.7* ^a	11.4"	9.1*
Chlorpyrifos	11	0.0	0.0	2.3	8.2*	11.4*	4.1*
Diazinon	11	0.0	0.0	0.0	6.8*	12.7"	9.1"
Dimethoate	11	0.0	0.0	0.0	6.4	6.4*	9.1"
Fluvalinate	11	0.0	0.0	0.0	8.6*	8.6"	10.9*
Untreated	30	0.0	0.0	5.0	35.0	39.0	30.5
LSD ^b				5.1	21.6	22.8	14.8

^a Treatments with an asterisk differ significantly from the control at the 5% level (Dunnett 1955).

^b Least significant difference value.

Although all the insecticides we tested were effective in 1988, the application rates of acephate and chlorpyrifos, at 0.56 kg active ingredient per hectare (0.5 lbs ai/a), were twice the recommended labeled rates. Based upon results from a concurrent operational effort at the Placerville Nursery, acephate appeared to be ineffective when applied twice as an operational spray in 1988 at the recommended rate of 0.28 kg ai/ha (0.25 lbs ai/a) during the growing season (B. Scheuner, personal communication). Our success at significantly reducing *Mindarus* infestation rates with acephate at 0.56 kg ai/ha suggests an increase in the recommended application rate will be necessary.

The *M. victoria* population apparently recovered 51 days after the initial insecticide application (Table 2). A second spray was applied on 27 May as the infestation rate in treated beds reached an arbitrary threshold established at 10%. All five insecticide treatments immediately caused a significant reduction in aphid-infested seedlings for 27 days after spraying (Table 3). The three insecticides without systemic properties (fluvalinate, chlorpyrifos, and diazinon) caused nearly a threefold reduction in the percentage of infested seedlings. The two systemic insecticides (acephate and dimethoate) reduced aphid populations to zero or close to zero. Chlorpyrifos was efficacious for the second spray treatment at the labeled rate of 0.28 kg ai/ha. This was half the effective rate used by Nettleton and Hain (1982) in Christmas tree plantations.

By 6 July, *M. victoria* populations naturally declined. Therefore, the third insecticide application was not necessary after the first week of July.

One half of the insecticides tested on established aphid colonies in 1989 were effective. Esfenvalerate, cyfluthrin, and fluvalinate significantly reduced in-

festated seedlings for 15 days (Table 4). Dimethoate, with its systemic properties, significantly reduced infested seedlings for at least 22 days. Once again the pyrethroids caused a threefold to fourfold reduction in aphid colonies, whereas the reduction associated with dimethoate approached 100% and the effects lasted longer. Azadirachtin, soap and both formulations of carbaryl were not effective for this aphid in a nursery environment with daily watering.

Host plant effects

The single application of all insecticides in 1988 significantly reduced the percentage of seedlings with dead apical buds at the end of the growing season (Table 5). A second application of any of the five insecticides afforded significant protection of the terminal buds. Apical bud damage did not appear to differ among the single and double spray applications for any of the five insecticides.

Three of the insecticides had a significant effect upon growth of 2-0 white fir seedlings. The first spray in 1988 was applied when lateral buds were open with new foliage less than 2.5 cm in length. Chemicals were purposely applied before terminal bud burst to minimize potential toxic effects on new terminal foliage. The second application in 1988 and the midseason application in 1989 were made when new growth was present on both terminal and lateral branches. None of the treatments applied to new lateral or terminal growth had any apparent impact upon foliage coloration. Seedlings treated with the double application of two of the insecticides significantly affected seedling growth for 12 weeks after spraying (Table 6): acephate caused a 96% reduction in height growth associated with a 196% increase in seedling diameter; and diazinon had a posi-

Table 3. Percentage of 2-0 white fir seedlings infested with *Mindarus victoria* after a second insecticide application on 27 May 1988

Treatment	N	Prespray	6 days	13 days	27 days	41 days
Acephate	11	11.4	0.9* ^a	0.0*	0.5*	0.0
Chlorpyrifos ^b	11	11.4	0.5*	0.0*	4.6*	0.0
Diazinon	11	12.7	0.0*	0.0*	6.8*	0.0
Dimethoate	11	6.4	0.0*	0.0*	0.0*	0.0
Fluvalinate	11	8.6	4.6*	3.6*	5.5*	0.0
Untreated	30	39.0	41.7	30.5	15.0	0.0
LSD ^c			19.7	21.9	7.5	

^a Treatments with an asterisk differ significantly from the control at the 5% level (Dunnett 1955).

^b The second application of chlorpyrifos was at the registered rate of 0.25 lbs active ingredient per acre.

^c Least significant difference value.

Table 4. Percentage (SEM) of 2-0 white fir seedlings infested with *Mindarus victoria* after insecticide application on 11 July, 1989

Treatment	N	Prespray (7/10)	8 days (7/18)	15 days (7/25)	22 days (8/1)	30 days (8/9)
Esfenvalerate	10	21.5	7.5* ^a	15.5*	10.0	23.5
Cyfluthrin	10	21.5	5.0*	15.5*	16.0	21.5
Fluvalinate	10	19.0	6.0*	10.5*	7.5	13.0
Azadirachtin	10	28.5	25.0	29.5	13.0	8.0
Carbaryl	10	30.5	22.0	38.0	19.5	9.0
Carbaryl (SL)	10	34.0	21.5	39.5	23.0	10.0
Dimethoate	10	33.5	1.0*	0.0*	5.5*	9.0
Soap	10	28.5	28.5	36.5	19.0	17.0
Untreated	10	32.5	34.0	45.0	20.0	15.0
LSD ^b		21.1	18.9	18.3	14.0	14.5

^a Azadirachtin and soap were sprayed a second time on 18 July at the 5% level (Dunnnett 1955)

^b Least significant difference value.

tive effect upon white fir growth with a 169% increase indiameter and no significant reduction in height growth. In 1989, six applications of azadirachtin also had a positive effect upon growth with a significant increase of 53% in seedling height (Table 7).

Conclusions

One (spring) or two (spring and summer) applications of acephate, chlorpyrifos, diazinon, dimethoate, and fluvalinate insecticides significantly reduced the percentage of aphid-infested 2-0 white fir seedlings. Established aphid colonies were also significantly reduced with one summer application of either dimethoate, esfenvalerate, cyfluthrin, or fluvalinate. With the combination of two spray applications each insecticide appeared to extend the period of reduced infestation until the time when *M. victoria* populations declined naturally. The second chlorpyrifos spray, at the labeled rate of 0.28 kg ai/ha, was efficacious even when reduced to half the effective application rate for a similar aphid species in Christmas tree plantations (Nettleton and Hain 1982; Osgood 1977).

If a viable terminal bud is important to seedling survival in plantations, a single spray application early in the aphid infestation apparently will significantly increase live apical buds on nursery stock destined for spring planting, and there is no particular advantage to spraying a second time.

Phytotoxicity was not apparent with the application of chlorpyrifos, diazinon, dimethoate, esfenvalerate, cyfluthrin, and fluvalinate in 1988 or 1989. Therefore,

we believe that an early season spray of any of these six insecticides could be applied after the appearance of terminal shoot growth. This would allow a management program to better assess *M. victoria* infestation potential and manipulate spray schedules to correspond with aphid biology and existing cultural practices within the nursery. We also believe that with a spray application after the appearance of the fundatrix stage of this aphid in late spring, the window of chemical effectiveness would occur during the aphid population increase and may eliminate the need for repeated applications during the same growing season.

Acknowledgments

We would like to thank Dr. John Neisess, Forest Pest Management and Dr. Michael Srago, Timber Resource Planning and Silviculture, U.S. Forest Service, Pacific Southwest Region for providing additional funding needed for this project. We express our gratitude to William Scheuner and his staff for their cooperation despite the disruption in their normal work routine. We also thank Carline Trummer for her dedication and hard work during the two years of this project.

Table 5. Percentage of 2-0 white fir seedlings with dead terminal buds previously infested with *Mindarus victoria*. November 1988

Treatment	Insecticide applications	
	Single	Double
Acephate	5.9* ^a	6.4*
Chlorpyrifos	6.8"	5.5"
Diazinon	12.7*	7.3"
Dimethoate	6.4*	5.0"
Fluvalinate	10.5"	5.0"
Untreated	65.7	65.7
LSD ^b	8.3	7.6

^aTreatments with an asterisk differ significantly from the control at the 1% level (Dunnett 1955).

^bLeast significant difference value.

Table 6. Mean difference in height and diameter growth (June 23 - October 27) of 2-0 white fir seedlings sprayed twice with insecticides at Placerville Nursery, 1988

Treatment	N	Height (cm)	Diameter (mm)
Acephate	2	0.05* ^a	1.06*
Chlorpyrifos	1	0.40	0.38
Diazinon	2	0.95	0.91*
Dimethoate	2	1.00	0.79
Fluvalinate	2	0.30	0.54
Untreated	4	1.30	0.54
LSD ^b	1.10	0.36	

^aTreatments with an asterisk differ significantly from the control at the 5% level (Dunnett 1955).

^bLeast significant difference for chlorpyrifos was 1.42 for height and 0.47 for diameter.

Table 7. Mean difference in height and diameter growth (March 13 - November 17) of 2-0 white fir sprayed with insecticides at the Placerville Nursery, 1989

Treatment	N	Height (cm)	Diameter (mm)
Esfenvalerate	10	6.17	1.55
Cyfluthrin	10	7.40	1.70
Fluvalinate	10	6.28	1.84
Azadirachtin ^a	10	9.42* ^b	1.90
Carbaryl	10	8.03	1.76
Carbaryl (SL)	10	7.88	1.80
Dimethoate	10	8.08	1.94
Soap ^a	10	8.42	1.72
Untreated	10	6.16	1.74
LSD		3.15	0.67

^aAzadirachtin and soap were sprayed six times during the growing season.

^bTreatments with an asterisk are significantly different from control at the 5% level (Dunnett 1955).

Literature Cited

- Bradbury, R.L.; Osgood, E.A. 1986. Chemical control of balsam twig aphid, *Mindarus abietinus* Koch (Homoptera: Aphididae). Maine Agricultural Experiment Station, Technical Bulletin 124. 12p.
- Dunnett, C.W. 1955. A multiple comparisons procedure for comparing several treatments with a control. *Journal of American Statistical Association* 50: 1096-1121.
- Essig, E.O. 1939. A new aphid of the genus *Mindarus* from white fir in British Columbia. *Pan-Pacific Entomologist* 15:105-110.
- Ferrell, G.T. 1989. Differential susceptibility of white fir provenances to balsam twig aphid. USDA Forest Service, Pacific Southwest Research Station, Res. Note PSW-403. 4 p.
- Nettleton, W.A.; Hain, F.P. 1982. The life history, foliage damage, and control of the balsam twig aphid, *Mindarus abietinus* (Homoptera: Aphididae), in Fraser fir Christmas tree plantations of western North Carolina. *Canadian Entomologist* 114:155-165.
- Osgood, E.A. 1977. Chemical control of the balsam gall midge and the balsam twig aphid in Maine. *American Christmas tree Journal* 21:18-19.
- Saunders, J.L. 1969. Occurrence and control of the balsam twig aphid on *Abies grandis* and *A. concolor*. *Journal of Economic Entomology* 62: 1106-1109.

Influence of inoculation conditions on severity of disease caused by *Pestalotiopsis glandicola* on *Chamaecyparis obtusa* seedlings

YASUO SUTO

Shimane Prefecture Forest Research Centre
Shinji-cho, Yatsuka-gun, Shimane 699-04, Japan

Presented at the first meeting of IUFRO Working Party S2.07-09
(Diseases and Insects in Forest Nurseries), Victoria, British Columbia, Canada, August 22-30, 1990.

Abstract

Two-year-old *Chamaecyparis obtusa* seedlings were inoculated with *Pestalotiopsis glandicola* under a variety of experimental conditions. Seedlings wounded artificially were seriously affected, while the unwounded seedlings remained healthy. A long moist post-inoculation period did not enhance infection. Disease severity decreased from severe to slight on seedlings inoculated immediately after wounding, and 3, 7, 14 or 21 days later. Seedlings inoculated in July or August were severely affected while inoculations in June or September, or May or October resulted in slight to almost no disease. Laboratory inoculations showed that the shoots collected in July, August, and September were susceptible, and that temperatures of 20 to 30°C favored disease development. These results corroborate field observations that the disease occurs on seedlings with fresh wounds during the summer.

Résumé

Cette étude consistait à inoculer, dans diverses conditions expérimentales, *Pestalotiopsis glandicola* à des semis de *Chamaecyparis obtusa* âgés de deux ans. Les semis lésés artificiellement ont montré des signes pathologiques graves tandis que les semis non lésés sont demeurés sains. La soumission des semis à une période postinoculatoire longue et humide n'a pas aggravé l'infection. Le degré de gravité de la maladie décroissait selon que les semis avaient été inoculés immédiatement après la lésion ou 3, 7, 14 ou 21 jours plus tard. Les semis inoculés en juillet ou en août ont révélé des signes pathologiques graves tandis que ceux inoculés en juin ou en septembre ou encore en mai ou en octobre n'ont affiché que peu ou pas de signes pathologiques. Les inoculations en laboratoire ont indiqué que les pousses récoltées en juillet, août et septembre étaient vulnérables et que la maladie se développait plus facilement à des températures se situant entre 20 °C et 30 °C. Ces résultats confirment les observations *in situ* voulant que la maladie survienne l'été sur des jeunes plants fraîchement lésés.

Introduction

Although *Pestalotia* needle blight occurs on various conifers in nurseries, it is most severe on *Chamaecyparis obtusa* (Sieb. & Zucc.) Endl. seedlings. Recently, the importance of the pathogen has increased due to the increased production of *Chamaecyparis* seedlings. To determine the effect of environmental factors on *Pestalotia* infection of *Chamaecyparis* seedlings, inoculation tests were made in 1986-1988 at Shimane Prefecture (Japan) using a variety of experimental conditions.

Materials and methods

Field experiments

A single conidiospore isolate of *Pestalotiopsis glandicola* (Castagne) Steyaert was used in the experiments. Conidia for inoculation were obtained by growing the fungus on potato-sucrose agar under continuous

irradiation from a black-light fluorescent lamp. The spore suspension (8x10⁴ conidia/mL), with Tween 20 (polyoxyethylene sorbitan monolaurate) as a spreader, was sprayed onto seedlings. Control (check) seedlings were sprayed with sterile distilled water.

Inoculations were made on 2-year-old potted *C. obtusa* seedlings. There were 15 inoculated seedlings and five control seedlings in each treatment. In most tests seedlings were wounded by rubbing the needles and twigs with sandpaper immediately before inoculation. After treatment, inoculated and control seedlings were usually enclosed in polyethylene bags for 2 days.

Inoculations were made in either late July or early August, and the seedlings were examined 15 days after inoculation. Disease severity for each seedling was rated as follows: 0 = no disease, 0.5 = five lesions or less, 1 = 6 to 10 lesions, 2 = 11 to 20 lesions, 3 = 21 to 30 lesions, 4 = over 31 lesions. A severity infection index

for each treatment was then calculated according to the formula:

$$\frac{On_0 + 0.5n_{0.5} + 1n_1 + 2n_2 + 3n_3 + 4n_4}{N}$$

Where N = the total number of seedlings of each treatment and $n_0, n_{0.5}, \dots, n_4$ are the number of seedlings in each index.

Laboratory experiments

To determine if the month of inoculation affected disease development, shoots (6 cm in length) were collected from 2-year-old *Chamaecyparis* seedlings each month from May to October, 1987. They were rubbed with sandpaper, and dipped into a suspension of *P. glandicola* conidia. Each shoot was then placed in a petri-dish with moist filter paper and cotton and the dishes incubated at 15, 20, 25, 30, or 35°C.

Ten shoots were used for each treatment and 10 days after inoculation disease severity was rated as follows: - = no disease, + = one-third of the shoot affected, ++ = one-half of the shoot affected, and +++ = two-thirds of shoot affected. Average disease severity of each treatment was then calculated.

Results

Influence of wounding on disease development

Seedlings were wounded immediately before inoculation or left unwounded. They were kept moist for different periods after inoculation. Wounded seedlings were seriously affected regardless of the period for which they were kept moist while non-wounded seedlings remained healthy even when kept moist for long periods. No disease was observed on control seedlings (Figure 1). On diseased seedlings yellow spots appeared on needles and twigs 7 days after inoculation. The lesions then developed rapidly and turned brown.

Duration of needle wetness to disease severity

Seedlings were wounded immediately before inoculation, and kept under moist conditions for different periods of time. The inoculations were made in the evening before dew fell.

Seedlings were seriously affected regardless of the period they were kept moist, even in the pots not covered by bags. No disease was observed on control seedlings (Figure 2).

Influence of the time of wounding before inoculation

Seedlings were inoculated at different times after wounding and kept moist for 2 days. Seedlings inoculated immediately after wounding or 3, 7, 14 or 21 days later resulted in disease severity ratings of serious, moderate, and slight, respectively. No disease was observed on the control seedlings (Figure 3).

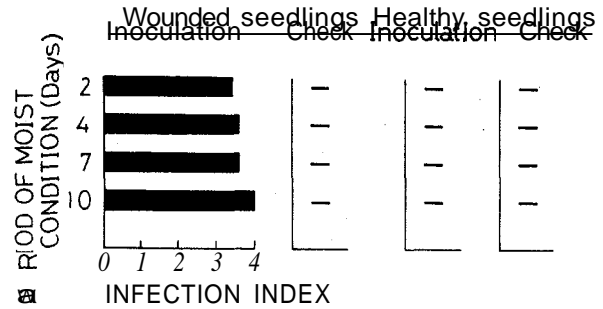

Figure 1. Influence of wounding on disease severity.

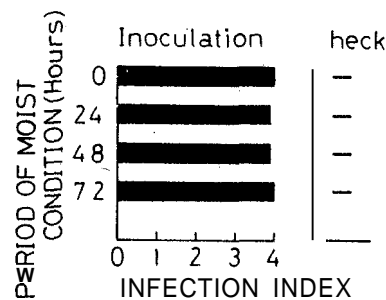

Figure 2. Influence of length of moist period on disease severity.

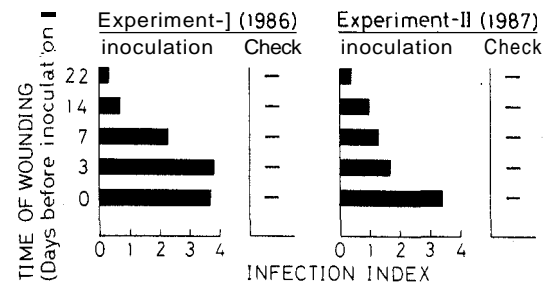

Figure 3. Influence of the time of wounding before inoculation on disease severity.

Influence of month of inoculation

Field experiments. Inoculations were made each month from May to October. Seedlings were inoculated immediately after wounding and kept moist for 2 days.

Disease severity ratings for seedlings inoculated in July or August, June or September, or May or October were serious, slight, and almost nil, respectively. No disease was observed on control seedlings (Figure 4).

Laboratory experiments. The shoots collected in July, August, and September were seriously affected at 20, 25, and 30°C, but much less so at 15 and 35°C. Shoots collected in May, June, and October were only slightly affected or uninfected, regardless of temperature (Table 1).

Discussion

The fungus *Pestalotiopsis* (*Pestalotia*) generally enters host tissue through wounds (Ito 1974). The results of the present study showed that wounding of needles and twigs was necessary for infection of seedlings of *C. obtusa* with *P. glandicola*. Inoculations of *C. obtusa* with *Pestalotia chamaecyparidis* Sawada resulted in disease when seedlings were wounded before inocula-

tion (Ito and Kontani 1954). Field observations indicated that the disease started on seedlings that were wounded by strong wind, damaged in transportation, or injured by insects (Suto 1974, 1984).

A long, moist post-inoculation period was not necessary for disease development. Under moist conditions conidia of the fungus germinate and the germination tubes penetrate host tissue within one night.

In the case of *Pestalotia* vine rot of grape (*Vitis vinifera* L.), caused by *P. menezesiana* Bresadola and Torrend, disease severity decreased as the period from wounding to inoculation increased (Ozoe *et al.* 1967). With *P. glandicola*, disease severity was greatest near wounds on *Chamaecyparis* seedlings, especially when the wound was made just before inoculation. Old wounds healed, which resulted in no disease.

Gray blight of field-grown tea (*Camelia sinensis* (L.) O. Kunze) caused by *Pestalotia longiseta* Spegazzini is most severe during July and August. Also, tea plants are most susceptible when inoculated in August (Hirokawa 1984). The optimum temperature for infection of grape with *P. menezesiana* was 25 and 30°C (Ozoe *et al.* 1967). In the present study disease was most severe when field-grown *Chamaecyparis* seedlings were inoculated during July and August. Laboratory inoculations corroborated these observations and also showed that September-collected shoots were also seriously affected. Inoculation of the shoots showed that temperatures of 20, 25, and 30°C favored the disease. Susceptibility of *Chamaecyparis* seedlings to infection is complex, and depends on the stage of seedling development and temperature.

The results of the present study suggest that fresh wounds during hot summers are major factors contributing to disease outbreaks on *Chamaecyparis* seedlings. Benomyl and thiophanate-methyl, both systemic

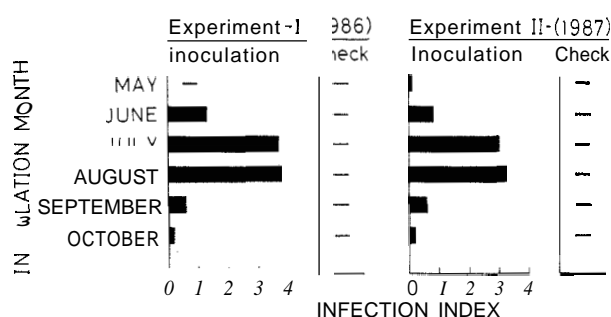

Figure 4. Influence of month of inoculation on disease severity.

Table 1. Influence of month of inoculation and temperature on disease severity (caused by *Pestalotiopsis glandicola*) of *Chamaecyparis obtusa*.

Temperature (°C)	Date of collection and inoculation of shoots					
	May 21	June 20	July 21	Aug. 25	Sept. 14	Oct. 16
15	a		+	+	+	
20		+	++	+++	++	
25	+	+	+++	+++	+++	+
30		+	+++	+++	++	+
35			++	++	+	+

^aDisease severity ratings: - No disease, + one-third of the shoot affected, ++ one-half of the shoot affected, +++ two-thirds of the shoot affected.

fungicides, were quite effective in controlling this disease. Good curative effects were obtained even when the fungicides were applied a few days after inoculation (Suto and Kanamori 1988). The time at which these

fungicides are applied is an important factor in control and suggest that nurserymen should apply the fungicides immediately after seedlings are wounded.

References

- Hirokawa, T. 1984. Occurrence of tea gray blight caused by *Pestalotia longiseta* Speg. and its control. Plant Prot. 38:275-279**.
- Ito, K. 1974. General book of forest pathology III. p. 163-173, Norin-shupan, Tokyo**.
- Ito, K.; Kontani, S. 1954. *Pestalotia* parasitic on seedlings of *Chamaecyparis obtusa* Sieb. et Zucc. Bull. Gov. Exp. Stn. 76: 64-70*.
- Ozoe, S.; Takuda, T.; Kawamoto, R. 1967. Studies on the ecology and control of the *Pestalotia* vine rot of grape. Bull. Shimane Agric. Exp. Stn. 8: 1-122*.
- Suto, Y. 1974. Researches on tree diseases in Shimane Prefecture in 1963-1972. Bull. Shimane Pref. For. Exp. Stn. 24: 1-40**.
- Suto, Y. 1984. Researches on tree diseases in Shimane Prefecture (11) In 1973-1982. Bull. Shimane Pref. For. Res. Cent. 35: 17-26*.
- Suto, Y.; Kanamori, H. 1988. Chemical control of *Pestalotia* needle blight of coniferous seedlings. Bull. Shimane Pref. For. Res. Cent. 39: 13-23*.

* In Japanese with English summary

** Only in Japanese

Species of pine seedlings affected by *Fusarium*

YANG JUN XIU AND ZHAO JUNXIA

Northwestern College of Forestry

Yangling, Shaanxi

The People's Republic of China

Presented at the first meeting of IUFRO Working Party S2.07-09
(Diseases and Insects in Forest Nurseries), Victoria, British Columbia, Canada, August 22-30, 1990.

Abstract

Six species of *Fusarium* (*F. solani*, *F. oxysporum*, *F. moniliforme*, *F. sporotrichioides*, *F. equiseti*, and an unidentified species) were isolated from *Pinus tabulaeformis* seedlings affected by damping-off at the nursery of the Northwestern College of Forestry.

Resume

On a isolé six espèces de *Fusarium* (*F. solani*, *F. oxysporum*, *F. moniliforme*, *F. sporotrichioides*, *F. equiseti* et une espèce non identifiée) à partir de semis de *Pinus tabulaeformis* atteints de la fonte des semis dans la pépinière du Collège de Foresterie du Nord-Ouest.

Introduction

In 1988, *Pinus tabulaeformis* seedlings were grown for tree improvement in the nursery of the Northwestern College of Forestry. Seeds were sown on March 25 and within 6 days some germination was evident. Damping-off losses occurred from April 16 to May 22. During that time, fungi were isolated from affected seedlings five times,

Materials and methods

Seedlings of *Pinus tabulaeformis* affected by damping-off were cultured on Martin's medium and potato sucrose agar (PSA). Seedlings were washed with fresh water and then a small piece of stem tissue in the transition zone between the healthy and diseased tissue was removed. These pieces were sterilized with 70% alcohol for 30 seconds, washed with bacteria-free water several times, and then cut into 0.4-cm pieces which were placed on Martin's medium. Species of *Fusarium* were obtained at all isolation times except the first. Isolates were purified using a 0.5-cm-diameter inoculum plug from the margin of a colony cultured at 25°C on PSA. In 4 days, colony diameter and pigmentation morphology, color and sporulation of the aerial mycelium, morphology and number of the conidia, and presence or absence of chlamydo spores were determined and the fusaria were identified using the taxonomic keys of Booth (1971) and Gerlach and Nirenberg (1982).

Results

Six species of *Fusarium* were isolated from diseased *P. tabulaeformis* seedlings: *Fusarium solani*, *F. oxysporum*, *F. moniliforme*, *F. sporotrichioides*, *F. equiseti*, and an unidentified *Fusarium* species. The characteristics of the fungi follow:

(i) *Fusarium solani* (Mart.) App. et Wollenw. (Figure 1). Colonies reaching 3.5 cm diam. in 4 days at 25°C on PDA, aerial mycelium felt-like, locally floccose, cream to pale grey, bluish-grey pigmentation; phialides monophialidic, long; microconidia single, oval, abundant; macroconidia slightly curved, with a short and blunt apical cell and an indistinctly pedicellate basal cell, predominantly 3-septate; chlamydo spores terminal or intercalary, globose, single.

(ii) *Fusarium oxysporum* Schlecht. (Figure 2). Colonies fast-growing, reaching 4.5 cm diam. in 4 days, at 25°C on potato dextrose agar (PDA), aerial mycelium rather abundant, comparatively delicate, initially whitish, later with a pale violet tinge, pigmentation pale purple greyish; sporulation starting in the aerial mycelium producing microconidia cohering in false heads; macroconidia solitarily scattered in the aerial mycelium; conidiophores single, short, in aerial mycelium; microconidia 0-1-septate, oval, ellipsoid to cylindrical, straight to slightly curved; macroconidia falcate, gradu-

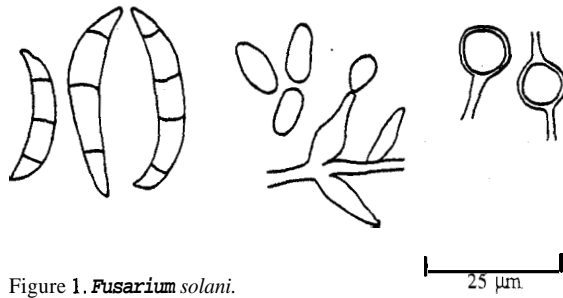

Figure 1. *Fusarium solani*.

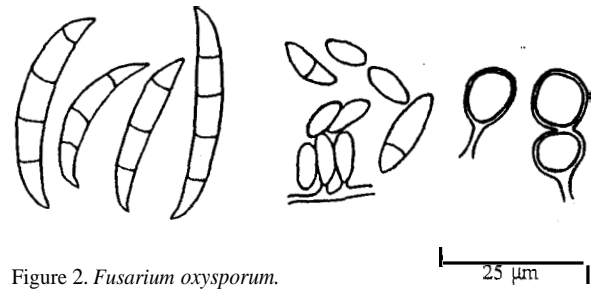

Figure 2. *Fusarium oxysporum*.

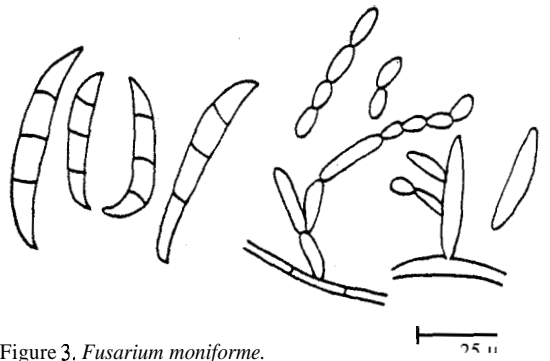

Figure 3. *Fusarium moniforme*.

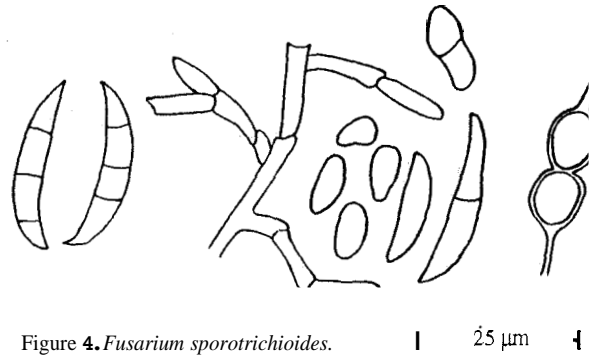

Figure 4. *Fusarium sporotrichioides*.

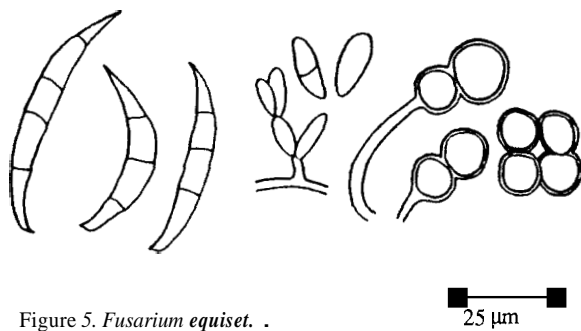

Figure 5. *Fusarium equiseti*.

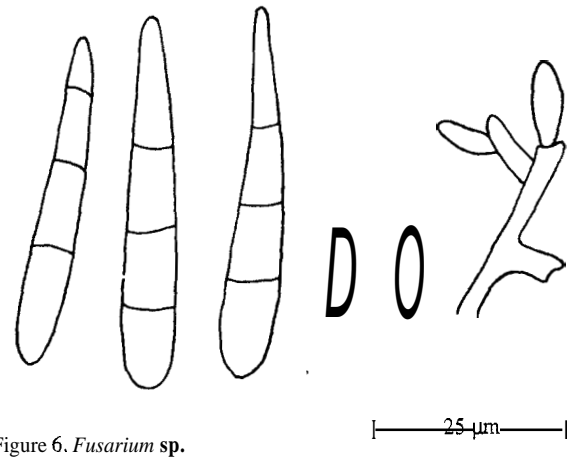

Figure 6. *Fusarium* sp.

ally tapering toward both ends, with a slightly hooked apical cell and usually a rather distinctly pedicellate basal cell, predominantly 3-5-septate, 27-60 x 3-5 μm; chlamydospores abundant, terminal or intercalary, single and in pairs.

(iii) *Fusarium moniforme* Sheld. (Figure 3). Colonies fast growing, reaching 4.6 cm diam. in 4 days at 25°C on PDA; aerial mycelium loosely pannose, vinaceous, pigmentation vinaceous dark; microconidia in long chains; macroconidia very rare; conidiophores strongly and densely branched; phialides monopialidic, almost

cylindric, slender; microconidia clavate, mostly 1-celled, sometimes with 1-septate; macroconidia delicate, falcate, but rather straight, broadest just below the apical cell which is often somewhat curved, foot cell distinct, and 3-4 septate, 34-50 x 3.5-4.7 μm; chlamydospores absent.

(iv) *Fusarium sporotrichioides* Sherb. (Figure 4). Colonies reaching 3.1 cm diam. in 4 days at 25°C on PDA; aerial mycelium abundant, loose lanuginous, at first whitish, bluish brown in 9 days; bluish-brown greyish pigmentation; microconidia pyriform, ovoid,

fusiform to slight falcate, 0-1 septate; macroconidia falcate, widest in the upper third, tapering toward both ends, indistinct foot cell often present, 3-5 septate, 24-50 X 4-5.2 μm ; chlamydospores abundantly formed in hyphae, intercalary, single, or in pairs.

(v) *Fusarium equiset* (Corda) Sacc. (Figure 5). Colonies reaching 4.3 cm diam. in 4 days at 25°C on PDA, aerial mycelium loosely floccose, buff-brown, ochraceous pigmentation; conidiospores arising as phialides in the aerial mycelium; microconidia sparse; macroconidia typically falcate, gradually tapering toward both ends, with a distinctly pedicellate basal cell,

mostly 3-5 septate, 22-60 X 3.5-9 μm ; chlamydospores intercalary, in pairs, frequently in chains or clusters.

(vi) *Fusarium* sp. (Figure 6). Colonies slow-growing, reaching 1.7 cm diam. in 4 days at 25°C on PDA; aerial mycelium rarely, lanuginose, initially whitish, later becoming orange-yellowish, orange-brown pigmentation, and a characteristic orange ring in centre of the colonies, the ring reaching 4 cm diam.; conidiogenous cell conidiospores polyblastic; microconidia sparse; macroconidia obclavate, with a blunt apical cell, mostly 3-septate, 50-72 X 6-8 μm ; chlamydospores absent.

Literature cited

- Booth, C. 1971. The genus *Fusarium*. Commonw. Mycol. Inst. 237 p.
Gerlach, W; and Nirenberg, H. 1982. The genus *Fusarium*. 386 p.
Wei Jingchao. 1979. The handbook for identification of fungi. Pages 609-638, Shanghai China.

Ectomycorrhizal fungi as hyperparasites of *Rhizoctonia solani*

ZHAO ZHI-PENG AND KUO SHIU-CHIEN
Chinese Academy of Forestry, Beijing 100091
The People's Republic of China

Presented at the first meeting of IUFRO Working Party S2.07-09
(Diseases and Insects in Forest Nurseries), Victoria, British Columbia, Canada, August 22-30, 1990.

Abstract

Light microscope observations showed that 8 of 18 ectomycorrhizal fungi were hyperparasites on *Rhizoctonia solani* Kuehn. Hyperparasitism resulted in appressed host growth, coiling around, penetration, or lysis of *R. solani* hyphae. Scanning electron microscopy and X-ray microanalysis studies demonstrated that several elements, including P, S, K and Ca, were transferred from *R. solani* mycelium to that of the three mycorrhizal fungi. Such transfer occurred in all of the host-parasite relationships except lysis.

Resume

Des observations au microscope optique ont montré que 8 champignons ectomycorhiziens sur 18 étaient des hyperparasites de *Rhizoctonia solani* Kuehn. L'hyperparasitisme se traduisait par une croissance apprimée de l'hôte, un enroulement, une pénétration ou la lyse des hyphes de *R. solani*. Des études au microscope électronique à balayage et par micro-analyse aux rayons X ont démontré que plusieurs éléments, dont P, S, K et Ca, étaient transférés du mycélium de *R. solani* à celui des trois champignons mycorhiziens. Un tel transfert se produisait lors de toutes les interactions hôte-parasite, sauf lors de la lyse.

Introduction

Several workers (2, 6, 7) have shown that ectomycorrhizal fungi protect unsterilized roots from attack by parasitic fungi. While much of this work has centered on the mechanisms of resistance, not much is known about parasitism of mycorrhizal fungi on pathogenic fungi. Such a relationship could help explain how ectomycorrhizal fungi impart resistance of seedlings to pathogens.

The purpose of the present study was to use light and electron microscope observations and X-ray microanalysis to obtain a better understanding of the mechanism of hyperparasitism by ectomycorrhizal fungi. Such studies could eventually lead to selection of ectomycorrhizal fungi to provide disease resistance to seedlings or accelerate their growth.

Materials and Methods

The ectomycorrhizal fungi used (Table 1) were collected from Beijing city and Yunnan and Shandong provinces. The pathogen, *Rhizoctonia solani* Kuehn, was isolated from a diseased seedling of *Pinus tabulaeformis* Carr. in Beijing. All fungi were cultured on potato-dextrose-agar (PDA).

Light microscope observations (4, 5, 10)

Three cover slips were placed in PDA to form an inverted trapezoid and 6-mm-diameter inoculum plugs,

cut from cultures of the ectotrophic fungi, were placed on one side of each cover slip. Similar plugs of *R. solani* were inoculated onto the other side of slips and once the hyphae of the test fungi made contact the slips were removed and observed with a light microscope.

Scanning electron microscope and X-ray microanalysis observations (1, 3, 8)

Strips of cellulose dialysis membrane (10 x 70 mm) were washed five times in distilled water and autoclaved, then placed on PDA in 9-cm petri dishes. Fungus inoculum was prepared as before and inoculum discs of *R. solani* and the mycorrhizal fungi *Gomphidium rhodophyllum*, *Laccaria bicolor*, and *Lactarius deliciosus*, were inoculated at opposite ends of the strips (one mycorrhizal fungus per strip). When hyphae of the two fungi grew together the strips were removed and observed under a light microscope to locate the regions where fungus growth intermingled. Sections (1 cm²) of the strips, where the fungi grew together, were then removed and, after being frozen and dried with liquid nitrogen, they were coated with carbon. The specimens were then inspected with an SEM505 scanning electron microscope equipped with an energy-dispersive spectrometer EDAX 9100 (20 keV and about 500 cps for 100 seconds). Using the principle of Full Scale (FS), the differences in relative content of elements between the interaction region and the non-interaction regions (on

Table 1. Hyperparasitism of *Rhizoctonia solani* by ectotrophic mycorrhizal fungi

Mycorrhizal fungi	Effect on <i>R. solani</i> (the host)			
	Growth of host appressed	Coiling of mycorrhizal hyphae around host	Penetration of host hyphae	Lysis of host hyphae
<i>Amanita pantherina</i> (D.C. ex Fr.) Schumm.	-	-	-	-
<i>Boletus griseus</i> Frost	-	-	-	-
B. sp.	+	-	+	-
<i>Cortinarius castaneus</i> Bull.	-	-	-	-
<i>Gomphidius rhodophyllus</i> Kauf.	+	+	+	+
<i>Laccaria amethystea</i> (Bull. ex Merat) Murr., (isolate 1)	+	-	-	-
<i>L. amethystea</i> (isolate 2)	-	-	-	-
<i>L. bicolor</i> (Maire) Orton	+	-	+	+
<i>Lactarius camphoratus</i> (Bull. ex Fr.) Fries	+	-	+	-
<i>L. deliciosus</i> (Fr.) S.F. Gray	+	+	+	+
<i>Pisolithus tinctorius</i> Pers., (isolate 1)	-	-	-	-
<i>P. tinctorius</i> (isolate 2)	-	-	-	-
<i>Russula lutea</i> (Huds. ex Fr.) S.F. Gray	-	-	-	-
<i>R. rubra</i> Fr.	+	-	-	-
<i>Suillus bovinus</i> (Fr.) O. Kuntze	-	-	-	-
<i>S. granulatus</i> (Fr.) O. Kuntze	-	-	-	-
<i>S. grevillei</i> (Klotsch) Sing.	+	-	+	-
<i>S. luteus</i> (Fr.) S.F. Gray	-	-	-	-

Table 2. Effect of ectotrophic mycorrhizal fungi on the relative content of elements in *Rhizoctonia solani* mycelium

Type of hyperparasitism	Element:			
	P	S	K	Ca
Appressed growth				
Mycorrhizal fungi	391.00	43.92	488.44	17.45
<i>R. solani</i>	-119.15	-147.29	-26.00	-16.07
Coiling				
Mycorrhizal fungi	419.00	175.95	45.76	35.51
<i>R. solani</i>	-131.00	4.16	-94.00	-8.88
Penetration				
Mycorrhizal fungi	249.00	20.67	106.62	-6.63
<i>R. solani</i>	-69.05	-13.02	21.09	-9.18
Lysis				
Mycorrhizal fungi	-1.00	-0.42	6.77	7.15

^a The data are means of FS differences (see text) between regions where the hyphae of the mycorrhizal fungi and *R. solani* intermingled and areas where no intermingling occurred.

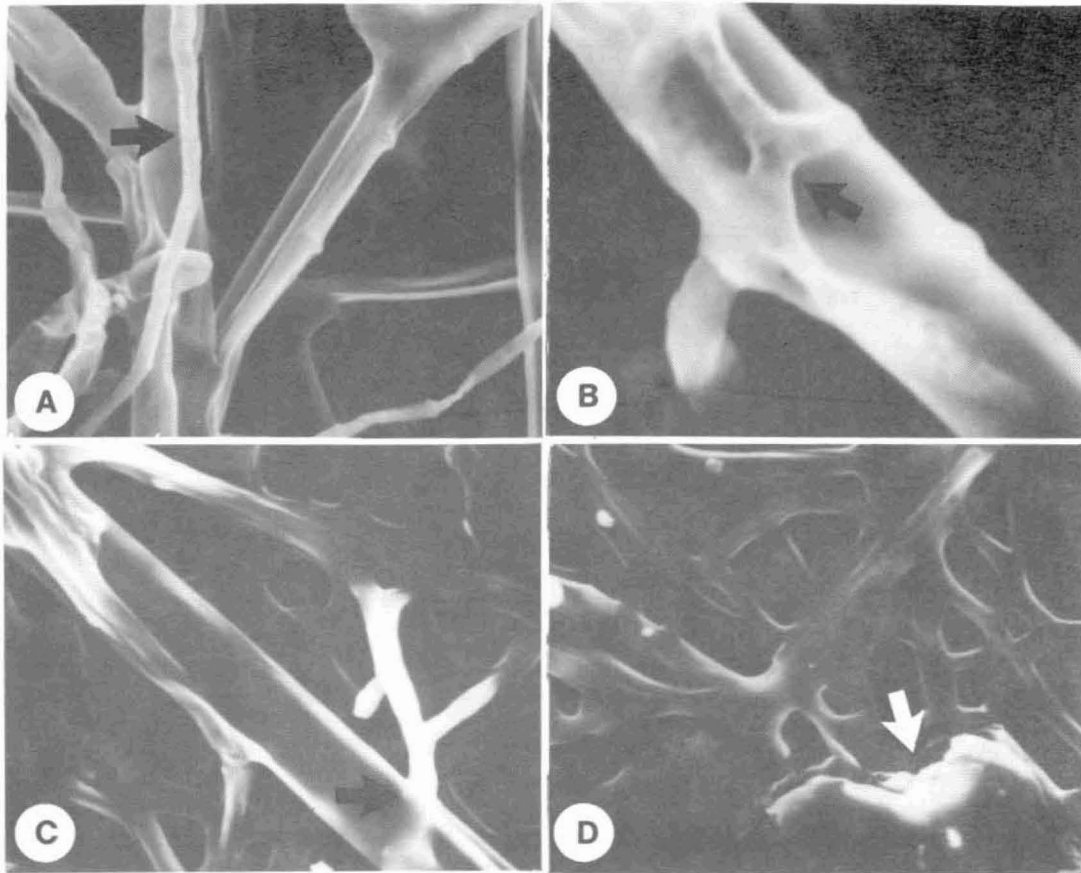

Fig. 1 A-D. Effect of *Laccaria bicolor* (A) and *Lactarius deliciosus* on *Rhizoctonia solani*. Appressed growth of *R. solani* caused by *L. bicolor* (A) and coiling of *L. deliciosus* hyphae around *R. solani* hyphae (B), penetration of *R. solani* hyphae (C), and lysis of *R. solani* hyphae by *L. deliciosus* (D).

the cellulose strip) were calculated. The transfer of elements between the mycorrhizal fungi and *R. solani* was then determined.

Results

Light microscope observations

Eight of the 18 mycorrhizal fungi parasitized *R. solani*. Four types of hyperparasitism were observed: appressed growth of *R. solani* (the host), coiling of the hyphae of the mycorrhizal fungi around hyphae of *R. solani*, penetration of *R. solani* hyphae, or lysis of host mycelium (Table 1). *Gomphidius rhodophyllus*, *Laccaria bicolor* and *L. deliciosus* were the most versatile parasites, exhibiting at least three and usually four of these types of hyperparasitism on *R. solani*.

Scanning electron microscope and X-ray microanalysis observations

The four types of mycorrhizal fungus - *R. solani* parasitism seen with the light microscope were also observed with SEM (Figure 1). The spectra of X-ray microanalysis showed the relative changes in the content of elements such as P, S, K, Ca between the various combinations of fungus hyphae (Table 2). It is obvious that *G. rhodophyllus*, *L. bicolor* and *L. deliciosus* obtain substances such as P, S, K and Ca from *R. solani*. Thus, these three mycorrhizal fungi can both inhibit *R. solani* growth and obtain nutrients from the pathogen. However, when parasitism results in hyphal lysis, mycorrhizal fungi get few substances from the host fungus *R. solani*, i.e., lysis is an ineffective type of parasitization. It could play an important role in the resistance of mycorrhizal fungi to pathogens.

Discussion

This is the first report of the use of X-ray microanalysis to study hyperparasitism among fungi. Such technology can be used to determine the transfer of substances between different fungal hyphae in various types of hyperparasitic interactions. Such studies collaborate the results observed with the light microscope. Although X-ray microanalysis cannot be used to detect C or N, the essential elements within hyphae, transfer of elements such as P, S, K, and Ca can be quantified. Our studies demonstrate that hyperparasitism by mycorrhizal fungi is an important aspect of host resistance to

pathogens. Hyperparasitism by such fungi can damage vegetative growth of pathogens and hinder their metabolism.

Acknowledgements

We thank Ren Jian-nan of the Chinese Academy of Forestry for assistance in the operation of instruments and Prof. Bi Kuo-chang of the Chinese Academy of Sciences for his helpful suggestions. The study was funded by the State Planning Commission of China. Z. P. Zhao was the recipient of a state scholarship for postgraduate studies.

References

1. Brown, M.F.; King, E.J. 1982. Electron microscopy of mycorrhizae. in N.C. Schenck, editor. Methods and principles of mycorrhizal research. Amer. Phytopathol. Society, St. Paul, MN.
2. Kuo, S.C.; Bi, K.C. 1989. [Mycorrhizae and their applications in forestry] (In Chinese). Chinese Publishing House of Forestry, Beijing, China.
3. Kuo, S.C.; Bi, K.C. 1988. A study of VA mycorrhizae formed on the tissue-cultured plantlets of *Paulownia*. in A. Mahadevan, editor, Proceedings of 1st Asian Conference On Mycorrhizae, University of Madras, India.
4. Kuter, G.A. 1984. Hyphal interactions between *Rhizoctonia solani* and some *Verticillium* species. *Mycologia* 76: 936-940.
- 5: Li, D.P. 1986. [Studies on the antagonists of *Rhizoctonia solani* Kuhn- Their species and biological activities] (In Chinese). Masters thesis, Beijing Agriculture University, Beijing, China.
6. Marx, D.H. 1973. Mycorrhizae and feeder root diseases. in G.C. Marks and T.T. Kozlowsky, editors. Ectomycorrhizae: Their ecology and physiology. Academic Press, London.
7. Marx, D.H.; Schenck, N.C. 1983. Potential of mycorrhizal symbiosis in agricultural and forest productivity. in T. Kommedahl and P.H. Williams, editors. Challenging problems in plant health. Amer. Phytopathol. Soc., St. Paul, MN.
8. Nordbring-Hertz, B. 1983. Dialysis membrane technique for studying microbial interaction. *Appl. Environ. Microbiol.* 45:290-293.
9. Tu, J.C.; Vaartaja, O. 1981. The effect of the hyperparasite (*Gliocladium virens*) on *Rhizoctonia solani* and on *Rhizoctonia* root rot of white beans. *Can. J. Bot.* 59: 22-27.
10. Wu, W.S.; Liu, S.D.; Chang, Y.C.; Tschien, J. 1986. Hyperparasitic relationships between antagonists and *Rhizoctonia solani*. *Plant Prot. Bull. (Taiwan)* 28: 91-100.

Appendix

Members of IUFRO Working Party S2.07-09 (Diseases and Insects in Forest Nurseries)
Asterisks indicate those members who attended the meeting in Victoria in August 1990.

- Dr. David Adams
California Dept. of Forestry
LAMRC
P.O. Box 1590
Davis, CA 95617
U.S.A.
- Ismail N. Al-Marouf
Dept. of Forestry
College of Agric. & Forestry
Hammam Al-Alil, Mosul
Iraq
- * Mr. Bemt Arvidsson
National Board of Forestry
S-551 83, Jonkoping
Sweden
- * Dr. Paige Axelrod
B.C. Research Corp.
Forest Biotechnology Centre
3650 Wesbrook Mall
Vancouver, B.C.
V6S 2L2
Canada
- Dr. E.L. Bamard
Florida Dept. of Agriculture
Box 1269 - Insect & Disease Section
Gainesville, FL 32602
U.S.A.
- * Dr. Liseolotte Beyer-Ericson
Avd For Skoglig Mykologi och
Patologi
Sveriges Lantbruksuniversitet
Box 7026
Uppsala, S-750 07
Sweden
- * Bradley Binges
University of Victoria
Department of Biology
P.O. Box 1700
Victoria, B.C.
V8W 2Y2
Canada
- Dr. George M. Blakeslee
Dept. of Forestry - SFRC
University of Florida
118N-Z Hall
Gainesville, FL 32611
U.S.A.
- * Ms. Dagmar Børja
Forest Pathology
Norwegian Forest Research Institute
P.O. Box 61
1432 AS-NLH,
Norway
- * Dr. Bruce Brown
Queensland Forest Service
Dept. of Primary Industries
P.O. Box 631
Indooroopilly, QLD 4068
Australia
- * Mr. Tracy Bums
Forestry Canada - Maritimes Region
P.O. Box 4000, Regent St.
Fredericton, NB
E3B 5P7
Canada
- * Ms. Sally J. Campbell
USDA Forest Service
Forest Pest Management
P.O. Box 3623
Portland, OR 97208
U.S.A.
- * Gary A. Chastagner
Washington State University
Research and Extension Center
Puyallup, WA 98371
U.S.A.
- Mr. Chen Shou-Chang
Director of Forest Protection
Research Division
Sichuan Academy of Forestry
Chengdu, Jinhua St.
Sichuan Province, 344 610081
The People's Republic of China
- * Dr. Charles Cordell
U.S. Forest Service
P.O. Box 2680
Asheville, NC 28802
U.S.A.
- Dr. John W. Dale
Forest Service - USDA
630 Sansome St.
San Francisco, CA 94111
U.S.A.
- * Eva Damm
Dept. of Forest Mycology and Path.
Swedish University of Agric.
Sciences
Box 7026
Uppsala, S-750 07
Sweden
- * Mr. C. Davis
Great Lakes Forestry Centre
Forestry Canada
P.O. Box 490
Sault St. Marie, Ontario
P6A 5M7
Canada
- Dr. Keith R. Day
Faculty of Science and Technology
University of Ulster
Colrairie
Co. Londonderry BT52 1SA
Northern Ireland
- * Dr. Enriqueito D. De Guzman
1020 S. Williams St. F8
Westmont, IL 60559
U.S.A.
- Dr. Jose Carmine Dianese
Dept. of Biologia Vegetal
University of Brasilia
70910 - Brasilia
Brazil
- Dr. Wayne N. Dixon
Florida Division of Forestry
P.O. Box 1269
Gainesville, FL 32602
U.S.A.
- Dr. M. Dumas
Great Lakes Forestry Centre
Box 490 - 1219 Queen St. E
Sault Ste. Marie, Ontario
P6A 5M7
Canada
- * Rex Eng
B.C. Forest Service
Red Rock Research Station
RR#7, RMD #6
Prince George, B.C.
V2N 2J5
Canada

- Dr. C.W. Fatzinger
US Forest Service
Box 70 - Forestry Sciences Lab
Olustee, FL 32072
U.S.A.
- * Dr. Francisco Alves Ferreira
Departamento de Fitopatologia - U.F.V
36570-Vicosa-MG
Brazil
- Dr. Mario B. Figueiredo
Inst. Biologico-DPT Pl Micology
CP 7119
San Paulo SP01000
Brazil
- * Carrie R. Foss
WSU - Puyallup Center
7612 Pioneer Way East
Puyallup, WA 98371-4998
U.S.A.
- Dr. Stephen Fraedrich
US Forest Service
Box 70 - Forestry Sciences Lab
Olustee, FL 32072
U.S.A.
- * Dr. Susan Frankel
S & PF U.S. Forest Service
630 Sansome St.
San Francisco, CA 94111
U.S.A.
- Wayne Gates
Pacific Regeneration Tech. Inc.
Chilliwack River Nursery
Box 242
Vedder Crossing, B.C.
VOZ 1Z0
Canada
- * Sylvia Greifenhagen
Ontario Ministry of Natural Res.
c/o Great Lakes Forestry Centre
Box 1000 - 1219 Queen St. East
Sault St. Marie, Ontario
P6A 5N5
Canada
- Glenna Halicki
Ontario Ministry of Natural
Resources
c/o Great Lakes Forestry Centre
Box 1000 - 1219 Queen St. East
Sault St. Marie, Ontario
P6A 5N5
Canada
- * Mr. Philip B. Hamm
Cordley Hall 2082
Dept. of Botany
Oregon State University
Corvallis, OR 97331-2902
U.S.A.
- Dr. Evert Hansen
Forest Pathologist
Dept. of Botany & Plant Pathology
Oregon State University
Corvallis, OR 97331
U.S.A.
- Mr. Stuart Heritage
Forestry Commission
Northern Research Station
Roslin, Midlothian
EH25 9SY
United Kingdom
- Dr. Diane M. Hildebrand
U.S. Forest Service
11177 W. 8th Avenue
Lakewood, CO 80225
U.S.A.
- Dr. Anthony Hopkin
Great Lakes Forestry Centre
Box 490 - 1219 Queen St. E
Sault Ste. Marie, Ontario
P6A 5M7
Canada
- Ralph Huber
Silviculture Branch
B.C. Min. of Forests
31 Bastion Square
Victoria, B.C.
V8W 3E7
Canada
- * Dr. Robert L. James
U.S.D.A. Forest Service
1201 Ironwood Dr.
Coeur d'Alene, ID 83814
U.S.A.
- Jing Yao
Northwestern College of Forestry
Yangling, Shaanxi
The People's Republic of China
- Dave Johnson
Institute for Forest Genetics
2480 Carson Rd.
Placerville, CA 95667
U.S.A.
- Dr. Scott Josiah
Pan American Development
Foundation
c/o PAP - MAF
P.O. Box 407103
Fort Lauderdale, FL 33340
U.S.A.
- * Dr. Jennifer Juzwik
US Department of Agriculture
North Central Forest Experiment
Station
1992 Folwell Ave.
St. Paul, MN 55108
U.S.A.
- * Dr. Alan Kanaski
Oregon State Dept. Forestry
2600 State St.
Salem, OR 97361
U.S.A.
- * Dr. Walter D. Kelley
School of Forestry
M. White Smith Hall
Auburn University, AL 36849-5418
U.S.A.
- Mr. Vlad Korelis
CPFP Nurseries Ltd.
8067 East Saanich Road
RR#1
Saanichton, B.C.
V0S 1M0
Canada
- Dr. Kuo Shiu-chien
Chinese Academy of Forestry
Research Institute of Forestry
Beijing 100091
The People's Republic of China
- * Dr. Tom D. Landis
U.S. Forest Service
Box 3623
Portland, OR 97208
U.S.A.
Li Li Sa
Forestry Research Institute
Yannan Province
Hei Long Tang
Kunming
The People's Republic of China
- * Dr. Willis R. Littke
Weyerhaeuser Research Station
Box 420 - 505 N. Pearl St.
Centralia, WA 98531
U.S.A.

- * Mr. Liu De Cheng
General Administration of Forest
Industry
Heilongjiang Province
26 Wen Chang St.
Nan Gang District, Harbin
The People's Republic of China
- * Dr. William H. Livingston
Dept. of Forest Biology
University of Maine
Orono, ME 04469
U.S.A.
- Dr. A.H. McCain
Plant Pathology
University of California
Berkeley, CA 94720
U.S.A.
- Dr. Fred D. McElroy
Peninsu - Lab
23976 N.E. Newellhurst Ct.
P.O. Box 3000
Kingston, WA 98346
U.S.A.
- Dr. George Mathew
Entomology Division
Kerala Forest Research Institute
Peechi-680 653
Kerala
India
- R. Mazodze
Forest Entomologist
Forest Research Centre
Box HG 595
Highlands, Harare
Zimbabwe
- Dr. T. Miller
US Forest Service
Box 70 -Forestry Sciences Lab.
Olustee, FL 32072
U.S.A.
- Paul Morgan
Phipps Nursery
2424 Wells Rd.
Elkton, OR 97436
U.S.A.
- Bruce Morton
Hybrid Nurseries Ltd
12682 Woolridge Rd.
Pitt Meadows, B.C.
V3Y 1Z1
Canada
- * Emma Motta
Istituto Sperimentale per la
Patologia Vegetale
Via C.G. Bertero, 22
00156 Roma
Italy
- Dr. R. Mukuka
Seed Pathologist
Forest Department
P.O. Box 22099
Kitwe
Zambia
- Dr. G.B. Neill
Investigations Section
PFRA Shelterbelt Centre,
Indian Head, Saskatchewan
SOG 2K0
Canada
- * Dr. Joseph G. O'Brien
Forest Service - USDA
1992 Folwell Ave.
St. Paul, MN 55108
U.S.A.
- Dr. Marg Palmer
Dept. of Plant Pathology
University of Minnesota
St. Paul, MN 55108
U.S.A.
- * Nancy Parrott
Peninsu - Lab
P.O. Box 3000
Kingston, WA 98346
U.S.A.
- Dr. Robert Perrin
Station De Recherches Sur La Flore
Pathogene
Dans Le Sol, INRA
17, Rue Sully, Dijon Cedex
21034
France
- * Allen J. Prey
Wisconsin Dept. Natural Resources
3911 Fish Hatchery Rd.
Madison, WI 53711
U.S.A.
- * Dr. Zdenka Prochazkova
Research Institute of Forestry &
Game Management
Station Uherske
Hradiste 686 02
Czechoslovakia
- * Dr. Paolo Raddi
C.S. Patol. Spege Legno. Se
Montane, C.N.R.
Piazelle delle Cascine 28
Firenze, 50144
Italy
- * Reed Radley
B.C. Research Corp.
Forest Biotechnology Centre
3650 Wesbrook Mall
Vancouver, B.C.
V6S 2L2
Canada
- Dr. John Ray
Forest Research Institute
Private Bag
Rotorua
New Zealand
- * Kathy Riley
Washington State University
Research and Extension Center
Puyallup, WA 98371
U.S.A.
- * Robin Rose
Dept. of Forest Science
Oregon State University
Peavy Hall 154
Corvallis, OR 97331-5705
U.S.A.
- * Mr. Ken Russell
Dept. of Natural Resources
Forest Pest Mgt. Centre MQ-11
Olympia, WA 98504
U.S.A.
- * Maria I. Salerno
Ministerio de Asuntos
Agrarios-Direccion Forestal-8 piso
51 esq 12- La Plata - 1900 Bs As
Argentina
- Mr. Rodolfo Salinas-Quinard
Asea de Patologia Forestal
Instituto Nal. de Invest. Forest Y
Agropecuarias
Av. Progreso No.5, C.P. 04010
Coyoacan 21, Mexico, D.F.
Mexico
- Mr. Roger Sandquist
USDA Forest Service
Pacific Northwest Region
319 S.W. Pine
Portland, OR 97208
U.S.A.

- Dr. Eileen Scott
Department of Plant Pathology
Waite Agricultural Research Institute
Department of Plant Pathology, PMB 1
Glen Osmond, SA5064
Australia
- * Dr. J.K. Sharma
Division of Forest Pathology
Kerala Forest Research Institute
Peechi-680 653
Kerala
India
- * Mike Shaw
General Manager
Sappi Forests Research Division
P.O. Box 473
Howick, 3290
South Africa
- Mr. Shi Jin Lin
Expt. Centre of Integrated Bio. Cont.
Ministry of Forestry in China
58 Huanghe North St.
Shenyang, Liaoning, 110031
The People's Republic of China
- * Ms. Gwen Shrimpton
Surrey Nursery
B.C. Ministry of Forests
3605 - 192nd Street
Surrey, B.C.
V3S 4N8
Canada
- Mr. Jack Simpson
Forestry Commission of New South
Wales
Wood Technology and Forest Res. Div.
P.O. Box 100
Beecroft, New South Wales 2119
Australia
- Ms. Helen Smith
Forestry Commission of New South
Wales
Wood Technology and Forest Res. Div.
P.O. Box 100
Beecroft, New South Wales 2119
Australia
- Dr. R.S. Smith, Jr.
U.S. Forest Service
Box 96090 - FIDR
Washington, D.C. 20090-6090
U.S.A.
- * Dr. David South
School of Forestry
Auburn University
Auburn, AL 36849-5418
U.S.A.
- * Dr. John Stein
US Forest Service
Pacific SW For. & Range Exp. Sta.
Box 245
Berkeley, CA 94701
U.S.A.
- * Tom Stevens
Weyerhaeuser Co.
8844 Gate Road
Olympia, WA 98502
U.S.A.
- Rona Sturrock
Pacific Forestry Centre
Forestry Canada
506 W. Bumside Road
Victoria, B.C.
V8Z 1M5
Canada
- * Dr. Jack Sutherland
Pacific Forestry Centre
Forestry Canada
506 W. Bumside Road
Victoria, B.C.
V8Z 1M5
Canada
- * Dr. Yasuo Suto
Shimane Prefecture Forest Research
Centre
Shinji-cho,
Yatsuka-gun, Shimane 699-04
Japan
- * Mr. Dave Trotter
Surrey Nursery
B.C. Ministry of Forests
3605 - 192nd Street
Surrey, BC
V3S 4N8
Canada
- * Dr. Torgny Unestam
Forest Mycology/Pathology
Swedish Univ. Agricultural Res.
Uppsala, S-75007
Sweden
- * Eric Van Steenis
369 15 Dawson Rd, RR#4
Abbotsford, B.C.
V2S 4N4
Canada
- Dr. Wang Wei-Young
Taiwan Forestry Research Institute
53 Nan-Hai Road
Taipei, Taiwan
The Republic of China (Taiwan)
- Mr. Wang Yan Sheng
Station of Prev./Control: Plant Dis.
& Pests
General Administration of Forest
Bureau
Heilongjiang Province
26 Wen Chang St.
Nan Gang District, Harbin
The People's Republic of China
- Mr. Tim Wardlaw
Forestry Commission of Tasmania
G.P.O. Box 207B
Hobart, TAS 7001
Australia
- Mr. Yang Jun Xiu
Department of Forest Protection
5-321 Northwestern College of
Forestry
Yangling, Xianyang
Shaanxi, 712100
The People's Republic of China
- Mr. Yang Xiyan
5-321 Northwestern College of
Forestry
Yangling, Xianyang
Shaanxi, 712100
The People's Republic of China
- Mr. Yao Guo Quan
General Bureau of Forest Industry
Heilongjiang Province
26 Wen Chang St.
Nan Gang District, Harbin
The People's Republic of China
- Dr. Jose Cola Zanuncio
UFV - Forest Entomology
36570-Vicososa-MG
Brazil
- Mr. Zhao Zhi-peng
Research Institute of Forestry
Chinese Academy of Forestry
Beijing 100091
The People's Republic of China
- Mr. Zheng Dapen
Forest Pathologist
The Chinese Academy of Forestry
Wan Shou Shan
Beijing
The People's Republic of China
- Mr. Zhou Jiayi
5-321 Northwestern College of
Forestry
Yangling, Xianyang
Shaanxi, 712100
The People's Republic of China