



# Edible coatings as a means to improve the quality and shelf-life of *Agaricus bisporus* (white button) mushroom

Marta Fernanda de Sousa

Mestrado em Ciências do Consumo e Nutrição  
Departamento Geociências, Ambiente e Ordenamento do Território  
2015

**Orientador**

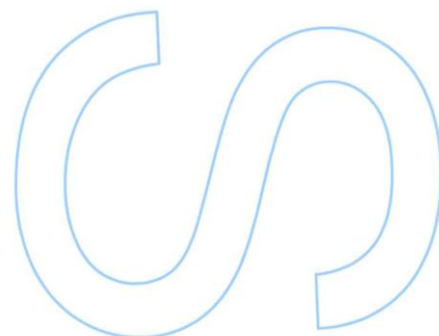
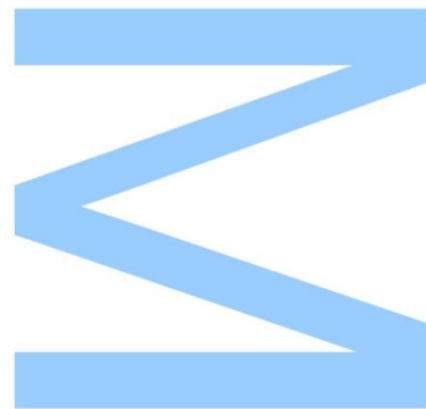
António Augusto Martins de Oliveira Soares Vicente, Professor Associado com Agregação, Universidade do Minho – Departamento de Engenharia Biológica

**Coorientador**

Luís Miguel Soares Ribeiro Leite da Cunha, Professor Associado, Faculdade de Ciências

**Supervisor**

Miguel Ângelo Parente Ribeiro Cerqueira, Departamento I&D+i, Improveat, Lda – Braga

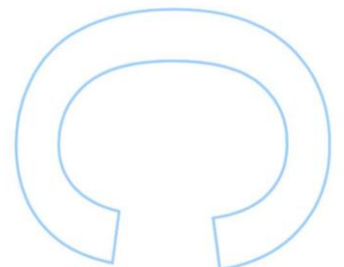
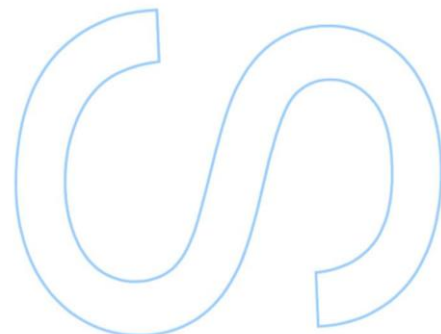
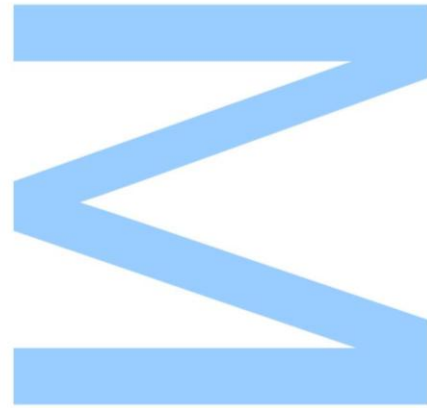




Todas as correções determinadas pelo júri, e só essas, foram efetuadas.

O Presidente do Júri,

Porto, \_\_\_\_/\_\_\_\_/\_\_\_\_



## Acknowledgements

Antes de mais gostaria de agradecer ao meu orientador, Professor António Vicente, por me ter acolhido no seu grupo, do Departamento de Engenharia Biológica da Universidade do Minho, pela definição do meu projeto de investigação, e pela simpatia e disponibilidade que sempre demonstrou, bem como pelo aconselhamento científico.

Ao Professor Luís Cunha, meu coorientador, pela transmissão de conhecimentos e pela oportunidade única que me concedeu de realizar este projeto, estabelecendo as pontes interinstitucionais necessárias à realização do mesmo.

Ao meu supervisor, Doutor Miguel Cerqueira, agradeço os ensinamentos, a paciência e a ainda maior disponibilidade. Porque mesmo tendo muito trabalho, arranjavas sempre um “tempinho” para me ajudar. Mais que ninguém mereces um agradecimento muito especial.

Agradeço a todo o pessoal do LIP que sempre se prontificaram a ajudar quando precisei.

Como não podia deixar de ser quero agradecer à minha família, especialmente à minha mãe e irmãos, e aos meus amigos que sempre demonstraram todo o apoio e incentivo.

A todos aqueles que de alguma forma contribuíram para a concretização deste trabalho, o meu sincero agradecimento.

## Abstract

Mushrooms are highly perishable products that tend to lose their unique organoleptic properties immediately after harvesting. Their short shelf-life is mainly explained by the water loss, high respiration rates high ( $200-500 \text{ mg kg}^{-1} \text{ h}^{-1}$  at  $20 \pm 1^\circ\text{C}$ ) and microbial colonization by bacteria or fungi. Furthermore, also enzymatic activity and biochemical alterations lead to mushrooms changes after harvesting.

Active edible coatings have been applied in the last years as an alternative method for the control of microbial contamination in food products, and the decrease of enzymatic browning. The incorporation of antimicrobial and anti-browning compounds showed potential for maintaining food quality and safety of foods during storage.

Aiming at developing an active edible coating to increase the shelf-life of *Agaricus bisporus* mushrooms, polysaccharide-based coatings were developed using chitosan, alginate and guar gum, glycerol (as plasticizer) and Tween 80 (as surfactant). Coating formulations were evaluated and an optimal formulation was selected. Two coatings were selected, one containing 0.5% (w/v) of chitosan, 0.125% (v/v) of glycerol and 0.15% (v/v) of Tween 80 and other with 0.5% (w/v) of alginate, 0.125% (v/v) of glycerol and 0.05% (v/v) of Tween 80.

Different concentrations (0-1%, v/v) of eugenol and carvacrol and a combination of both (1:1) were added to chitosan and alginate coatings and their antimicrobial activity was evaluated against *E. coli* and *P. fluorescens*. The best results of inhibition were obtained for eugenol with a concentration of 0.05%. Also, different concentrations (0-0.8 mM) of cinnamic acid (enzymatic inhibitor) were used and the effect of this compound on the enzymatic activity of mushroom tyrosinase was determined. A concentration of 0.6 mM of cinnamic acid was selected.

After the application of the coatings on mushrooms the effect of the coating in the mushroom colour was evaluated, and it was found that the application of chitosan coating on mushroom lead to a degradation of the mushrooms, so it was excluded.

Therefore, only the *Agaricus bisporus* (white button) mushrooms coated with sodium alginate-based coating with incorporation of eugenol and cinnamic acid were used during the shelf-life evaluation. The coated and uncoated mushrooms were stored at 90-95% RH and at 6-8 °C during 10 days. Shelf-life analyses were performed in coated and uncoated mushrooms in terms of colour, bacterial growth, weight loss, moisture, content of total solids, total soluble solids (TSS), pH, titratable acidity and enzymatic analyses.

The results showed that the coating prolongs the shelf life of mushrooms, decreasing weight loss, reducing changes in colour (confirmed by the decrease of

polyphenol oxydase activity), titratable acidity, pH and TSS during refrigerated storage. The coated mushrooms showed to be more effective in reducing the mesophilic and psychrophilic counts and was totally effective against the fungi, avoiding their presence.

These results show that the edible coating used in this work may be a promising method of maintaining the quality of the button mushrooms and increase their shelf-life during refrigerated storage.

## Resumo

Os cogumelos são produtos altamente perecíveis, que tendem a perder as suas propriedades organolépticas únicas imediatamente após a colheita. O seu período de vida curto é explicado, principalmente, pela perda de água, altas taxas de respiração ( $200\text{-}500\text{ mgkg}^{-1}\text{h}^{-1}$  at  $20 \pm 1^\circ\text{C}$ ) e colonização microbiana por bactérias ou fungos. Além disso, também a atividade enzimática e alterações bioquímicas levam a mudanças nos cogumelos após a colheita.

Revestimentos comestíveis activos têm sido aplicados nos últimos anos como um método alternativo para o controlo de contaminação microbiana em produtos alimentares, e a diminuição do escurecimento enzimático. A incorporação de compostos antimicrobianos e anti-escurecimento mostrou potencial para manter a qualidade e segurança dos alimentos durante o armazenamento.

Com o objetivo de desenvolver um revestimento comestível activo para aumentar o período de vida útil de cogumelos *Agaricus bisporus*, foram desenvolvidos revestimentos à base de polissacárido utilizando quitosano, alginato e goma guar, glicerol (como plasticizante) e Tween 80 (como tensoactivo). As formulações de revestimento foram avaliadas e a formulação óptima foi seleccionada. Dois revestimentos foram seleccionados, um contendo 0.5% (w/v) de quitosano, 0.125% (v/v) de glicerol e 0.15% (v/v) de Tween 80 e outro com 0.5% (w/v) de alginato, 0.125% (v/v) de glicerol e 0.05% (v/v) de Tween 80.

Diferentes concentrações (0-1%, v/v) de eugenol e carvacrol e uma combinação de ambos (1:1) foram adicionados aos revestimentos de alginato e quitosano e a sua actividade antimicrobiana foi avaliada contra *E. coli* e *P. fluorescens*. Os melhores resultados de inibição foram obtidos pelo eugenol com uma de concentração de 0.05%. Além disso, diferentes concentrações (0-0.8 mM) de ácido cinâmico (inibidor enzimático) foram usadas e os seus efeitos sobre a actividade enzimática da tirosinase de cogumelo foi determinada. Uma concentração de 0.6 mM de ácido cinâmico foi seleccionada.

Após a aplicação dos revestimentos nos cogumelos foi realizada uma avaliação para avaliar o efeito do revestimento na cor do cogumelo, e verificou-se que a aplicação do revestimento de quitosano no cogumelo conduziu a uma degradação dos cogumelos, por isso, foi excluída.

Portanto, apenas os cogumelos *Agaricus bisporus* (botão branco) revestidos com revestimento à base de alginato de sódio com incorporação de eugenol e ácido cinâmico foram usadas durante o período de vida útil de avaliação. Os cogumelos revestidos e não revestidos foram armazenados a 90-95% RH e em  $6\text{-}8^\circ\text{C}$  durante 10

dias. As análises prazo de validade foram realizados em cogumelos revestidos e não revestidos, em termos de cor, o crescimento bacteriano, perda de peso, humidade, conteúdo de sólidos totais, sólidos solúveis totais (SST), pH, acidez titulável e análises enzimáticas.

Os resultados mostraram que o revestimento prolonga a vida de prateleira dos cogumelos, diminui a perda de peso, reduz alterações na cor (verificada pela diminuição da actividade da polifenol oxidase), a acidez titulável, pH e SST durante o armazenamento refrigerado. Os cogumelos revestidos demonstraram ser mais eficazes na redução da contagem de mesófilos e psicrófilos e foi totalmente eficaz contra os fungos, evitando a sua presença.

Estes resultados mostram que o revestimento comestível usado no presente trabalho pode ser um método promissor para manter a qualidade dos cogumelos e aumentar a sua vida de prateleira durante o armazenamento refrigerado.

# List of contents

<b>Acknowledgements .....</b>	<b>iii</b>
<b>Abstract.....</b>	<b>iv</b>
<b>Resumo .....</b>	<b>vi</b>
<b>List of tables .....</b>	<b>x</b>
<b>List of figures.....</b>	<b>xi</b>
<b>List of abbreviations.....</b>	<b>xvi</b>
<b>List of symbols .....</b>	<b>xviii</b>
<b>Structure of the dissertation .....</b>	<b>xix</b>
<b>Chapter I – General introduction.....</b>	<b>21</b>
1.1. Mushrooms.....	21
1.1.1. Production.....	22
1.1.2. Chemical and nutritional composition .....	26
1.1.3. Main factors of postharvest deterioration.....	32
1.1.4. Methods to extend the shelf-life of fresh mushrooms.....	40
1.2. Edible coatings, their constituents and properties .....	51
1.2.1. Polysaccharides.....	52
1.2.2. Potential active ingredients .....	58
1.2.3. Properties of the edible coatings .....	64
1.3. Regulatory status of ingredients.....	67
1.4. Criteria to choose a type of coating.....	68
1.5. Objectives addressed in this dissertation .....	69
<b>Chapter II – Optimization of the coating.....</b>	<b>72</b>
2.1. Materials and methods.....	72
2.1.1. Preparation of polysaccharides solutions .....	72
2.1.2. Mushrooms.....	74
2.1.3. Critical surface tension and surface tension of mushroom skin.....	75
2.1.4. Wettability of the coating solutions .....	76
2.1.5. Statistical analysis.....	77
2.2. Results and discussion.....	77
2.2.1. Evaluation of critical surface tension and surface tension of mushroom skin .....	77
2.2.2. Evaluation of wettability.....	80
<b>Chapter III – Evaluation of bioactive compounds.....</b>	<b>87</b>
3.1. Materials and methods.....	87



3.1.1. Enzyme activity .....	87
3.1.2. Antimicrobial activity .....	88
3.2. Results and discussion.....	90
3.2.1. Enzyme activity .....	90
3.2.2. Antimicrobial activity .....	92
<b>Chapter IV – Coating application and evaluation of shelf-life parameters .....</b>	<b>98</b>
4.1. Materials and methods .....	98
4.1.1. Coating application on mushrooms and storage conditions .....	98
4.1.2. Shelf-life analyses.....	99
4.2. Results and discussion.....	102
4.2.1. Evaluation of weight loss, moisture and total solids content .....	102
4.2.2. Evaluation of TSS .....	105
4.2.3. Evaluation of pH and titratable acidity.....	106
4.2.4. Evaluation of colour and browning .....	106
4.2.5. Evaluation of enzymatic activity.....	111
4.2.6. Microbiological evaluation .....	112
4.2.7. Other observations .....	115
<b>Chapter V – General conclusions and future work.....</b>	<b>118</b>
5.1. General conclusions .....	118
5.2. Future work.....	119
<b>References .....</b>	<b>121</b>
<b>Annex .....</b>	<b>155</b>
A.1. Pareto charts.....	155
A.2. Results for pH, TSS, Titratable acidity, Moisture, Total solids and Weight loss ..	159
A.3. Results for <i>L</i> , <i>a</i> , <i>b</i> , $\Delta E$ , BI, PPO activity, Yeasts and molds count, Mesophilic count and Psychrophilic count .....	160
A.4. Yeasts and molds.....	162
A.5. Mesophilic .....	163
A.6. Psychrophilic.....	163
A.7. Abstract and oral presentation submitted at the 12 <sup>o</sup> Encontro de Química dos Alimentos .....	164

## List of tables

<b>Table 1:</b> Top mushrooms and truffles cultivation, in tones (t), 2013 data (FAOSTAT 2015). .....	23
<b>Table 2:</b> Dry matter ( $\text{g kg}^{-1}$ ), proximate composition ( $\text{g kg}^{-1}$ ) and energy ( $\text{kcal kg}^{-1}$ fresh matter) in some cultivated mushrooms (Kalac 2013). .....	27
<b>Table 3:</b> Free sugar contents ( $\text{g kg}^{-1}$ DM) in cultivated mushrooms (Kalac 2013). .....	29
<b>Table 4:</b> Usual contents ( $\text{g kg}^{-1}$ DM) of major mineral elements in cultivated mushrooms in descending order (Kalac 2010). .....	31
<b>Table 5:</b> Chitosan, plasticizer and surfactant concentrations used in the coatings formulation. ....	72
<b>Table 6:</b> Sodium alginate, plasticizer and surfactant concentrations used in the coatings formulation. ....	73
<b>Table 7:</b> Guar gum, plasticizer and surfactant concentrations used in the coatings formulation. ....	74
<b>Table 8:</b> Liquid-vapour tension values of the evaluated coating solutions. Means in the same line with different letters are significantly different ( $p < 0.05$ ). .....	82
<b>Table 9:</b> Values of $W_s$ , $W_a$ , $W_c$ and $\theta$ of the solutions of chitosan, sodium alginate and guar gum for pileus top. ....	84
<b>Table 10:</b> Values of $W_s$ , $W_a$ , $W_c$ and $\theta$ of the solutions of chitosan, sodium alginate and guar gum for pileus side. ....	85
<b>Table 11:</b> Eugenol and carvacrol concentrations used in the sodium alginate and chitosan coatings. ....	89
<b>Table 12:</b> pH, TSS, titratable acidity, moisture, total solids and weight loss of <i>Agaricus bisporus</i> mushrooms during 10 days of storage at 6-8 °C for coated (sodium alginate) and control mushrooms. ....	159
<b>Table 13:</b> $L$ , $a$ , $b$ , $\Delta E$ , BI, PPO activity, yeasts and molds count, mesophilic count and psychrophilic count of <i>Agaricus bisporus</i> mushrooms during 10 days of storage at 6-8 °C for coated (sodium alginate) and control mushrooms. ....	160

# List of figures

**Figure 1:** *Agaricus bisporus* (white button) (<http://mycitygarden.com.au/products/260/>).  
..... 21

**Figure 2:** Production of mushrooms and truffles in the world 1961 – 2013 (M=million) (FAOSTAT 2015). ..... 22

**Figure 3:** Production share by region in 2013 (FAOSTAT 2015). ..... 22

**Figure 4:** Schematic representation of the production of three types of mushrooms. Source – Sanchez (2010). ..... 25

**Figure 5:** Schematic representation of the factors that cause biochemical changes in mushrooms. Adapted for Fernandes, Antonio et al. (2012). ..... 32

**Figure 6:** Second Behbamain, Miller et al. (1992), it is believed that reactions (a) and (b) are enzymatically catalyzed while reactions (c) and (d) may be spontaneous. Dopachrome is slowly converted to melanin through a series of reactions. .... 37

**Figure 7:** Enzymatic oxidation of the phenolic amino acid tyrosine to melanin (Source – Seo, Sharma et al. 2003). ..... 38

**Figure 8:** Stipe tissue is brownish and contains several irregular holes spread in the stipe. The surface covering of the stipe remains white all the time unless it is infected (Umar and Van Griensven 1997). ..... 38

**Figure 9:** Stipe shows a surface with a wet and cloudy appearance and discoloration caused by *Pseudomonas tolaasii*, also the co-existence of green moulds (Umar and Van Griensven 1997). ..... 40

**Figure 10:** Bacterial infection: a large, light green coloured zone caused by pathogen fungi surrounds the central area (Umar and Van Griensven 1997). ..... 40

**Figure 11:** Stipe of the fruit body infected by *Trichoderma harzianum* (Umar and Van Griensven 1997). ..... 40

**Figure 12:** Quality attributes provided by edible coatings to food products. Adapted from Ramos, Fernandes et al. (2012). ..... 52

**Figure 13:** Chitosan molecular structure (Porta, Mariniello et al. 2011). ..... 55

**Figure 14:** Monomers of alginate (<http://www.fmcbiopolymer.com/portals/pharm/content/docs/alginates.pdf>). ..... 56

**Figure 15:** Alginate block types (<http://www.fmcbiopolymer.com/portals/pharm/content/docs/alginates.pdf>). ..... 56

**Figure 16:** General molecular structure of galactomannan (Cerqueira, Souza et al. 2011). ..... 57

**Figure 17:** Structural formula of carvacrol (Burt 2004). ..... 60

<b>Figure 18:</b> Structural formula of eugenol (Burt 2004).....	60
<b>Figure 19:</b> Chemical structure of cinnamic acid (Kong, Jo et al. 2008). .....	63
<b>Figure 20:</b> Regression of equation 2 for the pileus side.....	78
<b>Figure 21:</b> Regression of equation 2 for the pileus top. ....	78
<b>Figure 22:</b> Zisman plot of pileus side.....	79
<b>Figure 23:</b> Zisman plot of pileus top. ....	79
<b>Figure 24:</b> Measurement of the contact angle on the surface of the mushroom pileus, with $\theta=104.3^\circ$ .....	80
<b>Figure 25:</b> A few drops of coating solution on the surface of the pileus. ....	81
<b>Figure 26:</b> Effect of trans-cinnamic acid on the enzyme activity of mushroom tyrosinase. ....	90
<b>Figure 27:</b> Lineweaver-Burk plots for inhibition of trans-cinnamic acid on mushroom tyrosinase for the oxidation of L-DOPA. ....	92
<b>Figure 28:</b> Percent of inhibition of growth <i>E.coli</i> for antimicrobial concentrations of eugenol in the chitosan and sodium alginate coatings (E-eugenol, Chi.-chitosan, S.alg.-sodium alginate). ....	93
<b>Figure 29:</b> Percent of inhibition of growth <i>E.coli</i> for antimicrobial concentrations of carvacrol in the chitosan and sodium alginate coatings (C-carvacrol, Chi.-chitosan, S.alg.-sodium alginate). ....	93
<b>Figure 30:</b> Percent of inhibition of growth <i>E.coli</i> for antimicrobial concentrations of eugenol : carvacrol (1:1) in the chitosan and sodium alginate coatings (E-eugenol, C-carvacrol, Chi.-chitosan, S.alg.-sodium alginate). ....	94
<b>Figure 31:</b> Percent of inhibition of growth <i>P. fluorescens</i> for antimicrobial concentrations of eugenol in the chitosan and sodium alginate coatings (E-eugenol, Chi.-chitosan, S.alg.-sodium alginate).....	94
<b>Figure 32:</b> Percent of inhibition of growth <i>P.fluorescens</i> for antimicrobial concentrations of carvacrol in the chitosan and sodium alginate coatings (C-carvacrol, Chi.-chitosan, S.alg.-sodium alginate).....	94
<b>Figure 33:</b> Percent of inhibition of growth <i>P.fluorescens</i> for antimicrobial concentrations of eugenol : carvacrol (1:1) in the chitosan and sodium alginate coatings (E-eugenol, C-carvacrol, Chi.-chitosan, S.alg.-sodium alginate).....	95
<b>Figure 34:</b> Inhibition disc test for chitosan coating on <i>E.coli</i> (right) and <i>P. fluorescens</i> (left). ....	95
<b>Figure 35:</b> Inhibition disc test for sodium alginate coating on <i>E.coli</i> (right) and <i>P. fluorescens</i> (left). ....	96
<b>Figure 36:</b> Diagram of the preparation of the coating. ....	98

**Figure 37:** Mushrooms coated with the coating of sodium alginate (left) and chitosan (right). ..... 99

**Figure 38:** Weight loss of *Agaricus bisporus* mushrooms during 10 days of storage at 6-8 °C (I- standard deviation). ..... 103

**Figure 39:** Moisture of *Agaricus bisporus* mushrooms during 10 days of storage at 6-8 °C (I- standard deviation). ..... 104

**Figure 40:** Total solids content of *Agaricus bisporus* mushrooms during 10 days of storage at 6-8 °C (I- standard deviation). ..... 104

**Figure 41:** TSS of *Agaricus bisporus* mushrooms during 10 days of storage at 6-8 °C (I- standard deviation). ..... 105

**Figure 42:** pH of *Agaricus bisporus* mushrooms during 10 days of storage at 6-8°C (I- standard deviation). ..... 106

**Figure 43:** Whiteness of cap the mushroom of *Agaricus bisporus* mushrooms during 10 days of storage at 6-8 °C (I- standard deviation). ..... 108

**Figure 44:** Redness of cap the mushroom of *Agaricus bisporus* mushrooms during 10 days of storage at 6-8 °C (I- standard deviation) ..... 108

**Figure 45:** Yellowness of cap the mushroom of *Agaricus bisporus* mushrooms during 10 days of storage at 6-8 °C (I- standard deviation). ..... 108

**Figure 46:** Colour difference of cap the mushroom of *Agaricus bisporus* mushrooms during 10 days of storage at 6-8 °C (I- standard deviation). ..... 108

**Figure 47:** Browning index of cap the mushroom of *Agaricus bisporus* mushrooms during 10 days of storage at 6-8 °C (I- standard deviation). ..... 108

**Figure 48:** Whiteness of stipe the mushroom of *Agaricus bisporus* mushrooms during 10 days of storage at 6-8 °C (I- standard deviation). ..... 109

**Figure 49:** Redness of stipe the mushroom of *Agaricus bisporus* mushrooms during 10 days of storage at 6-8 °C (I- standard deviation). ..... 109

**Figure 50:** Yellowness of stipe the mushroom of *Agaricus bisporus* mushrooms during 10 days of storage at 6-8 °C (I- standard deviation). ..... 110

**Figure 51:** Colour difference of stipe the mushroom of *Agaricus bisporus* mushrooms during 10 days of storage at 6-8 °C (I- standard deviation). ..... 110

**Figure 52:** Browning index of cap the mushroom of *Agaricus bisporus* mushrooms during 10 days of storage at 6-8 °C (I- standard deviation). ..... 110

**Figure 53:** Colour difference (ideal) of cap the mushroom of *Agaricus bisporus* mushrooms during 10 days of storage at 6-8 °C (I- standard deviation). ..... 110

**Figure 54:** PPO activity of *Agaricus bisporus* mushrooms during 10 days of storage at 6-8 °C (I- standard deviation). ..... 112

**Figure 55:** Yeasts and moulds count of *Agaricus bisporus* mushrooms during 10 days of storage at 6-8 °C ( $\bar{x}$ - standard deviation). ..... 113

**Figure 56:** Mesophilic count of *Agaricus bisporus* mushrooms during 10 days of storage at 6-8 °C ( $\bar{x}$ - standard deviation). ..... 114

**Figure 57:** Psychrophilic count of *Agaricus bisporus* mushrooms during 10 days of storage at 6-8 °C ( $\bar{x}$ - standard deviation). ..... 115

**Figure 58:** Evolution of the colour and firmness in coated mushrooms during storage time at the days 2, 6 and 10. .... 116

**Figure 59:** Evolution of the colour and firmness in uncoated mushrooms during storage time at the days 2, 6 and 10. .... 116

**Figure 60:** Pareto charts showing the effect of the components of coating in  $W_s$  values for sodium alginate solutions in pileus side. .... 155

**Figure 61:** Pareto charts showing the effect of the components of coating in  $W_s$  values for sodium alginate solutions in pileus top. .... 155

**Figure 62:** Pareto charts showing the effect of the components of coating in  $W_s$  values for chitosan solutions in pileus side. .... 155

**Figure 63:** Pareto charts showing the effect of the components of coating in  $W_s$  values for chitosan solutions in pileus top. .... 156

**Figure 64:** Pareto charts showing the effect of the components of coating in  $W_a$  values for sodium alginate solutions in pileus side. .... 156

**Figure 65:** Pareto charts showing the effect of the components of coating in  $W_a$  values for sodium alginate solutions in pileus top. .... 156

**Figure 66:** Pareto charts showing the effect of the components of coating in  $W_a$  values for chitosan solutions in pileus side. .... 157

**Figure 67:** Pareto charts showing the effect of the components of coating in  $W_a$  values for chitosan solutions in pileus top. .... 157

**Figure 68:** Pareto charts showing the effect of the components of coating in  $W_c$  values for sodium alginate solutions in pileus side. .... 157

**Figure 69:** Pareto charts showing the effect of the components of coating in  $W_c$  values for sodium alginate solutions in pileus top. .... 158

**Figure 70:** Pareto charts showing the effect of the components of coating in  $W_c$  values for chitosan solutions in pileus side. .... 158

**Figure 71:** Pareto charts showing the effect of the components of coating in  $W_c$  values for chitosan solutions in pileus top. .... 158

**Figure 72:** Molds observed during storage. .... 162

**Figure 73:** Mold observed with yeast during storage. .... 162

**Figure 74:** White mold observed during storage. .... 162

**Figure 75:** Black mold observed during storage. .... 162

**Figure 76:** Yeasts observed during storage..... 162

**Figure 77:** Mesophilic bacteria observed during storage. .... 163

**Figure 78:** Psichrophilic bacteria observed during storage. .... 163

# List of abbreviations

- ATCC** – American Type Culture Collection
- AOAC** – Association of Official Analytical Chemists International
- BI** – Browning Index
- CA** – Controlled Atmosphere
- CFU** – Colony Forming Unit
- DM** – Dry Matter
- DMSO** – Dimethyl Sulfoxide
- DPP** – 3-2,4-dihydroxyphenyl propionic
- E** – Elongation
- EFSA** – European Food Safety Authority
- EOs** – Essential Oils
- EU** – European Union
- FAO** – Food and Agriculture Organization
- FDA** – Food and Drug Administration
- GRAS** – Generally Reconized As Safe
- IC<sub>50</sub>** – 50% Inhibitory Concentration
- L-DOPA** – L-3,4-dihydroxyphenylalanine
- MAP** – Modified Atmosphere Packaging
- NCAUR** – National Center for Agricultural Utilization Research
- PCA** – Plate Count Agar
- PDA** – Potato Dextrose Agar
- PL** – Pulsed Light
- PPO** – Polyphenol Oxidase
- PVC** – Polyvinyl Chloride
- PVA** – Polyvinyl Alcohol
- RH** – Relative Humidity
- RQ** – Respiratory Quotient
- TSS** – Total Soluble Solids
- TS** – Tensile Strength
- USA** – United States of America
- WHO** – World Health Organization
- WM** – Wet Matter
- WVP** – Water Vapour Pressure
- WVPD** – Water Vapour Pressure Deficit



**WVTR** – Water Vapour Transmission Rate

**YM** – Young's Modulus

## List of symbols

$a$  – colour evaluation of red/green

$b$  – colour evaluation of yellow/blue

$[E]$  – concentration of enzyme

$[I]$  – concentration of inhibitor

$K_i$  – equilibrium constant for the dissociation of enzyme inhibitor complexes

$K_M$  – Michaelis-Menten constant

$L$ -value – colour evaluation of whiteness/lightness or light/dark

$M_0$  – weight on the first day

$M_i$  – weight measured at day  $i$

$[S]$  – concentration of substrate

$v_{max}$  – maximum reaction velocity

$W_a$  – Work of Adhesion

$W_c$  – Work of Coesion

$W_s$  – Spreading Coefficient or Wettability

$\gamma_c$  – Critical Surface Tension

$\gamma_L^d$  – Pure Liquid Dispersive

$\gamma_L^p$  – Pure Liquid Polar

$\gamma_{LV}$  – Surface Tension (or interfacial liquid-vapour tension)

$\gamma_s^d$  – Dispersive Surface of the Solid

$\gamma_s^p$  – Polar Surface of the Solid

$\gamma_{SL}$  – Interfacial Solid-Liquid Tension

$\gamma_{SV}$  – Interfacial Solid-Vapour Tension

$\Delta E$  – Colour Difference

$\Theta$  – Contact Angle

## Structure of the dissertation

This dissertation is organized in 5 chapters, starting with the General introduction, then Optimization of the coating, Evaluation of bioactive compounds, Coating application and evaluation of shelf-life parameters and General conclusion and future work. The first chapter provides a general introduction which is divided into 5 parts. The first part is about the production of *Agaricus bisporus* as well as their chemical and nutritional composition, the main factors of postharvest deteriorating and the existing methods to extend their shelf-life. The second part of the first chapter describes in greater detail edible coatings as a method of extension of shelf-life which can be used in mushrooms. Here three different types of coatings are explored: chitosan, alginate and guar gum-based coatings, that will be used throughout the work. In addition, subjects such as the potential use of active agents in edible coatings (e.g. antimicrobial and anti-browning agents) and the main properties of the coatings mentioned above are also explored. The third and fourth parts of the first chapter address the regulatory status and criteria for choosing the type of coating, respectively. Finally in the fifth part contains the objectives of this thesis.

The subsequent chapters present the experimental results with the corresponding discussion and the main achievements of this work. Chapter 2 includes the results regarding the optimization of the coatings that will be used. Chapter 3 is where the bioactive compounds are studied, including their selection, activity and concentration for incorporation in coatings that were selected in the previous chapter. Chapter 4 the coating is applied on mushrooms and the analyses of several shelf-life parameters are performed.

Finally, the main conclusions are presented, together with suggestions for future work.

---

# CHAPTER I

## General introduction

---

# Chapter I – General introduction

## 1.1. Mushrooms

The human relationship with mushrooms is old and fascinating and throughout history there are several examples that they have been used by humans for multiples purposes. The Egyptians believed that mushrooms were a gift from the god Osiris. The ancient Romans also thought it was a divine food due their believes that the mushrooms were sent to the earth through lightning thrown by Jupiter during a storm. Already in ancient Greece, warriors believed that mushrooms source to give strength and courage. In Egypt, the pharaohs used them as a special gift and Rome claimed to be the "food of the gods" and therefore should be served only on special occasions (Manzi, Gambelli et al. 1999). Among Chinese, mushrooms were considered true "elixir of life" and used as good for health foods, and even among Mexican Indians they were used as hallucinogens and in religious rituals and witchcraft, as well as with therapeutic purposes (Chang and Miles 1989).

In Asian countries they began to be cultivated since 600 years BC (Aida, Shuhaimi et al. 2009). For thousands of years they have been part of a human diet, and in recent years the consumption of mushrooms have increased substantially, involving a larger number of species (Mattila, Konko et al. 2001). There are known 3 000 species of mushrooms, considered "prime edible species", being 100 of them commercially cultivated and 10 of those produced in industrial-scale (Chang and Miles 2004).

In Western culture consumption of mushrooms has increased, mostly involving species related to the popular "champignon" or also called the white button (Figure 1) (Mattila, Konko et al. 2001). The most cultivated mushroom worldwide is *Agaricus bisporus* (champignon), followed by *Pleurotus spp.* and *Lentinus edodes* (shiitake) (Roupas, Keogh et al. 2010; Rühl, Fischer et al. 2008; Sánchez 2004).



**Figure 1:** *Agaricus bisporus* (white button)  
(<http://mycitygarden.com.au/products/260/>).

### 1.1.1. Production

In last decades the production of mushrooms and truffles has been increased almost every each year according to Food and Agriculture Organization (FAO) (Figure 2). The last data provided by FAO dates from 2013 where in the production of truffles and mushrooms was almost 10 million t (tones), being China the largest producer with an output of over 7 million t. In Portugal the production of mushrooms and truffles is only 1 240 t, representing a very small share of global production. Table 1 shows the countries with higher production by continent and in Figure 3 is presented the production share by continent.

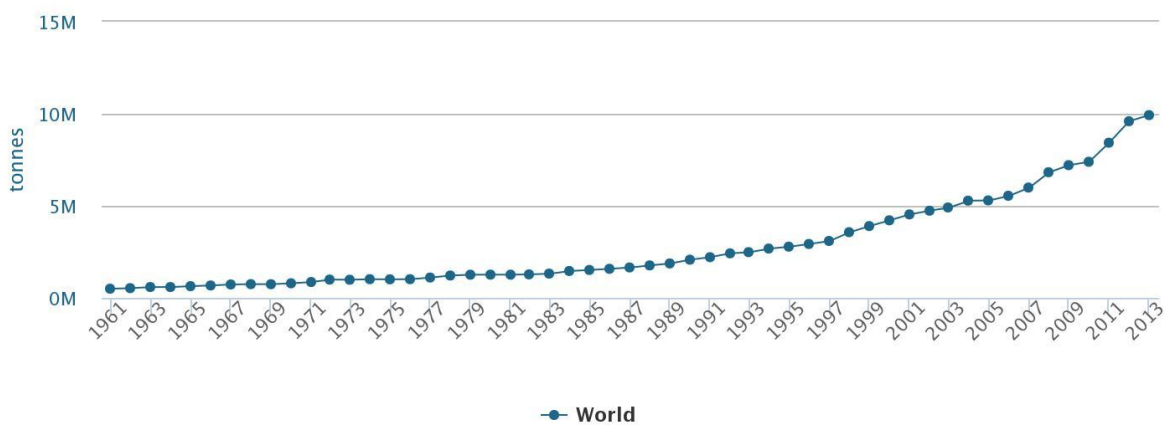


Figure 2: Production of mushrooms and truffles in the world 1961 – 2013 (M=million) (FAOSTAT 2015).

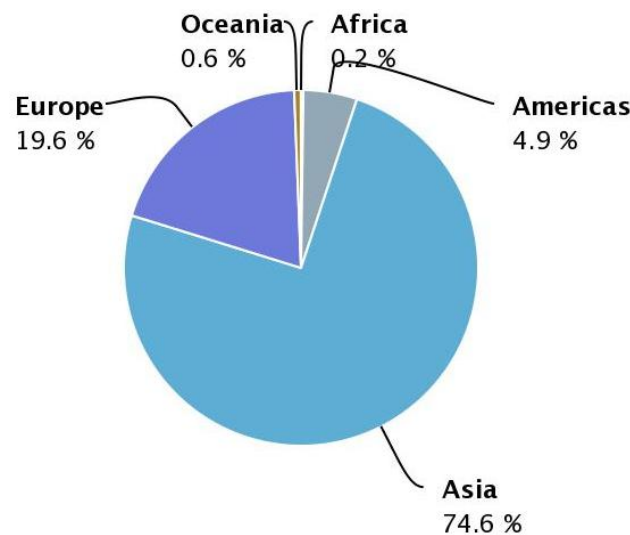


Figure 3: Production share by region in 2013 (FAOSTAT 2015).

**Table 1:** Top mushrooms and truffles cultivation, in tones (t), 2013 data (FAOSTAT 2015).

Continent	Production (t)	Country	Production (t)
Africa	21 185	South Africa	14 284
America	487 986	United States of America	406 198
		Canada	81 788
Asia	7 409 100	China	7 076 842
		Iran	87 675
		Japan	61 500
Europe	1 948 6257	Italy	792 000
		Netherlands	323 000
		Poland	220 000
		Spain	149 000
		France	104 621
		United Kingdom	79 500
		Ireland	63 600
		Germany	59 884
Oceania	60 070	Australia	49 954
World	9 926 966		

The global economic value of mushrooms is now staggering and the reason for the rise on the consumption is a combination of their nutritional value (Kalac 2009) and their medicinal or nutraceutical properties (Ferreira, Barros et al. 2009; Ferreira, Vaz et al. 2010).

Mushrooms have been cultivated for many years and the procedure is well standardized. In 1630, in France, it was found that mushrooms could develop on suitably prepared beds of horse manure in gardens. A few years later, mushrooms were cultivated in caves where the constant environmental conditions increased crop yields and the cultivation was no longer dependent on seasons and weather conditions. Today, mushroom cultivation is carried out in specialized mushroom houses, with artificial control of optimal environmental parameters such as relative humidity (RH), carbon dioxide (CO<sub>2</sub>), temperature and aeration (Godfrey 2003). This system allows

the recycling of agricultural and agro-industrial residues emerging as a promising agro-based land-independent enterprise (Singh, Langowski et al. 2010).

Mushroom culture involves different stages to be carefully performed. Several operations like substrate preparation, inoculation, incubation, and production conditions depends on the type of mushroom to be cultivated. Figure 4 shows an example for *A. bisporus*, *L. edodes* and *Pleurotus sp.* The first stage involves the obtaining of pure mycelium (from a specific *A. bisporus*, *L. edodes* and *Pleurotus sp.*) that can be obtained from spores (Figure 4a), a piece of the specific mushroom (Figure 4b) or from several germplasm (Figure 4c). To obtain the inoculum, the mycelium is developed on cereal grain, e.g., wheat, rye, or millet (Figure 4d), which is usually called the “spawn” (Figure 4e) where their quality is one of the keys to the successful production of mushrooms (Chang and Hayes 1978; Chang and Miles 1989). The purpose of the mycelium-coated grain is to rapidly colonize the specific bulk growing substrate (Figure 4f). The “spawn” must be prepared under sterile conditions to diminish contamination of the substrate (Figure 4g) (Sánchez 2010).

Regarding the mushroom with higher global production, *A. bisporus*, its substrate is the most complex culture medium used for edible mushroom production (Figure 4i). The substrate for the cultivation of this mushroom is horse manure compost, which consists on a mixture of horse manure, some broiler chicken manure, and water to which gypsum is added for structural stability and for stabilizing pH. Beyond this type of substrate can be used another, a synthetic compost that is based on wheat straw and broiler chicken manure. When carried out in the open air, phase I of composting is done in long narrow stacks, sized between 1.5 and 2.0 m in width and height (wind-rows). The stacks are turned twice a week in order to obtain uniform degradation of the mixture. At the end of the process, usually 7–8 days after setting up the stacks of 1 t of horse manure, a yield of just over 1 t of compost will have been obtained. This fresh compost (phase I), which still smells strongly of ammonia, is subjected to phase II treatment before actual cultivation can start. Phase II consists of a pasteurization process followed by further high-temperature fermentation. This is done by raising the air temperature to 56 °C and keeping it there for approximately 5 to 6 hours (h). Compost temperature then increases to slightly higher values, and this is maintained for at least 5 more hours. Thereafter, the compost is kept at a temperature of approximately 45 °C for 4–5 days until all the ammonia has evaporated. Both phases I and II of the composting process can take place in bulk in special fermentation rooms called tunnels. When that process has been completed, the compost can be spawned, and the mycelium can develop in either the same or another tunnel. Phase III then



yields fully grown compost ready for production (Van Griensven and Van Roestel 2004; Sánchez 2010).

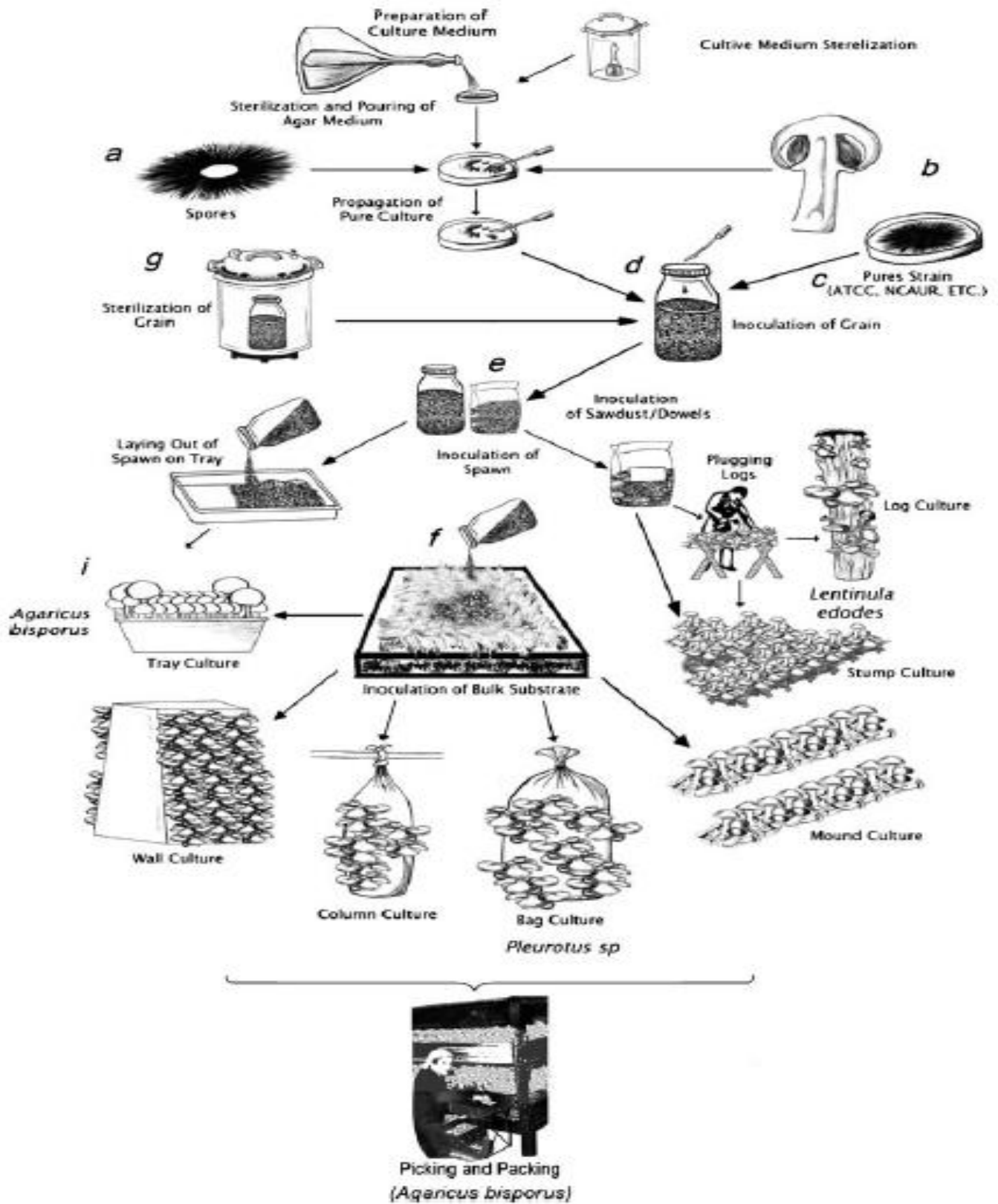


Figure 4: Schematic representation of the production of three types of mushrooms. Source – Sanchez (2010).

### 1.1.2. Chemical and nutritional composition

Mushrooms are appreciated not only for the texture and flavour but also for their chemical and nutritional characteristics. They are mainly water, containing about 92% (mass/mass) of this element (Donker and Van As 1999). Removing the high content of water, mushrooms contain a relatively high content of macronutrients and low calorific value.

Several publications describe the mushroom as a food of high protein value, a source of dietary fiber, with high content of vitamins (e.g. B2, niacin, and folates), minerals (e.g. potassium, phosphorus, zinc and copper), essential amino acids, and rich in polysaccharides, in addition to having a low fat content (Mattila, Konko et al. 2001; Vetter 2003; Fernandes, Antonio et al. 2012; Mohebbi, Ansarifard et al. 2012; Lagnika, Zhang et al. 2013; Liu, Wu et al. 2013). Moreover, mushrooms contain polyphenolics and flavonoids recognized as excellent antioxidants (Mohebbi, Ansarifard et al. 2012; Lagnika, Zhang et al. 2013).

Dry matter (DM) of and cultivated mushrooms is very low, commonly ranging between 80 and 120 g kg<sup>-1</sup> (Table 2). Typical carbohydrates constituents are: chitin, glycogen, mannitol and trehalose, moreover, some are only partially digestible or indigestible (e.g. mannitol and chitin) and calculated energy value available is thus somewhat overestimated (Fernandes, Antonio et al. 2012; Kalac 2013).

Mushrooms also contain various acids, and the content of prevailing acids decreased in the order malic > fumaric ≈ citric > oxalic acid (Ribeiro, Lopes et al. 2008).

#### 1.1.2.1. Proteins and amino acids

Mushrooms are considered a good source of protein, for most foods the protein content is calculated using a correction factor based on the contents of organic nitrogen. The factor 6.25 takes on that proteins contain 16% nitrogen and are fully digestible. This factor neglects the amounts of non-protein nitrogen compounds in food which are, in most cases, negligible. The mushrooms, however, have a significant amount of non-protein nitrogenous compounds in their cell walls (i.e. chitin), and such compounds are not digestible. For a true approximation of the protein content in mushrooms the factor 4.38 is adopted, since this value assumes that only 70% of existing nitrogenous compounds in the mushroom are digestible by the human body ( $0.70 \times 6.25 = 4.38$ ) (Breene 1990). Although this factor may not represent the correct value for protein in mushrooms, as there may be differences between species in the content of: chitin, ammonia and other non-protein nitrogen compounds (Furlani and Godoy 2005).

Chang and Miles (1989) suggest that *A. bisporus* contains, on a DM, from 23.9 to 34.8% of crude protein; for *Pleurotus* this value varies from 10.5 to 30.4% and for *L. edodes* the values ranged from 13.4 to 17.5%. Wang, Sakota et al. (2001) analyzed the amino acid composition in species of *Pleurotus* and verified the presence of high-essential amino acids, 126.7 mg/g dry weight, a total of 347.5 mg/g of total amino acids, presenting this mushroom all essential amino acids. Manzi, Gambelli et al. (1999) studied *A. bisporus* mushroom and found that this species contained all the essential amino acids, being the most abundant glutamic acid, aspartic acid and arginine. Table 2 presents the protein content in other species of mushroom.

Mushrooms contain various proteins with interesting biological and particularly medicinal activities (lectins) (Kalac 2013) and proportion of essential amino acids is nutritionally favorable (Fernandes, Antonio et al. 2012).

**Table 2:** Dry matter (g kg<sup>-1</sup>), proximate composition (g kg<sup>-1</sup>) and energy (kcal kg<sup>-1</sup> fresh matter) in some cultivated mushrooms (Kalac 2013)

Species	Dry matter	Crude protein	Lipids	Ash	Carbohydrates	Energy
<i>Agaricus bisporus</i>						
White	87.3	140.8	21.8	97.4	740.0	325
Brown	83.6	154.3	16.7	113.6	715.4	303
Unspecified	—	264.9	25.3	87.8	622.0	—
Unspecified	97.0	363.0	8.0	120.0	509.0	—
<i>Agaricus brasiliensis</i>						
<i>Flammulina velutipes</i>	121.3	38.7	28.9	72.5	859.9	467
	—	266.5	92.3	75.1	566.1	—
<i>Hypsizigus marmoreus</i>						
Normal strain	—	196.0	40.9	77.5	685.6	—
White strain	—	210.6	56.2	82.6	650.6	—
<i>Lentinula edodes</i>						
	202.2	44.0	17.3	67.3	871.4	772
	—	204.6	63.4	52.7	679.3	—
<i>Pleurotus ostreatus</i>						
	108.3	70.2	14.0	57.2	858.6	416
	—	238.5	21.6	75.9	664.0	—
	100.0	416.0	5.0	60.0	519.0	—
	88.0	166.9	54.5	67.0	711.6	—
<i>P. eryngii</i>						
	110.0	110.0	14.5	61.8	813.7	421
	—	221.5	15.7	57.6	705.2	—
<i>P. sajor-caju</i>						
	100.0	374.0	10.0	63.0	553.0	—

### 1.1.2.2. Lipids

The mushrooms have a lower amount of lipids, ranging from 1.1 to 8.3% (DM) (Chang and Miles 1989). Longvah and Deosthale (1998) studied edible mushrooms from northeast India, and quantified 2.1% of fat in the species *L. edodes* and the analysis of fatty acids, found that 77.7% of lipids were made up of unsaturated fatty acids, predominantly linoleic acid (Longvah and Deosthale 1998).

Mushrooms marketed in Taiwan and analyzed by Yang, Lin et al. (2001) showed that lipid levels ranged from 2.16% (*P. ostreatus*) to 6.3% (*L. edodes*) values on a DM. In Italy, the fat values analyzed are 0.33 and 0.36%, on wet matter (WM), for *A. bisporus* and *P. ostreatus*, respectively (Manzi, Aguzzi et al. 2001).

Ten fatty acids have been identified in mushroom lipids, however, only linoleic acid (C18:2c, n-6) and oleic acid (C18:1c, n-9) clearly prevail, forming a proportion of two-thirds and more of the weight of all identified fatty acid. Saturated palmitic acid (C16:0) is third in this order, but at a great distance. Nutritionally undesirable elaidic acid, being a *trans* isomer of oleic acid, was reported at very low levels. The contents of odd, branched-chain and hydroxy fatty acids are negligible (Kalac 2013). The nutritional contribution of mushroom lipids is limited due the low total lipid content and a low proportion of desirable n-3 fatty acids and its content is negligible (Fernandes, Antonio et al. 2012; Kalac 2013). Nevertheless, linoleic acid is a precursor of the attractive smell of dried mushrooms (Kalac 2013). More data of lipids in mushrooms is presented on Table 2.

### 1.1.2.3. Carbohydrates and fiber

In addition to water, carbohydrates are also major components of the mushroom. Carbohydrates are presented in values ranged between 3 and 28% and the fibers from 3 to 32%, on a dry basis. The mushroom *A. bisporus*, one of the most studied species, contains pentoses (xylose and ribose), hexoses (glucose, galactose, mannose), sucrose, methyl pentose (ramose, fucose) and other sugars (mannitol, inositol, glucuronic and galacturonic acids and glucosamine). The polymer of N-acetylglucosamine, called chitin is a major structural polysaccharide found in the cell wall of the fungus (Furlani and Godoy 2005).

Most analytical studies expresses on the literature determine the carbohydrate content in mushrooms by difference, that is, subtracting all the other components (proteins, lipids and ash) to the total content (100%) (Manzi, Gambelli et al. 2001; Martin-Belloso and Llanos-Barriobero 2001; Yang, Lin et al. 2001). The values vary for each species, *Pleurotus spp.* present values between 6.69 and 7.59%, in WM; *L.edodes* presents values ranged between 5.37 and 5.85% and *A. bisporus* presented

values from 0.80 to 5.24% (excluding fibers). More data concerning carbohydrates content in mushrooms is present in Table 2.

Dietary fiber are compounds (i.e. lignin and polysaccharides) of plant which are not digested by man's digestive enzymes and are classified according to their solubility in water as soluble and insoluble fibers and are composed by: cellulose, hemicellulose, gums, pectins and mucilages (Furlani and Godoy 2005). Contents are about 40–90 and 220–300 g kg<sup>-1</sup> DM for soluble and insoluble fiber, respectively. The relatively high content of particularly insoluble fiber is presented as a nutritional advantage (Kalac 2013).

Mannitol and trehalose (Table 3) are, respectively, the main representatives of alcoholic sugars and oligosaccharides. Recently, Reis, Barros et al. (2012) determined that values in mannitol and trehalose in some cultivated species are extraordinarily high 480, 495, 641 g kg<sup>-1</sup> DM and 167, 217, 412, 728 g kg<sup>-1</sup> DM for mannitol and trehalose, respectively (Table 3). Mannitol participates in volume growth and firmness of fruiting bodies and its digestibility for humans is low (Kalac 2013). Preservation processes of mushrooms such as drying and freezing cause a decreasing in content of mannitol and trehalose less pronounced than boiling (Barros, Baptista et al. 2007).

**Table 3:** Free sugar contents (g kg<sup>-1</sup> DM) in cultivated mushrooms (Kalac 2013).

Species	Ribose	Xylose	Mannose	Mannitol	Glucose	Fructose	Sucrose	Trehalose
<i>Agaricus bisporus</i>								
Brown	n.d.	1.45	84.6	—	4.68	n.d.	n.d.	n.d.
	—	—	—	480	—	4.78	n.d.	26.3
White	—	—	—	641	—	3.44	n.d.	18.3
<i>A. brasiliensis</i>	—	—	—	79.4	27.6	—	—	29.8
<i>Flammulina velutipes</i>	11.5	51.6	7.51	—	11.3	n.d.	n.d.	2.33
	—	—	—	80.0	—	379	7.42	217
<i>Hypsizigus marmoreus</i>	n.d.	—	n.d.	22.6	—	2.71	—	9.84
Normal strain								
White strain	n.d.	—	11.3	18.2	—	2.73	—	44.8
<i>Lentinula edodes</i>	2.40	7.98	23.1	—	36.3	n.d.	2.33	2.55
	—	—	—	495	—	34.1	n.d.	167
<i>Pleurotus ostreatus</i>	0.85	n.d.	10.6	—	14.3	n.d.	n.d.	3.03
	n.d.	—	—	31.6	11.5	n.d.	n.d.	32.8
	—	—	—	50.3	—	0.93	n.d.	412
<i>P. eryngii</i>	5.02	1.55	13.6	—	27.8	n.d.	n.d.	7.15
	—	—	—	54.5	—	2.73	2.73	728

n.d., content below detection limit

Chitin is a water-insoluble, structural N-containing polysaccharide. The polymer is characterized by  $\beta$ -(1 $\rightarrow$ 4)-branched *N*-acetylglucosamine units. Partial desacetylation of chitin yields chitosan (Kalac 2013). Chitin accounts for up to 80–90% DM in mushroom cell walls. In a recent study, chitin content was determined for several mushrooms species, with values of 7.6, 18.7, 31.6, 46.9 and 98.6 g kg<sup>-1</sup> DM for *P. ostreatus*, *L. edodes*, *P. eryngii*, *A. bisporus* and *F. velutipes*, respectively (Nitschke, Altenbach et al. 2011). Nevertheless, chitosan was detected only in part of the samples. This indicates that most of the amino groups of the glucosamine units are acetylated. Chitin is indigestible for humans, and apparently decreases the digestibility of other mushroom components (Kalac 2013).

#### 1.1.2.4. Vitamins

The mushrooms can be a good source of vitamin B1, B2, niacin, biotin and vitamin C. The vitamins presented in *A. bisporus*, vitamin B1, B2, B6 and C, were analyzed being obtained values 0.10, 0.29, 0.09 and 11.50 mg/100g, respectively (Furlani and Godoy 2005). Another study with the same species, vitamin B1 and B2 were analyzed, and the obtained values were 0.1 and 0.64 mg/100g, respectively (Esteve, Farre et al. 2001), yet another study, analyzed the same mushroom and vitamins plus vitamin B6 and the results were 0.041; 0.162 e 0.042 mg/100g, respectively (Martín-Belloso and Llanos-Barriobero 2001).

Mattila, Konko et al. 2001 determined the content of vitamins B1, B2, B12, C, D, niacin and total folate in *A. bisporus* (white and brown), *L. edodes* and *P. ostreatus* and found that mushrooms are good sources of vitamins, especially B2, niacin, and folate. The *L. edodes* showed the highest levels of vitamin C (2.1 mg/100g), B12 (0.07 $\mu$ g/100g) and D (0.1  $\mu$ g/100g). The species *P. ostreatus* showed the higher content of vitamins B1 (0.07 mg/100 g) and folate (0.051 mg/100g) and *A. bisporus* species (marrom) showed the higher content of niacin (4.1 mg/100g). *A. bisporus* species (white) showed higher values of vitamin B2 (0.39 mg/100g).

#### 1.1.2.5. Mineral composition

The mineral composition in mushrooms can be estimated by determining the ash content that ranges between 52 and 120 g kg<sup>-1</sup> DM (Table 2). Nevertheless, the variability of ash contents seems to be lower than that of crude protein, lipids and carbohydrates. The usual contents of seven major elements are given in Table 4. Potassium is the prevailing element, while calcium and sodium are the minerals in lower content. Overall, the content of ash and particularly of phosphorus and potassium

is somewhat higher than or comparable to those obtained in other foods, such as vegetables (Kalac 2013).

**Table 4:** Usual contents ( $\text{g kg}^{-1}$  DM) of major mineral elements in cultivated mushrooms in descending order (Kalac 2010).

Element	Content
Potassium	20 – 40
Phosphorus	5 – 10
Chlorine	1 – 6
Sulfur	1 – 6
Magnesium	0.8 – 1.8
Calcium	0.1 – 0.5
Sodium	0.1 – 0.4

#### 1.1.2.6. Other considerations

In addition, mushrooms in general have a history of traditional use in oriental therapies and modern clinical practices continue to rely on mushroom-derived preparations. They accumulate a variety of bioactive metabolites (e.g. phenolic compounds, polypeptides, terpenes, steroids and polysaccharides) with immunomodulatory, cardiovascular, liver protective, anti-fibrotic, anti-inflammatory, anti-diabetic, anti-viral, antimicrobial activities, hypoglycemic, hypocholesterolemic, and antitumor properties (Ferreira, Vaz et al. 2010; Lagnika, Zhang et al. 2013).

More particularly, *A. bisporus* has been demonstrated to possess various valuable biological properties and medicinal compounds. The potential source of health-protecting including antitumor, antimicrobial, immunomodulatory, anti-inflammatory and antioxidant activities (Meng, Song et al. 2012; Liu, Wu et al. 2013). The white button mushroom is widely recognized for its nutritional, organoleptic and medicinal properties, and is highly popular among consumers (Gao, Feng et al. 2014).

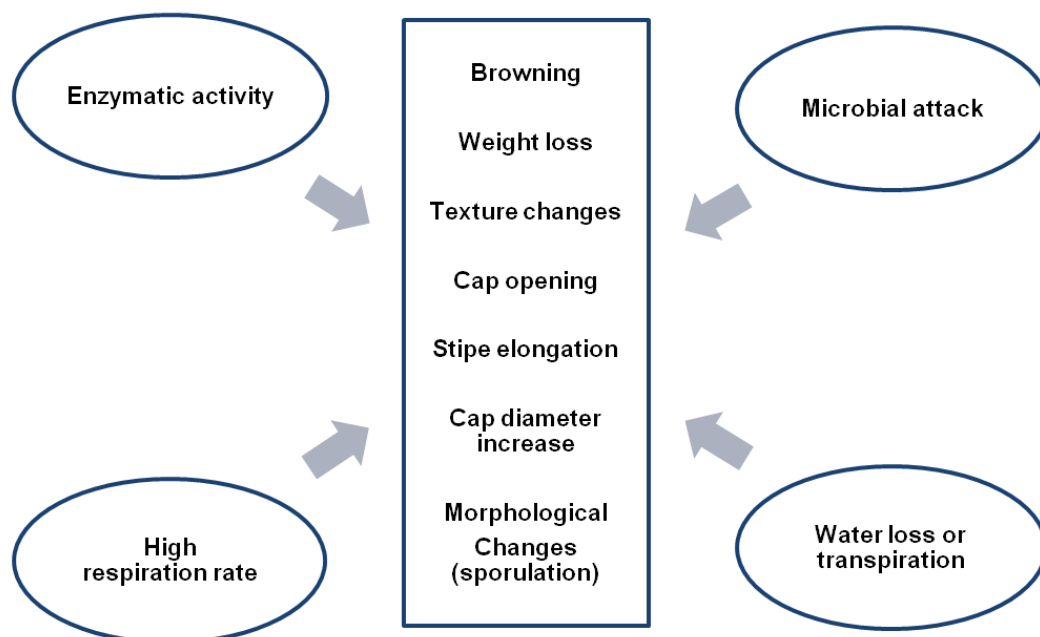
The data collected shows that there is a big difference in the percentages of macro and micro nutrients found in mushrooms. These values often discrepant, may originate from several points, since the choice of species, strains and varieties to the type of substrate used, the degree of maturation and the type of storage and the conservation process (Furlani and Godoy 2005).

Although there is a big difference in composition of mushrooms, these can be considered excellent food because of their nutritional characteristics, since they have high content of protein and carbohydrates and low in fat, resulting in a low calorific value. They also have considerable amount of dietary fiber and may be considered

source of essential amino acids and although cannot be considered source of vitamins, may contribute to the intake of the same on the diet (Furlani and Godoy 2005).

### 1.1.3. Main factors of postharvest deterioration

Fresh produce continues to lose water after harvest and, especially for mushrooms, this is a major problem causing shrinkage and weight loss. The weight loss of 5-10% on a fresh product makes it starts to shrink or constrict, making it unusable for consumption. Being mushrooms very sensitive to moisture, misfits humidity levels can cause serious damage to the product. For high levels of humidity, microbial growth and discoloration is favored, whereas low levels will lead to weight loss (and hence loss of economic value) and undesirable changes in texture (Singh Langowski et al. 2010). Bacteria, moulds, enzymatic activity (mainly polyphenol oxidase, PPO) and biochemical changes can cause spoilage during storage (Fernandes, Antonio et al. 2012) (Figure 5). Furthermore, the browning of mushroom cells occurs when they are subjected to forces that can disrupt cellular integrity such as vibrations, rough handling, and ageing (Beaulieu, D'Aprano et al. 2002; Fernandes, Antonio et al. 2012; Jiang, Luo et al. 2010).



**Figure 5:** Schematic representation of the factors that cause biochemical changes in mushrooms. Adapted for Fernandes, Antonio et al. (2012).

Mushrooms are one of the most perishable products and tend to lose quality after harvest, being an impediment for the distribution and marketing of the fresh product (Liu, Wu et al. 2013). Usually their shelf life is 1–3 days at ambient temperature under usual shipping and marketing conditions, mainly because they have no cuticle to



protect them from physical or microbial attack and water loss (Mahajan, Oliveira et al. 2008). In a modified atmosphere, the shelf-life can vary from 8 to 14 days, when storage at 3 °C with 2–5% O<sub>2</sub> (oxygen) and 3–8% CO<sub>2</sub> (De la Plaza, Alique et al. 1995). At high temperatures the mushrooms are saleable during about 3–5 days at 11 °C and 90% RH, but at 13 °C shelf life is reduced to less than 3 days (Singh, Langowski et al. 2010).

As mentioned in the previous section, the mushroom is constituted by a huge amount of water, losing large amounts of water, in their gas state. Due to the epidermal fine porous structure, the respiration rate (consumption O<sub>2</sub>) is relatively high (200-500 mgkg<sup>-1</sup>h<sup>-1</sup> at 20 ± 1°C) in comparison with fruits and vegetables (Singh, Langowski et al. 2010). This water vapor may accumulate in the form of drops on packet at the top of the package which is surrounded by plastic, and may fall in mushrooms, which will cause an increased moisture on the surface of the mushrooms, favoring microbial growth making mushrooms brown and spotted (Brennan, Le Port et al. 2000).

There are several indicators that determine the quality of mushrooms, such as whiteness, cap development, stipe elongation, number of ripe spores, respiration rate, mannitol content, weight loss and microbial deterioration (Lukkasse and Polderdijk 2003). The European Union (EU) provides guidelines for classification of cultivated mushrooms according to their appearance. Mushrooms classified as “Extra class” have superior quality; in this cases only very slight superficial defects are permitted and they should be practically free of casing material. Mushrooms in “Class I” have good quality and slight defects in shape and/or colouring, slight superficial bruising and only slight traces of casing materials are permitted. Mushrooms classified as “Class II” may have defects in shape or colouring, slight bruising or damage to the stalk, hollow stalks, slight internal moisture of stalks, and traces of casing material (Taghizadeh, Gowen et al. 2011). More precisely for *A. bisporus* specie, mushrooms are placed in six whiteness categories, measuring the *L*-value (whiteness), being categorized from excellent, *L* > 93, to very poor, *L* < 69. Mushrooms with *L* values <80 or <69 were considered unacceptable from a whiteness point of view at wholesale or consumer level, respectively (Singh, Langowski et al. 2010).

There are many factors associated with the mushrooms deterioration, for example, the impact of the RH on the appearance and texture is attributable to water loss. Many studies have been conducted evaluating the effects of temperature and RH in the mushrooms appearance (colour, brightness, wrinkles, weight loss, etc.) (Singh, Langowski et al. 2010).

Especially for *A. bisporus* button mushroom, quality is determined by colour, texture, cleanliness, maturity and flavour (Weijn, Tomassen et al. 2012). Of these,

colour is the most important parameter because it is first perceived by consumers and discolouration decreases the commercial value (Burton 2004; Weijn, Tomassen et al. 2012). The mushrooms are very sensitive to touch, being prone to develop brown spots, particularly those of lighter color, in particular *A. bisporus* white button, wherein the brown spots make up highlight. These stains may be caused by bad handling or even damage due to mechanical action during harvest, by microbial contamination or even to senescence of the fruit itself (Jolivet, Arpin et al. 1998; Weijn, Tomassen et al. 2012).

Many times during the transport of fresh produce companies have no ability to maintain optimal conditions for each type of product storage. Being the fresh fruits and vegetables are those who suffer greater damages and fluctuations of temperature during retail (Paull 1999). Despite the efforts of agricultural production, classification and packaging, one of the main problems in mushroom production is the uncontrollable effect of the product variability. The mushrooms arrive at retail in different batches of mushrooms that have different stages of maturity and in every batch there are product heterogeneity (Aguirre, Frías et al. 2008).

It becomes essential to understand which factors contribute to spoilage of mushrooms for a subsequent application of a conservation process appropriate of their characteristics and remain the freshness inherent a fresh produce.

#### **1.1.3.1. Temperature and relative humidity**

Water loss or transpiration is an important physiological process that affects the main quality characteristics of fresh mushrooms, such as weight, appearance and texture (Singh, Langowski et al. 2010).

The conditions of transportation and storage of a product have to be suited to the characteristics of it. For example, the mushrooms require a high rate of RH. There are parameters of transportation and storage more facies to control than others. The temperature is more easily controllable by the refrigeration equipment, necessary for a longer shelf life of fresh mushrooms during storage condition. However, the RH is also a factor to take into consideration, but it is more difficult to control in practice in large spaces with small fluctuations (Singh, Langowski et al. 2010).

The storage temperature is a major factor affecting the maturation and qualities of mushrooms and their fluctuations can became many oxidases active and increased physiological activities, speeding the maturation and causing several damages (Pai 2000). Nichols and Hammond (1973) overwrapped *A. bisporus* in styrene pre-packs with one of a range of plastic films for 3–5 days at 2 or 18 °C and concluded that the internal atmosphere of the pre-pack was very rapidly modified at 18 °C by the

respiration of the mushrooms. Low temperature has a positive effect in lowering biochemical reaction rates on fresh mushrooms and moisture was variable with the greatest effect on the transpiration rate compared with the temperature (Mahajan, Oliveira et al. 2008).

There are graphical representations such as psychrometric charts that give a graphical representation of the relationship between temperature, RH and water vapour pressure (WVP) in moist air (Gaffrey 1978). The rate of evaporation from a fresh commodity is dependent on water vapour pressure deficit (WVPD) which is the difference between actual vapour pressure and the saturated vapour pressure at a specific temperature. If the product is not at the surrounding air temperature, even if there is high rate of RH, it will not prevent moisture loss product. In the presence of a high RH, a small change in temperature ( $<0.5$  °C) can result in condensation on cool surfaces. Recently, there have been cold rooms and shipping containers with newer refrigeration controls, more rugged humidity detectors and humidification technologies increased the ability to vary both temperature and RH (Rai and Paul 2007).

However, a very high RH ( $\approx 100\%$ ) can maintain growth of microorganisms on the surface of *Agaricus* causing its decomposition. Typically, the RH should be maintained between 90-95% for horticulture product during storage, being 95% for *Agaricus* avoiding excessive water loss (Zhu, Wang et al. 2006). Aguirre, Frías et al. (2009) studied the effect of different temperatures and RH on the decrease of whiteness and appearance of brown spotting using an image analysis system. They showed that the kinetics of colour degradation and spotting followed a logistic pattern, and that the best storage conditions to delay the onset of browning and spotting could be found at high RH ( $<90\%$ ) and refrigeration temperatures as high as 11 °C.

#### 1.1.3.2. Respiration rate

Respiration is a metabolic process that provides energy for the plant biochemical processes. The ratio of  $\text{CO}_2$  produced to  $\text{O}_2$  consumed, known as the respiratory quotient (RQ), is normally assumed to be equal to 1.0 if the metabolic substrates are carbohydrates (Kader, Zagory et al. 1989). Beit-Halachmy and Mannheim (1992) found an RQ of approximately 1 for mushrooms at 20 °C and at  $\text{O}_2$  levels greater than 1.5–2%; below this  $\text{O}_2$  level, RQ increased rapidly to a value higher than 6. The internal factors affecting respiration are type and maturity stage of the product (Singh, Langowski et al. 2010). Even different varieties of the same product can exhibit different respiration rates. It is necessary very careful when packing mushrooms in modified atmosphere packaging (MAP) due to alterations in respiration rate over time that are not normally considered in MAP design (Rai and Paul 2007).

Mushrooms have a high respiratory rate and their postharvest behaviour will change. First, there is a rapid fall in respiratory rate compared to high values at harvest, which lasts for 5–10 h and in which the respiration may decrease by more than 50%. The magnitude of this fall decreases as the maturity of the sporophore at harvest increases (Singh, Langowski et al. 2010). After there is a slow decline in respiratory rate. Superimposed on this pattern of decreasing respiration there may be a peak in CO<sub>2</sub> production, the occurrence and timing of which depend on the stage of development of the sporophore at harvest and which roughly coincides with the opening of the mushroom (Burton, Partis et al. 1997). The overall decline in respiratory activity seen after harvest is due to the exhaustion of substrates and senescence of the tissues (Singh, Langowski et al. 2010).

At every 10 °C increase, within the range of temperatures normally encountered in the distribution and marketing chain, biological reactions can increase two to three times (Mahajan, Oliveirra et al. 2008). Enzymatic denaturation can occur at higher temperatures, reducing the rates of respiration, but if temperatures are too low it may result in physiological damage leading to increased respiration rate (Qi 1982).

Concentrations of gases such as O<sub>2</sub> and CO<sub>2</sub> are other external factors affecting respiration, this can be delayed by decreasing the available O<sub>2</sub> reducing the overall metabolic activity (Kader, Zagory et al. 1989). The temporary increase in CO<sub>2</sub> production shown by mushrooms at some developmental stages demonstrates that factors other than a shortage of substrate limit the absolute rate of respiration of the freshly harvested sporophore (Donker and Van as 1999).

#### **1.1.3.3. Browning**

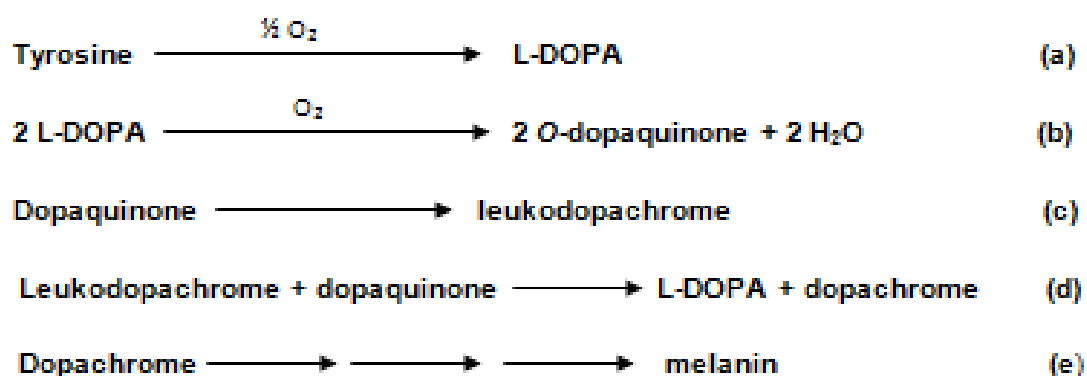
Mushroom browning is a major biochemical reaction that occurs in post-harvest, which is one of the main quality criteria defined by Gormley and MacCanna (1967). This phenomenon of browning is an important factor in determining the marketability and consumer acceptability in particular strains of white mushrooms (Singh, Langowski et al. 2010; Liu and Wang 2012). In the food industry, tyrosinase, which is also known as PPO, is responsible for enzymatic browning reactions in damaged fruits during post-harvest handling and processing. This reaction produces undesirable changes in colour, flavour, and nutritive value of the product (CoSeteng and Lee 1987; Sánchez-Ferrer, Rodríguez-López et al. 1995).

Browning occurs as a result of two distinct mechanisms of phenol oxidation, by activation of tyrosinase and/or spontaneous oxidation (Jolivet, Arpin et al. 1998; Vamos-Vigyazo 1981). Enzymatic browning is a consequence of PPO catalysed oxidation of phenolic substrates into quinones, which undergo further reactions to dark

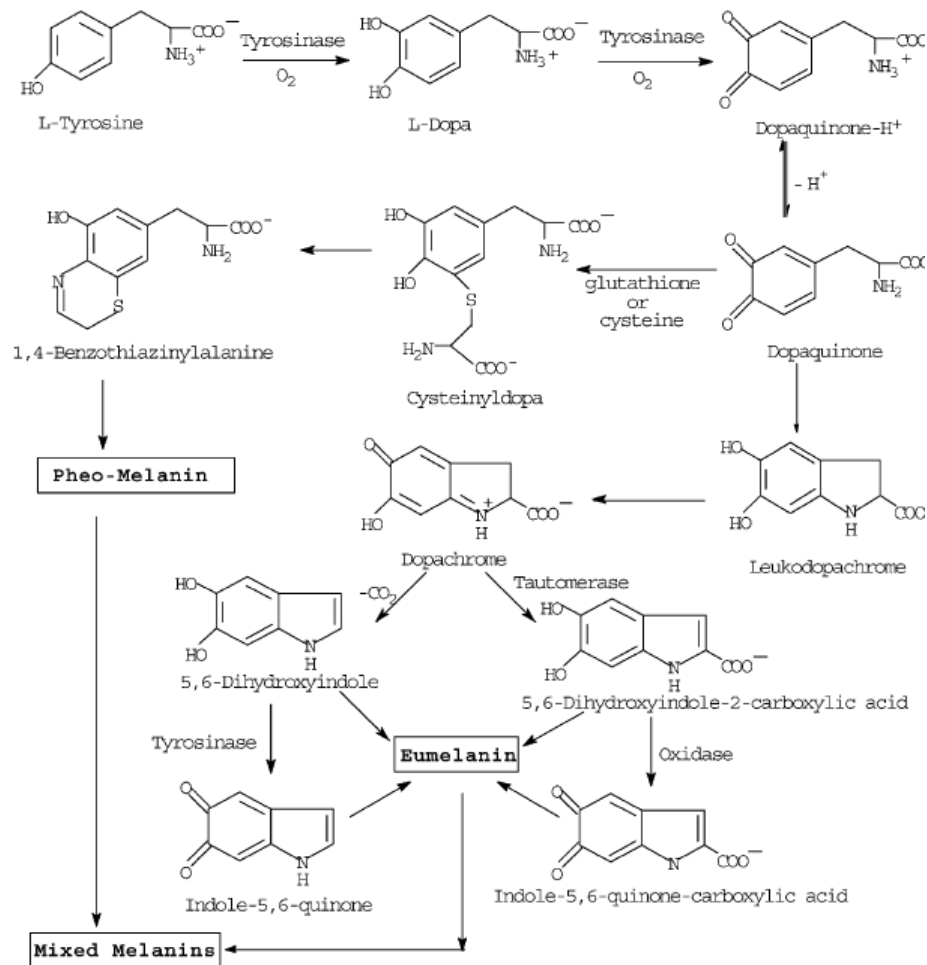
pigments called melanins. The major PPO enzyme responsible for browning in mushrooms appears to be tyrosinase (Jolivet, Arpin et al. 1998; Oms-Oliu, Aguilo-Aguayo et al. 2010).

Tyrosinase is a copper-containing enzyme. Tyrosinase enzyme is mainly involved in the initial steps of the pathway which consist of the hydroxylation of the p-monophenolic amino acid L-tyrosine (monophenolase activity of tyrosinase) and the oxidation of the product of this reaction, the o-diphenolic amino acid L-DOPA (diphenolase activity), to give rise to o-dopaquinone. This dopaquinone is converted to dopachrome by autooxidation and then to dihydroxyindole or dihydroxyindole-2-carboxylic acid to synthesize melanin that is brown or dark pigments (Girelli, Mattei et al. 2004). In Figures 6 and 7, are presents the different reactions of enzymatic browning, in Figure 6 more general context and in Figure 7 in greater detail. The monophenolase activity of tyrosinase is usually much lower than the diphenolase activity, and this ratio, which can vary from 1:40 to 1:1 (Vamos-Vigyazo 1981).

The most important factors that affect the rate of enzymatic browning are the concentrations of active PPO and phenolic compounds present, pH, temperature, water activity and oxygen availability of the tissue and rough handling cause fruiting body senescence (Jolivet, Arpin et al. 1998; Oms-Oliu, Aguilo-Aguayo et al. 2010; Singh, Langowski et al. 2010). Also the latent tyrosinase can become active after contact with bacteria *Pseudomonas tolaasii* or exposure to a toxin, tolaasin causing symptoms of brown spot disease on fresh mushrooms (Soler-Rivas, Arpin et al. 1997) (Figure 8).



**Figure 6:** Second Behbamain, Miller et al. (1992), it is believed that reactions (a) and (b) are enzymatically catalyzed while reactions (c) and (d) may be spontaneous. Dopachrome is slowly converted to melanin through a series of reactions.



**Figure 7:** Enzymatic oxidation of the phenolic amino acid tyrosine to melanin (Source – Seo, Sharma et al. 2003).



**Figure 8:** Stipe tissue is brownish and contains several irregular holes spread in the stipe. The surface covering of the stipe remains white all the time unless it is infected (Umar and Van Griensven 1997).

#### 1.1.3.4. Role of bacteria in spoilage of mushrooms

The presence of bacterial populations in fresh mushrooms is a factor that significantly diminishes their quality, causing a brown, blotchy appearance (Figures 9, 10 and 11) and the use of decontaminating agents during minimal processing often required (Oms-Oliu, Aguilo-Aguayo et al. 2010; Fernandes, Antonio et al. 2012). Doores, Kramer et al. (1987) demonstrated that normal healthy mushrooms have high bacterial populations being the total bacterial numbers ranged from 6.3 to 7.2 log CFU g<sup>-1</sup> of fresh mushroom tissue. The majority (54%) of bacteria isolated from the mushrooms were identified as fluorescent pseudomonas, with Flavobacteria comprising the second largest group (10%) (Singh, Langowski et al. 2010). *Pseudomonas tolaasii* is regarded as a normal constituent of the microflora of the mushroom bed that could produce a toxic metabolite to mushrooms under certain conditions; the infection appears as a brown injury on mushrooms (Beaulieu, D'Aprano et al. 1999, 2002; Fernandes, Antonio et al. 2012). Other Gram-negative microorganisms, such as *Pseudomonas fluorescens* and also contain significant moulds and yeasts, such as *Candida sake*, have been associated with mushroom spoilage (Fernandes, Antonio et al. 2012; Jiang, Luo et al. 2010; Masson, Ainsworth et al. 2002).

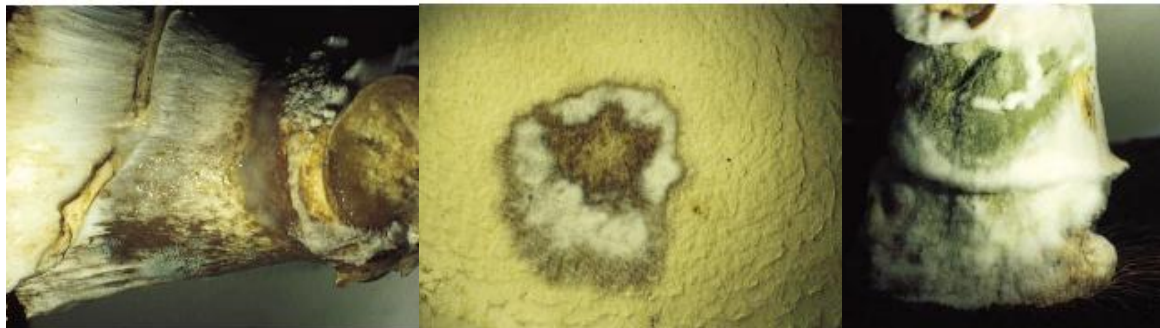
Chikthimmah and Beelman (2005) have shown that freshly harvested mushrooms containing approximately 3 log CFU of moulds and 6 log CFU of native yeast per gram of fresh tissue. *Verticillium maltousei* is a fungus that can contaminate the production of mushrooms causing brown spots (Beaulieu, D'Aprano et al. 1999, 2002; Fernandes, Antonio et al. 2012). During the storage period, population of yeasts can increase from 6.9 to 8.0 log CFU g<sup>-1</sup> but population of moulds can remain constant (3 log CFU g<sup>-1</sup>) (Chikthimmah, LaBorde et al. 2004; Chikthimmah, McMillen et al. 2003).

Doores, Kramer et al. (1987) also found that the bacterial population during post-harvest storage at 13 °C increased from an initial loading of 7 log CFU g<sup>-1</sup> to about 11 log CFU g<sup>-1</sup> over a storage period of 10 days, leading to a decrease of the quality factors of mushrooms, such as maturity and colour. *Pseudomonas spp.* and *Flavobacterium spp.* were the two main groups that predominated during *Agaricus* mushroom postharvest storage. Similarly, Chikthimmah and Beelman (2005) have observed that bacterial populations tend to increase from 7.3 to 8.4 log CFU g<sup>-1</sup> during the first day of storage at 4 °C.

The majority of mushrooms of good quality and colour, harvested and marketed, develop blotches at retail or in consumers' homes, even while kept at refrigeration temperatures (Singh, Langowski et al. 2010). Symptoms of brown blotch

disease are sunken, dark and brown spots on the mushroom fruit body surface (Oliver 1992). *Pseudomonas* is the major spoilage genus associated with blotch formation of fresh mushrooms (Geels, Heslen et al. 1994; Wong, Fletcher et al. 1982; Raincy, Brodey et al. 1992).

*Pseudomonas tolaasii* was identified as the main cause of the classical bacterial blotch disease of cultivated mushrooms, where the application of *Pseudomonas tolaasii* cells as low as 20 CFU cm<sup>-2</sup> of growing beds resulted in blotch formation in mushroom. Symptoms of mushrooms blotch become visible when the microbial growth reaches to 5.4 × 10<sup>6</sup> CFU cm<sup>-2</sup> being the number of cells of *P. tolaasii* present in the early stages of mushroom growth used to controls the extent of blotch disease seen at harvesting (Wong and Preece 1985).



**Figure 9:** Stipe shows a surface with a wet and cloudy appearance and discoloration caused by *Pseudomonas tolaasii*, also the co-existence of green moulds (Umar and Van Griensven 1997).

**Figure 10:** Bacterial infection: a large, light green coloured zone caused by pathogen fungi surrounds the central area (Umar and Van Griensven 1997).

**Figure 11:** Stipe of the fruit body infected by *Trichoderma harzianum* (Umar and Van Griensven 1997).

#### 1.1.4. Methods to extend the shelf-life of fresh mushrooms

In the last few years the consumption of fresh mushrooms has been experiencing a prominent increase. Methods to preserve the mushrooms became an important issue for their commercialization, from the production stage to the consumer. The most important point is the short shelf life that raises problems from harvest to consumption, due to their physiological characteristics, microbial contamination and others referred to in the previous section.

There are many methods to extend the shelf life of mushroom, but the most accepted is chilling and conventionally packed in plastic punnets overwrapped with perforated PVC (polyvinyl chloride) film (Gao, Feng et al. 2014). However, there are other techniques able to complement and strengthen it. Among them stands out MAP, which replaces the atmosphere in the package with an appropriate gas mixture that protects the product against oxidation that causes many alterations such as microbiological attack, colour and aroma variation. With the same finality, many studies



have been focused on mushrooms decadence through others methods as coating, refrigeration,  $\text{CaCl}_2$  solution during irrigation, ozone treatment, irradiation, wash solutions, treatment with anti-microbial and anti-browning solutions (Kukura, Beelman et al. 1998; Liu, Wang et al. 2010; Mohebbi, Ansarifar et al. 2012; Sedaghat and Zahedi 2012; Singh, Langowski et al. 2010).

#### **1.1.4.1. Modified atmosphere packaging and controlled atmosphere**

MAP is a technique used to extend the shelf life of fresh produce and has a preservative effect on the colour besides retarding enzymatic browning by slowing down the respiration. However it leads to water accumulation at the product surface if temperature fluctuation occur, promoting microbial growth and flaccid and slippery texture, which hampers the objective this methods of preservation (Burton and Twynning 1989; Singh, Langowski et al. 2010). Also, MAP can cause anaerobic conditions leading to metabolic disorders and unwanted fermentation, resulting in off flavours if incorrectly designed (Jacxsens, Devlieghere et al. 2002).

The steady-state in the package depends on the respiration by the product and through the polymeric film. The modified atmosphere is an equilibrium of concentrations of  $\text{O}_2$  and  $\text{CO}_2$  established so that transmission rates of gas through the packing material being equal produce respiration rate (Briones, Varoquaux et al. 1993; Simón, González-Fandos et al. 2005). The controlled atmosphere (CA) has the same principles as modified, but differs as to control the levels of  $\text{CO}_2$  and  $\text{O}_2$  during storage, where they must be constantly monitored and kept within tolerable values for each species. Although CA storage is effective on lowering respiration rate and mannitol content (Chikthimmah and Beelman 2005) and increases shelf life of fruit and vegetables, it is not appropriate for mushrooms, which have extremely high respiration rates (Singh, Langowski et al. 2010). CA storage is costly and not practical for short term storage of produce with a short post-harvest, such as mushrooms. Any beneficial effects are lost as soon as the produce is removed from CA (Roy, Anantheswaran et al. 1995b). There is little consensus on CA to increase shelf life of mushrooms (Singh, Langowski et al. 2010).

The steady-state equilibrium in the package depends on several parameters, such as temperature, respiration rate,  $\text{O}_2$  and  $\text{CO}_2$ , permeability of the packaging material, fill weight, free volume in the package and film surface area. In order to avoid metabolic damage on food, according to its respiration rate an atmosphere should be created. On the other hand, exposure to  $\text{O}_2$  levels below the tolerance limit and to  $\text{CO}_2$  levels above the tolerance limit will cause respectively anaerobic respiration and physiological disorders (Briones, Varoquaux et al. 1993).

Sveine, Klougart et al. (1967) showed that an atmosphere with low O<sub>2</sub> and high CO<sub>2</sub> at low temperature, prevent the opening of pileus. In the same study, a N<sub>2</sub> atmosphere with 0.15 O<sub>2</sub> and 5% CO<sub>2</sub> showed to be excellent storage conditions for mushrooms. Murr and Moris (1975) also showed that low concentration of O<sub>2</sub> (0%) and high CO<sub>2</sub> (5%) delayed the expansion of the pileus, but high concentration of O<sub>2</sub> (5%) increases its expansion.

Later, Nichols and Hammond (1973), changes gas concentration containers stored at 2 and 18 °C and the packages with high concentrations of CO<sub>2</sub> and low O<sub>2</sub> a storage temperature of 18 °C showed, as in the previous study, an opening of the pileus slower and less color deterioration. At 2 °C the equilibrium concentrations of O<sub>2</sub> e CO<sub>2</sub> mushrooms tended to change colour, which can be due to high CO<sub>2</sub> concentrations at the equilibrium values.

Briones, Varoquaux et al. (1992) suggested that storage atmosphere should contain 2.5–5% of CO<sub>2</sub> and 5–10% of O<sub>2</sub>, and Roy, Anantheswran et al. (1995a) reported the optimum in-package O<sub>2</sub> concentration to be 6% for a maximum increase in shelf life of mushrooms without creating anaerobic conditions. Whereas Beit-Halachmy and Mannheim (1992) concluded that MAP can be beneficial, but not essential for conservation, because if a particular batch of mushrooms breathe faster than expected, or exposed to large temperature variations, the MAP may have a detrimental effect. In another study, low O<sub>2</sub> concentrations were achieved in PVC treatments, which increased the browning (Kuyper, Weinert et al. 1993). It was concluded that no extension of the useful shelf life of mushrooms was attainable by MAP, while controlling the relative humidity inside the package is likely to be more effective way to increase the mushrooms shelf life (Varoquaux, Gouble et al. 1999). One study showed that without modifying the atmosphere, but by modifying the humidity within a conventional overcoat could also improve the quality and shelf life of mushrooms (Roy, Anantheswran et al. 1995b).

#### **1.1.4.2. Refrigeration**

The temperatures of refrigeration have demonstrated to reduce the physiological and microbial deterioration of mushrooms. Degree of whiteness is one of the most important quality factors associated with mushrooms and generally the whitest mushrooms command the highest price (Singh, Langowski et al. 2010).

The experimental data of laboratory studies from workgroup of Singh, Langowski et al. (2010) demonstrate that refrigeration at 5 °C of stored mushrooms in perforated ambient atmosphere packs significantly reduced the bacterial activity, having a beneficial effect on whiteness (*L*-value). In another study, the effects of storage at 1

°C in the whiteness of mushrooms were evaluated and has been shown that the time spent to place the mushrooms in the cold storage has an significant effect on the whiteness of the mushrooms (Gormley 1975).

Vacuum cooling is a technique that consists on rapid cooling evaporation of moisture from the product, it is widely used for cooling of agricultural and food products (McDonald and Sun 2000). For mushrooms this technique is fast and evenly cools this food within a stack, however behind high capital and operating costs, it turns out weight loss product (Barnard 1974). A study using Vacuum cooling was performed with white mushrooms to evaluate the effects of different storage conditions (i.e. cold room, hypobaric room and MAP) on weight loss, respiration rate, soluble solids content, membrane permeability and degree of mushroom browning and investigate the influence of the conditions storage on the properties of mushrooms. Results showed that the optimal storage condition was MAP after cooling vacuum, showing better chemical and physical properties for the mushrooms as compared to cold room or hypobaric room (Tao, Zhan et al. 2006).

#### **1.1.4.3. Washing**

In the last years, washing the mushrooms has gained commercial popularity as a way to remove particles of soil for the later use of applications as coating, browning inhibitors and microbial inhibitors. Aqueous solutions of sulfite, sodium metabisulfite in particular, were used to wash mushrooms to remove unwanted particles and improve the whiteness mushroom. However, after 3 days of refrigerated storage, bacterial decay of sulfide was evident in the mushrooms. Despite treatment with sulfite lead to initial whiteness and excellent overall quality of the mushrooms it do not inhibit the growth of spoilage bacteria, presenting brief improvements in the characteristics of mushrooms. Despite its wide use, in 1986, the Food and Drug Administration (FDA) banned the use of sulfite compounds on wash fresh mushrooms due to severe allergic reactions among certain asthmatics. After this banning, there have been several efforts to develop washing solutions that replace sulfites and that be safe for consumption (Singh, Langowski et al. 2010). Aqueous washing solutions should integrate compounds that are allowed by the regulatory authorities (FDA, European Food Safety Authority (EFSA), etc) as food additives and should be considered as edible. These additives become an integral part of the food and same after a cleaning with water to remove some of the additives, they may remain in the food in small amounts.

In 1991, several potential additives for washing of mushroom were evaluated, including sodium metabisulfite, hydrogen peroxide, potassium sorbate, and sodium salts of benzoate, ethylenediaminetetra acetic acid (EDTA) and phosphoric acids. It

was concluded that washing fresh mushrooms with effective antioxidant and antimicrobial compounds were required to increase shelf life. Copper is a functional cofactor of the mushroom browning enzyme tyrosinase. EDTA in the wash solution binds copper more readily than tyrosinase, thereby sequestering copper and reducing tyrosinase activity and associated enzymatic browning (McConnell 1991; Singh, Langowski et al. 2010).

Beelman and Duncan (1999) developed a washing process for mushrooms, wherein a first washing with high pH (pH of 9.0 or above) antibacterial wash followed by a neutralizing wash containing browning inhibitors. The neutralizing wash contained buffered solution of erythorbic acid and sodium erythorbate. Other browning inhibitors such as: ascorbates, EDTA or calcium chloride were identified as suitable ingredients for addition to the neutralizing solution, This process also helped to remove debris and delayed microbial spoilage of fresh mushrooms. Other studies were performed by Sapers, Miller et al. (1994, 1995, 1999, 2001) and Sapers and Simmons (1998) that reveal a higher whiteness, a major effective in reducing bacteria on the mushroom surface and minimal effects on the structure and composition of mushrooms when compared to sulfites using formerly. The wash process that these authors used were free of adhering soil, less subject to brown blotch than conventionally washed mushrooms and at least as resistant to enzymatic browning as unwashed mushrooms during storage at 4 °C, however at 10 °C happens an accelerated development of brown blotch and browning.

Others authors tested a wash step with citric acid, EDTA, hydrogen peroxide, sodium hypochlorite among others, despite found to be relatively inexpensive and could preserve mushrooms, their efficacy is very limited due to the induction of undesirable changes in the appearance and general quality of the final product (Guthrie and Beelman 1989; Sapers, Miller et al. 1994; Simón and González-Fandos 2006). Brennan, Le Port et al. (2000) observed that citric acid induces yellowing on the mushroom's cap surface. Although hydrogen peroxide present in the wash solution act as a bactericide (McConnell 1991).

#### **1.1.4.4. Use of humectants**

Is common the development of condensed water inside the packaging film that surrounds the mushroom, making the package unattractive (Burton, Frost et al. 1987; Burton 1991; Gormley and MacCanna 1967). This phenomenon can be explained by the high transpiration rate of mushrooms combined with a low water vapour transmission rate (WVTR) of the packaging (Singh, Langowski et al. 2010). To overcome this problem, several methods have been found in order to reduce in-

package RH during the storage time. But, although water condensation reduce, this can not be completely eliminated (Burton 1991).

Various irrigation treatments involving the addition of calcium salts applied throughout the growth of a mushroom crop have shown to improve the initial and postharvest shelf life of mushrooms (Beelman, Quinn et al. 1987; Miklus and Beelman 1996; Philippoussis, Diamantopoulou et al. 2001; Solomon, Beelman et al. 1991). A study using sorbitol and sodium chloride (NaCl) to modify the in-package RH of fresh mushrooms (water irrigated and CaCl<sub>2</sub> irrigated) stored in MAP at 12 °C showed that this methodology do not changes the maturity index and microbial population, having no differences between mushrooms stored in MAP with or without moisture absorbers. However, a continued lowering of in-package RH was observed in packages containing mushrooms with increasing amounts of moisture absorbers and mushroom irrigated with CaCl<sub>2</sub> showed lower in-package RH, lower weight loss and surface moisture content. Also the NaCl application resulted in lower RH in the package than did sorbitol. There was also a remarkable decrease in the moisture on the surface of mushrooms packaged with NaCl storage and larger amounts of sorbitol had better color than smaller amounts of sorbitol (Roy, Anantheswaran et al. 1996). Gormley and MacCanna (1967) reported wrinkling and brown patches on surfaces of uncovered mushrooms due to excessive moisture loss. Use of sorbitol in conventional packages (without MAP), resulted in mushrooms with better color than those packaged without sorbitol during 9 days of storage at 12 °C when moisture loss was less than 18% (Roy, Anantheswaran et al. 1995b). Moisture transfer through MAP occurs only by diffusion through the semipermeable film, making water condensation more evident than in conventional packages (Singh, Langowski et al. 2010). A study described the use of propylene glycol as a moisture absorbent between sheets of polyvinyl alcohol (PVA), using a bag with 55% ethanol, 35% silicon dioxide and 10% humidity, allowing a slow controlled release of ethanol into the atmosphere packaging. Ethanol reduced the water activity and acted as an antimicrobial agent (Labuza and Breene 1989).

Miklus and Beelman (1996) found a significantly increased calcium concentration in fresh mushrooms as well as significantly reduced postharvest browning in mushrooms irrigated with CaCl<sub>2</sub>. They also found a significant positive correlation among calcium concentration and colour (*L*-value) at harvest; as calcium concentration increased, *L*-value increased, indicating whiter mushrooms. From the results of their study, they hypothesized that colour improvements, both at harvest and during postharvest storage, observed in mushrooms irrigated with CaCl<sub>2</sub> may possibly be attributed to the stabilizing effect that calcium has on membranes or by directly reducing tyrosinase activity.

#### 1.1.4.5. Ozone treatment

Ozone is a powerful oxidizer, which decays spontaneously in air or water releasing O<sub>2</sub>, with an antimicrobial effects depending upon the level of growth, environmental pH, temperature and humidity (Komanapalli and Lau 1996). Being used to replace water disinfection (Oliver 1992), exhibiting bactericide activity, attacking vital parts of the microbial cells among other effects such as enzymatic destruction, unsaturated lipid oxidation and nucleic acid splitting (Komanapalli and Lau 1996).

A study by Escriche, Serra et al. (2001) evaluated the effect of ozone on the time and temperature of storage on the quality of post-harvest mushrooms. For 7 days, the mushrooms with different ozone treatment times and different temperature were stored in polystyrene containers, overwrapped with PVC plastic film and evaluated some quality parameters. The ozone treatment prior to packaging caused an increase in external browning rate and an internal reduction, but no significant difference in terms of texture, maturity index and weight loss of mushrooms. Increasing the temperature and time of storage showed an increased browning, senescence, weight loss and decrease in firmness. The temperature increase to a greater extent affect weight loss, since the lower temperature storage showed a better quality of the mushrooms.

Moreover, improvements also were shown nutritional level during storage of mushrooms. In a study of ozone effects on mushrooms in the fatty acid composition showed an increase in oleic/linoleic acid ratio (Watanabe, Tsuhasshi et al. 1994). Other study using *Pleurotus ostreatus* mushrooms examined the effect of ozone on the chemical composition showing an increased in weight, water content, proteins, Ca, K, Zn, riboflavin and ascorbic acid, and a decrease in carbohydrates, iron and thiamine (Watanabe, Takai et al. 1994).

#### 1.1.4.6. Use of tyrosinase inhibitors

Chemical control of enzymatic browning includes chelation of the copper present at the active site of the enzyme (tyrosinase) (Martinez and Whitaker 1995) and reduction of the diquinone to its uncolored form (Kubo and Kinst-Hori 1998). The tyrosinase inhibitors will be described most extensively more forward.

A number of tyrosinase inhibitors, mainly belonging to polyphenolics, aldehydes, alkenals, acids, peptides, and proteins, have been identified from both natural and synthetic sources (Kim and Uyama 2005; Schurink, vanBerkel et al. 2007). Many efforts have been spent in the search for feasible and effective tyrosinase inhibitors. Substrate analogues, such as cinnamic acid derivatives and 4-substituted resorcinols, could be potent enzyme inhibitors (Jiménez and García-Carmona 1997;

Shi, Chen et al. 2005). The inhibition reaction may be either reversible (competitive, noncompetitive, or mixed) or irreversible (mechanism based), depending on the type of inhibitors. Some important molecular mechanisms involved in the inhibition include alternative substrate action due to the structural similarity with natural tyrosinase substrates such as L-tyrosine and L-3,4-dihydroxyphenylalanine (L-DOPA), copper chelation in the active site (Kim and Uyama 2005).

Much work has been devoted to the development of methods for eliminating or at least retarding the process of enzymatic browning on fruits and vegetables. For example, Martinez and Whitaker (1995) shown that browning of fresh sliced mushrooms was inhibited by immersion in citric acid (4%) or hydrogen peroxide (5%). However, the shelf life extension was the result of antibacterial activity rather than tyrosinase inhibition. Shimizu, Kondo et al. (2001) examined the biochemical parameters of tyrosinase inhibition by 3-2,4-dihydroxyphenyl propionic acid (DPP acid) and concluded that it is a competitive inhibitor with an  $IC_{50}$  (50% inhibitory oncentration) of  $3.2 \mu\text{mol L}^{-1}$ .

Mushroom browning occurs mainly as a result of tyrosinase activity, which is known to be a key enzyme in melanin biosynthesis. A study realized by Nerya, Ben-Arie et al. (2006) was used an ethanolic extract from licorice roots (*Glycyrrhiza glabra*) and DPP acid isolated from fig leaves and fruit as inhibitors with the objective to has been shown to inhibit tyrosinase activity. Adding these inhibitors to sliced mushrooms had a very strong inhibitory effect on browning, but pre-storage immersion of intact mushroom in the licorice extract did not prevent browning after 8 days of storage at 4 °C. By the other way, treatment with DPP acid at  $1 \mu\text{g mL}^{-1}$  reduced browning by half.

Normally for mushroom browning by tyrosinase activity, in the fruit and vegetable industry, are used methods that depend on the reduction of quinones formed by the oxidation of phenols by PPO or the inhibition or inactivation of PPO. Reducing agents such as ascorbic acid, cysteine and sulfur dioxide reduce the o-quinones to their o-phenolp recursors (Walker 1977). However, the effect of such reducing agents is temporary, because they themselves are irreversibly oxidized during the process. The use of reducing agents also can lead to oxidation products with off-flavours, that are unwanted. Ascorbic acid is widely used to inhibit enzymatic browning of fruits and vegetables because it is a non-toxic compound at the levels employed. The inhibition of PPO by ascorbic acid is complex, however, ascorbic acid neither inhibits nor activates the enzyme (Golan-Goldhirsh and Whitaker 1984; Singh, Langowski et al. 2010).

#### 1.1.4.7. Coating

Fruits and vegetables coated with semi-permeable film has the beneficial effect of delaying ripening and prolonging the storage time, help to decrease moisture loss and slow respiration by reducing oxygen uptake from the environment (Donhowe and Fennema 1994; Park, Bunn et al. 1994). The use of edible films and coatings on fruits causes modification of fruits tissue metabolism. The main functional advantages attributed to the use of this method are the improvement of respiration rate, extension of storage life and firmness retention. Also can be incorporated on edible films and coatings antimicrobials, antioxidants, and other preservatives that control the microbial growth and browning (García, Pereira et al. 2010). In addition to prolonging shelf life and delaying senescence, coatings add sheen and luster to products and make them more attractive and appealing to consumers (Mohebbi, Ansarifar et al 2012).

Fruits or vegetables are usually coated by dipping in or spraying with a range of edible materials, forming a semi-permeable membrane on the surface that represses respiration, controls the moisture loss and provides other functions (Thompson 2003). Application of semi-permeable coatings has shown to improve the storage life of fruit and vegetables, especially edible coatings can maintain quality of fruits and vegetables by functioning as vapour and gas barriers (Jiang, Feng et al. 2013b).

A suitable coating depends on the adjustment of the coating solutions to the structure of the coated product, considering the parameters of viscosity, porosity, surface tension, wettability and roughness, among many others (Hershko and Nussinovitch 1998; Krochta and Mulder-Johnson 1997). Although much information is available on edible coatings in general less information is available on mushroom coating specifically (Hershko and Nussinovitch 1998).

According to Hershko and Nussinovitch (1998) an alginate–ergosterol–Tween coating combination was most suitable for maintaining the size and shape of the coated mushroom. A study realized by Nussinovitch and Kampf (1993) was utilized an application of calcium alginate coating after harvest for extend the shelf life and preserve the texture of fresh mushrooms. The results showed there was reduction of transpiration and atmosphere remains stable around the coated mushroom, improving colour and decreasing weight losses when compared with uncoated mushrooms. Coatings appears to be sufficient to extend the shelf life of mushrooms, evaluating the parameters of the coating itself, as *L*-value, making the mushrooms with a lighter color and better appearance. The rate of evaporation of water and integrity of the mushroom is maintained for a longer period of time than uncoated (Singh, Langowski et al. 2010).

The applicability of edible coatings can be combined with other preservation methods such as MAP. Kim, Ko et al. (2006) studied the effect of an appropriate MAP



film and a chitosan coating on the quality of whole and sliced *A. bisporus* mushrooms. Different ratios of CO<sub>2</sub>/O<sub>2</sub>, colour, weight loss and maturity were evaluated during storage at 12 °C and 80% relative humidity. The degree of darkening was higher in whole mushrooms than slices. The coatings did not seem to affect the maturity index, except for those involved in packaged MAP film, where the chitosan coating markedly reduced the rate of maturity of sliced mushrooms. Another similar study with the same type of mushrooms reported the effect of MAP and coating (chitosan and CaCl<sub>2</sub>) for 6 days of storage at 12 °C and 80% relative humidity. It was concluded that the package contained lower concentrations of O<sub>2</sub> and caused less weight loss, although chitosan coating had a negative effect on the colour of mushrooms (Lee 1999).

Development of natural preservative coatings to reduce respiration rate and inhibit enzymatic browning with antimicrobial agents is expanding due to the riskiness aspects of chemical preservatives (Lee, Park et al. 2003). A recent study showed that the application of a coating composed by arabic gum and natamycin in shiitake mushroom (*Lentinus edodes*) was more effective in maintaining tissue firmness and sensory quality, and reducing microbial counts like yeasts and moulds than applying arabic gum or natamycin alone. In addition, arabic gum and natamycin coating also delayed changes in the soluble solids concentration, total sugar and ascorbic acid during the storage period (Jiang, Feng et al. 2013b). Other studies suggest that the application of chitosan coating (with optimum concentration 2%) in fresh-cut mushrooms (*A. bisporus*) could be beneficial and be considered for commercial application in extending shelf life and maintaining quality and, to some extent, controlling decay of mushroom. In using chitosan for decay control, the authors consider that it may be suitable in treatment of mushroom stored for shorter periods (e.g. 3 days) or for short-distance transport and distribution. However, for longer storage and marketing, chitosan coating to control discolouration and decay in mushroom could be better (Eissa 2007). Jiang, Feng et al. (2012) studied the changes in microbial and postharvest quality of shiitake mushroom (*Lentinus edodes*) treated with chitosan–glucose complex coating under cold storage. They showed that the senescence inhibition of cold stored involved the maintenance of tissue firmness and sensory quality, inhibition of respiration rate, and reduction of microbial counts compared with the control. In addition, coating also delayed changes in the ascorbic acid and soluble solids concentration during the storage period.

#### 1.1.4.8. Other considerations

All preservation methods have associated some disadvantages, including safety considerations, discolouration, production of off-flavours, and contamination with pathogenic microorganisms, and some more than others can no longer be viable on the industrial scale (Duan, Xing et al. 2010).

There are others methods that are studied, for example ultrasound and high pressure and pulsed light. Heat and ionizing irradiation processing can inhibit or inactivate microbial growth completely, resulting in commercially sterile and shelf-stable food products (Gould 1989; Minnaar, Taylor et al. 1995). High oxygen has been proposed as an alternative to low O<sub>2</sub> modified atmosphere in order to inhibit microbial growth and therefore maintain fresh sensory quality (Liu and Wang 2012).

Lagnika, Zhang et al. (2013) studied the effects of ultrasound and high-pressure argon on physico-chemical properties of white mushrooms (*A. bisporus*) during 9 days of postharvest storage at 4 °C. Treated samples exhibited small weight loss and respiration rate compared to samples not treated. Ultrasound treatment of white mushrooms was able to preserve antioxidants. Mushrooms treated with high pressure argon revealed significant reduction of PPO activity and a slight increase in antioxidant capacity during storage. The application of ultrasound combined with high pressure argon appeared to be the most effective treatment to decrease of PPO. In addition, treated samples were effective in retaining mushrooms colour changes compared to control. Ultrasound pre-treatment is a promising technique to extend shelf-life and reduce the degradation of quality aspects of mushrooms during cold storage.

Oms-Oliu, Aguilo-Aguayo et al. (2010) investigated the impact of pulsed light (PL) treatments microbial quality, enzymatic browning, texture and antioxidant properties of fresh-cut mushrooms (*A. bisporus*). The mushrooms were flash at 4.8, 12 and 28 Jcm<sup>-2</sup> and evaluated during 15 days of refrigerated storage. PL treatments allowed extension of the microbiological shelf life of fresh-cut mushrooms by 2–3 days in comparison to untreated samples, while providing a high quality product. The use of high PL fluencies (12 and 28 Jcm<sup>-2</sup>) dramatically affected the texture of sliced mushrooms due to thermal damage induced by the treatments. Enzymatic browning was also promoted by an increase in PPO activity when the highest dose of PL was applied. At 28 Jcm<sup>-2</sup>, phenolic compounds, vitamin C and antioxidant capacity were significantly reduced. They suggest that the application of pulsed light at doses of 4.8 Jcm<sup>-2</sup> could extend the shelf life of fresh-cut mushrooms without dramatically affecting texture and antioxidant properties.

## 1.2. Edible coatings, their constituents and properties

The great interest in edible films and coatings in food preservation has been on the rise due their several advantages (Figure 12) over synthetic materials, such as: biodegradability and environmental friendliness (Tharanathan 2003).

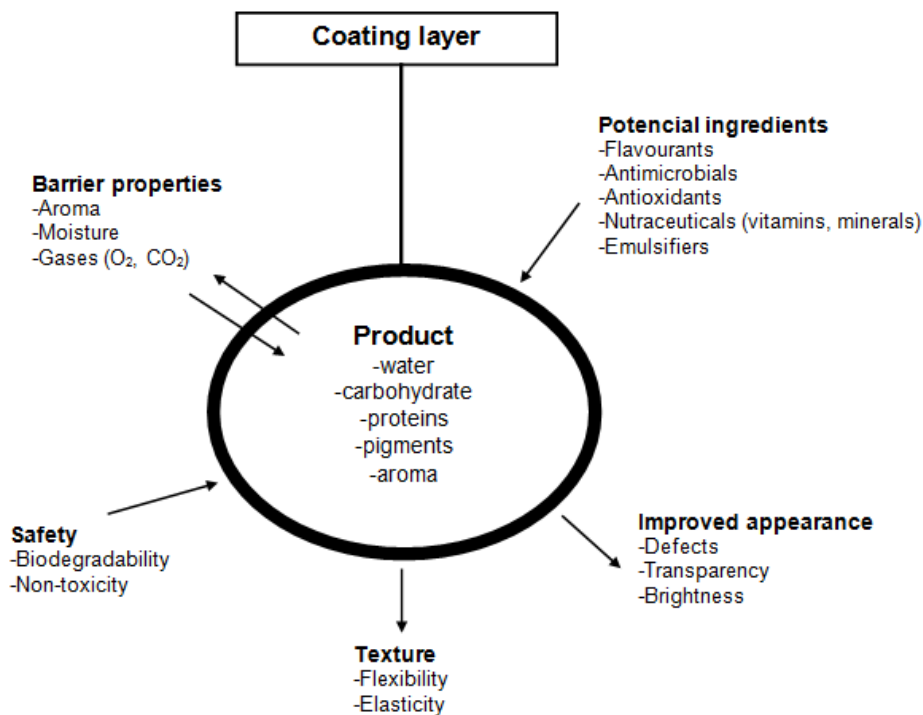
Coatings are a thin layers of a material, which are applied directly to the surface of a food product by dipping, spraying, among other means, that in the end is considered as part of the final product. Its purpose is to: provide good and a selective barrier to moisture transfer, oxygen uptake, lipid oxidation, losses of volatile aromas and flavours; act as carrier of active compounds (e.g. antioxidants, antimicrobial agents, nutrients and flavours): improve the mechanical properties; and allow the reduction of microbiological contamination, increasing shelf life or even improve the quality of the food (Baldwin, Nisperos et al. 1996; Cagri, Uspunol et al. 2004; Cha and Chinnan 2004; Cuq, Aymard et al. 1995; Cutter and Sumner 2002; Franssen and Krochta 2003; Guilbert, Gontard et al. 1996; Han 2000; 2001; Han and Gennadios 2005; Kester and Fennema 1986; Krochta and De Mulder-Johnston 1997; Nisperos-Carriedo 1994).

The use of coatings creates a modified atmosphere surrounding the commodity similar to that achieved by controlled or modified atmospheric storage conditions and it can protect the food from the moment it is applied, through transportation to its final retail destination, and in the home of the consumer (Cerqueira, Lima et al. 2009b; Kester and Fennema 1986; Lin and Zhao 2007; Nisperos-Carriedo 1994; Ribeiro, Vicente et al. 2007). Coated fruits showed a reduction of the internal oxygen partial pressure with a decrease in metabolism, as well as some kind of structural reinforcement (Shaidi, Arachchi et al. 1999). Therefore, some of the effects that can be observed in coated fruits during storage are a reduction of the respiration rate (Wong, Tillin et al. 1994; El Gaouth, Arul et al. 1991), a decrease of weight loss (Baldwin, Burns et al. 1999), a delay in the occurrence of enzymatic browning (Baldwin, Burns et al. 1999; McHugh and Senesi 2000; Le Tien, Vachon et al. 2001) and, in general, a significant extension of shelf-life.

The materials used in the production of edible coatings can be divided into three main categories: hydrocolloids, lipids, and composites. Hydrocolloids include proteins and polysaccharides, while lipids include waxes, glycerides, and fatty acids. Composites are the coatings that contain a mixture of hydrocolloids and lipids (Greener and Fennema 1994; Nisperos-Carriedo 1994). Its most favourable features are clearly the edibility and inherent biodegradability (Cuq, Aymard et al. 1995; Guilbert, Gontard et al. 1996; Han 2002; Krochta 2002).

Lipids, proteins and polysaccharides are the major constituents of edible coatings, obtained from a variety of agricultural commodities, wastes of the food production industry and/or natural sources (Jiang, Feng et al. 2003b). Polysaccharide-based coatings have been used widely to extend the shelf life of fruits and vegetables (Nisperos-Carriedo 1994) to retard the moisture loss, modification of gas exchanges and inhibition of microbial spoilage (Sedaghat and Zahedi 2012; Zahedi, Ghanbarzadeh et al. 2010).

In the last years there has been a considerable pressure by consumers to reduce or eliminate chemically synthesized additives in foods (Rojas-Graü, Soliva-Fortuny et al. 2009). So in this chapter only compounds derived from natural sources will be discussed. More specifically, the polysaccharides that will be described, are the used in this work, namely, chitosan, alginate and guar gum.



**Figure 12:** Quality attributes provided by edible coatings to food products. Adapted from Ramos, Fernandes et al. (2012).

### 1.2.1. Polysaccharides

Polysaccharides were the earliest, and hence the most extensively studied materials for the development of bio-based packaging. A variety of such compounds (and derivatives thereof) have been tested for potential use as biodegradable/edible coatings, which include alginate, pectin, carrageenan, konjac, chitosan, pullulan, cellulose, starch and other natural gums (Cha and Chinnan 2004; Ramos, Fernandes et al. 2012; Vargas, Pastor et al. 2008).

Most of polysaccharides are highly water soluble. At the molecular level, polysaccharides vary according to their molecular weight, degree of branching, conformation, electrical charge, and hydrophobicity. Variations in these molecular characteristics will lead to variations in the ability of different polysaccharides to form coatings, as well as to variations in their physicochemical properties and performance (Vargas, Pastor et al. 2008).

#### **1.2.1.1. Chitosan**

Chitin is the major component of the exoskeleton of approximately 1 million species of arthropods, such as insects, lobsters and crabs, and after cellulose, the most abundant polysaccharide in nature. It is a linear homopolysaccharide composed of units N-acetyl D-glucosamine in  $\beta$  bond (poly- $\beta$ -1, 4-linked glucosamine) (Shahidi, Arachchi et al. 1999). The extended form of chitin is similar to cellulose fibers and as this is indigestible by vertebrates (Nelson and Cox 2000). With an alkaline deacetylation process, the chitin can be converted into another form called chitosan that is a cationic polysaccharide (Kurita 2006). The desired degree of deacetylation to give a soluble product should be 80-85% or more. Chitosan (Figure 13) products are highly viscous, resembling natural gums (Peniston and Johnson 1980). Chitosan is characterized as having potentially reactive functional groups, such as amine groups, and number of primary and secondary hydroxyl groups (Shahidi, Arachchi et al. 1999). These features allow the structural modification of chitosan, increasing their possible use in several applications. The chitosan-based materials can also be used to produce edible films and coatings due to their viscoelastic properties, yielding tough, durable and flexible films. Most mechanical properties of chitosan films are comparable to those of many commercial polymers (Butler, Vergano et al. 1996).

The physicochemical and biological properties of chitosan justify its introduction in food formulations, as it may improve nutrition, hygiene and/or sensory characteristic properties and also the possible incorporation of emulsifiers, antimicrobials, antioxidants and gelling properties (Casariego, Souza et al. 2008).

Chitosan is not soluble in water, but forms viscous solutions in various organic acids (Park, Marsh et al. 2002). Acetic acid often has been used as a solvent for the production of chitosan films (Caner, Vergano et al. 1998), but it imparts a strong acidic flavour and aroma to the foods in which it is used. Lactic acid has been used instead of acetic acid because it has a weaker acidic flavour and aroma, which was found using a trained sensory panel that compared chitosan films produced with both acids (Forero 2001). Most of the naturally occurring polysaccharides, e.g. cellulose, dextran, pectin, alginic acid, agar, agarose and carragenans, are neutral or acidic in nature, whereas

chitin and chitosan are examples of highly basic polysaccharides (Casariego, Souza et al. 2008).

Chitosan has attracted increased attention for its commercial applications in the biomedical, chemical, food, cosmetic, and many other industries (Tripathi, Mehrotra et al. 2010). Due to its non-toxic nature, antioxidative and antibacterial activity, film-forming property, biocompatibility and biodegradability, chitosan has attracted much attention as a natural food additive (Jiang, Feng et al. 2012; Majeti and Ravi 2000). The use of chitin in many industrial processes generate solids residues and thus the use of chitosan would a further advantage to minimize these solid wastes (Casariego, Souza et al. 2008).

Chitosan is well known for its excellent film-forming property and broad antimicrobial activity against bacteria and fungi (Cagri, Ustunol et al. 2004; Cha and Chinnan 2004; Rabea, Badawy et al. 2003; Tripathi, Mehrotra et al. 2010). And also have a number of uses in the food industry. In the preservation of fruits, which has been used as a coating and antifungal agent, resulting in an increased quality and storage of the studied products (El Ghaouth, Arul et al. 1991). Chitosan-based coatings are generally good gas barrier and adhere well to cut surfaces of fruits and vegetables, but their hydrophobic nature makes them poor moisture barriers (Baldwin, Nisperos-Carriedo et al. 1995). Chitosan inhibits the growth of spoilage bacteria and of various fungi, resulting in improved sensory attributes. Also a good effect on the development of red colour of the meat during storage was observed (Darmadji and Izumimoto 1994).

Chitosan has been used in foods, as a clarifying agent in apple juice, and antimicrobial and antioxidant in muscle foods (Gómez-Estaca, Montero et al. 2007; Kim and Thomas 2007). Furthermore, the application of the coating chitosan has been used to maintain the quality of postharvest fruits and vegetables (Li and Yu 2000; Su, Zheng et al. 2001) such as citrus (Chien, Sheu et al. 2007), tomatoes (Badawy and Rabea 2009; El Ghaouth, Ponnampalam et al. 1992; Liu, Tian et al. 2007; Muñoz, Moret et al. 2009; Reddy, Angers et al. 2000), apples (de Capdeville, Wilson et al. 2002; Ippolito, El Ghaouth et al. 2000; Wu, Zivanovic et al. 2005), mango, banana (Kittur, Saroja et al. 2001), papaya (Bautista-Baños, Hernández-López et al. 2003; González-Aguilar, Valenzuela-Soto et al. 2009), grapes (Muñoz, Moret et al. 2009; Romanazzi, Nigro et al. 2002; Xu, Huang et al. 2007), strawberry (Campaniello, Bevilacqua et al. 2008; Han, Zhao et al. 2004; Park, Stan et al. 2005; Vargas, Albors et al. 2006), longan fruit (Jiang and Li 2001), peach (Li and Yu 2000), pear and kiwifruit (Du, Gemma et al. 1997) among many others and also between various products of meat, fish and dairy (Campos, Gerschenson et al. 2011; Elsabee and Abdou 2013; Sánchez-González, Vargas et al. 2011; Valencia-Chamorro, Palou et al. 2011). Chien, Sheu et al. (2007)

manually treated sliced mango with aqueous solutions of 0%, 0.5%, 1% or 2% chitosan. Chitosan coating retarded water loss, slowed the fall of the sensory quality, increasing the soluble solid content, the acidity and ascorbic acid content. It also inhibited the growth of microorganisms. Overall, results showed that applying a chitosan coating is possible to increase the quality attributes and extends the shelf life of sliced mango fruit.

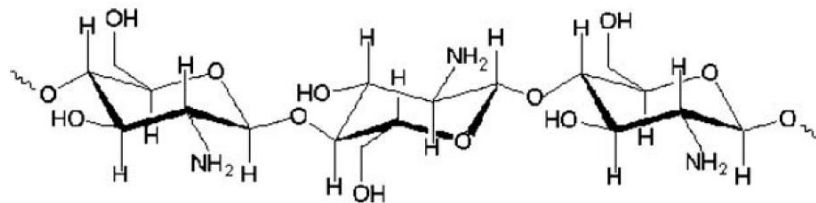


Figure 13: Chitosan molecular structure (Porta, Mariniello et al. 2011).

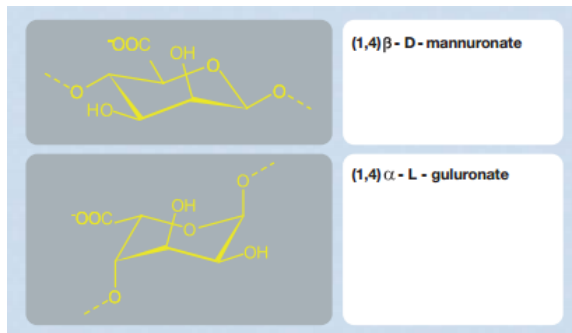
### 1.2.1.2. Alginate

Alginate is a polysaccharide derived from the marine brown algae (*Phaeophyceae*), has been extensively used in the production of edible films, due to its unique colloidal properties and its ability to form strong gels upon reaction with multivalent metal cations such as calcium (Jiang, Feng et al. 2013a; Rhim 2004). It was being used as a thickener, stabilizer and gelling agent in the food and pharmaceutical industry (Mancini and McHugh 2000).

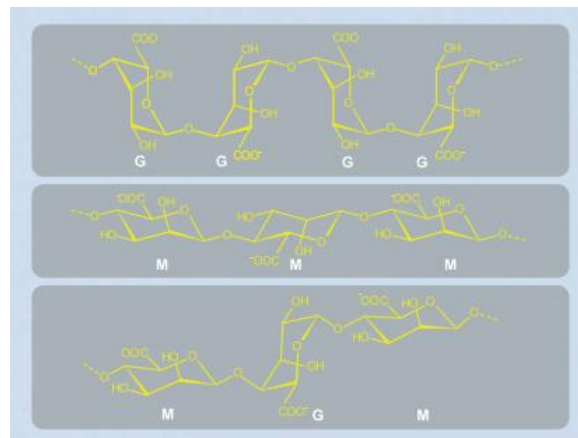
In molecular terms, alginate (Figures 14 and 15) is a linear copolymer compound with acid monomers of  $\beta$ -D-mannuronic (M) acid and  $\alpha$ -L-glucuronic acid (G) attached by glycosidic links. The homopolymer blocks of M and G and their alternating sequence are coexistent in the alginate molecule (Gacesa 1998). One of the most important properties of the alginate is its ability to react with divalent cations, especially calcium ions, to produce strong gels (Cha and Chinnan 2004).

Alginate has been used to reduce weight loss and natural microflora counts in carrots (Amanatidou, Slump et al. 2000), and also to maintain the quality and prolong shelf life of fresh-cut apples (Rojas-Graü, Raybaudi-Massilia et al. 2007). In addition, this type of film has shown potential as a carrier of active or functional food ingredients such as antibrowning agents, colourants, flavours, nutrients, spices, and antimicrobial compounds that can extend the product shelf-life and reduce the risk of pathogen growth on food surfaces (Jiang, Feng et al. 2013a; Lin and Zhao 2007; Rojas-Graü, Soliva-Fortuny et al. 2009). To prolong the shelf-life of mushroom, Nussinovitch and Kampf (1993) utilized alginate based coating. Hershko and Nussinovitch (1998) also coated mushrooms with alginate and alginate-ergosterol to evaluate their effect on the structural changes of mushrooms during storage.

Alginate-based coatings was also used in meat and fish products showing improvements at the level of total microorganisms and quality characteristics of these products (Cutter and Siragusa 1996; Earle 1968; Field, Pivamik et al. 1986; Lazarus, West et al. 1976; Williams, Oblinger et al. 1978).



**Figure 14:** Monomers of alginate (<http://www.fmcbiopolymer.com/portals/pharm/content/docs/alginate.pdf>).



**Figure 15:** Alginate block types (<http://www.fmcbiopolymer.com/portals/pharm/content/docs/alginate.pdf>).

### 1.2.1.3. Guar gum

Guar gum is one of the most important galactomannans (Dakia, Blecker et al. 2008; Dea and Morrison 1975; Fox 1992). Galactomannans (Figure 16) are polysaccharides composed by a β-(1-4)-D-mannan backbone with a single D-galactose branch linked α-(1-6). They are obtained from seed endosperm from several vegetable species, particularly from some *Leguminosae*. Depending on the botanical origin, they differ in the mannose/galactose (M/G) ratio, molecular weight and in the distribution of the galactose units (Cerqueira, Souza et al. 2011).

Galactomannans are used in a wide range of food applications due to their ability to form very viscous solutions at low concentrations, also is soluble in water and form stable aqueous solutions (Neukom 1989). They also are used as stabilizer, thickener and emulsifier, and the absence of toxicity allows their use in the textile, pharmaceutical, biomedical, cosmetics and food industries (Srivastava and Kapoor 2005; Vieira, Mendes et al. 2007; Yi and Zhang 2007). Some of the commercially available galactomannans are locust bean gum (*Ceratonia siliqua*), guar gum (*Cyamopsis tetragonolobus*) and tara gum (*Caesalpinia spinosa*) (Baveja, Ranga Rao et al. 1991; Krishnaiah, Karthikeyan et al. 2002; Varshosaz, Tavakoli et al. 2006).

Particularly in the food industry the main applications of galactomannans are in dairy products, fruit-based water gels, powdered products, bakery, dietary products, coffee whiteners, baby milk formulations, seasonings, sauces and soups, tinned meats



and frozen and cured meat foods (Cerqueira, Bourbon et al. 2011). Gum Arabic as an edible coating was used to extend the shelf-life of whole tomato, and enhanced the shelf-life up to 20 days without any spoilage and off-flavour (Ali, Maqbool et al. 2010). Sedaghat and Zahedi (2012) studied application of a gum Arabic-based coating to extend the storage time of mushrooms (*A. bisporus*) and was concluded that coating of mushroom is a beneficial method for extending their shelf-life. The coated mushrooms showed lower weight loss, higher firmness and better appearance in comparison to the uncoated mushrooms.

Galactomannans can also act as carriers for a broad range of food additives, including antioxidants, anti-browning agents, antimicrobials, colorants and flavours. However, the works in which galactomannan films/coatings are used as a vehicle for antimicrobial and antioxidant compounds are very scarce. Martins, Cerqueira et al. (2010) used galactomannan from *Gleditsia triacanthos* incorporating nisin to decrease the growth of *Listeria monocytogenes* on Ricotta cheese stored at 4°C. The results showed good performance in reducing surface post-contamination of cheese products during storage. After 7 days of storage, the count of *L. monocytogenes* on cheese samples treated with coating containing nisin was 2.2 log CFU g<sup>-1</sup> lower than those in cheese samples without coating.

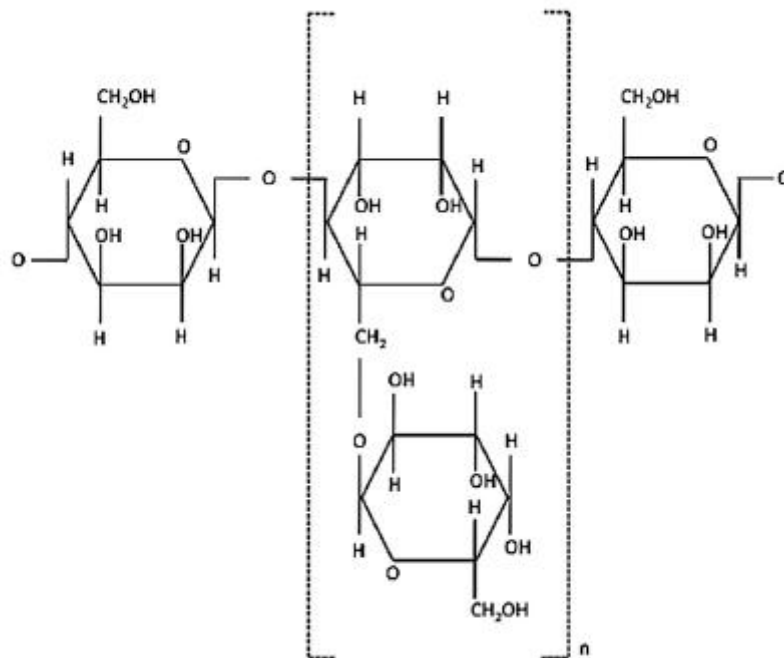


Figure 16: General molecular structure of galactomannan (Cerqueira, Souza et al. 2011).

### 1.2.2. Potential active ingredients

As previously stated, edible coatings can carry various agents such as antimicrobials, antioxidants, nutraceuticals or even flavours and colourants. All of these can contribute to enhance food quality and safety, but only up to the level at which such additives start interfering with the physical and mechanical properties of the coatings themselves (Ramos, Fernandes et al. 2012).

Antimicrobial agents have traditionally been added to the food, but their activity may be inhibited by many compounds in the food itself, thus constraining their efficiency. The use of antimicrobial compounds in the coatings may turn out to be more efficient, as these compounds will selectively and gradually migrate from the package material onto the surface of the food, and diffuse thereafter into the bulk of the food, so relatively high concentrations will be maintained on the surface of the food for extended periods of time (Ouattara, Simard et al. 2000).

Browning of fruits and vegetables is of great concern to food industry as it impairs the organoleptic properties of the products (Parvez, Kang et al. 2007). The rate of enzymatic browning depends on the concentration of active tyrosinase and phenolic compounds, oxygen availability, pH and temperature conditions in the tissue (Martinez and Whitaker 1995). It is therefore important to apply the antioxidants directly on the surface of the fruit and vegetables (e.g. antibrowning agent) to minimize this problem or incorporate in edible coatings that will enhance fruit and vegetable qualities as active packaging.

Western society seems increasingly focused on the use of "green" food (Smid and Gorris 1999), demanding for less synthetic additives and the utilization of compounds extracted directly from natural raw material (natural sources) in food (Burt 2004). For this reason active agents, antimicrobials and antioxidants (in this case antibrowning agents) from natural sources, were evaluated in this work and will be explained in more some detail.

#### 1.2.2.1. Antimicrobial agents

The incorporation of antimicrobial agents in edible coatings may prevent, or even inhibit, spoilage flora and decrease the risk of pathogenic microorganisms on the surface of food, being considered an active packaging (Appendini and Hotchkiss 2002; Debeaufort, Quezada-Gallo et al. 1998), leading to an extension of the shelf life and/ or the improved safety of the product. For the selection of an antimicrobial, it must be considered the effectiveness against the target microorganism and the possible interactions with the materials used in coatings productions (Campos, Gerschenson et al. 2011).

The most commonly antimicrobial agents (natural source and synthetic) used in edible coatings include organic acids (e.g., lactic, acetic, malic, citric, benzoic), bacteriocins (e.g., nisin, pediocin), enzymes (e.g., lysozyme), inorganic gases (e.g., carbon dioxide), polysaccharides (e.g., chitosan), fatty acids, fungicides (e.g., natamycin) and some plant extracts and its essential oils (EOs), among others (Campos, Gerschenson et al. 2011; Ramos, Fernandes et al. 2012; Valencia-Chamorro, Palou et al. 2011). Fruit and plant extracts (e.g., oregano and rosemary) have been used as antimicrobial agents, owing to their ability to control various food-borne bacteria, for example, *Salmonella spp.* (Helander, Alokomi et al. 1998; Paster, Juven et al. 1990) and *Escherichia coli* O157:H7 (Burt and Reinders 2003).

There is a trend to select the antimicrobials from natural sources and to use Generally Recognized As Safe (GRAS) compounds so as to satisfy consumer demands for healthy foods, free of chemical additives (Devlieghere, Vermeiren et al. 2004). The use of EOs as natural antimicrobial compounds in foods has attracted growing interest in the recent years, to meet the consumers' requirements in terms of food quality and safety, and also more recently in the development of antimicrobial edible coatings that have been extensively used.

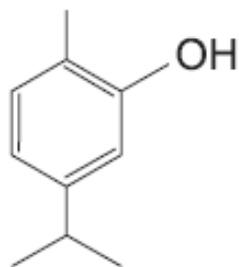
EOs are aromatic oily liquids obtained from plant material such as flowers, buds, seeds, leaves, twigs, bark, herbs, wood, fruits and roots (Burt 2004). An estimated 3000 EOs are known, of which about 300 are commercially important, destined chiefly for the flavours and fragrances market (Van de Braak and Leijten 1999). One of the major uses of EOs in the EU is in food (as flavourings) (Burt 2004).

Phenolic components are the primarily responsables for the antibacterial properties of EOs (Cosentino, Tuberoso et al. 1999). EOs contain a large number of compounds (majors components like carvacrol, eugenol or thymol) that are known to inhibit the metabolic activity of bacteria, yeasts, and moulds (Burt 2004; Di Pasqua, Betts et al. 2007; Gill and Holley 2006; Helander, Alakomi et al. 1998; López-Malo, Palou et al. 2005; Sikkema, Debont et al. 1995). For instance, it has been proved that essential oils of angelica, anise, carrot, cardamom, cinnamon, cloves, coriander, dill weed, fennel, garlic, nutmeg, oregano, parsley, rosemary, sage, or thyme are inhibitory to various spoilage or pathogenic bacteria, moulds, and yeasts (Burt 2004; Cagri, Ustunol et al. 2004; Rojas-Graü, Soliva-Fortuny et al. 2009; Sánchez-González, Vargas et al. 2011).

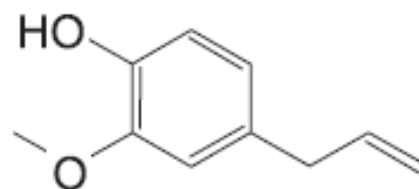
Nevertheless, direct incorporation of EOs in food still encounters technological limitations, related to the hydrophobic, reactive and volatile nature of the bioactive molecules constituting the EOs (Donsì, Annunziata et al. 2012). In order to retain their biological activity and minimize the impact on the organoleptic properties of foods

where they are incorporated, EOs constituents, like other bioactive compounds, need to be protected from the interaction with other food ingredients and from environmental stresses experienced during food manufacturing and storage (McClements 1999), for this reason its use in edible coatings is an asset to boost their antimicrobial properties. Moreover, antimicrobials added to coatings can be gradually released on the food surface, therefore, requiring smaller amounts to achieve the target shelf life (Min and Krochta 2005).

Carvacrol (Figure 17) is a phenolic compound found in high concentration (being a major component) in thyme and oregano EOs, is well known for its wide spectrum antimicrobial activity (Arfa, Combes et al. 2006; Chalier, Arfa et al. 2007; Periago and Moezelaar 2001; Roller and Sheedhar 2002), but also presents a great antioxidant capacity (Jukic and Milos 2005; Yanishlieva, Marinova et al. 1999). As aroma compound, carvacrol is GRAS and used as flavouring agents in baked goods, sweets, ice cream, beverages, and chewing gum (Chalier, Arfa et al. 2007). Moreover, carvacrol has been found efficient against a wide range spectrum of microorganisms both food spoilage and food-borne pathogenic microorganisms including bacteria such as *Bacillus* and *Shigella* species, *Listeria monocytogenes*, *Salmonella typhimurium*, *Escherichia coli*, *Pseudomonas fluorescens*, *Staphylococcus aureus* and fungi such as *Botrytis* and *Penicillium* species (Cosentino, Tuberoso et al. 1999; Kim, Marshall et al. 1995; Lambert, Skandamis et al. 2001; Pol and Smid 1999; Roller and Sheedhar 2002; Ultee, Bennik et al. 2002). Also, eugenol (Figure 18) is a phenolic compound found in high concentration (being a major component) in clove EOs, is well known for its wide spectrum antimicrobial activity against *Listeria monocytogenes*, *Salmonella typhimurium*, *Escherichia coli*, *Aspergillus*, *Bacillus cereus* among others (Burt 2004; Goñi, López et al. 2009; Gülçin, Sat et al. 2004; Kim, Marshall et al. 1995; Omidbeygi, Barzegar et al. 2007; Thoroski, Blank et al. 1989; Wenqiang, Shufen et al. 2007).



**Figure 17:** Structural formula of carvacrol (Burt 2004).



**Figure 18:** Structural formula of eugenol (Burt 2004).

Carvacrol and eugenol are able to disintegrate the outer membrane of Gram-negative bacteria, releasing lipopolysaccharides and increasing the permeability of the cytoplasmic membrane to ATP. Ultee, Kets et al. (2000) confirmed that cellular

membranes became more fluid in the presence of carvacrol. This compound forms channels through the membrane by pushing apart the fatty acid chains of the phospholipids, allowing ions to leave the cytoplasm. Thoroski, Blank et al. (1989) reported cell wall deterioration and a high degree of cell lysis in the presence of eugenol. The action of EOs not only affects the cytoplasmic membrane but also the mitochondrial membrane (Rasooli, Bagher et al. 2006). The high percentage content of phenolic compounds and the presence of a free hydroxyl group on aromatic cycle on chemical structure of carvacrol and eugenol is essential for antimicrobial activity, (Arfa, Combes et al. 2006; Burt 2004; Ultee, Bennik et al. 2002). Generally, it is accepted that the action of EOs, against microorganisms, are slightly more active against Gram-positive than Gram-negative bacteria (Burt 2004). Gram-negative organisms are less susceptible to the action of antimicrobials maybe because of they possess an outer membrane surrounding the cell wall (Ratledge and Wilkinson 1988), which restricts diffusion of hydrophobic compounds through its lipopolysaccharide covering (Vaara 1992).

Several studies evaluated the incorporating EOs into alginate and chitosan-based coatings against pathogenic bacteria (Ojagh, Rezaei et al. 2010b; Pranoto, Rakshit et al. 2005; Pranoto, Salokhe et al. 2005; Rojas-Graü, Avena-Bustilloos et al. 2007; Sánchez-González, Cháfer et al. 2010; Sánchez-González, González-Martínez et al. 2010; Zivanovic, Chi et al. 2005). Furthermore, EOs have been used to control microbial growth in foods and proposed for several products, such as fruits and vegetables (Arrebola, Sivakumar et al. 2010; Bhaskara Reddy, Angers et al. 1998; Gutierrez, Bourke et al. 2009; Omidbeygi, Barzegar et al. 2007; Skandamis and Nychas 2000), meat (Lemay, Choquette et al. 2002; Singh, Singh et al 2003; Skandamis and Nychas 2001; Solomakos, Govaris et al. 2008; Viuda-Martos, Ruiz-Navajas et al. 2010; Vrinda Menon and Garg 2001), fish (Kykkidou, Gitrakou et al. 2009; Mejlholm and Dalgaard 2002) and dairy (Karatzas, Kets et al. 2001; Vrinda Menon and Garg 2001). For instance, Roller and Seedhar (2002) observed that carvacrol and cinnamaldehyde were very effective at reducing the natural flora on kiwifruit when used at  $0.15 \mu\text{l ml}^{-1}$  in dipping solution, but less effective on honeydew melon. Blaszyk and Holley (1998) found that eugenol completely inhibited *L. monocytogenes* and *E. coli* O157:H7 growth in model microbial systems at concentrations greater than  $1 \mu\text{g/ml}$ . Also the incorporation of EOs in edible coatings have been used more and more on control microbial growth in meat and meat products, fish, dairy products, fruits and vegetables. Raybaudi-Massilia, Rojas-Graü et al. (2008) observed that the addition of cinnamon, clove or lemongrass oils at 0.7% (v/v) or their active compounds (citral, cinnamaldehyde and eugenol) at 0.5% (v/v) into

an alginate-based coating increased their antimicrobial effect, reduced the population of *E. coli* O157:H7 by more than 4 log CFU g<sup>-1</sup> and extended the microbiological shelf-life of Fuji apples for at least 30 days. Raybaudi-Massilia, Mosqueda-Melgar et al. (2008) reported a significant extension of the shelf-life of melon, of over 21 days, when alginate-based coatings enriched with cinnamon leaf, palmarosa or lemongrass oils were used. Lu, Ding et al. (2010) incorporated EOs on alginate to improve the quality of fish fillets. The application of EOs on chitosan-based coatings has been used to maintain the quality of postharvest fruits and vegetables such as banana (Win, Jitareerat et al. 2007), pineapple (Sangsuwan, Rattanapanone et al. 2008), squash (Ponce, Roura et al. 2008), also of fish (Gómez-Estaca, López de Lacey et al. 2010; Ojagh, Rezaei et al. 2010a).

#### 1.2.2.2. Antibrowning agents

The phenomenon of browning is usually caused by the enzyme tyrosinase (PPO), which in presence of oxygen, converts phenolic compounds into dark coloured pigments (Zawistowski, Biliaderis et al. 1991). The application of antioxidant by dipping after peeling and/or cutting is the most common way to control browning of fresh-cut fruits, but also in fruits or vegetables entire (Rojas-Graü, Soliva-Fortuny et al. 2009).

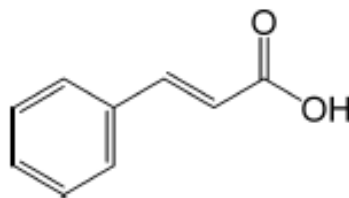
The antibrowning reagents are frequently used, previously, the most used method of antibrowning was the use of sulfating agents (sulfite) (Iyengar and McEvily 1992), but the United States (USA) FDA has banned sulfate agents for fruits and vegetables due the off-flavours and allergies which were related with their presence (Satooka and Kubo 2011). Thus, is essential find another antibrowning agents to substitutes this sulfating agents. For antibrowning agents, naturally occurring substances are usually more favorable than synthetic ones. The most common natural antibrowning agent is ascorbic acid. However, the effect of ascorbic acid against enzymatic oxidation is temporary because it is chemically oxidized to a nonfunctional form, dehydroascorbic acid (Komthong, Igura et al. 2007). These problems and given the fact consumers demanded less use of chemicals on minimally processed fruits and vegetables, has been paid more attention to the search for naturally occurring substances able to act as antioxidants. The addition of natural antioxidants derived from vegetable extracts as a way of increasing the shelf life of food products has become increasingly popular (Ponce, Roura et al. 2008).

Besides, fresh products as mushrooms cannot be treated with antioxidants (such as carboxylic acids - citric acid and oxalic acid among others) due to its low pH that causes lesions in mushrooms (Echegoyen and Nerín 2015; Rojas-Graü, Soliva-Fortuny et al. 2009). To protect the mushrooms against oxidation the use of active

packaging, is a smart solution to extend their shelf life through incorporation of inhibitors that prevent the action of tyrosinase (PPO). Inhibitors from natural sources have a great potential in the food industry, as they are considered to be safe and largely free from adverse side effects (Seo, Sharma et al. 2003).

Plants are a rich source of bioactive chemicals and there is an ongoing effort to search for tyrosinase inhibitors from them. A broad spectrum of compounds has been obtained from the natural products and investigated for mushroom tyrosinase inhibitory activity (Parvez, Kang et al. 2007).

The inhibitors are categorized into two main subgroups, polyphenols and benzaldehydes and benzoate derivatives. Polyphenols are a group of chemical compounds that are widely distributed in nature and also known as vegetable tannins because they are responsible for the colours of many flowers. Some of them are complex compounds present in the bark, root, and leaves of plants, whereas others are simple compounds present in most fresh fruits, vegetables and tea. Some tyrosinase inhibitory flavanoids are kaempferol, quercetin, myricetin among many others from various plants that have been reviewed by Chang (2009). In the past decade, a large number of benzaldehyde and benzoate derivatives have been isolated from plants and identified as tyrosinase inhibitors, including benzoic acid, benzaldehyde, anisic acid, anisaldehyde, cinnamic acid, and methoxycinnamic acid from the roots of *Pulsatilla cernua* (Jiménez, Chazarra et al. 2001) among many other (Chang 2009). Cinnamic acid (Figure 19) is one of the major components of *Cinnamomum cassia* BLUME (He, Qiao et al. 2005) and also can be obtained from *Pulsatilla cernua* (Jiménez, Chazarra et al. 2001) and *Lemna minor* (Kim, Hyun et al. 2012), however it can be also obtained from synthetic source (Seo, Sharma et al. 2003). It has been showed that cinnamic acid has a good inhibitory effect on tyrosinase activity (Kim, Hyun et al. 2012; Lee, Han et al. 2004; Masamoto, Murata et al. 2004; Shi, Chen et al. 2005).



**Figure 19:** Chemical structure of cinnamic acid (Kong, Jo et al. 2008).

Besides plants, some compounds from fungal sources have also been identified and reported for their inhibitory activity toward tyrosinase such azelaic acid and kojic acid (Parvez, Kang et al. 2007).

### 1.2.3. Properties of the edible coatings

The potential of edible coatings is essentially based on a combination of properties such as barrier to water vapour, oxygen, carbon dioxide, flavours, aromas and colour that allows this kind of applications increase and improve food shelf-life. Often these properties are dependent on: the polymer used, the added constituents, the storage conditions, the type of application, etc (Khwaldia, Perez et al. 2004). The transport properties most studied are: the permeability of water vapour, oxygen and carbon dioxide.

Oxygen is responsible for many degradation processes in foods such as lipid oxidation, microorganism growth, enzymatic browning and vitamin loss (Ayranci and Tunc 2003). The most common quality loss of packaged foods is caused by oxygen (Bonilla, Atarés et al. 2012). Although some oxygen availability is needed for respiration of living tissues, which allows the consumption of sugars and other compounds, thus increasing ethylene production and causing senescence (Oms-Oliu, Soliva-Fortuny et al. 2008; Rojas-Graü, Tapia et al. 2007). The application of edible coatings can reduce effectively the oxidation or the respiration in food, prolonging the shelf-lives of foods. There are several types of packaging and strategies to eliminate contact of food with oxygen, protecting the food. However, the permeability to oxygen and carbon dioxide is essential for respiration in living tissues such as fresh fruits and vegetables. Thus, coatings with moderate barrier are more appropriate. Therefore, if is chosen a coating with the appropriate permeability, can be established a controlled respiratory exchange and thus the preservation of fresh fruits and vegetables can be prolonged (Ayranci and Tunc 2003).

Edible coatings provides the potential to control transfer of moisture, oxygen, aroma, oil, and flavour compounds in food depending on the nature of edible film-forming materials. Their properties, such as barrier, mechanical, and optical properties, also depends on the nature of components and coating composition and structure (Khwaldia, Perez et al. 2004).

The main concepts of using the edible coatings are extending food shelf life, improvement food quality, addition the value of natural polymer material and also reduce the synthetic packaging materials. Many processing procedures had been used to form edible coating, such as panning, fluidized bed, dipping, and spraying. All these techniques exhibit several advantages and disadvantages and their performance depends principally on the characteristics of the foods to be coated and the physical properties of the coating (viscosity, density, surface tension, among others) (Andrade, Skurtys et al. 2012). Spray coating is the most commonly used technique for applying food coatings (Debeaufort and Voilley 2009). However, the dip application method is



advantageous when products require a total coating, it allows obtaining good uniformity around a complex and rough surface and usually used to coat fruits, cheeses, vegetables, fish and meat. After dipping the product and draining away the excess coating and it is dried, forming a film on the surface of the product (Andrade, Skurtys et al. 2012).

Polysaccharide coatings are characterized by good barrier properties to O<sub>2</sub> and CO<sub>2</sub> and a low barrier to water vapour (Park 1995). The formation of edible coatings based on polysaccharides requires in most cases the presence of a plasticizer. The films without plasticizer have a hard and brittle structure due to interactions between the polymer molecules. The plasticizers used for edible coatings include sucrose, glycerol, sorbitol, among others (Sothornvit and Krochta 2000; 2001) and water also acts as a plasticizer (Krochta and Mulder-Johnson 1997). The plasticizers are low molecular weight agents which once incorporated into the polymeric film is capable of positioning itself between the polymer molecules. They interfere with the polymer-polymer interactions and result in increased flexibility and processing capacity (Krochta 2002). The addition of plasticizers can modify the modulus of elasticity and other mechanical properties, improving the strenght of coatings to penetration of gases and vapours (Sothornvit and Krochta 2000). Glycerol and sorbitol are widely used as plasticizers because of their stability and edibility (Bangyekan, Aht-Ong et al. 2006; Rindlav-Westling, Stading et al. 1998). Surfactants are amphipathic substances and may be incorporated into the coating to reduce the surface tension of the solution, improving the wettability of coatings (Krochta 2002). The addition of a surfactant (Tween) for forming coating solution reduces the interfacial tension and improves the adhesion of the surface to be covered. Choi, Park et al. (2002) reported that addition of 1% Tween 80 to a 1.5% solution of chitosan improved the compatibility of the chitosan coating solution and apple skin.

Hydrophilic properties of the polysaccharides films are responsible for their high water vapour permeability in comparison with commercial plastic films (Vargas, Pastor et al. 2008). However, the addition of plasticizers improve this property, for example, the addition of glycerol lowers the water permeability by 30% (Elsabee and Abdou 2013). Contrary to what occurs for water vapour, polysaccharides films are good barriers to transmission of oxygen and carbon dioxide (Mali, Grossmann et al. 2006). In some foods, are required moderate permeability to these types of gases allows for a controlled exchange of gases with the atmosphere (Ayranci and Tunc 2003; Kester and Fennema 1986). This control can be realized, as in the case of water vapour permeability, with the addition of plasticizers (Caner, Vergano et al. 1998; Mathew and Abraham 2008; Sothornvit and Krochta 2000). Also, the incorporation of EOs into

coatings improve the water vapour permeability and seems to be a better barrier to gases (Sánchez-González, Vargas et al. 2011).

The main function of edible coatings is to offer a protective barrier between the food and the environment. In addition, edible coatings of polysaccharides may also maintain food integrity by providing some mechanical protection (Campos, Gerschenson et al. 2011). The ability of edible coatings to protect food against mechanical damage is usually assessed by determining the mechanical properties of the film: (1) Young's Modulus (YM), which determines film stiffness as determined by ratio of pulling force/area to degree-of-film-stretch, (2) tensile strength (TS), which indicates the pulling force per film cross-sectional area required to break the film, and (3) elongation at break (E), which gives the degree to which the film can stretch before breaking and it is expressed as percentage (Krochta 2002). The relative humidity affect the mechanical properties, its increase, decreases the TS and YM while E increases, due to the increase on the amount of water in the film (Olivas and Barbosa-Cánovas 2004). The amount of plasticizer present in the film affects in the same way the mechanical properties (Gennadios, Weller et al. 1994). The presence of increasing amounts of garlic oil in alginate-based edible coatings greatly modified the film mechanical properties. TS and E values were reduced by incorporation of garlic oil at 0.3 and 0.4% (v/v) (Pranoto, Salokhe et al. 2005). Rojas-Graü, Raybaudi-Massilia et al. (2007) evaluated the mechanical properties of alginate-apple puree films in the presence of plant EOs or oil compounds. Films that containing oregano oil and carvacrol presented lower TS values, and films with carvacrol had the highest E value. YM was reduced in all films contained EOs or oil compounds, but no significant differences were reported among coatings. In general, the addition of antimicrobial agents to films significantly reduced TS and increase E values.

It is important taken into account the affinity between the coating material and the product, especially in fruits and vegetables. The optimization of the composition of the coating solutions based on their ability to spread over a surface can be made considering three parameters: the wettability, the adhesion and the cohesion coefficients. The control of the adhesion and cohesion coefficients is very important because if the adhesion promotes the spreading of the liquid (between the coating and the fruit), the cohesion promotes its contraction (of the molecules within the coating) and an adequate equilibrium between these two forces is necessary (Lima, Cerqueira et al. 2010; Olivas and Barbosa-Cánovas 2005; Ribeiro, Vicente et al. 2007). Wettability has been used to evaluate the efficiency of the coating on the food surface (Casariego, Souza et al. 2008; Ribeiro, Vicente et al. 2007). The wettability is evaluated by determining the values of the spreading coefficient and allows the

characterization of the surface of the product (Souza, Cerqueira et al. 2010). The coating process involves the wetting of the food product by the coating solution, and the possible penetration of the solution into the food skin (Hershko, Klein et al. 1996). Wettability is one of the most important properties when evaluating the capacity of a solution to coat a designated surface (Lima, Cerqueira et al. 2010). Plasticizers are known to reduce cohesion of coatings (Guilbert, Gontard et al. 1996) and the surface adhesion of edible coatings can be improved via addition of surfactants, for example Tween, which reduces surface tension, and improve wettability (Lin and Krochta 2005).

Besides barrier and mechanical properties and wettability there are some other properties that have been evaluated in edible coatings such as thickness, flavour, colour, and microbiological stability, all of them also important for the selection of an edible coating (Olivas and Barbosa-Cánovas 2005). It is important to ensure that the coatings have as little impact as possible on the sensory quality of coated products in terms of colour, gloss, basic tastes (bitterness, sourness and sweetness), aroma and firmness (Vargas, Pastor et al. 2008). Sometimes, high water solubility is desired, is the case when the film or coating will be consumed simultaneously with the food (Campos, Gersehenson et al. 2011).

Biodegradable polysaccharide coatings with satisfactory mechanical properties and good appearance are potential and ecological alternatives to synthetic packaging in food applications. They can be used to help in the preservation of fruit and vegetables because they provide a partial barrier to moisture, O<sub>2</sub> and CO<sub>2</sub>, also improving mechanical handling properties, carrying additives (Olivas and Barbosa-Cánovas 2005) and could lead to a reduction in the spoilage of the fruits and vegetables. The protective function of edible coatings may be enhanced with the addition of antioxidants, antimicrobials, flavours, nutrients, etc (Valencia-Chamorro, Palou et al. 2011).

### **1.3. Regulatory status of ingredients**

Food packages allow a large number of important functions, such as protection of food as well as maintaining the sensory quality and mainly safety of food. In addition to sensory and safety aspects relating with foods, the development and selection of bio based food packages also involve other issues, such as legislation for human consumption.

Due to the fact that edible coatings be an integral part of the edible portion of food products, they should observe all regulations required for food ingredients (Guilbert and Gontard 1995). To maintain edibility, all coating formed components, as

well as any functional additives in the coating formed materials, should be food-grade non toxic materials, since they are consumed together with edible coatings (Guilbert and Gontard 1995; Guilbert, Gontard et al. 1996). The foremost governmental regulations concerning food additives are the FDA in US, the EU standards, and the Codex Alimentarius, which constitutes the FAO/WHO. The FDA mentions that any compound to be included in the edible coating formulation should be GRAS or regulated as food additive (Rojas-Graü, Soliva-Fortuny et al. 2009). Also, in Europe, the ingredients that can be incorporated into edible coating formulations are majorly regarded as food additives and are listed (Rojas-Graü, Soliva-Fortuny et al. 2009).

All substances used in this work are covered by the legislators entities, and will be described below. Chitosan was approved by the FDA as a feed additive in 1983 (Han, Zhao et al. 2004) and also has been accepted as food additive in many countries (e.g. Italy, France, Norway, Poland, United States of America, Argentine, Japan and Korea (Casariego, Souza et al. 2008). Also, the alginate is a GRAS substance by FDA (Jiang 2013). According to US regulations, organic acids including lactic acid are GRAS for many finalities and general usage (Rojas-Graü, Soliva-Fortuny et al. 2009). Many EOs are used widely in the food industries and are also classified as GRAS substances or permitted as food additives (Rojas-Graü, Soliva-Fortuny et al. 2009). A number of EOs components have been registered by the European Commission for use as flavourings in foodstuffs. The flavourings registered are considered to present no risk to the health of the consumer and include carvacrol, eugenol, among others (Burt 2004). The last update of the list of codex specifications for food additives and flavourings include carvacrol, eugenol, cinnamic acid, lactic acid, sodium alginate, guar gum, glycerol and Tween 80 (polyoxyethylene (20) sorbitan monostearate) and all additives that are allowed on food products (Codex Alimentarius 2015).

#### **1.4. Criteria to choose a type of coating**

Besides the properties of the coatings, which were reviewed before, other important parameter to consider when selecting a coating it is their cost. For a future application at the industrial level should be taken into consideration the prices of the constituents of coatings, that should have the lowest cost possible, aiming a lower impact on the final price of the food product. Moreover, the selection of compounds for use in the formulations should be GRAS, being permitted by legislators entities.

For the choice of a suitable coating formulation for a particular type of food product, there are several criteria that must be considered. The effectiveness of edible

coatings for food preservation depends, in a first phase, of the controlling the wettability of the coating to ensure a uniformly coated surface (Casariego, Souza et al. 2008).

The efficiency of edible coatings depends mainly controlling the wettability of the solution used (Park 1999). The edible coatings must wet and spread out evenly on the food surface. After drying, the coating should have an appropriate durability. The determination of wetting capability allows compare the wettability of different coatings and therefore choose the best for use in the food product.

A good choice of formulation of edible coatings solutions is essential to the durability and maintenance of the coating on the food products. Determination of wetting capability and the study of the surface properties of the product is essential for the correct application of edible coatings (Park 1999).

## 1.5. Objectives addressed in this dissertation

Fresh mushrooms have a short shelf-life period, therefore post-harvest treatments should be applied for effective preservation (Pei, Shi et al. 2014). Also, due to their high perishability, about 55% of mushrooms produced are processed (with 5% in dehydrated form and 50% in canned form) and only 45% are consumed in the fresh form (Singh, Langowski et al. 2010).

Currently, the demand for healthier, safer and natural foods has been growing among consumers. So it becomes necessary to extend the post-harvest period of fresh products, preserving their quality and safety (e.g., nutritional and microbiological), allowing them to be commercially available for higher periods of time thus imparting a greater commercialization flexibility, with benefit for food industry as well as for the consumers. One of the general trends in food preservation is the development of preservation techniques that are less invasive to the foods (Fernandes, Antonio et al. 2012).

There are few published works regarding the application of edible coatings on mushrooms aiming the extension of their shelf-life. The incorporation of bioactive compounds in edible coatings is still new for application on mushrooms, and even the use of tyrosinase inhibitors is almost nonexistent. Therefore, the aim of this study was to develop an edible coating to increase the shelf life of mushrooms (*A. bisporus*), as well as maintain their quality, using only natural compounds, meeting the consumers demand for natural products. Three polysaccharide-based coatings were studied (sodium alginate, chitosan and guar gum) with the incorporation of bioactive compounds, namely antimicrobials (essential oils compounds of eugenol and carvacrol) and tyrosinase inhibitors (cinnamic acid). After the optimization of the

coating in terms of wettability and the determination of the minimum concentration of bioactive compounds which should be used, the application of the edible coating was performed in fresh mushrooms. Physicochemical analysis were performed in coated and uncoated mushrooms in terms of colour, bacterial growth, weight loss, moisture, content of total solids, total soluble solids (TSS), pH, titratable acidity and enzymatic analyses. The performed analyses allow determining whether there will be improvement in the quality and shelf life compared to uncoated mushrooms during storage. Being desirable that the coated mushrooms have less water loss, microbiological growth and browning, also less enzymatic activity compared to the uncoated mushrooms.

---

## **CHAPTER II**

### **Optimization of the coating**

---

## Chapter II – Optimization of the coating

The optimization of a coating solution consists on the determination of the formulation that should be used to coat the food products and is essential for a good maintenance and durability of the coating. For the coating formulation were used three different polysaccharides (chitosan, sodium alginate and guar gum) and a plasticizer (glycerol) and a surfactant (Tween 80). The optimization was performed through the evaluation of the wettability. For that the spreading coefficient, the work of adhesion and cohesion, as well as the surface properties of the mushroom, were evaluated (Cerqueira, Pinheiro et al. 2009).

### 2.1. Materials and methods

#### 2.1.1. Preparation of polysaccharides solutions

##### 2.1.1.1. Chitosan

Coating formulations were produced based on a  $2^3$  factorial design with a central point (C), with polysaccharide concentrations ranged between 0.5 and 1% (w/v), plasticizer concentrations ranged between 0.125 and 0.250% (v/v) and surfactant concentrations ranged between 0.05 and 0.1% (v/v). Table 5 presents the formulations of the coatings tested.

**Table 5:** Chitosan, plasticizer and surfactant concentrations used in the coatings formulation.

Solution	Chitosan (w/v)	Glycerol (v/v)	Tween 80 (v/v)
1	0.5% (-1)	0.125% (-1)	0.05% (-1)
2	0.5% (-1)	0.125% (-1)	0.15% (+1)
3	0.5% (-1)	0.250% (+1)	0.05% (-1)
4	0.5% (-1)	0.250% (+1)	0.15% (+1)
5	1.0% (+1)	0.125% (-1)	0.05% (-1)
6	1.0% (+1)	0.125% (-1)	0.15% (+1)
7	1.0% (+1)	0.250% (+1)	0.05% (-1)
8	1.0% (+1)	0.250% (+1)	0.15% (+1)
9 (1)	0.75% (C)	0.1875% (C)	0.1% (C)
9 (2)	0.75% (C)	0.1875% (C)	0.1% (C)
9 (3)	0.75% (C)	0.1875% (C)	0.1% (C)



Chitosan solutions were prepared by dissolving chitosan (Aqua Premier Co., Thailand) (0.5, 0.75 and 1.0%, w/v) in a solution of 1% of L(+)-lactic acid (90%, Acros Organics, Belgium), under agitation for 16 h at the room temperature (22 °C). Tween 80 (Panreac, Spain) was added as surfactant (0.05, 0.1 and 0.15%, v/v) and glycerol (86-89%, Sigma, Germany) as a plasticizer (0.125, 0.1875 and 0.250%, v/v) and maintain under agitation for 4h at room temperature.

### 2.1.1.2. Sodium alginate

Coating formulations were evaluated based on a 2<sup>3</sup> factorial design with a central point (C), with polysaccharide concentrations ranged between 0.5 and 1% (w/v), plasticizer concentrations ranged between 0.125 and 0.250% (v/v) and surfactant concentrations ranged between 0.05 and 0.1% (v/v). Table 6 presents the formulations of the coatings tested.

**Table 6:** Sodium alginate, plasticizer and surfactant concentrations used in the coatings formulation.

Solution	Sodium alginate (w/v)	Glycerol (v/v)	Tween 80 (v/v)
1	0.5% (-1)	0.125% (-1)	0.05% (-1)
2	0.5% (-1)	0.125% (-1)	0.15% (+1)
3	0.5% (-1)	0.250% (+1)	0.05% (-1)
4	0.5% (-1)	0.250% (+1)	0.15% (+1)
5	1.0% (+1)	0.125% (-1)	0.05% (-1)
6	1.0% (+1)	0.125% (-1)	0.15% (+1)
7	1.0% (+1)	0.250% (+1)	0.05% (-1)
8	1.0% (+1)	0.250% (+1)	0.15% (+1)
9 (1)	0.75% (C)	0.1875% (C)	0.1% (C)
9 (2)	0.75% (C)	0.1875% (C)	0.1% (C)
9 (3)	0.75% (C)	0.1875% (C)	0.1% (C)

Sodium alginate solutions were prepared by dissolving Tween 80 used as surfactant (0.05, 0.1 and 0.15%, v/v) and glycerol (86-89%) used as a plasticizer (0.125, 0.1875 and 0.250%, v/v) under agitation for 4 h at room temperature (22 °C). After, sodium alginate (FMC BioPolymer, Eurosalmo) was added to the solution (0.5, 0.75 and 1.0% w/v) and maintained under agitation for 24 h at room temperature.

### 2.1.1.3. Guar gum

Coating formulations were evaluated based on a 2<sup>3</sup> factorial design with a central point (C), with polysaccharide concentrations ranged between 0.5 and 1% (w/v), plasticizer concentrations ranged between 0.125 and 0.250 % (v/v) and surfactant concentrations ranged between 0.05 and 0.1% (v/v). Table 7 presents the formulations of the coatings tested.

**Table 7:** Guar gum, plasticizer and surfactant concentrations used in the coatings formulation.

Solution	Guar gum (w/v)	Glycerol (v/v)	Tween 80 (v/v)
1	0.5% (-1)	0.125% (-1)	0.05% (-1)
2	0.5% (-1)	0.125% (-1)	0.15% (+1)
3	0.5% (-1)	0.250% (+1)	0.05% (-1)
4	0.5% (-1)	0.250% (+1)	0.15% (+1)
5	1.0% (+1)	0.125% (-1)	0.05% (-1)
6	1.0% (+1)	0.125% (-1)	0.15% (+1)
7	1.0% (+1)	0.250% (+1)	0.05% (-1)
8	1.0% (+1)	0.250% (+1)	0.15% (+1)
9 (1)	0.75% (C)	0.1875% (C)	0.1% (C)
9 (2)	0.75% (C)	0.1875% (C)	0.1% (C)
9 (3)	0.75% (C)	0.1875% (C)	0.1% (C)

Guar gum solutions were prepared by dissolving Tween 80 used as surfactant (0.05, 0.1 and 0.15%, v/v) and glycerol (86-89%) used as a plasticizer (0.125, 0.1875 and 0.250% v/v) under agitation for 4h at room temperature (22 °C). After, guar gum (Sigma, USA) was added to the solution (0.5, 0.75 and 1.0%, w/v) and maintained under agitation for 2 h at 40 °C.

### 2.1.2. Mushrooms

*A. bisporus* (white button) mushroom used were purchased at a local supermarket (Braga, Portugal) (under storage conditions of 6-8 °C). The mushrooms were harvested and packed the day before, with Portuguese production. 1 h after the acquisition, the mushrooms were selected for uniformity in size (40-50 mm pileus diameter) colour, maturity (closed cap) and free of any damage; they were then stored at 6-8 °C until further use.

The pileus is the main part of the fresh mushroom to be observed being the colour and shape the first features that attract consumers (Brosnan and Sun 2004).

Due to this fact, evaluations made on mushroom were performed on the pileus, subdivided into two parts: top and side.

### 2.1.3. Critical surface tension and surface tension of mushroom skin

Contact angle ( $\theta$ ) was determined with a contact angle meter (OCA 20, Dataphysics, Germany), where the coating solutions were placed in a 500 mL syringe (Hamilton, Switzerland) with 0.75 mm diameter. The measurement of contact angle on the pileus of mushroom surface was measured by the sessile drop method (Kwok and Neumann 1999); 20 replicates were performed on the pileus surface for each coating formulation (10 on top of the other and pileus 10 at the side. The surface tension ( $\gamma_{LV}$ ) was determined with a counter tensiometer (Krüss model K6, Germany), being performed at least three measurements for each coating formulations. The contact angles and surface tension measurements were carried out at room temperature ( $23.4 \pm 0.8$  °C).

According to Zisman (1964), systems that have a surface tension lower than  $100 \text{ mN m}^{-1}$  (low energy surfaces), the  $\theta$  formed by a liquid droplet on a solid surface will be a linear function of the surface tension of the liquid,  $\gamma_{LV}$  (where phase  $V$  is air saturated with the vapour of the liquid,  $L$ ). The Zisman method is applicable only for low energy surfaces.

For a pure liquid, if polar ( $\gamma_L^p$ ) and dispersive ( $\gamma_L^d$ ) interactions are known and if  $\theta$  is the contact angle between liquid and solid, the interaction can be described in terms of reversible work of adhesion ( $W_a$ ) (Zisman 1964), according to (equation 1)

$$W_a = W_a^d + W_a^p \Leftrightarrow W_a = 2 \left( \sqrt{\gamma_S^d \gamma_L^d} + \sqrt{\gamma_S^p \gamma_L^p} \right) \quad (\text{eq. 1})$$

where  $\gamma_S^p$  and  $\gamma_S^d$  are the polar and dispersive contributions to the surface of the studied solid. Rearranging the above equation yields (equation 2)

$$\frac{1 + \cos \theta}{2} \times \frac{\gamma_L}{\sqrt{\gamma_L^d}} = \sqrt{\gamma_S^p} \times \sqrt{\frac{\gamma_L^p}{\gamma_L^d}} + \sqrt{\gamma_S^d} \quad (\text{eq. 2})$$

The  $\theta$  determinations of at least three pure compounds should be performed on the surface of the mushrooms. In this case, bromonaphthalene (Merck, China), formamide (Merck, China) and ultrapure water, were tested on the surface of the mushrooms (15 repetitions for each side, top and side) combined with the respective

values of the dispersion and polar components will allow the calculation of both variables, the independent variable

$$\left( \sqrt{\frac{\gamma_L^p}{\gamma_L^d}} \right)$$

and the dependent variable  $\frac{1+\cos \theta}{2} \times \frac{\gamma_L}{\sqrt{\gamma_L^d}}$  from equation 2.

The surface tension and the dispersive and polar components were, respectively, 72.10, 19.90 and 52.20 mN m<sup>-1</sup> to water, 44.40, 44.40 and 0.00 mN m<sup>-1</sup> to bromonaphthalene and 56.90, 23.50 and 33.40 mN m<sup>-1</sup> to formamide (Busscher, van Pelt et al. 1984). The critical surface tension is an imaginary point of the  $\gamma_{sv}$  value, and it is frequently used to describe the wettability of a surface. It represents the value of  $\gamma_{LV}$  of a liquid above which the spreading of this liquid in a solid surface is complete. The estimation of the critical surface tension ( $\gamma_c$ ) is obtained by extrapolation from the Zisman plots (Zisman 1964), being defined as

$$\gamma_c = \lim \gamma_{LV} \quad \text{as } \theta \rightarrow 0 \quad (\text{eq. 3})$$

#### 2.1.4. Wettability of the coating solutions

Wettability was evaluated by determination of the spreading coefficient ( $W_s$ ), which represents a balance between the works of adhesion ( $W_a$ ) and cohesion ( $W_c$ ) (equation 4).

$$W_s = W_a - W_c = \gamma_{SV} - \gamma_{LV} - \gamma_{SL} \quad (\text{eq. 4})$$

While the  $W_a$  cause the liquid to spread on the solid surface, the  $W_c$  works make the fluid to contract. The  $W_s$  allows to compare the wettability of different coatings, where closer the value is to zero better will be the wettability of a given coating in the evaluated surface. The penetration of the liquid on the surface of the food is also an important factor (Hershko, Klein et al. 1996). The  $\theta$  of a liquid droplet on a solid surface is defined by the mechanical equilibrium of the drop under the action of

three interfacial tensions: solid-liquid ( $\gamma_{SL}$ ) solid-vapour ( $\gamma_{SV}$ ), and liquid-vapour ( $\gamma_{LV}$ ). The equilibrium spreading coefficient ( $W_s$ ) is defined by the equation Young (equation 4) (Rulon and Robert 1993) and can only be zero or negative. The surface energy or surface tension of the food product is also a factor in the control of adhesion of coatings on the surfaces of food process (Hong, Han et al. 2004; Karbowiak, Debeaufort et al. 2006).

$W_a$  and  $W_c$  are the works of adhesion and cohesion, defined by equations 5 and 6, respectively.

$$W_a = \gamma_{LV} + \gamma_{SV} - \gamma_{SL} \quad (\text{eq. 5})$$

$$W_c = 2\gamma_{LV} \quad (\text{eq. 6})$$

### 2.1.5. Statistical analysis

Experiments were performed using a completely randomized design. Data were subjected to one-way analysis of variance (ANOVA). Mean separations were performed by Tukey's multiple range test (SigmaPlot version 11.0, edition 2008, Germany). Differences at  $p < 0.05$  were considered significant.

Pareto analysis was used to determine the components of the coating that statistically influence the values of  $W_s$ ,  $W_a$  and  $W_c$ . Pareto charts were performed with the variables  $W_a$ ,  $W_c$  and  $W_s$  and the independent variables polysaccharide, glycerol and tween 80 using Statistica software (version 7, edition 2004, Statsoft, Tulsa, OK, USA).

## 2.2. Results and discussion

### 2.2.1. Evaluation of critical surface tension and surface tension of mushroom skin

The Zisman method is based on the plot of the cosine of the contact angle versus the superficial tension (liquid-vapour) on a given solid and is generally a straight line and is applicable only for systems with a surface tension below  $100 \text{ mN m}^{-1}$  (low energy surfaces) (Owens and Wendt 1969); Therefore, it is necessary to determine the surface energy of mushrooms in order to verify the applicability of that method. Determination of the surface tension involves the measurement of the contact angles of several standard liquids in the mushroom surface. The surface energy of the solid surface is then related to the surface tensions of the liquids and the contact angles.

This methodology involves an estimation of the critical surface tension of the surface of the solids studied, by extrapolation from the Zisman plot (Owolarafe, Olabige et al. 2007).

Equation 2 was used to calculate the values of the polar and dispersive components of the surface tension, being the surface tension the sum of these two components (Figures 20 and 21). To the side pileus, the polar ( $\gamma_S^p$ ) and dispersive ( $\gamma_S^d$ ) components are 1.46 and 40.08 mN m<sup>-1</sup>, respectively, being the surface tension value of 41.54 mN m<sup>-1</sup>. To the top pileus, the polar ( $\gamma_S^p$ ) and dispersive ( $\gamma_S^d$ ) components are 2.39 and 48.45 mN m<sup>-1</sup>, being the surface tension value of 50.84 mN m<sup>-1</sup>.

These results clearly show that the mushroom surface is a low-energy surface (<100 mN m<sup>-1</sup>) presenting a higher dispersive component which shows its ability to participate in nonpolar interactions. A surface with these characteristics interacts with liquid primarily by dispersion forces (Rulon and Robert 1993) influencing the effective spreading of the coating on the mushroom surface. The compatibility of the polarity (apolar or polar) between the surface and the coating may have an important role in the wettability of the coating on the surface of the mushroom.

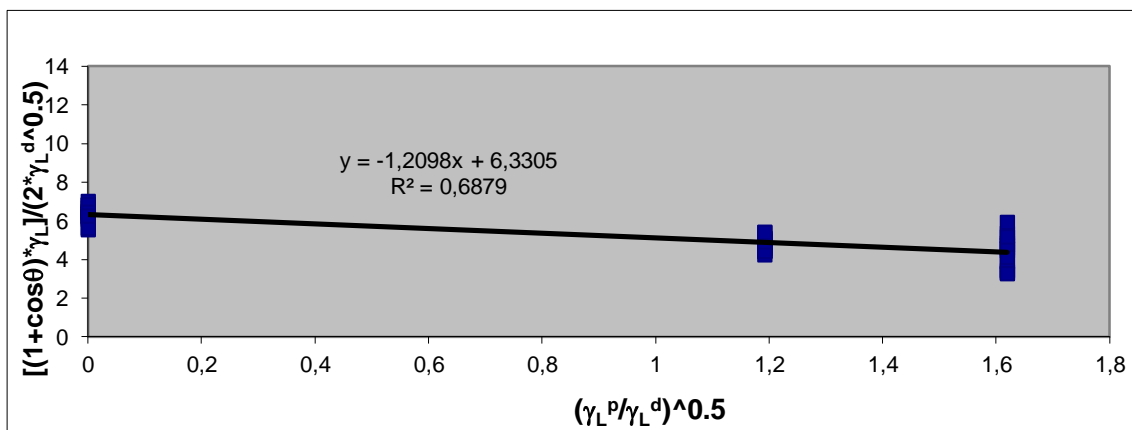


Figure 20: Regression of equation 2 for the pileus side.

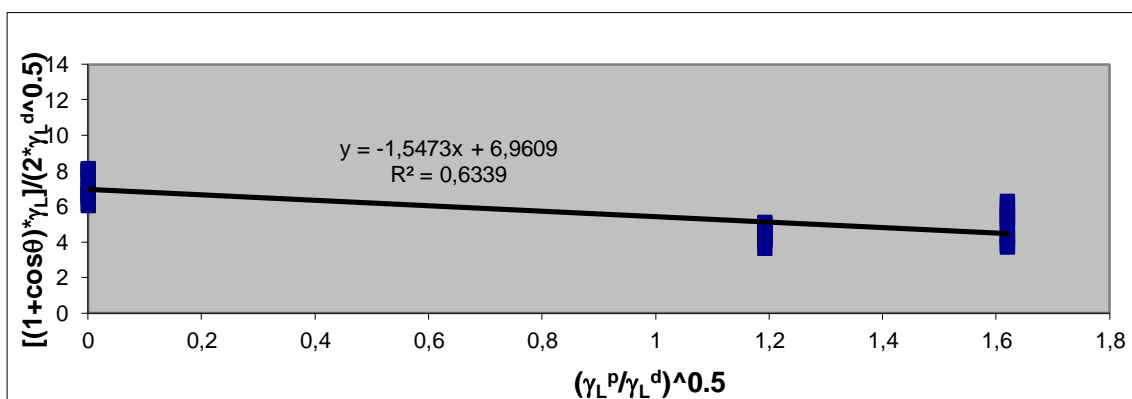


Figure 21: Regression of equation 2 for the pileus top.

The Zisman method can therefore be applied to estimate the critical surface tension. This value is obtained from the value of the superficial tension (liquid/vapour) at the intercept of the Zisman plot (Figures 22 and 23) for  $\cos \theta = 1$ , known as the critical surface tension ( $\gamma_c$ ). It should be noted that critical surface tension values had been reported to be lower than the surface tension values, for the same tested surfaces (Dann 1970). The critical surface tension values obtained for the pileus were 13.72 and 19.75  $\text{mN m}^{-1}$  for side and top, respectively, being less than the surface tension, in agreement with the expected.

The differences obtained for the surface tension and critical surface tension between the two parts (side and top) of the mushroom may be due to differences in their texture, being the top more uniform and smooth and the side more scaled, thus influencing the obtained results.

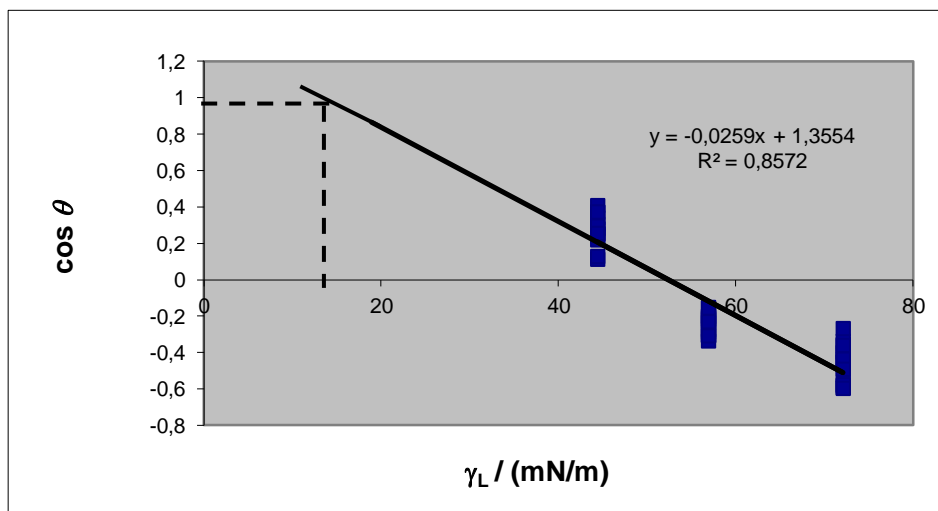


Figure 22: Zisman plot of pileus side.

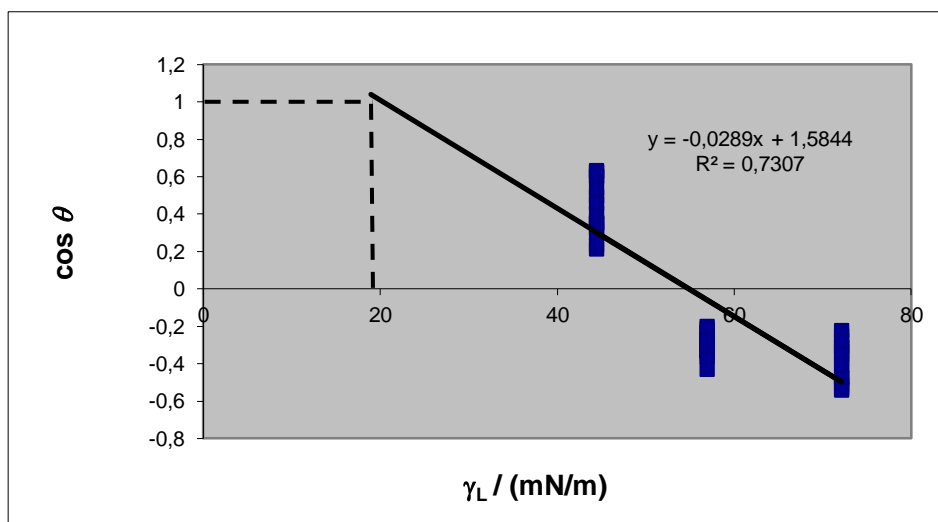


Figure 23: Zisman plot of pileus top.

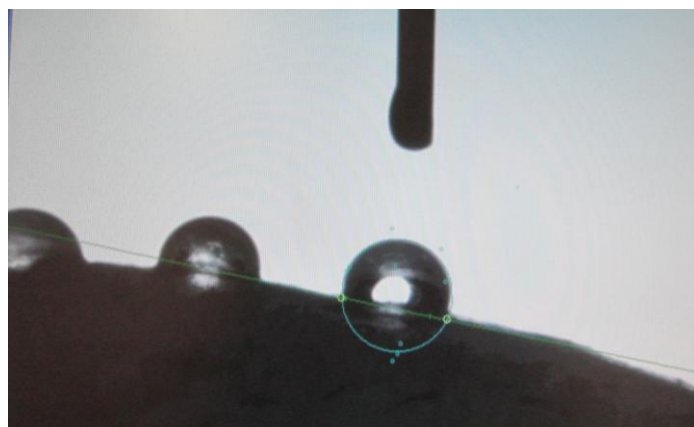
### 2.2.2. Evaluation of wettability

The wettability was taken as the most important criteria for choosing the formulation of the coating that will be then applied in mushrooms surface. First, based on wettability values, one of the three types of coatings (chitosan, sodium alginate or guar gum) will be eliminated, i.e., will be eliminated a whole set of formulations (11) of one coating; the one with the worst wettability values. After this, will be chosen the best formulation for each type of coating in the formulations (11) of two types of coating, i.e., one formulation of the 11 formulations of each coating, that will be used in further tests.

The behavior of a drop of a coating on the surface is affected by the molecular structure of the food surface, i.e., surface energy. Being the surface energy characteristics of the surface wettability hydrophilic or hydrophobic (Andrade, Skurtys et al. 2013).

When a drop of a liquid is placed on a solid (for example a fruit peel) the liquid can wet it totally or partially, for example, when liquid drop spreads completely the contact angle  $\theta = 0$  (Andrade, Skurtys et al. 2012). For surfaces exhibiting a water contact angle  $\theta > 65^\circ$  and  $\theta < 65^\circ$ , the surfaces were quantitatively definite by “hydrophobic” and “hydrophilic” surfaces, respectively (Ghanbarzadeh, Musavi et al. 2007; Vogler 1998). So, for  $\theta < 90^\circ$  the liquid is “mostly wetting”, for  $\theta \geq 90^\circ$  “mostly nonwetting” and if  $\theta = 180^\circ$ , the liquid is perfectly nonwetting (Andrade, Skurtys et al. 2012).

Contact angles obtained for all the different solutions are above  $90^\circ$  and below  $180^\circ$  ( $180^\circ > \theta \geq 90^\circ$ ), as presented in the Tables 9 and 10, which means that all solutions behave as hydrophobic on the surface of the mushroom, confirming previous data of the surface tension of mushroom as having a hydrophobic surface (Hershko and Nussinovitch 1998). The mushroom is composed by a hydrophobic protein (hydrophobin) forming a hydrophobic layer outside the fruiting body (Lugones, Bosscher et al. 1996). Example of the measurement of the contact angle on the surface of the mushroom, with  $\theta = 104.3^\circ$  is shown in Figure 24 and can also be observed in Figure 25 few drops of coating solution.



**Figure 24:** Measurement of the contact angle on the surface of the mushroom pileus, with  $\theta=104.3^\circ$ .





**Figure 25:** A few drops of coating solution on the surface of the pileus.

Finally, the optimization of the coating formulation was based on its ability to spread on a surface. Wettability was determined by the balance between the adhesion energy ( $W_a$ ) of the liquid on the solid and the cohesive energy ( $W_c$ ) of the liquid, being determined by equation 4. The values of tension liquid-vapour of the coating solutions (see Table 8) were used for the calculation  $W_c$  (equation 6).

The mushroom is known to be a kind of spongy material. The pileus has a porous structure that is a result of branching interconnected with hyphal filaments. Tables 9 and 10 show the values of wettability for the different evaluated coatings. A hydrophobic layer on mushroom can be responsible for the low wettability of the pileus, with most of the protein found in the same part of the mushroom (Hershko and Nussinovitch 1998).

In general, the coating solutions of guar gum are those with higher values ( $p < 0.05$ ) of liquid-vapour tension (Table 8), being then the coating solutions of chitosan and coating solutions of sodium alginate the ones that present lower values. Probably, guar gum presents higher values due to their ability to form thick solutions, becoming gel-like solutions with higher concentrations of biopolymer and thus leading to higher values of liquid-vapour surface tension. These coating solutions presented in general higher contact angles compared with the other coating solutions (chitosan and sodium alginate), probably due to its viscosity. Also, the contact angles (Tables 9 and 10) on the pileus side are slightly larger than the top, this may be due to the fact that the top be spongy, rather the side that seems to be more scaly.

Guar gum coatings have a lower ability to penetrate the porous tissue of the mushroom due to its high viscosity, therefore its uniformity as a coating is put in concern. While for the other coatings, which are more fluid, obtained results are better at the level of penetration by filamentous channels of the pileus.

**Table 8:** Liquid-vapour tension values of the evaluated coating solutions. Means in the same line with different letters are significantly different ( $p < 0.05$ ).

Solution	Liquid-vapour tension ( $\text{mN m}^{-1}$ )		
	Chitosan	Sodium alginate	Guar gum
1	42.83 $\pm$ 0.85 <sup>b</sup>	40.67 $\pm$ 1.04 <sup>a</sup>	42.83 $\pm$ 0.76 <sup>b</sup>
2	42.33 $\pm$ 0.62 <sup>a,b</sup>	42.00 $\pm$ 0.50 <sup>a</sup>	43.17 $\pm$ 0.58 <sup>b</sup>
3	43.00 $\pm$ 0.82 <sup>b</sup>	40.83 $\pm$ 0.76 <sup>a</sup>	43.50 $\pm$ 0.87 <sup>b</sup>
4	43.67 $\pm$ 0.47 <sup>b</sup>	42.17 $\pm$ 0.29 <sup>a</sup>	43.00 $\pm$ 0.00 <sup>c</sup>
5	44.33 $\pm$ 0.94 <sup>b</sup>	39.50 $\pm$ 1.00 <sup>a</sup>	46.00 $\pm$ 0.00 <sup>c</sup>
6	43.83 $\pm$ 0.62 <sup>b</sup>	40.83 $\pm$ 0.58 <sup>a</sup>	47.00 $\pm$ 0.00 <sup>c</sup>
7	42.83 $\pm$ 0.62 <sup>b</sup>	40.50 $\pm$ 0.87 <sup>a</sup>	49.00 $\pm$ 0.00 <sup>c</sup>
8	42.00 $\pm$ 0.00 <sup>b</sup>	40.67 $\pm$ 0.58 <sup>a</sup>	47.00 $\pm$ 0.00 <sup>c</sup>
9 (1)	41.83 $\pm$ 0.24 <sup>a</sup>	40.83 $\pm$ 1.26 <sup>a</sup>	42.00 $\pm$ 0.00 <sup>a</sup>
9 (2)	41.17 $\pm$ 0.24 <sup>a</sup>	40.17 $\pm$ 1.26 <sup>a</sup>	43.83 $\pm$ 0.29 <sup>b</sup>
9 (3)	41.17 $\pm$ 0.85 <sup>a</sup>	41.83 $\pm$ 0.76 <sup>a</sup>	43.33 $\pm$ 0.58 <sup>b</sup>

It is desirable that the value of  $W_s$  obtained are close to zero; the value closer to zero will represent the best wettability results of the coating on mushroom surface. Evaluating the results of  $W_s$  for the two parts of pileus, it is observed (Tables 9 and 10) that the guar gum-based coating has the lowest values of wettability, while chitosan and sodium alginate coatings present the better values of wettability (i.e. values closer to zero). Based on the obtained results will be chosen the best solution for each type of coating. At this stage the guar gum-based coatings are excluded and only chitosan and sodium alginate-based coatings are evaluated.

For the chitosan formulations, the best formulations to the pileus top, in decreasing sequence are the formulations: 9(3)-2-4-9(1)- 9(2)-8-1-7-6-5-3 (Table 9); and for the pileus side are the formulations: 9(1)-4-8-9(3)-2-1-9(2)-3-6-7-5 (Table 10). Comparing all the  $W_s$  values obtained for chitosan coatings it is observed that for the pileus top, the formulations 9(3), 2, 4, 9(1), 9(2) and 8 (values ranged between -56.97 and -64.96) do not present statistically significant differences ( $p > 0.05$ ), while for the pileus side the formulations which not showed statistically significant differences ( $p > 0.05$ ) for  $W_s$  values where the 9(1), 4, 8, 9(3) and 2 (values ranged between -60.44 and -59.86). When considering choosing one formulation was also considered the use of lower amounts of the components used in coating (i.e., amount of chitosan, glycerol and Tween 80). This is an important parameter that should be considered in the industrial level once is economically advantageous to use less amounts of ingredients

in the final product. However, this parameter should only be used when products with higher and lower amounts of components present similar results, showing no statistically significant differences between them. Therefore, to choose one formulation will be considered the 3 factors: best values of wettability, the least amount of components used in the coating, and then the solution that coincides in both parts of the pileus (side and top). Considering this factors, the formulation with the best  $W_s$  and the lower amount of components for the pileus, is the solution 2 composed by 0.5% of chitosan, 0.15% of Tween 80 and 0.125% of glycerol.

For sodium alginate coating solutions the best formulations to the pileus top, in decreasing sequence are the formulations: 3, 1, 9(1), 9(2), 9(3), 7, 6, 8, 5, 2 and 4 (Table 9); and for the pileus side are the formulations: 3, 9(1), 8, 9(3), 6, 1, 2, 9(2), 7, 5 and 4 (Table 10). From statistical analyses it can be concluded that for the pileus top, the formulations 3, 1, 9(1), 9(2), 9(3), 7, 8 and 5 do not present statistically significant differences ( $p>0.05$ ) between them, and for the pileus side no significant differences ( $p>0.05$ ) were determined between the formulations 3, 9(1), 8, 9(3), 6, 1, 2, 9(2), 7 and 5. Considering this factors, the formulation with the best  $W_s$  and the lower amount of components for the pileus, is the solution 1 composed by 0.5% of sodium alginate, 0.05% of Tween 80 and 0.125% of glycerol.

Pareto charts of effects (Figures 62 and 63 on Annex A.1.), showed that for chitosan coating solutions the components that influence the values of  $W_s$  on pileus side and top are Tween 80 and chitosan. For solutions of sodium alginate the pareto chart data (Figures 60 and 61 on Annex A.1.) either to the side or pileus top are sodium alginate and Tween 80. Results showed the great influence of Tween 80 and biopolymer concentrations on the  $W_s$  values. Also for  $W_a$  the Tween 80 and biopolymer concentration are the components that most affect the obtained values (Figures 64, 65, 66 and 67 on Annex A.1.). Regarding  $W_c$  the components that most affect the solutions of chitosan (Figures 70 and 71 on Annex A.1.) were biopolymer and glycerol concentrations; as the alginate solutions, all the components of the coating affect the  $W_c$  (Figures 68 and 69 on Annex A.1.).

The sodium alginate and chitosan-based coatings are polar and showed low values of  $W_a$  ( $<40.89 \text{ mN m}^{-1}$ ) even with the addition of glycerol and Tween 80. This may be due to the fact that the mushroom has a surface of low energy, as presented previously. Also, as already mentioned, the mushroom surface showed to interact with the coatings mainly by dispersion forces.

The addition of a surfactant in the coating solution improves wettability of the coating on the surface to be covered (Carneiro-da-Cunha, Cerqueira et al. 2009; Cerqueira, Lima et al. 2009a). Some studies have shown that addition of Tween 80

improves the values of  $W_s$  (closer to zero). Choi, Park et al. (2002) reported that the addition of 1% of Tween 80 solution to 1.5% chitosan solution improves the compatibility of the chitosan coating on the surface of apples and thus improves the wettability. Similar results were presented by other authors when evaluating other coatings on fruits and vegetables (Casariego, Souza et al. 2008; Cerqueira, Lima et al. 2009b; Ribeiro, Vicente et al. 2007). So, the solutions that will be used in this work are the solution 2 composed by 0.5% of chitosan, 0.15% of Tween 80 and 0.125% of glycerol and the solution 1 composed by 0.5% of sodium alginate, 0.05% of Tween 80 and 0.125% of glycerol.

**Table 9:** Values of  $W_s$ ,  $W_a$ ,  $W_c$  and  $\theta$  of the solutions of chitosan, sodium alginate and guar gum for pileus top.

Chitosan solution	$W_s$ (mN m <sup>-1</sup> )	$W_a$ (mN m <sup>-1</sup> )	$W_c$ (mN m <sup>-1</sup> )	$\theta$
1	-69.21 ± 4.27 <sup>b,c,d</sup>	16.46 ± 4.27	85.67 ± 0.85	128.29 ± 6.95
2	-59.86 ± 3.14 <sup>a</sup>	24.81 ± 3.14	84.67 ± 0.62	114.53 ± 4.66
3	-72.72 ± 2.48 <sup>d</sup>	13.28 ± 2.48	86.00 ± 0.82	133.87 ± 4.54
4	-60.36 ± 5.60 <sup>a,b</sup>	26.98 ± 5.60	87.33 ± 0.47	112.66 ± 7.89
5	-71.10 ± 3.21 <sup>c,d</sup>	17.57 ± 3.21	88.67 ± 0.94	127.30 ± 5.23
6	-70.89 ± 2.37 <sup>c,d</sup>	16.78 ± 2.37	87.67 ± 0.62	128.20 ± 3.88
7	-70.84 ± 2.14 <sup>c,d</sup>	14.83 ± 2.14	85.67 ± 0.62	130.93 ± 3.79
8	-64.96 ± 4.85 <sup>a,b,c</sup>	19.04 ± 4.85	84.00 ± 0.00	123.43 ± 7.77
9 (1)	-60.44 ± 8.70 <sup>a,b,c</sup>	23.22 ± 8.70	83.67 ± 0.24	117.01 ± 13.03
9 (2)	-63.01 ± 4.73 <sup>a,b,c</sup>	19.32 ± 4.73	82.33 ± 0.24	122.36 ± 7.88
9 (3)	-56.97 ± 3.37 <sup>a</sup>	22.66 ± 3.37	82.33 ± 0.85	116.82 ± 5.26
Sodium alginate solution	$W_s$ (mN m <sup>-1</sup> )	$W_a$ (mN m <sup>-1</sup> )	$W_c$ (mN m <sup>-1</sup> )	$\theta$
1	-42.87 ± 9.90 <sup>a</sup>	38.46 ± 9.90	81.33 ± 1.04	93.14 ± 14.13
2	-61.12 ± 5.74 <sup>b</sup>	22.88 ± 5.74	84.00 ± 0.50	117.38 ± 8.75
3	-40.78 ± 11.54 <sup>a</sup>	40.89 ± 11.54	81.67 ± 0.76	89.82 ± 16.59
4	-62.88 ± 5.45 <sup>b</sup>	21.45 ± 5.45	84.33 ± 0.29	119.73 ± 8.43
5	-59.29 ± 7.02 <sup>a,b</sup>	19.71 ± 7.02	79.00 ± 1.00	120.67 ± 11.75
6	-58.20 ± 3.70 <sup>b</sup>	23.46 ± 3.70	81.67 ± 0.58	115.30 ± 5.75
7	-57.51 ± 6.88 <sup>a,b</sup>	23.49 ± 6.88	81.00 ± 0.87	115.27 ± 10.81
8	-58.39 ± 6.31 <sup>a,b</sup>	22.94 ± 6.31	81.33 ± 0.58	116.17 ± 9.72
9 (1)	-53.89 ± 3.84 <sup>a,b</sup>	27.78 ± 3.84	81.67 ± 1.26	108.73 ± 5.71
9 (2)	-54.45 ± 5.83 <sup>a,b</sup>	25.88 ± 5.83	80.33 ± 1.26	111.06 ± 8.91
9 (3)	-55.24 ± 7.38 <sup>a,b</sup>	28.43 ± 7.38	83.67 ± 0.76	108.96 ± 10.67
Guar gum solution	$W_s$ (mN m <sup>-1</sup> )	$W_a$ (mN m <sup>-1</sup> )	$W_c$ (mN m <sup>-1</sup> )	$\theta$
1	-58.90 ± 5.92 <sup>a</sup>	26.77 ± 5.92	85.67 ± 0.76	112.30 ± 8.82
2	-67.94 ± 4.72 <sup>a,b</sup>	18.39 ± 4.72	86.33 ± 0.58	125.35 ± 7.66
3	-60.55 ± 8.33 <sup>a,b</sup>	26.45 ± 8.33	87.00 ± 0.87	113.51 ± 11.85
4	-62.19 ± 6.08 <sup>a,b</sup>	23.81 ± 6.08	86.00 ± 0.00	116.84 ± 9.22
5	-80.89 ± 3.42 <sup>c</sup>	11.11 ± 3.42	92.00 ± 0.00	139.71 ± 6.43
6	-82.53 ± 3.43 <sup>c</sup>	11.47 ± 3.43	94.00 ± 0.00	139.46 ± 6.31
7	-81.03 ± 3.58 <sup>c</sup>	16.97 ± 3.58	98.00 ± 0.00	131.03 ± 5.55
8	-79.13 ± 4.55 <sup>c</sup>	14.87 ± 4.55	94.00 ± 0.00	133.59 ± 7.83

9 (1)	$-57.69 \pm 6.93^a$	$26.31 \pm 6.93$	$84.00 \pm 0.00$	$112.43 \pm 11.21$
9 (2)	$-59.69 \pm 7.56^{a,b}$	$27.98 \pm 7.56$	$87.67 \pm 0.29$	$111.59 \pm 10.88$
9 (3)	$-67.55 \pm 2.39^b$	$19.12 \pm 2.39$	$86.67 \pm 0.58$	$124.05 \pm 3.86$

**Table 10:** Values of  $W_s$ ,  $W_a$ ,  $W_c$  and  $\theta$  of the solutions of chitosan, sodium alginate and guar gum for pileus side.

Chitosan solution	$W_s$ (mN m <sup>-1</sup> )	$W_a$ (mN m <sup>-1</sup> )	$W_c$ (mN m <sup>-1</sup> )	$\theta$
1	$-66.13 \pm 1.66^{b,c,d}$	$19.54 \pm 1.66$	$85.67 \pm 0.85$	$122.98 \pm 2.65$
2	$-64.96 \pm 3.30^{a,b,c}$	$19.71 \pm 3.30$	$84.67 \pm 0.62$	$122.44 \pm 5.26$
3	$-67.69 \pm 4.01^{b,c,d,e}$	$18.31 \pm 4.01$	$86.00 \pm 0.82$	$125.28 \pm 6.57$
4	$-61.95 \pm 9.22^{a,b}$	$25.38 \pm 9.22$	$87.33 \pm 0.47$	$115.29 \pm 13.00$
5	$-71.55 \pm 4.22^{b,d,e}$	$17.12 \pm 4.22$	$88.67 \pm 0.94$	$128.18 \pm 7.07$
6	$-69.52 \pm 2.56^{b,d,e}$	$18.15 \pm 2.56$	$87.67 \pm 0.62$	$125.97 \pm 4.13$
7	$-70.69 \pm 2.76^{b,e}$	$14.98 \pm 2.76$	$85.67 \pm 0.62$	$130.73 \pm 4.94$
8	$-62.11 \pm 7.47^{a,b}$	$21.89 \pm 7.47$	$84.00 \pm 0.00$	$119.08 \pm 11.20$
9 (1)	$-56.72 \pm 5.42^a$	$26.95 \pm 5.42$	$83.67 \pm 0.24$	$111.03 \pm 7.94$
9 (2)	$-66.24 \pm 3.15^{b,c,d,e}$	$16.09 \pm 3.15$	$82.33 \pm 0.24$	$127.70 \pm 5.42$
9 (3)	$-62.91 \pm 2.86^{a,b,c}$	$19.42 \pm 2.86$	$82.33 \pm 0.85$	$121.99 \pm 4.68$
Sodium alginate solution	$W_s$ (mN m <sup>-1</sup> )	$W_a$ (mN m <sup>-1</sup> )	$W_c$ (mN m <sup>-1</sup> )	$\theta$
1	$-56.85 \pm 6.66^{a,b}$	$24.48 \pm 6.66$	$81.33 \pm 1.04$	$113.76 \pm 10.07$
2	$-58.72 \pm 6.88^{a,b}$	$25.28 \pm 6.88$	$84.00 \pm 0.50$	$113.76 \pm 10.07$
3	$-48.20 \pm 9.56^a$	$33.46 \pm 9.56$	$81.67 \pm 0.76$	$100.68 \pm 13.91$
4	$-61.38 \pm 2.77^b$	$22.96 \pm 2.77$	$84.33 \pm 0.29$	$117.17 \pm 4.18$
5	$-61.00 \pm 4.81^{a,b}$	$18.00 \pm 4.81$	$79.00 \pm 1.00$	$123.31 \pm 8.24$
6	$-56.63 \pm 4.99^{a,b}$	$25.03 \pm 4.99$	$81.67 \pm 0.58$	$112.96 \pm 7.64$
7	$-60.10 \pm 4.55^{a,b}$	$20.90 \pm 4.55$	$81.00 \pm 0.87$	$119.17 \pm 7.33$
8	$-55.88 \pm 5.85^{a,b}$	$25.45 \pm 5.85$	$81.33 \pm 0.28$	$112.18 \pm 8.70$
9 (1)	$-53.76 \pm 6.52^{a,b}$	$27.91 \pm 6.52$	$81.67 \pm 1.26$	$108.68 \pm 9.61$
9 (2)	$-59.16 \pm 4.91^{a,b}$	$21.17 \pm 4.91$	$80.33 \pm 1.26$	$118.45 \pm 7.69$
9 (3)	$-56.24 \pm 7.85^{a,b}$	$27.43 \pm 7.85$	$83.67 \pm 0.76$	$110.47 \pm 11.43$
Guar gum solutions	$W_s$ (mN m <sup>-1</sup> )	$W_a$ (mN m <sup>-1</sup> )	$W_c$ (mN m <sup>-1</sup> )	$\theta$
1	$-65.89 \pm 1.64^b$	$19.77 \pm 1.64$	$85.67 \pm 0.76$	$122.61 \pm 2.62$
2	$-64.17 \pm 5.11^{a,b}$	$22.17 \pm 5.11$	$86.33 \pm 0.58$	$119.38 \pm 7.83$
3	$-63.32 \pm 4.56^{a,b}$	$23.68 \pm 4.56$	$87.00 \pm 0.87$	$117.30 \pm 6.87$
4	$-57.32 \pm 5.89^a$	$28.68 \pm 5.89$	$86.00 \pm 0.00$	$109.64 \pm 8.29$
5	$-79.87 \pm 2.30^{c,e,f}$	$12.13 \pm 2.30$	$92.00 \pm 0.00$	$137.56 \pm 4.16$
6	$-81.42 \pm 3.77^{c,e,f}$	$12.58 \pm 3.77$	$94.00 \pm 0.00$	$137.52 \pm 7.10$
7	$-70.99 \pm 12.14^{a,b,c}$	$27.01 \pm 12.14$	$98.00 \pm 0.00$	$117.58 \pm 15.80$
8	$-83.56 \pm 3.41^{c,f}$	$10.44 \pm 3.41$	$94.00 \pm 0.00$	$141.46 \pm 6.39$
9 (1)	$-74.00 \pm 4.19^{c,d,e}$	$10.00 \pm 4.19$	$84.00 \pm 0.00$	$140.37 \pm 8.87$
9 (2)	$-74.52 \pm 7.38^{b,c,d,e,f}$	$13.14 \pm 7.38$	$87.67 \pm 0.29$	$135.66 \pm 12.82$
9 (3)	$-71.64 \pm 4.47^{b,c,d}$	$15.02 \pm 4.47$	$86.67 \pm 0.58$	$131.21 \pm 7.83$

---

## **CHAPTER III**

### **Evaluation of bioactive compounds**

---

## Chapter III – Evaluation of bioactive compounds

The evaluation of active compounds is divided in two parts, where two types of active compounds were evaluated, one as inhibitor of tyrosinase (cinnamic acid) and other as antimicrobial (eugenol and carvacrol). It is important to select the optimum amount of compounds that will be use, for this the best concentrations of tyrosinase inhibitor and antimicrobial will be selected, as well as the antimicrobial (two antimicrobial were tested) that should be used.

The selected compounds will then be added to the formulations selected in the previous chapter that was for the chitosan-based coating the solution 2 composed by 0.5% of chitosan, 0.15% of Tween 80 and 0.125% of glycerol and the solution 1 for the alginate-based coating composed by 0.5% of sodium alginate, 0.05% of Tween 80 and 0.125% of glycerol.

### 3.1. Materials and methods

#### 3.1.1. Enzyme activity

##### 3.1.1.1. Enzyme activity assay

Diphenolase activity of mushroom tyrosinase (EC 1.14.18.1) (Sigma), assay was performed, as previously reported (Chen, Song et al. 2004; Shi, Chen et al. 2005). The reaction media (3 mL) containing different concentrations (0.125, 0.25, 0.5, 0.75, 1, 1.25, 1.5, 1.75 and 2 mM) of L-3,4-dihydroxyphenylalanine (L-DOPA) (Aldrich, St. Louis, MO, USA) in 50 mM  $\text{Na}_2\text{HPO}_4\text{-NaH}_2\text{PO}_4$  buffer (pH 6.8); a portion of 100  $\mu\text{L}$  of the natural enzyme (containing 20  $\mu\text{g}$ ) was used to assay the activity. The enzyme activity was determined by following the increase of optical density at 475 nm ( $\epsilon = 3700 \text{ M}^{-1}\text{cm}^{-1}$ ) (Jimenez, Chazarra et al. 2001) accompanying the oxidation of L-DOPA to dopachrome, that was immediately monitored for 6 min. A UV/vis-560 spectrophotometer (Jasco, Japan) was used for absorbance and kinetic measurements. The water used was distilled.

##### 3.1.1.2. Effect of inhibitor on the enzyme activity

The inhibitor, trans-cinnamic acid (Sigma, St. Louis, MO, USA), was first dissolved in dimethyl sulfoxide (DMSO) (Riedel-de-Haen, Germany) and used for the

experiment after a 30-fold dilution. The final concentration of DMSO in the test solution was 3.3%. Initially, 0.1 mL of DMSO solution, with different concentrations of the inhibitor (0, 0.1, 0.2, 0.3, 0.4, 0.5, 0.6, 0.7 and 0.8 mM) was first mixed with 2.8 mL of substrate solutions (containing different concentrations of L-DOPA in 50 mM  $\text{Na}_2\text{HPO}_4\text{--NaH}_2\text{PO}_4$  buffer, pH 6.8), then, a portion of 100  $\mu\text{L}$  of enzyme solution (20  $\mu\text{g}$ ) was added to this mixture and the residual activity determined. The extent of inhibition by the addition of the sample was expressed as the percentage necessary for 50% inhibition ( $\text{IC}_{50}$ ) (Shi, Chen et al. 2005).

### 3.1.1.3. Determination of the inhibition type and the inhibition constant

The inhibition type was assayed by the Lineweaver–Burk plot, and the inhibition constant was determined by the second plots of the apparent  $K_M/v_{\text{max}}$  or  $1/v_{\text{max}}$  versus the concentration of the inhibitor (Shi, Chen et al. 2005).

### 3.1.2. Antimicrobial activity

The coatings selected in chapter II were used for the incorporation of different concentrations of eugenol (Sigma-Aldrich, USA) and carvacrol (SAFC, USA) and evaluation of their antimicrobial activity. For sodium alginate-based coating, the solution 1 was used (0.5% of sodium alginate, 0.05% of Tween 80 and 0.125% of glycerol) and for the chitosan-based coating was selected solution 2 (0.5 % of chitosan, 0.05% of Tween 80 and 0.125% of glycerol). To test the antimicrobial capacity of the coatings with and without bioactive compounds, two Gram negative microorganisms were used: *Escherichia coli* and *Pseudomonas fluorescens* (ATCC 27663).

Table 11 presents the concentration of bioactive compounds used in the coatings. The poor water solubility of these essential oils extracts and values reported (Burt 2004; Elsabee and Abdou 2013; Gaysinsky, Davidson et al. 2005) for antimicrobials with inhibitory activity were taken into account for the selection of the eugenol and carvacrol concentrations.



**Table 11:** Eugenol and carvacrol concentrations used in the sodium alginate and chitosan coatings.

<b>Concentrations % (v/v)</b>		
<b>Eugenol</b>	<b>Carvacrol</b>	<b>Eugenol + Carvacrol (1:1)</b>
0.05	0.05	0.05
0.1	0.1	0.1
0.2	0.2	0.2
0.25	0.25	0.25
0.3	0.3	0.3
0.4	0.4	0.4
0.5	0.5	0.5
1.0	1.0	1.0

The methodology used for the incorporation of the essential oils extracts were conducted as presented in chapters 2.1.1.1 and 2.1.1.2 for chitosan and sodium alginate, respectively. After the coating production, the essential oil was added to the solutions and left under agitation until a complete solubilization. The antimicrobial activity was evaluated through CLSI M7-A9 (2012) method in a 96-well plate measuring biomass in a microplate ELISA (Synergy HT Biotech, Izasa) reader at 630 nm. Briefly this method consists in standardize the inoculum density for a susceptibility test, use a BaSO<sub>4</sub> turbidity standard equivalent to a 0.5 McFarland standard. The preparation of the inoculum is made in a broth or saline suspension of selected colonies isolated from an agar plate. The suspension is adjusted to obtain the equivalent of a 0.5 McFarland turbidity standard, resulting in a suspension containing about 1 to 2 x 10<sup>8</sup> CFU/mL. In the wells of the plate are then placed the coating and the inoculum at 1:1, being present at 10<sup>4</sup> CFU/mL. The microbial growth inhibition was determined during 24 h.

The disk diffusion assay was also performed to verify if the coatings present a bactericidal or bacteriostatic effect on microorganisms. According to the CLSI M7-A9 (2012) method the concentration of the microorganism was determined as done previously, using the same parameters, with a suspension with a microorganism concentration of 10<sup>4</sup> CFU/mL. Also, according to the method NCCLS M2-A8 (2003), Mueller Hinton Agar (MHA) (Fluka, USA) was used as the plating medium, and then the plate was contaminated through scattering. After, the films were placed on the plate in shape of discs with 8 mm in diameter and was utilized a filter paper as control.

The discs from the coatings were obtained by drying a constant amount (13 mL) of coating solution that was previously placed on a petri dish of 5.7 cm in diameter in

order to keep the film thickness. The films were dried at 30 °C for 24 h, and then carried out the cutting a disc of 8 mm of diameter.

## 3.2. Results and discussion

### 3.2.1. Enzyme activity

#### 3.2.1.1. Effect of trans-cinnamic acid on the enzyme activity of mushroom tyrosinase

Trans-cinnamic acid was evaluated as inhibitor and its effect on the enzymatic activity of mushroom tyrosinase for the oxidation of L-DOPA was tested. Figure 26 shows that with increase of inhibitor concentration for a given concentration of the substrate (L-DOPA) the enzyme activity decreases. However, this is more evident for smaller concentrations of L-DOPA, since the concentration of L-DOPA influence the inhibitory action on the enzyme. It can be seen that for a 50% inhibition of enzyme activity ( $IC_{50}$ ) is required about 0.5 mM of inhibitor (cinnamic acid) for the lower concentrations of substrate (0.125, 0.25 and 0.5 mM), and for intermediate and higher concentrations are needed about 0.6 mM and 0.7 mM of inhibitor, respectively.

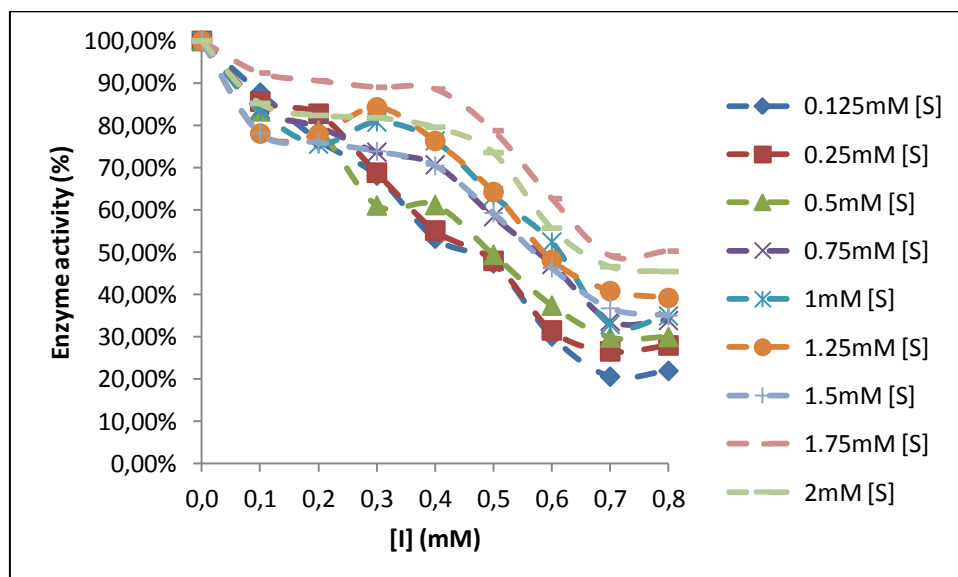


Figure 26: Effect of trans-cinnamic acid on the enzyme activity of mushroom tyrosinase.

### 3.2.1.2. Inhibition of trans-cinnamic acid on the enzyme activity of mushroom tyrosinase following a non-competitive mechanism.

First, the results of absorbance obtained were converted into in the remaining amount of enzyme ( $\mu\text{M min}^{-1}$ ) based on the formation of reaction product (dopachrome) by the equation 7.

$$\mu\text{mol. min}^{-1} = \Delta A. \text{min}^{-1} \times \frac{10^6}{\varepsilon(\lambda_{\text{max}})} \quad (\text{eq. 7})$$

The inhibitory mechanisms of trans-cinnamic acid on mushroom tyrosinase, during the oxidation of L-DOPA, were determined from Lineweaver–Burk double reciprocal plots. Figure 27 shows the double-reciprocal plots of the enzyme inhibited. The results showed that the plots of  $1/v$  versus  $1/[S]$  gave a family of straight lines with different slopes. Accompanying the enhancement of the inhibitor concentration, the values of  $v_{\text{max}}$  descended but the values of  $K_M$  increases, which indicates that trans-cinnamic acid is a non-competitive inhibitor of the enzyme, and more specifically an inhibitor of mixed type. This behaviour indicated that trans-cinnamic acid could bind, not only with free enzyme, but also with the enzyme–substrate complex. The equilibrium constant for the dissociation of enzyme inhibitor complexes is known as  $K_i$  that equals  $[E][I] / [EI]$  (Cheng and Prusoff 1973). The inhibition effect of  $K_i$  on the reaction kinetics is reflected on the normal  $K_M$  and or  $v_{\text{max}}$  observed in Lineweaver-Burk plots; in a pattern dependent on the type of the inhibitor (Nelson and Cox 2008). Thus, according to this type of inhibition the value of  $K_i$  is calculated by equation 8. Being the values of  $K_i$  0.61, 0.55, 0.34, 0.34, 0.17, 0.12 and 0.16 mM for 0.2, 0.3, 0.4, 0.5, 0.6, 0.7 and 0.8 mM of trans-cinnamic acid, respectively, for the 0.1 mM of trans-cinnamic acid the  $K_i$  not was effective. Therefore, the lower  $K_i$  value will be desirable, this value being 1.2 mM which corresponds to the concentration of 0.7 mM inhibitor. However, in the last three inhibitor concentrations (0.6, 0.7 and 0.8 mM) showed no considerable differences in values, and the  $K_i$  values began to stabilize the concentration of 0.6 mM inhibitor. Therefore, the use of smaller amount is more advantageous to the industry, as previously explained. That said, a concentration of 0.6 mM trans-cinnamic acid was used for further studies.

$$K_i = \frac{K_M}{v_{\text{max}}} \quad (\text{eq. 8})$$

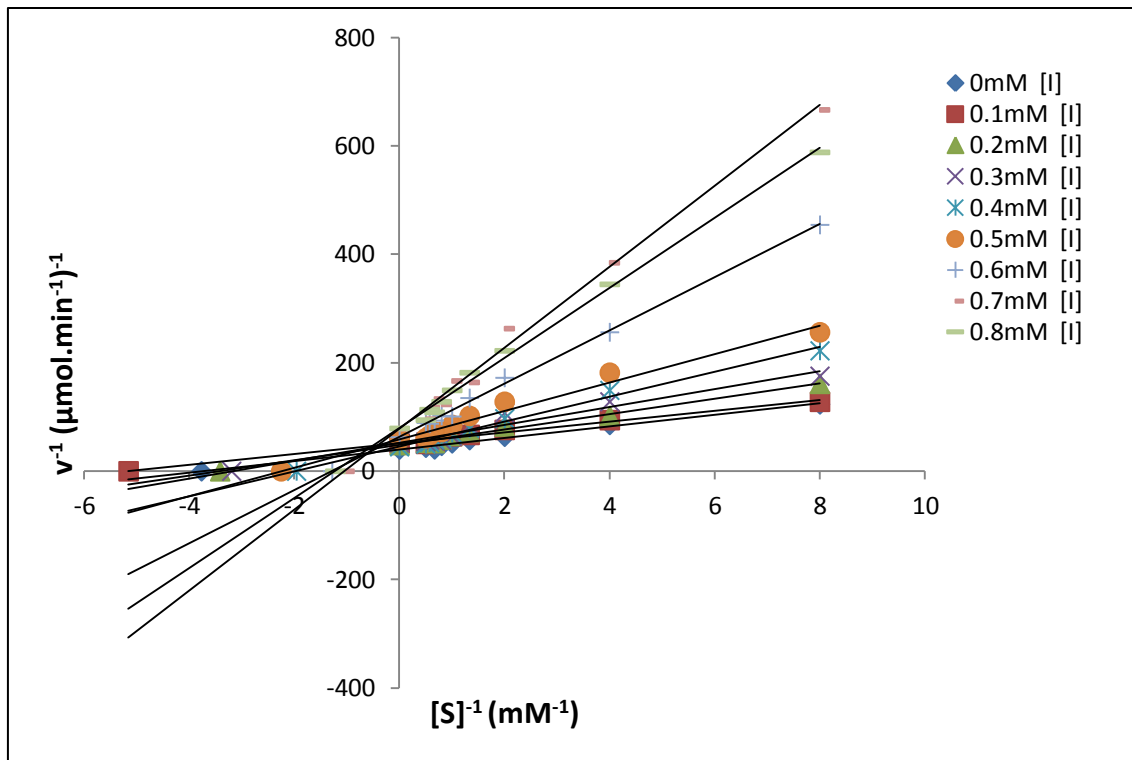


Figure 27: Lineweaver-Burk plots for inhibition of trans-cinnamic acid on mushroom tyrosinase for the oxidation of L-DOPA.

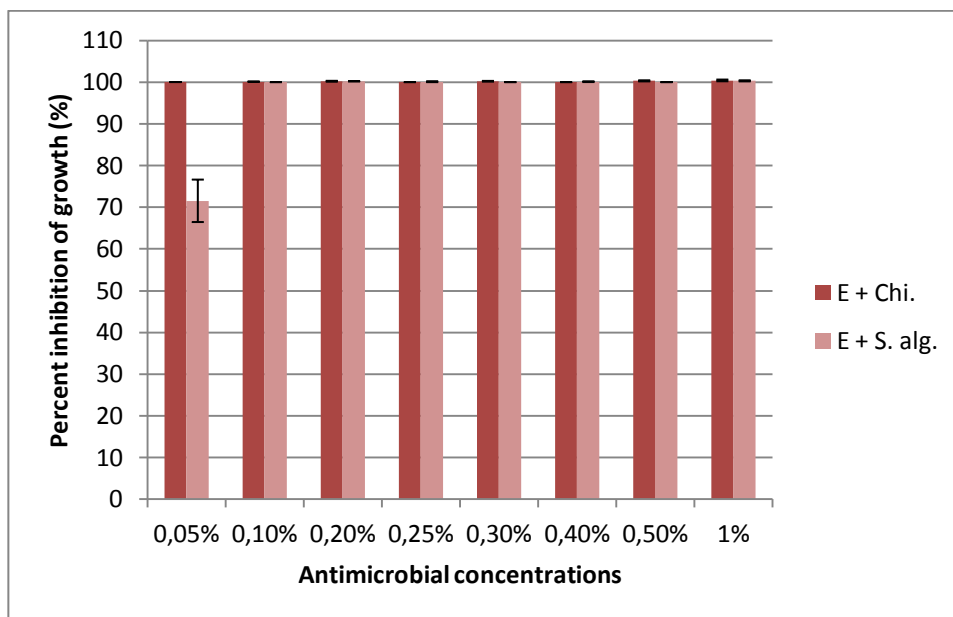
### 3.2.2. Antimicrobial activity

The results of the antimicrobial activity made by the first method, CLSI M7-A9 (2012), showed that the inhibitory activity of eugenol was generally better than the obtained for carvacrol when tested against *E. coli* and *P. fluorescens* (Figures 28 to 33). No synergism was found between these two antimicrobial agents when used simultaneously (1:1) (Figures 30 and 33), having better results when used separately in both coatings, for *E. coli* (Figures 28 and 29) and *P. fluorescens* (Figures 31 and 32). Synergism is observed when the effect of the combined substances is greater than the sum of the individual effects (Davidson and Parish 1989) and antagonism is observed when the effect of one or both compounds is less when they are applied together than when individually applied (Burt 2004). Some studies have concluded that whole EOs have a greater antibacterial activity than the major components mixed (Gill, Delaquis et al. 2002; Mourey and Canillac 2002), which suggests that the minor components are critical to the activity and may have a synergistic effect or potentiating their activity (Burt 2004). Therefore, eugenol showed the best results, and was selected to be used on edible coatings for application on the mushrooms.

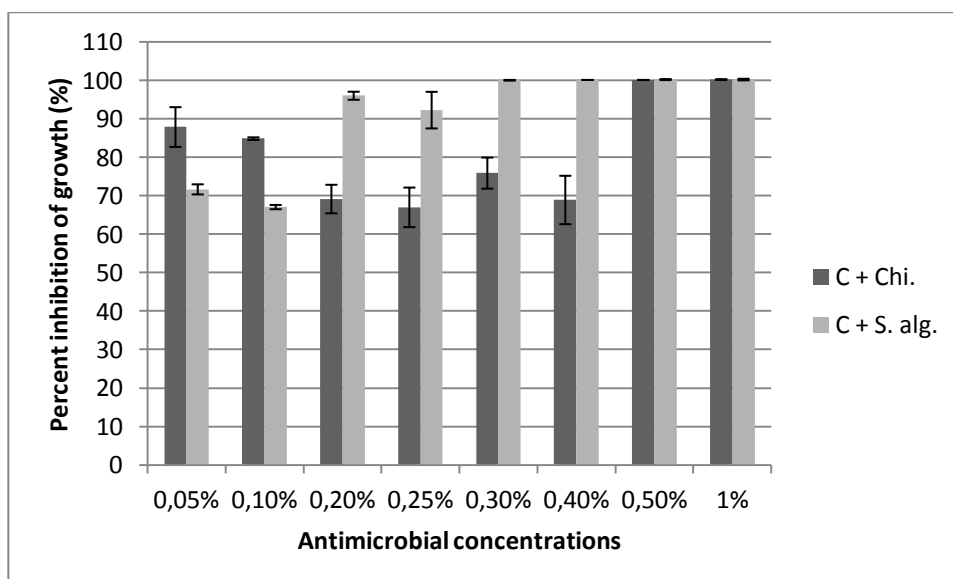
Chitosan is antimicrobial by itself, how was proved in some studies, where chitosan coatings exhibit antimicrobial activity (Elsabee and Abdou 2013), which was also confirmed in this study (data not shown). This type of coating showed better

results compared to sodium alginate coatings. The increased antimicrobial activity presented by the chitosan coating and incorporation of eugenol showed better results than the incorporation of carvacrol (Figures 28 and 31).

Chitosan-based coating with the incorporation of eugenol presented inhibition of microbial growth for all concentrations of eugenol used. Since all concentrations present inhibitory effect, was selected the lower concentration, i.e., 0.05% of eugenol will be used in the coatings. Also sodium alginate coating presented microbial inhibition but lower than chitosan. However, this inhibitory effect was not evident for the lowest concentrations of eugenol, and was also not totally clear for increasing concentrations of eugenol. Although not having a maximum growth inhibition, the lowest concentration (0.05%), exhibits good inhibitory percentage.

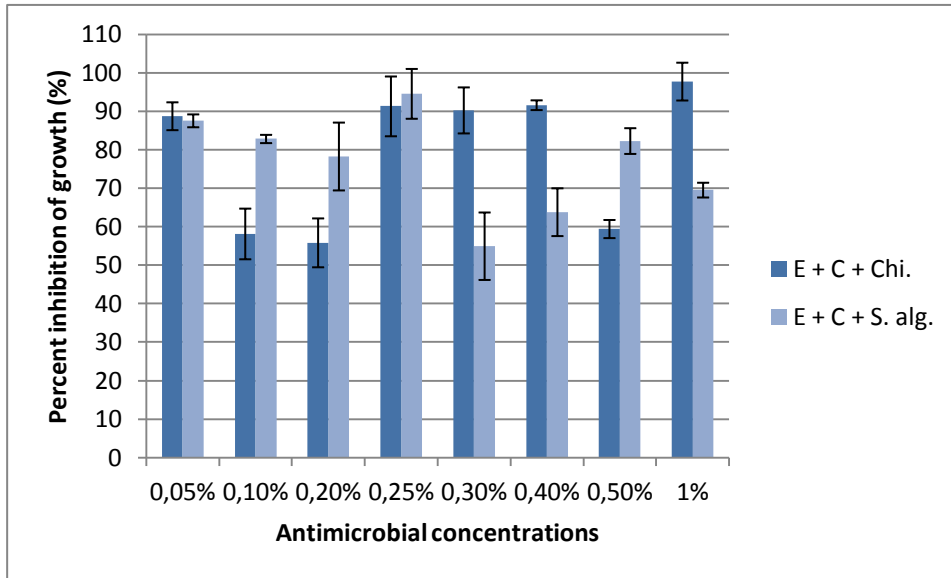


**Figure 28:** Percent of inhibition of growth *E.coli* for antimicrobial concentrations of eugenol in the chitosan and sodium alginate coatings (E-eugenol, Chi.-chitosan, S.alg.-sodium alginate).

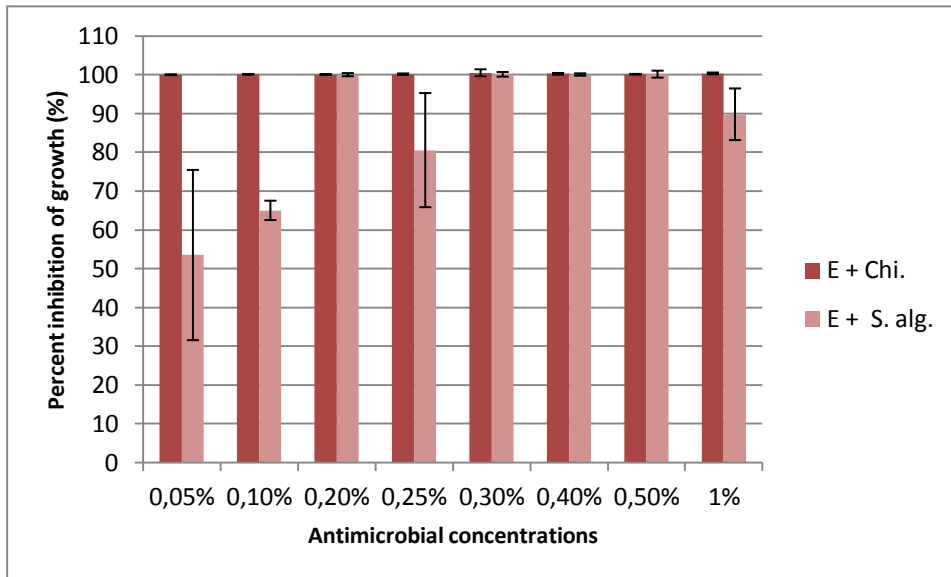


**Figure 29:** Percent of inhibition of growth *E.coli* for antimicrobial concentrations of carvacrol in the chitosan and sodium alginate coatings (C-carvacrol, Chi.-chitosan, S.alg.-sodium alginate).

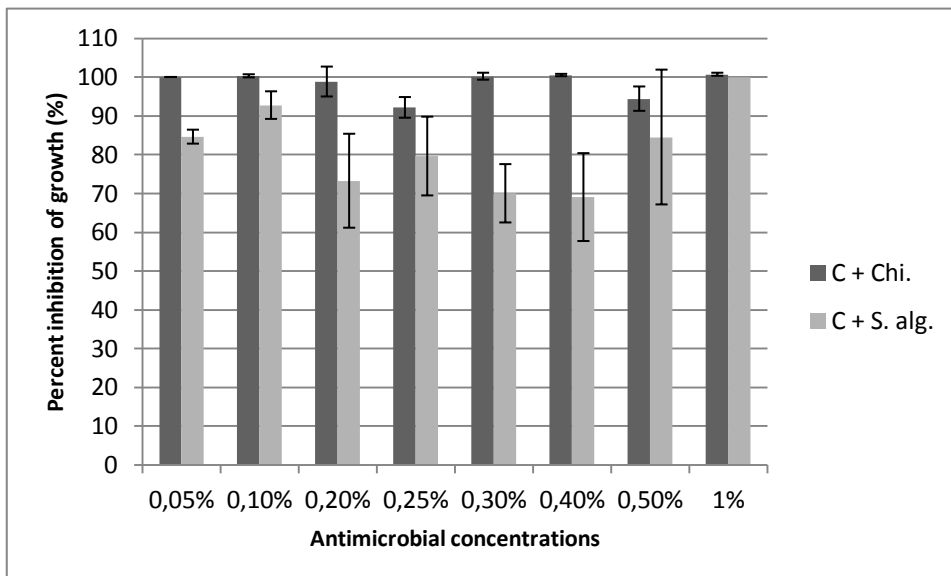
Edible coatings as a means to improve the quality and shelf-life of *Agaricus bisporus* (white button) mushroom



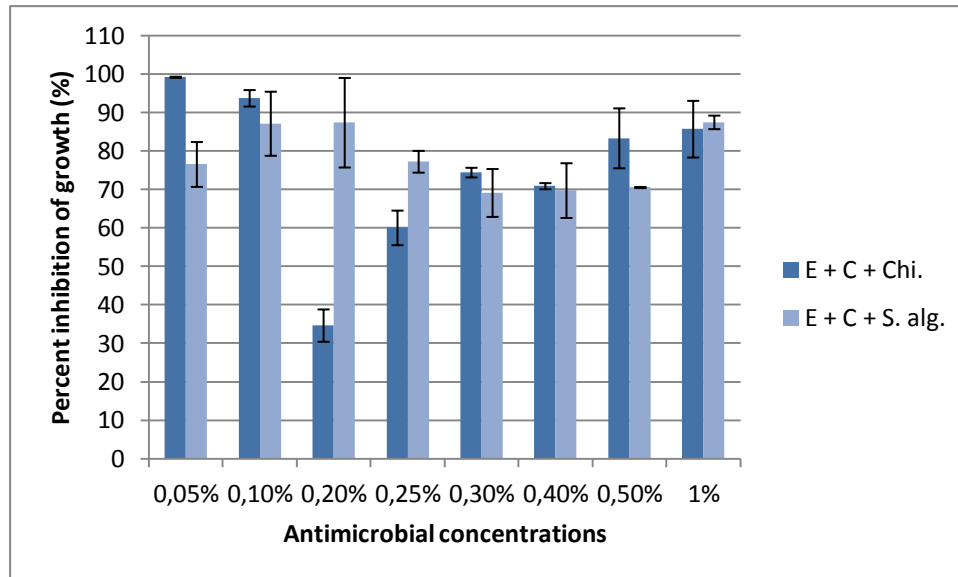
**Figure 30:** Percent of inhibition of growth *E. coli* for antimicrobial concentrations of eugenol : carvacrol (1:1) in the chitosan and sodium alginate coatings (E-eugenol, C-carvacrol, Chi.-chitosan, S.alg.-sodium alginate).



**Figure 31:** Percent of inhibition of growth *P. fluorescens* for antimicrobial concentrations of eugenol in the chitosan and sodium alginate coatings (E-eugenol, Chi.-chitosan, S.alg.-sodium alginate).

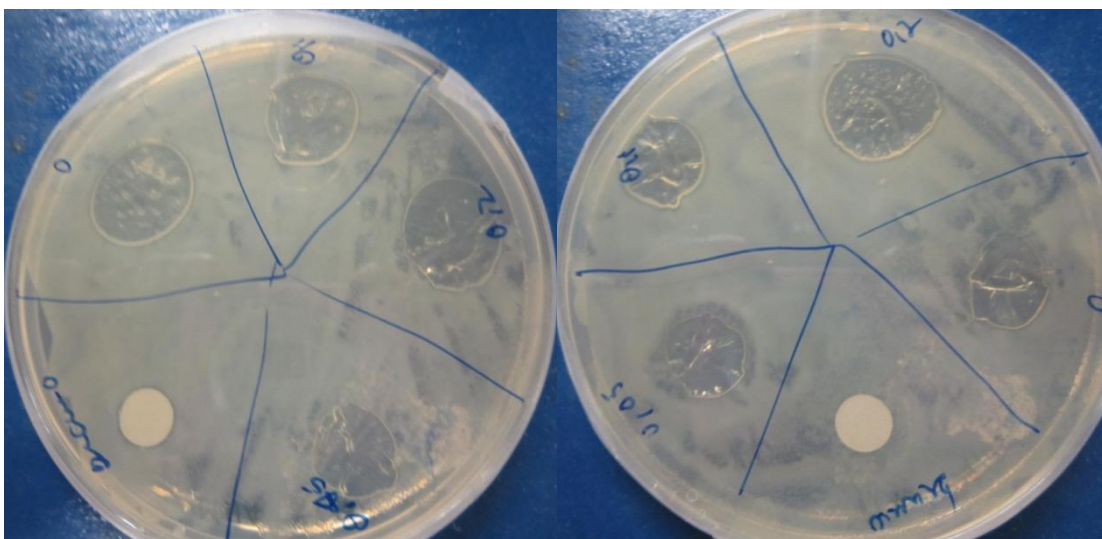


**Figure 32:** Percent of inhibition of growth *P. fluorescens* for antimicrobial concentrations of carvacrol in the chitosan and sodium alginate coatings (C-carvacrol, Chi.-chitosan, S.alg.-sodium alginate).

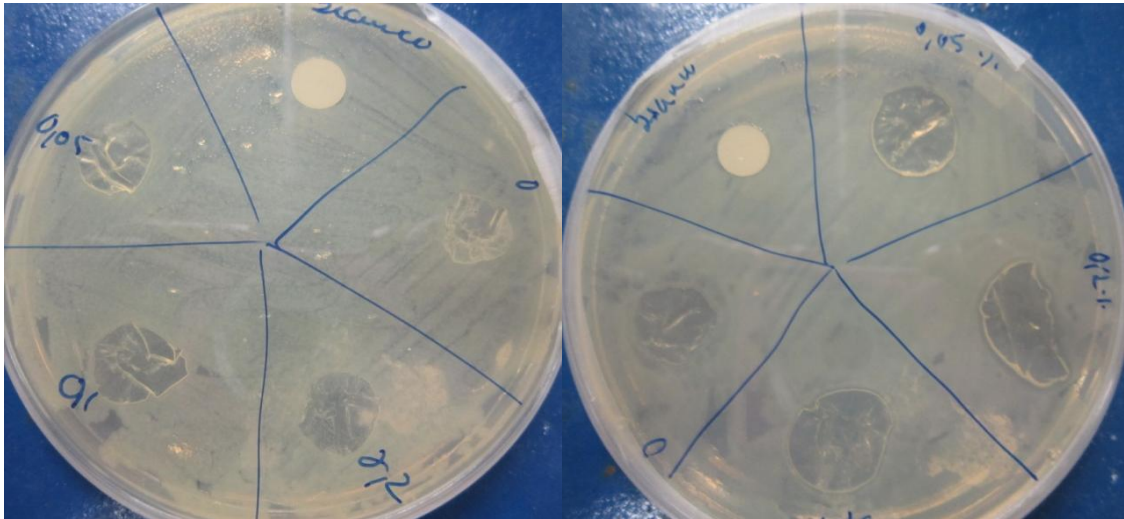


**Figure 33:** Percent of inhibition of growth *P. fluorescens* for antimicrobial concentrations of eugenol : carvacrol (1:1) in the chitosan and sodium alginate coatings (E-eugenol, C-carvacrol, Chi.-chitosan, S.alg.-sodium alginate).

Disk diffusion assay was performed to check whether there were differences at the level of different concentrations (for lower concentrations, 0, 0.05, 0.1 and 0.2%) of eugenol incorporated on sodium alginate coating (Figure 35), and also clarify the inhibition capacity of concentration of 0.05% of eugenol that was unclear in previous results. The results of this test showed that the behavior of inhibition was not influenced by the concentration, showing that for both low concentrations (0.05, 0.1 and 0.2%), the inhibition appeared is the same. It was also found that the films do not exhibit bactericidal but bacteriostatic activity, since in none of the disks of sodium alginate, regardless of the concentration tested, showed an inhibition halo. The same was done for disks of chitosan (Figure 34), which also showed no bactericidal but bacteriostatic activity for both bacteria studied.



**Figure 34:** Inhibition disc test for chitosan coating on *E. coli* (right) and *P. fluorescens* (left).



**Figure 35:** Inhibition disc test for sodium alginate coating on *E.coli* (right) and *P. fluorescens* (left).

The results presented by disk diffusion assay may be a little below that the first method by the fact the drying of the coating for the disk production may change the antimicrobial properties of the essential oils, since they may volatilize, which is expected for essential oils extracts (Elsabee and Abdou 2013).

Eugenol and carvacrol are phenolic compounds that are generally more effective against Gram-positive than against Gram-negative bacteria (Gaysinsky, Davidson et al. 2005). Therefore, these compounds may be more effective against Gram-positive bacteria, and the results for these more positive. Despite the results obtained, the amount of bacteria present in the testing may influence the activity of the compounds as well as their concentration. Therefore, for higher concentrations of eugenol and carvacrol for a given amount of bacteria present could have another type of behavior (Elsabee and Abdou 2013).



---

## **CHAPTER IV**

### **Coating application and evaluation of shelf-life parameters**

---

# Chapter IV – Coating application and evaluation of shelf-life parameters

## 4.1. Materials and methods

### 4.1.1. Coating application on mushrooms and storage conditions

The coating solutions were prepared as described before (Chapter II). For the coating was then added 0.6 mM of inhibitor (trans-cinnamic acid) that was maintained under stirring until its complete solubilisation and kept under refrigeration until further use (Figure 36).

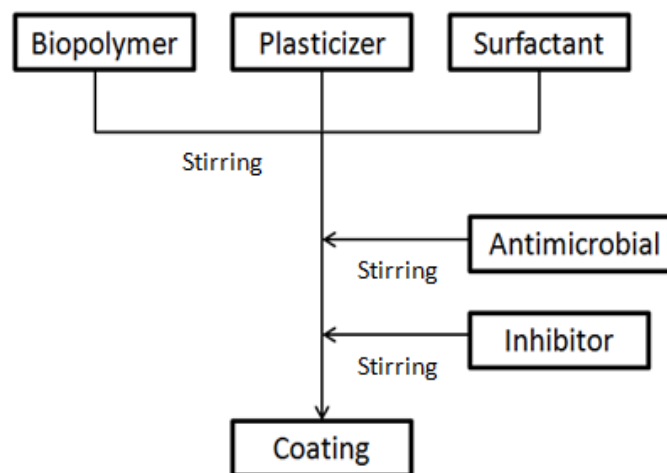


Figure 36: Diagram of the preparation of the coating.

Previously, it was performed an evaluation to observe the effect of the coating in the mushroom colour, and it was found that the application of chitosan coating on mushroom quickly (approximately one day) has a great influence in their visual appearance (Figure 37). The change on mushroom colour shown in Figure 37 is due to the fact that the chitosan coating solution have a very low pH (about pH = 3) in comparison with the mushroom that has a neutral pH. The chitosan coating presents a low pH because is necessary an acidic medium for dissolving the chitosan during coating preparation. By other side, the pH of the sodium alginate-based coating is approximately neutral and did not degradate the mushroom. For this reason the chitosan-based coating was not used during shelf-life evaluation.



**Figure 37:** Mushrooms coated with the coating of sodium alginate (left) and chitosan (right).

The mushrooms were divided into two groups of approximately 3.5 kg each: (1) the control and (2) the mushrooms with sodium alginate coating. Before coating application, mushrooms were washed with water to remove any presented residues and allowed to dry at refrigeration temperature during 1 h. Then a tissue paper was used to absorb excess water from the surface. The coating was applied by dipping, being the mushrooms (corresponding to group 2) were immersed by dipping into the coating solution during 30 s and left to dry during 2 h under refrigeration. The mushrooms in the control group were only washed with water. The two groups were stored at 90-95% RH and at 6-8 °C.

#### 4.1.2. Shelf-life analyses

Shelf-life analyses of the mushrooms were performed every days of storage, during 10 days, while enzymatic analyses were performed within a range of 3 days (at days 0, 3, 6 and 9). All measurements were performed in triplicate for each treated group being the samples randomly selected.

##### 4.1.2.1. Weight loss

Approximately 100 g of mushrooms were weighed for each group. Weight loss was determined by weighing each group of samples before and during the storage, which was expressed as the percentage of weigh loss with respect to the initial weight.

$$\text{Weight loss (\%)} = \frac{M_0 - M_i}{M_0} \times 100 \quad (\text{eq. 9})$$

where  $M_0$  is the weight on the first day and  $M_i$  the weight measured at day  $i$ .

#### 4.1.2.2. Moisture and total solids content

Moisture content was determined by AOAC method 925.10 (1998) with some modifications. Briefly, approximately 3 g of fresh mushrooms were weight for each group and dried at 105 °C during about 48 h until constant weight. Moisture was expressed in terms of percentage of weight loss.

The total solids content was determined subtracting the moisture percentage by the total percentage (100%).

#### 4.1.2.3. Colour and browning evaluation

Colour evaluation was performed using a Minolta colorimeter (CR 300; Minolta, Japan), where the changes in the surface of mushroom samples were measured by Hunter or CIE? total colour difference ( $\Delta E$ ) expressed as  $L^*$  (whiteness or light/dark),  $a^*$  (red/green) and  $b^*$  (yellow/blue). A white standard colour plate ( $Y=93.5$ ,  $x=0.3114$ ,  $y=0.3190$ ) for the instruments' calibration was used as a background for colour measurements. The  $\Delta E$  was calculated by:

$$\Delta E = \sqrt{(L - L_0)^2 + (a - a_0)^2 + (b - b_0)^2} \quad (\text{eq. 10})$$

where  $L_0$ ,  $a_0$ ,  $b_0$  are the initial values, obtained in time zero, and  $L$ ,  $a$ ,  $b$  are the values measured during the experiment.

For each measurement, 3 equidistant points were made in the cap surface (pileus) and one on the cutting zone (stipe). Measurements were performed in triplicate (three different mushrooms) performing a total of 12 measurements for each group.

Other evaluation of the colour difference was performed by comparing the colour with an ideal mushroom colour with the values  $L^* = 97$ ,  $a^* = -2$ ,  $b^* = 0$  using  $\Delta E$  as described by the following equation (Ajilouni 1991):

$$\Delta E = \sqrt{(L - 97)^2 + (a - (-2))^2 + b^2} \quad (\text{eq. 11})$$

where  $\Delta E$  indicates the degree of overall colour change in comparison to colour values of an ideal mushroom.

The browning index (BI), which represents the purity of brown colour (Palou, López-Malo et al. 1999) was determined according to the following equation:

$$BI = \frac{100(x-0.31)}{0.172} \quad (\text{eq. 12})$$

$$\text{where } x = \frac{a+1.75L}{5.645L+a-3.012b}$$

#### 4.1.2.4. Total soluble solids

Mushrooms were ground in a grinder and centrifuged slightly to get the juice that was analyzed for total soluble solids (TSS). TSS was measured at 25 °C with a refractometer (HI 96801, Hanna Instruments Inc., Romania) being the results expressed as °Brix.

#### 4.1.2.5. pH measurement and titratable acidity

The pH value of each sample was recorded using a digital pH meter (HI 2210, Hanna instruments Inc., Romania) equipped with a glass electrode that was inserted directly into the mushroom sample crushed for the measurement.

Titratable acidity was determined following the method AOAC method 920.149 (1998) and was expressed by  $g_{\text{acid}}$  per 100  $g_{\text{product}}$  by using the factor of malic acid that is 0.067. Malic acid is the most abundant acid in the mushroom (Ribeiro, Lopes et al. 2008) thus being their conversion factor considered for the titratable acidity determination.

#### 4.1.2.6. Microbiological analyses

All samples were analyzed in terms of total aerobic mesophilic and psychrophilic bacteria, yeasts and moulds. Samples were prepared by weighting 25 g of mushrooms that were removed aseptically from each group which were then diluted with 225 mL of 0.1% of peptone water (Trimedia, India). The samples were homogenized by a stomacher at high speed for 2 min. Serial dilutions ( $10^{-1}$ – $10^{-9}$ ) were made in serial dilution tubes by taking 1.0 mL with 9.0 mL of 0.1% of peptone water. Aerobic counts were determined on plate count agar (PCA; Merck, Germany) following incubation at 35 °C for 2 days for mesophilic bacteria, and at 4 °C for 7 days for psychrophilic bacteria. Yeasts and moulds were determined on potato dextrose agar (PDA; Liofilmchem, Italy) with the following incubation conditions:  $28 \pm 1$  °C for 5–7 days.

#### 4.1.2.7. Enzymatic analyses

Mushroom tissue (10 g) was homogenized in 20 mL of 50mM of  $\text{Na}_2\text{HPO}_4$ – $\text{NaH}_2\text{PO}_4$  buffer (pH 6.8) and the homogenate was filtered through two layers of cotton cloth and filter paper to remove cell debris. After centrifugation for 10 min at 4 °C at 9000 rpm (Sigma laboratory centrifuges 4K15, Germany) the clear supernatant was collected and referred as enzyme extract (Eissa 2007).

The reaction media (2.8 mL) as prepared containing 10mM of L-DOPA in 50 mM of  $\text{Na}_2\text{HPO}_4$ – $\text{NaH}_2\text{PO}_4$  buffer (pH 6.8), 0.1 mL of buffer and 0.1 mL of enzyme

extract. The increase in absorbance at 475 nm was immediately monitored for 3 min using a Jasco UV/Vis-560 spectrophotometer. One unit of enzyme activity was defined as the amount that caused a change of 0.001 in absorbance per minute (Eissa 2007).

#### 4.1.2.8. Statistical analysis

Experiments were performed using a completely randomized design. Data were subjected to one-way analysis of variance (ANOVA) and mean were performed by Tukey's multiple range test (SigmaPlot version 11.0, edition 2008, Germany). Differences at  $p < 0.05$  were considered significant.

## 4.2. Results and discussion

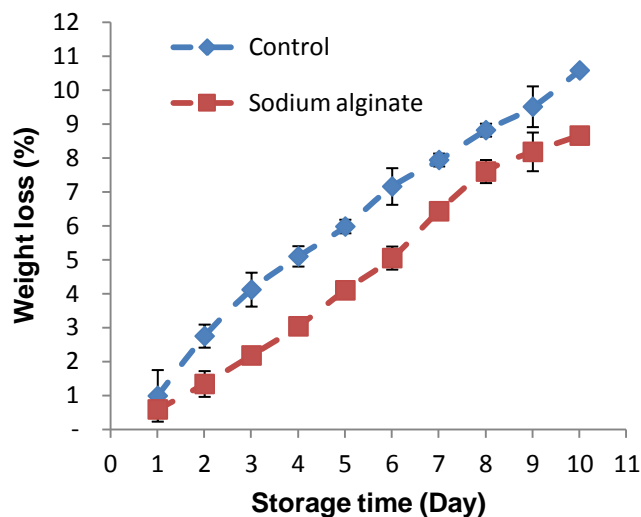
### 4.2.1. Evaluation of weight loss, moisture and total solids content

Weight loss is a crucial quality parameter in foods, since every loss in weight is translated into an economic loss. Additionally, in mushrooms the weight loss has a strong effect on the appearance, and due to the lack of a protective epidermal structure happens an excessive water loss through a high transpiration rate (Mohebbi, Ansarifar et al 2012).

Figure 38 shows the weight loss of the white button mushroom during storage. Generally, the weight loss increases for all samples during storage (control and coated). Nevertheless, the weight loss was lower in the coated mushrooms than in the control, showing significant differences ( $p < 0.05$ ) between them. Weight loss percentages at the end of storage period for coated mushrooms and control were 8.65% and 10.57% (Table 12 on Annex A.2.), respectively. Dehydration is an important process in mushroom quality loss during post-harvest storage. Being the highest weight loss values observed in the control samples, this can be attributed to the fact that mushrooms are not protected by a epidermal structure, which does not prevent a quick superficial dehydration resulting in shriveling and deterioration, while the coated mushrooms presents a thin layer of coating that will delay this dehydration.

According to Singh, Langowski et al. (2010), when the harvested mushroom loses 5-10% of its fresh weight, it begins to wilt and soon becomes unusable. According to this parameter, the coated mushrooms would be acceptable to the fifth day but the control would least one day of acceptability (Table 12 on Annex A.2.). A smaller weight loss in the coated mushrooms can be ascribed to the barrier effect of the edible coating, thereby restricting water transfer and protect mushroom epidermis from mechanical injuries, as well as sealing small wounds and thus delaying

dehydration. Being the main mechanism of weight loss the evaporation of water, this is activated by a gradient of water vapour pressure at different points between the mushroom tissue and the surrounding atmosphere and the storage temperature (Jiang, Feng et al. 2012). The mechanism for these positive effects of the coatings is based on their hygroscopic properties, which enables the formation of a barrier to water diffusion between mushroom and environments, thus avoiding its external transference (Jiang 2013). But it is well known that hydrocolloids (like alginate coatings) do not present good water vapour properties in high water activity foods, due to their high hydroscopic nature (Olivas, Mattinson et al. 2007; Jiang 2013). However, in this case, is clear the positive effect of the alginate-based coating in limiting water loss leading at least to a decrease of 2% of weight loss when compared with the control.



**Figure 38:** Weight loss of *Agaricus bisporus* mushrooms during 10 days of storage at 6-8 °C (I- standard deviation).

*L. edodes* mushrooms were coated using an alginate coating and then conventional packaged being stored for 16 days at 4 °C and at 95% RH (Jiang 2013). Results showed that at the end of the storage time the weight loss was decreased in 4% for the coated mushrooms. Similar results were reported by Jiang, Feng et al. (2013b) that coated the same kind of mushroom with gum arabica coating, losing less than 4% of weight at the end of 16 days of storage. In the same vein, Jiang, Feng et al. (2012) used chitosan coatings to coat the same strain of mushrooms, but showed loss weighing less than 3% at the end of 16 days of storage. Other similar studies were conducted with *A. bisporus* were has been showed the effect of alginate-based coating combined with MAP. Results showed that the coated mushrooms, under the same storage conditions previously mentioned, not lost more than 3% of their initial weigh (Jiang 2013). However, in this work no packaging was used in addition to the coating.

Sedaghat and Zahdi (2012) evaluated the application of an edible coating for extending the storage life of mushrooms (*A. bisporus*). Using similar conditions for this study showed that mushrooms coated with a gum arabic coating present approximately 33% of weight loss at the end of 10 days of storage. *A. bisporus* (white button) weight loss was also evaluated using a gum tragacanth based coating; results showed that at the end of 10 days of storage at 4 °C and 85% RH mushrooms lost about 25% of total weight (Mohebbi, Ansarifard et al. 2012).

The moisture content of the mushrooms ranged between 90.34 and 95.34% and between 90.15 and 93.26% for control and coated mushrooms, respectively (Table 12 on Annex A.2.) (Figure 39). A higher moisture corresponds to lower values of dry matter (total solids content) in mushrooms (Figure 40). This results are explained by the increasing water evaporation during storage. Therefore, there is a progressive loss of moisture with the storage time. By contrast, the solids content will be lower during the storage period due to a higher water loss. There was a statistically significant difference ( $p < 0.05$ ) between 5-7 days of storage (Table 12 on Annex A.2.). Results show that the coated mushroom loses a smaller amount of water during storage when compared with the control, which may be an indication of the capacity of the alginate-based coating to prolong the shelf life of mushrooms. The weight loss is also related to increased cap opening, that was observed in greater evidence in control than in coated mushrooms (data not shown).

It is clear the influence (decreasing the weight loss values) of the coating in the weight loss of mushrooms, that contributes to maintaining the better quality of mushroom during cold storage. Acting the coating as an epidermal structure helping to control weight loss promoted by the water evaporation.

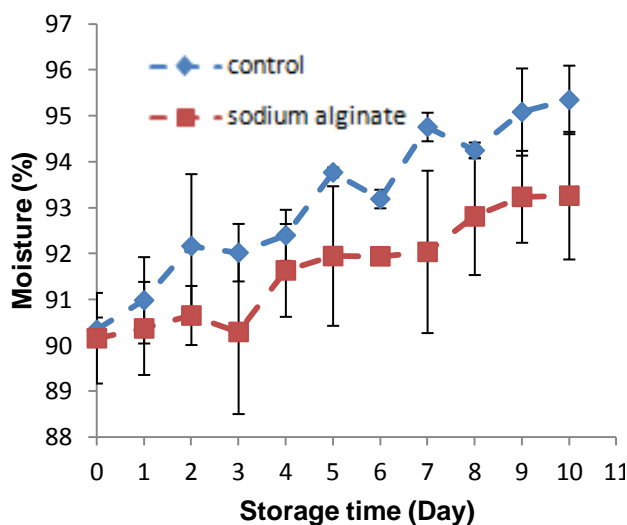


Figure 39: Moisture of *Agaricus bisporus* mushrooms during 10 days of storage at 6-8 °C (I- standard deviation).

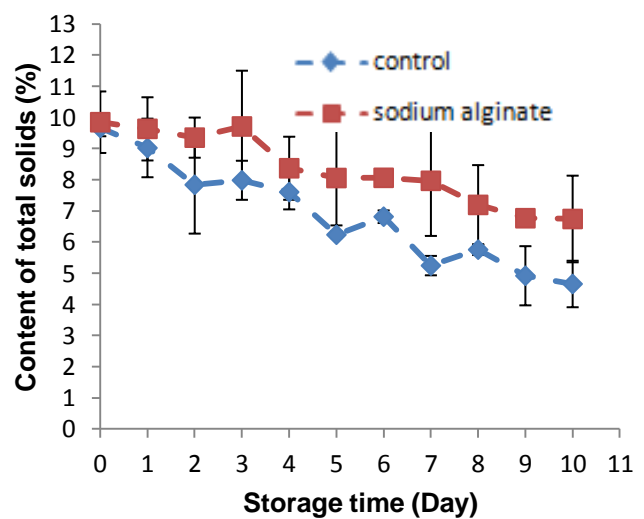


Figure 40: Total solids content of *Agaricus bisporus* mushrooms during 10 days of storage at 6-8 °C (I- standard deviation).

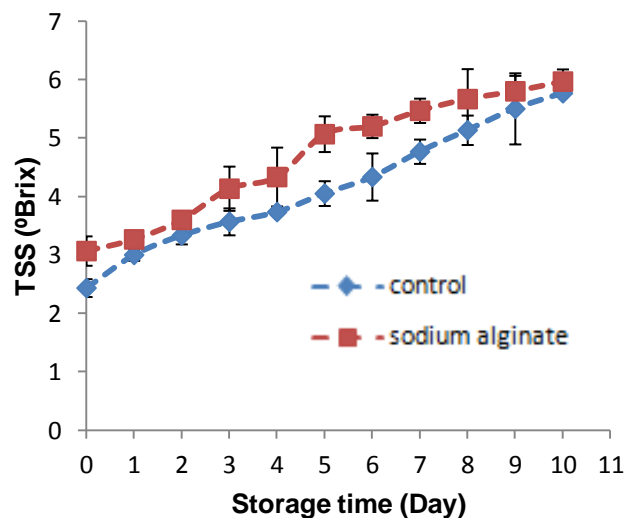


#### 4.2.2. Evaluation of TSS

Total soluble solids increased during the storage time (Figure 41), increasing about 94.5 and 137.4% the °Brix for coated and control mushrooms, respectively. But only for the days 5, 6 and 7 of storage there are a significant differences ( $p < 0.05$ ) between the coated and control mushrooms, being the coated mushrooms the ones that present the higher values of TSS. The values of TSS during the storage were in the range of 2.43–5.77 °Brix and 3.07–5.97 °Brix for control and coated mushrooms, respectively (Table 12 on Annex A.2.).

One of the reasons for the observed increment in the TSS values can be the considerable loss of water suffered by mushrooms during storage. Indeed, the greater changes in TSS occurred in those mushrooms which suffered the greatest water loss (5–7 days). The solubilisation of the cell wall polysaccharide and hemicelluloses in senescent mushroom might also contribute to the increase of TSS values. Coatings provided an excellent semi-permeable film around the mushroom, modifying the internal atmosphere by reducing  $O_2$  and/or elevating  $CO_2$ . This leads to a decreased of respiration rates that slow down the synthesis and the use of metabolites thus resulting in lower values of TSS, due to the slower hydrolysis of carbohydrates to sugars (Yaman and Bayoindirli 2002; Jiang, Feng et al. 2013a).

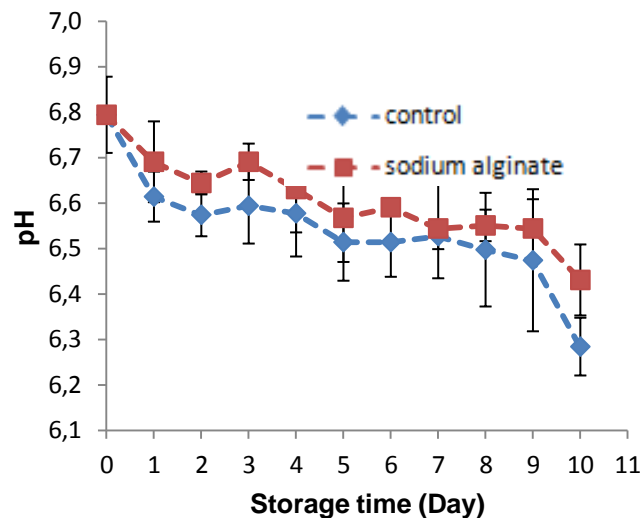
TSS was evaluated using different coatings such as alginate, chitosan and gum arabic in *A. bisporus* and *L edodes* during 16 days at 4 °C and 95% RH (Jiang, Feng et al. 2012; Jiang 2013; Jiang, Feng et al. 2013a; Jiang, Feng et al. 2013b). All these different studies showed similar results, revealing a increased of TSS values during storage time, and while TSS values of control mushrooms increased after 4 days of storage whilst coated mushrooms experienced a slight increase during the same period, and both increased slightly until 12 days after this storage period and decreasing until the end of storage, having a behaviour similar to the results presented here.



**Figure 41:** TSS of *Agaricus bisporus* mushrooms during 10 days of storage at 6–8 °C (I- standard deviation).

#### 4.2.3. Evaluation of pH and titratable acidity

pH values decrease during storage (Figure 42) presenting the control mushrooms the lower pH values than the coated mushrooms. The pH values ranged between 6.79–6.28 and 6.79–6.43 for control and coated mushrooms, respectively (Table 12 on Annex A.2.). The results between the two groups showed no significant differences ( $p>0.05$ ) between them. Also the titratable acidity values (in  $\text{g}(100\text{g})^{-1}$  of malic acid) underwent no significant variations ( $p>0.05$ ) during storage (Table 12). The titratable acidity during storage ranged between  $0.0290\text{--}0.0324 \text{ g}(100\text{g})^{-1}$  and  $0.0313\text{--}0.0358 \text{ g}(100\text{g})^{-1}$  for control and coated mushroom, respectively.



**Figure 42:** pH of *Agaricus bisporus* mushrooms during 10 days of storage at 6-8°C (I- standard deviation).

#### 4.2.4. Evaluation of colour and browning

The colour of the button mushroom is an important parameter, since colour relates directly to the perception of quality and acceptability by the consumer (Olivas and Barbosa-Cánovas 2005; Peretto, Du et al. 2014). Being the mushroom colour one of the most important attributes for consumer acceptance, changes in the external colour were monitored by measuring whiteness ( $L$ ), total colour difference ( $\Delta E$ ) and a browning index (BI). A lower  $L$  indicates the darkening of the mushroom ( $L=100$ , white;  $L=0$ , black) while the increasing of the values of  $a$  is related with the increase of the redness redness ( $+a$ ), and an increase of  $b$  value suggests an increasing yellowness ( $+b$ ) of the mushrooms (Du, Fu et al. 2009). If  $L$  value of mushroom is less than 80, wholesalers do not accept the mushrooms, however is known that for consumers a  $L$  value until 70 is acceptable (Briones, Varoquaux et al. 1992).

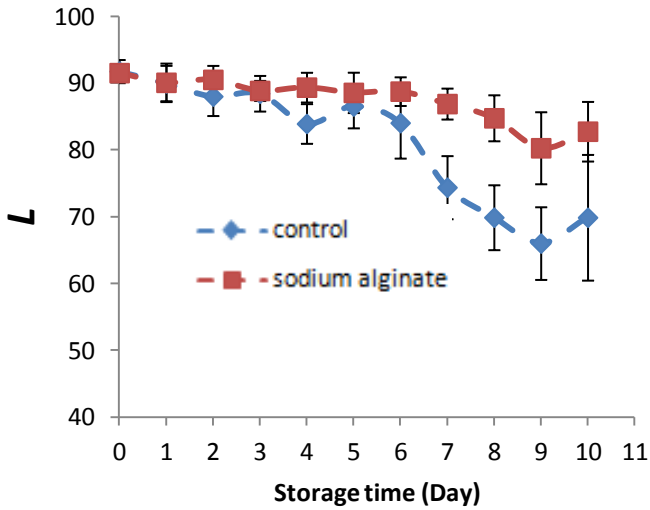
Table 13 (on Annex A.3.) presents the values of the colour parameters ( $L$ ,  $a$ ,  $b$ ,  $\Delta E$  and BI) for coated and control mushrooms. Although all samples chosen for the tests were white in colour, the browning of the mushrooms occurred during all storage

days and becomes more evident in the last days. When a coating is applied is important to guarantee that it have a little effect on the coated samples. The results showed that the coating did not influence ( $p>0.05$ ) the colour of mushrooms, and no differences between the two groups of mushrooms on day 0 (i.e. after the coating applications) were observed.

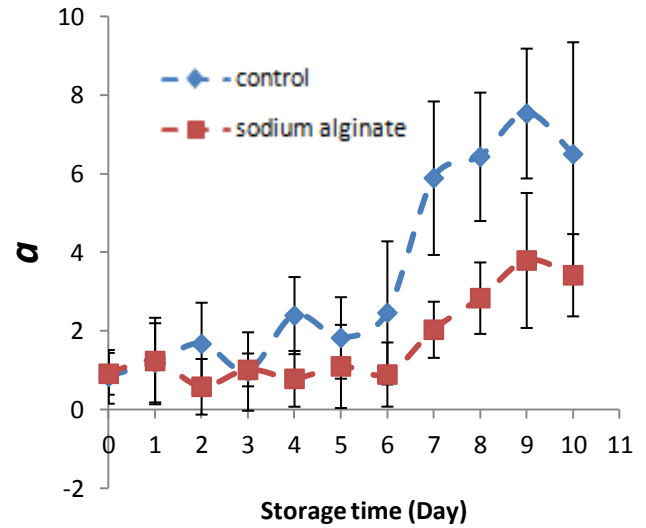
The  $L$  values (Figure 43) decreases, and  $\Delta E$  (Figure 46) and BI (Figure 6147) increased with storage time for coated and control mushrooms. For the cap, only from the day 7 it is that there was observed differences ( $p<0.05$ ) between the two groups, being the coated mushrooms those with higher whiteness, less colour difference and browning. Being in agreement with a study realized by Nussinovitch and Kampf (1993), where the  $L$  values of mushrooms coated with 1% and 2% alginate were significantly ( $p<0.05$ ) higher than that uncoated at 4 °C after 142 hours of storage. But for the last day of storage there was no significant differences ( $p>0.05$ ) for  $L$  and  $\Delta E$ , whereas that for BI was on the day 9.

The redness of mushrooms, given by the  $a$  value (Figure 44) remained low until the sixth day, and increased for the next days of analyses, with significant differences ( $p<0.05$ ) between the two groups. However, the redness also increases in coated mushrooms, but with less intensity. The coated mushrooms present an increase of redness from 0.92 to 3.43 until the end of storage while the control mushrooms present an increase from 0.84 to 6.50. The yellowing of mushrooms,  $b$  values (Figure 45), showed no significant differences ( $p>0.05$ ) between two groups during the storage time, having an increase in yellowness from 10.69 to 21.56 and from 11.33 to 21.16 for the control and coated mushrooms, respectively.

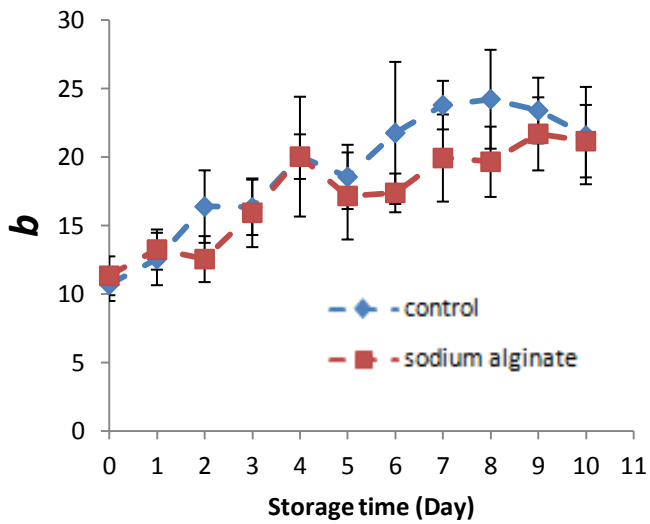
During storage the coated mushrooms had a decrease of the whiteness of 9.6% decrease, while the control had a reduction of 23.8%, so coated mushrooms showed greater whiteness at the end of storage compared to the control. Being the decrease of  $L$  values from 91.54 to 82.77 and 91.77 to 69.89 to control and coated mushrooms, respectively. For wholesalers accept the mushrooms, these have to have a  $L>80$ , thus coated mushrooms will be accepted until the last day of storage evaluated, while the control mushrooms will be accepted only until to sixth day. The colour difference between the two groups increased from 3.98 to 25.20 and from 3.63 to 13.55 for the control and coated mushrooms, respectively. The browning index at the end of storage had an increase from 12.66 to 44.96 and from 13.52 to 32.10 for the control and coated mushrooms, respectively, the latter having less enzymatic browning.



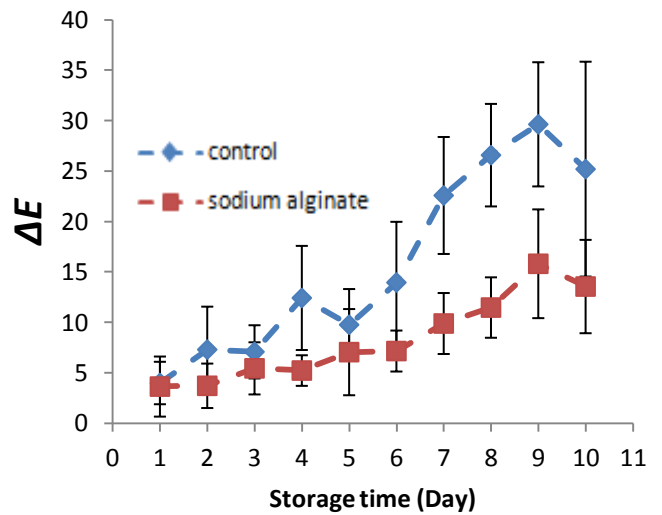
**Figure 43:** Whiteness of cap the mushroom of *Agaricus bisporus* mushrooms during 10 days of storage at 6-8 °C (I- standard deviation).



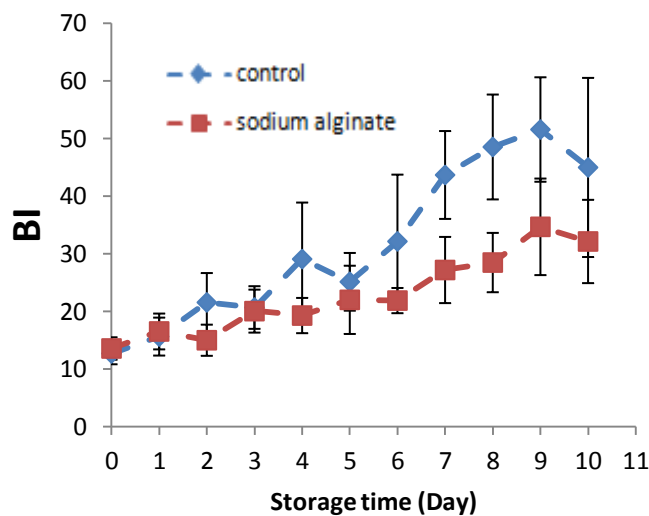
**Figure 44:** Redness of cap the mushroom of *Agaricus bisporus* mushrooms during 10 days of storage at 6-8 °C (I- standard deviation) .



**Figure 45:** Yellowness of cap the mushroom of *Agaricus bisporus* mushrooms during 10 days of storage at 6-8 °C (I- standard deviation).



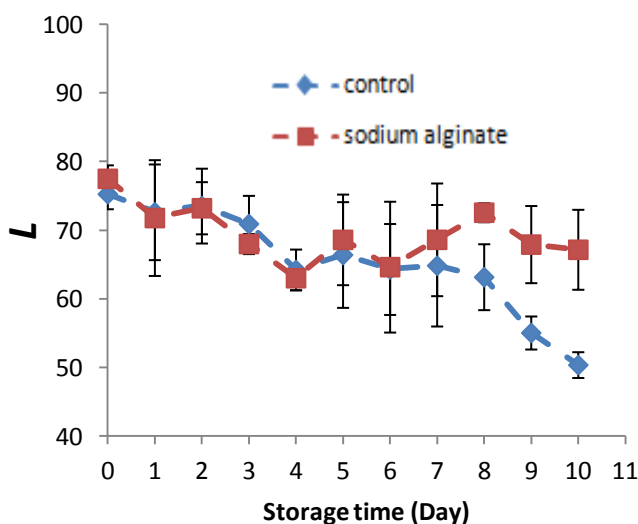
**Figure 46:** Colour difference of cap the mushroom of *Agaricus bisporus* mushrooms during 10 days of storage at 6-8 °C (I- standard deviation).



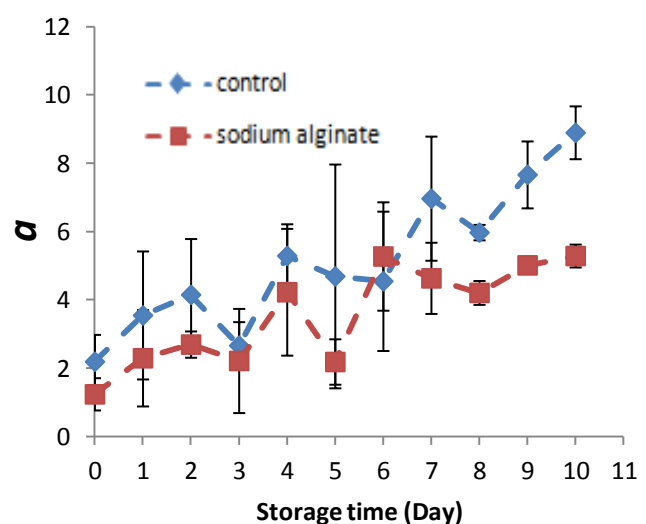
**Figure 47:** Browning index of cap the mushroom of *Agaricus bisporus* mushrooms during 10 days of storage at 6-8 °C (I- standard deviation).

Evaluating the parameters of colour between the stipe and the cap of mushroom, it can be said that the stipe is darker compared to the cap. For the  $L$  value, the stipe showed a similar behavior to the cap for both groups (Figure 48), presenting statistically significant differences ( $p < 0.05$ ) from the eighth day until the end of the storage time. Presenting  $L$  values from 75.28 to 50.39 and from 77.51 to 67.18 for the control and coated mushrooms, respectively. The redness ( $a$ ) (Figure 49) increased for both groups, with significant differences ( $p < 0.05$ ) from the eighth day. The values ranged from 1.23 to 5.28 and from 2.19 to 8.89 for control and coated mushroom, respectively. For the yellowing (parameter  $b$ ) (Figure 50), no significant differences ( $p > 0.05$ ) during the storage are observed between two groups, but happens an increase of the yellowness for both groups. For  $\Delta E$  (Figure 51) and BI values (Figure 52) there was an increase during the storage time, while for  $a$  value, there was significant differences ( $p < 0.05$ ) between the coated and uncoated mushrooms from the eighth day until the last day of storage. The colour difference increased from 7.82 to 26.59 and from 10.51 to 12.50 for the control and coated mushrooms, respectively; while for BI the values increased from 29.39 to 77.53 and from 30.62 to 50.68 for the control and coated mushrooms, respectively.

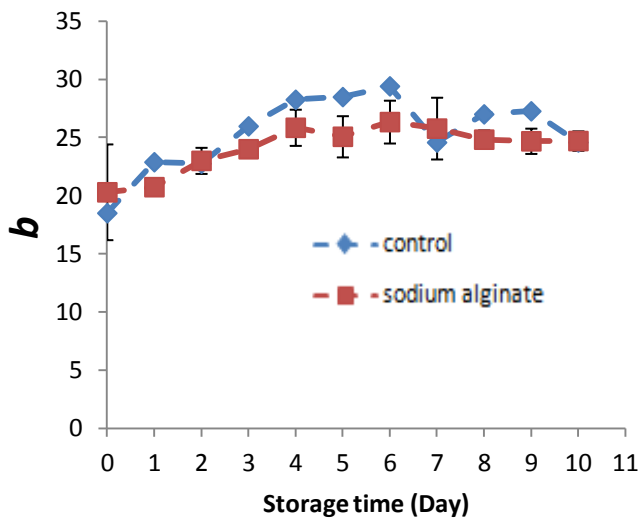
In comparison with an ideal mushroom (Figure 53), the coated mushrooms were the most nearly. It is important to mention that this analysis was only performed for the cap of the mushroom.



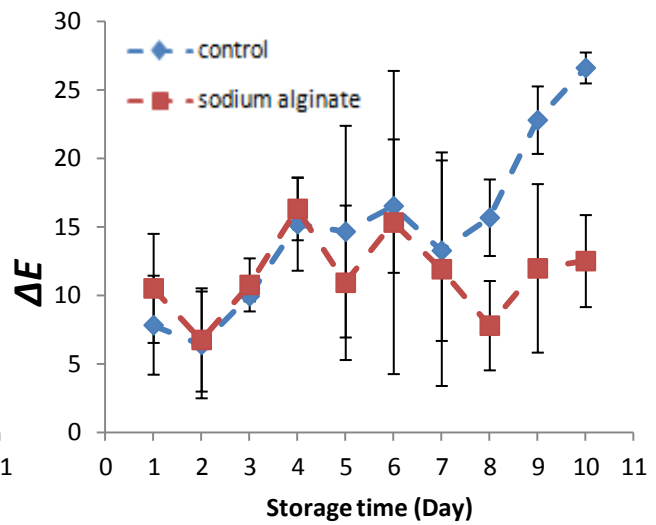
**Figure 48:** Whiteness of stipe the mushroom of *Agaricus bisporus* mushrooms during 10 days of storage at 6-8 °C (I-standard deviation).



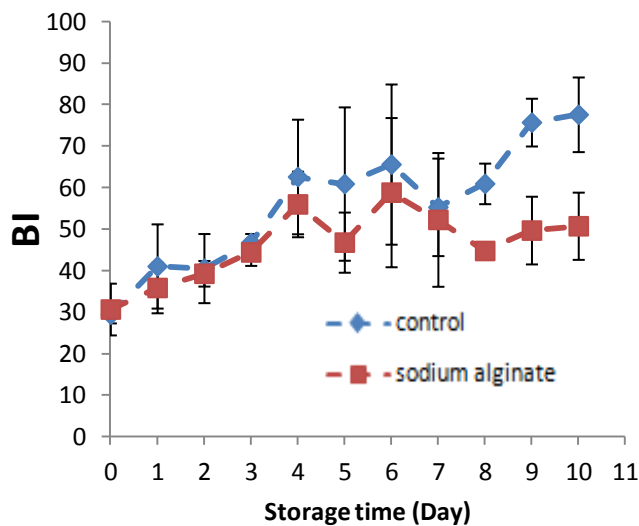
**Figure 49:** Redness of stipe the mushroom of *Agaricus bisporus* mushrooms during 10 days of storage at 6-8 °C (I-standard deviation).



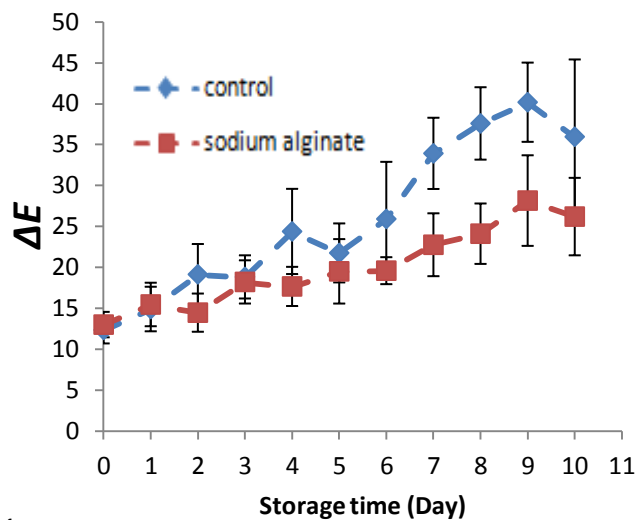
**Figure 50:** Yellowness of stipe the mushroom of *Agaricus bisporus* mushrooms during 10 days of storage at 6-8 °C (I- standard deviation).



**Figure 51:** Colour difference of stipe the mushroom of *Agaricus bisporus* mushrooms during 10 days of storage at 6-8 °C (I- standard deviation).



**Figure 52:** Browning index of cap the mushroom of *Agaricus bisporus* mushrooms during 10 days of storage at 6-8 °C (I- standard deviation).



**Figure 53:** Colour difference (ideal) of cap the mushroom of *Agaricus bisporus* mushrooms during 10 days of storage at 6-8 °C (I- standard deviation).

The colour deterioration and development of lesions in the cap of mushrooms was verified during the storage time, it can be justified by the increased of enzyme activity and the microbiological deterioration. The microbiological action mainly by *P. tolaasii* can lead to activation of polyphenol oxidase and oxidation of phenolic compounds to form spots (Soler-Rivas, Jolivet et al. 1999; Guan, Fan et al. 2013).

It can be said that the coated mushrooms showed generally lower colour changes during storage when compared to the control. This can be explained by the presence of cinnamic acid in the coating that its known by their anti-browning activity (inhibitor of tyrosinase-PPO); the ability of the coating to act as a barrier to oxygen,

needed for browning reactions occur; and the presence of eugenol identified as an antimicrobial agent that can inactivate certain bacteria, including *P. tolaasii* on the surface of mushrooms, which could result in brown spots on less developed mushroom (Guan, Fan et al. 2012; Sapers and Simmons 1998). Gao, Feng et al. (2014) showed that the treatment of button mushrooms (*A. bisporus*) with EOs fumigation leads to an improvement of the *L* value,  $\Delta E$  and BI comparing with the control, during 16 days on cold storage. Other study using an alginate-based coating on the same kind of mushrooms, also showed an improvement of the parameters of colour of the mushrooms, when storage at 4 °C (Jiang 2013). Nevertheless, the yellowing occurred in both coated and uncoated mushroom without significant differences between them, perhaps due to high relative humidity.

Visual observations made during the storage time showed that the uncoated mushroom had a higher amount of patches than coated mushrooms. It should be noted that the cap is the most important part of the mushroom to the consumers acceptability, so the stipe is no relevant in terms of colour.

#### 4.2.5. Evaluation of enzymatic activity

PPO is the major contributor for the browning of fresh white mushrooms, due to their influence in the oxidation of phenolics, resulting in the formation of brown-coloured substances. In Figure 54 is shown the PPO activity during storage, which increases for both groups of mushrooms. Results show a significant difference ( $p < 0.05$ ) between coated and control mushrooms, being the coated mushrooms the ones that presented the best results in terms of PPO activity (lower values) (Table 13 on Annex A.3.).

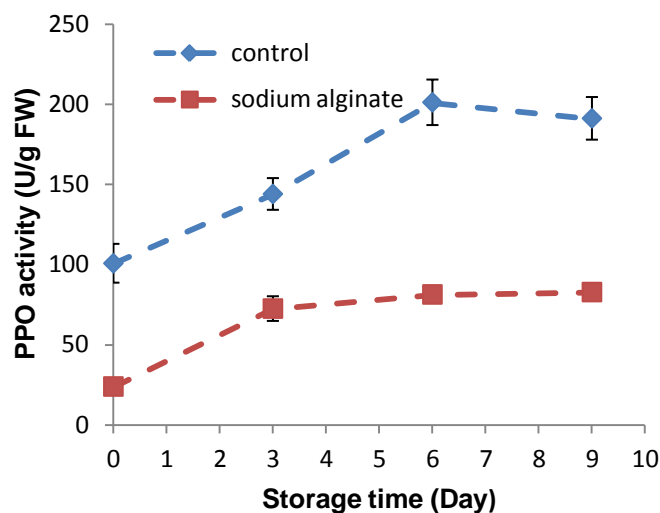
PPO activity increases from 23.67 to 82.57  $\text{Ug}^{-1}$  FW and from 100.53 to 190.93  $\text{Ug}^{-1}$  FW for the coated and control mushrooms, respectively. It may also be observed that the PPO activity increased more on control than the coated mushrooms. Showing a peak on day 6 and then stabilized, already for the mushrooms coated the peak of PPO activity was given on day 3, followed by stabilization. The rapid increase in PPO activity possibly accelerate the oxidation of polyphenols presents on the mushrooms. However, on coated mushrooms the coating seems inhibit the PPO immediately on the day of coating application (day zero). Being the percentage difference between the two groups of 76.86  $\text{Ug}^{-1}$  FW on day 0. This difference can be explained by the fact that the coating (that contain an inhibitor of the enzyme tyrosinase, cinnamic acid) inhibited the PPO, reducing drastically its activity.

Moreover, also EOs showed to have antioxidant activity (Bonilla, Atarés et al. 2012), in particular eugenol, that showed to have an inhibitory activity against tyrosinase (Echegoyen and Nerín 2015). Some studies, such as the presented by

Meng, Song et al. (2012), Gao, Feng et al. (2014) and Alikhani-Koupaei, Maziumzadeh et al. (2014) reported that the PPO activity of *A. bisporus* increase gradually with storage time, but that the coated mushrooms lead to better results than the control, confirming that favorable effects of the coating application in slowing enzymatic discoloration.

In addition, and as stated before, the alginate coating forms a protect barrier on the surface of the fresh produce, reducing supply of O<sub>2</sub> which can help reducing the PPO activity.

The coated mushrooms showed better colour that can be directly related to a lower PPO activity in comparison with the control, showing to have a lower degradation during the storage time.



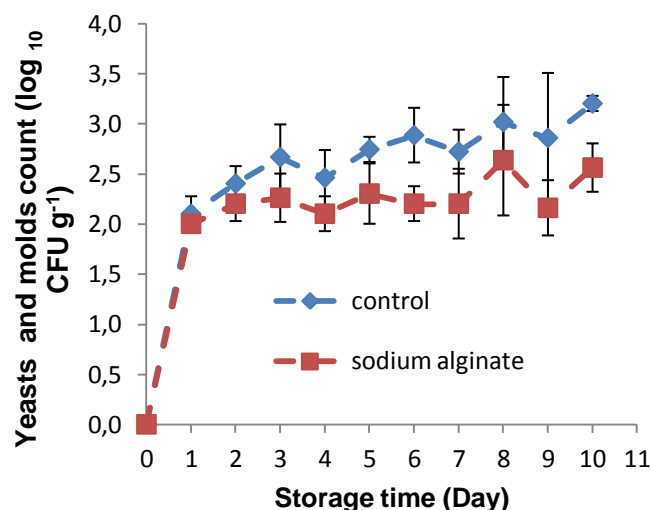
**Figure 54:** PPO activity of *Agaricus bisporus* mushrooms during 10 days of storage at 6-8 °C (I- standard deviation).

#### 4.2.6. Microbiological evaluation

Fruits and vegetables are a suitable environment for the microbial growing due to the large amount of water and nutrients presented on the surface. At refrigeration temperature, the capacity of microorganisms to multiply is reduced, however, refrigeration temperatures alone can not completely prevent the growth of pathogenic microorganisms (Olivas and Barbosa-Cánovas 2005). Under refrigerated storage conditions, pathogen populations can reach levels capable of causing disease even before the product is deteriorated by active microflora (USFDA 2001). So, the evaluation of the development of populations of mesophilic bacteria, psychrophilic, fungi and yeasts during storage on fresh produce is necessary to ensure microbiological safety.

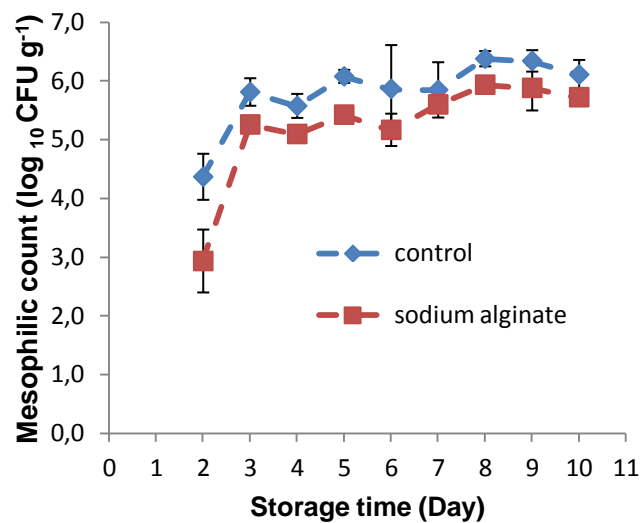


The impact of the coating on the mushrooms in comparison with the control was evaluated in terms of mesophilic and psychrophilic bacteria, yeasts and molds counts and the results are presented in Table 13 (on Annex A.3.). On day 0, were not detected fungi and yeasts (Figure 55) in the coated and control mushrooms. During the storage of 10 days, there were no significant differences ( $p>0.05$ ) between the two groups, with the exception for the mushrooms evaluated at the days 5, 6 and 10. There was a significant increase ( $p<0.05$ ) from the day 0 to the day 1, while from the day 1 to end the analysis this increase is not so evident. Having an increased from 0 to  $3.20 \log_{10} \text{CFUg}^{-1}$  and from 0 to  $2.56 \log_{10} \text{CFUg}^{-1}$  for control and coated mushrooms, respectively. However, the results obtained for both groups were better than in the results obtained in other studies. Jiang, Feng et al. (2012) studied *L. edodes* mushrooms, coated with chitosan-based coating with stored at 4 °C for 16 days, at showed that at the end of storage the mushrooms present a yeast and moulds count of  $5.76 \log_{10} \text{CFUg}^{-1}$ . Similar studies showed the presence of larger amounts of yeasts and molds on coated mushrooms, for example, with gum Arabic-based coating was obtained a total count of  $7.26 \log_{10} \text{CFUg}^{-1}$  (Jiang, Feng et al., 2013b) and for alginate-based coating were obtained values around  $6 \log_{10} \text{CFUg}^{-1}$  (Jiang, Feng et al. 2013a). However, observing the count plates, it was possible to verify that coated mushrooms only present yeasts, and no molds were observed. So, it can be concluded that the used coating and the incorporation of active agents, such as eugenol and cinnamic acid, prevent the fungal growth in mushroom. Eugenol and cinnamic acid with known antimicrobial activity (Roller and Sheedhar 2002) helped in inhibiting mold growth. According to Jacxsens, Devlieghere et al. (1999), the deterioration in fruit and vegetables is usually detected by consumers when yeasts counts reached levels greater than  $5 \log_{10} \text{CFUg}^{-1}$ , all samples were shown to be less than this value. In Annex A.4. (Figures 72 to 76) are presented some images of the fungi and yeast present in the samples during the storage time.



**Figure 55:** Yeasts and moulds count of *Agaricus bisporus* mushrooms during 10 days of storage at 6-8 °C (I- standard deviation).

The mesophilic count (Figure 56) performed on day 2 to the last day of storage, showed that until the day 5 there was a decrease in the growth of such bacteria, with significant differences ( $p < 0.05$ ) between the control and coated mushrooms. In the remaining days, the difference in growth reduction it was not so evident, and the increased growth during the storage was from 4.36 to 6.10  $\log_{10}$  CFUg<sup>-1</sup> and from 2.93 to 5.72  $\log_{10}$  CFUg<sup>-1</sup> for the control and coated mushrooms, respectively. Results are in agreement with other studies (Jiang, Feng et al. 2012; Jiang, Feng et al. 2013a; Jiang, Feng et al., 2013b). In Annex A.5. (Figure 77) it can be observed mesophilic bacteria present in the samples during the storage time.



**Figure 56:** Mesophilic count of *Agaricus bisporus* mushrooms during 10 days of storage at 6-8 °C (I- standard deviation).

The psychrophilic bacterial populations also increased with increasing storage time (Figure 57). At day 0 all samples showed a high number of these bacteria with values between 5.46 and 6.50  $\log_{10}$  CFUg<sup>-1</sup>. However, the coated mushrooms showed a lesser presence of these bacteria ( $p < 0.05$ ), which may be due to the action of the active agents, which could have an inhibitory activity against the present bacteria. In the following days (between days 1 and 5) the coated mushrooms showed a reduced growth of psychrophilic ( $p < 0.05$ ). In the remaining days (between days 6 and 10) the difference was not as evident ( $p > 0.05$ ). At the end of storage the coated mushrooms showed a lower growth of psychrophiles ( $p < 0.05$ ), being the variation between days 0 and 10 in growth 6.50 and 8.06  $\log_{10}$  CFUg<sup>-1</sup> and 5.46 and 7.82  $\log_{10}$  CFUg<sup>-1</sup> for control and coated mushrooms, respectively. In Annex A.6. (Figure 78) it can be observed psychrophilic bacteria present in the samples during the storage time.

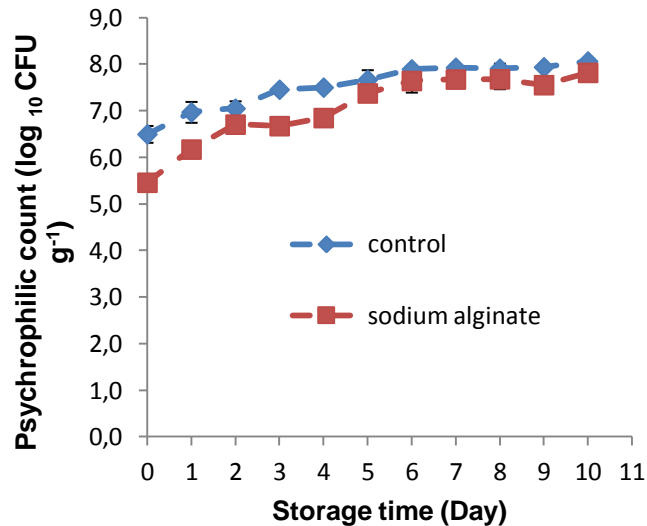


Figure 57: Psychrophilic count of *Agaricus bisporus* mushrooms during 10 days of storage at 6-8 °C (I- standard)

Jacxsens, Devlieghere et al. (2000; 2002) reported that the critical limit for total aerobic plate count in vegetables is  $9 \log_{10} \text{CFUg}^{-1}$ . Microbial analysis in both groups showed be less than this. Bacterial populations and factors influencing its growth play an important role in post-harvest quality of mushrooms (Soler-Rivas, Jolivet et al. 1999). According to Eastwood and Burton (2002), the organisms usually responsible for spoilage of mushrooms are Gram-negative, psychrotrophic bacteria, particularly belonging to the *Pseudomonaceae* family, because of contamination of the product from compost. As stated earlier, control mushrooms showed larger amount of brown strains during storage. The development of these strains are characteristic decay by *Pseudomonas*, accelerating the deterioration of mushrooms at the end of storage. Therefore, microbial degradation may result in changes such as browning, which was less evident in coated mushrooms. The coated mushrooms appear to reduce microbial growth, even better that to other studies.

#### 4.2.7. Other observations

During storage time it was observed some changes beyond of the analysis presented before. One of the visual observations during storage was the open-cap mushrooms, which was more evident on the control mushroom and that increased with the storage time. Being considered a major quality criterion for European consumers (Gormley 1975). This is related with the ripening process that are usually due to the modification of the respiration rates. Thus, the coating can delay the ripening of mushrooms by modifying the atmosphere by means of a permeability gases (decreasing  $\text{O}_2$  and/or increasing  $\text{CO}_2$ ). Also, the cap opening of mushrooms is related

to the dryness of mushrooms as a result of water loss during storage. The increased water loss during storage causes a decrease in cohesive forces of water and other hydrophilic molecules, such as proteins responsible for the intact position of the caps and veil in mushrooms (Jiang 2012). In this cases the coated mushrooms presents a reduced water loss and consequently the opening of the cap opening was less evident.

Through a cross-section cut of mushrooms was possible to perform the visual evaluation of the browning and firmness. These were deteriorating with storage time for all samples, but the coated mushrooms were those that showed less degradation. This evolution can be seen in Figures 58 and 59. In general, coating minimizes the weight loss and are also better maintaining firmness, since this attribute is highly influenced by water content. The overall acceptability based on colour, firmness and open caps of the mushrooms decreased with the increase of storage time, in coated and control mushrooms.



**Figure 58:** Evolution of the colour and firmness in coated mushrooms during storage time at the days 2, 6 and 10.



**Figure 59:** Evolution of the colour and firmness in uncoated mushrooms during storage time at the days 2, 6 and 10.

---

## **CHAPTER V**

### **General conclusions and future work**

---

# Chapter V – General conclusions and future work

## 5.1. General conclusions

Mushrooms are highly perishable products and new technologies designed to extend their shelf life and ensure their safety are demanded by the food industry and consumers. Edible coatings seem to be very promising as long as consumers accept this technique as safe and friendly. As a result of the increasing demand for fresh mushrooms by consumers and the need for keep the quality of the product, made edible coatings to become a field of interest in recent years. Coatings with natural compounds is a minimal process which is more accepted by consumers compared to other shelf life extension methods such as irradiation. Additionally, it is more economic and convenient in comparison with modified atmosphere packaging.

Regarding the aim of this work it can be concluded that the developed coating improved the quality of mushrooms. The application of the coating showed to prolong the shelf life of mushrooms, decreasing weight loss, reducing changes in colour, titratable acidity, pH and TSS during refrigerated storage. The coating was effective as a barrier in the reduction of weight loss during storage and also had beneficial effects in delaying the ripening process and improved the appearance of the coated mushrooms when compared with the uncoated.

The colour is related to the age of the mushrooms and it has been used as an indicator to quantify the shelf life. The microbial population could affect the color change of fresh mushrooms as well as the action of polyphenol oxidase (PPO) in browning. The coated mushrooms showed to be more effective in reducing the mesophilic and psychrophilic counts and was totally effective against the fungi, avoiding their presence. The PPO activity was also reduced, which helped in the decrease of the degradation by browning.

These results suggest that the edible coating used in this work may be a promising method of maintaining the quality of the button mushrooms and that can be used to increase shelf-life during refrigerated storage. The use of this coating may have commercial importance, since it is necessary small amounts of the active compounds to obtain positive results.

## 5.2. Future work

Suggestions for future complementary works are presented based on the results obtained within this work.

One of the suggestions is to increase the concentration of eugenol used in the coating, in order to improve the effect of the coating on the inhibition of microorganisms growth.

However, this increase rises some organoleptic issues arising from edible coatings enriched with EOS in food products. Being so, sensorial analysis should also be performed. This analysis, besides information of the effect of EO on mushrooms (flavour and odor) will also give information regarding colour and texture.

One of the suggestions to decrease the strong odor of the EOs and increase their antimicrobial activity is their encapsulation in micro or nano structures. This can be a viable and effective approach to increase physical stability of bioactive compounds, protecting them against interactions with food ingredients and, because of subcellular size, increasing its bioactivity. This solution can also help to improve the mechanical and barrier properties of the coatings.

---

## References

---



## References

- Aguirre, L., Frias, J.M., Barry-Ryan C. & Grogan, H. (2009). Modelling browning and brown spotting of mushrooms (*Agaricus bisporus*) stored in controlled environmental conditions using image analysis. *Journal of Food Engineering*, **91**: 280-286.
- Aida, F.M.N.A., Shuhaimi, M., Yazid, M. & Maaruf, A.G. (2009). Mushroom as a potential source of prebiotics: a review. *Trends in Food Science and Technology*, **20**: 567-575.
- Ali, A., Maqbool, M., Ramachandran, S. & Alderson, P.G. (2010). Gum arabic as a novel edible coating for enhancing shelf-life and improving postharvest quality of tomato (*Solanum lycopersicum* L.) fruit. *Postharvest Biology and Technology*, **58**: 42-47.
- Alikhani-Koupaei, M., Mazlumzadeh, M., Sharifani, M. & Adibian, M. (2014). Enhancing stability of essential oils by microencapsulation for preservation of button mushroom during postharvest. *Food Science and Nutrition*, **2**: 526-533.
- Ajlouni, S.O. (1991). *Quality characteristics of two hybrids of the cultivated mushrooms (Agaricus bisporus) and the improvement of their shelf life using stripe trimming and gamma irradiation*. Ph.D. Thesis. The Pennsylvania State University, University Park, Pennsylvania.
- Amanatidou, A., Slump, R.A., Gorris, L.G.M. & Smid, E.J. (2000). High oxygen and high carbon dioxide modified atmospheres for shelf life extension of minimally processed carrots. *Journal of Food Science*, **65**: 61-66.
- Andrade, R., Skurtys, O. & Osorio, F. (2013). Drop impact behavior on food using spray coating: fundamentals and applications. *Food Research International*, **54**: 397-405.
- Andrade, R.D., Skurtys, O. & Osorio, F.A. (2012). Atomizing spray systems for application of edible coatings. *Comprehensive Reviews in Food Science and Food Safety*, **11**: 323-337.
- AOAC method 925.10. Official methods of analysis of AOAC international. 16<sup>th</sup> edition, 4<sup>th</sup> revision Gaithersburg, Maryland, USA. 1998.
- AOAC method 920.149. Official methods of analysis of AOAC international. 16<sup>th</sup> edition, 4<sup>th</sup> revision Gaithersburg, Maryland, USA. 1998.
- Appendini, P. & Hotchkiss, J.H. (2002). Review of antimicrobial food packaging. *Innovative Food Science and Emerging Technologies*, **3**: 113-126.

- Arfa, A.B., Combes, S., Preziosi-Belloy, L., Gontard, N. & Chalier, P. (2006). Antimicrobial activity of carvacrol related to its chemical structure. *Letters in Applied Microbiology*. **43**: 149-154.
- Arrebola, E., Sivakumar, D., Bacigalupo, R. & Korsten, L. (2010). Combined application of antagonist *Bacillus amyloliquefaciens* and essential oils for the control of peach postharvest diseases. *Crop Protection*. **29**: 369-377
- Ayranci, E. & Tunc, S. (2003). A method for the measurement of the oxygen permeability and the development of edible films to reduce the rate of oxidative reactions in fresh foods. *Food Chemistry*. **80**: 423-431.
- Badawy, M.E.I. & Rabea, E.I. (2009). Potential of the biopolymer chitosan with different molecular weights to control postharvest gray mold of tomato fruit. *Postharvest Biology and Technology*. **51**: 397-402.
- Baldwin, E.A., Nisperos-Carriedo, M.O. & Baker, R.A. (1995). Edible coatings for lightly processed fruits and vegetables. *Journal of American Society for Horticultural Science*. **30**: 35-38.
- Baldwin, E.A., Burns, J.K., Kazokas, W., Brecht, J.K., Hagenmaier, R.D., Bender, R.J. & Pesis, E. (1999). Effect of two edible coatings with different permeability characteristics on mango *Mangifera indica* L. ripening during storage. *Postharvest Biology and Tecnology*. **17**: 215-226.
- Baldwin, E.A., Nisperos, M.O., Chen, X. & Hagenmaier, R.D. (1996). Improving storage life of cut apple and potato with edible coating. *Postharvest Biology and Technology*. **9**: 151-163.
- Bangyekan, C., Aht-Ong, D. & Srikulkit, K. (2006). Preparation and properties evaluation of chitosan-coated cassava starch films. *Carbohydrate Polymers*. **63**: 61-71.
- Barnard, N. (1974). Some experiments in vacuum cooling. *Mushrooms Journals*. **14**: 48-51.
- Barros, L., Baptista, P., Correia, D.M., Morais, J.S. & Ferreira, I.C.F.R. (2007). Effects of conservation treatment and cooking on the chemical composition and antioxidant activity of Portuguese wild edible mushrooms. *Journal of Agricultural and Food Chemistry*. **55**: 4781-4788.
- Bautista-Baños, S., Hernández-López, M., Bosquez-Molina, E. & Wilson, C. (2003). Effect of chitosan and plant extracts on growth of *Colletotrichum gloeosporoides*, anthracnose levels and quality of papaya fruit. *Crop Protection*. **22**: 1087-1092.

- Baveja, S.K., Ranga Rao, K.V., Arora, J., Mathur, N.K. & Vinayah, V.K. (1991). Chemical investigations of some galactomannan gums as matrix tablets for sustained drug delivery. *Indian Journal of Chemistry*. **30**: 133-137.
- Beaulieu, M., D'Aprano, G. & Lacroix, M. (1999). Dose rate effect of irradiation on phenolic compounds, polyphenol oxidase, and browning of mushrooms (*Agaricus bisporus*). *Journal of Agricultural and Food Chemistry*. **47**: 2537-2543.
- Beaulieu, M., D'Aprano, G. & Lacroix, M. (2002). Effect of dose rate of gamma irradiation on biochemical quality and browning of mushrooms *Agaricus bisporus*. *Radiation Physics and Chemistry*. **63**: 311-315.
- Beelman, R.B. & Duncan, E.M. (1999). Preservation composition and methods for mushrooms. US Patent 5919507.
- Beelman, R.B., Quinn, J.J., Okereke, A., Schisler, L.C., Muthersbaugh, H.R. & Evenson, K. (1987). Effect of peat casing layer and the addition of calcium chloride to watering treatments on quality and shelf life of mushrooms. In: Wuest, P.J., Royse, D.J. and Beelman, R.B. (eds.) *Cultivating edible fungi*, Elsevier Publishing Company, Amsterdam, Holland. pp. 271-282.
- Behbahani, I., Miller, S.A. & O'Keeffe, D.H. (1993). A comparison of mushroom tyrosinase dopaquinone and dopachrome assays using diode-array spectrophotometry: dopachrome formation vs ascorbate-linked dopaquinone reduction. *Microchemical Journal*. **47**: 251-260.
- Beit-Halachmy, I. & Mannheim, C.H. (1992). Is modified atmosphere packaging beneficial for fresh mushrooms? *Lebensmittel-Wissenschaft Und-Technologie-Food Science and Technology*. **25**: 426-432.
- Bhaskara Reddy, M.V., Angers, P., Gosselin, A. & Arul, J. (1998). Characterization and use of essential oil from *Thymus vulgaris* against *Botrytis cinerea* and *Rhizopus stolonifer* in strawberry fruits. *Photochemistry*. **47**: 1515-1520.
- Blaszyk, M. & Holley, R.A. (1998). Interaction of monolaurin, eugenol and sodium citrate on growth of common meat spoilage and pathogenic organisms. *Food Microbiology*. **39**: 175-183.
- Bonilla, J., Atarés, L., Vargas, M. & Chiralt, A. (2012). Edible films and coatings to prevent the detrimental effect of oxygen on food quality: possibilities and limitations. *Journal of Food Engineering*. **110**: 208-213.
- Breene, W.M. (1990). Nutritional and medicinal value of specialty mushrooms. *Journal of Food Protection*. **53**: 883-894.
- Brennan, M., Le Port, G. & Gormley, R. (2000). Post-harvest treatment with citric acid or hydrogen peroxide to extend the shelf life of fresh sliced mushrooms.

- Lebensmittel-Wissenschaft Und-Technologie-Food Science and Technology*. **33**: 285-289.
- Briones, G.L., Varoquaux, P., Chambroy, Y., Bouquant, J., Bureau, G. & Pascat, B. (1992). Storage of common mushrooms under controlled atmospheres. *International Journal of Food Science and Technology*. **27**: 493-505.
- Briones, G.L., Varoquaux, P., Bureau, G. & Pascat, B. (1993). Modified atmosphere packaging of common mushroom. *International Journal of Food Science and Technology*. **28**: 57-68.
- Brosnan, T. & Sun, D.W. (2004). Improving quality inspection of products by computer vision-review. *Journal of Food Engineering*. **61**: 3-16.
- Burt, S. (2004). Essential oils: their antibacterial properties and potential applications in foods: a review. *International Journal of Food Microbiology*. **94**: 223-253.
- Burt, S.A. & Reinders, R.D. (2003). Antibacterial activity of selected plant essential oils against *Escherichia coli* O157:H7. *Letters in Applied Microbiology*. **36**: 162-167.
- Burton, K.S. (1991). Modified atmosphere packaging of mushrooms: review and recent developments. In: Maher, D. (ed.). *Science and Cultivation of Edible Fungi*, Balkema, Rotterdam, Holland. pp. 683-688.
- Burton, K.S. (2004). Cultural factors affecting mushroom quality e cause and control of bruising. *Mushroom Science*. **16**: 397-402.
- Burton, K.S., Frost, C.E. & Atkey, P.T. (1987). Effect of vacuum cooling on mushroom browning. *International Journal of Food Science and Technology*. **22**: 599-606.
- Burton, K.S., Partis, M.D., Wood, D.A. & Thurston, C.F. (1997). Accumulation of serine proteinase in senescent sporophores of the cultivated mushroom, *Agaricus bisporus*. *Mycological Research*. **101**: 146-152.
- Burton, K.S. & Twynning, R.V. (1989). Extending mushroom storage-life by combining modified atmosphere packaging and cooling. *Acta Horticulturae*. **258**: 565-571.
- Busscher, H.J., van Pelt, A.W.J., de Boer, P., de Jong, H.P. & Arends, J. (1984). The effect of surface roughening of polymers on measured contact angles of liquids. *Colloids and Surfaces*. **9**: 319-331.
- Butler, B.L., Vergano, P.J., Testin, J.M., Bunn, J.M. & Wiles J.L. (1996). Mechanical and barrier properties of edible chitosan films as affected by composition and storage. *Journal of Food Science*. **61**: 953-955.
- Cagri, A., Ustunol, Z. & Ryser, E.T. (2004). Antimicrobial edible films and coatings. *Journal of Food Protection*. **67**: 833-848.
- Campaniello, D., Bevilacqua, A., Sinigaglia M. & Corbo, M.R. (2008). Chitosan: antimicrobial activity and potential applications for preserving minimally

- processed strawberries. *International Journal of Food Microbiology*. **25**: 992-1000.
- Campos, C.A., Gerschenson, L.N. & Flores, S.K. (2011). Development of edible films and coatings with antimicrobial activity. *Food and Bioprocess Technology*. **4**: 849-875.
- Caner, C., Vergano, P.J. & Wiles, J.L. (1998). Chitosan film mechanical and permeation properties as affected by acid, plasticizer and storage. *Journal of Food Science*. **63**: 1049-1053.
- Carneiro-da-Cunha, M.G., Cerqueira, M.A, Souza, B.W.S., Souza, M.P., Teixeira, J.A. & Vicente A.A. (2009). Physical properties of edible coatings and films made with a polysaccharide from *Anacardium occidentale* L. *Journal of Food Engineering*. **95**: 379-385.
- Casariogo, A., Souza, B.W.S., Vicente, A.A., Teixeira, J.A., Cruz, L. & Díaz, R. (2008). Chitosan coating surface properties as affected by plasticizer, surfactant and polymer concentrations in relation to the surface properties of tomato and carrot. *Food Hydrocolloids*. **22**: 1452-1459.
- Cerqueira, M.A., Bourbon, A.I., Pinheiro, A.C., Martins, J.T., Souza, B.W.S., Teixeira, J.A. & Vicente, A.A. (2011). Galactomannans use in the development of the edible films/coatings for food applications. *Trends in Food Science and Technology*. **22**: 662-671.
- Cerqueira, M.A., Lima, A.M., Souza, B.W.S., Teixeira, J.A., Moreira, R.A. & Vicente, A.A. (2009a). Functional polysaccharides as edible coatings for cheese. *Journal of Agricultural and Food Chemistry*. **57**: 1456-1462.
- Cerqueira, M.A., Lima, A.M., Teixeira, J.A., Moreira, R.A. & Vicente, A.A. (2009b). Suitability of novel galactomannans as edible coatings for tropical fruits. *Journal of Food Engineering*. **94**: 372-378.
- Cerqueira, M.A., Pinheiro, A.C., Souza, B.W.S., Lima, A.M.P., Ribeiro, C., Miranda, C., Teixeira, J.A., Moreira, R.A., Coimbra, M.A., Gonçalves, P. & Vicente, A.A. (2009). Extraction, purification and characterization of galactomannans from non-traditional sources. *Carbohydrate Polymers*. **75**: 408-414.
- Cerqueira, M. A., Souza, B.W.S., Simões, J., Teixeira, J.A., Domingues, M.R.M., Coimbra, M.A. & Vicente, A.A. (2011). Structural and thermal characterization of galactomannans from non-conventional sources. *Carbohydrate Polymers*. **83**: 179-185.
- Cha, D.S. & Chinnan, M.S. (2004). Biopolymer-based antimicrobial packaging: a review. *Critical Reviews in Food Science and Nutrition*. **44**: 223-237.

- Chalier, P., Arfa, A.B., Preziosi-Belloy, L. & Gontard, N. (2007). Carvacrol losses from soy protein based papers as a function of drying conditions. *Journal of Applied Polymer Science*. **106**: 611-620.
- Chang, T. (2009). An updated review of tyrosinase inhibitors. *International Journal of Molecular Sciences*. **10**: 2440-2475.
- Chang, S.T. & Hayes, W.A. (1978). The biology and cultivation of edible mushrooms. Academic, New York, USA. pp.137.
- Chang, S.T. & Miles, P.G. (1989). Edible mushrooms and their cultivation. CRC Press. Boca Raton, Florida, USA. pp. 345.
- Chang, S.T. & Miles, P.G. (2004). Mushrooms: cultivation, nutritional value, medicinal effect, and environmental impact. CRC Press, 2<sup>nd</sup> ed. Boca Raton, Florida, USA. pp. 451.
- Chen, Q.X., Song, K.K., Qiu, L., Liu, X.D. & Huang, H. (2004). *p*-Alkoxy-substituted benzoic acids as antibrowning agents: antioxidative tyrosinase inhibitors. *Food Chemistry*. **82**.
- Cheng, Y.-C. & Prusoff, W.H. (1973). Relationship between the inhibition constant ( $K_i$ ) and the concentration of inhibitor which causes 50 percent inhibition ( $I_{50}$ ) of an enzymatic reaction. *Biochemical Pharmacology*. **22**: 3099-3108.
- Chien, P.J., Sheu, F. & Lin, H.R. (2007). Coating citrus (*Murcott tangor*) fruit with low molecular weight chitosan increases postharvest quality and shelf life. *Food Chemistry*. **100**: 1160-1164.
- Chikthimma, N. & Beelman, R.B. (2005). Microbial spoilage of fresh mushrooms. In: Sapers, M., Gorny, J.R. and Yousef A.E. (eds.). *Microbiology of Fruits and Vegetables*, CRC Press, Boca Raton, Florida, USA. pp. 138-146 .
- Chikthimma, N., LaBorde, L.F. & Beelman, R.B. (2004). Irrigation with hydrogen peroxide and calcium chloride as a strategy to reduce bacterial populations on fresh mushrooms. *Book of Abstracts*. Institute of Food Technologists Annual Meeting, Las Vegas, Nevada, USA.
- Chikthimma, N., McMillen, J., LaBorde, L.F., Demirci, A. & Beelman, R.B. (2003) Irrigation with electrolyzed oxidizing water to reduce bacterial populations on fresh mushrooms. *Book of Abstracts*. Institute of Food Technologists Annual Meeting, Chicago, Illinois, USA
- Choi, W.Y., Park, H.J., Ahn, D.J., Lee, J. & Lee, C.Y. (2002). Wettability of chitosan coating solution on 'Fuji' apple skin. *Journal of Food Science*. **67**: 2668-2672.
- CLSI M7-A9 (2012). Methods for dilution antimicrobial susceptibility. Tests for bacteria that grow aerobically. Approved Standard - 9<sup>th</sup> Edition. CLSI document M07-A9. Clinical and Laboratory Standards Institute. Wayne, Pennsylvania, USA.

- Codex Alimentarius (2015). List of Codex Specifications for Food Additives CAC/MISC 6-2015. Accessed in 8/08/2015, in: <http://www.codexalimentarius.org/standards/list-of-standards/en/?provide=standards&orderField=fullReference&sort=asc&num1=CAC/MISC>.
- Cosentino, S., Tuberoso, C.I.G., Pisano, B., Satta, M., Mascia, V., Arzedi, E. & Palmas, F. (1999). In vitro antimicrobial activity and chemical composition of *Sardinian Thymus* essential oils. *Letters in Applied Microbiology*. **29**: 130-135.
- CoSeteng, M.Y. & Lee, C.Y. (1987). Changes in apple polyphenoloxidase and polyphenol concentrations in relation to degree of browning. *Journal of Food Science*. **52**: 985-989.
- Cuq, B., Aymard, C., Cuq, J.L. & Guilbert, S. (1995). Edible packaging films based on fish myofibrillar proteins: formulation and functional properties. *Journal of Food Science*. **60**: 1369-1374.
- Cutter, C.N. & Siragusa, G.R. (1996). Reduction of *Brochothrix thermosphacta* on beef surfaces following immobilization of nisin in calcium alginate gels. *Letters in Applied Microbiology*. **23**: 9-12.
- Cutter, N.C. & Sumner, S.S. (2002). Application of edible coatings on muscle foods. In: Gennadios, A. (ed.). *Protein-based films and coatings*. CRC Press.
- Dakia, P.A., Blecker, C., Roberta, C., Watheleta, B. & Paqueta, M. (2008). Composition and physicochemical properties of locust bean gum extracted from whole seeds by acid or water dehulling pre-treatment. *Food Hydrocolloids*. **22**: 807-818.
- Dann, J.R. (1970). Forces involved in the adhesive process 1. Critical surface tensions of polymeric solids as determined with polar liquids. *Journal of Colloids and Interface Science*. **32**: 302-319.
- Darmadji, P. & Izumimoto, M. (1994). Effect of chitosan in meat preservation. *Meat Science*. **38**: 243-254.
- Davidson, P.M. & Parish, M.E. (1989). Methods for testing the efficacy of food antimicrobials. *Food Technology*. **43**: 148-155.
- Dea, I.C.M. & Morrison, A. (1975). Chemistry and interactions of seed galactomannans. *Advances in Carbohydrate Chemistry and Biochemistry*. **32**: 241-312.
- Debeaufort, F., Quezada-Gallo, J. A. & Voilley, A. (1998). Edible films and coatings: tomorrow's packaging: a review. *Critical Reviews in Food Science and Nutrition*. **38**: 299-313.

- Debeaufort, F. & Voilley, A. (2009). Lipid-based edible films and coatings. In: Embuscado, M.E. and Huber, K.C. (eds.). *Edible films and coatings for food applications*, Springer, New York, USA. pp. 135-164.
- de Capdeville, G., Wilson, C.L., Beer, S.V. & Aist, J.R. (2002). Alternative disease control agents induce resistance to blue mold in harvested "Red Delicious" apple fruit. *Phytopathology*. **92**: 900-908.
- De la Plaza, J.L., Alique, R., Zamorano, J.P., Calvo, M.L. & Navarro, M.J. (1995). Effect of the high permeability to O<sub>2</sub> on the quality changes and shelf life of fresh mushrooms stored under modified atmosphere packaging. In: Elliott, T.J. (ed.) *Science and Cultivation of Edible Fungi*, Balkema, Rotterdam, Holland. pp. 709-716.
- Devlieghere, F., Vermeiren, L. & Debevere, J. (2004). New preservation technologies: Possibilities and limitations. *International Dairy Journal*. **14**: 273-285.
- Di Pasqua, R., Betts, G., Hoskins, N., Edwards, M., Ercolini, D. & Mauriello, G. (2007). Membrane toxicity of antimicrobial compounds from essential oils. *Journal of Agricultural and Food Chemistry*. **55**: 4863-4870.
- Donker, H.C.W. & Van As, H. (1999). Cell water balance of white button mushrooms (*Agaricus bisporus*) during its post-harvest lifetime studied by quantitative magnetic resonance imaging. *Biochimica Et Biophysica Acta-General Subjects*. **1427**: 287-297.
- Donsì, F., Annunziata, M., Vincenzi, M. & Ferrari, G. (2012). Design of nanoemulsion-based delivery systems of natural antimicrobials: effect of the emulsifier. *Journal of Biotechnology*. **159**: 342-350.
- Doores, S., Kramer, M. & Beelman, R. (1987). Evaluation and bacterial populations associated with fresh mushrooms (*Agaricus bisporus*). In: Wuest, P.J., Royce, D.L. and Beelman, R.B. (eds.) *Cultivating Edible Fungi: Developments in Crop Science*, Elsevier, Amsterdam, Holland. pp. 283-294.
- Donhowe, G., & Fennema, O. (1994). Edible films and coatings: characteristics, formation, definitions and testing methods. In: Krochta, J.M., Baldwin, E.A., & Nisperos-Carriedo, M.O. (eds.). *Edible coatings and films to improve food quality*, Technomic Publishing Company Inc, Lancaster, Pennsylvania, USA. pp. 1-24.
- Du, J., Fu, Y. & Wang, N. (2009). Effects of aqueous chlorine dioxide treatment on browning of fresh-cut lotus root. *Lebensmittel-Wissenschaft Und-Technologie-Food Science and Technology*. **42**: 654-659.



- Du, J.M., Gemma, H. & Iwahori, S. (1997). Effects of chitosan coating on the storage of peach, Japanese pear, and kiwifruit. *Journal of Japanese Society for Horticultural Science*. **66**: 15-22.
- Duan, Z., Xing, Z., Shao, Y. & Zhao, X. (2010). Effect of electron-beam irradiation on postharvest quality and selected enzyme activities of the white button mushroom, *Agaricus bisporus*. *Journal of Agricultural and Food Chemistry*. **58**: 9617-9621.
- Earle, R.D. (1968). Meat and fish coatings: alginate coatings. In: Daniels, R. (ed.). *Edible coatings and soluble packaging*, Noyes Data Corporation, Park Ridge, New Jersey, USA. pp. 188-196.
- Eastwood, D. & Burton, K. (2002). Mushrooms – A matter of choice and spoiling oneself. *Microbiology Today*. **29**: 18-19.
- Echegoyen, Y. & Nerín, C. (2015). Performance of an active paper based on cinnamon essential oil in mushrooms quality. *Food Chemistry*. **170**: 30-36.
- Eissa, H.A.A. (2007). Effect of chitosan coating on shelf life and quality of fresh-cut mushroom. *Journal of Food Quality*. **30**: 623-645.
- El Ghaouth, A., Arul, J., Grenier, J. & Asselin, A. (1992). Antifungal activity of chitosan on two postharvest pathogens of strawberry fruits. *Phytopathology*. **82**: 398-402.
- El Ghaouth, A., Ponnampalam, R., Castaigne, F. & Arul, J. (1992). Chitosan coating to extend the storage life of tomatoes. *Journal of American Society for Horticultural Science*. **27**: 1016-1018.
- Elsabee, M.Z. & Abdou, E.S. (2013). Chitosan based edible films and coatings: A review. *Materials Science and Engineering C*. **33**: 1819-1841.
- Escrive, I., Serra, J.A., Gomez, M. & Galotto, M.J. (2001). Effect of ozone treatment and storage temperature on physicochemical properties of mushrooms (*Agaricus bisporus*). *International Journal of Food Science and Technology*. **7**: 251-258.
- Esteve, M.J., Farré, R., Frígola, A. & García-Cantabella, J.M. (2001). Simultaneous determination of thiamin and riboflavin in mushrooms by liquid chromatography. *Journal of Agricultural and Food Chemistry*. **49**: 1450-1454.
- FAOSTAT (2015). Food and Agriculture Organization of the United Nations Statistics Division. Visited on 10/07/2015. [http://faostat3.fao.org/browse/Q/\\*/E](http://faostat3.fao.org/browse/Q/*/E)
- Fernandes, A., Antonio, A.L., Oliveira, M.B.P.P., Martins, A. & Ferreira, I.C.F.R. (2012). Effect of gamma and electron beam irradiation on the physico-chemical and nutritional properties of mushrooms: a review. *Food Chemistry*. **135**: 641-650.

- Ferreira, I.C., Barros, L. & Abreu, R.M. (2009). Antioxidants in wild mushrooms. *Current Medicinal Chemistry*. **16**: 1543-1560.
- Ferreira, I.C., Vaz, J.A., Vasconcelos, M.H. & Martins, A. (2010). Compounds from wild mushrooms with antitumor potential. *Anticancer Agents in Medicinal Chemistry*. **10**: 424-436.
- Field, C.E., Pivarnik, L.F., Barnett, S.M. & Rand Jr.A.G. (1986). Utilization of glucose oxidase for extending the shelf-life of fish. *Journal of Food Science*. **51**: 66-70.
- Forero, L.I. (2001). *Obtención de películas biodegradables a partir de quitosana*. MS Thesis, Instituto de Farmacia y Alimentos, Universidad de la Habana.
- Fox, J.E. (1992). In: Imeson, A. (ed.). *Thickening and gelling agents for food*, Chapman & Hall, London, London. pp. 153-169.
- Franssen, L.R. & Krochta, J.M. (2003). Edible coatings containing natural antimicrobials for processed foods. In: Roller, S. (ed.). *Natural antimicrobials for minimal processing of foods*, CRC Press, Boca Raton, Florida, USA. pp. 250-262.
- Furlani, R.P.Z. & Godoy, H.T. (2005). Nutricional value of edible mushrooms: a revision. *Revista do Instituto Adolfo Lutz*. **64**: 149-154.
- Gacesa, P. (1988). Alginates. *Carbohydrate Polymers*. **8**: 161-182.
- Gaffrey, J.J. (1978). Humidity: basic principles and measurement techniques. *Journal of American Society for Horticultural Science*. **13**: 551-555.
- García, L.C., Pereira, L.M., Sarantópoulos, C.I.L., & Hubinger, M.D. (2010). Selection of an edible starch coating for minimally processed strawberry. *Food and Bioprocess Technology*. **3**: 834-842.
- Gao, M., Feng, L. & Jiang, T. (2014). Browning inhibition and quality preservation of button mushroom (*Agaricus bisporus*) by essential oils fumigation treatment. *Food Chemistry*. **149**: 107-113.
- Gaysinsky, S., Davidson, P.M., Bruce, B.D. & Weiss, J. (2005). Growth inhibition of *Escherichia coli* O157:H7 and *Listeria monocytogenes* by carvacrol and eugenol encapsulated in surfactant micelles. *Journal of Food Protection*. **68**: 2559-2566.
- Geels, F.P., Heslen, L.P.W. & van Griensven L.J.P.D. (1994). Brown discoloration of mushrooms caused by *Pseudomonas agarici*. *Journal Phytopathology*. **140**: 249-259.
- Gennadios, A., Weller, C.L. & Gooding, C.H. (1994). Measurement errors in water vapor permeability of highly permeable, hydrophilic edible films. *Journal of Food Engineering*. **21**: 395-409.

- Ghanbarzadeh, B., Musavi, M., Oromiehie, A.R., Rezayi, K., Razmi Rad, E. & Milani, J. (2007). Effect of plasticizing sugars on water vapor permeability, surface energy and microstructure properties of zein films. *Lebensmittel-Wissenschaft Und-Technologie-Food Science and Technology*. **40**: 1191-1197.
- Gill, A.O., Delaquis, P., Russo, P. & Holley, R.A. (2002). Evaluation of antilisterial action of cilantro oil on vacuum packed ham. *International Journal of Food Microbiology*. **73**: 83-92.
- Gill, A.O. & Holley, R.A. (2006). Disruption of *Escherichia coli*, *Listeria monocytogenes* and *Lactobacillus sakei* cellular membranes by plant oil aromatics. *International Journal of Food Microbiology*. **108**: 1-9.
- Girelli, A.M., Mattei, E. & Messina, A. (2004). HPLC study of tyrosinase inhibition by thiopronine. *Biomedical Chromatography*. **18**: 436-442.
- Godfrey, S.A.C. (2003). *Molecular investigation of pseudomonads causative of Agaricus bisporus blotch disease in New Zealand mushroom farms*. Ph.D.Thesis. Department of Plant and Microbial Sciences, University of Canterbury, Christchurch, New Zealand. pp. 28.
- Golan-Goldhirsh, A. & Whitaker, J.R. (1984). Effect of ascorbic acid, sodium bisulfite and thiol compounds on mushroom polyphenol oxidase. *Journal of Agricultural and Food Chemistry*. **32**: 1003-1009.
- Gómez-Estaca, J., López de Lacey, A., López-Caballero, M.E., Gómez-Guillen, M.C. & Montero, P. (2010). Biodegradable gelatin-chitosan films incorporated with essential oils as antimicrobial agents for fish preservation. *Food Microbiology*. **27**: 889-96.
- Gómez-Estaca, J., Montero, P., Giménez, B. & Gómez-Guillén, M.C. (2007). Effect of functional edible films and high pressure processing on microbial and oxidative spoilage in cold-smoked sardine (*Sardina pilchardus*). *Food Chemistry*. **105**: 511-520.
- Gormley, R. (1975). Chill storage of mushrooms. *Journal of the Science of Food and Agriculture*. **26**: 401-411.
- Gormley, T. R. & MacCanna, C. (1967). Pre-packaging and shelf life of mushrooms. *Irish Journal of Agricultural Research*. **6**: 255-265.
- Goñi, P., López, P., Sánchez, C., Gómez-Lus, R., Becerril, R. & Nerín, C. (2009). Antimicrobial activity in the vapour phase of a combination of cinnamon and clove essential oils. *Food Chemistry*. **116**: 982-989.
- González-Aguilar, G.A., Valenzuela-Soto, E., Lizardi-Mendoza, J., Goycoolea, F., Martínez-Téllez, M.A., Villegas-Ochoa, M.A., Monroy-García, I.N. & Ayala-Zavala, J.F. (2009). Effect of chitosan coating in preventing deterioration and

- preserving the quality of fresh-cut papaya "Maradol". *Journal of the Science of Food and Agriculture*. **89**: 15-23.
- Gould, G.W. (1989). Mechanisms of action of food preservation procedures. *Elsevier Applied Science*, London, England. pp. 2-9.
- Greener, I. & Fennema, O. (1994). Edible films and coatings: characteristics, formation, definitions, and testing methods. In: Krochta, J.M., Baldwin, E.A. and Nisperos-Carriedo, M.O. (eds.). *Edible coatings and films to improve food quality*, Technomic Publishing Company, Inc., Lancaster, USA. pp. 1-24.
- Guan, W., Fan, X. & Yan, R. (2012). Effects of UV-C treatment on inactivation of *Escherichia coli* O157:H7, microbial loads, and quality of button mushrooms. *Postharvest Biology and Technology*. **64**: 119-125.
- Guan, W., Fan, X. & Yan, R. (2013). Effect of combination of ultraviolet light and hydrogen peroxide on inactivation of *Escherichia coli* O157:H7, native microbial loads, and quality of button mushrooms. *Food Control*. **34**: 554-559.
- Guilbert, S. & Gontard, N. (1995). Edible and biodegradable food packaging. In: Ackermann, P., Jägerstad, M. and Ohlsson, T. (eds.). *Foods and Packaging Materials and Chemical Interactions*, The Royal Society of Chemistry, England. pp. 159-168.
- Guilbert, S., Gontard, N. & Gorris, L.G.M. (1996). Prolongation of the shelf-life of perishable food products using biodegradable films and coatings. *Lebensmittel-Wissenschaft Und-Technologie-Food Science and Technology*. **29**: 10-17.
- Gülçin, I., Sat, I.G., Beydemir, S., Elmastas, M. & Küfrevioğlu, Ö.I. (2004). Comparison of antioxidant activity of clove (*Eugenia caryophyllata* Thunb) buds and lavender (*Lavandula stoechas* L.). *Food Chemistry*. **87**: 393-400.
- Guthrie, B.D. & Beelman, R.B. (1989). Control of bacterial deterioration in fresh washed mushrooms. Mushroom science XII (part II). *Proceedings of the 12<sup>th</sup> international congress on the science and cultivation of edible fungi*, Braunschweig, Germany. pp. 689-700.
- Gutierrez, J., Bourke, P., Lonchamp, J. & Barry-Ryan, C. (2009). Impact of plant essential oils on morphological, organoleptic and quality markers of minimally processed vegetables. *Innovative Food Science and Emerging Technologies*. **10**: 195-202.
- Han, J.H. (2000). Antimicrobial food packaging. *Journal of Food Technology*. **54**: 56-65.
- Han, J.H. (2001). Design of edible and biodegradable films/coatings containing active ingredients. In: Park, H.J., Testin, R.F., Chinnan, M.S. and Park, J.W. (eds.).

- Active biopolymer films and coatings for food and biotechnological uses*, 10<sup>th</sup> World Congress Organization, Seoul, South Korea. pp. 187-198.
- Han, J.H. (2002). Protein-based edible films and coatings carrying antimicrobial agents. In: Gennadios, A. (ed.). *Protein-based films and coatings*, CRC Press, Boca Raton, Florida, USA. pp. 485-499.
- Han, J.H. & Gennadios, A. (2005). Edible films and coatings: a review. In: Han, J.H. (ed.). *Innovations in Food Packaging*, Elsevier Academic Press, San Diego, California, USA. pp. 239-262.
- Han, J., Zhao, Y., Leonard, S.W. & Traber, M.G. (2004). Edible coatings to improve storability and enhance nutritional value of fresh and frozen strawberries (*Fragaria x ananassa*) and raspberries (*Rubus ideaus*). *Postharvest Biology and Technology*. **33**: 67-78.
- He, Z., Qiao, C., Han, Q., Cheng, C., Xu, H., Jiang, R., But, P.P. & Shaw, P. (2005). Authentication and quantitative analysis on the chemical profile of cassia bark (*cortex cinnamomi*) by high-pressure liquid chromatography. *Journal of Agriculture and Food Chemistry*. **53**: 2424-2428.
- Helander, I.M., Alokomi, H.L., Latva-Kala, K., Mattila-Sandholm, T., Pol, I. & Smid, E.J. (1998). Characterization of the action of selected essential oil components on Gram-negative bacteria. *Journal of Agricultural and Food Chemistry*. **46**: 3590-3595.
- Hershko, V., Klein, E. & Nuvissovitch, A. (1996). Relationships between edible coating and garlic skin. *Journal of Food Science*. **61**: 769-777.
- Hershko, V. & Nussinovitch, A. (1998). Relationships between hydrocolloid coating and mushroom structure. *Journal of Agricultural and Food Chemistry*. **46**: 2988-2997.
- Ippolito, A., El Ghaouth, A., Wilson, C.L. & Wisniewski, M. (2000). Control of postharvest decay of apple fruit by *Aureobasidium pullulans* and induction of defense responses. *Postharvest Biology and Technology*. **19**: 265-272.
- Iyengar, R. & McEvily, A.J. (1992). Anti-browning agents: alternatives to the use of sulfites in foods. *Trends in Food Science and Technology*. **3**: 60-64.
- Jacxsens, L., Devlieghere, F., Falcato, P. & Debevere, J. (1999). Behavior of *Listeria monocytogenes* and *Aeromonas spp.* on fresh-cut produce packaged under equilibrium-modified atmosphere. *Journal of Food Protection*. **62**: 1128-1135.
- Jacxsens, L., Devlieghere, F., De Rudder T. & Debevere, J. (2000). Designing equilibrium modified atmosphere packages for fresh-cut vegetables subjected to changes in temperature. *Lebensmittel-Wissenschaft Und-Technologie-Food Science and Technology*. **33**: 178-187.

- Jacxsens, L., Devlieghere, F. & Debevere, J. (2002). Predictive modelling for packaging design: equilibrium modified atmosphere packages of fresh-cut vegetables subjected to a simulated distribution chain. *International Journal of Food Microbiology*. **73**: 331-341.
- Jiang, T. (2012). Effect of natamycin in combination with pure oxygen treatment on postharvest quality and selected enzyme activities of button mushroom (*Agaricus bisporus*). *Journal of Agricultural and Food Chemistry*. **60**: 2562-2568.
- Jiang, T. (2013). Effect of alginate coating on physicochemical and sensory qualities of button mushrooms (*Agaricus bisporus*) under a high oxygen modified atmosphere. *Postharvest Biology and Technology*. **76**: 91-97.
- Jiang, T., Feng, L. & Li, J. (2012). Changes in microbial and postharvest quality of shiitake mushroom (*Lentinus edodes*) treated with chitosan-glucose complex coating under cold storage. *Food Chemistry*. **131**: 780-786.
- Jiang, T., Feng, L. & Wang, Y. (2013a). Effect of alginate/nano-Ag coating on microbial and physicochemical characteristics of shiitake mushroom (*Lentinus edodes*) during cold storage. *Food Chemistry*. **141**: 954-960.
- Jiang, T., Feng, L., Zheng, X. & Li, J. (2013b). Physicochemical responses and microbial characteristics of shiitake mushroom (*Lentinus edodes*) to gum arabic coating enriched with natamycin during storage. *Food Chemistry*. **138**: 1992-1997.
- Jiang, T., Luo, S., Chen, Q., Shen, L. & Ying, T. (2010). Effect of integrated application of gamma irradiation and modified atmosphere packaging on physicochemical and microbiological properties of shiitake mushroom (*Lentinus edodes*). *Food Chemistry*. **122**: 761-767.
- Jiang, Y. & Li, Y. (2001). Effects of chitosan coating on postharvest life and quality of longan fruit. *Food Chemistry*. **73**: 139-143.
- Jiménez, M., Chazarra, S., Escribano, J., Cabanes, J. & García-Carmona, F. (2001). Competitive inhibition of mushroom tyrosinase by 4-substituted benzaldehydes. *Journal of Agricultural and Food Chemistry*. **49**: 4060-4063.
- Jiménez, M. & García-Carmona, F. (1997). 4-substituted resorcinols (sulfite alternatives) as slow-binding inhibitors of tyrosinase catecholase activity. *Journal of Agricultural and Food Chemistry*. **45**: 2061-2065.
- Jolivet, S., Arpin, N., Wichers, H.J. & Pellon, G. (1998). *Agaricus bisporus* browning: a review. *Mycological Research*. **102**: 1459-1483.
- Jukic, M. & Milos, M. (2005). Catalytic oxidation and antioxidant properties of thyme essential oils (*Thymus vulgaris* L.). *Croatica Chemica Acta*. **78**: 105-110.

- Kader, A.A., Zagory, D. & Kerbel, E.L. (1989). Modified atmosphere packaging of fruits and vegetables. *Critical Reviews in Food Science and Nutrition*. **28**: 1-30.
- Kalac, P. (2013). A review of chemical composition and nutritional value of wild-growing and cultivated mushrooms. *Journal of the Science of Food and Agriculture*. **93**: 209-218.
- Kalac, P. (2009). Chemical composition and nutritional value of European species of wild growing mushrooms: a review. *Food Chemistry*. **113**: 9-16.
- Kalac, P. (2010). Trace element contents in European species of wild growing edible mushrooms: a review for the period 2000–2009. *Food Chemistry*. **122**: 2-15.
- Kampf, N. & Nussinovitch, A. (2000). Hydrocolloid coating of cheeses. *Food Hydrocolloids*. **14**: 531-537.
- Karatzas, A.K., Kets, E.P.W., Smid, E.J. & Bennik, M.H.J. (2001). The combined action of carvacrol and high hydrostatic pressure on *Listeria monocytogenes* Scott A. *Journal of Applied Microbiology*. **90**: 463-469.
- Karbowiak, T., Debeaufort, F. & Voilley, A. (2006). Importance of surface tension characterization for food, pharmaceutical and packaging products: a review. *Critical Reviews in Food Science and Nutrition*. **46**: 391-407.
- Kester, J.J. & Fennema, O.R. (1986). Edible films and coatings: a review. *Journal of Food Technology*. **40**: 47-59.
- Khwaldia, K., Perez, C., Banon, S., Desobry, S. & Hardy, J. (2004). Milk proteins for edible films and coatings. *Critical Reviews in Food Science and Nutrition*. **44**: 239-251.
- Kim, J., Marshall, M.R. & Wei, C.-I. (1995). Antibacterial activity of some essential oil components against five food borne pathogens. *Journal of Agricultural and Food Chemistry*. **43**: 2839-2845.
- Kim, K.M., Ko, J.A., Lee, J.S., Park, H.J. & Hanna, M.A. (2006). Effect of modified atmosphere packaging on the shelf life of coated, whole and sliced mushrooms. *Lebensmittel-Wissenschaft Und-Technologie-Food Science and Technology*. **39**: 364-371.
- Kim, K.W. & Thomas, R.L. (2007). Antioxidative activity of chitosans with varying molecular weights. *Food Chemistry*. **101**: 308-313.
- Kim, Y., Hyun, S., Park, H.E. & Choi, H. (2012). Metabolic profiling, free-radical scavenging and tyrosinase inhibitory activities of *Lemna minor* whole plants cultivated in various concentrations of proline and sucrose. *Process Biochemistry*. **47**: 62-68.

- Kim, Y.-J. & Uyama, H. (2005). Tyrosinase inhibitors from natural and synthetic sources: structure, inhibition mechanism and perspective for the future. *Cellular and Molecular Life Sciences*. **62**: 1707-1723.
- Kittur, F.S., Saroja, N., Habibunnisa & Tharanathan, R.N. (2001). Polysaccharide-based composite coating formulations for shelf-life extension of fresh banana and mango. *European Food Research and Technology*. **213**: 306-311.
- Komanapalli, I.R. & Lau, B.H.S. (1996). Ozone-induced damage of *Escherichia coli* K-12. *Applied Microbiology and Biotechnology*. **46**: 610-614.
- Komthong, P., Igura, N. & Shimoda, M. (2007). Effect of ascorbic acid on the odours of cloudy apple juice. *Food Chemistry*. **100**: 1342-1349.
- Kong, Y.H., Jo, Y.O., Cho, C.-W., Son, D., Park, S. Rho, J. & Choi, S.Y. (2008). Inhibitory effects of cinnamic acid on melanin biosynthesis in skin. *Biological Pharmaceutical Bulletin*. **31**: 946-948.
- Krishnaiah, Y.S.R., Karthikeyan, R.S., Gouri Sankar, V. & Satyanarayana, V. (2002). Three layer guar gum matrix tablet formulations for oral controlled delivery of highly soluble trimetazidine dihydrochloride. *Journal of Controlled Release*. **81**: 45-56.
- Krochta, J.M. (2002). Proteins as raw materials for films and coatings: definitions, current status, and opportunities. In: Gennadios, A. (ed.). *Protein-based films and coatings*, CRC press, Boca Raton, Florida, USA. pp. 367.
- Krochta, J.M. & Mulder-Johnson, C. (1997). Edible and biodegradable polymer films: challenges and opportunities. *Journal of Food Technology*. **51**: 61-74.
- Kubo, I. & Kinoshita, I. (1998). Tyrosinase inhibitors from cumin. *Journal of Agricultural and Food Chemistry*. **46**: 5338-5341.
- Kukura, J.L., Beelman, R.B., Peiffer, M. & Walsh, R. (1998). Calcium chloride added to irrigation water of mushrooms (*Agaricus bisporus*) reduces postharvest browning. *Journal of Food Science*. **63**: 454-457.
- Kurita, K. (2006). Chitin and chitosan: functional biopolymers from marine crustaceans. *Marine Biotechnology*. **8**: 203-226.
- Kuyper, L., Weinert, I.A.G. & McGill, A.E.J. (1993). The effect of modified atmosphere packaging and addition of calcium hypochlorite on the atmosphere composition, colour and microbial quality of mushrooms. *Lebensmittel-Wissenschaft Und-Technologie-Food Science and Technology*. **26**: 14-20.
- Kwok, D.K. & Neumann, A.W. (1999). Contact angle measurement and contact angle interpretation. *Advances in Colloid and Interface Science*. **81**: 161-249.
- Kykkidou, S., Giatrakou, V., Papavergou, A., Kontominas, M.G. & Savvaidis, I.N. (2009). Effect of thyme essential oil and packaging treatments on fresh



- Mediterranean swordfish fillets during storage at 4 °C. *Food Chemistry*. **115**: 169-175.
- Labuza, T.P. & Breene, W.M. (1989). Applications of active packaging for improvement of shelf-life and nutritional quality of fresh and extended shelf-life foods. *Journal of Food Processing and Preservation Impact Factor*. **13**: 1-69.
- Lagnika, C., Zhang, M. & Mothibe, K.J. (2013). Effects of ultrasound and high pressure argon on physico-chemical properties of white mushrooms (*Agaricus bisporus*) during postharvest storage. *Postharvest Biology and Technology*. **82**: 87-94.
- Lambert, R.J.W., Skandamis, P.N., Coote, P. & Nychas, G.-J.E. (2001). A study of the minimum inhibitory concentration and mode of action of oregano essential oil, thymol and carvacrol. *Journal of Applied Microbiology*. **91**: 453-462.
- Lazarus, C.R., West, R.L., Oblinger, J.L. & Palmer, A.Z. (1976). Evaluation of a calcium alginate coating and a protective plastic wrapping for the control of lamb carcass shrinkage. *Journal of Food Science*. **41**: 639-641.
- Lee, J.S. (1999). Effects of modified atmosphere packaging on the quality of chitosan and CaCl<sub>2</sub> coated mushroom (*Agaricus bisporus*). *Korean Journal of Food Science and Technology*. **31**: 1308-1314.
- Lee, J.Y., Park, H.J., Lee, C.Y. & Choi, W.Y. (2003). Extending shelf-life of minimally processed apples with edible coatings and antibrowning agents. *Lebensmittel-Wissenschaft Und-Technologie-Food Science and Technology*. **36**: 323-329.
- Lee, S., Han, J.M., Kim, H., Kim, E., Jeong, T.S., Lee, W.S. & Cho, K.H. (2004). Synthesis of cinnamic acid derivatives and their inhibitory effects on LDL-oxidation, acyl-CoA: cholesterol acyltransferase-1 and-2 activity, and decrease of HDL-particle size. *Bioorganic and Medicinal Chemistry Letters*. **14**: 4677-4681.
- Lemay, M.J., Choquette, J., Delaquis, P.J., Gariépy, C., Rodrigue, N. & Saucier, L. (2002). Antimicrobial effect of natural preservatives in a cooked and acidified chicken meat model. *International Journal of Food Microbiology*. **78**: 217-226.
- Le Tien, C., Vachon, C., Mateescu, M.A. & Lacroix, M. (2001). Milk protein coatings prevent oxidative browning of apples and potatoes. *Journal of Food Science*. **66**: 512-516.
- Li, H. & Yu, T. (2000). Effect of chitosan on incidence of brown rot, quality and physiological attributes of postharvest peach fruit. *Journal of the Science of Food and Agriculture*. **81**: 269-274.
- Lima, A.M., Cerqueira, M.A., Souza, B.W.S., Santos, E.C.M., Teixeira, J.A., Moreira, R.A. & Vicente, A.A. (2010). New edible coatings composed of galactomannans

- and collagen blends to improve the postharvest quality of fruits – influence on fruits gas transfer rate. *Journal of Food Engineering*. **97**: 101-109.
- Lin, D. & Zhao, Y. (2007). Innovations in the development and application of edible coatings for fresh and minimally processed fruits and vegetables. *Comprehensive Review in Food Science and Food Safety*. **6**: 60-75.
- Lin, S.Y. & Krochta, J.M. (2005). Whey protein coating efficiency on surfactant modified hydrophobic surfaces. *Journal of Agricultural and Food Chemistry*. **53**: 5018-5023.
- Liu, J., Tian, S., Meng, X. & Xu, Y. (2007). Effects of chitosan on control of postharvest diseases and physiological responses of tomato fruit. *Postharvest Biology and Technology*. **44**: 300-306.
- Liu, J., Wu, Y.C., Kan, J., Wang, Y. & Jinet, C.H. (2013). Changes in reactive oxygen species production and antioxidant enzyme activity of *Agaricus bisporus* harvested at different stages of maturity. *Journal of the Science of Food and Agriculture*. **93**: 2201-2206.
- Liu, Z., Wang, X., Zhu, J. & Wang, J. (2010). Effect of high oxygen modified atmosphere on post-harvest physiology and sensorial qualities of mushroom. *International Journal of Food Science and Technology*. **45**: 1097-1103.
- Liu, Z. & Wang, X. (2012). Changes in color, antioxidant, and free radical scavenging enzyme activity of mushrooms under high oxygen modified atmospheres. *Postharvest Biology and Technology*. **69**: 1-6.
- Longvah, T. & Deosthale, Y.G (1998). Compositional and nutritional studies on edible wild mushroom from northeast India. *Food Chemistry*. **63**: 331-334.
- López-Malo, A., Palou, E. & Alzamora, S.M. (2005). Naturally occurring compounds - plant source. In: Davidson, M.P., Sofos, J.N. and Branen, A.L. (eds.) *Antimicrobials in Food*, CRC Press, Boca Raton, Florida, USA. pp. 429-451.
- Lu, F., Ding, Y., Ye, X. & Liu, D. (2010). Cinnamon and nisin in alginate-calcium coating maintain quality of fresh northern snakehead fish fillets. *Journal of Food Science and Technology*. **43**: 1331-1335.
- Lugones, L.G., Bosscher, J.S., Scholtmeyer, K., de Vries, O.M.H. & Wessels, J.G.H. (1996). An abundant hydrophobin (ABH1) forms hydrophobic rodlet layers in *Agaricus bisporus* fruiting bodies. *Microbiology*. **142**: 1321-1329.
- Lukasse, L.J.S. & Polderdijk, J.J. (2003). Predictive modelling of post-harvest quality evolution in perishables, applied to mushrooms. *Journal of Food Engineering*. **59**: 191-198.

- Mahajan, P.V., Oliveira, F.A.R. & Macedo, I. (2008). Effect of temperature and humidity on the transpiration rate of the whole mushrooms. *Journal of Food Engineering*. **84**: 281-288.
- Majeti, N.V. & Ravi, K. (2000). A review of chitin and chitosan applications. *Reactive and Functional Polymers*. **46**: 1-27.
- Mali, S., Grossmann, M.V.E., Garcia, M.A., Martino, M.N. & Zaritzky, N.E. (2006). Effects of controlled storage on thermal, mechanical and barrier properties of plasticized films from different starch sources. *Journal of Food Engineering*. **75**: 453-460.
- Mancini, F. & McHugh, T.H. (2000). Fruit-alginate interactions in novel restructured products. *Nahrung*. **44**: 152-157.
- Manzi, P., Aguzzi, A. & Pizzoferrato, L. (2001). Nutritional value of mushrooms widely consumed in Italy. *Food Chemistry*. **73**: 321-325.
- Manzi, P., Gambelli, L., Marconi, S., Vivanti, V. & Pizzoferrato, L. (1999). Nutrients in edible mushrooms: an inter-species comparative study. *Food Chemistry* **65**: 477-482.
- Martin-Belloso, O. & Llanos-Barriobero, E. (2001). Proximate composition, minerals and vitamins in selected canned vegetables. *European Food Research and Technology*. **212**: 182-187.
- Martinez, M.V. & Whitaker, J.R. (1995). The biochemistry and control of enzymatic browning. *Trends in Food Science and Technology*. **6**: 195-200.
- Martins, J.T., Cerqueira, M.A., Souza, B.W.S., Avides, M.C. & Vicente, A.A. (2010). Shelf life extension of ricotta cheese using coatings of galactomannans from nonconventional sources incorporating nisin against *Listeria monocytogenes*. *Journal of Agricultural and Food Chemistry*. **58**: 1884-1891.
- Masamoto, Y., Murata, Y., Baba, K., Shimoishi, Y., Tada, M. & Takahata, K. (2004). Inhibitory effect of esculetin on melanin biosynthesis. *Biological and Pharmaceutical Bulletin*. **27**: 422-425.
- Masson, Y., Ainsworth, P., Fuller, D., Bozkurt, H. & Ibanoglu, S. (2002). Growth of *Pseudomonas fluorescens* and *Candida sake* in homogenized mushrooms under modified atmosphere. *Journal of Food Engineer*. **54**: 125-131.
- Mathew, S. & Abraham, T.E. (2008). Characterisation of ferulic acid incorporated starch-chitosan blend films. *Food Hydrocolloids*. **22**: 826-835.
- Mattila, P., Konko, K., Eurola, M., Pihlava, J.M., Astola, J., Vahteristo, L., Hietaniemi, V., Kumpulainen, J., Valtonen, M. & Piironen, V. (2001). Contents of vitamins, mineral elements, and some phenolic compounds in cultivated mushrooms. *Journal of Agricultural and Food Chemistry*. **49**: 2343-2348.

- McClements, J.D. (1999). *Food Emulsions: principles, practices and techniques*. CRC Press, Boca Raton, Florida, USA.
- McConnell, A.L. (1991). *Evaluation of wash treatments for the improvement of quality and shelf life of fresh mushroom (*Agaricus bisporus*)*. MS thesis, Pennsylvania State University, University Park, Pennsylvania, USA.
- McDonald, K. & Sun, D.-W. (2000). Vacuum cooling technology for the food processing industry: a review. *Journal of Food Engineering*. **45**: 55-65.
- McHugh, T.H. & Senesi, E. (2000). Apple wraps: A novel method to improve the quality and extend the shelf life of fresh-cut apples. *Journal of Food Science*. **65**: 480-485.
- Mejlholm, O. & Dalgaard, P. (2002). Antimicrobial effect of essential oils on the seafood spoilage microorganism *Photobacterium phosphoreum* in liquid media and fish products. *Letters in Applied Microbiology*. **34**: 27-31.
- Meng, D.M., Song, T.Z., Shen, L., Zhang, X.H. & Sheng, J.P. (2012). Postharvest application of methyl jasmonate for improving quality retention of *Agaricus bisporus* fruit bodies. *Journal of Agricultural and Food Chemistry*. **60**: 6056-6062.
- Miklus, M.B. and Beelman, R.B. (1996). CaCl<sub>2</sub> treated irrigation water applied to mushroom crops (*Agaricus bisporus*) increases Ca concentration and improves postharvest quality and shelf life. *Mycologia*. **88**: 403-409.
- Min, S. & Krochta, J. (2005). Inhibition of *Penicillium commune* by edible whey protein films incorporating lactoferrin, lacto-ferrin hydrolysate, and lactoperoxidase systems. *Journal of Food Science*. **70**: 87-94.
- Minnaar, A., Taylor, J.R.N. & McGill, A.E.J. (1995). Heat-irradiation combination processing as an effective method of producing high quality shelf-stable, lowacid food products. *Food Control*. **6**: 165-170.
- Mohebbi, M., Ansarifard, E., Hasanpour, N. & Amiryousefiet, M.R. (2012). Suitability of *Aloe vera* and gum tragacanth as edible coatings for extending the shelf life of button mushroom. *Food and Bioprocess Technology*. **5**: 3193-3202.
- Mourey, A. & Canillac, N. (2002). Anti-*Listeria monocytogenes* activity of essential oils components of conifers. *Food Control*. **13**: 289-292.
- Muñoz, Z., Moret, A. & Garcés S. (2009). Assessment of chitosan for inhibition of *Colletotrichum* sp. on tomatoes and grapes. *Crop Protection*. **28**: 36-40.
- Murr, D.P. & Morris, L.L. (1975). Effect of storage atmosphere on post harvest growth of mushrooms. *Journal of American Society for Horticultural Science*. **100**: 298-301.

- NCCLS M2-A8 (2003). Performance standards for antimicrobial disk susceptibility tests. Approved standard - 8<sup>th</sup> Edition. NCCLS document M2-A8. National Committee for Clinical Laboratory Standards. Wayne, Pennsylvania, USA.
- Nelson, D.L. & Cox, M.M. (2008). Lehninger Principles of Biochemistry. 5<sup>th</sup> Edition Freeman W.H. and Company. San Francisco, USA.
- Nelson, L.N. & Cox, M.M. (2000) Lehninger Principles of Biochemistry. 3<sup>rd</sup> Edition, Worth Publishers, New York, USA.
- Nerya, O., Ben-Arie, R., Luzzatto, T., Musa, R., Khativ, S. & Vaya, J. (2006). Prevention of *Agaricus bisporus* postharvest browning with tyrosinase inhibitors. *Postharvest Biology and Technology*. **39**: 272-277.
- Neukom, H. (1989). Galactomannans: properties and applications. *Lebensmittel Wissenschaft und Technologie*, London, England. pp. 41-45.
- Nichols, R. & Hammond, J.B.W. (1973). Storage of mushrooms in prepacks: the effect of changes in CO<sub>2</sub> and O<sub>2</sub> on quality. *Journal of the Science of Food and Agriculture*. **24**: 1371-1381.
- Nisperos-Carriedo, M.O. (1994). Edible coatings and films based on polysaccharides. In: Krochta, J.M., Baldwin, E.A. and Nisperos-Carriedo, M.O. (eds.). *Edible coatings and films to improve food quality*, Technomic Publishing Company Inc.. Lancaster, USA. pp. 322-323.
- Nitschke, J., Altenbach, H.J., Malolepszy, T. & Mölleken, H. (2011). A new method for the quantification of chitin and chitosan in edible mushrooms. *Carbohydrate Research*. **346**: 1307-1310.
- Nussinovitch, A. & Kampf, N. (1993). Shelf-life extension and conserved texture of alginate-coated mushrooms (*Agaricus bisporus*). *Lebensmittel-Wissenschaft Und-Technologie-Food Science and Technology*. **26**: 469-475.
- Ojagh, S.M., Rezaei, M., Razavi, S.H. & Hosseini, M.H. (2010a). Effect of chitosan coatings enriched with cinnamon oil on the quality of refrigerated rainbow trout. *Food Chemistry*. **120**: 193-198.
- Ojagh, S.M., Rezaei, M., Razavi, S.H. & Hosseini, S.M.H. (2010b). Development and essential oil evaluation of a novel biodegradable film made chitosan and cinnamon with low affinity toward water. *Food Chemistry*. **122**: 161-166.
- Olivas, G.I. & Barbosa-Cánovas, G.V. (2004). Alginate-calcium films: Water vapor permeability and mechanical properties as affected by plastizicer and relative humidity. *IFT Annual Meeting Technical Program Abstracts* 83C-10.
- Olivas, G.I. & Barbosa-Cánovas, G.V. (2005). Edible coatings for fresh-cut fruits. *Critical Reviews in Food Science and Nutrition*. **45**: 657-670.

- Olivas, G.I., Mattinson, D.S. & Barbosa-Cánovas, G.V. (2007). Alginate coatings for preservation of minimally processed 'Gala' apples. *Postharvest Biology and Technology*. **45**: 89-96.
- Oliver, X. (1992). Tratamiento de ozonización para la eliminación de *Pseudomonas aeruginosa* en las líneas de envasado de una embotelladora de agua mineral natural. *Alimentación Equipos y Tecnología Diciembre*. 133-137.
- Omidbeygi, M., Barzegar, M., Hamidi, Z. & Naghdibadi, H. (2007). Antifungal activity of thyme, summer savory and clove essential oils against *Aspergillus flavus* in liquid medium and tomato paste. *Food Control*. **18**: 1518-1523.
- Oms-Oliu, G., Aguilo-Aguayo, I., Martín-Belloso, O. & Soliva-Fortuny, R. (2010). Effects of pulsed light treatments on quality and antioxidant properties of fresh-cut mushrooms (*Agaricus bisporus*). *Postharvest Biology and Technology*. **56**: 216-222.
- Oms-Oliu, G., Soliva-Fortuny, R. & Martín-Belloso, O. (2008). Edible coatings with antibrowning agents to maintain sensory quality and antioxidant properties of fresh-cut pears. *Postharvest Biology and Technology*. **50**: 87-94.
- Ouattara, B., Simard, R.E., Piette, G., Bégin A. & Holley, R.A. (2000). Diffusion of acetic and propionic acids from chitosan-based antimicrobial packaging films. *Journal of Food Science*. **65**: 768-773.
- Owens, D.K. & Wendt, R.C. (1969). Estimation of the surface free energy of polymers. *Journal of Applied Polymer Science*. **13**: 1741-1747.
- Owolarafe, O.K., Olabige, T.M. & Faborode, M.O. (2007). Macrostructural characterization of palm fruit at different processing conditions. *Journal of Food Engineering*. **79**: 31-36.
- Pai, T. (2000). Effects of storage environmental conditions on weight loss whiteness change and microbial activity of mushrooms (*Agaricus bisporus*). *Agricultural Chemistry and Biotechnology*. **43**: 161-164.
- Palou, E., López-Malo, A., Barbosa-Cánovas, G.V., Welti-Chanes, J. & Swanson, G.B. (1999). Polyphenoloxidase activity and colour of blanched and high hydrostatic pressure treated banana puree. *Journal of Food Science*. **64**: 42-45.
- Gas and water vapor barrier properties of edible films from protein and cellulosic materials. *Journal of Food Engineering*. **25**: 497-507.
- Park, H.J. (1999). Development of advanced edible coatings for fruits. *Trends in Food Science and Technology*. **10**: 254-260.
- Park, H.J., Bunn, J.M., Vergano, P.J. & Testin, R.F. (1994). Gas permeation and thickness of the sucrose polyesters, semperfresh coatings on apples. *Journal of Food Processing and Preservation*. **18**: 349-358.

- Park, S., Stan, S., Daeschel, M. & Zhao, Y. (2005). Antifungal coating on fresh strawberries (*Fragaria x ananassa*) to control mold growth during cold storage. *Journal of Food Science*. **70**: 202-207.
- Park, S.Y., Marsh, K.S. & Rhim, J.W. (2002). Characteristics of different molecular weight chitosan films affected by the type of organic solvents. *Journal of Food Science*. **67**: 104-197.
- Parvez, S., Kang, M., Chung, H.S. & Bae, H. (2007). Naturally occurring tyrosinase inhibitors: mechanism and applications in skin health, cosmetics and agriculture industries. *Phytotherapy Research*. **21**: 805-816.
- Paster, N., Juven, B.J., Shaaya, E., Menasherov, M., Nitzan, R. & Weisslowiez, H. (1990). Inhibitory effect of oregano and thyme essential oils on moulds and foodborne bacteria. *Letters in Applied Microbiology*. **11**: 33-37.
- Paull, R. (1999). Effect of temperature and relative humidity on fresh commodity quality. *Postharvest Biology and Technology*. **15**: 263-277.
- Pei, F., Shi, Y., Gao, X., Wu, F., Mugambi, M.A., Yang, W., Zhao, L., An, X., Xin, Z., Yang, F. & Hua, Q. (2014). Changes in non-volatile taste components of button mushroom (*Agaricus bisporus*) during different stages of freeze drying and freeze drying combined with microwave vacuum drying. *Food Chemistry*. **165**: 547-554.
- Peniston, Q.P. & Johnson, E. (1980). Process for the manufacture of chitosan. US Patent 4,195,175, 5.
- Peretto, G., Du, W.-X., Avena-Bustillos, R.J., Sarreal, S.B.L., Hua, S.S.T., Sambo, P. & McHugh, T.H. (2014). Increasing strawberry shelf-life with carvacrol and methyl cinnamate antimicrobial vapors released from edible coatings. *Postharvest Biology and Technology*. **89**: 11-18
- Periago, P.M. & Moezelaar, R. (2001). Combined effect of nisin and carvacrol, at different pH and temperature levels on the viability of different strains of *Bacillus cereus*. *International Journal of Food Microbiology*. **68**: 141-148.
- Philippoussis, A., Diamantopoulou, P. & Zervakis, G. (2001). Calcium chloride irrigation influence on yield, calcium content, quality and shelf-life of the white mushroom *Agaricus bisporus*. *Journal of the Science of Food and Agriculture*. **81**: 1447-1454.
- Pol, I.E. & Smid, E.J. (1999). Combined action of nisin and carvacrol on *Bacillus cereus* and *Listeria monocytogenes*. *Letters in Applied Microbiology*. **29**: 166-170.
- Ponce, A., Roura, S., del Valle, C. & Moreira, M. (2008). Antimicrobial and antioxidant activities of edible coatings enriched with natural plant extracts: In vitro and in vivo studies. *Postharvest Biology and Technology*. **49**: 294-300.

- Porta, R., Mariniello, L., Di Pierro, P., Sorrentino, A. & Giosafatto, C.V.L. (2011). Transglutaminase crosslinked pectin and chitosan-based edible films: a review. *Critical Reviews in Food Science and Nutrition*. **51**: 228-238.
- Pranoto, Y., Rakshit, S.K. & Salokhe, V.M. (2005). Enhancing antimicrobial activity of chitosan films by incorporating garlic oil, potassium sorbate and nisin. *Lebensmittel-Wissenschaft Und-Technologie-Food Science and Technology*. **38**: 859-865.
- Pranoto, Y., Salokhe, V.M. & Rakshit, S.K. (2005). Physical and antibacterial properties of alginate-based edible films incorporated with garlic oil. *Food Research International*. **38**: 267-272.
- Qi, S.C. (1982). The application of mechanical refrigeration to cave storage of fruit. *International Journal of Refrigeration*. **5**: 235-237.
- Rabea, E.I., Badawy, M.E., Stevens, C.V., Smagghe, G. & Steurbaut, W. (2003). Chitosan as antimicrobial agent: applications and mode of action. *Biomacromolecules*. **4**: 1457-1465
- Rai, D.R. & Paul, S. (2007). Transient state in-pack respiration rates of mushroom under modified atmosphere packaging based on enzyme kinetics. *Biosystems Engineering*. **98**: 319-326.
- Raincy, P.B., Brodey, C.L. & Johnstone, K. (1992). Biology of *Pseudomonas tolaasii*, cause of brown blotch disease of the cultivated mushrooms. In: Andrews, J.H. and Tommerup, I. (eds.). *Advances in Plant Pathology*, Academic Press, New York, USA. pp. 95-117.
- Ramos, O.L., Fernandes, J.C., Silva, S.I., Pintado, M.E. & Malcata, F.X. (2012). Edible films and coatings from whey proteins: a review on formulation, and on mechanical and bioactive properties. *Critical Reviews in Food Science and Nutrition*. **52**: 533-552.
- Rasooli, I., Bagher Rezaei, M. & Allameh, A. (2006) Growth inhibition and morphological alterations of *Aspergillus niger* by essential oils from *Thymus eriocalyx* and *Thymus x-porlock*. *Food Control*. **17**: 359-364.
- Ratledge, C. & Wilkinson, S.G. (1988). An overview of microbial lipids. In: Ratledge, C. and Wilkinson, S.G. (eds.). *Microbial Lipids*, Academic Press, London, England. pp. 3-22.
- Raybaudi-Massilia, R.M., Mosqueda-Melgar, J. & Martín-Belloso, O. (2008). Edible alginate-based coating as carrier of antimicrobials to improve shelf-life and safety of fresh-cut melon. *International Journal of Food Microbiology*. **121**: 313-327.



- Raybaudi-Massilia, R.M., Rojas-Graü, M.A., Mosqueda-Melgar, J. & Martín-Belloso, O. (2008). Comparative study on essential oils incorporated into an alginate-based edible coating to assure the safety and quality of fresh-cut Fuji apples. *Journal of Food Protection*. **71**: 1150-1161.
- Reddy, M.V.B., Angers, P., Castaigne, F. & Arul, J. (2000). Chitosan effects on blackmold rot and pathogenic factors produced by *Alternaria alternata* in postharvest tomatoes. *Journal of American Society for Horticultural Science*. **125**: 742-747.
- Reis, F.S., Barros, L., Martins, A. & Ferreira, I.C.F.R. (2012). Chemical composition and nutritional value of the most widely appreciated cultivated mushrooms: an inter-species comparative study. *Food and Chemical Toxicology*. **50**: 191-197.
- Rhim, J.W. (2004). Physical and mechanical properties of water resistant sodium alginate films. *Lebensmittel-Wissenschaft Und-Technologie-Food Science and Technology*. **3**: 323-330.
- Ribeiro, B., Lopes, R., Andrade, P.B., Seabra, R.M., Goncalves, R.F., Baptista, P. & Quelhas, I., Valentao, P. (2008). Comparative study of phytochemicals and antioxidant potential of wild edible mushroom caps and stipes. *Food Chemistry*. **110**: 47-56.
- Ribeiro, C., Vicente, A.A., Teixeira, J.A. & Miranda, C. (2007). Optimization of edible coating composition to retard strawberry fruit senescence. *Postharvest Biology and Technology*. **44**: 63-70.
- Rindlav-Westling, A., Stading, M., Hermanson, A.M. & Gatenholm, P. (1998). Structure, mechanical and barrier properties of amylose and amylopectin films. *Carbohydrate Polymers*. **36**: 217-224.
- Rojas-Graü, M.A., Avena-Bustillos, R.J., Olsen, C.O., Friedman, M.F., Martín-Belloso, O., Pan, Z. & McHugh, T.H. (2007). Effects of plant essential oils and oil compounds on mechanical, barrier and antimicrobial properties of alginate-apple puree edible films. *Journal of Food Engineering*. **81**: 634-641.
- Rojas-Graü, M.A., Soliva-Fortuny, R. & Martín-Belloso, O. (2009). Edible coatings to incorporate active ingredients to fresh-cut fruit: a review. *Trends in Food Science and Technology*. **20**: 438-447.
- Rojas-Graü, M.A., Raybaudi-Massilia, R.M., Soliva-Fortuny, R.C., Avena-Bustillos, R.J., McHugh, T.H. & Martín-Belloso, O. (2007). Apple puree-alginate edible coating as carrier of antimicrobial agents to prolong shelf-life of fresh-cut apples. *Postharvest Biology and Technology*. **45**: 254-264.

- Rojas-Graü, M.A., Tapia, M.S., Rodríguez, F.J., Carmona, A.J. & Martín-Belloso, O. (2007). Alginate and gellan based edible coatings as support of antibrowning agents applied on fresh-cut Fuji apple. *Food Hydrocolloids*. **21**: 118-127.
- Roller, S. & Sheedhar, P. (2002). Carvacrol and cinnamic acid inhibit microbial growth in fresh cut melon and kiwifruit at 4 °C and 8 °C. *Letters in Applied Microbiology*. **35**: 390-394.
- Romanazzi, G., Nigro, F., Ippolito, A., Di Venere, D. & Salerno, M. (2002). Effects of pre- and postharvest chitosan treatments to control storage grey mold of table grapes. *Journal of Food Science*. **67**: 1862-1867.
- Roupas, P., Keogh, J., Noakes, M., Margetts, C. & Taylor, P. (2010). Mushrooms and agaritine: a mini-review. *Journal of Functional Foods*. **2**: 91-98.
- Roy, S., Anantheswaran, R.C. & Beelman, R.B. (1995a). Fresh mushroom quality as affected by modified atmosphere packaging. *Journal of Food Science*. **60**: 334-340.
- Roy, S., Anantheswaran, R.C. & Beelman, R.B. (1995b). Effect of moisture absorber on shelf-life of mushrooms (*Agaricus bisporus*) stored at 12 °C in conventional packages. *Journal of Food Science*. **60**: 1254-1259.
- Roy, S., Anantheswaran, R.C. & Beelman, R.B. (1996). Modified atmosphere and modified humidity packaging of fresh mushrooms. *Journal of Food Science*. **61**: 391-397.
- Rühl, M., Fisher, C.H. & Kües, U. (2008). Ligninolytic enzyme activities alternate with mushrooms production during industrial cultivation of *Pleurotus ostreatus* on wheat-straw based substrate. *Current Trends Biotechnology and Pharmatology*. **4**: 478-492.
- Rulon, J. & Robert, H. (1993). Wetting of low-energy surface. In: John, B. (ed.). *Wettability*, Dekker, New York, USA, 1993. pp. 4-77.
- Sánchez, C. (2004). Modern aspects of mushrooms culture technology. *Applied Microbiology and Biotechnology*. **64**: 756-762
- Sánchez, C. (2010). Cultivation of *Pleurotus ostreatus* and other edible mushrooms. *Applied Microbiology and Biotechnology*. **85**: 1321-1337.
- Sánchez-Ferrer, A., Rodríguez-López, J.N., García-Cánovas, F. & García-Carmona, F. (1995). Tyrosinase: a comprehensive review of its mechanism. *Biochimica Biophysica Acta*. **1247**: 1–11.
- Sánchez-González, L., Cháfer, M., Chiralt, A. & González-Martínez, C. (2010). Physical properties of edible chitosan films containing bergamot essential oil and their inhibitory action on *Penicillium italicum*. *Carbohydrate Polymers*. **82**: 277-283.

- Sánchez-González, L., González-Martínez, C., Chiralt, A. & Cháfer, M. (2010). Physical and antimicrobial properties of chitosan-tea tree essential oil composite films. *Journal of Food Engineering*. **98**: 443-452.
- Sánchez-González, L., Vargas, M., González-Martínez, C., Chiralt, M. & Cháfer, A. (2011). Use of essential oils in bioactive edible coatings. *Food Engineering Reviews*. **3**: 1-16
- Sangsuwan, J., Rattanapanone, N. & Rachtanapun, P. (2008). Effect of chitosan/methyl cellulose films on microbial and quality characteristics of fresh-cut cantaloupe and pineapple. *Postharvest Biology and Technology*. **49**: 403-410.
- Sapers, G.M., Miller, R.L., Miller, F.C., Cooke, P.H. & Choi, S.W. (1994). Enzymatic browning control in minimally processed mushrooms. *Journal of Food Science*. **59**: 1042-1047.
- Sapers, G.M., Miller, R.L. & Choi, S.W. (1995). Mushroom discoloration: new processes for improving shelf life and appearance. *Mushroom News*. **43**: 7-13.
- Sapers, G.M., Miller, R.L., Choi, S.W. & Cooke, P.H. (1999). Structure and composition of mushrooms as affected by hydrogen peroxide wash. *Journal of Food Science*. **64**: 889-892.
- Sapers, G.M., Miller, R.L., Pilizota, V. & Kamp, F. (2001). Shelf life extension of fresh mushrooms (*Agaricus bisporus*) by application of hydrogen peroxide and browning inhibitors. *Journal of Food Science*. **66**: 362-366.
- Sapers, G.M. & Simmons, G.F. (1998). Hydrogen peroxide disinfections of minimally processed fruits and vegetables. *Journal of Food Technology*. **52**: 48-52.
- Satooka, H. & Kubo, I. (2011). Effects of thymol on mushroom tyrosinase-catalyzed melanin formation. *Journal of Agricultural and Food Chemistry*. **59**: 8908-8914.
- Schurink, M., vanBerkel, W.J.H., Wichers, H.J. & Boeriu, C.G. (2007). Novel peptides with tyrosinase inhibitory activity. *Peptides*. **28**: 485-495.
- Sedaghat, N. & Zahedi, Y. (2012). Application of edible coating and acidic washing for extending the storage life of mushrooms (*Agaricus bisporus*). *Food Science and Technology International*. **18**: 523-530.
- Seo, S.Y., Sharma, V.K. & Sharma, N. (2003). Mushroom tyrosinase: recent prospects. *Journal of Agricultural and Food Chemistry*. **51**: 2837-2853.
- Shaidi, F., Arachchi, J.K.V. & Jeon, Y.J. (1999). Food applications of chitin and chitosan. *Trends in Food Science and Technology*. **10**: 37-51.
- Shi, Y., Chen, Q.-X., Wang, Q., Song, K.-K. & Ling, Q. (2005). Inhibitory effects of cinnamic acid and its derivatives on the diphenolase activity of mushroom (*Agaricus bisporus*) tyrosinase. *Food Chemistry*. **92**: 707-712.

- Shimizu, K., Kondo, R., Sakai, K., Takeda, N., Nagahata, T. & Oniki, T. (2001). Novel vitamin E derivative with 4-substituted resorcinol moiety has both antioxidant and tyrosinase inhibitory properties. *Lipids*. **36**: 1321-1326.
- Sikkema, J., Debont, J.A.M. & Poolman, B. (1995). Mechanisms of membrane toxicity of hydrocarbons. *Microbiological Reviews*. **59**: 201-222.
- Simón, A., González-Fandos, E. & Tobar, V. (2005). The sensory and microbiological quality of fresh sliced mushroom (*Agaricus bisporus* L.) packaged in modified atmospheres. *International Journal of Food Science and Technology*. **40**: 943-952.
- Simón, A. & González-Fandos, E. (2006). Efecto del lavado con hipoclorito sódico sobre la calidad sensorial y microbiana del champiñón fresco. In: Valero, D., Serrano, M. (eds.). *Innovaciones fisiológicas y tecnológicas de la maduración y post-recolección de frutas y hortalizas. VIII Simposio Nacional y V Ibérico de Maduración y Postrecolección*, Orihuela, Spain. pp. 205-208.
- Singh, P., Langowski, H.-C., Wani, A.A. & Saengerlaub, S. (2010). Recent advances in extending the shelf life of fresh *Agaricus* mushrooms: a review. *Journal of the Science of Food and Agriculture*. **90**: 1393-1402.
- Singh, A., Singh, R.K., Bhunia, A.K. & Singh, N. (2003). Efficacy of plant essential oils as antimicrobial agents against *Listeria monocytogenes* in hotdogs. *Lebensmittel-Wissenschaft Und-Technologie-Food Science and Technology*. **36**: 787-794.
- Skandamis, P.N. & Nychas, G.J.E. (2000). Development and evaluation of a model predicting the survival of *Escherichia coli* O157:H7 NCTC 12900 in homemade eggplant salad at various temperatures, pHs and oregano essential oil concentrations. *Applied and Environmental Microbiology*. **66**: 1646-1653.
- Skandamis, P.N. & Nychas, G.J.E. (2001). Effect of oregano essential oil on microbiological and physico-chemical attributes of minced meat stored in air and modified atmospheres. *Journal of Applied Microbiology*. **91**: 1011-1022.
- Smid, E.J. & Gorris, L.G.M. (1999). Natural antimicrobials for food preservation. In: Rahman, M.S. (ed.). *Handbook of Food Preservation*, Marcel Dekker, New York, USA. pp. 285-308.
- Soler-Rivas, C., Arpin, N., Olivier, J.M. & Wichers, H.J. (1997). Activation of tyrosinase in *Agaricus bisporus* strains following infection by *Pseudomonas tolaasii* or treatment with a tolaasin-containing preparation. *Mycological Research*. **101**: 375-382.

- Soler-Rivas, C., Jolivet, S., Arpin, N., Olivier, J. M., & Wichers, H. J. (1999). Biochemical and physiological aspects of brown blotch disease of *Agaricus bisporus*. *FEMS Microbiology Reviews*. **23**: 591-614.
- Solomakos, N., Govaris, A., Koidis, P. & Botsoglou, N. (2008). The antimicrobial effect of thyme essential oil, nisin, and their combination against *Listeria monocytogenes* in minced beef during refrigerated storage. *Food Microbiology*. **25**: 120-127.
- Solomon, J.M., Beelman, R.B., & Bartley, C.E. (1991). Addition of CaCl<sub>2</sub> and stabilized chlorine dioxide to irrigation water to improve quality and shelf life of *Agaricus bisporus*. *Mushroom Science*. **13**: 695-701.
- Sothornvit, R. & Krochta, J.M. (2000). Plasticizer effect on oxygen permeability of  $\beta$ -lactoglobulin films. *Journal of Agricultural and Food Chemistry*. **48**: 6298-6302.
- Sothornvit, R. & Krochta J.M. (2001). Plasticizer effect on mechanical properties of  $\beta$ -lactoglobulin films. *Journal of Food Engineering*. **50**: 149-155.
- Souza, B.W.S., Cerqueira, M.A., Ruiz, H.A., Martins, J.T., Casariego, A., Teixeira, J.A. & Vicente, A.A. (2010). Effect of chitosan-based coatings on the shelf life of salmon (*Salmo salar*). *Journal of Agricultural and Food Chemistry*. **58**: 11456-11462.
- Srivastava, M. & Kapoor, V.P. (2005). Seed galactomannans: an overview. *Chemistry and Biodiversity*. **2**: 295-317.
- Su, X.G., Zheng, Y.H., Zhang, L., Wang, F. & Zhang, Y.M. (2001). Effects of chitosan coating on postharvest quality and decay of vegetable soybean pods. *Acta Phytobiologica Sinica*. **27**: 467-472.
- Sveine, E., Klougart, A. & Rasmussen, C.R. (1967). Ways of prolonging the shelf-life of fresh mushrooms. *Mushroom Science*. **6**: 463-474.
- Taghizadeh, M., Gowen, A.A. & O'Donnell, C.P. (2011). The potential of visible-near infrared hyperspectral imaging to discriminate between casing soil, enzymatic browning and undamaged tissue on mushroom (*Agaricus bisporus*) surfaces. *Computers and Electronics in Agriculture*. **77**: 74-80.
- Tao, F., Zhang, M., Hangqing, Y. & Jincal, S. (2006). Effects of different storage conditions on chemical and physical properties of white mushrooms after vacuum cooling. *Journal of Food Engineering*. **77**: 545-549.
- Tharanathan, R.N. (2003). Biodegradable films and composite coatings: past, present and future. *Trends in Food Science and Technology*. **14**: 71-78.
- Thompson, A. K. (2003). Postharvest treatments. In fruit and vegetables. Blackwell Publishing Ltd., Ames, Iowa, USA. pp. 47-52.

- Thoroski, J., Blank, G. & Biliaderis, C. (1989). Eugenol induced inhibition of extracellular enzyme production by *Bacillus cereus*. *Journal of Food Protection*. **52**: 399-403.
- Tripathi, S., Mehrotra, G.K. & Dutta, P.K. (2010). Preparation and physicochemical evaluation of chitosan/poly(vinyl alcohol)/pectin ternary film for food-packaging applications. *Carbohydrate Polymers*. **79**: 711-716.
- Ultee, A., Bennik, M.H.J. & Moezelaar, R. (2002). The phenolic hydroxyl group of carvacrol is essential for action against the food borne pathogen *Bacillus cereus*. *Applied and Environmental Microbiology*. **68**: 1561-1568.
- Ultee, A., Kets, E.P.W., Alberda, M., Hoekstra, F.A. & Smid, E.J. (2000). Adaptation of the food-borne pathogen *Bacillus cereus* to carvacrol. *Archives of Microbiology*. **174**: 233-238.
- Umar, M.H. & Van Griensven, L. (1997). Morphological studies on the life span, developmental stages, senescence and death of fruit bodies of *Agaricus bisporus*. *Mycological Research*. **101**: 1409-1422.
- USFDA (2001). Microbiological safety of controlled and modified atmosphere packaging of fresh and fresh-cut produce. Analysis and evaluation of preventive control measures for the control and reduction/elimination of microbial hazards on fresh and fresh-cut produce.
- Vaara, M. (1992). Agents that increase the permeability of the outer membrane. *Microbiological Reviews*. **56**: 395-411.
- Valencia-Chamorro, S.A., Palou, L., Del Río, M.A. & Pérez-Gago, M.B. (2011). Antimicrobial edible films and coatings for fresh and minimally processed fruits and vegetables: a review. *Critical Reviews in Food Science and Nutrition*. **51**: 872-900.
- Vamos-Vigyazo, L. (1981). Polyphenol oxidase and peroxidase in fruits and vegetables. *Critical Reviews in Food Science and Nutrition*. **15**: 49-127.
- Van de Braak, S.A.A.J. & Leijten, G.C.J.J. (1999). Essential oils and oleoresins: a survey in the Netherlands and other major markets in the European Union. *CBI, Centre for the Promotion of Imports from Developing Countries*, Rotterdam, Holland. pp. 116.
- Van Griensven, J.J.L.D. & Van Roestel, A.J.J (2004). The cultivation of the button mushroom, *Agaricus bisporus*, in the Netherlands: a successful industry. *Revista mexicana de micología*. **19**: 95-102.
- Vargas, M., Albors, A., Chiralt, A. & González-Martínez, C. (2006). Quality of cold-stored strawberries as affected by chitosan-oleic acid edible coatings. *Postharvest Biology and Technology*. **41**: 164-172.

- Vargas, M., Pastor, C., Chiralt, A., McClements, D.J. & González-Martínez, C. (2008). Recent advances in edible coatings for fresh and minimally processed fruits. *Critical Reviews in Food Science and Nutrition*. **48**: 496-511.
- Varoquaux, P., Gouble, B., Barron, C. & Yildiz, F. (1999). Respiratory parameters and sugar metabolism of mushroom (*Agaricus bisporus*). *Postharvest Biology and Technology*. **16**: 51-61.
- Varshosaz, J., Tavakoli, N., & Eram, S. A. (2006). Use of natural gums and cellulose derivatives in production of sustained release metoprolol tablets. *Drug Delivery*. **13**: 113-119.
- Vetter, J. (2003). Chemical composition of fresh and conserved *Agaricus bisporus* mushroom. *European Food Research and Technology*. **217**: 10-12.
- Vieira, I.G.P.V., Mendes, F.N.P., Gallão, M.I. & de Brito, E.S. (2007). NMR study of galactomannans from the seeds of mesquite tree (*Prosopis juliflora* (Sw) DC). *Food Chemistry*. **101**: 70-73.
- Viuda-Martos, M., Ruiz-Navajas, Y., Fernández-López, J. & Pérez-Álvarez, J.A. (2010). Effect of added citrus fibre and spice essential oils on quality characteristics and shelf-life of mortadella. *Meat Science*. **85**: 568-576.
- Vogler, E.A. (1998). Structure and reactivity of water at biomaterial surfaces. *Advances in Colloid and Interface Science*. **74**: 69-117.
- Vrinda Menon, K. & Garg, S.R. (2001). Inhibitory effect of clove oil on *Listeria monocytogenes* in meat and cheese. *Food Microbiology*. **18**: 647-650.
- Walker, J.R.L. (1977). Enzymatic browning in foods, its chemistry and control. *Food Technology New Zealand*. **12**: 19-25.
- Wang, D., Sakoda, A. & Suzuku, M. (2001). Biological efficiency and nutritional value of *Pleurotus ostreatus* cultivated on spent beer grain. *Bioresource Technology*. **78**: 293-300.
- Watanabe, T., Tsuchihashi, N., Takai, Y., Tanaka, K. & Suzuki, A. (1994). Effects of ozone exposure during cultivation of oyster mushroom (*Pleurotus ostreatus*) on chemical components of the fruit bodies. *Journal of the Japanese Society for Food Science and Technology*. **41**: 705-708.
- Watanabe, T., Takai, Y., Tanaka, K. & Suzuki, A. (1994). Effects of ozone exposure during cultivation of nameko mushroom (*Pholiota nameko*) on fatty acid composition of the fruit bodies. *Journal of the Japanese Society for Food Science and Technology*. **41**: 709-714.
- Weijn, A., Tomassen, M.M.M., Bastiaan-Net, S., Wigham, M.L.I., Boer, E.P.J., Hendrix, E.A.H.J., Baars, J.J.P., Sonnenberg, A.S.M., Wichers, H.J. & Mes, J.J. (2012). A new method to apply and quantify bruising sensitivity of button mushrooms.

- Lebensmittel-Wissenschaft Und-Technologie-Food Science and Technology*. **47**: 308-314.
- Wenqiang, G., Shufen, L., Ruixiang, Y., Shaokun, T. & Can, Q. (2007). Comparison of essential oils of clove buds extracted with supercritical carbon dioxide and other three traditional extraction methods. *Food Chemistry*. **101**: 1558-1564.
- Williams, S.K., Oblinger, J.L. & West, R.L. (1978). Evaluation of a calcium alginate film for use on beef cuts. *Journal of Food Science*. **43**: 292-296.
- Win, N.K.K., Jitareerat, P., Kanlayanarat, S. & Sangchote, S. (2007). Effects of cinnamon extract, chitosan coating, hot water treatment and their combinations on crown rot disease and quality of banana fruit. *Postharvest Biology and Technology*. **45**: 333-340.
- Wong, D., Tillin, S.J., Hudson, J.S. & Pavlath, A.E. (1994). Gas exchange in cut apples with bilayer coatings. *Journal of Agricultural and Food Chemistry*. **42**: 2278-2285.
- Wong, W.C., Fletcher, J.T., Unsworth, B.A. & Preece, T.F. (1982). A note on ginger blotch, a new bacterial disease of the cultivated mushrooms, *Agaricus bisporus*. *Journal of Applied Bacteriology*. **52**: 43-48.
- Wong, W.C. & Preece, T.F. (1985). *Pseudomonas tolaasii* in cultivated mushroom (*Agaricus bisporus*) crops: effects of sodium hypochlorite on the bacterium and on blotch disease severity. *Journal of Applied Bacteriology*. **58**: 259-267.
- Wu, T., Zivanovic, S., Draughon, F.A., Conway, W.S. & Sams, C.E. (2005). Physicochemical properties and bioactivity of fungal chitin and chitosan. *Journal of Agricultural and Food Chemistry*. **53**: 3888-3894.
- Xu, W.T., Huang, K.L., Guo, F., Qu, W., Yang, J.J., Liang, Z.H. & Luo, Y.B. (2007). Postharvest grapefruit seed extract and chitosan treatments of table grapes to control *Botrytis cinerea*. *Postharvest Biology and Technology*. **46**: 86-94.
- Yaman, O. & Bayoindirli, L. (2002). Effects of an edible coating and cold storage on shelf-life and quality of cherries. *Lebensmittel-Wissenschaft Und-Technologie-Food Science and Technology*. **35**: 146-150.
- Yang, J.-H., Lin, H.-C. & Mau, J.L. (2001). Non-volatile taste components of several commercial mushrooms. *Food Chemistry*. **72**: 465-471.
- Yanishlieva, N.V., Marinova, E.M., Gordon, M.H. & Raneva, V.G. (1999). Antioxidant activity and mechanism of action of thymol and carvacrol in two lipid systems. *Food Chemistry*. **64**: 59-66.
- Yi, J.-Z. & Zhang, L.-M. (2007). Biodegradable blend films based on two polysaccharide derivatives and their use as Ibuprofen-releasing matrices. *Journal of Applied Polymer Science*. **103**: 3553-3559.



- Zahedi, Y., Ghanbarzadeh, B. & Sedaghat, N. (2010). Physical properties of edible emulsified films based on pistachio globulin protein and fatty acids. *Journal of Food Engineering*. **100**: 102-108.
- Zawistowski, J., Biliaderis, C.G. & Eskin, N.A.M. (1991). Polyphenol oxidases. In: Robinson, D.S. & Eskin, N.A.M. (eds.). *Oxidative enzymes in foods*, Elsevier, London, England. pp. 217-273.
- Zhu, J., Wang, X. & Xu, Y. (2006). Effects of the postharvest storage temperature and its fluctuations on the keeping quality of *Agaricus bisporus*. *International Journal of Food Engineering*. **2**: 1-10.
- Zisman, W.A. (1964). Contact angle, wettability and adhesion. *Advances in Chemistry Series*. American Chemical Society, Washington, DC, 1. Vol. 43. pp. 1-51.
- Zivanovic, S., Chi, S. & Draughon, F. (2005). Antimicrobial activity of chitosan films enriched with essential oils. *Journal of Food Science*. **70**: 45-51.

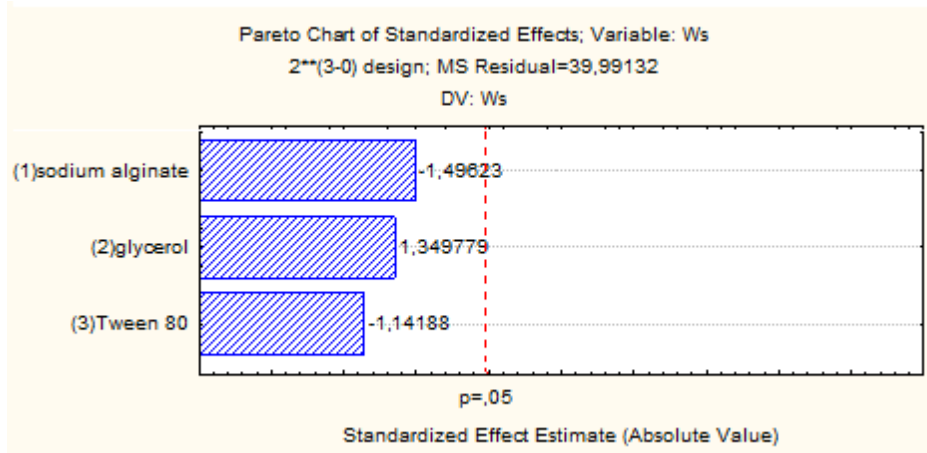
---

## Annex

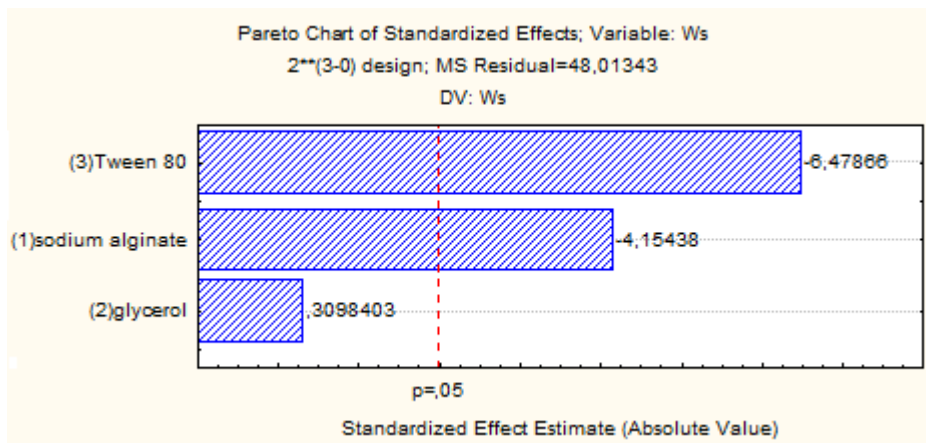
---

# Annex

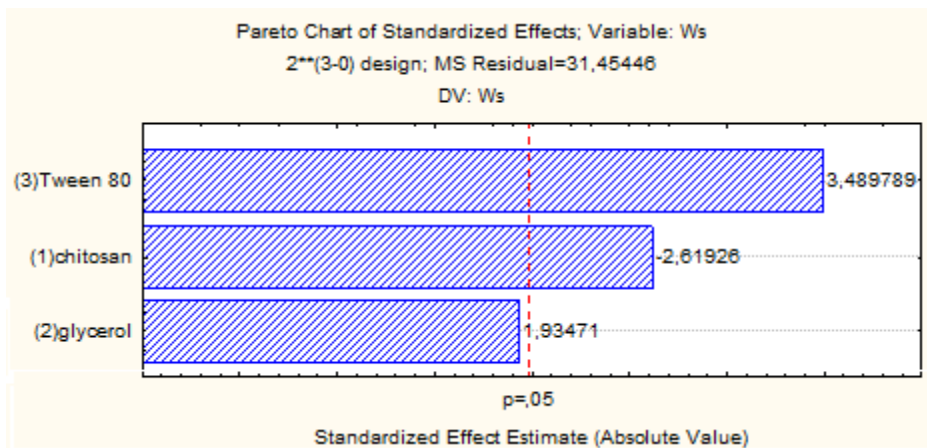
## A.1. Pareto charts



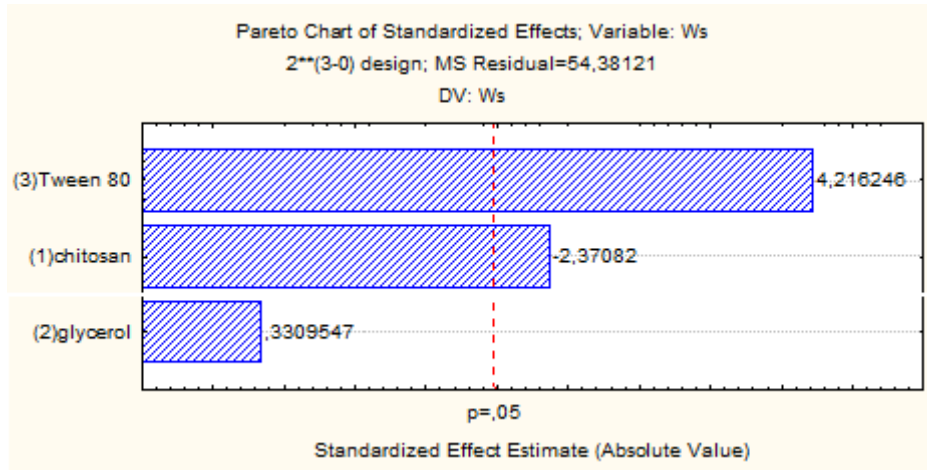
**Figure 60:** Pareto charts showing the effect of the components of coating in  $W_s$  values for sodium alginate solutions in pileus side.



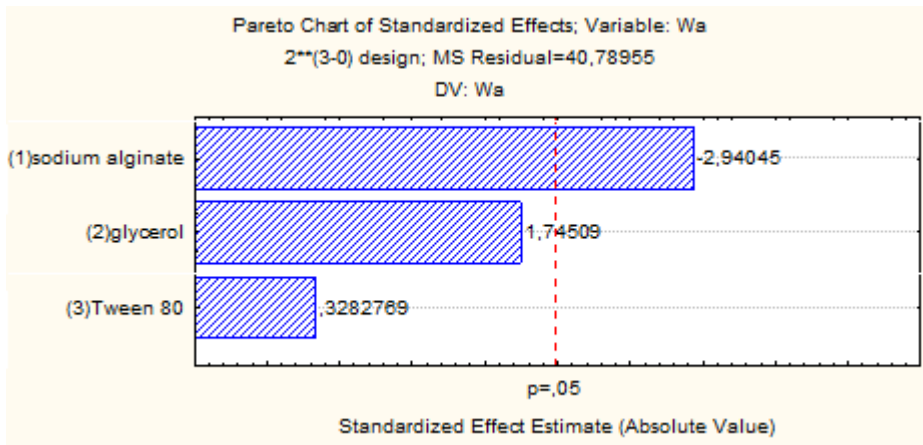
**Figure 61:** Pareto charts showing the effect of the components of coating in  $W_s$  values for sodium alginate solutions in pileus top.



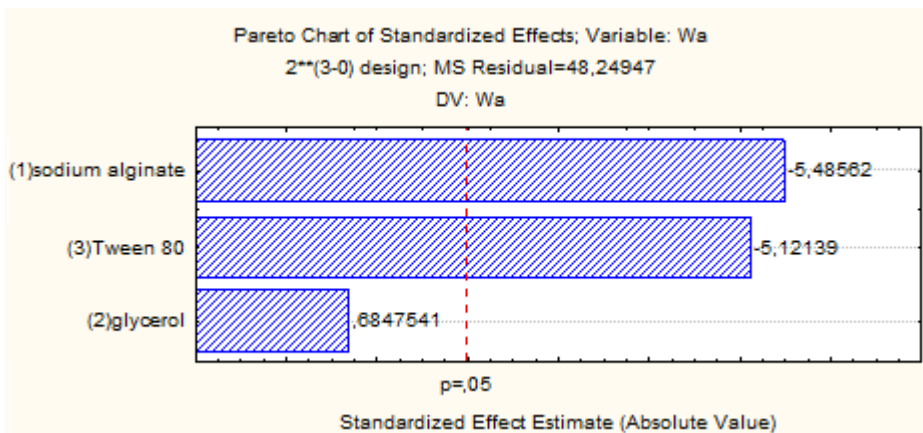
**Figure 62:** Pareto charts showing the effect of the components of coating in  $W_s$  values for chitosan solutions in pileus side.



**Figure 63:** Pareto charts showing the effect of the components of coating in  $W_s$  values for chitosan solutions in pileus top.



**Figure 64:** Pareto charts showing the effect of the components of coating in  $W_a$  values for sodium alginate solutions in pileus side.



**Figure 65:** Pareto charts showing the effect of the components of coating in  $W_a$  values for sodium alginate solutions in pileus top.

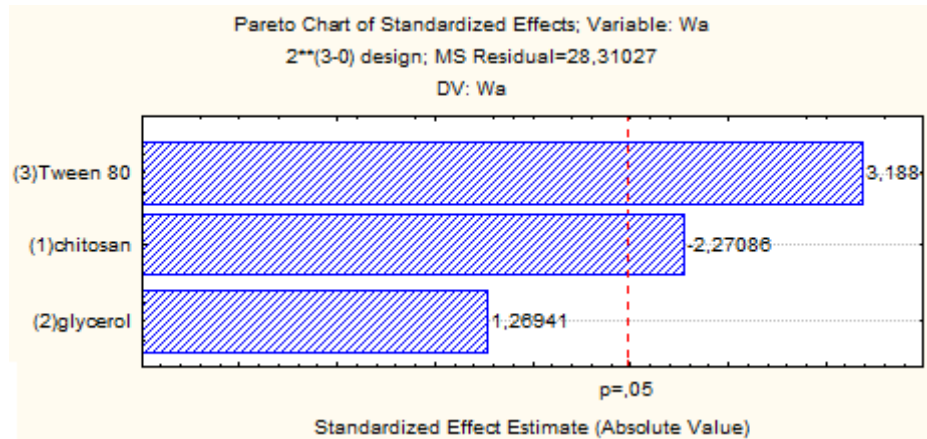


Figure 66: Pareto charts showing the effect of the components of coating in  $W_a$  values for chitosan solutions in pileus side.

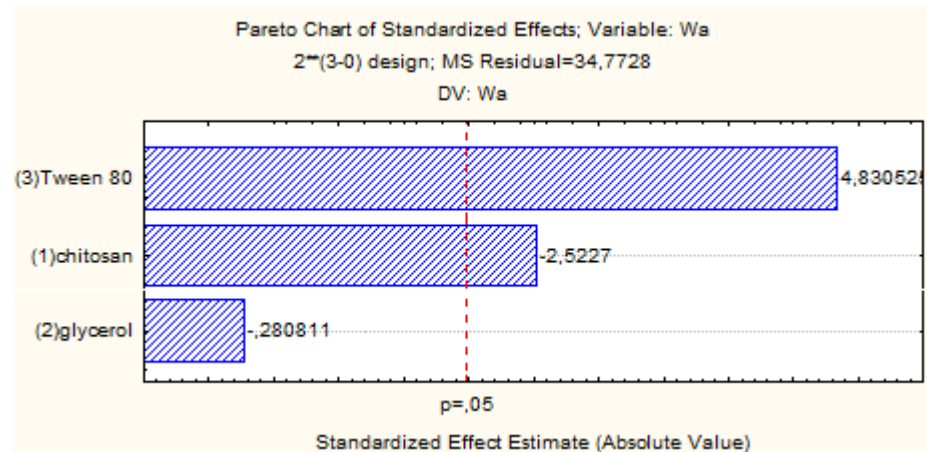


Figure 67: Pareto charts showing the effect of the components of coating in  $W_a$  values for chitosan solutions in pileus top.

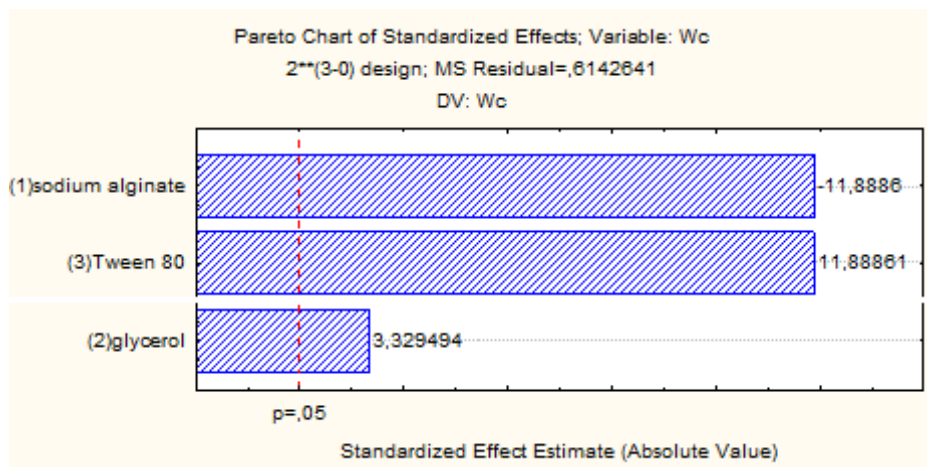
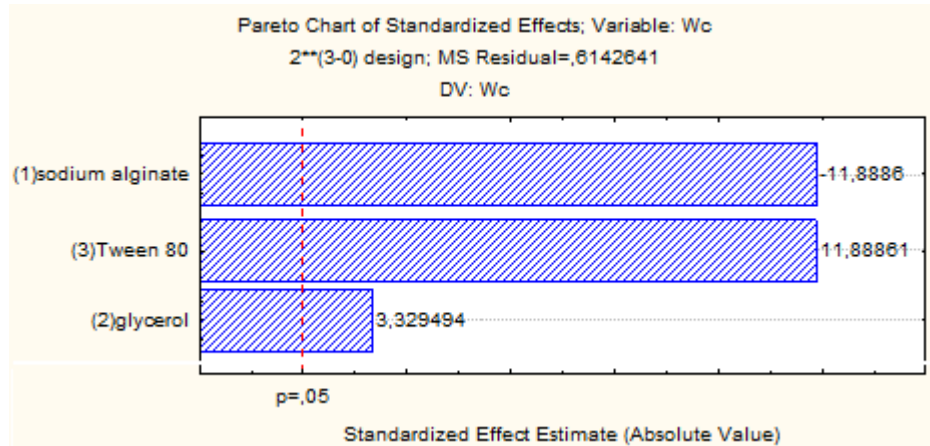
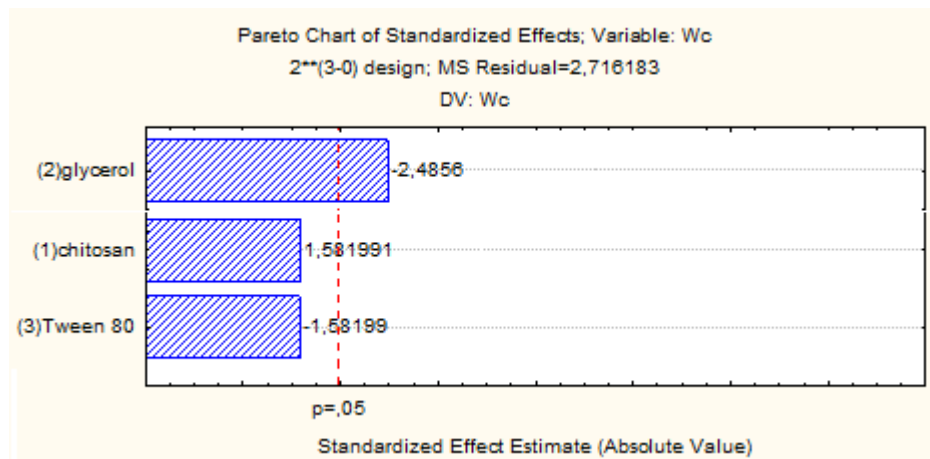


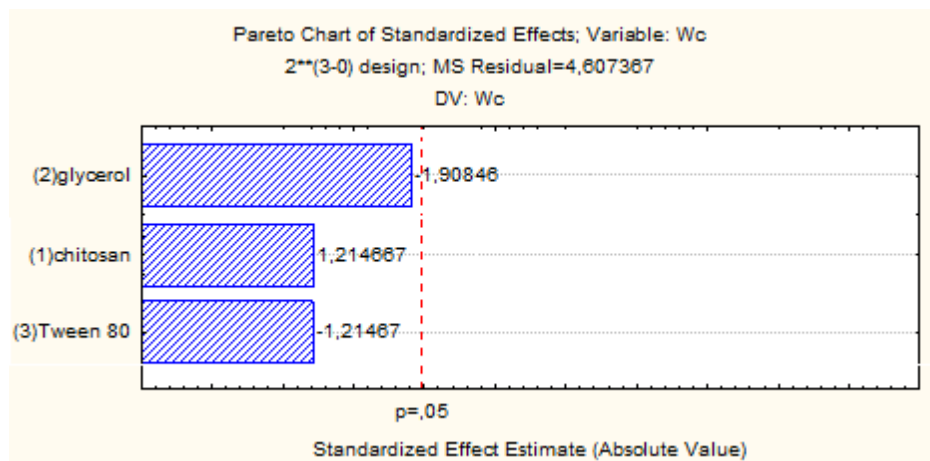
Figure 68: Pareto charts showing the effect of the components of coating in  $W_c$  values for sodium alginate solutions in pileus side.



**Figure 69:** Pareto charts showing the effect of the components of coating in  $W_c$  values for sodium alginate solutions in pileus top.



**Figure 70:** Pareto charts showing the effect of the components of coating in  $W_c$  values for chitosan solutions in pileus side.



**Figure 71:** Pareto charts showing the effect of the components of coating in  $W_c$  values for chitosan solutions in pileus top.

## A.2. Results for pH, TSS, Titratable acidity, Moisture, Total solids and Weight loss

**Table 12:** pH, TSS, titratable acidity, moisture, total solids and weight loss of *Agaricus bisporus* mushrooms during 10 days of storage at 6-8 °C for coated (sodium alginate) and control mushrooms.

Day		pH	TSS	Titratable acidity	Moisture	Total solids	Weight loss
0	Control	6.79 ± 0.01 <sup>a</sup>	2.43 ± 0.15 <sup>a</sup>	0.0290 ± 0.0019 <sup>a</sup>	90.34 ± 0.27 <sup>a</sup>	9.66 ± 0.27 <sup>a</sup>	nr
	Sodium alginate	6.79 ± 0.08 <sup>a</sup>	3.07 ± 0.25 <sup>b</sup>	0.0313 ± 0.0019 <sup>a</sup>	90.15 ± 0.99 <sup>a</sup>	9.85 ± 0.99 <sup>a</sup>	nr
1	Control	6.61 ± 0.06 <sup>a</sup>	3.00 ± 0.15 <sup>a</sup>	0.0290 ± 0.0039 <sup>a</sup>	90.98 ± 0.94 <sup>a</sup>	9.02 ± 0.94 <sup>a</sup>	0.98±0.20 <sup>b</sup>
	Sodium alginate	6.69 ± 0.09 <sup>a</sup>	3.27 ± 0.12 <sup>a</sup>	0.0324 ± 0.0019 <sup>a</sup>	90.37 ± 0.99 <sup>a</sup>	9.63 ± 1.01 <sup>a</sup>	0.58±0.50 <sup>a</sup>
2	Control	6.57 ± 0.05 <sup>a</sup>	3.33 ± 0.15 <sup>a</sup>	0.0324 ± 0.0019 <sup>a</sup>	92.16 ± 1.57 <sup>a</sup>	7.84 ± 1.57 <sup>a</sup>	2.74±0.76 <sup>b</sup>
	Sodium alginate	6.64 ± 0.03 <sup>a</sup>	3.60 ± 0.13 <sup>a</sup>	0.0369 ± 0.0034 <sup>a</sup>	90.65 ± 0.64 <sup>a</sup>	9.35 ± 0.64 <sup>a</sup>	1.33±0.20 <sup>a</sup>
3	Control	6.59 ± 0.08 <sup>a</sup>	3.57 ± 0.23 <sup>a</sup>	0.0357 ± 0.0019 <sup>a</sup>	92.02 ± 0.63 <sup>a</sup>	7.98 ± 0.63 <sup>a</sup>	4.11±0.34 <sup>b</sup>
	Sodium alginate	6.69 ± 0.04 <sup>a</sup>	4.13 ± 0.38 <sup>a</sup>	0.0380 ± 0.0019 <sup>a</sup>	90.29 ± 1.79 <sup>a</sup>	9.71 ± 1.79 <sup>a</sup>	2.17±0.38 <sup>a</sup>
4	Control	6.58 ± 0.10 <sup>a</sup>	3.73 ± 0.11 <sup>a</sup>	0.0357 ± 0.0039 <sup>a</sup>	92.39 ± 0.56 <sup>a</sup>	7.61 ± 0.56 <sup>a</sup>	5.09±0.50 <sup>b</sup>
	Sodium alginate	6.63 ± 0.10 <sup>a</sup>	4.33 ± 0.50 <sup>b</sup>	0.0380 ± 0.0019 <sup>a</sup>	91.63 ± 1.01 <sup>a</sup>	8.37 ± 1.01 <sup>a</sup>	3.03±0.23 <sup>a</sup>
5	Control	6.51 ± 0.09 <sup>a</sup>	4.05 ± 0.21 <sup>a</sup>	0.0357 ± 0.0051 <sup>a</sup>	93.76 ± 0.11 <sup>b</sup>	6.24 ± 0.11 <sup>b</sup>	5.97±0.30 <sup>b</sup>
	Sodium alginate	6.51± 0.08 <sup>a</sup>	5.07 ± 0.31 <sup>b</sup>	0.0380 ± 0.0019 <sup>a</sup>	91.94 ± 1.52 <sup>a</sup>	8.06 ± 1.52 <sup>a</sup>	4.09±0.13 <sup>a</sup>
6	Control	6.61 ± 0.10 <sup>a</sup>	4.33 ± 0.40 <sup>a</sup>	0.0335 ± 0.0034 <sup>a</sup>	93.19 ± 0.20 <sup>b</sup>	6.81 ± 0.20 <sup>b</sup>	7.15±0.20 <sup>b</sup>
	Sodium alginate	6.59 ± 0.01 <sup>a</sup>	5.20 ± 0.20 <sup>b</sup>	0.0357 ± 0.0039 <sup>a</sup>	91.94 ± 0.14 <sup>a</sup>	8.06 ± 0.14 <sup>a</sup>	5.04±0.18 <sup>a</sup>
7	Control	6.53 ± 0.03 <sup>a</sup>	4.77 ± 0.21 <sup>a</sup>	0.0313 ± 0.0039 <sup>a</sup>	94.76 ± 0.31 <sup>b</sup>	5.24 ± 0.31 <sup>b</sup>	7.93±0.54 <sup>b</sup>
	Sodium alginate	6.54 ± 0.11 <sup>a</sup>	5.47 ± 0.21 <sup>b</sup>	0.0346 ± 0.0039 <sup>a</sup>	92.03 ± 1.77 <sup>a</sup>	7.97 ± 1.77 <sup>a</sup>	6.52±0.34 <sup>a</sup>
8	Control	6.50 ± 0.13 <sup>a</sup>	5.13 ± 0.25 <sup>a</sup>	0.0290 ± 0.0019 <sup>a</sup>	94.24 ± 0.17 <sup>a</sup>	5.76 ± 0.17 <sup>a</sup>	8.81±0.19 <sup>b</sup>
	Sodium alginate	6.55 ± 0.03 <sup>a</sup>	5.67 ± 0.51 <sup>a</sup>	0.0346 ± 0.0051 <sup>a</sup>	92.81 ± 1.28 <sup>a</sup>	7.19 ± 1.28 <sup>a</sup>	7.59±0.17 <sup>a</sup>
9	Control	6.47 ± 0.16 <sup>a</sup>	5.50 ± 0.61 <sup>a</sup>	0.0290 ± 0.0039 <sup>a</sup>	95.08 ± 0.95 <sup>a</sup>	4.92 ± 0.95 <sup>a</sup>	9.50±0.19 <sup>b</sup>
	Sodium alginate	6.54 ± 0.06 <sup>a</sup>	5.80 ± 0.26 <sup>a</sup>	0.0357 ± 0.0039 <sup>a</sup>	93.23 ± 1.00 <sup>a</sup>	6.77 ± 0.07 <sup>a</sup>	8.17±0.34 <sup>a</sup>
10	Control	6.28 ± 0.06 <sup>a</sup>	5.77 ± 0.06 <sup>a</sup>	0.0324 ± 0.0019 <sup>a</sup>	95.34 ± 0.75 <sup>a</sup>	4.66 ± 0.75 <sup>a</sup>	10.57±0.60 <sup>b</sup>
	Sodium alginate	6.43 ± 0.08 <sup>a</sup>	5.97 ± 0.21 <sup>a</sup>	0.0358 ± 0.0052 <sup>a</sup>	93.26 ± 1.39 <sup>a</sup>	6.74 ± 1.39 <sup>a</sup>	8.65±0.57 <sup>a</sup>

Different letters between control and sodium alginate at a given storage day are significantly different ( $p < 0.05$ ).

nr- no results for this day

### A.3. Results for $L$ , $a$ , $b$ , $\Delta E$ , BI, PPO activity, Yeasts and molds count, Mesophilic count and Psychrophilic count

**Table 13:**  $L$ ,  $a$ ,  $b$ ,  $\Delta E$ , BI, PPO activity, yeasts and molds count, mesophilic count and psychrophilic count of *Agaricus bisporus* mushrooms during 10 days of storage at 6-8 °C for coated (sodium alginate) and control mushrooms.

	Day	0	1	2	3	4	5	6	7	8	9	10
$L_{cap}$	Control	91.77 ±1.73 a	89.98 ±2.65 a	88.02 ±2.90 a	88.45 ±2.67 a	83.93 ±2.97 a	86.53 ±3.26 a	84.05 ±5.51 a	74.39 ±4.72 b	69.89 ±4.86 b	66.02 ±5.44 b	69.89 ±9.41 a
	Sodium alginate	91.54 ±1.25 a	90.09 ±2.88 a	90.53 ±2.09 a	88.87 ±2.51 a	89.37 ±2.22 a	88.58 ±3.02 a	88.77 ±2.15 a	86.91 ±2.32 a	84.78 ±3.44 a	80.29 ±5.39 a	82.77 ±4.46 a
$L_{stipe}$	Control	75.28 ±2.9 a	72.64 ±6.98 a	73.55 ±5.45 a	70.93 ±4.10 a	64.25 ±2.97 a	66.42 ±7.70 a	64.32 ±6.62 a	64.86 ±8.85 a	63.19 ±4.80 a	55.07 ±2.41 a	50.39 ±1.88 a
	Sodium alginate	77.51 ±1.97 a	71.80 ±8.43 a	73.23 ±3.80 a	68.02 ±1.47 a	63.04 ±1.75 a	68.63 ±6.60 a	64.66 ±9.53 a	68.63 ±8.20 a	72.58 ±1.39 b	67.94 ±5.62 b	67.18 ±5.82 b
$a_{cap}$	Control	0.84 ±0.68 a	1.20 ±1.01 a	1.68 ±1.05 a	0.98 ±1.00 a	2.40 ±0.98 a	1.83 ±1.04 a	2.47 ±1.82 a	5.89 ±1.95 a	6.44 ±1.63 a	7.54 ±1.65 a	6.50 ±2.84 a
	Sodium alginate	0.92 ±0.53 a	1.25 ±1.10 a	0.59 ±0.71 a	1.02 ±0.42 a	0.79 ±0.71 a	1.11 ±1.06 a	0.90 ±0.82 a	2.04 ±0.71 b	2.84 ±0.91 b	3.80 ±1.72 b	3.43 ±1.05 a
$a_{stipe}$	Control	2.19 ±0.79 a	3.54 ±1.87 a	4.15 ±1.64 a	2.66 ±0.69 a	5.29 ±0.93 a	4.69 ±3.28 a	4.54 ±2.04 a	6.96 ±1.82 a	5.97 ±0.23 a	7.66 ±0.98 a	8.89 ±0.77 a
	Sodium alginate	1.23 ±0.47 a	2.29 ±1.41 a	2.69 ±0.39 a	2.21 ±1.53 a	4.22 ±1.86 a	2.18 ±0.66 a	5.27 ±1.59 a	4.63 ±1.04 a	4.20 ±0.35 b	5.01 ±0.23 b	5.28 ±0.33 b
$b_{cap}$	Control	10.69 ±1.19 a	12.56 ±1.91 a	16.38 ±2.65 a	16.33 ±2.02 a	20.03 ±4.37 a	18.55 ±2.34 a	21.75 ±5.18 a	23.79 ±1.77 a	24.21 ±3.61 a	23.39 ±2.40 a	21.56 ±3.55 a
	Sodium alginate	11.33 ±1.42 a	13.25 ±1.47 a	12.55 ±1.68 a	15.93 ±2.51 a	20.03 ±1.63 a	17.16 ±3.18 a	17.38 ±1.41 a	19.92 ±3.18 a	19.65 ±2.56 a	21.69 ±2.67 a	21.16 ±2.64 a
$b_{stipe}$	Control	18.50 ±1.11 a	22.88 ±2.60 a	22.75 ±1.46 a	25.96 ±2.41 a	28.25 ±3.20 a	28.48 ±1.99 a	29.40 ±3.20 a	24.57 ±1.17 a	26.99 ±0.78 a	27.26 ±2.84 a	24.57 ±1.68 a
	Sodium alginate	20.30 ±4.12 a	20.74 ±0.75 a	23.00 ±1.12 a	24.00 ±0.22 a	25.84 ±1.56 a	25.07 ±1.77 a	26.33 ±1.84 a	25.77 ±2.65 a	24.82 ±0.80 a	24.68 ±1.09 a	24.70 ±0.84 a
$\Delta E_{cap}$	Control	nr	3.98 ±2.11 a	7.29 ±4.26 a	7.07 ±2.64 a	12.42 ±5.17 a	9.76 ±3.55 a	13.95 ±6.02 a	22.59 ±5.80 a	26.58 ±5.08 a	29.64 ±6.16 a	25.20 ±10.66 a



	Sodium alginate	nr	3.63 ±2.98 a	3.70 ±2.20 a	5.43 ±2.59 a	5.22 ±1.52 a	7.04 ±4.28 a	7.15 ±2.03 a	9.88 ±3.03 b	11.47 ±3.00 b	15.81 ±5.40 b	13.55 ±4.63 a
$\Delta E_{\text{stipe}}$	Control	nr	7.82 ±3.61 a	6.39 ±3.90 a	9.94 ±0.37 a	15.18 ±3.39 a	14.65 ±7.72 a	16.51 ±4.87 a	13.26 ±6.59 a	15.66 ±2.79 a	22.78 ±2.46 a	26.59 ±1.13 a
	Sodium alginate	nr	10.51 ±3.98 a	6.75 ±3.77 a	10.76 ±1.93 a	16.31 ±2.29 a	10.92 ±5.63 a	15.31 ±11.06 a	11.91 ±8.52 a	7.79 ±3.26 b	11.97 ±6.15 b	12.50 ±3.36 b
$BI_{\text{cap}}$	Control	12.66 ±1.87 a	15.59 ±3.29 a	21.52 ±5.10 a	20.64 ±3.70 a	29.04 ±9.82 a	25.10 ±5.01 a	32.12 ±11.60 a	43.65 ±7.63 a	48.51 ±9.10 a	51.54 ±9.07 a	44.96 ±15.55 a
	Sodium alginate	13.52 ±1.95 a	16.48 ±3.11 a	14.96 ±2.71 a	20.01 ±3.73 a	19.24 ±3.06 a	21.97 ±5.92 a	21.84 ±2.19 a	27.15 ±5.74 b	28.44 ±5.15 b	34.65 ±8.38 a	32.10 ±7.23 a
$BI_{\text{stipe}}$	Control	29.39 ±2.11 a	41.00 ±10.14 a	40.49 ±8.33 a	46.67 ±2.15 a	62.55 ±13.80 a	60.85 ±18.47 a	65.53 ±19.29 a	55.23 ±11.74 a	60.88 ±4.89 a	75.64 ±5.75 a	77.53 ±8.99 a
	Sodium alginate	30.62 ±6.23 a	35.81 ±6.09 a	39.23 ±3.08 a	44.38 ±3.24 a	55.94 ±7.90 a	46.74 ±7.24 a	58.78 ±17.97 a	52.21 ±16.11 a	44.73 ±1.81 b	49.64 ±8.15 b	50.68 ±8.10 b
$\Delta E_{\text{ideal}}$	Control	12.31 ±1.65 a	14.87 ±2.72 a	19.11 ±3.71 a	18.79 ±2.64 a	24.35 ±5.20 a	21.72 ±3.61 a	25.88 ±6.98 a	33.89 ±4.35 a	37.55 ±4.42 a	40.14 ±4.84 a	35.92 ±9.44 a
	Sodium alginate	12.96 ±1.56 a	15.42 ±2.66 a	14.43 ±2.33 a	18.18 ±2.64 a	17.63 ±2.39 a	19.47 ±3.94 a	19.55 ±1.65 a	22.72 ±3.84 b	24.07 ±3.69 b	28.12 ±5.54 b	26.16 ±4.73 a
$PPO$ activity	Control	100.53 ±12.10 a	na	na	143.77 ±9.90 a	na	na	200.93 ±14.20 a	na	na	190.93 ±13.30 a	na
	Sodium alginate	23.67 ±3.3 b	na	na	72.27 ±7.70 b	na	na	81.10 ±4.60 b	na	na	82.57 ±5.5 b	na
Yeasts and molds count	Control	0.00 ±0.00 a	2.10 ±0.17 a	2.40 ±0.17 a	2.67 ±0.33 a	2.46 ±0.28 a	2.74 ±0.13 a	2.88 ±0.27 a	2.72 ±0.22 a	3.02 ±0.45 a	2.86 ±0.65 a	3.20 ±0.08 a
	Sodium alginate	0.00 ±0.00 a	2.00 ±0.00 a	2.20 ±0.17 a	2.26 ±0.24 a	2.10 ±0.17 a	2.30 ±0.30 b	2.20 ±0.17 b	2.20 ±0.35 a	2.63 ±0.55 a	2.16 ±0.28 a	2.56 ±0.24 b
Meso- philic count	Control	na	na	4.36 ±0.39 a	5.80 ±0.23 a	5.57 ±0.20 a	6.07 ±0.11 a	5.86 ±0.74 a	5.84 ±0.47 a	6.37 ±0.13 a	6.33 ±0.18 a	6.10 ±0.25 a
	Sodium alginate	na	na	2.93 ±0.54 b	5.25 ±0.07 b	5.09 ±0.05 b	5.42 ±0.10 b	5.16 ±0.28 a	5.59 ±0.11 a	5.93 ±0.04 b	5.87 ±0.38 a	5.72 ±0.12 b
Psychro- philic count	Control	6.50 ±0.18 a	6.97 ±0.22 a	7.05 ±0.16 a	7.46 ±0.06 a	7.50 ±0.05 a	7.67 ±0.21 a	7.89 ±0.07 a	7.93 ±0.06 a	7.91 ±0.11 a	7.94 ±0.00 a	8.06 ±0.06 a
	Sodium alginate	5.46 ±0.15 b	6.17 ±0.17 b	6.71 ±0.05 b	6.68 ±0.16 b	6.85 ±0.09 b	7.38 ±0.05 b	7.65 ±0.25 a	7.68 ±0.13 b	7.68 ±0.21 a	7.56 ±0.03 b	7.82 ±0.06 b

Different letters between control and sodium alginate at a given storage day are significantly different ( $p < 0.05$ ).

nr- no results for this day; na- it was not carried out the analysis for this day

### A.4. Yeasts and molds

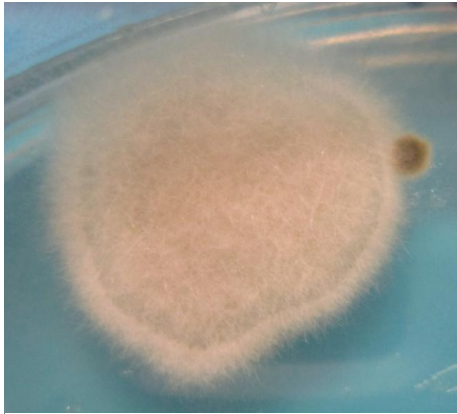


Figure 72: Molds observed during storage.

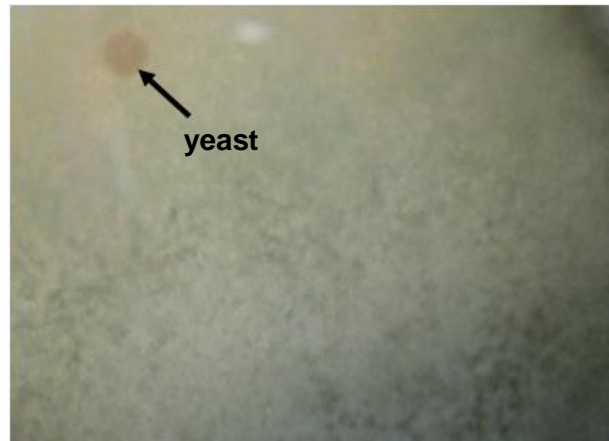


Figure 73: Mold observed with yeast during storage.

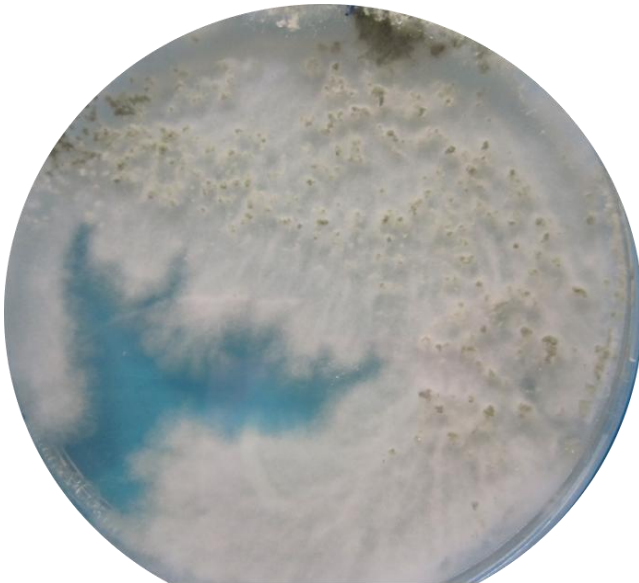


Figure 74: White mold observed during storage.



Figure 75: Black mold observed during storage.

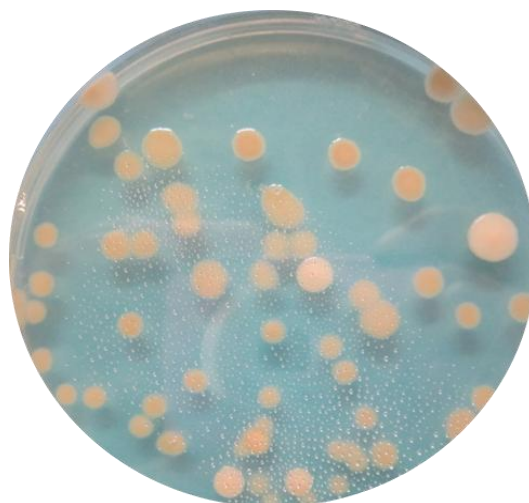


Figure 76: Yeasts observed during storage.

## A.5. Mesophilic

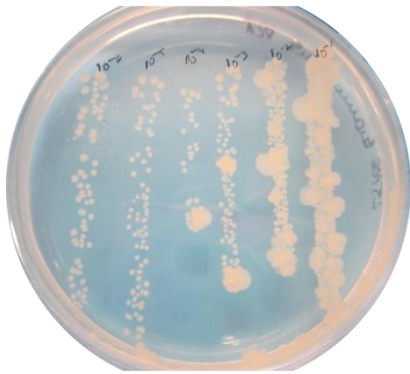


Figure 77: Mesophilic bacteria observed during storage.

## A.6. Psychrophilic

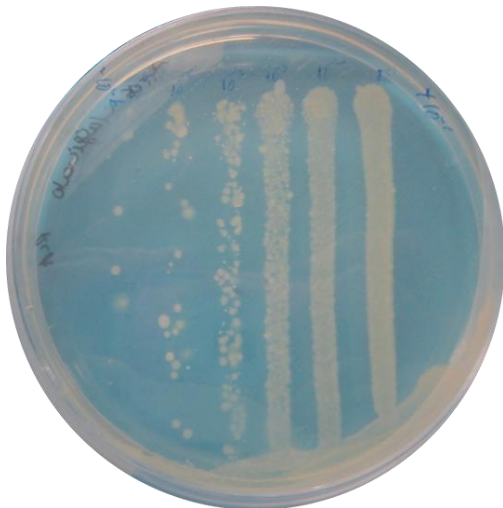


Figure 78: Psychrophilic bacteria observed during storage.

## A.7. Abstract and oral presentation submitted at the 12<sup>o</sup> Encontro de Química dos Alimentos

12<sup>o</sup> Encontro de Química dos Alimentos

### Development of active edible coatings for the preservation of *Agaricus bisporus* mushrooms

Marta F. Sousa<sup>a</sup>, Miguel A. Cerqueira<sup>b,c</sup>, António A. Vicente<sup>c</sup>, Luís M. Cunha<sup>a</sup>

<sup>a</sup>Faculty of Sciences, University of Porto, Porto, Portugal; <sup>b</sup> Improveat, Ltd. Spinpark – Centro de Incubação de Base Tecnológica, Guimarães, Portugal; <sup>c</sup> Centre of Biological Engineering, University of Minho, Campus de Gualtar, Braga, Portugal

\*avicente@deb.uminho.pt

Mushrooms are highly perishable food products that tend to lose their unique organoleptic properties immediately after harvesting. Their short shelf-life is mainly explained by the high losses of water vapour that favour dehydration, high respiration and microbial colonization by bacteria or fungi. Furthermore, enzymatic activity and biochemical alteration lead to mushrooms quality losses [1]. The microorganisms most often associated with mushroom spoilage and colonization are gram-negative bacteria especially those belonging to Pseudomonas family such as *Pseudomonas fluorescens* [2].

Active edible coatings have been increasingly applied in the last years as an alternative method for the control of microbial contamination in food products. The incorporation of antimicrobial compounds has potential for increasing food quality and safety thus extending its shelf-life [3-4]. Recently, several studies have been developed on the incorporation of natural antimicrobial compounds in edible coatings, responding to an increasing demand by the consumers for foods without chemical additives. Some of the natural antimicrobials are essential oils, such as carvacrol and eugenol, which were shown to possess antimicrobial activity against *P. fluorescens* and *E. coli* [5].

Aiming at developing an active edible coating to increase the shelf-life of *Agaricus bisporus* mushrooms polysaccharide-based coatings were developed using chitosan and alginate, glycerol (as plasticizer) and Tween 80 (as surfactant). Coating formulations were evaluated through a 2<sup>2</sup> factorial experimental setup with one central point where the influence of the added compounds on  $W_s$  (spreading coefficient - wettability) was determined (Pareto charts analyses,  $p < 0.05$ ).  $W_s$  was evaluated on the pileus of the mushroom once this is the main part of the mushroom and is a indicator of quality and freshness [6]. Tween 80 and polysaccharide concentrations showed to influence the values of  $W_s$ . The optimal coating formulation to be applied was selected through the determination of the coating that presents the minor value of  $W_s$  (i.e. value close to zero) and need less quantity of ingredients (i.e. more economic coating). Based on this, two coatings were selected, one containing 0.5% (w/v) of chitosan, 0.125% (v/v) of glycerol and 0.15% (v/v) of Tween 80 and other with 0.5% (w/v) of alginate, 0.125% (v/v) of glycerol and 0.05% (v/v) of Tween 80, presenting  $W_s$  values of -62.4 and -49.9 mN/m, respectively.

Different concentrations (0-1% v/v) of eugenol and carvacrol and a combination of both (1:1 – v/v) were incorporated in chitosan and alginate coatings and their antimicrobial activity was evaluated through CLSI M7-A7 [7]. In the case of *E. coli*, the chitosan-based coatings containing eugenol showed higher antimicrobial activity than the ones containing carvacrol, being this activity clear after 48 h of incubation. The same behaviour was observed for alginate-based coatings containing eugenol and carvacrol. Results with *P. fluorescens* were similar to those obtained for *E. coli*, being the only difference registered for the results of inhibition at 24 and 48 h of incubation, where the values of inhibition were similar for both times of incubation. There was a clearly the larger microbial inhibition against *P. fluorescens* in comparison to *E. coli*, for both coatings - in the presence of eugenol and carvacrol.

These results suggest that active polysaccharide-based coatings may present a valuable solution for food packaging in order to prevent microbiological spoilage of *Agaricus bisporus* mushrooms by *P. fluorescens* and *E. coli*. Further studies will be addressed evaluating the effect of developed coatings on shelf-life parameters of *Agaricus bisporus* mushrooms during storage.

[1] A Simon, E Gonzalez-Fandos, V Tobar, J. Food Sci. Technol, 2005, 40, 1–10.

[2] Y Masson, P Ainsworth, D Fuller, H Bozkurt, S Ibanoglu, J Food Eng, 2002, 54, 125–131.


[3] P Appendini, J.H Hotchkiss, Innovat Food Sci. Emerg. Tech., 2002, 3, 113-126.

[4] S Quintavalla, L Vicini, Meat Science, 2002, 62, 373–380.

[5] M Gutierrez-Larrainzar, J Rúa, I Caro, C Castro, D Arriaga, M García-Arnesto, P Valle, Food Control, 2012. 26(2): 555-563.

[6] T Brosnan, D.W Sun, J Food Eng, 2004, 61, 3–16.


[7] CLSI M7-A7, Methods for Dilution Antimicrobial Susceptibility Tests for Bacteria That Grow Aerobically, 7<sup>th</sup>, 2006, USA

## Development of active edible coatings for the preservation of *Agaricus bisporus* mushrooms



**Marta F. Sousa,** Miguel A. Cerqueira, António A. Vicente,  
Luís M. Cunha

XII Encontro de Química dos Alimentos



## INTRODUCTION


- **Problems**
  - Mushrooms are highly perishable food products**
  - Their short shelf-life**
    - ↳ high losses of water vapour that favour dehydration
    - ↳ high respiration
    - ↳ microbial colonization by bacteria (*Pseudomonas fluorescens*) or fungi
    - ↳ enzymatic activity and biochemical alteration

Bacterial infection: a large, light green coloured zone caused by pathogen fungi surrounds the central area

Stipe of the fruit body infected by *Trichoderma harzianum*


XII Encontro de Química dos Alimentos



## INTRODUCTION

- **Active edible coatings**
  - Alternative method for the control of microbial contamination**
    - incorporation of antimicrobial compounds
      - ↳ food quality → extending shelf-life
      - ↳ food safety
    - natural antimicrobial compounds
      - ↳ essential oils extracts → carvacrol
      - ↳ eugenol
      - ↳ *P. fluorescens*
      - ↳ *E. coli*

XII Encontro de Química dos Alimentos




## INTRODUCTION

- Objective

Developing active edible coatings to increase the shelf-life of *Agaricus bisporus* mushrooms where polysaccharide-based coatings were developed using chitosan and alginate, glycerol (as plasticizer) and Tween 80 (as surfactant).

XII Encontro de Química do Alimentos




## DEVELOPMENT WORK

Coating formulations were evaluated through a 2<sup>2</sup> factorial experimental setup with one central point

Alginate	Glycerol	Tween 80	Chitosan	Glycerol	Tween 80
0.5 % (-1)	0.125 %	0.05 %	0.5 % (-1)	0.125 %	0.05 %
0.5 % (-1)	0.125 %	0.15 %	0.5 % (-1)	0.125 %	0.15 %
0.5 % (-1)	0.250 %	0.05 %	0.5 % (-1)	0.250 %	0.05 %
0.5 % (-1)	0.250 %	0.15 %	0.5 % (-1)	0.250 %	0.15 %
1.0 % (+1)	0.125 %	0.05 %	1.0 % (+1)	0.125 %	0.05 %
1.0 % (+1)	0.125 %	0.15 %	1.0 % (+1)	0.125 %	0.15 %
1.0 % (+1)	0.250 %	0.05 %	1.0 % (+1)	0.250 %	0.05 %
1.0 % (+1)	0.250 %	0.15 %	1.0 % (+1)	0.250 %	0.15 %
0.75 % (C)	0.1875 %	0.1 %	0.75 % (C)	0.1875 %	0.1 %
0.75 % (C)	0.1875 %	0.1 %	0.75 % (C)	0.1875 %	0.1 %
0.75 % (C)	0.1875 %	0.1 %	0.75 % (C)	0.1875 %	0.1 %

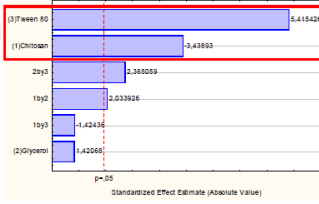
XII Encontro de Química dos Alimentos



## DEVELOPMENT WORK

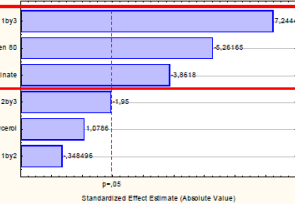
Influence of the added compounds on  $W_s$  (spreading coefficient - wettability) was determined by Pareto charts analyses ( $p < 0.05$ ).  $W_s$  was evaluated on the pileus of the mushroom once this is the main part of the mushroom and is a indicator of quality and freshness.

Pareto Chart of Standardized Effects Variable:  $W_s$   
2<sup>11</sup>(3-4) design; M5 Residual=43.76327  
DV:  $W_s$



Factor	Standardized Effect Estimate (Absolute Value)
(3)Tween 80	5.615426
(1)Chitosan	3.433993
22y5	2.365059
12y3	2.033524
12y3	1.42436
(2)Glycerol	1.42095

Pareto Chart of Standardized Effects Variable:  $W_s$   
2<sup>11</sup>(3-4) design; M5 Residual=49.04744  
DV:  $W_s$



Factor	Standardized Effect Estimate (Absolute Value)
12y3	7.2444
(3)Tween 80	4.261165
(1)Alginate	3.8618
22y5	1.06
(2)Glycerol	1.0788
12y2	1.048496


XII Encontro de Química dos Alimentos

## DEVELOPMENT WORK

The optimal coating formulation to be applied was selected through the determination of the coating that presents the minor value of  $W_s$  (i.e. value close to zero) and need less quantity of ingredients (i.e. more economic coating).

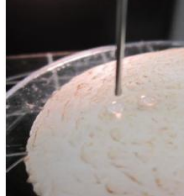
Alginate	Glycerol	Tween 80	Chitosan	Glycerol	Tween 80
0.5 %	0.125 %	0.05 %	0.5 %	0.125 %	0.15 %

$W_s = -49.9 \text{ mN/m}$



Measurement of the contact angle on the surface of the mushroom pileus, with  $\theta=104.3^\circ$

$W_s = -62.4 \text{ mN/m}$



Drops of coating solution on the surface of the pileus

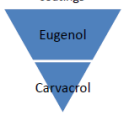
XII Encontro de Química dos Alimentos

## DEVELOPMENT WORK

Different concentrations (0-1% v/v) of eugenol and carvacrol and a combination of both (1:1 - v/v) were incorporated in chitosan and alginate coatings and their antimicrobial activity was evaluated through CLSI M7-A7.

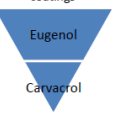
***E. coli***

chitosan-based coatings



clear after 48 h of incubation

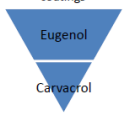
alginate-based coatings



clear after 48 h of incubation

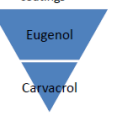
***P. fluorescens***

chitosan-based coatings



values of inhibition were similar for both times of incubation (24h and 48h)

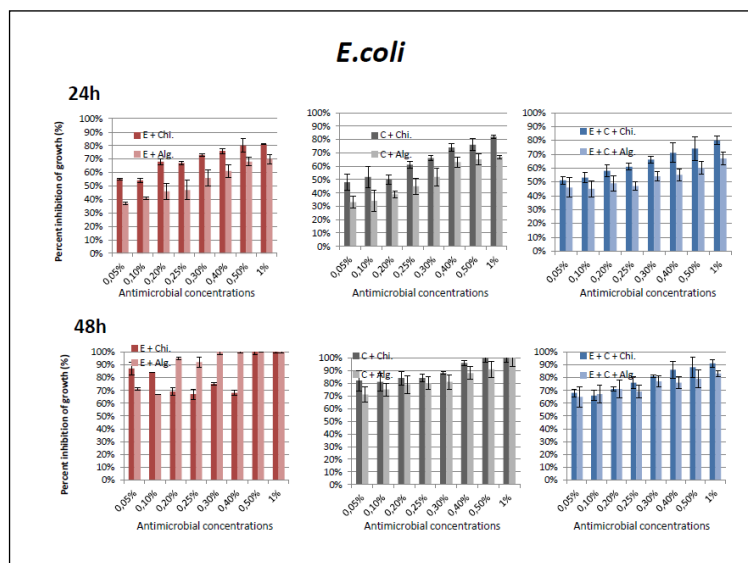
alginate-based coatings

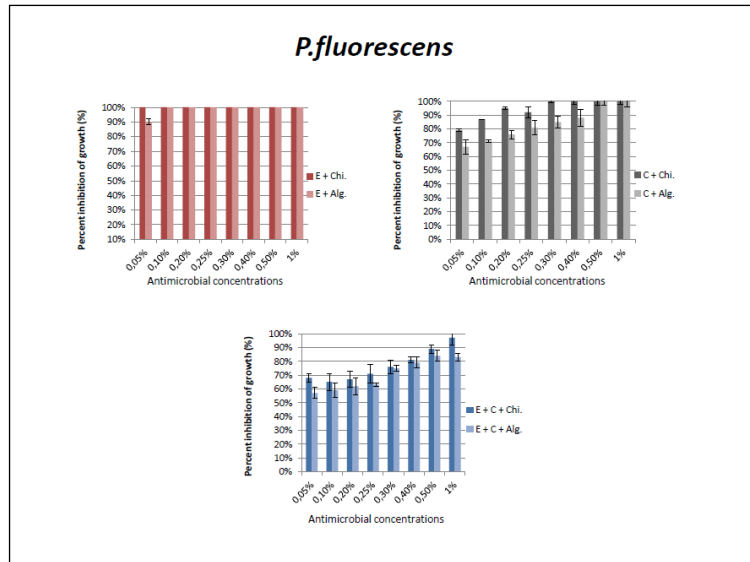


values of inhibition were similar for both times of incubation (24h and 48h)

**There was a clearly larger microbial inhibition against *P. fluorescens* in comparison to *E. coli*, for both coatings - in the presence of eugenol and carvacrol.**

XII Encontro de Química dos Alimentos





## DEVELOPMENT WORK

The disk diffusion test was also performed to check whether the films had one bactericidal or bacteriostatic behavior of microorganisms on plate.

*E. coli*

*P. fluorescens*

The results showed no bactericidal activity for both bacteria tested

XII Encontro de Química dos Alimentos


## DEVELOPMENT WORK

- **Conclusions**

These results suggest that active polysaccharide-based coatings may present a valuable packaging solution in order to prevent microbiological spoilage of *Agaricus bisporus* mushrooms by *P. fluorescens* and *E. coli*.

XII Encontro de Química dos Alimentos





## ACKNOWLEDGEMENTS

Would like to acknowledge the input provided by the Department of Biological Engineering from the University of Minho, especially the LIP (Laboratory of Instrumentation and Experimental Particle Physics). Thank LIP, for having received me and helped in the development of this work, especially to Miguel Cerqueira, PhD and Professor António Vicente that guided this work, not discarding all colleagues of the laboratory.

XII Encontro de Química dos Alimentos