

# Friends, enemies and everything in between

Citation for published version (APA):

Juliana, N. C. A. (2021). *Friends, enemies and everything in between: vaginal microbiota and sexually transmitted infections among sub-Saharan African pregnant women*. [Doctoral Thesis, Maastricht University]. Maastricht University. <https://doi.org/10.26481/dis.20210107nj>

## Document status and date:

Published: 01/01/2021

## DOI:

[10.26481/dis.20210107nj](https://doi.org/10.26481/dis.20210107nj)

## Document Version:

Publisher's PDF, also known as Version of record

## Please check the document version of this publication:

- A submitted manuscript is the version of the article upon submission and before peer-review. There can be important differences between the submitted version and the official published version of record. People interested in the research are advised to contact the author for the final version of the publication, or visit the DOI to the publisher's website.
- The final author version and the galley proof are versions of the publication after peer review.
- The final published version features the final layout of the paper including the volume, issue and page numbers.

[Link to publication](#)

## General rights

Copyright and moral rights for the publications made accessible in the public portal are retained by the authors and/or other copyright owners and it is a condition of accessing publications that users recognise and abide by the legal requirements associated with these rights.

- Users may download and print one copy of any publication from the public portal for the purpose of private study or research.
- You may not further distribute the material or use it for any profit-making activity or commercial gain
- You may freely distribute the URL identifying the publication in the public portal.

If the publication is distributed under the terms of Article 25fa of the Dutch Copyright Act, indicated by the "Taverne" license above, please follow below link for the End User Agreement:

[www.umlib.nl/taverne-license](http://www.umlib.nl/taverne-license)

## Take down policy

If you believe that this document breaches copyright please contact us at:

[repository@maastrichtuniversity.nl](mailto:repository@maastrichtuniversity.nl)

providing details and we will investigate your claim.

**Friends, enemies and everything  
in between**

**Vaginal microbiota and sexually transmitted  
infections among sub-Saharan African  
pregnant women**

Naomi Christine Angela Juliana

# **Friends, enemies and everything in between**

## **Vaginal microbiota and sexually transmitted infections among sub-Saharan African pregnant women**

### **DISSERTATION**

To obtain the degree of Doctor at  
Maastricht University,  
on the authority of Rector Magnificus, prof. dr. Rianne M. Letschert,  
in accordance with the decision on the Board of Deans,

to be defended Thursday January 7th, 2021  
on 13.00

by

**Naomi Christine Angela Juliana**

Born on the 2<sup>nd</sup> of December 1992 in Willemstad, Curaçao

**ISBN:** 9789464191004

**Design/lay-out:** Wendy Bour-van Telgen

**Cover design:** Naomi Juliana with the help of Karun Breukelman.

The cover illustrates that light is shining in the darkness of the vaginal microbiota, also known as the vaginal microflora, in the African continent via research. The dead flowers in the back illustrates the possible contamination of sexually transmitted pathogens in the vaginal microflora.

© Naomi Christine Angela Juliana, 2021 All rights are reserved. No part of this book may be reproduced, distributed, stored in a retrieval system, or transmitted in any form or by any means, without prior written permission of the author.

## TABLE OF CONTENTS

<b>Chapter 1</b>	General introduction	7
<b>Chapter 2</b>	Composition of the vaginal microbiota during pregnancy among women living in sub-Saharan Africa <i>Submitted to International urogynecology journal, 2020</i>	35
<b>Chapter 3</b>	The association between vaginal microbiota dysbiosis, bacterial vaginosis and aerobic vaginitis, and adverse pregnancy outcomes of women living in sub-Saharan Africa: A systematic review <i>Frontiers in Public Health, 2020 8:567885</i>	65
<b>Chapter 4</b>	The prevalence of <i>Chlamydia trachomatis</i> and three other non-viral sexually transmitted infections among pregnant women in Pemba Island Tanzania <i>Pathogens 2020, 9(8),62594</i>	107
<b>Chapter 5</b>	The natural course of <i>Chlamydia trachomatis</i> , <i>Neisseria gonorrhoeae</i> , <i>Trichomonas vaginalis</i> , and <i>Mycoplasma genitalium</i> in pregnant and post-delivery women in Pemba Island, Tanzania <i>To be submitted to PLOS pathogens</i>	127
<b>Chapter 6</b>	Detection of high-risk human papillomavirus (HPV) by the novel AmpFire isothermal HPV assay among pregnant women in Pemba Island, Tanzania <i>Pan African Medical Journal. 2020;37:183</i>	151
<b>Chapter 7</b>	The vaginal microbiota composition and genital infections during and after pregnancy among women in Pemba Island, Tanzania <i>To be submitted to Microorganisms</i>	163
<b>Chapter 8</b>	General discussion	205
<b>Chapter 9</b>	Addendum	
	Summary	232
	Valorization	237
	About the author	240
	Gratitude	241
	Affiliation list of publications and presentations	252

### Supervisor

Prof. dr. Servaas A. Morré

### Co-Supervisor

Dr. Elena Ambrosino

### Assesment Committee

Prof. dr. P.H.M. (Paul) Savelkoul (Chairman)	Maastricht University Medical Center +
Prof.dr. C.J.P.A. (Christian) Hoebe Prof.dr.	Maastricht University Medical Center +
H.J.C. (Henry) de Vries	Academic Medical Center Amsterdam
Prof. dr. J.H.H.M. (Janneke) van de Wijgert	University Medical Center Utrecht

There is no power for change greater than a community discovering  
what it cares about.

*- Margaret Wheatley*



# 1

## General introduction

## INTRODUCTION TO THIS THESIS

A disproportionate share of the global burden of diseases and death is borne by sub-Saharan African women, especially in relation to female reproductive health [1–3] (Figure 1). Approximately fourteen percent of the world female population reside in the sub-Saharan region, numbering more than 500 million, of which about 47% are in the reproductive age bracket (15-49 years) [4]. This year, the fertility rate in sub-Sahara Africa stands at 4.3 births per women, and the birth rate is 32.8 births per 1000 people [5,6]. In comparison to the European Union, where in 2018 the fertility rate was 1.5 and the birth rate was 9.8 births per 1000 people.

Pregnancy is a delicate period in woman's life, and requires structured care in the form of antenatal care. Indeed, at least 15% of all pregnancies are complicated by life-threatening conditions for the mother, fetus or newborn [7]. Pregnancy-related complications such as preterm birth, small for gestational age, pregnancy loss and stillbirth are the leading cause of morbidity and mortality among women of reproductive age and their newborns [8]. These complications are a public health concern in low-income countries and countries in sub-Saharan Africa [9]. Pregnancy-related complications often relate to preventable or treatable causes, for e.g. gestational diabetes, hypertensive disorders and infections [10,11]. Pregnant women are more susceptible to infections and to their complications because their immune system tends to be more geared towards an anti-inflammatory state due to the increased levels of steroid hormones (oestradiol and progesterone) [12].

Several microorganisms have an impact on the expectant mother's health, among them are those ascending from the genital tract. In the female genital tract, particularly the lower genital tract and vaginal area, various bacteria, protozoa, and fungi live in a mutualistic relationship, the vaginal microbiota (VMB). They can promote a beneficial vaginal state, as is the case for Lactobacilli and other lactic acid producing microorganism. However, disruption in the vaginal microbiota can occur, mostly due to an increased microbial diversity. This results in an overgrowth of facultative anaerobes and low abundance of *Lactobacillus* species - defined as vaginal dysbiosis. With a prolonged shift from a low- to a high-diversity vaginal microbiota, vaginal communities often include *Gardnerella (G.) vaginalis*, *Atopobium (A.) vaginae* and multiple other anaerobic bacteria, with or without a low relative abundance of *Lactobacillus (L.) iners* [13]. Contrary to common expectations, vaginal dysbiosis is rarely made up by strictly low-diversity anaerobic dysbiosis dominated by *G. vaginalis* or *A. vaginae* [13].

Vaginal dysbiosis and sexually-transmitted infections (STIs) such as *Chlamydia (C.) trachomatis*, *Neisseria (N.) gonorrhoeae*, *Trichomonas (T.) vaginalis*, *Mycoplasma (M.) genitalium*, human papillomaviruses, herpes simplex viruses and *Candida* species, promote a non-beneficial pro-inflammatory vaginal state and relate to various health conditions for mother and fetus [14]. During pregnancy, infections by *C. trachomatis*, *N. gonorrhoeae*, *T. vaginalis* and *M. genitalium*, and vaginal dysbiosis including bacterial vaginosis (BV), could be vertically transmitted and independently result in an adverse pregnancy outcome such as a spontaneous abortion,

stillbirth, prematurity, low birth weight (LBW), postpartum endometritis, and various sequelae in surviving neonates [15–18]. BV is a polymicrobial condition in which a characteristic set of bacterial species appear to synergistically over grow and cause vaginal symptoms and upper genital tract pathology [19]. It is the leading cause of unusual vaginal discharge worldwide [19].

Various studies of antenatal clinic attendees in sub-Saharan Africa have observed that up to 40% of women had BV, 2.5 - 17% had serological evidence of syphilis, while the prevalence of gonorrhoea and chlamydia ranged between 2 - 7% and 3 - 29% respectively [15,18]. STIs, including *human immunodeficiency virus* (HIV), are believed to be of particular importance in influencing pregnancy outcomes in low- and middle-income countries (LMICs), including sub-Saharan Africa, because the prevalence of infection is high [20]. Therefore, it is important to generate and supplement information on causes and contributors of pregnancy-related conditions in sub-Saharan Africa. Particularly so, as both infections and pregnancy complications are burdensome in that region. A critical understanding of the role of STIs and vaginal dysbiotic conditions in pregnancy is essential for achievement of at least one of the sustainable developing goals (SDGs) by 2030; SDG 3 - Good health and Well-being, which ultimately aims to contribute to a more sustainable future [9]. Some of these targets are: to reduce the global maternal and neonatal mortality ratio, to end preventable deaths of newborns and children under 5 years of age, and to end epidemic of communicable diseases by 2030 [9]. Hence comprehensive information about the microbial role in pregnancy, in both health and disease, is needed and will offer opportunities for the development of therapeutic and public health strategies to improve female and newborn health in sub-Saharan Africa, with implications for society and future generations.

### Contents of this chapter:

- 1.1 Vaginal microbiota in reproductive age and pregnant women
- 1.2 Sexually transmitted infections among pregnant women in sub-Saharan Africa
- 1.3 Microbial characteristics of the vaginal microbiota and sexually transmitted microorganism
- 1.4 The interplay between the host immune system, vaginal microbiota and sexually-transmitted infections.
- 1.5 Microbial detection of vaginal microbiota and sexually transmitted infections
- 1.6 Research setting of this thesis
- 1.7 Aims and outline of the thesis



Figure 1. Sub-Saharan African Map [21].

## 1.1 VAGINAL MICROBIOTA IN REPRODUCTIVE AGE AND PREGNANT WOMEN

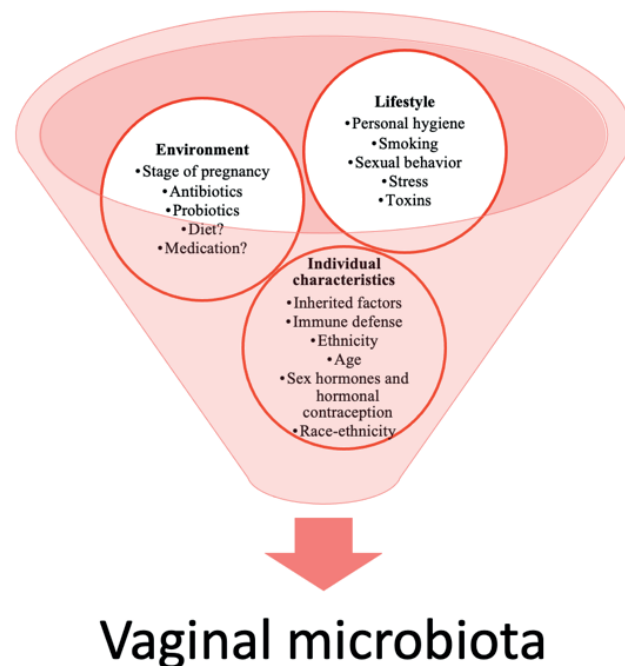
The human VMB, also known as the vaginal flora, is unique in contrast with the VMB of other species or human microbiotas at the other body sites, such as gut or oral microbiota [22]. In women of reproductive age, VMB is characterized by low bacterial diversity (diversity based on relative abundance of taxa at some rank) and is mostly dominated by Lactobacilli, which promotes stability and low diversity of the vaginal communities [23,24]. Twenty of the 130 *Lactobacillus* identified so far have been isolated from the human vagina [25,26]. The VMB composition is mostly described by the dominant bacteria based on hierarchical clustering on the bacteria's relative abundance. In most cases, this is classified as community state types (CSTs), as described by Ravel et al. [26]. Five main CSTs are used, CST I (*L. crispatus* dominated), CST II (*L. gasseri* dominated), CST III (*L. iners* dominated), CST V (*L. jensenii* dominated), and CST IV (characterized by diverse strictly anaerobic bacterial species) [26]. A shift from a *Lactobacillus* dominant VMB (CST IV) promotes dysbiotic conditions such as BV and aerobic vaginitis (AV) [27,28].

BV is the most common vaginal dysbiotic condition, and is defined by a heterogenous mixture of Bacterial Vaginosis Associated Bacteria (BVAB) pathobionts (potentially pathogenic microorganisms) such as *Bifidobacterium* species, *Dialister* species, *Prevotella* species, *Atopobium* species, *Megasphaera* species, Group B *Streptococcus*, *Mycoplasma* species, *Bacteriodes* species, *Mobiluncus* species, *Gardnerella* species, *Sneathia* species, *Anaerococcus* species, *Corynebacterium* species, and other taxa of the order Clostridiales [29]. BV is a treatable condition that is mostly asymptomatic; it is a common cause of unusual vaginal discharge. Sexual activity is a risk factor for BV. Conversely, although not an STI, BV can increase the risk of contracting an STI. The most common symptom of BV is a malodorous off-white watery discharge, however approximately 50% of cases are asymptomatic.

AV is another dysbiotic condition characterized by aerobic pathobionts in the VMB, such as Group B *Streptococcus* and *E.coli* [27]. Age, ethnicity, lifestyle habits, sexual and cleaning practices, use of anti- and pro-biotics and hormones are a few factors that influence the VMB composition [26,30,31] (Figure 2). During pregnancy, high estrogen levels promote glycogen deposition in the vaginal epithelium [32,33]. A glycogen-rich environment supports proliferation of Lactobacilli, which in turn metabolizes glycogen products into lactic acid, leading to a healthy and acid vaginal milieu (pH<4.5) [32,33]. Therefore, the VMB composition in pregnancy is most commonly *Lactobacillus* dominant compared to the non-pregnant state; it is also less diverse and more stable throughout the pregnancy [34–37]. During the first trimester, the VMB diversity is at the highest in pregnancy (possibly due to major hormonal changes). Towards parturition, VMB richness (number of species) increases, becoming more similar to the non-pregnant state [34,35,37,38].

Ethnicity also influences the VMB composition; outwith pregnancy, a larger proportion of African women, or with those with African ancestry harbor either a *L. iners*-dominated VMB or anaerobic, diverse and non-*Lactobacillus* dominated VMB compared to women of Asian or Caucasian ancestry [39–43]. However across all ethnicities, the VMB has been shown to shift towards a more *Lactobacillus*-dominant composition in the early stages of pregnancy [43]. This finding is consistent with previous observations: the prevalence (up to 52%) of a BV-associated vaginal profile in African and African-American women is more than double (23%) that observed in Caucasian populations [44].

Moreover, the adverse outcomes associated with having BV during pregnancy (preterm delivery, fetal mortality/miscarriage, maternal infection, small for gestational age and low birth) have also been associated with VMB dysbiosis and adverse pregnancy outcomes, such as preterm birth [16,17,45–47]. Nonetheless, it might be that specific organisms, rather than BV or vaginal dysbiosis itself, may be linked to adverse pregnancy outcomes. For instance, *Mycoplasma hominis*, *G. vaginalis*, *Ureaplasma Urealyticum*, and *A. vaginae* in isolation, or in combination, have been associated with preterm delivery and preterm birth pregnancy loss [48,49]. Regrettably, significant differences (such as ethnic population differences and methodology) between studies make it challenging to prove an overall link between VMB and adverse pregnancy outcomes.



**Figure 2.** Factors that influence the vaginal microbiota. Figure adapted from Kervinen et al. [50]. Data also retrieved from [50–52].

## VAGINAL MICROBIOTA AFTER PREGNANCY

After parturition, the estrogen levels drop and the *Lactobacillus*-rich microbiome promptly changes [53]. The VMB becomes more diverse, richer, colonized by aerobic bacterial species, and less stable [54,55]. These changes occur irrespective of ethnicity, mode of delivery or community structure during pregnancy, [32,56] and can persist for up to a year [56]. Moreover, it has been hypothesized that a healthy *Lactobacillus*-dominant VMB environment is crucial for a future pregnancy, and in a bid to reduce the risk for BV-related health outcomes [38,56]. Thus it is more beneficial to have a subsequent pregnancy a year after the latest parturition.

## 1.2 SEXUALLY TRANSMITTED INFECTIONS AMONG PREGNANT WOMEN FROM SUB-SAHARAN AFRICA

STIs are a common global infection, particularly in LMICs. *C. trachomatis*, *N. gonorrhoeae*, and *M. genitalium* are the most prevalent bacterial STIs worldwide [57,58]. Human papillomavirus (HPV) is the most prevalent viral genital infection, while *T. vaginalis* is the most prevalent non-viral STI. Syphilis (caused by the bacterium *Treponema pallidum*) and HIV remain the most burdensome STIs, especially in sub-Saharan Africa [59]. The burden of STIs is mostly carried by women in LMICs as its consequences can impact pregnancy, and maternal and infant health. In particular, the prevalence of *N. gonorrhoeae*, *C. trachomatis* and *T. vaginalis* among pregnant women in LMICs can be as high as 31%. In 2016, it was reported that the pooled prevalence rate of *C. trachomatis* was between 5-9% in pregnant women in sub-Saharan Africa [15]. From 2010 – 2015, the pooled prevalence rates in pregnant women in the sub-Saharan African region were between 2 - 5.2% for *N. gonorrhoeae*, and between 4.6 - 31.4% for *T. vaginalis* [60]. Moreover, the pooled prevalence of syphilis among pregnant women in sub-Saharan Africa was 2.9% (95% CI: 2.4% - 3.4%) from studies published between 1999 to 2018 [61]. Comparatively, there is a paucity of compiled data on the prevalence of *M. genitalium* and HPV during pregnancy in sub-Saharan women. The estimated prevalence of *M. genitalium*, based on data from four countries outside of sub-Sahara Africa (France, United Kingdom, Japan, and United States of America), was 1.4% (95% CI: 0.8% - 2.4%) among pregnant women [57]. While for HPV, the prevalence rates were between 5.4 - 46% from studies conducted independently in pregnant women from Nigeria, South Africa, and Ghana [62–66].

Most of these STIs are however asymptomatic, up to 80% for *C. trachomatis*, up to 60% for *N. gonorrhoeae*, up to 80% for *M. genitalium*, and up to 8% for *T. vaginalis* [67–70]. Furthermore during pregnancy, pre-existing STI can increase the risk of acquiring another, and associated complications, for example co-infection of an STI and HIV can nearly double the risk of mother-to-child HIV transmission [60,71,72]. Additionally, BV might also increase the risk of STI acquisition [73–75].



Furthermore, some STIs are also linked with adverse perinatal and neonatal outcomes. Persistence of *N. gonorrhoeae*, *C. trachomatis*, *T. vaginalis*, *Mycoplasma genitalium*, syphilis, and HPV during pregnancy has been linked with stillbirths, preterm birth, intrauterine growth retardation, low birth weight, premature rupture of membranes, preeclampsia, fetal growth restriction, small for gestational age and upper genital tract infection [61,76,77]. The combination of factors (high prevalence of STI, high asymptotology rate, and STI association with adverse pregnancy outcomes), mean that despite availability of treatment, it remains an important public health issue globally and in sub-Sahara Africa.

### 1.3 MICROBIAL CHARACTERISTICS OF THE VAGINAL MICROBIOTA AND SEXUALLY TRANSMITTED MICROORGANISM

#### LACTOBACILLUS SPECIES

*Lactobacillus* species acidify the vaginal environment and benefit the host by preventing invasion of potential pathogens due to the production of lactic acid, hydrogen peroxide (H<sub>2</sub>O<sub>2</sub>), and bacteriocin substances (bactericidal, proteinaceous compounds with a very narrow-spectrum of killing which is achieved by enhancing the permeability of the target cell membranes) [14,78,79]. Lactic acid also affects host immune responses, such as pro-inflammatory cytokines, and microbial interactions [80]. Various Lactobacilli (eg. *L. crispatus*, *L. gasseri*, and *L. jensenii*) produce D-lactic acid [81]. *L. crispatus* is particularly associated with low vaginal pH (pH <4), while VMB of women with higher *L. iners* concentrations are associated with both low and high pH [82]. *L. iners* is also a poor lactate producer, producing L-lactate isoforms only [82]. Generally, *Lactobacillus* species are associated with a healthy vaginal state, low proinflammatory cytokine production, and desirable birth outcomes [83,84]. *L. iners* is generally considered a vaginal symbiont, but it can also be a potential opportunist pathogen [81]. Furthermore, *L. crispatus* has been shown to hinder colonization by anaerobe bacteria such as *G. vaginalis*, whereas *L. iners* co-exists with aerobic microorganisms [85]. However, it is not yet clear whether harboring facultative anaerobic bacteria correlates to can be categorized as an unhealthy vaginal microbiota state, as this composition had also been observed in healthy female [85].

#### VAGINAL DYSBIOSIS ASSOCIATED BACTERIA

A reduction in the relative abundance of Lactobacilli in the VMB can lead to an overgrowth of other anaerobic bacteria species associated with vaginal dysbiosis and related conditions such as BV and AV [29]. The presence of these bacteria is associated with a higher vaginal pH and BV. *G. vaginalis* and *Mycoplasma* are the most common facultative anaerobe bacteria in the vaginal tract [78]. *G. vaginalis* is a small, non-motile, non-capsulated gram variable organism that grows best in the presence of carbon dioxide. Moreover, it has an adherent biofilm and

produces the toxic compound cytolysin [86–88]. Cytolysin can protect the bacteria against the host immune system, instigate an inflammatory response, and has adhesion functions[86]. *Mycoplasma* and *Ureaplasma* are eubacteria. Various *Mycoplasma* species have been associated with BV and poor birth outcomes [49]. *Ureaplasma* species are highly immunogenic, can generate metabolic energy through hydrolyze urea and [78] can produce proinflammatory cytokines, elastase (protease), IgA protease and can directly activate the first component of the complement system [78]. *A. vaginae*'s function is still uncertain as it is an anaerobe gram-positive coccus which produces lactic acid, but has been identified multiple times in women with BV [89]. *Prevotella* species, a gram-negative pleomorphic, anaerobic and non-motile rods, produces amines (organic compound that are derivatives of ammonia) which increase vaginal pH and stimulate the growth of *G. vaginalis* and other microorganisms [90]. AV is another dysbiotic condition and is characterized by aerobic pathobionts in the VMB such as *E.coli* and group B *Streptococcus* [45]. *Streptococcus agalactiae* or group B streptococcus (GBS) is a gram-positive encapsulated coccus with high prevalence in sub-Saharan Africa (54% of global cases) and has been associated with stillbirth, low birth weight, early and late onset sepsis, and meningitis in neonates [91]. GBS has the ability to activate the innate immunity and adhere to mucosal surfaces, certain serotypes can also produce biofilms in acidic environments [92].

#### SEXUALLY TRANSMITTED MICROORGANISMS

*C. trachomatis* is a gram-negative intracellular bacterium, and has a biphasic development cycle that consists of elementary bodies and reticulate bodies [93]. The elementary bodies (metabolically inactive) can infect epithelial cells. After intra-membrane-vacuoles cellular uptake, elementary bodies can differentiate into reticulate bodies (metabolically active) which can replicate and transform back into elementary bodies (Figure 3). Those can in turn, through exocytosis, infected other cells. To date, nineteen serovars have been identified, of which serovars D -K is responsible for ano-urogenital and oropharyngeal infections [94].

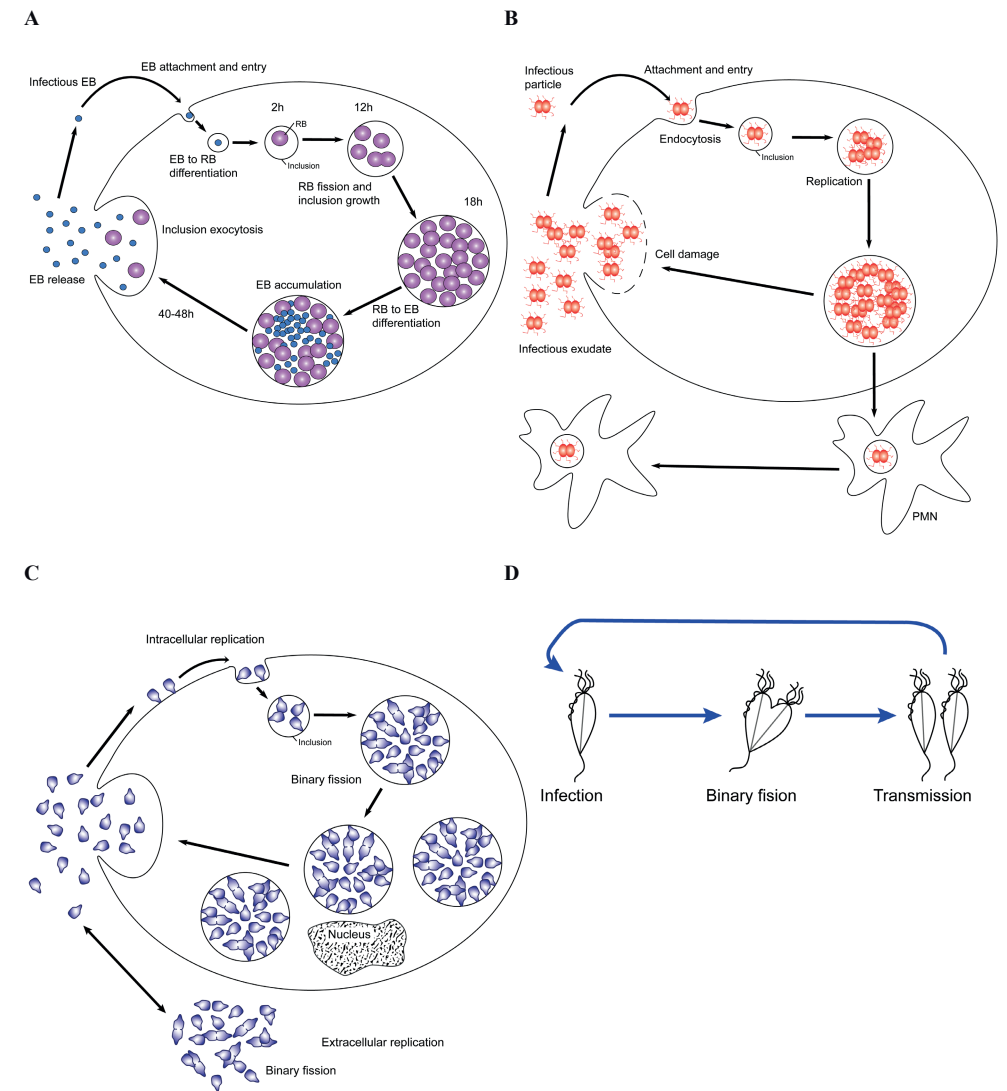
Comparable to *C. trachomatis* serovars D - K, *N. gonorrhoeae* is also a gram-negative intracellular bacterium that can infect genital and oropharyngeal epithelium cells. After adhesion and invasion of the cells, replication occurs intercellularly [95] (Figure 3). Afterwards, through cell-damage mechanisms, the infectious bacteria exudates are released [95].

*M. genitalium*, a bacterium which is both intracellular & extracellular, can infect the genital tract. It is one of the smallest prokaryotes, a flask shaped bacterium that lacks a cell wall and is capable of autonomous replication [96]. (Figure 3) The main virulence ability of *M. genitalium* is that it adheres to host epithelial cells using the terminal tip organelle with its adhesins, the release of enzymes, and the ability to evade the host immune response by antigenic variation [96]. Besides bacterial sexually transmitted infections, there are also protozoan parasites (*T. vaginalis*) and viruses (HPV) that can colonize the vaginal tract.

*T. vaginalis* is an anaerobic, extracellular protozoal parasite, it is a pear-shaped flagellated trophozoite that cannot be enclosed (Figure 3). Movements of the parasite can occur through its

multiple flagella and axostyle (sheet of microtubes) [97]. It replicates most of the time through binary fission, and once in contact with epithelial cells it transforms into an amoeboid.

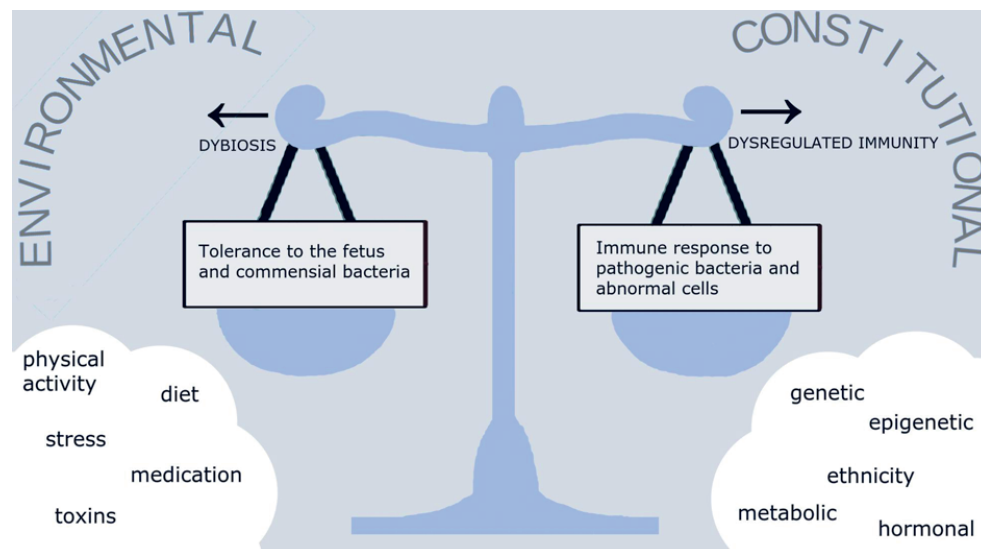
HPVs are ubiquitous double-stranded deoxyribonucleic acid (DNA) viruses that infect epithelial tissue of the anogenital tract and oropharynx. There are more than 200 type of HPVs described, of which 40 can infect cells of mucosal areas [98]. These viruses are classified as: low-risk oncogenic HPV or high- risk oncogenic HPV. Low-risk oncogenic HPV cause hyper-proliferative lesions with a very limited tendency for malignant progression, mostly caused by HPV 6 and 11 and associated with anogenital warts [98]. Of high- risk oncogenic HPV, the most common genotypes are HPV 16 and 18; these are strongly associated with premalignant and malignant cervical lesions [98]. HPV replicates in terminally differentiating keratinocyte that are about to expire. This allows the virus to remain in the host for months or years, escaping the host immune system [98]. Generally, HPV viral genomes persist in this stage as episomes (non-essential genetic element) at low-copy numbers [99]. Its life cycle begins after infection of the stem cells in the basal layer of the epithelium. Following entry into the cell, the virus tries to maintain a low number of genome copies via genes *E1* and *E2* expression [98]. Expression of these genes, and *E6* and *E7*, modulate cell-cycle regulators to maintain replication in the long term [98]. Thereafter, increased production of certain viral proteins act to increase their cellular proliferation [98]. This leads to more HPV-infected cells, number of viral genome copies per cell, and number of cells producing infectious virions. Infection of stem cell-like cells of the basal layer ensures persistence of infection [100].



**Figure 3.** Life cycle of *C. trachomatis* (A), *N. gonorrhoeae* (B), *M. genitalium* (C), and *T. vaginalis* (D) infection. Courtesy of Dr. S. Ouburg.

#### 1.4 THE INTERPLAY BETWEEN THE HOST IMMUNE SYSTEM, VAGINAL MICROBIOTA AND SEXUALLY-TRANSMITTED INFECTIONS

Defence against the negative effect of microorganisms, including during pregnancy, involves two main processes: resistance and tolerance [101]. Resistance is the ability to recognize the presence of an invading microorganism and mount an effective and protective pro-inflammatory immune response [101]. Tolerance is a mechanism that minimizes the consequences of invasion by a pathogen, but without the induction of inflammation [101]. During pregnancy, the tolerance mechanism is prioritized in order to protect the fetus from the negative effects of inflammation and minimize the risk of premature parturition (Figure 4).



**Figure 4.** Environmental and constitutional factors that affect the balance between tolerance to the fetus and commensal bacteria (other name for normal microflora, indigenous microbiota), and the immune response to pathogens and abnormal cells. Imbalance of microbiome and immune responses would lead to either abnormal commensal microbiome and pathogenic infection “dysbiosis” or excessive immune reaction and sterile inflammation “dysregulated immunity”. Figure and text retrieved from [52].

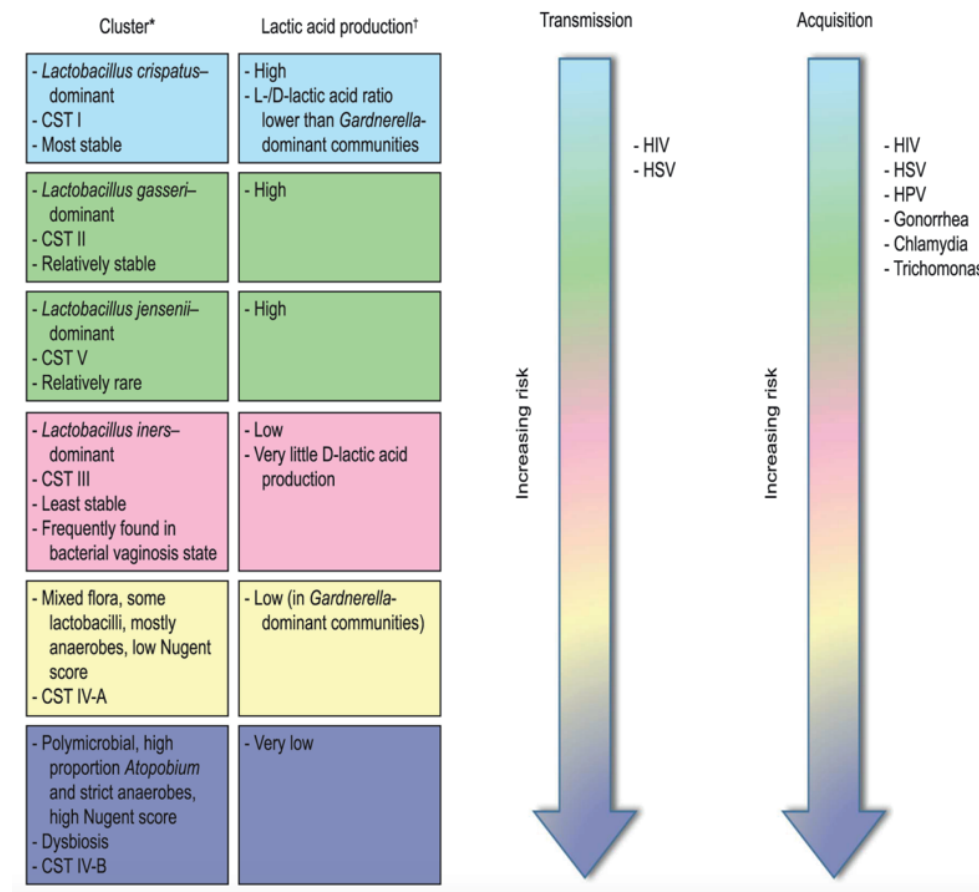
The acidic environment provided by Lactobacilli has been associated with decreased activity of *C. trachomatis* and *N. gonorrhoea*, HPV and other pathogens [102] (Figure 5). Furthermore, sex hormones are key regulators of the interplay between VMB and the immune system; this is through the production of antimicrobial peptides and pro-inflammatory cytokines (Interleukin (IL)-6 and 8) by the vaginal epithelial cells to prevent infection by pathogens [103].

Furthermore, *Lactobacillus*-stimulated autophagy results in the absorption and degradation of bacteria, viruses and protozoa even within the epithelial cell cytoplasm [101]. However, *L. crispatus* and *L. jensenii* appear to not only promote release of pro-inflammatory mediators from vaginal epithelial cells, but also able to inhibit their release when activators of innate

immunity are already present [101]. Consequently, Lactobacilli reduces susceptibility to STIs (such as *C. trachomatis* and HIV), without inducing an immune-mediated inflammatory response [101] (Figure 5). However, an increase in diverse, non-*Lactobacillus* dominant VMB reduces resilience to disturbance, and increases susceptibility to infections [56,104,105]. BV, vaginal pathobiont carriage and STIs are interrelated, and their association is bidirectional [106,107]. With dysbiosis of the vaginal microbiota, the host is between two and three times as likely to be infected by *C. trachomatis* [108–110]. Recent studies found approximately 1.5 - 2 times increase in susceptibility to *N. gonorrhoeae* infection when the vaginal microbiome is in a dysbiotic state [109,110].

Pre-existence of an STI or other urogenital infection increases susceptibility to another STI through related behavioral and biological risk factors e.g. sexual activity [51,89]. Additionally, the vaginal mucosal barrier and other components of the host’s initial defense are compromised [111]. Loss of the protective mucus provides pathogens with unhindered access to target cells, increasing epithelial binding potential [112,113]. These disruptions create more portals of entry for pathogens (such as HPV, *N. gonorrhoeae*, *C. trachomatis*, *M. genitalium*) and induce cervicovaginal inflammation [111]. However, increased susceptibility for *C. trachomatis* in a dysbiotic environment can also occur due to other factors. For instance, *Prevotella* species produce the amino acid (tryptophan) that *C. trachomatis* in turn uses for growth and proliferation [114]. Several other products from species related to VMB dysbiosis produce metabolites for other (pathogenic) bacteria, thereby increasing their activity. D-lactic acid, produced by various *Lactobacillus* species but not *L. iners*, has been associated with long-term protection against *C. trachomatis* infection [115]. *T. vaginalis* also appears to be strongly associated with non-*Lactobacillus* dominant VMB [115]. HPV positive women had VMB dominated by *L. iners* or with high abundance of *Atopobium*, *Prevotella* or *Gardnerella*, furthermore they had the slowest rate of infection clearance [116–118]. Additionally, HPV infection can increase vaginal bacterial richness and diversity, and lower the percentage of *Lactobacillus* during pregnancy by altering the acidic environment and inducing pro-inflammatory cytokines [117,119,120]. HPV does not appear to induce changes in the VMB [121,122]. BV has been linked to *M. genitalium* acquisition, however there is a paucity of studies on the association between VMB and *M. genitalium* [123].

Interest on the interplay between VMB and various STIs is growing, and more studies are trying to decipher the exact mechanisms between host, VMB and common pathogens. More data is also needed to fully understand how infections are influenced by the VMB and vice versa.



**Figure 5.** Vaginal communities and risk of sexually transmitted infections (STIs). Risk of STI acquisition and transmission increases with increasing diversity of vaginal flora; it is lowest with *Lactobacillus crispatus*-dominant communities. Higher levels of lactic acid has been strongly associated with a beneficial vaginal health, and production of lactic acid is conserved across healthy vaginal communities. L- and D-lactic acid isomers may have different functions within the vaginal microenvironment, and their ratio may influence expression of host genes and immune response. CST, community-state types according to Ravel et al. [26]; HIV, human immunodeficiency virus; HSV, herpes simplex virus; HPV, human papillomavirus. \*Figure and text retrieved from [51]. Data from references [101,124,125].

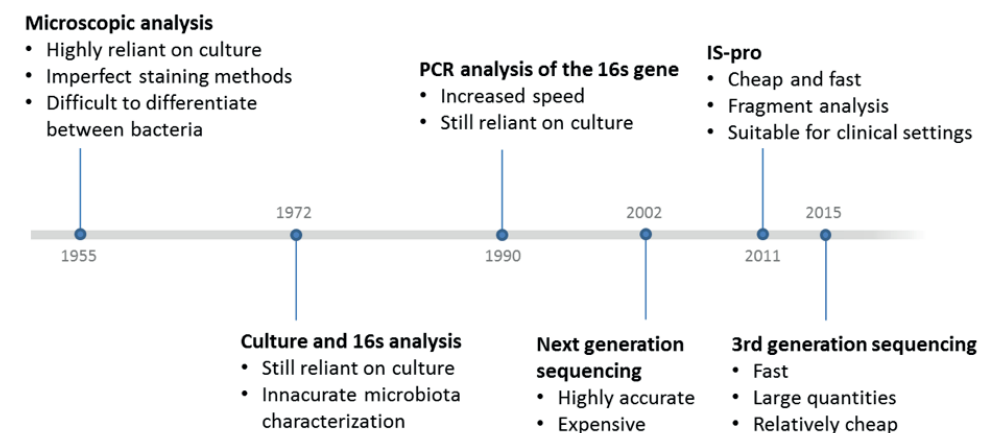
## 1.5 MICROBIAL DETECTION OF VAGINAL MICROBIOTA AND SEXUALLY TRANSMITTED INFECTIONS

For centuries, microscopy and culture-dependent microbiology techniques have been used to detect and analyse microorganism. Culture-dependant techniques are relatively low cost but have big limitations, for instance certain microbial species cannot be cultured in the labora-

tory. Since the introduction of molecular microbiology techniques, mostly based on the 16S ribosomal DNA (rDNA) genes, more species that were often difficult or impossible to cultivate have been detected [126]. The 16S rRNA gene encodes the small subunit ribosomal RNA molecules. It is widely present in all bacterial species, and 16S rRNA gene sequencing is one of the most common methods for targeting housekeeping genes to study bacterial phylogeny and genus/species classification [127]. Sequencing based on 16S rDNA genes, whole genome shotgun sequencing, Next Generation Sequencing (NGS), Intergenic space (IS)-pro profiling, and quantitative (real-time) polymerase chain reaction (PCR) are a few of many emerging molecular based techniques used to detect the presence of microbes [126] (Figure 6).

In this thesis, the IS-pro technique will be used to detect vaginal microorganisms. This is a high throughput method based on the amplification of the 16S–23S rDNA IS-region, whose lengths are specific for each bacterial species [128]. Compared to the 16S rRNA gene, the IS region is extremely variable in size and sequence, even within closely related taxonomic groups, making it more suitable for analysis of complex communities [128].

The introduction of molecular techniques has also improved the specificity and sensitivity of genital pathogen detection. Currently, nucleic acid amplification test (NAAT) and real-time PCR are considered gold standard for diagnosis, since they are easy, fast and highly sensitive and specific. Newer techniques such as multilocus sequencing typing (MLST), multi-antigen sequencing (MAST) and restriction fragment length polymorphism (RFLP) are also available to detect specific pathogenic genotypes [129]. In this thesis, the use of two commercially available, validated PCR assays for the detection of *C. trachomatis*, *N. gonorrhoeae*, *T. vaginalis*, and HPV, namely Presto assay (Microbiome Ltd., the Netherlands) and AmpFire HPV screening assay (Atila, USA) have been used. For *M. genitalium* detection, the *M. genitalium* assay as described in Muller et al. was used [130].



**Figure 6.** Timeline illustrating the introduction of different characterization tools for microbiome. Courtesy of Dr. M. Singer.

## 1.6 RESEARCH SETTING OF THIS THESIS

Pemba Island is the second largest island of the Zanzibar archipelago, located off the mainland of the Republic of Tanzania. The island is divided into 85 Shehias (Assignment of communities), made up of 3-5 villages under a common leader (Figure 7). There are four towns: Chake Chake, Pemba's administrative capital; Wete, in the north, the largest town on the island; Mkoani, in the south, the main port, and Micheweni also in the north [131]. The island is densely populated with approximately 390,000 people [131]. In 2018, approximately 19744 pregnant women and 14000 annual births were reported [132,133]. Most people are of Arab, Indian, Persian and African descent (jaenish, pemba website) and speak Kiswahili [131,134]. The Swahili culture is therefore mixed, with some Portuguese and British influences. The majority of population are Muslims, with a minority identifying as Christians [131]. Subsistence agriculture (mostly cloves, coconuts, groundnuts and cassava) and fishing represent the main economic activities [135].

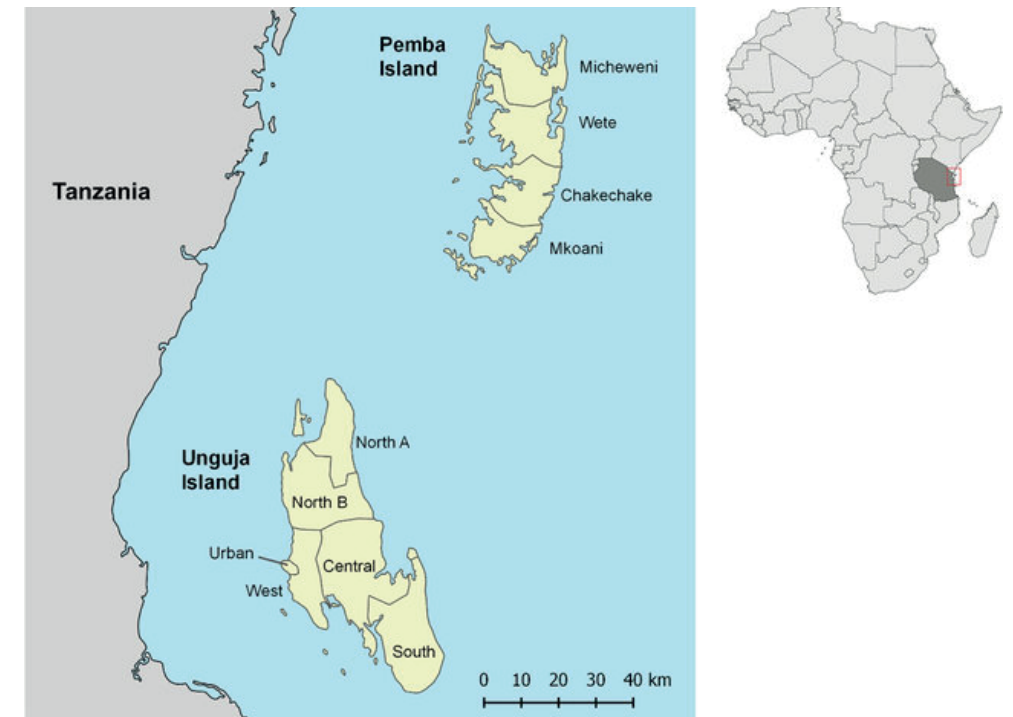
Unfortunately, most Pembans live below the UN poverty line (less than \$1 day). The life-expectancy is about 60 years old, and the quality of maternal and infant health services is rated inadequate or poor [131,134]. Healthcare in the Zanzibar archipelago includes both public and private facilities. Private facilities on Pemba Island include over-the-counter shops and pharmacies. First line primary public health care units services (n = 58) include basic health care and maternal-child care. While primary health services (n = 2) include; in-patient basic medical and surgical care, emergency obstetric services, psychiatric assessments, and ambulance services [134]. There are three district hospitals on the Pemba. Island (n =3) [136]. Mortality and morbidity in Zanzibar continues to be dominated by preventable communicable diseases such as malaria, tuberculosis, and conditions related to pregnancy and childbirth; respiratory infections in young children also contribute significantly [134]. In 2016 the neonatal mortality rate was 16 per 1000 live births and the maternal mortality rate was 350 per 100 000 livebirths [133].

Data from 2001 indicate a aimed to be syndromic approach to STI, but is not yet implemented in all primary health care units [134]. Syndromic management is based on the identification of a group of symptoms and easily recognized signs, and the provision of treatment targeting primary causative organisms of the syndrome [58]. With STIs, broad spectrum antibiotics are administrated, in the hope of targeting the most sinister pathogens that might be the origin of the symptoms. However, this approach has relatively low sensitivity for *N. gonorrhoeae*, *C. trachomatis*, *T. vaginalis*, *M. genitalium* and HPV since most cases are asymptomatic. Nevertheless, in many settings with limited diagnostic tools, this is the only viable approach [137].

In 2014, the global Alliance for Maternal and Newborn Health Improvement (AMANHI) project was initiated with support from the WHO and the Bill and Melinda Gates Foundation with an aim to determine the burden, timing and causes of maternal death, stillbirth and neonatal death using harmonized methods across eleven sites in sub-Saharan Africa and South

Asia [132]. In the context of this project, biobanking efforts were initiated in three locations (Pakistan, Bangladesh and Tanzania). The AMANHI Biobank in Pemba was set up as one of the locations (in Tanzania) in collaboration with the Public Health Laboratory-Ivo de Carneri [132]. Different types of maternal biological samples, demographic and health data from expectant mothers were collected.

The vaginal samples, and demographic and healthcare data used in this research were previously collected in the context of the AMANHI Biobank in Pemba.



**Figure 7.** Map of Pemba (upper) and Unguja (lower) Islands, main ones of the Zanzibar archipelago, with district boundaries (left). Locator map with Tanzania Mainland and the Zanzibar archipelago shaded (right) [138].

## 1.7 AIMS AND OUTLINE OF THE THESIS

The overall **aim** of this thesis is to investigate role and association of vaginal microorganisms and pregnancy outcomes in sub-Saharan African women. In particular, the following objectives were pursued: (i) to review current knowledge of the role of vaginal microbiota (VMB) in pregnant women from sub-Saharan African (ii) to investigate the epidemiology and natural history of VMB composition and five burdensome sexually transmitted infections (STIs (*C. trachomatis*, *N. gonorrhoeae*, *T. vaginalis*, *M. genitalium*, and human papillomavirus)) in pregnant women in Pemba Island Tanzania. Evidence from this research provides new insight into the burden of vaginal dysbiosis, vaginal dysbiotic conditions, and STIs during pregnancy in sub-Saharan Africa and Pemba Island, in particularly.

Previous studies have suggested that the VMB of women with African ancestry is more likely to be non-*Lactobacillus* dominant (dysbiotic) compared to other populations. In **chapter 2**, published evidence of the VMB composition in pregnant women from sub-Saharan Africa is reviewed. Earlier studies also described the association between VMB dysbiosis and related dysbiotic conditions such as bacterial vaginosis (BV) and aerobic vaginitis (AV), and various adverse pregnancy outcomes. There is limited overview of this association from countries in sub-Saharan Africa, a region which bears a disproportionately high burden of both vaginal dysbiotic conditions and adverse pregnancy outcomes. In **chapter 3**, using a systematic approach, the evidence for the association between VMB dysbiosis, BV, and AV, and late adverse pregnancy outcomes in women living in sub-Saharan Africa is reviewed.

To assess the STI burden in pregnant women on Pemba Island, the prevalence of *C. trachomatis*, *N. gonorrhoeae*, *T. vaginalis*, and *M. genitalium* among local pregnant women is described in **chapter 4**. Furthermore, during pregnancy, the natural course of infection might be altered because of the hormonal and immune changes. Data on the STI persistence, particularly among pregnant women, is limited. In **chapter 5**, the persistence of these four pathogens during and after delivery, in women from Pemba Island was further determined. The prevalence and persistence of fifteen high-risk human papillomavirus genotypes was analyzed separately and described in **chapter 6**. In **chapter 7**, the VMB composition among pregnant and post-delivery women in Pemba Island was characterized and associated with presence of the five previously mentioned STIs.

A general discussion is provided in **chapter 8**, where data presented in this thesis is summarized and discussed. Moreover, in this chapter reflections and recommendations are provided for future implications and a way forward towards improving STIs and vaginal dysbiosis research, burden and management during pregnancy in sub-Saharan Africa.

## REFERENCES

1. WHO, UNICEF, U.; The World Bank; Division, T.U.N.P. Trends in maternal mortality: 1990 to 2013: estimates by WHO, UNICEF, UNFPA, The World Bank and the United Nations Population Division. **2014**, 56.
2. WHO African Region The African Regional Health Report 2014. **2014**.
3. Narayan, K.; Donnenfeld, Z. *Envisioning a healthy future: Africa's shifting burden of disease*; 2030; Vol. 18;.
4. The World Bank Group World Development Indicators. **2015**.
5. World Population Prospects - Population Division - United Nations Available online: <https://population.un.org/wpp/Maps/> (accessed on Oct 16, 2020).
6. Africa Birth Rate 1950-2020 | MacroTrends Available online: <https://www.macrotrends.net/countries/AFR/africa/birth-rate> (accessed on Oct 16, 2020).
7. Kyei-Nimakoh, M.; Carolan-Olah, M.; McCann, T. V. Access barriers to obstetric care at health facilities in sub-Saharan Africa-a systematic review. *Syst. Rev.* **2017**, 6.
8. Filippi, V.; Chou, D.; Ronsmans, C.; Graham, W.; Say, L. Levels and Causes of Maternal Mortality and Morbidity. In *Disease Control Priorities, Third Edition (Volume 2): Reproductive, Maternal, Newborn, and Child Health*; The World Bank, 2016; pp. 51–70.
9. World Health Organization *World health statistics 2019: monitoring health for the SDGs, sustainable development goals.* ; Geneva, 2019; ISBN CC BY-NC-SA 3.0 IGO.
10. Khan, K.S.; Wojdyla, D.; Say, L.; Gülmezoglu, A.M.; Van Look, P.F. WHO analysis of causes of maternal death: a systematic review. *Lancet* **2006**, 367, 1066–1074.
11. Organization, W.H. *Trends in maternal mortality: 1990-2015: estimates from WHO, UNICEF, UNFPA, World Bank Group and the United Nations Population Division*; 2015;
12. García-Gómez, E.; González-Pedraja, B.; Camacho-Arroyo, I. Role of sex steroid hormones in bacterial-host interactions. *Biomed Res. Int.* **2013**, 2013.
13. van de Wijgert, J.H.H.M.; Jespers, V. The global health impact of vaginal dysbiosis. *Res. Microbiol.* **2017**.
14. Chaban, B.; Links, M.G.; Jayaprakash, T.P.; Wagner, E.C.; Bourque, D.K.; Lohn, Z.; Albert, A.Y.K.; van Schalkwyk, J.; Reid, G.; Hemmingsen, S.M.; et al. Characterization of the vaginal microbiota of healthy Canadian women through the menstrual cycle. *Microbiome* **2014**, 2.
15. Adachi, K.; Nielsen-Saines, K.; Klausner, J.D. Chlamydia trachomatis Infection in Pregnancy: The Global Challenge of Preventing Adverse Pregnancy and Infant Outcomes in Sub-Saharan Africa and Asia. *Biomed Res Int.* **2016**, 2016, 9315757.
16. Leitich, H.; Bodner-Adler, B.; Brunbauer, M.; Kaider, A.; Egarter, C.; Husslein, P. Bacterial vaginosis as a risk factor for preterm delivery: A meta-analysis. *Am. J. Obstet. Gynecol.* **2003**, 189, 139–147.
17. Stout, M.J.; Zhou, Y.; Wylie, K.M.; Tarr, P.I.; Macones, G.A.; Tuuli, M.G. Early pregnancy vaginal microbiome trends and preterm birth. *Am. J. Obstet. Gynecol.* **2017**, 217, 356.e1-356.e18.
18. Mullick, S.; Watson-Jones, D.; Beksinska, M.; Mabey, D. Sexually transmitted infections in pregnancy: Prevalence, impact on pregnancy outcomes, and approach to treatment in developing countries. *Sex. Transm. Infect.* **2005**, 81, 294–302.
19. Borchardt, K.A.; Noble, M.A. *Sexually transmitted diseases: epidemiology, pathology, diagnosis, and treatment*; CRC Press: Boca Raton, 1997; ISBN 0849394767.
20. World Health Organization *Global incidence and prevalence of selected curable sexually transmitted infections-2008*; 2012;

21. Khandke, V. Sub-Saharan Africa and the Sustainable Development Goals | Dining for Women Available online: <https://diningforwomen.org/sub-saharan-africa-and-the-sustainable-development-goals/> (accessed on Oct 17, 2020).
22. Huttenhower, C.; Gevers, D.; Knight, R.; Abubucker, S.; Badger, J.H.; Chinwalla, A.T.; Creasy, H.H.; Earl, A.M.; Fitzgerald, M.G.; Fulton, R.S.; et al. Structure, function and diversity of the healthy human microbiome. *Nature* **2012**, *486*, 207–214.
23. Belizário, J.E.; Napolitano, M. Human microbiomes and their roles in dysbiosis, common diseases, and novel therapeutic approaches. *Front. Microbiol.* **2015**, *6*.
24. De Seta, F.; Campisciano, G.; Zanutta, N.; Ricci, G.; Comar, M. The vaginal community state types microbiome-immune network as key factor for bacterial vaginosis and aerobic vaginitis. *Front. Microbiol.* **2019**, *10*.
25. Zhou, X.; Bent, S.J.; Schneider, M.G.; Davis, C.C.; Islam, M.R.; Forney, L.J. Characterization of vaginal microbial communities in adult healthy women using cultivation-independent methods. *Microbiology* **2004**, *150*, 2565–2573.
26. Ravel, J.; Gajer, P.; Abdo, Z.; Schneider, G.M.; Koenig, S.S.K.; McCulle, S.L.; Karlebach, S.; Gorle, R.; Russell, J.; Tacket, C.O.; et al. Vaginal microbiome of reproductive-age women. *Proc. Natl. Acad. Sci. U. S. A.* **2011**, *108*, 4680–4687.
27. Donders, G.G.G.; Vereecken, A.; Bosmans, E.; Dekeersmaecker, A.; Salembier, G.; Spitz, B. Definition of a type of abnormal vaginal flora that is distinct from bacterial vaginosis: Aerobic vaginitis. *BJOG An Int. J. Obstet. Gynaecol.* **2002**.
28. Nelson, T.M.; Borgogna, J.L.C.; Brotman, R.M.; Ravel, J.; Walk, S.T.; Yeoman, C.J. Vaginal biogenic amines: Biomarkers of bacterial vaginosis or precursors to vaginal dysbiosis? *Front. Physiol.* **2015**, *6*.
29. Smith, S.B.; Ravel, J. The vaginal microbiota, host defence and reproductive physiology. *J. Physiol.* **2017**, *595*, 451–463.
30. Brooks, J.P.; Edwards, D.J.; Blythe, D.L.; Fettweis, J.M.; Serrano, M.G.; Sheth, N.U.; Strauss, J.F.; Buck, G.A.; Jefferson, K.K. Effects of combined oral contraceptives, depot medroxyprogesterone acetate and the levonorgestrel-releasing intrauterine system on the vaginal microbiome. *Contraception* **2017**, *95*, 405–413.
31. Macklaim, J.M.; Clemente, J.C.; Knight, R.; Gloor, G.B.; Reid, G. Changes in vaginal microbiota following antimicrobial and probiotic therapy. *Microb. Ecol. Heal. Dis.* **2015**, *26*.
32. MacIntyre, D.A.; Chandiramani, M.; Lee, Y.S.; Kindinger, L.; Smith, A.; Angelopoulos, N.; Lehne, B.; Arulkumaran, S.; Brown, R.; Teoh, T.G.; et al. The vaginal microbiome during pregnancy and the postpartum period in a European population. *Sci. Rep.* **2015**, *5*.
33. O'Hanlon, D.E.; Moench, T.R.; Cone, R.A. Vaginal pH and microbicidal lactic acid when lactobacilli dominate the microbiota. *PLoS One* **2013**, *8*.
34. Aagaard, K.; Riehle, K.; Ma, J.; Segata, N.; Mistretta, T.-A.; Coarfa, C.; Raza, S.; Rosenbaum, S.; Van den Veyver, I.; Milosavljevic, A.; et al. A Metagenomic Approach to Characterization of the Vaginal Microbiome Signature in Pregnancy. *PLoS One* **2012**, *7*, e36466.
35. Goltsman, D.S.A.; Sun, C.L.; Proctor, D.M.; DiGiulio, D.B.; Robaczewska, A.; Thomas, B.C.; Shaw, G.M.; Stevenson, D.K.; Holmes, S.P.; Banfield, J.F.; et al. Metagenomic analysis with strain-level resolution reveals fine-scale variation in the human pregnancy microbiome. *Genome Res.* **2018**, *28*, 1467–1480.
36. Romero, R.; Hassan, S.S.; Gajer, P.; Tarca, A.L.; Fadrosh, D.W.; Bieda, J.; Chaemsaitong, P.; Miranda, J.; Chaiworapongsa, T.; Ravel, J. The vaginal microbiota of pregnant women who subsequently have spontaneous preterm labor and delivery and those with a normal delivery at term. *Microbiome* **2014**, *2*.
37. Walther-Antônio, M.R.S.; Jeraldo, P.; Berg Miller, M.E.; Yeoman, C.J.; Nelson, K.E.; Wilson, B.A.; White, B.A.; Chia, N.; Creedon, D.J. Pregnancy's Stronghold on the Vaginal Microbiome. *PLoS One* **2014**, *9*, e98514.
38. Kroon, S.; Ravel, J.; sterility, W.H.-F. and; 2018, undefined Cervicovaginal microbiota, women's health, and reproductive outcomes. *Elsevier*.
39. Anahtar, M.N.; Byrne, E.H.; Doherty, K.E.; Bowman, B.A.; Yamamoto, H.S.; Soumillon, M.; Padavattan, N.; Ismail, N.; Moodley, A.; Sabatini, M.E.; et al. Cervicovaginal Bacteria Are a Major Modulator of Host Inflammatory Responses in the Female Genital Tract. *Immunity* **2015**, *42*, 965–976.
40. Hummelen, R.; Fernandes, A.D.; Macklaim, J.M.; Dickson, R.J.; Changalucha, J.; Gloor, G.B.; Reid, G. Deep Sequencing of the Vaginal Microbiota of Women with HIV. *PLoS One* **2010**, *5*, e12078.
41. Dominguez-Bello, M.G. Gestational shaping of the maternal vaginal microbiome. *Nat. Med.* **2019**, *25*, 882–883.
42. Zhou, X.; Brown, C.J.; Abdo, Z.; Davis, C.C.; Hansmann, M.A.; Joyce, P.; Foster, J.A.; Forney, L.J. Differences in the composition of vaginal microbial communities found in healthy Caucasian and black women. *ISME J.* **2007**, *1*, 121–133.
43. Serrano, M.G.; Parikh, H.I.; Brooks, J.P.; Edwards, D.J.; Arodz, T.J.; Edupuganti, L.; Huang, B.; Girerd, P.H.; Bokhari, Y.A.; Bradley, S.P.; et al. Racioethnic diversity in the dynamics of the vaginal microbiome during pregnancy. *Nat. Med.* **2019**, *25*, 1001–1011.
44. Fettweis, J.M.; Paul Brooks, J.; Serrano, M.G.; Sheth, N.U.; Girerd, P.H.; Edwards, D.J.; Strauss, J.F.; Jefferson, K.K.; Buck, G.A. Differences in vaginal microbiome in African American women versus women of European ancestry. *Microbiol. (United Kingdom)* **2014**, *160*, 2272–2282.
45. Donders, G.G.G.; Vereecken, A.; Bosmans, E.; Dekeersmaecker, A.; Salembier, G.; Spitz, B. Definition of a type of abnormal vaginal flora that is distinct from bacterial vaginosis: Aerobic vaginitis. *BJOG An Int. J. Obstet. Gynaecol.* **2002**, *109*, 34–43.
46. Ralph, S.G.; Rutherford, A.J.; Wilson, J.D. Influence of bacterial vaginosis on conception and miscarriage in the first trimester: Cohort study. *Br. Med. J.* **1999**, *319*, 220–223.
47. Hillier, S.L.; Nugent, R.P.; Eschenbach, D.A.; Krohn, M.A.; Gibbs, R.S.; Martin, D.H.; Cotch, M.F.; Edelman, R.; Pastorek, J.G.; Rao, A.V.; et al. Association between bacterial vaginosis and preterm delivery of a low-birth-weight infant. *N. Engl. J. Med.* **1995**, *333*, 1737–1742.
48. White, B.A.; Creedon, D.J.; Nelson, K.E.; Wilson, B.A. The vaginal microbiome in health and disease. *Trends Endocrinol. Metab.* **2011**, *22*, 389–393.
49. Foxman, B.; Wen, A.; Srinivasan, U.; Goldberg, D.; Marrs, C.F.; Owen, J.; Wing, D.A.; Misra, D. Mycoplasma, bacterial vaginosis-associated bacteria BVAB3, race, and risk of preterm birth in a high-risk cohort. *Am. J. Obstet. Gynecol.* **2014**, *210*, 226.e1–226.e7.
50. Kervinen, K.; Kalliala, I.; Glazer-Livson, S.; Virtanen, S.; Nieminen, P.; Salonen, A. Vaginal microbiota in pregnancy: Role in induction of labor and seeding the neonate's microbiota? *J. Biosci.* **2019**, *44*, 1–6.
51. Lewis, F.M.T.; Bernstein, K.T.; Aral, S.O. Vaginal microbiome and its relationship to behavior, sexual health, and sexually transmitted diseases. *Obstet. Gynecol.* **2017**, *129*, 643–654.
52. Al-Nasiry, S.; Ambrosino, E.; Schlaepfer, M.; Morré, S.A.; Wieten, L.; Voncken, J.W.; Spinelli, M.; Mueller, M.; Kramer, B.W. The Interplay Between Reproductive Tract Microbiota and Immunological System in Human Reproduction. *Front. Immunol.* **2020**, *11*, 378.
53. Nott, P.N.; Franklin, M.; Armitage, C.; Gelder, M.G. Hormonal changes and mood in the puerperium. *Br. J. Psychiatry* **1976**, *128*, 379–383.
54. Bisanz, J.E.; Enos, M.K.; PrayGod, G.; Seney, S.; Macklaim, J.M.; Chilton, S.; Willner, D.; Knight, R.; Fusch, C.; Fusch, G.; et al. Microbiota at multiple body sites during pregnancy in a rural tanzanian

- population and effects of Moringa-supplemented probiotic yogurt. *Appl. Environ. Microbiol.* **2015**, *81*, 4965–4975.
55. McMillan, A.; Rulisa, S.; Gloor, G.B.; Macklaim, J.M.; Sumarah, M.; Reid, G. Pilot assessment of probiotics for pregnant women in Rwanda. *PLoS One* **2018**, *13*, e0195081.
  56. DiGiulio, D.B.; Callahan, B.J.; McMurdie, P.J.; Costello, E.K.; Lyell, D.J.; Robaczewska, A.; Sun, C.L.; Goltsman, D.S.A.; Wong, R.J.; Shawa, G.; et al. Temporal and spatial variation of the human microbiota during pregnancy. *Proc. Natl. Acad. Sci. U. S. A.* **2015**, *112*, 11060–11065.
  57. Baumann, L.; Cina, M.; Egli-Gany, D.; Goutaki, M.; Halbeisen, F.S.; Lohrer, G.-R.; Ali, H.; Scott, P.; Low, N. Prevalence of *Mycoplasma genitalium* in different population groups: systematic review and meta-analysis. *Sex Transm Infect* **2018**, *94*, 254–261.
  58. World Health Organization *Global health sector strategy on sexually transmitted infections 2016–2021. Towards ending STIs*; Geneva, Switzerland, 2016;
  59. UNAIDS, U.; response, W.H.O.-G.H.; 2011, undefined Global HIV/AIDS response: epidemic update and health sector progress towards universal access: progress report 2011. *cabdirect.org*.
  60. Joseph Davey, D.; Shull, H.; Billings, J.; Wang, D.; Adachi, K.; Klausner, J. Prevalence of Curable Sexually Transmitted Infections in Pregnant Women in Low- and Middle-Income Countries From 2010 to 2015. *Sex. Transm. Dis.* **2016**, *43*, 450–458.
  61. Hussen, S.; Tadesse, B.T. Prevalence of syphilis among pregnant women in Sub-Saharan Africa: A systematic review and meta-analysis. *Biomed Res. Int.* **2019**, 2019.
  62. Brandful JA, Bonney EY, Asmah RH, A.-K.K. Oncogenic human papillomavirus (HPV) in women from Ghana. *J. Cancer Res. Exp. Oncol.* **2014 Dec 31**; *6(4)*:31-8 **2014**, *6*, 31–38.
  63. Schulze, M.H.; Völker, F.M.; Lugert, R.; Cooper, P.; Hasenclever, K.; Groß, U.; Pfister, H.; Silling, S. High prevalence of human papillomaviruses in Ghanaian pregnant women. *Med. Microbiol. Immunol.* **2016**, *205*, 595–602.
  64. Elukunbi, A.H.; Kolawole, E.O.; Kola, J.O.; Afolabi, Y.O. Human papillomavirus in pregnant women at Bowen University Teaching Hospital, Ogbomoso, Nigeria. *J. Immunoass. Immunochem.* **2019**, *40*, 283–288.
  65. Stevens, D.; Kaplan, E. *Streptococcal infections: clinical aspects, microbiology, and molecular pathogenesis*; Oxford University Press, Ed.; USA, 2000;
  66. O'Farrell, N.; Hoosen, A.A.; Kharsany, A.B.; van den Ende, J. Sexually transmitted pathogens in pregnant women in a rural South African community. *Sex. Transm. Infect.* **1989**, *65*, 276–280.
  67. Peipert, J.F. Genital Chlamydial Infections. *N. Engl. J. Med.* **2003**, *349*, 2424–2430.
  68. Tosh, A.K.; Van Der Pol, B.; Fortenberry, J.D.; Williams, J.A.; Katz, B.P.; Batteiger, B.E.; Orr, D.P. *Mycoplasma genitalium* among Adolescent Women and their Partners. *J. Adolesc. Heal.* **2007**, *40*, 412–417.
  69. Sutton, M.; Sternberg, M.; Koumans, E.H.; McQuillan, G.; Berman, S.; Markowitz, L. The prevalence of *Trichomonas vaginalis* infection among reproductive-age women in the United States, 2001-2004. *Clin. Infect. Dis.* **2007**, *45*, 1319–1326.
  70. Moodley, D.; Moodley, P.; Sebitloane, M.; Soowamber, D.; McNaughton-Reyes, H.L.; Groves, A.K.; Maman, S. High prevalence and incidence of asymptomatic sexually transmitted infections during pregnancy and postdelivery in KwaZulu Natal, South Africa. *Sex. Transm. Dis.* **2015**, *42*, 43–47.
  71. Kinuthia, J.; Drake, A.L.; Matemo, D.; Richardson, B.A.; Zeh, C.; Osborn, L.; Overbaugh, J.; Scott McClelland, R.; John-Stewart, G. HIV acquisition during pregnancy and postpartum is associated with genital infections and partnership characteristics. *AIDS* **2015**, *29*, 2025–2033.
  72. C. King, C.; R. Ellington, S.; P. Kourtis, A. The Role of Co-Infections in Mother-to-Child Transmission of HIV. *Curr. HIV Res.* **2013**, *11*, 10–23.
  73. Morris, M.; Nicoll, A.; Simms, I.; Wilson, J.; Catchpole, M. Bacterial vaginosis: a public health review. *BJOG An Int. J. Obstet. Gynaecol.* **2001**, *108*, 439–450.
  74. Gatski, M.; Martin, D.; Clark, R.; ... E.H.-S. transmitted; 2011, undefined Co-occurrence of *Trichomonas vaginalis* and bacterial vaginosis among HIV-positive women. *ncbi.nlm.nih.gov*.
  75. Chehoud, C.; Stieh, D.; ... A.B.-A. (London; 2017, undefined Associations of the vaginal microbiota with HIV infection, bacterial vaginosis and demographic factors. *ncbi.nlm.nih.gov*.
  76. Pandey, D.; Solleti, V.; Jain, G.; Das, A.; Shama Prasada, K.; Acharya, S.; Satyamoorthy, K. Human Papillomavirus (HPV) infection in early pregnancy: Prevalence and implications. *Infect. Dis. Obstet. Gynecol.* **2019**, 2019.
  77. Mullick, S.; Watson-Jones, D.; Beksinska, M. Sexually transmitted infections in pregnancy: prevalence, impact on pregnancy outcomes, and approach to treatment in developing countries. *sti.bmj.com*.
  78. Donati, L.; Di Vico, A.; Nucci, M.; Quagliozi, L.; Spagnuolo, T.; Labianca, A.; Bracaglia, M.; Ianniello, F.; Caruso, A.; Paradisi, G. Vaginal microbial flora and outcome of pregnancy. *Arch. Gynecol. Obstet.* **2010**, *281*, 589–600.
  79. Macklaim, J.M.; Fernandes, A.D.; Di Bella, J.M.; Hammond, J.A.; Reid, G.; Gloor, G.B. Comparative meta-RNA-seq of the vaginal microbiota and differential expression by *Lactobacillus iners* in health and dysbiosis. *Microbiome* **2013**, *1*.
  80. Hearps, A.; Gugasyan, R.; Srbinovski, D.; Tyssen, D.; Aldunate, M.; Anderson, D.J.; Cone, R.; Tachedjian, G. Lactic Acid, a Vaginal Microbiota Metabolite, Elicits an Anti-inflammatory Response from Vaginal and Cervical Epithelial Cells. *AIDS Res. Hum. Retroviruses* **2014**, *30*, A238–A239.
  81. Petrova, M.I.; Reid, G.; Vaneechoutte, M.; Lebeer, S. *Lactobacillus iners*: Friend or Foe? *Trends Microbiol.* **2017**, *25*, 182–191.
  82. Vaneechoutte, M. *Lactobacillus iners*, the unusual suspect. *Res. Microbiol.* **2017**, *168*, 826–836.
  83. Sakai, M.; Ishiyama, A.; Tabata, M.; Sasaki, Y.; Yoneda, S.; Shiozaki, A.; Saito, S. Relationship between cervical mucus interleukin-8 concentrations and vaginal bacteria in pregnancy. *Am. J. Reprod. Immunol.* **2004**, *52*, 106–112.
  84. Nikolaitchouk, N.; Andersch, B.; Falsen, E.; Strömbeck, L.; Mattsby-Baltzer, I. The lower genital tract microbiota in relation to cytokine-, SLPI- and endotoxin levels: Application of checkerboard DNA-DNA hybridization (CDH). *APMIS* **2008**, *116*, 263–77.
  85. Gupta, P.; Singh, M.P.; Goyal, K. Diversity of Vaginal Microbiome in Pregnancy: Deciphering the Obscurity. *Front. Public Heal.* **2020**, *8*, 326.
  86. Patterson, J.; Stull-Lane, A.; Girerd, P.; Microbiology, K.J.-; 2010, undefined Analysis of adherence, biofilm formation and cytotoxicity suggests a greater virulence potential of *Gardnerella vaginalis* relative to other bacterial-vaginosis. *ncbi.nlm.nih.gov*.
  87. Hale, L.P.; Swidsinski, A.; Mendling, W. Bacteria associated with bacterial vaginosis. *N. Engl. J. Med.* **2006**, *354*, 202.
  88. Fichorova, R.N.; Buck, O.R.; Yamamoto, H.S.; Fashemi, T.; Dawood, H.Y.; Fashemi, B.; Hayes, G.R.; Beach, D.H.; Takagi, Y.; Delaney, M.L.; et al. The Villain Team-Up or how *Trichomonas vaginalis* and bacterial vaginosis alter innate immunity in concert. *Sex. Transm. Infect.* **2013**, *6*, 460–6.
  89. Bradshaw, C.S.; Tabrizi, S.N.; Fairley, C.K.; Morton, A.N.; Rudland, E.; Garland, S.M. The Association of *Atopobium vaginae* and *Gardnerella vaginalis* with Bacterial Vaginosis and Recurrence after Oral Metronidazole Therapy. *J. Infect. Dis.* **2006**, *6*, 826–36.
  90. Pybus, V.; Onderdonk, A. A commensal symbiosis between *Prevotella bivia* and *Peptostreptococcus anaerobius* involves amino acids: potential significance to the pathogenesis of bacterial vaginosis. *FEMS Immunol. Med. Microbiol.* **1998**, *4*, 317–327.



91. Lawn JE, et al. Group B streptococcal disease worldwide for pregnant women, stillbirths, and children: why, what, and how to undertake estimates? *Clin. Infect. Dis.* **2017**, *6*, S89-99.
92. Parker, R.E.; Laut, C.; Gaddy, J.A.; Zadoks, R.N.; Davies, H.D.; Manning, S.D. Association between genotypic diversity and biofilm production in group B Streptococcus. *BMC Microbiol.* **2016**, *16*.
93. Mouldert, J.W. Interaction of Chlamydiae and Host Cells In Vitro. *Microbiol. Rev.* **1991**, *55*, 143–190.
94. Lal, J.A.; Malogajski, J.; Verweij, S.P.; de Boer, P.; Ambrosino, E.; Brand, A.; Ouburg, S.; Morré, S.A. Chlamydia trachomatis Infections and Subfertility: Opportunities to Translate Host Pathogen Genomic Data into Public Health. *Public Health Genomics* **2013**, *16*, 50–61.
95. Griffiss, J.M.; Lammel, C.J.; Wang, J.; Dekker, N.P.; Brooks, G.F. Neisseria gonorrhoeae Coordinately Uses Pili and Opa To Activate HEC-1-B Cell Microvilli, Which Causes Engulfment of the Gonococci †. *Infect. Immun.* **1999**, *67*, 3469–3480.
96. Sethi, S.; Singh, G.; Samanta, P.; Sharma, M. Mycoplasma genitalium: An emerging sexually transmitted pathogen. *Indian J. Med. Res.* **2012**, *136*, 942–955.
97. Hirt, R.P. Trichomonas vaginalis virulence factors: An integrative overview. *Sex. Transm. Infect.* **2013**, *89*, 439–443.
98. Fernandes, J.V.; de Araújo, J.M.G.; Fernandes, T.A.A. de M. Biology and natural history of human papillomavirus infection. *Open Access J. Clin. Trials* **2013**, *5*, 1–12.
99. Torcia, M.G. Interplay among vaginal microbiome, immune response and sexually transmitted viral infections. *Int. J. Mol. Sci.* **2019**, *20*.
100. Egawa, N.; Egawa, K.; Griffin, H.; Doorbar, J. Human papillomaviruses; Epithelial tropisms, and the development of neoplasia. *Viruses* **2015**, *7*, 3863–3890.
101. Witkin, S.S.; Linhares, I.M. Why do lactobacilli dominate the human vaginal microbiota? *BJOG An Int. J. Obstet. Gynaecol.* **2017**, *124*, 606–611.
102. Atashili, J.; Poole, C.; Ndumbe, P.M.; Adimora, A.A.; Smith, J.S. Bacterial vaginosis and HIV acquisition: A meta-analysis of published studies. *AIDS* **2008**, *22*, 1493–1501.
103. Wira, C.R.; Fahey, J. V.; Rodriguez-Garcia, M.; Shen, Z.; Patel, M. V. Regulation of mucosal immunity in the female reproductive tract: The role of sex hormones in immune protection against sexually transmitted pathogens. *Am. J. Reprod. Immunol.* **2014**, *72*, 236–258.
104. Aldunate, M.; Srbnovski, D.; Hearps, A.C.; Latham, C.F.; Ramsland, P.A.; Gugasyan, R.; Cone, R.A.; Tachedjian, G. Antimicrobial and immune modulatory effects of lactic acid and short chain fatty acids produced by vaginal microbiota associated with eubiosis and bacterial vaginosis. *Front. Physiol.* **2015**, *6*.
105. Van De Wijkert, J.H.H.M.; Borgdorff, H.; Verhelst, R.; Crucitti, T.; Francis, S.; Verstraelen, H.; Jaspers, V. The vaginal microbiota: What have we learned after a decade of molecular characterization? *PLoS One* **2014**, *9*.
106. van de Wijkert, J.H.H.M.; Morrison, C.S.; Brown, J.; Kwok, C.; Van Der Pol, B.; Chipato, T.; Byamugisha, J.K.; Padian, N.; Salata, R.A. Disentangling Contributions of Reproductive Tract Infections to HIV Acquisition in African Women. *Sex. Transm. Dis.* **2009**, *36*, 357–364.
107. Cools, P.; Jaspers, V.; Hardy, L.; Crucitti, T.; Delany-Moretlwe, S.; Mwaura, M.; Ndayisaba, G.F.; Van De Wijkert, J.H.H.M.; Vaneechoutte, M. A multi-country cross-sectional study of vaginal carriage of group B streptococci (GBS) and Escherichia coli in resource-poor settings: Prevalences and risk factors. *PLoS One* **2016**, *11*.
108. Wiesenfeld, H.; Manhart, L. Mycoplasma genitalium in women: current knowledge and research priorities for this recently emerged pathogen. *J. Infect. Dis.* **2017**, S389–S395.
109. Brotman, R.M. Vaginal microbiome and sexually transmitted infections: An epidemiologic perspective. *J. Clin. Invest.* **2011**, *121*, 4610–4617.
110. Gallo, M.F.; Macaluso, M.; Warner, L.; Fleenor, M.E.; Hook, E.W.; Brill, I.; Weaver, M.A. Bacterial Vaginosis, Gonorrhoea, and Chlamydial Infection Among Women Attending a Sexually Transmitted Disease Clinic: A Longitudinal Analysis of Possible Causal Links. *Ann. Epidemiol.* **2012**, *22*, 213–220.
111. Borgdorff, H.; Gautam, R.; Armstrong, S.D.; Xia, D.; Ndayisaba, G.F.; Van Teijlingen, N.H.; Geijtenbeek, T.B.H.; Wastling, J.M.; Van De Wijkert, J.H.H.M. Cervicovaginal microbiome dysbiosis is associated with proteome changes related to alterations of the cervicovaginal mucosal barrier. *Mucosal Immunol.* **2016**, *9*, 621–633.
112. Atashili, J.; Poole, C.; Ndumbe, P.M.; Adimora, A.A.; Smith, J.S. Bacterial vaginosis and HIV acquisition: A meta-analysis of published studies. *AIDS* **2008**, *22*, 1493–1501.
113. Bertini, M. Bacterial Vaginosis and Sexually Transmitted Diseases: Relationship and Management. In *Fundamentals of Sexually Transmitted Infections*; InTech, 2017.
114. Ziklo, N.; Huston, W.M.; Taing, K.; Katouli, M.; Timms, P. In vitro rescue of genital strains of Chlamydia trachomatis from interferon- $\gamma$  and tryptophan depletion with indole-positive, but not indole-negative Prevotella spp. *BMC Microbiol.* **2016**, *16*, 286.
115. Edwards, V.L.; Smith, S.B.; McComb, E.J.; Tamarelle, J.; Ma, B.; Humphrys, M.S.; Gajer, P.; Gwilliam, K.; Schaefer, A.M.; Lai, S.K.; et al. The cervicovaginal microbiota-host interaction modulates chlamydia trachomatis infection. *MBio* **2019**, *10*.
116. Di Paola, M.; Sani, C.; Clemente, A.M.; Iossa, A.; Perissi, E.; Castronovo, G.; Tanturli, M.; Rivero, D.; Cozzolino, F.; Cavalieri, D.; et al. Characterization of cervico-vaginal microbiota in women developing persistent high-risk Human Papillomavirus infection. *Sci. Rep.* **2017**, *7*.
117. Gao, W.; Weng, J.; Gao, Y.; Chen, X. Comparison of the vaginal microbiota diversity of women with and without human papillomavirus infection: A cross-sectional study. *BMC Infect. Dis.* **2013**, *13*.
118. Audirac-Chalifour, A.; Torres-Poveda, K.; Bahena-Román, M.; Téllez-Sosa, J.; Martínez-Barnetche, J.; Cortina-Ceballos, B.; López-Estrada, G.; Delgado-Romero, K.; Burguete-García, A.I.; Cantú, D.; et al. Cervical microbiome and cytokine profile at various stages of cervical cancer: A pilot study. *PLoS One* **2016**, *11*.
119. Woodworth, C. HPV innate immunity. *Front. Biosci. a J. virtual Libr.* p.d2058.
120. Lee, J.E.; Lee, S.; Lee, H.; Song, Y.M.; Lee, K.; Han, M.J.; Sung, J.; Ko, G.P. Association of the Vaginal Microbiota with Human Papillomavirus Infection in a Korean Twin Cohort. *PLoS One* **2013**, *8*.
121. Godoy-Vitorino, F.; Romaguera, J.; Zhao, C.; Vargas-Robles, D.; Ortiz-Morales, G.; Vázquez-Sánchez, F.; Sanchez-Vázquez, M.; De La Garza-Casillas, M.; Martinez-Ferrer, M.; White, J.R.; et al. Cervicovaginal fungi and bacteria associated with cervical intraepithelial neoplasia and high-risk human papillomavirus infections in a hispanic population. *Front. Microbiol.* **2018**, *9*.
122. Bienkowska-Haba, M.; Luszczek, W.; Myers, J.E.; Keiffer, T.R.; DiGiuseppe, S.; Polk, P.; Bodily, J.M.; Scott, R.S.; Sapp, M. A new cell culture model to genetically dissect the complete human papillomavirus life cycle. *PLoS Pathog.* **2018**, *14*, e1006846.
123. Tamarelle, J.; Thiébaud, A.C.M.; de Barbeyrac, B.; Bébéar, C.; Ravel, J.; Delarocque-Astagneau, E. The vaginal microbiota and its association with human papillomavirus, Chlamydia trachomatis, Neisseria gonorrhoeae and Mycoplasma genitalium infections: a systematic review and meta-analysis. *Clin. Microbiol. Infect.* **2019**, *25*, 35–47.
124. Nelson, D.; Bellamy, S.; Nachamkin, I.; sterility, R.N.-F. and; 2007, undefined First trimester bacterial vaginosis, individual microorganism levels, and risk of second trimester pregnancy loss among urban women. *Elsevier*.
125. Ravel, J.; Brotman, R.M.; Gajer, P.; Ma, B.; Nandy, M.; Fadrosch, D.W.; Sakamoto, J.; Koenig, S.S.K.; Fu, L.; Zhou, X.; et al. Daily temporal dynamics of vaginal microbiota before, during and after episodes of bacterial vaginosis. *Microbiome* **2013**, *1*.

126. Koedooder, R.; Mackens, S.; Budding, A.; Fares, D.; Blockeel, C.; Laven, J.; Schoenmakers, S. Identification and evaluation of the microbiome in the female and male reproductive tracts. *Hum. Reprod. Update* **2019**, *25*, 298–325.
127. Wang, X.; King Jordan, I.; Mayer, L.W. A Phylogenetic Perspective on Molecular Epidemiology. In *Molecular Medical Microbiology: Second Edition*; Elsevier Ltd, 2014; Vol. 1–3, pp. 517–536 ISBN 9780123971692.
128. Budding, A.E.; Grasman, M.E.; Lin, F.; Bogaards, J.A.; Soeltan-Kaersenhout, D.J.; Vandenbroucke-Grauls, C.M.J.E.; Van Bodegraven, A.A.; Savelkoul, P.H.M. IS-pro: high-throughput molecular fingerprinting of the intestinal microbiota. *FASEB J.* **2010**, *24*, 4556–4564.
129. Klint, M.; Fuxelius, H.H.; Goldkuhl, R.R.; Skarin, H.; Rutemark, C.; Andersson, S.G.E.; Persson, K.; Herrmann, B. High-resolution genotyping of Chlamydia trachomatis strains by multilocus sequence analysis. *J. Clin. Microbiol.* **2007**, *45*, 1410–1414.
130. Müller, E.E.; Venter, J.M.E.; Magooa, M.P.; Morrison, C.; Lewis, D.A.; Mavedzenge, S.N. Development of a rotor-gene real-time PCR assay for the detection and quantification of Mycoplasma genitalium. *J. Microbiol. Methods* **2012**, *88*, 311–315.
131. pemba foundation Available online: <http://pembafoundation.org/where.php> (accessed on Oct 13, 2020).
132. Alliance for Maternal and Newborn Health Improvement; Baqui, A.H.; Khanam, R.; Rahman, M.S.; Ahmed, A.; Rahman, H.H.; Moin, M.I.; Ahmed, S.; Jehan, F.; Nisar, I.; et al. Understanding biological mechanisms underlying adverse birth outcomes in developing countries: Protocol for a prospective cohort (AMANHI bio-banking) study. *J. Glob. Health* **2017**, *7*, 021201.
133. Ahmed, I.; Ali, S.M.; Amenga-Etego, S.; Ariff, S.; Bahl, R.; Baqui, A.H.; Begum, N.; Bhandari, N.; Bhatia, K.; Bhutta, Z.A.; et al. Population-based rates, timing, and causes of maternal deaths, stillbirths, and neonatal deaths in south Asia and sub-Saharan Africa: a multi-country prospective cohort study. *Lancet Glob. Heal.* **2018**, *6*, e1297–e1308.
134. Ministry of Health and Social Welfare Zanzibar Revolutionary Government of Zanzibar, Ministry of Health and Social Welfare Zanzibar Health Sector Reform, Strategic Plan II. 2006/7–2010/11. Available online: [https://www.healthresearchweb.org/files/Zanzibar Health Sector Reform Strategic Plan II 2007-2011.pdf](https://www.healthresearchweb.org/files/Zanzibar%20Health%20Sector%20Reform%20Strategic%20Plan%20II%202007-2011.pdf) (accessed on Oct 13, 2020).
135. Thairu, L.; Pelto, G. Newborn care practices in Pemba Island (Tanzania) and their implications for newborn health and survival. *Matern. Child Nutr.* **2008**, *4*, 194–208.
136. Kaljee, L.M.; Pach, A.; Thriemer, K.; Ley, B.; Ali, S.M.; Jiddawi, M.; Puri, M.; Von Seidlein, L.; Deen, J.; Ochiai, L.; et al. Utilization and accessibility of healthcare on Pemba Island, Tanzania: Implications for health outcomes and disease surveillance for typhoid fever. *Am. J. Trop. Med. Hyg.* **2013**, *88*, 144–152.
137. Francis, S.C.; Ao, T.T.; Vanobberghen, F.M.; Chilongani, J.; Hashim, R.; Andreasen, A.; Watson-Jones, D.; Chagalucha, J.; Kapiga, S.; Hayes, R.J. Epidemiology of Curable Sexually Transmitted Infections among Women at Increased Risk for HIV in Northwestern Tanzania: Inadequacy of Syndromic Management. *PLoS One* **2014**, *9*, e101221.
138. Ashton, R.A.; Bennett, A.; Al-Mafazy, A.W.; Abass, A.K.; Msellem, M.I.; McElroy, P.; Kachur, S.P.; Ali, A.S.; Yukich, J.; Eisele, T.P.; et al. Use of Routine Health Information System Data to Evaluate Impact of Malaria Control Interventions in Zanzibar, Tanzania from 2000 to 2015. *EClinicalMedicine* **2019**, *12*, 11–19.

If life gives you melons, you might be dyslexic

- Jay McLean



2

**Composition of the vaginal microbiota  
during pregnancy among women living in  
sub-Saharan Africa**

**Naomi C.A. Juliana, Remco P.H. Peters,  
Salwan Al-Nasiry, Andries E. Budding,  
Servaas A. Morré, Elena Ambrosino**

*Submitted to International Urogynecology Journal*

## ABSTRACT

**Background:** The vaginal microbiota (VMB) are the set of microorganisms residing in the human vagina. During pregnancy, their composition is *Lactobacillus*-dominant in most Caucasian women. Previous studies suggest that the VMB of women with African ancestry is more likely to be non-*Lactobacillus* dominant (dysbiotic) compared to other populations. This work reviewed the evidence on the VMB composition in pregnant women from sub-Saharan Africa.

**Methods:** A search was conducted in PubMed and Embase databases following PRISMA guidelines. Observational and intervention studies were included in which VMB communities from sub-Saharan African pregnant women were analyzed with molecular techniques.

**Results:** Ten studies conducted in seven sub-Saharan African countries were identified. These studies used different molecular based methods (e.g. 16S ribosomal RNA- or whole genome shotgun sequencing, PCR) to reported the VMB composition at different timepoints and in different groups; sexually transmitted infection (STI)-positive women, sex-workers, women who received folic-acid and iron supplements or *Lactobacillus*-based probiotics. These studies independently showed that a *Lactobacillus*-dominant VMB (in particularly *L. iners* or *L. crispatus*) or VMB containing Lactobacilli are the most prevalent, followed by a more diverse anaerobe-dominant VMB in pregnant women. The majority of pregnant women with a STI also had a *Lactobacillus*-dominant VMB but with a significantly higher presence of anaerobic species in their VMB.

**Conclusion:** In concordance with other populations, *Lactobacillus* species are also the most prevalent bacterial species during pregnancy in sub-Saharan African women. The frequency of diverse anaerobe-dominant VMB is also high in these populations. In Africa VMB pregnancy related studies are scant, heterogeneous in methodology, and therefore the knowledge remains limited. Since a diverse anaerobe-dominant VMB profile has been previously linked to adverse pregnancy outcomes, more insight about the VMB composition and its possible sequelae among these populations is needed. Extensive epidemiological studies using consistent reporting methods are also warranted.

## 2.1 INTRODUCTION

The number of studies on the microbial communities residing in the human vagina, the vaginal microbiota (VMB), and their role in female reproductive health has increased over the past two decades. Recent developments in molecular biology offer innovative opportunities for VMB profiling, but a full understanding of its role in reproductive health is still missing [1]. Usually, the VMB communities are characterized by the most dominant bacterial species, as it is the case for the Community State Types (CSTs) classification [2,3]. Studies in North America and Europe consistently show that most women of reproductive age, irrespective of the pregnancy status, have a VMB dominated by one of four *Lactobacillus* species: *Lactobacillus iners*, *Lactobacillus crispatus*, *Lactobacillus gasseri*, or *Lactobacillus jensenii* [2,3]. Lactobacilli can control the vaginal pH levels by producing lactic acid, which is one of the mechanisms maintaining eubiosis and protecting the vaginal milieu from pathogens. Recent studies show that women from African countries or African ancestry more often have a VMB composition that contains bacterial vaginosis (BV)-related bacteria compared to Caucasian women [2–8]. In these studies, the VMB composition was dominated by *Gardnerella vaginalis*, *Atopobium vaginae*, and other anaerobic species instead of by *Lactobacillus* species [2–8]. Some of these studies observed that most women from sub-Saharan African or with sub-Saharan African ancestry that displayed a non-*Lactobacillus*-dominant VMB did not have any clinical symptoms associated with bacterial vaginosis. This suggests the possibility of a healthy non-Lactobacilli-dominant VMB state [2,4,9,10]. It is possible that ethnicity, among other factors, influences the VMB composition, through host-genetic factors.

Understanding the role of VMB in health and disease becomes complex when comparing women with different ethnic backgrounds [2,9,11,12]. Besides ethnicity also, hormones influence the VMB. In early pregnancy, changes in hormone levels affect the VMB composition: *Lactobacillus* species are increased and *G. vaginalis* and other (facultative) anaerobic bacteria progressively decrease from the first to the third trimester [9,11,13–15]. Following these changes, the VMB remains relatively stable (especially compared to the non-pregnancy state) along most of the pregnancy. During pregnancy changes commonly entail transitions between different Lactobacilli species [7,14]. However, even in pregnancy, the frequency of *Lactobacillus*-dominant VMB among women of African ancestry is lower compared to women of European ancestry. Furthermore, women of African ancestry are more likely to switch from *Lactobacillus* dominated VMB to a VMB commonly associated with vaginal dysbiosis [7]. Vaginal dysbiosis has been related to various adverse pregnancy outcomes, including preterm birth and higher susceptibility to sexually transmitted infections (STIs) [1,10,16–18].

An exhaustive understanding of what constitutes a healthy/normal VMB is lacking. Such knowledge, including appreciation of how VMB composition might impact pregnancy outcomes, is of great importance in areas where the overall burden of pregnancy complications and infections is high [19,20]. Sub-Saharan Africa suffers a particularly high burden of these

conditions: this region has an estimated preterm birth rate of 12% in 2014, accounting for 25% of all preterm births globally. Between 2010 and 2015, the estimated STI prevalence in pregnancy was up to 4.6% for *Neisseria gonorrhoeae* (NG), 6.5% for syphilis, 7.2% for *Chlamydia trachomatis* (CT), 25% for *Trichomonas vaginalis* (TV), and mother-to-child transmission of the human immunodeficiency virus (HIV) ranged between 5-30% in sub-Saharan Africa [1,10,16,21–24].

There is increasing research interest in understanding how the VMB composition might contribute to, and offer a predictive diagnostic potential for reproductive health outcomes. To date, most VMB pregnancy-related studies and reviews are based on data from North-American and European cohorts of women. Factors influencing the VMB, such as the host (including host-genetics), behavioral (including sexual and cleaning practices), sociodemographic, nutritional, and environmental ones, are nonetheless different across geographical regions and cultures [12,25,26]. Comparing VMB composition across women of different populations and extrapolating data from one to explain health outcomes on others might not be an accurate approach [27,28].

This review aims to compile available data from original research that characterized the VMB composition among pregnant women living in sub-Saharan Africa. Insights from this review are expected to offer background evidence to assist in designing future observational studies to investigate the VMB's role on pregnancy outcomes and STIs. These are also expected to assist the design of future VMB-related intervention studies that aim to decrease vaginal dysbiosis and its related health problems in sub-Saharan African countries.

## 2.2 METHODS

Searches according to the Preferred Reporting Items for Systematic Review and Meta-Analysis Statement (PRISMA) guidelines were conducted in PubMed/Medline and Embase (Ovid) among studies published up to July 15th, 2020 (Supplementary Table 1) [29]. The used following keywords were used: “vaginal microbiome”, “vaginal microbiota”, “vaginal dysbiosis”, “bacterial vaginosis”, “Africa”, “sub-Saharan Africa”, “pregnant women”, “pregnancy”, and “pregnancy outcome”. To ensure all of the available studies were included, keywords “Africa” or “sub-Saharan Africa” were switched to the individual name of the 48 sub-Saharan African countries (as defined by the World Bank) [30]. The exact Medical Subject Heading (MeSH) and Embase subject heading (Emtree) terms, free-text terms, and combinations of these keywords are compiled in Supplementary Table 1. Lastly, bibliographies of articles with information about BV or VMB were examined, even if articles were excluded, to retrieve potential articles via snowballing. Cohort and intervention studies that reported the VMB composition in women living in sub-Saharan African countries were reviewed. Inclusion criteria were: studies on human participants, pregnancy at the time of sampling, participants recruited in sub-Saharan

African countries, as per World Bank classification [30]. Studies were excluded when data and analysis from pregnant and non-pregnant women were combined and when they performed culture-dependent VMB analysis and did not use molecular techniques. Reviews, case reports, abstracts from conferences and case series were also excluded. Studies were not restricted based on specific participant's characteristics, language or date of publication. The VMB results from molecular techniques reported at phylum, genus, or species level were included in this review. Characterization of vaginal microbial communities based on species' relative abundance or clustering reported by the studies were also summarized. Summary of VMB composition data from the intervention or case groups and placebo or non-intervention/control groups were reported separately in this review. Data from the non-interventional/control group might be representative of the VMB at the population-level. Data from the case group might inform on women's VMB status with specific health conditions, such as STIs, or taking compounds that can potentially modulate the VMB, such as medication or supplements.

## 2.3 SUMMARY AND DISCUSSION OF RESULTS

### 2.3.1 STUDY CHARACTERISTICS OF VAGINAL MICROBIOTA STUDIES

Searches in PubMed and Embase database yielded 475 records; an additional 135 records were further identified through snowballing. After the screening procedure, ten articles were included in this review (Figure 1). The characteristics of the retrieved studies are summarized in Table 1. These studies used different approaches to characterize the composition of VMB. However, all consistently clustered *Lactobacillus* species in other groups than anaerobic bacteria, e.g. *Gardnerella* species (Table 2 and Figure 2). Only one study characterized bacterial communities dominated by *Streptococci* and *Staphylococci* species, with a smaller Lactobacilli [31]. These ten included studies independently showed that a *Lactobacillus*-dominant VMB or VMB containing Lactobacilli are the most prevalent, followed by a more diverse anaerobe-dominant VMB in pregnant women living in South Africa, Burkina Faso, Rwanda, Kenya, Tanzania, Zambia, and Zimbabwe (Figure 2). Different study populations were included: (Table 1); two studies included results of known HIV-infected and HIV-uninfected women [32,33]. One study included new cases of CT and TV infections in their case-control study [18], and another study tested the VMB of pregnant sex-workers [27]. One study had a group receiving folic-acid and iron supplements and another group only folic acid supplements [34].

In comparison, two other studies had given their intervention group probiotic (live organisms intended to have health benefits) capsules and their control group placebo or no intervention [33,35]. The rest of the studies did an observational or cross-sectional analysis of one or more populations [8,9,36]. Most studies used (cervico)vaginal swabs for sampling, except the study by Frank et al. that used cervicovaginal lavage. The time of sampling was also different between the studies (Table 1). For bacterial detection, the included studies used molecular-based

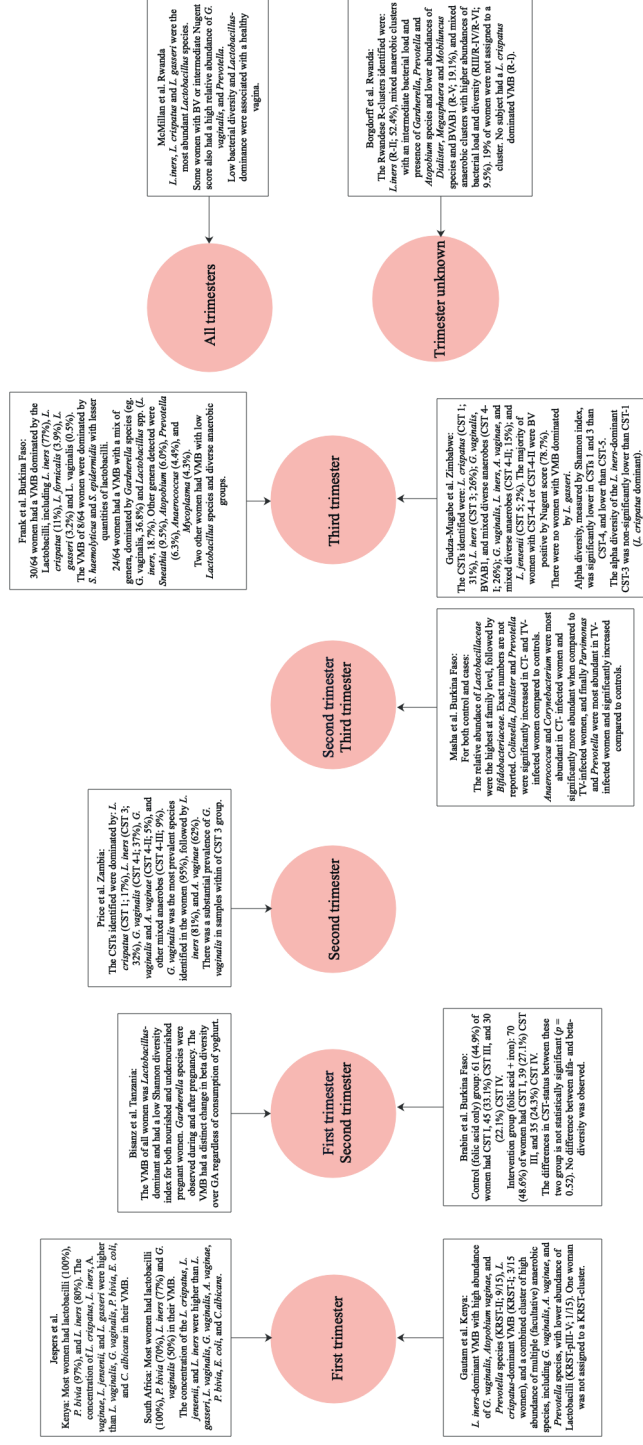
methods, such as pyrosequencing, Illumina MiSeq sequencing, Ion 16S Metagenomics™ Kit, DNA hybridization microarray of the variable regions of the 16S ribosomal (r) RNA gene, quantitative PCR, or whole-genome shotgun sequencing (Table 1). Three of the studies used the common VMB classification method by CSTs, as first described by Ravel et al. [2]. Two other studies developed, via the same manner, the Rwanda (R)-cluster and Kenya, Rwanda South Africa, Tanzania (KRST)-clusters [8,37]. However, no consistent set of VMB clusters, particularly when it comes to the most diverse VMB, was identified across the included studies (Table 2) [2,8,32,34,36,37].

**Table 1.** Study characteristics and VMB diversity findings of included articles that characterized the VMB composition in pregnant women in the sub-Saharan African region.

Author, year Country	Study design	Study population	Number of pregnant participants	Mean or range of Maternal age (years)	Gestational age at sampling (weeks)	Method /technique used to detect microbiota or vaginal microbiota dysbiosis
Frank et al. 2012 [31] Burkina Faso	Case-control (nested in within a prospective cohort MTCT prevention clinical trial of azidothymidine and the microbicide benzalkonium chloride.)	HIV-1 infected pregnant women at 36-38 GA weeks (and their live- born children)	64 women (10 whose babies had a MTCT of HIV and 54 with uninfected babies)	21-27	36-38	16S rRNA pyrosequencing
Borgdorff et al. 2015 [37] Rwanda	Prospective cohort	Sex-workers	61	24 (19-44)	NR	DNA hybridization microarray of 16S rRNA gene probes
Gautam et al. 2015 [8] Kenya	Multi-country prospective observational cohort study	Pregnant women < 14 GA weeks	15	NR	NR	16S rDNA phylogenetic microarray
Jespers et al. 2015 [9] Kenya.	Cross-sectional	Pregnant women < 14 weeks gestation	30	24-26	NR	Quantitative PCR
Jespers et al. 2015 [9] South Africa.			30	24-26	NR	Quantitative PCR
Bisanz et al. 2015 [33] Tanzania	Open-label study	Healthy pregnant women between 18-40 years and a GA 12-24 weeks	-23 women that that received moringa- supplemented probiotic yogurt. -24 women without intervention.	24	20	Illumina MiSeq sequencing of the V4 rRNA gene region of the 16S rRNA gene

<i>Brabin et al. 2017</i> [34] <i>Burkina Faso</i>	Healthy nulliparous women between 15-24 years -136 women in folic acid group CST was determined -136 women in folic acid group CST was determined	double blind, non-inferiority, RCT. -intervention: folic acid + iron supplements -Control: folic acid supplement	- 144 women in folic acid+ iron-arm group CST was determined	17.1 (both groups)	NR (13-15) (both groups)	Schloss wet-lab MiSeq sequencing of the V4 rRNA gene region of the 16S rRNA gene
<i>McMillan et al. 2018</i> [38] <i>Rwanda</i>	Healthy pregnant women between 18-55 years and a GA < 36 weeks - 13 women remained in the placebo arm one month after visit 1.	RCT, blinded and placebo controlled - intervention: probiotic capsules - control: placebo	-18 women in the placebo arm visit at -13 women remained in the placebo arm one month after visit 1.	27.6	22 (8-32)	Illumina MiSeq sequencing of the V6 rRNA gene region of the 16S rRNA gene
<i>Price et al. 2019</i> [36] <i>Zambia</i>	Pregnant women <24 GA weeks	Cross-sectional	Pregnant women <24 GA weeks	27 (22-32)	18 (17-19)	Whole genome shotgun sequencing
<i>Masha et al. 2019</i> [18] <i>Burkina Faso</i>	Pregnant women, 18-45 years, ≥14 weeks, and resident of the study area - Cases: TV or CT cases - Controls: women that were negative for TV, CT, and bacterial vaginosis	nested case-control study - Cases: TV or CT cases - Controls: women that were negative for TV, CT, and bacterial vaginosis	-18 TV cases -14 CT cases -21 control	NR In category groups: TV cases: - 18-24: 38.9% - ≥ 25: 6.1% CT cases: - 18-24: 64.3% - ≥ 25: 35.74% Control: - 18-24: 28.6% - ≥ 25: 71.4%	NR In category groups: TV cases: - 14-27: 55.6% - ≥ 28: 44.4% CT cases: - 14-27: 53.9% - ≥ 28: 46.2% Control: - 14-27: 66.7% - ≥ 28: 33.3%	Ion 16S MetagenomicsTM Kit primer set for V2-4-8 amplification of the 16S rRNA gene
<i>Gudza-Mugabe et al. 2019</i> [32] <i>Zimbabwe</i>	Pregnant women > 18 years and a GA of 15 - 35 weeks	Cross-sectional study design	356 (42 HIV-infected and 314 HIV-uninfected women)	29 (24-34)	29 (25-33)	Sequencing of the V4 hypervariable regions of the 16S rRNA gene

16S ribosomal ribonucleic acid (rRNA) gene. ANC, antenatal care. Antiretroviral therapy. ART. BV, bacterial vaginosis. CI, confidence interval. CT, *Chlamydia trachomatis*. GA, gestational age. HIV, human immunodeficiency virus. MTC-T, mother-to-child transmission. NR, not reported. OR, odds ratio. PCR, Polymerase Chain Reaction. RCT, randomized control trail. TV, *Trichomonas vaginalis*. VMB, vaginal microbiota. NR, not reported.



**Figure 1.** Main findings of vaginal microbiota in studies conducted among sub-Saharan African pregnant women. Illustration is based on collection timepoint (trimesters) during pregnancy. BV, bacterial vaginosis. BYAB1, Bacterial Vaginosis Associated Bacteria 1. CST, community state types numeric system described by Ravel et al. [2]. CT, *Chlamydia trachomatis*. KRST-clusters, vaginal microbiota cluster method in Kenyan, Rwandese, South African and Tanzanian women as describe in Gautam et al.[8]. R-clusters, vaginal microbiota cluster method in Rwandese women as described in Borgdorff et al.[39]. TV, *Trichomonas vaginalis*. VMB, vaginal microbiota.



### 2.3.2 THE VAGINAL MICROBIOTA THROUGHOUT THE PREGNANCY AMONG PREGNANT AFRICAN COHORTS

Pregnancy is characterized by high circulating estrogen levels produced by the ovaria/oocyte and later the placenta [40]. High levels of estradiol promote glycogen deposition in the vaginal epithelium that supports proliferation of various *Lactobacillus* species abundance [3,41]. Both Estrogen levels and microbiota composition change over the course of the pregnancy. It is essential to consider the stage of pregnancy at sample collection when interpreting or comparing findings of different studies because VMB dysbiosis at the end of the pregnancy might not have the same impact as VMB dysbiosis earlier on [1,42,43]. Previous studies in North America showed that the diversity of VMB is highest during the first trimester of pregnancy and declines during the second and third trimester, possibly due to yet rising estrogen levels [44–46].

Two studies included in this review collected specimens in the first trimester (<13 weeks gestational age (GA)) (Figure 2). In Kenyan women less than 14 weeks of gestation, the most common VMB cluster observed was *L. iners*-dominant in conjunction with a high abundance of *G. vaginalis*, *A. vaginae*, and *Prevotella* species (60%); this was followed by an *L. crispatus*-dominant VMB cluster (20%) [8]. However, Jesper et al. only reported the presence of microorganisms and not their relative abundance, they did observe that the *Lactobacillus* genus was present in all 30 Kenyan pregnant women at 14 weeks of gestation, followed by *P. bivia* (97%), *L. iners* (80%), and *G. vaginalis* (50%) [9]. These microorganisms were also observed in 30 South African pregnant women at 14 weeks of gestation. However, in this latter cohort, fewer women (70%) had *P. bivia* in their VMB, than in the Kenyan one [9]. In South Africa, the *Lactobacillus* species *L. crispatus*, *L. jensenii*, *L. gasseri*, *L. vaginalis* were detected, along with *A. vaginae*, *E. coli*, and *C. albicans* [9].

Two studies reported the VMB of pregnant women in the first and the second trimester (13-27 weeks GA) (Figure 2). Bisanz et al. reported that all 42 tested pregnant Tanzanian women around 20 weeks of gestation (range 12-24 weeks GA) had a *Lactobacillus*-dominant VMB [33]. Still, unfortunately, the species of Lactobacilli were not identified [33]. Between 13-15 GA weeks' were *Lactobacillaceae* again observed as the dominant VMB bacterial family among 478 Burkinabe pregnant women [34]. In the 220 Burkinabe women, belonging to the control group (only took folic acid supplements), a *Lactobacillus*-dominant VMB were present in 78% of participants, *L. crispatus* in 44.9% and *L. iners* in 33.1% [34]. The remaining Burkinabe pregnant women (22.1%) had a diverse VMB with reduced Lactobacilli [34].

Moreover in 96 HIV-infected and 158 HIV-uninfected Zambian pregnant women had a *Lactobacillus*-dominant VMB, either by *L. iners* (32%) or *L. crispatus* (17%) during the second trimester of the pregnancy [36] (Figure 2). Ninety-five percent of women carried *G. vaginalis*, and 42% of women had a *G. vaginalis*-dominant VMB [36]. Other common species present in the VMB in the Zambian cohort were *L. iners* (81%) and *A. vaginae* (62%) [36].

Masha et al. included samples collected in the second and third trimester ( $\geq 14$  weeks GA) and identified *Lactobacillaceae* as the dominant VMB bacterial family among 53 pregnant Kenyan women [18] (Figure 2).

The two studies that reported the VMB composition at the third pregnancy trimester (>27 weeks GA) also reported that most Burkinabe and Zimbabwean women had *Lactobacillus*-dominant VMB. In Burkina Faso, 47% of women had a *Lactobacillus*-dominant VMB, while 37.5% of them had a VMB dominated by both *Gardnerella species* and *L. iners* [31]. In 314 HIV-uninfected and 42 HIV-infected Zimbabwe pregnant women, the *Lactobacillus* species were further identified. The majority of pregnant women in that cohort had a VMB dominated by *L. crispatus* (31%), subsequently by *L. iners* (26%), and *L. jensenii* (2%), followed by a diverse VMB with various mixed anaerobes bacteria, including *G. vaginalis* (41%) [32]. Another study identified *Lactobacillaceae* as the dominant VMB bacterial family among 38 Rwandan pregnant women across all trimesters (20 women who received *Lactobacillus rhamnosus GR-1* and *Lactobacillus reuteri RC-14* and 18 women who received placebo) [35] (Figure 2).

Lastly, Borgdorff et al. did not report sampling time [37] (Figure 2). But like the other studies, they observed that during pregnancy, *Lactobacillus* species were most prevalent among 21 Rwandese pregnant women, in particular *L. iners* [37]. The second most prevalent VMB composition in Rwandese pregnant women were women with diverse anaerobic communities and BV-related bacteria, such as *Gardnerella* and *Prevotella species* [37,38].

These sub-Saharan African studies, irrespective of sampling time and population reported that most women had a VMB *Lactobacillus*-dominant VMB composition or high concentrations of *Lactobacillus species* in their VMB. However, the frequency of a diverse anaerobic VMB was also increased in these populations (Figure 2). Based on the higher frequency of a diverse anaerobic VMB in the sub-Saharan African population and women with African ancestry, two hypotheses were drawn [7,47,48]. Firstly, it might be that the role of hormones, in particular estradiol, is not as influential on the VMB during pregnancy as host-genetic factors. Secondly, since a diverse anaerobic VMB is common among non-pregnant sub-Saharan African women [2–8], the VMB composition during the pregnancy might remain diverse because there is already a high presence of anaerobic bacteria before pregnancy. Future longitudinal studies containing information on the VMB composition before, during, and after pregnancy might provide information on the VMB composition changes between these periods and whether the VMB before pregnancy influences the VMB during pregnancy in sub-Saharan African populations.

### 2.3.3 VAGINAL MICROBIOTA COMMUNITIES BY CLUSTERING

To date, there is no consensus on how best to classify VMB communities (Table 2) [42]. Most of the studies in our review showed that a *Lactobacillus*-dominant VMB is the most prevalent vaginal microbiota in tested pregnant women despite differences in methodology and definitions [8,18,31–34,36–38,49]. This evidence is in line with findings from other populations



in Asia, North-America, and Europe [3,11,50]. Independent of the type of clusters used to classify the VMB and the gestational age at sampling when speciated, *L. iners* was the most pervasive *Lactobacillus* species detected, followed by *L. crispatus* [8,9,31,33,34,36,38] (Figure 2). Unlike pregnant cohorts in Europe and North America, the second most prevalent VMB composition detected in Burkina Faso, Rwanda, and Zambia were diverse VMB clusters with high abundances of anaerobic bacteria, in most cases *G. vaginalis* [3,11,31,36,37]. Several factors have been proposed to contribute to women becoming tolerant to a non-*Lactobacillus* dominant vaginal milieu, such as genetic variation, like polymorphism in the immune and hormone-response genes, for instance single nucleotide polymorphisms in TLR4 (rs1554973 and rs7856729 or anti-inflammatory interleukin-10 (*IL10*-819 T/T and *IL10*-1082 A/A) [51–56]. Several studies observed that host genetics, via polymorphism in immune-related genes, increases colonization of specific bacteria in the vagina [57–60]. Interestingly, women with African ancestry carry polymorphisms in cytokine genes, making them more susceptible to inadequately respond to lipopolysaccharides (LPS) and develop vaginal dysbiotic conditions, such as BV [17,61]. The high frequency of a more diverse VMB and anaerobic composition observed among sub-Saharan African (pregnant) women are in agreement with the high prevalence of BV (proximally 40%) also observed among sub-Saharan African women [6,26,52]. Early-life exposure to non-*Lactobacillus* dominant VMB may mediate the host immunological reaction to microbiota species and nurture immunological tolerance [52]. Genetic variations and host immunological mediators may partially clarify the VMB composition variability across ethnicities, but more evidence is warranted [3,5,61].

In pregnant Zimbabwean women, the prevalence of *L. crispatus*-dominant VMB was slightly higher than the prevalence of *L. iners*-dominant VMB or VMB with a high abundance of *G. vaginalis*, Bacterial vaginosis-associated bacterium 1 (BVAB1), and mixed diverse anaerobic bacteria [32]. Interestingly, none of the pregnant Rwandan sex-workers had an *L. crispatus* dominant VMB [37]. These observations are in line with results from pregnant African-American women in which *L. iners* and diverse anaerobic VMB were the most dominant VMB [47,48]. Unfortunately, Jesper et al., Bisanz et al., and Masha et al. did not report the dominant species in the VMB of their South-African, Kenyan, Tanzanian, or Burkinabe pregnant cohort [9,18,33]. Masha et al. and Bisanz et al. independently characterized the VMB based on the genus and reported separately that the relative abundance of the *Lactobacillus* genus was the highest in their cohort from Burkina Faso and Tanzania, respectively [18,33]. Their findings are in concordance with the results of Brabin et al. also reporting a high prevalence of *Lactobacillus*-dominant VMB clusters (*L. crispatus* and *L. iners*) in Burkinabe women [34]. Jesper et al. did report that all pregnant women tested in both countries had *Lactobacillus* genus in their VMB, *P. bivia* (70%), and *G. vaginalis* (50%) were also detected in the majority of women in South Africa [9]. In Kenya, 97% of pregnant women had *P. bivia* present in their VMB [9]. Petrova et al. reviewed and proposed how the various VMB composition clusters, as classified by CSTs, can be associated with vaginal health or dysbiosis [62]. It has been suggested multiple

times that VMB dominated by *L. crispatus*, *L. gasseri*, or *L. jensenii* relates to a healthy vaginal state and an overgrowth of anaerobes as *Gardnerella*, *Atopobium*, and *Prevotella* species most likely contributes to a dysbiotic-BV state. However, it is unclear whether the VMB clusters consistent with the presence of modest *Lactobacillus* species with a higher relative abundance of anaerobic bacteria, such as BVAB1, *G. vaginalis*, *A. vaginae*, but without an overgrowth of anaerobes bacteria, associate with a healthy vaginal state or with a transitional state of the vaginal milieu to a BV state [62]. Shifts from eubiosis to dysbiosis, and vice-versa, remain unpredictable processes, and their causes are not yet understood [63].

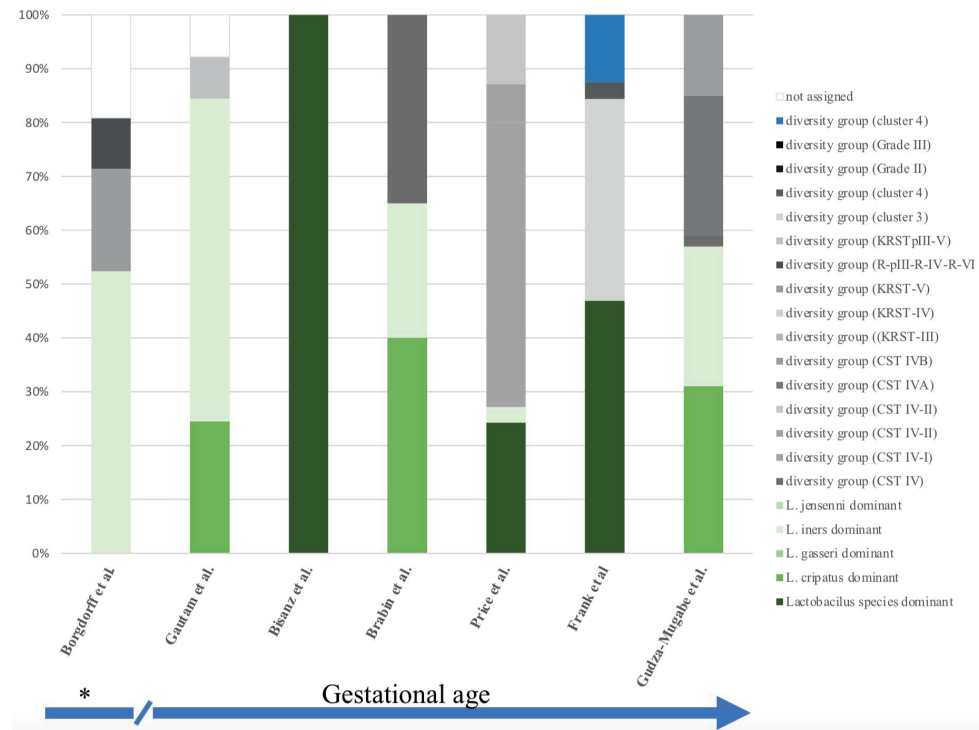
Moreover, it is unclear what type of vaginal state is associated with a *L. iners*-dominated VMB [28]. Unlike the other *Lactobacillus* species, *L. iners* does secrete some amounts of hydrogen peroxide (H<sub>2</sub>O<sub>2</sub>), but not D-lactic acid, both common secretory products of most *Lactobacilli* [64]. Several data showed that VMB-dominated by *L. iners* are more likely to transition to a BV-associated VMB and offer limited protection against vaginal dysbiosis, clearance of urogenital pathogens, and might be a risk factor to adverse pregnancy outcomes [39,64,65]. However, the debate about what composition defines a healthy and unhealthy VMB is ongoing, especially across different ethnic populations. Further investigation should determine what the exact role of an *L. iners*-dominant VMB and a diverse VMB are on the vaginal state, especially in the sub-Saharan population where the prevalence of these VMB compositions are high.

**Table 2.** Different types of vaginal microbiota clusters in pregnant women in the sub-Saharan African region.

Included articles that used VMB clustering	Price et al.	Gudza et al.	Brabin et al.	Borgdorff et al.	Gautam et al.	Bisanz et al.	Frank et al.	Donders et al.
Name of cluster	Community state type (CST)		ClusterR	Cluster KRST	Not formulated	Genus-level clustering	morpho-types grades	
<i>Lactobacillus</i> dominant					✓	Cluster I	Grade I	
<i>L. crispatus</i> dominant	CST-I	CST-I	CST-I	R-I	KRST-I			
<i>L. gasseri</i> dominant	CST-II	CST-II						
<i>L. iners</i> dominant	CST-III	CST-III	CST-III	R-II	KRST-II			
<i>L. jensenii</i>	CST-V	CST-V						
Diversity group: Higher proportions of strictly anaerobic bacteria, including <i>Prevotella</i> , <i>Dialister</i> , <i>Atopobium</i> , <i>Gardnerella</i> , <i>Megasphaera</i> , <i>Peptoniphilus</i> , <i>Sneathia</i> , <i>Eggerthella</i> , <i>Aerococcus</i> , <i>Finegoldia</i> , and <i>Mobiluncus</i> .	CST-IV							
Diversity group: High abundances of <i>Gardnerella</i> , <i>Prevotella</i> and <i>Atopobium</i> species and lower abundances of <i>Dialister</i> , <i>Megasphaera</i> and <i>Mobiluncus</i> species and BV/ABI and the presence of a lower abundance of <i>L. iners</i> .				R-III	KRST-III			
Diversity group: Higher proportions of strictly anaerobic bacteria, especially <i>G. vaginalis</i> , <i>L. iners</i> , and <i>A. vaginae</i> .	CST-IVA							
Diversity group: Higher proportions of strictly anaerobic bacteria, especially <i>G. vaginalis</i> , <i>L. iners</i> , and <i>A. vaginae</i> .	CST-IVB							
Diversity group: High abundances of <i>Gardnerella</i> , <i>Prevotella</i> and <i>Atopobium</i> species and lower abundances of <i>Dialister</i> , <i>Megasphaera</i> and <i>Mobiluncus</i> species and BV/ABI, <i>L. iners</i> , and high abundance <i>Gardnerella</i> genus.	CST-IV-I			R-IV	KRST-IV			

Diversity group: High abundances of <i>Gardnerella</i> , <i>Prevotella</i> and <i>Atopobium</i> species and lower abundances of <i>Dialister</i> , <i>Megasphaera</i> and <i>Mobiluncus</i> species and BV/ABI, and lower total bacterial abundance than the other mixed anaerobic clusters.				R-V	KRST-V			
Diversity group: High abundances of <i>Gardnerella</i> , <i>Prevotella</i> and <i>Atopobium</i> species and lower abundances of <i>Dialister</i> , <i>Megasphaera</i> and <i>Mobiluncus</i> species and BV/ABI, <i>L. iners</i> , and highest levels of <i>Prevotella</i> species.				R-VI	KRST-VI			
Diversity group: Higher proportions of strictly anaerobic bacteria and <i>G. vaginalis</i> , and <i>Atopobium</i> vaginae.	CST-IV-II							
Diversity group: Higher proportions of strictly anaerobic bacteria other than <i>G. vaginalis</i> and <i>Atopobium</i> vaginae.	CST-IV-III							
Diversity group: pooled dysbiotic clusters.					KRST-pIII-V		Cluster 3	
Diversity group: Mixed of variety of genera, dominated by <i>Gardnerella</i> spp. and <i>Lactobacillus</i> spp.							Cluster 4	
Diversity group: low <i>Lactobacillus</i> spp. and diverse anaerobic groups (eg, <i>Prevotella</i> , <i>Sneathia</i> , <i>Peptostreptococcus</i> )								Grade II
Diversity group: lesser <i>Lactobacillus</i> spp mixed with other bacteria.								Grade III
Diversity group: Absence of <i>Lactobacillus</i> spp or overwhelming presence of other bacteria (not specified).				CST IV				
Diversity group: Dominated by coagulase-negative staphylococci ( <i>S. haemolyticus</i> and <i>S. epidermidis</i> ) with lesser quantities of <i>Lactobacilli</i>							Cluster 2	

CST, community state types numeric system described by Ravel et al, [2]. R-clusters, vaginal microbiota cluster method in Rwandese women as described in Borgdorff et al. [37]. KRST-clusters, vaginal microbiota cluster method in Kenyan, Rwandese, South African and Tanzanian women as describe in Gautam et al. [8].



**Figure 2.** Percentages pregnant women living in sub-Sahara Africa corresponding to certain vaginal microbiota clusters. \*Unknown time range of sampling. Colors and abbreviations are correspondent to data in Table 3.

### 2.3.4 THE VAGINAL MICROBIOTA COMPOSITION OF WOMEN CARRYING A SEXUALLY-TRANSMITTED PATHOGEN

Globally, 70% of all people living with HIV live in sub-Saharan Africa [17,52,66]. The articles by Frank et al. and Price et al. provide an essential insight into the role of HIV in the VMB of pregnant women living in the region with the global highest burden of HIV and other STIs [31,36]. A high frequency of vaginal dysbiosis were observed in both studies (Figure 2). In non-pregnancy studies it was reported that the most common clinical diagnosis of vaginal dysbiosis (BV) was associated with a 60% increase in the risk of acquiring HIV after exposed, and that presence of *L. crispatus* associates with suppression of viral replication and virus inactivation [67–70]. As mentioned before, *Lactobacillus* species, other than *L. iners*, are important to vaginal health as they produce antimicrobial molecules. For instance,  $H_2O_2$  and other bacteriocins can destroy urogenital pathogens, and lactic acid can inhibit pathogenic bacteria's growth and disrupt the bacterial cell membranes, thereby contributing to the host immune response to bacterial liposaccharides [67]. Lactic acid is thought to be the main regulator of “healthy” vaginal function, rather than *Lactobacillus* species, since the vaginal tracts of asymptomatic

women with a diverse VMB are also dominated by taxa that produce lactic acid [62]. Women with low production of lactic acid and vaginal dysbiosis have a higher risk of acquiring STI when exposed and of adverse reproductive and obstetric sequelae [67,71].

Luckily, antiretroviral therapy (ART) and associated approaches for the prevention of MTCT are becoming more standard practice in most sub-Saharan African settings [72–75]. Price et al. observed that the prevalence of anaerobes dominated VMB, or CST IV, was higher among HIV-infected women taking ART prior to conception (63.5%) and among the non-ART group (85.3%), compared to HIV uninfected participants (45.3%) [36]. They also reported an association between an anaerobic- dominant VMB, maternal HIV infection, and ART timing before or during the pregnancy [36]. Future studies are needed to investigate whether specific interventions, such as ART, antibiotics, and probiotics, can modulate the VMB into a healthy state, which might be different based on ethnicity, and might lower the risk of HIV acquisition and MTCT.

Besides HIV, other STIs are highly endemic in sub-Saharan Africa, including TV and CT, and have been associated multiple times with vaginal dysbiosis, lower Lactobacilli levels, and alkaline vaginal milieu [67,76–78]. Brabin et al. reported in their study that TV and BV were associated ( $P < 0.01$ ) with a more diverse and anaerobic VMB composition in Burkinabe pregnant women [34]. Even though in their cohort, most women with *T. vaginalis* (80%) had a *Lactobacillus*-dominant VMB [34].

The included study by Masha et al. characterized the VMB profiles in TV- and CT-infected, and non-infected pregnant women in Kenya [18]. Lactobacilli were the most abundant in all three groups. The VMB of the three groups of women were different from each other (*Collin-sella*, *Dialister*, and *Prevotella* were significantly more present in the infected groups) [18]. In CT-infected pregnant women, *Anaerococcus* and *Corynebacterium* were most abundant compared to TV-infected women or controls. In line with other studies' observations, in TV-infected women, *Parvimonas* and *Prevotella* were most abundant and significantly more present compared to controls [79]. The anaerobes *Prevotella*, *Anaerococcus*, *Parvimonas* (formerly *Peptostreptococcus*), and *Dialister* have been observed frequently in women with vaginal dysbiosis (with CST IV) or BV; however, it is still unclear what the role of *Parvimonas*, *Anaerococcus*, *Dialister*, and *Corynebacterium* is in the pathology of TV and CT infections and its effect on the VMB state [1,18]. Therefore, the interplay between VMB and STIs should be further investigated in in-vitro models or samples from women living in a high-risk population. Such findings are crucial for vulnerable populations with high STI prevalence, such as pregnant women in sub-Saharan Africa countries.

### 2.3.5 EFFECT OF PROBIOTICS, VITAMINS, AND MINERAL ON THE VMB DURING PREGNANCY

Besides, the high burden of STIs, malnutrition, or undernourishment is also prevalent in low-income areas in sub-Saharan Africa, especially among pregnant women [80]. Currently,

vitamins and minerals (especially folic acid and iron) are recommended during pregnancy for every woman across sub-Saharan Africa, particularly for undernourished women. Brabin et al. did not observe any association between VMB composition, extra iron supplements, and host iron status in pregnant Burkinabe women [34].

McMillan et al. and Bisanz et al. aimed to examine whether probiotics containing specific Lactobacilli would alter the VMB composition during pregnancy in Rwandese (probiotic *L. rhamnosus* GR-1 combined with *L. reuteri* RC-14) and Tanzanian (probiotic *Lactobacillus rhamnosus* GR-1 and supplement of *Moringa oleifera* (Moringa) rich in vitamin A, proteins, carbohydrate, fiber, minerals, calcium, magnesium, phosphorus, potassium, copper, iron, zinc, and manganese) women, respectively [33,38]. Unfortunately, VMB data solely from the control group was not reported in Bisanz et al. [33]. However, their data were still included in this review because similar to McMillan et al., they explicitly mentioned that there was no difference in the VMB composition between the probiotic group and the control group [33,38]. Interestingly, McMillan et al. did report that the Rwandese women in the calcium carbonate placebo group were significantly more likely to give birth preterm than women in their probiotic group [38]. However, both groups' sample sizes were too small to draw a final conclusion [38]. The relationship between these pregnancy outcomes with their respective VMB was not further analyzed or discussed [38].

Different *Lactobacillus*-based probiotics, made with mixtures of *Lactobacillus* species, *Bifidobacterium*, and *Streptococcus* strains have been studied [16,81]. Lately, the use of probiotic (containing *Lactobacillus* strains, mostly *Lactobacillus rhamnosus*) have been claimed to restore *Lactobacillus*-dominated VMB in women with BV [82–84]. The two included intervention studies also proved that probiotic supplements are safe for use. However the probiotic adherence (important feature of probiotics associated with their potential for colonization) to the human vagina mucus and the cost-effective strategies for its implementation should also be considered [33,38]. Ideally, there is need for a cost-effective treatment that targets specific pathobionts (commensal microorganisms with pathogenic potential) or dysbiosis-associated anaerobes while sparing *Lactobacillus* species could restore VMB eubiosis and simultaneously nourish malnourished (pregnant) women in resources-constrained settings.

### 2.3.6 VMB CHARACTERISTICS AND PREGNANCY OUTCOME

VMB characteristics, or presence of pathobionts, have been linked to various maternal, fetal health issues and adverse pregnancy outcomes, primarily preterm birth, but also chorioamnionitis, premature rupture of membranes, stillbirth, preeclampsia [14,85–89]. The retrieved studies that analyzed the VMB by molecular approaches did not investigate the association between VMB and an adverse pregnancy outcome. To our knowledge, to date, there is only one culture-based study that analyzed the relationship between VMB and late pregnancy complications (after 20 weeks' gestation) in sub-Saharan African pregnant women. Donders et al. observed that South African women with little or no Lactobacilli were 3.6 times more likely to have an

infant with low birthweight (<2 kg) compared to women with a high abundance of Lactobacilli [90]. Discussion on the mechanisms behind this possible causal effect of VMB dysbiosis on several adverse pregnancy outcomes were previously reviewed and are outside the scope of this review [1,91]. Nevertheless, there is a need for future studies using newer molecular diagnostic techniques to confirm these findings and determine whether low birthweight, preterm birth, or other adverse pregnancy outcomes are generally associated with maternal VMB composition in sub-Saharan African women.

### 2.3.7 LIMITATIONS AND FUTURE CONSIDERATIONS

The heterogeneity of results included in this review is high since different study designs were included, different study populations (from sex-workers to people with low sexual and reproductive risk behavior), and studies that used diverse molecular approaches. Pyrosequencing and Illumina MiSeq sequencing-of the 16S ribosomal (r)RNA gene allow for an unprecedented high-resolution detection of the microbiota [92]. However, microarray approaches, like that used by Borgdorff et al., cannot detect genes of species that are not a priori included in the array [37]. Furthermore, comparing 16S rRNA gene sequencing results from different studies should also be done carefully since there is a lack of standardization in methodologies used to prepare samples and analyze the VMB results [93]. Also, each variable (V)16S rRNA region has a different resolution to identify bacterial strains; for instance, the V2-V3 fragment has the highest resolution to detect species and genera [94]. These technical differences can also result in under- or overrepresentation of a bacterial taxon [42,95].

The present review identified many research gaps. It is still unclear what the mechanism behind a healthy and balanced VMB is [42]. The role of common vaginal bacteria in pregnant sub-Saharan African women, such as *L. crispatus* (mostly present in a eubiotic state), *L. iners* (which has a possible role in both dysbiosis and eubiosis), *Prevotella* species, *G. vaginalis*, *Atopobium* species (present in eubiosis, but more abundant in dysbiosis) is still not clearly understood. Furthermore, the number of different dysbiotic clusters reported in this review (Table 2) and the high prevalence of *L. iners* and *G. vaginalis* among pregnant sub-Saharan women might indicate eubiosis or healthy VMB, rather than a transitional or abnormal VMB as seen in other ethnic populations [36,96]. A multi-country study and a more tailored sub-classification of the VMB characterized by high diversity might be more relevant in the African population than in other populations. The clinical and biological relevance of defining the VMB by clusters also remains to be further investigated in women from sub-Saharan Africa [42]. Deciphering the relationship between host, VMB, and the immune system can even provide therapeutic intervention strategies, for instance, pro- or antibiotics, that might benefit maternal health [1]. To do so in a more personalized manner, the host ethnicity's role should also be taken into account.

Furthermore, the role of pathogens on VMB composition, especially STIs that have a high incidence and prevalence, the latest estimate was made in 2012, where in Africa there were 357

million new episodes of four curable STIs (chlamydia, gonorrhoea, syphilis, and trichomoniasis) [97]. These STIs also cause a high burden of disease in African communities, should also be further evaluated [17,18,32,36]. Moreover, interventions with dietary strategies, including human colostrum/milk or prebiotics/probiotics, have already been studied in preterm infant and early pregnancy development after in-vitro fertilization [16,81]. Considering the possible association between individual VMB states and adverse pregnancy outcomes, affordable and easily accessible interventions that beneficially modulate the VMB should be evaluated and are urgently needed [14].

## 2.4 CONCLUSION

This study provides an overview of the current knowledge of VMB composition in pregnant women living in seven sub-Saharan Africa. It remains challenging to compare VMB characteristics across studies performed in this region since populations and experimental methods vary considerably [17]. Nevertheless, the evidence provided here highlights that most sub-Saharan African studies reported pregnant women having VMB dominated by *L. iners* or more diverse anaerobic communities, mostly with a high abundance of *G. vaginalis*. Future research should investigate the pathogenesis and host-immunological role of the VMB bacteria on various health conditions and outcomes in more detail. To allow for analysis across studies, consensus on how to test and report VMB composition in sub-Saharan African women should be reached for a better comparison of data sets. Furthermore, a large shared multi-county/international database could also help to minimize these problems. A systematic comparison of evidence across countries will help provide substantial qualitative evidence for public health strategies to improve reproductive and maternal health in sub-Saharan Africa.

## 2 REFERENCES

- Al-Nasiry, S.; Ambrosino, E.; Schlaepfer, M.; Morr , S.A.; Wieten, L.; Voncken, J.W.; Spinelli, M.; Mueller, M.; Kramer, B.W. The Interplay Between Reproductive Tract Microbiota and Immunological System in Human Reproduction. *Front. Immunol.* **2020**, *11*, 378.
- Ravel, J.; Gajer, P.; Abdo, Z.; Schneider, G.M.; Koenig, S.S.K.; McCulle, S.L.; Karlebach, S.; Gorle, R.; Russell, J.; Tacket, C.O.; et al. Vaginal microbiome of reproductive-age women. *Proc. Natl. Acad. Sci. U. S. A.* **2011**, *108*, 4680–4687.
- MacIntyre, D.A.; Chandiramani, M.; Lee, Y.S.; Kindinger, L.; Smith, A.; Angelopoulos, N.; Lehne, B.; Arulkumaran, S.; Brown, R.; Teoh, T.G.; et al. The vaginal microbiome during pregnancy and the postpartum period in a European population. *Sci. Rep.* **2015**, *5*.
- Fettweis, J.M.; Serrano, M.G.; Brooks, J.P.; Edwards, D.J.; Girerd, P.H.; Parikh, H.I.; Huang, B.; Arodz, T.J.; Edupuganti, L.; Glascock, A.L.; et al. The vaginal microbiome and preterm birth. *Nat. Med.* **2019**, *25*, 1012–1021.
- Hyman, R.W.; Fukushima, M.; Jiang, H.; Fung, E.; Rand, L.; Johnson, B.; Vo, K.C.; Caughey, A.B.; Hilton, J.F.; Davis, R.W.; et al. Diversity of the vaginal microbiome correlates with preterm birth. *Reprod. Sci.* **2014**, *21*, 32–40.
- Zhou, X.; Brown, C.J.; Abdo, Z.; Davis, C.C.; Hansmann, M.A.; Joyce, P.; Foster, J.A.; Forney, L.J. Differences in the composition of vaginal microbial communities found in healthy Caucasian and black women. *ISME J.* **2007**, *1*, 121–133.
- Serrano, M.G.; Parikh, H.I.; Brooks, J.P.; Edwards, D.J.; Arodz, T.J.; Edupuganti, L.; Huang, B.; Girerd, P.H.; Bokhari, Y.A.; Bradley, S.P.; et al. Racioethnic diversity in the dynamics of the vaginal microbiome during pregnancy. *Nat. Med.* **2019**, *25*, 1001–1011.
- Gautam, R.; Borgdorff, H.; Jespers, V.; Francis, S.C.; Verhelst, R.; Mwaura, M.; Delany-Moretlwe, S.; Ndayisaba, G.; Kyongo, J.K.; Hardy, L.; et al. Correlates of the molecular vaginal microbiota composition of African women. *BMC Infect. Dis.* **2015**, *15*, 86.
- Jespers, V.; van de Wijgert, J.; Cools, P.; Verhelst, R.; Verstraelen, H.; Delany-Moretlwe, S.; Mwaura, M.; Ndayisaba, G.F.; Mandaliya, K.; Menten, J.; et al. The significance of *Lactobacillus crispatus* and *L. vaginalis* for vaginal health and the negative effect of recent sex: A cross-sectional descriptive study across groups of African women. *BMC Infect. Dis.* **2015**, *15*.
- Anahtar, M.N.; Byrne, E.H.; Doherty, K.E.; Bowman, B.A.; Yamamoto, H.S.; Soumillon, M.; Padavattan, N.; Ismail, N.; Moodley, A.; Sabatini, M.E.; et al. Cervicovaginal Bacteria Are a Major Modulator of Host Inflammatory Responses in the Female Genital Tract. *Immunity* **2015**, *42*, 965–976.
- DiGiulio, D.B.; Callahan, B.J.; McMurdie, P.J.; Costello, E.K.; Lyell, D.J.; Robaczewska, A.; Sun, C.L.; Goltsman, D.S.A.; Wong, R.J.; Shawa, G.; et al. Temporal and spatial variation of the human microbiota during pregnancy. *Proc. Natl. Acad. Sci. U. S. A.* **2015**, *112*, 11060–11065.
- Zhou, X.; Brown, C.J.; Abdo, Z.; Davis, C.C.; Hansmann, M.A.; Joyce, P.; Foster, J.A.; Forney, L.J. Differences in the composition of vaginal microbial communities found in healthy Caucasian and black women. *ISME J.* **2007**, *1*, 121–133.
- Ma, B.; Forney, L.J.; Ravel, J. Vaginal Microbiome: Rethinking Health and Disease. *Annu. Rev. Microbiol.* **2012**, *66*, 371–389.
- Stout, M.J.; Zhou, Y.; Wylie, K.M.; Tarr, P.I.; Macones, G.A.; Tuuli, M.G. Early pregnancy vaginal microbiome trends and preterm birth. *Am. J. Obstet. Gynecol.* **2017**, *217*, 356.e1–356.e18.
- Doyle, R.; Gondwe, A.; Fan, Y.M.; Maleta, K.; Ashorn, P.; Klein, N.; Harris, K. A *Lactobacillus*-deficient vaginal microbiota dominates postpartum women in rural Malawi. *Appl. Environ. Microbiol.* **2018**, *84*.

16. Singer, M.; Borg, M.; Ouburg, S.; Morré, S.A. The relation of the vaginal microbiota to early pregnancy development during in vitro fertilization treatment—A meta-analysis. *J. Gynecol. Obstet. Hum. Reprod.* **2019**, *48*, 223–229.
17. Bayigga, L.; Kateete, D.P.; Anderson, D.J.; Sekikubo, M.; Nakanjako, D. Diversity of vaginal microbiota in sub-Saharan Africa and its effects on HIV transmission and prevention. *Am. J. Obstet. Gynecol.* **2019**.
18. Masha, S.C.; Cools, P.; Descheemaeker, P.; Reynders, M.; Sanders, E.J.; Vanechoutte, M. Urogenital pathogens, associated with *Trichomonas vaginalis*, among pregnant women in Kilifi, Kenya: a nested case-control study. *BMC Infect. Dis.* **2018**, *18*, 549.
19. Watson-Jones, D.; ... H.W.-B. of the W.; 2007, undefined Adverse birth outcomes in United Republic of Tanzania: impact and prevention of maternal risk factors. *SciELO Public Heal.*
20. WHO; UNICEF; UNFPA; World Bank Group; United Nations Population Division Global health observatory. Global Strategy for Women's, Children's and Adolescents' Health (2016-2030) Available online: <https://www.who.int/reproductivehealth/publications/maternal-mortality-2000-2017/en/> (accessed on Jul 27, 2020).
21. Chawanpaiboon, S.; Vogel, J.P.; Moller, A.B.; Lumbiganon, P.; Petzold, M.; Hogan, D.; Landoulsi, S.; Jampathong, N.; Kongwattanakul, K.; Laopaiboon, M.; et al. Global, regional, and national estimates of levels of preterm birth in 2014: a systematic review and modelling analysis. *Lancet Glob. Heal.* **2019**, *7*, e37–e46.
22. Davey, D.L.J.; Shull, H.I.; Billings, J.D.; Wang, D.; Adachi, K.; Klausner, J.D. Prevalence of curable sexually transmitted infections in pregnant women in low- and middle-income countries from 2010 to 2015: A systematic review. *Sex. Transm. Dis.* **2016**, *43*, 450–458.
23. UNAIDS Africa prepares to eliminate mother-to-child transmission of HIV by 2015 Available online: <https://www.unaids.org/en/resources/presscentre/featurestories/2010/may/20100526pmtct> (accessed on Sep 28, 2020).
24. Blackstone, S.R.; Nwaozuru, U.; Iwelunmor, J. Antenatal HIV Testing in Sub-Saharan Africa During the Implementation of the Millennium Development Goals: A Systematic Review Using the PEN-3 Cultural Model. *Int. Q. Community Health Educ.* **2018**, *38*, 115–128.
25. Gupta, V.K.; Paul, S.; Dutta, C. Geography, ethnicity or subsistence-specific variations in human microbiome composition and diversity. *Front. Microbiol.* **2017**, *8*, 1162.
26. Zhou, X.; Hansmann, M.A.; Davis, C.C.; Suzuki, H.; Brown, C.J.; Schütte, U.; Pierson, J.D.; Forney, L.J. The vaginal bacterial communities of Japanese women resemble those of women in other racial groups. *FEMS Immunol. Med. Microbiol.* **2010**, *58*, 169–181.
27. Borgdorff, H.; van der Veer, C.; van Houdt, R.; Alberts, C.J.; de Vries, H.J.; Bruisten, S.M.; Snijder, M.B.; Prins, M.; Geerlings, S.E.; Schim van der Loeff, M.F.; et al. The association between ethnicity and vaginal microbiota composition in Amsterdam, the Netherlands. *PLoS One* **2017**, *12*, e0181135.
28. Van De Wijgert, J.H.H.M.; Borgdorff, H.; Verhelst, R.; Crucitti, T.; Francis, S.; Verstraelen, H.; Jaspers, V. The vaginal microbiota: What have we learned after a decade of molecular characterization? *PLoS One* **2014**, *9*.
29. Moher, D.; Liberati, A.; Tetzlaff, J.; Altman, D.; The PRISMA Group Preferred Reporting Items for Systematic Reviews and Meta-Analyses: The PRISMA Statement. *PLoS Med* **2009**, *6*, e1000097.
30. World Bank Sub-Saharan Africa | Data Available online: <https://data.worldbank.org/region/sub-saharan-africa> (accessed on Jan 10, 2020).
31. Frank, D.N.; Manigart, O.; Leroy, V.; Meda, N.; Valéa, D.; Zhang, W.; Dabis, F.; Pace, N.R.; Van De Perre, P.; Janoff, E.N. Altered vaginal microbiota are associated with perinatal mother-to-child transmission of HIV in African women from Burkina Faso. *J. Acquir. Immune Defic. Syndr.* **2012**, *60*, 299–306.
32. Gudza-Mugabe, M.; Havyarimana, E.; Jaumdally, S.; Garson, K.L.; Lennard, K.; Tarupiwa, A.; Mugabe, F.; Marere, T.; Mavengwa, R.T.; Masson, L.; et al. HIV infection is associated with preterm delivery independent of vaginal microbiota in pregnant African women. *J. Infect. Dis.* **2019**.
33. Bisanz, J.E.; Enos, M.K.; PrayGod, G.; Seney, S.; Macklaim, J.M.; Chilton, S.; Willner, D.; Knight, R.; Fusch, C.; Fusch, G.; et al. Microbiota at multiple body sites during pregnancy in a rural tanzanian population and effects of Moringa-supplemented probiotic yogurt. *Appl. Environ. Microbiol.* **2015**, *81*, 4965–4975.
34. Brabin, L.; Roberts, S.A.; Gies, S.; Nelson, A.; Diallo, S.; Stewart, C.J.; Kazienga, A.; Birtles, J.; Ouedraogo, S.; Claeys, Y.; et al. Effects of long-term weekly iron and folic acid supplementation on lower genital tract infection - a double blind, randomised controlled trial in Burkina Faso. *BMC Med.* **2017**, *15*.
35. McMillan, A.; Rulisa, S.; Gloor, G.B.; Macklaim, J.M.; Sumarah, M.; Reid, G. Pilot assessment of probiotics for pregnant women in Rwanda. *PLoS One* **2018**, *13*, e0195081.
36. Price, J.T.; Vwalika, B.; Hobbs, M.; Nelson, J.A.E.; Stringer, E.M.; Zou, F.; Rittenhouse, K.J.; Azcarate-Peril, A.; Kasaro, M.P.; Stringer, J.S.A. Highly diverse anaerobe-predominant vaginal microbiota among HIV-infected pregnant women in Zambia. *PLoS One* **2019**, *14*, e0223128.
37. Borgdorff, H.; Verwijs, M.C.; Wit, F.W.N.M.; Tsvitvadze, E.; Ndayisaba, G.F.; Verhelst, R.; Schuren, F.H.; Van De Wijgert, J.H.H.M. The impact of hormonal contraception and pregnancy on sexually transmitted infections and on cervicovaginal microbiota in african sex workers. *Sex. Transm. Dis.* **2015**, *42*, 143–152.
38. McMillan, A.; Rulisa, S.; Gloor, G.B.; Macklaim, J.M.; Sumarah, M.; Reid, G. Pilot assessment of probiotics for pregnant women in Rwanda. *PLoS One* **2018**, *13*, e0195081.
39. Borgdorff, H.; Armstrong, S.D.; Tytgat, H.L.P.; Xia, D.; Ndayisaba, G.F.; Wastling, J.M.; Van De Wijgert, J.H.H.M. Unique insights in the cervicovaginal *Lactobacillus iners* and *L. crispatus* proteomes and their associations with microbiota dysbiosis. *PLoS One* **2016**, *11*.
40. Siiteri, P.K.; MacDonald, P.C. Placental estrogen biosynthesis during human pregnancy. *J. Clin. Endocrinol. Metab.* **1966**, *26*, 751–761.
41. O'Hanlon, D.E.; Moench, T.R.; Cone, R.A. Vaginal pH and microbicidal lactic acid when lactobacilli dominate the microbiota. *PLoS One* **2013**, *8*.
42. Van De Wijgert, J.H.H.M.; Borgdorff, H.; Verhelst, R.; Crucitti, T.; Francis, S.; Verstraelen, H.; Jaspers, V. The Vaginal Microbiota: What Have We Learned after a Decade of Molecular Characterization? **2014**.
43. Freitas, A.C.; Chaban, B.; Bocking, A.; Rocco, M.; Yang, S.; Hill, J.E.; Money, D.M.; Hemmingsen, S.; Reid, G.; Dumonceaux, T.; et al. The vaginal microbiome of pregnant women is less rich and diverse, with lower prevalence of Mollicutes, compared to non-pregnant women. *Sci. Rep.* **2017**, *7*.
44. Kroon, S.J.; Ravel, J.; Huston, W.M. Cervicovaginal microbiota, women's health, and reproductive outcomes. *Fertil. Steril.* **2018**, *110*, 327–336.
45. Walther-Antônio, M.R.S.; Jeraldo, P.; Berg Miller, M.E.; Yeoman, C.J.; Nelson, K.E.; Wilson, B.A.; White, B.A.; Chia, N.; Creedon, D.J. Pregnancy's Stronghold on the Vaginal Microbiome. *PLoS One* **2014**, *9*, e98514.
46. Kervinen, K.; Kalliala, I.; Glazer-Livson, S.; Virtanen, S.; Nieminen, P.; Salonen, A. Vaginal microbiota in pregnancy: Role in induction of labor and seeding the neonate's microbiota? *J. Biosci.* **2019**, *44*, 1–6.
47. Hyman, R.W.; Fukushima, M.; Jiang, H.; Fung, E.; Rand, L.; Johnson, B.; Vo, K.C.; Caughey, A.B.; Hilton, J.F.; Davis, R.W.; et al. Diversity of the vaginal microbiome correlates with preterm birth. *Reprod. Sci.* **2014**, *21*, 32–40.
48. Tabatabaei, N.; Eren, A.; Barreiro, L.; Yotova, V.; Dumaine, A.; Allard, C.; Fraser, W. Vaginal microbiome in early pregnancy and subsequent risk of spontaneous preterm birth: a case-control study. *BJOG An Int. J. Obstet. Gynaecol.* **2019**, *126*, 349–358.

49. Balaka, B.; Agbèrè, A.; Dagnra, A.; Baeta, S.; Kessie, K.; Assimadi, K. Portage génital bactérien au dernier trimestre de la grossesse et infection néonatale précoce. *Arch. Pediatr.* **2005**, *12*, 514–519.
50. Kim, J.H.; Yoo, S.M.; Sohn, Y.H.; Jin, C.H.; Yang, Y.S.; Hwang, I.T.; Oh, K.Y. Predominant Lactobacillus species types of vaginal microbiota in pregnant Korean women: quantification of the five Lactobacillus species and two anaerobes. *J. Matern. Neonatal Med.* **2017**, *30*, 2329–2333.
51. Onderdonk, A.B.; Delaney, M.L.; Fichorova, R.N. The human microbiome during bacterial vaginosis. *Clin. Microbiol. Rev.* **2016**, *29*, 223–238.
52. Abdool Karim, S.S.; Baxter, C.; Passmore, J.S.; McKinnon, L.R.; Williams, B.L. The genital tract and rectal microbiomes: their role in HIV susceptibility and prevention in women. *J. Int. AIDS Soc.* **2019**, *22*, e25300.
53. Ravel, J.; Brotman, R.M. Translating the vaginal microbiome: Gaps and challenges. *Genome Med.* **2016**, *8*.
54. Nguyen, D.P.; Genc, M.; Vardhana, S.; Babula, O.; Onderdonk, A.; Witkin, S.S. Ethnic Differences of Polymorphisms in Cytokine and Innate Immune System Genes in Pregnant Women. *Obstet. Gynecol.* **2004**, *104*, 293–300.
55. Ness, R.B.; Haggerty, C.L.; Harger, G.; Ferrell, R. Differential distribution of allelic variants in cytokine genes among African Americans and white Americans. *Am. J. Epidemiol.* **2004**, *160*, 1033–1038.
56. Ryckman, K.K.; Williams, S.M.; Krohn, M.A.; Simhan, H.N. Racial differences in cervical cytokine concentrations between pregnant women with and without bacterial vaginosis. *J. Reprod. Immunol.* **2008**, *78*, 166–171.
57. Barton, P.T.; Gerber, S.; Skupski, D.W.; Witkin, S.S. Interleukin-1 Receptor Antagonist Gene Polymorphism, Vaginal Interleukin-1 Receptor Antagonist Concentrations, and Vaginal Ureaplasma urealyticum Colonization in Pregnant Women Downloaded from. *Infect. Immun.* **2003**, *71*, 271–274.
58. Genc, M.R.; Vardhana, S.; Delaney, M.L.; Onderdonk, A.; Tuomala, R.; Norwitz, E.; Witkin, S.S. Relationship between a toll-like receptor-4 gene polymorphism, bacterial vaginosis-related flora and vaginal cytokine responses in pregnant women. *Eur. J. Obstet. Gynecol. Reprod. Biol.* **2004**, *116*, 152–156.
59. Goepfert, A.R.; Varner, M.; Ward, K.; Macpherson, C.; Klebanoff, M.; Goldenberg, R.L.; Mercer, B.; Meis, P.; Iams, J.; Moawad, A.; et al. Differences in inflammatory cytokine and Toll-like receptor genes and bacterial vaginosis in pregnancy. *Am. J. Obstet. Gynecol.* **2005**, *193*, 1478–1485.
60. Si, J.; You, H.J.; Yu, J.; Sung, J.; Ko, G.P. Prevotella as a Hub for Vaginal Microbiota under the Influence of Host Genetics and Their Association with Obesity. *Cell Host Microbe* **2017**, *21*, 97–105.
61. Murphy, K.; Mitchell, C.M. The Interplay of Host Immunity, Environment and the Risk of Bacterial Vaginosis and Associated Reproductive Health Outcomes. *J. Infect. Dis.* **2016**, *214*, S29–S35.
62. Petrova, M.I.; Reid, G.; Vanechoutte, M.; Lebeer, S. Lactobacillus iners: Friend or Foe? *Trends Microbiol.* **2017**, *25*, 182–191.
63. Koedooder, R.; Mackens, S.; Budding, A.; Fares, D.; Blockeel, C.; Laven, J.; Schoenmakers, S. Identification and evaluation of the microbiome in the female and male reproductive tracts. *Hum. Reprod. Update* **2019**, *25*, 298–325.
64. Vanechoutte, M. Lactobacillus iners, the unusual suspect. *Res. Microbiol.* **2017**, *168*, 826–836.
65. Petricevic, L.; Domig, K.J.; Nierscher, F.J.; Sandhofer, M.J.; Fidesser, M.; Krondorfer, I.; Husslein, P.; Kneifel, W.; Kiss, H. Characterisation of the vaginal Lactobacillus microbiota associated with preterm delivery. *Sci. Rep.* **2014**, *4*.
66. UNAIDS *Miles to go closing gaps breaking barriers righting injustices*; Geneva. Switzerland, 2018;
67. Lewis, F.M.T.; Bernstein, K.T.; Aral, S.O. Vaginal microbiome and its relationship to behavior, sexual health, and sexually transmitted diseases. *Obstet. Gynecol.* **2017**, *129*, 643–654.
68. Atashili, J.; Poole, C.; Ndumbe, P.M.; Adimora, A.A.; Smith, J.S. Bacterial vaginosis and HIV acquisition: A meta-analysis of published studies. *AIDS* **2008**, *22*, 1493–1501.
69. Pyles, R.B.; Vincent, K.L.; Baum, M.M.; Elsom, B.; Miller, A.L.; Maxwell, C.; Eaves-Pyles, T.D.; Li, G.; Popov, V.L.; Nusbaum, R.J.; et al. Cultivated Vaginal Microbiomes Alter HIV-1 Infection and Antiretroviral Efficacy in Colonized Epithelial Multilayer Cultures. *PLoS One* **2014**, *9*, e93419.
70. Cone, R.A. Vaginal microbiota and sexually transmitted infections that may influence transmission of cell-associated HIV. *J. Infect. Dis.* **2014**, *210*, S616–S621.
71. Brotman, R.M.; Bradford, L.L.; Conrad, M.; Gajer, P.; Ault, K.; Peralta, L.; Forney, L.J.; Carlton, J.M.; Abdo, Z.; Ravel, J. Association between trichomonas vaginalis and vaginal bacterial community composition among reproductive-age women. *Sex. Transm. Dis.* **2012**, *39*, 807–812.
72. UNAIDS AIDSinfo, people living with HIV receiving ART Available online: <http://aidsinfo.unaids.org/> (accessed on Nov 4, 2020).
73. Avert HIV and AIDS in East and Southern Africa regional overview Available online: <https://www.avert.org/professionals/hiv-around-world/sub-saharan-africa/overview> (accessed on Nov 4, 2020).
74. Linguissi, L.S.G.; Sagna, T.; Soubeiga, S.T.; Gwom, L.C.; Nkenfou, C.N.; Obiri-Yeboah, D.; Ouattara, A.K.; Pietra, V.; Simporé, J. Prevention of mother-to-child transmission (PMTCT) of HIV: A review of the achievements and challenges in Burkina-Faso. *HIV/AIDS - Res. Palliat. Care* **2019**, *11*, 165–177.
75. Organization, W.H. *PMTCT strategic vision 2010-2015: preventing mother-to-child transmission of HIV to reach the UNGASS and Millennium Development Goals: moving towards*; 2010; ISBN 9789241599030.
76. Bell, C.; Hough, E.; Smith, A.; Greene, L. Targeted screening for Trichomonas vaginalis in women, a pH-based approach. *Int. J. STD AIDS* **2007**, *18*, 402–3.
77. Brotman, R.M.; Klebanoff, M.A.; Nansel, T.R.; Yu, K.F.; Andrews, W.W.; Zhang, J.; Schwebke, J.R. Bacterial Vaginosis Assessed by Gram Stain and Diminished Colonization Resistance to Incident Gonococcal, Chlamydial, and Trichomonal Genital Infection. *J. Infect. Dis.* **2010**, *202*, 1907–1915.
78. Mirmonsef, P.; Krass, L.; Landay, A.; Spear, G.T. The role of bacterial vaginosis and trichomonas in HIV transmission across the female genital tract. *Curr. HIV Res.* **2012**, *10*, 202–10.
79. Martin, David H.; Marcela Zozaya; Rebecca A. Lillis, L.M.; M. Jacques Nsuami; Michael J. Ferris. Unique Vaginal Microbiota That Includes an Unknown Mycoplasma-Like Organism Is Associated With Trichomonas vaginalis Infection. *J. Infect. Dis.* **2013**, *207*, 1922–1931.
80. Food and Agriculture Organization of the United Nation *State of food insecurity in the world*; Rome, 2014;
81. Ruiz, L.; Moles, L.; Gueimonde, M.; Rodriguez, J.M. Perinatal Microbiomes' Influence on Preterm Birth and Preterms' Health. *J. Pediatr. Gastroenterol. Nutr.* **2016**, *63*, e193–e203.
82. Torcia, M.G. Interplay among vaginal microbiome, immune response and sexually transmitted viral infections. *Int. J. Mol. Sci.* **2019**, *20*.
83. Anukam, K.C.; Osazuwa, E.; Osemene, G.I.; Ehigiagbe, F.; Bruce, A.W.; Reid, G. Clinical study comparing probiotic Lactobacillus GR-1 and RC-14 with metronidazole vaginal gel to treat symptomatic bacterial vaginosis. *Microbes Infect.* **2006**, *8*, 2772–2776.
84. Macklaim, J.M.; Clemente, J.C.; Knight, R.; Gloor, G.B.; Reid, G. Changes in vaginal microbiota following antimicrobial and probiotic therapy. *Microb. Ecol. Heal. Dis.* **2015**, *26*.
85. Taddei, C.R.; Cortez, R. V.; Mattar, R.; Torloni, M.R.; Daher, S. Microbiome in normal and pathological pregnancies: A literature overview. *Am. J. Reprod. Immunol.* **2018**, *80*, e12993.
86. Brown, R.G.; Marchesi, J.R.; Lee, Y.S.; Smith, A.; Lehne, B.; Kindinger, L.M.; Terzidou, V.; Holmes, E.; Nicholson, J.K.; Bennett, P.R.; et al. Vaginal dysbiosis increases risk of preterm fetal membrane rupture, neonatal sepsis and is exacerbated by erythromycin. *BMC Med.* **2018**, *16*, 9.

87. Peelen, M.J.; Luef, B.M.; Lamont, R.F.; de Milliano, I.; Jensen, J.S.; Limpens, J.; Hajenius, P.J.; Jørgensen, J.S.; Menon, R. The influence of the vaginal microbiota on preterm birth: A systematic review and recommendations for a minimum dataset for future research. *Placenta* 2019, 79, 30–39.
88. Solt, I. The human microbiome and the great obstetrical syndromes: A new frontier in maternal-fetal medicine. *Best Pract. Res. Clin. Obstet. Gynaecol.* 2015, 29, 165–175.
89. Parnell, L.A.; Briggs, C.M.; Mysorekar, I.U. Maternal microbiomes in preterm birth: Recent progress and analytical pipelines. *Semin. Perinatol.* 2017, 41, 392–400.
90. Donders, G.; De Wet, H.G.; Hoof, P.; Desmyter, J. Lactobacilli in Papanicolaou Smears, Genital Infections, and Pregnancy. *Am. J. Perinatol.* 1993, 10, 358–361.
91. Juliana NCA, Suiters MJM, Al-Nasiry S, Morré SA, P.R. and A.E. The association between vaginal microbiota dysbiosis, bacterial vaginosis and aerobic vaginitis, and adverse pregnancy outcomes of women living in sub-Saharan Africa: A systematic review. *Unpublished* 2020.
92. Hummelen, R.; Fernandes, A.D.; Macklaim, J.M.; Dickson, R.J.; Chagalucha, J.; Gloor, G.B.; Reid, G. Deep Sequencing of the Vaginal Microbiota of Women with HIV. *PLoS One* 2010, 5, e12078.
93. Xue, Z.; Kable, M.E.; Marco, M.L. Impact of DNA Sequencing and Analysis Methods on 16S rRNA Gene Bacterial Community Analysis of Dairy Products. *mSphere* 2018, 3.
94. Bukin, Y.S.; Galachyants, Y.P.; Morozov, I. V.; Bukin, S. V.; Zakharenko, A.S.; Zemskaya, T.I. The effect of 16s rRNA region choice on bacterial community metabarcoding results. *Sci. Data* 2019, 6, 1–14.
95. Schellenberg, J.; Links, M.G.; Hill, J.E.; Dumonceaux, T.J.; Peters, G.A.; Tyler, S.; Ball, T.B.; Severini, A.; Plummer, F.A. Pyrosequencing of the chaperonin-60 universal target as a tool for determining microbial community composition. *Appl. Environ. Microbiol.* 2009, 75, 2889–2898.
96. Callahan, B.J.; DiGiulio, D.B.; Aliaga Goltsman, D.S.; Sun, C.L.; Costello, E.K.; Jeganathan, P.; Biggio, J.R.; Wong, R.J.; Druzin, M.L.; Shaw, G.M.; et al. Replication and refinement of a vaginal microbial signature of preterm birth in two racially distinct cohorts of US women. *Proc. Natl. Acad. Sci. U. S. A.* 2017, 114, 9966–9971.
97. World Health Organization *Global health sector strategy on sexually transmitted infections 2016–2021. Towards ending STIs*; Geneva. Switzerland, 2016;

## 2 SUPPLEMENTARY DATA

### PRISMA 2009 FLOW DIAGRAM

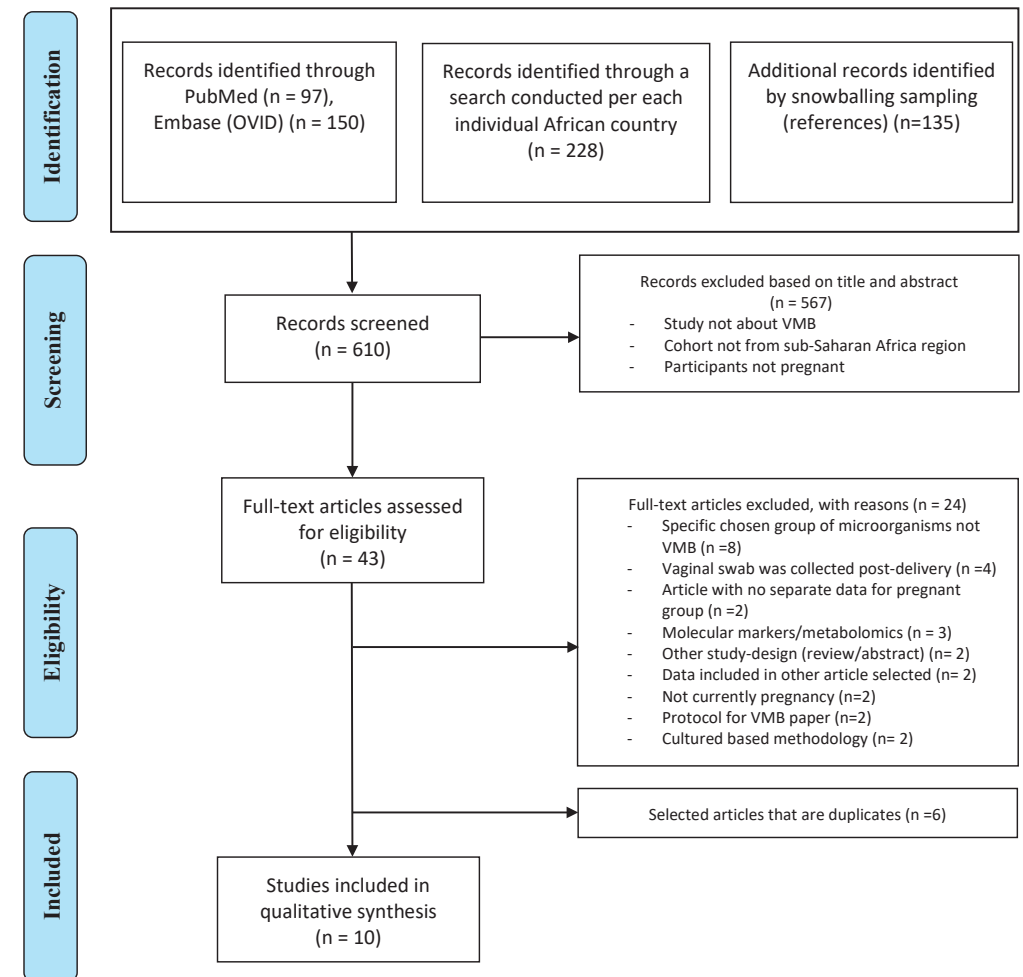


Figure S.1. PRISMA based Flow diagram displaying the study selection (122)



**Table S.2.** Search strategies and hits based on searches last conducted on July 10, 2020.

Database	Search strategy	Number hits
Pubmed	(((((Vaginal microbiota[MeSH Terms]) OR vaginal microbiome[MeSH Terms]) OR vaginal microbiota) OR vaginal microbiome) OR vaginal dysbiosis') OR bacterial vaginosis OR aerobic vaginitis)) AND ((africa[MeSH Terms]) OR sub-saharan africa[MeSH Terms])) AND (((pregnant women[MeSH Terms]) OR pregnancy[MeSH Terms]) OR pregnant) OR pregnancy) OR pregnancy outcome[MeSH Terms]) OR pregnancy outcome)	97
Pubmed	(((((Vaginal microbiota[MeSH Terms]) OR vaginal microbiome[MeSH Terms]) OR vaginal microbiota) OR vaginal microbiome) OR vaginal dysbiosis') OR bacterial vaginosis)) AND (((("xxx"[Mesh]) OR ("xxx") OR ("xxx" women)) AND (((pregnant women[MeSH Terms]) OR pregnancy[MeSH Terms]) OR pregnant) OR pregnancy) OR (((pregnancy outcome[MeSH Terms]) OR pregnancy outcome))))))	228
Embase (Ovid)	(exp Vaginal microbiota/ or exp vaginal microbiome/ or exp vaginal flora/ or (vaginal microbiota or vaginal microbiome or vaginal dysbiosis or bacterial vaginosis or aerobic vaginitis).ti,ab,kw.) AND (exp africa/ or exp Africa south of Sahara/ or sub-Saharan Africa. ti,ab,kw.) AND (exp pregnant women/ or exp pregnancy/ or exp pregnancy outcome/ or (pregnant or pregnancy or pregnancy outcome).ti,ab,kw.)	150

At the "xxx" each Sub-Saharan African country was filled in per search, countries selected based on the world bank organization database: Angola, Benin, Botswana, Burkina Faso, Burundi, Cabo Verde, Cameroon, Central African Republic, Chad, Comoros, Congo, Cote D'Ivoire, Equatorial guinea, Eritrea, Eswatini, Ethiopia, Gabon, Gambia, Ghana, Guinea, Guinea-Bissau, Kenya, Lesotho, Liberia, Madagascar, Malawi, Mali, Mauritania, Mauritius, Mozambique, Namibia, Niger, Nigeria, Rwanda, Sao Tome and Principe, Senegal, Seychelles, Sierra Leone, Somalia, South Africa, South sudan, Sudan, Tanzania, Togo, Uganda, Zambia, Zimbabwe (32).

## 2 SUPPLEMENTARY INFORMATION

### AUTHOR CONTRIBUTIONS

NJ performed the systematic search and the screening. NJ and EA retrieved potential studies for the inclusion of the study. NJ wrote the introduction, materials, methods, results, and discussion sections. SA-N, AB, and SM critically reviewed the manuscript. RP and EA conceived the original idea, supervised the study, critically reviewed and edited the manuscript. All authors contributed to the final versions of the manuscript.

### ACKNOWLEDGMENTS

We are grateful to Meghan Suiters for her assistance with screening eligible articles through titles and abstracts.

I'd rather live with a good question than a bad answer.

- Aryeh Frimer



# 3

## **The association between vaginal microbiota dysbiosis, bacterial vaginosis and aerobic vaginitis, and adverse pregnancy outcomes of women living in sub-Saharan Africa: A systematic review.**

**Naomi C.A. Juliana, Meghan J.M. Suiters, Salwan Al-Nasiry,  
Servaas A. Morré1, Remco P.H. Peters, Elena Ambrosino**

*Frontiers in Public Health 2020, 8:567885.*

## ABSTRACT

**Background.** Previous studies have described the association between dysbiosis of the vaginal microbiota (VMB) and related dysbiotic conditions such as bacterial vaginosis (BV) and aerobic vaginitis (AV), and various adverse pregnancy outcomes. There is limited overview of this association from countries in sub-Saharan Africa (SSA), which bear a disproportionately high burden of both vaginal dysbiotic conditions and adverse pregnancy outcomes. This systematic review assesses the evidence on the association between VMB dysbiosis, BV, and AV, and late adverse pregnancy outcomes in women living in SSA.

**Methods.** The PRISMA guidelines were followed. Three databases (PubMed, Embase (Ovid) and Cochrane) were used to retrieve observational and intervention studies conducted in SSA that associated VMB dysbiosis, BV or AV and preterm birth/labor/delivery, preterm rupture of membranes (PROM), low birthweight, small for gestational age, intra-uterine growth restriction, intra-uterine infection, intra-uterine (fetal) death, stillbirth, perinatal death, or perinatal mortality.

**Results.** Twelve studies out of 693 search records from five SSA countries were included. One study identified a positive association between VMB dysbiosis and low birthweight. Despite considerable differences in study design and outcome reporting, studies reported an association between BV and preterm birth (7/9), low birthweight (2/6), PROM (2/4), intra-uterine infections (1/1), and small for gestational age (1/1). None of the retrieved studies found an association between BV and pregnancy loss (5/5) or intra-uterine growth retardation (1/1). At least two studies support the association between BV and PROM, low birthweight, and preterm birth in Nigerian pregnant women. No reports were identified investigating the association between AV and late adverse pregnancy outcomes in SSA.

**Conclusion.** Two of the included studies from SSA support the association between BV and PROM. The remaining studies show discrepancies in supporting an association between BV and preterm birth or low birthweight. None of the studies found an association between BV and pregnancy loss. As for the role of VMB dysbiosis, BV, and AV during pregnancy among SSA women, additional research is needed. These results provide useful evidence for prevention efforts to decrease vaginal dysbiosis and its contribution to adverse pregnancy outcomes in SSA.

## 3.1 INTRODUCTION

Improving maternal and perinatal health is one of the biggest medical and public health challenges in sub-Saharan Africa (1–3). Infectious diseases are one of the multiple causes of adverse pregnancy outcomes (1,4,5). To improve maternal health and reduce adverse pregnancy outcomes in Africa, various prevention measurements to lower malaria transmission, mother-to-child human immunodeficiency virus (HIV) transmission, and improve symptomatic sexually-transmitted infections screening have been implemented during antenatal and perinatal consultations (6,7).

Over the past decades, there have been increasing discussions on whether vaginal dysbiosis (defined here as not dominated by lactobacilli), the imbalance of the vaginal commensal bacterial communities (microbiota), influences pregnancy outcomes and should be monitored antenatally (8,9). In sub-Saharan Africa there is a particularly high burden of vaginal dysbiosis-related conditions (10).

Generally, the vaginal microbiota (VMB) consists of commensal microorganisms that exist in a dynamic, complex, and mutually beneficial relationship with the host (11). Healthy VMB are crucial to the lower female reproductive tract. VMB contains a predominance of hydrogen peroxide-producing *Lactobacillus* species that contribute to an immunological balance, and therefore support a healthy reproductive tract (12–14). However, many factors can influence the VMB composition, such as nutrition, sexual and hygienic practices, ethnicity, and hormonal fluctuations during menstruation or pregnancy (15). Bacterial vaginosis (BV) is one of the most common vaginal dysbiotic conditions worldwide. It affects 10–30% of women at any given time, with a higher prevalence in sub-Saharan African women compared to other world regions (16–18). However, some populations in parts of Africa have low BV prevalence (6–8%), as for instance reported in Burkina Faso, while in South Africa studies have reported high BV prevalence (34–58%) (18). This vaginal condition occurs when there is a shift from a *Lactobacillus*-dominant VMB to a more diverse VMB, rich in anaerobic bacteria with, for instance, species from *Gardnerella*, *Prevotella*, and *Atopobium* genera (19). BV prevalence varies with ethnicity, socioeconomic conditions, and gestational age. BV is also common during pregnancy and multiple independent studies have observed an association between BV and preterm birth (PTB), as well as miscarriage, maternal infection, and low birth weight (LBW) (17,19,20). Two decades ago, two meta-analyses confirmed that BV during pregnancy increased PTB risk by > 2-fold (21,22). However, compared to PTB, less research had been conducted for other obstetric outcomes (23). Aerobic vaginitis (AV) is another vaginal dysbiotic condition characterized by an abnormal VMB composed mostly of commensal aerobic microorganisms of intestinal origin, typically *Escherichia coli*, *Staphylococcus aureus*, coagulase-negative staphylococci such as *S. epidermidis*, group B *Streptococcus* (*Streptococcus agalactiae*) and *Enterococcus faecalis* (24–29). The prevalence of AV is between 5–10.5% among symptomatic nonpregnant women and between 4–8% among pregnant women (26,29). AV has also been associated with a higher risk

of spontaneous miscarriage, preterm pre-labor rupture of membranes, chorioamnionitis, and preterm delivery (PTD) (30–32). Increasing evidence is suggesting that VMB dysbiosis is associated with various adverse pregnancy outcomes, such as an increased risk of post-abortion infection, early and late miscarriage, histological chorioamnionitis, postpartum endometritis, premature rupture of membranes (PROM) and preterm birth (PTB) (20,33–42). A significant decrease in VMB richness (number of species), evenness (relative abundance of each species), and diversity (the overall richness and evenness of species) during pregnancy is associated with PTB (43). Furthermore, individual vaginal colonization with bacterial pathobionts (symbionts with pathogenic potential, like streptococci, staphylococci, or *Enterobacteriaceae* species) during pregnancy can associate with adverse pregnancy outcomes (44,45). Son et al. 2018 reported that a *Klebsiella pneumoniae*-dominant VMB might be associated with PTB before 28 weeks of gestational age (GA), *L. iners* with PTB before 34 weeks of GA, and *S. agalactiae* with late miscarriage (46). In contrast, VMB dominated by *L. crispatus* have not been associated with PTB (46–48).

It has been proposed that the increased risk of adverse reproductive and pregnancy outcomes might be attributable to BV-related bacterial species rather than BV itself. In the context of in vitro fertilization (IVF) studies, patients with high incidence of *Gardnerella*, *Atopobium* and *Prevotella* failed to become pregnant after embryo transfer or experienced miscarriage (49,50). Indeed, in early pregnancy, the reduction of lactobacilli and the overgrowth of *Gardnerella*, *Atopobium* and *Prevotella* genera disrupt the microbial homeostasis, hindering embryo implantation (49). Other studies also observed that anaerobe bacteria influence the late stages of pregnancy. For instance, DiGiulio et al. reported a strong association between PTB and presence of *Gardnerella* and *Ureaplasma*, both BV-related bacteria (51). Interestingly, these last findings were not supported by a larger study conducted by Romero et al. (52). The small sample sizes and different study populations may explain disparities between the two studies. The former study included mostly Caucasian women (60%), whereas the latter mostly African American women (86%) (51,52). The inherent differences in the VMB between women of different ethnic backgrounds have been first reported in the ground-breaking comparative study conducted by Ravel et al. (53). The study observed that healthy asymptomatic women of African ancestry living in North America had a more diverse and less *Lactobacillus*-rich VMB than women from other ethnic backgrounds living in the same environment (53). Increasing evidence on the topic suggests that non *Lactobacillus*-dominant VMB might not correspond to clinically relevant dysbiosis in asymptomatic healthy non-Caucasian women (54).

Nonetheless, women of African ancestry living in the United States of America, have a higher probability of PTB attributable to BV and vaginal inflammation, compared to Caucasian or Hispanic women living in the same area (55,56).

To date, most VMB profiling studies, especially those in pregnancy, have been conducted among Caucasian in Europe or North America. There is increasing research interest in understanding how VMB composition and related conditions might contribute to, and offer diagnos-

tic potential for, adverse pregnancy outcomes. There is a knowledge gap on VMB diversity or vaginal conditions and associated pregnancy outcomes in settings with high rates of pregnancy complications and with populations of non-Caucasian ancestries, such as sub-Saharan Africa.

This study aimed to systematically review evidence on the association between VMB dysbiosis, BV and AV, and late adverse pregnancy outcomes in women living in sub-Saharan Africa. The results provide information for the improvement of risk assessment and the effectiveness of clinical practices during pregnancy in sub-Saharan Africa.

### 3.2 METHODS

This review was conducted in line with the Preferred Reporting Items for Systematic Review and Meta-Analysis Statement (PRISMA) guidelines. Supplementary Table 1 contains the corresponding completed PRISMA Checklist form (57). Articles were retrieved from PubMed/Medline, Embase (Ovid), and the Cochrane Databases.

#### 3.2.1 ELIGIBILITY CRITERIA

All original studies that analyzed the association between VMB dysbiosis, BV, AV, and late adverse pregnancy outcomes in sub-Saharan African countries were eligible for inclusion. Studies were only included if at the time of sampling the participants were pregnant. Studies that diagnosed BV via Gram staining or Amsel clinical criteria were included (58–60). For AV, studies that diagnosed AV via wet mounts of fresh vaginal discharge, as Donders et al. reported, or followed clinical features and wet smear microscopy diagnosis as Tempera et al. proposed, were included (24,61). Non *Lactobacillus*-dominant VMB were considered indicative of VMB dysbiosis in this review. Studies were not selected based on participants' characteristics. All observational and intervention study designs were eligible for inclusion, except case reports, case series, surveys, and other (systematic) reviews. Studies were excluded if they were not performed on human subjects, did not occur among women from the sub-Saharan African region, or if they observed pregnancy outcomes that occurred solely before 20 weeks of GA. No language or date restriction was used.

#### 3.2.2 TYPE OF OUTCOME MEASURES

Various late adverse pregnancy outcomes in relation with BV, AV or VMB dysbiosis in pregnant women from sub-Saharan Africa were selected. Studies that observed pregnancy outcomes that occurred at 20 weeks of GA, or after, were classified as late pregnancy outcomes. These outcomes were PTB, preterm labor (PTL), PTD, PROM, LBW, late miscarriage, small for gestational age (SGA), intra-uterine growth restriction (IUGR), intra-uterine infection, including chorioamnionitis, intra-uterine death (IUD), intra-uterine fetal death (IUFD), perinatal death (PND), stillbirth, and perinatal mortality. The outcomes had to be from the current pregnancy.

### 3.2.3 LITERATURE SEARCH

PubMed, Embase (Ovid), and Cochrane database searches were independently conducted up to May 7<sup>th</sup>, 2020. Medical subject heading (MeSH) and Embase subject heading (Emtree) terms, free text terms, and the combination of keywords used for these searches can be found in Supplementary Table 2. The corresponding keywords were: “vaginal microbiome”, “vaginal microbiota”, “vaginal dysbiosis”, “bacterial vaginosis”, “aerobic vaginitis”, “abnormal vaginal flora”, “Africa”, “sub-Saharan Africa”, “pregnant women”, “pregnancy”, and “pregnancy outcome”. In order to ensure that no studies were missed, additional searches were performed, in which the keywords “Africa” or “sub-Saharan Africa” were changed into the name of each sub-Saharan African country, based on the world bank organization database (62).

### 3.2.4 SELECTION OF STUDIES

Titles and abstracts were assessed independently by two reviewers (NJ, MS). Thereafter, selected articles were fully read to determine if they met the inclusion criteria. If there were any uncertainties to include an article, a third reviewer (EA or RP) was consulted to achieve consensus. Conference abstracts and the bibliographies of articles, also if excluded but relevant, were examined to retrieve further potential articles containing unique data.

### 3.2.5 DATA EXTRACTION

For evidence on the contribution of BV, AV or VMB diversity to pregnancy outcomes, the full set of related results from each article was extracted. The odds ratio (OR) and 95% confidence intervals (CI) were extracted separately from each study. Additionally, the OR, 95 CI%, or *P*-value were calculated from the reported data if they were not mentioned in the original article (63–65). Findings of studies where no ORs were mentioned or could not have been calculated were also reported.

### 3.2.6 RISK OF BIAS IN INDIVIDUAL STUDIES

To assess the methodological quality of the different individual studies, the Joanna Briggs Institute (JBI) Critical Appraisal Tool was used (66). Different JBI checklists for specific study designs were used to determine their potential risk of bias (Supplementary Table 3). Questions that were answered with “yes” were assigned 1 point, “unclear or only partly discussed” 0.5 points, and “no” 0 points. The risk of bias of individual studies was determined as “low risk of bias” if the study scored at least 70%, “moderate risk of bias” if the study score was between 50 to 69%, and “high risk of bias” if the study scored 49% or less (66–68).

## 3.4 RESULTS

### 3.4.1 STUDY SELECTION

The search strategies used yielded 693 records, among them twelve studies that met the inclusion criteria. The study selection process is shown in the PRISMA flow diagram in Figure 1. Of these selected studies, one reported the VMB composition and eleven BV status in relation to pregnancy outcomes in pregnant sub-Saharan African women. No retrieved study investigated the role of AV in late adverse pregnancy outcomes in women living in sub-Saharan Africa countries. Seven selected articles were retrieved both via PubMed and Embase (Ovid) (69–75), four articles were retrieved solely via PubMed (31,76–78), and a conference abstract retrieved on Embase (Ovid) led to an additional article (79). The bibliography from one systematic review retrieved from Cochrane was also assessed (80). However, all the articles that were possibly eligible from it were duplicates on the PubMed or Embase search. Only one article was written in French, the rest were in English. To avoid duplicate the study by Steyn et al., was not included because their results were further analyzed in an already included study (Schoeman et al) (77,81). The cohorts of women of both studies were the same and the main conclusions were in line, however the number of included participants in each analysis was slightly different (77,81).

## PRISMA 2009 FLOW DIAGRAM

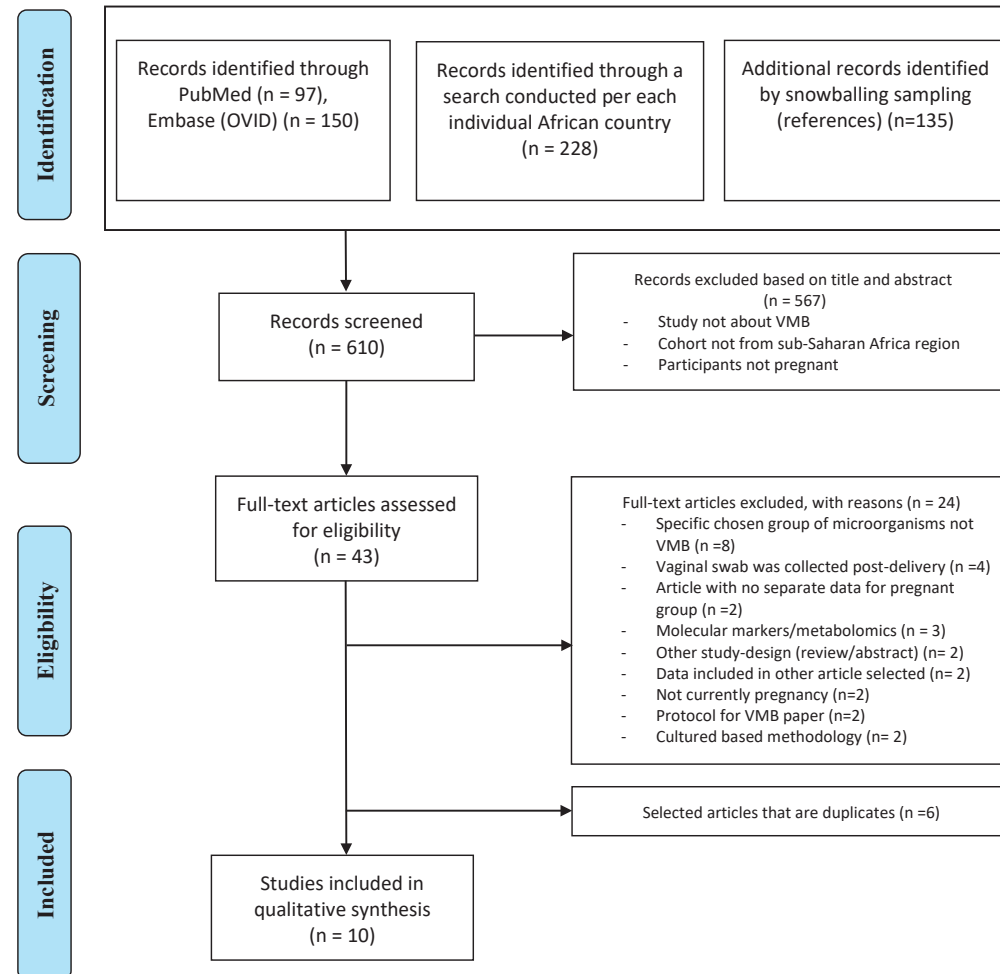


Figure 1. PRISMA based Flow diagram displaying the study selection (143)

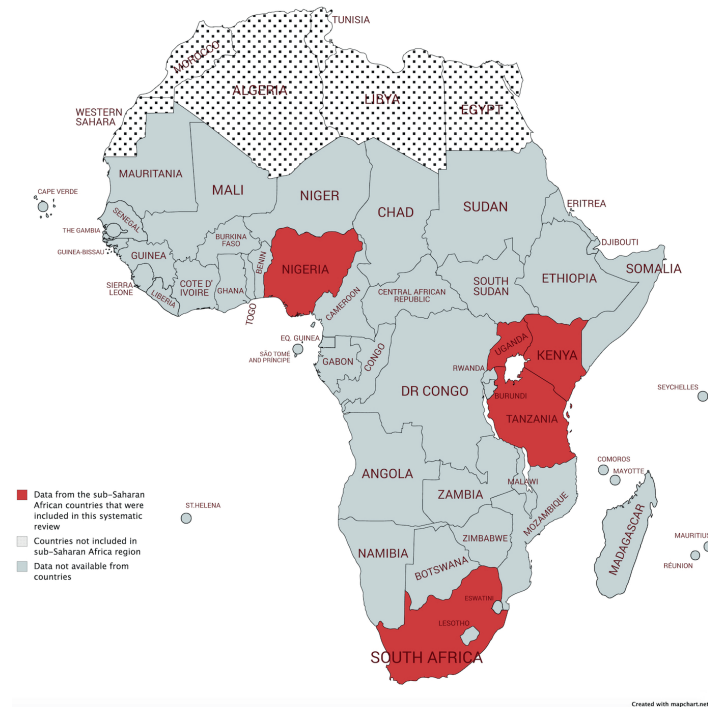


Figure 2. Map of Africa depicting sub-Saharan countries (in gray) where the included studies were conducted (in red), and countries not considered within the sub-Saharan region (spotted). Map created with Mapchart (82).

### 3.4.2 POPULATION AND STUDY CHARACTERISTICS

In total, study reports from five sub-Saharan countries were retrieved (Figure 2) (82). Four cohorts of pregnant women were based in South Africa, three in Nigeria, two in Tanzania and Kenya, and one in Uganda. **Tables 1 and 2 provide a summary of the cohort characteristics and methodological features of the retrieved studies on the VMB and BV, respectively.** All but one study reported baseline characteristics of the women at the time of sampling (83). The GA at sampling was not reported in 9/12 studies. Two studies collected their vaginal samples between 13–28 weeks of GA (second trimester) and Slyker et al. collected the vaginal samples after 28 weeks of GA (third trimester) (71,74,78). Odendaal et al. reported that they collected the vaginal samples soon after enrollment and Schoeman et al. mentioned in their method that a posterior fornix smear was taken at each visit between 14–34 weeks of GA (75,77).

All studies used cervicovaginal swabs for sampling (83) except Donders et al., which used exocervical scraping swabs. Odendaal et al. obtained posterior vaginal fornix smear from an Ayre spatula, while the other nine studies used vaginal swabs from the anterior, lateral vaginal wall, or posterior vaginal fornix (75). All of the ten studies used Gram staining, but seven combined it with Nugent score, while two studies used solely Gram staining. The study by Aduloju et al. used three different methods, namely Spiegel method, Nugent score and three

of the four criteria recommended by Amsel (Table 2) (58–60,71). Schröder's classification was used by Donders et al. to classify the *Lactobacillus* morphotypes (Table 1) (83).

### 3.4.3 VAGINAL MICROBIOTA IN RELATION TO PREGNANCY OUTCOMES

The present systematic search identified only one study by Donders et al. that reported the association between VMB diversity and LBW in sub-Saharan African women (83). In this study, the authors reported a significant association between VMB characteristics and newborn's LBW (Table 1). Specifically, pregnant women with a VMB without lactobacilli or with overgrowth of other bacteria (15.7% with grade III *Lactobacillus* flora) at the first antenatal examination had a 3.6 times higher risk (95% CI 1.3-11.6,  $P = 0.03$ ) of giving birth to a newborn weighting <2 kg, compared to those with a *Lactobacillus*-dominated VMB or mixed bacteria with a low abundance of *Lactobacillus* species (4.8% with grade I and II *Lactobacillus* flora) (83).

### 3.4.4 VAGINAL CONDITIONS IN RELATION TO PREGNANCY OUTCOMES

The included studies reported seven main types of late adverse pregnancy outcomes, namely LBW, IUGR, SGA, PTB, PROM, pregnancy loss, and intra-uterine infection (Table 3).

Six studies looked at the association between BV and LBW (71,73–76,78). All studies, except Odendaal et al., used the traditional cut-off value of birthweight less than 2.5 kg to define LBW and to calculate the association with BV-positivity (75). Independent studies from South Africa, the United Republic of Tanzania, and Kenya did not find any statistical association between BV and LBW (73,78,84). However, both studies from Nigeria had independently reported a positive association between BV and LBW with OR ranging from 3.56 to 19.93 (71,76). The precision of the OR in the latest study is low since the 95% CI is broad (95% CI 5.3-75) (71). In Odendaal et al., the difference in mean birthweight between BV-positive and BV-negative groups of South African pregnant women was used as the outcome and the association was stratified by gravidity and treatment (metronidazole or vitamin C) (75). There was a significant difference in mean birth weights among the metronidazole-treated group (2.48 kg), the placebo-treated group (2.76 kg) and BV-negative group (2.75 kg) ( $P < 0.01$ ) (75). This effect was confined to multigravid women, but not for primigravid women. Only one study from the United Republic of Tanzania studied IUGR as an outcome and found no significant difference in IUGR prevalence between the BV-treated women and the BV-negative women (74). One study conducted in Kenya reported a 3.2 fold increase in the incidence of SGA in BV positive women compared to BV-negative women (95% CI 1.4-7.3;  $P = 0.005$ ) (78).

Nine studies investigated the association between BV and PTB (71–79) (Table 3). In total, seven studies reported a significant positive association between BV-positive individuals and PTB (71,73–77,79). However, the difference in PTB incidence was not consistent across all subgroups (Table 3). For example, Shoeman et al. reported a significant increase in incidence (OR 2.56; 95% CI 1.05-6.32;  $P < 0.03$ ) of PTB attributable to BV only in the subgroup of women tested for BV before 20 weeks of GA (77). Also, Odendaal et al. reported a significant

increase (OR 1.83, 95% CI 1.1-3.1) in incidence of PTB only among the metronidazole treated subgroup and not in the placebo treated subgroup compared to the BV-negative multigravid women (75). Furthermore, Watson-Jones et al. observed that Tanzanian women who received treatment in their group were less likely to have a PTB compared to women who were BV-negative (OR = 0.91; 95% CI 0.6-1.4) (74). Even though the study conducted by Watson-Jones et al. did not report a separate  $P$ -value, the OR for PTB when comparing treated BV-positive individuals to untreated BV-positive individuals was higher than 1 (OR = 2.95; 95% CI 1.3-6.6). Moreover, neither the study conducted by Slyker et al. in Kenya, nor the study by Shayo et al. in the Republic of Tanzania observed a significant association between BV-positive individuals and PTB in their study cohorts (72,78). In Nigeria, three studies reported a significant positive association between BV-positive individuals and PTB with a wide range (3.24 – 16.44 folds) increase in incidence of PTB in BV positive women compared to BV-negative women (71,76,79).

Two studies of these three studies found a significant increase in incidence of PROM: 9.18 fold (95% CI 3.8-22.3) and 11.18 fold (95% CI 4.4-28.1), respectively, in BV positive women compared to BV-negative women (71,76). Whilst Govender et al. found a 2.5 fold (but not significant) increase in incidence (95% CI 0.98-6.4) of having PROM associated with BV-positivity (73). That study also reported an association between BV and intra-uterine infection in the sub-Saharan region (OR= 2.71; 95% CI 0.8-8.9) (73). Due to the paucity of data, late miscarriage, stillbirth, IUD, perinatal death, and neonatal death outcomes from the included studies were all considered as different pregnancy loss measures in this review (Table 3). None of the studies included reported a significant association between BV and pregnancy loss. Only Govender et al. investigated the association between BV and intra-uterine infection in the sub-Saharan region (OR= 2.71; 95% CI 0.8-8.9) (73).

### 3.4.5 RISK OF BIAS WITHIN STUDIES

Five studies had a low risk of bias, six moderate risks of bias, and one high risk of bias (Table 4). One of the first studies that aimed to assess the vaginal microbiota of African women was from Donders et al..This study has a high risk of performance bias mainly because it used outdated culture techniques, failed to mention patient's characteristics and which kind of strategies they used in order to reduce confounding (83). Selection bias and measurement bias factors such as age, parity, smoking status, obstetric history, gestational age of sampling were not reported (83,85). All cohort studies included are at risk for selection bias as described by the JBI critical appraisal tool. None of them addressed “the numbers of loss to follow up” or “which strategies were used to address the potential loss to follow up” (66). Selection bias could have also played a role in the case-control study conducted by Nakubulwa et al., namely because cases were not matched to controls (69). Both randomized control trials (RCT) included were low for risk of bias (75,77).

**Table 1.** Study characteristics and findings of the association between VMB composition and pregnancy outcomes in pregnant women in the sub-Saharan African region.

Author, year Country	Study design	Study population	Methods	Number of participants	Maternal age (years)	Gestational age at sampling (weeks)	Gravidity/parity	Pregnancy outcomes	Other genital infections (Not BV)	Number of women infected with HIV	Factors considered when measuring the association	Main findings
Donders et al. 1993 (83) South Africa	Prospective cohort study	Pregnant women at their first antenatal visit	Exocervical scraping and Schröder's classification for <i>Lactobacillus</i> morphotypes	256	NR	NR	NR	17/165 neonates with LBW ( $\leq 2$ kg)	- Candida: 25% - CT Ag: 9% - GC: 3% <sup>d</sup> - TP: 9% - TV: 36%	0	No factors considered when measuring the association (univariate analysis)	15.7% (n=165) of mothers with Grade III <i>Lactobacillus</i> flora at the first antenatal examination gave birth to < 2 kg birth weight. This was significantly more often than the 4.7% of mothers with Grade I+II <i>Lactobacillus</i> flora at the first antenatal examination that gave birth to < 2 kg baby. OR = 3.6 (95% CI 1.3-11.6, P-value = 0.03). <sup>a</sup>

BV: bacterial vaginosis. CT Ag: *Chlamydia trachomatis* antigen, GC: cultured gonococci, NR: not reported, OR: odds ratio, TP: *Treponema Pallidum*, TV; *Trichomonas vaginalis*.<sup>a</sup> Calculated based on the number given in the original paper (63–65). Grade I *Lactobacillus* flora: Normal appearance of numerous *Lactobacillus* morphotypes (83). Grade II *Lactobacillus* flora: The presence of a diminished amount mixed with other bacteria (83). Grade III *Lactobacillus* flora: Absence of *Lactobacillus* or overwhelming presence of other bacteria (83).

**Table 2.** Study characteristics of studies that investigated the association between BV and pregnancy outcomes of pregnant women in the sub-Saharan African region.

Author, year	Country	Study design	Study population	Follow-up	Methods to detect BV	Number of participants	Maternal age (years)	GA at sampling (weeks)	Gravidity/parity	Other genital infections (n)	Women infected with HIV	Confounding factors considered
Govender et al. 1996 (73)	Durban, South Africa	Prospective cohort study	Pregnant women on first visit to ANC (<30 wks) with no vaginal discharge	Followed until delivery	Nugent score	BV+ 88 BV- 80	24 (16-44)	NR	Gr: NR Parity: 3 [0-6]	- Candida: 16 - CT: 14 - NG: 5 - TP: 20 - TV: 35	9 (5%)	None
Odendaal et al. 2002 (75)	Western Cape, South Africa	Randomized control trial	Pregnant women (15-26 wks) who had had a previous preterm labor or midtri-mester miscarriage. Gr=1: 464 Gr≥2: 491**	Patients were followed up for the rest of the pregnancy, labor and puerperium	Gram stain, wet mount smear, amine test, Spiegel test, 3 of 5 Amstel criteria	BV+ group: 277 - Gr=1: 150 - Gr≥2: 127 BV- group: 678 - Gr=1: 314 - Gr≥2: 364	BV+ group: - Gr=1 treated: 21.2 ± 5.0 - Gr=1 placebo: 22.3 ± 4.9 - Gr≥2 treated: 27.1 ± 4.5 - Gr≥2 placebo: 27.9 ± 5.4 BV- group: - Gr=1: 21.3 ± 5.2 - Gr≥2: 28.4 ± 5.4 placebo: 27.9 ± 5.4	“Soon after enrollment”: BV+ group: - Gr=1 treated: 20.2 - Gr=1 placebo: ± 3.1 - Gr=1 placebo: 20.4 ± 3.0 - Gr≥2 treated: 27.1 ± 4.5 - Gr≥2 placebo: 27.9 ± 5.4	Gr (n): - Primigravidae: 464 - Multigravidae: 491 Parity: NR	NR	NR	None





Author, year	Country	Study design	Study population	Follow-up	Methods to detect BV	Number of participants	Maternal age (years)	GA at sampling (weeks)	Gravidity/ parity	Other genital infections (n)	Women infected with HIV	Confounding factors considered
Schoeman et al. 2005 (77)	South Africa	Double-blind randomized placebo-controlled trial. Intervention: Vitamin C	Pregnant women (14-26 wks) with a history of a previous mid-trimester miscarriage or a preterm delivery	Until delivery	Nugent score	82	Vitamin C group: 28 [18-44] Placebo group: 28 [19-45]	NR (samples were taken until 34 wks)	Gr: - Vitamin C group: 3 (2-8) - Placebo group: 3 (2-7)	NR	NR	None
Wason-Jones et al. 2007 (74)	Mwanza, United Republic of Tanzania	Prospective cohort study	Women attending antenatal clinic	Followed up to the point of delivery	Nugent's score	459	23.8 (Mean)	25.4 ± 6.1	Gr (n): 1-2: 828 3-5: 566 ≥ 6: 142	- Candida: 454 - CT: 114 - NG: 33 - TV: 315	177 (11.7%)	*
Shayo et al. 2012 (72)	Mwanza, Tanzania	Cross sectional descriptive study	Delivering women	No follow up	Nugent's score	81	26 (Median)	NR	Gr: NR	Candida: 74 1.5 (5.3%)	None	None
Slyker et al. 2014 (78)	Nairobi, Kenya	Retrospective cohort study	HIV-infected women with ≥28 wks	Follow-up until one year after delivery	Nugent score	144	25 (22-28)	32 wks	Gr: NR Parity: 1 (1-2)	- Candida: 124 - CT: 16 - NG: 8 - TP: 10 - TV: 65 Any STI: 88	All women were HIV infected	Univariate analysis and logistic regression
Nakubulwa et al. 2015 (69)	Uganda	Unmatched case-control study	Cases: women with confirmed PROM, ≥ 28 wks. Controls: Women without PROM in latent phase of labor	No follow up	Gram stain	2	Cases: Age: (n) <20: 10 20-35: 73 ≥35: 4 Controls: Age: (n) <20: 9 20-35: 69 ≥35: 9	NR	Gr cases (n): 1: 31 2-4: 47 > 5: 9 Gr controls (n): 1: 31 2-4: 48 > 5: 8 Parity: NR	- Candida: 61 - CT: 6 - NG: 1 - TP: 0 - TV: 25 -HSV-Ab: 95 -HSV- ELISA: 51	24 (13.8%)	No further analysis was done for BV due to few numbers
Afolabi et al. 2016 (76)	Lagos State, Nigeria	Prospective observational study	Healthy pregnant women (14-36 wks)	Until one week after delivery	Nugent score	64	30.9 (20-44) (Mean (range))	NR	Gr: NR Parity: (n) 1: 92 ≥ 2: 154	NR	0	None
Aderoba et al. 2016	Benin City, Nigeria	Unmatched case-control study	Cases: women with PTL (28-37 wks). Controls: women with term labor (≥ 37 wks)	No follow up	Nugent score	22	Cases: 29.2 ± 5.7 Controls: 29.7 ± 3.8	NR	Gr: NR Parity: 1.89 (0-5) (Mean(range)) <sup>y</sup>	NR	NR	Marital status
Aduloju et al. 2019 (71)	Ado-Ekiti, Nigeria	Descriptive cross-sectional study	Pregnant women with abnormal vaginal discharge	Until delivery	Spiegel's method, 3 of 4 Amsel criteria, Nugent score	60	BV+: 26.24 ± 6.14 BV-: 28.13 ± 4.38	BV+: 25.27 ± 3.42 BV-: 26.63 ± 2.52	Gr: NR Parity: BV+: 2.7 ± 2.3 BV-: 3.0 ± 1.1	NR	NR	None
Warr et al. 2019 (70)	Nyanza region, Kenya	Nested longitudinal cohort study	pregnant women (HIV uninfected)	9 months postpartum	Nugent score	271	22 (19-27)	NR	Gr: 2 (1-4) Parity: 2 (1-3)	- Candida: 302 - CT: 65 - NG: 29 - TP: 10 - TV: 79	0	None

Note: Data are reported as means ± SD, median (IQR), median [range] or n (%), unless otherwise specified.

Ab: antibody, ANC: antenatal care, ANC: Antenatal clinic, BV: bacterial vaginosis, BW: birth weight, CT: *Chlamydia trachomatis*, EGA: estimate gestational age, GA: gestational age, Gr: gravidity, HIV: human immunodeficiency virus, HSV-2: human simplex virus type 2, IQR: interquartile range, IUFD: intrauterine fetal death, IUGR: intrauterine growth restriction, IUI: intrauterine infection, LBW: low birth weight, NG: *Neisseria gonorrhoeae*, NND: neonatal death, NR: not reported, PND: perinatal death, PROM: premature rupture of the membranes, PTB: preterm birth, PTL: preterm labor, SD: standard deviation, SGA: small for gestational age, STI: sexual transmitted infection, TP: *Treponema Pallidum*, Wks: weeks.

\* Stillbirth: adjusted for age, height, gravidity, history of stillbirth, HIV at delivery and maternal anemia. Prematurity: adjusted for age, occupation, gravidity, HIV at delivery, maternal malaria. LBW: adjusted for age, tribe, occupation, height, gravidity, *Chlamydia trachomatis* at recruitment, HIV at delivery and maternal malaria. IUGR: adjusted for age, tribe, occupation, height, gravidity, baby's sex, maternal malaria and HIV at delivery.

\*\* Analysis was done for primigravidae and multigravidae separately.

**Table 3.** The association between bacterial vaginosis infection and adverse pregnancy outcomes in pregnant women living in sub-Saharan Africa.

Author, year, country	Pregnancy outcome (definition)	n or % of women with adverse pregnancy outcomes over total women tested	Number of women with BV- status and adverse pregnancy outcome	Odds ratio (95% CI)	P-value	
Gowder et al. 1996 (73) South Africa	LBW (<2.5 kg)	361/68	19 BV+ 17 BV-	OR = 1.02 (0.5-2.1)*	P = 0.96*	
	LBW (<2.5 kg)	108/1260	BV treated NR BV untreated NR	OR = 1.08 (0.7-1.8) OR = 2.02 (0.7-5.7)	NR NR	
	6% of 332 infants had LBW (<2.5 kg)	20/332	In total 144 BV+ and 241 BV- women were diagnosed. Cases	OR = 2.1 (0.8-5.6)	P = 0.10	
	LBW (<2.5 kg)	17/246*	9 BV+ 8 BV-	OR = 3.56 (1.3-9.7)*	P < 0.01*	
	LBW (not defined)	13/262*	10 BV+ 3 BV-	OR = 19.93 (5.3-75)*	P < 0.01*	
Watsons-Jones et al. 2007 (74) United Republic of Tanzania	IUGR (LBW infant born ≥37 GA weeks)	4% of 1117	BV treated NR	OR = 1.09 (0.6-2.2)	P = 0.79	
	SGA (using Mikolajczyk [21] and using Dubowitz-estimated gestational age.)	28/311	In total 144 BV+ and 241 BV- women were diagnosed.	OR = 3.2 (1.4-7.3)	P < 0.01	
	Gowder et al. 1996 (73) South Africa	PTD (<37 GA weeks)	35/268	24 BV+ 11 BV-	OR = 2.35 (1.1-5.2)*	P = 0.03*
		PTD (<37 GA weeks) treated primigravida	76/377	12 BV+ 64 BV-	OR = 0.86 (0.4-1.7)*	P = 0.66*
		PTD (<37 GA weeks) placebo primigravida	77/393	13 BV+ 64 BV-	OR = 0.73 (0.38-1.4)*	P = 0.34*
PTD (<37 GA weeks) treated multigravida		132/421	30 BV+ 102 BV-	OR = 1.83 (1.1-3.1)*	P = 0.02*	
Schwartz et al. 2005 (77) South Africa	PTD (<37 GA weeks) placebo multigravida	114/402	12 BV+ 102 BV-	OR = 0.75 (0.4-1.5)*	P = 0.41*	
	PTD (<37 GA weeks) treated <20 GA weeks	46/103	23 BV+ 23 BV-	OR = 5.56 (1.05-6.32)	P = 0.03	
	PTD (<37 GA weeks) treated >20 GA weeks	37/95	19 BV+ 18 BV-	OR = 1.25 (0.5-3.11)	P = 0.59	
	Pretermity (<37 GA weeks)	12% of 1516	BV treated NR BV untreated NR	OR = 0.91 (0.6-1.4) OR = 2.95 (1.3-6.6)	NR NR	
Shayo et al. 2012 (72) United Republic of Tanzania	GA < 37 GA weeks	104/291	29 BV+ 67 BV-	OR = 0.88 (0.52-1.53)	P = 0.67*	
	PTD (<37 GA weeks)	33/246*	16 BV+ 17 BV-	OR = 3.24 (1.5-6.9)*	P = 0.01*	
	PTB (<37 GA weeks)	41/PTB vs. 41 term birth	17 BV+ 24 BV-	OR = 4.5 (1.4-14.4)**	P < 0.01**	
	Pretermity (not defined)	21/262*	15 BV+ 6 BV-	OR = 16.44 (6.1-44.6)*	P < 0.01**	
Nabubaru et al. 2015 (69) Uganda	PROM (spontaneous rupture of membranes prior to the onset of labor irrespective of the gestation) PROM (women in latent labor with clear fluid from perineum and through as the speculum examination) PROM (not de fined) PROM (not de fined)	17 BV+ 7 BV-	OR = 2.50 (0.98-6.4)*	P = 0.06*		
		0 BV+ 2 BV-	No analysis conducted due to few numbers	NR		
		19 BV+ 8 BV-	OR = 9.18 (3.8-22.3)*	P < 0.01*		
		14 BV+ 8 BV-	OR = 11.18 (4.4-28.1)*	P < 0.01*		
Gowder et al. 1996 (73) South Africa	Pregnancy losses (miscarriage, stillbirths, neonatal deaths)	25/168	14 BV+ 11 BV-	OR = 1.19 (0.5-2.8)*	P = 0.69*	
	IUD (not de fined) under primigravidae treated group	5/377	0 BV+ 5 BV-	OR = 0.42 (0.02-7.7)*	P = 0.55*	
	IUD (not de fined) under primigravidae placebo group	7/393	2 BV+ 5 BV-	OR = 1.53 (0.3-8.0)*	P = 0.62*	
	PND (not de fined) under primigravidae treated group	8/377	1 BV+ 7 BV-	OR = 0.67 (0.08-5.5)*	P = 0.71*	
	PND (not de fined) under primigravidae placebo group	9/393	2 BV+ 7 BV-	OR = 1.08 (0.3-5.5)*	P = 0.92*	
	IUD (not de fined) under multigravidae treated group	16/421	4 BV+ 12 BV-	OR = 1.71 (0.5-5.5)*	P = 0.36*	
	IUD (not de fined) under multigravidae placebo group	13/402	1 BV+ 12 BV-	OR = 0.57 (0.1-4.4)*	P = 0.59*	
	PND (not de fined) under multigravidae treated group	25/421	7 BV+ 18 BV-	OR = 2.06 (0.8-5.1)*	P = 0.12*	
	PND (not de fined) under multigravidae placebo group	19/402	1 BV+ 18 BV-	OR = 0.37 (0.1-2.8)*	P = 0.34*	
	Stillbirth (≥22 GA weeks)	42/1536 (2.7%) women experienced a stillbirth or IUD	Treated BV NR	OR = 1.79 (0.8-4.2)	P = 0.18	
	Stillbirth (fetal death at ≥20 weeks gestation and included births without signs of life)	19/1221	5 BV+ 14 BV-	OR = 1.34 (0.47-3.80)	P = 0.58	
	Pregnancy loss (14-28 GA weeks)	92/46*	3 BV+ 6 BV-	OR = 1.44 (0.4-5.9)*	P = 0.61*	
Gowder et al. 1996 (73) South Africa	Intrauterine infection (diagnosed on clinical findings of maternal pyrexia and tachycardia, fetal tachycardia, uterine tenderness and/or offensive liquor)	15/168	11 BV+ 4 BV-	OR = 2.71 (0.8-8.9)*	P = 0.09*	

Forest plot of the association between bacterial vaginosis (BV) infection and adverse pregnancy outcomes in pregnant women living in sub-Saharan Africa. P values indicate differences in outcomes between pregnant women with BV (BV+) and without BV (BV-) in individual studies (statistically significant differences in bold = P < 0.05). Data are expressed as Odds ratio's (OR). OR = 1 is indicated as a grey line in the forest plots. Adjusted OR (a OR) were calculated based on the values given in the selected articles as described by Altman or Pagano and Gauvreau, and P-value based on Sheskin (59-61). \*\* adjusted odds ratio for marital status. BV: Bacterial vaginosis. CI, confidence interval. IUD: Intrauterine death. IUGR: intrauterine growth restriction. a Calculated based on the number given in the original paper. LBW: Low birth weight. NND: Neonatal death. OR, odds ratio PND: Perinatal death. PTB: Preterm birth. PTD: Preterm delivery. PTL: Preterm rupture of membrane. SGA: Small for gestational age



**Table 4.** Assessment of risk of bias according to the Joanna Briggs Institute Critical Appraisal Tool

Study	Q1	Q2	Q3	Q4	Q5	Q6	Q7	Q8	Q9	Q10	Q11	Q12	Q13	% yes	Risk <sup>b</sup>
<i>Cohort studies</i>															
Warr et al. (2019) (70)	✓	✓	✓	×	×	✓	×	✓	×	×	✓	N/A	N/A	55% (6/11)	Moderate
Watson-Jones et al. (2007) (74)	✓	✓	✓	✓	✓	✓	✓	✓	×	×	✓	N/A	N/A	82% (9/11)	Low
Afolabi et al. (2016) (76)	✓	✓	✓	×	✓	✓	×	✓	×	×	✓	N/A	N/A	68% (7.5/11)	Moderate
Govender et al. (1996) (73)	✓	✓	✓	×	×	✓	×	✓	×	×	✓	N/A	N/A	59% (6.5/11)	Moderate
Slyker et al. (2012) (78)	✓	✓	✓	✓	✓	✓	×	✓	×	×	✓	N/A	N/A	73% (8/11)	Low
Donders et al. (1993) (83)	×	✓	×	×	×	N/A	×	×	×	×	✓	N/A	N/A	25% (2.5/10)	High
<i>Cross sectional studies</i>															
Aduloju et al. (2019) (71)	✓	✓	✓	✓	×	×	×	✓	N/A	N/A	N/A	N/A	N/A	69% (5.5/8)	Moderate
Shayo et al. (2012) (72)	✓	✓	✓	✓	×	×	×	✓	N/A	N/A	N/A	N/A	N/A	69% (5.5/8)	Moderate
<i>Case-control studies</i>															
Aderoba et al. (2016) (79)	×	×	✓	✓	✓	✓	✓	✓	✓	✓	N/A	N/A	N/A	80% (8/10)	Low
Nakubulwa et al (2015) (69)	×	×	✓	✓	✓	×	×	×	✓	✓	N/A	N/A	N/A	50% (5/10)	Moderate
<i>Randomized controlled trial</i>															
Schoeman et al (2005) (77)	✓	✓	✓	✓	✓	×	✓	✓	?	✓	?	✓	✓	84% (11/13)	Low
Odendaal et al (2002) (75)	✓	✓	✓	×	×	×	✓	×	?	✓	✓	✓	✓	77% (10/13)	Low

Studies included in this review were assessed for risk of bias according to JBI (Joanna Briggs Institute) Critical Appraisal Tool, detailed in reference (66) and Supplementary material 2. ✓: Indicates yes (1 point). O: Indicates No (0 points). ‘?’: Indicates unclear (0,5 points). Risk<sup>b</sup>: The risk of bias was ranked as high when the study score reached up to 49%, moderate when the study score reached from 50 to 69%, and low when the study score reached more than 70%. N/A = not applicable.

### 3.5 DISCUSSION

The aim of this study was to review evidence on the association between the diversity of the vaginal bacterial ecosystems in sub-Saharan African women and pregnancy outcomes. To identify all relevant work on the topic, studies on the association between VMB diversity, presence of BV and AV and pregnancy outcomes were systematically identified and reviewed.

### 3.5.1 VAGINAL MICROBIOTA CHARACTERISTICS AND PREGNANCY OUTCOMES

Several studies in North America have investigated the association between VMB characteristics and PTB. DiGiulio et al. observed that an increased prevalence of diverse VMB is associated with PTB (51). In a relatively small number of participants, they also found that a high abundance of *Gardnerella* or *Ureaplasma* with a low abundance of *Lactobacillus* species was associated with PTB (51). Stout et al. observed in a predominantly African-American cohort that PTB was associated with a significant decrease of VMB richness and diversity, rather than changes in specific taxa or a taxon (43). In women who delivered preterm, they did observe that *Ureaplasma* abundance increased in the second and third trimesters, however this increase was not significant (43). On the other hand, the longitudinal study conducted by Romero et al. did not find an association between PTB and any abundance of specific taxa or vaginal ecosystem characteristic (52). These differences between studies might be attributed to the frequency and timing of sample collection, ethnical differences in the study populations, and methods used to detect the microbial species (43). Nevertheless, these combined results raise further interest in investigating the relationship between VMB characteristics and PTB, LBW, and other late adverse pregnancy outcomes in SSA women.

To date, only the study by Donders et al. has investigated the association between VMB diversity and pregnancy outcomes in sub-Saharan Africa (83). This work suggested an association between VMB with no or low lactobacilli and risk of having a child weighting less than 2 kg (83). Very low birthweight can be an indicator of PTB (83). As reported by two independent non-pregnant cohort studies from sub-Saharan Africa, a correlation between the presence of non-*Lactobacillus* dominant VMB and increased inflammatory cytokines and chemokines in the vagina has been observed (14,86,87). A longitudinal study in the United States of America that consisted of pregnant women predominantly of African ancestry observed that pro-inflammatory cytokines in the vaginal fluid were correlated with taxa associated with dysbiosis and PTB (88). More recent studies suggest that high production of pro-inflammatory cytokines due to VMB dysbiosis contributes to further activation of the host inflammatory response in the reproductive tract, which in turn can induce labor, also a premature one (14,86,88,89).

The work by Donders et al. is also one of the first that studied the genital bacteria in pregnancy in sub-Saharan Africa (83). The culture-based approach and analysis methods (Schröder's classification for lactobacilli morphology detection) used are now outdated and poorly described in the paper (83). The main limitations of using culture-dependent methods are that only medium-specific species can grow, and that highly abundant or fast-growing VMB species will limit the detection of others (48,90,91). In the last decade the use of culture-independent, molecular techniques, such as PCR based techniques and sequencing of the 16S ribosomal (r)RNA gene allow for an unprecedented high resolution detection of the microbiota (92). Hence, more studies using molecular microbiology techniques are needed to confirm the findings by Donders

et al. and to further investigate whether the VMB also has a role in other adverse pregnancy outcomes, such as PTB or neonatal mortality, that remain burdensome in sub-Saharan Africa.

### 3.5.2 THE ASSOCIATION BETWEEN BV AND ADVERSE PREGNANCY OUTCOMES

Three of the six studies included found a positive association between BV-positive individuals and LBW (71,75,76). However, the study by Watson-Jones et al., did report that untreated BV was associated with LBW only before adjustment for age, tribe, occupation, height, gravidity, *Chlamydia trachomatis* infection at recruitment, HIV at delivery, and maternal malaria (74). Furthermore, in three studies that did not observe an association between BV and LBW, there was confounding effect of gravidity or parity reported (74,75,78).

The findings in sub-Saharan African women are in contrast with those in a healthy, homogeneous, Caucasian Danish population study (93). In this Danish study, the authors found an association between BV and LBW in nulliparous women (adjusted OR 4.3; 95% CI 1.5-12) (93). In the same study, this association was not observed for multiparous women (93).

The effect of BV on fetal and neonatal growth is difficult to interpret as LBW can result from either IUGR, SGA, or premature delivery. Even though Slyker et al., did not report a significant association between BV and LBW during pregnancy the newborns of mothers with BV were significantly smaller for their gestational age than newborns from BV-negative women (78). However, in this study, Dubowitz scoring was used to determine gestational age at birth, which could have influenced the results. This score is feasible to use in low-resource settings and is as reliable a method as ultrasound (the gold standard). However, the Dubowitz score can overestimate the gestational age by 3.9 days ( $\pm 7.1$ ) compared to ultrasound (94). This may have masked the potential association between BV and PTB (94,95). The SGA results of Slyker et al. are in line with the results from the Danish population study in which they also observed a significant association between BV and SGA in nulliparous women (adjusted OR 1.6; 95% CI 0.7-3.1) (93). These differences in LBW according to gravidity and parity, and the role of BV in this, need to be further investigated.

Although most studies (seven of the eleven) reported a significant association between BV-positive status and PTB (71,73–77), However this evidence is weakened by the fact that two of the seven studies that reported a positive association between BV-positive individuals and PTB did not consider the possible confounding effect of baseline characteristics, such as mean maternal age, marital status and antenatal antibiotic use (73,76). However, it is unlikely that these variables would cause such an increased prevalence of PTB or other adverse pregnancy outcome in the BV positive group (96).

On the other hand, the results of the two studies that did not find a significant association between BV and PTB should be analyzed carefully (72,78). One of these two studies did not make a comparison of the baseline characteristics between BV-positive and BV-negative women, thus other differences between the two groups could have played a role in masking

the association (72). The other study observed a borderline significance between BV and PTB ( $p$ -value = 0.06). But the usage of Dubowitz score in their study to detect the gestational age could have also cause a misclassification of PTB as outcome (78).

Schoeman et al. showed that women who were diagnosed with BV before 20 weeks of GA were significantly more at risk for PTD than women diagnosed after 20 weeks of GA (77). Thus, gestational age at diagnosis should also be taken into account. This is in agreement with the results of a systematic review conducted by Leitich et al., which confirmed the hypothesis that BV early in pregnancy, or in the first 16 weeks of GA, is a much stronger risk factor for PTB than BV late in pregnancy (22). In their meta-analysis included studies were not restricted to those performed in sub-Saharan Africa (22). Overall, more evidence is needed in African women to confirm this association.

A positive association between BV and PTB was found in several other studies or meta-analyses that were not explicitly limited to the sub-Saharan African population (20,22,97). However, in the study conducted by Thorsen et al., BV was not associated with PTB in a Danish population (93).

In low-income countries, including some countries from sub-Saharan Africa, spontaneous preterm PROM contributes to a third of all PTB (17,98). In the current review, two studies found a positive association between BV and PROM (71,76). Another study could not assess the association since only two women had PROM and were both BV-negative (69). As also seen in other populations, such as Northern American women, the association between BV and PROM seems relatively strong (97,99). PROM and PTB are probably attributable to both inflammation and bacterial enzymes, such as proteases, that are being produced by certain bacteria (97). Both can have a causative role in the disruption of the collagen network of the membrane morphology, enhance placental inflammation, and activate uterine contractions (100). PROM can be caused by intra-uterine infection, and one of its main risk factors can be BV (101). In the South African cohort, Govender et al. observed a non-significant 2.7 fold increase in odds in the association between BV and intra-uterine infection (73). As reviewed in Redelinguys et al., increased microbial activity from certain anaerobic Gram-negative bacteria, such as *G. vaginalis*, particularly when they are heavily colonizing the vagina, may lead to toll-like receptors (TLR) activation. Subsequently, TLR activation induces the production of proinflammatory cytokines and activation of the adaptive immune system in the reproductive tract (102–104). IUD might be induced by proteases that stimulate the production of proinflammatory cytokines, and PROM, chorioamnionitis, and preterm labor might be induced by the increased phospholipase A2 production, also stimulated by proteases (73,102,104,105).

BV is characterized by the absence of inflammation, such as no increase in circulating leukocytes, decreased production of interleukin (IL) 8, elevated levels of IL-1 $\beta$ , IL-6, and absence of clinical signs of inflammation, such as pain or redness of the vaginal mucosa (104,106,107). However, it is hypothesized that women with a genetic predisposition for pathological inflammatory responses to BV are more susceptible to having PROM or PTB (104,108). For instance,

BV can activate tumor necrosis factor (TNF)- $\alpha$  expression in women (109). Furthermore, it has been observed that some women with African ancestry living in north-America, that have a TNF- $\alpha$  polymorphism (TNF- $\alpha$  -308G > A) have a 6-fold increased risk of preterm labor (107,110). Other types of polymorphisms that may affect specific cytokine and chemokine secretion, such as IL-6, have also been observed among women with sub-Saharan African ancestry (12,109). Thus, there seems to be an interaction between the host immune system and the VMB, especially in its dysbiotic state, and this interaction can be enhanced by host genetic factors (14,104).

Pregnancy loss variables were assessed in five out of twelve of the included studies, and none found an association between BV and pregnancy loss (70,73–76). Conclusions whether there is an association between BV and second trimester pregnancy losses vary between studies from different global regions. In line with the findings of this systematic review, a study conducted in North America also did not find an association between BV and second trimester pregnancy loss (111). However, other studies conducted in England, Belgium, Pakistan, and the United States of America did independently associate BV with second trimester pregnancy loss in their cohorts (112–115). As for third trimester pregnancy loss due to BV, scarce data is available on it. It is possible that the variation of the association between BV and pregnancy loss might be explained by ethnicity and geographical region, just as the differences in the BV prevalence, especially in women with asymptomatic BV (18). Therefore, more studies are needed to evaluate the correct associations and to explain differences in the association between different populations.

### 3.5.3 AEROBIC VAGINITIS AND PREGNANCY OUTCOMES

In 2017, Kamboj and Africa conducted an electronic search on studies investigating the association between AV and pregnancy outcomes (116). Similar to our findings, they reported a paucity of studies on the topic (116). To this date, there is a need for published research on the role of AV in adverse pregnancy outcomes for the sub-Saharan Africa region. Nevertheless, in the past years, there has been growing interest in this topic. Donders et al. found an association between AV and increased early PTB rate (<35 weeks of GA) (OR = 3.2; 95% CI 1.4-9.1;  $P$ -value = 0.04), but not PTB rate (25-37 weeks of GA) in a Belgium population (117). Moreover, in a prospective study conducted in Saudi Arabia, there was an association between AV and PTB (adjusted OR 3.06, 95% CI 1.58-5.95;  $P$ -value < 0.01) and PROM (adjusted OR 6.17; 95% CI 3.24-11.7;  $P$ -value < 0.01), but not LBW (adjusted OR = 2.13; 95% CI 0.85-5.4;  $P$ -value = 0.11) (32). They also observed that severe forms of AV significantly increased the incidence of PTB ( $P$ -value < 0.01) and PROM ( $P$ -value < 0.01) compared to less severe forms of AV (32). As mentioned, the present study did not retrieve any full peer-reviewed article from sub-Saharan Africa. However, via the Embase (Ovid) search engine, a conference abstract that investigated the role between AV and PTB was found (118). Unfortunately, after a correspondence with the authors it became clear that no paper has been published yet on the study.

However, this suggests that research about the role of AV in adverse pregnancy outcomes might be ongoing in sub-Saharan Africa (116).

### 3.4.4 FACTORS INFLUENCING THE VAGINAL DIVERSITY AND PREGNANCY OUTCOMES

Among the factors already mentioned, there are many other methodology, biological or sociological factors that should be considered when analyzing the VMB, vaginal dysbiotic conditions and their role with pregnancy outcomes.

In the past two decades, the introduction of molecular genotypic methods, such as 16S rRNA-based phylogeny, revealed many other species and the extensive diversity of species within a genus, including the *Lactobacillus* genus (119,120). It has been increasingly recognized that some species until now classified as part of the *Lactobacillus* genus or other bacterial genera have a different phylogenetic, ecological, and physiological characteristics that match more to other bacterial genera (119). Therefore, common genera or species in the reproductive tract, including *Lactobacillus* and *Gardnerella*, are undergoing taxonomic reclassifications based on phylogenetic analyses (119–121).

Although the different taxonomic classification might not directly impact the clinical community, food and health-related industries, lay-person, and public health approaches, it will assist in forthcoming microbiology and biomedical research (119). Reclassifications of different taxa based on phylogenetic genera that include species containing the same ecological and metabolic properties, and the introduction of separate species, might provide new and more specific insights on their beneficial or pathogenic potential. In turn, when species result clinically relevant, this information might be useful for diagnostics or therapeutic approaches beneficial for female reproductive and maternal health.

Furthermore, co-occurring infections with various organisms, such as *Candida albicans*, *Trichomonas vaginalis*, and other sexually-transmitted infections, are burdensome in sub-Saharan Africa and can induce inflammatory responses in the vagina (122,123). Therefore, these organisms should be considered potential confounders when investigating the role between vaginal dysbiotic conditions or VMB and adverse pregnancy outcomes. Donders et al. observed that women with absent *Lactobacillus* morphotypes giving birth to a child with LBW ( $\leq 2$  kg) had an average of 1.15 infections with *T. vaginalis*, *C. trachomatis*, gonococci, or syphilis, against an average of 0.7 infections when the birthweight was more than 2 kg (83). While women with a *Lactobacillus*-dominated VMB, or mixed bacteria with a low abundance of *Lactobacillus* species, had an average of 0.21 infections, irrespective of the birthweight of their infant (83). The same study also reported a positive association between absent *Lactobacillus* morphotypes and *T. vaginalis*, *C. trachomatis*, and Gonococci (83). However, since the authors did not aim to detect BV in their cohort, they raised the question of whether a VMB with absent *Lactobacillus* morphotypes could be primarily associated with BV, rather than with these detected pathogens (83). This could be especially the case since BV is a dysbiotic vaginal

condition, and women with BV frequently have other vaginal infections. Interestingly, only one of the included studies on BV corrected for other co-occurring infections. This raises the question of whether the found associations can be attributed to BV alone, to other specific infections, or a combination of BV and other infections. The study conducted by Govender et al. reported a 2.35 fold higher incidence of having a PTB and a 2.71 fold higher incidence of having an intra-uterine infection in women with BV compared to women having other infections or no infection (73). These findings advocate for BV contributing to PTB and intra-uterine infection independently of other co-occurring infections.

However, there was no significant increase in OR for the association of BV with LBW, pregnancy loss, and PROM (73). As already mentioned above, the downside of the study of Govender et al. is that no comparison was made for the baseline characteristics between the two groups. Thus, it is unknown whether differences between the baseline variables (such as age, disease, or other sexual risk factors) could influence the outcome and cause chance bias (73).

When comparing populations, besides genetics different socio-cultural factors should also be considered. Those are, for instance, socioeconomic status, poor access to healthcare services, poor nutrition, hygiene and sexual practices, education and household income, which have been associated with VMB differences even in very homogenous study groups (124). Moreover, local epidemics of STI and burden of adverse pregnancy outcomes, might also explain population differences in VMB composition across sub-Saharan Africa (55,125–130). Studies across Europe, Latin America and sub-Saharan Africa have suggested that school attendance and school-based sexual and reproductive health programs promote acceptance of care during pregnancy and avoidance of early high-risk sexual activities that might lead to increase susceptibility to BV or other genital infections (131,132). Nonetheless, school attendance in certain parts of sub-Saharan Africa is lower than in other world regions due to social (for instance gender-inequality), economical and infrastructural reasons (132–134), therefore, access to sexual education remains a problem for these populations, particularly girls (132). Even if school education is provided in certain urban communities in sub-Sahara Africa, as in other low- and middle-income countries, misconceptions and stigma about sexual and reproductive health related issues persist (135). Also, inadequate or incorrect knowledge of symptoms of certain diseases might lead to delayed recognition of vaginal dysbiotic conditions in women, delayed diagnosis of possible sequelae and delayed ante- and perinatal care.

Furthermore, in many resource-constrained settings, laboratory diagnosis, even in the form of Gram staining, is not practical (136), and even if diagnostic services are available treatment is mostly the result of syndromic management (treatment directed to the organisms that most often cause specific signs and symptoms) (136). This type of management misses asymptomatic BV or vaginal dysbiotic condition, which are most of the cases. Healthcare-seeking behavior of patients, integration of treatment within antenatal care services, knowledge of health providers on the efficacy of chosen drugs, and drugs availability are important when implementing

syndromic management in the public health system and are still challenging in certain parts of sub-Saharan Africa (136).

### 3.4.5 LIMITATIONS

The inclusion of different study designs contributes to the heterogeneity of data included in this systematic review. Most studies had an observational design, and their analysis should be interpreted with caution since causality and confounding are two factors that can lead to the overestimation of an association (OR), and the latter were not always adjusted for. The decision to include intervention and cross-sectional studies and studies that did not adjust for potential confounders was due to the limited number of original studies available on the VMB, AV, and BV in pregnant women in the sub-Saharan region (137–139).

Another factor contributing to the heterogeneity of included studies is the different measurements used for the same outcome, and the annotation of the GA or trimester at sampling collection. Indeed, the GA was not always reported or not consistently so. Previous longitudinal studies have demonstrated differences in VMB characteristics throughout the pregnancy, even within the same subjects (43,51). The exact mechanisms behind VMB changes during pregnancy and whether they provide any physiological benefit to either mother or fetus are still topics of debate (14). Even though the most appropriate timing for biospecimen collection during pregnancy is unclear, it remains essential to consider the gestational age of pregnancy at the time of collection when comparing findings from different studies.

The limitations of Gram staining, Spiegel and Nugent scoring system should also be taken into account. Even though Nugent scoring is standardized, reproducible, reliable, and its degree of inter- and intra-observer variability is lower than for the Amsel criteria, all three methods require testing facilities, training and quality control procedures, which were not always stipulated in the included articles (140). Moreover Gram staining only provides gross morphologic-based diagnosis, with only a limited understanding of the VMB composition and relative abundance of bacterial species (140–142).

The use of ORs to report outcomes can lead to overestimation of the risk in case of a positive association, and this overestimation can increase if the outcome is common. As observed in the meta-analysis conducted by Flynn et al., even after using a random effect model, the summary OR of three (LBW, PROM, premature onset of labor) of the four adverse pregnancy outcomes investigated exceeded the relative risk, possibly due to pooling different subset of cohort studies (21).

### 3.5 CONCLUSION AND IMPLICATIONS FOR FUTURE RESEARCH

An overview of the evidence on the role of VMB dysbiosis status and related vaginal dysbiotic conditions with late adverse pregnancy outcomes is essential to improve maternal and newborn health sub-Saharan Africa. In this systematic review, twelve studies investigated the association between *Lactobacillus*-deficient VMB or BV and seven different types of late adverse pregnancy outcomes. Due to the various methodological differences between the retrieved studies, only the individual strengths of association were summarized per late adverse pregnancy outcome.

Unfortunately, no published evidence was found on the association between AV and late adverse pregnancy outcomes in sub-Saharan Africa, which advocates for research on the topic.

Furthermore, only one study was retrieved to support a positive association between *Lactobacillus*-deficient VMB and LBW. The association between VMB dysbiosis and other types of late adverse pregnancy outcomes could not be assessed. Eleven studies were retrieved that investigated the association between BV and seven late pregnancy outcomes. Two out of four studies independently reported a positive association between BV and PROM. Across the included studies, there were discrepancies to support the association between BV and PTB or LBW. At least two studies conducted in Nigeria supported the association between BV and PROM, PTB, and LBW in Nigerian women. The association between BV and any type of pregnancy loss variable was not been observed in any study. Moreover, there was a single evidence supporting the association between BV and intra-uterine infection, BV and SGA, or the absence of association between BV and IUGR, respectively. Thus, more high-quality observational studies are needed to investigate the association between BV and PTB, LBW, PROM, SGA, and intra-uterine infection within populations in this geographical region.

Prospective studies of pregnancy complications should correct for baseline characteristics and take gestational age at collection into account. Moreover, other co-occurring infections and use of antibiotic treatments should also be measured and corrected for. From this systematic review, it is difficult to ascertain whether the findings are unique to sub-Saharan Africa or ethnic background, and whether adverse pregnancy outcomes attributable to VMB dysbiosis or related conditions are reflected in other geographical regions. Therefore, it is of interest to expand on this research topic with further studies across world regions considering differences, such as VMB characterization methodologies, clinical classification of BV and AV, and other known confounding factors between populations.

The high burden of BV, sexually-transmitted infections and pregnancy complications, and the potential role of the VMB dysbiosis on them, supports the need for future studies to determine the vaginal eubiotic state among sub-Saharan African women adequately. Further investigations on the physiological and pathological function of the VMB and related vaginal dysbiotic conditions, especially AV and BV, during pregnancy will provide evidence for health promotion strategies and the prevention of health conditions among mothers, with in turn a meaningful impact on public health.

### 3 REFERENCES

1. Mombo-Ngoma G, Mackanga JR, González R, Ouedraogo S, Kakolwa MA, Manego RZ, Basra A, Rupérez M, Cot M, Kabanywany AM, et al. Young adolescent girls are at high risk for adverse pregnancy outcomes in sub-Saharan Africa: An observational multicountry study. *BMJ Open* (2016) doi:10.1136/bmjopen-2016-011783
2. Kinney M V., Kerber KJ, Black RE, Cohen B, Nkrumah F, Coovadia H, Nampala PM, Lawn JE. Sub-Saharan Africa's mothers, newborns, and children: Where and why do they die? *PLoS Med* (2010) doi:10.1371/journal.pmed.1000294
3. WHO. WHO | Maternal and perinatal health. Available at: [https://www.who.int/maternal\\_child\\_adolescent/topics/maternal/maternal\\_perinatal/en/](https://www.who.int/maternal_child_adolescent/topics/maternal/maternal_perinatal/en/) [Accessed March 11, 2020]
4. Ramharter M, Grobusch MP, Kießling G, Adegnikaa AA, Möller U, Agnandji STM, Kramer M, Schwarz N, Kun JFJ, Oyakhirome S, et al. Clinical and Parasitological Characteristics of Puerperal Malaria. *J Infect Dis* (2005) doi:10.1086/427781
5. Adegnikaa AA, Verweij JJ, Agnandji ST, Chai SK, Breitling LP, Ramharter M, Frolich M, Issifou S, Kremsner PG, Yazdanbakhsh M. Microscopic and sub-microscopic Plasmodium falciparum infection, but not inflammation caused by infection, is associated with low birth weight. *Am J Trop Med Hyg* (2006) doi:10.4269/ajtmh.2006.75.798
6. Morikawa E, Mudau M, Olivier D, De Vos L, Joseph Davey D, Price C, McIntyre JA, Peters RP, Klausner JD, Medina-Marino A. Acceptability and Feasibility of Integrating Point-of-Care Diagnostic Testing of Sexually Transmitted Infections into a South African Antenatal Care Program for HIV-Infected Pregnant Women. *Infect Dis Obstet Gynecol* (2018) doi:10.1155/2018/3946862
7. Friberg IK, Kinney M V., Lawn JE, Kerber KJ, Odubanjo MO, Bergh A-M, Walker N, Weissman E, Chopra M, Black RE. Sub-Saharan Africa's Mothers, Newborns, and Children: How Many Lives Could Be Saved with Targeted Health Interventions? *PLoS Med* (2010) 7:e1000295. doi:10.1371/journal.pmed.1000295
8. Guise JM, Mahon SM, Aickin M, Helfand M, Peipert JF, Westhoff C. Screening for bacterial vaginosis in pregnancy. *Am J Prev Med* (2001) doi:10.1016/s0749-3797(01)00257-4
9. Kekki M, Kurki T, Kotomäki T, Sintonen H, Paavonen J. Cost-effectiveness of screening and treatment for bacterial vaginosis in early pregnancy among women at low risk for preterm birth. *Acta Obstet Gynecol Scand* (2004) doi:10.1111/j.1600-0412.2004.00262.x
10. van de Wijgert JHHM, Jaspers V. The global health impact of vaginal dysbiosis. *Res Microbiol* (2017) doi:10.1016/j.resmic.2017.02.003
11. Marchesi JR, Ravel J. The vocabulary of microbiome research: a proposal. *Microbiome* (2015) 3: doi:10.1186/s40168-015-0094-5
12. Bayigga L, Kateete DP, Anderson DJ, Sekikubo M, Nakanjako D. Diversity of vaginal microbiota in sub-Saharan Africa and its effects on HIV transmission and prevention. *Am J Obstet Gynecol* (2019) doi:10.1016/j.ajog.2018.10.014
13. Selle K, Klaenhammer TR. Genomic and phenotypic evidence for probiotic influences of *Lactobacillus gasseri* on human health. *FEMS Microbiol Rev* (2013) doi:10.1111/1574-6976.12021
14. Al-Nasiry S, Ambrosino E, Schlaepfer M, Morré SA, Wieten L, Voncken JW, Spinelli M, Mueller M, Kramer BW. The Interplay Between Reproductive Tract Microbiota and Immunological System in Human Reproduction. *Front Immunol* (2020) 11:378. doi:10.3389/fimmu.2020.00378

15. Borgdorff H, van der Veer C, van Houdt R, Alberts CJ, de Vries HJ, Bruisten SM, Snijder MB, Prins M, Geerlings SE, Schim van der Loeff MF, et al. The association between ethnicity and vaginal microbiota composition in Amsterdam, the Netherlands. *PLoS One* (2017) **12**:e0181135. doi:10.1371/journal.pone.0181135
16. Bilardi J, Walker S, McNair R, Mooney-Somers J, Temple-Smith M, Bellhouse C, Fairley C, Chen M, Bradshaw C. Women's Management of Recurrent Bacterial Vaginosis and Experiences of Clinical Care: A Qualitative Study. *PLoS One* (2016) **11**:e0151794. doi:10.1371/journal.pone.0151794
17. Meis PJ, Goldenberg RL, Mercer B, Moawad A, Das A, McNellis D, Johnson F, Iams JD, Thom E, Andrews WW. The preterm prediction study: Significance of vaginal infections. *Am J Obstet Gynecol* (1995) **173**:1231–1235. doi:10.1016/0002-9378(95)91360-2
18. Kenyon C, Colebunders R, Crucitti T. The global epidemiology of bacterial vaginosis: A systematic review. *Am J Obstet Gynecol* (2013) **209**:505–523. doi:10.1016/j.ajog.2013.05.006
19. Onderdonk AB, Delaney ML, Fichorova RN. The human microbiome during bacterial vaginosis. *Clin Microbiol Rev* (2016) **29**:223–238. doi:10.1128/CMR.00075-15
20. Hillier SL, Nugent RP, Eschenbach DA, Krohn MA, Gibbs RS, Martin DH, Cotch MF, Edelman R, Pastorek JG, Rao AV, et al. Association between bacterial vaginosis and preterm delivery of a low-birth-weight infant. *N Engl J Med* (1995) **333**:1737–1742. doi:10.1056/NEJM199512283332604
21. Flynn, C.A, Helwig L.A. MLN. Bacterial Vaginosis in Pregnancy and the Risk of Prematurity A Meta-Analysis. *J Fam Pract* (1999) **48**:885–892.
22. Leitich H, Bodner-Adler B, Brunbauer M, Kaidler A, Egarter C, Husslein P. Bacterial vaginosis as a risk factor for preterm delivery: A meta-analysis. *Am J Obstet Gynecol* (2003) **189**:139–147. doi:10.1067/mob.2003.339
23. McGregor JA, French JI. Bacterial vaginosis in pregnancy. *Obstet Gynecol Surv* (2000) **55**:1–19. Available at: [https://journals.lww.com/obgynsurvey/Fulltext/2000/05001/Bacterial\\_Vaginosis\\_in\\_Pregnancy.1.aspx?casa\\_token=DXCGilB4Gx4AAAAA:sLFVh3af37EjeC9A0PgSk7oOSknWDLcmIn7dEyTEI1\\_qpTgU-wrC-OCMLgwzR-r6iXJXuJ\\_4KKI4ZShZUoqcyqgtEQ](https://journals.lww.com/obgynsurvey/Fulltext/2000/05001/Bacterial_Vaginosis_in_Pregnancy.1.aspx?casa_token=DXCGilB4Gx4AAAAA:sLFVh3af37EjeC9A0PgSk7oOSknWDLcmIn7dEyTEI1_qpTgU-wrC-OCMLgwzR-r6iXJXuJ_4KKI4ZShZUoqcyqgtEQ) [Accessed May 7, 2020]
24. Donders GGG, Vereecken A, Bosmans E, Dekeersmaecker A, Salembier G, Spitz B. Definition of a type of abnormal vaginal flora that is distinct from bacterial vaginosis: Aerobic vaginitis. *BJOG An Int J Obstet Gynaecol* (2002) doi:10.1111/j.1471-0528.2002.00432.x
25. Dermendjiev T, Pehlivanov B, Hadjieva K, Stanev S. Epidemiological, clinical and microbiological findings in women with aerobic vaginitis. *Akusherstvo i Ginekol* (2015) **54**:4–8.
26. Tansarli GS, Kostaras EK, Athanasiou S, Falagas ME. Prevalence and treatment of aerobic vaginitis among non-pregnant women: Evaluation of the evidence for an underestimated clinical entity. *Eur J Clin Microbiol Infect Dis* (2013) doi:10.1007/s10096-013-1846-4
27. Rumyantseva TA, Bellen G, Savochkina YA, Guschin AE, Donders GGG. Diagnosis of aerobic vaginitis by quantitative real-time PCR. *Arch Gynecol Obstet* (2016) doi:10.1007/s00404-015-4007-4
28. Fan A, Yue Y, Geng N, Zhang H, Wang Y, Xue F. Aerobic vaginitis and mixed infections: Comparison of clinical and laboratory findings. *Arch Gynecol Obstet* (2013) doi:10.1007/s00404-012-2571-4
29. Donders GGG, Bellen G, Grinceviciene S, Ruban K, Vieira-Baptista P. Aerobic vaginitis: no longer a stranger. *Res Microbiol* (2017) doi:10.1016/j.resmic.2017.04.004
30. Donders GGG, Bellen G, Rezeberga D. Aerobic vaginitis in pregnancy. *BJOG An Int J Obstet Gynaecol* (2011) doi:10.1111/j.1471-0528.2011.03020.x
31. Donders GG, Van Calsteren K, Bellen G, Reybrouck R, Van Den Bosch T, Riphagen I, Van Lierde S. Predictive value for preterm birth of abnormal vaginal flora, bacterial vaginosis and aerobic vaginitis during the first trimester of pregnancy. *BJOG An Int J Obstet Gynaecol* (2009) **116**:1315–1324. doi:10.1111/j.1471-0528.2009.02237.x
32. Hassan MF, Rund NMA, El-Tohamy O, Moussa M, Ali YZ, Moussa N, Abdelrazik AA, Abdallah EAA. Does Aerobic Vaginitis Have Adverse Pregnancy Outcomes? Prospective Observational Study. *Infect Dis Obstet Gynecol* (2020) **2020**:5842150. doi:10.1155/2020/5842150
33. Freitas AC, Chaban B, Bocking A, Rocco M, Yang S, Hill JE, Money DM, Hemmingsen S, Reid G, Dumonceaux T, et al. The vaginal microbiome of pregnant women is less rich and diverse, with lower prevalence of Mollicutes, compared to non-pregnant women. *Sci Rep* (2017) **7**: doi:10.1038/s41598-017-07790-9
34. Parry S, Strauss JF. Premature rupture of the fetal membranes. *N Engl J Med* (1998) **338**:663–670. doi:10.1056/NEJM199803053381006
35. Larsson P-G, Platz-Christensen J-J, Dalaker K, Eriksson K, Fåhraeus L, Irminger K, Jerve F, Stray-Pedersen B, Wölner-Hanssen P. Treatment with 2% clindamycin vaginal cream prior to first trimester surgical abortion to reduce signs of postoperative infection: A prospective, double-blinded, placebo-controlled, multicenter study. *Acta Obstet Gynecol Scand* (2000) **79**:390–396. doi:10.1080/j.1600-0412.2000.079005390.x
36. Larsson PG, Platz-Christensen JJ, Thejls H, Forsum U, Pålsson C. Incidence of pelvic inflammatory disease after first-trimester legal abortion in women with bacterial vaginosis after treatment with metronidazole: A double-blind, randomized study. *Am J Obstet Gynecol* (1992) **166**:100–103. doi:10.1016/0002-9378(92)91838-2
37. Donders GG, Van Bulck B, Caudron J, Londers L, Vereecken A, Spitz B. Relationship of bacterial vaginosis and mycoplasmas to the risk of spontaneous abortion. *Am J Obstet Gynecol* (2000) **183**:431–437. doi:10.1067/mob.2000.105738
38. Ralph SG, Rutherford AJ, Wilson JD. Influence of bacterial vaginosis on conception and miscarriage in the first trimester: Cohort study. *Br Med J* (1999) **319**:220–223. doi:10.1136/bmj.319.7204.220
39. Llahí-Camp JM, Rai R, Ison C, Regan L, Taylor-Robinson D. Association of bacterial vaginosis with a history of second trimester miscarriage. *Hum Reprod* (1996) **11**:1575–1578. doi:10.1093/oxfordjournals.humrep.a019440
40. Hay PE, Lamont RF, Taylor-Robinson D, Morgan DJ, Ison C, Pearson J. Abnormal bacterial colonisation of the genital tract and subsequent preterm delivery and late miscarriage. *BMJ* (1994) **308**:295. doi:10.1136/bmj.308.6924.295
41. Gibbs RS. Chorioamnionitis and bacterial vaginosis. *Am J Obstet Gynecol* (1993) **169**:460–462. doi:10.1016/0002-9378(93)90341-F
42. Hillier SL, Martius J, Krohn M, Kiviat N, Holmes KK, Eschenbach DA. A Case–Control Study of Chorioamnionic Infection and Histologic Chorioamnionitis in Prematurity. *N Engl J Med* (1988) **319**:972–978. doi:10.1056/NEJM198810133191503
43. Stout MJ, Zhou Y, Wylie KM, Tarr PI, Macones GA, Tuuli MG. Early pregnancy vaginal microbiome trends and preterm birth. *Am J Obstet Gynecol* (2017) **217**:356.e1–356.e18. doi:10.1016/j.ajog.2017.05.030
44. van de Wijgert JHHM. The vaginal microbiome and sexually transmitted infections are interlinked: Consequences for treatment and prevention. *PLoS Med* (2017) doi:10.1371/journal.pmed.1002478
45. van de Wijgert JHHM, Verwijs MC, Gill AC, Borgdorff H, van der Veer C, Mayaud P. Pathobionts in the Vaginal Microbiota: Individual Participant Data Meta-Analysis of Three Sequencing Studies. *Front Cell Infect Microbiol* (2020) **10**: doi:10.3389/fcimb.2020.00129
46. Son KA, Kim M, Kim YM, Kim SH, Choi SJ, Oh SY, Roh CR, Kim JH. Prevalence of vaginal microorganisms among pregnant women according to trimester and association with preterm birth. *Obstet Gynecol Sci* (2018) **61**:38–47. doi:10.5468/ogs.2018.61.1.38



47. Kindinger LM, Bennett PR, Lee YS, Marchesi JR, Smith A, Cacciatore S, Holmes E, Nicholson JK, Teoh TG, MacIntyre DA. The interaction between vaginal microbiota, cervical length, and vaginal progesterone treatment for preterm birth risk. *Microbiome* (2017) **5**: doi:10.1186/s40168-016-0223-9
48. Koedooder R, Mackens S, Budding A, Fares D, Blockeel C, Laven J, Schoenmakers S. Identification and evaluation of the microbiome in the female and male reproductive tracts. *Hum Reprod Update* (2019) **25**:298–325. doi:10.1093/humupd/dmy048
49. Kong Y, Liu Z, Shang Q, Gao Y, Li X, Zheng C, Deng X, Chen T. The Disordered Vaginal Microbiota Is a Potential Indicator for a Higher Failure of in vitro Fertilization. *Front Med* (2020) **7**:217. doi:10.3389/fmed.2020.00217
50. Singer M, Borg M, Ouburg S, Morré SA. The relation of the vaginal microbiota to early pregnancy development during in vitro fertilization treatment—A meta-analysis. *J Gynecol Obstet Hum Reprod* (2019) **48**:223–229. doi:10.1016/j.jogoh.2019.01.007
51. DiGiulio DB, Callahan BJ, McMurdie PJ, Costello EK, Lyell DJ, Robaczewska A, Sun CL, Goltsman DSA, Wong RJ, Shawa G, et al. Temporal and spatial variation of the human microbiota during pregnancy. *Proc Natl Acad Sci U S A* (2015) **112**:11060–11065. doi:10.1073/pnas.1502875112
52. Romero R, Hassan SS, Gajer P, Tarca AL, Fadrosch DW, Bieda J, Chaemsaitong P, Miranda J, Chaiworapongsa T, Ravel J. The vaginal microbiota of pregnant women who subsequently have spontaneous preterm labor and delivery and those with a normal delivery at term. *Microbiome* (2014) **2**: doi:10.1186/2049-2618-2-18
53. Ravel J, Gajer P, Abdo Z, Schneider GM, Koenig SSK, McCulle SL, Karlebach S, Gorle R, Russell J, Tacket CO, et al. Vaginal microbiome of reproductive-age women. *Proc Natl Acad Sci U S A* (2011) **108**:4680–4687. doi:10.1073/pnas.1002611107
54. Abdool Karim SS, Baxter C, Passmore JS, McKinnon LR, Williams BL. The genital tract and rectal microbiomes: their role in HIV susceptibility and prevention in women. *J Int AIDS Soc* (2019) **22**:e25300. doi:10.1002/jia2.25300
55. Serrano MG, Parikh HI, Brooks JP, Edwards DJ, Arodz TJ, Edupuganti L, Huang B, Girerd PH, Bokhari YA, Bradley SP, et al. Racioethnic diversity in the dynamics of the vaginal microbiome during pregnancy. *Nat Med* (2019) **25**:1001–1011. doi:10.1038/s41591-019-0465-8
56. Simhan HN, Bodnar LM, Krohn MA. Paternal race and bacterial vaginosis during the first trimester of pregnancy. *Am J Obstet Gynecol* (2008) **198**:196.e1-196.e4. doi:10.1016/j.ajog.2007.09.006
57. Moher D, Liberati A, Tetzlaff J, Altman D, The PRISMA Group. Preferred Reporting Items for Systematic Reviews and Meta-Analyses: The PRISMA Statement. *PLoS Med* (2009) **6**:e1000097. doi:10.1371/journal.pmed1000097
58. Nugent RP, Krohn MA, Hillier SL. Reliability of diagnosing bacterial vaginosis is improved by a standardized method of gram stain interpretation. *J Clin Microbiol* (1991) **29**:297–301.
59. Spiegel CA, Amsel R, Holmes KK. Diagnosis of bacterial vaginosis by direct gram stain of vaginal fluid. *J Clin Microbiol* (1983)
60. Amsel R, Totten PA, Spiegel CA, Chen KCS, Eschenbach D, Holmes KK. Nonspecific vaginitis. Diagnostic criteria and microbial and epidemiologic associations. *Am J Med* (1983) doi:10.1016/0002-9343(83)91137-3
61. Tempera G, Furneri PM. Management of aerobic vaginitis. *Gynecol Obstet Invest* (2010) doi:10.1159/000314013
62. World Bank. Sub-Saharan Africa | Data. Available at: <https://data.worldbank.org/region/sub-saharan-africa> [Accessed January 10, 2020]
63. Altman D. *Practical statistics for medical research*. Chapman and Hall, London, 1991. London: Chapman and Hall. (1991). doi:10.1002/sim.4780101015
64. Pagano M, Cole KG. *Principles of biostatistics*. 2nd ed. Belmont, CA: Brooks/Cole (2000).
65. Sheskin DJ. *Handbook of Parametric and Nonparametric Statistical Procedures*. 3rd ed. Boca Raton: Chapman & Hall /CRC (2004). doi:10.4324/9780203489536
66. Aromataris E, Munn Z (Editors). Joanna Briggs Institute Reviewer's Manual. (2017) Available at: <https://reviewersmanual.joannabriggs.org/> [Accessed January 10, 2020]
67. Melo G, Dutra KL, Rodrigues Filho R, Ortega AOL, Porporatti AL, Dick B, Flores-Mir C, De Luca Canto G. Association between psychotropic medications and presence of sleep bruxism: A systematic review. *J Oral Rehabil* (2018) **45**:545–554. doi:10.1111/joor.12633
68. Goplen CM, Verbeek W, Kang SH, Jones CA, Voaklander DC, Churchill TA, Beaupre LA. Preoperative opioid use is associated with worse patient outcomes after Total joint arthroplasty: a systematic review and meta-analysis. *BMC Musculoskelet Disord* (2019) **20**:234. doi:10.1186/s12891-019-2619-8
69. Nakubulwa S, Kaye DK, Bwanga F, Tumwesigye NM, Mirembe FM. Genital infections and risk of premature rupture of membranes in Mulago Hospital, Uganda: a case control study. *BMC Res Notes* (2015) **8**:573. doi:10.1186/s13104-015-1545-6
70. Warr AJ, Pintye J, Kinuthia J, Drake AL, Unger JA, McClelland RS, Matemo D, Osborn L, John-Stewart G. Sexually transmitted infections during pregnancy and subsequent risk of stillbirth and infant mortality in Kenya: A prospective study. *Sex Transm Infect* (2019) **95**:60–66. doi:10.1136/sextrans-2018-053597
71. Aduloju OP, Akintayo AA, Aduloju T. Prevalence of bacterial vaginosis in pregnancy in a tertiary health institution, South Western Nigeria. *Pan Afr Med J* (2019) **33**: doi:10.11604/pamj.2019.33.9.17926
72. Shayo PA, Kihunrwa A, Massinde AN, Mirambo M, Rumanyika R, Ngwalida N, Gumodoka B, Kidola J, Magoma M. Prevalence of bacterial vaginosis and associated factors among pregnant women attending at Bugando Medical Centre, Mwanza, Tanzania. *Tanzan J Health Res* (2012) **14**: doi:10.4314/thrb.v14i3.3
73. Govender L, Hoosen AA, Moodley J, Moodley P, Sturm AW. Bacterial vaginosis and associated infections in pregnancy. *Int J Gynecol Obstet* (1996) **55**:23–28. doi:10.1016/0020-7292(96)02744-0
74. Watson-Jones D, Weiss HA, Chagalucha JM, Todd J, Gumodoka B, Bulmer J, Balira R, Ross D, Mugeye K, Hayes R, et al. Adverse birth outcomes in United Republic of Tanzania - Impact and prevention of maternal risk factors. *Bull World Health Organ* (2007) **85**:9–18. doi:10.2471/BLT.06.033258
75. Odendaal HJ, Popov I, Schoeman J, Smith M, Grové D. Preterm labour - Is bacterial vaginosis involved? *South African Med J* (2002) **92**:231–234.
76. Afolabi BB, Moses OE, Oduyebo OO. Bacterial vaginosis and pregnancy outcome in Lagos, Nigeria. *Open Forum Infect Dis* (2016) **3**: doi:10.1093/ofid/ofw030
77. Schoeman J, Steyn PS, Odendaal HJ, Grové D. Bacterial vaginosis diagnosed at the first antenatal visit better predicts preterm labour than diagnosis later in pregnancy. *J Obstet Gynaecol (Lahore)* (2005) **25**:751–753. doi:10.1080/01443610500314660
78. Slyker JA, Patterson J, Ambler G, Richardson BA, Maleche-Obimbo E, Bosire R, Mbori-Ngacha D, Farquhar C, John-Stewart G. Correlates and outcomes of preterm birth, low birth weight, and small for gestational age in HIV-exposed uninfected infants. *BMC Pregnancy Childbirth* (2014) **14**:7. doi:10.1186/1471-2393-14-7
79. Aderoba A, Olorok O, Olagbujii B, Ande A, Okonkwo C, Ojide C. Bacterial vaginosis in spontaneous preterm and term birth: A case-control study. *Trop J Obstet Gynaecol* (2016) **33**:297. doi:10.4103/0189-5117.199820
80. Medley N, Vogel JP, Care A, Alfirevic Z. Interventions during pregnancy to prevent preterm birth: an overview of Cochrane systematic reviews. *Cochrane Database Syst Rev* (2018) doi:10.1002/14651858.CD012505.pub2

81. Steyn PS, Odendaal HJ, Schoeman J, Stander C, Fanie N, Grové D. A randomised, double-blind placebo-controlled trial of ascorbic acid supplementation for the prevention of preterm labour. *J Obstet Gynaecol (Lahore)* (2003) **23**:150–155. doi:10.1080/014436103000074673
82. Mapchart. Mapchart Africa countries. Available at: <https://mapchart.net/africa.html> [Accessed December 21, 2019]
83. Donders G, De Wet HG, Hooft P, Desmyter J. Lactobacilli in Papanicolaou Smears, Genital Infections, and Pregnancy. *Am J Perinatol* (1993) **10**:358–361. doi:10.1055/s-2007-994761
84. Watson-Jones D, ... HW-B of the W, 2007 undefined. Adverse birth outcomes in United Republic of Tanzania: impact and prevention of maternal risk factors. *SciELO Public Heal* Available at: <https://www.scielosp.org/article/bwaho/2007.v85n1/9-18/en/> [Accessed March 23, 2020]
85. Peelen MJ, Luef BM, Lamont RF, de Milliano I, Jensen JS, Limpens J, Hajenius PJ, Jørgensen JS, Menon R. The influence of the vaginal microbiota on preterm birth: A systematic review and recommendations for a minimum dataset for future research. *Placenta* (2019) **79**:30–39. doi:10.1016/j.placenta.2019.03.011
86. Jespers V, Kyongo J, Joseph S, Hardy L, Cools P, Crucitti T, Mwaura M, Ndayisaba G, Delany-Moretlwe S, Buyze J, et al. A longitudinal analysis of the vaginal microbiota and vaginal immune mediators in women from sub-Saharan Africa. *Sci Rep* (2017) **7**: doi:10.1038/s41598-017-12198-6
87. Anahtar MN, Byrne EH, Doherty KE, Bowman BA, Yamamoto HS, Soumillon M, Padavattan N, Ismail N, Moodley A, Sabatini ME, et al. Cervicovaginal Bacteria Are a Major Modulator of Host Inflammatory Responses in the Female Genital Tract. *Immunity* (2015) **42**:965–976. doi:10.1016/j.immuni.2015.04.019
88. Fettweis JM, Serrano MG, Brooks JP, Edwards DJ, Girerd PH, Parikh HI, Huang B, Arodz TJ, Edupuganti L, Glascock AL, et al. The vaginal microbiome and preterm birth. *Nat Med* (2019) **25**:1012–1021. doi:10.1038/s41591-019-0450-2
89. Torcia MG. Interplay among vaginal microbiome, immune response and sexually transmitted viral infections. *Int J Mol Sci* (2019) **20**: doi:10.3390/ijms20020266
90. Nadkarni MA, Martin FE, Hunter N, Jacques NA. Methods for optimizing DNA extraction before quantifying oral bacterial numbers by real-time PCR. *FEMS Microbiol Lett* (2009) **296**:45–51. doi:10.1111/j.1574-6968.2009.01629.x
91. Hiergeist A, Gläsner J, Reischl U, Gessner A. Analyses of intestinal microbiota: Culture versus sequencing. *ILAR J* (2015) **56**:228–240. doi:10.1093/ilar/ilv017
92. Hummelen R, Fernandes AD, Macklaim JM, Dickson RJ, Chantalucha J, Gloor GB, Reid G. Deep Sequencing of the Vaginal Microbiota of Women with HIV. *PLoS One* (2010) **5**:e12078. doi:10.1371/journal.pone.0012078
93. Thorsen P, Vogel I, Olsen J, Jeune B, Westergaard JG, Jacobsson B, Møller BR. Bacterial vaginosis in early pregnancy is associated with low birth weight and small for gestational age, but not with spontaneous preterm birth: A population-based study on Danish women. *J Matern Neonatal Med* (2006) **19**:1–7. doi:10.1080/14767050500361604
94. Rosenberg RE, Ahmed ASMNU, Ahmed S, Saha SK, Chowdhury MAKA, Black RE, Santosham M, Darmstadt GL. Determining gestational age in a low-resource setting: Validity of last menstrual period. *J Heal Popul Nutr* (2009) **27**:332–338. doi:10.3329/jhpn.v27i3.3375
95. Hutcheon J, Platt R. The missing data problem in birth weight percentiles and thresholds for “small-for-gestational-age.” *Am J Epidemiol* (2008) **167**:786–792. doi:10.1093/aje/kwm327
96. Sheehy O, Santos F, Ferreira E, Bérard A. The Use of Metronidazole During Pregnancy: A Review of Evidence. *Curr Drug Saf* (2015) **10**:170–179. doi:10.2174/157488631002150515124548
97. McGregor JA, French JI, Seo K. Premature rupture of membranes and bacterial vaginosis. *Am J Obstet Gynecol* (1993) **169**:463–466. doi:10.1016/0002-9378(93)90342-G
98. Onwughara CE, Moodley D, Valashiya N, Sebitloane M. Preterm prelabour rupture of membranes (PPROM) and pregnancy outcomes in association with HIV-1 infection in KwaZulu-Natal, South Africa. *BMC Pregnancy Childbirth* (2020) **20**: doi:10.1186/s12884-020-02911-1
99. Wiraguna AAGP, Rusyati LMM, Vijayamurthy IDAV. Bacterial vaginosis as a risk factor of preterm premature rupture of membrane (PPROM). *Bali Dermatology Venereol J* (2019) **1**: doi:10.15562/bdv.v1i2.13
100. Tchirikov M, Schlalritz-Loutsevitch N, Maher J, Buchmann J, Naberezhnev Y, Winarno AS, Seliger G. Mid-trimester preterm premature rupture of membranes (PPROM): Etiology, diagnosis, classification, international recommendations of treatment options and outcome. *J Perinat Med* (2018) **46**:465–488. doi:10.1515/jpm-2017-0027
101. Rzanek-Głowacka J, Pieta-Dolińska A, Zieba K, Oszukowski P. Is the mother’s bacterial vaginosis with PROM a significant factor for intrauterine infection of the fetus in preterm labor before 32 weeks of gestation. *Ginekol Pol* (2003) **74**:1262–1268. Available at: <https://europepmc.org/abstract/med/14669428> [Accessed May 9, 2020]
102. Genc MR, Onderdonk A. Endogenous bacterial flora in pregnant women and the influence of maternal genetic variation. *BJOG An Int J Obstet Gynaecol* (2011) **118**:154–163. doi:10.1111/j.1471-0528.2010.02772.x
103. Witkin SS, Linhares IM, Giraldo P. Bacterial flora of the female genital tract: function and immune regulation. *Best Pract Res Clin Obstet Gynaecol* (2007) **21**:347–354. doi:10.1016/j.bpobgyn.2006.12.004
104. Redelinguys MJ, Ehlers MM, Dreyer AW, Kock MM. Normal flora and bacterial vaginosis in pregnancy: an overview. *Crit Rev Microbiol* (2015) **42**:1–12. doi:10.3109/1040841X.2014.954522
105. Nelson D, Bellamy S, Nachamkin I, sterility RN-F and, 2007 undefined. First trimester bacterial vaginosis, individual microorganism levels, and risk of second trimester pregnancy loss among urban women. *Elsevier* Available at: <https://www.sciencedirect.com/science/article/pii/S0015028207001677> [Accessed May 9, 2020]
106. Donati L, Di Vico A, Nucci M, Quagliozzi L, Spagnuolo T, Labianca A, Bracaglia M, Ianniello F, Caruso A, Paradisi G. Vaginal microbial flora and outcome of pregnancy. *Arch Gynecol Obstet* (2010) **281**:589–600. doi:10.1007/s00404-009-1318-3
107. Murphy K, Mitchell CM. The Interplay of Host Immunity, Environment and the Risk of Bacterial Vaginosis and Associated Reproductive Health Outcomes. *J Infect Dis* (2016) **214**:S29–S35. doi:10.1093/infdis/jiw140
108. Denney J, Medicine JC-S in F and N, 2009 undefined. Bacterial vaginosis: a problematic infection from both a perinatal and neonatal perspective. *Elsevier* Available at: <https://www.sciencedirect.com/science/article/pii/S1744165X09000092> [Accessed May 9, 2020]
109. Murphy K, diseases CM-TJ of infectious, 2016 undefined. The interplay of host immunity, environment and the risk of bacterial vaginosis and associated reproductive health outcomes. *academic.oup.com* Available at: [https://academic.oup.com/jid/article-abstract/214/suppl\\_1/S29/2237837](https://academic.oup.com/jid/article-abstract/214/suppl_1/S29/2237837) [Accessed May 9, 2020]
110. Macones G, Parry S, Elkousy M, Clothier B, Ural S, Strauss JF 3rd. A polymorphism in the promoter region of TNF and bacterial vaginosis: preliminary evidence of gene-environment interaction in the etiology of spontaneous. *Am J Obstet Gynecol* (2004) **190**:1504–8; discussion 3A. doi:10.1016/j.ajog.2004.01.001
111. Nelson DB, Bellamy S, Nachamkin I, Ness RB, Macones GA, Allen-Taylor L. First trimester bacterial vaginosis, individual microorganism levels, and risk of second trimester pregnancy loss among urban women. *Fertil Steril* (2007) **88**:1396–1403. doi:10.1016/j.fertnstert.2007.01.035

112. McGregor JA, French JI, Parker R, Draper D, Patterson E, Jones W, Thorsgard K, McFee J. Prevention of premature birth by screening and treatment for common genital tract infections: Results of a prospective controlled evaluation. *Am J Obstet Gynecol* (1995) **173**:157–167. doi:10.1016/0002-9378(95)90184-1
113. Hay PE. Bacterial vaginosis and miscarriage. *Curr Opin Infect Dis* (2004) **17**:41–44. doi:10.1097/00001432-200402000-00008
114. Hay PE, Lamont RF, Taylor-Robinson D, Morgan DJ, Ison C, Pearson J. Abnormal bacterial colonisation of the genital tract and subsequent preterm delivery and late miscarriage. *BMJ* (1994) **308**:295. doi:10.1136/bmj.308.6924.295
115. Shahgheibi S, Seied-Al-Shohadaie F, Seied-Al-Shohadaie A, Ghaderi E. Complications of bacterial vaginosis in pregnancy. *Pakistan J Med Sci* (2009) **25**:953–956. Available at: www.pjms.com.pk953 [Accessed May 27, 2020]
116. Kaambo E, Africa CWJ. The threat of aerobic vaginitis to pregnancy and neonatal morbidity. *Afr J Reprod Health* (2017) **21**:108–118.
117. Donders GG, Van Calsteren K, Bellen G, Reybrouck R, Van Den Bosch T, Riphagen I, Van Lierde S. Predictive value for preterm birth of abnormal vaginal flora, bacterial vaginosis and aerobic vaginitis during the first trimester of pregnancy. *BJOG An Int J Obstet Gynaecol* (2009) doi:10.1111/j.1471-0528.2009.02237.x
118. Africa C, Kaambo E, Stemmet M. Opportunistic vaginal infections implicated in the risk for adverse pregnancy outcomes. in *11th International Symposium on Antimicrobial Agents and Resistance (ISAAR) and 3rd International Interscience Conference on Infection and Chemotherapy (ICIC)*, S84.
119. Zheng J, Wittouck S, Salvetti E, Franz CMAP, Harris HMB, Mattarelli P, O'toole PW, Pot B, Vandamme P, Walter J, et al. A taxonomic note on the genus *Lactobacillus*: Description of 23 novel genera, emended description of the genus *Lactobacillus* beijerinck 1901, and union of *Lactobacillaceae* and *Leuconostocaceae*. *Int J Syst Evol Microbiol* (2020) **70**:2782–2858. doi:10.1099/ijsem.0.004107
120. Zheng J, Ruan L, Sun M, Gänzle M. A Genomic View of *Lactobacilli* and *Pediococci* Demonstrates that Phylogeny Matches Ecology and Physiology Downloaded from. *Appl Environ Microbiol* (2015) **81**:2020. doi:10.1128/AEM.02116-15
121. Castro J, Jefferson KK, Cerca N. Genetic Heterogeneity and Taxonomic Diversity among *Gardnerella* Species. *Trends Microbiol* (2020) **28**:202–211. doi:10.1016/j.tim.2019.10.002
122. Mwatelah R, McKinnon LR, Baxter C, Abdool Karim Q, Abdool Karim SS. Mechanisms of sexually transmitted infection-induced inflammation in women: implications for HIV risk. *J Int AIDS Soc* (2019) **22**: doi:10.1002/jia2.25346
123. Yano J, Noverr MC, Fidel PL. Cytokines in the host response to *Candida* vaginitis: Identifying a role for non-classical immune mediators, S100 alarmins. *Cytokine* (2012) **58**:118–128. doi:10.1016/j.cyto.2011.11.021
124. Africa CWJ, Nel J, Stemmet M. Anaerobes and bacterial vaginosis in pregnancy: Virulence factors contributing to vaginal colonisation. *Int J Environ Res Public Health* (2014) **11**:6979–7000. doi:10.3390/ijerph110706979
125. Van De Wijgert JHHM, Borgdorff H, Verhelst R, Crucitti T, Francis S, Verstraelen H, Jaspers V. The Vaginal Microbiota: What Have We Learned after a Decade of Molecular Characterization? (2014) doi:10.1371/journal.pone.0105998
126. van de Wijgert JHHM, Jaspers V. The global health impact of vaginal dysbiosis. *Res Microbiol* (2017) **168**:859–864. doi:10.1016/j.resmic.2017.02.003
127. Virtanen S, Rantsi T, Virtanen A, Kervinen K, Nieminen P, Kalliala I, Salonen A. Vaginal Microbiota Composition Correlates Between Pap Smear Microscopy and Next Generation Sequencing and Associates to Socioeconomic Status. *Sci Rep* (2019) **9**:1–9. doi:10.1038/s41598-019-44157-8
128. Fettweis JM, Paul Brooks J, Serrano MG, Sheth NU, Girerd PH, Edwards DJ, Strauss JF, Jefferson KK, Buck GA. Differences in vaginal microbiome in African American women versus women of European ancestry. *Microbiol (United Kingdom)* (2014) **160**:2272–2282. doi:10.1099/mic.0.081034-0
129. Goldenberg RL, Culhane JF, Iams JD, Romero R. Epidemiology and causes of preterm birth. *Lancet* (2008) **371**:75–84. doi:10.1016/S0140-6736(08)60074-4
130. Moosa Y, Kwon D, de Oliveira T, Wong EB. Determinants of Vaginal Microbiota Composition. *Front Cell Infect Microbiol* (2020) **10**:467. doi:10.3389/fcimb.2020.00467
131. Mason-Jones AJ, Sinclair D, Mathews C, Kagee A, Hillman A, Lombard C. School-based interventions for preventing HIV, sexually transmitted infections, and pregnancy in adolescents. *Cochrane Database Syst Rev* (2016) **2016**: doi:10.1002/14651858.CD006417.pub3
132. Kazeem A, Jensen L, Stokes CS. School attendance in nigeria: Understanding the impact and intersection of gender, Urban-Rural residence, and socioeconomic status. *Comp Educ Rev* (2010) **54**:295–319. doi:10.1086/652139
133. ISSC, IDS, UNESCO. World Social Science Report 2016, Challenging Inequalities: Pathways to a Just World. Paris (2016). Available at: [http://publishing.unesco.org/details.aspx?&Code\\_Livre=5160&change=E](http://publishing.unesco.org/details.aspx?&Code_Livre=5160&change=E) [Accessed September 22, 2020]
134. UNESCO (United Nations Educational S and CO. EFA Global Monitoring Report 2008. Overcoming Inequality: Why Governance Matters. . Paris and London (2008). Available at: <https://unesdoc.unesco.org/ark:/48223/pf0000177683> [Accessed September 22, 2020]
135. Gueye A, Speizer IS, Corroon M, Okigbo CC. Belief in family planning myths at the individual and community levels and modern contraceptive use in Urban Africa. *Int Perspect Sex Reprod Health* (2015) **41**:191–199. doi:10.1363/4119115
136. Mullick S, Watson-Jones D, Beksinska M, Mabey D. Sexually transmitted infections in pregnancy: Prevalence, impact on pregnancy outcomes, and approach to treatment in developing countries. *Sex Transm Infect* (2005) **81**:294–302. doi:10.1136/sti.2002.004077
137. Bisanz JE, Enos MK, PrayGod G, Seney S, Macklaim JM, Chilton S, Willner D, Knight R, Fusch C, Fusch G, et al. Microbiota at multiple body sites during pregnancy in a rural tanzanian population and effects of Moringa-supplemented probiotic yogurt. *Appl Environ Microbiol* (2015) **81**:4965–4975. doi:10.1128/AEM.00780-15
138. McMillan A, Rulisa S, Gloor GB, Macklaim JM, Sumarah M, Reid G. Pilot assessment of probiotics for pregnant women in Rwanda. *PLoS One* (2018) **13**:e0195081. doi:10.1371/journal.pone.0195081
139. Price JT, Vwalika B, Hobbs M, Nelson JAE, Stringer EM, Zou F, Rittenhouse KJ, Azcarate-Peril A, Kasaro MP, Stringer JSA. Highly diverse anaerobe-predominant vaginal microbiota among HIV-infected pregnant women in Zambia. *PLoS One* (2019) **14**:e0223128. doi:10.1371/journal.pone.0223128
140. Kenyon C, Colebunders R, Crucitti T. The global epidemiology of bacterial vaginosis: A systematic review. *Am J Obstet Gynecol* (2013) **209**:505–523. doi:10.1016/j.ajog.2013.05.006
141. Schwabke JR, Hillier SL, Sobel JD, McGregor JA, Sweet RL. Validity of the vaginal gram stain for the diagnosis of bacterial vaginosis. *Obstet Gynecol* (1996) **88**:573–576. doi:10.1016/0029-7844(96)00233-5
142. Marrazzo JM, Martin DH, Watts DH, Schulte J, Sobel JD, Hillier SL, Deal C, Fredricks DN. Bacterial vaginosis: Identifying research gaps proceedings of a workshop sponsored by DHHS/NIH/NIAID. *Sex Transm Dis* (2010) **37**:732–744. doi:10.1097/OLQ.0b013e3181fbbce95
143. Moher D, Tetzlaff J, Altman Dg LA. PRISMA 2009 Flow Diagram. *Prism statement* (2009) doi:10.1371/journal.pmed1000097

## 3 SUPPLEMENTARY DATA

Supplementary Table 1. PRISMA checklist displaying the page numbers where the section or topic is provided.

Section/topic	# Checklist item	Reported on page #
<b>Title</b>		
Title	1 Identify the report as a systematic review, meta-analysis, or both.	1
<b>Abstract</b>		
Structured summary	2 Provide a structured summary including, as applicable: background; objectives; data sources; study eligibility criteria, participants, and interventions; study appraisal and synthesis methods; results; limitations; conclusions and implications of key findings; systematic review registration number.	1
<b>Introduction</b>		
Rationale	3 Describe the rationale for the review in the context of what is already known.	2
Objectives	4 Provide an explicit statement of questions being addressed with reference to participants, interventions, comparisons, outcomes, and study design (PICOS).	2
<b>Methods</b>		
Protocol and registration	5 Indicate if a review protocol exists, if and where it can be accessed (e.g., Web address), and, if available, provide registration information including registration number.	Not applicable
Eligibility criteria	6 Specify study characteristics (e.g., PICOS, length of follow-up) and report characteristics (e.g., years considered, language, publication status) used as criteria for eligibility, giving rationale.	4
Information sources	7 Describe all information sources (e.g., databases with dates of coverage, contact with study authors to identify additional studies) in the search and date last searched.	4
Search	8 Present full electronic search strategy for at least one database, including any limits used, such that it could be repeated.	4, supplementary data 2
Study selection	9 State the process for selecting studies (i.e., screening, eligibility, included in systematic review, and, if applicable, included in the meta-analysis).	4
Data collection process	10 Describe method of data extraction from reports (e.g., piloted forms, independently, in duplicate) and any processes for obtaining and confirming data from investigators.	5
Data items	11 List and define all variables for which data were sought (e.g., PICOS, funding sources) and any assumptions and simplifications made.	4
Risk of bias in individual studies	12 Describe methods used for assessing risk of bias of individual studies (including specification of whether this was done at the study or outcome level), and how this information is to be used in any data synthesis.	5
Summary measures	13 State the principal summary measures (e.g., risk ratio, difference in means).	Not applicable
Synthesis of results	14 Describe the methods of handling data and combining results of studies, if done, including measures of consistency (e.g., $I^2$ ) for each meta-analysis.	Not applicable
Risk of bias across studies	15 Specify any assessment of risk of bias that may affect the cumulative evidence (e.g., publication bias, selective reporting within studies).	5
Additional analyses	16 Describe methods of additional analyses (e.g., sensitivity or subgroup analyses, meta-regression), if done, indicating which were pre-specified.	Not applicable
<b>Results</b>		
Study selection	17 Give numbers of studies screened, assessed for eligibility, and included in the review, with reasons for exclusions at each stage, ideally with a flow diagram.	5
Study characteristics	18 For each study, present characteristics for which data were extracted (e.g., study size, PICOS, follow-up period) and provide the citations.	5, 6, Table 1 and 2
Risk of bias within studies	19 Present data on risk of bias of each study and, if available, any outcome level assessment (see item 12).	7
Results of individual studies	20 For all outcomes considered (benefits or harms), present, for each study: (a) simple summary data for each intervention group (b) effect estimates and confidence intervals, ideally with a forest plot.	7
Synthesis of results	21 Present results of each meta-analysis done, including confidence intervals and measures of consistency.	7
Risk of bias across studies	22 Present results of any assessment of risk of bias across studies (see item 15).	7
Additional analysis	23 Give results of additional analyses, if done (e.g., sensitivity or subgroup analyses, meta-regression [see item 16]).	Not applicable
<b>Discussion</b>		
Summary of evidence	24 Summarize the main findings including the strength of evidence for each main outcome; consider their relevance to key groups (e.g., healthcare providers, users, and policy makers).	7 - 12
Limitations	25 Discuss limitations at study and outcome level (e.g., risk of bias), and at review-level (e.g., incomplete retrieval of identified research, reporting bias).	12
Conclusions	26 Provide a general interpretation of the results in the context of other evidence, and implications for future research.	13
<b>Funding</b>		
Funding	27 Describe sources of funding for the systematic review and other support (e.g., supply of data); role of funders for the systematic review.	Not applicable

**Supplementary Table 2.** Search strategies and hits based on searches last conducted on May 6, 2020.

Database	Search strategy	Number hits
Pubmed	((((((((Vaginal microbiota[MeSH Terms] OR vaginal microbiome[MeSH Terms]) OR vaginal microbiota) OR vaginal microbiome) OR vaginal dysbiosis) OR bacterial vaginosis OR aerobic vaginitis)) AND ((africa[MeSH Terms]) OR sub-saharan africa[MeSH Terms])) AND (((((pregnant women[MeSH Terms]) OR pregnancy[MeSH Terms]) OR pregnant) OR pregnancy) OR pregnancy outcome[MeSH Terms]) OR pregnancy outcome)	95
Pubmed	((((((((Vaginal microbiota[MeSH Terms]) OR vaginal microbiome[MeSH Terms]) OR vaginal microbiota) OR vaginal microbiome) OR vaginal dysbiosis) OR bacterial vaginosis)) AND (((("xxx"[Mesh]) OR ("xxx" women)) AND (((((pregnant women[MeSH Terms]) OR pregnancy[MeSH Terms]) OR pregnant) OR pregnancy) OR pregnancy outcome[MeSH Terms]) OR pregnancy outcome))))))	207
Embase (Ovid)	(exp Vaginal microbiota/ or exp vaginal microbiome/ or exp vaginal flora/ or (vaginal microbiota or vaginal microbiome or vaginal dysbiosis or bacterial vaginosis or aerobic vaginitis).ti,ab,kw.) AND (exp africa/ or exp Africa south of Sahara/ or sub-Saharan Africa.ti,ab,kw.) AND (exp pregnant women/ or exp pregnancy/ or exp pregnancy outcome/ or (pregnant or pregnancy or pregnancy outcome).ti,ab,kw.)	148
Cochrane	vaginal microbio* OR genital microbio* in All Text OR "bacterial vaginosis" in All Text OR "aerobic vaginitis" in All Text AND Africa in All Text AND pregnan* in All Text - (Word variations have been searched)	108

At the "xxx" each Sub-Saharan African country was filled in per search, countries selected based on the world bank organization database: Angola, Benin, Botswana, Burkina Faso, Burundi, Cabo Verde, Cameroon, Central African Republic, Chad, Comoros, Congo, Cote D'Ivoire, Equatorial guinea, Eritrea, Eswatini, Ethiopia, Gabon, Gambia, Ghana, Guinea, Guinea-Bissau, Kenya, Lesotho, Liberia, Madagascar, Malawi, Mali, Mauritania, Mauritius, Mozambique, Namibia, Niger, Nigeria, Rwanda, Sao Tome and Principe, Senegal, Seychelles, Sierra Leone, Somalia, South Africa, South sudan, Sudan, Tanzania, Togo, Uganda, Zambia, Zimbabwe (32).

**Supplementary Table 3.** Questions for the critical appraisal checklist for cohort studies, cross sectional studies, case-control studies, and randomized controlled trial as provided by Joanna Briggs Institute Reviewer's Manual (64).

Question numbers	Cohort studies	Cross-sectional studies	Case-control studies	Randomized control trial
1	Were the two groups similar and recruited from the same population?	Were the criteria for inclusion in the sample clearly defined?	Were the groups comparable other than the presence of disease in cases or the absence of disease in controls?	Was true randomization used for assignment of participants to treatment groups?
2	1. Were the exposures measured similarly to assign people to both exposed and unexposed groups?	Were the study subjects and the setting described in detail?	Were cases and controls matched appropriately?	Was allocation to treatment groups concealed?
3	Was the exposure measured in a valid and reliable way?	Was the exposure measured in a valid and reliable way?	Were the same criteria used for identification of cases and controls?	Were treatment groups similar at the baseline?
4	Were confounding factors identified?	Were objective, standard criteria used for measurement of the condition?	Was exposure measured in a standard, valid and reliable way?	Were participants blind to treatment assignment?
5	Were strategies to deal with confounding factors stated?	Were confounding factors identified?	Was exposure measured in the same way for cases and controls?	Were those delivering treatment blind to treatment assignment?
6	Were the groups/participants free of the outcome at the start of the study (or at the moment of exposure)?	Were strategies to deal with confounding factors stated?	Were confounding factors identified?	Were outcomes assessors blind to treatment assignment?
7	Were the outcomes measured in a valid and reliable way?	Were the outcomes measured in a valid and reliable way?	Were strategies to deal with confounding factors stated?	Were treatment groups treated identically other than the intervention of interest?
8	Was the follow up time reported and sufficient to be long enough for outcomes to occur?	Was appropriate statistical analysis used?	Were outcomes assessed in a standard, valid and reliable way for cases and controls?	Was follow up complete and if not, were differences between groups in terms of their follow up adequately described and analyzed?
9	Was follow up complete, and if not, were the reasons to loss to follow up described and explored?	Not applicable	Was the exposure period of interest long enough to be meaningful?	Were participants analyzed in the groups to which they were randomized? Were outcomes measured in the same way for treatment groups?

Question numbers	Cohort studies	Cross-sectional studies	Case-control studies	Randomized control trial
10	Were strategies to address incomplete follow up utilized?	Not applicable	Was appropriate statistical analysis used?	Were outcomes measured in a reliable way?
11	Was appropriate statistical analysis used?	Not applicable	Not applicable	Was appropriate statistical analysis used?
12	Not applicable	Not applicable	Not applicable	Was the trial design appropriate, and any deviations from the standard RCT design (individual randomization, parallel groups) accounted for in the conduct and analysis of the trial?
13	Not applicable	Not applicable	Not applicable	Not applicable

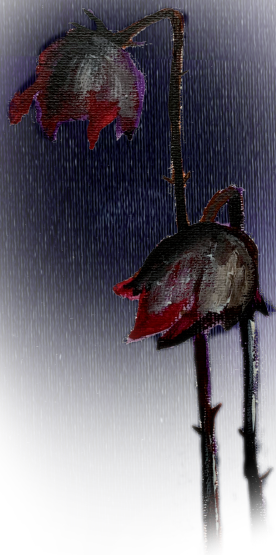
### 3 SUPPLEMENTARY INFORMATION

#### AUTHOR CONTRIBUTIONS

NJ and MS both performed the systematic search, screening, and inclusion of the study. They both wrote the introduction, materials, methods, results, and discussion sections. SA-N and SM critically reviewed the manuscript. RP and EA conceived the original idea, supervised the study, critically reviewed and edited the manuscript. All authors contributed to the final versions of the manuscript.

Support microorganisms - they're the only culture some people have.

*- Adapted joke from Steven Wright*



# 4

## **The Prevalence of *Chlamydia trachomatis* and Three Other Non-Viral Sexually Transmitted Infections among Pregnant Women in Pemba**

**Naomi C.A. Juliana\*, Saikat Deb\*, Sander Ouburg, Aishwarya Chauhan,  
Jolein Pleijster, Said M. Ali, Servaas A. Morré, Sunil Sazawal\*,  
and Elena Ambrosino\***

*\*Shared authorship  
Pathogens 2020, 9(8), 625*

## ABSTRACT

**Background.** Efforts to map the burden of infections globally have shown a high prevalence of genital infections, including *Chlamydia trachomatis*, in sub-Saharan Africa. This retrospective study aimed to investigate the prevalence of selected non-viral genital infections among pregnant women in Pemba Island, Tanzania.

**Methods.** Vaginal swabs were collected during pregnancy and stored in eNAT buffer. Detection of *C. trachomatis*, *Neisseria gonorrhoeae*, *Trichomonas vaginalis*, and *Mycoplasma genitalium* pathogens was performed by PCR using validated detection kits.

**Results.** Vaginal samples of 439 pregnant women between 16 and 48 years were tested. In fifty-five (12.5%) of them, at least one genital pathogen was detected. The most prevalent pathogen was *T. vaginalis* (7.1%), followed by *C. trachomatis* (4.6%) and *M. genitalium* (2.1%). None of the vaginal samples tested positive for *N. gonorrhoeae*. Consequently, among positive samples, 7.3% were for *C. trachomatis* and at least one other genital pathogen.

**Conclusion.** This study provides insights on the burden of the four studied genital infections, and on the coinfections among pregnant women in Pemba Island, Tanzania. These results offer a starting point that can be useful to design further research in the field of maternal and child health in Pemba Island.

## 4.1 INTRODUCTION

Sexually transmitted infections (STIs) are one of the most prevalent communicable diseases globally [1]. Every day, more than 1 million such infections are reported worldwide, with varying prevalence per region [2]. Between 2009 and 2016, the sub-Saharan African region bore 40% of the global burden of STIs, with a prevalence of 20.2% curable STIs (*Chlamydia trachomatis*, *Neisseria gonorrhoeae*, *Treponema pallidum*, and *Trichomonas vaginalis*) among women of reproductive age [1,3]. About 5.1 million (2.6%) women in sub-Saharan Africa were infected with the most common bacterial STI, *C. trachomatis*, in 2008 [4].

This Gram-negative intracellular bacterium can affect (uro)genital epithelial cells, can escape the host immunological system, and cause pathology to the reproductive system, possibly resulting in cervicitis, pelvic inflammatory disease, and tubal factor infertility. During pregnancy, the infection is a risk factor for complications and adverse pregnancy outcomes, including preterm delivery, low birth weight, and postpartum sepsis [5–7]. The consequences of *C. trachomatis* infection on pregnant women are higher in women at risk of, or having, complicated pregnancies [6]. Therefore, *C. trachomatis* infection is particularly burdensome on residents of low- and middle-income countries, where the burden of adverse pregnancy outcomes is already high [2]. However, in approximately 60 to 80% of the cases, the infection with *C. trachomatis* might not manifest and remains asymptomatic [8]. This is unfortunate since the treatment strategy in most low-income countries has a syndromic approach, making it challenging to diagnose and eradicate this pathogen [8]. Once *C. trachomatis* or another STI are present, the host is more susceptible to the acquisition and transmission of other bacterial, protozoan, and viral STIs, including by the human immunodeficiency virus (HIV) [9].

Other treatable and mostly asymptomatic STIs, such as by *Neisseria gonorrhoeae*, *Trichomonas vaginalis*, and *Mycoplasma genitalium*, can also cause serious pathology of the reproductive system if left untreated, and have been independently associated with various adverse pregnancy outcomes [10–15]. Similarly to *C. trachomatis*, these pathogens are highly prevalent in sub-Saharan African countries, where limited research has evaluated the association between maternal infection and adverse pregnancy outcomes in these populations [4]. In addition, older studies might have utilized culture-based methodologies, whereas more recent ones employ the more sensitive molecular testing techniques to test for pathogens presence [10,11,14].

In 2016, the World Health Organization (WHO) developed the Global Health Sector Strategy on STI 2016–2021 that provided vision, goals, targets, and strategies for the prevention, control, and management of sexually transmitted infections [3]. In order to reach the Strategy’s goal of “ending STI epidemics as major public health concern”, five directions were suggested [3]. In line with the first direction, “information for focused action”, more data on STI burden, including STI prevalence estimates, are needed for both general and high-risk populations in urban and rural settings [3,16,17].

In their review, Adachi et al. suggested that the individual studies’ prevalence rates between 0 and 31.1% for *C. trachomatis* infection in pregnant women from sub-Saharan Africa are similar,



or higher, than the prevalence (2.6%) in non-pregnant women aged 15–49 years old in sub-Saharan Africa reported by the WHO [6]. Currently, only a few studies reported the prevalence of STIs during pregnancy in individual countries (Sudan, Cameroon, Democratic Republic of Congo (DRC), Gabon, Nigeria, Kenya, Uganda, Tanzania, Malawi, Zambia, Botswana, Mozambique, and South Africa) in the sub-Saharan African region [6]. A recent systematic review of antenatal clinic attenders in East Africa, including Tanzania, reported a mean prevalence of 6.8% for *T. vaginalis*, 4.2% for *C. trachomatis*, and 2.3% for *N. gonorrhoeae* infections [18]. A prevalence of 3.2% for *M. genitalium* infection has been reported in a non-pregnant Tanzanian cohort [19].

Limited data about STIs prevalence exist for the islands belonging to the Zanzibar archipelago in Tanzania, particularly Pemba Island. Pemba Island is mainly rural, with minimal access to doctors and laboratory facilities in the primary health care system [20]. To promote maternal and child health and follow the WHO Global Health Sector Strategy on Sexually Transmitted Infections 2016–2021, each country needs to define specific populations that are affected by STI epidemics based on epidemiological and social context [3]. It is important to investigate the burden of curable STIs in rural African populations, especially in pregnant women where the risk to develop health complications for both the parturient and her fetus is high. This study aimed to provide initial insights in the field by assessing the presence of *C. trachomatis*, *N. gonorrhoeae*, *T. vaginalis*, and *M. genitalium* pathogens and reporting their prevalence among a subset of pregnant women from Pemba Island.

## 4.2 METHODS

### 4.2.1 SAMPLE COLLECTION AND DESIGN

Samples collection was performed in the context of the previously established AMANHI biobanking effort that was initiated in 2017 in Pemba Island and is still ongoing [21]. This biobanking effort includes data and vaginal samples from women with ultrasound-confirmed pregnancy and who are more than 8 weeks of gestation at the time of sampling [21]. The vaginal swabs analyzed in this retrospective cohort study were collected between March 2018 and January 2019 under the supervision of a health worker in health care facilities in Pemba Island. The vaginal swabs were stored in 1 ml eNAT buffer (Copan Italia, Brescia, Italy) at  $-20^{\circ}\text{C}$  at the Public Health Laboratory—Ivo de Carneri in Pemba Island. The participants filled a questionnaire before sample collection, on baseline sociodemographic data and health information about the current and previous pregnancies. For the purpose of this study, the vaginal sample collected at the earliest timepoint from each participant was selected to be tested for this study. The mean gestational age (GA) at sampling was  $15.5 \pm 6$  weeks. The GA range of collection was 8–40 GA weeks. Samples were transported in dry-ice to the Netherlands and stored at  $-20^{\circ}\text{C}$  until further processing. In the context of the previously established biobank-

ing effort, all the participants gave their informed consent to samples and data collection, and an ethical approval for the samples' use was obtained from the Zanzibar Medical Research and Ethics Committee (ZAMREC) [21].

### 4.2.2 DNA ISOLATION AND REAL-TIME PCR

DNA from 439 vaginal swabs was extracted with the Chemagen (Perkin-Elmer, Baesweiler, Germany) automated DNA extraction machine by using the buccal swab extraction kit according to the manufacturer's instructions [22]. In short, 66.7  $\mu\text{L}$  of eNAT swab suspension per sample was defrosted and 133.3  $\mu\text{L}$  Chemagen lysis buffer was added. The vaginal swab eNAT/Lysis mix was vortexed with 200  $\mu\text{L}$  Chemagen lysis buffer and 10  $\mu\text{L}$  Proteinase K. In addition, 5  $\mu\text{L}$  of internal amplification control (IAC) of the CE-IVD-certified Presto test (Goffin Molecular Diagnostics, Houten, The Netherlands) was added to the eNAT/Lysis mix. The mix was incubated at  $56^{\circ}\text{C}$  while being shaken at 450 rpm for 15 min before being placed in the Chemagen machine for the washing and elution process [22]. Samples were later stored at  $5^{\circ}\text{C}$ .

Afterwards, *C. trachomatis*, *N. gonorrhoeae*, and *T. vaginalis* were detected by their respective CE-IVD-certified Presto *C. trachomatis*, *N. gonorrhoeae* (Goffin Molecular Diagnostics, Houten, The Netherlands), and Presto *T. vaginalis* (Goffin Molecular Diagnostics, Houten, The Netherlands) tests and real-time polymerase chain reaction (PCR) with ABI Taqman 7500 (Applied Biosystems, Foster City, CA, USA) according to the manufacturer's instructions [23,24]. For *M. genitalium* detection, an *M. genitalium* assay, as described in Muller et al., was used on the LightCycler 480 II PCR machine (Roche Diagnostics, Basel, Switzerland) [25]. The following primers were used to target the *mg219* gene of *M. genitalium*: MG-041 (forward primer) 5'-CGG ATC AAG ACC AAG ATA CTT AAC TTT-3' and MG-042 (reverse primer) 5'-AGC TTG GGT TGA GTC AAT GAT AAA C-3' together with probe MG-48 (5'-6 FAM-CCA GGG TTT GAA AAA GCA CAA CAA GCT - BHQ1-3') (Biologio BV) [25]. The mastermix of the in-house *M. genitalium* assay consisted of 12.5  $\mu\text{L}$  of SensiMix (Bioline, Australia), 0.75  $\mu\text{L}$  of 300 nM Forward and 0.75  $\mu\text{L}$  of 300 nM Reverse Primer, 0.5  $\mu\text{L}$  of 200 nM Probe, and 0.5  $\mu\text{L}$  of PCR water. The LightCycler 480 II instrument was programmed as follows: after an initial denaturation of 10 min at  $95^{\circ}\text{C}$ , 45 cycles were performed consisting of 15 s at  $95^{\circ}\text{C}$  and 1 min at  $60^{\circ}\text{C}$ . After each cycle, a single fluorescence reading (FAM<sup>TM</sup> at 465–510 nm) was taken. Color compensation objects were created as described in the LightCycler<sup>®</sup> 480 Operator's Manual. A total of 15  $\mu\text{L}$  of the mastermix was added to 10  $\mu\text{L}$  DNA extraction for the PCR detection.

The positive controls of *C. trachomatis*, *N. gonorrhoeae*, *T. vaginalis*, and *M. genitalium* pathogens consisted of different concentrations of their DNA that were isolated from standardized cultures for these microorganisms. Water was used as negative control in each PCR run. Samples were tested in duplicates for *C. trachomatis*, *N. gonorrhoeae*, and *T. vaginalis*. They were considered positive if the crossing point value (Cp) was between 11 and 38. In addition, samples with a Cp value of 39–40, but an S-shape amplification curve, were also considered

positive. No replicates were performed for *M. genitalium* analysis, but the same Cp value thresholds were considered for determination of the positivity. If the duplicates were discordant or the amplification curve was not S-shaped (in case of *M. genitalium*, only the latter applied), a third (or second for *M. genitalium*) PCR reaction was performed to determine the definite result.

### 4.3.2 STATISTICAL ANALYSIS

The sample size for this study was calculated beforehand using the formula by Daniel WW [26], with a population size of 19,744 pregnant women as recorded in 2018 in Pemba [27], and precision was set at 0.05 and a 95% level of confidence interval (CI). The adequate sample size estimation was 62, 97, 35, and 48 pregnant women for *C. trachomatis*, *N. gonorrhoeae*, *T. vaginalis*, and *M. genitalium*, respectively. Thus, 242 pregnant women were needed to estimate the combined prevalence of these curable genital infections in Pemba Island, Tanzania. The 95% CI for each proportion was also calculated.

To compare dichotomous data, Fisher's exact test was performed with IBM SPSS Statistics version 25 (IBM, Armonk, NY, USA). Odds ratios (OR) with 95% confidence intervals (CI) are provided for the association between maternal age or school attainment and infection status. A *p*-value of less than 0.05 was considered statistically significant.

## 4.3 RESULTS

### 4.3.1 CHARACTERISTICS OF THE STUDY POPULATION

All 439 tested women were of Shirazi ethnic origin, and 99.8% of them were Muslims. The mean and median maternal age was 28 years (range 16–48) (Table 1). Most of the women were multigravida (84%), and the minority reported to have had an eventful obstetric history with stillbirth (8.0%), pre-rupture of membranes (PROM) (4.9%), or preterm delivery (7.0%). One woman reported that she had been previously diagnosed with human immunodeficiency virus/acquired immune deficiency syndrome (HIV/AIDS).

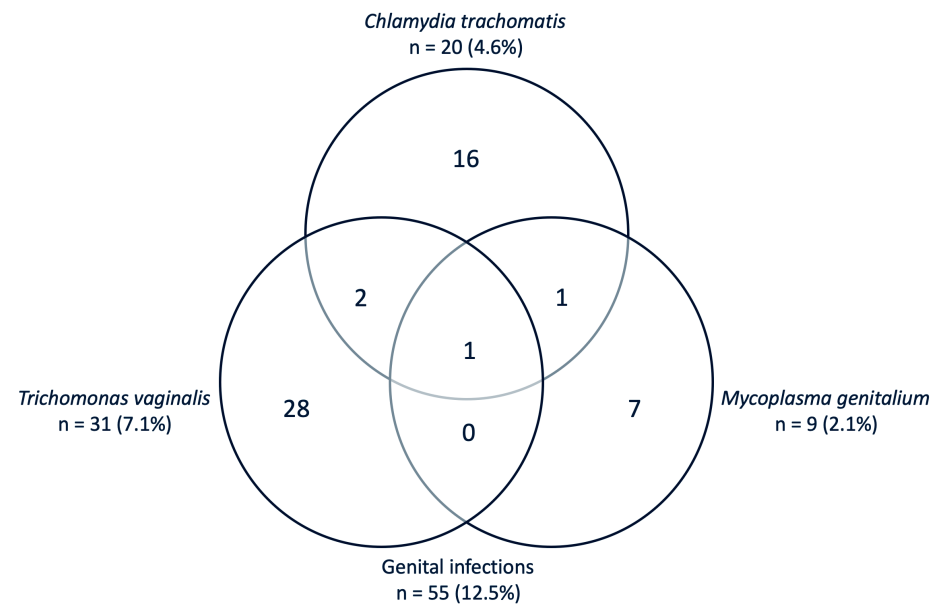
**Table 1.** Baseline characteristics of the study participants.

Characteristics	No (%) or Mean (Range)
Mean maternal age (n = 439)	28.3 (16–48) year
Mean gravidity (n = 434)	4.6 (1–16)
Mean parity (n = 374)	3.6 (0–10)
Number of first pregnancy (n = 374)	60 (16.0%)
History with stillbirth (n = 374)	30 (8.0%)
History with PROM (n = 371)	18 (4.9%)
History with preterm delivery (n = 371)	26 (7.0%)
Previously diagnosed with HIV/AIDS * (n = 430)	1 (0.23%)
Number of years attended in school (n = 434)	2.1 ± 1.7 (1–5) (Mean ± SD (range)) n = 127 (29.3 %) one year n = 241 (55.5 %) two years n = 13 (3.0 %) three years n = 3 (0.7 %) four years n = 50 (11.5%) five years
Smoking (n = 431)	0 (0%)
Ethnicity (n = 439)	100% Shirazi (Zanzibar Africans)
Religion	
- Islam	433 (99.8%)
- Christian	1 (0.2%)

HIV/AIDS: human immunodeficiency virus/acquired immune deficiency syndrome. PROM: pre-rupture of membranes. \* HIV/AIDS status is based on self-reporting.

### 4.3.2 GENITAL INFECTIONS PREVALENCE

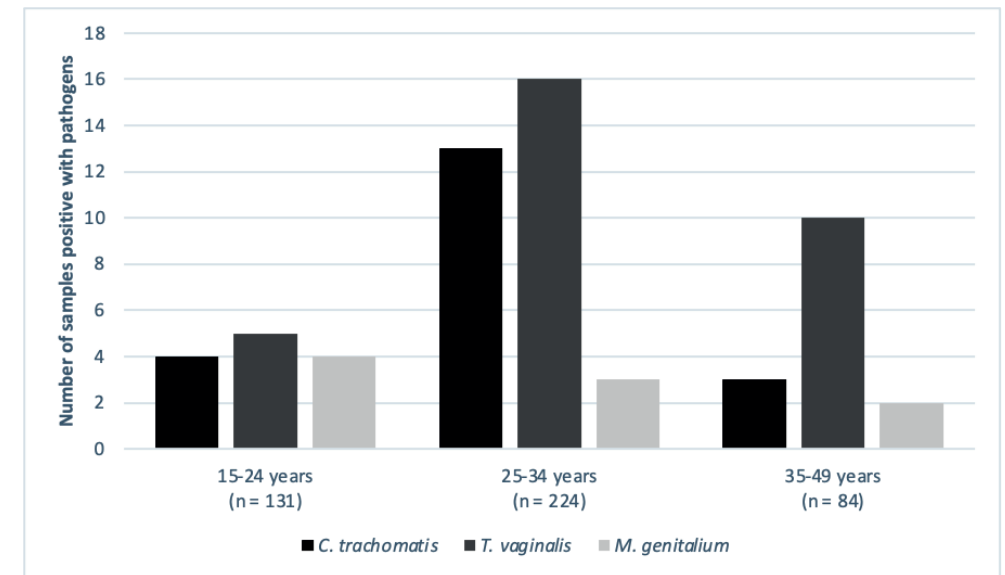
In total, 55 of the 439 (12.5%) vaginal samples tested positive for one or more genital pathogens (Figure 1). The prevalence of *C. trachomatis* infection was 4.6% (95% CI 2.8–6.9%), of *T. vaginalis* 7.1% (95% CI 4.8–9.9%), and of *M. genitalium* 2.1% (95% CI 0.9–3.9%) in vaginal samples of this pregnant cohort. *N. gonorrhoeae* was not detected in any of these vaginal samples. In four vaginal samples, two or more STI pathogens were detected (Figure 1). Among them, two vaginal samples resulted positive for *C. trachomatis* and *T. vaginalis* coinfection, one vaginal sample for *C. trachomatis* and *M. genitalium* coinfection, and one vaginal sample for *C. trachomatis*, *T. vaginalis*, and *M. genitalium* coinfection. One of the women whose vaginal sample tested positive for *C. trachomatis* and *T. vaginalis* coinfection also self-reported in the questionnaire that she had been previously diagnosed with HIV/AIDS.



**Figure 1.** Venn diagram with absolute numbers and prevalence (%) of infections in tested vaginal samples from 439 pregnant women.

Pathogens were mostly detected in vaginal samples of women between 25–34 years old (Figure 2), which was also the largest group. The risk of infections associated to different age groups (15–24 years, 25–34 years, and 35–49 years) was tested. Overall, no significant difference was observed (data not shown), except for three times higher risk of *T. vaginalis* infection in women in the older age group (35–49 years), compared to women between 15 and 24 years (OR = 0.29, 95% CI 0.020–0.88,  $p$  value = 0.03).

Five women did not report the number of years they attended school. Overall, results from this study show that the prevalence of detected infections in samples from women who attended school for more than three years was lower compared to women who attended school up to two years, which was also the largest group. Such a difference was not significant (data not shown).



**Figure 2.** Distribution of genital pathogens among maternal age groups.

Twelve of the 371 women who filled in the question of urinary tract infections (UTI) symptoms in the questionnaire reported that during the ongoing pregnancy, they had been having symptoms of UTI. Of these women, one of the vaginal samples tested positive for *C. trachomatis* infection and another vaginal sample for *T. vaginalis* infection. However, no association was found between these symptoms and having a genital pathogen (*C. trachomatis*:  $p$ -value = 0.44; *T. vaginalis*:  $p$ -value = 1.0). In total, 404 women whose samples were used in this study filled the antibiotic use question in the questionnaire. Thirteen women self-reported antibiotics use during their ongoing pregnancy. None of their vaginal samples tested positive for either one of the four genital pathogens.

#### 4.4 DISCUSSION

To our knowledge, this is the first study that reports the burden of these selected STIs in samples from a group of pregnant women living in Pemba Island, Tanzania. In the tested vaginal samples, the prevalence of *T. vaginalis* infection (7.1%) was the highest, followed by *C. trachomatis* (4.6%) and *M. genitalium* (2.1%) infections.

Both *T. vaginalis* and *C. trachomatis* infections' prevalence is within the same range of most reported studies from the East African region, which is respectively 6.8% (95% CI 4.6–9.0) for *T. vaginalis* and 4.2% (95% CI, 2.8–5.6) for *C. trachomatis* infection [18]. The burden of *T. vaginalis* and *C. trachomatis* genital infections in pregnant women living in Pemba seems to be also in concordance with the burden found among antenatal clinic attendees in two urban cities

in mainland Tanzania, namely Tanga and Dar es Salaam [28,29]. Chidou et al. retrospectively analyzed the STI prevalence based on HIV status in pregnant women between 18 and 44 years old attending antenatal care clinics in Tanga city [29]. HIV-positive pregnant women, compared to HIV-negative ones, had a lower prevalence of *C. trachomatis* (0% vs. 3%) and higher prevalence of *T. vaginalis* (18.8% vs. 5%) infection [29]. The current study did not assess the HIV status in the tested samples. Nonetheless, older governmental surveillance data from 2000 showed a low HIV infection prevalence (0.93%) in pregnant women from Pemba [30]. In line with this, the data from the current study relate the most to Chidou et al.'s results from the HIV-negative group. Between 2001 and 2003 in Dar es Salaam, one of the largest urban cities of East Africa, the prevalence of *C. trachomatis* infection was 3.5% and *T. vaginalis* infection was 4.2% in a cohort of pregnant HIV-positive women that were mostly (>68%) between 20 and 30 years old [28]. However, Chidou et al. and Aboud et al. argued in their paper that the unexpected low trichomoniasis prevalence might be due to the laboratory-based diagnostic approach and use of a low insensitivity microscopic examination, instead of the syndromic approach and molecular-based diagnostic techniques [28]. This present study used Presto PCR-based test kits, which have been shown to have high sensitivity and specificity for the detection of *C. trachomatis*, *N. gonorrhoeae*, and *T. vaginalis* [23,24]. *N. gonorrhoeae* was not detected in this studied cohort. Similar to the prevalence of *N. gonorrhoeae* infection in this study, the prevalence was also low in the other pregnant cohorts in Dar es Salaam (0.2%) and Tanga (0% in the HIV-negative cohort and 3.5% in the HIV-positive group) [28,29].

In contrast with the results from this study, the prevalence for *T. vaginalis* (12.4%), *C. trachomatis* (11.4%), and *N. gonorrhoeae* (6.7%) infections is higher among a cohort of 403 pregnant adolescents between 15 and 19 years old living in rural areas of Mwanza in mainland Tanzania [31]. Both study settings are rural sites in Tanzania, but the number of tested samples, age difference, and religious practices might help explain the difference with the results presented here. Firstly, in this current study, the median age (28 years) was above the adolescent age range and only 33 women were tested in the age range category of 15 to 19 years old. Among them, two vaginal samples were positive for *T. vaginalis* and one for *M. genitalium* (data not shown in tables). Previous studies from the United States of America, the Netherlands, China, and other sub-Saharan African countries also have shown that adolescents (<25 years) have a higher risk of acquiring STIs due to their biological susceptibility to STIs, sociological, psychological, and behavioral factors [31–37]. However, religion and cultural differences might also play a role, Mwanza city has a predominantly Christian rural population, while Pemba Island has a predominately rural community of Afro-Shirazi Muslims. Sociologists argue that the predominance of Muslim religion may have an impact on sexual behavior, particularly less pre- and extramarital sex, that are risk-factors for acquiring STIs [38,39]. This study also observed that pregnant women between 35 and 49 years old in Pemba have a higher risk of having an *T. vaginalis* infection than women between 15 and 24 years old. This might be explained because of the natural history of some pathogens and the ability of the

human body to clear *C. trachomatis*, *T. vaginalis*, *M. genitalium*, and *N. gonorrhoeae*. Due to the treatment options and ethical considerations, data about the natural course of these curable STI pathogens, especially during pregnancy, are scarce. However, earlier studies have shown that non-pregnant women can have an average duration of *T. vaginalis* for at least three–five years, while other studies show a faster resolution for *C. trachomatis* (45% of non-pregnant women cleared in one year and 44% pregnant women cleared in 1–14 weeks), *M. genitalium* (median clearance was 2.1 months), and *N. gonorrhoeae* (25% of asymptomatic women cleared over 5.4 months) [40–44]. Therefore, it is hypothesized that the slower host defense clearance for *T. vaginalis* might explain how the point prevalence for *T. vaginalis* infection of women with a longer reproductive history (older women) might be higher than women with a shorter one (younger women), particularly when individuals were not treated. Even though there is good treatment for these four mostly asymptomatic STIs, further (retrospective) research on the clearance of these pathogens is needed to determine the long-term effect of pathogens on sexual, maternal, and fetal health. This information might be particularly important for rural populations, where medication acquirement is more difficult.

Unfortunately, data from *M. genitalium* infections among pregnant women in Tanzania, or even East Africa, are scarce. The prevalence of 2.1% (95% CI 0.9–3.9) for *M. genitalium* found in this study corresponds with the prevalence found in a non-pregnant Tanzanian female cohort between 20 and 44 years old (3.2%; 95% CI 2.8–4.2) [19]. Similar prevalence for *M. genitalium* infection was observed in a pregnant cohort of women between 18 and 45 years old in Kenya, that reported a prevalence of 6.3% (95% CI 2.1–14.2%) [45]. Both studies in Tanzania and Kenya also used molecular diagnosis to detect the presence of *M. genitalium*, namely real-time and quantitative PCR, respectively.

The present study identified genital coinfections in 7.3% of the tested-positive vaginal samples among pregnant women in Pemba Island. Interestingly, all of the vaginal samples with multiple pathogens infection were positive for the *C. trachomatis* one. Previous studies mostly researched the interaction between *C. trachomatis* and *N. gonorrhoeae* solely and did not consider including other sexually transmitted pathogens in their analysis [46,47]. From these previous studies, the exact pathogenesis of *C. trachomatis* in the pathogen–pathogen and pathogen–host interaction is still not well understood [46]. However, this study suggests that coinfections of *C. trachomatis* with other pathogens, such as *M. genitalium* or *T. vaginalis*, might be more prevalent than the *C. trachomatis* and *N. gonorrhoeae* coinfections in some cohorts. This should also be considered when analyzing pathogen–pathogen interaction, host–pathogen response, and both maternal as neonatal health outcomes in these populations [46,48].

There are multiple strengths of this study, for instance, that the vaginal samples were collected in a biobank setting, where large-scale biospecimens have been collected in a harmonized way [21]. Furthermore, unlike other epidemiological studies that overestimate the true prevalence because their cohort includes data from patients seeking medical help due to symptoms, this study included samples collected from pregnant woman enrolled within their communities

across the island, irrespective of their symptoms or medical history. In previous studies, mostly the prevalence of *C. trachomatis* and *N. gonorrhoeae* during pregnancy is reported, whereas in this study, two other pathogens, *M. genitalium* and the most prevalent non-viral STI globally *T. vaginalis*, were also investigated [41]. Additionally, the use of molecular diagnostics techniques for the detection of these four pathogens, regardless of the symptoms is also a strength of this study, since these techniques are more sensitive than Gram staining cultures or wet mount microscopic methods used by earlier studies, and are more specific than syndromic testing [49].

However, this study has also some limitations. Firstly, the questionnaire filled by participating women did not specifically ask for STI symptoms, but solely for UTI ones. Often women find it difficult to differentiate between STI and UTI symptoms, especially during pregnancy [50]. In this cohort, only a low number of women (3.2%) reported that they experienced UTI symptoms during the current pregnancy, indicating that urogenital tract symptoms were not highly prevalent. Furthermore, a low number of women (3.2%) used antibiotics during their pregnancies, indicating that the majority of women did not seek or receive any medical help for urogenital symptoms during their current pregnancy. Moreover, the use of antibiotics during the current pregnancy was not an exclusion criterion in the selection of samples for this study, and not all women filled this question in their questionnaire. Thus, the prevalence data of the tested STIs, that are cleared under antibiotic treatment, might have been underestimated.

Education has been considered a protective factor against engagement in high-risk sexual behavior and STI diagnosis [51,52]. Data from the questionnaire show that there is a small range (one–five) in schoolyears attendance between participants and more than 80% of women reported that they attended school for one or two years only. In the group attending up to two years of school, there were more samples positive for three tested genital infections compared to the women that went to school between three and five years. Nonetheless, there was no statistical association between a shorter school attendance and *C. trachomatis*, *N. gonorrhoeae*, or *M. genitalium* infection. Due to the smaller number of women in the three–five years attendance group, it remains interesting to further analyze the importance of attending school more than three years in relation to sexual and reproductive health. Additional socio-economic factors associated with STIs in other studies, including marital status and household income, are not investigated in this study [53,54]. Other sociological baseline characteristics (ethnicity, religion, smoking status) reported in this study, and additional characteristics of Pemba's population by the Tanzania Demographic and Health Survey and Malaria Indicator Survey in 2015–2016 (low use of health insurance, low teenage motherhood, low use of contraceptives) also suggest that the population studied here is quite homogeneous. Socio-economic factors and marital status might follow the same homogenous trend [55].

In 2018, the reported stillbirth rate in Pemba Island was 25.7 (23.5–27.9), and the neonatal mortality rate was 16.0 (14.3–17.8) per 1000 births [27]. As previously mentioned, these four studied non-viral STIs continue to have an impact on maternal health and pregnancy outcomes in various countries [56,57]. The approach to diagnosis and managing them should align with

global STI eradication strategies, depending on the available resources and epidemiological information per country [57,58]. In this low-resource setting, where antenatal and health care is limited, and maternal and infant morbidity is high, it is important to understand the burden of (curable) pathogens that might cause long-term impact on female reproductive health beyond pregnancy, causing, for instance, ectopic pregnancy or successive infertility [58,59]. Establishing the burden of these pathogens through epidemiological biobank data-driven research in (a)symptomatic populations is an important first step for the management and control of the burden of pathogen-related diseases in communities, including in Pemba Island [58]. However, more opportunities to strengthen the diagnostic capacity and further investigate the burden of pathogens, for instance, through hospitals and health care institution databases, are needed, with particular attention to the data from pregnant women between 35 and 49 years. With further research efforts, not only better medical treatment can be provided for infected women, but culture-specific educational, prevention, and awareness strategies can be adjusted or be created with the relevant Ministry of Health. Evidence of STIs among pregnant women in this island warrants a follow-up on the effects of such genital pathogens on adverse pregnancy outcomes in this population.

#### 4.5 CONCLUSION

In conclusion, this study detected an overall 12.5% prevalence for three out of the four studied non-viral STIs in vaginal samples from a homogeneous pregnant population in Pemba Island, Tanzania. In order to improve health outcomes in mothers and children, and align with the WHO's Global Health Sector Strategy on STI goals, it is essential to not solely monitor the epidemiology of *C. trachomatis*, *T. vaginalis*, *N. gonorrhoeae*, and *M. genitalium* infections at a local and regional level, but also detect coinfections and understand their role in adverse pregnancy outcomes. The present study provides the first evidence and awareness of the burden of genital pathogens within Pemba Island, Tanzania.

## 4 REFERENCES

1. Rowley, J.; Vander Hoorn, S.; Korenromp, E.; Low, N.; Unemo, M.; Abi-Raddad, L.J.; Chico, R.M.; Smolak, A.; Newman, L.; Gottlieb, S.; et al. Chlamydia, gonorrhoea, trichomoniasis and syphilis: Global prevalence and incidence estimates. *Bull. World Health Org.* **2019**, *97*, 548–562.
2. World Health Organization. *Report on Global Sexually Transmitted Infection Surveillance, 2018*; WHO: Geneva, Switzerland, 2018.
3. World Health Organization. *Global Health Sector Strategy on Sexually Transmitted Infections 2016—Towards Ending STIs*; WHO: Geneva, Switzerland, 2016.
4. World Health Organization. *Global Incidence and Prevalence of Selected Curable Sexually Transmitted Infections-2008*; WHO: Geneva, Switzerland, 2012.
5. McGregor, J.A.; French, J.I.; Seo, K. Premature rupture of membranes and bacterial vaginosis. *Am. J. Obstet. Gynecol.* **1993**, *169*, 463–466.
6. Adachi, K.; Nielsen-Saines, K.; Klausner, J.D. Chlamydia trachomatis Infection in Pregnancy: The Global Challenge of Preventing Adverse Pregnancy and Infant Outcomes in Sub-Saharan Africa and Asia. *Biomed Res Int.* **2016**, *2016*, 9315757.
7. Oakeshott, P.; Hay, P.; Taylor-Robinson, D.; Hay, S.; Dohn, B.; Kerry, S.; Jensen, J.S. Prevalence of Mycoplasma genitalium in early pregnancy and relationship between its presence and pregnancy outcome. *BJOG Int. J. Obstet. Gynaecol.* **2004**, *111*, 1464–1467.
8. World Health Organization. *Guidelines for the Treatment of Chlamydia Trachomatis*; WHO: Geneva, Switzerland, 2016; ISBN 9789241549714.
9. Nusbaum, M.; Wallace, R.; Slatt, L.M.; Kondrad, E.C. Sexually transmitted infections and increased risk of co-infection with human immunodeficiency virus. *J. Am. Osteopath. Assoc.* **2004**, *104*, 527–535.
10. Watson-Jones, D.; Weiss, H.A.; Chagalucha, J.M.; Todd, J.; Gumodoka, B.; Bulmer, J.; Balira, R.; Ross, D.; Mugeye, K.; Hayes, R.; et al. Adverse birth outcomes in United Republic of Tanzania—Impact and prevention of maternal risk factors. *Bull. World Health Organ.* **2007**, *85*, 9–18.
11. Donders, G.G.G.; Desmyter, J.; De Wet, D.H.; Van Assche, F.A. The association of gonorrhoea and syphilis with premature birth and low birthweight. *Genitourin. Med.* **1993**, *69*, 98–101.
12. Gravett, M.G.; Nelson, H.P.; Derouen, T.; Critchlow, C.; Eschenbach, D.A.; Holmes, K.K. Independent Associations of Bacterial Vaginosis and Chlamydia trachomatis Infection With Adverse Pregnancy Outcome. *JAMA J. Am. Med. Assoc.* **1986**, *256*, 1899–1903.
13. Cotch, M.F.; Pastorek, J.G.; Nugent, R.P.; Hillier, S.L.; Gibbs, R.S.; Martin, D.H.; Eschenbach, D.A.; Edelman, R.; Carey, J.C.; Regan, J.A.; et al. Trichomonas vaginalis associated with low birth weight and preterm delivery. The Vaginal Infections and Prematurity Study Group. *Sex. Transm. Dis.* **1997**, *24*, 353–360.
14. Heumann, C.L.; Quilter, L.A.S.; Eastment, M.C.; Heffron, R.; Hawes, S.E. Adverse birth outcomes and maternal Neisseria gonorrhoeae infection: A population-based cohort study in Washington State. *Sex. Transm. Dis.* **2017**, *44*, 266–271.
15. Martius, J.; Krohn, M.A.; Millier, S.L.; Stamm, W.E.; Holmes, K.K.; Eschenbach, D.A. Relationships of vaginal lactobacillus species, cervical chlamydia trachomatis, and bacterial vaginosis to preterm birth. *Obstet. Gynecol.* **1988**, *71*, 89–95.
16. Torrone, E.A.; Morrison, C.S.; Chen, P.L.; Kwok, C.; Francis, S.C.; Hayes, R.J.; Looker, K.J.; McCormack, S.; McGrath, N.; van de Wijgert, J.H.H.M.; et al. Prevalence of sexually transmitted infections and bacterial vaginosis among women in sub-Saharan Africa: An individual participant data meta-analysis of 18 HIV prevention studies. *PLoS Med.* **2018**, *15*, e1002511.
17. World Health Organization. *Global Health Sector Strategy on Sexually Transmitted Infections 2016—Towards Ending STIs. Report*; WHO: Geneva, Switzerland, 2016.
18. Davey, D.L.J.; Shull, H.I.; Billings, J.D.; Wang, D.; Adachi, K.; Klausner, J.D. Prevalence of curable sexually transmitted infections in pregnant women in low- and middle-income countries from 2010 to 2015: A systematic review. *Sex. Transm. Dis.* **2016**, *43*, 450–458.
19. Kapiga, S.H.; Sam, N.E.; Mlay, J.; Aboud, S.; Ballard, R.C.; Shao, J.F.; Larsen, U. The epidemiology of HIV-1 infection in northern Tanzania: Results from a community-based study. *AIDS Care Psychol. Socio-Med Asp. AIDS/HIV* **2006**, *18*, 379–387.
20. Thriemer, K.; Ley, B.; Ame, S.; von Seidlein, L.; Pak, G.D.; Chang, N.Y.; Hashim, R.; Schmied, W.H.; Busch, C.J.-L.; Nixon, S.; et al. The Burden of Invasive Bacterial Infections in Pemba, Zanzibar. *PLoS ONE* **2012**, *7*, e30350.
21. Alliance for Maternal and Newborn Health Improvement; Baqui, A.H.; Khanam, R.; Rahman, M.S.; Ahmed, A.; Rahman, H.H.; Moin, M.I.; Ahmed, S.; Jehan, F.; Nisar, I.; et al. Understanding biological mechanisms underlying adverse birth outcomes in developing countries: Protocol for a prospective cohort (AMANHI bio-banking) study. *J. Glob. Health* **2017**, *7*, 021201.
22. Dols, J.A.M.; Molenaar, D.; van der Helm, J.J.; Caspers, M.P.M.; Angelino-Bart, A.K.; Schuren, F.H.J.; Speksnijder, A.G.C.L.; Westerhoff, H.V.; Richardus, J.H.; Boon, M.E.; et al. Molecular assessment of bacterial vaginosis by Lactobacillus abundance and species diversity. *BMC Infect. Dis.* **2016**, *180*, 1–8.
23. de Waaij, D.J.; Ouburg, S.; Dubbink, J.H.; Peters, R.P.H.; Morré, S.A. Evaluation of Prestoplus assay and LightMix kit Trichomonas vaginalis assay for detection of Trichomonas vaginalis in dry vaginal swabs. *J. Microbiol. Methods* **2016**, *127*, 102–104.
24. de Waaij, D.J.; Dubbink, J.H.; Peters, R.P.H.; Ouburg, S.; Morré, S.A. Comparison of GMT presto assay and Roche cobas® 4800 CT/NG assay for detection of Chlamydia trachomatis and Neisseria gonorrhoeae in dry swabs. *J. Microbiol. Methods* **2015**, *118*, 70–74.
25. Müller, E.E.; Venter, J.M.E.; Magooa, M.P.; Morrison, C.; Lewis, D.A.; Mavedzenge, S.N. Development of a rotor-gene real-time PCR assay for the detection and quantification of Mycoplasma genitalium. *J. Microbiol. Methods* **2012**, *88*, 311–315.
26. Daniel, W. *Biostatistics: A Foundation for Analysis in the Health Sciences*; John Wiley & Sons: New York, NY, USA, 1999; pp. 120–159.
27. Ahmed, I.; Ali, S.M.; Amenga-Etego, S.; Ariff, S.; Bahl, R.; Baqui, A.H.; Begum, N.; Bhandari, N.; Bhatia, K.; Bhutta, Z.A.; et al. Population-based rates, timing, and causes of maternal deaths, stillbirths, and neonatal deaths in south Asia and sub-Saharan Africa: A multi-country prospective cohort study. *Lancet Glob. Health* **2018**, *6*, e1297–e1308.
28. Aboud, S.; Msamanga, G.; Read, J.S.; Mwatha, A.; Chen, Y.Q.; Potter, D.; Valentine, M.; Sharma, U.; Hoffmann, I.; Taha, T.E.; et al. Genital tract infections among HIV-infected pregnant women in Malawi, Tanzania and Zambia. *Int. J. STD AIDS* **2008**, *19*, 824–832.
29. Chiduo, M.; Theilgaard, Z.P.; Bakari, V.; Mtatifikolo, F.; Flanholc, L.; Gerstoft, J.; Christiansen, C.B.; Phd, L.; Katzenstein, T.L. Prevalence of sexually transmitted infections among women attending antenatal clinics in Tanga, north eastern Tanzania. *Int. J. STD AIDS* **2012**, *23*, 325–329.
30. World Health Organization; United Nations; Unicef. Epidemiological Fact Sheets on HIV/AIDS and Sexually Transmitted Infections. Available online: [http://data.unaids.org/publications/fact-sheets/01/tanzania\\_en.pdf](http://data.unaids.org/publications/fact-sheets/01/tanzania_en.pdf) (accessed on 31 March 2020).
31. Hokororo, A.; Kihunrwa, A.; Hoekstra, P.; Kalluvya, S.E.; Chagalucha, J.M.; Fitzgerald, D.W.; Downs, J.A. High prevalence of sexually transmitted infections in pregnant adolescent girls in Tanzania: A multi-community cross-sectional study. *Sex. Transm. Infect.* **2015**, *91*, 473–478.

32. McCleary-Sills, J.; Douglas, Z.; Rwehumbiza, A.; Hamisi, A.; Mabala, R. Gendered norms, sexual exploitation and adolescent pregnancy in rural Tanzania. *Reprod. Health Matters* **2013**, *21*, 97–105.
33. Chacko, M.R.; Lovchik, J.C. Chlamydia trachomatis Infection in Sexually Active Adolescents: Prevalence and Risk Factors. *Pediatrics* **1984**, *73*, 836–840.
34. Chen, X.-S.; Yin, Y.-P.; Chen, L.-P.; Thuy, N.T.T.; Zhang, G.-Y.; Shi, M.-Q.; Hu, L.-H.; Yu, Y.-H. Sexually Transmitted Infections Among Pregnant Women Attending an Antenatal Clinic in Fuzhou, China. *Sex. Transm. Dis.* **2006**, *33*, 296–301.
35. Slurink, I.A.; National Institute for Public Health and the Environment (RIVM); Netherlands Institute for Health Services Research (Nivel); Stichting HIV Monitoring (SHM) (HIV Monitoring Foundation). *Sexually Transmitted Infections in The Netherlands in 2018*; RIVM: Bilthoven, The Netherlands, 2019.
36. Williams, C.L.; Harrison, L.L.; Llata, E.; Smith, R.A.; Meites, E. Sexually Transmitted Diseases Among Pregnant Women: 5 States, United States, 2009. *Matern. Child Healthj.* **2018**, *22*, 538–545.
37. Teasdale, C.A.; Abrams, E.J.; Chiasson, M.A.; Justman, J.; Blanchard, K.; Jones, H.E. Incidence of sexually transmitted infections during pregnancy. *PLoS ONE* **2018**, *13*, e0197696.
38. Adamczyk, A.; Hayes, B.E. Religion and Sexual Behaviors: Understanding the Influence of Islamic Cultures and Religious Affiliation for Explaining Sex Outside of Marriage. *Am. Sociol. Rev.* **2012**, *77*, 723–746.
39. Kakaire, O.; Byamugisha, J.K.; Tumwesigye, N.M.; Gamzell-Danielsson, K. Prevalence and Factors Associated with Sexually Transmitted Infections among HIV Positive Women Opting for Intrauterine Contraception. *PLoS ONE* **2015**, *10*, e0122400.
40. Lovett, A.; Duncan, J.A. Human immune response and the natural history of neisseria gonorrhoeae infection. *Front. Immunol.* **2019**, *9*, 1–10.
41. Van Der Pol, B. Trichomonas vaginalis Infection: The Most Prevalent Nonviral Sexually Transmitted Infection Receives the Least Public Health Attention. *Clin. Infect. Dis.* **2007**, *44*, 23–25.
42. Sheffield, J.S.; Andrews, W.W.; Klebanoff, M.A.; MacPherson, C.; Carey, J.C.; Ernest, J.M.; Wapner, R.J.; Trout, W.; Moawad, A.; Miodovnik, M.; et al. Spontaneous resolution of asymptomatic Chlamydia trachomatis in pregnancy. *Obstet. Gynecol.* **2005**, *105*, 557–562.
43. Bowden, F.J.; Garnett, G.P. Trichomonas vaginalis epidemiology: Parameterising and analysing a model of treatment interventions. *Sex. Trans. Inf.* **2000**, *76*, 248–256.
44. Morr , S.A.; Van den Brule, A.J.C.; Rozendaal, L.; Boeke, A.J.P.; Voorhorst, F.J.; De Blok, S.; Meijer, C.J.L.M. The natural course of asymptomatic Chlamydia trachomatis infections: 45% Clearance and no development of clinical PID after one-year follow-up. *Proc. Int. J. STD AIDS* **2002**, *13*, 12–18.
45. Masha, S.C.; Cools, P.; Descheemaeker, P.; Reynders, M.; Sanders, E.J.; Vanechoutte, M. Urogenital pathogens, associated with Trichomonas vaginalis, among pregnant women in Kilifi, Kenya: A nested case-control study. *BMC Infect. Dis.* **2018**, *18*, 549.
46. Leonard, C.A.; Schoborg, R.V.; Low, N.; Unemo, M.; Borel, N. Pathogenic Interplay Between Chlamydia trachomatis and Neisseria gonorrhoeae that Influences Management and Control Efforts—More Questions than Answers? *Curr. Clin. Microbiol. Rep.* **2019**, *6*, 182–191.
47. Reekie, J.; Donovan, B.; Guy, R.; Hocking, J.S.; Kaldor, J.M.; Mak, D.; Preen, D.; Ward, J.; Liu, B.; Chlamydia and Reproductive Health Outcome. Risk of ectopic pregnancy and tubal infertility following gonorrhoea and chlamydia infections. *Clin. Infect. Dis.* **2019**, *69*, 1621–1623.
48. Malogajski, J.; Brankovic, I.; Stephan, P.V.; Ambrosino, E.; Van Agtmael, M.A.; Brand, A.; Ouburg, S.; Servaas, A.M. Translational potential into health care of basic genomic and genetic findings for human immunodeficiency virus, Chlamydia trachomatis, and human. *BioMed Res. Int.* **2013**, *2013*, 1–10, doi:10.1155/2013/892106
49. Janssen, K.J.H.; Dirks, J.A.M.C.; Dukers-Muijrsers, N.H.T.M.; Hoebe, C.J.P.A.; Wolffs, P.F.G. Review of Chlamydia trachomatis viability methods: Assessing the clinical diagnostic impact of NAAT positive results. *Expert Rev. Mol. Diagn.* **2018**, *18*, 739–747.
50. Berg, E.; Benson, D.M.; Haraszkiwicz, P.; Grieb, J.; McDonald, J. High Prevalence of Sexually Transmitted Diseases in Women with Urinary Infections. *Acad. Emerg. Med.* **1996**, *3*, 1030–1034.
51. Annang, L.; Walsemann, K.M.; Maitra, D.; Kerr, J.C. Does education matter? Examining racial differences in the association between education and STI diagnosis among black and white young adult females in the U.S. *Public Health Rep.* **2010**, *125*, 110–121.
52. Halpern, C.T.; Joyner, K.; Udry, J.R.; Suchindran, C. Smart teens don't have sex (or kiss much either). *J. Adolesc. Health* **2000**, *26*, 213–225.
53. Abdul, R.; Gerritsen, A.A.M.; Mwangome, M.; Geubbels, E. Prevalence of self-reported symptoms of sexually transmitted infections, knowledge and sexual behaviour among youth in semi-rural Tanzania in the period of adolescent friendly health services strategy implementation. *BMC Infect. Dis.* **2018**, *18*, 1–10.
54. Wilson Chialepeh, N.; Sathiyasuman, A. Associated Risk Factors of STIs and Multiple Sexual Relationships among Youths in Malawi. *PLoS ONE* **2015**, *10*, e0134286.
55. Ministry of Health, Community Development, Gender, Elderly and Children—MoHCDGEC/Tanzania Mainland, Ministry of Health—MoH/Zanzibar, National Bureau of Statistics—NBS/Tanzania, Office of Chief Government Statistician—OCGS/Zanzibar, and ICF. *Tanzania Demographic and Health Survey and Malaria Indicator Survey (TDHS-MIS) 2015–16*; NBS: Dar es Salaam, Africa, 2016.
56. Wiesenfeld, H.; Manhart, L. Mycoplasma genitalium in women: Current knowledge and research priorities for this recently emerged pathogen. *J. Infect. Dis.* **2017**, S389–S395.
57. Mullick, S.; Watson-Jones, D.; Beksinska, M.; Mabey, D. Sexually transmitted infections in pregnancy: Prevalence, impact on pregnancy outcomes, and approach to treatment in developing countries. *Sex. Transm. Infect.* **2005**, *81*, 294–302.
58. Thomas, P.P.M.; Allam, R.R.; Ambrosino, E.; Malogajski, J.; Lal, J.A.; Morr , S.A.; Peters, R.P.H. An Integrated Care Model With Implementation Roadmap to Improve Chlamydia trachomatis Management and Control in India. *Front. Public Health* **2018**, *6*, 321.
59. Lal, J.A.; Malogajski, J.; Verweij, S.P.; de Boer, P.; Ambrosino, E.; Brand, A.; Ouburg, S.; Morr , S.A. Chlamydia trachomatis Infections and Subfertility: Opportunities to Translate Host Pathogen Genomic Data into Public Health. *Public Health Genom.* **2013**, *16*, 50–61.

## **4 SUPPLEMENTARY INFORMATION**

### **AUTHOR CONTRIBUTIONS**

Conception of the idea: E.A, S.M; methodology: N.J. and J.P.; formal analysis: N.J. and S.O.; data and biospecimen collections: S.D.; A.C. and S.A.; resources: S.D.; S.A. and S.S.; writing—original draft: N.J.; writing—review and editing, N.J.; E.A.; S.M.; supervision: E.A.; S.M.; project administration, S.D.; S.S.; funding acquisition: E.A. S.M.; S.S. All the authors read and approved the final manuscript.

### **ACKNOWLEDGEMENTS**

Sonja N.H. Puljhun, Monique M. Verveer, dr. Martine P. Bos, and Nina B. Uijldert for their direct technical assistance in the laboratory.

### **FUNDING**

The study was in part subsidized by the Otto Kranendonk Fund from the Netherlands Society for Tropical Medicine and International Health (NVTG).



# 5

The cure for boredom is curiosity. There is no cure for curiosity.

- Dorothy Parker / Ellen Parr



## **The natural course of *Chlamydia trachomatis*, *Neisseria gonorrhoeae*, *Trichomonas vaginalis*, and *Mycoplasma genitalium* in pregnant and post-delivery women in Pemba Island, Tanzania.**

Naomi C. A. Juliana\* , Abdulla Mbaruk Omar\* , Jolein Pleijster, Fahad Aftab,  
Nina B. Uijldert, Said M. Ali, Sander Ouburg, Sunil Sazawal, Servaas A. Morr el,  
Saikat Deb\* and Elena Ambrosino\*

*\*Shared authorship  
To be submitted to PLOS pathogens*

**ABSTRACT**

**Background.** *Chlamydia trachomatis*, *Neisseria gonorrhoeae*, *Trichomonas vaginalis* and *Mycoplasma genitalium* infections remain burdensome in sub-Saharan Africa. Data about their natural history, particularly among pregnant women, is limited. This study aimed to determine their persistence during pregnancy and after delivery in vaginal swabs of Tanzanian women.

**Methods.** In the context of an earlier biobanking effort, vaginal swabs were collected at three timepoints, namely two timepoints during pregnancy and once post-delivery. Detection of *C. trachomatis*, *N. gonorrhoeae*, *T. vaginalis*, and *M. genitalium* microorganisms was performed by PCR using validated detection kits.

**Results.** Vaginal samples of 441 pregnant women between 16 and 48 years of age were tested. Only 202 vaginal samples were available at both timepoints during pregnancy. Moreover, 38 samples were available at the second timepoint during pregnancy and at post-delivery. Of the samples taken during pregnancy, 33 tested positive for at least one of the four infection. The persistence of *C. trachomatis* was 100% (n = 11) after an average of eight weeks, *T. vaginalis* was 82% (n = 11) after ten weeks, *M. genitalium* was 75% (n = 4) after ten weeks. Samples from eight women were positive for at least one genital infection at the second timepoint during pregnancy, and their persistence post-delivery (after approximately 22 weeks) was 100% for *C. trachomatis* (n = 1) and 20% for *T. vaginalis* (n = 5). *N. gonorrhoeae* was only detected at the last collection timepoints, therefore its persistence rate could not be determined.

**Interpretation.** This study provides evidence on persistence and clearance of curable infections during and after pregnancy in a small cohort of women from Pemba Island, Tanzania. These results show that analysis of biobanked samples is a valuable approach in the investigation of the natural history of curable pathogens and can further provide guidance for the design and planning of interventions to manage them in pregnancy.

**5.1 INTRODUCTION**

*Chlamydia trachomatis*, *Neisseria gonorrhoeae*, *Trichomonas vaginalis* and *Mycoplasma genitalium* are common curable sexually-transmitted infections (STIs) that are mostly asymptomatic and have a high burden in sub-Saharan Africa (1,2). In 2016 the estimated prevalence among women between 15 and 49 years of age was 5% for *C. trachomatis* infection, 1.9% for *N. gonorrhoeae* infection and 12% for *T. vaginalis* infections in the African region (3). For *M. genitalium*, no recent regional data for sub-Saharan Africa is available but prevalence among reproductive age women in South Africa has been reported between 1.6 and 11% (4). These STIs can cause acute urogenital problems, such as inflammation of the cervix (cervicitis), but their often asymptomatic presentation (as is often the case for *C. trachomatis* and *N. gonorrhoeae* infections) accounts for why most cases remain undiagnosed, thus contributing to long-term sequelae such as pelvic inflammatory disease (3,5). During pregnancy and delivery, vertical transmission might occur, possibly causing adverse neonatal outcomes (3). In recent years, infections with these four pathogens have been in turn associated with, among others, premature delivery, low birthweight and neonatal sepsis (5–12). Despite the availability of effective antibiotic treatments, the burden of STIs remains high in general and pregnant women in most African countries (2,13).

Fortunately, natural protective immunity to these infections does occur in some women, but studies on their natural history, especially in pregnancy, are limited due to the standard care available once the pathogen is diagnosed (14–16). Notwithstanding, one study observed that 44% of 140 women with asymptomatic *C. trachomatis* infection spontaneously cleared over the course of 1 to 14 days during pregnancy (17). Information about the natural history of *C. trachomatis*, *N. gonorrhoeae*, *T. vaginalis* and *M. genitalium* infections during pregnancy is scantier. However, data exists on non-pregnant women (14,18–21). A previous study on asymptomatic non-pregnant women showed the resolution rate of *C. trachomatis* to be 11–45% (14). The follow-up intervals differed by weeks, months and even years (14). For instance, *C. trachomatis* cleared in 45% of non-pregnant Dutch women in a year, and in 94% of non-pregnant Colombian women after a 4 years follow-up (22,23). Studies showed that asymptomatic *N. gonorrhoeae* infection can persist as long as five months in non-pregnant women, and that close to 25% of patients clear the infection within that time period (21). For *M. genitalium* infection in non-pregnant women, the median clearance time is about 2 months; one study showed that 93% of 119 women involved in the study cleared it within 12 months (24). Finally, prediction studies suggest that the average duration of untreated *T. vaginalis* infection is 3 to 5 years in non-pregnant women (19,20). The infection persistence rate differs between pregnant and non-pregnant women, possibly due to the difference in the immune response as a result of hormonal regulation (25,26). For some infections, pregnant women are more susceptible, and at times more severely affected than non-pregnant women (26). Inflammatory responses that are important to clear a pathogen can have negative consequences on the outcome of the

pregnancy; pregnant women are biased towards an anti-inflammatory phenotype that is less aggressive towards disease pathogenesis, in a bid to protect viability of the pregnancy (25,26).

Designing longitudinal studies to investigate the persistence of curable infections is ethically challenging and for prospective studies unacceptable, but evidence on the natural history of infections is paramount, particularly among the most vulnerable hosts, as is the case for pregnant women. More so in communities with a high burden of STIs and related pregnancy complications, as is the case in Tanzania (27–30). In the Eastern part of the country, on the Island of Pemba, a biobanking effort was established in 2014, and follow up studies have been set up to investigate contributors to maternal mortality and morbidity (31,32).

The present study retrospectively analyzed previously collected vaginal swabs to determine persistence of *C. trachomatis*, *N. gonorrhoeae*, *T. vaginalis*, and *M. genitalium* infections during pregnancy and after delivery. Information on the natural history of curable genital infections in pregnancy provides insight into pathophysiology and offers useful scientific guidance to public health efforts in infection screening and control.

Furthermore, the generated data will provide insight on the progression of untreated infections during pregnancy among undiagnosed women and support the need for perinatal screening in order to improve maternal and child health globally.

## 5.2 METHODS

Vaginal samples and health data were collected by healthcare officials in an established biobanking effort (AMANHI) (31). As previously reported, vaginal swabs were collected in eNAT buffer (Copan, Italy) under the supervision of a healthcare worker in healthcare facilities (33). All women gave consent to participate in the biobanking effort and further research, and study ethics approval was obtained from the Zanzibar Medical Research and Ethics Committee (ZAMREC) (31). In total 686 vaginal samples from 441 women were included for analysis in this study. Of these, 385 samples were collected at first timepoint during pregnancy (between 8-20 gestational age (GA) weeks), 257 samples at second timepoint during pregnancy (between 20-40 GA weeks), and 44 samples post-delivery (between 42 - 60 days after birth). All vaginal samples were tested for the presence of *C. trachomatis*, *N. gonorrhoeae*, *T. vaginalis* and *M. genitalium*. Details on sample processing and on the genital infections molecular assays have been previously described elsewhere (33–37).

Due to logistical and practical constraints, not all women were consecutively sampled at all timepoints. Longitudinal analysis was performed on vaginal samples collected from the same women at more than one timepoint. Persistence and clearance of infection was investigated if women who tested positive at a specific timepoint were also samples at later timepoints, thus women tested at two subsequent timepoints. Infection persistence was defined as two or more consecutively sampled vaginal swabs testing positive for the same genital pathogen. Clearance

was defined by a subsequent negative result on a sample which had previously tested positive for the same pathogen. Demographic and health data such as maternal age, parity, gravidity, school attendance years, religion, previous diagnosis with human immunodeficiency virus (HIV), current symptoms of urinary tract infection and antibiotics use were self-reported via a questionnaire at each sample collection visit. Even though the questionnaire was filled in at each visit by all women included in the study, it is important to note that not every questionnaire item might have been answered. Therefore, the total number of responders at a specific demographic and health questionnaire item was explicitly mentioned if the total number of available demographic and health data did not match the total number of samples at a specific timepoint. The frequency and descriptive analysis of the demographic and health data retrieved from the biobank questionnaire were analyzed using IBM SPSS statistical software version 26 (SPSS Inc., Chicago, USA).

## 5.3 RESULTS

### 5.3.1 POPULATION CHARACTERISTICS

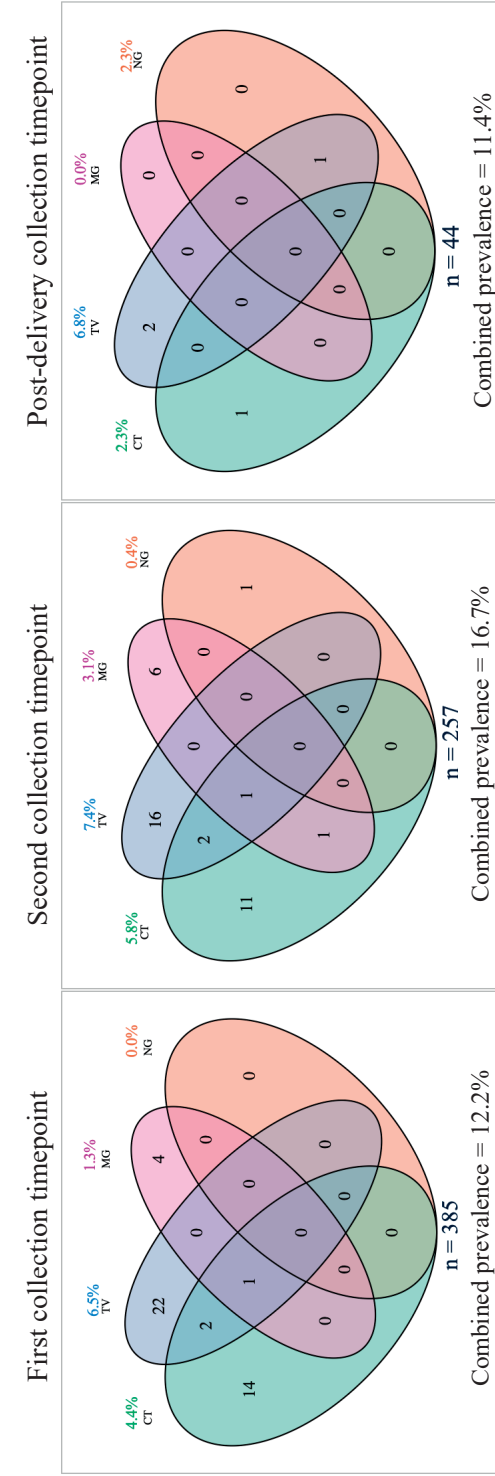
Vaginal samples of 441 pregnant women from Pemba Island were included in this study. The mean maternal age at first sampling was 28.3 years (range 16-48), the mean parity 3.5 (0-10), and 60 (14%) women were primigravida. Mean gravidity was 4.6 (n = 436; range 1-16), and only one woman self-reported having HIV infection (n = 433; 0.23%). The mean school attendance was two years (range 0-5). A significant majority of subjects identified as (n= 436) Muslim Shirazi (99.8%), while one woman identified as Christian-Shirazi.

### 5.3.2 SEXUALLY TRANSMITTED INFECTIONS PREVALENCE AND SYMPTOMATOLOGY

In this cohort, the STI burden was 12.2% among the 385 vaginal samples tested at the first timepoint. Twenty-five (6.5 %) vaginal samples tested positive for *T. vaginalis* infection, seventeen (4.4 %) for *C. trachomatis* infection, five (1.3 %) for *M. genitalium* infection and none (0%) for *N. gonorrhoeae* infection (Figure 1). At this timepoint, twelve of the 325 women (3.7%) that filled in the questionnaire item reported that they had urinary tract infections symptoms, vaginal samples of one of which tested positive for *C. trachomatis* infection, and the vaginal sample of another for *T. vaginalis* infection. One woman (of the 357 women that filled in the questionnaire item) reported having urinary tract infection symptoms and admitted to taking antibiotics (unknown indication). Eight other women also reported antibiotics use. None of the nine women that reported antibiotics usage (2.5%) tested positive for a genital infection.

At the second timepoint, the STI burden was 16.7% in the 257 vaginal samples tested. Nineteen of the 257 (7.4%) vaginal samples tested positive for *T. vaginalis* infection, fifteen (5.8 %) for *C. trachomatis* infection, eight (3.1 %) for *M. genitalium* infection and one (0.4 %)

for *N. gonorrhoeae* infection (Figure 1). One respondent out of 255 (0.4%) for the questionnaire item, reported urinary tract infections symptoms. Her vaginal sample was negative for all tested infections. Nine out of the 248 respondents (3.6%), self-reported antibiotics use between first and second timepoint in pregnancy. The vaginal sample of one the nine women that self-reported antibiotics use was positive for *T. vaginalis* infection. The type and exact time of antibiotics use was not available. Of the 44 vaginal samples tested post-delivery, three (6.8%) were positive for *T. vaginalis* infection, one (2.3%) for *C. trachomatis* infection, one (2.3%) for *N. gonorrhoeae* infection, and none (0%) for *M. genitalium* infection (Figure 1). The total STI burden was 11.4%. Post-delivery, none of the 37 respondents reported symptoms of urinary tract infections (100%), and five women self-reported antibiotic use (13.5%) (of which none tested positive for a genital infection).



**Figure 1.** Venn diagrams with point prevalence and combined prevalence of genital infections during and after pregnancy. The number represents the amount (n) of samples with a detected microorganism. Above is the individual point prevalence per genital infection and below each diagram is the total number of tested samples and the combined point prevalence of genital infections.

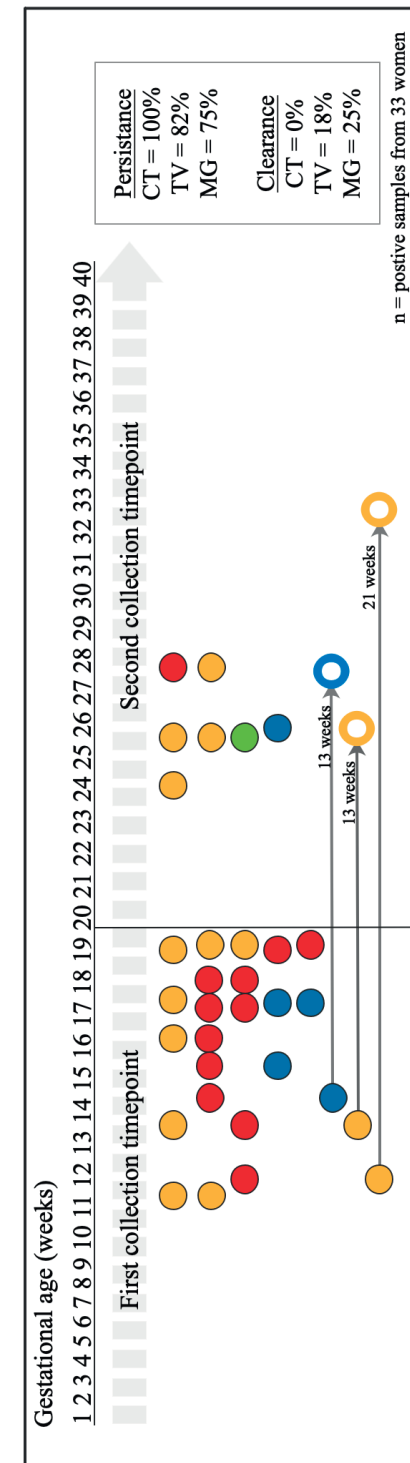
### 5.3.3. SEXUALLY TRANSMITTED INFECTIONS PERSISTENCE AND CLEARANCE DURING PREGNANCY

In total, 202 women were sampled at first and second timepoints. Among them, eleven (5.4 %) tested positive for *C. trachomatis* infection at the first time point, eleven (5.4%) for *T. vaginalis* infection, four (3.1 %) for *M. genitalium* infection, and none for *N. gonorrhoeae* infection (Figure 2). Of the 202 participants, persistence of *C. trachomatis* infection was 100% (average time between sampling collection was  $8^{+2}$  weeks<sup>(+days)</sup>), 82% for *T. vaginalis* infection (average time between sampling collection was  $9^{+6}$  weeks) and 75% for *M. genitalium* infection (average time between sampling collection was  $9^{+6}$  weeks) (Figure 2). Clearance of *T. vaginalis* infection during pregnancy (n=2) happened within  $13^{+0}$  and  $21^{+5}$  weeks respectively (Figure 2). Where clearance of *M. genitalium* infection occurred during pregnancy (n=1), it occurred within  $12^{+6}$  weeks (Figure 2). The vaginal samples of seven women tested positive for a genital infection at the second timepoint, while their samples at the first timepoint were negative (Figure 2).

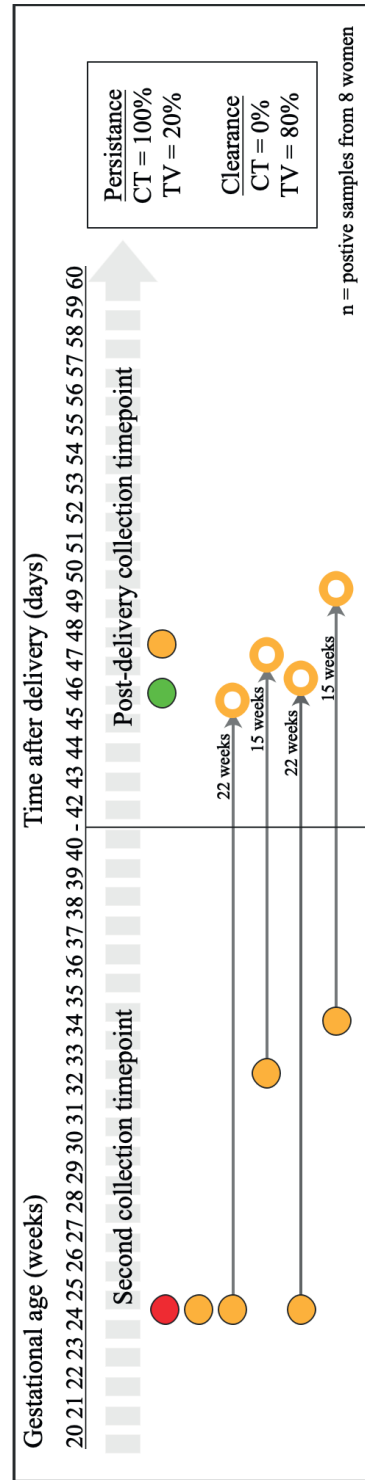
Nine women self-reported symptoms of urinary tract infection at the first timepoint during pregnancy, but only one of whom tested positive for *C. trachomatis* infection, and remained so at the second timepoint (despite being asymptomatic at second testing). None of these women reported antibiotic use during pregnancy. Furthermore, six women reported use of antibiotics at the first time point, none of these tested positive for a genital infection at first timepoint; one subsequently tested positive for *C. trachomatis* infection at the second timepoint. At the second timepoint, six women reported antibiotics use, with only one testing positive for *T. vaginalis* infection at the same timepoint. No information on the indication and type for antibiotics used was available.

### 5.3.4 SEXUALLY TRANSMITTED INFECTIONS PERSISTENCE AND CLEARANCE AFTER PREGNANCY

Thirty-eight women were sampled at the second timepoint during pregnancy and post-delivery. Of these women, one of the vaginal samples (2.6 %) was positive for *C. trachomatis* infection, five (13.2%) for *T. vaginalis* infection, and none for *M. genitalium* or *N. gonorrhoeae* infections at the second timepoint (Figure 3). Twenty-two weeks after the second timepoint, the persistence rate post-delivery was 100% for *C. trachomatis* (n=1) and 20% for *T. vaginalis* infections (n = 1) (Figure 3). Four women had post-delivery samples test negative for *T. vaginalis* after an average of  $18^{+6}$  (range  $15^{+1}$  -  $22^{+0}$ ) weeks of having tested positive (Figure 3). In the group of 38 women, one vaginal sample with *N. gonorrhoeae* and another with *T. vaginalis* were newly detected post-delivery (Figure 3). None of these 38 women self-reported symptoms of urinary tract infection. Six women self-reported use of antibiotics at the second timepoint during pregnancy, and no genital infection was detected at second timepoint during pregnancy and post-delivery in their vaginal samples.



**Figure 2.** Schematic overview of the persistence and clearance of genital infections of positive vaginal swabs collected during pregnancy (n = 33 infected women out of 202 tested women). Horizontal labels indicate the time of collection in gestational age in weeks. Each dot represents a vaginal sample positive for *C. trachomatis* (in red), *T. vaginalis* (in yellow), *N. gonorrhoeae* (in green), and *M. genitalium* (in blue). Open dots represent cleared infections. The thin grey arrows, with the interval between testing in weeks on top, connect a positive sample with matching coloured open dot and it refers to cleared infections. The seven dots in the second collection timepoint period indicate samples with de novo infections (as samples from the same women collected earlier were not positive for the same pathogens). All infections detected at first time point did persist if no thin grey arrow was connected to them.



**Figure 3.** Schematic overview of the persistence and clearance of genital infections of positive vaginal swabs collected during pregnancy and post-delivery (n= 8 infected women out of 38 tested women). Horizontal labels indicate the time of collection in gestational age in weeks. Each dot represents a vaginal sample positive for *C. trachomatis* (in red), *T. vaginalis* (in yellow), *N. gonorrhoeae* (in green), and *M. genitalium* (in blue). *M. genitalium* was not detected at the second timepoint in this sub-cohort. Open dots represent cleared infections. The thin grey arrows, with the interval between testing in weeks on top, connect a positive sample with matching coloured open dot and it refers to cleared infections. The two dots in the post-delivery collection period indicate samples with de novo infections (as samples from the same women collected at the second timepoint were not positive for the same pathogens). All infections detected at second time point did persist if no thin grey arrow was connected to them.

## 5.4 DISCUSSION

The study observed the persistence of genital infections during pregnancy (*C. trachomatis*, *T. vaginalis* and *M. genitalium*) and post-delivery (*C. trachomatis* and *T. vaginalis*). During pregnancy, *T. vaginalis* infection clearance (26 and 33 weeks after first collection) occurred in two (18%) of the cases, and *M. genitalium* infection clearance (27 weeks after first collection) in one case (25%); *C. trachomatis* infection did not clear in any of the eleven cases. Pre and post-delivery, *T. vaginalis* infection cleared in one (80%) case (an average of 18 weeks after second collection), while there was no clearance of *C. trachomatis* infection 22 weeks after the second collection. For *N. gonorrhoeae*, the persistence of infection could not be determined.

To our knowledge, this is the first study to observe the natural history of *T. vaginalis* and *M. genitalium* during pregnancy and post-delivery. In a non-pregnant cohort of 119 *M. genitalium* infected sex-workers in Kenya (prevalence 14%), 45% spontaneously cleared the infection over the course of three months, whereas in this study (in a much smaller *M. genitalium* infected cohort (n = 4) than in Kenya) that was the case for just 25% over the course of almost 13 weeks (18). However, it is worth mentioning that the intervals between sample collection points were not uniform in this study. The sample of the woman who cleared from *M. genitalium* infection was collected almost 13 weeks after the first pregnancy collection timepoint, while there was a shorter interval between initial detection, and the second collection timepoint (8 - 10 weeks) for the other three women that had a persistence of infection. As expected, the wider the time-interval between collection timepoints, the greater the chance of clearance (17,18).

Existing results from a non-pregnant adolescent (14-17 years) cohort in the United States of America indicate that untreated *T. vaginalis* infection can persist for up to 12 weeks, and that individuals can be asymptomatic for the entire duration of infection (20). Modelling based on data from non-pregnant women show that *T. vaginalis* persistence might be longer (3-5 years) in older women, and might also explain why the prevalence of *T. vaginalis* is higher in older women (19). In this study, the mean maternal age of the cohort was 28.3 years, thus the results might be less comparable with the findings in the American adolescent cohort, and more comparable with the longer persistence rate observed in the modelling (15). *T. vaginalis* infection also cleared more often in women whose samples were collected at larger time intervals; in two cases 13- and 21-weeks during pregnancy, and in four cases an average of 18 weeks before and post-delivery. Although the exact date of infection is unknown, in this small cohort persistence of *T. vaginalis* infection was observed in 82% of women (average time interval of 10 weeks) during pregnancy, and 20% post-delivery (average time interval of 22 weeks) and clearance was observed after a time interval of 17 weeks and 19 weeks during and after pregnancy, respectively. Further retrospective longitudinal analysis with a bigger cohort will help expand knowledge of *T. vaginalis* and *M. genitalium* clearance.

Furthermore, this study shows a persistence of *C. trachomatis* infection for up to 13 weeks during pregnancy. The *C. trachomatis* persistence (100%) reported in the current study differs

from that reported by Sheffield et al. (pregnant cohort) and other non-pregnant data (retrieved from Golden et al and Geisler et al.) (Figure 4) (14,17,38). The discrepancy can be accounted for by the limited number of *C. trachomatis* positive samples at the first timepoint (n=8) in this study compared to others studies (Figure 4). Spontaneous resolution of *C. trachomatis* occurred in 44% of 1521 pregnant North-American women in the course 3 months (17). Moreover, the lower prevalence of *C. trachomatis* in the present study (5.4%), compared to that from Sheffield et al. (9%), might also explain the difference in clearance (17). A retrospective follow-up study with a larger sample size will help clarify the difference observed in sub-Saharan African women.

Additionally, several studies have suggested that sub-Saharan African women, or women with sub-Saharan African ancestry, have a higher prevalence of dysbiotic vaginal microbiota compared to Caucasian women (39–42). Dysbiotic vaginal microbiota has been linked with increased susceptibility to genital infections (43,44). Therefore it will be of further interest to investigate how vaginal microbiota diversity, as well as other individual factors like host genetic determinant of infections, influence clearance of *C. trachomatis* or other genital pathogens, in particular during pregnancy (25,26,45).

It was hypothesized that the persistence level of genital infections would be higher among pregnant women, since the women's innate and acquired immune systems are altered compared to the non-pregnant state (46). Mothers' immune system needs to prevent the rejection of a semi-allogeneic foetus, while protecting both mother and foetus from infection (46). The macrophages in the maternal decidual epithelium (part of innate immunity) have the ability to remodel tissue, suppress maternal immune response and present antigens (47,48). While changes in acquired immunity also occur in pregnancy; there is a decrease in circulating levels of pro-inflammatory cytokines and interleukin-10, the amount of regulatory T-cells is increased in the decidua, maternal immunity shifts towards a T helper (Th) 2 cells phenotype, and Th2 cells outnumber Th1 cells in the decidua (49–51). The mechanism of immune cell interactions in pregnancy has been extensively reviewed elsewhere and are out of scope of this paper (25,46,52–55). Nevertheless, because of these immunological changes, data about infection persistence and clearance observed in non-pregnant women is not fully representative of pregnant women (56,57). Our findings show indeed a trend that the clearance might be lower in pregnant women than in non-pregnant cohorts (Figure 4). As discussed, due to the low number of samples tested more pregnancy-related information is warranted to also confirm this trend (Figure 4). Additionally, prospective research should further investigate the interplay between genital infections and host immunity, and the burden genital infections potentially have on mother and foetus (such as intra-uterine infections, low birthweight, preterm birth, respiratory infections) (46).

Drawbacks of this study are the relatively small sample size and the limited longitudinal sampling, which combined with the prevalence of infections has provided results of a limited power, therefore cautious extrapolation is recommended. Furthermore, information on the indication for, and type of antibiotics used were lacking; samples from women using antibiotics was not excluded from the analysis. The relationship between antibiotic use in the preceding months (not directly related to an STI) and lower prevalence of STIs is still debatable. Lower prevalence of *C. trachomatis* has only been reported in the use of certain antibiotics (tetracycline) and not others (azithromycin) (58,59). Data about general antibiotic use in Pemba is limited and has been obtained via a questionnaire as reported in this study. Nevertheless, background antibiotic treatment might have an effect on *C. trachomatis* prevalence even in countries with low per capita antibiotics consumption (58). Doxycycline or azithromycin are also treatments for *M. genitalium*, while metronidazole is first line treatment for *T. vaginalis*. Still to date, information about the effect of background antibiotics use on *M. genitalium* and *T. vaginalis* prevalence is scant. For *N. gonorrhoeae*, incidental treatment is probably limited as ceftriaxone (first line treatment for *N. gonorrhoeae*) is infrequently used (58). It should be noted that a large part of background antibiotics use are not first-line treatments for certain STIs, such as *C. trachomatis*, *M. genitalium*, or *N. gonorrhoeae*, and might not have an impact on their course (58). Moreover, in relation to this study, detailed information on genital symptoms was missing. Only one woman self-reported urinary tract infections symptoms, however symptoms of the urinary tract and genital ones are often hard to differentiate (33,60). Lastly, there was no differentiation between persistence of infections and re-infection, it is therefore possible that some women achieved clearance from a specified pathogen, and were re-infected before the subsequent collection timepoint. To mitigate against this phenomenon in a future study, pathogen genotyping testing should be considered especially in larger cohort analysis (18). Additionally, bacterial load and co-infections with other burdensome pathogens, for example HIV, should also be taken into consideration to better understand the clinical implications of these infections. However, in this cohort the number of women who self-reported diagnosis of HIV was very low. Persistent genital infections or chronic inflammation could possibly enhance the susceptibility of the genital tract to acquisition of other genital infections, and might contribute to the persistence of infections in the genital tract (18).

Current understanding of the natural history of *C. trachomatis*, *T. vaginalis*, *N. gonorrhoeae* and *M. genitalium* is hampered by a lack of robust scientific studies; it is mostly limited to that provided by low sensitivity and specificity studies (using culture-based methods) in the pre-antibiotic era (16,17,61). Logically, with current antibiotic treatment possibilities, ethical constraints is the major reason for the lack of studies investigating the natural history of curable pathogens during pregnancy. Nonetheless, and as shown with this retrospective approach, information about the natural history of infection in a specific population can still be obtained with the help of existing biobank samples and database. Retrieving this information remains important, as evidence like the one provided here is essential to public health officials when





## 5 REFERENCES

1. Newman L, Rowley J, Vander Hoorn S, Wijesooriya NS, Unemo M, Low N, et al. Global Estimates of the Prevalence and Incidence of Four Curable Sexually Transmitted Infections in 2012 Based on Systematic Review and Global Reporting. Meng Z, editor. PLoS One [Internet]. 2015 Dec 8 [cited 2020 Jul 30];10(12):e0143304. Available from: <https://dx.plos.org/10.1371/journal.pone.0143304>. DOI:10.1371/journal.pone.0143304.
2. Adachi K, Nielsen-Saines K, Klausner JD. Chlamydia trachomatis Infection in Pregnancy: The Global Challenge of Preventing Adverse Pregnancy and Infant Outcomes in Sub-Saharan Africa and Asia. Biomed Res Int [Internet]. 2016 [cited 2020 Mar 23];2016(9315757):9315757. Available from: <http://dx.doi.org/10.1155/2016/9315757>. DOI:10.1155/2016/9315757.
3. Rowley J, Vander Hoorn S, Korenromp E et al. Chlamydia, gonorrhoea, trichomoniasis and syphilis: global prevalence and incidence estimates, 2016. Bull World Health Organ [Internet]. 2019 [cited 2020 Mar 23];(97):548562. Available from: <http://www.who.int/entity/bulletin/volumes/97/8/18-228486.pdf>. DOI:10.2471/BLT.18.228486.
4. Nodjokoumbaye ZA, Compain F, Sadjoli D, Mboumba Bouassa RS, Péré H, Veyer D, et al. Accuracy of curable sexually transmitted infections and genital mycoplasmas screening by multiplex real-time PCR using a self-collected veil among adult women in Sub-Saharan Africa. Infect Dis Obstet Gynecol [Internet]. 2019 [cited 2020 Sep 2];2019:15. Available from: [/pmc/articles/PMC6662439/?report=abstract](https://pubmed.ncbi.nlm.nih.gov/33111111/). DOI:10.1155/2019/8639510.
5. Taylor-Robinson D, Lamont R. Mycoplasmas in pregnancy. BJOG An Int J Obstet Gynaecol [Internet]. 2011 Jan 1 [cited 2020 Sep 2];118(2):164–74. Available from: <http://doi.wiley.com/10.1111/j.1471-0528.2010.02766.x>. DOI:10.1111/j.1471-0528.2010.02766.x.
6. Creighton S. Gonorrhoea [Internet]. Vol. 2014, BMJ clinical evidence. BMJ Publishing Group; 2014 [cited 2020 Sep 3]. Available from: [/pmc/articles/PMC3931440/?report=abstract](https://pubmed.ncbi.nlm.nih.gov/26111111/). DOI:10.5005/jp/books/11611\_34.
7. Watson-Jones D, Weiss HA, Changalucha JM, Todd J, Gumodoka B, Bulmer J, et al. Adverse birth outcomes in United Republic of Tanzania - Impact and prevention of maternal risk factors. Bull World Health Organ. 2007 Jan;85(1):9–18. . DOI:10.2471/BLT.06.033258.
8. Donders GGG, Desmyter J, De Wet DH, Van Assche FA. The association of gonorrhoea and syphilis with premature birth and low birthweight. Genitourin Med [Internet]. 1993 Apr [cited 2020 Apr 7];69(2):98–101. Available from: <http://www.ncbi.nlm.nih.gov/pubmed/8509101>. DOI:10.1136/sti.69.2.98.
9. Gravett MG, Nelson HP, Derouen T, Critchlow C, Eschenbach DA, Holmes KK. Independent Associations of Bacterial Vaginosis and Chlamydia trachomatis Infection With Adverse Pregnancy Outcome. JAMA J Am Med Assoc. 1986 Oct 10;256(14):1899–903. . DOI:10.1001/jama.1986.03380140069024.
10. Cotch MF, Pastorek JG, Nugent RP, Hillier SL, Gibbs RS, Martin DH, et al. Trichomonas vaginalis associated with low birth weight and preterm delivery. The Vaginal Infections and Prematurity Study Group. Sex Transm Dis [Internet]. 1997 Jul [cited 2020 Apr 7];24(6):353–60. Available from: <http://www.ncbi.nlm.nih.gov/pubmed/9243743>
11. Heumann CL, Quilter LAS, Eastment MC, Heffron R, Hawes SE. Adverse birth outcomes and maternal Neisseria gonorrhoeae infection: A population-based cohort study in Washington State. Sex Transm Dis. 2017;44(5):266–71. . DOI:10.1097/OLQ.0000000000000592.
12. Martius J, Krohn MA, Millier SL, Stamm WE, Holmes KK, Eschenbach DA. Relationships of vaginal lactobacillus species, cervical chlamydia trachomatis, and bacterial vaginosis to preterm birth. Obstet Gynecol. 1988;71(1):89–95.
13. Dubbink JH, De Waaij DJ, Bos M, Van Der Eem L, Bébéar C, Mbambazela N, et al. Microbiological characteristics of chlamydia trachomatis and neisseria gonorrhoeae infections in South African women. J Clin Microbiol. 2016 Jan 1;54(1):200–3. . DOI:10.1128/JCM.02848-15.
14. Geisler WM. Duration of Untreated, Uncomplicated *Chlamydia trachomatis* Genital Infection and Factors Associated with Chlamydia Resolution: A Review of Human Studies. J Infect Dis [Internet]. 2010 Jun 15 [cited 2020 Sep 3];201(S2):104–13. Available from: <https://academic.oup.com/jid/article-lookup/doi/10.1086/652402>. DOI:10.1086/652402.
15. Van Der Pol B. Trichomonas vaginalis Infection: The Most Prevalent Nonviral Sexually Transmitted Infection Receives the Least Public Health Attention. Clin Infect Dis [Internet]. 2007 [cited 2020 Apr 17];44:23–5. Available from: <https://academic.oup.com/cid/article-abstract/44/1/23/432673>. DOI:10.1086/509934.
16. Stupiansky NW, Van Der Pol B, Williams JA, Weaver B, Taylor SE, Fortenberry JD. The natural history of incident gonococcal infection in adolescent women. Sex Transm Dis [Internet]. 2011 Aug [cited 2020 Sep 5];38(8):750–4. Available from: <https://pubmed.ncbi.nlm.nih.gov/21317686/>. DOI:10.1097/OLQ.0b013e31820ff9a4.
17. Sheffield JS, Andrews WW, Klebanoff MA, MacPherson C, Carey JC, Ernest JM, et al. Spontaneous resolution of asymptomatic Chlamydia trachomatis in pregnancy. Obstet Gynecol [Internet]. 2005 Mar [cited 2020 Jul 21];105(3):557–62. Available from: <https://pubmed.ncbi.nlm.nih.gov/15738024/>. DOI:10.1097/01.AOG.0000153533.13658.c2.
18. Vandepitte J, Weiss HA, Kyakuwa N, Nakubulwa S, Muller E, Buvé A, et al. Natural history of mycoplasma genitalium infection in a cohort of female sex workers in Kampala, Uganda. Sex Transm Dis [Internet]. 2013 May [cited 2020 Sep 3];40(5):422–7. Available from: [/pmc/articles/PMC3928562/?report=abstract](https://pubmed.ncbi.nlm.nih.gov/23928562/). DOI:10.1097/OLQ.0b013e31828bfccf.
19. Bowden FJ, Garnett GP. Trichomonas vaginalis epidemiology: parameterising and analysing a model of treatment interventions. [cited 2020 Jul 21]; Available from: <http://sti.bmj.com/>. DOI:10.1136/sti.76.4.248.
20. Van Der Pol B, Williams JA, Orr DP, Batteiger BE, Fortenberry JD. Prevalence, incidence, natural history, and response to treatment of Trichomonas vaginalis infection among adolescent women. J Infect Dis [Internet]. 2005 Dec 15 [cited 2020 Sep 3];192(12):2039–44. Available from: <https://academic.oup.com/jid/article-lookup/doi/10.1086/498217>. DOI:10.1086/498217.
21. Lovett A, Duncan JA. Human immune response and the natural history of neisseria gonorrhoeae infection. Front Immunol [Internet]. 2019 [cited 2020 Jul 21];9(3187):1–10. Available from: <https://pubmed.ncbi.nlm.nih.gov/30838004/>. DOI:10.3389/fimmu.2018.03187.
22. Molano M, Meijer CJLM, Weiderpass E, Arslan A, Posso H, Franceschi S, et al. The natural course of Chlamydia trachomatis infection in asymptomatic Colombian women: A 5-year follow-up study. J Infect Dis [Internet]. 2005 Mar 15 [cited 2020 Oct 4];191(6):907–16. Available from: <https://pubmed.ncbi.nlm.nih.gov/15717266/>. DOI:10.1086/428287.
23. Morré SA, Van den Brule AJC, Rozendaal L, Boeke AJP, Voorhorst FJ, De Blok S, et al. The natural course of asymptomatic Chlamydia trachomatis infections: 45% Clearance and no development of clinical PID after one-year follow-up. In: International Journal of STD and AIDS [Internet]. Royal Society of Medicine Press Ltd; 2002 [cited 2020 Jul 22]. p. 12–8. Available from: <http://journals.sagepub.com/doi/10.1258/095646202762226092>. DOI:10.1258/095646202762226092.
24. Vandepitte J, Weiss HA, Kyakuwa N, Nakubulwa S, Muller E, Buvé A, et al. Natural history of mycoplasma genitalium infection in a cohort of female sex workers in Kampala, Uganda. Sex Transm Dis [Internet]. 2013 May [cited 2020 Sep 9];40(5):422–7. Available from: [/pmc/articles/PMC3928562/?report=abstract](https://pubmed.ncbi.nlm.nih.gov/23928562/). DOI:10.1097/OLQ.0b013e31828bfccf.

25. Mor G, Cardenas I. The Immune System in Pregnancy: A Unique Complexity [Internet]. Vol. 63, American Journal of Reproductive Immunology. NIH Public Access; 2010 [cited 2020 Sep 2]. p. 425–33. Available from: [/pmc/articles/PMC3025805/?report=abstract](https://pubmed.ncbi.nlm.nih.gov/20100836/). DOI:10.1111/j.1600-0897.2010.00836.x.
26. Robinson DP, Klein SL. Pregnancy and pregnancy-associated hormones alter immune responses and disease pathogenesis [Internet]. Vol. 62, Hormones and Behavior. NIH Public Access; 2012 [cited 2020 Sep 2]. p. 263–71. Available from: [/pmc/articles/PMC3376705/?report=abstract](https://pubmed.ncbi.nlm.nih.gov/22020202/). DOI:10.1016/j.yhbeh.2012.02.023.
27. Francis SC, Ao TT, Vanobberghen FM, Chilongani J, Hashim R, Andreassen A, et al. Epidemiology of Curable Sexually Transmitted Infections among Women at Increased Risk for HIV in Northwestern Tanzania: Inadequacy of Syndromic Management. Price MA, editor. PLoS One [Internet]. 2014 Jul 15 [cited 2020 Sep 20];9(7):e101221. Available from: <https://dx.plos.org/10.1371/journal.pone.0101221>. DOI:10.1371/journal.pone.0101221.
28. Watson-Jones D, ... HW-B of the W, 2007 undefined. Adverse birth outcomes in United Republic of Tanzania: impact and prevention of maternal risk factors. SciELO Public Heal [Internet]. [cited 2020 Mar 23]; Available from: <https://www.scielo.org/article/bwho/2007.v85n1/9-18/en/>
29. World Health Organization. WHO country cooperation strategy at a glance: Tanzania (United Republic of) [Internet]. Geneva.; 2017. Available from: <https://apps.who.int/iris/handle/10665/136888>.
30. Ministry of Health Community Development Gender Elderly and Children (MoHCDGEC); et al. Tanzania Demographic and Health Survey and Malaria Indicator Survey (TDHS-MIS) 2015-16 [Internet]. Dar es Salaam, Tanzania, and Rockville, Maryland, USA; 2016 [cited 2020 Jul 3]. p. 1–445. Available from: <https://dhsprogram.com/pubs/pdf/FR321/FR321.pdf>
31. Alliance for Maternal and Newborn Health Improvement, Baqui AH, Khanam R, Rahman MS, Ahmed A, Rahman HH, et al. Understanding biological mechanisms underlying adverse birth outcomes in developing countries: Protocol for a prospective cohort (AMANHI bio-banking) study. J Glob Health. 2017 Nov 1;7(2):021201. . DOI:10.7189/jogh.07.021202.
32. Ahmed I, Ali SM, Amenga-Etego S, Ariff S, Bahl R, Baqui AH, et al. Population-based rates, timing, and causes of maternal deaths, stillbirths, and neonatal deaths in south Asia and sub-Saharan Africa: a multi-country prospective cohort study. Lancet Glob Heal. 2018 Dec 1;6(12):e1297–308. . DOI:10.1016/S2214-109X(18)30385-1.
33. Juliana NCA, Deb S, Ouburg S, Chauhan A, Pleijster J, Ali SM, et al. The Prevalence of Chlamydia trachomatis and Three Other Non-Viral Sexually Transmitted Infections among Pregnant Women in Pemba Island Tanzania. Pathogens [Internet]. 2020 Jul 31 [cited 2020 Aug 21];9(8):625. Available from: <https://www.mdpi.com/2076-0817/9/8/625>. DOI:10.3390/pathogens9080625.
34. Dols JAM, Molenaar D, van der Helm JJ, Caspers MPM, Angelino-Bart A de K, Schuren FHJ, et al. Molecular assessment of bacterial vaginosis by Lactobacillus abundance and species diversity. BMC Infect Dis. 2016;180(16):1–8. . DOI:10.1186/s12879-016-1513-3.
35. de Waaij DJ, Ouburg S, Dubbink JH, Peters RPH, Morr  SA. Evaluation of Prestoplus assay and Light-Mix kit Trichomonas vaginalis assay for detection of Trichomonas vaginalis in dry vaginal swabs. J Microbiol Methods [Internet]. 2016 Aug 1 [cited 2020 Mar 25];127:102–4. Available from: <http://www.ncbi.nlm.nih.gov/pubmed/27268968>. DOI:10.1016/j.mimet.2016.06.002.
36. de Waaij DJ, Dubbink JH, Peters RPH, Ouburg S, Morr  SA. Comparison of GMT presto assay and Roche cobas® 4800 CT/NG assay for detection of Chlamydia trachomatis and Neisseria gonorrhoeae in dry swabs. J Microbiol Methods [Internet]. 2015 Nov 1 [cited 2020 Mar 25];118:70–4. Available from: <http://www.ncbi.nlm.nih.gov/pubmed/26327539>. DOI:10.1016/j.mimet.2015.08.020.
37. M ller EE, Venter JME, Magooa MP, Morrison C, Lewis DA, Mavedzenge SN. Development of a rotor-gene real-time PCR assay for the detection and quantification of Mycoplasma genitalium. J Microbiol Methods. 2012 Feb 1;88(2):311–5. . DOI:10.1016/j.mimet.2011.12.017.
38. Golden M, Schillinger J, Markowitz L. Duration of untreated genital infections with Chlamydia trachomatis: a review of the literature. Sex Transm Dis [Internet]. 2000 [cited 2020 Oct 6];6(27):329–37. Available from: [https://journals.lww.com/stdjournal/Fulltext/2000/07000/Duration\\_of\\_Untreated\\_Genital\\_Infections.6.aspx?casa\\_token=aXyt00P4NaoAAAAA:reHcmi3AJWoOg0Y2Opkre3ezqHTpYxoHrJFqDflwnuk0OAxWCWwPxIyoCPAKPTcaJKquBbYiFKXmlu72xiX2g7yFaw](https://journals.lww.com/stdjournal/Fulltext/2000/07000/Duration_of_Untreated_Genital_Infections.6.aspx?casa_token=aXyt00P4NaoAAAAA:reHcmi3AJWoOg0Y2Opkre3ezqHTpYxoHrJFqDflwnuk0OAxWCWwPxIyoCPAKPTcaJKquBbYiFKXmlu72xiX2g7yFaw)
39. Serrano MG, Parikh HI, Brooks JP, Edwards DJ, Arodz TJ, Edupuganti L, et al. Racioethnic diversity in the dynamics of the vaginal microbiome during pregnancy. Nat Med. 2019 Jun 1;25(6):1001–11. . DOI:10.1038/s41591-019-0465-8.
40. van de Wijgert JHHM, Jaspers V. The global health impact of vaginal dysbiosis. Res Microbiol. 2017; . DOI:10.1016/j.resmic.2017.02.003.
41. Ravel J, Gajer P, Abdo Z, Schneider GM, Koenig SSK, McCulle SL, et al. Vaginal microbiome of reproductive-age women. Proc Natl Acad Sci U S A. 2011 Mar 15;108(SUPPL. 1):4680–7. . DOI:10.1073/pnas.1002611107.
42. Romero R, Hassan SS, Gajer P, Tarca AL, Fadrosh DW, Nikita L, et al. The composition and stability of the vaginal microbiota of normal pregnant women is different from that of non-pregnant women. Microbiome [Internet]. 2014 Dec 3 [cited 2020 Jan 10];2(1):4. Available from: <https://microbiomejournal.biomedcentral.com/articles/10.1186/2049-2618-2-4>. DOI:10.1186/2049-2618-2-4.
43. Masha SC, Cools P, Descheemaeker P, Reynders M, Sanders EJ, Vanechoutte M. Urogenital pathogens, associated with Trichomonas vaginalis, among pregnant women in Kilifi, Kenya: a nested case-control study. BMC Infect Dis [Internet]. 2018 Dec 6 [cited 2020 Mar 31];18(1):549. Available from: <https://bmcinfectdis.biomedcentral.com/articles/10.1186/s12879-018-3455-4>. DOI:10.1186/s12879-018-3455-4.
44. van de Wijgert JHHM. The vaginal microbiome and sexually transmitted infections are interlinked: Consequences for treatment and prevention. PLoS Med. 2017; . DOI:10.1371/journal.pmed.1002478.
45. Malogajski J, Brankovic I, Verweij SP, Ambrosino E, Van Agtmael MA, Brand A, et al. Translational potential into health care of basic genomic and genetic findings for human immunodeficiency virus, chlamydia trachomatis, and human papilloma virus. Vol. 2013, BioMed Research International. 2013. . DOI:10.1155/2013/892106.
46. Howie S, Horner P, Horne A. Chlamydia trachomatis Infection During Pregnancy—Known Unknowns. Discov Med [Internet]. 2011 [cited 2020 Oct 4];12(62):57–64. Available from: <http://www.discovery-medicine.com/Sarah-E-Howie/2011/07/25/chlamydia-trachomatis-infection-during-pregnancy-known-unknowns/>
47. Gustafsson C, Mj sberg J, Matussek A, Geffers R, Matthiesen L, Berg G, et al. Gene expression profiling of human decidual macrophages: Evidence for immunosuppressive phenotype. PLoS One [Internet]. 2008 Apr 30 [cited 2020 Oct 4];3(4). Available from: <https://pubmed.ncbi.nlm.nih.gov/18446208/>. DOI:10.1371/journal.pone.0002078.
48. Houser BL, Tilburgs T, Hill J, Nicotra ML, Strominger JL. Two Unique Human Decidual Macrophage Populations. J Immunol [Internet]. 2011 Feb 15 [cited 2020 Oct 4];186(4):2633–42. Available from: <http://www.jimmunol.org/content/186/4/2633>. DOI:10.4049/jimmunol.1003153.
49. Szarka A, Rig  J, L z r L, Beko G, Molvarec A. Circulating cytokines, chemokines and adhesion molecules in normal pregnancy and preeclampsia determined by multiplex suspension array. BMC Immunol [Internet]. 2010 Dec 2 [cited 2020 Oct 4];11. Available from: <https://pubmed.ncbi.nlm.nih.gov/21126355/>. DOI:10.1186/1471-2172-11-59.

50. Mjösberg J, Berg G, Jenmalm MC, Ernerudh J. FOXP3+ regulatory T cells and T helper 1, T helper 2, and T helper 17 cells in human early pregnancy decidua. *Biol Reprod* [Internet]. 2010 Apr [cited 2020 Oct 4];82(4):698–705. Available from: <https://pubmed.ncbi.nlm.nih.gov/20018909/>. DOI:10.1095/biolreprod.109.081208.
51. Witkin SS, Linhares IM, Bongiovanni AM, Herway C, Skupski D. Unique alterations in infection-induced immune activation during pregnancy [Internet]. Vol. 118, *BJOG: An International Journal of Obstetrics and Gynaecology*. Blackwell Publishing Ltd; 2011 [cited 2020 Oct 4]. p. 145–53. Available from: <https://pubmed.ncbi.nlm.nih.gov/21054766/>. DOI:10.1111/j.1471-0528.2010.02773.x.
52. Erlebacher A. Immune surveillance of the maternal/fetal interface: Controversies and implications [Internet]. Vol. 21, *Trends in Endocrinology and Metabolism*. Trends Endocrinol Metab; 2010 [cited 2020 Oct 4]. p. 428–34. Available from: <https://pubmed.ncbi.nlm.nih.gov/20304670/>. DOI:10.1016/j.tem.2010.02.003.
53. Seavey MM, Mosmann TR. Immunoregulation of fetal and anti-paternal immune responses [Internet]. Vol. 40, *Immunologic Research*. Springer; 2008 [cited 2020 Oct 4]. p. 97–113. Available from: <https://link.springer.com/article/10.1007/s12026-007-8005-x>. DOI:10.1007/s12026-007-8005-x.
54. Al-Nasiry S, Ambrosino E, Schlaepfer M, Morré SA, Wieten L, Voncken JW, et al. The Interplay Between Reproductive Tract Microbiota and Immunological System in Human Reproduction. Vol. 11, *Frontiers in Immunology*. Frontiers Media S.A.; 2020. p. 378. . DOI:10.3389/fimmu.2020.00378.
55. Horne AW, Stock SJ, King AE. Innate immunity and disorders of the female reproductive tract [Internet]. Vol. 135, *Reproduction*. Reproduction; 2008 [cited 2020 Oct 4]. p. 739–49. Available from: <https://pubmed.ncbi.nlm.nih.gov/18502890/>. DOI:10.1530/REP-07-0564.
56. Nobbenhuis MAE, Helmerhorst TJM, Van den Brule AJC, Rozendaal L, Bezemer PD, Voorhorst FJ, et al. High-risk human papillomavirus clearance in pregnant women: Trends for lower clearance during pregnancy with a catch-up postpartum. *Br J Cancer* [Internet]. 2002 Jul 1 [cited 2020 Oct 29];87(1):75–80. Available from: [/pmc/articles/PMC2364279/?report=abstract](https://pubmed.ncbi.nlm.nih.gov/120364279/?report=abstract). DOI:10.1038/sj.bjc.6600367.
57. Sethi S, Muller M, Schneider A, Blettner M, Smith E, Turek L, et al. Serologic response to the E4, E6, and E7 proteins of human papillomavirus type 16 in pregnant women. *Am J Obstet Gynecol*. 1998 Feb 1;178(2):360–4. . DOI:10.1016/S0002-9378(98)80026-4.
58. Dukers-Muijers NHTM, Van Liere GAFS, Wolffs PFG, Heijer C Den, Werner MILS, Hoebea CJPA. Antibiotic use before chlamydia and gonorrhea genital and extragenital screening in the sexually transmitted infection clinical setting. *Antimicrob Agents Chemother* [Internet]. 2015 Jan 1 [cited 2020 Oct 4];59(1):121–8. Available from: [/pmc/articles/PMC4291339/?report=abstract](https://pubmed.ncbi.nlm.nih.gov/24291339/?report=abstract). DOI:10.1128/AAC.03932-14.
59. Ginige S, Chen MY, Hocking JS, Read TRH, Fairley CK. Antibiotic consumption and chlamydia prevalence in international studies. *Sex Health* [Internet]. 2006 [cited 2020 Oct 4];3(4):221–4. Available from: <https://pubmed.ncbi.nlm.nih.gov/17112431/>. DOI:10.1071/SH06013.
60. Berg E, Benson DM, Haraszkiewicz P, Grieb J, McDonald J. High Prevalence of Sexually Transmitted Diseases in Women with Urinary Infections. *Acad Emerg Med* [Internet]. 1996 Nov 1 [cited 2020 Apr 17];3(11):1030–4. Available from: <http://doi.wiley.com/10.1111/j.1553-2712.1996.tb03349.x>. DOI:10.1111/j.1553-2712.1996.tb03349.x.
61. Van Der Pol B, Williams JA, Orr DP, Batteiger BE, Fortenberry JD. Prevalence, Incidence, Natural History, and Response to Treatment of *Trichomonas vaginalis* Infection among Adolescent Women . *J Infect Dis* [Internet]. 2005 Dec 15 [cited 2020 Jul 21];192(12):2039–44. Available from: <https://academic.oup.com/jid/article-lookup/doi/10.1086/498217>. DOI:10.1086/498217.
62. Davey DLJ, Shull HI, Billings JD, Wang D, Adachi K, Klausner JD. Prevalence of curable sexually transmitted infections in pregnant women in low- and middle-income countries from 2010 to 2015: A systematic review. Vol. 43, *Sexually Transmitted Diseases*. Lippincott Williams and Wilkins; 2016. p. 450–8. . DOI:10.1097/OLQ.0000000000000460.
63. Seale A, Broutet N, Narasimhan M. Assessing process, content, and politics in developing the global health sector strategy on sexually transmitted infections 2016–2021: Implementation opportunities for policymakers [Internet]. Vol. 14, *PLoS Medicine*. Public Library of Science; 2017 [cited 2020 Sep 9]. Available from: <https://pubmed.ncbi.nlm.nih.gov/28654670/>. DOI:10.1371/journal.pmed.1002330.
64. World Health Organization. Guidelines for the Treatment of Chlamydia trachomatis [Internet]. WHO Guidelines for the Treatment of Chlamydia trachomatis. Geneva; 2016 [cited 2020 Apr 7]. 44 p. Available from: <http://www.ncbi.nlm.nih.gov/pubmed/27559553>
65. World Health Organization. Global health sector strategy on sexually transmitted infections 2016–2021. Towards ending STIs. Report. Geneva: 2016 June. Report No. WHO/RHR/16.09. 2016.
66. WHO, UNICEF, UNFPA, World Bank Group, United Nations Population Division. Global health observatory. Global Strategy for Women’s, Children’s and Adolescents’ Health (2016–2030) [Internet]. WHO. World Health Organization; 2019 [cited 2020 Jul 27]. Available from: <https://www.who.int/reproductive-health/publications/maternal-mortality-2000-2017/en/>
67. Jensen JS, Bradshaw CS, Tabrizi SN, Fairley CK, Hamasuna R. Azithromycin treatment failure in Mycoplasma genitalium-positive patients with nongonococcal urethritis is associated with induced macrolide resistance. *Clin Infect Dis* [Internet]. 2008 Dec 15 [cited 2020 Sep 16];47(12):1546–53. Available from: <https://pubmed.ncbi.nlm.nih.gov/18990060/>. DOI:10.1086/593188.
68. Ison CA, Dillon JAR, Tapsall JW. The epidemiology of global antibiotic resistance among *Neisseria gonorrhoeae* and *Haemophilus ducreyi*. *Lancet* [Internet]. 1998 [cited 2020 Sep 16];351(SUPPL.3):8–11. Available from: <https://pubmed.ncbi.nlm.nih.gov/9652713/>. DOI:10.1016/S0140-6736(98)90003-4.
69. Horner PJ. Azithromycin antimicrobial resistance and genital Chlamydia trachomatis infection: Duration of therapy may be the key to improving efficacy [Internet]. Vol. 88, *Sexually Transmitted Infections*. Sex Transm Infect; 2012 [cited 2020 Sep 16]. p. 154–6. Available from: <https://pubmed.ncbi.nlm.nih.gov/22416272/>. DOI:10.1136/sextrans-2011-050385.
70. Stamm L V. Global challenge of antibiotic-resistant *Treponema pallidum* [Internet]. Vol. 54, *Antimicrobial Agents and Chemotherapy*. Antimicrob Agents Chemother; 2010 [cited 2020 Sep 16]. p. 583–9. Available from: <https://pubmed.ncbi.nlm.nih.gov/19805553/>. DOI:10.1128/AAC.01095-09.
71. Krupp K, Madhivanan P. Antibiotic resistance in prevalent bacterial and protozoan sexually transmitted infections. *Indian J Sex Transm Dis AIDS* [Internet]. 2015 [cited 2020 Sep 16];36(1):3. Available from: [/pmc/articles/PMC4555895/?report=abstract](https://pubmed.ncbi.nlm.nih.gov/24555895/?report=abstract). DOI:10.4103/2589-0557.156680.
72. Sheffield JS, Andrews WW, Klebanoff MA, MacPherson C, Carey JC, Ernest JM, et al. Spontaneous resolution of asymptomatic Chlamydia trachomatis in pregnancy. *Obstet Gynecol* [Internet]. 2005 Mar [cited 2020 Sep 3];105(3):557–62. Available from: <https://pubmed.ncbi.nlm.nih.gov/15738024/>. DOI:10.1097/01.AOG.0000153533.13658.c2.

## **5 SUPPLEMENTARY INFORMATION**

### **AUTHORS' CONTRIBUTIONS**

Conceived the idea: S.D., S.A.M., E.A.; Methodology, N.J., J.P., N.U.; formal analysis, N.J., S.O.; data and biospecimen collections, A.M.O., F.A., S.D.; resources, S.A., S.S., S.D.; writing-original draft, N.J.; writing-review and editing, N.J., S.M., E.A., supervision: S.M., S.D., E.A.; project administration, S.S., S.D.; funding acquisition: S.S., S.M., E.A. All the authors read and approved the final manuscript.

### **ACKNOWLEDGEMENTS**

To all the women who participated in the biobank effort, and the staff at the biobank in Pemba Island, Tanzania. A further thanks to Sonja N.H. Puljhun, Monique M. Verveer and Roel Heijmans for their technical assistance in the laboratory in the Netherlands.

### **FUNDING**

The study was in part subsidized by the Otto Kranendonk Fund from the Netherlands Society for Tropical Medicine and International Health (NVTG).

Un dia si'n hari ta un dia si'n biba.

Saying in Papiamentu.  
"A day without laughter is a day wasted."



# 6

## **Detection of high-risk human papillomavirus (HPV) by the novel AmpFire isothermal HPV assay among pregnant women in Pemba Island, Tanzania**

**Naomi Christine Angela Juliana\*, Mohamed Hamad Juma\*, Roel Heijmans, Sander Ouburg, Said Mohammed Ali, Aishwarya Singh Chauhan, , Sunil Sazawal, Servaas Antonie Morré, Saikat Deb\*, and Ambrosino E\***

*\* shared authorship  
Pan African Medical Journal. 2020;37:183*

## ABSTRACT

**Background:** Human papillomavirus (HPV) is the most common sexually transmitted virus in the world. Prevalence of infection differs, with highest rates reported in Sub-Saharan African, including the country of Tanzania. In pregnancy, the hormonal changes and immune changes seem to facilitate HPV persistence, increasing the cancer risk and the risk of vertical transmission towards the placenta and the fetus. The burden of HPV infection is still high despite multiple screening and detection test available. The AmpFire® HPV assay is a novel nucleic acid isothermal amplification with real-time fluorescence detection assay that can test simultaneously 15 high-risk HPV. This nested cohort study aims to contribute evidence on the prevalence of HPV infection and persistence across two time points among pregnant women in Pemba Island, Tanzania.

**Methods:** Vaginal swabs that were previously collected during pregnancy were stored in eNAT buffer ( $n_1=385$  and  $n_2=187$ ) and were tested with AmpFire® screening assay, for simultaneous detection of the HPV 16, 18, and other high-risk HPV genotypes 31, 33, 35, 39, 45, 51, 52, 53, 56, 58, 59, 66, 68.

**Results:** The AmpFire® HPV assay detected an 11% and 6% high-risk HPV prevalence at the two time points among pregnant women in Pemba Island, consecutively. For the 133 women whose samples were tested at both time points, the persistence rate of high-risk HPV was 64%.

**Conclusion:** Novel isothermal HPV assay, such as the AmpFire®, might be feasible to use in low-income regions

## 6.1 INTRODUCTION

Genital human papillomavirus (HPV) is the most common sexually-transmitted virus in the world. Prevalence of infection differs among regions, with the highest rates reported in South America and sub-Saharan Africa, including the country of Tanzania [1]. In most cases, vaginal HPV infections are transient and cleared by the body. In other cases, the virus might persist and cause numerous pathologies in the female reproductive system [1]. Such differences might be caused by host genetic factors or by different HPV strains [2]. The presence of high-risk HPV (hrHPV) infection during pregnancy has been associated with various adverse pregnancy-related complications or outcomes, such as vaginal infection, preterm birth (PTB), and preterm prelabor rupture of membranes [3,4]. In pregnancy, hormonal and immune changes seem to facilitate HPV persistence, therefore increasing the cancer risk and the risk of vertical transmission towards the placenta [5]. Cervical infection with hrHPV has been particularly associated with placental abnormalities and PTB [4,6]. Vertical transmission from HPV infected mothers to their children during pregnancy, labor and delivery has also been reported in multiple studies [6].

Considering the significance of HPV in numerous pathologies, the interest to develop innovative diagnostic methods has grown. To date, there are several molecular diagnostic tests available to detect hrHPV genotypes [7]. Even though the Southern blot is the gold standard for HPV genomic analysis, it has low sensitivity, and it is time-consuming. In addition, it needs a large amount of purified DNA [7]. Luckily, higher sensitive and specific HPV signal or nucleic acids amplification assays, such as Hybrid Capture II (Qiagen, Australia), Aptima (Hologic Inc, USA), and Cobas 4800 (Roche Molecular Diagnostics, Switzerland), are currently used in most HPV screening programs [8].

Recently, assays based on the Isothermal Amplification technique, such as the AmpFire Multiplex HPV assay (Atila BioSystems, Inc., CA, USA), are some of the newer isothermal methods available. Compared to the widely available APTIMA HPV isothermal assay, the real-time fluorescent multiplex nucleic acid amplification AmpFire assay can test more hrHPV genotypes in a single reaction tube. It can distinguish between HPV 16 (cyanine5 fluorophore (CY5™)), HPV 18 (carboxyrhodamine (ROX™)), other hrHPV genotypes (fluorescein amidites (FAM™)): 31, 33, 35, 39, 45, 51, 52, 53, 56, 58, 59, 66 and 68) (thereafter referred to as other hrHPV), and internal control (HEX™). Sequence-specific primers targeting each of the 15 hrHPV genotypes are used in the isothermal amplification system to amplify targeted sequences in the different HPV genotype regions.

AmpFire HPV assay was Conformité Européenne (CE, European Community)-marked in 2017 and received Chinese Food and Drug Administration approval in December 2015. For self-collected vaginal samples, the AmpFire test has shown similar specificity (92.9%) and almost comparable sensitivity (92.9%) rates as the Roche Cobas 4800 [9,10]. Besides, the AmpFire Assay is expected to be easy to use in low-income settings, since the isothermal

method does not require an advanced PCR machine, requires almost no sample processing for HPV detection, and gives results in a short amount of time (AmpFire HPV Screening Assay kit user manual). As such, this methodology might prove useful in resources-constrained settings, such as Tanzania, where ideal tests should be affordable and require minimal extra tools and training. Consistent with the association between hrHPV and adverse pregnancy outcomes, HPV detection during pregnancy will contribute towards optimising a better female reproductive and child health care in Tanzania [11,12]. It has been previously suggested that during pregnancy the hormonal and immunological factors lower hrHPV clearance [5,13–15]. However, information on HPV persistence during pregnancy is not well established and data on HPV persistence during pregnancy in sub-Saharan Africa is scant [15–17]. Therefore, this study aims to assess the prevalence and persistence of hrHPV infection in samples collected among pregnant women in Tanzania using the AmpFire HPV assay.

## 6.2 MATERIAL AND METHODS

### 6.2.1 SAMPLE COLLECTION

The vaginal samples were collected in a context of a previously established biobanking effort (AMANHI) with the support of the Bill and Melinda Gates Foundation [18] initiated in 2014 in Pemba Island, Tanzania. Pregnant women of more than 8 weeks of Gestational Age (GA) and who gave their informed consent for sample collection were eligible to participate in the biobanking effort [18]. The vaginal swabs were collected at two different time points of their pregnancy in health clinics during antenatal visits, and under the supervision of a health worker. The study has received ethical approval from the local Zanzibar Medical Research and Ethics Committee (ZAMREC) [18].

For the analysis of this retrospective study, a total of 572 vaginal swabs from 439 women that were collected between March 2018 and January 2019 were used. Three hundred eighty-five vaginal swabs were collected between 8–19 GA weeks of as the first time point samples, and 187 vaginal swabs were collected either at 24–28 GA weeks or 32–36 GA weeks as the second time point samples. In total, 133 women participated in this study at both time points.

The vaginal swabs were preserved in 1ml eNAT buffer (Copan Italia, Brescia, Italy), and stored at -20 °C. Samples were transported on dry ice to the Netherlands and stored at -24 °C until further processing. Vials of samples that had less than 300ul eNAT buffer content were not tested.

### 6.2.2. DNA ISOLATION

DNA was extracted from the collected vaginal swabs with the Chemagen (Perkin-Elmer, Germany) automated DNA extraction machine by using the buccal swab extraction kit according to the manufacturer's instructions and were afterwards stored at 5 °C [19].

### 6.2.3 AMPFIRE HPV SCREENING ASSAY

The AmpFire HPV Screening Assay kit (Atila BioSystems, CA, USA) was used in this study following the information in the user manual provided in the kit. The kit includes reaction mix, primer mix, external positive control template and negative control template. Briefly, 12 µl reaction mix was mixed with 11 µl primer mix in a 0.2 ml optical 96-well plate. Two µl of processed DNA samples were added to the reaction tube to bring the total volume to 25 µl. Real-time PCR was performed using the Applied Biosystems™ 7500 Real-Time PCR System with the isothermal reaction condition set at 60°C while taking fluorescence dye reading at the FAM™/HEX™/CY5™/ROX™ channels once every minute for a total of 75 minutes.

The thermocycling software system automatically reports the results of the cycle threshold (Ct) values for each amplification curve in all fluorescence channels. For each sample, an exponential amplification curve in CY5™, ROX™, FAM™ and HEX™ channels indicates the presence of DNA of HPV 16, HPV 18, other hrHPV genotypes, and internal control, respectively. The lack of exponential amplification curve in the HEX channel was interpreted as an invalid result. The test results were used to determine: 1. hrHPV point prevalence, 2. Co-infections of HPV 16 and/or HPV 18 with other hrHPV, 3. Persistence and incidence rate of hrHPV during pregnancy.

### 6.2.4 STATISTICAL ANALYSIS

Dichotomous variables were generated as pregnant women were either negative or positive for hrHPV infection. Persistence of infection was considered when the vaginal samples of the same women tested positive for HPV infection at both timepoints. Chi-square test was used to determine whether the point prevalence changed significantly over time during pregnancy. A *p*-value of < 0.05 indicated a significant difference.

## 6.3 RESULTS

### 6.3.1 HPV PREVALENCE

A total of 11.2% (43/385) of pregnant women tested positive for HPV infection at the first time and 5.9% (11/187) at the second time point (Figure 1 and 2). Of the women who tested positive, none of them were infected with HPV genotype 18. However, for HPV 16, 4/385 pregnant women tested positive at the first time point and 1/187 pregnant women at the second time point. The majority of the detected HPV infections were caused by other hrHPV genotypes (Figure 1 and 2). Among 133 women who were tested at both time points, the overall hrHPV prevalence was not significantly higher at the first time point (8.3%, 11/133) compared to the second time point (6.8%, 9/133) ( $X^2 = 0.22$ ; *P*-value = 0.64).

For women tested only once at either time point, the overall hrHPV prevalence was 11.1%, HPV16 prevalence was 1.5%, and other hrHPV prevalence was 10.5% (data not shown in the

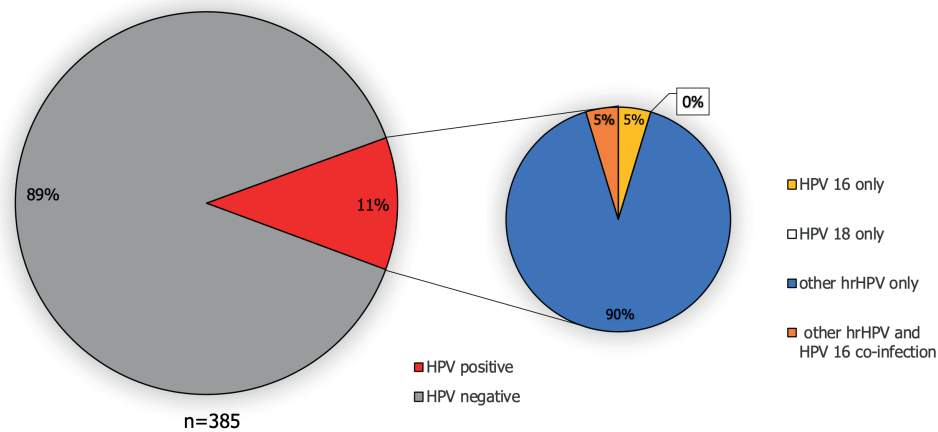
figures). Within this group of women, the overall hrHPV prevalence at the first time point was 12.7% and at the second time point 3.7%. The distribution of the infected women was not symmetrical within both time point (Figure 3). The hrHPV prevalence at the first time point is borderline significant ( $P$ -value=0.04) as compared to the second time point. Whilst, the number of infected women tested at both time points compared to the women tested only at first or second time point, were not significantly different at either time point (Figure 3).

### 6.3.2 CO-INFECTIONS

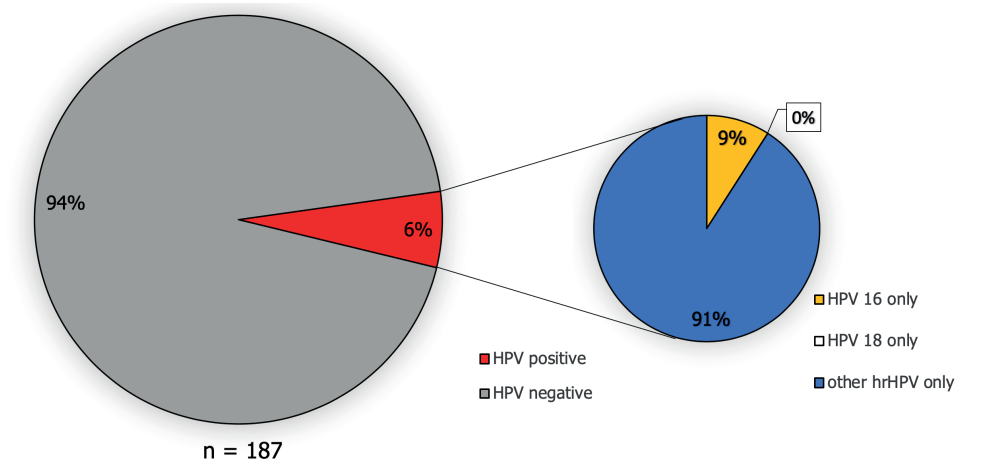
Only at the first time point, the assay detected multiple hrHPV infections in two women. These two women tested positive simultaneously for HPV 16 and other hrHPV genotypes.

### 6.3.3 THE PERSISTENCE RATE AND NEW INCIDENCES

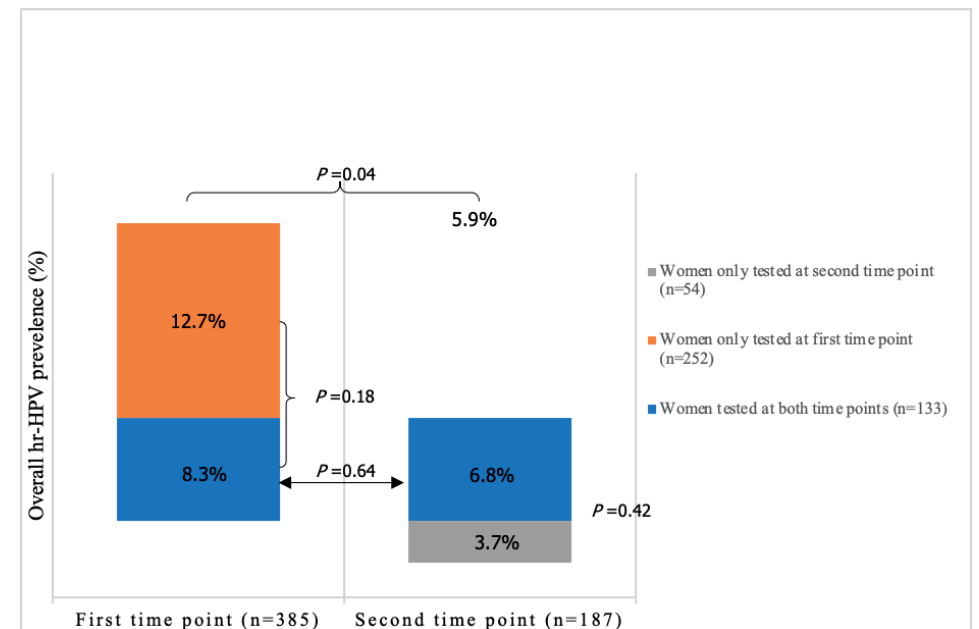
Among the 133 pregnant women tested at both time points, eleven were hrHPV positive at the first time point, and seven remained positive at the second time point. The persistence rate for hrHPV was 63.6% in this subgroup. Among the women who tested negative for HPV at time point one, two acquired a new HPV infection and resulted positive at the second time point. One of the women had a de novo HPV 16 infection, and a different women was superinfected with other hrHPV during the course of her pregnancy.



**Figure 1.** Prevalence of HPV infection and high-risk HPV genotype distribution in the first vaginal sample collection of pregnant women in Tanzania. Decimals have been rounded to full numbers.



**Figure 2.** Prevalence of HPV infection and high-risk HPV genotype distribution in the second vaginal sample collection among pregnant women in Tanzania. Decimals have been rounded to full numbers in the figure.



**Figure 3:** Three categorical groups of women tested positive for hrHPV at time point one or time point two. Arrows and accolades indicate whether or not the difference in two prevalences are statistically significant. The percentage of infected women in each group at both time points were not significantly different ( $P$ -value > 0.05).



## 6.4 DISCUSSION

In this cohort of pregnant women in Pemba Island Tanzania, the hrHPV point prevalence was between 5.9% and 11.2%. The overall hrHPV positive status was higher in an earlier pregnancy stage compared to a later stage, although the difference was borderline significant. There is no logical biological argument why the hrHPV prevalence should be higher at the start of the pregnancy or why it should clear during pregnancy. Moreover, when the comparison was made between the paired samples, no significant difference was observed between the two time points. Once the study is complete at all time points, a more definite answer can be drawn.

Previous studies showed a higher hrHPV infection rate among pregnant women, compared to non-pregnant ones [20]. Unexpectedly, both hrHPV point prevalence of this study were lower than the previously reported overall prevalence of 20% observed in non-pregnant women across rural and urban areas in mainland Tanzania [21]. This difference can be explained by regional variation and the cultural impact of religion on sexual behavior [21,22].

Compared to other pregnant cohort studies, differences in geographical regions with varying exposures to infection and risk factors might explain the dissimilar HPV prevalence. This might partially explain the broad range in hrHPV prevalence reported: among Ghanaian (21% and 46%), Lithuanian (7-9%), Brazilian (25%), Turkish (15%), and Indian (39%) pregnant women [3,20,23–26]. However, the low overall HPV prevalence observed among pregnant women in Nigeria (5.4%, IgM serology based) [27] and in rural South Africa (5.7%, Cytology based) [28] are more in line with the prevalence observed in the current study.

With regard to the persistence of hrHPV, we found a maximum rate of 64% in this cohort. This AmpFire screen HPV assay does not distinguish between hrHPV genotypes other than HPV 16 or HPV 18. Therefore, the exact persistence rate of specific hrHPV genotypes might be lower since now those fall within the same other hrHPV group. In addition, some women might have had triple or even multiple HPV genotype infections. Nevertheless, the persistence rate during pregnancy found in this study is roughly comparable with previous findings among pregnant women in Uganda (50.4% and 71.8%), Brazil (53%) and the Netherlands (58%), but is higher than in human immunodeficiency virus (HIV) positive pregnant women in Spain (46%) [5,13,15,29]. However, it should be noted that the method to determine HPV status, the types of HPV genotypes analyzed, the method to determine the persistence or clearance, the number of primiparous women, the genetic background of participants, their nutritional and health status, and the follow-up periods between studies differ and should be taken into account when comparing viral clearance in different populations.

The AmpFire assay was previously compared to the Roche Cobas 4800 HPV assay and showed comparable sensitivity and specificity [10]. Also, when we compared the AmpFire assay with our in-house assay, we observed a 100% concordance between the results (data not shown). Further comparison studies are highly recommended to determine the diagnostic values of this assay compared to others.

In this study, we used DNA that had been previously isolated by the validated Chemagen automated technology, as the samples were prior tested for other infections. This approach of using pure DNA might have resulted in an overestimation of the hrHPV prevalences compared to the DNA isolation method from Atila BioSystems, which is simpler, possibly less effective, thus have a higher chance for inhibition of the amplification reaction. The AmpFire HPV assay does not require DNA extraction or purification. Therefore, the simple sample processing procedure might be helpful for HPV screening in clinical diagnostic settings, especially in resource-limited areas.

To our knowledge, this study is the first that investigated the prevalence of HPV in pregnant women in Pemba Island, Tanzania. The sample size included in this study is higher than other pregnancy studies conducted in Uganda, Kenya, Nigeria, Ghana, South Africa, Brazil, Lithuania, and India.

## 6.5 CONCLUSION

Among pregnant women in Pemba Island the hrHPV prevalence is rather low, but not negligible, and the persistence rate seems to be high. This study highlights the importance of monitoring this viral infection during pregnancy. Therefore, good diagnostics methods for the detection and screening of HPV in pregnancy are essential to manage the burden of infection, as well as further co-infections that might affect the mother, fetus or newborn.

## 6. REFERENCES

1. Runge AS, Bernstein ME, Lucas AN, Tewari KS. Cervical cancer in Tanzania: A systematic review of current challenges in six domains. *Gynecologic Oncology Reports*. 2019;29:40–47.
2. Malogajski J, Brankovic I, Verweij SP, Ambrosino E, Van Agtmael MA, Brand A, et al. Translational potential into health care of basic genomic and genetic findings for human immunodeficiency virus, chlamydia trachomatis, and human papilloma virus. *BioMed Research International*. 2013;2013. doi:10.1155/2013/892106.
3. Pandey D, Solleti V, Jain G, Das A, Shama Prasada K, Acharya S, et al. Human Papillomavirus (HPV) infection in early pregnancy: Prevalence and implications. *Infect Dis Obstet Gynecol*. 2019;2019. doi:10.1155/2019/4376902.
4. Zuo Z, Goel S, Carter JE. Association of cervical cytology and HPV DNA status during pregnancy with placental abnormalities and preterm birth. *Am J Clin Pathol*. 2011;136(2):260–5.
5. Nobbenhuis MAE, Helmerhorst TJM, Van den Brule AJC, Rozendaal L, Bezemer PD, Voorhorst FJ, et al. High-risk human papillomavirus clearance in pregnant women: Trends for lower clearance during pregnancy with a catch-up postpartum. *Br J Cancer*. 2002;87(1):75–80.
6. Trottier H, Mayrand MH, Coulée F, Monnier P, Laporte L, Niyibizi J, et al. Human papillomavirus (HPV) perinatal transmission and risk of HPV persistence among children: Design, methods and preliminary results of the HERITAGE study. *Papillomavirus Res*. 2016. doi:10.1016/j.pvr.2016.07.001.
7. Abreu ALP, Souza RP, Gimenes F, Consolaro MEL. A review of methods for detect human Papillomavirus infection. *Virology Journal*. 2012;9(1). doi:10.1186/1743-422X-9-262.
8. Salazar KL, Duhon DJ, Olsen R, Thrall M. A review of the FDA-approved molecular testing platforms for human papillomavirus. *J Am Soc Cytopathol*. 2019;8(5):284–292.
9. Lozano García; L. Diagnóstico de los carcinomas orofaríngeos relacionados con el virus del papiloma humano (VPH) : detección viral mediante técnicas comerciales de uso clínico y análisis de su valor pronóstico. *Proy Investig*. 2019. <https://digitum.um.es/digitum/handle/10201/72623>. Accessed 4 October 2019.
10. Wei Zhang, Hui Du, ChunWang, Xia Huang, Bin Yang, Jerome L Belinson RW. Evaluation an isothermal amplification HPV detection assay for self-collection as primary cervical cancer screening. 2019;1.
11. Ministry of Health Community Development Gender Elderly and Childeren (MoHCDGEC); et al. Tanzania Demographic and Health Survey and Malaria Indicator Survey (TDHS-MIS) 2015-16. 2016;1–445.
12. Ahmed I, Ali SM, Amenga-Etego S, Ariff S, Bahl R, Baqui AH, et al. Population-based rates, timing, and causes of maternal deaths, stillbirths, and neonatal deaths in south Asia and sub-Saharan Africa: a multi-country prospective cohort study. *Lancet Glob Heal*. 2018;6(12):e1297–e1308.
13. Castellsagué X, Drudis T, Cañadas MP, Goncé A, Ros R, Pérez JM, et al. Human Papillomavirus (HPV) infection in pregnant women and mother-to-child transmission of genital HPV genotypes: A prospective study in Spain. *BMC Infect Dis*. 2009;9:74.
14. Fife KH, Katz BP, Brizendine EJ, Brown DR. Cervical human papillomavirus deoxyribonucleic acid persists throughout pregnancy and decreases in the postpartum period. *Am J Obstet Gynecol*. 1999;180(5):1110–1114.
15. Banura C, Franceschi S, van Doorn L-J, Arslan A, Kleter B, Wabwire-Mangen F, et al. Prevalence, incidence and clearance of human papillomavirus infection among young primiparous pregnant women in Kampala, Uganda. *Int J Cancer*. 2008;123(9):2180–2187.
16. Chan PKS, Chang AR, Tam WH, Cheung JLK, Cheng AF. Prevalence and genotype distribution of cervical human papillomavirus infection: Comparison between pregnant women and non-pregnant controls. *J Med Virol*. 2002;67(4):583–588.
17. Chang-Claude J, Schneider A, Smith E, Blettner M, Wahrendorf J, Turek L. Longitudinal study of the effects of pregnancy and other factors on detection of HPV. *Gynecol Oncol*. 1996;60(3):355–362.
18. Alliance for Maternal and Newborn Health Improvement, Baqui AH, Khanam R, Rahman MS, Ahmed A, Rahman HH, et al. Understanding biological mechanisms underlying adverse birth outcomes in developing countries: Protocol for a prospective cohort (AMANHI bio-banking) study. *J Glob Health*. 2017;7(2):021201.
19. Dols JAM, Molenaar D, van der Helm JJ, Caspers MPM, Angelino-Bart A de K, Schuren FHJ, et al. Molecular assessment of bacterial vaginosis by Lactobacillus abundance and species diversity. *BMC Infect Dis*. 2016;180(16):1–8.
20. Aydin Y, Atis A, Tutuman T, Goker N. Prevalence of human papilloma virus infection in pregnant Turkish women compared with non-pregnant women. *Eur J Gynaecol Oncol*. 2010;31(1):72–4.
21. Dartell M, Rasch V, Kahesa C, Mwaiselage J, Ngoma T, Junge J, et al. Human papillomavirus prevalence and type distribution in 3603 HIV-positive and HIV-negative women in the general population of Tanzania: the PROTECT study. *Sex Transm Dis*. 2012;39(3):201–8.
22. Adamczyk A, Hayes BE. Religion and Sexual Behaviors: Understanding the Influence of Islamic Cultures and Religious Affiliation for Explaining Sex Outside of Marriage. *Am Sociol Rev*. 2012;77(5):723–746.
23. Brandful JA, Bonney EY, Asmah RH A-KK. Oncogenic human papillomavirus (HPV) in women from Ghana. *J Cancer Res Exp Oncol* 2014 Dec 31;6(4)31-8. 2014;6(4):31–38.
24. Domža G, Gudlevičienė Z, Didžiapetriene J, Valuckas KP, Kazbariene B, Drasutiene G. Human papillomavirus infection in pregnant women. *Arch Gynecol Obstet*. 2011;284(5):1105–1112.
25. Salcedo MMBP, Damin APS, Agnes G, Pessini SA, Beitune P El, Alexandre COP, et al. Prevalence of human papillomavirus infection in pregnant versus non-pregnant women in Brazil. *Arch Gynecol Obstet*. 2015;292(6):1273–1278.
26. Schulze MH, Völker FM, Lugert R, Cooper P, Hasenclever K, Groß U, et al. High prevalence of human papillomaviruses in Ghanaian pregnant women. *Med Microbiol Immunol*. 2016;205(6):595–602.
27. Elukunbi AH, Kolawole EO, Kola JO, Afolabi YO. Human papillomavirus in pregnant women at Bowen University Teaching Hospital, Ogbomoso, Nigeria. *J Immunoass Immunochem*. 2019;40(3):283–288.
28. O'Farrell N, Hoosen AA, Kharsany AB, van den Ende J. Sexually transmitted pathogens in pregnant women in a rural South African community. *Sex Transm Infect*. 1989;65(4):276–280.
29. Jalil EM, Bastos FI, Melli PPDS, Duarte G, Simoes RT, Yamamoto AY, et al. HPV clearance in postpartum period of HIV-positive and negative women: A prospective follow-up study. *BMC Infect Dis*. 2013;13(1):564.

## 6 SUPPLEMENTARY INFORMATION

### AUTHORS' CONTRIBUTIONS

Methodology, N.J., R.H.; formal analysis, N.J., S.O.; data and biospecimen collections, M.J., S.A., A.C.; resources, S.S., S.D.; writing-original draft, N.J.; writing-review and editing, N.J., E.A., supervision: S.D., S.M., E.A.; project administration, S.S., S.D.; funding acquisition: S.S., S.M., E.A. All the authors read and approved the final manuscript.

### COMPETING INTEREST

Atila Biosystems Inc. (California, USA) sponsored the study by providing the HPV kits for free. The authors declare no further interests.

# 7

I never lose. I either win or learn.

*- Nelson Mandela*



## **The vaginal microbiota composition and genital infections during and after pregnancy among women in Pemba Island, Tanzania**

**Naomi C.A Juliana\*, Saikat Deb\*, Mohamed H. Juma, Linda Poort, Andries E Budding,  
Abdalla Mbarouk, Said M. Ali, Sander Ouburg, Servaas A. Morré, Sunil Sazawal\* and  
Elena Ambrosino\***

*\*Shared authorship  
To be submitted to Microorganisms*

## ABSTRACT

**Background.** This study characterized the vaginal microbiota (VMB) composition and reported genital pathogens among pregnant and post-delivery women in Pemba Island, Tanzania.

**Methods.** Vaginal swabs were collected at two time points during pregnancy and once after delivery. The IS-pro assay was used to characterize the VMB. Shannon diversity index, which measures the number (richness) and relative abundance of each species in a sample, was calculated. Specific qPCRs were used to detect *Chlamydia trachomatis* (CT), *Neisseria gonorrhoea* (NG), *Trichomonas vaginalis* (TV), *Mycoplasma genitalium* (MG), and human papillomavirus (HPV).

**Results.** Vaginal swabs of ninety women, of a mean age of 30 years, were tested. VMB were *Lactobacillus* dominant during pregnancy (65% at first, and 81% at second timepoint), and non-*Lactobacillus* dominant (73.9%) postdelivery. A significant decrease in VMB richness ( $p = 0.02$ ) was observed during pregnancy. Shannon diversity was significantly lower during pregnancy than postdelivery ( $p = 0.03$ ). *Klebsiella species* and *Streptococcus anginosus* were the most commonly identified microorganisms with pathogenic potential (pathobionts) at all three timepoints and a high abundance of pathobionts was mostly seen in women with non-*Lactobacillus* dominant VMB. At the second timepoint during pregnancy, 67% of the women carrying one or more genital pathogen (either HPV, CT, TV, or MG) had *Lactobacillus iners* dominant VMB. NG was not detected at any timepoint.

**Interpretation.** This study contributes to understanding VMB composition and its microbial changes during pregnancy and post-delivery, and the role of pathobionts and genital pathogens with the VMB composition.

## 7.1 INTRODUCTION

The vaginal microbiota (VMB) consists of commensal microorganisms that exist in a mutually beneficial relationship with the host environment [1]. The composition of the VMB is dynamic and also changes due to multiple factors, for instance, hormonal fluctuations during the menstrual cycle, age, sexual activity, pregnancy, and parity [2]. The human VMB are mostly dominated by protective lactic-acid producing *Lactobacillus* species in the majority of Caucasian women. These bacteria create an acidic environment with anti-microbial properties which hinders growth and colonization of pathogenic microbial species [3–5]. Common *Lactobacillus* species in the vagina include *L. iners*, *L. crispatus*, *L. gasseri*, or *L. jensenii* [6]. Jesper et al. also showed that next to the common *Lactobacillus* species, *L. vaginalis* plays a vital role in the VMB in African women [7]. However, when *Lactobacillus* species are in low abundance, women can carry higher levels of facultative anaerobic bacteria with species such as *Atopobium*, *Gardnerella*, *Ureaplasma*, *Bacteroides*, and *Prevotella* [8]. Furthermore, if the vaginal microbial community is dominated by non-lactic acid producing species, it is less stable and tends to shift over time [9]. The polymicrobial anaerobic overgrowth disrupts the ecological balance of the VMB and is linked to vaginal anaerobic dysbiotic conditions like bacterial vaginosis (BV) [2,10]. BV is a common vaginal disorder in African women or women with sub-Saharan African ethnic background [2,10]. BV has been associated with adverse outcomes such as miscarriage, premature rupture of membranes, preterm birth, and low birth weight [11,12]. Presence of pathobionts in the VMB, defined as potentially pathological organisms that generally live in a non-harming symbiosis, such as *Streptococcus agalactiae* (Group B streptococcus or GBS), *Staphylococcus aureus*, and species in the *Enterobacteriaceae* family, have also been associated with pelvic inflammatory disease or maternal and neonatal infections [13–16].

In individual women, the VMB composition differs between the non-pregnant and pregnant state. Indeed, the increased estrogen and progesterone levels during pregnancy lead to physiological changes that also affect the VMB composition [17]. Compared to the non-pregnant state, the VMB remain relatively stable during pregnancy, with an overall decrease in richness (number of species), abundance and evenness (relative abundance) of aerobic commensal bacteria and an increase in abundance of *Lactobacillus* species from first to third trimester [7,8,18–20]. VMB changes in pregnancy mostly occur as transitions between species within the *Lactobacillus* genus and there is rarely a shift to a polymicrobial state [18,21–23]. However, towards the end of the pregnancy and, especially, after delivery, following a decrease in estrogen, a switch to a non-*Lactobacillus* dominant and more diverse VMB community is common [8,18]. This switch can persist up to one year postpartum [8,18].

*Lactobacillus* species- poor vaginal microbiota and an increase in richness and diversity of VMB between 2<sup>nd</sup> and 3<sup>rd</sup> trimester have been associated with adverse pregnancy outcomes such as preterm birth, low birth weight, and miscarriage [24–30]. However, it is important

to note that also women with *Lactobacillus* dominant VMB have risk of developing adverse outcomes (even though this risk might be low), and low abundances of pathobionts occur more often with lactobacilli than with BV-associated anaerobes [31–33]. Thus, it might be that certain individual and in low abundance microorganisms might influence the pregnancy health status, rather than the dominant VMB species. To date, the role of VMB in preterm birth or other adverse pregnancy outcomes is controversial and still under investigation, especially since it seems to vary on the ethnic background of the population studied.

The composition of the VMB of women with African and non-African ancestry respond differently during pregnancy probably because of host genomics, immunological factors, microbial physiology and environmental influences [22,34–36]. Studies conducted on women with African ancestry observed that their VMB is less likely dominated by *Lactobacillus* species and more likely with BV-associated bacteria [6,22,26,37–41]. Several studies have investigated the VMB composition, irrespective of the pregnancy status, across African populations, such as in Kenyan, Rwandan, South African, and Tanzanian women [42–44]. During pregnancy it seems that *Lactobacillus*-dominant VMB (mostly *L. iners* and *L. crispatus*) are the most prevalent vaginal composition in women living in sub-Saharan Africa, followed by a more diverse VMB composition [45]. However, in the study conducted in mainland Tanzania, the VMB bacteria were only characterized on genus level and not species level [46][38].

Because of the possible impact that certain VMB compositions and microorganisms have on health (reproductive and pregnancy outcomes) it is important to investigate also in populations where the burden of disease is highest. In sub-Saharan Africa there not only high burden of vaginal dysbiosis condition (BV), but also genital infections (such as sexually transmitted infections) and adverse pregnancy outcomes [47–51]. The interaction between VMB with exposure of genital pathogens and pathobionts during pregnancy is complex and remain mostly unclear [16,52]. Moreover, data about the VMB composition and presence of pathobionts in sub-Saharan African population, especially Tanzania are still limited. In 2014, a biobanking effort was initiated in Pemba Island, Tanzania with the support of the Bill and Melinda Gates Foundation [53]. Within this previously established (AMANHI) biobanking effort, adverse pregnancy outcomes and vaginal samples were collected various times during pregnancy and once after parturition.

The aim of this study was to longitudinally characterize the VMB composition, and its changes, including in the presence of pathobionts and genital infections, across two timepoints during pregnancy and once after delivery using the previously collected biobank data and samples. It is hypothesized that the most prevalent VMB composition will be *Lactobacillus*-dominant VMB, but the frequency of a more diverse VMB composition and the presence of pathobionts will be high within this sub-Saharan African population. Insights from this first attempt to characterize the VMB composition in Pemban women will contribute evidence for the broader research questions exploring the role of microorganism in maternal health and neonatal health among sub-Saharan African women.

## 7.2 METHODS

### 7.2.1 SAMPLES AND STUDY DESIGN

Vaginal samples collection was performed in the context of a biobanking effort established with the support of the Bill and Melinda Gates Foundation and initiated in 2014 as part of the Alliance for Maternal and Newborn Health Improvement (AMANHI) [53]. In the biobank setting, women were included if they gave their consent and data collection was conducted as per protocol [53]. In short, the vaginal swabs collection was performed one or more time at 2 timepoints during pregnancy and once after delivery under staff supervision in health care facilities in Pemba Island [53]. Baseline sociodemographic and previous health care information were collected at first antenatal contact and at each sample collection point additional health information was collected by the biobank staff [53]. Swabs were stored in 1 ml eNAT buffer (Copan Italia, Brescia, Italy) at  $-20^{\circ}\text{C}$  at the Public Health Laboratory - Ivo de Carneri in Pemba Island. The collection tubes with eNAT buffer were later transported in dry-ice to Amsterdam Medical Centre in the Netherlands, where they were stored at  $-20^{\circ}\text{C}$  until further processing [54]. In this study, vaginal swabs collected at one or more of the 3 collection timepoints up until January 2019 were analysed. The Zanzibar Health Research Ethical Committee (ZAHREC) approved this study.

### 7.2.2 DNA EXTRACTION AND VAGINAL MICROBIOTA ANALYSIS

DNA from the vaginal swabs was extracted with the Chemagen (Perkin-Elmer, Baesweiler, Germany) automated DNA extraction machine according to the buccal swab extraction kit manufacturer's instructions as previously describe elsewhere [55]. Elution volume was 200  $\mu\text{l}$ . The IS-pro Microbiota assay (inBiome, Amsterdam, The Netherlands) was used for the VMB analysis [55]. The assay is based on length polymorphisms of the 16S-23S interspace region combined with sequence polymorphisms of the 16S rDNA. The IS-pro assay consisted of two multiplex PCRs and was performed according to the manufacturer's protocol as previously described [55–57]. In short, the first PCR used two different fluorescently-labeled primers, one for the phyla *Bacteroidetes*, and *Fusobacteria*, *Actinobacteria*, *Firmicutes*, and *Verucomicrobia* (FAFV). The second PCR includes primers for the phylum *Proteobacteria*. An internal amplification control (IAC) was used for quality control of the process and downstream software analyses. After DNA amplification with the GeneAmp PCR system 9700 (Applied Biosystems, Foster City, CA), 5  $\mu\text{l}$  of PCR product was mixed with 20  $\mu\text{l}$  formamide and 0.5  $\mu\text{l}$  MapMaker 1500 ROX-labeled size maker (BioVentures, TN, USA). The ABI Prism 3500 Genetic Analyzer (Thermo-Fisher) was used for the DNA fragment analysis via high-resolution capillary electrophoresis. Species were assigned to resulting amplicon length and color using a reference database compiled of IS-pro fragments obtained from in-silico and in-vitro IS-pro PCRs of known vagina associated bacterial species (species calling). The IAC tested positive for all samples. TIBCO Spotfire 7.6 (TIBCO Spotfire Inc., Palo Alto, USA) software was used

to visualize the IS-pro color labeled nucleotide peaks, species and to cluster the sample profiles according to the unweighted pair-group with arithmetic mean (UPGMA) method. To cluster the microbiome profiles based on similarity column correlation, the process was performed with the UPGMA on a similarity matrix based on cosine similarity of bacterial profiles. Row hierarchical clustering was used to identify and order the most frequent IS-fragments or bacterial taxa related to the microbiome profiles. For the purpose of this study, six pathobionts *Streptococcus*, *Staphylococcus*, *Enterococcus*, *Escherichia/Shigella*, *Haemophilus*, and *Campylobacter* are considered pathobionts, as suggested by Wijgert et al. [16]. Pathobionts with a relative abundance higher than 20% are considered to be of substantial presence in the VMB profile [16]. After the hierarchical clustering of vaginal microbiome profiles, five microbial communities, in line with the previously defined Community State Types (CST) were identified [58]. Alpha diversity indices of the VMB were measured by calculating the richness (number of species) and the Shannon diversity (the richness and relative abundance of bacterial species) index of each sample on the Spotfire software [59].

### 7.2.3 GENITAL PATHOGENS ANALYSIS

Presence of *C. trachomatis*, *N. gonorrhoeae*, *T. vaginalis* were detected by their respective CE-IVD certified Presto and Real-Time polymerase chain reaction (PCR) with ABI Taqman 7500 (Applied Biosystems, Foster City, CA, USA) according to the manufacturer's instructions and as previously described [60,61]. For *M. genitalium* detection, a *M. genitalium* assay targeting the *mg219* gene was used on the LightCycler 480 II PCR machine (Roche Diagnostics, Basel, Switzerland) [54,62]. In order to detect the presence of high-risk human papillomavirus (hrHPV), AmpFire® HPV assay was used according to the user manual instruction, to simultaneously detect either HPV 16 genotype, HPV 18 genotype or fifteen other hrHPV genotypes (31, 33, 35, 39, 45, 51, 52, 53, 56, 58, 59, 66 and 68, not individually identified and further referred in this manuscript as HPV others) [63].

### 7.2.4 STATISTICAL ANALYSIS

Data was analyzed using IBM SPSS statistical software version 26 (SPSS Inc., Chicago, USA). Fisher's exact test was performed to compare dichotomous data; to test whether the presence of genital infections associated with CST III compared to other CSTs (I, II, IV, V) [64,65]. To test whether alpha diversity indices were significantly different across time points, the Wilcoxon signed rank test (for matched samples) or Mann-Whitney U-test (for unmatched samples) was used. A  $p$ -value  $< 0.05$  was considered statistically significant.

## 7.3 RESULTS

In total, 170 vaginal samples from 90 Muslim Shirazi women were included for this analysis. Forty-four samples collected between 8 - 20 weeks gestational age (GA), eighty-two samples between 20 - 40 weeks GA, and forty-four samples between 42 - 60 days post-delivery (Figure S.1). Seventy-eight women underwent sample collection at two timepoints (either both during pregnancy or once during pregnancy and the other post-delivery) and two women at three timepoints. It is important to note that of the 90 participants, we do not have vaginal samples tested at all three timepoints (Figure S.1), but the questionnaire has been filled by most participant at baseline and the other collection timepoints (Table 1- 3).

### 7.3.1 SOCIODEMOGRAPHIC CHARACTERISTICS AND BIRTH DATA

The sociodemographic and health-related questions were filled by more than 85% of the 90 participants (Table 1). The mean maternal age of the participants was  $29.9 \pm 6.6$  years, mean gravidity  $5.2 \pm 2.6$ , and mean parity of  $4.0 \pm 2.4$ . The majority of the women were multiparous (93.2%). Most of the participants had a healthy weight (44.4%). None of the participants smoked at the time of enrollment, and 96.6% were not on any dietary restrictions ( $n = 88$ ). At biobanking enrollment, the most common obstetric history complication reported was miscarriage/abortion (29.3%), followed by stillbirth (12.2%), preterm birth (3.8%), and premature rupture of membranes (PROM) (2.5%). Two of the 88 women (2.3%) reported they had malaria at the time of enrollment in the biobanking effort. Other medical problems or infections (diabetes, thyroid disease infections with human immunodeficiency virus (HIV), tuberculosis, hepatitis B or C, and urinary tract infection) were not reported.

**Table 1.** Description of the sociodemographic, clinical and pregnancy outcomes across cohort.

Characteristics	# of total women	Descriptive
Mother's Age (years)	90	29.9 ± 6.6 (16 - 45) (Mean ± SD (range))
15-19		n = 1 (1.1 %)
20-24		n = 20 (22.2 %)
25-29		n = 27 (30 %)
30-34		n = 16 (17.8 %)
35-39		n = 16 (17.8 %)
40-44		n = 9 (10 %)
45-49		n = 1 (1.1 %)
Gravidity	88	5.2 ± 2.6 (1 - 11) (Mean ± SD (range))
Parity	82	4.0 ± 2.4 (0 - 9) (Mean ± SD (range))
Number of first pregnancy	88	n = 6 (6.8 %)
Maternal age at first pregnancy	80	19.8 ± 4.0 (15 - 32) (Mean ± SD (range))
Maternal body mass index	81	25.35 ± 5.29 (17.54 - 41.8) (Mean ± SD (range))
		n = 6 (7.4 %) Underweight (<18.5)
		n = 36 (44.4 %) Normal weight (18.51-24.9)
		n = 23 (28.4 %) Overweight (25.0-29.9)
		n = 15 (18.5 %) Obese (> 30)
Ethnicity	90	n = 90 (100 %) Shirazi (Zanzibar Africans)
Religion	88	n = 88 (100 %) Muslim, Islam
Number of schoolyears completed	88	2.2 ± 1.2 (1 - 5) (Mean ± SD (range))
		n = 23 (26.1 %) one year
		n = 52 (85.2 %) two years
		n = 1 (1.1 %) three years
		n = 12 (13.6 %) five years
Never Smoked	88	n = 88 (100 %)
Diet	88	n = 1 (1.1 %) followed diet pre-pregnancy
		n = 1 (1.1 %) followed diet in the past 3 months
		n = 1 (1.1 %) is currently following a diet
		n = 85 (96.6 %) did not follow a diet
History with one or more complicated pregnancy	79	n = 14 (17.7 %)
		n = 9 (11.4%) had one stillbirth
		n = 1 (1.2 %) had three stillbirths
		n = 2 (2.5 %) experienced PROM
		n = 3 (3.8 %) ever had a preterm delivery

PROM: premature rupture of membranes. \*n = 6 women are on their first pregnancy and therefore excluded from calculations.

The information collected might be different per timepoint, depending on the number of women that responded to the questionnaire item (Table 1, 2, and 3). At the time of second sampling during pregnancy, 34 (43%) women self-reported the use of multivitamins or iron and other minerals, and four (5.1%) women self-reported that they had taken antibiotics during their pregnancy. The participants gums or teeth complaints (2.5% and 6.3%, respectively), but did not report any other health condition (hemorrhage, bleeding, diabetes, thyroid disease, HIV, malaria, tuberculosis, jaundice, hepatitis B or C, and urinary tract symptoms) (n = 79). At the time of sampling post-delivery 78 women filled in the summary and one (1.3%) woman self-reported she had diabetes during her pregnancy. No other medical conditions or infections that might have occur during the current pregnancy were reported (thyroid disease, cancer, cardiac problems, epilepsy, mental illness, hypertension HIV, malaria, tuberculosis, jaundice, hepatitis B or C, and urinary tract symptoms). Five women (6.4%) reported that they had received antibiotics, and 26 (33.3%) women reported they had received other types of medicine (not specified). The gestational time at vaginal swab collection, pregnancy data, pregnancy outcomes, and neonatal outcomes are described in Table 2. The majority of the women (89%) received assistance at birth either by a doctor, nurse or midwife (n = 90). One participant experienced a stillbirth, four women a miscarriage, six women had a preterm delivery (<37 GA weeks), the rest had an uncomplicated birth (Table 3). Two women reported that their neonates were ill within the first 48 hours of life, however, the type of illness was not further specified. The pregnancy outcomes of the women that had vaginal samples collected post-delivery are described in Table 2.

**Table 2.** Mean gestational age at each swab collection

Collection timepoint	# of total women	gestational age (Mean ± SD (Range))
First pregnancy samples	44	118.2 ± 16.7 (69-139) days 16.9 ± 1.3 (9.9 - 19.9) weeks
Second pregnancy samples	82	193.5 ± 27.37 (168-280) days
Post-delivery samples	44	52.2 ± 7.9 (42-72) days

**Table 3.** Delivery information and pregnancy outcomes.

Delivery information	# of total women	Pregnancy outcomes
Outcome of delivery all included participants	90	n = 83 (92.2 %) single live born n = 2 (2.2 %) multiple births n = 4 (4.4%) miscarriage/abortion n = 1 (1.1%) Still birth n = 6 (6.7 %) preterm delivery of which one are twins
Outcome of delivery women with vaginal samples tested at post-delivery	44	n = 38 (86.4 %) single live born n = 2 (4.5 %) multiple births n = 4 (9.1 %) miscarriage/abortion n = 0 (0 %) Still birth
The baby was ill after delivery (< 48 hour)	44	n = 1 (2.3 %)

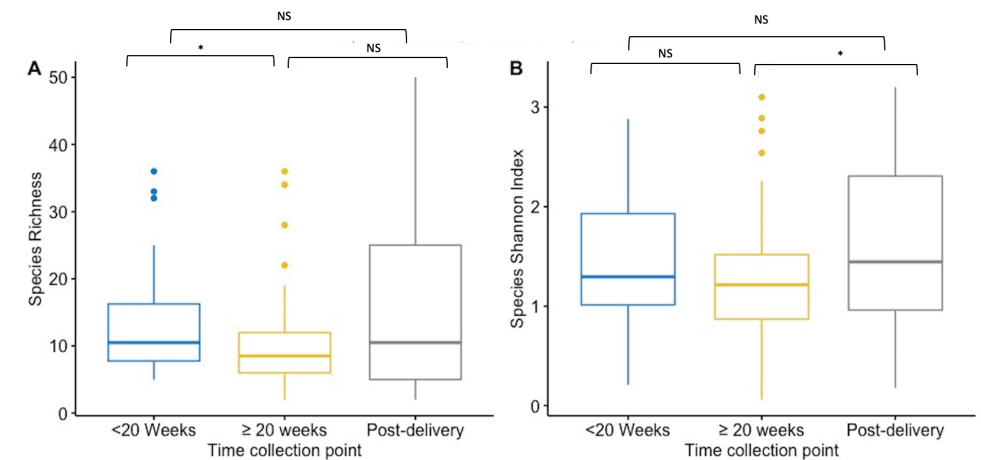
### 7.3.2 SPECIES IN THE VAGINAL MICROBIOTA

The fluorescent color and the length of the interspace (IS) region in units of nucleotides per sample were identified in three groups at the phyla level, namely Bacteroidetes, FAFV, and Proteobacteria (Supplementary Figure 2-4). In the included samples from 90 women, 554 different bacterial species were detected. Across the combined vaginal samples, *Lactobacillus* species (*L. crispatus*, *L. iners*, and *L. jensenii*) or *Klebsiella* species were the most identified species of the VMB during pregnancy (Supplementary Figure 4). In contrast, in post-delivery samples, the most identified species were *L. iners*, *G. vaginalis* and *L. crispatus*, and *Klebsiella* species (Supplementary Figure 5).

### 7.3.3 SHANNON INDEX AND DIVERSITY

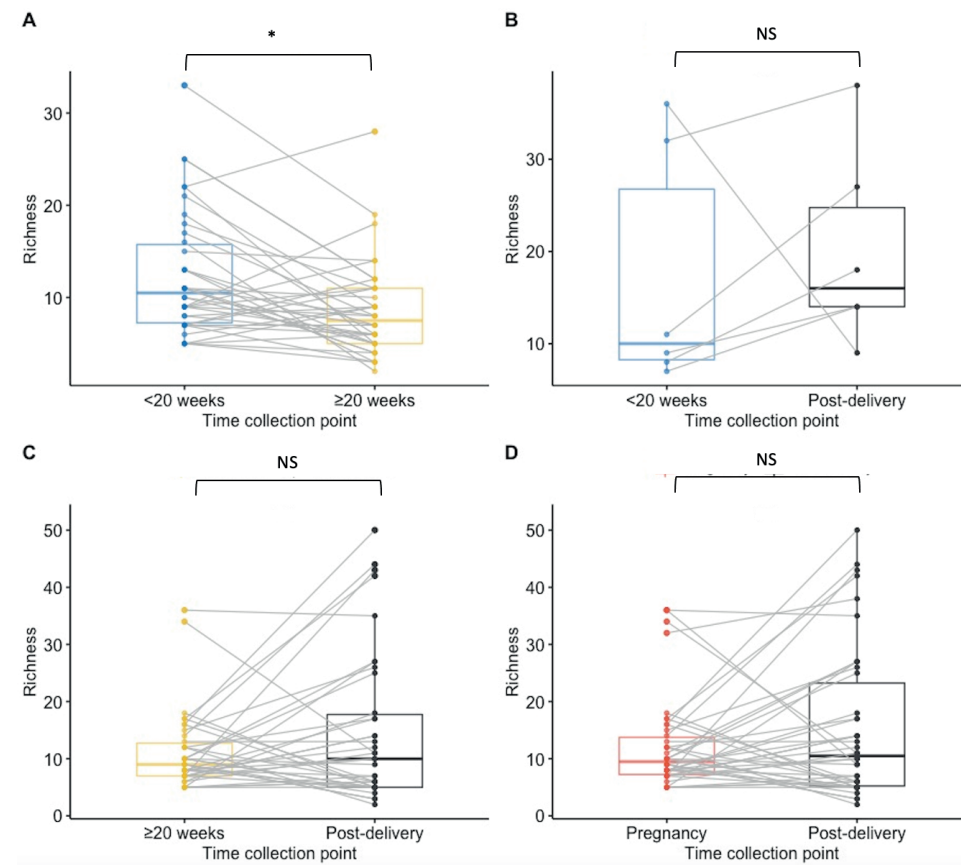
Alfa-diversity indices (richness and Shannon diversity index) of the VMB community were compared between paired and unpaired vaginal samples collected at first and second pregnancy timepoint, and post-delivery for species and IS-fragment count. Data on IS-fragment count are shown in the Supplementary Figure 7.1-7.3. When performing unpaired analysis, species richness decreased significantly during pregnancy (from mean 10 species to mean 13 species) ( $p = 0.02$ ) (Figure 1.A). Even though, the mean richness (15.39 species) was the highest post-delivery, there were no significant difference in the mean richness in the vaginal samples collected at enrolment or at the second pregnancy sampling collection (Figure 1.A). During pregnancy, the Shannon index did not differ significantly between the two collection points (mean Shannon diversity index was 1.42 at first timepoint compare to 1.23 at second timepoint) (Figure 1.B). However, the mean Shannon diversity index was significantly higher in post-delivery collected vaginal samples (mean Shannon diversity index = 1.62) compared to the second pregnancy collection point ( $p = 0.03$ ), but not significantly higher compared to the first timepoint (Figure 1.B).

Paired analysis of samples from 38 women tested at both timepoints during pregnancy showed a significant decrease in richness during pregnancy (median first timepoint = 10.5 species; median second collection pregnancy point = 7.5,  $p = 0.02$ ) and no statistically significant difference between other time points (Figure 2A-D). The Shannon index findings across timepoints using paired analysis are similar to the Richness findings, with only significance decrease in diversity observed during pregnancy (Figure 3.A, 3.B, 3D). Unlike in the unpaired analysis, for the paired analysis the Shannon diversity index did not significantly increase when analyzing data of a subset of 38 other women that were tested both at the second timepoint during pregnancy and post-delivery ( $p$ -value = 0.068) (Figure 3.C).

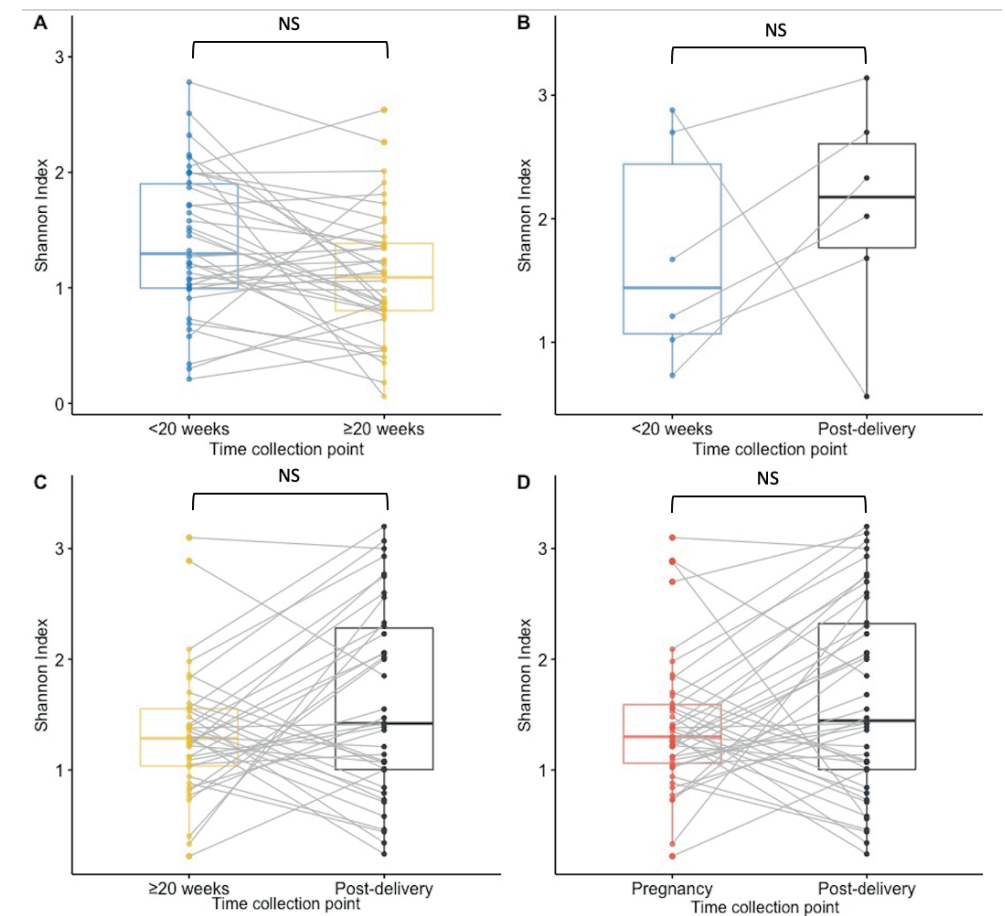


**Figure 1.** Boxplot for the richness (A) and Shannon diversity index (B) at species level for each collection point. Results of first pregnancy collection are in blue ( $n = 44$ ), second pregnancy collection in yellow ( $n = 82$ ), and post-delivery in grey ( $n = 44$ ). A. Species richness is lower at second pregnancy collection compared to the pregnancy collection at first pregnancy collection ( $p = 0.02$ ), but between the other timepoints there were no significant difference. B. The Shannon diversity index is higher at post-delivery compared to the index at second pregnancy collection ( $p = 0.03$ ), but not compared to the diversity index at first pregnancy collection. During the pregnancy the index did not differ significantly.





**Figure 2.** Boxplots for species richness at each collection point for paired samples. Results of first pregnancy collection are in blue, second pregnancy collection in yellow, and postdelivery in black and pregnancy in red. A. The richness was significantly lower at the second pregnancy collection point than at first pregnancy collection ( $p = 0.02$ ) in matched samples from 38 women. B. There was no significant difference in the richness between first pregnancy collection and post-delivery matched samples from 6 women. C. Non significant difference was calculated in the richness between second pregnancy collection and post-delivery matched samples from 38 women. D. For 42 women that had samples collected at least once during pregnancy and post-delivery, no significant difference in the species richness was calculated.



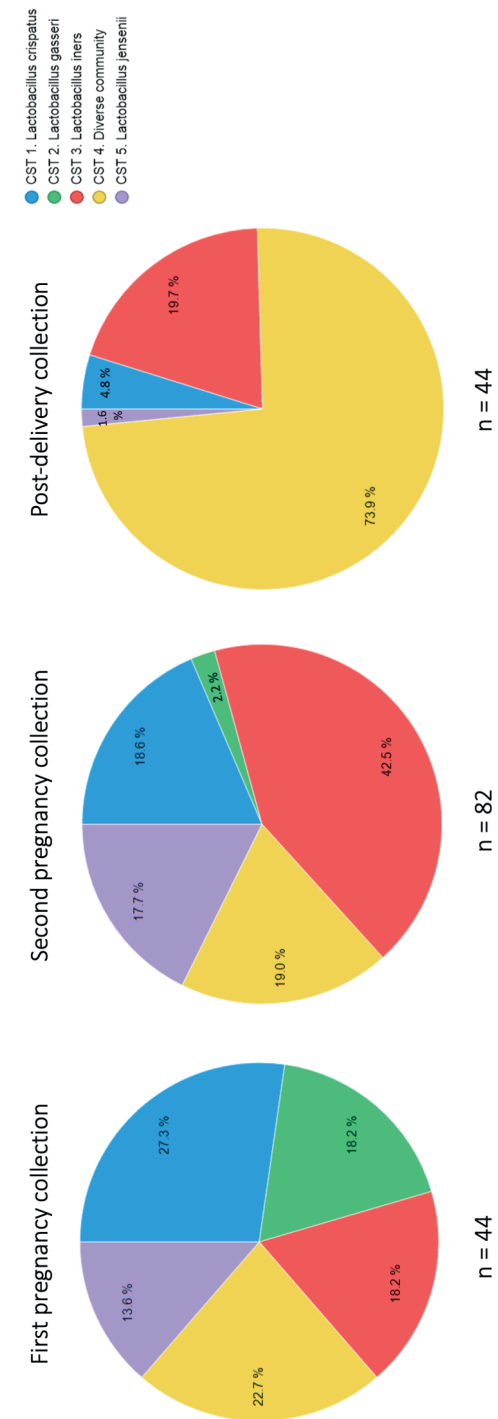
**Figure 3.** Boxplots for Shannon diversity index at species level for paired samples. Results of first pregnancy collection are in blue, second pregnancy collection in yellow, and postdelivery in black and pregnancy in red. A. The Shannon diversity index was not significantly higher at the second pregnancy collection point than at first pregnancy collection in matched samples from 38 women. B. There was no significant difference in the Shannon diversity index between first pregnancy collection and post-delivery matched samples from 6 women. C. Non significant difference was calculated in the Shannon diversity between second pregnancy collection and post-delivery matched samples from 38 women. D. For 42 women that had samples collected at least once during pregnancy and post-delivery, no significant difference in the Shannon diversity index was calculated.

### 7.3.4 COMMUNITY STATE TYPES

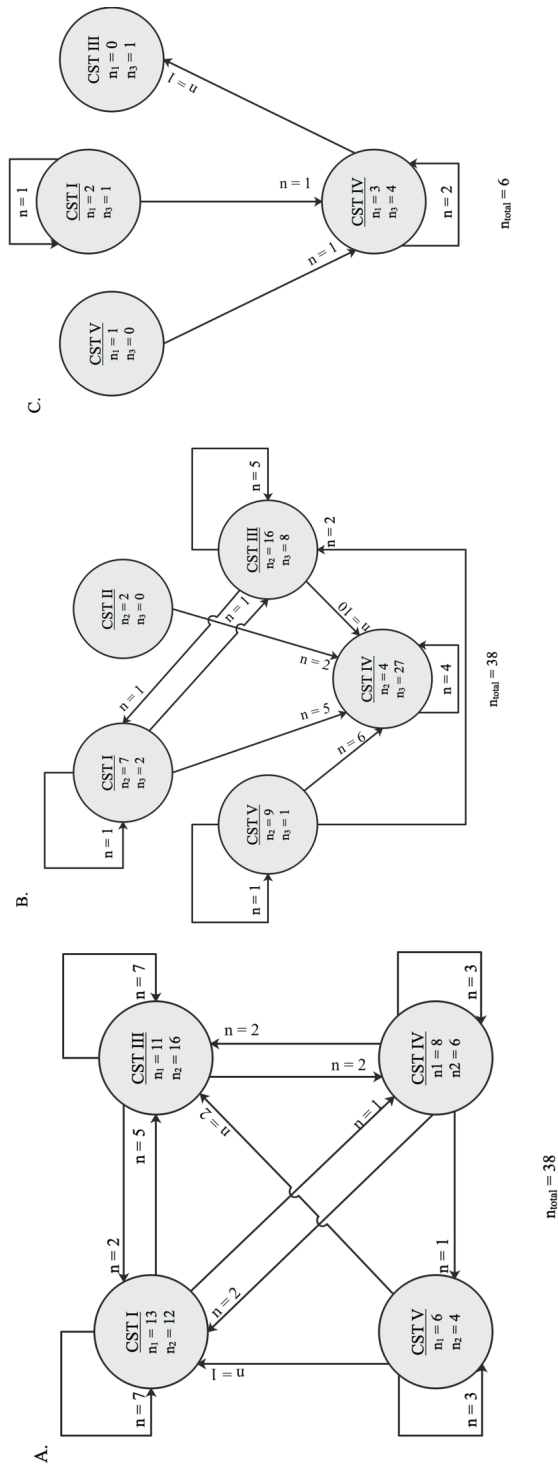
Hierarchical clustering of VMB profiles from samples collected during pregnancy and post-delivery yielded five different CSTs as previously described by Ravel et al. [58] (Figure 4). The VMB profiles of the vaginal samples collected at the first timepoint during pregnancy (n = 44), were dominated by *Lactobacillus* species (64.9%) belonging to three different CSTs: CST I (*L. crispatus*, 26.5%), CST III (*L. iners*, 25.0%), and CST V (*L. jensenii*, 13.5%), respectively (Figure 4). The rest of the women (35.1%) had a diverse VMB clustered as CST IV. Compared to samples collected at the first timepoint, the VMB profiles of the vaginal samples collected at the second pregnancy timepoint (n = 82) were less diverse (CST IV; 19% compare to 35%) and more vaginal samples (81% compare to 65%) had a *Lactobacillus* dominant profile belonging to: CST I (18.6%), CST II (*L. gasseri*, 2.2%), CST III (42.5%), and CST V (*L. jensenii*, 17.7%) (Figure 5), respectively. Most of the vaginal samples collected post-delivery had a diverse VMB profile (CST IV; 73.9%) followed by *L. iners* dominated VMB (CST 3; 19.7%) (Figure 4). The remaining vaginal samples were clustered in CST I (4.8%) and CST V (1.6%).

Among the six women that had preterm delivery, during pregnancy two women had CST I (33%), two CST IV (33%), one CST V (17%), and another had CST III (17%). The two women carrying twins both had vaginal samples belonging to CST I at the first timepoint during pregnancy. One of the women with multiple gestation also had CST I at the second timepoint, after parturition the VMB profile switched to CST IV. The other participant switched from CST I to CST III at the second timepoint, unfortunately there was no vaginal sample available post-delivery. The only woman that reported a stillbirth delivery had a vaginal sample belonging to CST III at timepoint two. The vaginal profile at timepoint one and post-delivery could not have been analyzed due to unavailability of these vaginal swabs.

For the four women that had a miscarriage, two vaginal samples at the first pregnancy collection belonged to CST IV, one to CST III, and another to CST I. Vaginal profiles from three women were also analyzed at the post-delivery timepoint; one woman had CST I, another women CST IV, and another women CST III. Furthermore, four women reported antibiotics usage at the second pregnancy collection timepoint. At that timepoint, their vaginal samples belonged to CST III (n = 2), CST I (n = 1), CST IV (n = 1). Overall, in the tested samples, changes of vaginal profiles occur during pregnancy and after delivery (Figure 6). During pregnancy, the VMB communities shifted from one CST to another in 18 of the 38 (47%) vaginal profiles that were analyzed between the first and second timepoint during pregnancy (Figure 5.A). Between the two timepoints during pregnancy, a switch to CST III accounted for 9 (50%) of these changes. The CST shifted in 27 of the 38 women (71%) whose vaginal profiles were analyzed at the second timepoint during pregnancy and post-delivery (Figure 5.B). Moreover, the CST shifted in 3 out of 6 (50%) vaginal profiles that were analyzed at first timepoint in pregnancy and post-delivery (Figure 5.C). From pregnancy to post-pregnancy timepoints, a switch to CST IV accounted for 23 (85%) of these changes. While CST I and CST III were the most interconnected states across longitudinal timepoints, with bidirectional transitions with each other and other CSTs (mostly CST IV) (Figure 5. A-C).



**Figure 4.** Frequency of five community state type (CST) identified each collection time point. In the pie charts the CST cluster are given in color; CST I; blue, CST II; green, CST III; red, CST IV, yellow, CST V, purple.



**Figure 5.** Schematic representation of switch between community state types (CSTs) between two sampling points. Number in the circles indicate how many vaginal samples were clustered in a certain CST by the time collection (during pregnancy). Arrows represent the direction of the switch. The number by the arrow represents the number of vaginal microbiota tested belonging to the same women who switched to a given CST at a later timepoint. A. Thirty-eight women were clustered with a specific CST at timepoint < 20 weeks and ≥ 20 weeks during pregnancy, of which 18 CST changed type during pregnancy. B. The paired vaginal swabs tested at ≥ 20 weeks gestational age (GA) pregnant and post-delivery, 27 of the 38 CST changed. C. The CST of three of the vaginal swabs, from the same six women, tested at < 20 weeks GA and post-delivery changed.

### 7.3.5 VAGINAL PATHOBIANTS AND GENITAL PATHOGENS

The following bacterial species of the VMB with pathogenic potential were identified: *Escherichia coli*, *Klebsiella species*, *Staphylococcus aureus*, *Staphylococcus simulans*, *Streptococcus agalactiae*, *Streptococcus anginosus*, *Streptococcus mitis* group, *Streptococcus pyogenes*, *Streptococcus species* (other than already mentioned). In total, 73% (32/44) vaginal swabs contained at least one such pathobiont at first timepoint during pregnancy, 68% (58/82) at second and 86% (38/44) post-delivery. The most common pathobiont at all three timepoint was *Klebsiella species*, followed by *Streptococcus anginosus*, *Streptococcus pyogenes*, *Streptococcus mitis* group, *Staphylococcus simulans* and *Streptococcus agalactiae* (with the two pathobiont especially post-delivery) (Figure 6).

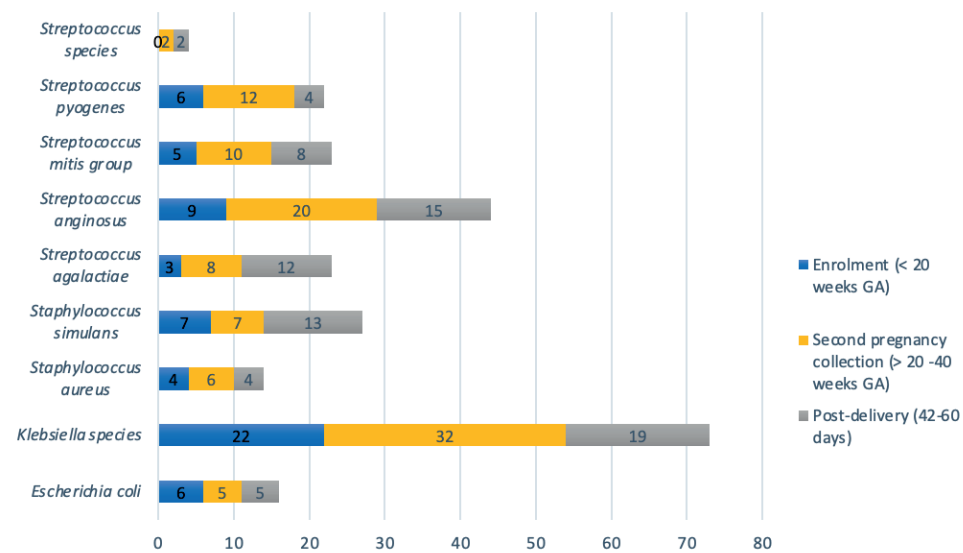
Three samples containing pathobionts at the first timepoint (3/58) also had a substantial presence (>20% relative abundance, range between 22 and 35%) of pathobionts (two samples with *Klebsiella species*, and one sample with *Streptococcus mitis* group and *Streptococcus anginosus*). Among these samples, the sample with a relative abundance above 30% with the pathobiont *Klebsiella species* belonged to CST 3, while the other two samples belonged to CST 4. At the second time point, seven vaginal samples (7/38) had a substantial (relative abundance range: 20 - 44%) presence of pathobionts at the second timepoint (*Klebsiella species* (n = 2), *Streptococcus agalactiae* (n = 1), *Streptococcus anginosus* (n = 3), and *Staphylococcus simulans* (n = 1)). Among those samples with high pathobionts load, one had a VMB belonging to CST III, while the others belonged to CST IV (n = 6) or CST V.

Nine vaginal samples (9/38) had a substantial presence of pathobionts (relative abundance 24 - 89%) at the post-delivery collection point. Two different vaginal samples had a combination of a high relative abundance of *Staphylococcus simulans* (>30%) and *Streptococcus anginosus* (>44%). The rest of the samples had a high relative abundance of *Klebsiella species* (42%), *Streptococcus anginosus* (26% and 32%), and *Streptococcus agalactiae* (24%, 69%, 76%, and 89%). All nine post-delivery samples with a substantial presence of pathobionts belonged to CST IV. The overall relative abundance of pathobionts was higher in the samples collected post-delivery than in samples collected during pregnancy (data not reported).

The known genital pathogens *C. trachomatis*, *T. vaginalis*, *M. genitalium*, *N. gonorrhoeae* and hrHPV other than genotype 16 or 18 were also detected in the samples (Table 4). Nine samples (20.5%) were positive for at least one genital pathogen at first timepoint (< 20 weeks GA) (Table 5). *C. trachomatis* was detected in 4 vaginal samples, each belonging to CST I, CST III, CST IV, and CST V, respectively. The two vaginal samples that were positive for *T. vaginalis* at first timepoint belonged to CST I and CST III, while three others were positive for hrHPV genotypes and belonged to CST I, CST III or CST V, respectively (Table 5). The presence of urogenital pathogens at the first timepoint during pregnancy did not cluster significantly more within CST III (Table 4).

At second timepoint during pregnancy, eighteen (22.8%) vaginal samples tested positive for one or more genital pathogen (Table 4), most of them belonged to CST III (n = 12), followed by CST I (n = 2), CST V (n = 2), CST II (n = 1), and CST IV (n = 1). Most of the samples with a genital pathogen at second timepoint belonged to CST III (12/38), this difference was statistically significant ( $p=0.01$ ) when comparing all combined pathogens across CSTs (6/38).

Of the 44 post-delivery samples, 5 (11.4%) were positive for *C. trachomatis* (n = 1), 3 (6.8%) for *T. vaginalis*, one (2.3%) for *N. gonorrhoeae*, or 4 (9.1%) for hrHPV genotypes. The sample positive for a genital infection were clustered either in CST III along or CST IV (Table 4).



**Figure 6.** Nine pathobionts observed in vaginal samples per collection point. Numbers of vaginal samples detected with pathobionts at first pregnancy collection (n = 44), second pregnancy collection (n = 82), and post-delivery (n = 44).

**Table 4.** Number of vaginal samples positive for urogenital pathogen within a community state type.

	CST I	CST II	CST III	CST IV	CST V	Total (%)
<b>Samples of enrollment collection point</b>						
CT	1/15	0/0	1/12	1/11	1/6	4/44 (9.1)
TV	1/15	0/0	1/12	0/11	0/6	2/44 (4.5)
HPV others	1/15	0/0	1/12	1/11	0/6	3/44 (6.8)
urogenital pathogens combined	3/15	0/0	3/12	2/11	1/6	9/44 (20.5)
<b>Samples of 2<sup>nd</sup> pregnancy collection point</b>						
CT	1/18	0/2	3/38	1/11	0/13	5/82 (6.1)
TV	1/18	1/2	5/38	0/11	1/13	8/82 (9.76)
MG	0/18	0/2	3/38	0/11	0/13	3/82 (3.7)
HPV others	0/15 <sup>a</sup>	0/2	2/38	0/11	1/13	3/79 <sup>a</sup> (3.7)
urogenital pathogens combined	2/15 <sup>a</sup>	1/2	12/38 <sup>b,c</sup>	1/11	2/13	18/79 <sup>a</sup> (22.8)
<b>Samples of post-delivery collection point</b>						
CT	0/3	0/0	1/11	0/29	0/1	1/44 (2.3)
TV	0/3	0/0	1/11	2/29	0/1	3/44 (6.8)
NG	0/3	0/0	0/11	1/29	0/1	1/44 (2.3)
HPV others	0/3	0/0	1/11	3/29	0/1	4/44 (9.1)
urogenital pathogens combined	0/3	0/0	3/11	6/29	0/1	9/44 (20.5)

CST: community state types. CT: *Chlamydia trachomatis*, HPV: *human papillomavirus* (Genotypes; 31, 33, 35, 39, 45, 51, 52, 53, 56, 58, 59, 66 and 68), MG: *M. genitalium*, TV: *T. vaginalis*.

<sup>a</sup> Three samples were not tested for HPV at the second pregnancy collection

<sup>b</sup> The difference between the number of urogenital infections is significantly higher at CST III compare with all the other CSTs ( $P=0.01$ ).

<sup>c</sup> one person has a co-infection with HPV others and TV at CST III.

## 7.4 DISCUSSION

Using vaginal samples and questionnaire data previously collected from a biobank in Pemba Island, this study analyzed VMB and genital infections among 90 local Muslim-Shirazi women during pregnancy and post-delivery. This study strived to comprehensively characterize the vaginal microbial environment, by identifying the bacterial species present, including pathobionts, by using this information to cluster the VMB into CSTs, and by identifying the presence of selected genital pathogens. During pregnancy, the VMB communities were mostly *Lactobacillus*-dominated with most VMB profiles belonging to CST I, II, III, and V (65% of the vaginal samples at first timepoint and 81% of the vaginal samples at the second [8]). These results are in concordance with previous (longitudinal) observations where a high relative abundance of *Lactobacillus* species were observed during pregnancy, and *L. crispatus* (CST I) and *L. iners*

(CST III) were the most commonly identified species of the VMB community during pregnancy [19,21,66]. Alike previous studies among African and African-American pregnant women, this study also showed the presence of *L. jensenii* or *L. gasseri*, though most often not as dominant *Lactobacillus* species [7,19,42]. These observations during pregnancy in this and other studies are in discordance with the studies of non-pregnant Tanzanian women and another cohort of sub-Saharan African women [7,19,42,44].

Across the two timepoints in pregnancy, Shannon diversity index, a measure of alpha diversity, of VMB was stable, and the richness decreased significantly ( $P = 0.02$ ), as previously observed by other longitudinal studies [21]. Similar to a study in North American women from African ancestry, the prevalence of *Lactobacillus*-dominated VMB in this current study was lower in the first than in later trimesters of pregnancy, and the switch in VMB in pregnancy was most commonly (50% (9/18) of cases) towards *L. iners* dominant VMB [22]. The high frequency of a *Lactobacillus* dominant VMB and the stability of the alpha diversity in pregnancy has been attributed to the high levels of estrogens that indirectly promote glycogen production and support *Lactobacillus* species colonization, which in turn metabolize lactic acid and promote a healthy low vaginal pH [19]. This hypothesis might explain the predominant role of high estrogens levels during pregnancy, independently of ethnicity, in promoting *Lactobacillus* abundance. In the non-pregnant state, on the other hand, when estrogens' role is not as important, the frequency of the non-*Lactobacillus* dominated CST IV has been reported to be higher in women from sub-Saharan Africa or with African ancestry [22,42,67,68].

After delivery, a 100- to 1000-fold drop of estrogens, and resulting disruption of the vaginal microbial environment is expected [8,39,69,70], including the estrogen-driven *Lactobacillus* species dominance [39]. In agreement with these data, this study results showed that in paired samples most vaginal profiles shifted to CST IV post-delivery. In total 74% of the vaginal samples collected post-delivery the VMB profile were more diverse, belonging to CST IV, and were less *Lactobacillus* dominant than VMB during pregnancy. This observation agrees with previous ones among British women of different ethnic background and among American women. Such changes have been reported to persist up to one year, independently of ethnicity [8,39]. Mean and median richness and Shannon diversity index were higher in the post-delivery samples compared to samples collected during pregnancy, though this difference was only statistically significant for the mean Shannon diversity index calculated for unpaired samples ( $P = 0.03$ ). The median Shannon diversity index calculated for the paired samples collected at the second pregnancy timepoint and post-delivery was close to statistical significance ( $p = 0.07$ ). Nevertheless, these findings combined suggest that the VMB diversity and richness during the pregnancy is lower than in the VMB post-delivery women from Pemba Island, Tanzania. These findings are also in concordance with previous observations in post-delivery VMB analysis from mainland Tanzanian, British, American women, in which the authors also describe a more diverse and richness VMB throughout the pregnancy [8,39,46]. Also similar to other studies, an increase in BV-associated bacteria such as, *G. vaginalis*, *Prevotella* species, and *Anaerococcus*

species, was also observed post-delivery [8,39,46]. The presence of *Prevotella* species and *Anaerococcus* species have been associated with a higher vaginal pH and BV [6,71]. In this present study presence of clinical BV could not be assessed, as this was not addressed in the questionnaire. However, in the questionnaires, none of the women reported any urinary tract infections symptoms, which often present as urogenital tract symptoms [54]. Thus, it is likely, as in most BV- and VMB dysbiotic condition cases in sub-Saharan women, that most women in this cohort with a dysbiotic (CST IV) VMB were asymptomatic [10]. However further studies should investigate the exact prevalence of BV and BV-symptomatology in this Tanzanian population. Nonetheless, even though mostly asymptomatic, the role of certain BV-associated species during pregnancy is gaining increasing interest as BV-associated species have been associated with preterm birth in Caucasian cohorts [8,26,72]. However, a more extensive African-American study found no specific taxon, including *Gardnerella*, as a significant marker for preterm birth [19,26]. In sub-Saharan African cohorts the role of BV-associated bacteria should also be further research, especially since the burden of preterm birth is high in this world region [73].

The presence of certain vaginal commensal microorganisms, such as *S. agalactiae*, *Staphylococcus aureus*, and species in the *Enterobacteriaceae* family that under certain circumstances can be also of clinical relevance in various maternal, pregnancy-related and neonatal health conditions [13,14,74,75]. In the samples tested in this study, pathobionts were more present post-delivery (86%) than during pregnancy (68% at first timepoint and 73% at second timepoint in pregnancy). Moreover, post-delivery, more women (20%) had a VMB containing a substantial presence of pathobionts (relative abundance more than 20%) compared to VMB from samples collected during pregnancy (6.8% at first and 8.5% at the second timepoint during pregnancy). However, it is for debate if the risk of pathogenic potential increases when the VMB contains a substantial presence of a pathobiont (higher abundance) [16]. As also previously observed in the non-pregnant cohorts studies by Wijgert et al., in this cohort pathobionts co-occur with both lactobacilli and BV-associated bacterial species during pregnancy [16]. However post-delivery most pathobionts were detected in women with a dysbiotic vaginal profile (CST IV). The causal association between CST IV and pathobionts' abundance, along with their role in complication of pregnancy, such as preterm birth, should be further investigated.

*Klebsiella* species and *Streptococcus anginosus* were the most prevalent during pregnancy and post-delivery, and in most cases, they were also the most prevalent pathobionts with a substantial presence in the VMB. The prevalence of *Klebsiella* species during pregnancy (2.3 at first and 4.5% at second timepoint) were similar in this study compared to previous findings in pregnant Nigerian or Nepalese women where the point-prevalence was 3% or 5.6%, respectively [76,77]. *Streptococcus anginosus* is one of most identified pathobionts in patients with aerobic vaginitis, together with other pathobionts (including *Escherichia coli*, *Streptococcus spp.*, *Staphylococcus aureus*, *Staphylococcus epidermidis*) [78]. The exact role of *Streptococcus anginosus* in the female genital tract and the influence of aerobic vaginitis in pregnancy is

still unknown, however, there have been cases where fatal neonatal sepsis was reported to occur due to a specific *Streptococcus anginosus* biotype [75,79].

There are also indications that *K. pneumoniae* in particular is associated with neonatal deaths and premature pregnancy loss [80]. Thus, identifications of these pathogens (also in substantial presence) in this cohort indicate the need to further investigate, in larger studies, the clinical association between *Klebsiella* species and *Streptococcus anginosus* and adverse pregnancy outcomes.

Currently, in certain parts of the world, especially high-income countries, *S. agalactiae* also known as GBS is tested in pregnancy as part of antenatal care to minimize the risk of vertical infection to the fetus and newborn [81]. GBS infection can lead to preterm birth and can be fatal for neonates, causing severe cases of pneumonia, meningitis, or sepsis [13,14,82]. The prevalence of GBS observed in this study (6.8% at first, 10% at second timepoint in pregnancy, and 27% post-delivery) are in line with the pooled prevalence of a recent meta-analysis report of the prevalence of GBS in pregnant and post-delivery women in Tanzania (16.14%; 95% CI 2.9, 29.4) [83]. It should be noted that about 1 in 100 infants born from mothers carrying GBS develop invasive GBS infection disease in other populations [84,85]. Thus, as evidence suggests the involvement of pathobionts in maternal and newborn health, and their possible vertical transmission, it is essential also to further investigate the association between an abundance of GBS, and other pathobionts, and perinatal health. It is even more so, now that some of these pathobionts strains, like *Klebsiella* and *E. coli*, are becoming increasingly resistance to a broad range of antibiotics [77,85].

In addition to pathobionts, this study also investigated the presence of the pathogens *C. trachomatis*, hrHPV, *M. genitalium*, and *T. vaginalis* in this cohort. In total, 21%, 23%, and 11% of vaginal samples tested positive for a genital pathogen at first and second timepoint during pregnancy, and post-delivery, respectively. It has been proposed that a VMB characterized by low diversity of species has a protective role against ascending infections of the genital tract and adverse pregnancy outcomes, and that infections in early pregnancy may hinder the transition of VMB to a beneficial state associated to a lower risk of pregnancy complication, i.e. CST I [64,86,87]. *T. vaginalis* has been associated with reduced *Lactobacillus* species in the VMB, but not BV-related species [87,88]. In contrast, *L. iners* has been associated with susceptibility of genital infections (HIV and other sexually transmitted infections) [64,65,89]. In this study, The VMB samples of most women with carrying a genital pathogen belonged to CST III (*L. iners* dominant) at the second pregnancy timepoint. However, at the other timepoints, the presence of none of the genital pathogens clustered with VMB belonging this specific CST. To this date, the role of *L. iners* in the VMB equilibrium is not fully understood, as it has been associated with both eubiotic and dysbiotic VMB states [64,90]. Thus, the role of *L. iners* in VMB's health and the association between *L. iners* dominant VMB (CST III) and genital pathogens during pregnancy should be further evaluated.

The main limitation of this study was the limited availability of longitudinal paired samples. This was mainly due to practical challenges in the sample collection process. Currently, only vaginal samples from two-woman that were collected at all three-collection timepoints were available for testing. Nevertheless, the findings of this first analysis in pregnant Pemba women raise many questions (regarding the role of VMB with pathobionts, genital infections and pregnancy outcomes) that could be further investigated in a bigger cohort. In this study, the number of participants was limited to 90 and, as such, the prevalence of adverse pregnancy outcomes was low. However, pregnancy complications are prevalent in Pemba, and the role of VMB in pregnancy outcomes should be further investigated in this population in a bigger cohort [91]. This study does nonetheless provide baseline characteristics, including clinically relevant ones, and insights on pregnancy outcomes among women in Pemba Island. Unfortunately, due to the use of pre-existing biobank data, some gynecology related information, such as BV-related clinical data, would have been relevant to our aim was not among the information available from the questionnaire.

With regards to the methodological approached used in this study, the IS-pro Microbiota assay gives comparable results as next-generation sequencing (NGS), and has been shown to even outperform NGS when using samples with lower bacterial loads [57,92]. Nonetheless, not all bacterial taxa to species level has been identify due to restrictions of the available database. However, this mainly effect low-abundant organisms. For instance, *L. vaginalis* could not be identified yet in this analysis. Finally, the use of antibiotics and the women with twin pregnancies, both factors of which can interfere with VMB composition, were only reported by a small number of women and therefore the were not excluded from this analysis.

Furthermore, the use of the term “pathobiont” in this study and other studies should be taken carefully, as it is not a well-defined concept [93]. It has been shown in some studies that conditions under which pathobionts exhibit virulence are in susceptible host of which there has been an impaired host immune defenses or an altered microbiota composition [93]. This in turn suggests that it is already well-defined what a balanced VMB state or an alter VMB state is [52]. While there is still debates on the clinical significance of VMB compositions, especially among women from sub-Saharan Africa or African ancestry [45,93,94].

## 7.5 CONCLUSION

The VMB was generally *Lactobacillus* dominant (65% at first, and 81% at second timepoint) during pregnancy and non-*Lactobacillus* dominant (73.9%) postdelivery in women from Pemba Island. The VMB richness significantly increases during pregnancy, whereas the Shannon diversity significantly increases post-delivery. A substantial presence of pathobionts were only present in a diverse- or *L. iners*-dominant VMB at all three timepoint. Solely at the second pregnancy collection, genital infection positivity was associated with an *L. iners* dominant VMB. Future studies should further investigate the temporal and directional microbial changes during pregnancy, the role of CSTs with adverse pregnancy outcomes, and how pathobionts and genital pathogens interfere with the VMB composition, especially with *L. iners* dominant VMB. Investigating the causality of particular VMB characteristics in reproductive health might be essential to improve maternal and child health, especially in populations where the burden of VMB dysbiotic diseases, genital infections and adverse pregnancy outcomes are high, such as in certain parts of sub-Saharan Africa.

## 7 REFERENCES

1. Marchesi, J.R.; Ravel, J. The vocabulary of microbiome research: a proposal. *Microbiome* **2015**, *3*.
2. Brotman, R.M. Vaginal microbiome and sexually transmitted infections: An epidemiologic perspective. *J. Clin. Invest.* **2011**, *121*, 4610–4617.
3. Chu, D.M.; Seferovic, M.; Pace, R.M.; Aagaard, K.M. The microbiome in preterm birth. *Best Pract. Res. Clin. Obstet. Gynaecol.* **2018**, *52*, 103–113.
4. O'Hanlon, D.E.; Moench, T.R.; Cone, R.A. Vaginal pH and microbicidal lactic acid when lactobacilli dominate the microbiota. *PLoS One* **2013**, *8*.
5. O'Hanlon, D.E.; Moench, T.R.; Cone, R.A. In vaginal fluid, bacteria associated with bacterial vaginosis can be suppressed with lactic acid but not hydrogen peroxide. *BMC Infect. Dis.* **2011**, *11*, 200.
6. Ravel, J.; Gajer, P.; Abdo, Z.; Schneider, G.M.; Koenig, S.S.K.; McCulle, S.L.; Karlebach, S.; Gorle, R.; Russell, J.; Tacket, C.O.; et al. Vaginal microbiome of reproductive-age women. *Proc. Natl. Acad. Sci. U. S. A.* **2011**, *108*, 4680–4687.
7. Jaspers, V.; van de Wijgert, J.; Cools, P.; Verhelst, R.; Verstraelen, H.; Delany-Moretlwe, S.; Mwaura, M.; Ndayisaba, G.F.; Mandaliya, K.; Menten, J.; et al. The significance of *Lactobacillus crispatus* and *L. vaginalis* for vaginal health and the negative effect of recent sex: A cross-sectional descriptive study across groups of African women. *BMC Infect. Dis.* **2015**, *15*.
8. DiGiulio, D.B.; Callahan, B.J.; McMurdie, P.J.; Costello, E.K.; Lyell, D.J.; Robaczewska, A.; Sun, C.L.; Goltsman, D.S.A.; Wong, R.J.; Shawa, G.; et al. Temporal and spatial variation of the human microbiota during pregnancy. *Proc. Natl. Acad. Sci. U. S. A.* **2015**, *112*, 11060–11065.
9. Bayigga, L.; Kateete, D.P.; Anderson, D.J.; Sekikubo, M.; Nakanjako, D. Diversity of vaginal microbiota in sub-Saharan Africa and its effects on HIV transmission and prevention. *Am. J. Obstet. Gynecol.* **2019**.
10. Woodman, Z. Can one size fit all? Approach to bacterial vaginosis in sub-Saharan Africa. *Ann. Clin. Microbiol. Antimicrob.* **2016**, *15*, 16.
11. Arif, F. Bacterial Vaginosis: Risk of Adverse Pregnancy Outcome. *J. Gynecol. Res. Obstet.* **2018**, 015–017.
12. Kervinen, K.; Kalliala, I.; Glazer-Livson, S.; Virtanen, S.; Nieminen, P.; Salonen, A. Vaginal microbiota in pregnancy: Role in induction of labor and seeding the neonate's microbiota? *J. Biosci.* **2019**, *44*, 1–6.
13. Cools, P.; Jaspers, V.; Hardy, L.; Crucitti, T.; Delany-Moretlwe, S.; Mwaura, M.; Ndayisaba, G.F.; Van De Wijgert, J.H.H.M.; Vaneechoutte, M. A multi-country cross-sectional study of vaginal carriage of group B streptococci (GBS) and *Escherichia coli* in resource-poor settings: Prevalences and risk factors. *PLoS One* **2016**, *11*.
14. Black, C.G.; Tavares, L.; Stachel, A.; Ratner, A.J.; Randis, T.M. Distribution of Late-Onset Neonatal Sepsis Pathogens Differs in Inpatient and Outpatient Settings. *Am. J. Perinatol.* **2019**, *36*, 1136–1141.
15. Brunham, R.C.; Gottlieb, S.L.; Paavonen, J. Pelvic inflammatory disease. *N. Engl. J. Med.* **2015**, *372*, 2039–2048.
16. van de Wijgert, J.H.H.M.; Verwijs, M.C.; Gill, A.C.; Borgdorff, H.; van der Veer, C.; Mayaud, P. Pathobionts in the Vaginal Microbiota: Individual Participant Data Meta-Analysis of Three Sequencing Studies. *Front. Cell. Infect. Microbiol.* **2020**, *10*.
17. Wira, C.R.; Fahey, J. V.; Rodriguez-Garcia, M.; Shen, Z.; Patel, M. V. Regulation of mucosal immunity in the female reproductive tract: The role of sex hormones in immune protection against sexually transmitted pathogens. *Am. J. Reprod. Immunol.* **2014**, *72*, 236–258.
18. Doyle, R.; Gondwe, A.; Fan, Y.M.; Maleta, K.; Ashorn, P.; Klein, N.; Harris, K. A *Lactobacillus*-deficient vaginal microbiota dominates postpartum women in rural Malawi. *Appl. Environ. Microbiol.* **2018**, *84*.

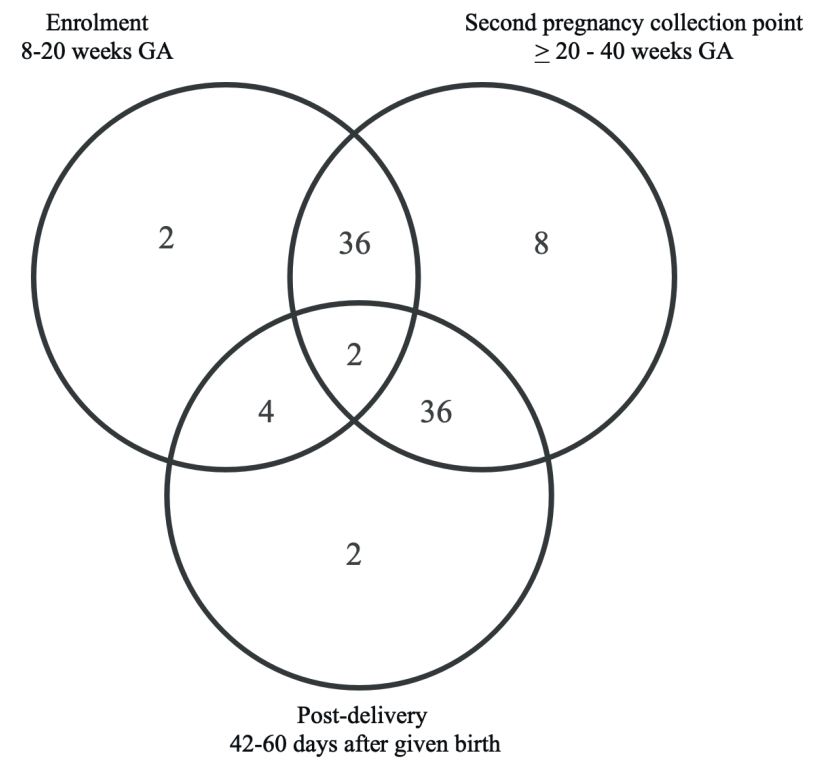
19. Romero, R.; Hassan, S.S.; Gajer, P.; Tarca, A.L.; Fadrosh, D.W.; Nikita, L.; Galuppi, M.; Lamont, R.F.; Chaemsaitong, P.; Miranda, J.; et al. The composition and stability of the vaginal microbiota of normal pregnant women is different from that of non-pregnant women. *Microbiome* **2014**, *2*, 4.
20. Stout, M.J.; Conlon, B.; Landeau, M.; Lee, I.; Bower, C.; Zhao, Q.; Roehl, K.A.; Nelson, D.M.; MacOnes, G.A.; Mysorekar, I.U. Identification of intracellular bacteria in the basal plate of the human placenta in term and preterm gestations. *Am. J. Obstet. Gynecol.* **2013**, *208*, 226.e1-226.e7.
21. Avershina, E.; Slangsvold, S.; Simpson, M.R.; Storror, O.; Johnsen, R.; Øien, T.; Rudi, K. Diversity of vaginal microbiota increases by the time of labor onset. *Sci. Rep.* **2017**, *7*, 1–7.
22. Serrano, M.G.; Parikh, H.I.; Brooks, J.P.; Edwards, D.J.; Arodz, T.J.; Edupuganti, L.; Huang, B.; Girerd, P.H.; Bokhari, Y.A.; Bradley, S.P.; et al. Racioethnic diversity in the dynamics of the vaginal microbiome during pregnancy. *Nat. Med.* **2019**, *25*, 1001–1011.
23. Aagaard, K.; Riehle, K.; Ma, J.; Segata, N.; Mistretta, T.A.; Coarfa, C.; Raza, S.; Rosenbaum, S.; van den Veyver, I.; Milosavljevic, A.; et al. A metagenomic approach to characterization of the vaginal microbiome signature in pregnancy. *PLoS One* **2012**.
24. Callahan, B.J.; DiGiulio, D.B.; Aliaga Goltsman, D.S.; Sun, C.L.; Costello, E.K.; Jeganathan, P.; Biggio, J.R.; Wong, R.J.; Druzin, M.L.; Shaw, G.M.; et al. Replication and refinement of a vaginal microbial signature of preterm birth in two racially distinct cohorts of US women. *Proc. Natl. Acad. Sci. U. S. A.* **2017**, *114*, 9966–9971.
25. Kroon, S.J.; Ravel, J.; Huston, W.M. Cervicovaginal microbiota, women's health, and reproductive outcomes. *Fertil. Steril.* **2018**, *110*, 327–336.
26. Stout, M.J.; Zhou, Y.; Wylie, K.M.; Tarr, P.I.; Macones, G.A.; Tuuli, M.G. Early pregnancy vaginal microbiome trends and preterm birth. *Am. J. Obstet. Gynecol.* **2017**, *217*, 356.e1-356.e18.
27. Brown, R.G.; Marchesi, J.R.; Lee, Y.S.; Smith, A.; Lehne, B.; Kindinger, L.M.; Terzidou, V.; Holmes, E.; Nicholson, J.K.; Bennett, P.R.; et al. Vaginal dysbiosis increases risk of preterm fetal membrane rupture, neonatal sepsis and is exacerbated by erythromycin. *BMC Med.* **2018**, *16*, 9.
28. Romero, R.; Hassan, S.S.; Gajer, P.; Tarca, A.L.; Fadrosh, D.W.; Bieda, J.; Chaemsaitong, P.; Miranda, J.; Chaiworapongsa, T.; Ravel, J. The vaginal microbiota of pregnant women who subsequently have spontaneous preterm labor and delivery and those with a normal delivery at term. *Microbiome* **2014**, *2*.
29. Hyman, R.W.; Fukushima, M.; Jiang, H.; Fung, E.; Rand, L.; Johnson, B.; Vo, K.C.; Caughey, A.B.; Hilton, J.F.; Davis, R.W.; et al. Diversity of the vaginal microbiome correlates with preterm birth. *Reprod. Sci.* **2014**, *21*, 32–40.
30. Jayaprakash, T.P.; Wagner, E.C.; Van Schalkwyk, J.; Albert, A.Y.K.; Hill, J.E.; Money, D.M.; Hemmingsson, S.M.; Castillo, E.; Janssen, P.A. High diversity and variability in the vaginal microbiome in women following Preterm Premature Rupture of Membranes (PPROM): A prospective cohort study. *PLoS One* **2016**, *11*.
31. van de Wiggert, J.H.H.M.; Jaspers, V. The global health impact of vaginal dysbiosis. *Res. Microbiol.* **2017**.
32. Van De Wiggert, J.H.H.M.; Borgdorff, H.; Verhelst, R.; Crucitti, T.; Francis, S.; Verstraelen, H.; Jaspers, V. The vaginal microbiota: What have we learned after a decade of molecular characterization? *PLoS One* **2014**, *9*.
33. Van De Wiggert, J.H.H.M.; Morrison, C.S.; Cornelisse, P.G.A.; Munjoma, M.; Moncada, J.; Awio, P.; Wang, J.; Van Der Pol, B.; Chipato, T.; Salata, R.A.; et al. Bacterial vaginosis and vaginal yeast, but not vaginal cleansing, increase HIV-1 acquisition in African women. *J. Acquir. Immune Defic. Syndr.* **2008**, *48*, 203–210.
34. Modi, B.P.; Teves, M.E.; Pearson, L.N.; Parikh, H.I.; Haymond-Thornburg, H.; Tucker, J.L.; Chaemsaitong, P.; Gomez-Lopez, N.; York, T.P.; Romero, R.; et al. Mutations in fetal genes involved in innate immunity and host defense against microbes increase risk of preterm premature rupture of membranes (PPROM). *Mol. Genet. Genomic Med.* **2017**, *5*, 720–729.
35. York, T.P.; Eaves, L.J.; Neale, M.C.; Strauss, J.F. The contribution of genetic and environmental factors to the duration of pregnancy. *Am. J. Obstet. Gynecol.* **2014**, *210*, 398–405.
36. Barcelona de Mendoza, V.; Wright, M.L.; Agaba, C.; Prescott, L.; Desir, A.; Crusto, C.A.; Sun, Y. V.; Taylor, J.Y. A Systematic Review of DNA Methylation and Preterm Birth in African American Women. *Biol. Res. Nurs.* **2017**, *19*, 308–317.
37. Ravel, J.; Brotman, R.M.; Gajer, P.; Ma, B.; Nandy, M.; Fadrosh, D.W.; Sakamoto, J.; Koenig, S.S.K.; Fu, L.; Zhou, X.; et al. Daily temporal dynamics of vaginal microbiota before, during and after episodes of bacterial vaginosis. *Microbiome* **2013**, *1*.
38. Fettweis, J.M.; Paul Brooks, J.; Serrano, M.G.; Sheth, N.U.; Girerd, P.H.; Edwards, D.J.; Strauss, J.F.; Jefferson, K.K.; Buck, G.A. Differences in vaginal microbiome in African American women versus women of European ancestry. *Microbiol. (United Kingdom)* **2014**, *160*, 2272–2282.
39. MacIntyre, D.A.; Chandiramani, M.; Lee, Y.S.; Kindinger, L.; Smith, A.; Angelopoulos, N.; Lehne, B.; Arulkumaran, S.; Brown, R.; Teoh, T.G.; et al. The vaginal microbiome during pregnancy and the postpartum period in a European population. *Sci. Rep.* **2015**, *5*.
40. Hyman, R.W.; Fukushima, M.; Jiang, H.; Fung, E.; Rand, L.; Johnson, B.; Vo, K.C.; Caughey, A.B.; Hilton, J.F.; Davis, R.W.; et al. Diversity of the vaginal microbiome correlates with preterm birth. *Reprod. Sci.* **2014**, *21*, 32–40.
41. Zhou, X.; Brown, C.J.; Abdo, Z.; Davis, C.C.; Hansmann, M.A.; Joyce, P.; Foster, J.A.; Forney, L.J. Differences in the composition of vaginal microbial communities found in healthy Caucasian and black women. *ISME J.* **2007**, *1*, 121–133.
42. Gautam, R.; Borgdorff, H.; Jaspers, V.; Francis, S.C.; Verhelst, R.; Mwaura, M.; Delany-Moretlwe, S.; Ndaiyisaba, G.; Kyongo, J.K.; Hardy, L.; et al. Correlates of the molecular vaginal microbiota composition of African women. *BMC Infect. Dis.* **2015**, *15*, 86.
43. McMillan, A.; Rulisa, S.; Gloor, G.B.; Macklaim, J.M.; Sumarah, M.; Reid, G. Pilot assessment of probiotics for pregnant women in Rwanda. *PLoS One* **2018**, *13*, e0195081.
44. Hummelen, R.; Fernandes, A.D.; Macklaim, J.M.; Dickson, R.J.; Chagalucha, J.; Gloor, G.B.; Reid, G. Deep Sequencing of the Vaginal Microbiota of Women with HIV. *PLoS One* **2010**, *5*, e12078.
45. Juliana NCA, Suiters MJM, Al-Nasiry S, Morr e SA, P.R. and A.E. The association between vaginal microbiota dysbiosis, bacterial vaginosis and aerobic vaginitis, and adverse pregnancy outcomes of women living in sub-Saharan Africa: A systematic review. *Unpublished* **2020**.
46. Bisanz, J.E.; Enos, M.K.; PrayGod, G.; Seney, S.; Macklaim, J.M.; Chilton, S.; Willner, D.; Knight, R.; Fusch, C.; Fusch, G.; et al. Microbiota at multiple body sites during pregnancy in a rural tanzanian population and effects of Moringa-supplemented probiotic yogurt. *Appl. Environ. Microbiol.* **2015**, *81*, 4965–4975.
47. Kyei-Nimakoh, M.; Carolan-Olah, M.; McCann, T. V. Access barriers to obstetric care at health facilities in sub-Saharan Africa—a systematic review. *Syst. Rev.* **2017**, *6*.
48. World Health Organization *World health statistics 2019: monitoring health for the SDGs, sustainable development goals.* ; Geneva, 2019; ISBN CC BY-NC-SA 3.0 IGO.
49. Mullick, S.; Watson-Jones, D.; Bekinska, M.; Mabey, D. Sexually transmitted infections in pregnancy: Prevalence, impact on pregnancy outcomes, and approach to treatment in developing countries. *Sex. Transm. Infect.* **2005**, *81*, 294–302.
50. Adachi, K.; Nielsen-Saines, K.; Klausner, J.D. Chlamydia trachomatis Infection in Pregnancy: The Global Challenge of Preventing Adverse Pregnancy and Infant Outcomes in Sub-Saharan Africa and Asia. *Biomed Res Int.* **2016**, *2016*, 9315757.



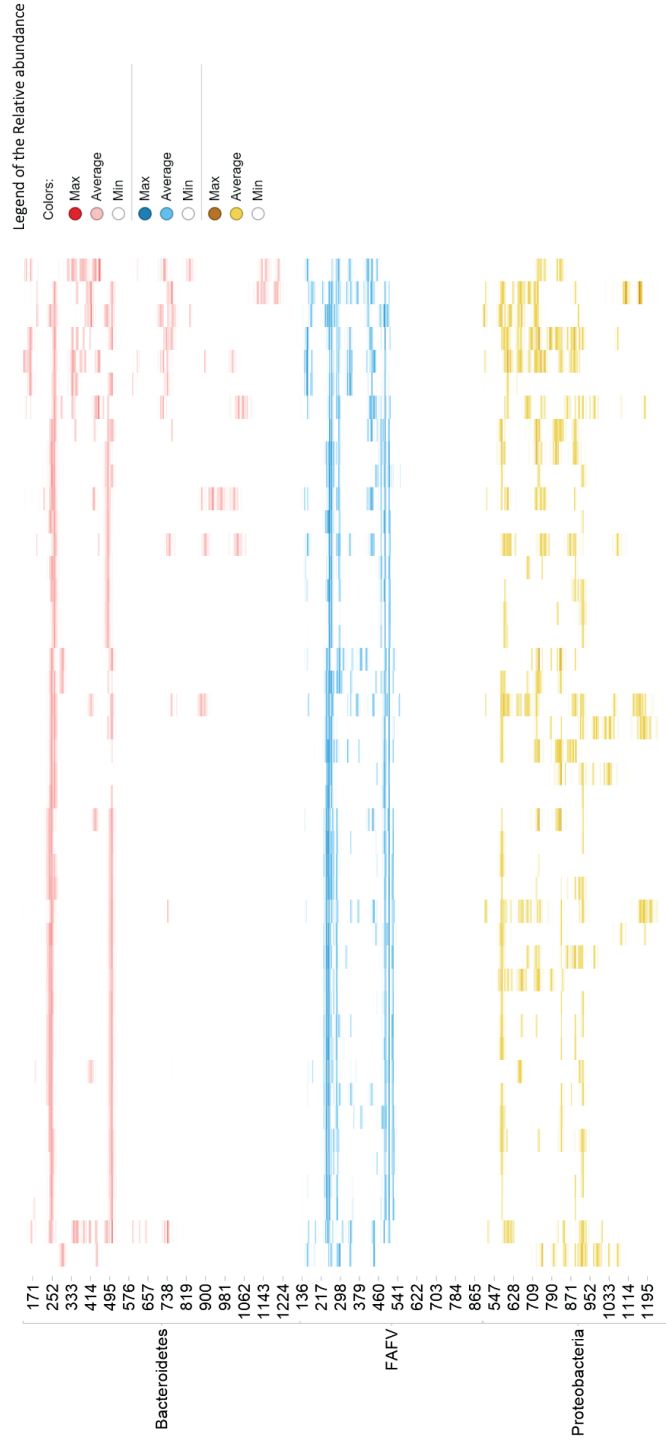
51. World Health Organization *Global incidence and prevalence of selected curable sexually transmitted infections-2008*; 2012;
52. Al-Nasiry, S.; Ambrosino, E.; Schlaepfer, M.; Morr , S.A.; Wieten, L.; Voncken, J.W.; Spinelli, M.; Mueller, M.; Kramer, B.W. The Interplay Between Reproductive Tract Microbiota and Immunological System in Human Reproduction. *Front. Immunol.* 2020, *11*, 378.
53. Alliance for Maternal and Newborn Health Improvement; Baqui, A.H.; Khanam, R.; Rahman, M.S.; Ahmed, A.; Rahman, H.H.; Moin, M.I.; Ahmed, S.; Jehan, F.; Nisar, I.; et al. Understanding biological mechanisms underlying adverse birth outcomes in developing countries: Protocol for a prospective cohort (AMANHI bio-banking) study. *J. Glob. Health* 2017, *7*, 021201.
54. Juliana, N.C.A.; Deb, S.; Ouburg, S.; Chauhan, A.; Pleijster, J.; Ali, S.M.; Morr , S.A.; Sazawal, S.; Ambrosino, E. The Prevalence of Chlamydia trachomatis and Three Other Non-Viral Sexually Transmitted Infections among Pregnant Women in Pemba Island Tanzania. *Pathogens* 2020, *9*, 625.
55. Dols, J.A.M.; Molenaar, D.; van der Helm, J.J.; Caspers, M.P.M.; Angelino-Bart, A. de K.; Schuren, F.H.J.; Speksnijder, A.G.C.L.; Westerhoff, H. V.; Richardus, J.H.; Boon, M.E.; et al. Molecular assessment of bacterial vaginosis by Lactobacillus abundance and species diversity. *BMC Infect. Dis.* 2016, *180*, 1–8.
56. Budding, A.E.; Hoogewerf, M.; Vandenbroucke-Grauls, C.M.J.E.; Savelkoul, P.H.M. Automated Broad-Range Molecular Detection of Bacteria in Clinical Samples. *Am Soc Microbiol* 2016.
57. Budding, A.E.; Grasman, M.E.; Lin, F.; Bogaards, J.A.; Soeltan-Kaersenhout, D.J.; Vandenbroucke-Grauls, C.M.J.E.; Van Bodegraven, A.A.; Savelkoul, P.H.M. IS-pro: high-throughput molecular fingerprinting of the intestinal microbiota. *FASEB J.* 2010, *24*, 4556–4564.
58. Ravel, J.; Gajer, P.; Abdo, Z.; Schneider, G.M.; Koenig, S.S.K.; Mcculle, S.L.; Karlebach, S.; Gorle, R.; Russell, J.; Tacket, C.O.; et al. Vaginal microbiome of reproductive-age women.
59. Jost, L. The Relation between Evenness and Diversity. *Diversity* 2010, *2*, 207–232.
60. de Waaij, D.J.; Ouburg, S.; Dubbink, J.H.; Peters, R.P.H.; Morr , S.A. Evaluation of Prestoplus assay and LightMix kit Trichomonas vaginalis assay for detection of Trichomonas vaginalis in dry vaginal swabs. *J. Microbiol. Methods* 2016, *127*, 102–104.
61. de Waaij, D.J.; Dubbink, J.H.; Peters, R.P.H.; Ouburg, S.; Morr , S.A. Comparison of GMT presto assay and Roche cobas® 4800 CT/NG assay for detection of Chlamydia trachomatis and Neisseria gonorrhoeae in dry swabs. *J. Microbiol. Methods* 2015, *118*, 70–74.
62. M ller, E.E.; Venter, J.M.E.; Magooa, M.P.; Morrison, C.; Lewis, D.A.; Mavedzenge, S.N. Development of a rotor-gene real-time PCR assay for the detection and quantification of Mycoplasma genitalium. *J. Microbiol. Methods* 2012, *88*, 311–315.
63. Juliana, N.C.A.; Juma, M.H.; Heijmans, R.; Ouburg, S.; Ali, S.M.; Chauhan, A.S.; Pemba, A.B.; Sazawal, S.; Morr , S.A.; Deb, S.; et al. Detection of high-risk human papillomavirus (HPV) by the novel AmpFire isothermal HPV assay among pregnant women in Pemba Island, Tanzania. *Pan Afr. Med. J.* 2020, *37*.
64. Masha, S.C.; Cools, P.; Descheemaeker, P.; Reynders, M.; Sanders, E.J.; Vanechoutte, M. Urogenital pathogens, associated with Trichomonas vaginalis, among pregnant women in Kilifi, Kenya: a nested case-control study. *BMC Infect. Dis.* 2018, *18*, 549.
65. Vanechoutte, M. Lactobacillus iners, the unusual suspect. *Res. Microbiol.* 2017, *168*, 826–836.
66. Freitas, A.C.; Chaban, B.; Bocking, A.; Rocco, M.; Yang, S.; Hill, J.E.; Money, D.M.; Hemmingsen, S.; Reid, G.; Dumonceaux, T.; et al. The vaginal microbiome of pregnant women is less rich and diverse, with lower prevalence of Mollicutes, compared to non-pregnant women. *Sci. Rep.* 2017, *7*.
67. Gudza-Mugabe, M.; Havyarimana, E.; Jaumdally, S.; Garson, K.L.; Lennard, K.; Tarupiwa, A.; Mugabe, F.; Marere, T.; Mavyenyenga, R.T.; Masson, L.; et al. HIV infection is associated with preterm delivery independent of vaginal microbiota in pregnant African women. *J. Infect. Dis.* 2019.
68. Borgdorff, H.; Verwijs, M.C.; Wit, F.W.N.M.; Tsvitivadze, E.; Ndayisaba, G.F.; Verhelst, R.; Schuren, F.H.; Van De Wijgert, J.H.H.M. The impact of hormonal contraception and pregnancy on sexually transmitted infections and on cervicovaginal microbiota in african sex workers. *Sex. Transm. Dis.* 2015, *42*, 143–152.
69. O’Hara, M.W.; Schlechte, J.A.; Lewis, D.A.; Wright, E.J. Prospective Study of Postpartum Blues: Biological and Psychosocial Factors. *Arch. Gen. Psychiatry* 1991, *48*, 801–806.
70. Nott, P.N.; Franklin, M.; Armitage, C.; Gelder, M.G. Hormonal changes and mood in the puerperium. *Br. J. Psychiatry* 1976, *128*, 379–383.
71. Onderdonk, A.B.; Delaney, M.L.; Fichorova, R.N. The human microbiome during bacterial vaginosis. *Clin. Microbiol. Rev.* 2016, *29*, 223–238.
72. Parnell, L.A.; Briggs, C.M.; Mysorekar, I.U. Maternal microbiomes in preterm birth: Recent progress and analytical pipelines. *Semin. Perinatol.* 2017, *41*, 392–400.
73. Kinney, M. V.; Lawn, J.E.; Howson, C.P.; Belizan, J. 15 million preterm births annually: What has changed this year? *Reprod. Health* 2012, *9*, 28.
74. Donders, G.G.G.; Bellen, G.; Grinceviciene, S.; Ruban, K.; Vieira-Baptista, P. Aerobic vaginitis: no longer a stranger. *Res. Microbiol.* 2017.
75. Kaambo, E.; Africa, C.W.J. The threat of aerobic vaginitis to pregnancy and neonatal morbidity. *Afr. J. Reprod. Health* 2017, *21*, 108–118.
76. Akerele, J.; Abhulimen, P.; Okonofua, F. Prevalence of asymptomatic genital infection among pregnant women in Benin City, Nigeria. *Afr. J. Reprod. Health* 2002, *6*, 93–97.
77. Shrestha, L.B.; Baral, R.; Poudel, P.; Khanal, B. Clinical, etiological and antimicrobial susceptibility profile of pediatric urinary tract infections in a tertiary care hospital of Nepal. *BMC Pediatr.* 2019, *19*, 1–8.
78. Tao, Z.; Zhang, L.; Zhang, Q.; Lv, T.; Chen, R.; Wang, L.; Huang, Z.; Hu, L.; Liao, Q. The pathogenesis of streptococcus anginosus in aerobic vaginitis. *Infect. Drug Resist.* 2019, *12*, 3745–3754.
79. Cox, R.A.; Chen, K.; Coykendall, A.L.; Wesbecher, P.; Hersont, V.C. Fatal infection in neonates of 26 weeks’ gestation due to Streptococcus milleri: report of two cases. *JClin Pathol* 1987, *40*, 190–193.
80. Omwandho, C.O.A.; Gruessner, S.E.M.; Tinneberg, H.R. Early pregnancy loss and neonatal deaths associated with Klebsiella pneumonia infection: A mini review of possible occupational health risk. *Arch. Gynecol. Obstet.* 2006, *273*, 258–260.
81. Le Doare, K.; Heath, P.T.; Plumb, J.; Owen, N.A.; Brocklehurst, P.; Chappell, L.C. Uncertainties in Screening and Prevention of Group B Streptococcus Disease. *Clin. Infect. Dis.* 2019, *69*, 720–725.
82. Stevens, D.; Kaplan, E. *Streptococcal infections: clinical aspects, microbiology, and molecular pathogenesis*; Oxford University Press, Ed.; USA, 2000;
83. Gizachew, M.; Tiruneh, M.; Moges, F.; Tessema, B. Streptococcus agalactiae maternal colonization, antibiotic resistance and serotype profiles in Africa: A meta-analysis. *Ann. Clin. Microbiol. Antimicrob.* 2019, *18*, 14.
84. O’Sullivan, C.P.; Lamagni, T.; Patel, D.; Efstratiou, A.; Cunney, R.; Meehan, M.; Ladhani, S.; Reynolds, A.J.; Campbell, R.; Doherty, L.; et al. Group B streptococcal disease in UK and Irish infants younger than 90 days, 2014–15: a prospective surveillance study. *Lancet Infect. Dis.* 2019, *19*, 83–90.
85. Nanayakkara, D.; Liyanapathirana, V.; Kandauda, C.; Gihan, C.; Ekanayake, A.; Adasooriya, D. Maternal vaginal colonization with selected potential pathogens of neonatal sepsis in the era of antimicrobial resistance, a single center experience from Sri Lanka. *BMC Infect. Dis.* 2018, *18*, 1–9.
86. Romero, R.; Hassan, S.S.; Gajer, P.; Tarca, A.L.; Fadrosh, D.W.; Nikita, L.; Galuppi, M.; Lamont, R.F.; Chaemsaitong, P.; Miranda, J.; et al. Correction to : The composition and stability of the vaginal microbiota of normal pregnant women is different from that of non-pregnant women. *Microbiome* 2014, *2*, 10.

87. Brabin, L.; Roberts, S.A.; Gies, S.; Nelson, A.; Diallo, S.; Stewart, C.J.; Kazienga, A.; Birtles, J.; Ouedraogo, S.; Claeys, Y.; et al. Effects of long-term weekly iron and folic acid supplementation on lower genital tract infection - a double blind, randomised controlled trial in Burkina Faso. *BMC Med.* **2017**, *15*.
88. Fichorova, R.N.; Buck, O.R.; Yamamoto, H.S.; Fashemi, T.; Dawood, H.Y.; Fashemi, B.; Hayes, G.R.; Beach, D.H.; Takagi, Y.; Delaney, M.L.; et al. The villain team-up or how trichomonas vaginalis and bacterial vaginosis alter innate immunity in concert. *Sex. Transm. Infect.* **2013**, *89*, 460–466.
89. Borgdorff, H.; Armstrong, S.D.; Tytgat, H.L.P.; Xia, D.; Ndayisaba, G.F.; Wastling, J.M.; Van De Wijgert, J.H.H.M. Unique insights in the cervicovaginal *Lactobacillus iners* and *L. crispatus* proteomes and their associations with microbiota dysbiosis. *PLoS One* **2016**, *11*.
90. Petrova, M.I.; Reid, G.; Vanechoutte, M.; Lebeer, S. *Lactobacillus iners*: Friend or Foe? *Trends Microbiol.* **2017**, *25*, 182–191.
91. Ahmed, I.; Ali, S.M.; Amenga-Etego, S.; Ariff, S.; Bahl, R.; Baqui, A.H.; Begum, N.; Bhandari, N.; Bhatia, K.; Bhutta, Z.A.; et al. Population-based rates, timing, and causes of maternal deaths, stillbirths, and neonatal deaths in south Asia and sub-Saharan Africa: a multi-country prospective cohort study. *Lancet Glob. Heal.* **2018**, *6*, e1297–e1308.
92. Singer, M.; Borg, M.; Ouburg, S.; Morré, S.A. The relation of the vaginal microbiota to early pregnancy development during in vitro fertilization treatment—A meta-analysis. *J. Gynecol. Obstet. Hum. Reprod.* **2019**, *48*, 223–229.
93. Jochum, L.; Stecher, B. Label or Concept - What Is a Pathobiont? *Trends Microbiol.* **2020**, *28*, 789–792.
94. McBurney, M.I.; Davis, C.; Fraser, C.M.; Schneeman, B.O.; Huttenhower, C.; Verbeke, K.; Walter, J.; Latulippe, M.E. Establishing What Constitutes a Healthy Human Gut Microbiome: State of the Science, Regulatory Considerations, and Future Directions. *J. Nutr.* **2019**, *149*, 1882–1895.

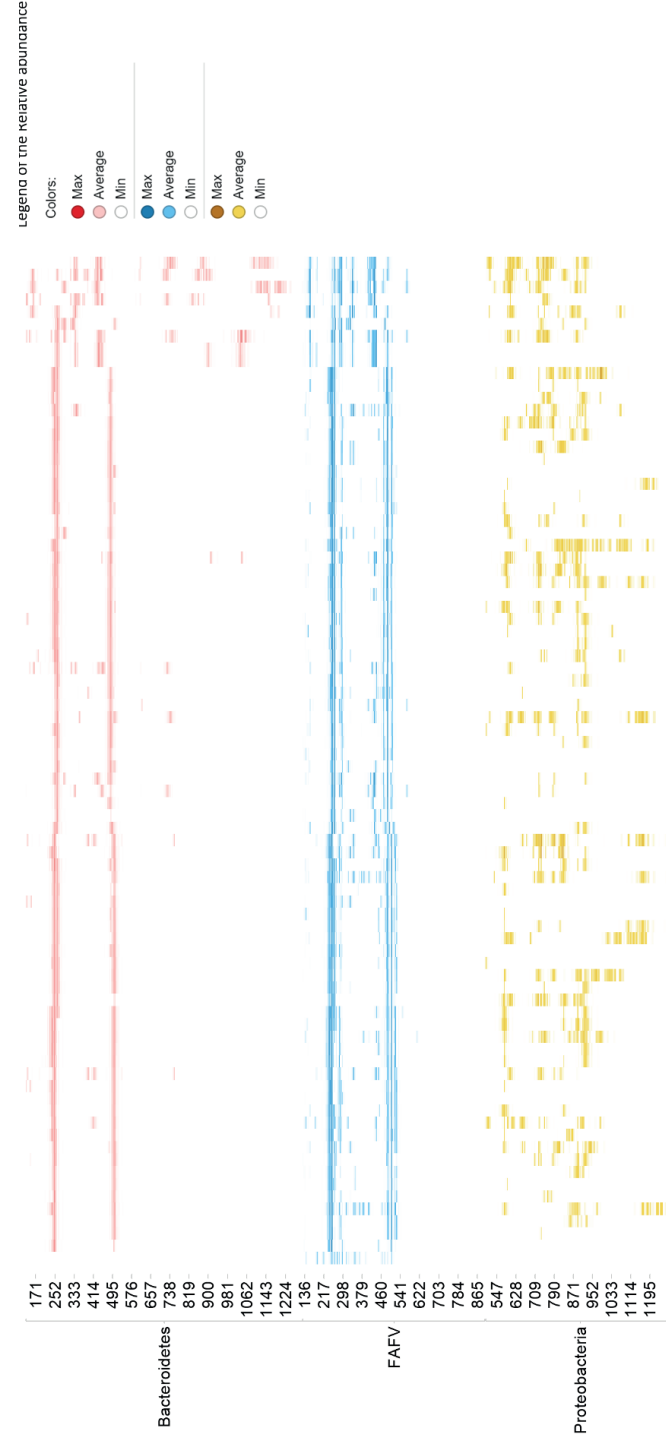
## 7 SUPPLEMENTARY DATA



**Figure S1.** Number of vaginal samples at each collection point. In total 170 vaginal samples from 90 women were tested and analyzed, 44 vaginal samples at enrollment, 82 at second pregnancy collection point and 44 post-delivery.

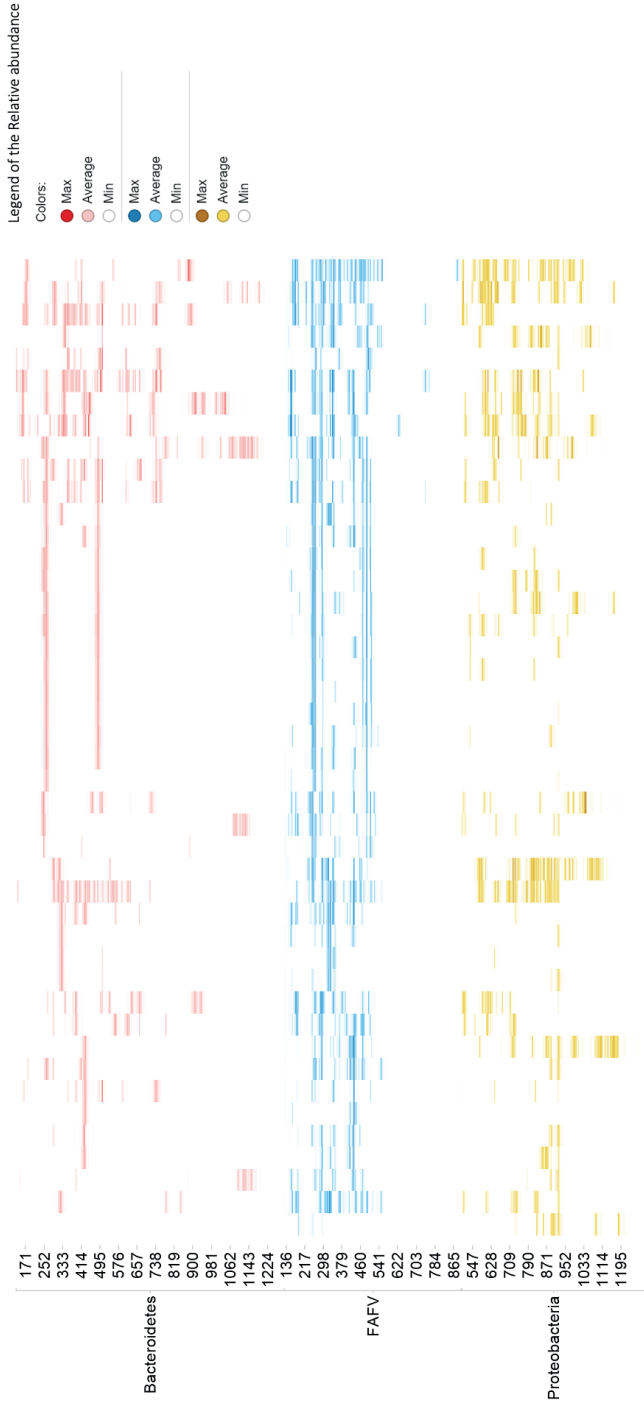


**Figure S2.** Cluster analysis 44 vaginal samples collected during pregnancy at fist pregnancy collection point. Each column represents a sample, each row represents a bacterial species corresponding to a specific nucleotide number (bacteria from the phyla *Bacteroidetes* in red, *Actinobacteria*, *Fusobacteria*, *Firmicutes*, and *Verrucomicrobia* in blue, bacteria from the phylum *Proteobacteria* in yellow).

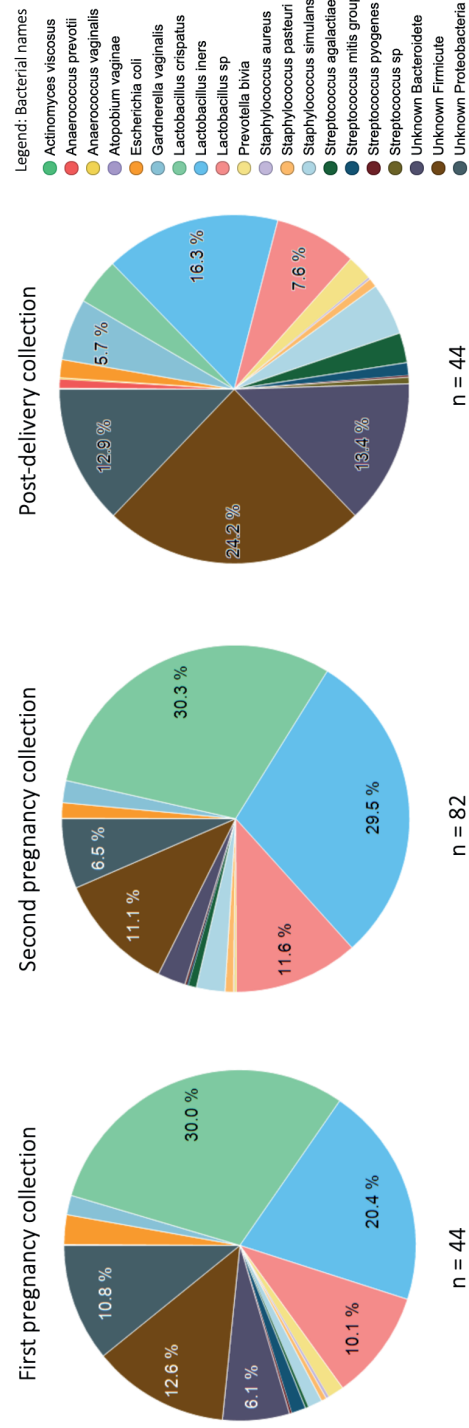


**Figure S3.** Cluster analysis 82 vaginal samples collected during pregnancy at second pregnancy collection. Each column represents a sample, each row represents a bacterial species corresponding to a specific nucleotide number (bacteria from the phyla *Bacteroidetes* in red, *Actinobacteria*, *Fusobacteria*, *Firmicutes*, and *Verrucomicrobia* in blue, bacteria from the phylum *Proteobacteria* in yellow).



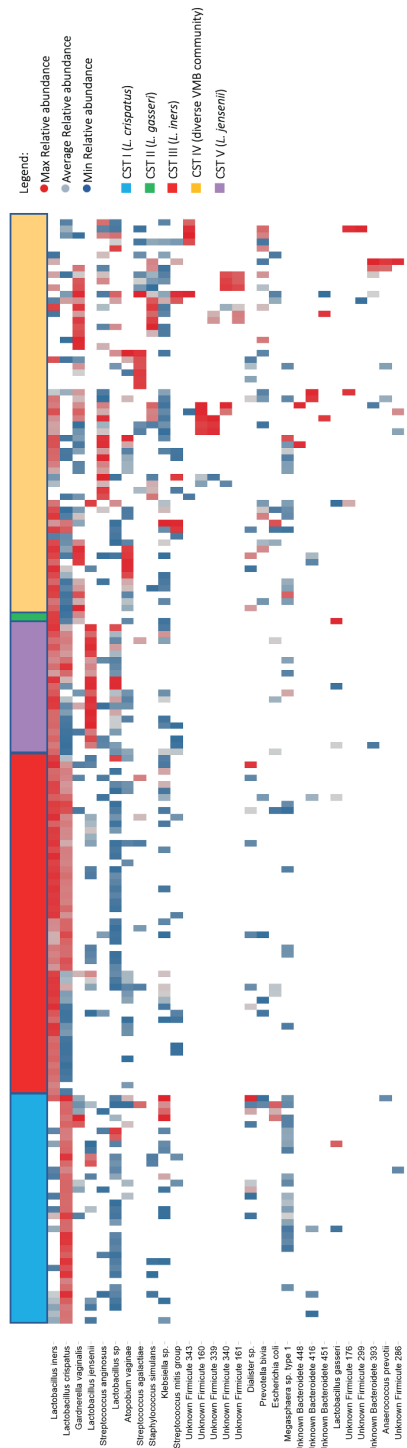


**Figure S4.** Cluster analysis 44 vaginal samples collected post-delivery. Each column represents a sample, each row represents a bacterial species corresponding to a specific nucleotide number (bacteria from the phyla *Bacteroidetes* in red, *Actinobacteria*, *Fusobacteria*, *Firmicutes*, and *Verrucomicrobia* in blue, bacteria from the phylum *Proteobacteria* in yellow).

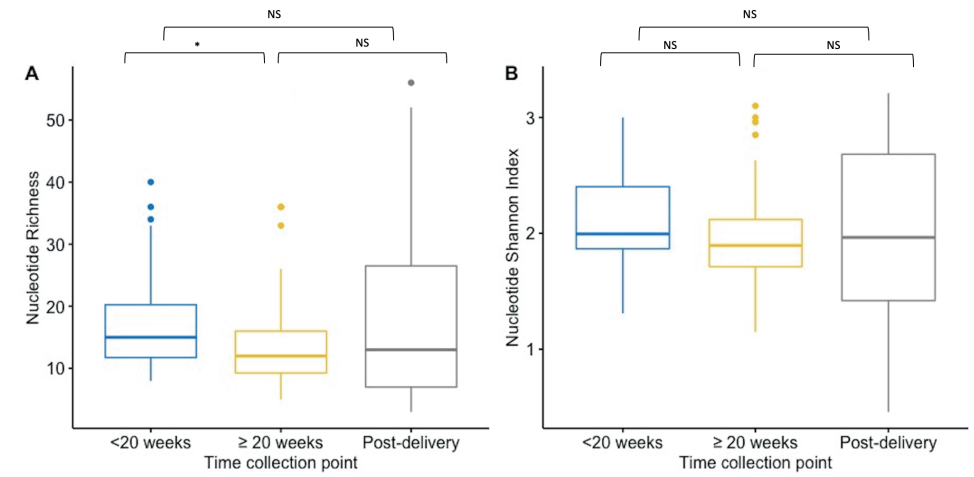


**Figure S5.** The frequency of bacterial species or unknown genus/family bacteria observed per collection time point.



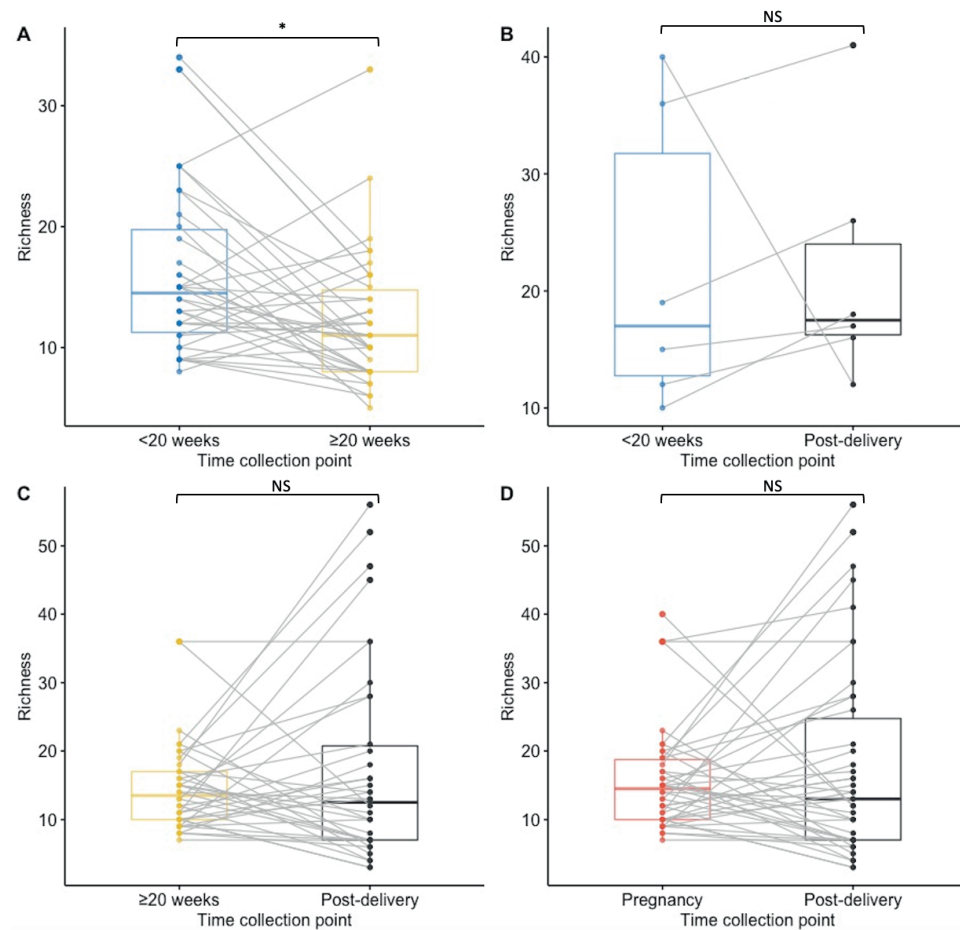


**Figure S6.** Heatmap of all samples of the cohort in Pemba Island showing the 29 species with the highest relative abundance. Each column represents a sample, each row represents a bacterial species. In the dendrogram the community state type (CST) cluster are given in color; CST I; blue, CST II; green, CST III; red, CST IV; yellow, CST V; purple

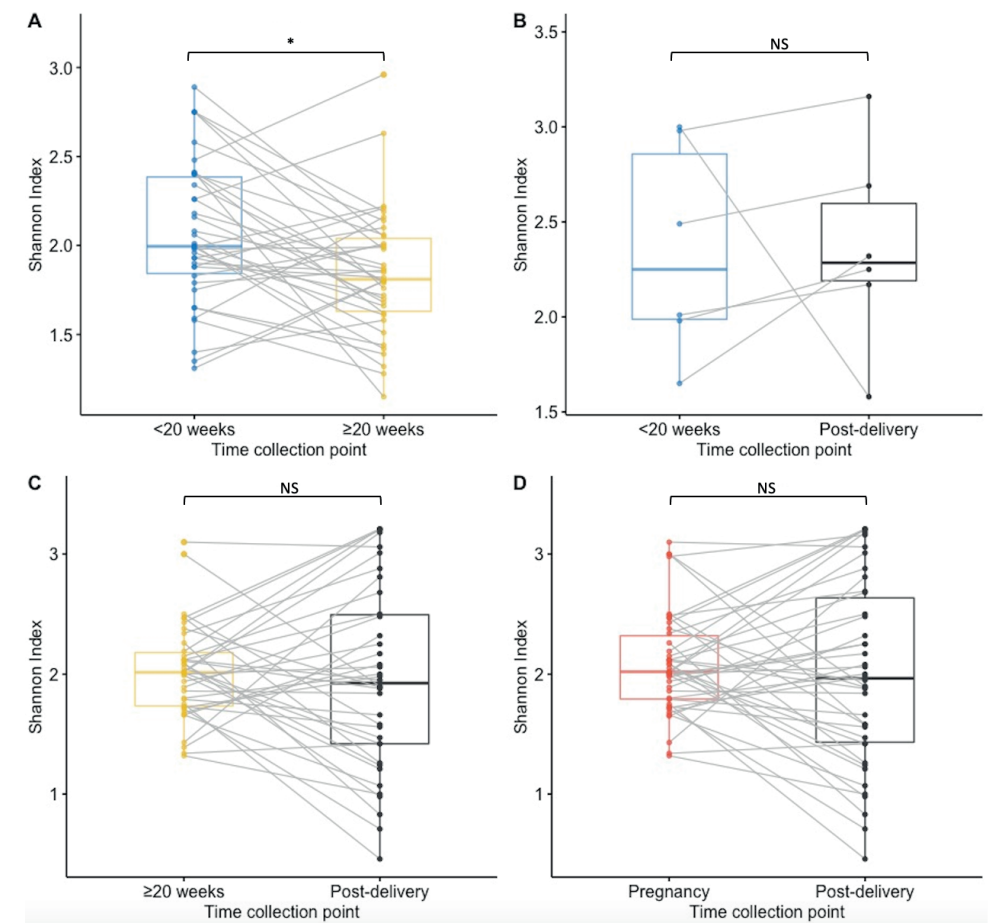


**Figure S7.1.** Boxplot for the richness (A) and Shannon diversity index (B) at nucleotide level for each collection point. Results of first pregnancy collection are in blue (n = 44), second pregnancy collection in yellow (n = 82), and postdelivery in grey (n = 44). A. Nucleotides richness is lower at second pregnancy collection compare to the pregnancy collection at first pregnancy collection ( $p = 0.02$ ), but between the other timepoints there were no significance difference. B. The Shannon diversity index did not significantly differ between the collection timepoints.





**Figure S7.2.** Boxplots for nucleotide richness at each collection point for paired samples. Results of first pregnancy collection are in blue, second pregnancy collection in yellow, and postdelivery in black and pregnancy in red. A. The nucleotide richness was significantly lower at the second pregnancy collection point than at first pregnancy collection ( $p < 0.01$ ) in matched samples from 38 women. B. There was no significant difference in the nucleotide richness between first pregnancy collection and post-delivery matched samples from 6 women. C. Non significant difference was calculated in the nucleotide richness between second pregnancy collection and post-delivery matched samples from 38 women. D. For 42 women that had samples collected at least once during pregnancy and post-delivery, no significant difference in the species richness was calculated.



**Figure S7.3.** Boxplots for Shannon diversity index at nucleotide level for paired samples. Results of first pregnancy collection are in blue, second pregnancy collection in yellow, and postdelivery in black and pregnancy in red. A. The Shannon diversity index was significantly higher at the second pregnancy collection point than at first pregnancy collection in matched samples from 38 women ( $p < 0.01$ ). B. There was no significant difference in the Shannon diversity index between first pregnancy collection and post-delivery matched samples from 6 women. C. Non significant difference was calculated in the Shannon diversity between second pregnancy collection and post-delivery matched samples from 38 women. D. For 42 women that had samples collected at least once during pregnancy and post-delivery, no significant difference in the Shannon diversity index was calculated.

## 7 SUPPLEMENTARY INFORMATION

### AUTHOR CONTRIBUTIONS

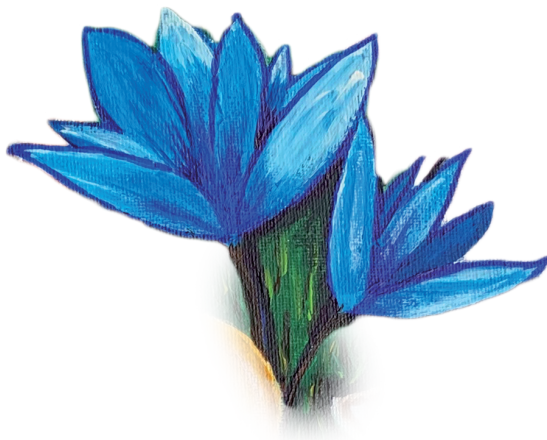
Conception of the idea: E.A, S.M; Methodology, N.C.A.J., L.P, and A.E.B.; formal analysis, N.C.A.J., L.P, A.E.B., S.O. and S.M.; data and biospecimen collections, M.A.J., A.M., and S.M.A.; resources, A.E.B., S.D., S.S., S.A.M.; writing-original draft, N.C.A.J.; writing-review and editing, N.C.A.J., A.E.B., S.M., E.A.; supervision: S.M., S.S., E.A.; project administration: E.A. S.S., S.D.; funding acquisition: S.M., S.S., E.A. All the authors read and approved the final manuscript.

### ACKNOWLEDGEMENTS

All the women who participated in the biobank study in Pemba Island Tanzania and all staff of the biobank. Sonja N.H. Puljhun, Monique M. Verveer, Maarten Boon, and Nina B. Uiljdert for their direct technical assistance in the laboratory or with Spotify. H. Wang for his assistance with generating some of the figures.

You didn't come this far to only come this far.

*- Mick Kremling*



# 8

## **GENERAL DISCUSSION**



## 8 GENERAL DISCUSSION

This thesis describes the microbiota (VMB) composition and burden of sexually transmitted infections (STIs) and their pivotal role in pregnancy of sub-Saharan African women, with a focus on Pemba Island, Tanzania. Primarily, previous findings that reported the relationship between the VMB and related vaginal conditions in pregnancy, and its role with adverse pregnancy outcomes, STIs and other (environmental, host genetics, socioeconomics, and hormonal) factors in the sub-Saharan African population were reviewed. Additionally, the VMB composition and the occurrence and persistence of five STIs by *Chlamydia (C.) trachomatis*, *Neisseria (N.) gonorrhoeae*, *Trichomonas (T.) vaginalis*, *Mycoplasma (M.) genitalium*, and human papillomaviruses (HPV) were assessed in pregnant Tanzanian women living on the Pemba Island, an island in the Zanzibar archipelago.

Firstly, the vaginal tract *friends* (lactic-acid producing microbes, such as most species belonging to *Lactobacillus* genus and particularly *L. crispatus*) and *frenemies* (e.g., VMB related bacteria with potential pathological sequelae, also known as pathobionts) have been discussed in **chapter 2** and **3**. Previous evidence on the VMB compositions in pregnant women from sub-Saharan Africa was reviewed in **chapter 2**. **Chapter 3** resumes on the preceding evidence on the association between VMB dysbiosis, BV, and AV, and late adverse pregnancy outcomes in women living in sub-Saharan Africa.

Secondly, insights into the genital tract *enemies* (such as STIs) during and after pregnancy among women in Pemba Island, Tanzania are provided. The prevalence of *C. trachomatis*, *N. gonorrhoeae*, *T. vaginalis*, and *M. genitalium* among pregnant women in Pemba Island has been described in **chapter 4**, and the prevalence of high-risk HPV (hrHPV) genotypes in **chapter 6**. In this latter chapter, the persistence of high-risk HPV genotypes in pregnancy has been investigated, while that of *C. trachomatis*, *N. gonorrhoeae*, *T. vaginalis*, and *M. genitalium* during and after delivery of these women have been reported in **chapter 5**.

Finally, evidence of the vaginal environment *friends, enemies, and frenemies (or everything in between)* during pregnancy is combined and discussed in **chapter 7** for women of Pemba Island and in **chapter 8** for women in sub-Saharan Africa. In **chapter 7**, the VMB composition among pregnant and post-delivery women in Pemba Island, Tanzania, is characterized, along with the presence of the five previously mentioned STIs.

In this **chapter 8**, findings from the previous chapter and factors that can influence the VMB, STIs and performing research on them are summarized and discussed. In addition, recommendations on improving STIs and vaginal dysbiosis research, STI prevention, and management during pregnancy in sub-Saharan Africa are further elaborated. It is expected that based on the conclusion and recommendations statements, future research and public health implications can be developed *to preserve the vaginal environment's friends, make efforts to combat its enemies, and control the frenemies*.

### Contents of this chapter

1. Presence of Lactobacilli in the VMB of pregnant women in sub-Saharan Africa
2. Burden of STIs during pregnancy and post-delivery in Pemba Island, Tanzania
3. Factors that influence the VMB and STI burden in pregnancy
4. The way forward on further improving the VMB and STI research and policies in sub-Saharan Africa
5. Conclusions and recommendations

### 8.1 PRESENCE OF LACTOBACILLI IN THE VMB OF PREGNANT WOMEN IN SUB-SAHARAN AFRICA

Most of the VMB studies during pregnancy have been conducted among North-American and European populations; however, there were some reports from studies that have been conducted in Asia and Sub-Saharan Africa [1–8]. **Chapter 2** reviews previous studies that analyzed the VMB composition during pregnancy in sub-Saharan African women. The majority of studies observed a *Lactobacillus* dominant VMB in most pregnant women (frequency ranging between 29–100%; median 56%) [5,9–17]. These frequencies were independent of the type of classification used to characterize the VMB and of the gestational age at sampling. Moreover, most of the studies which characterized the VMB by its most dominant species, observed a VMB frequently dominated by *L. iners* or *L. crispatus*. These findings agree with previous results from North America and the United Kingdom [8,18,19]. Additionally, VMB dominated by *L. gasseri* and *L. jenseni* were also often present among pregnant women from sub-Saharan Africa. This was also observed in a study among pregnant women with African ancestry in the United Kingdom and pregnant women in North America [8,20,21]. Furthermore, many pregnant women in sub-Saharan Africa also had a diverse VMB community, characterized by lower proportions of lactic acid bacteria and higher proportions of strictly anaerobic organisms (frequency ranging between 0–71%; median 38%) [7,8,10,14,15]. These findings are in alignment with previous results from pregnant women with African ancestry in North-America [22,23].

Most of these diverse VMB clusters were based on the higher abundance of *Gardnerella vaginalis* or other (anaerobic) bacteria, such as *Prevotella* and *Atopobium* species. In some cases a low abundance of *L. iners* was present [9,11,14,24]. There is increasing evidence that a VMB dominated by *L. crispatus*, *L. gasseri*, or *L. jenseni* relates to a healthy vaginal state and an overgrowth of (facultative) anaerobes as *Gardnerella*, *Atopobium*, and *Prevotella* species most likely contributes to a dysbiotic vaginal state. A dysbiotic vaginal state (an overgrowth of (facultative) anaerobes) is often defined as a prolonged deviation from a low-diversity, Lactobacilli-dominated VMB [25]. This vaginal state and its associated bacteria have been linked to the vaginal condition bacterial vaginosis (BV) [26]. However, it remains unclear what type of vaginal state is associated with an *L. iners*-dominated VMB [27–29]. There is increasing research interest to evaluate *L. iners* exact role, especially in high abundance, in the VMB and its relation to female reproductive health.

Furthermore, a diverse VMB seems to be associated with infertility and multiple adverse pregnancy outcomes such as stillbirth, preterm birth, and low birthweight [1–3]. **Chapter 3** compiles previous findings on the association between VMB and adverse pregnancy outcomes in the sub-Saharan African region. Unfortunately, to date only one study has investigated this relationship using the outdated culture-based method [30]. Donders et al. suggested an association between VMB with no or low Lactobacilli and the risk of having a child weighing less than 2 kg [30]. However, newer studies, using molecular-based methods, are required to confirm this finding and investigate the relationship of a diverse VMB and various adverse pregnancy outcomes in pregnant women from sub-Saharan Africa.

Moreover, a number of studies investigating the relationship between VMB and preterm birth or other adverse pregnancy outcomes in various populations show different results. Some studies found that a high abundance of *Gardnerella* or *Ureaplasma*'s is associated with a low abundance of *Lactobacillus* species with preterm birth (PTB), while other studies did not [7,19]. Others have reported that changes in the alpha diversity indices, the number of species (richness) and number and relative abundance of species (Shannon diversity), are associated with PTB [23]. Thus, these indices might better predict an adverse pregnancy outcome than the exclusive presence of specific taxa or a taxon [23].

Fortunately, more studies (n= 11) have investigated the relationship between BV and seven late adverse pregnancy outcomes. As shown in **chapter 3**, there are still conflicting findings regarding an association between BV and low birthweight, premature pre-rupture of membranes, preterm birth, intra-uterine infection, and small for gestational age. However, for most adverse pregnancy outcomes these findings were only a few times reported, and a general conclusion is still lacking. However, an interesting observation is made in **chapter 3**; no study so far has reported to observe a relationship between BV and pregnancy loss in sub-Saharan Africa.

Evidence to support the effect of BV in early pregnancy is much higher for PTB or other adverse pregnancy than BV in later pregnancy. In a multicenter North-American cohort study of 10 397 pregnant women (with BV prevalence of 16%) the presence of BV was found to be positive correlated with preterm delivery of a low-birth-weight infants (< 2500 gram) (odds ratio (OR), 1.4; 95 percent confidence interval (CI), 1.1 - 1.8) [31]. These findings are in agreement with the results of a previous meta-analysis, even though this meta-analysis was not specific to the sub-Saharan African populations [32]. Furthermore, the authors not only observed the association between asymptomatic BV and preterm delivery (OR: 2.16, 95% CI: 1.56–3.00), they also reported that BV and patients with symptoms of preterm labor (OR: 2.38, 95% CI: 1.02–5.58), late miscarriages (OR: 6.32, 95% CI: 3.65–10.94) and maternal infection (OR: 2.53, 95% CI 1.26–5.08) were positively associated [32]. Similar to the findings of **chapter 3**, no significant results were reported in their meta-analysis for the outcomes of neonatal infection or perinatal mortality with BV. As suggested before, specific BV-related bacteria may be the culprit rather than BV. For instance, in a different study conducted in North-America, various bacteria were more prevalent in the VMB of women with a subsequent spontaneous

preterm birth (*Megasphaera* phylotype 1 (relative risk (RR) = 2.00, 95% CI: 0.94– 4.26), *Gardnerella vaginalis* (RR = 1.21, 95% CI: 0.73–2.01) and *Leptotrichia/Sneathia* (RR = 1.44, 95% CI: 0.75–2.79)) measured at 32 weeks' gestation, were more prevalent among women with a subsequent spontaneous preterm birth [33]. Systematic research on BV-related species' role in adverse pregnancy outcomes is still warranted among sub-Saharan African women. Additionally, for another less well-known vaginal dysbiotic condition, aerobic vaginitis (AV), almost a 3-fold increase of risk of (early) preterm birth has been reported separately for women in Belgium and Saudi Arabia [34,35]. A relationship between AV and other adverse outcomes, such as premature rupture of membranes, was also reported [35]. **Chapter 3** calls for further research on AV and pregnancy outcomes in sub-Saharan Africa as no articles investigating this relationship have yet been published.

**Chapter 7** investigates the VMB characteristics of 90 local pregnant women from Pemba Island. The prevalence of *Lactobacillus* dominant VMB was 65% before 20 gestational weeks (GA) and 81% after 20 GA weeks, which is in accordance with the outcome of the sub-Saharan African studies reported in **chapter 2**. Similar to other studies during pregnancy, in this population from Pemba Island, *L. iners* (<20 GA weeks; 25% and ≥ 20 GA weeks: 43%) and *L. crispatus* (<20 GA weeks; 26% and ≥ 20 GA weeks 19%) were the most dominant species during pregnancy. A high prevalence of a diverse VMB community (<20 GA weeks; 35% and ≥ 20 GA weeks: 19%) was also observed in this local population; however, in line with other longitudinal studies, the frequency of diverse VMB community decreases as the pregnancy progresses [7,22]. Heatmaps (graphical representation of the relative abundance of species in the microbiota) in **Chapter 7** also illustrate that when *Lactobacillus* species are in low abundance, women can carry higher levels of facultative anaerobic bacteria with species such as *Atopobium*, *Gardnerella*, and *Prevotella*; this is also in concordance with previous observations [7].

Furthermore, several pathobionts were also observed in this cohort. *Klebsiella species* and *Streptococcus anginosus* were the most commonly identified pathobionts. In **Chapter 7**, conditions (such as premature pregnancy loss) associated with those and other pathobionts are discussed in more detail. Due to the low number of samples (n =170) and cases with adverse pregnancy outcomes (4% miscarriage, 1% stillbirth, 6% preterm delivery), no relationship between pregnancy complications and VMB dysbiosis or pathobionts was reported in **chapter 7**. However, it is essential to note that it remains unclear whether pathobionts in the VMB are clinically relevant, since evidence is still weak [36].

Furthermore, **Chapter 7** covers one of the few studies in sub-Saharan Africa looking at the VMB composition in post-delivery women. Similar to other findings in different populations, the prevalence of a diverse VMB community was high (74%) 42-60 days after parturition. Also, more pathobionts and with higher abundances of them were observed postpartum compared to vaginal samples collected during pregnancy. Other related VMB characteristics analysis, such as richness and the Shannon diversity, were discussed in **Chapter 7**. A significant decrease in

VMB richness ( $p = 0.02$ ) was observed during pregnancy. The Shannon diversity was significantly lower during pregnancy than postdelivery ( $p = 0.03$ ). Previous studies suggested that it is beneficial for a woman to wait at least one year (after the VMB is restored to a healthy state) before a subsequent gestation to minimize the risk for adverse pregnancy outcomes related to VMB dysbiosis or BV [7,37]. However, the estimated risk should be further evaluated in prospective studies.

## 8.2 BURDEN OF STI DURING PREGNANCY AND POST-DELIVERY IN PEMBA ISLAND, TANZANIA

Currently, there is not much data available about the STI prevalence and surveillance/monitoring of women suffering from STI's in low-income countries which restricts an estimation of the burden of these women. This thesis provides evidence of STI burden in Muslim-Shirazi women between the age of 16 – 48 years living in Pemba Island in Tanzania. Most women tested were multigravida (84%), 8% had a history of stillbirth, 5% the membranes (amniotic sac) ruptured before their labor began (premature rupture of membranes (PROM)), and 7% preterm delivery (**chapter 4-7**). The number of women who self-reported being previously diagnosed with the human immunodeficiency virus (HIV) was very low ( $n = 1$ ). It should be noted that the number of vaginal samples analyzed across different chapters vary due to sample availability and distinct aims.

In **Chapter 4** the prevalence of several STI has been revealed; the vaginal samples, taken from 439 pregnant women in Pemba, were analyzed and in 4.6% *C. trachomatis*, 7.1% *T. vaginalis*, and 2.1% *M. genitalium* were found.

The data were collected from vaginal swab which were collected at first time point (< 20 GA weeks) during pregnancy. If the sample of the first timepoint was not available, the sample collected at the second timepoint  $\geq 20$  GA weeks was included. In chapter 5, multiple vaginal swab samples of the same women at different time points were analyzed to investigate the persistence of four STIs. Unlike **chapter 4**, in this dataset *N. gonorrhoeae* was detected along with the previously observed microorganism (*C. trachomatis*, *T. vaginalis*, and *M. genitalium*). The combined point prevalence of STIs in samples collected at first timepoint < 20 GA was 12% ( $n = 385$ ), lower than for samples collected at the second timepoint collected  $\geq 20$  GA weeks (point prevalence 17%;  $n = 257$ ) (**Figure 1, Chapter 5**). At the second timepoint, *N. gonorrhoeae* was detected in one sample (point prevalence 0.4%) as a de novo infection. For hrHPV, on the other hand, the point prevalence was 11% at the first timepoint and 6% at the second timepoint (**Chapter 6**). HPV 18 was also not detected in this cohort. This difference might be due to the sample size, since it can be hypothesized that as the pregnancy progress the prevalence will be similar (in the same cohort) or even higher because of a lower pro-inflammatory state during pregnancy [38]. In **chapter 6**, 187 vaginal samples were included in the second timepoint analysis, whereas this was 257 samples in **chapter 5**. Accordingly, it can be concluded from data reported in **chapters 5 and 6** that at the first timepoint, the burden of hrHPV (point prevalence 11%) was the highest among the STI tested in pregnant women living in Pemba. This was followed by a high burden of *T. vaginalis* (6.5%), *C. trachomatis* (4.4%), and *M. genitalium* (1.3%). Similar trends were also observed, even when considering the dissimilarities in the number of samples tested, at the second timepoint in **chapters 5 and 6 (Figure 1, Chapter 5)**. Compared to other non-sub Saharan Africa population data from 2018, the burden of STI was higher in this population. For instance in United States of America (USA) (*T. vaginalis* (1.0%), *C. trachomatis* (2.4%), *N. gonorrhoeae* (0.5%) and among the pooled prevalence of different studies conducted in Europe, Japan or USA (*M. genitalium* (0.9%) [39,40]). Point prevalences (of *T. vaginalis*, *C. trachomatis*, *N. gonorrhoeae*) observed in chapter 4, 5, and 6 are also in accordance with previous prevalences observed in pregnant women in sub-Saharan Africa (Table 1). In addition to that, the point prevalence of *M. genitalium* in line with prevalences seen in other pregnant populations outside of sub-Saharan Africa (Table 1).

The persistence rate during pregnancy for *C. trachomatis*, *N. gonorrhoeae*, *T. vaginalis*, and *M. genitalium* were determined among 202 vaginal samples in **chapter 5** and for hrHPV among 133 vaginal samples in **chapter 6**. The persistence of *C. trachomatis* (100% persistence rate,  $n = 11$ ), *T. vaginalis* (82% persistence rate,  $n = 11$ ), and *M. genitalium* (75% persistence rate,  $n = 4$ ), was observed during pregnancy. A persistence rate of 64% for hrHPV was observed in a bigger cohort of matched samples ( $n = 133$ ). However, in **chapter 6**, fifteen genotypes of hrHPV were overall tested in this cohort, but genotype-specific detection was solely made for HPV genotype 16 and 18. Thus, based on the method used,

it is unclear whether there was indeed persistence of the same HPV genotype infection or whether some women cleared their one genotype HPV infection and were then infected with another genotype. This might be especially significant if the sexual partner is positive (and have not been treated) or the woman is engaging in high sexual risk behavior. Unfortunately, in Pemba's previously established biobank, does not yet hold (bio)data of sexual partners or other relevant data, including antibiotic usage during pregnancy or risk classification of participant sexual behavior. However, further analysis of species genotypes, strains, or *C. trachomatis* serovars, can also provide more information whether the infection persisted or there is a de novo infection.

Furthermore, coinfections between different types of STIs were also reported in **chapter 5 and chapter 6**. The most common coinfection detected during pregnancy was from *C. trachomatis* and *T. vaginalis* ( $n = 4$ ) (**Figure 1, chapter 5**). Whereas in chapter 6, coinfections were less often observed, most probable because one detection combined the results of 13 hrHPV (hrHPV others). Nevertheless, two women had a coinfection of hrHPV 16 and genotypes hrHPV others group (**Figure 1, chapter 6**).

Recently, further analyzation was started to distinguish between the seventeen different hrHPV genotypes; the samples which were before analyzed by the AmpFire Atila assay (**chapter 6**) are now being tested separately in a multiplex assay by Atila biosystems. Preliminary results of the additional analysis show 12 hrHPV genotypes (HPV 16, HPV 31, HPV 35, HPV

45, HPV 51, HPV 52, HPV 53, HPV 56, HPV 58, HPV 59, HPV 66, HPV 68) present in pregnant women sampled from Pemba. This additional analysis also shows that besides HPV 18, HPV 33 was also not detected in this cohort, thus these two hrHPV might be less relevant in this pregnant cohort (unpublished data). The preliminary data from the additional analysis of the 'hrHPV others' group reveal 17 pregnant women who had a hrHPV coinfection at the first timepoint; twelve women had a double infection, two had a triple infection, and four women had a quadruple infection (unpublished data). Nine women (53%) had a coinfection of HPV 52 with another hrHPV. HPV 52 causes the development of squamous intraepithelial lesions and in up to 2% of the cases infected with HPV 52 it leads to cancerous lesions of the cervix [41]. It is one of the most frequent hrHPV genotypes in Canadian and Japanese women [41,42]. Since, it is also present among pregnant Tanzanian women (based on the preliminary results); further analysis regarding HPV 52 and HPV 16 among other genotypes of hrHPV, in sub-Saharan African is also warranted.

Moreover, samples collected post-delivery were also tested for STI positivity and persistence rate. These data are reported in **chapter 5** and **chapter 7**. Even though there were fewer samples tested at post-delivery (n=44), the STI combined prevalence rate (11%) was almost similar to the one at the first collection timepoint (12%) (**Figure 1, chapter 5**). Furthermore, that by hrHPV was the most prevalent STI at this timepoint (9.1%) (**chapter 7**), followed by that by *T. vaginalis* (6.8%), *C. trachomatis* (2.3%), and *N. gonorrhoeae* (2.3%). In these samples *M. genitalium* was not detected. The persistence rate between samples from the same women collected at the second timepoint during pregnancy and post-delivery (n=38) was 100% for *C. trachomatis* (n = 1) and 20% for *T. vaginalis* (n = 5). The number of STI positive samples were so low at the second timepoint, that all the persistence results in **chapter 5** should be approached more as a proof of concept. Overall, previously collected samples (in the context of a biobank) can be used to determine the STI and the persistence of STIs among a population otherwise unscreened for STI.

The analysis to determine the persistence rate of hrHPV has not yet been conducted for this sub-Saharan African cohort. However, in Dutch pregnant women, a trend for increased hrHPV clearance during the third trimester and postpartum, compared to non-pregnant women was observed (hazard ratios 3.3 (0.8–13.7) and 4.6 (1.6–12.8), respectively) [38]. These Dutch women's results suggest a lowered immune-response against hrHPV during the first two trimesters of pregnancy with a catch-up postpartum [38]. Pregnancy has been associated with an altered immune-response and reduced humoral immune response against pathogens, including hrHPV [38,43]. It had been suggested that cervical trauma occurring at the time of delivery with additional repair of the cervical epithelium might explain why there is a downward trend in HPV, or other intracellular STI pathogens, prevalence post-delivery in this and other cohorts [44,45]. It can be hypothesized that after trauma a new risk of infection is generated, but also that after trauma of the epithelial cells exposes intracellular microorganism (that normally escape the immune system) to the environment and consequently they can be detected by the immune

system for clearance. However, the number of samples tested post-delivery were lower than the samples tested during pregnancy, thus future analysis with the Pemba Biobank's vaginal samples could provide more insights on the hrHPV presence rate during and after pregnancy in a local sub-Saharan African population (**Chapter 5, figure 1**).

**Table 1.** Comparison point prevalences of sexually transmitted infections observed in pregnant women from Pemba Island with pooled prevalence of sub-Saharan African countries. Previously observed prevalence was used if pooled prevalence was not available

Microorganism	Reference	Prevalence (%)	Lowest and highest point prevalence observed in vaginal samples from pregnant women in Pemba Island
<i>T. vaginalis</i>	[46]	4.6 - 31.4	6.5 - 7.4
<i>C. trachomatis</i>	[47]	5 - 9	2.3 - 5.8
<i>N. gonorrhoeae</i>	[46]	2 - 5.2	0 - 2.3
<i>M. genitalium</i>	[48] <sup>ab</sup>	0.6 - 2.4	0 - 3.1
HPV	[40,49–53] <sup>a</sup>	5.4 - 46	5.9 - 11.2

<sup>a</sup> Previously observed prevalence as pooled prevalence was not available

<sup>b</sup> data from *France, United Kingdom, Japan, Denmark, and United States of America*

STIs during pregnancy have been associated with several adverse pregnancy outcomes including preterm birth and low birth weight. These two adverse pregnancy outcomes are significant determinants of infant morbidity and mortality, especially in low-income settings where neonatal intensive care facilities are not widely available [54]. In **Chapter 7**, a limited number of pregnant women with an STI infection and adverse pregnancy outcomes in Pemba was observed. Of the six women who had a preterm birth, one whose vaginal samples were taken at both time points during pregnancy was positive for *C. trachomatis*. Another woman had a sample positive for *M. genitalium* at the second time point (data not shown). It should be noted that, of these six women, one vaginal sample at the second time point during pregnancy was not analyzed. Furthermore, one of the vaginal sample positive for *M. genitalium* at the second timepoint was of a participant that also had experienced a stillbirth (data not shown). Due to the low cases of STI positive women experiencing an adverse pregnancy outcome in this local cohort, the association between STIs and adverse pregnancy outcomes could not have been determined in **chapter 7**.

Studying the impact of untreated STI on pregnancy outcomes prospectively is unethical since most of them are treatable infections. Therefore, many studies are retrospective in design and collected at birth or in the perinatal period [54]. Consequently, many confounding factors during pregnancy cannot be controlled or eliminated because of this collection period. Nevertheless, fifteen years ago, Mullick et al. reviewed studies investigating an association between syphilis, *C. trachomatis*, *N. gonorrhoeae*, *T. vaginalis*, BV, herpes simplex virus, and HIV [54]. The findings of the review vary per STI and clinical outcome (summarized in table 2). Regrettably, the STI's burden in sub-Saharan Africa remains high despite various treatment options and

several global prevention approaches to lower the STI prevalence worldwide. Therefore, a more up-to-date systematic review is currently being conducted by this study group. Preliminary results show that there a large amount of studies has been published after the publication of Mullick et al., investigating the relationship between STI and pregnancy outcomes [54,55]. This new data will provide an up-to-date insight into the STI sequelae during pregnancy, and further point out where current diagnostics and management strategies are failing to combat STI in sub-Saharan Africa [55].

**Table 2.** Overview of the relationship between sexually transmitted infections (*C. trachomatis*, *N. gonorrhoeae*, and *T. vaginalis*) and adverse pregnancy outcomes as review in 2015 by Mullick et al. [54]

Reference:	Country	number women	Adverse pregnancy outcome	odds ratio	Confidence interval
<b><i>C. trachomatis</i></b>					
[56]	United States of America	801	intrauterine growth retardation	2.4	1.3 - 4.2
			preterm delivery	1.6	1.0 – 2.5
[57]	United States of America	534	low birth weight	2.7	1.3 – 5.7
			premature rupture of membranes	2.4	1.1 – 5.4
			preterm labour	4.0	1.7 – 9.2
[58]	United States of America	1365	No association with adverse pregnancy outcomes. Immunoglobulin (Ig) M-seropositive <i>C. trachomatis</i> -infected women had more low-birth-weight infants and more premature rupture of membranes than either IgM-negative <i>C. trachomatis</i> -infected women or <i>C. trachomatis</i> culture-negative women.		
20 Plummer [59]	Kenya		There was no association with postpartum endometritis		
<b><i>N. gonorrhoeae</i></b>					
[60]	Kenya	341	low birth weight	2.9	1.2 – 7.2
[61]	South Africa	167	preterm delivery	Relative risk 6.0	1.5 - 34
			low birth weight	significant different between infected and non-infected women (p <0.01)	
<b><i>T. vaginalis</i></b>					
[62]	<i>T. vaginalis</i> is responsible for 20-25% of premature delivery cases in sub-Saharan Africa				
[63]	Congo	421	low birth weight	2.4	1.2 – 4.5
[64–66]	<i>T. vaginalis</i> is associated with preterm delivery and low birth weight				

### 8.2.1 THE VAGINAL MICROBIOTA AND STI INFECTION

Certain Lactobacilli species, especially those with a high lactic acid production, have been associated with decreased STIs prevalence, including *C. trachomatis*, *N. gonorrhoeae*, and HPV [67]. In most cases, Pembani women who were positive for STI had a *L. iners* dominant VMB or diverse VMB community during and after pregnancy (**chapter 7**). At the first timepoint and second timepoint, 13% and 11% of the vaginal samples dominated by *L. crispatus* were also positive for *C. trachomatis*, hrHPV, and *T. vaginalis*, respectively. However similar to other

populations, genital infections were more associated with *L. iners* dominant VMB compared to other vaginal clusters (*L. crispatus*-, *L. jensenii*-, *L. gaserri*- or a diverse community vaginal state) [5,26,29]. These findings further contribute to the debate that even though *L. iners* belongs to the Lactobacilli genus, (a high abundance of) this species provides for a different vaginal milieu than VMB containing (high abundance of) *L. crispatus*, *L. jensenii* or *L. gaserri* [28,68]. Not only are there currently many research interests on the role of *L. iners* in the vaginal environment, but taxonomists are also presently reclassifying the *Lactobacillus* genus based on phylogenetic analysis [69] (**chapter 3**). Thus, microbiology and biomedical research-based characterization of these common vaginal *Lactobacillus* species might provide new insights into their role in the defense mechanisms against invading microorganisms. Ultimately, these research findings might also be beneficial to understand the clinical significance of these species and their role in maternal and female reproductive health.

### 8.3 FACTORS THAT INFLUENCE THE VMB AND STIs IN PREGNANCY

Different factors influence the VMB composition and susceptibility to STIs in pregnancy of sub-Saharan African women. Various hosts (including host-genetics and inflammatory response), behavioral, sociodemographic, nutritional, and environmental factors have been discussed across this thesis's different chapters (Figure 1). In this section of the thesis, some microbiology, host and sociological factors that were not discussed or elaborated on in the previous chapter are further touched upon (Figure 1).

Firstly, commencing with the microbiology factors, some microorganisms residing in the human vaginal form a specific biofilm (a structured community of bacteria in a self-produced extracellular matrix, adherent to an inert surface or biological tissue) [70]. BV is characterized by a slowly growing polymicrobial biofilm formed on the vaginal epithelial cells. Biofilms are rarely entirely eradicated by the host defense, system since the produced antibodies cannot pass the biofilm structures and eliminate bacteria in the biofilm, therefore accumulating around the epithelial cells and promoting host tissue injury [70]. Thus, the infection is difficult to treat, and women will probably experience the persistence of infections that might become chronic [70]. Individual roles of specific bacterial species in the BV biofilms triggering their formation and the exact composition are still not completely understood [70]. Biofilms in the amniotic fluid close to the cervix have been associated with preterm delivery and histologic chorioamnionitis [71,72].

Nonetheless, the significance of vaginal biofilms in pregnancy needs to be further investigated, especially among sub-Saharan African women or women with African ancestry. Among the same women, the burden and persistence of BV are high [73]. Moreover, in sub-Saharan Africa, the prevalence of other communicable (tropical) infections are also high [74]. Systemic infections such as malarial infections during pregnancy also contribute to complications, such as anemia and placental malaria, leading to low birth weight and perinatal morbidity and mortality [75]. Other neglected STIs such as chancroid, caused by the bacteria *Haemophilus ducreyi*, are still present in some sub-Saharan African communities. At the same time, they are

eradicated in industrialized areas [76]. Therefore, the high prevalence of infection diseases and neglected tropical STI infection in the sub-Saharan communities, and their influence on pregnancy-related complications, should also be taken into account when analyzing STs and VMB dysbiosis in sub-Saharan African women.

Secondly, the formation and physical barrier of the cervical mucus plug during pregnancy, the maternal age, and the mode of delivery are hosts specific factors that might influence or be influenced by the VMB composition or presence of STIs. Throughout gestation, the cervix's function is to remain closed (despite multiple forces acting upon it) to protect the growing fetus within the uterus [77]. It undergoes two main changes to act as an effective barrier; namely, it retains a sufficient length and produces a cervical mucus plug (CMP) [78]. The CMP is a visco-elastic, gel-like structural barrier produced by endocervical secretory cells that fill the cervical canal during pregnancy [79]. It is part of the innate immune response that contains various antimicrobial compounds. It protects the lower genital tract against ascending microorganisms (e.g., *Ureaplasma* and *Streptococcus agalactiae*) that have been linked to adverse pregnancy outcomes [80]. *Lactobacillus*-induced pH changes may help the CMP structure to remain thick and resistant to microbial migration, as low pH makes the mucus less susceptible to invasion [80,81]. As reviewed by Vornhagen et al., it is plausible that CMPs in women from different geographic regions exhibit differences in proteomic profiles and biological functionality due to variations in genetics, epigenetics, and environment [82]. More research is necessary to further determine the composition of CMP across the different populations and its exact role with host-genetics, immunity, VMB, vertical transmissions of STIs, and pregnancy outcomes.

Moreover, maternal age has been linked to susceptibility for prolonged (> 41 GA weeks) or post-term (> 42 GA weeks) delivery. Post-term delivery has, in turn, been associated with various adverse neonatal and maternal outcomes [83]. VMB has been linked to preterm birth, which appeals to VMB's possible significance to prolonged pregnancy as well [84].

However, the relationship between maternal age and VMB is yet to be studied. In contrast, younger maternal age (< 27 years) and higher gestational age have been recently associated with increased burden of STIs in two different South African populations [85]. The Centres for Disease Control and Prevention (CDC), the American Congress of Obstetricians and Gynaecologists, and the U.S. Preventive Services Task Force all recommend maternal age- and risk-based screening for certain STIs (e.g., chlamydia and gonorrhoea) [86–89]. To evaluate the risk of vertical transmission and the high prevalence of STI in sub-Saharan pregnant women, a risk-based screening could also be a better strategy to minimize STI sequelae, instead of the now recommended and implemented syndromic management (the standard management for STIs in most low and middle-income countries) [90].

The role of the mode of delivery can have consequences for the transmission of STIs. Globally, the lowest rates of cesarean section (CS) were found in Africa (7.3 %) [91]. However, at least half of all births in low- and middle-income countries occur in the absence of skilled birth attendants [92]. This is largely influenced by socio-cultural factors, lack of understanding of the importance of skilled attendance at birth, financial hardship, and physical accessibil-

ity to reach a health care facility [92,93]. Nevertheless, an elective CS substantially reduces vertical transmission among herpes simplex virus, and untreated HIV positive pregnant women [86,89,94]. However, it should be noted that the risk of vertical transmission for most STIs (e.g. HPV, chlamydia, gonorrhoea) is not solely limited by passage through the vaginal canal as a newborn may be infected even after being delivered by CS due to ascending microorganisms from the vaginal canal [94–96]. The risk of curable STI transmission can be eliminated if women are adequately treated, either way the mode should be discussed with the woman, and invasive procedures should be avoided if possible since the risk of invasive procedures is high, particularly in low resource settings [97].

Moreover, the delivery mode also influences the diversity and colonization gut microbiota of the infant's first year of life [98,99]. Increasing studies provide evidence that maternal VMB characteristics and mode of delivery influence the offspring, not solely in the early year of life but also in the long term. A recent pilot study showed that adults born by CS tend towards a low relative abundance of *Lactobacillus*-dominated VMB (however, this trend was non-significant in North-American women) [100]. Thus, the importance of further investigations on the short- and long-term significance of the maternal VMB composition during pregnancy is now becoming more evident. Also in light of that fact that in sub-Saharan Africa the CS-sections number is rising [91].

Lastly, environmental, sociological, and health systems factors are of equal importance as microorganisms and host factors when observing the epidemiology of VMB compositions and STIs. Although ethnically and genetically exceptionally diverse, populations residing in sub-Saharan Africa have ethnically and culturally more in common with each other, than with the populations in the Arab countries in the northern part of the Sahara Desert or other part of the world. However, sub-Saharan Africa has many urban and village residential areas, communities with their history, religions, languages, beliefs, and traditions. These differences have a singular effect on women's hygiene practices, and related to their sexual health (education, stigmatization, knowledge of diseases, use of contraception) and health-seeking behavior (seeking traditional medicine help or the delayed evidence-based treatments) [101,102]. These sociological factors should also be considered when comparing different populations in sub-Saharan Africa. For instance, the VMB composition and STI epidemiology described in **chapters 4 -7** in this thesis are data from mostly Muslim-Shirazi women living on a rural island. In contrast, **chapters 2 and 3** also describe the VMB of women living in urban areas, characterized by other religious beliefs (for instance Christianity) and cultures. Furthermore, public health strategies, such as accessibility to healthcare, antenatal screening for HIV and other STIs, and syndromic management of treatment, also have a pronounced influence on STI control and the burden of adverse pregnancy outcomes at the population level [102].

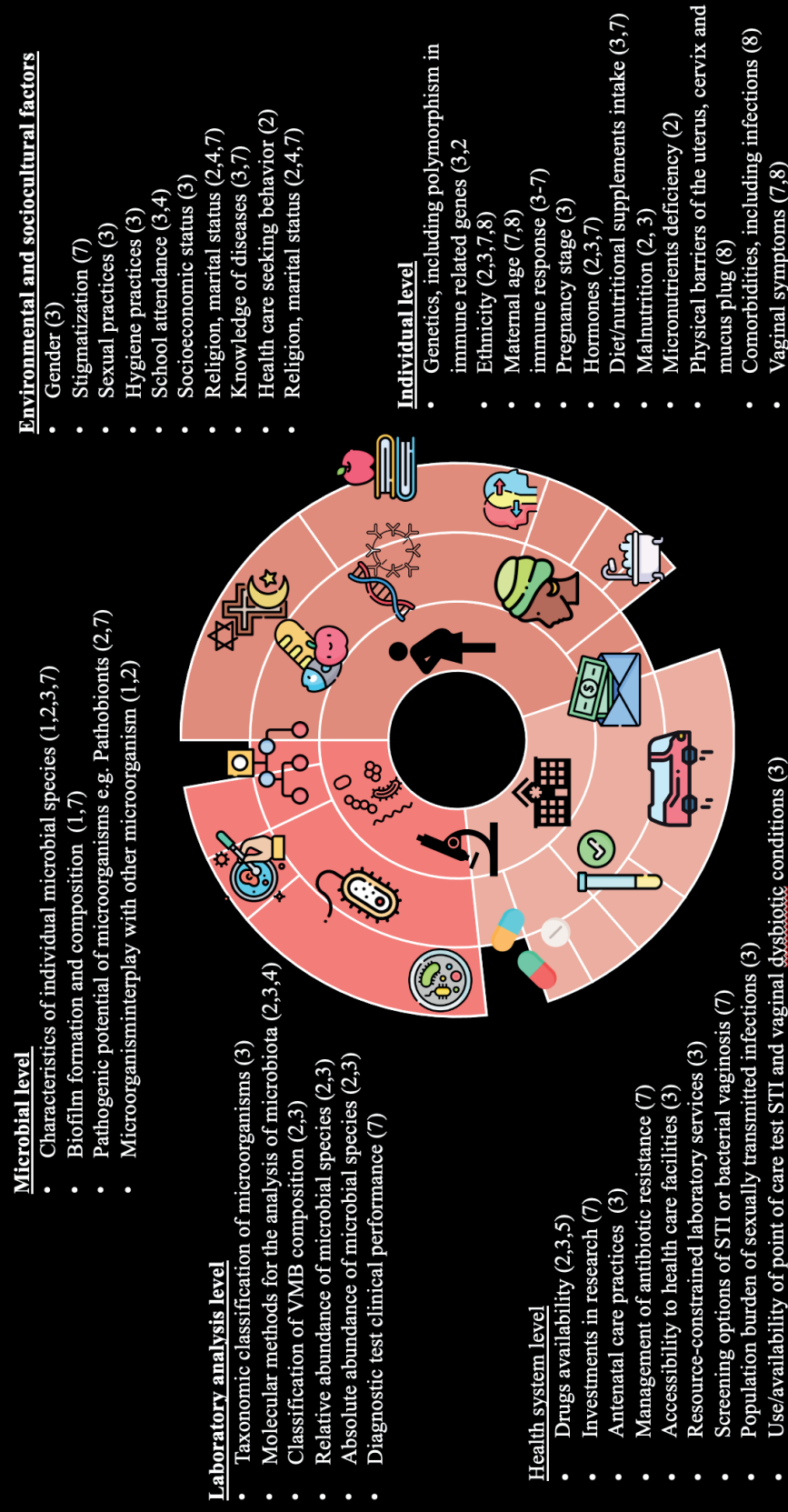


Figure 1. Summary of the most relevant points that were discussed in this thesis. These should be considered at different levels when investigating the vaginal microbiota during pregnancy. Numbers indicate the chapters where the point was discussed.

#### 8.4 THE WAY FORWARD ON FURTHER IMPROVING THE VMB AND STI RESEARCH AND POLICIES IN SUB-SAHARAN AFRICA

The findings and the factors discussed in this thesis ultimately gain insight on how to improve reproductive health, specifically maternal health, in sub-Saharan Africa, and in particularly Pemba Island, Tanzania. These components should ideally be the stepping stone towards future research. Eventually, evidence-based policy practices aim to control, eliminate, or even eradicate factors (such as vaginal dysbiosis and STIs) that might burden maternal and neonatal health.

Most of the available research, including the one described in **chapter 7**, is limited by a small sample size. Therefore, further research is needed to specify the VMB composition in a larger group of women, if possible, in multiple-cohorts, and identify biomarkers associated with adverse pregnancy outcomes in both uninfected women and women with STIs and VMB dysbiosis. Currently, in Pemba Island, vaginal samples and health-related data of more than 600 women have been collected for further analysis. Unfortunately, due to logistical reasons, worsened by the COVID-19 pandemic, these analyses could not be included in this thesis. Nonetheless, the results of this thesis generated innovative data on an under-researched population and offered an initial step to be further expanded in a bigger cohort. Among next studies are further genotyping of HPV and other STI species, determine the prevalence of adverse pregnancy outcomes on Pemba Island, and further investigate the interplay and association between VMB composition, STI, and adverse pregnancy outcomes.

Furthermore, the latest reclassification of VMB related species and genera, such as for *Gardnerella* and *Lactobacillus* species, should be implemented in biomedical research to explore these exact species' role in the genital tract [69,103]. As seen in **chapter 2**, one of the main difficulties to pooled results is that fact that VMB characterization and clusters, especially non-*Lactobacillus* dominant species, varied across studies. To eliminate this issue for upcoming studies, a consensus should be made to standardise VMB cluster profiles.

As seen in **chapter 4-7**, the burden of curable STI remains high in pregnant sub-Saharan Africa women. There is an urgent need to identify and treat affected community members, especially pregnant women. A more personalized-based medicine approach (treatment based on health history and behavioral risk) and point-of care-tests (POCT) (such as rapid diagnostic antigen tests or PCR-based approaches) could also detect more specifically microorganisms in asymptomatic women compared to the current implemented syndromic management in most sub-Saharan African countries [104]. As discussed in **chapter 6**, isothermal PCR might be a viable option for laboratory settings in middle- and low-income countries. Even though, this personalized-based strategy might be more expensive implementation-wide (costly equipment), it is expected to be more cost-effective at longer-term [104,105]. Moreover, the opportunity to perform microorganism testing such as by POCT diagnostics, can allow more precise treatment and reduce the risk of antimicrobial resistance for broad-spectrum antibiotics.

With the latest also being a research priority, namely, to investigate new or alternative safe and efficacious treatment for STIs and vaginal dysbiotic conditions during pregnancy as microbial resistance antibiotics are also arising [106]. In low-income settings, besides the STI management difficulties; poverty, gender inequality, and implement STI education and prevention measurements (eg. via awareness campaigns) remain challenging [104,106,107]. Policies with multisystem approaches, similar to President's Emergency Plan for AIDS Relief (PEPFAR) (HIV risk-reducing strategy interventions), should also be evaluated for STI control, elimination, and eradication [104,106,108]. As implementation of this comprehensive, multi-sectoral interventions have decreased poverty, gender inequality, sexual violence, and lack of education [104,106,108], these structural approaches should also become available to STI screening and treatment.

Moreover, the plea to include routine STI screening during pregnancy in the World Health Organization guidelines is still warranted [106]. Experts meeting on the idea to close research gaps, and periodic discussions to implement an integrated approach to antenatal care, postnatal care, and STI surveillance should be continuously set up by researchers, policymakers, and clinicians [106]. Ultimately, succeeding with these research and public health recommendations will contribute to providing better - state of the art- VMB and STI related research and implementation policies that aim to conserve the vaginal microbiomes' *friends*, make efforts to combat its *enemies* (STIs) and control the *frenemies or the ones between good and bad*.

## 8.5 CONCLUSION

This thesis addresses the high frequency of non-*Lactobacillus* dominant VMB and STIs (HPV, *T. vaginalis*, *C. trachomatis*, and *M. genitalium*) in pregnant women living in Pemba Island, Tanzania. Despite the high prevalence of VMB dysbiosis, *Lactobacillus*- dominant VMB, especially *L. iners* and (the beneficial) *L. crispatus*, are the most common VMB profiles among pregnant women on Pemba Island, and by extension pregnant women in sub-Saharan Africa. Other significant conclusions from this thesis are:

In sub-Sahara African women:

- Comparing pregnancy-related VMB composition using available data from sub-Saharan Africa is challenging because laboratory microbiology methodology used to detect VMB between the VMB profiles differ extensively across studies.
- Data on the association between VMB and adverse pregnancy outcomes among the sub-Saharan African populace is still limited.
- There are discrepancies in evidence supporting the association between BV and PTB, LBW, PROM, SGA, and intra-uterine infection within populations in sub-Saharan Africa.
- To date, there is no evidence available to support an association between BV and any type of pregnancy loss variable.
- To date, there is no published evidence which investigated and supports an association between AV and late adverse pregnancy outcomes in sub-Saharan Africa.

In women from Pemba Island, Tanzania:

- The VMB richness decreases during pregnancy, and the diversity increases after parturition.
- As seen in other populations, the VMB was in most women non-*Lactobacillus* dominant following childbirth.
- *Klebsiella species* and *Streptococcus anginosus* were the most commonly identified pathobionts during pregnancy and post-delivery
- A relatively high abundance of pathobionts was mostly seen in women with a diverse, non-*Lactobacillus* dominant VMB.
- *Lactobacillus iners* dominant VMB was common among pregnant women with an STI (HPV, *T. vaginalis*, *C. trachomatis* or *M. genitalium*).
- The point prevalence for non-viral STI (*T. vaginalis*, *C. trachomatis*, *M. genitalium*, and *N. gonorrhoeae*) ranged from 13 - 17%, depending on the time of collection; that of HPV ranged from 6 - 11% during pregnancy.
- After parturition, the point prevalence for non-viral STI was 11%.



Based on these findings, it is apparent that further research is warranted to address VMB dysbiosis, STIs prevalence, and related conditions during pregnancy among sub-Saharan women. The following recommendations have therefore been formulated for future efforts in sub-Saharan Africa:

- To improve VMB and STI related research, a consensus should be reached about the classification of vagina related species and the clustering of vaginal profiles. Bigger cohort sizes across different sub-Saharan African communities, and multi-country database sharing, are warranted to analyze and compare microbiotas, including the VMB across populations. Investigating VMB and STI using biobank samples is a valuable approach to study VMB compositions and STI epidemiology and persistence. Therefore, efforts to participate and collaborate in biobanking studies should be further encouraged. The use of PCR methods in laboratories and rapid diagnostic (point-of-care) testing in clinics might replace the current syndromic management strategy. This will ultimately reduce reliance on broad-spectrum antibiotics (as describe in the syndromic management regime) to more pathogen-specific antibiotic usage. To test for a specific species, the use of STI assays based on isothermal PCR methods might be suitable for use in middle and low-income laboratories; thus, its cost-effectiveness in these settings should be further investigated.
- To continuously develop up-to-date antenatal and STI screening policies and other public health control programs, research, alongside periodic meetings with health organizations, researchers, policymakers (international and nationals), and clinicians is needed. With these efforts, an integrated approach to further improve antenatal care, postnatal care, and STI surveillance can be developed in sub-Saharan Africa or globally.

Thus, based on these findings, discussions and public health recommendations, this thesis provides current knowledge that in the (near) future might help us to *conserve the vaginal microbiomes' friends, make efforts to combat its enemies and control the frenemies or the ones between good and bad* among pregnant women, in particular those from sub-Sahara Africa.

## 8 REFERENCES

1. Singer, M.; Borg, M.; Ouburg, S.; Morré, S.A. The relation of the vaginal microbiota to early pregnancy development during in vitro fertilization treatment—A meta-analysis. *J. Gynecol. Obstet. Hum. Reprod.* **2019**, *48*, 223–229.
2. Anahtar, M.N.; Byrne, E.H.; Doherty, K.E.; Bowman, B.A.; Yamamoto, H.S.; Soumillon, M.; Padavattan, N.; Ismail, N.; Moodley, A.; Sabatini, M.E.; et al. Cervicovaginal Bacteria Are a Major Modulator of Host Inflammatory Responses in the Female Genital Tract. *Immunity* **2015**, *42*, 965–976.
3. Al-Nasiry, S.; Ambrosino, E.; Schlaepfer, M.; Morré, S.A.; Wieten, L.; Voncken, J.W.; Spinelli, M.; Mueller, M.; Kramer, B.W. The Interplay Between Reproductive Tract Microbiota and Immunological System in Human Reproduction. *Front. Immunol.* **2020**, *11*, 378.
4. Bayigga, L.; Kateete, D.P.; Anderson, D.J.; Sekikubo, M.; Nakanjako, D. Diversity of vaginal microbiota in sub-Saharan Africa and its effects on HIV transmission and prevention. *Am. J. Obstet. Gynecol.* **2019**.
5. Masha, S.C.; Cools, P.; Descheemaeker, P.; Reynders, M.; Sanders, E.J.; Vaneechoutte, M. Urogenital pathogens, associated with *Trichomonas vaginalis*, among pregnant women in Kilifi, Kenya: a nested case-control study. *BMC Infect. Dis.* **2018**, *18*, 549.
6. Kim, J.H.; Yoo, S.M.; Sohn, Y.H.; Jin, C.H.; Yang, Y.S.; Hwang, I.T.; Oh, K.Y. Predominant *Lactobacillus* species types of vaginal microbiota in pregnant Korean women: quantification of the five *Lactobacillus* species and two anaerobes. *J. Matern. Neonatal Med.* **2017**, *30*, 2329–2333.
7. DiGiulio, D.B.; Callahan, B.J.; McMurdie, P.J.; Costello, E.K.; Lyell, D.J.; Robaczewska, A.; Sun, C.L.; Goltsman, D.S.A.; Wong, R.J.; Shawa, G.; et al. Temporal and spatial variation of the human microbiota during pregnancy. *Proc. Natl. Acad. Sci. U. S. A.* **2015**, *112*, 11060–11065.
8. MacIntyre, D.A.; Chandiramani, M.; Lee, Y.S.; Kindinger, L.; Smith, A.; Angelopoulos, N.; Lehne, B.; Arulkumaran, S.; Brown, R.; Teoh, T.G.; et al. The vaginal microbiome during pregnancy and the postpartum period in a European population. *Sci. Rep.* **2015**, *5*.
9. Gautam, R.; Borgdorff, H.; Jespers, V.; Francis, S.C.; Verhelst, R.; Mwaura, M.; Delany-Moretlwe, S.; Ndayisaba, G.; Kyongo, J.K.; Hardy, L.; et al. Correlates of the molecular vaginal microbiota composition of African women. *BMC Infect. Dis.* **2015**, *15*, 86.
10. Frank, D.N.; Manigart, O.; Leroy, V.; Meda, N.; Valéa, D.; Zhang, W.; Dabis, F.; Pace, N.R.; Van De Perre, P.; Janoff, E.N. Altered vaginal microbiota are associated with perinatal mother-to-child transmission of HIV in African women from Burkina Faso. *J. Acquir. Immune Defic. Syndr.* **2012**, *60*, 299–306.
11. Gudza-Mugabe, M.; Havyarimana, E.; Jaumdally, S.; Garson, K.L.; Lennard, K.; Tarupiwa, A.; Mugabe, F.; Marere, T.; Mavnyengwa, R.T.; Masson, L.; et al. HIV infection is associated with preterm delivery independent of vaginal microbiota in pregnant African women. *J. Infect. Dis.* **2019**.
12. Bisanz, J.E.; Enos, M.K.; PrayGod, G.; Seney, S.; Macklaim, J.M.; Chilton, S.; Willner, D.; Knight, R.; Fusch, C.; Fusch, G.; et al. Microbiota at multiple body sites during pregnancy in a rural tanzanian population and effects of Moringa-supplemented probiotic yogurt. *Appl. Environ. Microbiol.* **2015**, *81*, 4965–4975.
13. Brabin, L.; Roberts, S.A.; Gies, S.; Nelson, A.; Diallo, S.; Stewart, C.J.; Kazienga, A.; Birtles, J.; Ouedraogo, S.; Claeys, Y.; et al. Effects of long-term weekly iron and folic acid supplementation on lower genital tract infection - a double blind, randomised controlled trial in Burkina Faso. *BMC Med.* **2017**, *15*.
14. Price, J.T.; Vwalika, B.; Hobbs, M.; Nelson, J.A.E.; Stringer, E.M.; Zou, F.; Rittenhouse, K.J.; Azcarate-Peril, A.; Kasaro, M.P.; Stringer, J.S.A. Highly diverse anaerobe-predominant vaginal microbiota among HIV-infected pregnant women in Zambia. *PLoS One* **2019**, *14*, e0223128.

15. Borgdorff, H.; Verwijs, M.C.; Wit, F.W.N.M.; Tsvitsivadze, E.; Ndayisaba, G.F.; Verhelst, R.; Schuren, F.H.; Van De Wijgert, J.H.H.M. The impact of hormonal contraception and pregnancy on sexually transmitted infections and on cervicovaginal microbiota in african sex workers. *Sex. Transm. Dis.* **2015**, *42*, 143–152.
16. McMillan, A.; Rulisa, S.; Gloor, G.B.; Macklaim, J.M.; Sumarah, M.; Reid, G. Pilot assessment of probiotics for pregnant women in Rwanda. *PLoS One* **2018**, *13*, e0195081.
17. Balaka, B.; Agbèrè, A.; Dagnra, A.; Baeta, S.; Kessie, K.; Assimadi, K. Portage génital bactérien au dernier trimestre de la grossesse et infection néonatale précoce. *Arch. Pediatr.* **2005**, *12*, 514–519.
18. Romero, R.; Hassan, S.S.; Gajer, P.; Tarca, A.L.; Fadrosch, D.W.; Nikita, L.; Galuppi, M.; Lamont, R.F.; Chaemsaitong, P.; Miranda, J.; et al. The composition and stability of the vaginal microbiota of normal pregnant women is different from that of non-pregnant women. *Microbiome* **2014**, *2*, 4.
19. Romero, R.; Hassan, S.S.; Gajer, P.; Tarca, A.L.; Fadrosch, D.W.; Bieda, J.; Chaemsaitong, P.; Miranda, J.; Chaiworapongsa, T.; Ravel, J. The vaginal microbiota of pregnant women who subsequently have spontaneous preterm labor and delivery and those with a normal delivery at term. *Microbiome* **2014**, *2*.
20. Romero, R.; Hassan, S.S.; Gajer, P.; Tarca, A.L.; Fadrosch, D.W.; Nikita, L.; Galuppi, M.; Lamont, R.F.; Chaemsaitong, P.; Miranda, J.; et al. Correction to : The composition and stability of the vaginal microbiota of normal pregnant women is different from that of non-pregnant women. *Microbiome* **2014**, *2*, 10.
21. Ravel, J.; Gajer, P.; Abdo, Z.; Schneider, G.M.; Koenig, S.S.K.; McCulle, S.L.; Karlebach, S.; Gorle, R.; Russell, J.; Tacket, C.O.; et al. Vaginal microbiome of reproductive-age women. *Proc. Natl. Acad. Sci. U. S. A.* **2011**, *108*, 4680–4687.
22. Serrano, M.G.; Parikh, H.I.; Brooks, J.P.; Edwards, D.J.; Arodz, T.J.; Edupuganti, L.; Huang, B.; Girerd, P.H.; Bokhari, Y.A.; Bradley, S.P.; et al. Racioethnic diversity in the dynamics of the vaginal microbiome during pregnancy. *Nat. Med.* **2019**, *25*, 1001–1011.
23. Stout, M.J.; Zhou, Y.; Wylie, K.M.; Tarr, P.I.; Macones, G.A.; Tuuli, M.G. Early pregnancy vaginal microbiome trends and preterm birth. *Am. J. Obstet. Gynecol.* **2017**, *217*, 356.e1-356.e18.
24. Borgdorff, H.; Armstrong, S.D.; Tytgat, H.L.P.; Xia, D.; Ndayisaba, G.F.; Wastling, J.M.; Van De Wijgert, J.H.H.M. Unique insights in the cervicovaginal Lactobacillus iners and L. crispatus proteomes and their associations with microbiota dysbiosis. *PLoS One* **2016**, *11*.
25. van de Wijgert, J.H.H.M. The vaginal microbiome and sexually transmitted infections are interlinked: Consequences for treatment and prevention. *PLOS Med.* **2017**, *14*, e1002478.
26. Ravel, J.; Gajer, P.; Abdo, Z.; Schneider, G.M.; Koenig, S.S.K.; McCulle, S.L.; Karlebach, S.; Gorle, R.; Russell, J.; Tacket, C.O.; et al. Vaginal microbiome of reproductive-age women.
27. Van De Wijgert, J.H.H.M.; Borgdorff, H.; Verhelst, R.; Crucitti, T.; Francis, S.; Verstraelen, H.; Jaspers, V. The vaginal microbiota: What have we learned after a decade of molecular characterization? *PLoS One* **2014**, *9*.
28. Petrova, M.I.; Reid, G.; Vaneechoutte, M.; Lebeer, S. Lactobacillus iners: Friend or Foe? *Trends Microbiol.* **2017**, *25*, 182–191.
29. Vaneechoutte, M. Lactobacillus iners, the unusual suspect. *Res. Microbiol.* **2017**, *168*, 826–836.
30. Donders, G.; De Wet, H.G.; Hooft, P.; Desmyter, J. Lactobacilli in Papanicolaou Smears, Genital Infections, and Pregnancy. *Am. J. Perinatol.* **1993**, *10*, 358–361.
31. Hillier, S.L.; Nugent, R.P.; Eschenbach, D.A.; Krohn, M.A.; Gibbs, R.S.; Martin, D.H.; Cotch, M.F.; Edelman, R.; Pastorek, J.G.; Rao, A.V.; et al. Association between bacterial vaginosis and preterm delivery of a low-birth-weight infant. *N. Engl. J. Med.* **1995**, *333*, 1737–1742.
32. Leitich, H.; Bodner-Adler, B.; Brunbauer, M.; Kaider, A.; Egarter, C.; Husslein, P. Bacterial vaginosis as a risk factor for preterm delivery: A meta-analysis. *Am. J. Obstet. Gynecol.* **2003**, *189*, 139–147.
33. Nelson, D.B.; Hanlon, A.; Hassan, S.; Britto, J.; Geifman-Holtzman, O.; Haggerty, C.; Fredricks, D.N. Preterm labor and bacterial vaginosis-associated bacteria among urban women. **2007**.
34. Donders, G.G.; Van Calsteren, K.; Bellen, G.; Reybrouck, R.; Van Den Bosch, T.; Riphagen, I.; Van Lierde, S. Predictive value for preterm birth of abnormal vaginal flora, bacterial vaginosis and aerobic vaginitis during the first trimester of pregnancy. *BJOG An Int. J. Obstet. Gynaecol.* **2009**.
35. Hassan, M.F.; Rund, N.M.A.; El-Tohamy, O.; Moussa, M.; Ali, Y.Z.; Moussa, N.; Abdelrazik, A.A.; Abdallah, E.A.A. Does Aerobic Vaginitis Have Adverse Pregnancy Outcomes? Prospective Observational Study. *Infect. Dis. Obstet. Gynecol.* **2020**, *2020*, 5842150.
36. van de Wijgert, J.H.H.M.; Verwijs, M.C.; Gill, A.C.; Borgdorff, H.; van der Veer, C.; Mayaud, P. Pathobionts in the Vaginal Microbiota: Individual Participant Data Meta-Analysis of Three Sequencing Studies. *Front. Cell. Infect. Microbiol.* **2020**, *10*, 129.
37. Kroon, S.; Ravel, J.; sterility, W.H.-F. and; 2018, undefined Cervicovaginal microbiota, women's health, and reproductive outcomes. *Elsevier*.
38. Nobbenhuis, M.A.E.; Helmerhorst, T.J.M.; Van den Brule, A.J.C.; Rozendaal, L.; Bezemer, P.D.; Voorhorst, F.J.; Meijer, C.J.L.M. High-risk human papillomavirus clearance in pregnant women: Trends for lower clearance during pregnancy with a catch-up postpartum. *Br. J. Cancer* **2002**, *87*, 75–80.
39. Williams, C.L.; Harrison, L.L.; Llata, E.; Smith, R.A.; Meites, E. Sexually Transmitted Diseases Among Pregnant Women: 5 States, United States, 2009–2011. *Matern. Child Health J.* **2018**, *22*, 538–545.
40. Baumann, L.; Cina, M.; Egli-Gany, D.; Goutaki, M.; Halbeisen, F.S.; Lohrer, G.R.; Ali, H.; Scott, P.; Low, N. Prevalence of Mycoplasma genitalium in different population groups: systematic review and meta-analysis. *Sex. Transm. Infect.* **2018**, *94*, 255–262.
41. Aho, J.; Hankins, C.; Tremblay, C.; Forest, P.; Pourreaux, K.; Rouah, F.; Coutlée, F. Genomic polymorphism of human papillomavirus type 52 predisposes toward persistent infection in sexually active women. *J. Infect. Dis.* **2004**.
42. Takehara, K.; Toda, T.; Nishimura, T.; Sakane, J.; Kawakami, Y.; Mizunoe, T.; Nishiwaki, M.; Taniyama, K. Human Papillomavirus Types 52 and 58 Are Prevalent in Uterine Cervical Squamous Lesions from Japanese Women. *Patholog. Res. Int.* **2011**, *2011*, 1–7.
43. Sethi, S.; Muller, M.; Schneider, A.; Blettner, M.; Smith, E.; Turek, L.; Wahrendorf, J.; Gissmann, L.; Chang-Claude, J. Serologic response to the E4, E6, and E7 proteins of human papillomavirus type 16 in pregnant women. *Am. J. Obstet. Gynecol.* **1998**, *178*, 360–364.
44. Nobbenhuis, M.A.E.; Helmerhorst, T.J.M.; Van den Brule, A.J.C.; Rozendaal, L.; Bezemer, P.D.; Voorhorst, F.J.; Meijer, C.J.L.M. High-risk human papillomavirus clearance in pregnant women: Trends for lower clearance during pregnancy with a catch-up postpartum. *Br. J. Cancer* **2002**, *87*, 75–80.
45. Yost, N.P.; Santoso, J.T.; McIntire, D.D.; Iliya, F.A. Postpartum regression rates of antepartum cervical intraepithelial neoplasia II and III lesions. *Obstet. Gynecol.* **1999**, *93*, 359–362.
46. Joseph Davey, D.; Shull, H.; Billings, J.; Wang, D.; Adachi, K.; Klausner, J. Prevalence of Curable Sexually Transmitted Infections in Pregnant Women in Low- and Middle-Income Countries From 2010 to 2015. *Sex. Transm. Dis.* **2016**, *43*, 450–458.
47. Adachi, K.; Nielsen-Saines, K.; Klausner, J.D. Chlamydia trachomatis Infection in Pregnancy: The Global Challenge of Preventing Adverse Pregnancy and Infant Outcomes in Sub-Saharan Africa and Asia. *Biomed Res Int.* **2016**, *2016*, 9315757.
48. Baumann, L.; Cina, M.; Egli-Gany, D.; Goutaki, M.; Halbeisen, F.S.; Lohrer, G.-R.; Ali, H.; Scott, P.; Low, N. Prevalence of Mycoplasma genitalium in different population groups: systematic review and meta-analysis. *Sex Transm Infect* **2018**, *94*, 254–261.
49. Brandful JA, Bonney EY, Asmah RH, A.-K.K. Oncogenic human papillomavirus (HPV) in women from Ghana. *J. Cancer Res. Exp. Oncol.* **2014 Dec 31**; *6(4)31-8* **2014**, *6*, 31–38.

50. Schulze, M.H.; Völker, F.M.; Lugert, R.; Cooper, P.; Hasenclever, K.; Groß, U.; Pfister, H.; Silling, S. High prevalence of human papillomaviruses in Ghanaian pregnant women. *Med. Microbiol. Immunol.* **2016**, *205*, 595–602.
51. Elukunbi, A.H.; Kolawole, E.O.; Kola, J.O.; Afolabi, Y.O. Human papillomavirus in pregnant women at Bowen University Teaching Hospital, Ogbomoso, Nigeria. *J. Immunoass. Immunochem.* **2019**, *40*, 283–288.
52. Stevens, D.; Kaplan, E. *Streptococcal infections: clinical aspects, microbiology, and molecular pathogenesis*; Oxford University Press, Ed.; USA, 2000;
53. O'Farrell, N.; Hoosen, A.A.; Kharsany, A.B.; van den Ende, J. Sexually transmitted pathogens in pregnant women in a rural South African community. *Sex. Transm. Infect.* **1989**, *65*, 276–280.
54. Mullick, S.; Watson-Jones, D.; Beksinska, M.; Mabey, D. Sexually transmitted infections in pregnancy: Prevalence, impact on pregnancy outcomes, and approach to treatment in developing countries. *Sex. Transm. Infect.* **2005**, *81*, 294–302.
55. Juliana, N.; Peters, R.; Al-Nasiry, S.; Morré, S.A.; Ambrosino, E. Sexually transmitted infections in pregnancy and its association with pregnancy outcomes in the Sub-Saharan region. *Unpublished* **2020**.
56. Johns Hopkins Association of Chlamydia trachomatis and Mycoplasma hominis with intrauterine growth retardation and preterm delivery: Investigators of the Johns Hopkins study of cervicitis and adverse pregnancy outcome. *Am. J. Epidemiol.* **1989**.
57. Gravett, M.G.; Nelson, H.P.; Derouen, T.; Critchlow, C.; Eschenbach, D.A.; Holmes, K.K. Independent Associations of Bacterial Vaginosis and Chlamydia trachomatis Infection With Adverse Pregnancy Outcome. *JAMA J. Am. Med. Assoc.* **1986**, *256*, 1899–1903.
58. Harrison, H.R.; Alexander, E.R.; Weinstein, L.; Lewis, M.; Nash, M.; Sim, D.A. Cervical Chlamydia trachomatis and Mycoplasma Infections in Pregnancy: Epidemiology and Outcomes. *JAMA J. Am. Med. Assoc.* **1983**, *250*, 1721–1727.
59. Plummer, F.A.; Laga, M.; Brunham, R.C.; Piot, P.; Ronald, A.R.; Bhullar, V.; Mati, J.Y.; Ndinya-Achola, J.O.; Cheang, M.; Nsanze, H. Postpartum Upper Genital Tract Infections in Nairobi, Kenya: Epidemiology, Etiology, and Risk Factors. *J. Infect. Dis.* **1987**, *156*, 92–98.
60. Elliott, B.; Brunham, R.C.; Laga, M.; Piot, P.; Ndinya-Achola, J.O.; Maitha, G.; Cheang, M.; Plummer, F.A. Maternal gonococcal infection as a preventable risk factor for low birth weight. *J. Infect. Dis.* **1990**, *161*, 531–536.
61. Donders, G.G.G.; Desmyter, J.; De Wet, D.H.; Van Assche, F.A. The association of gonorrhoea and syphilis with premature birth and low birthweight. *Genitourin. Med.* **1993**, *69*, 98–101.
62. Bowden, F.J.; Garnett, G.P. Trichomonas vaginalis epidemiology: Parameterising and analysing a model of treatment interventions. *Sex. Transm. Infect.* **2000**, *76*, 248–256.
63. Sutton, M.Y.; Sternberg, M.; Nsuami, M.; Behets, F.; Nelson, A.M.; St. Louis, M.E. Trichomoniasis in pregnant human immunodeficiency virus-infected and human immunodeficiency virus-uninfected Congolese women: Prevalence, risk factors, and association with low birth weight. *Am. J. Obstet. Gynecol.* **1999**, *181*, 656–662.
64. Schwebke, J.R. Update of trichomoniasis. *Sex. Transm. Infect.* **2002**, *78*, 378–379.
65. Hardy, P.H.; Nell, E.E.; Spence, M.R.; Hardy, J.B.; Graham, D.A.; Rosenbaum, R.C. Prevalence of six sexually transmitted disease agents among pregnant inner-city adolescents and pregnancy outcome. *Lancet* **1984**, *324*, 333–337.
66. Cotch, M.F.; Pastorek, J.G.; Nugent, R.P.; Hillier, S.L.; Gibbs, R.S.; Martin, D.H.; Eschenbach, D.A.; Edelman, R.; Carey, J.C.; Regan, J.A.; et al. Trichomonas vaginalis associated with low birth weight and preterm delivery. *Sex. Transm. Dis.* **1997**, *24*, 353–360.
67. Atashili, J.; Poole, C.; Ndumbe, P.M.; Adimora, A.A.; Smith, J.S. Bacterial vaginosis and HIV acquisition: A meta-analysis of published studies. *AIDS* **2008**, *22*, 1493–1501.
68. Lewis, F.M.T.; Bernstein, K.T.; Aral, S.O. Vaginal microbiome and its relationship to behavior, sexual health, and sexually transmitted diseases. *Obstet. Gynecol.* **2017**, *129*, 643–654.
69. Zheng, J.; Wittouck, S.; Salvetti, E.; Franz, C.M.A.P.; Harris, H.M.B.; Mattarelli, P.; O'toole, P.W.; Pot, B.; Vandamme, P.; Walter, J.; et al. A taxonomic note on the genus Lactobacillus: Description of 23 novel genera, emended description of the genus Lactobacillus Beijerinck 1901, and union of Lactobacillaceae and Leuconostocaceae. *Int. J. Syst. Evol. Microbiol.* **2020**, *70*, 2782–2858.
70. Hardy, L.; Cerca, N.; Jespers, V.; Vanechoutte, M.; Crucitti, T. Bacterial biofilms in the vagina. *Res. Microbiol.* **2017**, *168*, 865–874.
71. Espinoza, J.; Gonçalves, L.F.; Romero, R.; Nien, J.K.; Stites, S.; Kim, Y.M.; Hassan, S.; Gomez, R.; Yoon, B.H.; Chaiworapongsa, T.; et al. The prevalence and clinical significance of amniotic fluid “sludge” in patients with preterm labor and intact membranes. *Ultrasound Obstet. Gynecol.* **2005**, *25*, 346–352.
72. Romero, R.; Schaudinn, C.; Kusanovic, J.P.; Gorur, A.; Gotsch, F.; Webster, P.; Nhan-Chang, C.L.; Erez, O.; Kim, C.J.; Espinoza, J.; et al. Detection of a microbial biofilm in intraamniotic infection. *Am. J. Obstet. Gynecol.* **2008**, *198*, 135.e1–135.e5.
73. Jespers, V.; Crucitti, T.; Menten, J.; Verhelst, R.; Mwaura, M.; Mandaliya, K.; Ndayisaba, G.F.; Delany-Moretwe, S.; Verstraelen, H.; Hardy, L.; et al. Prevalence and Correlates of Bacterial Vaginosis in Different Sub-Populations of Women in Sub-Saharan Africa: A Cross-Sectional Study. *PLoS One* **2014**, *9*, e109670.
74. Gouda, H.N.; Charlson, F.; Sorsdahl, K.; Ahmadzade, S.; Ferrari, A.J.; Erskine, H.; Leung, J.; Santamauro, D.; Lund, C.; Aminde, L.N.; et al. Burden of non-communicable diseases in sub-Saharan Africa, 1990–2017: results from the Global Burden of Disease Study 2017. *Lancet Glob. Heal.* **2019**, *7*, e1375–e1387.
75. Feleke, D.G.; Adamu, A.; Gebreweld, A.; Tesfaye, M.; Demisiss, W.; Molla, G. Asymptomatic malaria infection among pregnant women attending antenatal care in malaria endemic areas of North-Shoa, Ethiopia: A cross-sectional study. *Malar. J.* **2020**, *19*, 67.
76. González-Beiras, C.; Marks, M.; Chen, C.Y.; Roberts, S.; Mitjà, O. Epidemiology of Haemophilus ducreyi infections. *Emerg. Infect. Dis.* **2016**, *22*, 1–8.
77. Myers, K.M.; Feltovich, H.; Mazza, E.; Vink, J.; Bajka, M.; Wapner, R.J.; Hall, T.J.; House, M. The mechanical role of the cervix in pregnancy. *J. Biomech.* **2015**, *48*, 1511–1523.
78. Nott, J.P.; Bonney, E.A.; Pickering, J.D.; Simpson, N.A.B. The structure and function of the cervix during pregnancy. *Transl. Res. Anat.* **2016**, *2*, 1–7.
79. Becher, N.; Waldorf, K.A.; Hein, M.; Uldbjerg, N. The cervical mucus plug: Structured review of the literature. *Acta Obstet. Gynecol. Scand.* **2009**, *88*, 502–513.
80. Hansen, L.K.; Becher, N.; Bastholm, S.; Glavind, J.; Ramsing, M.; Kim, C.J.; Romero, R.; Jensen, J.S.; Uldbjerg, N. The cervical mucus plug inhibits, but does not block, the passage of ascending bacteria from the vagina during pregnancy. *Acta Obstet. Gynecol. Scand.* **2014**, *93*, 102–108.
81. Brunelli, R.; Papi, M.; Arcovito, G.; Bompiani, A.; Castagnola, M.; Parasassi, T.; Sampaiolese, B.; Vincenzoni, F.; De Spirito, M. Globular structure of human ovulatory cervical mucus. *FASEB J.* **2007**, *21*, 3872–3876.
82. Vornhagen, J.; Quach, P.; Santana-Ufret, V.; Alishetti, V.; Brokaw, A.; Armistead, B.; Qing Tang, H.; Macdonald, J.W.; Bammler, T.K.; Adams Waldorf, K.M.; et al. Human Cervical Mucus Plugs Exhibit Insufficiencies in Antimicrobial Activity Towards Group B Streptococcus. *J. Infect. Dis.* **2018**, *217*, 1626–1636.

83. Olesen, A.W.; Westergaard, J.G.; Olsen, J. Perinatal and maternal complications related to postterm delivery: A national register-based study, 1978-1993. *Am. J. Obstet. Gynecol.* **2003**, *189*, 222–227.
84. Kervinen, K.; Kalliala, I.; Glazer-Livson, S.; Virtanen, S.; Nieminen, P.; Salonen, A. Vaginal microbiota in pregnancy: Role in induction of labor and seeding the neonate's microbiota? *J. Biosci.* **2019**, *44*, 1–6.
85. Nyemba, D.C.; Medina-Marino, A.; Peters, R.P.H.; Klausner, J.D.; Ngwepe, P.; Myer, L.; Johnson, L.F.; Davey, D.J. Prevalence, incidence and associated risk factors of STIs during pregnancy in South Africa. *Sex. Transm. Infect.* **2020**, *0*, sextrans-2020-054631.
86. Workowski KA, B.G. Sexually transmitted diseases treatment guidelines, 2015. *MMWR. Recomm. reports Morb. Mortal. Wkly. report. Recomm. reports.* **2015**, *5*, RR03.
87. Kriebs, J.M. Guidelines for Perinatal Care, Sixth Edition: By the American Academy of Pediatrics and the American College of Obstetricians and Gynecologists. *J. Midwifery Womens. Health* **2010**, *55*.
88. Williams, C.L.; Harrison, L.L.; Llata, E.; Smith, R.A.; Meites, E. Sexually Transmitted Diseases Among Pregnant Women: 5 States, United States, 2009–2011. *Matern. Child Health J.* **2018**, *22*, 538–545.
89. Frieden, T.R.; Harold Jaffe, D.W.; Rasmussen, S.A.; Leahy, M.A.; Martinroe, J.C.; Spriggs, S.R.; Doan, Q.M.; King Terraye M Starr, P.H.; Roper, W.L.; Hill, C.; et al. *Morbidity and Mortality Weekly Report Sexually Transmitted Diseases Treatment Guidelines, 2015 Centers for Disease Control and Prevention MMWR Editorial and Production Staff (Serials) MMWR Editorial Board*; 2015;
90. Garrett, N.J.; McGrath, N.; Mindel, A. Advancing STI care in low/middle-income countries: Has STI syndromic management reached its use-by date? *Sex. Transm. Infect.* **2017**, *93*, 4–5.
91. Harrison, M.S.; Goldenberg, R.L. Cesarean section in sub-Saharan Africa. *Matern. Heal. Neonatol. Perinatol.* **2016**, *2*.
92. Doctor, H. V.; Nkhana-Salimu, S.; Abdulsalam-Anibilowo, M. Health facility delivery in sub-Saharan Africa: Successes, challenges, and implications for the 2030 development agenda. *BMC Public Health* **2018**, *18*, 765.
93. Gabrysch, S.; Campbell, O.M.R. Still too far to walk: Literature review of the determinants of delivery service use. *BMC Pregnancy Childbirth* **2009**, *9*, 34.
94. Singhal, P.; Naswa, S.; Marfatia, Y.S. Pregnancy and sexually transmitted viral infections. *Indian J. Sex. Transm. Dis. AIDS* **2009**, *30*, 71.
95. Bell, T.A.; Stamm, W.E.; Kuo, C. chou; Wang, S. pin; Holmes, K.K.; Grayston, J.T. Risk of perinatal transmission of Chlamydia trachomatis by mode of delivery. *J. Infect.* **1994**, *29*, 165–169.
96. Strand, C.L.; Arango, V.A. Gonococcal ophthalmia neonatorum after delivery by cesarean section: Report of a case. *Sex. Transm. Dis.* **1979**, *6*, 77–78.
97. Allstaff, S.; Wilson, J. The management of sexually transmitted infections in pregnancy. *Obstet. Gynaecol.* **2012**, *14*, 25–32.
98. Rutayisire, E.; Huang, K.; Liu, Y.; Tao, F. The mode of delivery affects the diversity and colonization pattern of the gut microbiota during the first year of infants' life: A systematic review. *BMC Gastroenterol.* **2016**, *16*, 86.
99. Reyman, M.; van Houten, M.A.; van Baarle, D.; Bosch, A.A.T.M.; Man, W.H.; Chu, M.L.J.N.; Arp, K.; Watson, R.L.; Sanders, E.A.M.; Fuentes, S.; et al. Impact of delivery mode-associated gut microbiota dynamics on health in the first year of life. *Nat. Commun.* **2019**, *10*, 1–12.
100. Stennett, C.A.; Dyer, T. V.; He, X.; Robinson, C.K.; Ravel, J.; Ghanem, K.G.; Brotman, R.M. A cross-sectional pilot study of birth mode and vaginal microbiota in reproductive-age women. *PLoS One* **2020**, *15*, e0228574.
101. Agadjanian, V. Religion, social milieu, and the contraceptive revolution. *Popul. Stud. (NY)*. **2001**, *55*, 135–148.
102. Chesson, H.W.; Mayaud, P.; Aral, S.O. Sexually Transmitted Infections: Impact and Cost-Effectiveness of Prevention. In *Disease Control Priorities, Third Edition (Volume 6): Major Infectious Diseases*; The World Bank, 2017; pp. 203–232 ISBN 9781464805240.
103. Castro, J.; Jefferson, K.K.; Cerca, N. Genetic Heterogeneity and Taxonomic Diversity among Gardnerella Species. *Trends Microbiol.* **2020**, *28*, 202–211.
104. Dubbink, J.-H. Sexually transmitted Infections in rural South Africa towards better control strategies 2016.
105. Volk, J.E.; Marcus, J.L.; Phengrasamy, T.; Blechinger, D.; Nguyen, D.P.; Follansbee, S.; Hare, C.B. No New HIV Infections with Increasing Use of HIV Preexposure Prophylaxis in a Clinical Practice Setting. *Clin. Infect. Dis.* **2015**, *61*, 1601–1603.
106. Wynn, A.; Bristow, C.C.; Cristillo, A.D.; Murphy, S.M.; van den Broek, N.; Muzny, C.; Kallapur, S.; Cohen, C.; Ingalls, R.R.; Wiesenfeld, H.; et al. Sexually Transmitted Infections in Pregnancy and Reproductive Health. *Sex. Transm. Dis.* **2020**, *47*, 5–11.
107. Thomas, P. ChlamIndia: burden of Chlamydia trachomatis in India, Implications for policy and practice 2018.
108. Saul, J.; Bachman, G.; Allen, S.; Toiv, N.F.; Cooney, C.; Beamon, T. The DREAMS core package of interventions: A comprehensive approach to preventing HIV among adolescent girls and young women. *PLoS One* **2018**, *13*, e0208167.

Asiye funzwa na mamae hufunzwa na ulimwengu

*Swahili proverb*  
*"It takes a village to raise a child"*



# 9

## **Addendum**

Summary  
Valorization  
About the author  
Gratitude  
Affiliation list of publications and presentations

## SUMMARY

This thesis reviewed the current knowledge about the role of the VMB in pregnant women from sub-Saharan Africa. It also investigated the VMB composition and the infection status of five burdensome STIs (*Chlamydia (C.) trachomatis*, *Neisseria (N.) gonorrhoeae*, *Trichomonas (T.) vaginalis*, *Mycoplasma (M.) genitalium*, human papillomaviruses (HPV)) among pregnant women living in Pemba Island, Tanzania. On this matter, this thesis provides the latest insights into the burden of vaginal dysbiosis, vaginal dysbiotic conditions, and STIs during pregnancy in sub-Saharan Africa and Pemba Island, in particular.

Pregnancy is a delicate period in a woman's life and pregnancy-related complications can be life-threatening for mothers and their children. Preterm birth, below average length for gestational age, low birthweight, pregnancy loss, and stillbirth are common pregnancy complications leading to morbidity and mortality among newborns. These complications are more common and more severe in middle and low-income countries, including sub-Saharan Africa. Several microorganisms ascending from the lower genital tract have been associated with adverse pregnancy outcomes. That is the case for diverse microorganisms (bacteria, fungi, viruses) able to colonize the vaginal environment. Such as the commensal vaginal microbiota (VMB) and microorganisms that can be transmitted after sexual contact, or sexually transmitted infections (STIs). Lactobacilli and other lactic acid-producing microorganisms in the VMB have been associated with a beneficial vaginal state. In contrast, an overgrowth of (facultative) anaerobes combined with a low abundance of *Lactobacillus* species (also known as vaginal dysbiosis) has been related to a less beneficial vaginal state.

Both vaginal dysbiosis, vaginal dysbiosis related conditions, and STIs such as *C. trachomatis*, *N. gonorrhoeae*, *T. vaginalis*, *M. genitalium*, HPV, herpes simplex viruses, and *Candida* species, promote a non-beneficial pro-inflammatory vaginal state and relate to various health conditions for expectant mothers and fetus. A common vaginal related condition that has been linked to maternal and neonatal morbidity is bacterial vaginosis (BV). Multiple studies of antenatal clinic attendees in sub-Saharan Africa observed that up to 40% of women had BV. Simultaneously, between 2010 - 2015, the pooled prevalence of *T. vaginalis*, *C. trachomatis*, and *N. gonorrhoeae* during pregnancy ranged between 4.6 - 31.4%, 5 - 9%, and 2 - 5.2%, respectively. Furthermore, during pregnancy, prevalence rates between 5.4 - 46% for HPV and 0.8 - 2.4% for *M. genitalium* have been reported in several independent studies from, and outside of, sub-Saharan Africa. Overall, it appears there is a high frequency of vaginal dysbiosis among women from sub-Saharan Africa or women with sub-Saharan ancestry. However, only limited data exists concerning the VMB composition during pregnancy, and new data for STI during pregnancy in rural settings of sub-Saharan Africa are still warranted. With this in mind, the burden of vaginal dysbiosis, VMB dysbiosis related conditions, and STI was investigated.

In the general introduction of this thesis, **chapter 1**, the VMB, its associated bacteria and conditions, along with the five STIs (*C. trachomatis*, *N. gonorrhoeae*, *T. vaginalis*, *M. genitalium*, and HPV) are described and introduced. The research setting is also outlined in **chapter 1**. The vaginal samples from pregnant and post-delivery women analyzed in this thesis were previously collected and stored in a biobank in Pemba Island, Tanzania. Pemba Island is one of the largest Islands in the Zanzibar archipelago, with approximately 19744 pregnant women, and 14000 annual births reported in 2018. Most inhabitants live below the UN poverty line, and the quality of antenatal and infant health care services remain poor. Limited data is available for STI burden among women from this Island, and to date, no information has been published on the VMB composition, particularly among pregnant women.

In **chapter 2**, the results of ten studies were systematically reviewed. These studies independently show that a *Lactobacillus*-dominant VMB or VMB containing Lactobacilli are the most prevalent, followed by a more diverse anaerobe-dominant VMB among pregnant women in sub-Saharan Africa. If further speciated, a VMB profile dominated by *L. iners* or *L. crispatus* were observed as the most common *Lactobacillus*-dominant VMB among pregnancy in several populations. Most pregnant women with an STIs (*C. trachomatis* and *T. vaginalis*) also had a *Lactobacillus*-dominant VMB, but with a significantly higher presence of anaerobic species in their VMB. For human immunodeficiency virus (HIV), another highly common STI in sub-Saharan Africa, one study reported an association between an anaerobic-dominant VMB, maternal HIV infection, and timing of antiretroviral therapy use before or during the pregnancy.

Moreover, use of probiotics (bacterial strains that can potentially modulate the microbiota) and other mineral or vitamin supplements with the VMB composition was also briefly addressed. Two of the included studies reported that the VMB did not differ between women who consumed probiotics and controls. Overall, the number of studies limited the evidence regarding the effect of STIs, medication, and supplements on the VMB. Thus, the use and efficacy of *Lactobacillus*-based probiotics, medicine (antiretroviral therapy), and other supplements on the VMB among sub-Saharan pregnant women need to be further investigated.

Previous studies have linked VMB dysbiosis and dysbiotic conditions with various adverse pregnancy outcomes among different populations. To gain more insights into this association among sub-Saharan African women, **chapter 3** systematically reviewed the findings of twelve studies that investigated this subject. However, merely one culture-based study from 1993 reported about the relationship between VMB related bacteria and pregnancy outcomes. They observed that pregnant women in sub-Saharan Africa with VMB without Lactobacilli, or with overgrowth of other bacteria at the first antenatal examination, had 3.6 times higher risk of giving birth to a newborn with low birth weight (< 2 kg). This was in comparison women with a *Lactobacillus*-dominated VMB or mixed bacteria with a low abundance of *Lactobacillus* species. More studies were retrieved investigating the association between BV and several

adverse pregnancy outcomes among women from sub-Saharan Africa. An association between BV and preterm birth was most often reported (7/9 studies). None of the studies included found an association between BV and pregnancy loss (5/5) or intra-uterine growth retardation (1/1). Finally, there were discrepancies or a low number of studies to support the evidence between BV and low birthweight (2/6), PROM (2/4), intra-uterine infections (1/1), and small for gestational age (1/1). For another but a less well-known vaginal dysbiotic condition, aerobic vaginitis (AV), no article was retrieved that investigated its role with pregnancy outcomes in sub-Saharan African populations. Due to the considerable differences in study design and outcome reporting, the high burden of BV in sub-Saharan Africa, and the limited studies available on VMB composition and AV, additional research is needed to better determine the role of VMB dysbiosis, BV, and AV among sub-Saharan African women.

As highlighted earlier some sexually transmitted microorganisms can cause pregnancy-related sequelae. Thus, the burden of infections should continuously be monitored in vulnerable populations, such as pregnant women. In **chapter 4**, the burden of four non-viral STIs was investigated in vaginal samples from Muslim-Shirazi women between 16-48 years old in Pemba Island, Tanzania. In 55 vaginal samples from 439 (12.5%) local pregnant women, at least one STI was detected. The prevalence of *T. vaginalis* (7.1%) was the highest, followed by *C. trachomatis* (4.6%) and *M. genitalium* (2.1%). The presence of *N. gonorrhoeae* was not detected.

In **chapter 5** the (natural) course of the four genital pathogens in pregnant women from Pemba Island were investigated. When compared to chapter 4, more vaginal samples across two timepoints (before 20 gestational (GA) weeks and after 20 GA weeks) during pregnancy and one timepoint post-delivery (42-62 days after parturition) were investigated for the presence and persistence of STIs across timepoints. *N. gonorrhoeae* was detected in vaginal samples from two different women. This further analysis provided evidence of this pathogen's presence in Pemba Island's local population. Interestingly, during pregnancy, the combined prevalence of STI was higher at the second timepoint (n = 385; 16.7%) compared to the prevalence at the first timepoint (n = 257, 12.2%). Moreover, in 44 post-delivery samples, the prevalence of *T. vaginalis* (6.8%) was the highest, followed by *C. trachomatis* (2.3%), and *N. gonorrhoeae* (2.3%), while *M. genitalium* was not detected at this timepoint. Owing to the low prevalence of *N. gonorrhoeae*, its natural history could not be determined. Some women cleared off *T. vaginalis* (n = 11; 18%) and *M. genitalium* (n = 4; 25%) infections within ten weeks following initial detection during pregnancy. Clearance post-delivery was observed for *T. vaginalis* (n = 5; 80%) approximately 22 weeks after the last detection in pregnancy. Persistence for *C. trachomatis* during (n = 11) or after pregnancy (n = 1) was observed in all of the vaginal samples from the infected women. The study cohort size was small; therefore, careful extrapolation of results is recommended. However, the findings in **chapter 5** support the need for further investigation in a bigger cohort, and the usage of biobanked samples is a valuable approach in this sense.

The burden of 15 high-risk HPV (hrHPV) genotypes among local pregnant women in Pemba were further investigated in **Chapter 6**. The prevalence of high-risk HPV was between 5.9% and 11.2% in pregnant women in Pemba Island, Tanzania. The persistence rate for high-risk HPV during pregnancy was high (63.6%) in this Tanzanian cohort. For future implementation of this assay in resource-poor setting, it is worth mentioning that the HPV detection kit used in **Chapter 6** does not require additional DNA extraction or purification. Additionally, it is based on an isothermal amplification system to amplify targeted sequences in the different HPV genotype regions. This is an example of a simple sample processing procedure method that might be helpful for HPV screening in clinical diagnostic settings, especially in resource-limited laboratories.

The findings in **chapter 7** show for the first time that among the tested pregnant women from Pemba Island, the VMB was generally *Lactobacillus* dominant during pregnancy (65% before 20 GA weeks and 81% after 20 GA weeks) and non-*Lactobacillus* dominant (74%) postdelivery. During pregnancy, the most common *Lactobacillus* species were *L. crispatus* at the first timepoint (26.5%; the prevalence was 1.5% higher than *L. iners*) and *L. iners* at the second timepoint (42.5%). VMB richness (number of species) significantly decreased during pregnancy, while the VMB diversity (number of species and their relative abundance, assessed by the Shannon diversity index) significantly increased between the second pregnancy timepoint and post-delivery. Data from matched samples show that in almost 50% of the women (n = 38) tested at both timepoints the VMB shifted profile during pregnancy. This shift was most commonly towards an *L. iners* dominant VMB. From the second pregnancy to post-pregnancy timepoints, a switch to a diverse VMB community accounted for 85% of these changes. Several pathobionts (VMB related bacteria with potential pathological sequelae) were identified in the tested samples, with *Klebsiella species* and *Streptococcus anginosus* as the most prevalent during and after pregnancy. The substantial presence of pathobionts was most commonly detected in diverse, non-*Lactobacillus* dominant VMB, followed by *L. iners* dominant VMB. There was a higher frequency of pathobionts and a substantial presence (higher relative abundance) of pathobionts in vaginal samples collected post-delivery compared to samples collected during pregnancy. At the second timepoint during pregnancy, significantly more women carrying a genital pathogen (HPV, *C. trachomatis*, *T. vaginalis*, and *M. genitalium*) had VMB belonging to by *L. iners* dominant VMB. Evidence from this study enhances the understanding of VMB during pregnancy and in the post-delivery period in a (rural) sub-Saharan African population.

Based on the evidence of the vaginal environment *friends* (lactic-acid producing microbes, such as most species belonging to *Lactobacillus* genus and particularly *L. crispatus*), *enemies* (STIs), and *frenemies or everything in between* (e.g., pathobionts) during pregnancy and after pregnancy, a general discussion and recommendation of this thesis are provided in **chapter 8**.

A high frequency of non-*Lactobacillus* dominant VMB is reported among pregnant women living in sub-Saharan Africa, including Pemba Island, Tanzania. Furthermore, among Pemban women, the burden of viral, bacterial and protozoan STIs were also revealed during and after pregnancy. Post-pregnancy, most women in Pemba had a diverse, non-*Lactobacillus* dominant, VMB profile. Various hosts (including host-genetics, hormonal and inflammatory response), microbial, behavioural, sociodemographic, nutritional, and environmental factors directly or indirectly influence VMB composition and susceptibility to STIs in pregnancy. However, microbiology methods to detect microorganisms in the vaginal space, and a consensus approach to characterize the VMB profiles, should be further developed to provide more and improved evidence-based VMB and STIs related research, including for resources-limited settings. An integrated approach involving different stakeholders (researchers, clinicians, and policymakers) should be considered to implement better research, policy and management strategies. These efforts are crucial to improve female and newborn health globally, particularly in sub-Saharan Africa, with implications for society and future generations.

## VALORIZATION

### RELEVANCE AND SOCIETAL IMPACT

This thesis provides knowledge generation around cutting-edge microbiome research - the vaginal microbiota (VMB) - and information on prevalence status of some the most fastidious and long-lasting sexually transmitted infections (STIs) in sub-Saharan African women. Via a systematic search our work confirms that for most of the pregnant women living in sub-Saharan Africa, the VMB composition is *Lactobacillus* dominant (**chapter 2**). This is also the case among the pregnant women in Pemba Island, Tanzania, this thesis's chosen research setting (**chapter 7**). In this very same population, *Chlamydia (C.) trachomatis*, *Neisseria (N.) gonorrhoeae*, *Trichomonas (T.) vaginalis*, *Mycoplasma (M.) genitalium*, and human papillomaviruses (HPV) was present during and after parturition (**chapter 4-7**). Moreover, a high frequency of VMB dysbiosis (defined as non-*Lactobacillus* dominant VMB) was observed post-delivery in this population (**chapter 7**). These findings expand scientific knowledge, for clinicians, researchers, and public health officials, on vastly under-research topics: vaginal conditions (vaginal dysbiosis, bacterial vaginosis, and aerobic vaginitis) and STIs in low- and middle-income countries, especially those belonging to the STI endemic areas in sub-Saharan Africa. It also highlights their burden in a vulnerable population, namely pregnant women. Therefore, it is essential to further research and monitor STIs' burden and VMB composition in pregnant women, their role on health outcomes and implement up-to-date strategies to better control and eliminate STIs and vaginal dysbiosis, particularly so during pregnancy.

Regrettably, despite continued public health efforts, maternal and neonatal morbidity and mortality remain high in sub-Saharan Africa. There is also increasing evidence related to the contribution of STIs, VMB dysbiosis, or VMB dysbiotic conditions, such as bacterial vaginosis (BV) on maternal and neonatal morbidity (**chapter 3**). This evidence is yet to be confirmed in the Pemban population. Nevertheless, the novel scientific knowledge about the VMB composition in expectant and new mothers from Pemba should be used as a stepping stone for upcoming pregnancy and VMB-related research in sub-Saharan African communities (**chapter 7**). Additional research on this topic will ultimately provide evidence whether and how VMB composition is of clinical utility and can assist in making evidence-based VMB-related strategies to improve maternal and neonatal health.

This work is part of a collaborative effort between the Institute of Public Health Genomics (Maastricht, the Netherlands), the Public health laboratory - Ivo de Carneri (Pemba Island, Tanzania) and the Center for Public Health Kinetics (India). This thesis provides the earliest testing results output of this collaboration (**Chapter 4, 5,6 and 7**). In order to maximize and continue this effort, different approaches will be sustained or further reinforced;



1. More plans for knowledge and skills transfer and for capacity strengthening between the local setting in Pemba and other international stakeholders involved are planned in the near future, or as soon as the international travels are allowed.
2. Fostering international connections between the Pemba Biobank and European institute, such as Maastricht University, Maastricht University Medical Center (MUMC+), and the University Medical Center Amsterdam will be strengthened.

Furthermore, additional samples (from a total of up to 600 women) in the Biobank in Pemba are available and will be part of the next shared research efforts. The availability of these samples and related clinical information will offer opportunities to expand the research in Pemba, will continue collaborations with partners such as our research group, shared efforts in requests for funding, with the ultimate goal to identify clinically relevant associations with the potential to impact the local population.

There are also multiple options for follow-up research based on these primary results. This research can for instance be a starting point for further research in the field of infectious diseases and host-pathogens interactions, with the option to:

- Investigate bacterial serovars of *Chlamydia trachomatis*; including the one responsible for trachoma
- Detect and characterize other genital pathogens (*Waddlia chondrophila*, *Lymphogranuloma venereum* (LGV) *Ureaplasma* species, *Mycoplasma hominis*, *Treponema pallidum*, *Candida* species, Herpes simplex virus 1 (HSV1) and Herpes simplex virus 2 (HSV2))
- Investigate possible Antimicrobial Resistance (AMR) carried by the detected pathogens
- Further investigate the antibiotic usage in Pemba
- Assess the host-genetic determinants of infections
- Investigate the relationship between VMB and genital pathogens with adverse pregnancy outcomes

These and subsequent research outcomes from biobanking activities have the potential to inform future policymaking in the field of public health and mother and child health care. Among the ultimate goals are efforts to lower the prevalence of STI on the Island (e.g. by using more efficient screening strategies), reduce the morbidity caused by these pathogens, and lower the amount of vertical transmission of STIs or other vaginal pathogens from mother to newborn.

### SCIENTIFIC INNOVATION AND IMPLEMENTATION

As observed in **chapter 2** and **3**, VMB data in pregnancy among women from sub-Saharan Africa is scant, highlighting the need for further research on the topic. Since VMB composition differ within and between women (due to several factors, as discussed in **chapter 8**), a larger dataset

will provide more definite insights on VMB composition in a population and its role in health. As expansion of this clinical samples set will be a first contribution in this direction.

The findings and key discussions in this thesis might serve as a starting ground on which bases new strategies and approaches can be developed and might be of interest for various stakeholders involved in the advancements or manufacturing of (commercial) VMB or STI testing kits. In the work described in this thesis, previously validated samples collection and testing kits for genital infections (i.e. swabs and eNAT buffer, IS-pro assay for VMB, Presto *C. trachomatis*, *N. gonorrhoea*, and *T. vaginalis* kit, and Atila AmpFire HPV isothermal PCR kit) were used providing evidence that they can be used also on samples collected in this biobank setting. The new Atila AmpFire for the HPV detection might be in particular a very compelling detection method for many low-resource laboratory settings as the kit includes the materials and protocol for a quick DNA isolation process. Unfortunately, in this project we did not use the DNA isolation protocol as the DNA were already isolated for the non-viral STI testing. Thus, investigating the utility and practicality of the Atila Ampfire HPV kit and other similar STI testing kits in a low-resource laboratory setting is still warranted. Nevertheless, such methodological innovations will hopefully pave the way towards easier and more affordable molecular diagnostics tools that might be also be widely-implemented for future use in low- and middle-income countries. Easier diagnostic tools such as rapid nucleic acid amplification tests (NAATs) and point of care (POC) testing can improve healthcare, in this case particularly for expectant mothers.

Research around VMB diversity, particularly in expectant mothers, is still at an early stage and its link to health outcomes needs to be further clarified. Nevertheless, in the last decade new evidence has been increasingly shared on the association between VMB and reproductive health. Several studies have suggested that urogenital microbiome composition might predict reproductive technology success and early pregnancy health (**chapter 3**). The link between VMB and later pregnancy complication, such as preterm birth, appears less clear and more research is needed. However low- and middle-income countries, especially those with high burden of adverse pregnancy outcomes, would greatly benefit from research that are investigating causes and factors contributing to this burden. If relevant association with pregnancy-related health burdens are found, they can hopefully contribute means to tackle those burdens.

At this early VMB research stage, various stakeholders in the public and private sector should continue to develop state of the art methods for VMB analysis. Alike, innovative STI testing will offer new research opportunities. It will remain of utmost important that public health official constantly evaluate healthcare options to improve maternal and newborn health, especially the latest evidence based STI and VMB methods and strategies from both the private and the public scientific community.

## ABOUT THE AUTHOR

Naomi C. A. Juliana was born on the 2<sup>nd</sup> of December 1992 in Willemstad, Curaçao. She received her high school education at Radulphus College (Curaçao), graduating from the same institution in 2012. In the same year, Naomi relocated to the Netherlands to commence studies in Biomedical Sciences at the Maastricht University. During her studies, she participated in a multitude of extracurricular activities; she was a member of the Promoteam at the Maastricht University, and Chair for various committees at the Maastricht University and at the student association “Lux ad Mosam”. Naomi obtained a teaching qualification in secondary education Biology during her Bachelor’s program, in addition to being a member of the student assistance team for two research programs. Her interest in research and sub-Saharan Africa developed during her final year internship in South Africa. Under the supervision of Prof. L. M. Birkholtz and Prof. R. Peters, she investigated the “Detection of molecular markers associated with Plasmodium falciparum resistance”. Following completion of her Bachelor’s degree in 2015, she commenced the Master Physician-Clinical Investigator (A-KO) programme to fulfill her combined interest of medicine and research; a highlight of this period was a clinical rotation at Byumba Hospital in Rwanda. At Byumba Hospital, she had to opportunity to participate in various clinical activities on the maternal and neonatal wards of a secondary healthcare facility in sub-Saharan Africa and got to experience first-hand the challenges of healthcare provision in a resource-poor setting.



In November 2017, Naomi joined the Institute of Public Health Genomics (IPHG) at the Maastricht University as a researcher focusing on *Chlamydia trachomatis* induced subfertility, under the supervision of Prof. M. Zeegers and Prof S.A. Morré. In November 2018, she commenced work on genital microorganisms in pregnant women in sub-Saharan Africa, with a focus on Pemba Island, Tanzania, under the supervision of Prof. S.A. Morré and Dr. E. Ambrosino; this work was carried out concurrently with her Master research internship.

Nearing completion of her Master Physician-Clinical Investigator programme, she conducted her final clinical rotation at the department of Obstetrics and Gynecology at Maastricht University Medical Center, under supervision of Dr. S. Al-Nasiry, and graduates in September 2019. In addition to research, Naomi has taught on Bachelor and Master courses at the Faculty of Health, Medicine and Life Sciences, Maastricht University. The following year, she returned to clinical practice, working as a physician at the Mondriaan Addiction Treatment Center in Zuid-Limburg.

On completion of her PhD, Naomi plans to return home to Curaçao, where she will commence work in February 2021 as a physician at the Department of Obstetrics and Gynecology at Curaçao Medical Center. Her long-term ambition is to combine clinical and research practice in her future career.

## GRADITUTE

*Disclaimer: this section is written in a genuine Naomi style. Thus, there will be no grammar or spelling checks from an amazing person (most probably because they are mentioned in this list and should not read this beforehand), there would be use of multiple languages, I will call some people “u” in Dutch but please don’t get mad, and this section is very long. So, feel free to skip the non-italic parts and go immediately to a name.*

*“Never be afraid to laugh at yourself after all, you could be missing out the joke of the century” (dame Edna Everage). This might be the perfection quote of how I felt several times when I was “reading” sections of this thesis and caught myself not reading it (well) all. This last years, I had to face my dyslexia so many times and this lead to many internal frustrations. Nonetheless after many irritations the only thing I could do was laugh and try again. Turns out my motivation to discover new theories and sharing knowledge was greater than re-writing a sentence for the 5<sup>th</sup> time. Yes, to me this might be the joke of the century; Naomi, the person that hates reading, writing a 200+ pages long thesis... And to be honest only **God** knows where I find the courage to take up these academic challenges. Therefore, to Him goes my first and biggest salutation. He provides me with hope, strength, intelligence and patience, and I truly believe he makes sure I have the greatest community of all. Because even with all my intrinsic motivation and perseverance in the world, this thesis would not have this structure and quality if it was not for the ideas, discussions, and support of these great people:*

Geachte **Prof. dr. Servaas Antonie Morré**, Beste Servaas, in het begin was het best een uitdaging om de originele Twin studie een goede start te geven, maar gelukkig was er op de juiste moment een zeldzame aanbod die heel goed paste aan mijn interesses (obstetrie, microbiologie en tropische geneeskunde gerelateerde problematieken). Uw begeleiding bleef niet bij onderzoek alleen, u motiveerde me altijd om te blijven ontplooiën en mijn “hidden ambitions” beter te laten zien. Dankzij ons eerste gesprek ben ik niet bang om een uitblinkerder CV te schrijven, om toch een last minute abstracts te schrijven voor een nationale en internationale conference en toch wat meer onderwijstaken/presentatis op te pakken. De highlights van onze tijd samen was voor mij de momenten waar u genoeg tijd had om mijn vragen uitgebreid te beantwoorden (zonder dat er een telefoontje ging) en uw hooggeleerd kennis kon over te dragen. Jammer genoeg door COVID-19 pandemie zijn deze momenten minder geworden dan we eerst hoopten, maar ik hoop van harte dat het niet tot hier blijft. Servaas, ik weet niet hoe ik u moeten bedanken voor deze mooie gelegenheid. Dat u mij, toen der tijd nog een master student die midden in haar co-schappen en toevallig ook niet zo lekker in haar vel zat, toch de kans gaf om te profileren in de academische wereld. Ik ben ultiem blij dat ik deze uitdaging met u mocht beleven en ik hoop dat u trots bent met ons resultaat.

Dear **Dr. Elena Ambrosino**, dear Elena, I will never forget our first encounter. You definitely left me speechless and thinking who is this woman. Looking back, I can only laugh now of how unnecessary scared I was of you... luckily this feeling quickly changed after our informal talk on the boat trip to the Maastrichtse grotten. Elena you are truly amazing supervisor and if I have to do this again, I would not ask for anyone else to be my co-supervisor. Lots of people react how fast I wrote my thesis, and I make sure to let them know that my super-fast supervisors are the main reason! Having a supervisor so involved and passionate in the project really accelerate the process. I am super grateful for the perseverance you had with this project, the time you took to quickly but thoroughly read all my very long papers (correct the English language, make it sound more scientifically and concise), provide feedback, and help me achieve some of my ambitions in a very short time. For instance, motivating me to write a small-grant to go to Pemba two weeks before my contract end; just because Naomi really wants to go to Tanzania. Unfortunately, because of the current travel ban, visiting Tanzania is on hold, but soon we will go! Off course I will never forget my first international conference with you in Milan, together with **Salwan, dr. van Teeffelen**, and **Santina** of Copan Diagnostics (Santina also thank you for your help and support!).

Cara Elena, spero che continuerai a ottenere il credito che meriti. Sei una grande insegnante, una ricercatrice appassionata, una donna che lavora sodo nell'ambito scientifico, una buona madre e una delle persone più straordinarie che ora posso chiamare mia amica. Spero che questa sia la base di molte altre collaborazioni a venire.

ps. Sto ancora aspettando le mie lezioni di risotto.

Geachte **Prof. dr. Remco Petrus Hendricus Peters**, Beste Remco, wie had gedacht dat na ons avontuur in Pretoria we nog een nieuw avontuur zouden gaan beginnen? Het was toen al een eer om u als bachelor supervisor te mogen hebben in Zuid-Afrika en nu was extra special om weer met u te werken aan verschillende papers. Ik ben u zo dankbaar dat u altijd de tijd neemt om kennis over te dragen, zoals kennis van wetenschap en tips en tricks van het leven. Uw blik op zaken en mijn gestelde vragen heeft mij geholpen om de projecten tot een hoger niveau te tillen en ook mijn eigen blik aan te scherpen. Ik kan niet wachten totdat we weer naar een café kunnen gaan om over het leven te praten (hopelijk dan ook in Zuid-Afrika!). Ik hoop dat we in de toekomst met elkaar kunnen blijven werken, want ik krijg toch een bittersweet en maar stiekem meer een blij gevoel als ik een mail van u krijg die eindigt met "as always more than happy to discuss further" met andere woorden ons document staat vol met opbouwende commentaren.

Geachte **Dr. Salwan Al-Nasiry**, Beste Salwan, een twee weken stage bij de gynaecologie werd kort daarna een sollicitatiegesprek voor een PhD-traject bij Servaas. Ik ben blij dat u zo positief over mij was om mij deze kans ook te gunnen. Ik blijf verast hoe druk u bent en toch tijd kunt maken om duidelijk, kritisch en inhoudelijk vragen te stellen en om opbouwende feedback te geven. Wellicht moest ik vaak achter u aanrennen voor uw hulp, maar eenmaal ik uw aandacht had - dan

was het ook meteen zeer behulpzaam en educatief. Ontzettend bedankt voor alle inzichten en kennis die u met mij heeft gedeeld. Uw enthousiasme voor zowel de wetenschap als patiëntenzorg is aanstekelijk en ik ben zo blij dat we na mijn A-KO master nog samen konden blijven werken. Ik hoop dat ik in de toekomst een even goede clinicus (gynaecoloog), onderzoeker en onderwijzer mag worden als u. En dat we nog vele jaartjes nog samen mogen werken.

Geachte **ingenieur Linda Poort**, Beste Linda, Linda en Linda! Samen met jou werken, onderzoek doen naar de vaginale samples en samen sparren over ons volgende zet was in een woord: fantastisch! We hebben zoveel samen geleerd, ontdekt, maar ook gelachen! Ik hoop dat ik in de toekomst samen met even leuke en oprecht geïnteresseerde collega's als jou mag werken. Echter laten we eerlijk zijn; er is maar een Linda! En wat ben ik blij dat ik met jou de vaginale microbiota van Tanzaniaanse vrouwen mocht analyseren.

Geachte **ingenieur Jolein Pleijster**, Beste Jolein, mijn lab supervisor in Amsterdam. Ik ben zo blij moet uw hulp en gezelligheid in het lab. Het was zeker voor mij een uitdaging om na 3 jaartjes terug te zijn in een lab. De vijf maanden in Amsterdam ging in een rap tempo en we hebben veel samples mogen analyseren. Jolein bedankt voor u hulp met dit project. Het is jammer dat we daarna minder persoonlijk met elkaar konden werken, maar ik hoop dat we elkaar snel weer mogen zien.

Geachte **Dr. Sander Ouburg**, Beste Sander (ja, hier heb ik achteraf opzettelijk alle u veranderd in je). Ik wil je ook bedanken voor jouw hulp met het project. Zonder jouw kennisoverdracht met betrekking tot de database, sommige lab-analyse en het maken van figuren zou deze project toch moeizamer zijn gelopen. Het is jammer dat door de drukte ivm met de COVID-19 pandemie je minder betrokken had kunnen zijn met de laatste fase van mijn onderzoek. Ik hoop wel van harte dat je wel nu even de tijd neemt om te genieten van onze prestaties en hopelijk in de toekomst kunnen we weer samen nieuwe onderzoekjes gaan verrichten.

Geachte **Dr. Andries Budding**, Beste Dries, Danki danki i mas danki pa tuma tempu i lagami siña mas di microbiologia i pa lagami kolabora ku Inbiome. Ik zal nooit meer vergeten hoe blij u kan worden om een "puzzelstukje" op Excel op te lossen en hoe belangrijk het is om te blijven genieten op het werk (hoe druk het ook is). Ook zal ik niet vergeten hoe u papiaments begon te praten met mij tijdens de lunch. Ik wens u allerbeste met Inbiome, IS-pro en uw toekomstige plannen. Het was/is een eer om te mogen werken met een ambitieuze entrepreneur, onderzoeker en clinicus als u. Hopelijk gaan we vaker samenwerken.

Beste **ingenieur Roel Heijmans**, "heeee Roel!" Net als Jolein je was altijd klaar voor me als ik hulp nodig had in het lab. We hebben een kort en krachtig HPV-paper samen kunnen publiceren, wat mooi he? Bedankt voor de fijne samenwerking en gezelligheid!

Dear **Dr. Pierre Thomas**, Diere Pierre, Dear Torro! Definitely my protector during this research trajectory and my “outlet valve”. Together with **Dr. Rachel Elands**, you provide some of the most unforgettable lunch meetings a colleague can ask for. Whenever I am stuck with something, I know to whom I can come to get some inspiration and help. Pierre you were right... no matter how much you like your research topic there will be one day you will hate it... and when that day came I was so lucky to have you right by my side and you put me right back on track! Thank you for this, thank you for the Friday croissant and the brainstorm sessions. We have two main trips coming up... one to India (with Miss Jyothirmayi Vadlamudi Rao, MSc) and one to Curaçao.

Beste **Diana Kramp**, u bent ook een van de grootste key-players die me heeft geholpen met alle regelzaken rondom mijn onderzoek. Ik ben een ramp met mijn administratieve zaken, maar ik ben blij dat u dit wist op te pakken voor mij en dat u er ook altijd was voor een leuk babbeltje. Bedankt hiervoor en veel succes met u eigen carrière.

**Prof. dr. Jolanda Land**, **Dr. Willem Vocken**, en **Dr. Henk van Kranen** ook aan jullie bedankt voor alle tips and tricks met betrekking tot het promoveren. Het was voor mij een zeer grote eer om met jullie te werken en van jullie te leren.

**Prof. dr. M. Zeegers** and **Dr. Elena Torre**, thank you both for your help in the beginning with the twin project. It is a shame it could have not work out with the global biobanks and in the time-setting we wanted too, but I did learn a lot in this period and from working with both of you.

Beste **Dr. Martin Singer** en **Maarten Boonen**, een speciale dank aan jullie om mij te helpen in de beginfase van de microbiota analyse. Jullie tips waren tot aan het eind nog steeds gebruikelijk. Lieve **Sonja** en **Monique** bedankt dat ik in jullie lab mocht binnendringen om zoveel samples te isoleren. **Nina** erg bedankt voor je kennisoverdracht en hulp, jou inzet zorgde dat we een snel begin konden maken met het testen van de samples. Ik wens jullie allemaal veel succes met jullie toekomstige carrière en keep having fun (met goede muziek) in the lab!!

Beste **Dr. Anne Ammerdorffer**, lieve Anne, bedankt voor al je handige tips en mooie gesprekken met betrekking tot mij onderzoek en de onderzoekerswereld. Ik heb echt veel van je geleerd! Daarnaast ook bedankt dat ik drie weken lang in je huis in Amsterdam mocht verblijven.

Lieve dokter **Omaima**, je bent echt een van de tofste collega's! Ons specialiteit is urenlang met elkaar sparren aan de telefoon “wat de beste carrière zet zal zijn” en dan maandenlang niet meer met elkaar praten. Omaima ik hoop dat je weet dat je een speciale plek in mijn hart hebt en ik wens je het allerbeste in je privé leven en met je carrière! Succes met de laatste loodjes voor het behalen van je PhD!

**Niloofar**, **June**, **Wies**, **Arnold**, **Martine**, **Bernice**, **Lisanne** en **alle andere medewerkers van diverse teams in Amsterdam** bedankt voor jullie steun en gezelligheid op de werkvloer. Mijn PhD voorgangers, **Jan-Henk**, **Dewi** en **Elaine**, ook een dank aan jullie voor de inspirerende publicaties en jullie mooie thesis. Deze boeken hebben mij talloze keren geholpen om mijn eigen thesis structureel te schrijven.

**Meghan**, hopi master ku nos por a skibi un manuscript i publika huntu! Danki pa yudami ku esaki! Mi ta kere ku henter Kòrsou mag di ta bon orguyoso di nos i ami sigur ta dibo i bo perseveransha!

**Dorothea**, **Lenya**, **Maya** en “mijn” **A-KO Core** groepje jaar 1 ook aan jullie bedankt om me te steunen gedurende mijn onderzoek traject. Allerbeste met jullie toekomst en ik hoop dat we in de toekomst kunnen (blijven) samenwerken.

**Ricardo** en **Haoyi**, two very involved master students at IPHG. Thank for all your support and tips with my presentations. **Haoyi**, once again a major thanks for helping me with the vaginal microbiota figures! Your time and enthusiasm are very much appreciated. I hope this is only the beginning of your career in making “nice” figures and you will become very successful in your academic career.

To all the amazing **collaborators in India and Tanzania**. Thank you for collecting the vaginal samples and reporting the health data so precisely. It really made the analyzation process much easier. I hope this project and collaborations will flourish more and the aims and goals of this project can be met so that the public and individual health of the Pemban women, Tanzanian women, and sub-Saharan Africa community can be improved.

Verder wil ik alle leden van de promotiecommissie, **Prof. dr. Paul H.M. Savelkoul**, **Prof. dr. Christian J.P.A. Hoebe**, **Prof. dr. Henry J.C. de Vries**, **Prof. dr. Janneke H.H.M. van de Wijgert**, and **dr. John Penders** bedanken voor jullie tijd om mijn proefschrift te lezen en een oordeel erover te vellen.

*Besides the people and organizations that helped closely with the research project and my thesis, I am also grateful for my support system in my private life. Without them I probably would not get in touch with Servaas and have the support that I needed to push through!*

This whole research project started with the help of my paranymp **Melisa**. She was helping Servaas finding a match for a twin research PhD project. Somehow, she was asking everybody if there interested (and continuously skipping me) until I grab the courage and casually told her I am also interested. Followed by a very surprised Melisa and a super “why not” Naomi face. And yes, Melisa knew that I was clueless of how hard a PhD trajectory would be and even more naïve how much writing it would entail. Nevertheless, after I said yes to this new challenge, she motivated me through thick and thin so I can achieve my goals. When I was feeling overwhelmed, I know who to call or even visit in Berlin. Melisa you are more than an amazing paranymp, you are a one-of-a-kind friend. Thank you for always being there for me!

Nonetheless, the project would have been harder to accomplished if we (IPHG and I) did not have the support of my aunt **Omaira Wallé** and uncle **Willem Wiltjer**. They offer me a roof over my head, quality food and great company in Zaandam while I was working at the laboratory at VUMC. They became involve with the project and always supported me where I needed help. Dear both, again a million thanks, danki, bedankt for this continuous support! I am glad oom Wim accepted to be my other paranymp, since I cannot think of a better way to honor him for supporting me during my bachelors, masters and research trajectories.

Beste **Oom Wim**, u heeft vele uurtjes gestoken in het controleren van honderden BMW, AKO en andere verslagen of brieven zonder één keer te klagen. U heeft het altijd met veel liefde gedaan en ik weet dat u ook veel van hebt genoten van mijn opgedane kennis en/of inzichten. U maakte dat ik zonder te veel stress mijn verslagen kon inleveren en dat ik werd beoordeeld op mijn kwaliteit en niet werd benadeeld door mijn taal of dyslexie. Ik ben zo dankbaar dat ik een oom heb die me zoveel kon helpen. U heeft een groot aandeel in het succes van mijn academische carrière en ik ben u voor altijd dankbaar.

**Tante Omaira**, dimes bo steun tambe ta inolvidabel! Si’n bo alegria, idea pa trips of djis chill wak televishon I relax lo a hasi e processo dimi na Hulanda un poko mas difisil! Danki pa semper tei pami i kuidami ora mi no ta sintimi hopi bon! For my second mom- I Love you!

*Before I continue, I would like to thank all my dear family and friends in Curaçao, the Netherlands, South Africa, Dominican Republic, Aruba, and Rwanda for your support, love, and sometimes concerns. Not all of you might understand fully what I was doing, but you continue showing your interest and kept blessing me with encouraging words. Without you I probably have neglected life a bit more, since I was so busy with the research life. For me it will be almost impossible to express my gratitude in words and to name everyone one by one. It would be a succession of names and repetition of thanks and understatement of my gratitude. I hope that everyone, including the people I have not mentioned by name, knows what you mean to me and how happy I am to have you in my life.*

Mi amiga stima **Charlotte** (i famia), danki pa e countless hoursnan di companion i steun for di kleuterklas! Kubo ta tolerami keha tokante tur kos chikitu i grandi i kubo tei semper pa enjoy kumi mi logronan.

Lieve **Kitty**, mijn andere hartsvriendin en the original Heugem sister! Yes, je weekly-planner was goed gebruikt tijdens mijn onderzoekstraject en je tips en tricks voor de lay-out van de thesis waren ook super gewaardeerd. Het is altijd fijn om te weten dat ik op jou kan steunen in goede en minder goede tijden!

Mijn sisterfriend, **Ianthe de Jong**, wie had gedacht dat ik door ging met onderzoek en in de thema van microbiologie en sub-Sahara Afrika. Jij ook bedank voor de wijze woorden, gezellige tijden en goede steun!! Op naar een mooie en happy carrière voor ons beide! Ik ben echt super enthousiast om samen met jou weer te zijn en te werken op Curaçao. Daarnaast ook bedankt dat ik deel mag zijn van je mooie (en al grote) familie! **Godelieve, Philip, Rosanne, Tijmen en Lauran, Pien** en **Fred** ook bedankt voor jullie steun en voor de gezellige en voedzame etentjes in Bemelen of Zuid-Afca.

Mi amiga i mentor **Danitsa**, mi no sa kon di pa kuminsa of kaba di yamabu danki pa bo yudansa. For di day-one in Maastricht bo tabata para pami i mi ta super agradesido pa tur bo tips nan, lokura i bo steun imenso! Danki danki I mas danki! Un danki tambe pa **Uchi, Kenrick** i **Ryan** ku apesar di e distancia misa kumi por konta ahinda riba bosnan!

**Dr. Indira Vonhögen**, Indiraaaaa, e amiga kumi a unwillingly follow su amazing academic journey; BMW, AKO and PhD steps, i unbeki asta ANIOS gynaecologie na Curaçao Medical Center. Mi ta asina agradesido ku den tur e stepnan aki bo a yudami asina tremedo. Palabra ta tiki pa bisabu kuantu mi ta apresia bo yudansa i amistad. I palabra ta mas tiki ahinda pa expresa kon orguyoso mi ta dibo! Mi ta asina kontentu kumi por tin un ambitious friend mane abo ku tambe ta geintereseerd den onderzoek plus gynaecologie. I ku nos ta komparti e interes aki. Mi no por warda pa nos traha huntu na CMC i porta asta despues! I mi ta spera nos por sigui guia i steun otro pa hooopii aña mas.

My foodies **Rodiene** i **Tiffany**, ta mane ayera nos a bin hulanda i kuminsa e student life. Pa bosnan tambe un danki special pa steun mi durante mi estudio i tambe onderzoekstraject. Misa ku semper mi por konta riba bosnan!! Rodiene danki pa bai sport kumi tambe despues di trabou, nos no a kome so pero tambe move un tiki! ;)

**Jeavanny-Dennior!** Super thanks pa bai un aventura kumi na Indonesië. Bo a yudami ontspan bon prome kumi kuminsa full-time kumi onderzoek, danki pa esaki. Mi ta hanja asina great ku semper bo ta interesa den mi progreso i asta lesa mi paper den *Pathogens*. Danki pabo steun i bunita amistad!

Mijn A-KO vrienden **Zora, Gil, Rokus, Iris, Daniëlle, Aurelia, Johnny, Pia, Chanty** en **Astrid**; bedankt voor de mooie vriendschap en steun tijdens en na de A-KO! Hetzelfde voor mijn liefste BMW-bachelor groep vriendinnen, **Kayleigh, Claudia, Nina, Miek, Karlijn** en **Mariël**. Ons gezellige en ontspannende onderonsjes en jullie support tijdens de A-KO en mijn onderzoek traject hadden een enorme betekenis voor mij! Daarnaast wil ik ook mensen van de allertofste studentenvereniging in Maastricht “**Lux ad Mosam**” bedanken voor hun gebedjes en steun, met name **Jeanine, Dennis** en **Abigail**. Mijn favoriete ex-huisgenoot en super rij-instructeur **Yasmin**, ook bedankt voor jou steun en gezelligheid en lieverd jij ook success met je nieuwe uitdaging als PhD-student. Het is voor mij bijzonder dat ik deze mooie vriendschappen had kunnen vormen en behouden gedurende mijn bachelor en master periode. Hopelijk weten jullie ook dat ik altijd voor jullie klaar zou staan als jullie hulp nodig hebben.

**Karun**, wie had nou gedacht dat iemand super casual ontmoeten op een kerst-dinner zou toveren in een vijfjarige vriendschap en een goede partner om de cover van mijn thesis te maken. **Karun en Yoko** jullie hadden altijd begrip voor mijn “drukke leventje” en de juiste peptalks, zodat ik de zwaarste momenten aankon en mijn promotie met success mocht af ronden. Bedankt voor jullie mooie vriendschap, gezelschap en lekkere dinertjes.

My other foodies-sushi lovers- **Jeandra** en **Moeke**, danki pa entretenemi i lagami keda un tiki bij di mundu na e momentunan kumi tabata isola trahando duru riba mi proefschrift! Jeandra hopii credits tambe pa mi mooie CV-foto! 😊

Mi otro amiga/unan; **Amy, Mandy/Will, Wesley, Rianne, Bryan, Nishita, Danique** i **Paola** danki tambe pa semper tei pami. Maske sa pasa momentunan ku nos no ta papia masha ku otro, bosnan ta semper den mi kurason!

*They say never forget where you came from. Hence, I want to thank these following people that had a positive impact on me as a scholar.*

**Júffrou Chinka Olario** was the person that motivate to find out why I was not finishing reading my text on time in VWO. Turned out I am dyslexic and that explained a lot of my previous struggles. Even with this knowledge I always try to find a way to hide this “handicap” and ask other for their help. Luckily throughout the years she (and others like **Jolein**) really told me to start telling people about my struggles and embrace the difficulties that this learning disorder brings with. Dear Chinka, thank you for this and your continuous support... I think now we should give the teacher that told me- I should not pretend that I can do VWO - this book.

**Dr. Sasha. Hutchinson** and **Dr. Shanly Seferina**, thank you for showing me that small-island ladies can also thrive in the medical and academic field. I admire both your courage, strengths, and perseverance. You both inspire me to follow whatever dream I have.

I am also super grateful for the opportunities **Prof. dr. Harald H.H.W. Schmidt** and his team gave me during my bachelor period. It was one of my first experience in the research field and I did truly learn a lot from this time period.

Dear **Prof. dr. Lynn-Marie Birkholtz** and the amazing malariologists at the Malaria Parasite Molecular Laboratory at the University of Pretoria. My bachelor internship was unforgettable, a gigantic thank you also to **Dr. Abayomi Sijuade, Dr. Shehu Awandu, Dr. N. Coetzee** and **B. Verlinden**. Because of your enthusiasm and the opportunities, you gave me; I fell in love with research and the African continent!

**Dr. Ayo Adedokun**, I can also not thank you enough for your continuous mental support. **Dra. Halibi** i **Dra. van der Heijden**, dos dokter fememina professional na Kòrsou kumi ta admira masha hopi mes. Mi no por warda pa traha den futuro ku bosnan i siña mas di bosnan. Danki pa bosnan steun i guia professional.

And last but not least, also a huge thanks to **Dr. Christine Willekes**. For your guidance and support with my A-KO project, internship, career and simple life tips. I hope that in the future I can continue to learn from you and to become at least 80% as passionate of a gynecologist as you are.

Dan nu mijn nieuwe collega's uit **verslavingszorg in Mondriaan** en **Maandag. Ivar** en **Cas** bedankt om een goede carrière match voor mij te vinden naast het afronden van mijn promotieonderzoek. Werken bij de verslavingszorg onder leiding van **Monique Bongaerts** en **Wouter Gronheid** zorgde dat ik een leerzame transitie terug naar het kliniek kon hebben. Niet alleen de werktijden waren goed te combineren met het afronden van mijn promotietraject, maar ook de aardige patienten en de steun van mijn lieve collega's **Anita, Julia, Kristien, Miriam, Noortje, Peter, Paola, Mandy Jansen, Marjon** en **Monique** gaven mij energie om door mijn dag te komen en 's avonds nog te schrijven. **Anita** ik zal nooit vergeten hoe blij u was toen ik vertelde dat ik mijn proefschrift had ingeleverd bij de leescommissie. Na de COVID pandemie

wil ik nog steeds die knuffel van u! Beste collega's, jammer genoeg was mijn tijd bij jullie kort, maar het was zeer leerzaam en ik ben jullie zeer dankbaar dat ik deze kans heb gekregen om mij te ontplooiën als jonge dokter en meer te leren over de verslavingsproblematiek.

As most people know, I have an **AMAZING family and adopted family**. As I said I can't and won't mentioned all their names and expand on my gratitude. But I simply can't leave this special list of great supports out of my published book: **Tio Fofó, Tio Boysitu, Tio Willy, On Jul, Tante Icha, Raïna, Chuchu, Tante Marly, Oom Gerard, Tante Maria, Jaja, Uka, Lu, Nancy, Magali, Princella, Tante Cordella, Oom Loek, Esmeralda, Valerie, Tante Edna, Danielle, Chandani, Tio Henry, Tante Jesselyn, tanchi Setty, tante Marilyn, Dajanara, Rudailo, JD, Kristel, Dajanitha, Gene, Gio, Jüffrou Rochelle, tanchi Nila, Tio Eric, Tante Diana, Tante Ruth, tante Anaida, tante Sharline, Tante Lissy, tanchi Ivy, Tante Te, Carol and Leon (SA), Silver (Rwanda), Barbarita, Choni, Amelie, Lisa-Marie, Tayra, Graciella, Quincy, Michelle, Cheyenne, Malaja, Melo, Zairo, Deniel, Sulien, Zaion, en al mijn andere neefjes en nichtjes**. Jullie zijn de mensen die me door dik en dun steunen. Masha masha danki mes!!! Zonder jullie gekkigheid, jullie gesprekken, whatapp berichtjes en jullie steun zou mijn wereld een stuk minder rooskleurig zijn. Un brasa I sunchi grandi pa bosnan.

**Dear Flt Lt Kwaku Owusu-Achaw, MD**, Dear Kwaku, I remember you asking me “why do you want to do research if you want to be a clinician” and me thinking from that moment; this man doesn't support my ambitions. Well as we both know I could not be more wrong. Most probably you are the only person (next to Elena, Servaas and I) that know this thesis from the beginning to the end. Kwaku I know you don't like acknowledgements; but you helped me the best ways possible with my research. I want to thank you for always being there for me as a friend. Also an extra thanks for my graduation gift- aka proofreading some parts of this thesis- as you know I truly appreciate it.. But my foremost immense gratitude is for the mental support you gave me throughout this process. I don't even want to imagine how this research trajectory would have been without your continuous support. GM, a million thanks for the good times, relaxing trips, and love.

*And last but not least my core family, the one and only “famia ku pasenshi”.*

Ja, unda mi tin ku kuminsa... Misa ku den begin tabata un struggle pa mama i tata pa ami ku skol i drumimentu na ora. Mi a kuminsa papia lat i mi ta soña lanta hopi. Vooral ku taal vakken, **mama** tabata preokupa yen biaha si mi lo por haal sierto di nan. Nos a lucha i mi haal nan si. Fuera di esei **tata** tabata great pa yudami ku exacte vakken. E problema ta si mi puntra tata pa yudami ku algu pa skol, asta den mi soño e tin chens pa overhoor mi. Dus mi tabata kies kouteloso ku kua thema mi tabata tin mester ayudo. En fin, mama i tata; check mi awor, nos por konklui tur e bijlesnan no tabata pornada! I no drumi na ora ta handig ora mi tin ku traha dienst anochi ;). Papi, mamita, madrina, oma ku opa lo ta orguyoso i misa ku bosnan i **jaja** tambe! **Jaja** danki pa Jaja su sosten i amor! Tambe tio Willy Ku a yudami ku yen spreekbeurt, siñami pami ta creativo, hasi presentashon “out of the box” i sakami for di mi comfort zone for na basisschool. Danki pa tur esakinan!

**Ianthe**, mi uniko ruman i esun mas stima, hahaha. Ianthe danki pa sostenemi den mi bida i karera. Tambe pa zorg ku no tur ora mi tin ku keda “siña, siña so mane mucha kèns”, “kana ku tas pisa mane un nerd” i zorg pami tin “un kèds na tinu pa hende no bisa ta kiko e kos ku Ianthe su ruman tin bisti ei”. Danki Dios, kubo a haña pas kumi kabei brua despues di años. I no, mi no tabata gaña bai siña of traha huiswerk net ora mamanan yega kas for di trabou. A resulta mi gusta drumi den dia i siña anochi asta ora mi a biba 8 año miso. Pero si'n hopi wega, danki pa sostenemi, wak mi verslagnan si mi mester ayudo i tambe pa yudami ontspan (den sauna, na kas of un bon fiesta). You are an amazing sister, one of a kind, and I would not ask for anyone else!

**Mama, tata i Ianthe** danki pa dunami un tremendo hubentut, edukashon i liberdat pami gosa dimi bida. Misa ku ratu ratu mi a duna bosnan dolo di kabes ku sierto pregunta nan kumi tabata hasi of paisnan kumi a bai bishita. Pero bosnan ta keda sostenemi i stimami. Misa tambe ku no ta tur ora bosnan ta kompronde of mi ta bisa bosnan kiko mi ta bezig kune. Pero no ta pasa ni un siman, ku bosnan ta keda si'n puntra kon ta bayendo kumi onderzoek. Ora no ta bayendo asina bon mi ta haña un hala di tips pa kon di kuida mi kurpa, “pa no stress, no rabia, laba kara ku awa frieu i bebe hopi vitamina”. Ora ta bayendo bon bosnan ta selebra mi logro kumi. Mi no mester skibi hopi paso bosnan sa kuantu mi ta apresia bosnan tur tres den mi bida. I bosnan mag di rei 2-3 biaha kuantu mi stima boso! <3

I tata bisa tur hende numa: “Tami kara ta fregami, pero mi ta leu for di ta kèns” (My father tells me a lot: your face might fool you, but your far from being dumb).

## PUBLICATIONS AND PRESENTATIONS

## MANUSCRIPTS

**Composition of the vaginal microbiota during pregnancy among women living in sub-Saharan Africa.**

Naomi C.A. Juliana, Remco P.H. Peters, Salwan Al-Nasiry, Andries Budding, Servaas A. Morré, Elena Ambrosino.

*Manuscript submitted to International urogynecology journal.*

**The association between vaginal microbiota dysbiosis, bacterial vaginosis and aerobic vaginitis, and adverse pregnancy outcomes of women living in sub Saharan Africa: A systematic review.**

Naomi C.A. Juliana, Meghan J.M. Suiters, Salwan Al-Nasiry, Servaas A. Morré, Remco P.H. Peters, Elena Ambrosino.

*Frontiers in Public Health, 2020; 2020, 8:567885*

**The prevalence of *Chlamydia trachomatis* and three other non-viral sexually transmitted infections among pregnant women in Pemba Island Tanzania.**

Naomi C. A. Juliana\*, S. Deb\*, Sander Ouburg, Aishwarya Chauhan, Jolein Pleijster, Said M. Ali, Servaas A. Morré, Sunil Sazawal\* and Elena Ambrosino\*.

*Pathogens 2020, 9(8),625*

**The natural course of *Chlamydia trachomatis*, *Neisseria gonorrhoeae*, *Trichomonas vaginalis*, and *Mycoplasma genitalium* in pregnant and post-delivery women in Pemba Island, Tanzania.**

Naomi C. A. Juliana\*, Abdulla Mbaruk Omar\*, Jolein Pleijster, Fahad Aftab, Nina B. Uijldert, Said M. Ali, Sander Ouburg, Sunil Sazawal, Servaas A. Morré, Saikat Deb\* and Elena Ambrosino\*.

*In progress to be submitted to PLoS Pathogens*

**Detection of high-risk human papillomavirus (HPV) by the novel AmpFire isothermal HPV assay among pregnant women in Pemba Island, Tanzania.**

Naomi C. A. Juliana\*, Mohamed H. Juma\*, Roel Heijmans, Sander Ouburg, Said M. Ali, Aishwarya Singh Chauhan, Sunil Sazawal, Servaas A Morré, Saikat Deb\*, and Elena Ambrosino\*.

*Pan African Medical Journal. 2020;37:183*

**The vaginal microbiota composition and genital infections during and after pregnancy among women in Pemba Island, Tanzania.**

Naomi C.A. Juliana\*, Saikat Deb\*, Mohamed H. Juma, Linda Poort, Andries E. Budding, Abdalla Mbarouk, Said M. Ali, Sander Ouburg, Servaas A. Morré, Sunil Sazawal\* and Elena Ambrosino\*.

*Manuscript in preparation.*

*\*Shared authorship*

## PRESENTATIONS

**Oral presentation: Genital infections among pregnant women in Pemba Island, Tanzania.**

Host organisation – Annual Amsterdam Chlamydiae meeting

Date – 02/14/2020, Location - Amsterdam, the Netherlands

**Oral Pitch: Natural history of genital infections among pregnant women**

Host organisation – Annual Amsterdam Chlamydiae meeting

Date – 02/14/2020, Location - Amsterdam, the Netherlands

**Poster presentation: Vaginal microbiota and genital infections among pregnant women in Pemba Tanzania.**

Host organisation – research school GROW, Maastricht University.

Date – 11/21/2019, Location – Maastricht, the Netherlands

**Oral presentation: Vaginal microbiota and genital infections among pregnant women in Pemba Tanzania.**

Host organisation – NVTG Congress 2019

Date – 11/06/2019, Location – Amsterdam, the Netherlands

**Poster presentation: Vaginal microbiota among pregnant women in Pemba Tanzania.**

Host organisation – World of Microbiome Pregnancy, Birth and Infancy

Date – 10/30/2019-11/2/2019, Location – Milan, Italy

**Poster presentation: Vaginal microbiota and genital infections among pregnant women in Pemba Tanzania.**

Host organisation – Mosa conference

Date – 06/03/2019, Location – Maastricht, the Netherlands

**Pitch: Vaginal microbiota and genital infections among pregnant women**

Host organisation – Annual Amsterdam Chlamydiae meeting

Date - 02/13/2019, Location - Amsterdam, the Netherland



**THESIS WORK PRESENTED AT INTERNATIONAL EVENTS****Poster presentation at International Conference World of Microbiome: Pregnancy, Birth and Infancy (WoMPBI 2020)**

Date - 11/4/2020-11/6/2020, Location – virtual conference

**Poster presentation at the 33rd International Papillomavirus Conference (IPVC 2020)**

Date - 06/20/2020-06/24/2020, Location - Barcelona (Spain)

**Poster presentation at the 11th European Congress on Tropical Medicine and International Health (ECTMIH)**

Date - 09/16/2020-09/20/2020, Location - Liverpool (UK)

**Poster presentation at 33rd IUSTI-Europe Congress on Sexually Transmitted Infections**

Date - 09/5/2019-09/7/2019, Location - Tallinn (Estonia)

**Oral presentation by dr. Ambrosino at European Meeting on Molecular Diagnostics (EMMD)**

Date - 10/9/2019-10/11/2019, Location - Noordwijk (The Netherlands)

**AFFILIATION LIST****AUTHORS NAME**

Aftab, Fahad<sup>2,4</sup>  
 Al-Nasiry, Salwan<sup>6</sup>  
 Ali, Said M<sup>2</sup>  
 Ambrosino, Elena<sup>1</sup>  
 Budding, Andries E<sup>3</sup>  
 Chauhan, Aishwarya S<sup>2</sup>  
 Deb, Saikat<sup>2,3\*</sup>  
 Heijmans, Roel<sup>5</sup>  
 Juliana, Naomi C.A<sup>1</sup>  
 Juma, Mohamed H<sup>2</sup>  
 Mbaruk, Abdulla O<sup>2</sup>  
 Morré, Servaas A<sup>1,5</sup>  
 Ouburg, Sander<sup>5</sup>  
 Peters, Remco P.H<sup>7,8,9</sup>  
 Pleijster, Jolein<sup>5</sup>  
 Poort, Linda<sup>3</sup>  
 Sazawal, Sunil<sup>4</sup>  
 Suiters, Meghan J.M<sup>1</sup>  
 Uijldert, Nina B<sup>5</sup>

**AFFILIATION**

1. Institute for Public Health Genomics (IPHG), Department of Genetics and Cell Biology, Research School GROW (School for Oncology & Developmental Biology), Faculty of Health, Medicine & Life Sciences, University of Maastricht, Maastricht, The Netherlands
2. Public Health Laboratory-Ivo de Carneri, Chake Chake, Pemba Island, Tanzania
3. inBiome, Amsterdam, The Netherlands
4. Centre for Public Health Kinetics, New Delhi, India
5. Laboratory of Immunogenetics; Department of Medical Microbiology and Infection Control, Amsterdam UMC, Location AMC, Amsterdam, The Netherlands
6. Department of Obstetrics and Gynecology, GROW School of Oncology and Developmental Biology, Maastricht University Medical Center (MUMC), Maastricht, The Netherlands
7. Department of Medical Microbiology, University of Pretoria, Pretoria, South Africa,
8. Department of Medical Microbiology, School for Public Health and Primary Care (CAPRHI), Maastricht University, Maastricht, The Netherlands
9. Research Unit, Foundation for Professional Development, East London, South Africa

This thesis is dedicated to my biggest fear:  
writing.

And to everyone that helps me tackle this fear.