

SANMOTION

5-PHASE STEPPING SYSTEMS

F5



SANYO DENKI

Ver.2

Extensive lineup

F series driver features

1

Lower vibration

AC input

DC input

AC input

- Automicro function and microstepping system enables further reduction of vibration compared to current models.

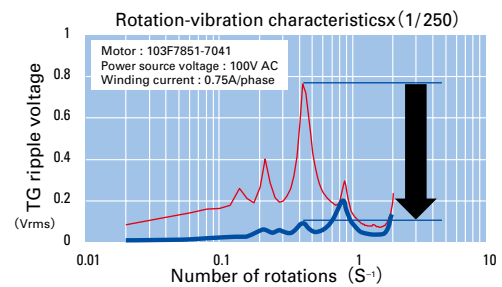
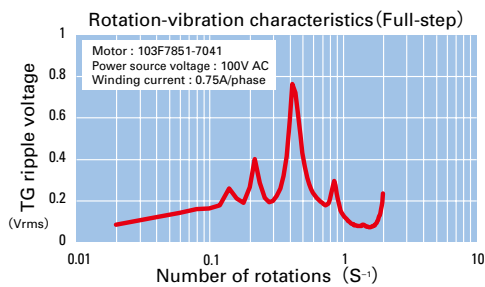

Automicro function

Vibration suppression is executed internally and independently from the controller.

Microstepping system

The basic step angle is divided by a maximum of 1/250 using 16 selectable resolution levels to enable smooth and vibration-free operation.

$$\frac{0.72}{1 \text{ to } 250 \text{ divisions}} = 0.72 \text{ to } 0.00288 \text{ degrees/pulse}$$

DC input

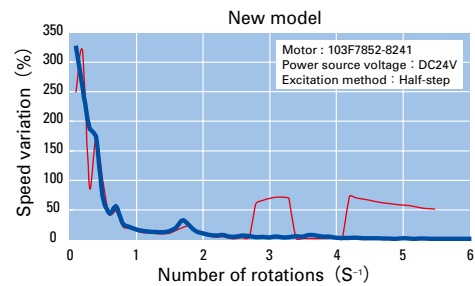
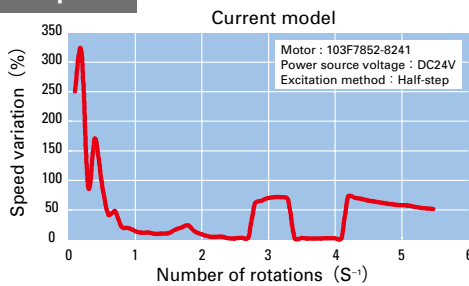

2

Shorter cycle time

AC input

- Improved response (up to 10% compared to current models) shortens the machine cycle time for repetitive operations.

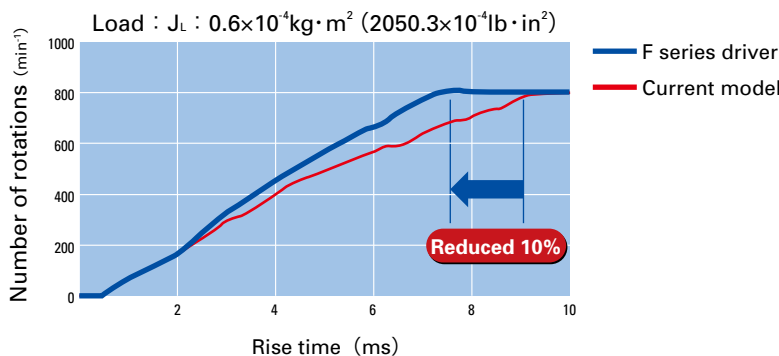

3

Control panel space is reduced

AC input
DC input

Volume is reduced by up to 50% for AC input types and 45% for DC input types compared to current models.

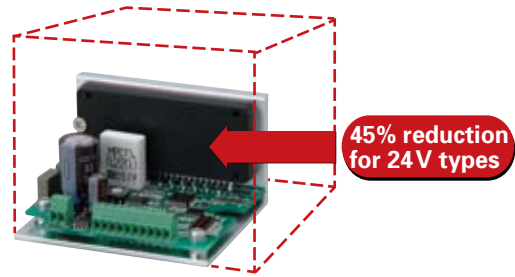
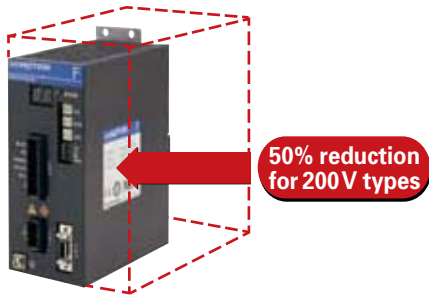

4

Easy maintenance

AC input

2-digit 7-segment LED displays operating status and alarm for easy troubleshooting and faster system recovery.



Test run function (JOG)

AC input

With built-in positioning function

On-board JOG operation function is available for testing motor and amplifier connection without the need to connect to host device.

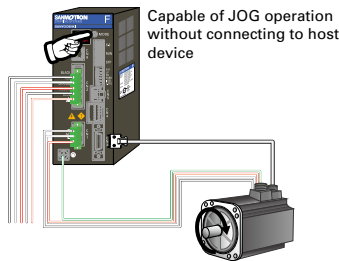

General-purpose I/O input for positioning

AC input

With built-in positioning function

System positioning is easily executed by using general-purpose I/O from an upper-level controller (PLC) to designate preset program numbers.

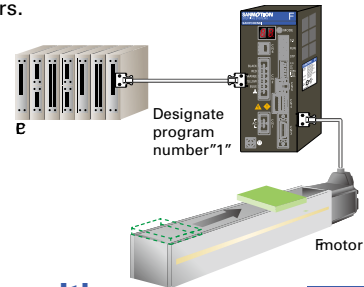

Encoder I/F Control

AC input

With built-in positioning function

Motor stall detection is possible by connecting a motor encoder. 500P/R (1000/2000 multiplier function) line driver method.

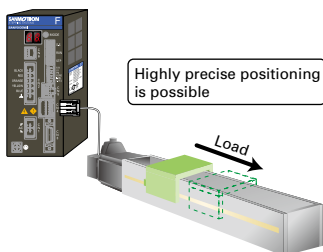

Compliance with international standards

AC input

DC input

The standard specification SANMOTION F series stepping driver complies with UL and EN safety standards. Stepping motors complying with UL and EN standards are available upon request. EMC filters are also available to comply with the EMC directive.



PC-based setup monitor

AC input

With built-in positioning function

Parameter and program settings can be made from the bundled setup software.

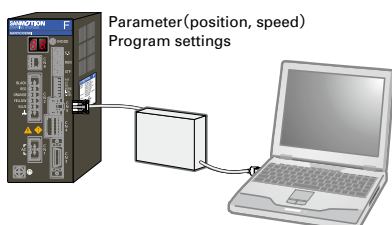

Brake control

AC input

Automatic brake activation timing control is available when using electromagnetic brake motors.

• Internal power source for brake (FP type)

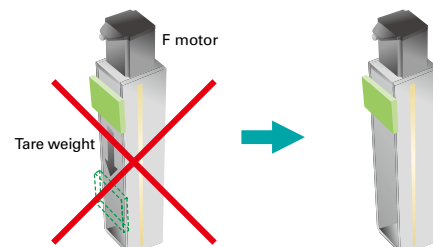

Control method

How do you want to control the equipment ? The F series offers the choice of 3 different control methods

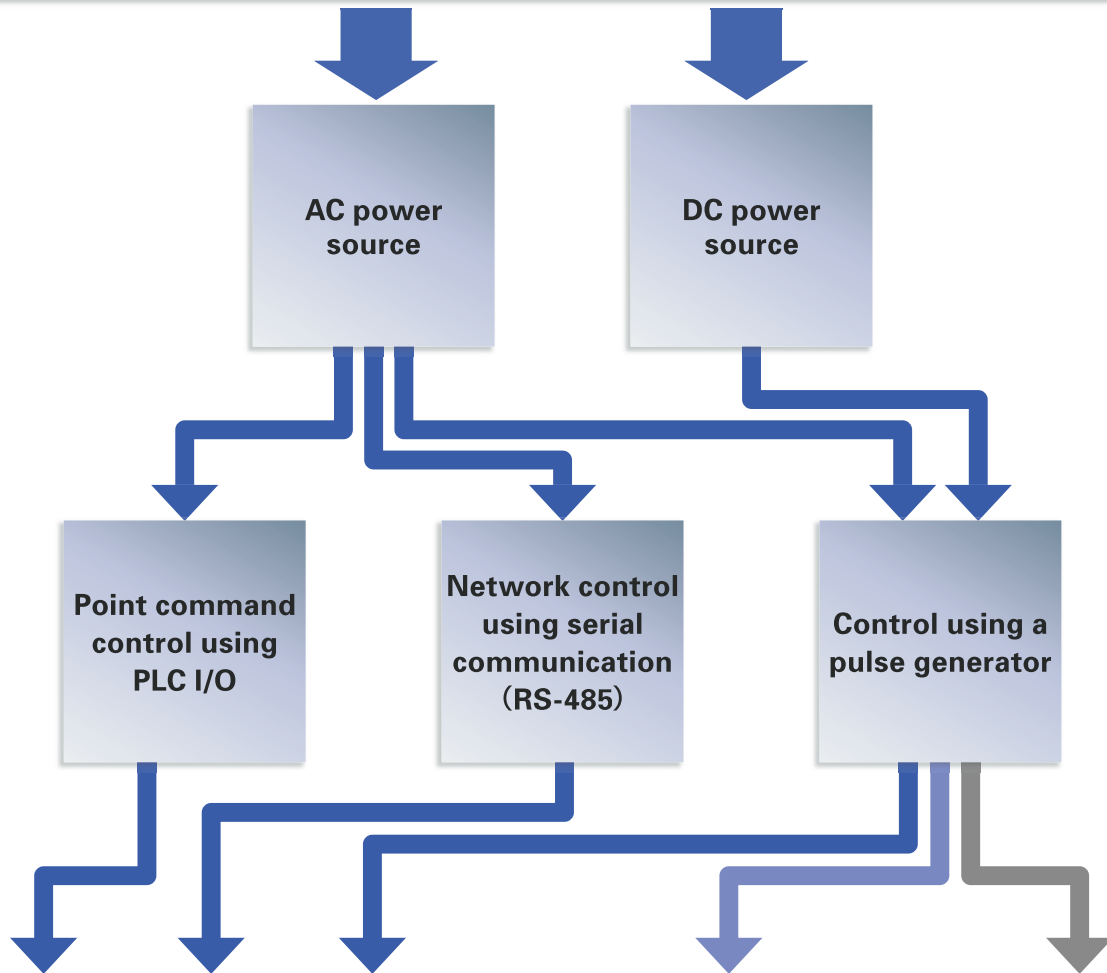

AC input with built-in positioning function



Startup via I/O : Initiate program containing speed, acceleration/deceleration, and travel distance commands stored in the driver via the I/O.	Startup via serial communication: Control by sending data for speed, acceleration/deceleration, and travel distance commands via serial communication.
System configuration diagram	P7
Set part number nomenclature	P9
Motor specifications	P47 to 58
General specifications	P25·26, 60
Motor dimension drawing	P61 to 64
Driver dimension drawing	P65

AC input standard type



Motion is generated by pulse input commands from an upper-level controller.

System configuration diagram	P5
Set part number nomenclature	P9
Motor specifications	P47 to 58
General specifications	P23·24, 60
Motor dimension drawing	P59 to 62
Driver dimension drawing	P63

DC input



Motion is generated by pulse input commands from an upper-level controller.

System configuration diagram	P31
Set part number nomenclature	P32
Motor specifications	P47 to 58
General specifications	P43·44, 60
Motor dimension drawing	P59 to 62
Driver dimension drawing	P63

Set model

AC input

Standard model P.11

The standard set includes a F series driver and a F series motor.



Motor flange size
 □28 (1.10inch) □42 (1.65inch) □60 (2.35inch) □86 (3.39inch) □106 (4.17inch)

CE / UL model P.13

The UL/CE set includes a F Series driver and a M Series motor.



Motor flange size
 □42 (1.65inch) □60 (2.35inch) □86 (3.39inch) □106 (4.17inch)

Low-backlash gear model P.15

This set includes a low backlash gear that uses tapered hobbled gears to engage the final stage of the speed reduction mechanism.



Motor flange size
 □42 (1.65inch) □60 (2.35inch) □86 (3.39inch)

Reduction gear ratios
 1/3.6, 1/7.2, 1/10, 1/20, 1/30, 1/36

Spur gear model P.18

This set utilizes a spur gear in the speed reduction mechanism.



Motor flange size
 □28 (1.10inch)

Reduction gear ratios
 1/3.6, 1/7.2, 1/10, 1/20, 1/30, 1/50

Harmonic gear model P.19

This set utilizes a harmonic gear.



Motor flange size
 □28 (1.10inch) □42 (1.65inch) □60 (2.35inch) □86 (3.39inch)

Reduction gear ratios
 1/30, 1/50, 1/100

Electromagnetic brake model P.21

This set utilizes a non-excitation electromagnetic brake to maintain position in vertical load applications and hold load even during power off.



Motor flange size
 □42 (1.65inch) □60 (2.35inch) □86 (3.39inch)

DC input

Standard model P.33

The standard set includes a F series driver and a F series motor.



Motor flange size
 □28 (1.10inch) □42 (1.65inch) □60 (2.35inch) □86 (3.39inch)

Low-backlash gear model P.35

This set includes a low backlash gear that uses tapered hobbled gears to engage the final stage of the speed reduction mechanism.



Motor flange size
 □42 (1.65inch) □60 (2.35inch) □86 (3.39inch)

Reduction gear ratios
 1/3.6, 1/7.2, 1/10, 1/20, 1/30, 1/36

Spur gear model P.38

This set utilizes a spur gear in the speed reduction mechanism.



Motor flange size
 □28 (1.10inch)

Reduction gear ratios
 1/3.6, 1/7.2, 1/10, 1/20, 1/30, 1/50

Harmonic gear model P.39

This set utilizes a harmonic gear.



Motor flange size
 □28 (1.10inch) □42 (1.65inch) □60 (2.35inch) □86 (3.39inch)

Reduction gear ratios
 1/30, 1/50, 1/100

Electromagnetic brake model P.41

This set utilizes a non-excitation electromagnetic brake to maintain position in vertical load applications and hold load even during power off.



Motor flange size
 □42 (1.65inch) □60 (2.35inch) □86 (3.39inch)

Standard type

Flange side

Spur gear model

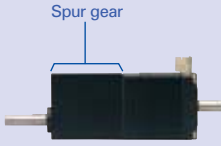

Motor flange size
□28 (□1.10inch)

Low-backlash gear model

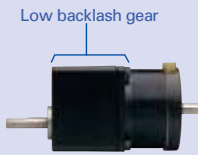

Motor flange size
□42mm (□1.65inch) / □60mm (□2.35inch) / *86mm (*3.39inch)

Harmonic gear model



Motor flange size
□28mm (□1.10inch) / □42mm (□1.65inch) / □60mm (□2.35inch) / *86mm (*3.39inch)



Standard model : F series motor
□28mm (□1.10inch) / □42mm (□1.65inch) / □60mm (□2.35inch) / *86mm (*3.39inch) / *106mm (*4.17inch)

CE / UL model : M series motor
□42mm (□1.65inch) / □60mm (□2.35inch) / *86mm (*3.39inch) / *106mm (*4.17inch)

● Motors are available in standard or vacuum types.

End-cap side

Damper



Magnetic dampers can be selected according to the required inertia.

Electromagnetic brake model

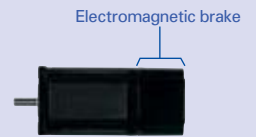

Motor flange size
□42mm (□1.65inch) / □60mm (□2.35inch) / *86mm (*3.39inch)

Brake power source (DC24V)



Required for brake-equipped stepping motor models.

Ⓢ Motor cable (optional)

■ Bundled connectors (set models only)

Connector type	Housing	Contact	Applicable motor flange size
① AC power connector	1-178128-2 (AMP)	1-175218-5 (AMP)	—
② Motor connector	1-178128-6 (AMP)	1-175216-5 (AMP)	□28mm (□1.10inch), □42mm (□1.65inch)
	1-178128-6 (AMP)	1-175217-5 (AMP)	□60mm (□2.35inch), *86mm (*3.39inch)
	1-178128-6 (AMP)	1-175218-5 (AMP)	*106mm (*4.17inch)
③ I/O signal connector	10314-52A0-008 (3M)	10114-3000PE (3M)	—

■ Optional cables

Ⓐ AC power cable

L : m (feet)	Part number
10 (32.81)	PM-C03P1000-05
5 (16.40)	PM-C03P0500-05
3 (9.84)	PM-C03P0300-05
1 (3.28)	PM-C03P0100-05

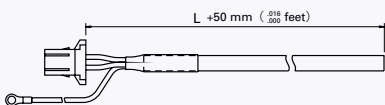

Leadwire	600V vinyl cab tire cable 3-core AWG16(1.25mm ²)
Housing	1-178128-2 (AMP)
Contact	1-175218-5 (AMP)
Round-type crimp contact	1.25M4 (J.S.T. Mfg Co.)

● Cables 10m (32.81 feet) or longer are available upon request.

Ⓑ Motor cable

L : m (feet)	Part number
10 (32.81)	PM-C06M1000-11
5 (16.40)	PM-C06M0500-11
3 (9.84)	PM-C06M0300-11
1 (3.28)	PM-C06M0100-11

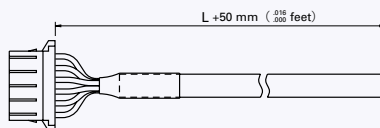

Leadwire	600V vinyl cab tire cable 6-core AWG16(0.75mm ²)
Housing	1-178128-6 (AMP)
Contact	1-175218-5 (AMP)

● Cables 10m (32.81 feet) or longer are available upon request.

Ⓒ I/O signal cable

L : m (feet)	Part number
2 (6.56)	PM-C14S0200-03
1 (3.28)	PM-C14S0100-03

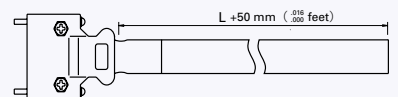

Leadwire	7-pair PVC shielded cable AWG28 (0.08mm ²)
Shell	10314-52A0-008 (3M)
Plug	10114-3000PE (3M)

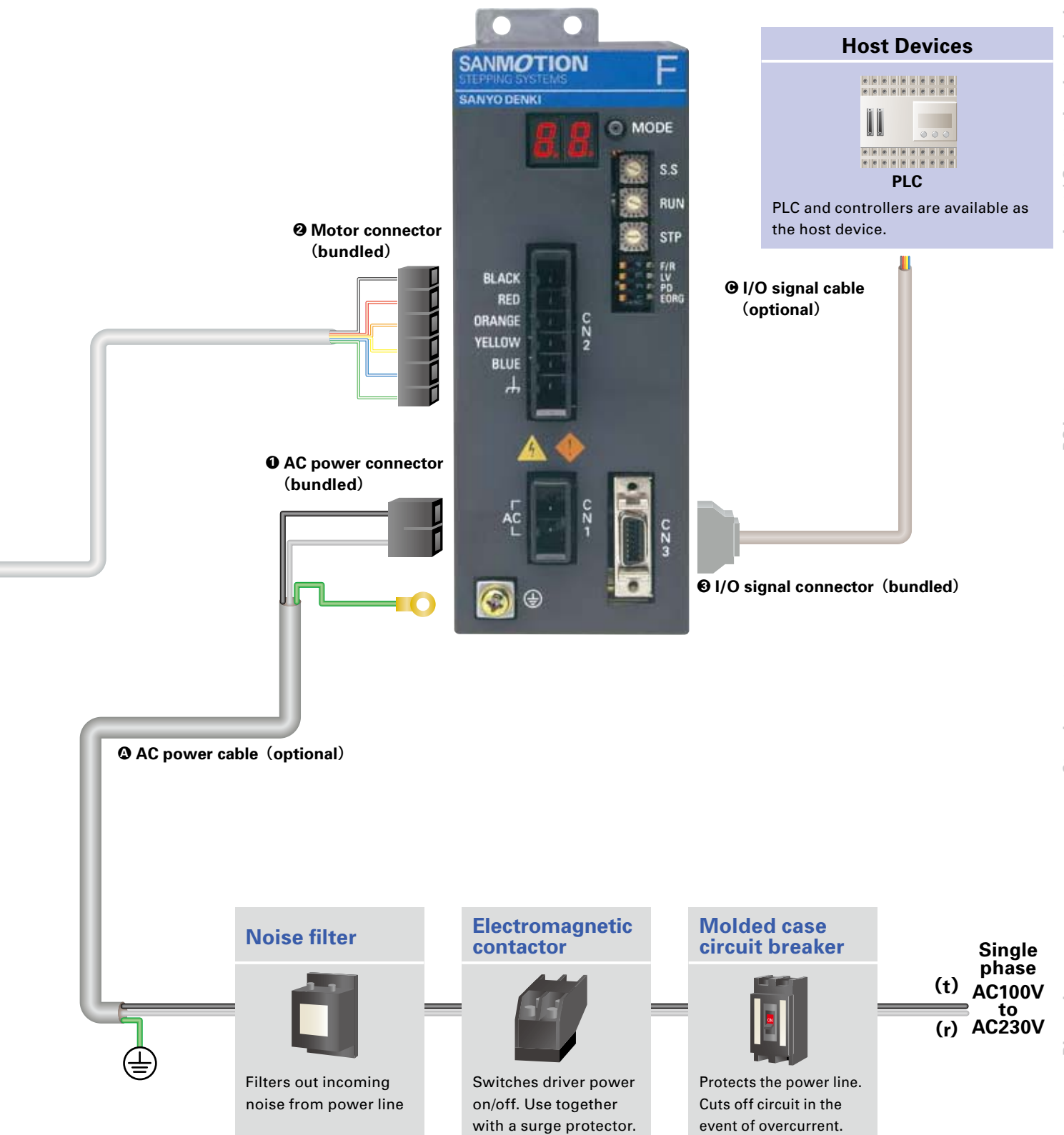

With built-in positioning function

Flange side

Spur gear model

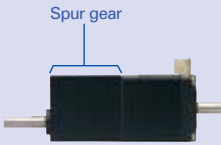

Motor flange size
□28 (□1.10inch)

Low-backlash gear model

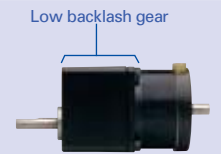

Motor flange size
□42mm (□1.65inch) / □60mm (□2.35inch) / *86mm (*3.39inch)

Harmonic gear model



Motor flange size
□28mm (□1.10inch) / □42mm (□1.65inch) / □60mm (□2.35inch) / *86mm (*3.39inch)

End - cap side

Damper



Magnetic dampers can be selected according to the required inertia.

Electromagnetic brake model

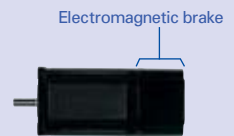

Motor flange size
□42mm (□1.65inch) / □60mm (□2.35inch) / *86mm (*3.39inch)



Standard model : F series motor
□28mm (□1.10inch) / □42mm (□1.65inch) / □60mm (□2.35inch) / *86mm (*3.39inch) / *106mm (*4.17inch)
CE / UL model : M series motor
□42mm (□1.65inch) / □60mm (□2.35inch) / *86mm (*3.39inch) / *106mm (*4.17inch)

● Motors are available in standard or vacuum types.

Ⓞ Option cable for motor

Encoder equipped model

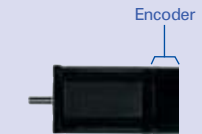

Optional

■ Bundled connectors (set models only)

Connector type	Housing	Contact	Applicable motor flange size
① AC power connector	1-178128-2 (AMP)	1-175218-5 (AMP)	—
	1-178128-6 (AMP)	1-175216-5 (AMP)	□28mm (□1.10inch), □42mm (□1.65inch)
② Motor connector	1-178128-6 (AMP)	1-175217-5 (AMP)	□60mm (□2.35inch), *86mm (*3.39inch)
	1-178128-6 (AMP)	1-175218-5 (AMP)	*106mm (*4.17inch)
③ I/O signal connector	10314-52A0-008 (3M)	10114-3000PE (3M)	—

■ Optional cables

Ⓜ AC power cable

L : m (feet)	Part number
10 (32.81)	PM-C03P1000-05
5 (16.40)	PM-C03P0500-05
3 (9.84)	PM-C03P0300-05
1 (3.28)	PM-C03P0100-05

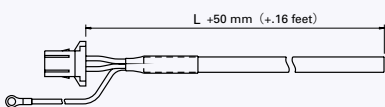

Leadwire	600V vinyl cab tire cable 3-core AWG16(1.25mm ²)
Housing	1-178128-2 (AMP)
Contact	1-175218-5 (AMP)
Round-type crimp tool	1.25M4 (J.S.T.)

● Cables 10 m (32.81 feet) or longer are available upon request.

Ⓞ Motor cable

L : m (feet)	Part number
10 (32.81)	PM-C06M1000-11
5 (16.40)	PM-C06M0500-11
3 (9.84)	PM-C06M0300-11
1 (3.28)	PM-C06M0100-11

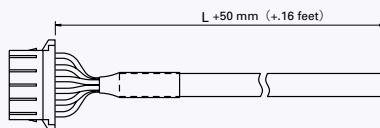

Leadwire	600V vinyl cab tire cable 6-core AWG16(0.75mm ²)
Housing	1-178128-6 (AMP)
Contact	1-175218-5 (AMP)

● Cables 10 m (32.81 feet) or longer are available upon request.

Ⓞ I/O signal cable

L : m (feet)	Part number
2 (6.56)	PM-C20S0200-01
1 (3.28)	PM-C20S0100-01

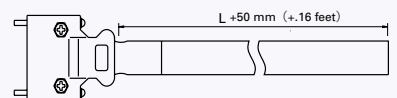

Leadwire	10-pair PVC shielded cable AWG28 (0.08mm ²)
Shell	10320-52A0-008 (3M)
Plug	10120-3000PE (3M)

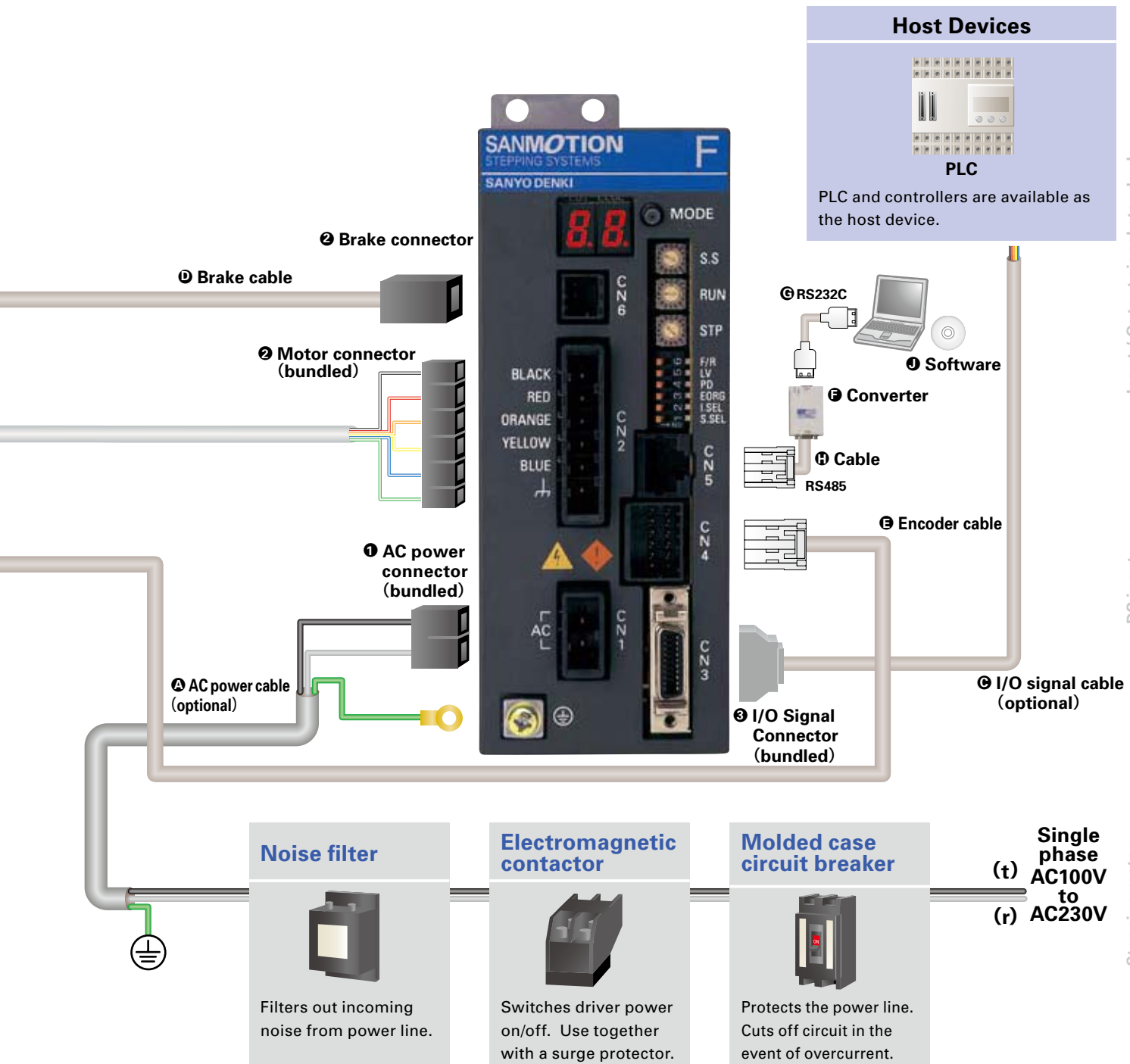

Host Devices

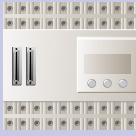

PLC

PLC and controllers are available as the host device.

Noise filter



Filters out incoming noise from power line.

Electromagnetic contactor



Switches driver power on/off. Use together with a surge protector.

Molded case circuit breaker



Protects the power line. Cuts off circuit in the event of overcurrent.

Single phase AC100V to AC230V (t) (r)

① Brake cable

L : m (feet)	Part number
10 (32.81)	PM-C03B1000-01
5 (16.40)	PM-C03B0500-01
3 (9.84)	PM-C03B0300-01
1 (3.28)	PM-C03B0100-01

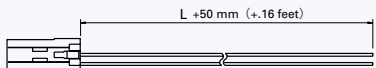

Leadwire	PVC cable AWG22 (0.3mm ²)
Housing	1-1318120-3 (AMP)
Contact	1318107-1 (AMP)

③ Cable for encoder use

L : m (feet)	Part number
10 (32.81)	PM-C12S1000-01
5 (16.40)	PM-C12S0500-01
3 (9.84)	PM-C12S0300-01
1 (3.28)	PM-C12S0100-01

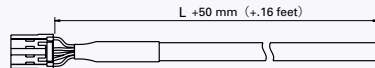

Leadwire	4-pair PVC shielded cable AWG22 (0.3mm ²)
Housing	1-1318118-6 (AMP)
Plug	1318107-1 (AMP)

⑤ Converter [unit : mm (inch)]

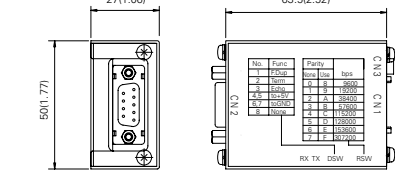

- ⑤ Part number for RS232C-RS485 converter : 232485CFP01-01
- ⑥ RS232 cable is supplied by user.
- ④ Part number for FP communications cable : PM-C08S0100-05
- ① Part number for bundled software : SFP1W-01 (please download from website)

Part number convention

The following part number specifies a system with an F series driver (type code : FS1W075P) and a single shaft F series motor (type code : 103F7851-7041), □60mm (□2.36inch) square flange, and 46.5mm (1.83inch) motor length, equipped with low-backlash gear (reduction ratio of 1/3.6).

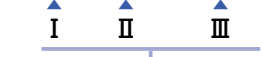

System spec

System type	I (Flange side)	II (End cap side)	III (Reduction ratio)
Spur gear	G	—	—
Low-backlash gear	C	—	—
Harmonic gear	H	—	—
No system at Flange side	X	—	—
Electromagnetic brake	—	B	—
No system at End cap side	—	X	—
Gear ratio	—	—	3.6 to 100

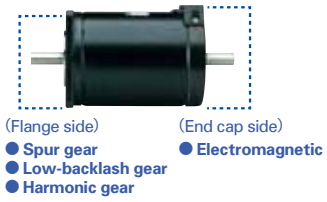

Stepping motor shaft spec
S : Single shaft D : Double shaft

Stepping motor total length

Code	Motor flange size									
	□28mm (□1.10inch)		□42mm (□1.65inch)		□60mm (□2.36inch)		φ86mm (φ3.39inch)		φ106mm (φ4.17inch)	
	Type code	Motor length : mm (inch)	Type code	Motor length : mm (inch)	Type code	Motor length : mm (inch)	Type code	Motor length : mm (inch)	Type code	Motor length : mm (inch)
1	3505	31 (1.22)	5505	34 (1.34)	7851	46.5 (1.83)	8581	62.2 (2.45)		
2			5508	40 (1.57)	7852	55 (2.17)	8582	92.2 (3.63)	89582	163.3 (6.43)
3					7853	87.5 (3.44)	8583	125.9(4.96)	89583	221.3(8.71)
4			5510	49 (1.93)						
6	3515	50.5 (1.99)								

Stepping motor flange size
35 : □28mm (□1.10inch) 85 : φ86mm (φ3.39inch)
55 : □42mm (□1.65inch) 89 : φ106mm (φ4.17inch)
78 : □60mm (□2.36inch)

Stepping motor series name
F : F series motor
M : M series motor (CE/UL)

FS : AC Power source Standard type
FP : AC Power positioning-function-included type

Combination list of 5-phase driver

System type	Motor flange size	Single shaft			Double shaft			
		Set part number		Combination stepping motor type code	Set part number		Combination stepping motor type code	
		S type	P type		S type	P type		
Standard model	□ 28mm (□ 1.10inch)	FSF351S	FPF351S	103F3505-7041	FSF351D	FPF351D	103F3505-7011	
		FSF356S	FPF356S	103F3515-7041	FSF356D	FPF356D	103F3515-7011	
		FSF551S	FPF551S	103F5505-7041	FSF551D	FPF551D	103F5505-7011	
	□ 42mm (□ 1.65inch)	FSF552S	FPF552S	103F5508-7041	FSF552D	FPF552D	103F5508-7011	
		FSF554S	FPF554S	103F5510-7041	FSF554D	FPF554D	103F5510-7011	
		FSF781S	FPF781S	103F7851-7041	FSF781D	FPF781D	103F7851-7011	
	□ 60mm (□ 2.36inch)	FSF782S	FPF782S	103F7852-7041	FSF782D	FPF782D	103F7852-7011	
		FSF783S	FPF783S	103F7853-7041	FSF783D	FPF783D	103F7853-7011	
		FSF851S	FPF851S	103F8581-7041	FSF851D	FPF851D	103F8581-7011	
	φ 86mm (φ 3.39inch)	FSF852S	FPF852S	103F8582-7041	FSF852D	FPF852D	103F8582-7011	
		FSF853S	FPF853S	103F8583-7041	FSF853D	FPF853D	103F8583-7011	
		FSF892S	FPF892S	103F89582-7041	FSF892D	FPF892D	103F89582-7011	
	φ 106mm (φ 4.17inch)	FSF893S	FPF893S	103F89583-7041	FSF893D	FPF893D	103F89583-7011	
	Low-backlash gear model	□ 42mm (□ 1.65inch)	FSF551S-CX3.6	FPF551S-CX3.6	103F5505-70CXA4	FSF551D-CX3.6	FPF551D-CX3.6	103F5505-70CXA1
			FSF551S-CX7.2	FPF551S-CX7.2	103F5505-70CXB4	FSF551D-CX7.2	FPF551D-CX7.2	103F5505-70CXB1
			FSF551S-CX10	FPF551S-CX10	103F5505-70CXE4	FSF551D-CX10	FPF551D-CX10	103F5505-70CXE1
FSF551S-CX20			FPF551S-CX20	103F5505-70CXG4	FSF551D-CX20	FPF551D-CX20	103F5505-70CXG1	
FSF551S-CX30			FPF551S-CX30	103F5505-70CXJ4	FSF551D-CX30	FPF551D-CX30	103F5505-70CXJ1	
FSF551S-CX36			FPF551S-CX36	103F5505-70CXX4	FSF551D-CX36	FPF551D-CX36	103F5505-70CXX1	
□ 60mm (□ 2.36inch)		FSF781S-CX3.6	FPF781S-CX3.6	103F7851-70CXA4	FSF781D-CX3.6	FPF781D-CX3.6	103F7851-70CXA1	
		FSF781S-CX7.2	FPF781S-CX7.2	103F7851-70CXB4	FSF781D-CX7.2	FPF781D-CX7.2	103F7851-70CXB1	
		FSF781S-CX10	FPF781S-CX10	103F7851-70CXE4	FSF781D-CX10	FPF781D-CX10	103F7851-70CXE1	
		FSF781S-CX20	FPF781S-CX20	103F7851-70CXG4	FSF781D-CX20	FPF781D-CX20	103F7851-70CXG1	
		FSF781S-CX30	FPF781S-CX30	103F7851-70CXJ4	FSF781D-CX30	FPF781D-CX30	103F7851-70CXJ1	
		FSF781S-CX36	FPF781S-CX36	103F7851-70CXX4	FSF781D-CX36	FPF781D-CX36	103F7851-70CXX1	
φ 86mm (φ 3.39inch)		FSF851S-CX3.6	FPF851S-CX3.6	103F8581-70CXA4	FSF851D-CX3.6	FPF851D-CX3.6	103F8581-70CXA1	
		FSF851S-CX7.2	FPF851S-CX7.2	103F8581-70CXB4	FSF851D-CX7.2	FPF851D-CX7.2	103F8581-70CXB1	
		FSF851S-CX10	FPF851S-CX10	103F8581-70CXE4	FSF851D-CX10	FPF851D-CX10	103F8581-70CXE1	
		FSF851S-CX20	FPF851S-CX20	103F8581-70CXG4	FSF851D-CX20	FPF851D-CX20	103F8581-70CXG1	
		FSF851S-CX30	FPF851S-CX30	103F8581-70CXJ4	FSF851D-CX30	FPF851D-CX30	103F8581-70CXJ1	
		FSF851S-CX36	FPF851S-CX36	103F8581-70CXX4	FSF851D-CX36	FPF851D-CX36	103F8581-70CXX1	
Spur gear model		□ 28mm (□ 1.10inch)	FSF351S-GX3.6	FPF351S-GX3.6	103F3505-70GXA4	FSF351D-GX3.6	FPF351D-GX3.6	103F3505-70GXA1
			FSF351S-GX7.2	FPF351S-GX7.2	103F3505-70GXB4	FSF351D-GX7.2	FPF351D-GX7.2	103F3505-70GXB1
			FSF351S-GX10	FPF351S-GX10	103F3505-70GXE4	FSF351D-GX10	FPF351D-GX10	103F3505-70GXE1
			FSF351S-GX20	FPF351S-GX20	103F3505-70GXG4	FSF351D-GX20	FPF351D-GX20	103F3505-70GXG1
			FSF351S-GX30	FPF351S-GX30	103F3505-70GXJ4	FSF351D-GX30	FPF351D-GX30	103F3505-70GXJ1
		FSF351S-GX50	FPF351S-GX50	103F3505-70GXL4	FSF351D-GX50	FPF351D-GX50	103F3505-70GXL1	
	□ 42mm (□ 1.65inch)	FSF551S-HX50	FPF551S-HX50	103F5505-70HXL4	FSF551D-HX50	FPF551D-HX50	103F5505-70HXL1	
		FSF551S-HX100	FPF551S-HX100	103F5505-70HXM4	FSF551D-HX100	FPF551D-HX100	103F5505-70HXM1	
		FSF551S-HX30	FPF551S-HX30	103F5505-70HXJ5	FSF551D-HX30	FPF551D-HX30	103F5505-70HXJ2	
		FSF551S-HX50	FPF551S-HX50	103F5505-70HXL5	FSF551D-HX50	FPF551D-HX50	103F5505-70HXL2	
FSF551S-HX100		FPF551S-HX100	103F5505-70HXM5	FSF551D-HX100	FPF551D-HX100	103F5505-70HXM2		
□ 60mm (□ 2.36inch)	FSF781S-HX50	FPF781S-HX50	103F7851-70HXL4	FSF781D-HX50	FPF781D-HX50	103F7851-70HXL1		
	FSF781S-HX100	FPF781S-HX100	103F7851-70HXM4	FSF781D-HX100	FPF781D-HX100	103F7851-70HXM1		
φ 86mm (φ 3.39inch)	FSF851S-HX50	FPF851S-HX50	103F8581-70HXL4	FSF851D-HX50	FPF851D-HX50	103F8581-70HXL1		
	FSF851S-HX100	FPF851S-HX100	103F8581-70HXM4	FSF851D-HX100	FPF851D-HX100	103F8581-70HXM1		
Electromagnetic brake model	□ 42mm (□ 1.65inch)	FSF551S-XB	FPF551S-XB	103F5505-70XB41	-	-	-	
		FSF552S-XB	FPF552S-XB	103F5508-70XB41	-	-	-	
		FSF554S-XB	FPF554S-XB	103F5510-70XB41	-	-	-	
	□ 60mm (□ 2.36inch)	FSF781S-XB	FPF781S-XB	103F7851-70XB41	-	-	-	
		FSF782S-XB	FPF782S-XB	103F7852-70XB41	-	-	-	
		FSF783S-XB	FPF783S-XB	103F7853-70XB41	-	-	-	
	φ 86mm (φ 3.39inch)	FSF851S-XB	FPF851S-XB	103F8581-70XB41	-	-	-	
		FSF852S-XB	FPF852S-XB	103F8582-70XB41	-	-	-	
		FSF853S-XB	FPF853S-XB	103F8583-70XB41	-	-	-	
CE/UL model	□ 42mm	FSM551S	FPM551S	103M5505-7041	FSM551D	FPM551D	103M5505-7011	
		FSM552S	FPM552S	103M5508-7041	FSM552D	FPM552D	103M5508-7011	
		FSM554S	FPM554S	103M5510-7041	FSM554D	FPM554D	103M5510-7011	
	□ 60mm	FSM781S	FPM781S	103M7851-7041	FSM781D	FPM781D	103M7851-7011	
		FSM782S	FPM782S	103M7852-7041	FSM782D	FPM782D	103M7852-7011	
		FSM783S	FPM783S	103M7853-7041	FSM783D	FPM783D	103M7853-7011	
	φ 86mm	FSM851S	FPM851S	103M8581-7041	FSM851D	FPM851D	103M8581-7011	
		FSM852S	FPM852S	103M8582-7041	FSM852D	FPM852D	103M8582-7011	
		FSM853S	FPM853S	103M8583-7041	FSM853D	FPM853D	103M8583-7011	
	φ 106mm	FSM892S	FPM892S	103M89582-7041	FSM892D	FPM892D	103M89582-7011	
		FSM893S	FPM893S	103M89583-7041	FSM893D	FPM893D	103M89583-7011	

AC input

Input / Output signal standard

DC input

Stepping motor

Dimensions

Standard model

F series driver + F series motor

Motor flange size



Size	Motor flange size	28mm (1.10inch)			
		31mm (1.22inch)		50.5mm (1.99inch)	
Set part number	Single shaft	FSF351S	FPF351S	FSF356S	FPF356S
	Double shaft	FSF351D	FPF351D	FSF356D	FPF356D
Holding torque	N·m(oz·in)	0.036 (5.10)		0.065 (9.20)	
Rotor inertia	$\times 10^{-4}$ kg·m ² (oz·in ²)	0.009 (0.05)		0.016 (0.09)	
Mass (Weight)	kg (lbs)	0.11 (0.22)		0.2 (0.44)	
Allowable thrust load	N (lbs)	3 (0.68)		3 (0.68)	
Allowable radial load ^(Note1)	N (lbs)	34 (7.65)		34 (7.65)	

(Note1) When load is applied at 1/3 length from output shaft edge.



AC100V

AC200V

Operating current:
0.75A/phase

- Pull-out torque
- - - Source current (load applied)
- · · Source current (no load)
- 1-division fs
- 2-division fs

Fs: Maximum self-start frequency when not loaded

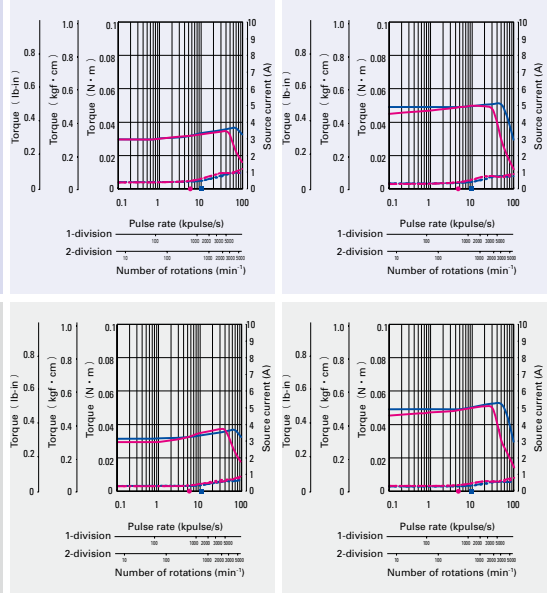

The data are measured under the drive condition of our company. The drive torque may very depending on the accuracy of customer-side equipment.

Size	Motor flange size	60mm (2.36inch)		86mm (3.39inch)					
		87.5mm (3.45inch)		62.15mm (2.47inch)		92.2mm (3.63inch)		125.85mm (4.95inch)	
Set part number	Single shaft	FSF783S	FPF783S	FSF851S	FPF851S	FSF852S	FPF852S	FSF853S	FPF853S
	Double shaft	FSF783D	FPF783D	FSF851D	FPF851D	FSF852D	FPF852D	FSF853D	FPF853D
Holding torque	N·m(oz·in)	1.79 (253.5)		2.06 (291.7)		4.02 (569.3)		6.17 (873.7)	
Rotor inertia	$\times 10^{-4}$ kg·m ² (oz·in ²)	0.84 (4.60)		1.45 (7.93)		2.9 (15.86)		4.4 (24.06)	
Mass (Weight)	kg (lbs)	1.36 (3.0)		1.5 (3.3)		2.5 (5.5)		3.5 (7.7)	
Allowable thrust load	N (lbs)	20 (4.5)		60 (13.5)		60 (13.5)		60 (13.5)	
Allowable radial load ^(Note1)	N (lbs)	80 (18)		220 (49.5)		220 (49.5)		220 (49.5)	

(Note1) When load is applied at 1/3 length from output shaft edge.

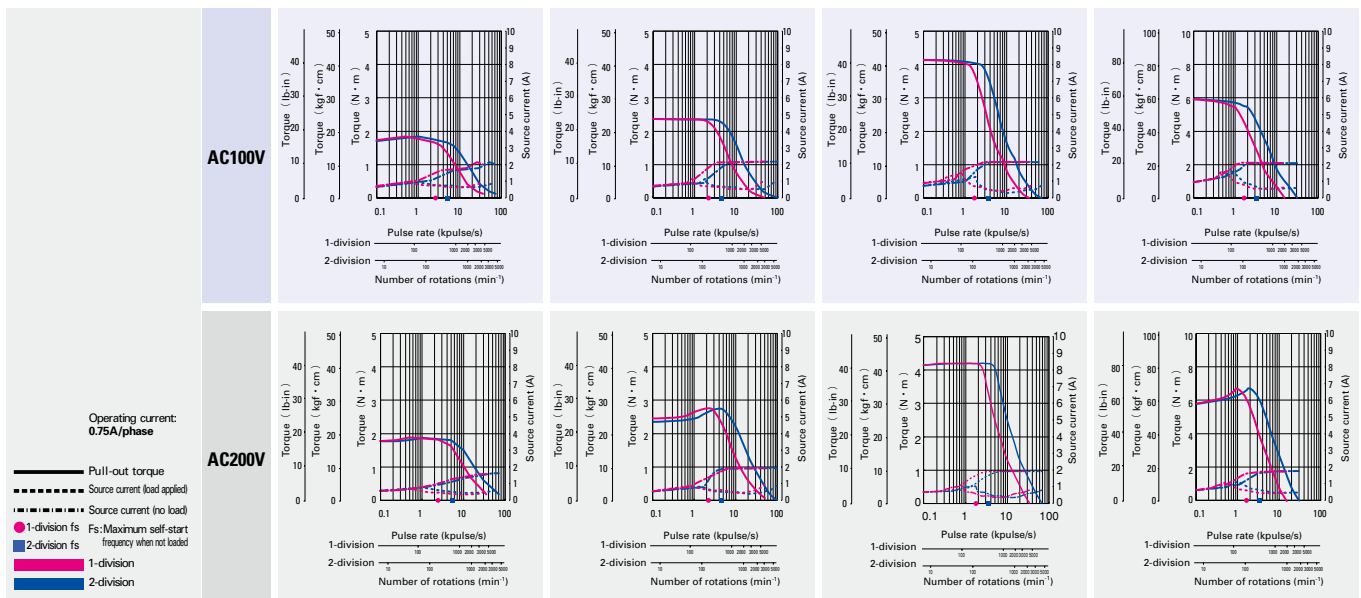

The data are measured under the drive condition of our company. The drive torque may very depending on the accuracy of customer-side equipment.

□ 42mm (□ 1.65inch)

□ 60mm (□ 2.36inch)

34mm (1.34inch)		40mm (1.57inch)		49mm (1.93inch)		46.5mm (1.83inch)		55mm (2.17inch)	
FSF551S	FPF551S	FSF552S	FPF552S	FSF554S	FPF554S	FSF781S	FPF781S	FSF782S	FPF782S
FSF551D	FPF551D	FSF552D	FPF552D	FSF554D	FPF554D	FSF781D	FPF781D	FSF782D	FPF782D
0.13 (18.41)		0.18 (25.49)		0.26 (36.82)		0.6 (85.0)		0.93 (131.7)	
0.03 (0.16)		0.053 (0.29)		0.065 (0.36)		0.275 (1.50)		0.4 (2.19)	
0.23 (0.50)		0.28 (0.62)		0.37 (0.81)		0.6 (1.32)		0.78 (1.72)	
10 (2.25)		10 (2.25)		10 (2.25)		20 (4.5)		20 (4.5)	
35 (8.75)		35 (8.75)		35 (8.75)		80 (18)		80 (18)	

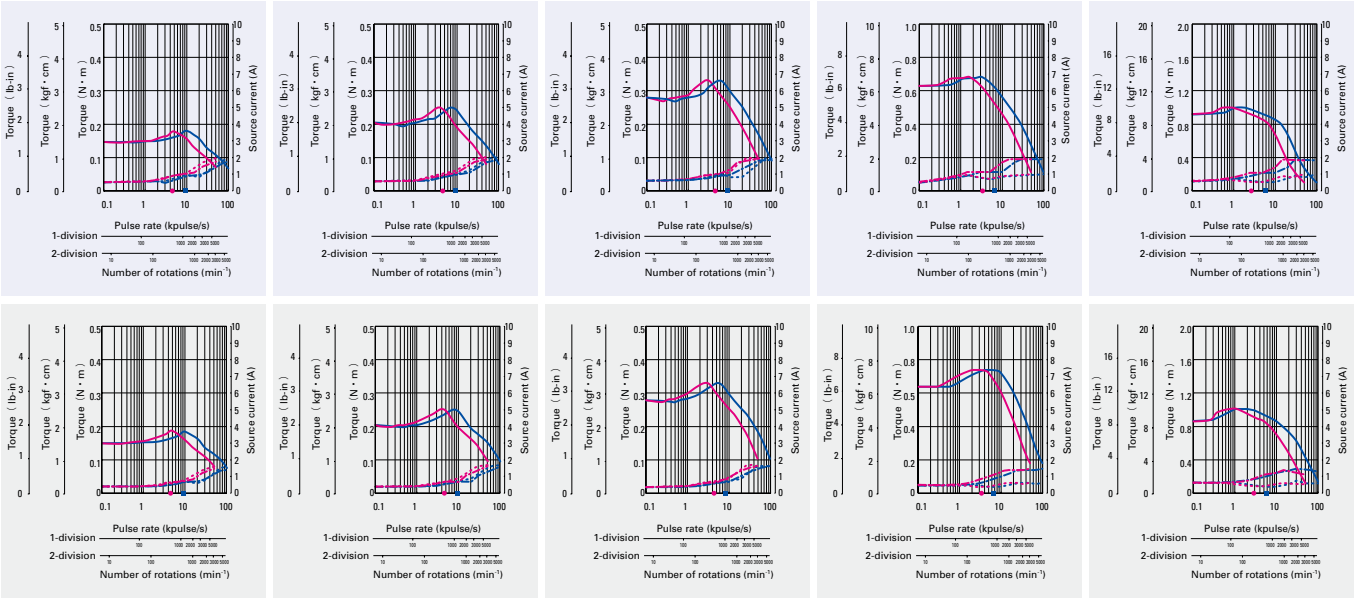

φ 106mm (φ 4.17inch)

163.3mm (6.43inch)		221.3mm (8.71inch)	
FSF892S	FPF892S	FSF893S	FPF893S
FSF892D	FPF892D	FSF893D	FPF893D
10.8 (1529.4)		16 (2265.7)	
14.6 (79.83)		22 (120.28)	
7.5 (16.5)		10.5 (23.1)	
100 (22.5)		100 (22.5)	
360 (81)		360 (81)	

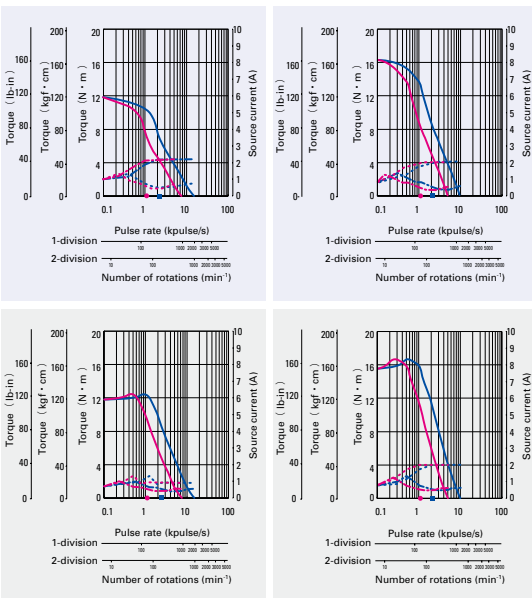

CE / UL model

F series driver + M series motor

Motor flange size



Size	Motor flange size	42mm (1.65inch)			
		31mm (1.22inch)		50.5mm (1.99inch)	
Set part number	Single shaft	F5M551S	F5P551S	F5M552S	F5P552S
	Double shaft	F5M551D	F5P551D	F5M552D	F5P552D
Holding torque	N·m(oz·in)	0.13 (18.41)		0.18 (25.49)	
Rotor inertia	$\times 10^{-4}$ kg·m ² (oz·in ²)	0.03 (0.16)		0.053 (0.29)	
Mass (Weight)	kg (lbs)	0.23 (0.51)		0.28 (0.62)	
Allowable thrust load	N (lbs)	10 (2.25)		10 (2.25)	
Allowable radial load ^(Note1)	N (lbs)	35 (8.75)		35 (8.75)	

(Note1) When load is applied at 1/3 length from output shaft edge.



AC100V

AC200V

Operating current:
0.75A/phase

- Pull-out torque
- Source current (load applied)
- Source current (no load)
- 1-division fs
- 2-division fs

Fs: Maximum self-start frequency when not loaded

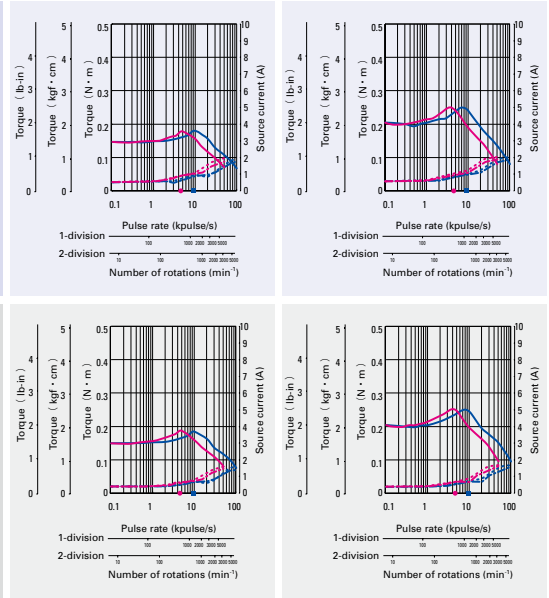

The data are measured under the drive condition of our company. The drive torque may very depending on the accuracy of customer-side equipment.

Size	Motor flange size	86mm (3.39inch)				106mm (4.17inch)			
		92.2mm (3.63inch)		125.85mm (4.95inch)		163.3mm (6.43inch)		221.3mm (8.71inch)	
Set part number	Single shaft	F5M852S	F5P852S	F5M853S	F5P853S	F5M892S	F5P892S	F5M893S	F5P893S
	Double shaft	F5M852D	F5P852D	F5M853D	F5P853D	F5M892D	F5P892D	F5M893D	F5P893D
Holding torque	N·m(oz·in)	4.02 (569.3)		6.17 (873.7)		10.8 (1529.4)		16 (2265.7)	
Rotor inertia	$\times 10^{-4}$ kg·m ² (oz·in ²)	2.9 (15.86)		4.4 (24.06)		14.6 (79.83)		22 (120.28)	
Mass (Weight)	kg (lbs)	2.5 (5.5)		3.5 (7.7)		7.5 (16.5)		10.5 (23.1)	
Allowable thrust load	N (lbs)	60 (13.5)		60 (13.5)		100 (22.5)		100 (22.5)	
Allowable radial load ^(Note1)	N (lbs)	220 (49.5)		220 (49.5)		360 (81)		360 (81)	

(Note1) When load is applied at 1/3 length from output shaft edge.

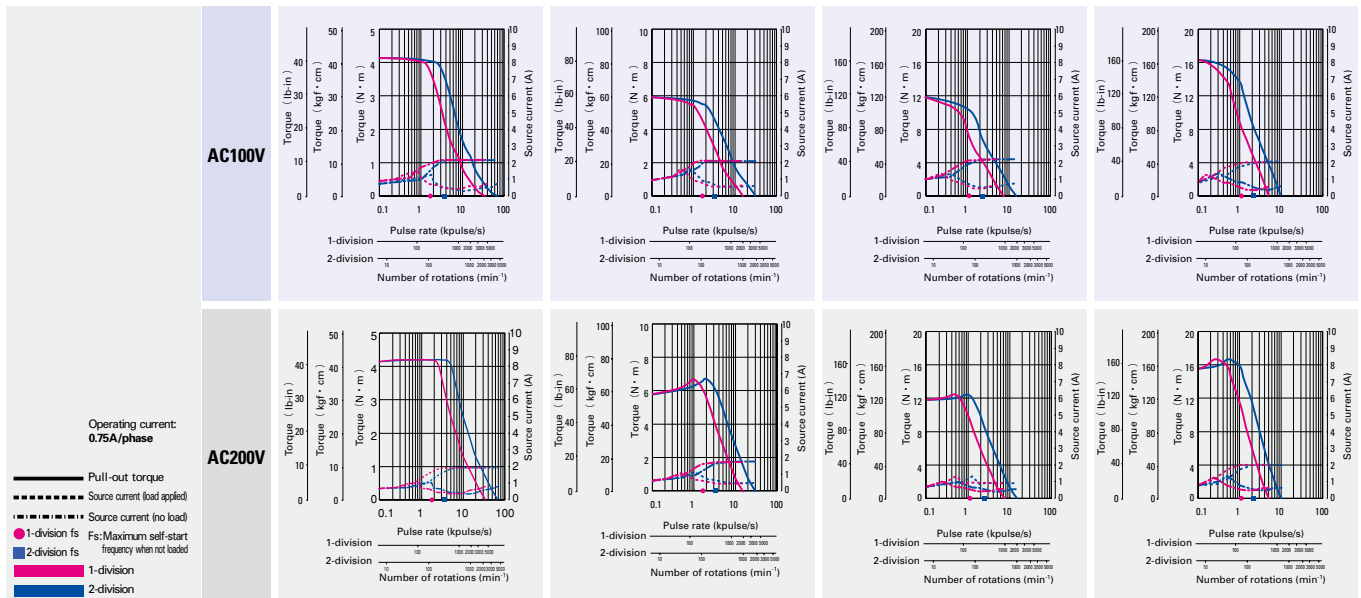

Operating current:
0.75A/phase

- Pull-out torque
- Source current (load applied)
- Source current (no load)
- 1-division fs
- 2-division fs

Fs: Maximum self-start frequency when not loaded

The data are measured under the drive condition of our company. The drive torque may very depending on the accuracy of customer-side equipment.

□ 42mm (□ 1.65inch)		□ 60mm (□ 2.36inch)				φ 86mm (φ 3.39inch)			
49mm (1.93inch)		46.5mm (1.83inch)		55mm (2.17inch)		87.5mm (3.44inch)		62.15mm (2.47inch)	
FSM554S	FPM554S	FSM781S	FPM781S	FSM782S	FPM782S	FSM783S	FPM783S	FSM851S	FPM851S
FSM554D	FPM554D	FSM781D	FPM781D	FSM782D	FPM782D	FSM783D	FPM783D	FSM851D	FPM851D
0.26 (36.82)		0.6 (85.0)		0.065 (9.20)		1.79 (253.5)		2.06 (291.7)	
0.065 (0.36)		0.275 (1.50)		0.016 (0.09)		0.84 (4.59)		1.45 (7.93)	
0.37 (0.81)		0.6 (1.32)		0.2 (0.44)		1.36 (3.0)		1.5 (3.3)	
10 (2.25)		20 (4.5)		3 (0.68)		20 (4.5)		60 (13.5)	
35 (8.75)		80 (18)		34 (7.65)		80 (18)		220 (49.5)	

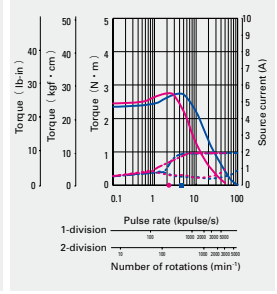
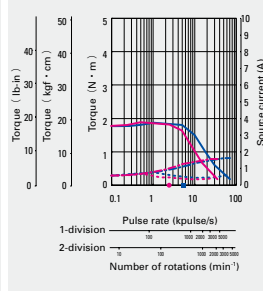
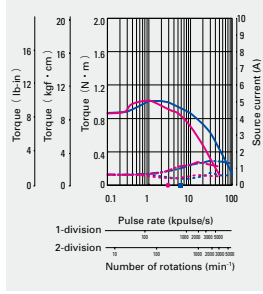
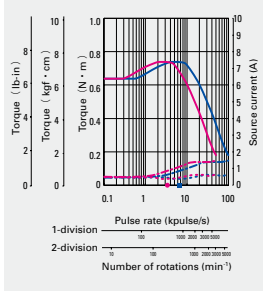
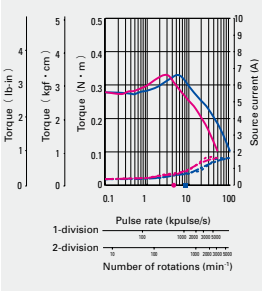
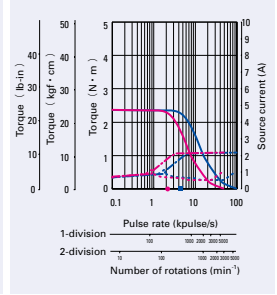
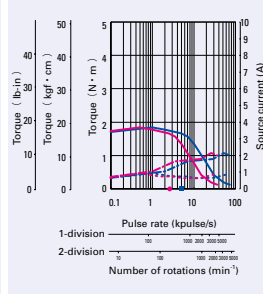
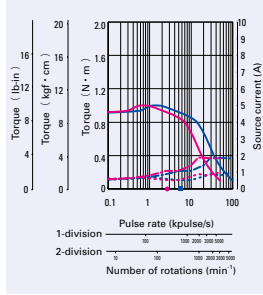
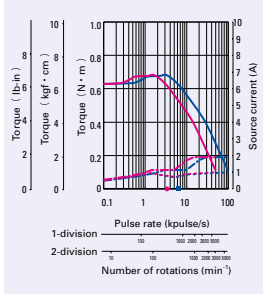
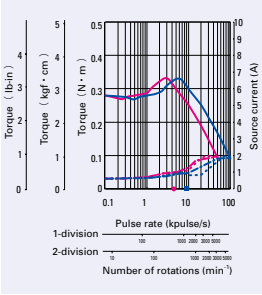

Low-backlash gear model

F series driver +
F series motor with low-backlash gear

Motor flange size



Size	Motor flange size	□ 42mm (□ 1.65inch)			
	Motor + gear length	64.5mm (2.54inch)		64.5mm (2.54inch)	
Set part number	Single shaft	FSF551S-CX3.6	FPF551S-CX3.6	FSF551S-CX7.2	FPF551S-CX7.2
	Double shaft	FSF551D-CX3.6	FPF551D-CX3.6	FSF551D-CX7.2	FPF551D-CX7.2
Allowable torque	N·m(oz·in)	0.35 (44.6)		0.7 (99.1)	
Rotor inertia	×10 ⁻⁴ kg·m ² (oz·in ²)	0.03 (0.16)		0.03 (0.16)	
Basic step angle		0.2		0.1	
Gear ratio		1 : 3.6		1 : 7.2	
Backlash	DEG	0.6		0.4	
Allowable speed	min ⁻¹	500		250	
Mass (Weight)	kg (lbs)	0.36 (0.79)		0.36 (0.79)	
Allowable thrust load	N (lbs)	15 (3.38)		15 (3.38)	
Allowable radial load (Note 1)	N (lbs)	20 (4.5)		20 (4.5)	

Directions of motor rotation and gear output shaft are the same for models with reduction ratio 1 : 3.6, 1 : 7.2, and 1 : 10 opposite for reduction ratio 1 : 20, 1 : 30, and 1 : 36.

(Note1) When load is applied at 1/3 length from output shaft edge.



AC100V

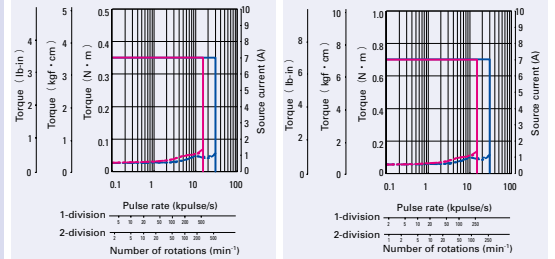

AC200V

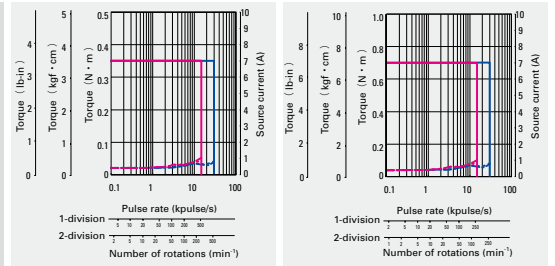

Operating current:
0.75A/phase

— Allowable torque
- - - Source current (load applied)
- · - · - Source current (no load)

— 1-division
— 2-division

The data are measured under the drive condition of our company. The drive torque may very depending on the accuracy of customer-side equipment.

Size	Motor flange size	□ 60mm (□ 2.36inch)							
	Motor + gear length	92mm (3.62inch)		92mm (3.62inch)		92mm (3.62inch)		92mm (3.62inch)	
Set part number	Single shaft	FSF781S-CX7.2	FPF781S-CX7.2	FSF781S-CX10	FPF781S-CX10	FSF781S-CX20	FPF781S-CX20	FSF781S-CX30	FPF781S-CX30
	Double shaft	FSF781D-CX7.2	FPF781D-CX7.2	FSF781D-CX10	FPF781D-CX10	FSF781D-CX20	FPF781D-CX20	FSF781D-CX30	FPF781D-CX30
Allowable torque	N·m(oz·in)	2.5 (354.0)		3 (424.8)		3.5 (495.6)		4 (566.4)	
Rotor inertia	×10 ⁻⁴ kg·m ² (oz·in ²)	0.275 (1.5)		0.275 (1.5)		0.275 (1.5)		0.275 (1.5)	
Basic step angle		0.1		0.072		0.036		0.024	
Gear ratio		1 : 7.2		1 : 10		1 : 20		1 : 30	
Backlash	DEG	0.25		0.25		0.17		0.17	
Allowable speed	min ⁻¹	250		180		90		60	
Mass (Weight)	kg (lbs)	0.97 (2.13)		0.97 (2.13)		0.97 (2.13)		0.97 (2.13)	
Allowable thrust load	N (lbs)	30 (6.75)		30 (6.75)		30 (6.75)		30 (6.75)	
Allowable radial load (Note 1)	N (lbs)	100 (22.5)		100 (22.5)		100 (22.5)		100 (22.5)	

Directions of motor rotation and gear output shaft are the same for models with reduction ratio 1 : 3.6 and 1:7.2, opposite for reduction ratio 1 : 10, 1 : 20 and 1 : 30.

(Note1) When load is applied at 1/3 length from output shaft edge.

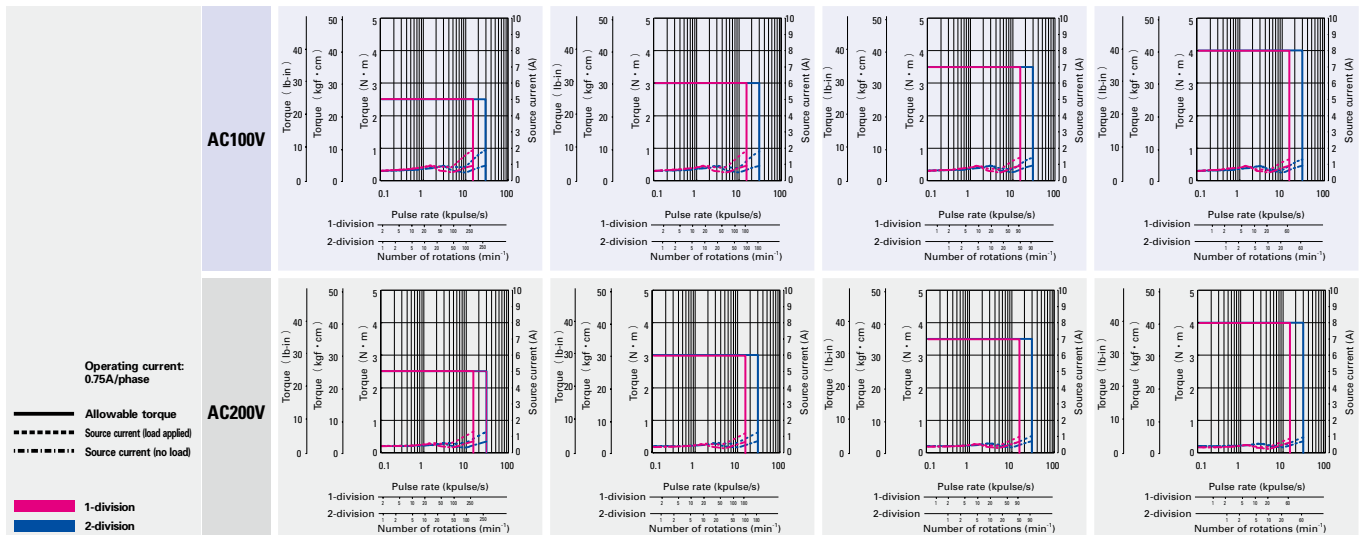

The data are measured under the drive condition of our company. The drive torque may very depending on the accuracy of customer-side equipment.

□ 42mm (□ 1.65inch)

□ 60mm (□ 2.36inch)

64.5mm (2.54inch)		64.5mm (2.54inch)		64.5mm (2.54inch)		64.5mm (2.54inch)		92mm (3.62inch)	
FSF551S-CX10	FPF551S-CX10	FSF551S-CX20	FPF551S-CX20	FSF551S-CX30	FPF551S-CX30	FSF551S-CX36	FPF551S-CX36	FSF781S-CX3.6	FPF781S-CX3.6
FSF551D-CX10	FPF551D-CX10	FSF551D-CX20	FPF551D-CX20	FSF551D-CX30	FPF551D-CX30	FSF551D-CX36	FPF551D-CX36	FSF781D-CX3.6	FPF781D-CX3.6
1 (141.6)		1.5 (212.4)		1.5 (212.4)		1.5 (212.4)		1.25 (177.0)	
0.03 (0.16)		0.03 (0.16)		0.03 (0.16)		0.03 (0.16)		0.275 (1.5)	
0.072		0.036		0.024		0.02		0.2	
1 : 10		1 : 20		1 : 30		1 : 36		1 : 3.6	
0.35		0.25		0.25		0.25		0.55	
180		90		60		50		500	
0.36 (0.79)		0.36 (0.79)		0.36 (0.79)		0.36 (0.79)		0.97 (2.13)	
15 (3.38)		15 (3.38)		15 (3.38)		15 (3.38)		30 (6.75)	
20 (4.5)		20 (4.5)		20 (4.5)		20 (4.5)		100 (22.5)	

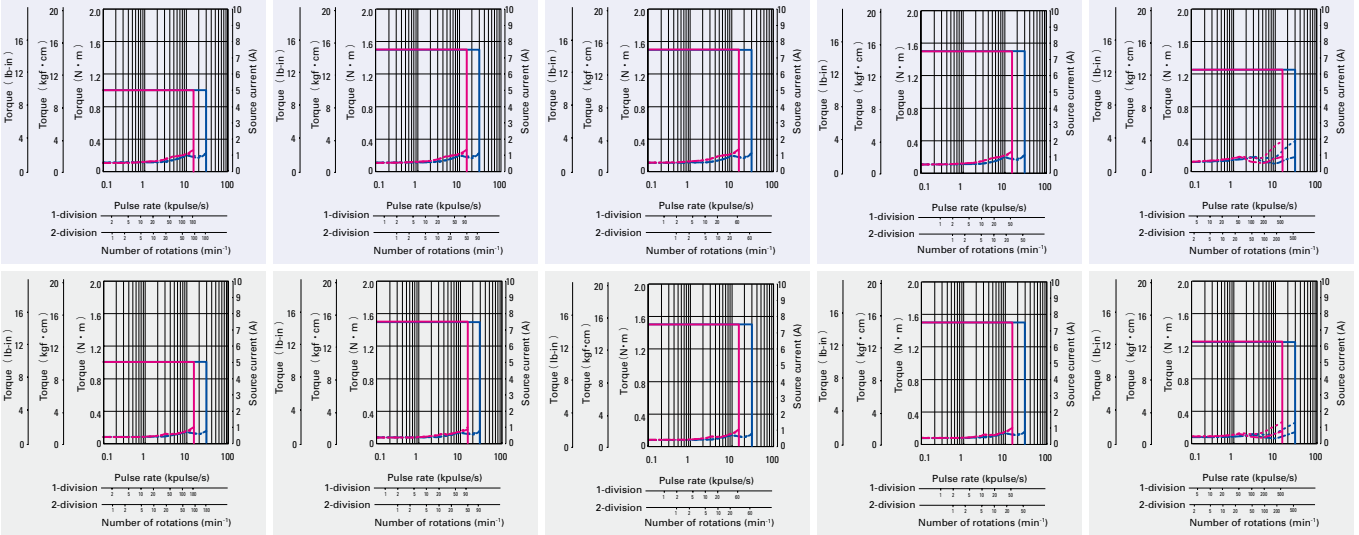

□ 60mm (□ 2.36inch)

φ 86mm (φ 3.39inch)

92mm (3.62inch)		127.3mm (5.01inch)		127.3mm (5.01inch)		127.3mm (5.01inch)		127.3mm (5.01inch)	
FSF781S-CX36	FPF781S-CX36	FSF851S-CX3.6	FPF851S-CX3.6	FSF851S-CX7.2	FPF851S-CX7.2	FSF851S-CX10	FPF851S-CX10	FSF851S-CX20	FPF851S-CX20
FSF781D-CX36	FPF781D-CX36	FSF851D-CX3.6	FPF851D-CX3.6	FSF851D-CX7.2	FPF851D-CX7.2	FSF851D-CX10	FPF851D-CX10	FSF851D-CX20	FPF851D-CX20
4 (566.4)		4.5 (637.2)		9 (1274.5)		9 (1274.5)		12 (1699.3)	
0.275 (1.5)		1.45 (7.93)		1.45 (7.93)		1.45 (7.93)		1.45 (7.93)	
0.02		0.2		0.1		0.072		0.036	
1 : 36		1 : 3.6		1 : 7.2		1 : 10		1 : 20	
0.17		0.4		0.25		0.25		0.17	
50		500		250		180		90	
0.97 (2.13)		2.7 (5.94)		2.7 (5.94)		2.7 (5.94)		2.7 (5.94)	
30 (6.75)		30 (6.75)		30 (6.75)		30 (6.75)		30 (6.75)	
100 (22.5)		100 (22.5)		100 (22.5)		100 (22.5)		100 (22.5)	

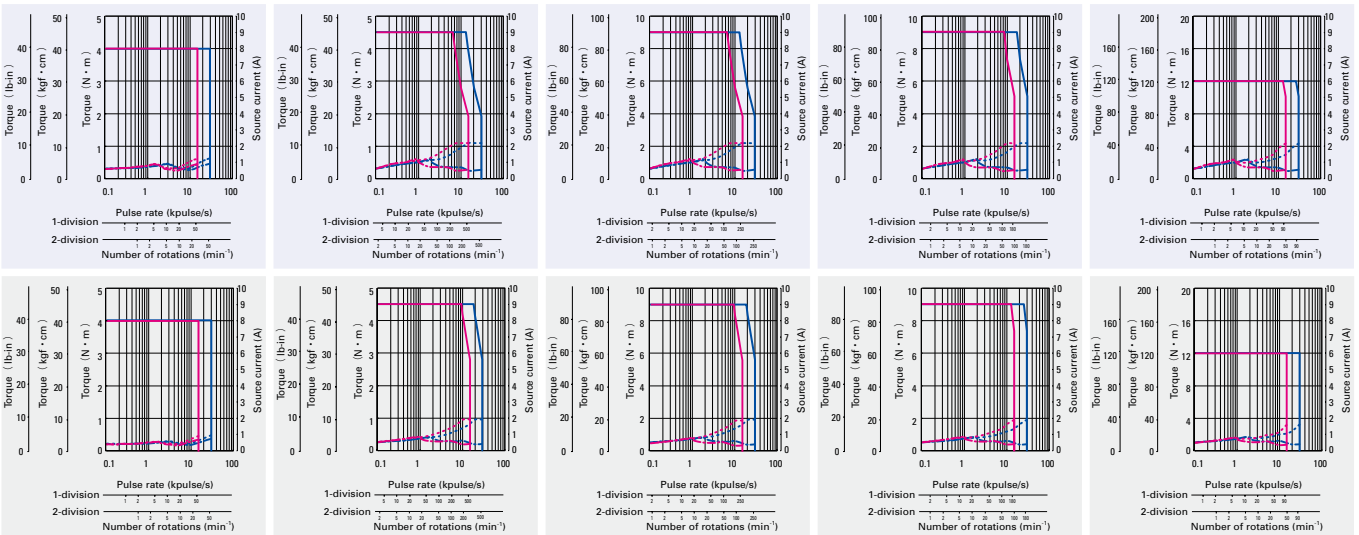

Low-backlash gear model

F series driver +
F series motor with low-backlash gear

Size	Motor flange size	φ 86mm (φ 3.39inch)			
		127.3mm (5.01inch)		127.3mm (5.01inch)	
Set part number	Motor + gear length				
	Single shaft	FSF851S-CX30	FPF851S-CX30	FSF851S-CX36	FPF851S-CX36
Allowable torque	Double shaft	FSF851D-CX30	FPF851D-CX30	FSF851D-CX36	FPF851D-CX36
	N·m(oz·in)	12 (1699.3)		12 (1699.3)	
Rotor inertia	×10 ⁻⁴ kg·m ² (oz·in ²)	1.45 (7.93)		1.45 (7.93)	
Basic step angle		0.024		0.02	
Gear ratio		1 : 30		1 : 36	
Backlash	DEG	0.17		0.15	
Allowable speed	min ⁻¹	60		50	
Mass (Weight)	kg (lbs)	2.7 (5.94)		2.7 (5.94)	
Allowable thrust load	N (lbs)	60 (13.5)		60 (13.5)	
Allowable radial load (Note 1)	N (lbs)	300 (67.5)		300 (67.5)	

Directions of motor rotation and gear output shaft are the same for models with reduction ratio 1 : 3.6 and 1:7.2, opposite for reduction ratio 1 : 10, 1 : 20, 1 : 30, and 1 : 36.
(Note1) When load is applied at 1/3 length from output shaft edge.

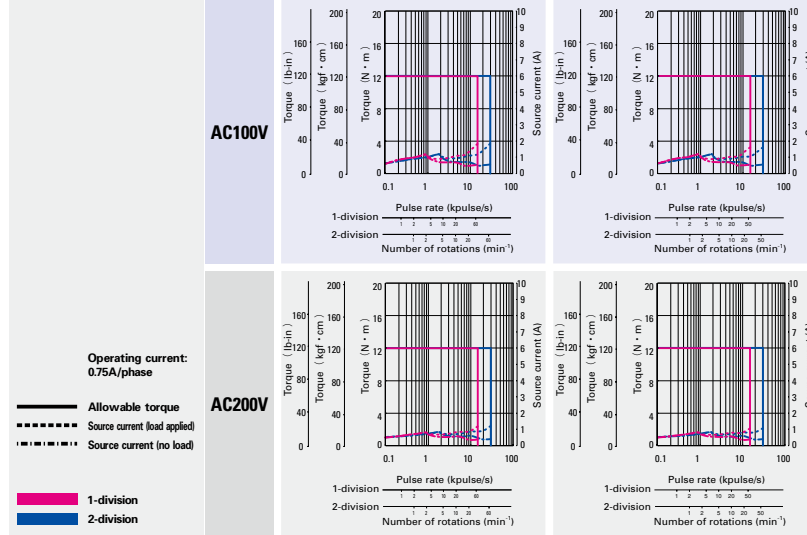

The data are measured under the drive condition of our company. The drive torque may vary depending on the accuracy of customer-side equipment.

Spur gear model

F series driver + F series motor with spur gear

Motor flange size

□28
(-1.10inch)

Size	Motor flange size	□28mm (□1.10inch)			
	Motor + gear length	60.3mm (2.37inch)		60.3mm (2.37inch)	
Set part number	Single shaft	FSF351S-GX3.6	FPF351S-GX3.6	FSF351S-GX7.2	FPF351S-GX7.2
	Double shaft	FSF351D-GX3.6	FPF351D-GX3.6	FSF351D-GX7.2	FPF351D-GX7.2
Allowable torque	N·m(oz·in)	0.1 (14.16)		0.15 (21.24)	
Rotor inertia	$\times 10^{-4}$ kg·m ² (oz·in ²)	0.009 (0.05)		0.009 (0.05)	
Basic step angle		0.2		0.1	
Gear ratio		1 : 3.6		1 : 7.2	
Backlash	DEG	2		2	
Allowable speed	min ⁻¹	800		400	
Mass (Weight)	kg (lbs)	0.17 (0.37)		0.17 (0.37)	
Allowable thrust load	N (lbs)	10 (2.25)		10 (2.25)	
Allowable radial load (Note 1)	N (lbs)	15 (3.38)		15 (3.38)	

Directions of motor rotation and gear output shaft are the same for models with reduction ratio 1 : 3.6, 1 : 7.2, 1 : 20, 1 : 30, and 1:50 opposite for reduction ratio 1 : 10.
(Note1) When load is applied at 1/3 length from output shaft edge.

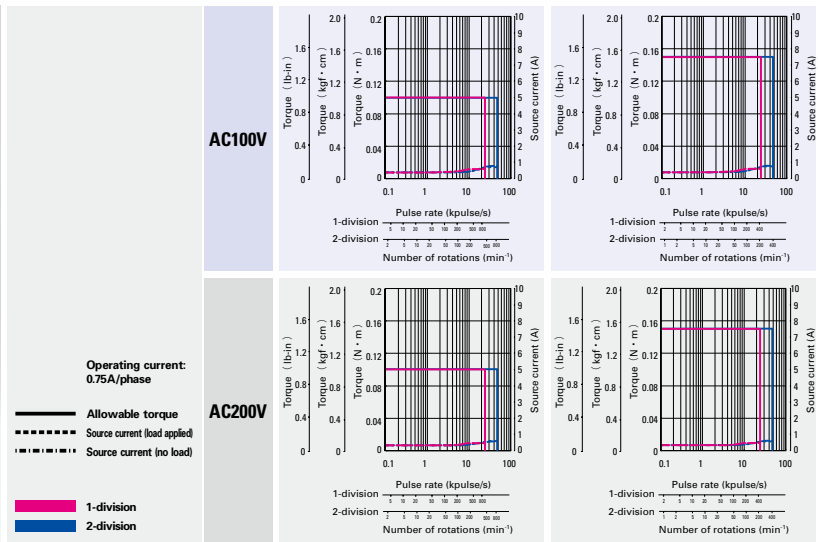

The data are measured under the drive condition of our company. The drive torque may very depending on the accuracy of customer-side equipment.

Size	Motor flange size	□28mm (□1.10inch)							
	Motor + gear length	60.3mm (2.37inch)		60.3mm (2.37inch)		60.3mm (2.37inch)		60.3mm (2.37inch)	
Set part number	Single shaft	FSF351S-GX10	FPF351S-GX10	FSF351S-GX20	FPF351S-GX20	FSF351S-GX30	FPF351S-GX30	FSF351S-GX50	FPF351S-GX50
	Double shaft	FSF351D-GX10	FPF351D-GX10	FSF351D-GX20	FPF351D-GX20	FSF351D-GX30	FPF351D-GX30	FSF351D-GX50	FPF351D-GX50
Allowable torque	N·m(oz·in)	0.2 (28.32)		0.35 (49.6)		0.5 (70.80)		0.5 (70.80)	
Rotor inertia	$\times 10^{-4}$ kg·m ² (oz·in ²)	0.009 (0.05)		0.009 (0.05)		0.009 (0.05)		0.009 (0.05)	
Basic step angle		0.072		0.036		0.024		0.0144	
Gear ratio		1 : 10		1 : 20		1 : 30		1 : 50	
Backlash	DEG	2		1.5		1.5		1.5	
Allowable speed	min ⁻¹	300		150		100		60	
Mass (Weight)	kg (lbs)	0.17 (0.37)		0.17 (0.37)		0.17 (0.37)		0.17 (0.37)	
Allowable thrust load	N (lbs)	10 (2.25)		10 (2.25)		10 (2.25)		10 (2.25)	
Allowable radial load (Note 1)	N (lbs)	15 (3.38)		15 (3.38)		15 (3.38)		15 (3.38)	

Directions of motor rotation and gear output shaft are the same for models with reduction ratio 1 : 3.6, 1 : 7.2, 1 : 20, 1 : 30, and 1:50 opposite for reduction ratio 1 : 10.
(Note1) When load is applied at 1/3 length from output shaft edge.

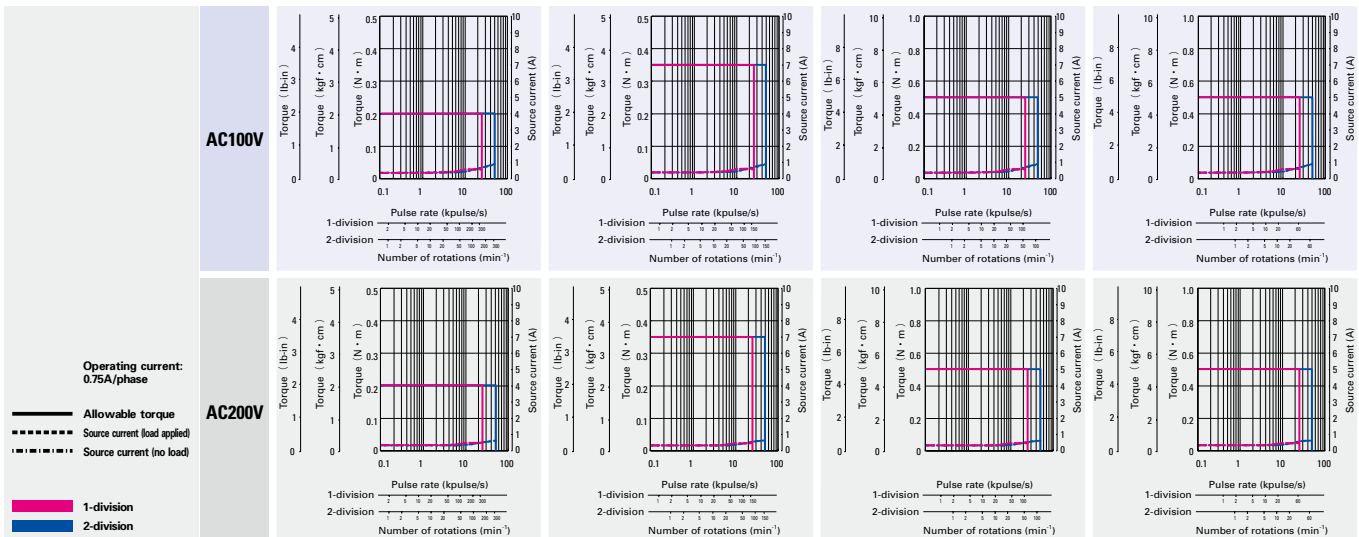

The data are measured under the drive condition of our company. The drive torque may very depending on the accuracy of customer-side equipment.

AC input

Input / Output signal standard

DC input

Stepping motor

Dimensions

Harmonic gear model

F series driver +
F series motor with harmonic gear

Motor flange size



Size	□ 28mm (□ 1.10inch)				
	69.5mm (2.74inch)		69.5mm (2.74inch)		
Motor flange size					
Motor + gear length					
Set part number	Single shaft	FSF351S-HX50	FPF351S-HX50	FSF351S-HX100	FPF351S-HX100
	Double shaft	FSF351D-HX50	FPF351D-HX50	FSF351D-HX100	FPF351D-HX100
Allowable torque	N·m(oz·in)	1.5 (212.4)		2 (283.2)	
Momentary allowable torque	N·m(oz·in)	2.7 (382.4)		3.6 (509.8)	
Rotor inertia	$\times 10^{-4}$ kg·m ² (oz·in ²)	0.012 (0.065)		0.012 (0.065)	
Basic step angle		0.0144		0.0072	
Gear ratio		1 : 50		1 : 100	
Lost motion	Minute	0.4 to 3 ± 0.006N·m (0.85oz·in)		0.4 to 3 ± 0.008N·m (1.133oz·in)	
Allowable speed	min ⁻¹	70		35	
Mass (Weight)	kg(lbs)	0.22 (0.48)		0.22 (0.48)	
Allowable thrust load	N(lbs)	100 (22.5)		100 (22.5)	
Allowable radial load (Note 1)	N(lbs)	160 (36)		160 (36)	

Directions of gear output shaft are the opposite.
(Note1) When load is applied at 1/3 length from output shaft edge.



AC100V

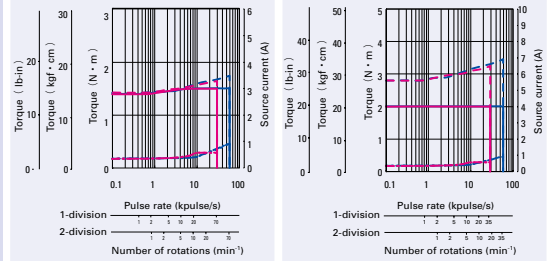

AC200V

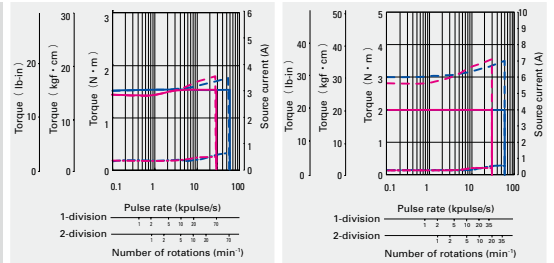

Operating current:
0.75A/phase

--- Momentary allowable torque
--- Allowable torque
- - - Source current (load applied)
- - - Source current (no load)

1 - 1-division
2 - 2-division

The data are measured under the drive condition of our company. The drive torque may very depending on the accuracy of customer-side equipment.

Size	□ 60mm (□ 2.36inch)				φ 86mm (φ 3.39inch)				
	113.5mm (4.47inch)		113.5mm (4.47inch)		113.5mm (4.47inch)		113.5mm (4.47inch)		
Motor flange size									
Motor + gear length									
Set part number	Single shaft	FSF781S-HX50	FPF781S-HX50	FSF781S-HX100	FPF781S-HX100	FSF851S-HX50	FPF851S-HX50	FSF851S-HX100	FPF851S-HX100
	Double shaft	FSF781D-HX50	FPF781D-HX50	FSF781D-HX100	FPF781D-HX100	FSF851D-HX50	FPF851D-HX50	FSF851D-HX100	FPF851D-HX100
Allowable torque	N·m(oz·in)	5.5 (778.8)		8 (1132.9)		25 (3540.2)		41 (5805.9)	
Momentary allowable torque	N·m(oz·in)	14 (1982.6)		20 (2832.2)		34 (4814.8)		59 (8355.1)	
Rotor inertia	$\times 10^{-4}$ kg·m ² (oz·in ²)	0.31 (1.695)		0.31 (1.695)		1.65 (9.021)		1.65 (9.021)	
Basic step angle		0.0144		0.0072		0.0144		0.0072	
Gear ratio		1 : 50		1 : 100		1 : 50		1 : 100	
Lost motion	Minute	0.4 to 3 ± 0.028N·m (3.965oz·in)		0.4 to 3 ± 0.4N·m (56.645oz·in)		0.4 to 3 ± 1N·m (141.612oz·in)		0.4 to 3 ± 1.2N·m (169.934oz·in)	
Allowable speed	min ⁻¹	70		35		70		35	
Mass (Weight)	kg(lbs)	1.2 (2.64)		1.2 (2.64)		3.3 (7.26)		3.3 (7.26)	
Allowable thrust load	N(lbs)	400 (90)		400 (90)		1400 (315)		1400 (315)	
Allowable radial load (Note 1)	N(lbs)	360 (81)		360 (81)		1380 (310.5)		1380 (310.5)	

Directions of gear output shaft are the opposite.
(Note1) When load is applied at 1/3 length from output shaft edge.

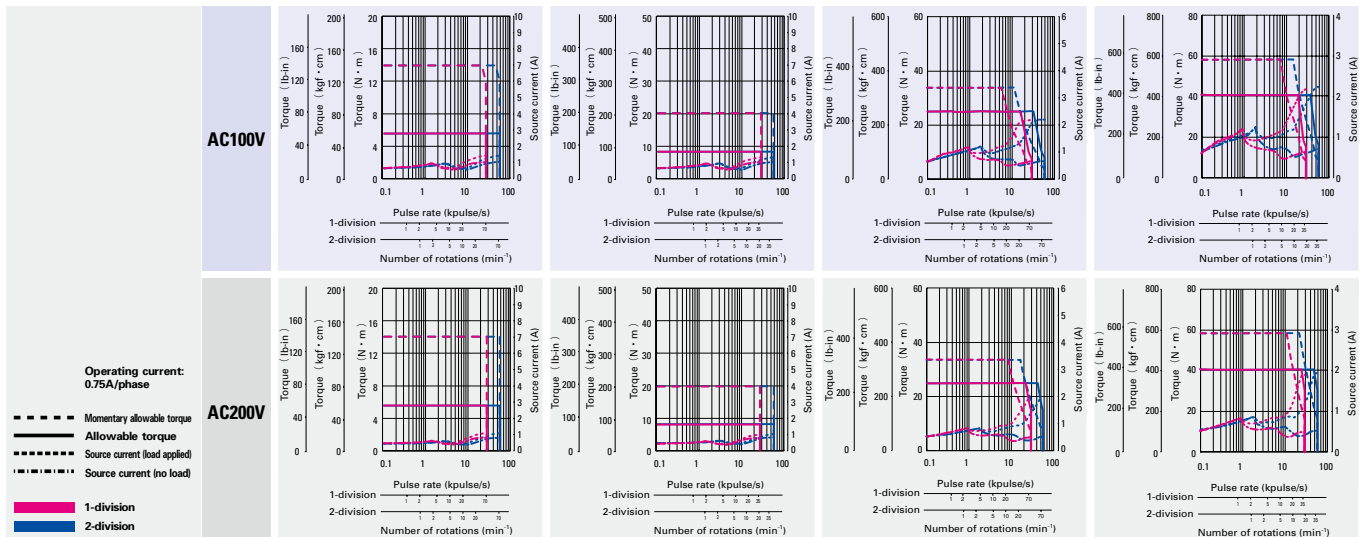

The data are measured under the drive condition of our company. The drive torque may very depending on the accuracy of customer-side equipment.

Size	Motor flange size	□ 42mm (□ 1.65inch)					
	Motor + gear length	73.5mm (2.89inch)		73.5mm (2.89inch)		73.5mm (2.89inch)	
Set part number	Single shaft	FSF551S-HX30	FPF551S-HX30	FSF551S-HX50	FPF551S-HX50	FSF551S-HX100	FPF551S-HX100
	Double shaft	FSF551D-HX30	FPF551D-HX30	FSF551D-HX50	FPF551D-HX50	FSF551D-HX100	FPF551D-HX100
Allowable torque	N·m(oz·in)	2.2 (311.5)		3.5 (495.6)		5 (708.1)	
Momentary allowable torque	N·m(oz·in)	4.5 (637.3)		8.3 (1175.4)		11 (1557.7)	
Rotor inertia	$\times 10^{-4} \text{kg} \cdot \text{m}^2 (\text{oz} \cdot \text{in}^2)$	0.042 (0.23)		0.042 (0.23)		0.042 (0.23)	
Basic step angle		0.024		0.0144		0.0072	
Gear ratio		1:30		1:50		1:100	
Hysteresis loss	Minute	3.6		2.4		2.4	
Allowable speed	min^{-1}	116		70		35	
Mass (Weight)	kg (lbs)	0.42 (0.92)		0.42 (0.92)		0.42 (0.92)	
Allowable thrust load	N (lbs)	1150 (258.75)		1150 (258.75)		1150 (258.75)	
Allowable radial load ^(Note 1)	N (lbs)	209 (46.98)		209 (46.98)		209 (46.98)	

Directions of gear output shaft are the opposite.
 (Note1) The load point is an output axis point.

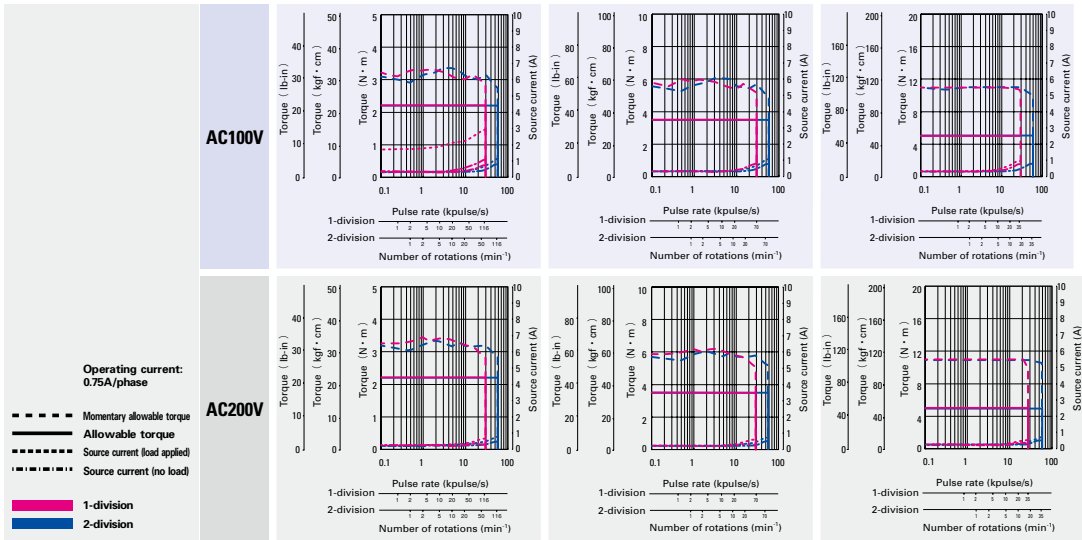

Electromagnetic brake model

F series driver + F series motor with electromagnetic brake

Motor flange size



Size	Motor flange size		42mm (1.65inch)			
	Motor + brake length		64.5mm (2.54inch)		70.5mm (2.78inch)	
Set part number	Single shaft		FSF551S-XB	FPF551S-XB	FSF552S-XB	FPF552S-XB
Holding torque	N·m(oz·in)		0.13 (8.4)		0.18 (25.49)	
Rotor inertia	×10 ⁻⁴ kg·m ² (oz·in ²)		0.045 (0.246)		0.068 (0.372)	
Mass (Weight)	kg (lbs)		0.38 (0.84)		0.43 (0.95)	
Allowable thrust load	N (lbs)		10 (2.25)		10 (2.25)	
Allowable radial load ^(Note 1)	N (lbs)		35 (8.75)		35 (8.75)	
Brake type			No excitation actuating type		No excitation actuating type	
Electromagnetic brake	Power supply input	V	DC24V ± 5%		DC24V ± 5%	
	Excitation current	A	0.08		0.08	
	Power consumption	W	2		2	
	Static fiction torque	N·m(oz·in)	0.22 (31.15)		0.22 (31.15)	
	Brake operating time	ms	30		30	
	Brake release time	ms	20		20	

(Note1) When load is applied at 1/3 length from output shaft edge.



AC100V

AC200V

Operating current:
0.75A/phase

- Pull-out torque
- - - Source current (load applied)
- · - · - Source current (no load)
- 1-division fs
- 2-division fs
- Fs: Maximum self-start frequency when not loaded
- 1-division
- 2-division

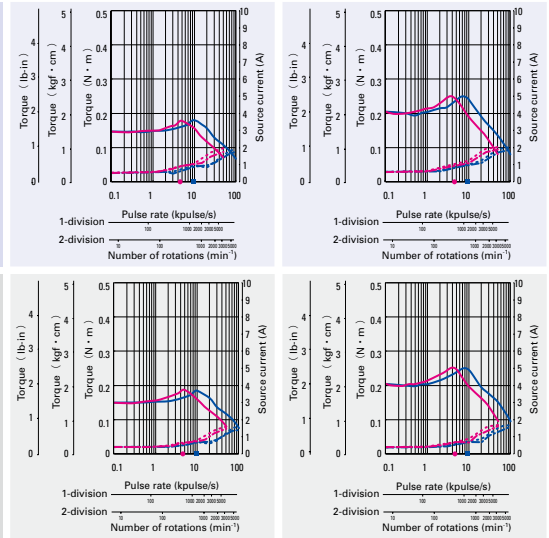

The data are measured under the drive condition of our company. The drive torque may very depending on the accuracy of customer-side equipment.

Size	Motor flange size		86mm (3.39inch)			
	Motor + brake length		146.8mm (5.78mm)		180.4mm (7.10mm)	
Set part number	Single shaft		FSF852S-XB	FPF852S-XB	FSF853S-XB	FPF853S-XB
Holding torque	N·m(oz·in)		4.02 (569.3)		6.17 (873.7)	
Rotor inertia	×10 ⁻⁴ kg·m ² (oz·in ²)		3.69 (20.175)		5.19 (28.376)	
Mass (Weight)	kg (lbs)		4.5 (9.9)		5.5 (12.1)	
Allowable thrust load	N (lbs)		60 (13.5)		60 (13.5)	
Allowable radial load ^(Note 1)	N (lbs)		220 (49.5)		220 (49.5)	
Brake type			No excitation actuating type		No excitation actuating type	
Electromagnetic brake	Power supply input	V	DC24V ± 5%		DC24V ± 5%	
	Excitation current	A	0.42		0.42	
	Power consumption	W	10		10	
	Static fiction torque	N·m(oz·in)	4 (566.45)		4 (566.45)	
	Brake operating time	ms	50		50	
	Brake release time	ms	20		20	

(Note1) When load is applied at 1/3 length from output shaft edge.

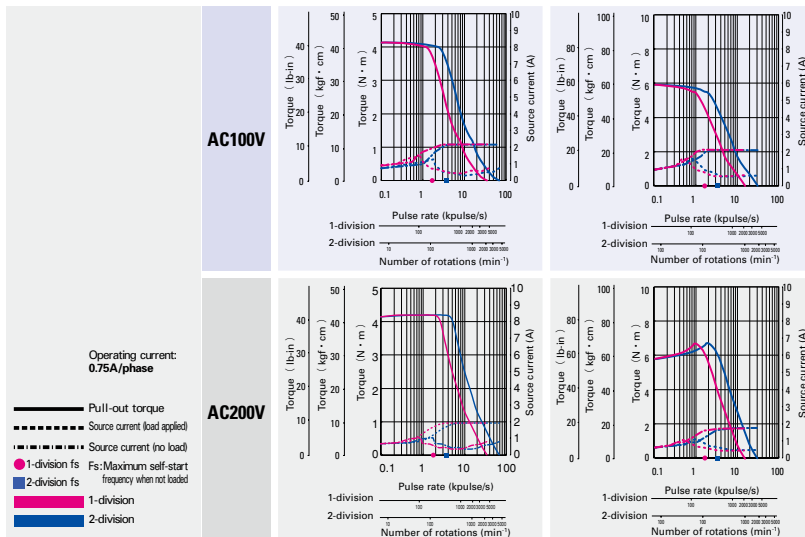

□ 42mm (□ 1.65inch)		□ 60mm (□ 2.36inch)				φ 86mm (φ 3.39inch)			
79.5mm (3.13inch)		85.8mm (3.38inch)		94.5mm (3.72inch)		126.7mm (4.99inch)		116.7mm (4.59inch)	
FSF554S-XB	PPF554S-XB	FSF781S-XB	PPF781S-XB	FSF782S-XB	PPF782S-XB	FSF783S-XB	PPF783S-XB	FSF851S-XB	PPF851S-XB
0.26 (36.82)		0.6 (85.0)		0.98 (138.8)		1.79 (253.5)		2.06 (291.7)	
0.08 (0.437)		0.43 (2.351)		0.56 (3.062)		1 (5.468)		2.24 (12.247)	
0.52 (1.14)		0.94 (2.07)		1.12 (2.46)		1.7 (3.74)		3.5 (7.7)	
10 (2.25)		20 (4.5)		20 (4.5)		20 (4.5)		60 (13.5)	
35 (8.75)		80 (18)		80 (18)		80 (18)		220 (49.5)	
No excitation actuating type		No excitation actuating type		No excitation actuating type		No excitation actuating type		No excitation actuating type	
DC24V ± 5%		DC24V ± 5%		DC24V ± 5%		DC24V ± 5%		DC24V ± 5%	
0.08		0.25		0.25		0.25		0.42	
2		6		6		6		10	
0.22 (31.15)		0.8 (113.29)		0.8 (113.29)		0.8 (113.29)		4 (566.45)	
30		30		30		30		50	
20		20		20		20		20	

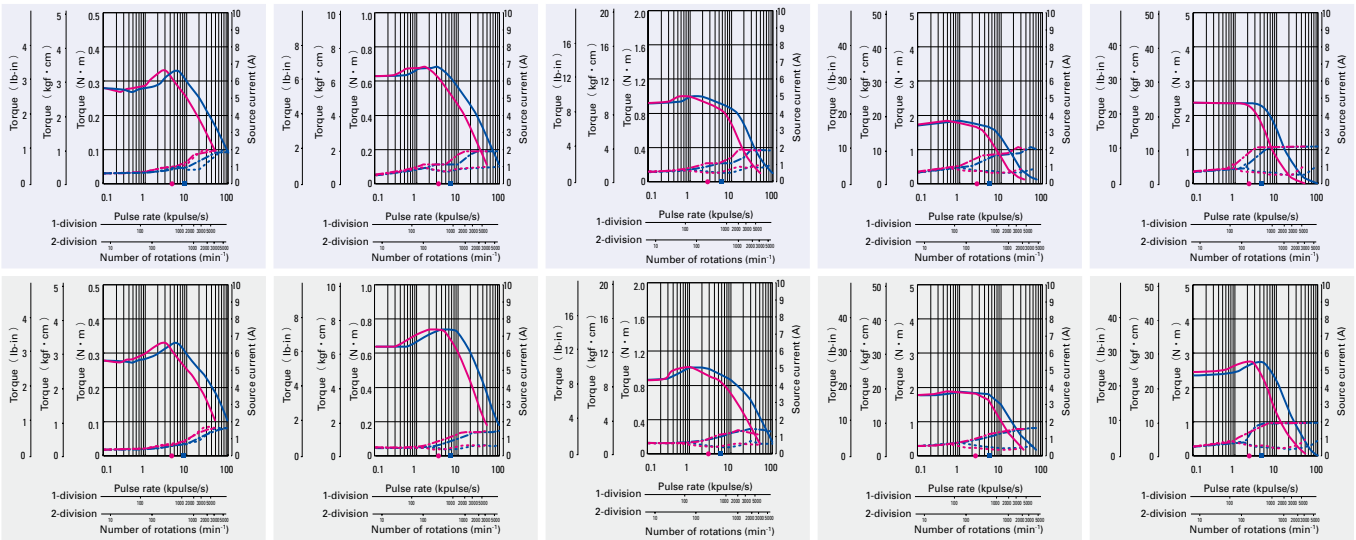

Common specifications

F series driver

Basic specifications	Type code	FS1W075S	
	Power supply	Single phase AC100V to 230V +10, -15% 50/60/Hz	
	Source current	4 A MAX.	
	Environment	Protection class	Class I
		Operation environment	Installation category (over-voltage category) : II , pollution degree: 2
		Applied standards	EN50178, UL508C
		Ambient operation temperature	0 to 50°C
		Storage temperature	-20 to +70°C
		Ambient operation humidity	35 to 85%RH (no condensation)
		Storage humidity	10 to 90%RH (no condensation)
		Operation altitude	1000 m (3280 feet) MAX. above sea level
		Vibration resistance	Tested under the following conditions ; 4.9m/s ² , frequency range 10 to 55Hz, direction along X, Y and Z axes, for 2 hours each
		Impact resistance	Not influenced at NDS-C-0110 standard section 3.2.2 division "C" .
	Withstand voltage	Not influenced when 1500V AC is applied between power input terminal and cabinet for one minute.	
Insulation resistance	10M ohm MIN. when measured with 500V DC megohmmeter between input terminal and cabinet.		
Mass (Weight)	0.8kg (1.77lbs)		
Functions	Protection functions	Driver overheating, main circuit power supply error, and over-current	
	LED indication	Power monitor, phase origin monitor, pulse monitor, alarm	
CN3	Input signal	Photo-coupler input system ; input resistance: 220 Ω ; input-signal "H" level : 4.0 to 5.5V ; input-signal "L" level : 0 to 0.5V	
	Output signal	From the photo coupler by the open collector output Output specification : V _{ceo} = 30V MAX., I _c = 5mA	

F series motor / M series motor

Stepping motor type	F series motor	M series motor
Motor Type	103F35 □□ /103F55 □□ /103F785 □ /103F858 □ /103F8958 □	103M55 □□ /103M785 □ /103M858 □ /103M8958 □
Type	—	S1 (continuous operation)
Insulation class	Class B (+130°C)	Class B (+130°C) [UL class A (+105°C)]
Operation altitude	1000m (3280 feet) MAX. above sea level	
Withstand voltage	□28mm (□1.10inch) : AC1000V 50/60Hz for 1 minute, □42mm (□1.65inch) , □60mm (□2.36inch) , °86mm (°3.39inch) , °106mm (°4.17inch) : AC1500V 50/60Hz for 1 minute	
Insulation resistance	100M ohm MIN. against DC500V	
Protection grade	IP40	
Vibration resistance	Amplitude of 1.52mm (0.06inch) (P-P) at frequency range 10 to 500Hz for 15 minutes sweep time along X, Y, and Z axes for 12 times.	
Impact resistance	490m/s ² of acceleration for 11 ms with half-sine wave applying three times for X, Y, and Z axes each, 18 times in total.	
Ambient operation temperature	-10 to +50°C (0 to +40°C for harmonic gear model)	
Ambient operation humidity	90% MAX. at less than 40°C, 57% MAX. at less than 50°C , 35% MAX. at 60°C (no condensation)	

External wiring diagram : FS type

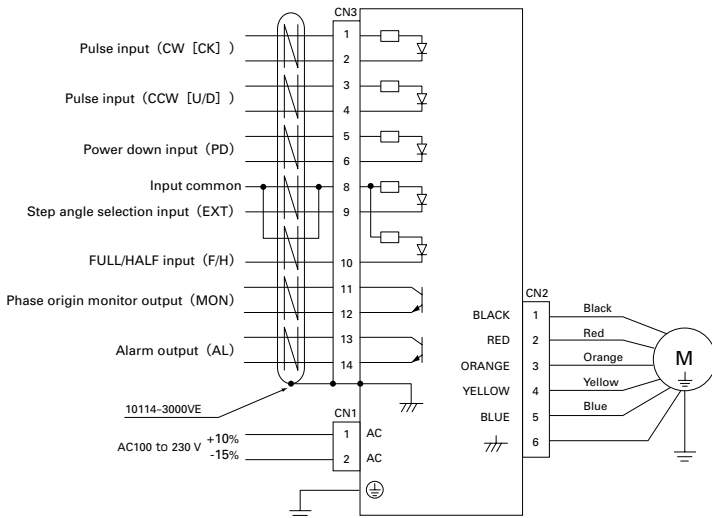

- * Marking : 1 red marking / pitch
 - ◎ Marking : 1 black marking / pitch
 - △ Marking : 2 red markings / pitch
 - ☆ Marking : 2 black markings / pitch
- * Marking size : width : 1mm,
space : 1mm,
pitch : 12mm

Specification summary of CN3 I/O signal

Signal name	CN3 Pin number	Function
CW pulse input (standard)	1	When using "2-input mode"
	2	Drive pulse for the CW direction rotation is input.
Pulse column input	1	When using "Pulse and direction mode"
	2	Drive pulse train for the stepping motor rotation is input.
CCW pulse input (standard)	3	When using "2-input mode"
	4	Drive pulse for the CCW direction rotation is input.
Rotation direction input	3	The rotation direction signal of stepping motor is input for the "Pulse and direction mode".
	4	Internal photocoupler ON...CW direction Internal photocoupler OFF...CCW direction
Power down input	5	Inputting the PD signal cuts OFF the current flowing through the stepping motor (turns OFF the power) . (The power down input can be changed to the power low function by selecting dipswitches.)
	6	PD input signal ON (internal photocoupler ON) ...PD function enabled PD input signal OFF (internal photocoupler OFF) ...PD function disabled
Step angle selection input	8	Inputting the EXT signal enables the FULL/HALF selection input.
	9	EXT input signal ON (internal photocoupler ON) ...External input signal F/H enabled EXT input signal OFF (internal photocoupler OFF) ...Main unit rotary switch S. S enabled
FULL/HALF selection input	8	When the EXT input signal is ON (internal photocoupler ON).
	10	F/H input signal ON (internal photocoupler ON) ...HALF step F/H input signal OFF (internal photocoupler OFF) ...FULL step
Phase origin monitor output	11	It is turned ON when the excitation phase is at the origin (in the state when the power is turned ON)
	12	It is turned ON once per 10 pulses when setting to HALF step. It is turned ON once per 20 pulses when setting to FULL step.
Alarm output	13	The signal is externally output when one of several alarm circuits operates in the PM driver. At this time, the stepping motor is in the unexcited state.
	14	

(Note) The CW rotation direction of stepping motor means the clockwise direction rotation as viewed from the output shaft side (flange side) . The CCW rotation direction means the counterclockwise direction rotation as viewed from the output shaft side (flange side) .

Driver part name

2-digit LED indication

	Indication	Description
Status	88	Internal power is established.
	88	Excitation phase is origin status at power on.
	88	Command pulse is under status at input.
Alarm	01	Over-current.
	02	Overheat.
	03	Low voltage power.
	04	Over-voltage power.
	05 08	Hardware fault



Display switch Alarm history of 10 previous alarms can be displayed on 2-digit LED.

- ① Step angle selection switch
- ② Current selection switch
- ③ 0-speed current adjustment switch
- ④ Function selection DIP switch

Motor interface connector

Power connector

Earth

⑤ **Input/output signal interface connector**

① Step angle selection switch

Basic step angle divisor (up to 250 divisions) .

Indication	0	1	2	3	4	5	6	7
Number of divisions	1	2	2.5	4	5	8	10	20
Indication	8	9	A	B	C	D	E	F
Number of divisions	25	40	50	80	100	125	200	250

Initial configuration of factory shipment is set to 1 (Half steps) .

② Operation current selection switch

Motor current during operation can be selected from 100 to 25%.

Indication	0	1	2	3	4	5	6	7
Motor current (%)	100 (Rated value)	95	90	85	80	75	70	65
Indication	8	9	A	B	C	D	E	F
Motor current (%)	60	55	50	45	40	35	30	25

Initial configuration of factory shipment is set to 0 (rated value) .

③ Current adjustment at operation halt switch

Motor current at 0-speed can be selected from 100 to 25%.

Indication	0	1	2	3	4	5	6	7
Motor current (%)	100 (Rated value)	95	90	85	80	75	70	65
Indication	8	9	A	B	C	D	E	F
Motor current (%)	60	55	50	45	40	35	30	25

Initial configuration of factory shipment is set to A (50% of rated value) .
Driver and motor should be operated at around 50% of rated value to reduce heat.

⑤ Input/output signal interface connector

Input signal connector is used for interface with upper level controller, etc. Driver side connector is 10214-52A2JL. (Sumitomo 3M)

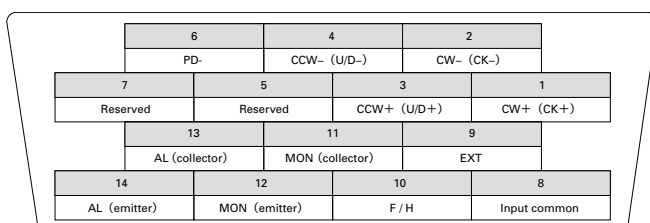

Terminal arrangement of CN3 connector

④ Function selection DIP switch

Selects an appropriate function for specification. Check that the ex-factory settings are as follows.

	OFF	ON
F/R	<input type="checkbox"/>	<input type="checkbox"/>
LV	<input type="checkbox"/>	<input type="checkbox"/>
PD	<input type="checkbox"/>	<input type="checkbox"/>
EORG	<input type="checkbox"/>	<input type="checkbox"/>

OFF Input method select
OFF Low-vibration mode select
OFF Power down select
OFF Excitation select

Input method select (F/R)

Selects input pulse type.

F/R	Input pulse type
ON	1 input (Pulse&direction)
OFF	2 input (CW, CCW)

Low-vibration mode select (LV)

Provides low-vibration, smooth operation even if resolution is rough (1-division, 2-division, etc)

LV	Operation
ON	Auto-micro function
OFF	Micro-step

Power down select (PD)

Selects current for power down signal input.

PD	Motor current
ON	Current by rotary switch STP (power low)
OFF	0A (power off)

Excitation select (EORG)

The excitation phase when the power supply is turned on is selected.

EORG	Original excitation phase
ON	Excitation phase at power shut off
OFF	Phase origin

By turning on the EORG, excitation phase when power OFF will be saved. Therefore, there will be no shaft displacement when turning the power ON.

Common specifications

F series driver

Basic specifications	Type code	FP1W075P		
	Power supply	Single phase AC100V to 230V +10, -15% 50/60/Hz		
	Source current	4 A MAX.		
	Environment	Protection class	Class I	
		Operation environment	Installation category (over-voltage category) : II , pollution degree: 2	
		Applied standards	EN50178, UL508C	
		Ambient operation temperature	0 to 50°C	
		Storage temperature	-20 to +70°C	
		Ambient operation humidity	35 to 85% RH (no condensation)	
		Storage humidity	10 to 90% RH (no condensation)	
		Operation altitude	1000m (3280feet) MAX. above sea level	
		Vibration resistance	Tested under the following conditions ; 4.9m/s ² , frequency range 10 to 55Hz, direction along X, Y and Z axes, for 2 hours each	
		Impact resistance	Not influenced at NDS-C-0110 standard section 3.2.2 division "C" .	
	Withstand voltage	Not influenced when 1500V AC is applied between power input terminal and cabinet for one minute.		
Insulation resistance	10M ohm MIN. when measured with 500V DC megohmmeter between input terminal and cabinet.			
Mass (Weight)	0.8kg (1.77lbs)			
Functions	Protection functions	Driver overheating, main circuit power supply error, and over-current		
	LED indication	Power monitor, phase origin monitor, pulse monitor, alarm		
CN3	Input signal	Photo-coupler input system ; input resistance: 220 Ω ; input-signal "H" level : 4.0 to 5.5V ; input-signal "L" level : 0 to 0.5V		
	Output signal	From the photo coupler by the open collector output	Output specification : Vceo = 30V MAX., Ic = 5mA	

F series motor / M series motor

Stepping motor type	F series motor	M series motor
Motor Type	103F35□□ / 103F55□□ / 103F785 □ / 103F858□ / 103F8958□	103M55□ / 103M785□ / 103M858□ / 103M8958 □
Type	—	S1 (continuous operation)
Insulation class	Class B (+130°C)	Class B (+130°C) [UL class A (+105°C)]
Operation altitude	1000m (3280 feet) MAX. above sea level	
Withstand voltage	□28mm (□1.10inch) : AC1000V 50/60Hz for 1 minute, □42mm (□1.65inch) , □60mm (□2.36inch) , □86mm (□3.39inch) , □106mm (□4.17inch) : AC1500V 50/60Hz for 1 minute	
Insulation resistance	100M ohm MIN. against DC500V	
Protection grade	IP40	
Vibration resistance	Amplitude of 1.52mm (0.06inch) (P-P) at frequency range 10 to 500Hz for 15 minutes sweep time along X, Y, and Z axes for 12 times.	
Impact resistance	490m/s ² of acceleration for 11 ms with half-sine wave applying three times for X, Y, and Z axes each, 18 times in total.	
Ambient operation temperature	-10 to +50°C (0 to +40°C for harmonic gear model)	
Ambient operation humidity	90% MAX. at less than 40°Cs, 57% MAX. at less than 50°C , 35% MAX. at 60°C (no condensation)	

The □ symbol in the motor model number indicates the length of the motor.

External wiring diagram : FP type

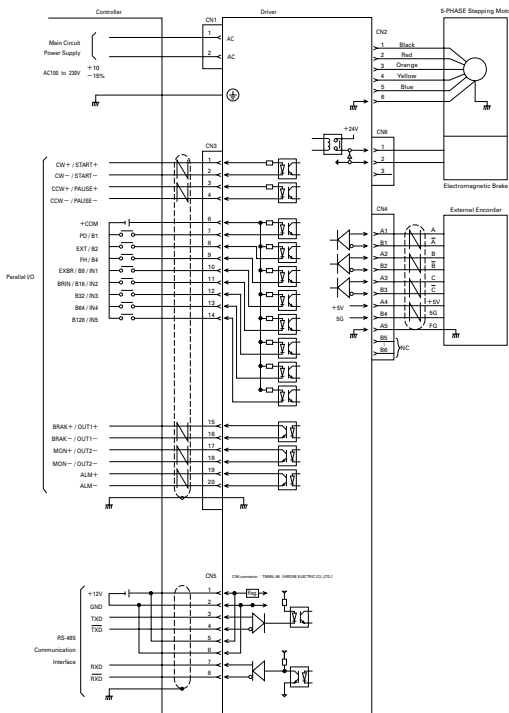

- * Marking : 1 red marking / pitch
- Marking : 1 black marking / pitch
- △ Marking : 2 red markings / pitch
- ☆ Marking : 2 black markings / pitch
- ※ Marking size : width : 1mm, space : 1mm, pitch : 12mm

Specification summary of CN3 I/O signal (Pulse train I/F mode)

Signal name	Pin number	Function
CW pulse input (standard)	1	When using "2-input mode" Drive pulse for the CW direction rotation is input.
Pulse column input	2	Drive pulse train for the stepping motor rotation is input.
CCW pulse input (standard)	3	When using "2-input mode" Drive pulse for the CCW direction rotation is input.
Rotation direction input	4	The rotation direction signal of stepping motor is input for the "Pulse and direction mode". Internal photocoupler ON...CW direction Internal photocoupler OFF...CCW direction
General-purpose input common	6	Input signal common of the 7 to 14 pins DC5V to DC24V is input.
Power down input	7	Inputting the PD signal cuts OFF the current flowing through the stepping motor (turns OFF the power). (The power down input can be changed to the power low function by selecting dipswitches.) PD input signal ON (internal photocoupler ON) ...PD function enabled PD input signal OFF (internal photocoupler OFF) ...PD function disabled
Step angle selection input	8	Inputting the EXT signal enables the FULL/HALF selection input. EXT input signal ON (internal photocoupler ON) ...HALF step EXT input signal OFF (internal photocoupler OFF) ...Main unit rotary switch S. S enabled
FULL/HALF selection input	9	When the EXT input signal is ON (internal photocoupler ON) . F/H input signal ON (internal photocoupler ON) ...HALF step F/H input signal OFF (internal photocoupler OFF) ...FULL step
Brake control select input	10	Brake retention/release timing can be controlled by the BRIN signal by inputting the EXBR signal. EXBR input signal ON (internal photo coupler ON) ...External input signal BRIN effective EXBR input signal OFF (internal photo coupler OFF) ...The driver controls the brake automatically
Brake control input	11	When the EXBR input signal on (internal photo coupler on) BRIN input signal ON (internal photo coupler on) ...Brake release BRIN input signal OFF (internal photo coupler off) ...Brake retention
Brake status output	15, 16	When the brake is released it turns ON, when the brake is retained it turns OFF.
Phase origin monitor output	17, 18	It is turned ON when the excitation phase is at the origin (in the state when the power is turned ON) It is turned ON once per 10 pulses when setting to HALF step. It is turned ON once per 20 pulses when setting to FULL step.
Alarm output	19, 20	The signal is externally output when one of several alarm circuits operates in the PM driver. At this time, the stepping motor is in the unexcited state.

(Note) The CW rotation direction of stepping motor means the clockwise direction rotation as viewed from the output shaft side (flange side) . The CCW rotation direction means the counterclockwise direction rotation as viewed from the output shaft side (flange side) .

Driver part name

2-digit LED indication

	Indication	Description
Status	88	Internal power is established.
	88	Excitation phase is origin status at power on.
	88	Command pulse is under status at input.
Alarm	01	Over-current.
	02	Overheat.
	03	Low voltage power.
	04	Over-voltage power.
	05 08	Hardware fault



Display switch Alarm history of 10 previous alarms can be displayed on 2-digit LED.

- ① Step angle selection switch
- ② Current selection switch
- ③ 0-speed current adjustment switch
- ④ Function selection DIP switch

Serial (RS-485)

Encoder

- ⑤ Input/output signal interface connector

Brake connector

Motor interface connector

Power connector

Earth

① Step angle selection switch

Basic step angle divisor (up to 250 divisions).

Indication	0	1	2	3	4	5	6	7
Number of divisions	1	2	2.5	4	5	8	10	20
Indication	8	9	A	B	C	D	E	F
Number of divisions	25	40	50	80	100	125	200	250

Initial configuration of factory shipment is set to 1 (Half steps)

② Operation current selection switch

Motor current during operation can be selected from 100 to 25%.

Indication	0	1	2	3	4	5	6	7
Motor current (%)	100 (Rated value)	95	90	85	80	75	70	65
Indication	8	9	A	B	C	D	E	F
Motor current (%)	60	55	50	45	40	35	30	25

Initial configuration of factory shipment is set to 0 (rated value).

③ Current adjustment at operation halt switch

Motor current at 0-speed can be selected from 100 to 25%.

Indication	0	1	2	3	4	5	6	7
Motor current (%)	100 (Rated value)	95	90	85	80	75	70	65
Indication	8	9	A	B	C	D	E	F
Motor current (%)	60	55	50	45	40	35	30	25

Initial configuration of factory shipment is set to A (50% of rated value).

Driver and motor should be operated at around 50% of rated value to reduce heat.

⑤ Input/output signal interface connector

Input signal connector is used for interface with upper level controller, etc. Driver side connector is 10214-52A2JL. (Sumitomo 3M)

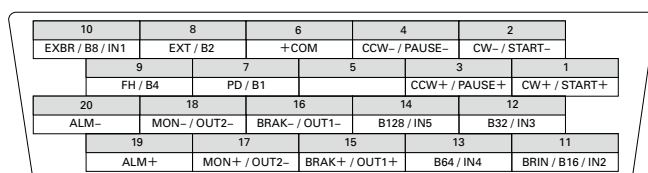

Terminal arrangement of CN3 connector

④ Function selection DIP switch

Selects an appropriate function for specification. Check that the ex-factory settings are as follows.

	OFF	ON	
F/R	<input type="checkbox"/>	<input type="checkbox"/>	OFF Input method select
LV	<input type="checkbox"/>	<input type="checkbox"/>	OFF Low-vibration mode select
PD	<input type="checkbox"/>	<input type="checkbox"/>	OFF Power down select
EORG	<input type="checkbox"/>	<input type="checkbox"/>	OFF Excitation select
I.SEL	<input type="checkbox"/>	<input type="checkbox"/>	OFF
S.SEL	<input type="checkbox"/>	<input type="checkbox"/>	OFF

Input method select (F/R)

Selects input pulse type.

F/R	Input pulse type
ON	1 input (Pulse&direction)
OFF	2 input (CW, CCW)

Low-vibration mode select (LV)

Provides low-vibration, smooth operation even if resolution is rough (1-division, 2-division, etc)

LV	Operation
ON	Auto-micro function
OFF	Micro-step

Power down select (PD)

Selects current for power down signal input.

PD	Motor current
ON	Current by rotary switch STP (power low)
OFF	0A (power off)

Excitation select (EORG)

The excitation phase when the power supply is turned on is selected.

EORG	Original excitation phase
ON	Excitation phase at power shut off
OFF	Phase origin

By turning on the EORG, excitation phase when power OFF will be saved. Therefore, there will be no shaft displacement when turning the power ON.

(I.SEL)

The operation mode is selected.

I.SEL	
ON	Selects S.SEL-setting operation mode
OFF	Pulse-train I/F mode

(S.SEL)

The operation mode is selected.

S.SEL	
ON	Serial I/F mode
OFF	Parallel I/F mode

(Note) Function descriptions for switches 1 to 4 apply to pulse-train I/F mode. See the user's manual for settings in serial-I/F and parallel-I/F modes.

Input circuit configuration of CW (CK), CCW (U/D)

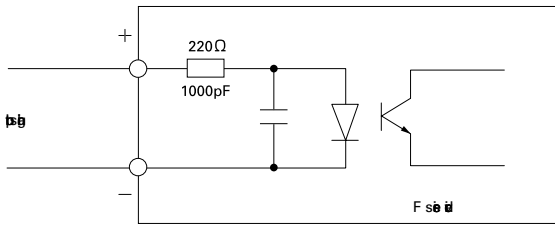

- Pulse duty 50% MAX.
- Maximum input frequency: 250kpulse/s
- When the crest value of the input signal exceeds 5V, use the external limit resistance R to limit the input current to approximately 15mA.

Input signal specification

(Photo coupler)

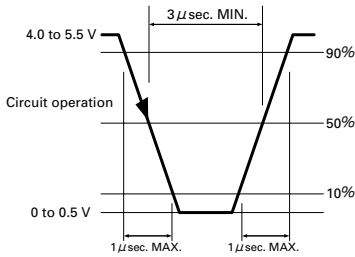

Timing of command pulse

2 input type (CW, CCW)

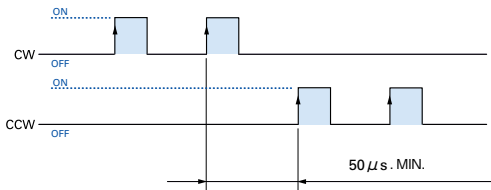

- Shaded area indicates internal photo coupler "ON". Internal circuit (motor) starts operating at leading edge of the photo coupler "ON".
- To apply pulse to CW, set CCW side internal photo coupler to "OFF".
- To apply pulse to CCW, set CW side internal photo coupler to "OFF".

1 input type (CW, CCW)

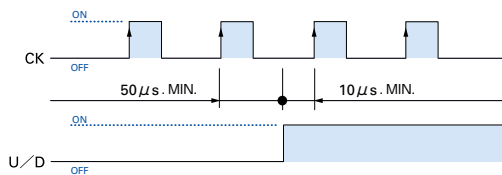

- Shaded area indicates internal photo coupler "ON". Internal circuit (motor) starts operating at leading edge of CK side photo coupler "ON".
- Switching of U/D input signal must be done while CK side internal photo coupler is "OFF".

Input circuit configuration of PD, EXT, F/H

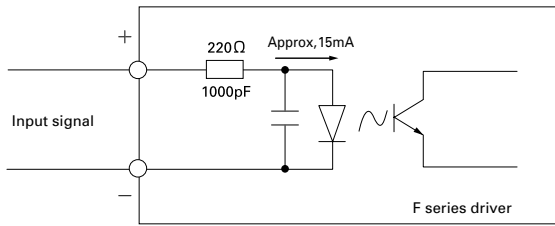

• If the peak value exceeds 5V, set the input current to approx. 15mA using the external limit resistance R.

AC input

Output signal configuration of MON, AL

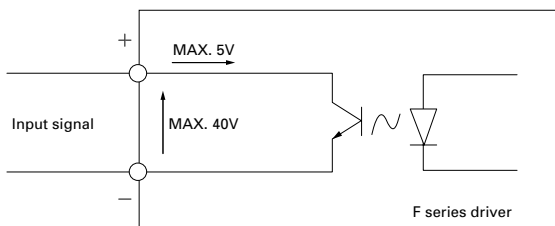

MON output

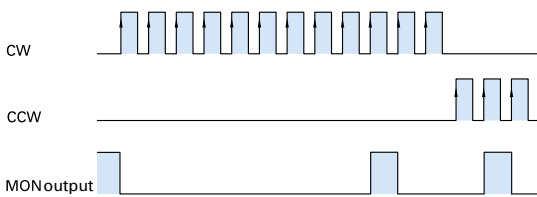

- Photo coupler at phase origin of motor excitation (status at power on) is set to "ON" (setting when number of divisions is 1).
- Output from MON is set to on at every 7.2 degrees of motor output shaft from phase origin.

Input / Output signal standard

DC input

Internal wire connection and direction of motor rotate

Internal wire connection

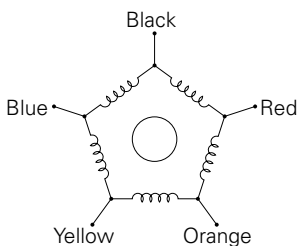

Direction of motor rotate

The direction of motor rotate is counterclockwise when viewed from the output shaft side at the direct current energization in the following order.

Type	Exciting order									
	1	2	3	4	5	6	7	8	9	10
Color of leads	Black	-	-	-	-	+	+	+	+	-
	Red	+	+	+	+	-	-	-	-	-
	Orange	-	-	-	-	+	+	+	+	+
	Yellow	+	+	+	+	-	-	-	-	-
Blue	-	-	-	-	+	+	+	+	+	+

Stepping motor

Dimensions

Flange side

Spur gear model

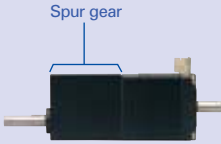

Motor flange size
□28 (□1.10inch)

Low-backlash gear model

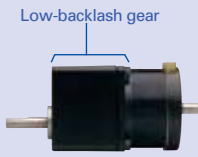

Motor flange size
□42mm (□1.65inch) / □60mm (□2.35inch) / ∅86mm (∅3.39inch)

Harmonic gear model



Motor flange size
□28mm (□1.10inch) / □42mm (□1.65inch) / □60mm (□2.35inch) / ∅86mm (∅3.39inch)



Standard model : F series motor
□28mm (□1.10inch) / □42mm (□1.65inch) / □60mm (□2.35inch) / ∅86mm (∅3.39inch)

End cap side

Damper



Magnetic dampers can be selected according to required inertia.

Electromagnetic brake model

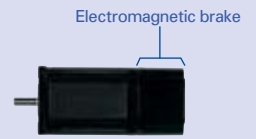

Motor flange size
□42mm (□1.65inch) / □60mm (□2.35inch) / ∅86mm (∅3.39inch)

Brake power source (DC24V)

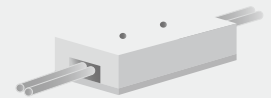

Required for brake-equipped stepping motor models.

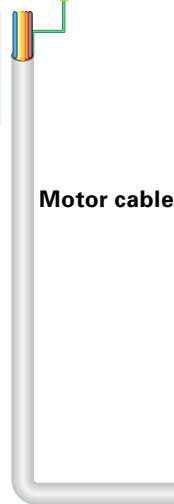

Single phase
AC100V
to
AC230V

(t)
(r)

Molded case circuit breaker



Protects the power line. Cuts off circuit in the event of overcurrent.

Electromagnetic contactor



Switches driver power on/off. Use together with a surge protector.

Noise filter



Filters out incoming noise from power line.

Switching power supply



Converts AC power to DC power.

DC24V/
DC36V

Host Devices

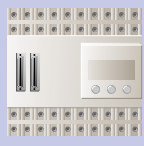

PLC

PLC and controllers are available as the host device.



To motor

I/O signal cable

To DC power source

I/O signal connector

Part number convention

The following part number specifies a system with an F series driver (type code : FS1D140P) and a single shaft F series motor (type code : 103F7851-8421) , □ 60mm (□ 2.36inch) square flange, and 46.5mm (1.83inch) motor length, equipped with low-backlash gear (reduction ratio of 1/3.6).

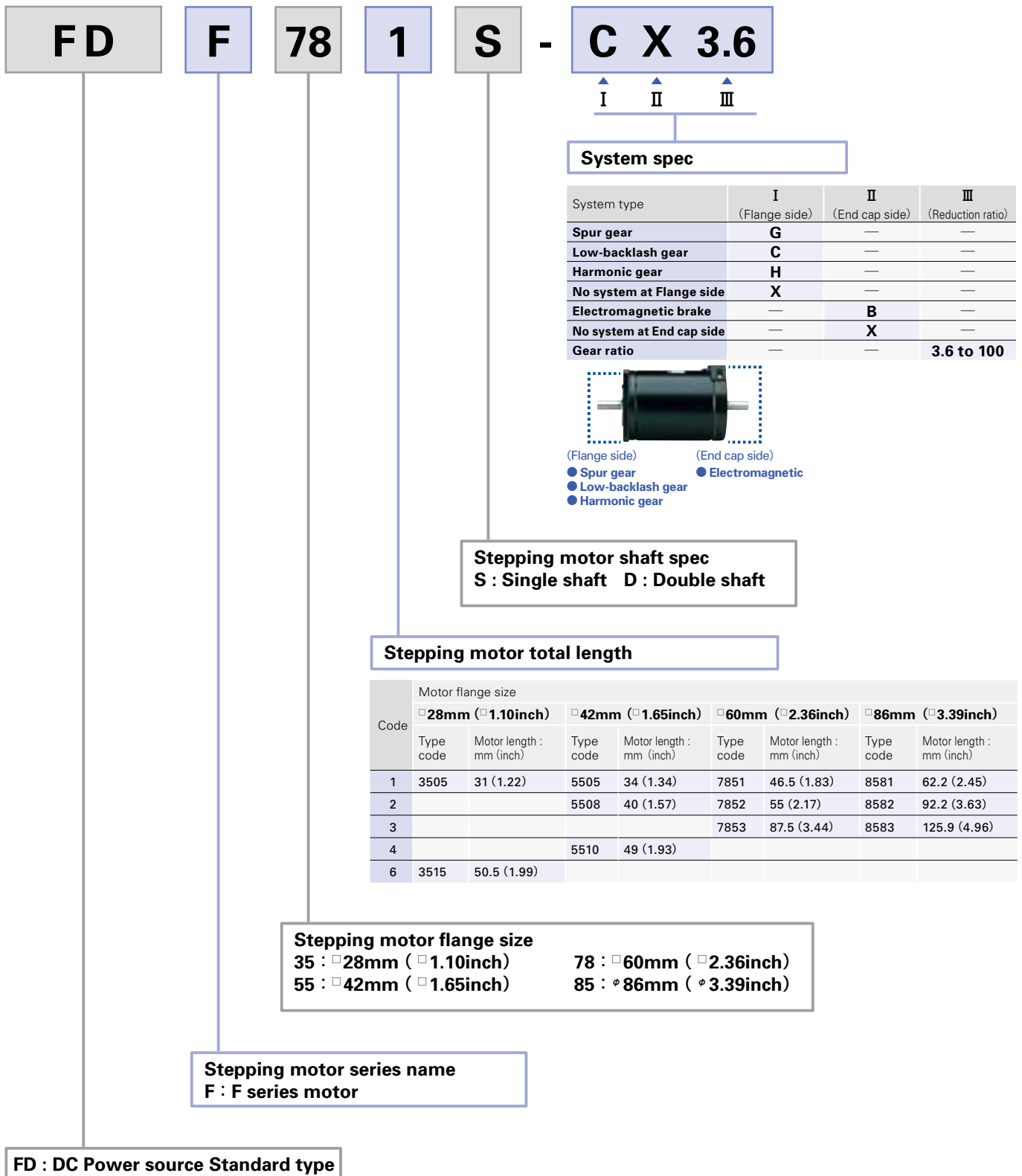

Combination list of 5-phase driver

Combination	Motor flange size	Set part number		Motor model number		Rated current	
		Single shaft	Double shaft	Single shaft	Double shaft		
Standard model	□ 28mm (□ 1.10inch)	FDf351S	FDf351D	103F3505-7441	103F3505-7411	0.75A	
		FDf356S	FDf356D	103F3515-7441	103F3515-7411	0.75A	
	□ 42mm (□ 1.65inch)	FDf551S	FDf551D	103F5505-8241	103F5505-8211	1.4A	
		FDf552S	FDf552D	103F5508-8241	103F5508-8211	1.4A	
	□ 60mm (□ 2.36inch)	FDf554S	FDf554D	103F5510-8241	103F5510-8211	1.4A	
		FDf781S	FDf781D	103F7851-8241	103F7851-8211	1.4A	
	φ 86mm (φ 3.39inch)	FDf782S	FDf782D	103F7852-8241	103F7852-8211	1.4A	
		FDf783S	FDf783D	103F7853-8241	103F7853-8211	1.4A	
	φ 86mm (φ 3.39inch)	FDf851S	FDf851D	103F8581-8241	103F8581-8211	1.4A	
		FDf852S	FDf852D	103F8582-8241	103F8582-8211	1.4A	
	Low-backlash gear model	□ 42mm (□ 1.65inch)	FDf551S-CX3.6	FDf551D-CX3.6	103F5505-82CXA4	103F5505-82CXA1	1.4A
			FDf551S-CX7.2	FDf551D-CX7.2	103F5505-82CXB4	103F5505-82CXB1	1.4A
FDf551S-CX10			FDf551D-CX10	103F5505-82CXE4	103F5505-82CXE1	1.4A	
FDf551S-CX20			FDf551D-CX20	103F5505-82CXG4	103F5505-82CXG1	1.4A	
FDf551S-CX30			FDf551D-CX30	103F5505-82CXJ4	103F5505-82CXJ1	1.4A	
FDf551S-CX36			FDf551D-CX36	103F5505-82CXX4	103F5505-82CXX1	1.4A	
□ 60mm (□ 2.36inch)		FDf781S-CX3.6	FDf781D-CX3.6	103F7851-82CXA4	103F7851-82CXA1	1.4A	
		FDf781S-CX7.2	FDf781D-CX7.2	103F7851-82CXB4	103F7851-82CXB1	1.4A	
		FDf781S-CX10	FDf781D-CX10	103F7851-82CXE4	103F7851-82CXE1	1.4A	
		FDf781S-CX20	FDf781D-CX20	103F7851-82CXG4	103F7851-82CXG1	1.4A	
		FDf781S-CX30	FDf781D-CX30	103F7851-82CXJ4	103F7851-82CXJ1	1.4A	
		FDf781S-CX36	FDf781D-CX36	103F7851-82CXX4	103F7851-82CXX1	1.4A	
φ 86mm (φ 3.39inch)		FDf851S-CX3.6	FDf851D-CX3.6	103F8581-82CXA4	103F8581-82CXA1	1.4A	
		FDf851S-CX7.2	FDf851D-CX7.2	103F8581-82CXB4	103F8581-82CXB1	1.4A	
		FDf851S-CX10	FDf851D-CX10	103F8581-82CXE4	103F8581-82CXE1	1.4A	
		FDf851S-CX20	FDf851D-CX20	103F8581-82CXG4	103F8581-82CXG1	1.4A	
		FDf851S-CX30	FDf851D-CX30	103F8581-82CXJ4	103F8581-82CXJ1	1.4A	
		FDf851S-CX36	FDf851D-CX36	103F8581-82CXX4	103F8581-82CXX1	1.4A	
Spur gear model		□ 28mm (□ 1.10inch)	FDf351S-GX3.6	FDf351D-GX3.6	103F3505-74GXA4	103F3505-74GXA1	0.75A
			FDf351S-GX7.2	FDf351D-GX7.2	103F3505-74GXB4	103F3505-74GXB1	0.75A
			FDf351S-GX10	FDf351D-GX10	103F3505-74GXE4	103F3505-74GXE1	0.75A
			FDf351S-GX20	FDf351D-GX20	103F3505-74GXG4	103F3505-74GXG1	0.75A
			FDf351S-GX30	FDf351D-GX30	103F3505-74GXJ4	103F3505-74GXJ1	0.75A
			FDf351S-GX50	FDf351D-GX50	103F3505-74GXL4	103F3505-74GXL1	0.75A
Harmonic gear model	□ 28mm (□ 1.10inch)	FDf351S-HX50	FDf351D-HX50	103F3505-74HXL4	103F3505-74HXL1	0.75A	
		FDf351S-HX100	FDf351D-HX100	103F3505-74HXM4	103F3505-74HXM1	0.75A	
	□ 42mm (□ 1.65inch)	FDf5515S-HX30	FDf551D-HX30	103F5505-82HXJ5	103F5505-82HXJ2	1.4A	
		FDf5515S-HX50	FDf551D-HX50	103F5505-82HXL5	103F5505-82HXL2	1.4A	
	□ 60mm (□ 2.36inch)	FDf5515S-HX100	FDf551D-HX100	103F5505-82HXM5	103F5505-82HXM2	1.4A	
		FDf781S-HX50	FDf781D-HX50	103F7851-82HXL4	103F7851-82HXL1	1.4A	
	φ 86mm (φ 3.39inch)	FDf781S-HX100	FDf781D-HX100	103F7851-82HXM4	103F7851-82HXM1	1.4A	
		FDf851S-HX50	FDf851D-HX50	103F8581-82HXL4	103F8581-82HXL1	1.4A	
φ 86mm (φ 3.39inch)	FDf851S-HX100	FDf851D-HX100	103F8581-82HXM4	103F8581-82HXM1	1.4A		
	FDf551S-XB	—	103F5505-82XB41	—	1.4A		
Electromagnetic brake model	□ 42mm (□ 1.65inch)	FDf552S-XB	—	103F5508-82XB41	—	1.4A	
		FDf554S-XB	—	103F5510-82XB41	—	1.4A	
		FDf781S-XB	—	103F7851-82XB41	—	1.4A	
	□ 60mm (□ 2.36inch)	FDf782S-XB	—	103F7852-82XB41	—	1.4A	
		FDf783S-XB	—	103F7853-82XB41	—	1.4A	
	φ 86mm (φ 3.39inch)	FDf851S-XB	—	103F8581-82XB41	—	1.4A	
		FDf852S-XB	—	103F8582-82XB41	—	1.4A	

AC input

Input / Output signal standard

DC input

Stepping motor

Dimensions

Standard model

F series driver + F series motor

Motor flange size



Size	Motor flange size	□ 28mm (□ 1.10inch)	
		31mm (1.22inch)	50.5mm (1.99inch)
Set part number	Single shaft	FD351S	FD356S
	Double shaft	FD351D	FD356D
Holding torque	N·m(oz·in)	0.036 (5.10)	0.065 (9.20)
Rotor inertia	$\times 10^{-4}$ kg·m ² (oz·in ²)	0.009 (0.05)	0.016 (0.09)
Mass (Weight)	kg (lbs)	0.11 (0.22)	0.2 (0.44)
Allowable thrust load	N (lbs)	3 (0.68)	3 (0.68)
Allowable radial load ^(Note 1)	N (lbs)	34 (7.65)	34 (7.65)

(Note1) When load is applied at 1/3 length from output shaft edge.



DC24V

DC36V

Operating current:
0.75A/phase

- Pull-out torque
- - - Source current (load applied)
- - - Source current (no load)
- 1-division fs
- 2-division fs
- Fs: Maximum self-start frequency when not loaded
- 1-division
- 2-division

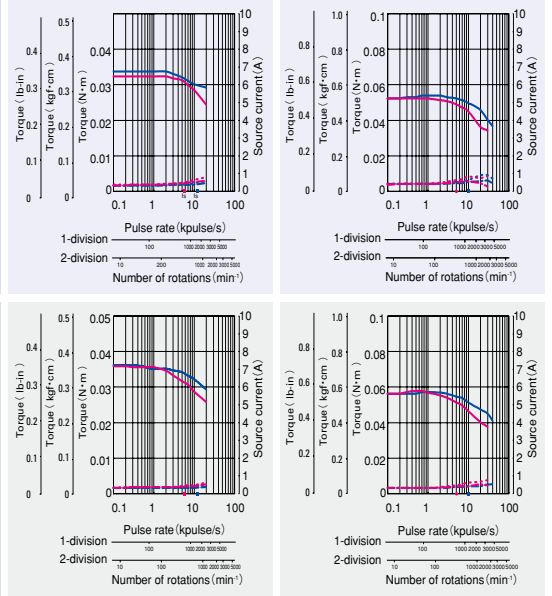

The data are measured under the drive condition of our company. The drive torque may vary depending on the accuracy of customer-side equipment.

Size	Motor flange size	□ 60mm (□ 2.36inch)		
		46.5mm (1.83inch)	55mm (2.17inch)	55mm (2.17inch)
Set part number	Single shaft	FD781S	FD782S	FD783S
	Double shaft	FD781D	FD782D	FD783D
Holding torque	N·m(oz·in)	0.6 (85.0)	0.98 (38.8)	1.79 (253.5)
Rotor inertia	$\times 10^{-4}$ kg·m ² (oz·in ²)	0.275 (1.50)	0.4 (2.19)	0.84 (4.59)
Mass (Weight)	kg (lbs)	0.6 (1.32)	0.78 (1.72)	1.36 (3.0)
Allowable thrust load	N (lbs)	20 (4.5)	20 (4.5)	20 (4.5)
Allowable radial load ^(Note 1)	N (lbs)	80 (18)	80 (18)	80 (18)

(Note1) When load is applied at 1/3 length from output shaft edge.

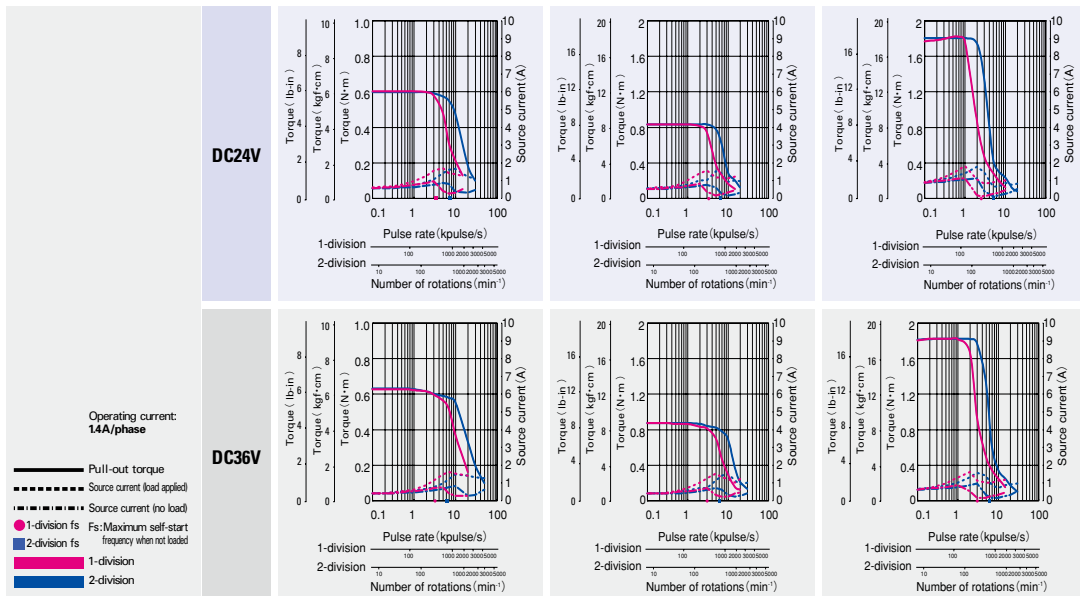

The data are measured under the drive condition of our company. The drive torque may vary depending on the accuracy of customer-side equipment.

Size	Motor flange size	□ 42mm (□ 1.65inch)		
	Motor length	34mm (1.34inch)	40mm (1.57inch)	49mm (1.93inch)
Set part number	Single shaft	FD551S	FD552S	FD554S
	Double shaft	FD551D	FD552D	FD554D
Holding torque	N·m(oz·in)	0.13 (18.41)	0.18 (25.49)	0.26 (36.82)
Rotor inertia	$\times 10^{-4}$ kg·m ² (oz·in ²)	0.03 (0.16)	0.053 (0.29)	0.065 (0.36)
Mass (Weight)	kg (lbs)	0.23 (0.50)	0.28 (0.62)	0.37 (0.81)
Allowable thrust load	N (lbs)	10 (2.25)	10 (2.25)	10 (2.25)
Allowable radial load ^(Note 1)	N (lbs)	35 (8.75)	35 (8.75)	35 (8.75)

(Note1) When load is applied at 1/3 length from output shaft edge.

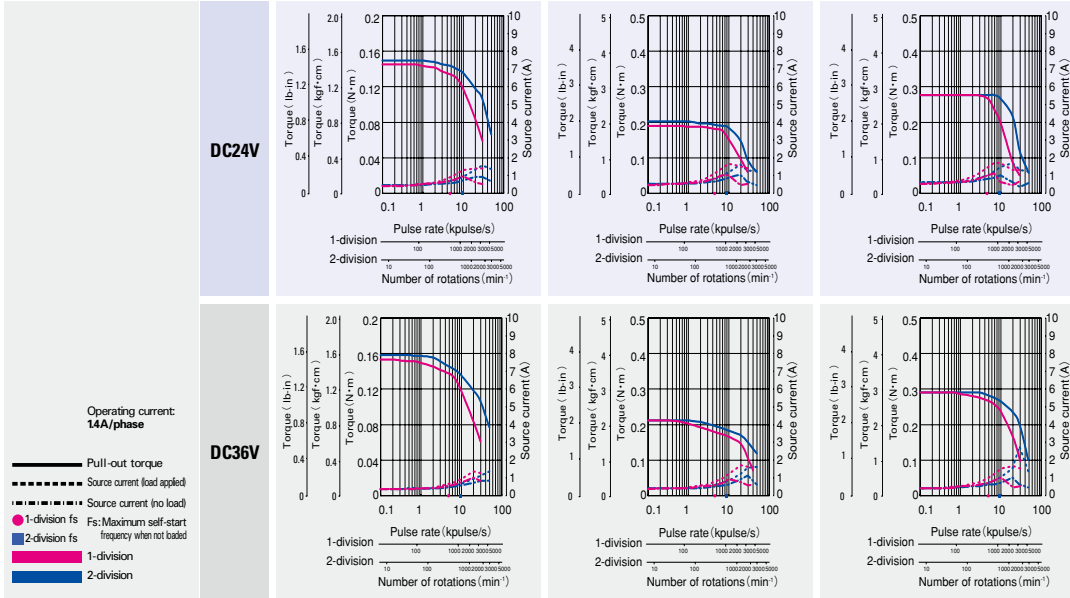

The data are measured under the drive condition of our company. The drive torque may vary depending on the accuracy of customer-side equipment.

Size	Motor flange size	φ 86mm (φ 3.39inch)	
	Motor length	62.15mm (2.47inch)	92.2mm (3.63inch)
Set part number	Single shaft	FD851S	FD852S
	Double shaft	FD851D	FD852D
Holding torque	N·m(oz·in)	2.06 (291.7)	4.02 (569.3)
Rotor inertia	$\times 10^{-4}$ kg·m ² (oz·in ²)	1.45 (7.93)	2.9 (15.86)
Mass (Weight)	kg (lbs)	1.5 (3.3)	2.5 (5.5)
Allowable thrust load	N (lbs)	60 (13.5)	60 (13.5)
Allowable radial load ^(Note 1)	N (lbs)	220 (49.5)	220 (49.5)

(Note1) When load is applied at 1/3 length from output shaft edge.

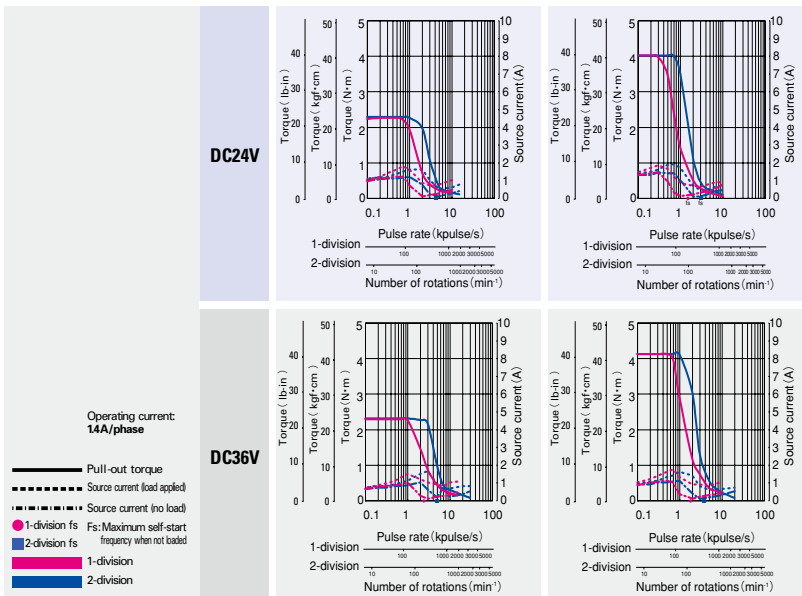

The data are measured under the drive condition of our company. The drive torque may vary depending on the accuracy of customer-side equipment.

Low-backlash gear model

F series driver +
F series motor with low-backlash gear

Motor flange size



Size	Motor flange size	□ 42mm (□ 1.65inch)	
	Motor + gear length	64.5mm (2.54inch)	64.5mm (2.54inch)
Set part number	Single shaft	FD551S-CX3.6	FD551S-CX7.2
	Double shaft	FD551D-CX3.6	FD551D-CX7.2
Allowable torque	N·m(oz·in)	0.35 (44.6)	0.7 (99.1)
Rotor inertia	×10 ⁻⁴ kg·m ² (oz·in ²)	0.03 (0.16)	0.03 (0.16)
Basic step angle		0.2	0.1
Gear ratio		1 : 3.6	1 : 7.2
Backlash	DEG	0.6	0.4
Allowable speed	min ⁻¹	500	250
Mass (Weight)	kg (lbs)	0.36 (0.79)	0.36 (0.79)
Allowable thrust load	N (lbs)	15 (3.38)	15 (3.38)
Allowable radial load ^(Note 1)	N (lbs)	20 (4.5)	20 (4.5)

Directions of motor rotation and gear output shaft are the same for models with reduction ratio 1 : 3.6, 1 : 7.2 and 1 : 10 opposite for reduction ratio 1 : 20, 1 : 30, and 1 : 36.

(Note1) When load is applied at 1/3 length from output shaft edge.

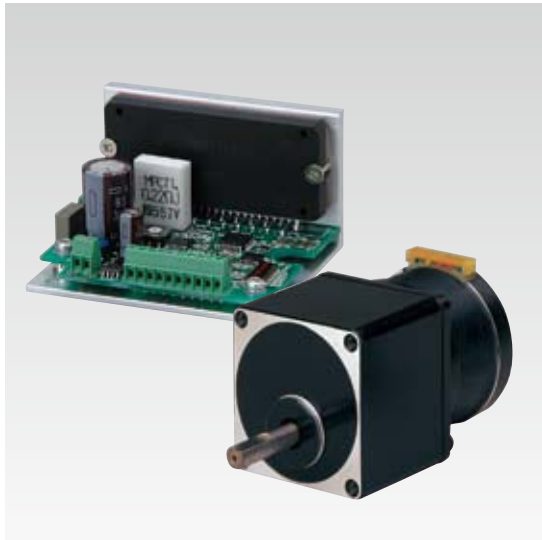

DC24V

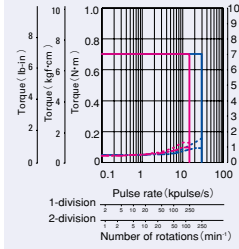
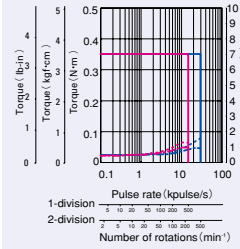

DC36V

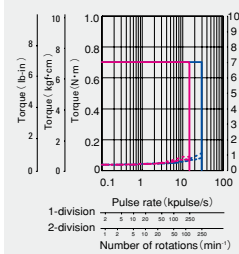
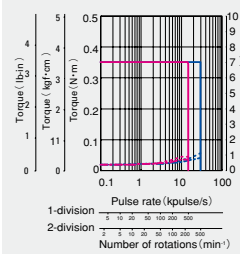

Operating current:
14A/phase

— Allowable torque
- - - Source current (load applied)
- · - · - Source current (no load)

■ 1-division
■ 2-division

The data are measured under the drive condition of our company. The drive torque may very depending on the accuracy of customer-side equipment.

Size	Motor flange size	□ 60mm (□ 2.36inch)			
	Motor + gear length	92mm (3.62inch)	92mm (3.62inch)	92mm (3.62inch)	92mm (3.62inch)
Set part number	Single shaft	FD781S-CX7.2	FD781S-CX10	FD781S-CX20	FD781S-CX30
	Double shaft	FD781D-CX7.2	FD781D-CX10	FD781D-CX20	FD781D-CX30
Allowable torque	N·m(oz·in)	2.5 (354.0)	3 (424.8)	3.5 (495.6)	4 (566.4)
Rotor inertia	×10 ⁻⁴ kg·m ² (oz·in ²)	0.275 (1.5)	0.275 (1.5)	0.275 (1.5)	0.275 (1.5)
Basic step angle		0.1	0.072	0.036	0.024
Gear ratio		1 : 7.2	1 : 10	1 : 20	1 : 30
Backlash	DEG	0.25	0.25	0.17	0.30
Allowable speed	min ⁻¹	250	180	90	60
Mass (Weight)	kg (lbs)	0.97 (2.13)	0.97 (2.13)	0.97 (2.13)	0.97 (2.13)
Allowable thrust load	N (lbs)	30 (6.75)	30 (6.75)	30 (6.75)	30 (6.75)
Allowable radial load ^(Note 1)	N (lbs)	100 (22.5)	100 (22.5)	100 (22.5)	100 (22.5)

Directions of motor rotation and gear output shaft are the same for models with reduction ratio 1 : 3.6 and 1:7.2, opposite for reduction ratio 1 : 10, 1 : 20 and 1 : 30. (Note1) When load is applied at 1/3 length from output shaft edge.

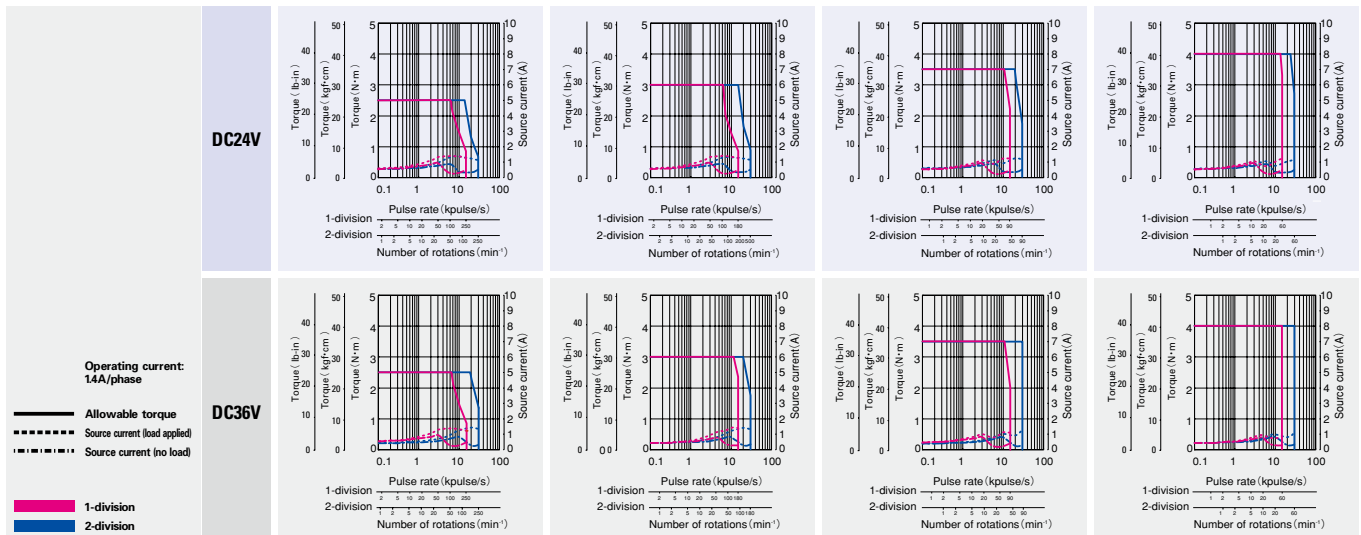

The data are measured under the drive condition of our company. The drive torque may very depending on the accuracy of customer-side equipment.

□ 42mm (□ 1.65inch)

□ 60mm (□ 2.36inch)

64.5mm (2.54inch)	64.5mm (2.54inch)	64.5mm (2.54inch)	64.5mm (2.54inch)	92mm (3.62inch)
DFD551S-CX10	DFD551S-CX20	DFD551S-CX30	DFD551S-CX36	DFD781S-CX3.6
DFD551D-CX10	DFD551D-CX20	DFD551D-CX30	DFD551D-CX36	DFD781D-CX3.6
1 (141.6)	1.5 (212.4)	1.5 (212.4)	1.5 (212.4)	1.25 (177.0)
0.03 (0.16)	0.03 (0.16)	0.03 (0.16)	0.03 (1.5)	0.275
0.072	0.036	0.024	0.02	0.2
1 : 10	1 : 20	1 : 30	1 : 36	1 : 3.6
0.35	0.25	0.25	0.25	0.55
180	90	60	50	500
0.36 (0.79)	0.36 (0.79)	0.36 (0.79)	0.36 (0.79)	0.97 (2.13)
15 (3.38)	15 (3.38)	15 (3.38)	15 (3.38)	30 (6.75)
20 (4.5)	20 (4.5)	20 (4.5)	20 (4.5)	100 (22.5)

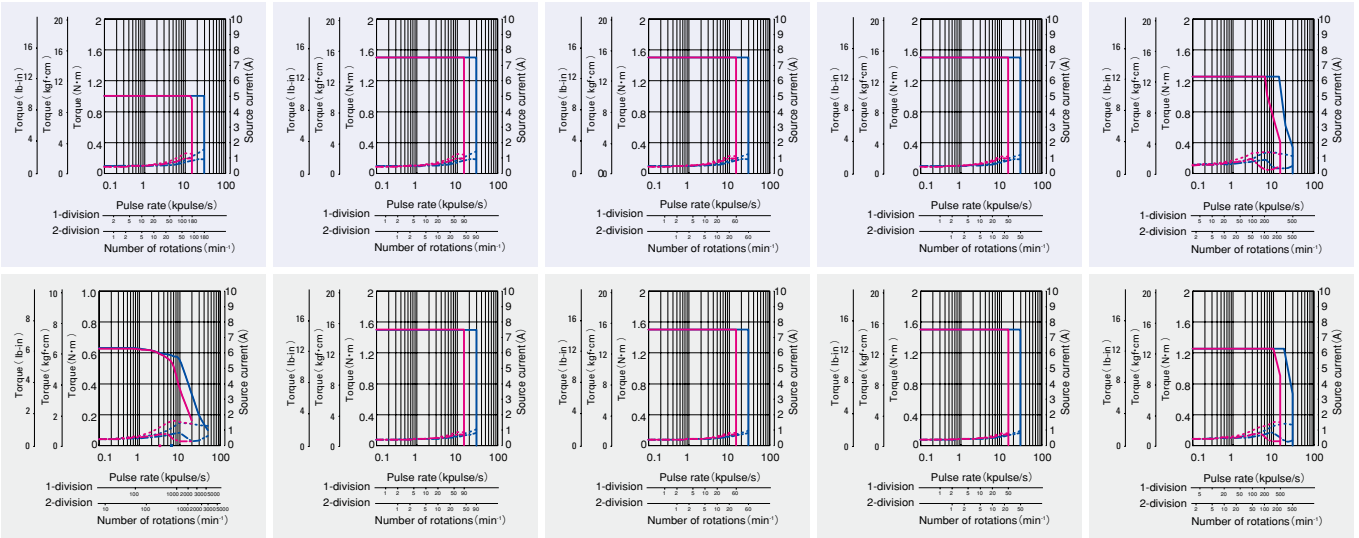

□ 60mm (□ 2.36inch)

φ 86mm (φ 3.39inch)

92mm (3.62inch)	127.3mm (5.01inch)	127.3mm (5.01inch)	127.3mm (5.01inch)	127.3mm (5.01inch)
DFD781S-CX36	DFD851S-CX3.6	DFD851S-CX7.2	DFD851S-CX10	DFD851S-CX20
DFD781D-CX36	DFD851D-CX3.6	DFD851D-CX7.2	DFD851D-CX10	DFD851D-CX20
4 (566.4)	4.5 (637.2)	9 (1274.5)	9 (1274.5)	12 (1699.3)
0.275 (1.51)	1.45 (7.93)	1.45 (7.93)	1.45 (7.93)	1.45 (7.93)
0.02	0.2	0.1	0.072	0.036
1 : 36	1 : 3.6	1 : 7.2	1 : 10	1 : 20
0.17	0.4	0.25	0.25	0.17
50	500	250	180	90
0.97 (2.13)	2.7 (5.94)	2.7 (5.94)	2.7 (5.94)	2.7 (5.94)
30 (6.75)	60 (13.5)	60 (13.5)	60 (13.5)	60 (13.5)
100 (22.5)	300 (67.5)	300 (67.5)	300 (67.5)	300 (67.5)

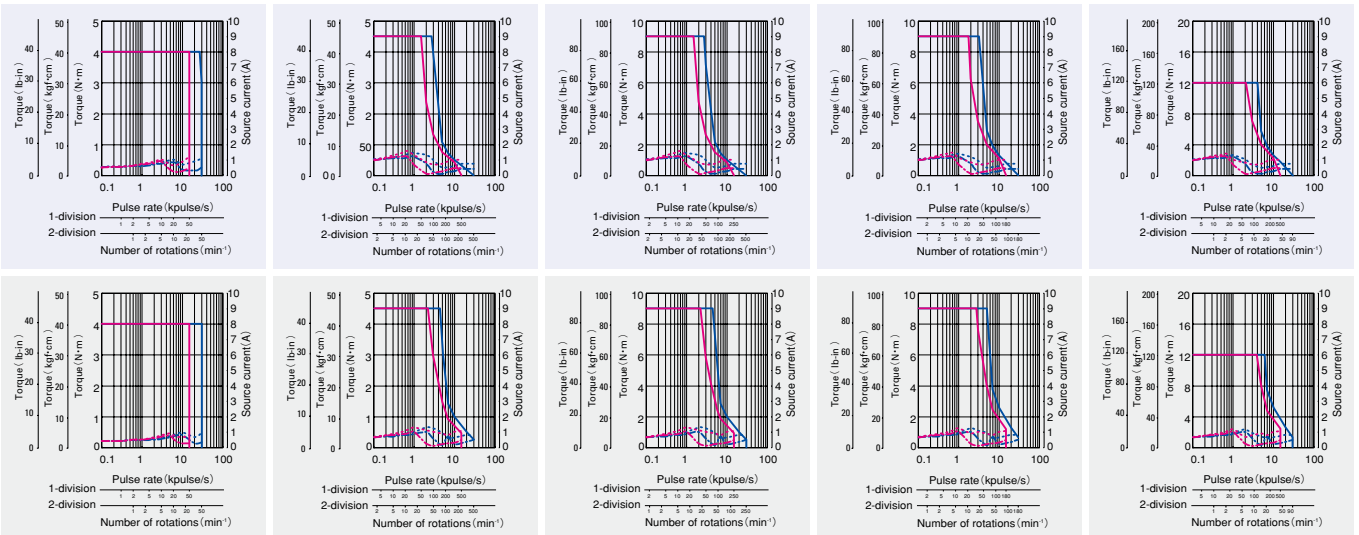

AC input

Input / Output signal standard

DC input

Stepping motor

Dimensions

Low-backlash gear model

F series driver +
F series motor with low-backlash gear

Size	Motor flange size	φ 86mm (φ 3.39inch)	
		127.3mm (5.01inch)	127.3mm (5.01inch)
Set part number	Motor + gear length	127.3mm (5.01inch)	127.3mm (5.01inch)
	Single shaft	FD851S-CX30	FD851S-CX36
Allowable torque	Double shaft	FD851D-CX30	FD851D-CX36
	N·m(oz·in)	12 (1699.3)	12 (1699.3)
Rotor inertia	×10 ⁻⁴ kg·m ² (oz·in ²)	1.45 (7.93)	1.45 (7.93)
Basic step angle		0.024	0.02
Gear ratio		1 : 30	1 : 36
Backlash	DEG	0.17	0.15
Allowable speed	min ⁻¹	60	50
Mass (Weight)	kg (lbs)	2.7 (5.94)	2.7 (5.94)
Allowable thrust load	N (lbs)	60 (13.5)	60 (13.5)
Allowable radial load ^(Note 1)	N (lbs)	300 (67.5)	300 (67.5)

Directions of motor rotation and gear output shaft are the same for models with reduction ratio 1 : 3.6, opposite for reduction ratio 1 : 10, 1 : 20, 1 : 30, and 1 : 36.
(Note1) When load is applied at 1/3 length from output shaft edge.

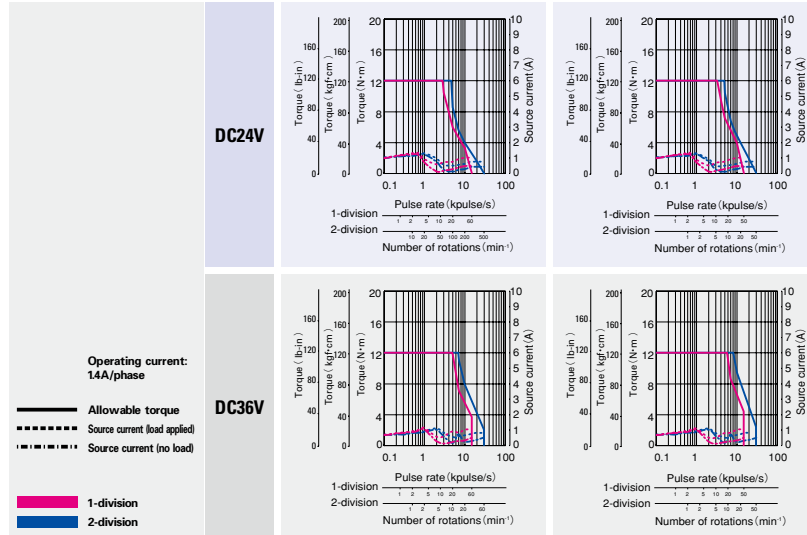

The data are measured under the drive condition of our company. The drive torque may vary depending on the accuracy of customer-side equipment.

Spur gear model

F series driver + F series motor with spur gear

Motor flange size

□28
(~1.10inch)

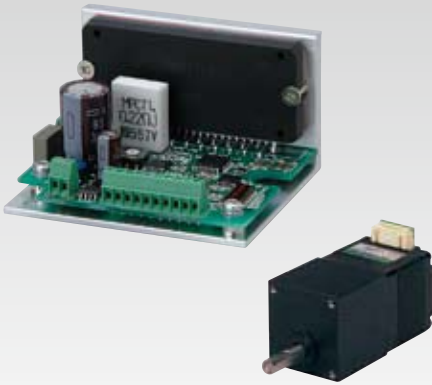

Size	Motor flange size	□28mm (□1.10inch)	
	Motor + gear length	60.3mm (2.37inch)	60.3mm (2.37inch)
Set part number	Single shaft	FD351S-GX3.6	FD351S-GX7.2
	Double shaft	FD351D-GX3.6	FD351D-GX7.2
Allowable torque	N·m(oz·in)	0.1 (14.16)	0.15 (21.24)
Rotor inertia	$\times 10^{-4}$ kg·m ² (oz·in ²)	0.009 (0.05)	0.009 (0.05)
Basic step angle		0.2	0.1
Gear ratio		1 : 3.6	1 : 7.2
Backlash	DEG	2	2
Allowable speed	min ⁻¹	800	400
Mass (Weight)	kg (lbs)	0.17 (0.37)	0.17 (0.37)
Allowable thrust load	N (lbs)	10 (2.25)	10 (2.25)
Allowable radial load ^(Note 1)	N (lbs)	15 (3.38)	15 (3.38)

Directions of motor rotation and gear output shaft are the same for models with reduction ratio 1 : 3.6, 1 : 7.2, 1 : 30 and 1 : 50 opposite for reduction ratio 1 : 10.
(Note1) When load is applied at 1/3 length from output shaft edge.

DC24V

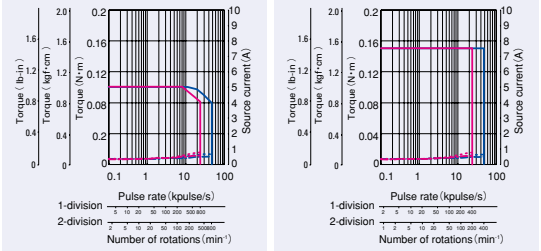

DC36V

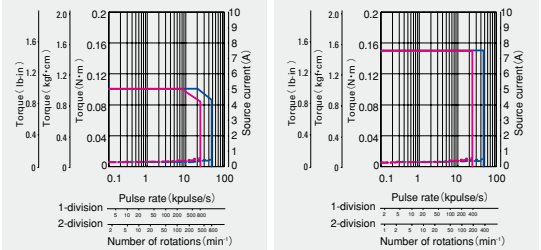

Operating current:
0.75A/phase

— Allowable torque
- - - Source current (load applied)
- · - · - Source current (no load)

■ 1-division
■ 2-division

The data are measured under the drive condition of our company. The drive torque may very depending on the accuracy of customer-side equipment.

Size	Motor flange size	□28mm (□1.10inch)			
	Motor + gear length	60.3mm (2.37inch)	60.3mm (2.37inch)	60.3mm (2.37inch)	60.3mm (2.37inch)
Set part number	Single shaft	FD351S-CX10	FD351S-CX20	FD351S-CX30	FD351S-CX50
	Double shaft	FD351D-CX10	FD351D-CX20	FD351D-CX30	FD351D-CX50
Allowable torque	N·m(oz·in)	0.2 (28.32)	0.35 (49.6)	0.5 (70.80)	0.5 (70.80)
Rotor inertia	$\times 10^{-4}$ kg·m ² (oz·in ²)	0.009 (0.05)	0.009 (0.05)	0.009 (0.05)	0.009 (0.05)
Basic step angle		0.072	0.036	0.024	0.0144
Gear ratio		1 : 10	1 : 20	1 : 30	1 : 50
Backlash	DEG	2	1.5	1.5	1.5
Allowable speed	min ⁻¹	300	150	100	60
Mass (Weight)	kg (lbs)	0.17 (0.37)	0.17 (0.37)	0.17 (0.37)	0.17 (0.37)
Allowable thrust load	N (lbs)	10 (2.25)	10 (2.25)	10 (2.25)	10 (2.25)
Allowable radial load ^(Note 1)	N (lbs)	15 (3.38)	15 (3.38)	15 (3.38)	15 (3.38)

Directions of motor rotation and gear output shaft are the same for models with reduction ratio 1 : 3.6, 1 : 7.2, 1 : 30, and 1 : 50 opposite for reduction ratio 1 : 10.
(Note1) When load is applied at 1/3 length from output shaft edge.

DC24V

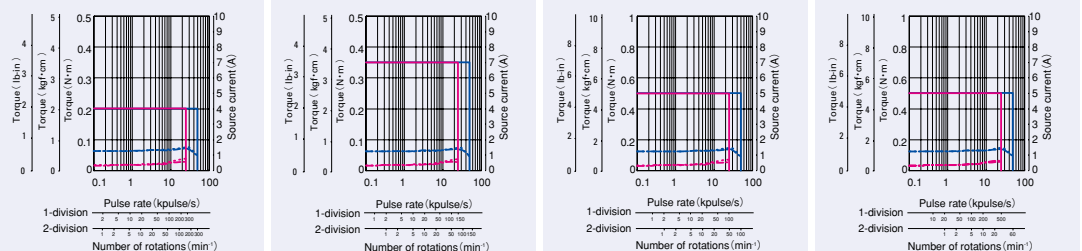

DC36V

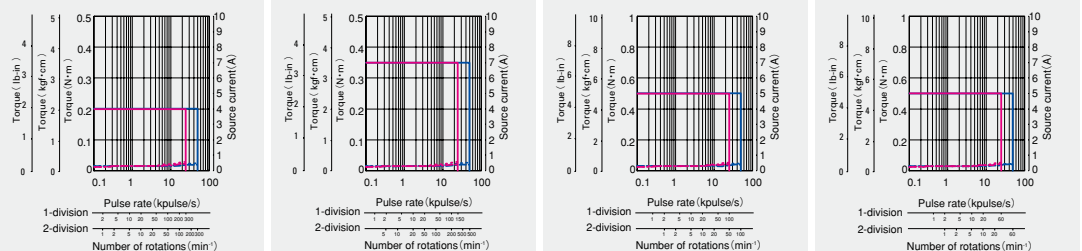

Operating current:
0.75A/phase

— Allowable torque
- - - Source current (load applied)
- · - · - Source current (no load)

■ 1-division
■ 2-division

The data are measured under the drive condition of our company. The drive torque may very depending on the accuracy of customer-side equipment.

Harmonic gear model

F series driver +
F series motor with harmonic gear

Motor flange size

- 28 (1.10inch)
- 42 (1.65inch)
- 60 (2.35inch)
- φ86 (3.39inch)

Size	Motor flange size		□28mm (□1.10inch)	
	Motor + gear length		69.5mm (2.74inch)	69.5mm (2.74inch)
Set part number	Single shaft		FD F351S-HX50	FD F351S-HX100
	Double shaft		FD F351D-HX50	FD F351D-HX100
Allowable torque	N·m(oz·in)		1.5 (212.4)	2 (283.2)
Momentary allowable torque	N·m(oz·in)		2.7 (382.4)	3.6 (509.8)
Rotor inertia	×10 ⁻⁴ kg·m ² (oz·in ²)		0.012 (0.066)	0.012 (0.066)
Basic step angle			0.0144	0.0072
Gear ratio			1 : 50	1 : 100
Lost motion	Minute		0.4 to 3 ± 0.006N · m (0.85oz · in)	0.4 to 3 ± 0.008N · m (1.133oz · in)
Allowable speed	min ⁻¹		70	35
Mass (Weight)	kg (lbs)		0.22 (0.48)	0.22 (0.48)
Allowable thrust load	N (lbs)		100 (22.5)	100 (22.5)
Allowable radial load ^(Note 1)	N (lbs)		160 (36)	160 (36)

Directions of gear output shaft are the opposite.
(Note1) When load is applied at 1/3 length from output shaft edge.



DC24V

DC36V

Operating current:
0.75A/phase

- Allowable torque
- - - Source current (load applied)
- · · Source current (no load)
- 1-division
- 2-division

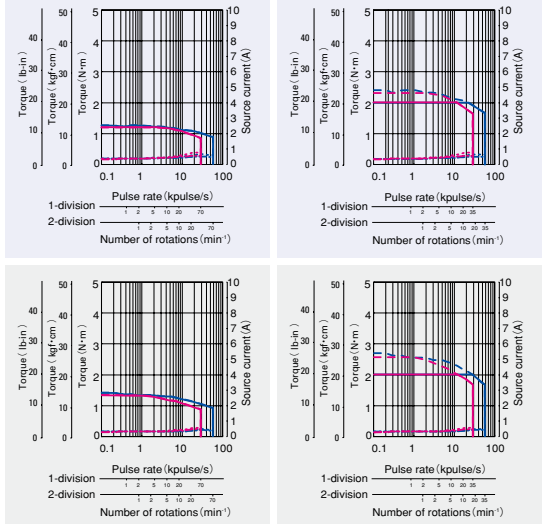

The data are measured under the drive condition of our company. The drive torque may very depending on the accuracy of customer-side equipment.

Size	Motor flange size		□60mm (□2.36inch)		φ86mm (φ3.39inch)	
	Motor + gear length		113.5mm (4.47inch)	113.5mm (4.47inch)	144.15mm (5.68inch)	144.15mm (5.68inch)
Set part number	Single shaft		FD F781S-HX50	FD F781S-HX100	FD F851S-HX50	FD F851S-HX100
	Double shaft		FD F781D-HX50	FD F781D-HX100	FD F851D-HX50	FD F851D-HX100
Allowable torque	N·m(oz·in)		5.5 (778.8)	8 (1132.9)	25 (3540.2)	41 (5805.9)
Momentary allowable torque	N·m(oz·in)		14 (1982.6)	20 (2832.2)	34 (4814.8)	59 (8355.1)
Rotor inertia	×10 ⁻⁴ kg·m ² (oz·in ²)		0.31 (1.695)	0.31 (1.695)	1.65 (9.02)	1.65 (9.02)
Basic step angle			0.0144	0.0072	0.0144	0.0072
Gear ratio			1 : 50	1 : 100	1 : 50	1 : 100
Lost motion	Minute		0.4 to 3 ± 0.28N · m (3.965oz · in)	0.4 to 3 ± 0.4N · m (56.645oz · in)	0.4 to 3 ± 1N · m (141.612oz · in)	0.4 to 3 ± 1.2N · m (169.934oz · in)
Allowable speed	min ⁻¹		70	35	70	35
Mass (Weight)	kg (lbs)		1.2 (2.64)	1.2 (2.64)	3.3 (7.26)	3.3 (7.26)
Allowable thrust load	N (lbs)		400 (90)	400 (90)	1400 (315)	1400 (315)
Allowable radial load ^(Note 1)	N (lbs)		360 (81)	360 (81)	1380 (310.5)	1380 (310.5)

Directions of gear output shaft are the opposite.
(Note1) When load is applied at 1/3 length from output shaft edge.

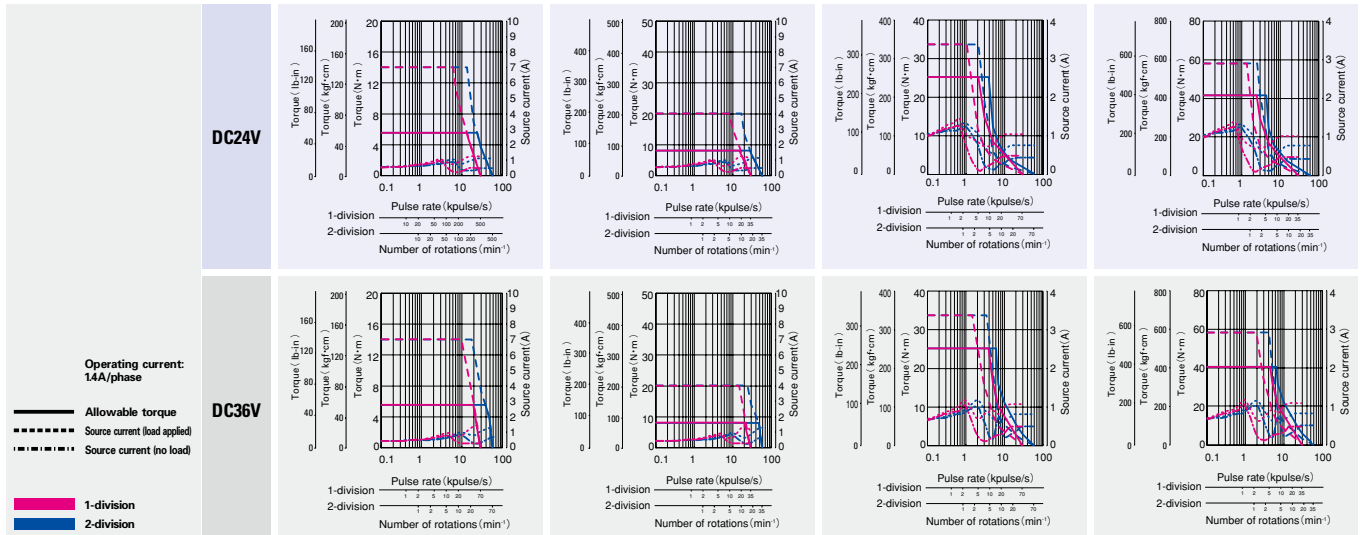

The data are measured under the drive condition of our company. The drive torque may very depending on the accuracy of customer-side equipment.

Size	Motor flange size	□ 42mm (□ 1.65inch)		
	Motor + gear length	73.5mm (2.89inch)	73.5mm (2.89inch)	73.5mm (2.89inch)
Set part number	Single shaft	FDF551S-HX30	FDF551S-HX50	FDF551S-HX100
	Double shaft	FDF551D-HX30	FDF551D-HX50	FDF551D-HX100
Allowable torque	N·m(oz·in)	2.2 (311.547)	3.5 (495.643)	5 (708.061)
Momentary allowable torque	N·m(oz·in)	4.5 (637.3)	8.3 (1175.4)	11 (1557.7)
Rotor inertia	$\times 10^4 \text{kg}\cdot\text{m}^2(\text{oz}\cdot\text{in}^2)$	0.042 (0.23)	0.042 (0.23)	0.072 (0.39)
Basic step angle		0.024	0.0144	0.0144
Gear ratio		1 : 30	1 : 50	1 : 100
Lost motion	Minute	0.4 to 1.5 ± 0.16N·m (22.658oz·in) *reference	0.4 to 1.5 ± 0.16N·m (22.658oz·in) *reference	0.4 to 1.5 ± 0.2N·m (28.322oz·in) *reference
Hysteresis loss	Minute	3.6	2.4	2.4
Allowable speed	min ⁻¹	116	70	35
Mass (Weight)	kg (lbs)	0.42 (0.92)	0.42 (0.92)	0.42 (0.92)
Allowable thrust load	N (lbs)	1150 (258.75)	1150 (258.75)	1150 (258.75)
Allowable radial load ^(Note 1)	N (lbs)	275 (61.88)	275 (61.88)	275 (61.88)

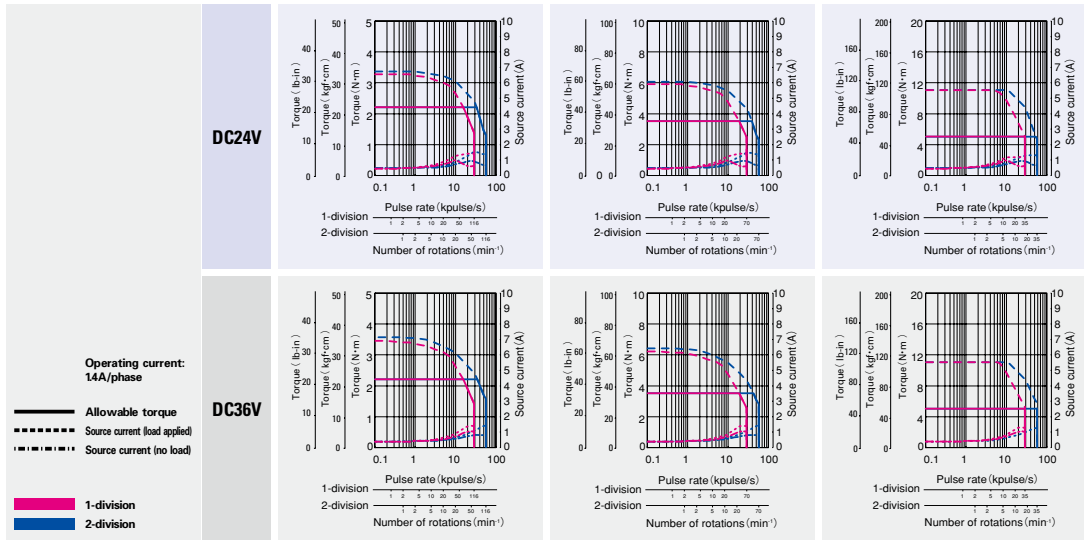

Electromagnetic brake model

F series driver +
F series motor with electromagnetic brake

Motor flange size



Size		□ 42mm (□ 1.65inch)	
Motor flange size		64.5mm (2.54inch)	70.5mm (2.78inch)
Motor + brake length		64.5mm (2.54inch)	70.5mm (2.78inch)
Set part number	Single shaft	FD551S-XB	FD552S-XB
		FD551D-XB	FD552D-XB
Holding torque	N·m(oz·in)	0.13 (8.4)	0.18 (25.49)
Rotor inertia	$\times 10^{-4}$ kg·m ² (oz·in ²)	0.045 (0.25)	0.068 (0.37)
Mass (Weight)	kg (lbs)	0.38 (0.84)	0.43 (0.95)
Allowable thrust load	N (lbs)	10 (2.25)	10 (2.25)
Allowable radial load ^(Note 1)	N (lbs)	35 (8.75)	35 (8.75)
Brake type		No excitation actuating type	No excitation actuating type
Electromagnetic brake	Power supply input	V	DC24V \pm 5%
	Excitation current	A	0.08
	Power consumption	W	2
	Static friction torque	N·m(oz·in)	0.22 (31.15)
	0.22 (31.15)		
Brake operating time	ms	30	30
Brake release time	ms	20	20

(Note1) When load is applied at 1/3 length from output shaft edge.

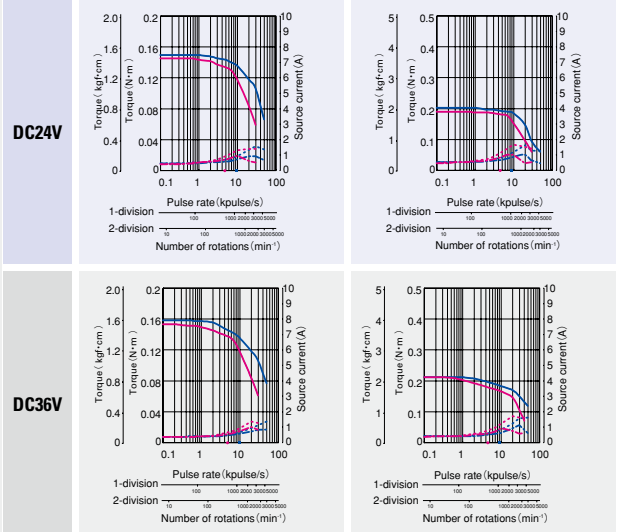
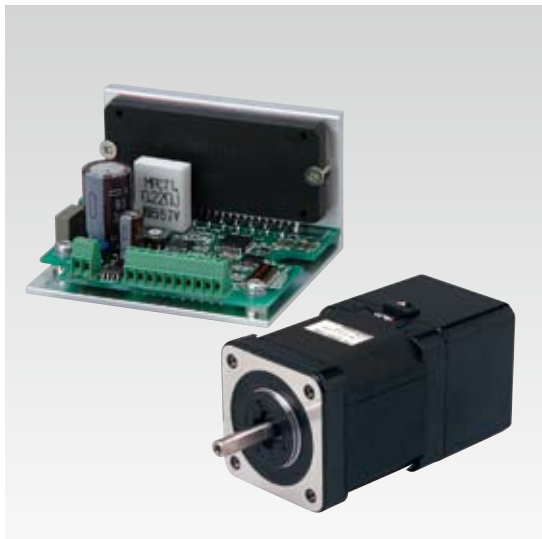

The data are measured under the drive condition of our company. The drive torque may very depending on the accuracy of customer-side equipment.

Size		φ 86mm (φ 3.39inch)	
Motor flange size		146.8mm (5.78mm)	
Motor + brake length		146.8mm (5.78mm)	
Set part number	Single shaft	FD852S-XB	FD852D-XB
		FD852S-XB	FD852D-XB
Holding torque	N·m(oz·in)	4.02 (569.3)	
Rotor inertia	$\times 10^{-4}$ kg·m ² (oz·in ²)	3.69 (20.18)	
Mass (Weight)	kg (lbs)	4.5 (9.9)	
Allowable thrust load	N (lbs)	60 (13.5)	
Allowable radial load ^(Note 1)	N (lbs)	220 (49.5)	
Brake type		No excitation actuating type	
Electromagnetic brake	Power supply input	V	DC24V \pm 5%
	Excitation current	A	0.42
	Power consumption	W	10
	Static friction torque	N·m(oz·in)	4 (566.45)
	4 (566.45)		
Brake operating time	ms	50	
Brake release time	ms	20	

(Note1) When load is applied at 1/3 length from output shaft edge.

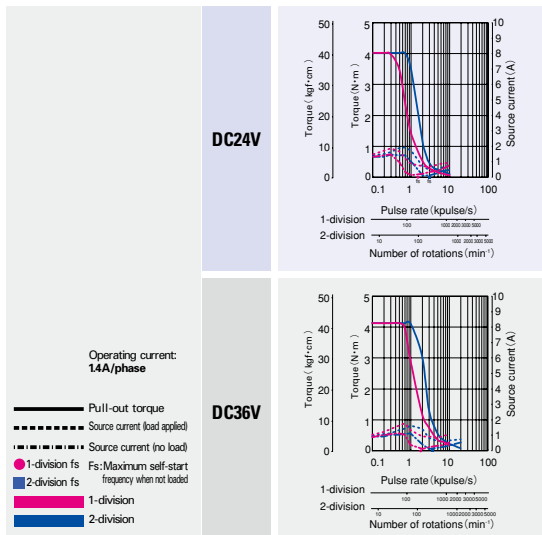

□ 42mm (□ 1.65inch)	□ 60mm (□ 2.36inch)			φ 86mm (φ 3.39inch)
79.5mm (3.13inch)	85.8mm (3.38inch)	94.5mm (3.72inch)	126.7mm (4.99inch)	116.7mm (4.59inch)
FD554S-XB	FD781S-XB	FD782S-XB	FD783S-XB	FD851S-XB
FD552D-XB	FD781D-XB	FD782D-XB	FD783D-XB	FD851D-XB
0.26 (36.82)	0.6 (85.0)	0.98 (138.8)	1.79 (253.5)	2.06 (291.7)
0.08 (0.44)	0.43 (2.35)	0.56 (3.06)	1 (5.47)	2.24 (12.25)
0.52 (1.14)	0.94 (2.07)	1.12 (2.46)	1.7 (3.74)	3.5 (7.7)
10 (2.25)	20 (4.5)	20 (4.5)	20 (4.5)	60 (13.5)
35 (8.75)	80 (18)	80 (18)	80 (18)	220 (49.5)
No excitation actuating type	No excitation actuating type	No excitation actuating type	No excitation actuating type	No excitation actuating type
DC24V ± 5%	DC24V ± 5%	DC24V ± 5%	DC24V ± 5%	DC24V ± 5%
0.08	0.25	0.25	0.25	0.42
2	6	6	6	10
0.22 (31.15)	0.8 (113.29)	0.8 (113.29)	0.8 (113.29)	4 (566.45)
30	30	30	30	50
20	20	20	20	20

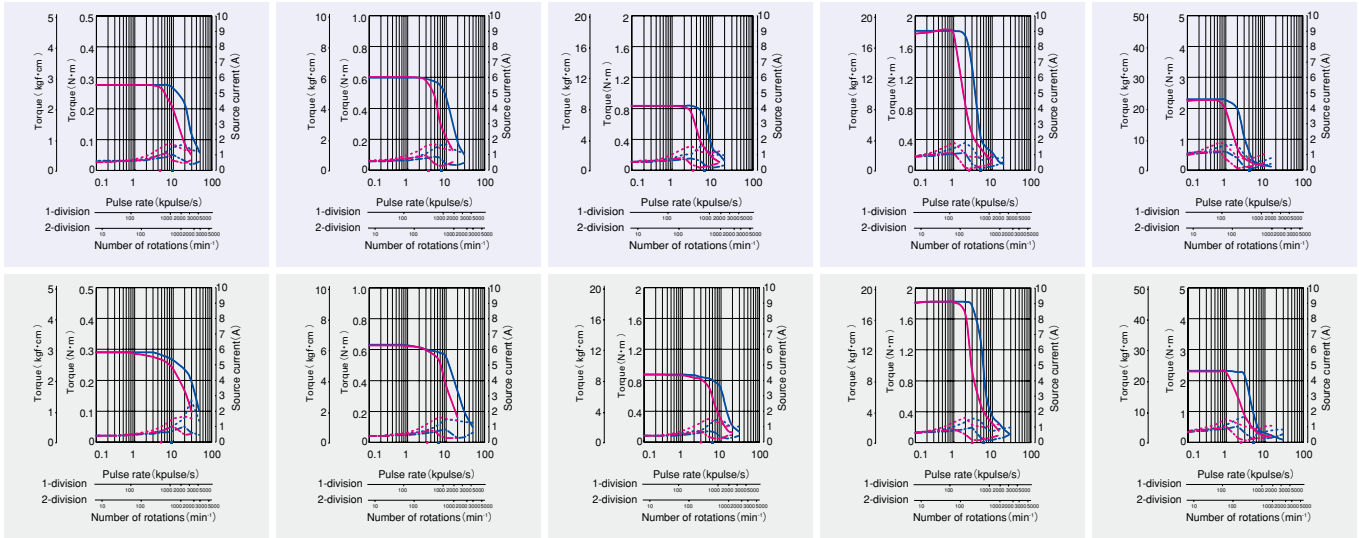

Common specifications

F series driver

Basic specifications	Item	FS1D140P □□	
	Power supply	DC24 V / 36 V ±10 %	
	Source current	3 A MAX.	
	Environment	Protection class	Class III
		Operation environment	Installation category (over-voltage category) : I , pollution degree: 2
		Applied standards	EN61010-1, UL508C
		Ambient operation temperature	0 to 50°C
		Storage temperature	-20 to +70°C
		Ambient operation humidity	35 to 85%RH (no condensation)
		Storage humidity	10 to 90%RH (no condensation)
		Operation altitude	1000 m (3280 feet) or less above sea level
		Vibration resistance	Tested under the following conditions ; 4.9m/s ² , frequency range 10 to 55Hz, direction along X, Y and Z axes, for 2 hours each
		Impact resistance	Not influenced at NDS-C-0110 standard section 3.2.2 division "C" .
Withstand voltage	Not influenced when 1500V AC is applied between power input terminal and cabinet for one minute.		
Insulation resistance	10M ohm MIN. when measured with 500V DC megohmmeter between input terminal and cabinet.		
Mass (Weight)	0.1kg (0.05lbs)		
Functions	Selection function	Step angle, pulse input method, step current, non-operating current, and operating current	
	Protection functions	Open phase protection	
	LED indication	Power monitor, alarm	
I/O signals	Command pulse input signal	Photo-coupler input system ; input resistance: 220 Ω ; input-signal "H" level : 4.0 to 5.5V ; input-signal "L" level : 0 to 0.5V, MAX. input frequency : 35kpulse/s	
	Power down input signal	Photo-coupler input system ; input resistance: 220 Ω ; input-signal "H" level : 4.0 to 5.5V ; input-signal "L" level : 0 to 0.5V	
	Input signal	Open collector output by photo coupler, output signal standard, V _{ceo} = 40V MAX., I _c = 10 mA MAX.	
	Output signal	Open collector output by photo coupler, output signal standard, V _{ceo} = 40V MAX., I _c = 10 mA MAX.	

F series motor

Stepping motor type	F series motor
Motor Type	103F35□□ /103F55□□ /103F785□ /103F858□ /103F8958□
Type	—
Insulation class	Class B (+130°C)
Operation altitude	1000m (3280 feet) or less above sea level
Withstand voltage	□ 28mm (□ 1.10inch) : AC1000V 50/60Hz for 1 minute, □ 42mm (□ 1.65inch) , □ 60mm (□ 2.36inch) , ° 86mm (° 3.39inch) , ° 106mm (° 4.17inch) : AC1500V 50/60Hz for 1 minute
Insulation resistance	100Mohm MIN. against DC500V
Protection grade	IP40
Vibration resistance	Amplitude of 1.52mm (0.06inch) (P-P) at frequency range 10 to 500Hz for 15 minutes sweep time along X, Y, and Z axes for 12 times.
Impact resistance	490m/s ² of acceleration for 11 ms with half-sine wave applying three times for X, Y, and Z axes each, 18 times in total.
Ambient operation temperature	-10 to +50°C (0 to +40°C for harmonic gear model)
Ambient operation humidity	90% MAX. at less than 40°C, 57% MAX. at less than 50°C , 35% MAX. at 60°C (no condensation)

External wiring diagram

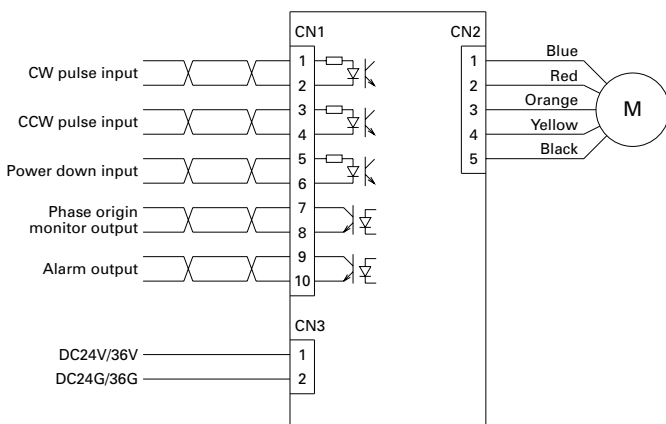

Specification summary of CN1 I/O signal

Signal name	CN1 Pin number	Function
CW pulse input (standard)	1	When using "2-input mode"
	2	Drive pulse for the CW direction rotation is input.
Pulse column input	1	When using "Pulse and direction mode"
	2	Drive pulse train for the stepping motor rotation is input.
CCW pulse input (standard)	3	When using "2-input mode"
	4	Drive pulse for the CCW direction rotation is input.
Rotation direction input	3	The rotation direction signal of stepping motor is input for the "Pulse and direction mode".
	4	Internal photocoupler ON...CW direction Internal photocoupler OFF...CCW direction
Power down input	5	Inputting the PD signal cuts OFF the current flowing through the stepping motor.
	6	internal photocoupler ON...PD function enabled internal photocoupler OFF...PD function disabled
Phase origin monitor output	7	It is turned ON when the excitation phase is at the origin (in the state when the power is turned ON)
	8	It is turned ON once per 10 pulses when setting to HALF step. It is turned ON once per 20 pulses when setting to FULL step.
Alarm output	9	The signal is externally output when one of several alarm circuits operates in the PM driver. At this time, the stepping motor is in the unexcited state.
	10	

The CW rotation direction of stepping motor means the clockwise direction rotation as viewed from the output shaft side (flange side) . The CCW rotation direction means the counterclockwise direction rotation as viewed from the output shaft side (flange side) .

Applicable wire sizes

Part	size	Allowable wire length
Power supply	AWG22(0.3mm ²)	2m MAX.
Input/output signal	AWG24(0.2mm ²) to AWG22(0.3mm ²)	photo coupler type : 2m MAX.
Motor	AWG22(0.3mm ²)	3m MIN.

Driver part name

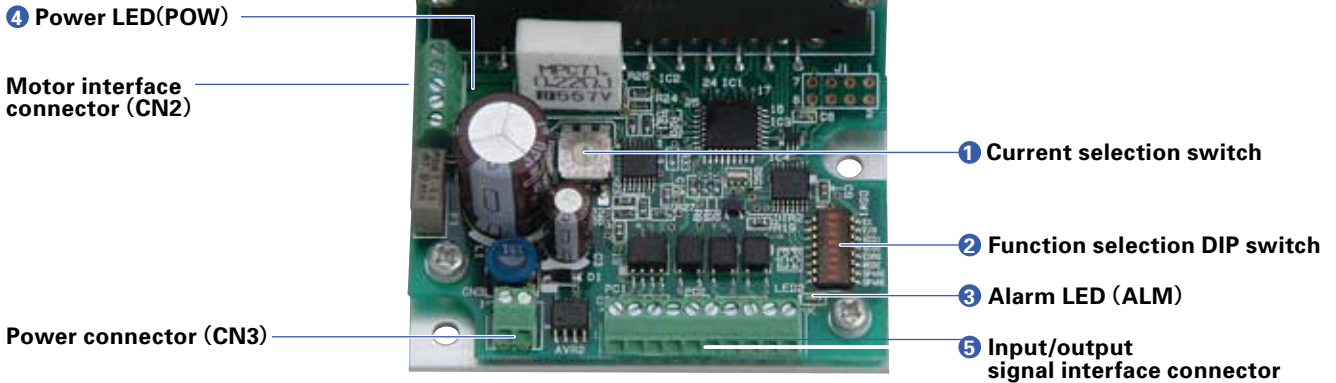

1 Current selection switch (RUN)

Enable to select operating current value to stepping motor.

Dial	0	1	2	3	4	5	6	7
Stepping motor current (A)	1.4	1.35	1.3	1.25	1.2	1.15	1.1	1.05
Dial	8	9	A	B	C	D	E	F
Stepping motor current (A)	1.0	0.95	0.9	0.85	0.8	0.75	0.7	0.65

3 Power LED (POW)

Lights up when main circuit power supply is switched on.

Indicator	Explanation
"POW" is displayed.	Main circuit power supply is switched on.

2 Function selection DIP switch

Selects an appropriate function for specification. Check that the ex-factory settings are as follows.

	OFF	ON	
EX	<input type="checkbox"/>	<input type="checkbox"/>	Half step
F/R	<input type="checkbox"/>	<input type="checkbox"/>	2-input mode (CW, CCW pulse-input method)
ACD1	<input type="checkbox"/>	<input type="checkbox"/>	Stopping current : 40% of driving current
ACD2	<input type="checkbox"/>	<input type="checkbox"/>	
EORG	<input type="checkbox"/>	<input type="checkbox"/>	Phase crigin
MODE	<input type="checkbox"/>	<input type="checkbox"/>	Reservation : Don't turn it ON.
SPARE	<input type="checkbox"/>	<input type="checkbox"/>	
SPARE	<input type="checkbox"/>	<input type="checkbox"/>	

4 Alarm LED (ALM)

Lights up during alarm conditions.

Indicator	Explanation
"ALM" is displayed.	Motor cable is broken, or switching element in driver is faulty. The main circuit voltage is out of specifications range (Less than DC19V).

When "ALM" is displayed, the winding current of the stepping motor is cut off and it is in a "non-excitation" state. At the same time, an output signal is transmitted from the alarm output terminal (AL) to an external source. When the alarm circuit is operating, this state is maintained until it is reset by switching on the power supply again. When an alarm condition has occurred, please take corrective actions to rectify the cause of the alarm before switching on the power supply again.

Step angle selection (EX)

Selects the basic step angle.

EX	Exciting mode
ON	Full step (0.72° /pulse)
OFF	Half step (0.36° /pulse)

Input method select (F/R)

Selects input pulse type.

F/R	Input pulse type
ON	1 input (pulse & direction)
OFF	2 input (CW, CCW)

Current adjustment at operation halt (ACD1、ACD2)

Selects the value of the motor current during stand-still.

ACD2	ACD1	Motor current
ON	ON	100% of driving current
ON	OFF	60% of driving current
OFF	ON	50% of driving current
OFF	OFF	40% of driving current

Initial configuration of factory shipment is set to A(50% of rated value). Driver and motor should be operated at around 50% of rated value to reduce heat.

Excitation select (EORG)

The excitation phasse when the power supply is turned on is selected.

EORG	Original excitation phase
ON	Excitation phase at power shut off
OFF	Phase origin

By turning on the EORG, excitation phase when power OFF will be saved. Therefore, there will be no shaft displacement when turning the power ON.

Input circuit configuration of CW (CK), CCW (U/D)

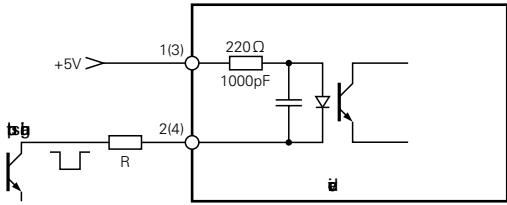

- Pulse duty 50% MAX.
- Maximum input frequency: 35kpulse/s
- When the crest value of the input signal exceeds 5V, use the external limit resistance R to limit the input current to approximately 15mA.

Input signal specification

(Photo coupler)

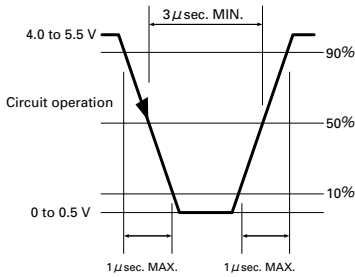

Timing of command pulse

2 input type (CW, CCW)

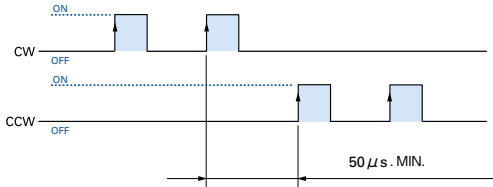

- Shaded area indicates internal photo coupler "ON". Internal circuit (motor) starts operating at leading edge of the photo coupler "ON".
- To apply pulse to CW, set CCW side internal photo coupler to "OFF".
- To apply pulse to CCW, set CW side internal photo coupler to "OFF".

1 input type (CW, U/D)

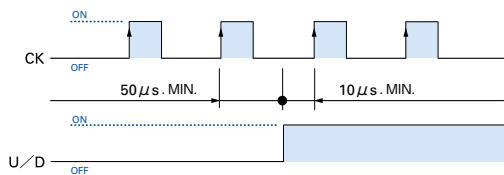

- Shaded area indicates internal photo coupler "ON". Internal circuit (motor) starts operating at leading edge of CK side photo coupler "ON".
- Switching of U/D input signal must be done while CK side internal photo coupler is "OFF".

Input circuit configuration of PD

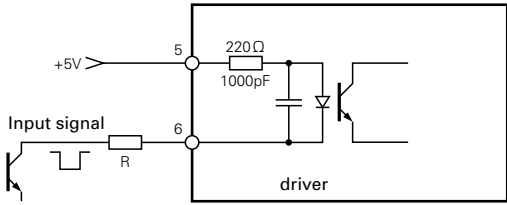

- If the peak value exceeds 5V, set the input current to approx. 15mA using the external limit resistance R.

AC input

Output signal configuration of MON, AL

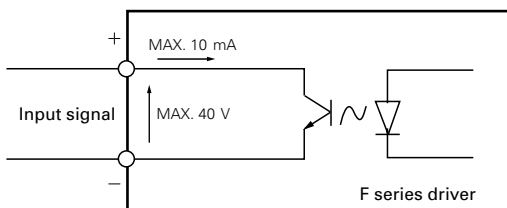

MON output

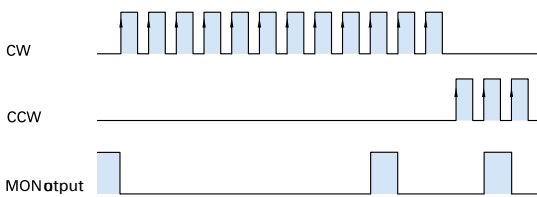

- Photo coupler at phase origin of motor excitation (status at power on) is set to "ON" (setting when number of divisions is 1).
- Output from MON is set to on at every 7.2 degrees of motor output shaft from phase origin.

Input / Output signal standard

DC input

Internal wire connection and direction of motor rotate

Internal wire connection

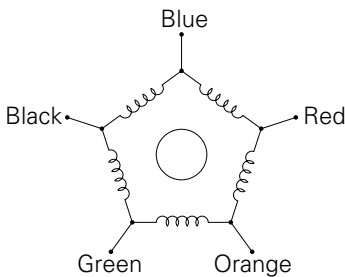

Direction of motor rotate

The direction of motor rotate is counterclockwise when viewed from the output shaft side at the direct current energization in the following order.

Type	Exciting order									
	1	2	3	4	5	6	7	8	9	10
Color of leads	Blue			+	+	+				
	Red	-	+				+	+		
	Orange			-	-			+	+	+
	Green	+				-	-			+
	Black	+	+	+				-	-	

Stepping motor

Dimensions



5-phase stepping motor

39mm sq. (1.54inch sq.)

103-45 □□ -70 □□
0.36° /step

Model		Holding torque at 5-phase energization	Rated current	Wiring resistance	Winding inductance	Rotor inertia	Mass (Weight)
Single shaft	Double shafts	[N · m (oz · in) MIN.]	A/phase	Ω /phase	mH/phase	[×10 ⁻⁴ kg · m ² (oz · in ²)]	[kg (lbs)]
103-4505-7040	-7010	0.078 (11.05)	0.75	2	1.97	0.0182 (0.10)	0.0182 (0.10)
103-4507-7040	-7010	0.108 (15.29)	0.75	2.35	3.8	0.024 (0.13)	0.024 (0.13)
103-4510-7040	-7010	0.167 (23.65)	0.75	3	6.2	0.036 (0.20)	0.036 (0.20)

Pulse rate-torque characteristics

■ 103-4505-70 □□

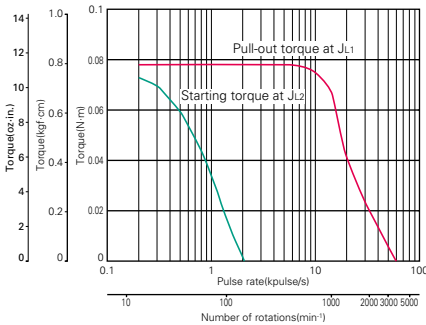

Constant current circuit
Source voltage : DC24V · operating current : 0.75A/phase, 5-phase excitation (full step)
J_{L1} = [0.33×10⁻⁴kg · m² (1.80oz · in²) use the rubber coupling]
J_{L2} = [0.18×10⁻⁴kg · m² (0.98oz · in²) use the direct coupling]

■ 103-4507-70 □□

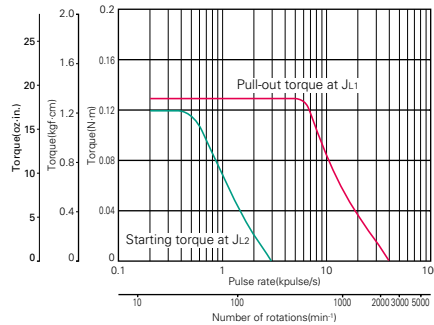

Constant current circuit
Source voltage : DC24V · operating current : 0.75A/phase, 5-phase excitation (full step)
J_{L1} = [0.33×10⁻⁴kg · m² (1.80oz · in²) use the rubber coupling]
J_{L2} = [0.18×10⁻⁴kg · m² (0.98oz · in²) use the direct coupling]

■ 103-4510-70 □□

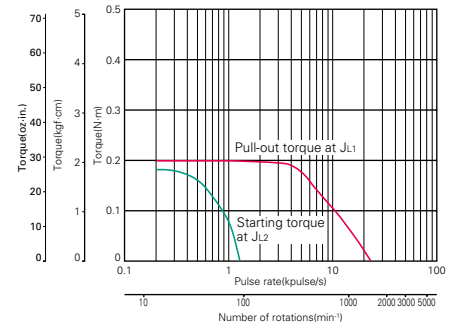

Constant current circuit
Source voltage : DC24V · operating current : 0.75A/phase, 5-phase excitation (full step)
J_{L1} = [0.94×10⁻⁴kg · m² (5.14oz · in²) use the rubber coupling]
J_{L2} = [0.8×10⁻⁴kg · m² (4.37oz · in²) use the direct coupling]



5-phase stepping motor

60mm cir. (2.36inch cir.)

103-7566-70 □□
0.45° /step

Model		Holding torque at 5-phase energization	Rated current	Wiring resistance	Winding inductance	Rotor inertia	Mass (Weight)
Single shaft	Double shafts	[N · m (oz · in) MIN.]	A/phase	Ω /phase	mH/phase	[$\times 10^{-4}$ kg · m ² (oz · in ²)]	[kg (lbs)]
103-7566-7041	-7011	0.91 (128.9)	0.75	4.8	23	0.235 (1.28)	1.1 (2.43)

Pulse rate-torque characteristics

■ 103-7566-70 □□

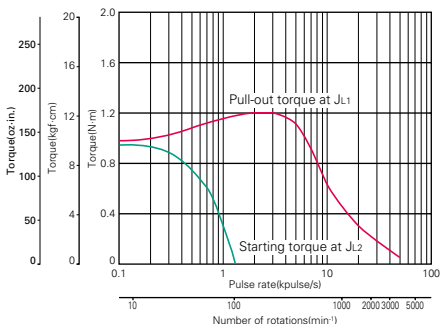

Constant current circuit

Source voltage : AC100V · operating current : 0.75A/phase,
5-phase excitation (full step)

$J_{1.1}$ = [2.6 $\times 10^{-4}$ kg · m² (14.22oz · in²) use the rubber coupling]

$J_{1.2}$ = [2.6 $\times 10^{-4}$ kg · m² (14.22oz · in²) use the direct coupling]



5-phase stepping motor

28mm sq. (1.10inch sq.)

103H35 □□ -70 □□
0.72° /step

■ Motor with leads

Model		Holding torque at 5-phase energization [N · m (oz · in) MIN.]	Rated current A/phase	Wiring resistance Ω /phase	Winding inductance mH/phase	Rotor inertia [×10 ⁻⁴ kg · m ² (oz · in ²)]	Mass (Weight) [kg (lbs)]
Single shaft	Double shafts						
103H3505-7070	-7020	0.026 (3.68)	0.75	1.2	0.32	0.009 (0.05)	0.11 (0.24)
103H3515-7070	-7020	0.052 (7.36)	0.75	1.5	0.4	0.016 (0.09)	0.2 (0.44)

■ Motor with connector

Model		Holding torque at 5-phase energization [N · m (oz · in) MIN.]	Rated current A/phase	Wiring resistance Ω /phase	Winding inductance mH/phase	Rotor inertia [×10 ⁻⁴ kg · m ² (oz · in ²)]	Mass (Weight) [kg (lbs)]
Single shaft	Double shafts						
103H3505-7040	-7010	0.026 (3.68)	0.75	1.1	0.32	0.009 (0.05)	0.11 (0.24)
103H3515-7040	-7010	0.052 (7.36)	0.75	1.4	0.4	0.016 (0.09)	0.2 (0.44)

Pulse rate-torque characteristics

■ 103H3505-70 □□

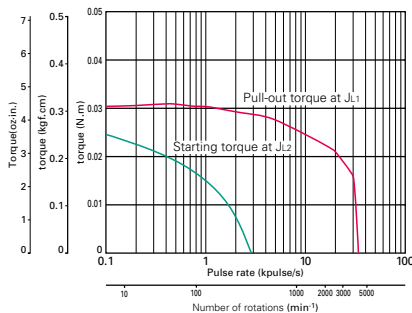

Constant current circuit
Source voltage : DC24V · operating current : 0.75A/phase,
5-phase excitation (full step)
J₁ = [0.01×10⁻⁴kg · m² (0.05oz · in²) pulley balancer system]
J₂ = [0.01×10⁻⁴kg · m² (0.05oz · in²) pulley balancer system]

■ 103H3515-70 □□

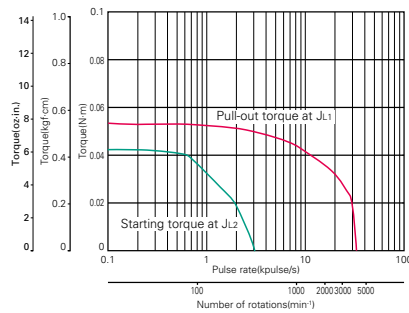

Constant current circuit
Source voltage : DC24V · operating current : 0.75A/phase,
5-phase excitation (full step)
J₁ = [0.01×10⁻⁴kg · m² (0.05oz · in²) pulley balancer system]
J₂ = [0.01×10⁻⁴kg · m² (0.05oz · in²) pulley balancer system]

5-phase stepping motor

42mm sq. (1.65inch sq.)

103H55 -70
 0.72° /step



AC input

Input / Output signal standard

DC input

Stepping motor

Dimensions

Model		Holding torque at 5-phase energization	Rated current	Wiring resistance	Winding inductance	Rotor inertia	Mass (Weight)
Single shaft	Double shafts	[N · m (oz · in) MIN.]	A/phase	Ω /phase	mH/phase	[×10 ⁻⁴ kg · m ² (oz · in ²)]	[kg (lbs)]
103H5505-7040	-7010	0.127 (17.98)	0.75	1.45	1.2	0.03 (0.16)	0.23 (0.50)
103H5508-7040	-7010	0.176 (24.92)	0.75	1.6	1.8	0.053 (0.29)	0.28 (0.62)
103H5510-7040	-7010	0.255 (36.11)	0.75	2.2	2.2	0.065 (0.36)	0.37 (0.82)

Pulse rate-torque characteristics

■ 103H5505-70

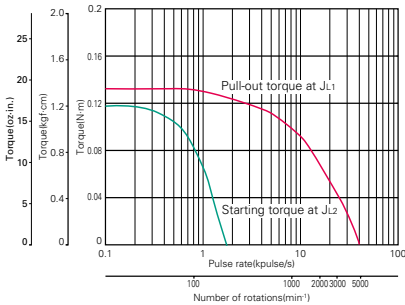

Constant current circuit
 Source voltage : DC24V · operating current:0.75A/phase,
 5-phase excitation (full step)
 $J_{L1} = [0.94 \times 10^{-4} \text{kg} \cdot \text{m}^2 (5.14 \text{oz} \cdot \text{in}^2)$ use the rubber coupling]
 $J_{L2} = [0.8 \times 10^{-4} \text{kg} \cdot \text{m}^2 (4.37 \text{oz} \cdot \text{in}^2)$ use the direct coupling]

■ 103H5508-70

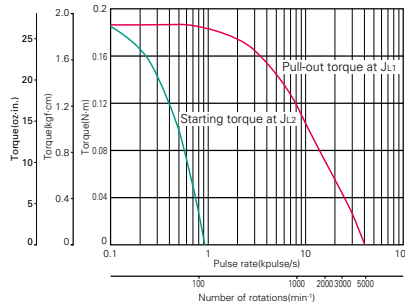

Constant current circuit
 Source voltage : DC24V · operating current:0.75A/phase,
 5-phase excitation (full step)
 $J_{L1} = [0.94 \times 10^{-4} \text{kg} \cdot \text{m}^2 (5.14 \text{oz} \cdot \text{in}^2)$ use the rubber coupling]
 $J_{L2} = [0.8 \times 10^{-4} \text{kg} \cdot \text{m}^2 (4.37 \text{oz} \cdot \text{in}^2)$ use the direct coupling]

■ 103H5510-70

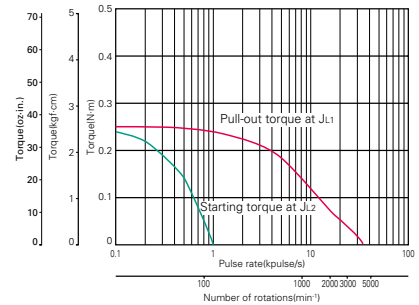

Constant current circuit
 Source voltage : DC24V · operating current:0.75A/phase,
 5-phase excitation (full step)
 $J_{L1} = [0.94 \times 10^{-4} \text{kg} \cdot \text{m}^2 (5.14 \text{oz} \cdot \text{in}^2)$ use the rubber coupling]
 $J_{L2} = [0.8 \times 10^{-4} \text{kg} \cdot \text{m}^2 (4.37 \text{oz} \cdot \text{in}^2)$ use the direct coupling]



5-phase stepping motor

50mm sq. (1.97inch sq.)

103H650 □ - □□□□
0.72° /step

Model		Holding torque at 5-phase energization	Rated current	Wiring resistance	Winding inductance	Rotor inertia	Mass (Weight)
Single shaft	Double shafts	[N · m (oz · in) MIN.]	A/phase	Ω /phase	mH/phase	[×10 ⁻⁴ kg · m ² (oz · in ²)]	[kg (lbs)]
103H6500-7041	-7011	0.235 (33.28)	0.75	2	4	0.057 (0.31)	0.38 (0.84)
103H6500-8041	-8011	0.225 (31.86)	1.5	0.47	0.85	0.057 (0.31)	0.38 (0.84)
103H6501-7041	-7011	0.39 (55.23)	0.75	2.6	5.6	0.105 (0.57)	0.44 (0.97)
103H6501-8041	-8011	0.39 (55.23)	1.5	0.65	1.45	0.105 (0.57)	0.44 (0.97)

Pulse rate-torque characteristics

103H6500-70 □□

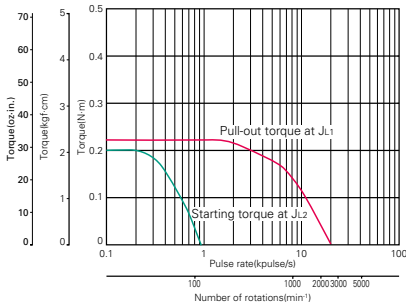

Constant current circuit
Source voltage : DC24V · operating current : 0.75A/phase, 5-phase excitation (full step)
J₁=[0.94×10⁻⁴kg · m² (5.14oz · in²) use the rubber coupling]
J₂=[0.8×10⁻⁴kg · m² (4.37oz · in²) use the direct coupling]

103H6500-80 □□

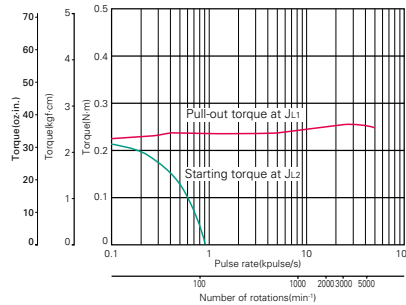

Constant current circuit
Source voltage : AC100V · operating current : 1.5A/phase, 5-phase excitation (full step)
J₁=[0.94×10⁻⁴kg · m² (5.14oz · in²) use the rubber coupling]
J₂=[0.8×10⁻⁴kg · m² (4.37oz · in²) use the direct coupling]

103H6501-70 □□

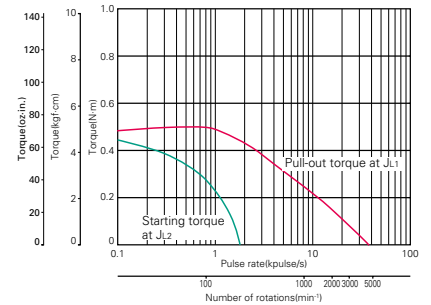

Constant current circuit
Source voltage : DC24V · operating current : 0.75A/phase, 5-phase excitation (full step)
J₁=[0.94×10⁻⁴kg · m² (5.14oz · in²) use the rubber coupling]
J₂=[0.105×10⁻⁴kg · m² (4.37oz · in²) pulley balancer system]

103H6501-80 □□

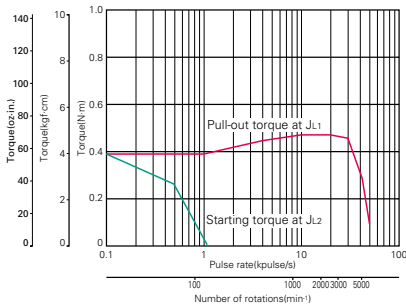

Constant current circuit
Source voltage : AC100V · operating current : 1.5A/phase, 5-phase excitation (full step)
J₁=[0.94×10⁻⁴kg · m² (5.14oz · in²) use the rubber coupling]
J₂=[0.8×10⁻⁴kg · m² (4.37oz · in²) use the direct coupling]



5-phase stepping motor

60mm sq. (2.36inch sq.)

103H785 □ - □□□□

0.72° /step

Model		Holding torque at 5-phase energization	Rated current	Wiring resistance	Winding inductance	Rotor inertia	Mass (Weight)
Single shaft	Double shafts	[N · m (oz · in) MIN.]	A/phase	Ω /phase	mH/phase	[×10 ⁻⁴ kg · m ² (oz · in ²)]	[kg (lbs)]
103H7851-7051	-7021	0.65 (92.0)	0.75	2.75	4.75	0.275 (1.50)	0.6 (1.32)
103H7851-8051	-8021	0.65 (92.0)	1.5	0.64	1.2	0.275 (1.50)	0.6 (1.32)
103H7852-7051	-7021	0.98 (138.8)	0.75	3.4	7.75	0.4 (2.19)	0.78 (1.72)
103H7852-8051	-8021	0.98 (138.8)	1.5	0.8	2	0.4 (2.19)	0.78 (1.72)
103H7853-7051	-7021	1.86 (263.4)	0.75	5.5	15	0.84 (4.59)	1.36 (3.00)
103H7853-8051	-8021	1.86 (263.4)	1.5	1.28	3.85	0.84 (4.59)	1.36 (3.00)

Pulse rate-torque characteristics

103H7851-70 □□

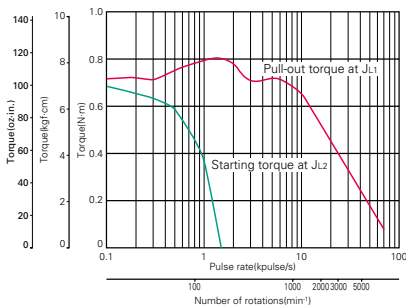

Constant current circuit
 Source voltage : AC100V·operating current : 0.75A/phase,
 5-phase excitation (full step)
 $J_{L1} = [0.94 \times 10^{-4} \text{kg} \cdot \text{m}^2 (5.14 \text{oz} \cdot \text{in}^2)]$ use the rubber coupling]
 $J_{L2} = [0.8 \times 10^{-4} \text{kg} \cdot \text{m}^2 (4.37 \text{oz} \cdot \text{in}^2)]$ use the direct coupling]

103H7852-70 □□

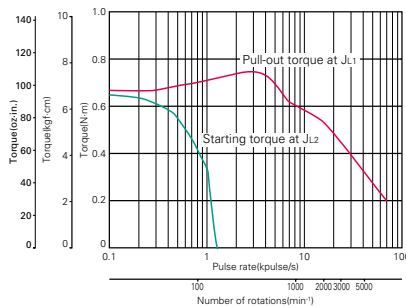

Constant current circuit
 Source voltage : AC100V·operating current : 0.75A/phase,
 5-phase excitation (full step)
 $J_{L1} = [0.94 \times 10^{-4} \text{kg} \cdot \text{m}^2 (5.14 \text{oz} \cdot \text{in}^2)]$ use the rubber coupling]
 $J_{L2} = [0.8 \times 10^{-4} \text{kg} \cdot \text{m}^2 (4.37 \text{oz} \cdot \text{in}^2)]$ use the direct coupling]

103H7853-70 □□

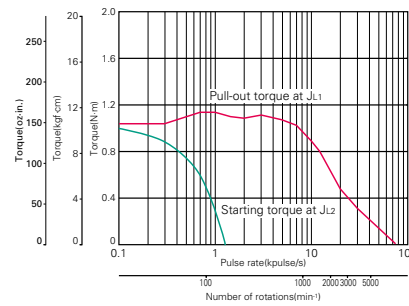

Constant current circuit
 Source voltage : AC100V·operating current : 0.75A/phase,
 5-phase excitation (full step)
 $J_{L1} = [7.4 \times 10^{-4} \text{kg} \cdot \text{m}^2 (40.46 \text{oz} \cdot \text{in}^2)]$ use the rubber coupling]
 $J_{L2} = [7.4 \times 10^{-4} \text{kg} \cdot \text{m}^2 (40.46 \text{oz} \cdot \text{in}^2)]$ use the direct coupling]

103H7851-80 □□

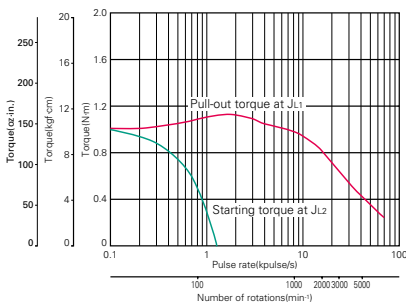

Constant current circuit
 Source voltage : AC100V·operating current : 1.5A/phase,
 5-phase excitation (full step)
 $J_{L1} = [0.94 \times 10^{-4} \text{kg} \cdot \text{m}^2 (5.14 \text{oz} \cdot \text{in}^2)]$ use the rubber coupling]
 $J_{L2} = [0.8 \times 10^{-4} \text{kg} \cdot \text{m}^2 (4.37 \text{oz} \cdot \text{in}^2)]$ use the direct coupling]

103H7852-80 □□

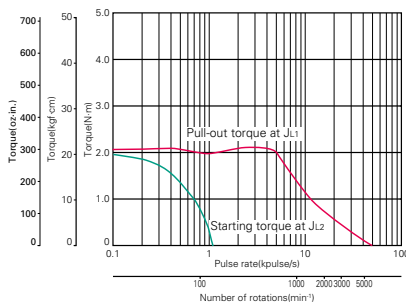

Constant current circuit
 Source voltage : AC100V·operating current : 1.5A/phase,
 5-phase excitation (full step)
 $J_{L1} = [2.6 \times 10^{-4} \text{kg} \cdot \text{m}^2 (14.22 \text{oz} \cdot \text{in}^2)]$ use the rubber coupling]
 $J_{L2} = [2.6 \times 10^{-4} \text{kg} \cdot \text{m}^2 (14.22 \text{oz} \cdot \text{in}^2)]$ use the direct coupling]

103H7853-80 □□

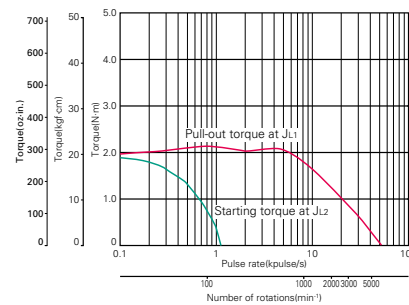

Constant current circuit
 Source voltage : AC100V·operating current : 1.5A/phase,
 5-phase excitation (full step)
 $J_{L1} = [7.4 \times 10^{-4} \text{kg} \cdot \text{m}^2 (40.46 \text{oz} \cdot \text{in}^2)]$ use the rubber coupling]
 $J_{L2} = [7.4 \times 10^{-4} \text{kg} \cdot \text{m}^2 (40.46 \text{oz} \cdot \text{in}^2)]$ use the direct coupling]



5-phase stepping motor

60mm cir. (2.36inch cir.)

103H752 □ - □□□□
0.72° /step

Model		Holding torque at 5-phase energization	Rated current	Wiring resistance	Winding inductance	Rotor inertia	Mass (Weight)
Single shaft	Double shafts	[N · m (oz · in) MIN.]	A/phase	Ω /phase	mH/phase	[×10 ⁻⁴ kg · m ² (oz · in ²)]	[kg (lbs)]
103H7521-7051	-7021	0.46 (65.1)	0.75	2.4	4.3	0.148 (0.81)	0.51 (1.12)
103H7521-8051	-8021	0.46 (65.1)	1.5	0.6	1.1	0.148 (0.81)	0.51 (1.12)
103H7522-7051	-7021	0.735 (104.1)	0.75	3.3	7.5	0.18 (0.98)	0.6 (1.32)
103H7522-8051	-8021	0.735 (104.1)	1.5	0.75	2	0.18 (0.98)	0.6 (1.32)
103H7523-7051	-7021	1.568 (222.0)	0.75	5.2	21	0.423 (2.31)	1.1 (2.43)
103H7523-8051	-8021	1.568 (222.0)	1.5	1.4	5.4	0.423 (2.31)	1.1 (2.43)

Pulse rate-torque characteristics

■ 103H7521-70 □□

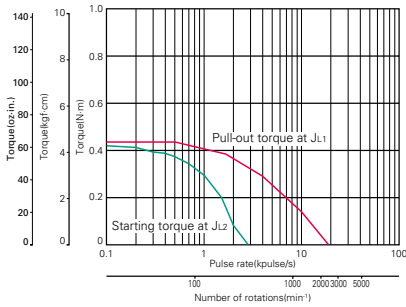

Constant current circuit
Source voltage: DC24V·operating current : 0.75A/phase,
5-phase excitation (full step)
J₁=[0.94×10⁻⁴kg·m²(5.14oz·in²) use the rubber coupling]
J₂=[0.51×10⁻⁴kg·m²(2.79oz·in²) pulley balancer system]

■ 103H7521-80 □□

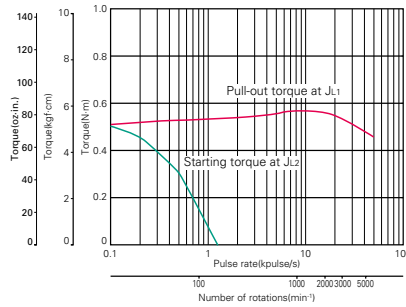

Constant current circuit
Source voltage: AC100V·operating current : 1.5A/phase,
5-phase excitation (full step)
J₁=[0.94×10⁻⁴kg·m²(5.14oz·in²) use the rubber coupling]
J₂=[0.8×10⁻⁴kg·m²(4.37oz·in²) use the direct coupling]

■ 103H7522-70 □□

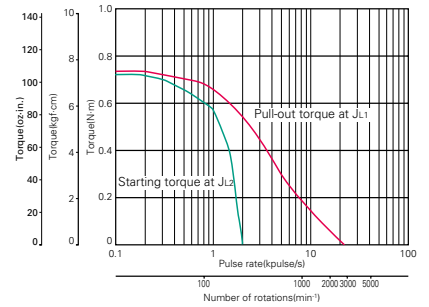

Constant current circuit
Source voltage: DC24V·operating current : 0.75A/phase,
5-phase excitation (full step)
J₁=[2.6×10⁻⁴kg·m²(14.22oz·in²) use the rubber coupling]
J₂=[0.6×10⁻⁴kg·m²(3.28oz·in²) pulley balancer system]

■ 103H7522-80 □□

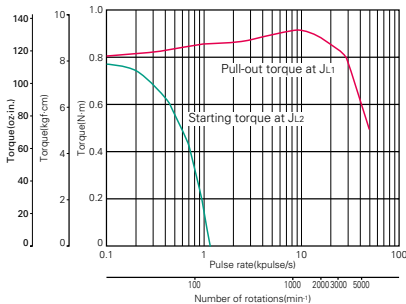

Constant current circuit
Source voltage: AC100V·operating current : 1.5A/phase,
5-phase excitation (full step)
J₁=[2.6×10⁻⁴kg·m²(14.22oz·in²) use the rubber coupling]
J₂=[2.6×10⁻⁴kg·m²(14.22oz·in²) use the direct coupling]

■ 103H7523-70 □□

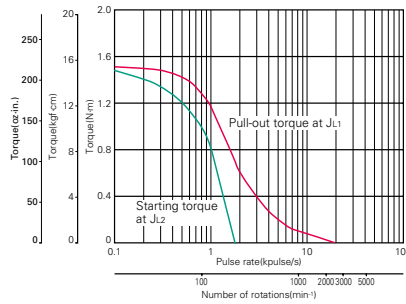

Constant current circuit
Source voltage: DC24V·operating current : 0.75A/phase,
5-phase excitation (full step)
J₁=[7.4×10⁻⁴kg·m²(40.46oz·in²) use the rubber coupling]
J₂=[1.1×10⁻⁴kg·m²(6.01oz·in²) pulley balancer system]

■ 103H7523-80 □□

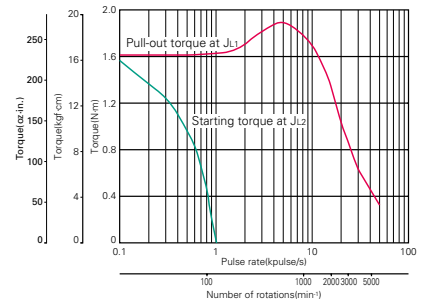

Constant current circuit
Source voltage: AC100V·operating current : 1.5A/phase,
5-phase excitation (full step)
J₁=[7.4×10⁻⁴kg·m²(40.46oz·in²) use the rubber coupling]
J₂=[7.4×10⁻⁴kg·m²(40.46oz·in²) use the direct coupling]



5-phase stepping motor

86mm cir. (3.39inch cir.)

103H858 □ - □□□□

0.72° /step

Model		Holding torque at 5-phase energization	Rated current	Wiring resistance	Winding inductance	Rotor inertia	Mass (Weight)
Single shaft	Double shafts	[N · m (oz · in) MIN.]	A/phase	Ω /phase	mH/phase	[$\times 10^{-4}$ kg · m ² (oz · in ²)]	[kg (lbs)]
103H8581-7041	-7011	2.06 (291.7)	0.75	5.7	25	1.45 (7.93)	1.5 (3.31)
103H8581-8041	-8011	2.06 (291.7)	1.5	1.5	5.6	1.45 (7.93)	1.5 (3.31)
103H8582-7041	-7011	4.02 (569.3)	0.75	8.6	41	2.9 (15.86)	2.5 (5.51)
103H8582-8041	-8011	4.02 (569.3)	1.5	2	10.6	2.9 (15.86)	2.5 (5.51)
103H8583-7041	-7011	6.17 (873.7)	0.75	10.5	59	4.4 (24.06)	3.5 (7.72)
103H8583-8041	-8011	6.17 (873.7)	1.5	2.5	15	4.4 (24.06)	3.5 (7.72)

Pulse rate-torque characteristics

■ 103H8581-70 □□

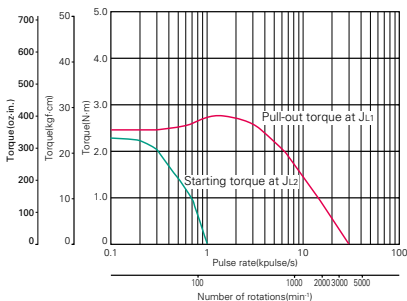

Constant current circuit
 Source voltage : AC100V · operating current : 0.75A/phase,
 5-phase excitation (full step)
 $J_{L1} = [7.4 \times 10^{-4} \text{kg} \cdot \text{m}^2 (40.46 \text{oz} \cdot \text{in}^2)]$ use the rubber coupling)
 $J_{L2} = [1.45 \times 10^{-4} \text{kg} \cdot \text{m}^2 (7.93 \text{oz} \cdot \text{in}^2)]$ pulley balancer system

■ 103H8581-80 □□

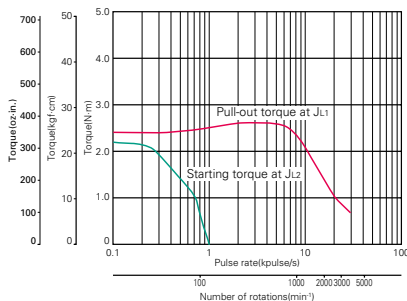

Constant current circuit
 Source voltage : AC100V · operating current : 1.5A/phase,
 5-phase excitation (full step)
 $J_{L1} = [7.4 \times 10^{-4} \text{kg} \cdot \text{m}^2 (40.46 \text{oz} \cdot \text{in}^2)]$ use the rubber coupling)
 $J_{L2} = [1.45 \times 10^{-4} \text{kg} \cdot \text{m}^2 (7.93 \text{oz} \cdot \text{in}^2)]$ pulley balancer system

■ 103H8582-70 □□

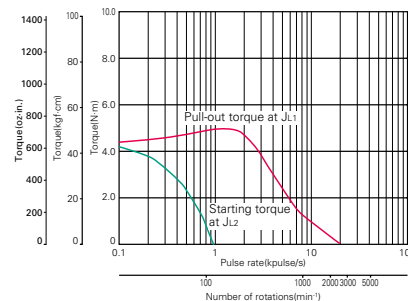

Constant current circuit
 Source voltage : AC100V · operating current : 0.75A/phase,
 5-phase excitation (full step)
 $J_{L1} = [15.3 \times 10^{-4} \text{kg} \cdot \text{m}^2 (83.65 \text{oz} \cdot \text{in}^2)]$ use the rubber coupling)
 $J_{L2} = [2.9 \times 10^{-4} \text{kg} \cdot \text{m}^2 (15.86 \text{oz} \cdot \text{in}^2)]$ pulley balancer system

■ 103H8582-80 □□

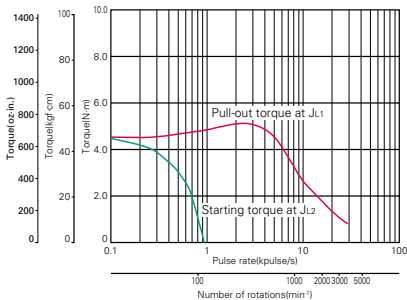

Constant current circuit
 Source voltage : AC100V · operating current : 1.5A/phase,
 5-phase excitation (full step)
 $J_{L1} = [15.3 \times 10^{-4} \text{kg} \cdot \text{m}^2 (83.65 \text{oz} \cdot \text{in}^2)]$ use the rubber coupling)
 $J_{L2} = [2.9 \times 10^{-4} \text{kg} \cdot \text{m}^2 (15.86 \text{oz} \cdot \text{in}^2)]$ pulley balancer system

■ 103H8583-70 □□

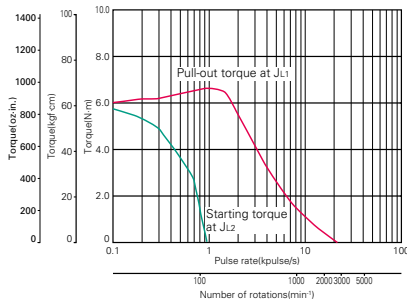

Constant current circuit
 Source voltage : AC100V · operating current : 0.75A/phase,
 5-phase excitation (full step)
 $J_{L1} = [43 \times 10^{-4} \text{kg} \cdot \text{m}^2 (235.10 \text{oz} \cdot \text{in}^2)]$ use the rubber coupling)
 $J_{L2} = [4.4 \times 10^{-4} \text{kg} \cdot \text{m}^2 (24.06 \text{oz} \cdot \text{in}^2)]$ pulley balancer system

■ 103H8583-80 □□

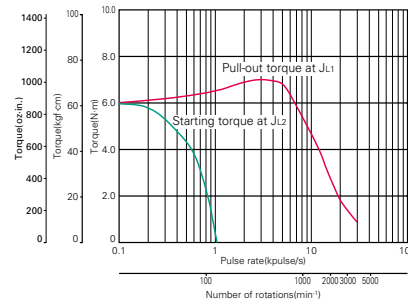

Constant current circuit
 Source voltage : AC100V · operating current : 1.5A/phase,
 5-phase excitation (full step)
 $J_{L1} = [43 \times 10^{-4} \text{kg} \cdot \text{m}^2 (235.10 \text{oz} \cdot \text{in}^2)]$ use the rubber coupling)
 $J_{L2} = [4.4 \times 10^{-4} \text{kg} \cdot \text{m}^2 (24.06 \text{oz} \cdot \text{in}^2)]$ pulley balancer system



5-phase stepping motor

106mm cir. (4.17inch cir.)

103H8958 □ - □□□□
0.72° /step

Model		Holding torque at 5-phase energization	Rated current	Wiring resistance	Winding inductance	Rotor inertia	Mass (Weight)
Single shaft	Double shafts	[N · m (oz · in) MIN.]	A/phase	Ω /phase	mH/phase	[×10 ⁻⁴ kg · m ² (oz · in ²)]	[kg (lbs)]
103H89582-7041	-7011	10.8 (1529.4)	0.75	9	90	14.6 (79.83)	7.5 (16.53)
103H89582-8041	-8011	10.8 (1529.4)	1.5	2	26	14.6 (79.83)	7.5 (16.53)
103H89583-7041	-7011	16 (2265.7)	0.75	12.5	125	22 (120.28)	10.5 (23.15)
103H89583-8041	-8011	16 (2265.7)	1.5	2.9	33.4	22 (120.28)	10.5 (23.15)

Pulse rate-torque characteristics

103H89582-70 □□

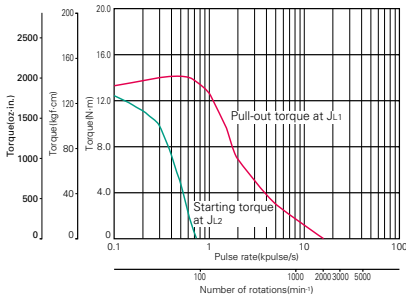

Constant current circuit
Source voltage: AC100V·operating current: 0.75A/phase, 5-phase excitation (full step)
J₁=[43x10⁻⁴kg·m²(235.10oz·in²) use the rubber coupling]
J₂=[43x10⁻⁴kg·m²(235.10oz·in²) use the rubber coupling]

103H89582-80 □□

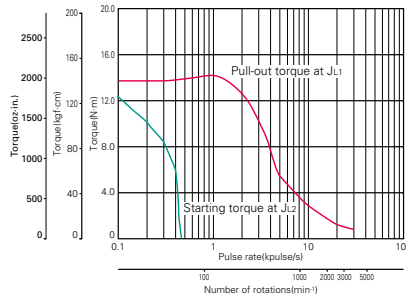

Constant current circuit
Source voltage: AC100V·operating current: 1.5A/phase, 5-phase excitation (full step)
J₁=[43x10⁻⁴kg·m²(235.10oz·in²) use the rubber coupling]
J₂=[43x10⁻⁴kg·m²(235.10oz·in²) use the rubber coupling]

103H89583-70 □□

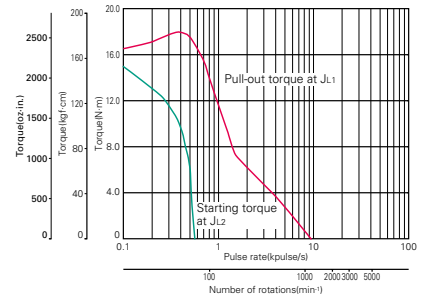

Constant current circuit
Source voltage: AC100V·operating current: 0.75A/phase, 5-phase excitation (full step)
J₁=[43x10⁻⁴kg·m²(235.10oz·in²) use the rubber coupling]
J₂=[43x10⁻⁴kg·m²(235.10oz·in²) use the rubber coupling]

103H89583-80 □□

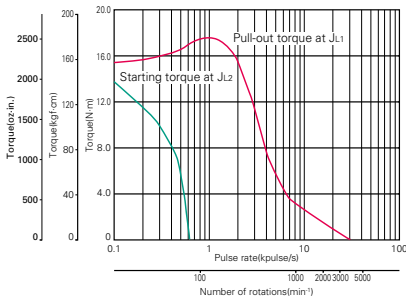

Constant current circuit
Source voltage: AC100V·operating current: 1.5A/phase, 5-phase excitation (full step)
J₁=[43x10⁻⁴kg·m²(235.10oz·in²) use the rubber coupling]
J₂=[43x10⁻⁴kg·m²(235.10oz·in²) use the rubber coupling]



5-phase stepping motor

60mm cir. (2.36inch cir.)

103H752 -6

CE marked

0.72° /step



AC input

Input / Output signal standard

Model		Holding torque at 5-phase energization	Rated current	Wiring resistance	Winding inductance	Rotor inertia	Mass (Weight)
Single shaft	Double shafts	[N · m (oz · in) MIN.]	A/phase	Ω /phase	mH/phase	[×10 ⁻⁴ kg · m ² (oz · in ²)]	[kg (lbs)]
103H7521-6050	-6020	0.46 (65.1)	0.75	2.4	4.3	0.148 (0.81)	0.51 (1.12)
103H7521-6250	-6220	0.46 (65.1)	1.5	0.6	1.1	0.148 (0.81)	0.51 (1.12)
103H7522-6050	-6020	0.735 (104.1)	0.75	3.3	7.5	0.18 (0.98)	0.6 (1.32)
103H7522-6250	-6220	0.735 (104.1)	1.5	0.75	2	0.18 (0.98)	0.6 (1.32)
103H7523-6050	-6020	1.568 (222.0)	0.75	5.2	21	0.423 (2.31)	1.1 (2.43)
103H7523-6250	-6220	1.568 (222.0)	1.5	1.4	5.4	0.423 (2.31)	1.1 (2.43)

Pulse rate-torque characteristics

103H7521-60

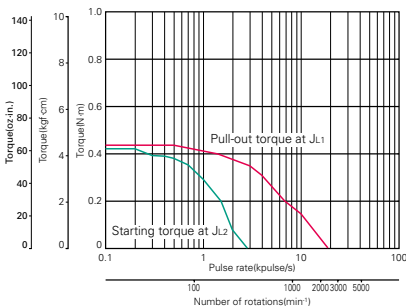

Constant current circuit
 Source voltage : DC24V · operating current : 0.75A/phase,
 5-phase excitation (full step)
 $J_{11} = [0.94 \times 10^{-4} \text{kg} \cdot \text{m}^2 (5.14 \text{oz} \cdot \text{in}^2)]$ use the rubber coupling]
 $J_{12} = [0.51 \times 10^{-4} \text{kg} \cdot \text{m}^2 (2.79 \text{oz} \cdot \text{in}^2)]$ pulley balancer system]

103H7521-62

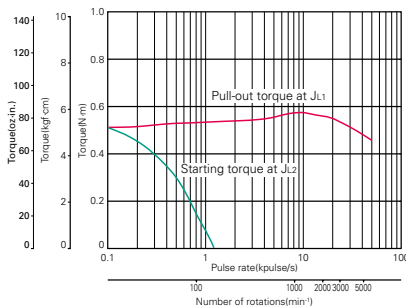

Constant current circuit
 Source voltage : AC100V · operating current : 1.5A/phase,
 5-phase excitation (full step)
 $J_{11} = [0.94 \times 10^{-4} \text{kg} \cdot \text{m}^2 (5.14 \text{oz} \cdot \text{in}^2)]$ use the rubber coupling]
 $J_{12} = [0.8 \times 10^{-4} \text{kg} \cdot \text{m}^2 (4.37 \text{oz} \cdot \text{in}^2)]$ use the direct coupling]

103H7522-60

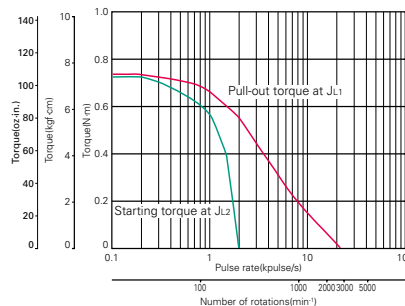

Constant current circuit
 Source voltage : DC24V · operating current : 0.75A/phase,
 5-phase excitation (full step)
 $J_{11} = [2.6 \times 10^{-4} \text{kg} \cdot \text{m}^2 (14.22 \text{oz} \cdot \text{in}^2)]$ use the rubber coupling]
 $J_{12} = [0.6 \times 10^{-4} \text{kg} \cdot \text{m}^2 (3.28 \text{oz} \cdot \text{in}^2)]$ pulley balancer system]

103H7522-62

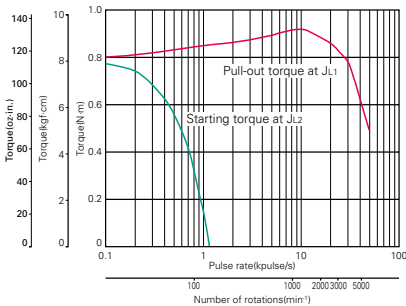

Constant current circuit
 Source voltage : AC100V · operating current : 1.5A/phase,
 5-phase excitation (full step)
 $J_{11} = [2.6 \times 10^{-4} \text{kg} \cdot \text{m}^2 (14.22 \text{oz} \cdot \text{in}^2)]$ use the rubber coupling]
 $J_{12} = [2.6 \times 10^{-4} \text{kg} \cdot \text{m}^2 (14.22 \text{oz} \cdot \text{in}^2)]$ use the direct coupling]

103H7523-60

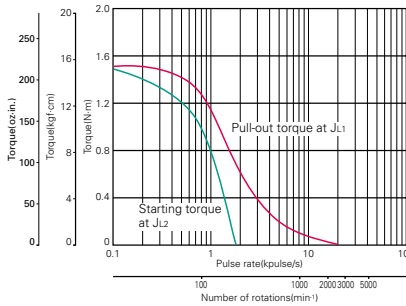

Constant current circuit
 Source voltage : DC24V · operating current : 0.75A/phase,
 5-phase excitation (full step)
 $J_{11} = [7.4 \times 10^{-4} \text{kg} \cdot \text{m}^2 (40.46 \text{oz} \cdot \text{in}^2)]$ use the rubber coupling]
 $J_{12} = [1.1 \times 10^{-4} \text{kg} \cdot \text{m}^2 (6.01 \text{oz} \cdot \text{in}^2)]$ pulley balancer system]

103H7523-62

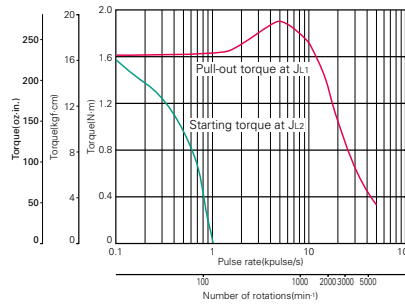

Constant current circuit
 Source voltage : AC100V · operating current : 1.5A/phase,
 5-phase excitation (full step)
 $J_{11} = [7.4 \times 10^{-4} \text{kg} \cdot \text{m}^2 (40.46 \text{oz} \cdot \text{in}^2)]$ use the rubber coupling]
 $J_{12} = [7.4 \times 10^{-4} \text{kg} \cdot \text{m}^2 (40.46 \text{oz} \cdot \text{in}^2)]$ use the direct coupling]

DC input

Stepping motor

Dimensions



5-phase stepping motor

86mm cir. (3.39inch cir.)

103H858 □ -6 □ □ □

CE marked

0.72° /step



Model	Holding torque at 5-phase energization	Rated current	Wiring resistance	Winding inductance	Rotor inertia	Mass (Weight)
Single shaft	Double shafts	[N · m (oz · in) MIN.]	A/phase	Ω /phase	mH/phase	[×10 ⁻⁴ kg · m ² (oz · in ²)] [kg (lbs)]
103H8581-6050	-6020	2.06 (291.7)	0.75	5.7	25	1.45 (7.93) 1.5 (3.31)
103H8581-6250	-6220	2.06 (291.7)	1.5	1.5	5.6	1.45 (7.93) 1.5 (3.31)
103H8582-6050	-6020	4.02 (569.3)	0.75	8.6	41	2.9 (15.86) 2.5 (5.51)
103H8582-6250	-6220	4.02 (569.3)	1.5	2	10.6	2.9 (15.86) 2.5 (5.51)
103H8583-6050	-6020	6.17 (873.7)	0.75	10.5	59	4.4 (24.06) 3.5 (7.72)
103H8583-6250	-6220	6.17 (873.7)	1.5	2.5	15	4.4 (24.06) 3.5 (7.72)

Pulse rate-torque characteristics

103H8581-60 □ □ □

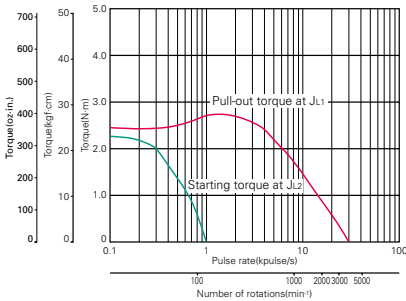

Constant current circuit
Source voltage : AC100V·operating current:0.75A/phase, 5-phase excitation (full step)
J₁=[7.4×10⁻⁴kg·m²(40.46oz·in²) use the rubber coupling]
J₂=[1.45×10⁻⁴kg·m²(7.93oz·in²) pulley balancer system]

103H8581-62 □ □ □

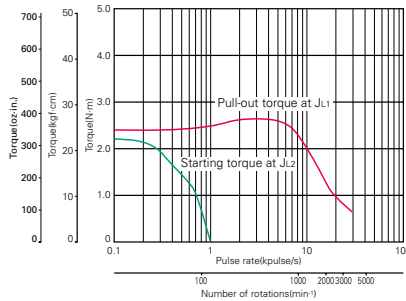

Constant current circuit
Source voltage : AC100V·operating current :1.5A/phase, 5-phase excitation (full step)
J₁=[7.4×10⁻⁴kg·m²(40.46oz·in²) use the rubber coupling]
J₂=[1.45×10⁻⁴kg·m²(7.93oz·in²) pulley balancer system]

103H8582-60 □ □ □

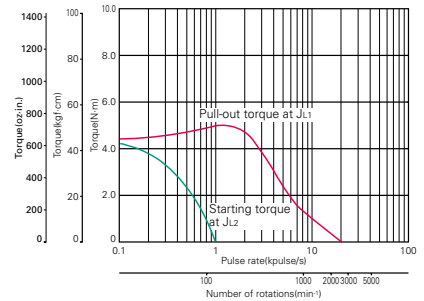

Constant current circuit
Source voltage : AC100V·operating current :0.75A/phase, 5-phase excitation (full step)
J₁=[15.3×10⁻⁴kg·m²(83.65oz·in²) use the rubber coupling]
J₂=[2.9×10⁻⁴kg·m²(15.86oz·in²) pulley balancer system]

103H8582-62 □ □ □

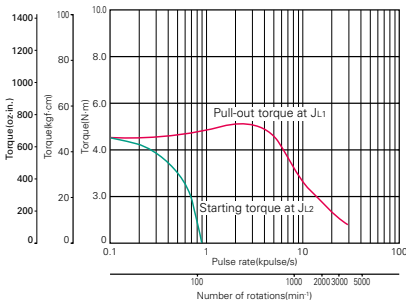

Constant current circuit
Source voltage : AC100V · operating current :1.5A/phase, 5-phase excitation (full step)
J₁=[15.3×10⁻⁴kg·m²(83.65oz·in²) use the rubber coupling]
J₂=[2.9×10⁻⁴kg·m²(15.86oz·in²) pulley balancer system]

103H8583-60 □ □ □

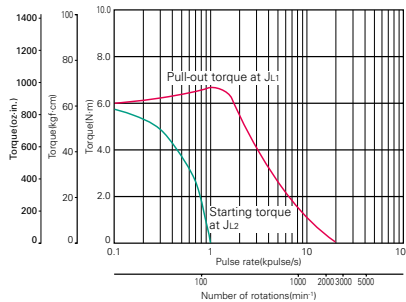

Constant current circuit
Source voltage : AC100V·operating current :0.75A/phase, 5-phase excitation (full step)
J₁=[43×10⁻⁴kg·m²(235.10oz·in²) use the rubber coupling]
J₂=[4.4×10⁻⁴kg·m²(24.06oz·in²) pulley balancer system]

103H8583-62 □ □ □

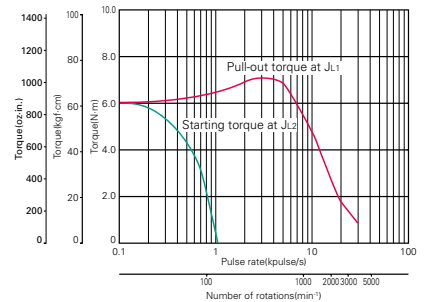

Constant current circuit
Source voltage : AC100V·operating current :1.5A/phase, 5-phase excitation (full step)
J₁=[43×10⁻⁴kg·m²(235.10oz·in²) use the rubber coupling]
J₂=[4.4×10⁻⁴kg·m²(24.06oz·in²) pulley balancer system]

5-phase stepping motor

106mm cir. (4.17inch cir.)

103H8958 □ -6 □ □ □

CE marked

0.72° /step



AC input

Input / Output signal standard

Model		Holding torque at 5-phase energization	Rated current	Wiring resistance	Winding inductance	Rotor inertia	Mass (Weight)
Single shaft	Double shafts	[N · m (oz · in) MIN.]	A/phase	Ω /phase	mH/phase	[×10 ⁻⁴ kg · m ² (oz · in ²)]	[kg (lbs)]
103H89582-6050	-6020	10.8 (1529.4)	0.75	9	90	14.6 (79.83)	7.5 (16.53)
103H89582-6250	-6220	10.8 (1529.4)	1.5	2	26	14.6 (79.83)	7.5 (16.53)
103H89583-6050	-6020	16 (2265.7)	0.75	12.5	125	22 (120.28)	10.5 (23.15)
103H89583-6250	-6220	16 (2265.7)	1.5	2.9	33.4	22 (120.28)	10.5 (23.15)

Pulse rate-torque characteristics

103H89582-60 □ □ □

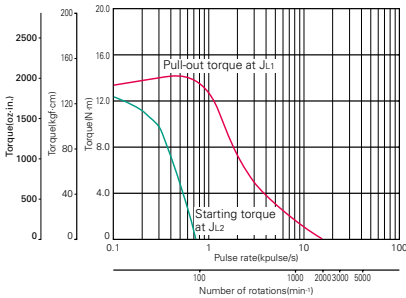

Constant current circuit
 Source voltage : AC100V·operating current : 0.75A/phase,
 5-phase excitation (full step)
 $J_{1.1} = [43 \times 10^{-4} \text{kg} \cdot \text{m}^2 (235.10 \text{oz} \cdot \text{in}^2)]$ use the rubber coupling]
 $J_{1.2} = [43 \times 10^{-4} \text{kg} \cdot \text{m}^2 (235.10 \text{oz} \cdot \text{in}^2)]$ use the rubber coupling]

103H89582-62 □ □ □

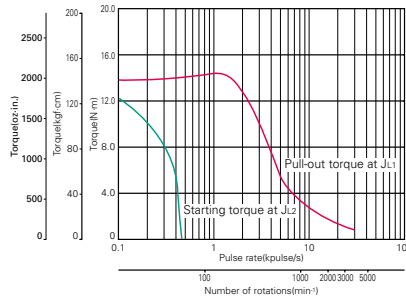

Constant current circuit
 Source voltage : AC100V·operating current : 1.5A/phase,
 5-phase excitation (full step)
 $J_{1.1} = [43 \times 10^{-4} \text{kg} \cdot \text{m}^2 (235.10 \text{oz} \cdot \text{in}^2)]$ use the rubber coupling]
 $J_{1.2} = [43 \times 10^{-4} \text{kg} \cdot \text{m}^2 (235.10 \text{oz} \cdot \text{in}^2)]$ use the rubber coupling]

103H89583-60 □ □ □

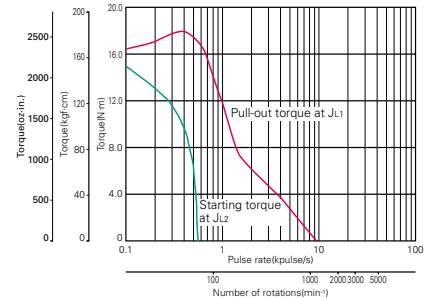

Constant current circuit
 Source voltage : AC100V·operating current : 0.75A/phase,
 5-phase excitation (full step)
 $J_{1.1} = [43 \times 10^{-4} \text{kg} \cdot \text{m}^2 (235.10 \text{oz} \cdot \text{in}^2)]$ use the rubber coupling]
 $J_{1.2} = [43 \times 10^{-4} \text{kg} \cdot \text{m}^2 (235.10 \text{oz} \cdot \text{in}^2)]$ use the rubber coupling]

103H89583-62 □ □ □

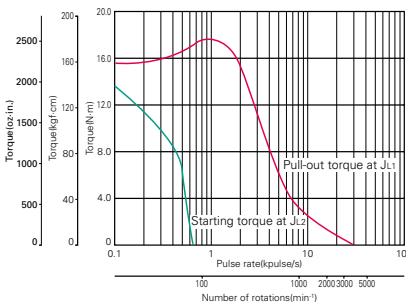

Constant current circuit
 Source voltage : AC100V·operating current : 1.5A/phase,
 5-phase excitation (full step)
 $J_{1.1} = [43 \times 10^{-4} \text{kg} \cdot \text{m}^2 (235.10 \text{oz} \cdot \text{in}^2)]$ use the rubber coupling]
 $J_{1.2} = [43 \times 10^{-4} \text{kg} \cdot \text{m}^2 (235.10 \text{oz} \cdot \text{in}^2)]$ use the rubber coupling]

DC input

Stepping motor

Dimensions

Allowable radial / thrust load

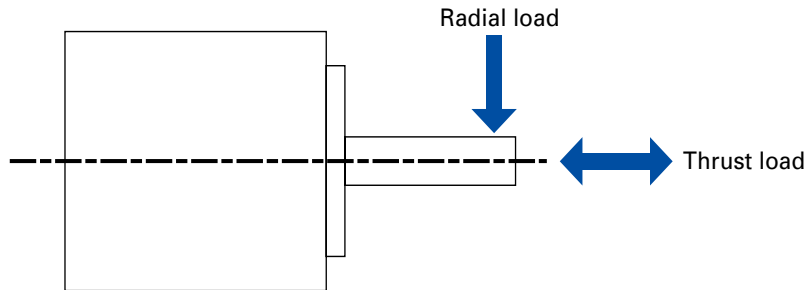

unit = upper section : N / lower berth : lbs

Frange size	Model number	Distance from end of shaft : mm (inch)				Thrust load : N (lbs)
		0 (0)	5 (0.2)	10 (2.25)	15 (3.38)	
		Radial load : N (lbs)				
□ 28mm (□ 1.10 inch)	103H35 □□ (3515-7040)	30 (1.18)	39 (1.54)	53 (2.09)	84 (3.31)	3 (0.12)
		6 (0.24)	8 (0.31)	11 (0.43)	18 (0.71)	0.67 (0.03)
□ 28mm (□ 1.10 inch)	103F35 □□ (3515-7041)	39 (1.54)	53 (2.09)	84 (3.31)	—	3 (0.12)
		8 (0.31)	11 (0.43)	18 (0.71)	—	0.67 (0.03)
□ 39mm (□ 1.54 inch)	103-45 □□ (4510-7040)	26 (1.02)	33 (1.3)	42 (1.65)	60 (2.36)	10 (2.25)
		5 (0.2)	7 (0.28)	9 (0.35)	13 (0.51)	2.25 (0.09)
□ 42mm (□ 1.65 inch)	103H55 □□ 103F55 □□ (F5510-7041)	29 (1.14)	36 (1.42)	49 (1.93)	52 (2.05)	10 (2.25)
		6 (0.24)	8 (0.31)	11 (0.43)	11 (0.43)	2.25 (0.09)
□ 50mm (□ 1.97 inch)	103H65 □□	71 (2.8)	87 (3.43)	115 (4.53)	167 (6.57)	15 (3.38)
		15 (0.59)	19 (0.75)	25 (0.98)	37 (1.46)	3.37 (0.13)
φ 60mm (φ 2.36 inch)	103H75 □□ 103-75 □□	94 (3.7)	116 (4.57)	153 (6.02)	222 (8.74)	15 (3.38)
		21 (0.83)	26 (1.02)	34 (1.34)	49 (1.93)	3.37 (0.13)
		68 (2.68)	85 (3.35)	113 (4.45)	166 (6.54)	15 (3.38)
□ 60mm (□ 2.36 inch)	103H78 □□ 103F78 □□ 103M78 □□	15 (0.59)	19 (0.75)	25 (0.98)	37 (1.46)	3.37 (0.13)
		70 (2.76)	87 (3.43)	114 (4.49)	165 (6.5)	20 (0.79)
		62 (2.44)	75 (2.95)	94 (3.7)	127 (5)	20 (0.79)
φ 86mm (φ 3.39 inch)	103H85 □□ 103F85 □□ 103M85 □□	13 (0.51)	16 (0.63)	21 (0.83)	28 (1.1)	4.50 (0.18)
		191 (7.52)	234 (9.21)	301 (11.85)	421 (16.57)	60 (2.36)
		42 (1.65)	52 (2.05)	67 (2.64)	94 (3.7)	13.488 (0.53)
		350 (13.78)	424 (16.69)	535 (21.06)	726 (28.58)	60 (2.36)
φ 106mm (φ 4.17 inch)	103H895 □□ 103F895 □□ 103M895 □□	78 (3.07)	95 (3.74)	120 (4.72)	163 (6.42)	13.488 (0.53)
		321 (12.64)	356 (14.02)	401 (15.79)	457 (18)	100 (3.94)
		72 (2.83)	80 (3.15)	90 (3.54)	102 (4.02)	22.48 (0.89)
		—	—	—	—	—

General specifications

	103H35 □□	103H55 □□	103H650 □	103H752 □	103H785 □	103H858 □	103H8958 □	103-45 □□	103-7556
Insulation class	Class B (130°C)								
Insulation resistance	Not less than 100M Ω between winding and frame by DC500V megger at normal temperature and humidity.								
Withstand voltage	Without abnormality when applying 50/60Hz,1000V AC (500V AC for 103H35 □□ and 103H55 □□) for 1 minute (leakage current 1mA) between winding and frame at normal temperature and humidity.				Without abnormality when applying 50/60Hz,1000V AC (500V AC for 103-45 □□) for 1 minute (leakage current 1mA) between winding and frame at normal temperature and humidity.				
Operating environment	Ambient temperature -10°C to +50°C								
	Ambient humidity 20% to 90%								
Wiring temperature increase	80K MAX. (based on Sanyo Denki standard)								
Standing angle error	± 0.09°	± 0.09°	± 0.09°	± 0.09°	± 0.09°	± 0.09°	± 0.09°	± 0.04°	± 0.09°
Axial play	0.075mm (0.002952inch)	0.075mm (0.002952inch)	0.075mm (0.002952inch)	0.075mm (0.002952inch)	0.075mm (0.002952inch)	0.075mm (0.002952inch)	0.075mm (0.002952inch)	0.075mm (0.002952inch)	0.075mm (0.002952inch)
	MAX., Load 4.4N (1lbs)	MAX., Load 4.4N (1lbs)	MAX., Load 9N (2lbs)	MAX., Load 9N (2lbs)	MAX., Load 9N (2lbs)	MAX., Load 9N (2lbs)	MAX., Load 9N (2lbs)	MAX., Load 9N (2lbs)	MAX., Load 4.4N (1lbs)
Radial play (Note 1)	0.025mm (0.00098inch) MAX., Load 4.4N (1lbs)								
Shaft runout	0.025mm (0.00098inch)								
Inserted part concentricity against shaft	*0.05mm (0.00197inch)	*0.05mm (0.00197inch)	*0.075mm (0.00295inch)	*0.075mm (0.00295inch)	*0.075mm (0.00295inch)	*0.075mm (0.00295inch)	*0.075mm (0.00295inch)	*0.05mm (0.00197inch)	*0.075mm (0.00295inch)
Fitted surface angularity against shaft	0.1mm (0.00394inch)	0.1mm (0.00394inch)	0.075mm (0.00295inch)	0.075mm (0.00295inch)	0.075mm (0.00295inch)	0.075mm (0.00295inch)	0.075mm (0.00295inch)	0.075mm (0.00295inch)	0.075mm (0.00295inch)

(Note1) When load is applied at 1/3 length from output shaft edge.

General specifications (models to CE marking)

	103H752 □	103H858 □	103H8958 □
Rated voltage	DC12-200V	DC12-300V	
Applied standards (Low voltage directive)	EN60034-1, IEC34-5 (EN60034-5) , EN60204-1, EN60950, EN61010-1		
Specification type	S1 (continuous running duty type)		
Protection grade	IP43		
Protection class	Class I		
Operating environment	Pollution degree 2		
Insulation class	Class B (130°C)		
Insulation resistance	Not less than 100M Ω between winding and frame by DC500V megger at normal temperature and humidity.		
Withstand voltage	Without abnormality when applying 50/60Hz, 1600V AC (1500kV AC for 103H752 □) for 1 minute (leakage current 10mA) between winding and frame at normal temperature and humidity.		
Operating environment	Ambient temperature -10°C to +50°C		
	Ambient humidity 20% to 90% (no condensation)		
Wiring temperature increase	80K MAX. (Based on Sanyo Denki standard)		
Standing angle error	± 0.09°	± 0.09°	± 0.09°
Axial play	0.075mm (0.002952inch) MAX., Load 9N (2lbs)		
Radial play (Note 1)	0.075mm (0.002952inch) MAX., Load 4.4N (1lbs)		
Shaft runout	0.025mm (0.00098inch)		
Inserted part concentricity against shaft	*0.075 mm (0.00295inch)	*0.075 mm (0.00295inch)	*0.075 mm (0.00295inch)
Fitted surface angularity against shaft	0.075 mm (0.00295inch)	0.075 mm (0.00295inch)	0.075 mm (0.00295inch)

(Note 1) When load is applied at 1/3 length from output shaft edge.

Internal wire connection and direction of motor rotate

Internal wire connection

Connector pin number in the parentheses

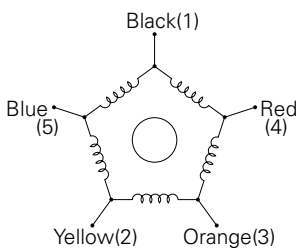

Direction of motor rotate

The direction of motor rotate is counterclockwise when viewed from the output shaft side at the direct current energization in the following order.

Type	Exciting order									
	1	2	3	4	5	6	7	8	9	10
Color of leads	Black	(1)	-	-	-	-	+	+	+	+
	Red	(4)	-	+	+	+	-	-	-	-
	Orange	(3)	+	-	-	-	-	+	+	+
	Yellow	(2)	-	-	+	+	+	+	-	-
	Blue	(5)	+	+	+	-	-	-	-	+

Standard model / CE/UL model

[Unit : mm (inch)]

□ 28mm (□ 1.10inch)

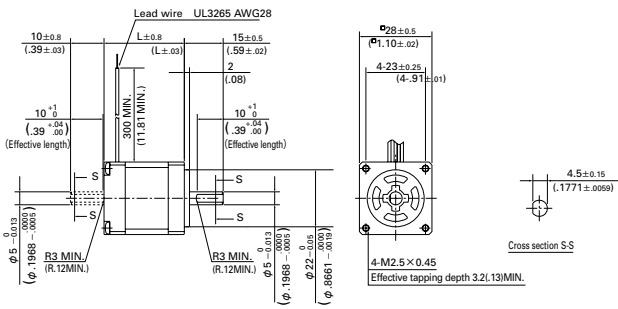

Set part number	Motor model number	Motor length (L) : mm (inch)
F □ F351 △	103F3505-70 △ 1	31 (1.22)
F □ F356 △	103F3515-70 △ 1	50.5 (1.99)
FD F351 △	103F3505-74 △ 1	31 (1.22)
FD F356 △	103F3515-74 △ 1	50.5 (1.99)

□ : Driver specifications

Motor shaft spec	Set type code
AC Power source Standard type	S
AC Power source Positioning function included type	P
DC Power source Standard type	D

■ : Motor specifications

Motor shaft spec	Set type code
F Series motor	F
M Series motor (CE · UL)	M

△ : Motor shaft specification code

Motor shaft spec	Set type code	Motor type code
Single shaft	S	4
Double shaft	D	1

▲ : Motor shaft specification code

Motor shaft spec	Set type code	Motor type code
Single shaft	S	7
Double shaft	D	2

▼ : Motor shaft specification code

	Set type code	Motor type code
Single shaft	S	5
Double shaft	D	2

◆ : Rated current

0.75A	0
1.5A	2

◇ : Motor shaft specification code

Motor shaft spec	Set type code	Motor type code
Single shaft	S	5
Double shaft	D	2

● : Rated current

0.75A	7
1.5A	8

□ 28mm (Lead wire type)

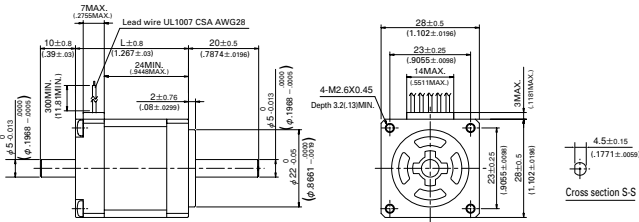

Set part number	Motor model number	Motor length (L) : mm (inch)
—	103H3505-70 ▲ 0	32.2 (1.27)
—	103H3515-70 ▲ 0	51.4 (2.02)

□ 28mm (Connector type)

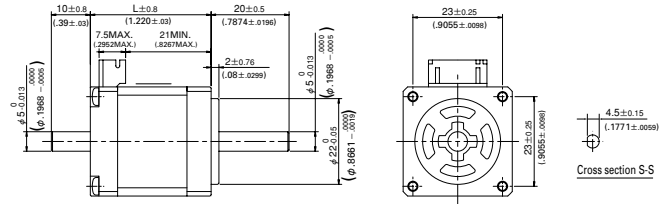

Set part number	Motor model number	Motor length (L) : mm (inch)
—	103H3505-70 △ 0	31 (1.22)
—	103H3515-70 △ 0	50.2 (1.98)

□ 39mm (□ 1.54inch)

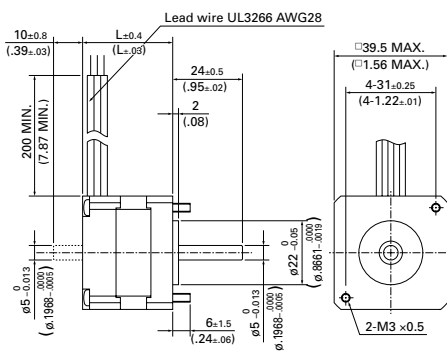

Set part number	Motor model number	Motor length : mm (inch)
—	103-4505-70 △ 0	31 (1.22)
—	103-4507-70 △ 0	35.2 (1.39)
—	103-4510-70 △ 0	44.3 (1.74)

□ 42mm (□ 1.65inch)

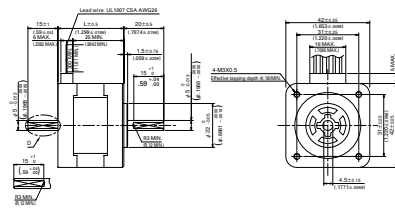
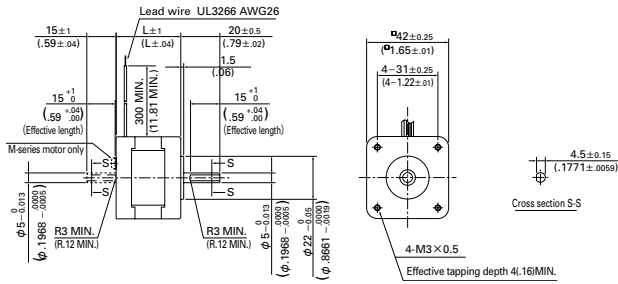

Set part number	Motor model number	Motor length (L) : mm (inch)
F □ F551 △	103 ■ 5505-70 △ 1	34 (1.34)
F □ F552 △	103 ■ 5508-70 △ 1	40 (1.57)
F □ F554 △	103 ■ 5510-70 △ 1	49 (1.93)
FD F551 △	103 F5505-82 △ 1	34 (1.34)
FD F552 △	103 F5508-82 △ 1	40 (1.57)
FD F554 △	103 F5510-82 △ 1	49 (1.93)

Set part number	Motor model number	Motor length (L) : mm (inch)
—	103H5505-70 △ 0	33 (1.3)
—	103H5508-70 △ 0	39 (1.54)
—	103H5510-70 △ 0	48 (1.89)

□ 60mm (□ 2.36inch)

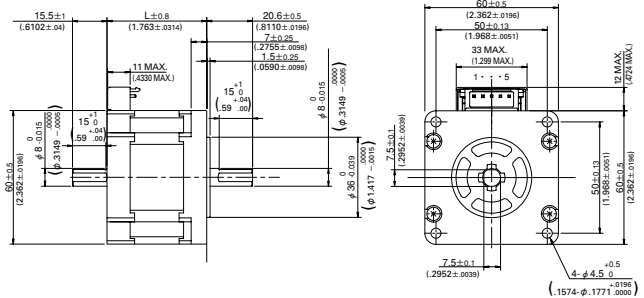
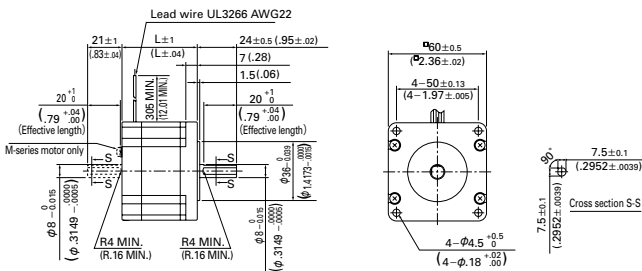

Set part number	Motor model number	Motor length (L) : mm (inch)
F □ F781 △	103 ■ 7851-70 △ 1	46.5 (1.83)
F □ F782 △	103 ■ 7852-70 △ 1	55 (2.17)
F □ F783 △	103 ■ 7853-70 △ 1	87.5 (3.44)
FD F781 △	103 F7851-82 △ 1	46.5 (1.83)
FD F782 △	103 F7852-82 △ 1	55 (2.17)
FD F783 △	103 F7853-82 △ 1	87.5 (3.44)

Set part number	Motor model number	Motor length (L) : mm (inch)
—	103H7851-● 0 △ 1	44.8 (1.76)
—	103H7852-● 0 △ 1	53.8 (2.1)
—	103H7853-● 0 △ 1	85.8 (3.38)

φ 60mm (φ 2.36inch)

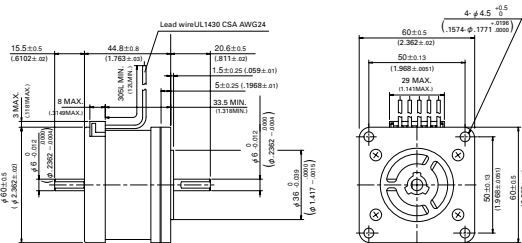
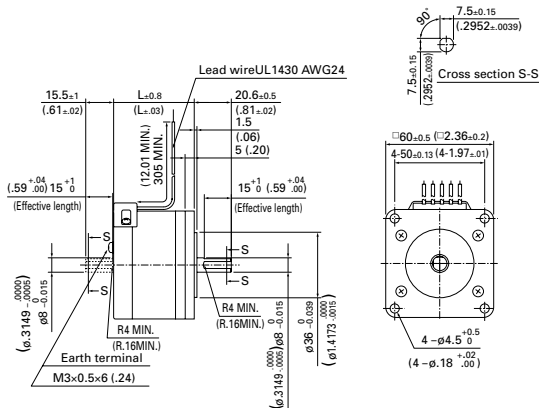

Set part number	Motor model number	Motor length : mm (inch)
—	103H7521-6 ◆▼ 0	44.8 (1.76)
—	103H7522-6 ◆▼ 0	53.8 (2.12)
—	103H7523-6 ◆▼ 0	85.8 (3.38)

Set part number	Motor model number	Motor length : mm (inch)
—	103H7521-● 0 ▼ 1	44.8 (1.76)
—	103H7522-● 0 ▼ 1	53.8 (2.12)
—	103H7523-● 0 ▼ 1	85.8 (3.38)

Dimensions

φ 86mm (φ 3.39inch)

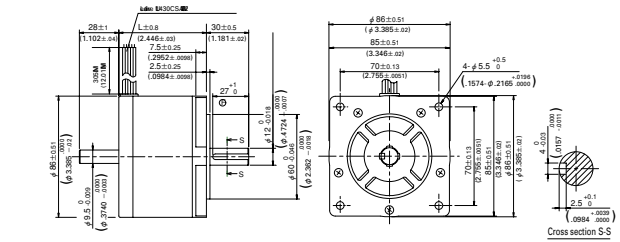
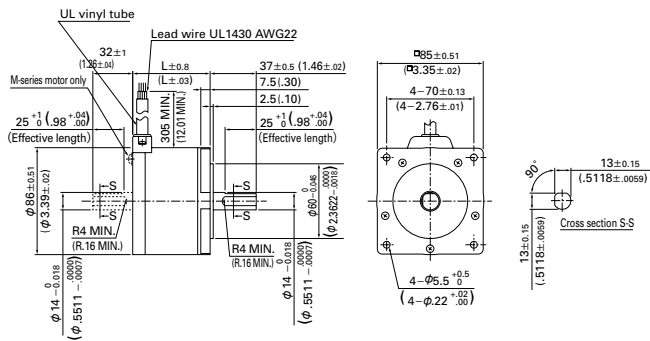

Set part number	Motor model number	Motor length (L): mm (inch)
F □ F851 △	103 ■ 8581-70 △ 1	62.15 (2.45)
F □ F852 △	103 ■ 8582-70 △ 1	92.2 (3.63)
F □ F853 △	103 ■ 8583-70 △ 1	125.85 (4.95)
FD F851 △	103 F8581-82 △ 1	62.15 (2.45)
FD F852 △	103 F8582-82 △ 1	92.2 (3.63)

Set part number	Motor model number	Motor length (L): mm (inch)
—	103H8581-● 0 △ 1	62.15 (2.45)
—	103H8582-● 0 △ 1	92.2 (3.63)
—	103H8583-● 0 △ 1	125.85 (4.95)

φ 106mm (φ 4.17inch)

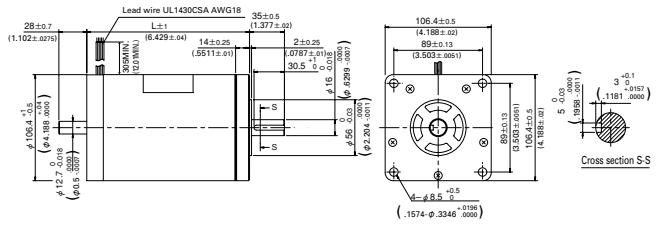
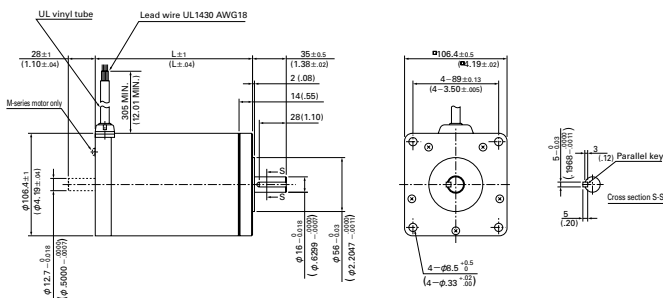

Set part number	Motor model number	Motor length (L) : mm (inch)
F □ F892 △	103 ■ 89582-70 △ 1	163.3 (6.43)
F □ F893 △	103 ■ 89583-70 △ 1	221.3 (8.71)

Set part number	Motor model number	Motor length (L) : mm (inch)
—	103H89582-● 0 △ 1	163.3 (6.43)
—	103H89583-● 0 △ 1	221.3 (8.71)

□ : Driver specifications

Motor shaft spec	Set type code
AC Power source Standard type	S
AC Power source Positioning function included type	P
DC Power source Standard type	D

△ : Motor shaft specification code

Motor shaft spec	Set type code	Motor type code
Single shaft	S	4
Double shaft	D	1

● : Rated current

0.75A	7
1.5A	8

■ : Motor specifications

Motor shaft spec	Set type code
F Series motor	F
M Series motor (CE · UL)	M

Low-backlash gear model

[Unit : mm (inch)]

□ 42mm (□ 1.65inch)

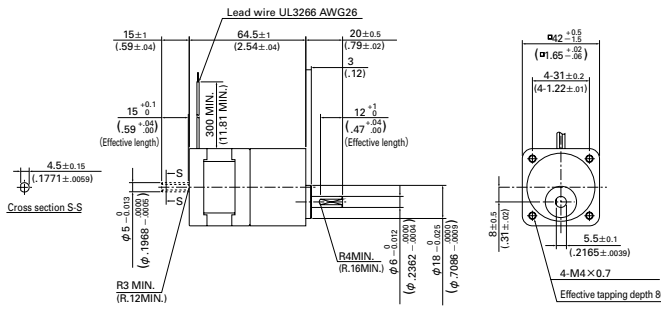

□ 60mm (□ 2.36inch)

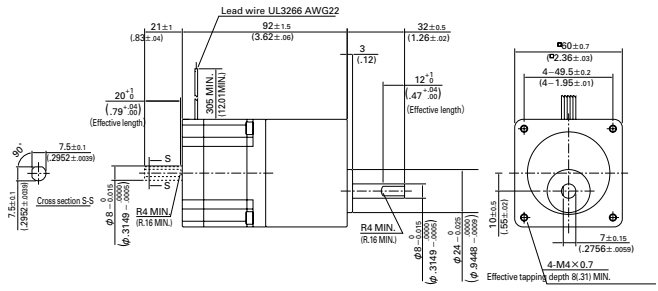

Set part number	Motor model number
FSF551 Δ -CX3.6	103F5505-70CXA △
FSF551 Δ -CX7.2	103F5505-70CXB △
FSF551 Δ -CX10	103F5505-70CXE △
FSF551 Δ -CX20	103F5505-70CXG △
FSF551 Δ -CX30	103F5505-70CXJ △
FSF551 Δ -CX36	103F5505-70CXX △

Set part number	Motor model number
FSF781 Δ -CX3.6	103F7851-70CXA △
FSF781 Δ -CX7.2	103F7851-70CXB △
FSF781 Δ -CX10	103F7851-70CXE △
FSF781 Δ -CX20	103F7851-70CXG △
FSF781 Δ -CX30	103F7851-70CXJ △
FSF781 Δ -CX36	103F7851-70CXX △

φ 86mm (φ 3.39inch)

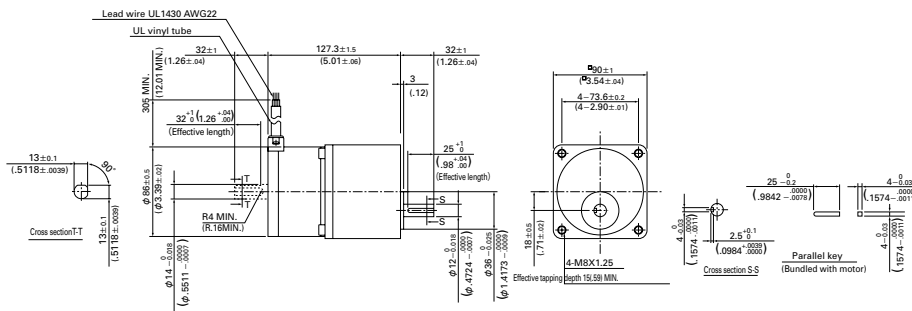

Set part number	Motor model number
FSF851 Δ -CX3.6	103F8581-70CXA △
FSF851 Δ -CX7.2	103F8581-70CXB △
FSF851 Δ -CX10	103F8581-70CXE △
FSF851 Δ -CX20	103F8581-70CXG △
FSF851 Δ -CX30	103F8581-70CXJ △
FSF851 Δ -CX36	103F8581-70CXX △

△ : Motor shaft specification code

Motor shaft spec	Set type code	Motor type code
Single shaft	S	4
Double shaft	D	1

Spur gear model

[Unit : mm (inch)]

□ 28mm (□ 1.10inch)

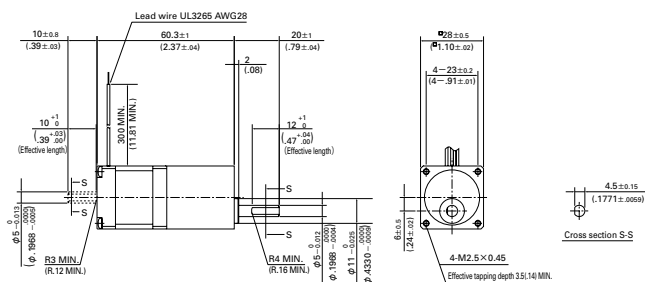

Set part number	Motor model number
FSF351 Δ -GX3.6	103F3505-70GXA △
FSF351 Δ -GX7.2	103F3505-70GXB △
FSF351 Δ -GX10	103F3505-70GXE △
FSF351 Δ -GX20	103F3505-70GXG △
FSF351 Δ -GX30	103F3505-70GXJ △
FSF351 Δ -GX50	103F3505-70GXL △

△ : Motor shaft specification code

Motor shaft spec	Set type code	Motor type code
Single shaft	S	4
Double shaft	D	1

AC input

Input / Output signal standard

DC input

Stepping motor

Dimensions

Harmonic gear model

[Unit : mm (inch)]

□ 28mm (□ 1.10inch)

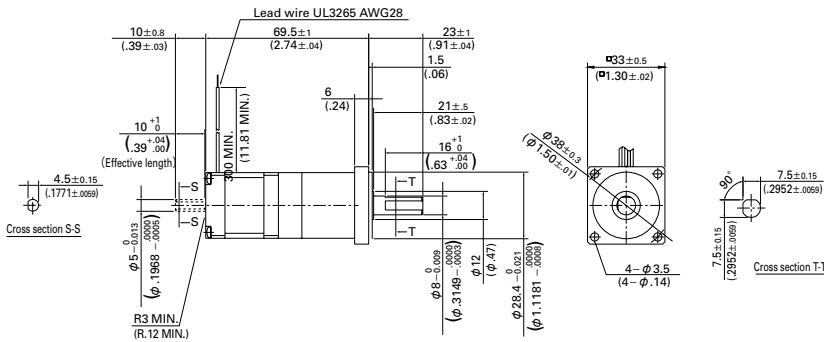

Set type code	Motor type code
FSF351 Δ -HX50	103F3505-70HXL Δ
FSF351 Δ -HX100	103F3505-70HXM Δ

□ 42mm (□ 1.65inch)

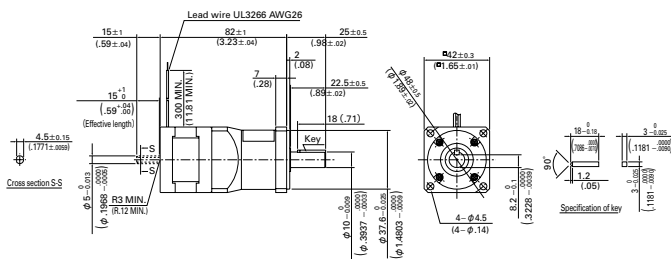

Set type code	Motor type code
FSF551 Δ -HX30	103F5505-70HXJ ◇
FSF551 Δ -HX50	103F5505-70HXL ◇
FSF551 Δ -HX100	103F5505-70HXM ◇

□ 60mm (□ 2.36inch)

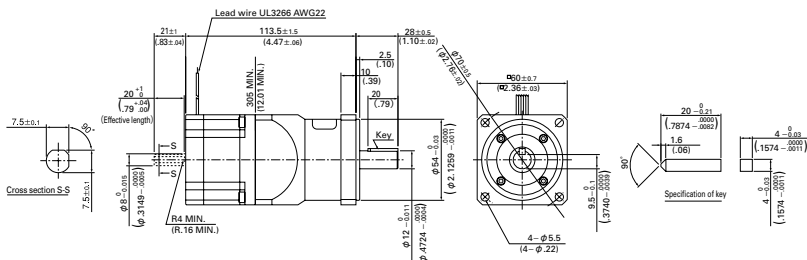

Set type code	Motor type code
FSF781 Δ -HX50	103F7851-70HXL Δ
FSF781 Δ -HX100	103F7851-70HXM Δ

φ 86mm (φ 3.39inch)

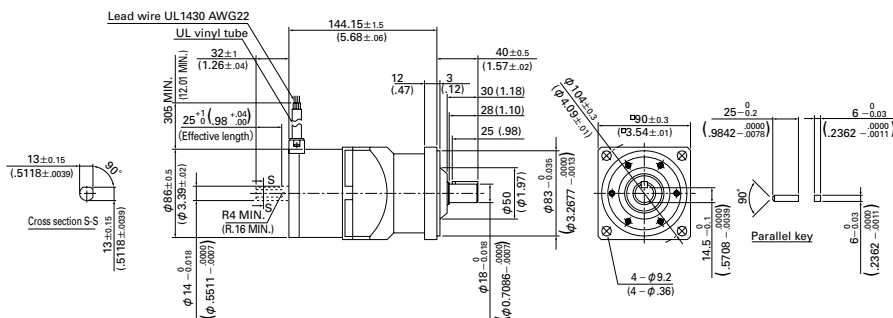

Set type code	Motor type code
FSF851 Δ -HX50	103F8581-70HXL Δ
FSF851 Δ -HX100	103F8581-70HXM Δ

△ : Motor shaft specification code

Motor shaft spec	Set type code	Motor type code
Single shaft	S	4
Double shaft	D	1

◇ : Motor shaft specification code

Motor shaft spec	Motor type code
Single shaft	5
Double shaft	2

Electromagnetic brake model

[Unit : mm (inch)]

□ 42mm (□ 1.65inch)

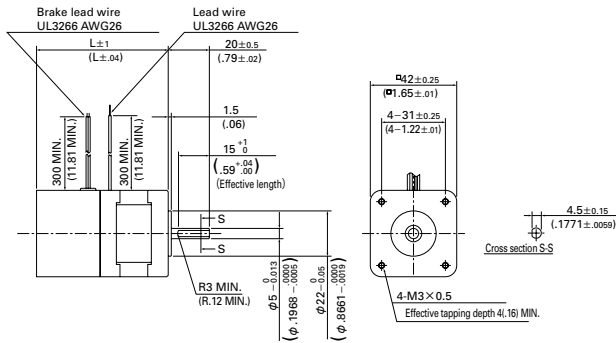

Set part number	Motor model number	Motor + brake length : mm (inch)
FSF551S-XB	103F5505-70XB41	64.5 (2.54)
FSF552S-XB	103F5508-70XB41	70.5 (2.78)
FSF554S-XB	103F5510-70XB41	79.5 (3.13)

□ 60mm (□ 2.36inch)

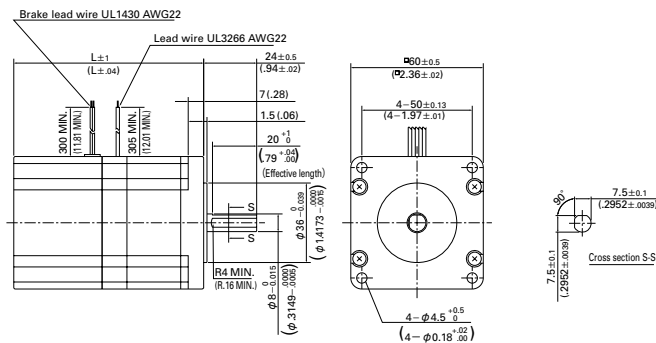

Set part number	Motor model number	Motor + brake length : mm (inch)
FSF781S-XB	103F7851-70XB41	85.8 (3.38)
FSF782S-XB	103F7852-70XB41	94.5 (3.72)
FSF783S-XB	103F7853-70XB41	126.7 (4.99)

φ 86mm (φ 3.39inch)

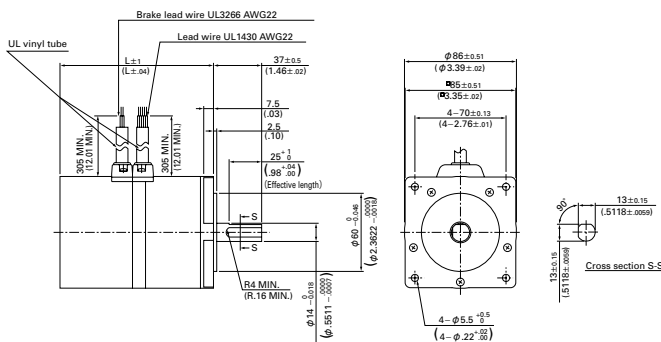

Set part number	Motor model number	Motor + brake length : mm (inch)
FSF851S-XB	103F8581-70XB41	116.7 (4.59)
FSF852S-XB	103F8582-70XB41	146.8 (5.78)
FSF853S-XB	103F8583-70XB41	180.4 (7.10)

AC input

Input / Output signal standard

DC input

Stepping motor

Dimensions

F series driver (CE [TÜV] • UL)

[Unit : mm (inch)]

AC input

FS type

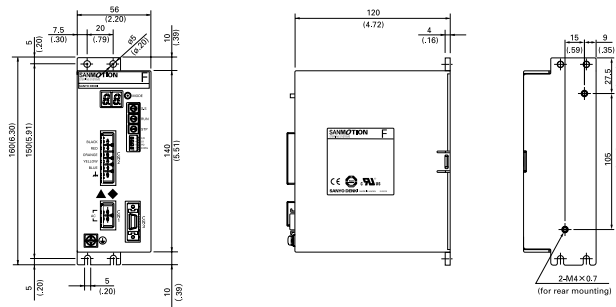

FP type

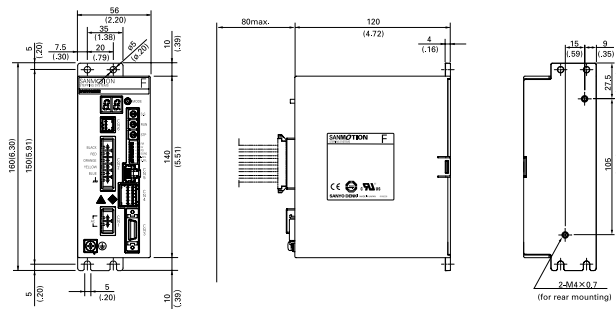

DC input

FD type

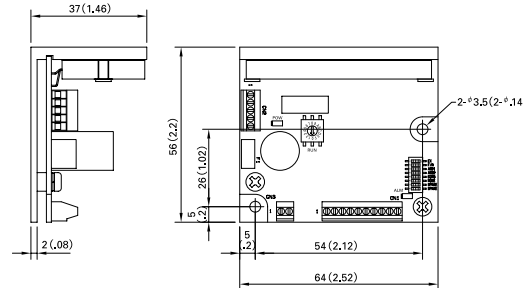

Safety standards

F series AC driver

UL	Acquired standards		File No.	Standard part
	UL		E179775	UL508C
UL for Canada				
CE (TÜV)	Directives	Category	Name	Standard part
	Low-voltage directives	-	-	EN50178
	EMC directives	Emission	Terminal disturbance voltage	EN55011-A
			Electromagnetic radiation disturbance	EN55011-A
			ESD (Electrostatic discharge)	EN61000-4-2
			RS (Radio-frequency amplitude modulated electromagnetic field)	EN61000-4-3
		Immunity	Fast transients	EN61000-4-4
			Surges	EN61000-4-6
			CS (Radio-frequency common mode)	EN61000-4-5
			Voltage dips, Voltage interruptions	EN61000-4-11

F series AC driver

UL	Acquired standards		File No.	Standard part
	UL		E179775	UL508C
UL for Canada				
CE (TÜV)	Directives	Category	Name	Standard part
	Low-voltage directives	-	-	EN61010-1
	EMC directives	Emission	Terminal disturbance voltage	EN55011-A
			Electromagnetic radiation disturbance	EN55011-A
			ESD (Electrostatic discharge)	EN61000-4-2
			RS (Radio-frequency amplitude modulated electromagnetic field)	EN61000-4-3
		Immunity	Fast transients	EN61000-4-4
			Surges	EN61000-4-6

- EMC characteristics may vary depending on the configuration of the users' control panel, which contains the driver or stepping motor, or the arrangement and wiring of other electrical devices.
- Validation test of F series driver has been performed for low-voltage EMC directives at TÜV (TÜV SUD Japan) for self-declaration of CE marking.

M series motor

UL	Acquired standards		File No.
	UL		E208878
UL for Canada			
CE	Standard category		Standard part
	Low-voltage directives		EN-60034-1
			IEC34-5 (EN-60034-5)

Safety Consideration

The drivers and stepping motors are the products designed to be used for the general industrial devices.

When using those, pay enough attention to the following points.

- Read thoroughly the Operation Manual prior to placement, assembly and/or operation in order to use the product properly.
- Refrain from modifying or processing the product in any way.
- Consult with the distributor or professional experts for placement or maintenance services of the product.
- In case of the following uses of the product, contact with us for the special care required to the operation, maintenance and management such as multiplexing the system, installing an emergency electric generator set, or so forth.

- 1 Use for the medical devices concerned with a fatal accident.
- 2 Use for trains, elevators, and so forth that are likely to cause an accident resulting in injury, damage or death.
- 3 Use in the computer system highly influential to the social life or the public systems.
- 4 Use in other devices highly influential to maintaining the human safety or the public functions.

In addition to the above, consult with us for use in such a vibration environment as automobile or transportation.

Read the Operation Manual thoroughly prior to the use (placement, operation, maintenance and inspection) to put the product in use properly.

Make yourself knowledgeable and familiarize with the devices, safety issues and cautions before handling the product.

After reading the Operation Manual or the like, keep it in the place where the users can refer to whenever necessary.

Indication by (Warning Label) on the product

Either or all of the following indications are given by the Warning Labels depending on the type of the driver or stepping motor.



This label is stuck near the high voltage part such as the electrically charged or cover-protected section, warning that the place where it is likely to cause an electric shock.



This label is stuck on the place where the driver or stepping motor body should be easily acknowledged, warning that it is likely to cause burns from high temperature.



必ずアース線を
接続して下さい
Use proper
grounding
techniques.

This label is stuck near the GND terminals of the driver or stepping motor for which grounding is required, suggesting that the terminals should be actually grounded.



危険
WARNING
感電注意
May Cause
electric shock

This label is stuck for the driver or stepping motor to which the power source is applied in the voltage exceeding the safety standard, drawing attention against the electric shock.

Safety ranks of the cautions

Following four ranks are provided.



DANGER Improper operations or use is most likely to result in serious injury or death.



CAUTION Improper operations or use is likely to result in average or minor injury, or in property damage.

In spite of the cautions with the Δ_{CAUTION} CAUTION label, it may cause serious results. Either the contents of the labels is describing important cautions to be followed inevitably.



PROHIBITED Indicates what shall not be done.



COMPULSORY Indicates what shall be done.

DANGER

< General matters >

1. Do not use the product in an explosive, flammable or corrosive atmosphere, watery place or near a combustible material. Doing so may cause injury or fire.
2. Have a person with expert knowledge for performing the transportation, placement, wiring, operation, maintenance or inspection of the product. Without such knowledge, it may cause an electric shock, injury or fire.
3. Do not work for wiring, maintenance servicing or inspection with the electric power on. Perform either of those five minutes after turning the power off, or otherwise, it may cause an electric shock.
4. When the protective functions of the product is activated, turn the power off immediately and eliminate the cause. If continuing the operation without eliminating the cause, the product may operate improperly and cause injury or a breakdown of the system devices.
5. Stepping motor may run out of order at the operating and stopping occasions, depending on the magnitude of the load. Put the product into use after confirming with the adequate trial test operation in the maximum load conditions that the product performs reliable operation. Doing otherwise may cause a breakdown of the system. (Should the product run out of order in the use to drive upward/downward, it may cause a fall of the load.)
6. Do not touch the internal parts of the driver. Doing so may cause an electric shock.

< Wiring >

7. Do not connect the stepping motor directly with the commercial power outlet. Doing so may cause an electric shock, injury or fire. The power shall be supplied to the stepping motor through the driving circuit.
8. Use the electric power source within the rated input voltage. Using otherwise may cause fire or an electric shock.
9. Connect the driver and stepping motor to the ground. Using without grounding may cause an electric shock.
10. Do not harm, forcibly put a stress, or load a heavy article on the cable or get it caught between the articles. Doing so may cause an electric shock.
11. Perform wiring with the power cable as instructed by the wiring diagram or the Operation Manual. Doing otherwise may cause an electric shock or fire.

< Operation >

12. Be sure not to touch the rotating part of the stepping motor during its operation. Touching it may cause injury.
13. Neither reach or touch the electric terminals while electric power is on. Doing so may cause an electric shock.
14. Never disconnect any of the connectors while electric power is on. Doing so may cause an electric shock and corruption.

< General matters >

1. Prior to placement, operation, maintenance servicing or inspection, be sure to read the Operation Manual and follow the instructions to perform those. Failure to follow the instructions may cause an electric shock, injury or fire.
2. Do not use the driver or the stepping motor outside the specified conditions. Doing so may cause an electric shock, injury or fire.
3. Do not insert a finger or a thing into the opening of the product. Doing so may cause an electric shock, injury or fire.
4. Do not use the damaged driver or stepping motor. Doing so may cause injury, fire or the like.
5. Use the driver and stepping motor in the designated combination. Using otherwise may cause fire or a trouble.
6. Be careful that the temperature rises in the operating driver, stepping motor or peripheral devices. Failure to be careful may cause a burn.

< Unpacking >

7. Unpack while confirming the ceiling. Failure to do so may cause injury.
8. Confirm if the product is the one having been ordered. Installing an incorrect product may cause a breakdown.

< Wiring >

9. Do not perform measurement of the insulation resistance or withstand insulation voltage of the product. Doing so may cause a breakdown. Instead, contact with us for such inspection.
10. Perform wiring conforming to the technical standards of electric facility or the internal rule. Doing otherwise may cause burning or fire.
11. Ensure that wiring has been correctly done. Operating without correct wiring may cause the stepping motor to run out of control and result in injury.

12. Take insulation process for the attached condenser or the external resistance connection terminals. Failure to do so may cause an electric shock.

< Placement >

13. Do not climb or attach a heavy article on the product. Doing so may cause injury.
14. Neither block nor stuff the aspiration/exhaust vent with a foreign particle. Doing so may cause fire.
15. Follow the instructions for the direction to place. Failure to do so may cause a trouble.
16. Keep a distance as instructed by the Operation Manual for the driver from the inner surface of the control console or other devices. Failure to do so may cause a trouble.
17. Place the product with a great care so as to prevent from the danger such as a tumble or a turnover.

CAUTION

18. Mount the product on an incombustible material such as metal. Doing otherwise may cause fire.
19. Confirm the rotating direction before connecting with the mechanical device. Failure to do so may cause injury or a breakdown.
20. Do not touch the motor output spindle (including the key slot and gears) with a bare hand. Doing so may cause injury.

< Operation >

21. The stepping motor is not equipped with any protective device. Take protective measures using an over-current protective relay, a ground fault interrupter, a protective device from excess temperature, and an emergency stopping device. Failure to do so may cause injury or fire.
22. Do not touch the product for a period after the power is on or has been turned off, since the driver and stepping motor remain in the high temperature. Doing so may cause burns. Especially the temperature rises considerably of the stepping motor depending on the operating conditions. Use the motor on the condition so that its surface temperature becomes 100°C or under.
23. Stop the operation immediately when an emergency occurs. Failure to do so may cause an electric shock, injury or fire.
24. Do not change adjustment to an extreme, for such a change results in the unstable operation. Doing so may cause injury.
25. When conducting the trial operation, make the stepping motor fixed firmly, and confirm the operation by disconnecting with the mechanical system before connecting with it. Failure to do so may cause injury.
26. When the alarm has been activated, eliminate the cause and ensure the safety to resume operation. Failure to do so may cause injury.
27. When the electric power recovers after the momentary interruption, do not approach the devices because the system may re-start operation by itself. (Set the system so as to secure the safety even when it re-start on such occasion.) Failure to do so may cause injury.
28. Confirm that the electric power supply is all proper conforming to the specifications. Failure to do so may cause a trouble.
29. The brake mechanism of the motor with the electro-magnetic brake is to hold the movable section and the motor position. Do not use it as a safety measure, or doing so may cause the breakdown of the system.
30. Fix the key firmly when operating the motor with key individually. Failure to do so may cause injury.

< Maintenance services >

31. Be careful when performing maintenance services or inspection about the temperature which rises highly in the driver and stepping motor frame. Failure to do so may cause burns.
32. It is recommended to replace the electrolytic condenser of the driver with a new one for securing the preventive measure after using for 5 years, the expected life in the average 40°C. The expected life of the fuse and cooling fan motor is 10 years in the average 40°C. Thus, the periodical replacement is recommended.

33. Contact with us for repair. If the product is disassembled by the user, it may put it out of action.

< Transportation >

34. Handle the product with care during transportation so as to prevent from the danger such as a tumble or a turnover.
35. Do not hold with the cable or the motor spindle. Doing so may cause a trouble or injury.

< Retirement >

36. When scrapping the driver or stepping motor, treat it for the general industrial waste.

PROHIBITED

< Storage >

1. Avoid the place exposed to rain or water drops, or in an environment with hazardous gas or liquid for storing the product. Failure to do so may cause a trouble.

< Maintenance services >

2. Do not assemble or repair the product. Doing so may cause fire or an electric shock.

< General matters >

3. Do not remove the rating plate.

COMPULSORY

< Storage >

1. Store the product within the specified conservation temperature and humidity in the place not exposed to the sun beam.

2. If the driver has been stored for a long period (3 years or longer for a guide), consult with us. The capacitance may have decreased with the electrolytic condenser due to the long period storage, and it may cause a trouble.

< Operation >

3. Install an external emergency stop circuit to turn the power off for the instant halt of operation.
4. Put the product into operation in the specified ambient temperature and humidity.

< Transportation >

5. Excess loading of the product on the carrier may cause the load to fall in pieces. Follow the instructions given outside the package.

Inquiry Check Sheet

Please provide the following information when placing an order or making an inquiry.
Also feel free to include any questions that require our attention.

Company Name: _____

Date: _____

Department: _____

To contact us: _____

Telephone : _____

Phone: +81 3 3917 5157

Fax: _____

Fax: +81 3 3917 0643

1) Application: _____

2) Name of Machinery: _____

3) Number of Units: _____

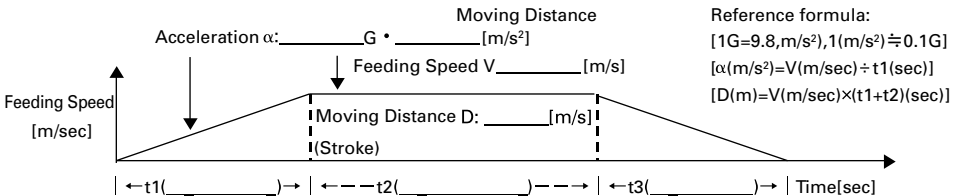
Item	Contents																																																																																																						
1	Name of target equipment Equipment name, category (transport, processing, test, other)																																																																																																						
2	Name of servo axis Axis name, axial mechanism (horizontal/vertical), brake mechanism (yes/no)																																																																																																						
3	Current condition of above axis Manufacturer Name () Series Name () Motor Capacity () Hydraulic, Mechanical, or New System ()																																																																																																						
4	Positioning accuracy ± mm / ± μm																																																																																																						
5	Operation pattern  <p>Reference formula: $[1G=9.8, m/s^2], 1(m/s^2) \approx 0.1G]$ $[\alpha(m/s^2)=V(m/sec) \div t1(sec)]$ $[D(m)=V(m/sec) \times (t1+t2)(sec)]$</p>																																																																																																						
6	Mechanism Ball-screw/screw-rotation type (horizontal), ball-screw/nut-rotation type (horizontal), rack and pinion (horizontal), belt/chain (horizontal), rotary table, roll feed, instability																																																																																																						
7	Mechanical structure <table border="0" style="width:100%; border-collapse: collapse;"> <tr> <td style="width:33%;">WT (table mass)</td> <td style="width:10%;">kg</td> <td style="width:33%;">WL (work mass)</td> <td style="width:10%;">kg</td> <td style="width:14%;">WA (mass of other drive parts)</td> <td style="width:10%;">kg</td> </tr> <tr> <td>WR (rack mass)</td> <td>kg</td> <td>WB (belt/chain mass)</td> <td>kg</td> <td>WC (counterbalance mass)</td> <td>kg</td> </tr> <tr> <td>Fa (external force in axial direction)</td> <td>N</td> <td>Fb (ball-screw preload)</td> <td>N</td> <td>T (roll pushing force)</td> <td>N</td> </tr> <tr> <td>Dr1 (drive-side roll diameter)</td> <td>mm</td> <td>Dr2 (follower-side roll diameter)</td> <td>mm</td> <td></td> <td></td> </tr> <tr> <td>Lr1 (drive-side roll length)</td> <td>mm</td> <td>Lr2 (follower-side roll length)</td> <td>mm</td> <td>G (reduction ratio)</td> <td></td> </tr> <tr> <td>JG (speed-reducer inertia)</td> <td>kg·m²</td> <td>JC (coupling inertia)</td> <td>kg·m²</td> <td></td> <td></td> </tr> <tr> <td>JN (nut inertia)</td> <td>kg·m²</td> <td>JO (other motor-axis conversion inertia)</td> <td>kg·m²</td> <td></td> <td></td> </tr> <tr> <td>Db (ball-screw diameter)</td> <td>mm</td> <td>Lb (ball-screw axial length)</td> <td>mm</td> <td>Pb (ball-screw lead)</td> <td>mm</td> </tr> <tr> <td>Dp (pinion/pulley diameter)</td> <td>mm</td> <td>Lp (pinion axial length)</td> <td>mm</td> <td>Tp (pulley thickness)</td> <td>mm</td> </tr> <tr> <td>Dt (table diameter)</td> <td>mm</td> <td>Dh (table-support diameter)</td> <td>mm</td> <td>LW (load shift from axis)</td> <td>mm</td> </tr> <tr> <td>Ds (table shaft diameter)</td> <td>mm</td> <td>Ls (table shaft length)</td> <td>mm</td> <td></td> <td></td> </tr> <tr> <td colspan="2">ρ (specific gravity of ball-screw/pinion/pulley/table-shaft material)</td> <td colspan="2"></td> <td></td> <td>kg/cm³</td> </tr> <tr> <td colspan="2">μ (friction coefficient between sheet and sliding-surface/support-section/roll)</td> <td colspan="2">ρ1 (specific gravity of roll-1 material)</td> <td colspan="2">kg/cm³</td> </tr> <tr> <td colspan="2">ρ2 (specific gravity of roll-2 material)</td> <td colspan="2">kg/cm³</td> <td colspan="2">κ (internal friction coefficient of preload nut)</td> </tr> <tr> <td colspan="2">η (mechanical efficiency)</td> <td colspan="2">JL (load inertia of motor-axis conversion)</td> <td colspan="2">kg·m²</td> </tr> <tr> <td colspan="2">TF (friction torque of motor axis conversion)</td> <td colspan="2">N·m</td> <td colspan="2">TU (imbalance torque of motor axis conversion)</td> </tr> <tr> <td colspan="2"></td> <td colspan="2"></td> <td colspan="2">N·m</td> </tr> </table>	WT (table mass)	kg	WL (work mass)	kg	WA (mass of other drive parts)	kg	WR (rack mass)	kg	WB (belt/chain mass)	kg	WC (counterbalance mass)	kg	Fa (external force in axial direction)	N	Fb (ball-screw preload)	N	T (roll pushing force)	N	Dr1 (drive-side roll diameter)	mm	Dr2 (follower-side roll diameter)	mm			Lr1 (drive-side roll length)	mm	Lr2 (follower-side roll length)	mm	G (reduction ratio)		JG (speed-reducer inertia)	kg·m ²	JC (coupling inertia)	kg·m ²			JN (nut inertia)	kg·m ²	JO (other motor-axis conversion inertia)	kg·m ²			Db (ball-screw diameter)	mm	Lb (ball-screw axial length)	mm	Pb (ball-screw lead)	mm	Dp (pinion/pulley diameter)	mm	Lp (pinion axial length)	mm	Tp (pulley thickness)	mm	Dt (table diameter)	mm	Dh (table-support diameter)	mm	LW (load shift from axis)	mm	Ds (table shaft diameter)	mm	Ls (table shaft length)	mm			ρ (specific gravity of ball-screw/pinion/pulley/table-shaft material)					kg/cm ³	μ (friction coefficient between sheet and sliding-surface/support-section/roll)		ρ1 (specific gravity of roll-1 material)		kg/cm ³		ρ2 (specific gravity of roll-2 material)		kg/cm ³		κ (internal friction coefficient of preload nut)		η (mechanical efficiency)		JL (load inertia of motor-axis conversion)		kg·m ²		TF (friction torque of motor axis conversion)		N·m		TU (imbalance torque of motor axis conversion)						N·m	
WT (table mass)	kg	WL (work mass)	kg	WA (mass of other drive parts)	kg																																																																																																		
WR (rack mass)	kg	WB (belt/chain mass)	kg	WC (counterbalance mass)	kg																																																																																																		
Fa (external force in axial direction)	N	Fb (ball-screw preload)	N	T (roll pushing force)	N																																																																																																		
Dr1 (drive-side roll diameter)	mm	Dr2 (follower-side roll diameter)	mm																																																																																																				
Lr1 (drive-side roll length)	mm	Lr2 (follower-side roll length)	mm	G (reduction ratio)																																																																																																			
JG (speed-reducer inertia)	kg·m ²	JC (coupling inertia)	kg·m ²																																																																																																				
JN (nut inertia)	kg·m ²	JO (other motor-axis conversion inertia)	kg·m ²																																																																																																				
Db (ball-screw diameter)	mm	Lb (ball-screw axial length)	mm	Pb (ball-screw lead)	mm																																																																																																		
Dp (pinion/pulley diameter)	mm	Lp (pinion axial length)	mm	Tp (pulley thickness)	mm																																																																																																		
Dt (table diameter)	mm	Dh (table-support diameter)	mm	LW (load shift from axis)	mm																																																																																																		
Ds (table shaft diameter)	mm	Ls (table shaft length)	mm																																																																																																				
ρ (specific gravity of ball-screw/pinion/pulley/table-shaft material)					kg/cm ³																																																																																																		
μ (friction coefficient between sheet and sliding-surface/support-section/roll)		ρ1 (specific gravity of roll-1 material)		kg/cm ³																																																																																																			
ρ2 (specific gravity of roll-2 material)		kg/cm ³		κ (internal friction coefficient of preload nut)																																																																																																			
η (mechanical efficiency)		JL (load inertia of motor-axis conversion)		kg·m ²																																																																																																			
TF (friction torque of motor axis conversion)		N·m		TU (imbalance torque of motor axis conversion)																																																																																																			
				N·m																																																																																																			
8	Speed reducer Customer-provided (/); Sanyo standard (planet/spur/no-backlash-planet:: /); other (/)																																																																																																						
9	Sensor type Sensor type specified (yes / no) Yes: (incremental , optical absolute , optical absolute [resolver absolute with incremental function]) Resolution ()																																																																																																						
10	Input format Position , speed, torque, communications (SERCOS / CAN / DeviceNet) other ()																																																																																																						
11	Upper-level equipment (controller) Sequencer , laptop , customer-developed product , Sanyo-provided , other ()																																																																																																						
12	Usage environment and other requirements Cutting , clean-room use , anti-dust measures , other ()																																																																																																						
13	Estimated production Single product: () units/month () units/year																																																																																																						
14	Development schedule Prototype period: ()Year ()Month Production period: ()Year ()Month																																																																																																						
15	Various measures Related documentation (already submitted ; send later by mail) Visit/PR desired (yes / no) Meeting desired (yes / no)																																																																																																						
16	Miscellaneous (questions, pending problems, unresolved issues, etc.)																																																																																																						

■ Precautions For Adoption



Failure to follow the precautions on the right may cause moderate injury and property damage, or in some circumstances, could lead to a serious accident.
Always follow all listed precautions.

Cautions

- Read the accompanying Instruction Manual carefully prior to using the product.
- If applying to medical devices and other equipment affecting people's lives, please contact us beforehand and take appropriate safety measures.
- If applying to equipment that can have significant effects on society and the general public, please contact us beforehand.
- Do not use this product in an environment where vibration is present, such as in a moving vehicle or shipping vessel.
- Do not perform any retrofitting, re-engineering, or modification to this equipment.
- The drivers and motors presented in this catalog are meant to be used for general industrial applications. If using for special applications related to aviation and space, nuclear power, electric power, submarine repeaters, etc., please contact us beforehand.

* For any question or inquiry regarding the above, contact our Sales Department.

SANYO DENKI CO., LTD.

1-15-1, Kita-Otsuka, Toshima-ku, Tokyo 170-8451, Japan

SANYO DENKI AMERICA, INC.

468 Amapola Avenue Torrance, CA 90501 U.S.A.

SANYO DENKI EUROPE SA.

P.A. Paris Nord II 48 Allée des Erables-VILLEPINTE BP.57286 F-95958 ROISSY CDG Cedex France

SANYO DENKI GERMANY GmbH

Frankfurter Strasse 63-69 65760 Eschborn Germany

SANYO DENKI KOREA CO., LTD.

9F 5-2, Sunwha-dong Jung-gu Seoul, 100-130, Korea

SANYO DENKI SHANGHAI CO., LTD.

Room 2116, Bldg B, FAR EAST INTERNATIONAL PLAZA, No.317 XianXia Rd., Shanghai 200051 China

SANYO DENKI TAIWAN CO., LTD.

Room 1208, 12F, No.96 Chung Shan N, Rd., Sec.2, Taipei 104, Taiwan, R.O.C.

SANYO DENKI (H.K.) CO., LIMITED

Room 2305, 23/F, South Tower, Concordia Plaza, 1 Science Museum Rd., TST East, Kowloon, Hong Kong

SANYO DENKI SINGAPORE PTE. LTD.

10 Hoe Chiang Road #14-03A/04 Keppel Towers Singapore 089315

<http://www.sanyodenki.co.jp>

Phone: +81 3 3917 5157

Phone: +1 310 783 5400

Phone: +33 1 48 63 26 61

Phone: +49 6196 76113 0

Phone: +82 2 773 5623

Phone: +86 21 6235 1107

Phone: +886 2 2511 3938

Phone: +852 2312 6250

Phone: +65 6223 1071

SANMOTION

5-PHASE STEPPING SYSTEMS

F5



Ver.2

SANYO DENKI

Extensive lineup

F series driver features

1

Lower vibration

AC input

DC input

AC input

- Automicro function and microstepping system enables further reduction of vibration compared to current models.

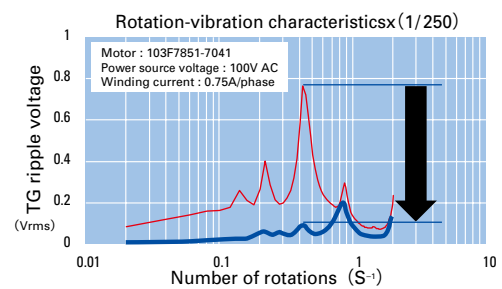
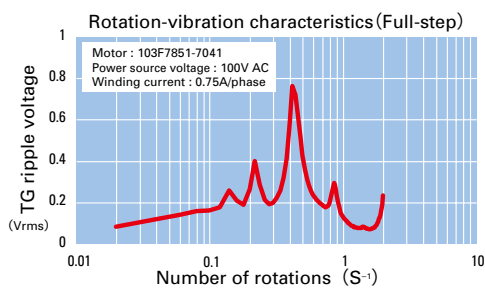

Automicro function

Vibration suppression is executed internally and independently from the controller.

Microstepping system

The basic step angle is divided by a maximum of 1/250 using 16 selectable resolution levels to enable smooth and vibration-free operation.

$$\frac{0.72}{1 \text{ to } 250 \text{ divisions}} = 0.72 \text{ to } 0.00288 \text{ degrees/pulse}$$

DC input

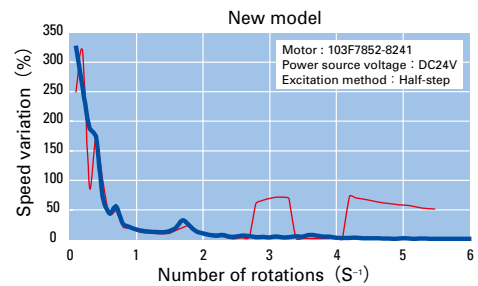
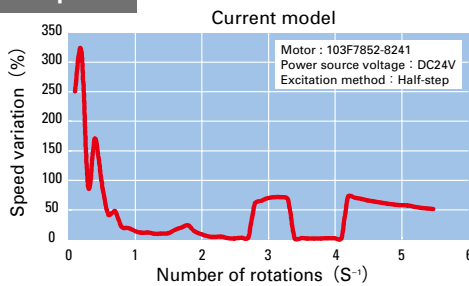

2

Shorter cycle time

AC input

- Improved response (up to 10% compared to current models) shortens the machine cycle time for repetitive operations.

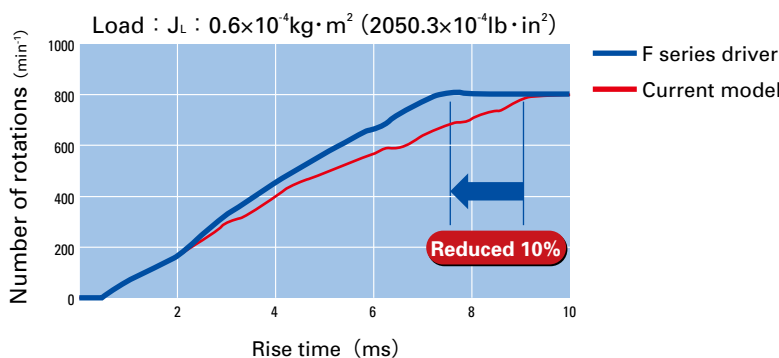

3

Control panel space is reduced

AC input
DC input

Volume is reduced by up to 50% for AC input types and 45% for DC input types compared to current models.

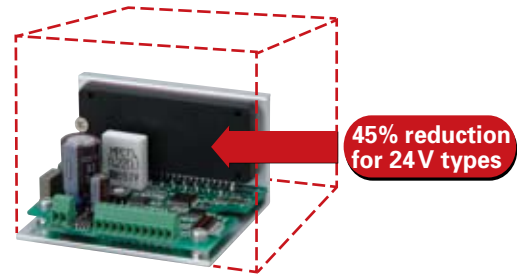
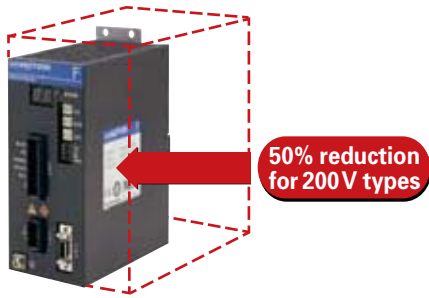

4

Easy maintenance

AC input

2-digit 7-segment LED displays operating status and alarm for easy troubleshooting and faster system recovery.



Test run function (JOG)

AC input

With built-in positioning function

On-board JOG operation function is available for testing motor and amplifier connection without the need to connect to host device.

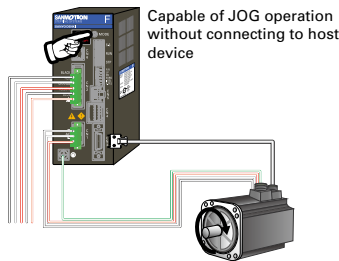

General-purpose I/O input for positioning

AC input

With built-in positioning function

System positioning is easily executed by using general-purpose I/O from an upper-level controller (PLC) to designate preset program numbers.

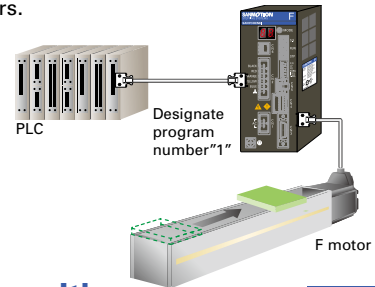

Encoder I/F Control

AC input

With built-in positioning function

Motor stall detection is possible by connecting a motor encoder. 500P/R (1000/2000 multiplier function) line driver method.

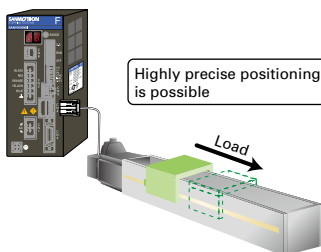

Compliance with international standards

AC input
DC input

The standard specification SANMOTION F series stepping driver complies with UL and EN safety standards. Stepping motors complying with UL and EN standards are available upon request. EMC filters are also available to comply with the EMC directive.



PC-based setup monitor

AC input

With built-in positioning function

Parameter and program settings can be made from the bundled setup software.

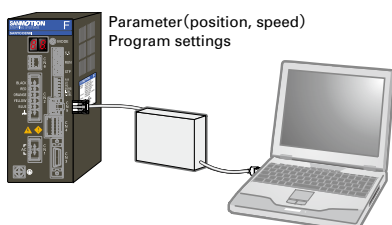

Brake control

AC input

Automatic brake activation timing control is available when using electromagnetic brake motors.

• Internal power source for brake (FP type)

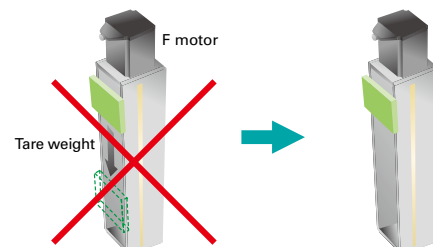

Control method

How do you want to control the equipment ?
 The F series offers the choice of 3 different control methods

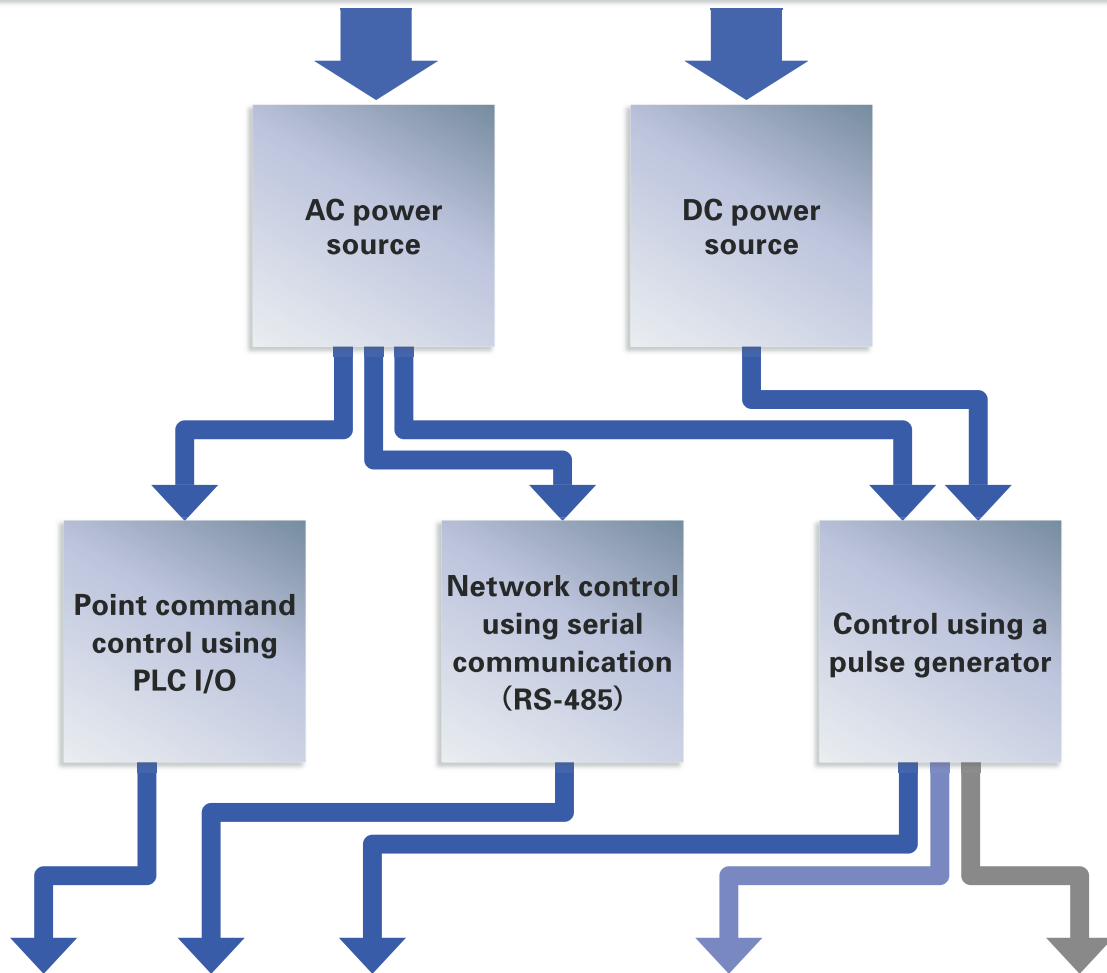

AC input with built-in positioning function



Startup via I/O : Initiate program containing speed, acceleration/deceleration, and travel distance commands stored in the driver via the I/O.	Startup via serial communication: Control by sending data for speed, acceleration/deceleration, and travel distance commands via serial communication.
System configuration diagram	P7
Set part number nomenclature	P9
Motor specifications	P47 to 58
General specifications	P25·26, 60
Motor dimension drawing	P61 to 64
Driver dimension drawing	P65

AC input standard type



Motion is generated by pulse input commands from an upper-level controller.	
System configuration diagram	P5
Set part number nomenclature	P9
Motor specifications	P47 to 58
General specifications	P23·24, 60
Motor dimension drawing	P59 to 62
Driver dimension drawing	P63

DC input



Motion is generated by pulse input commands from an upper-level controller.	
System configuration diagram	P31
Set part number nomenclature	P32
Motor specifications	P47 to 58
General specifications	P43·44, 60
Motor dimension drawing	P59 to 62
Driver dimension drawing	P63

Set model

AC input

Standard model P.11

The standard set includes a F series driver and a F series motor.



Motor flange size
 □28 (1.10inch) □42 (1.65inch) □60 (2.35inch) Ø86 (3.39inch) Ø106 (4.17inch)

CE / UL model P.13

The UL/CE set includes a F Series driver and a M Series motor.



Motor flange size
 □42 (1.65inch) □60 (2.35inch) Ø86 (3.39inch) Ø106 (4.17inch)

Low-backlash gear model P.15

This set includes a low backlash gear that uses tapered hobbled gears to engage the final stage of the speed reduction mechanism.



Motor flange size
 □42 (1.65inch) □60 (2.35inch) Ø86 (3.39inch)

Reduction gear ratios
 1/3.6, 1/7.2, 1/10, 1/20, 1/30, 1/36

Spur gear model P.18

This set utilizes a spur gear in the speed reduction mechanism.



Motor flange size
 □28 (1.10inch)

Reduction gear ratios
 1/3.6, 1/7.2, 1/10, 1/20, 1/30, 1/50

Harmonic gear model P.19

This set utilizes a harmonic gear.



Motor flange size
 □28 (1.10inch) □42 (1.65inch) □60 (2.35inch) Ø86 (3.39inch)

Reduction gear ratios
 1/36, 1/50, 1/100

Electromagnetic brake model P.21

This set utilizes a non-excitation electromagnetic brake to maintain position in vertical load applications and hold load even during power off.



Motor flange size
 □42 (1.65inch) □60 (2.35inch) Ø86 (3.39inch)

DC input

Standard model P.33

The standard set includes a F series driver and a F series motor.



Motor flange size
 □28 (1.10inch) □42 (1.65inch) □60 (2.35inch) Ø86 (3.39inch)

Low-backlash gear model P.35

This set includes a low backlash gear that uses tapered hobbled gears to engage the final stage of the speed reduction mechanism.



Motor flange size
 □42 (1.65inch) □60 (2.35inch) Ø86 (3.39inch)

Reduction gear ratios
 1/3.6, 1/7.2, 1/10, 1/20, 1/30, 1/36

Spur gear model P.38

This set utilizes a spur gear in the speed reduction mechanism.



Motor flange size
 □28 (1.10inch)

Reduction gear ratios
 1/3.6, 1/7.2, 1/10, 1/20, 1/30, 1/50

Harmonic gear model P.39

This set utilizes a harmonic gear.



Motor flange size
 □28 (1.10inch) □42 (1.65inch) □60 (2.35inch) Ø86 (3.39inch)

Reduction gear ratios
 1/30, 1/50, 1/100

Electromagnetic brake model P.41

This set utilizes a non-excitation electromagnetic brake to maintain position in vertical load applications and hold load even during power off.



Motor flange size
 □42 (1.65inch) □60 (2.35inch) Ø86 (3.39inch)

Standard type

Flange side

Spur gear model

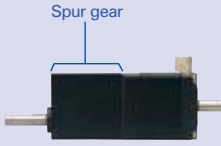

Motor flange size
□28 (□1.10inch)

Low-backlash gear model

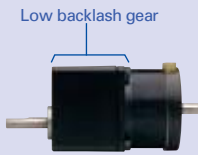

Motor flange size
□42mm (□1.65inch) / □60mm (□2.35inch) / *86mm (*3.39inch)

Harmonic gear model



Motor flange size
□28mm (□1.10inch) / □42mm (□1.65inch) / □60mm (□2.35inch) / *86mm (*3.39inch)



Standard model : F series motor
□28mm (□1.10inch) / □42mm (□1.65inch) / □60mm (□2.35inch) / *86mm (*3.39inch) / *106mm (*4.17inch)

CE / UL model : M series motor
□42mm (□1.65inch) / □60mm (□2.35inch) / *86mm (*3.39inch) / *106mm (*4.17inch)

● Motors are available in standard or vacuum types.

End-cap side

Damper



Magnetic dampers can be selected according to the required inertia.

Electromagnetic brake model

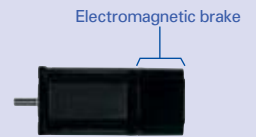

Motor flange size
□42mm (□1.65inch) / □60mm (□2.35inch) / *86mm (*3.39inch)

Brake power source (DC24V)

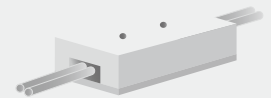

Required for brake-equipped stepping motor models.

Ⓢ Motor cable (optional)

■ Bundled connectors (set models only)

Connector type	Housing	Contact	Applicable motor flange size
① AC power connector	1-178128-2 (AMP)	1-175218-5 (AMP)	—
② Motor connector	1-178128-6 (AMP)	1-175216-5 (AMP)	□28mm (□1.10inch), □42mm (□1.65inch)
	1-178128-6 (AMP)	1-175217-5 (AMP)	□60mm (□2.35inch), *86mm (*3.39inch)
	1-178128-6 (AMP)	1-175218-5 (AMP)	*106mm (*4.17inch)
③ I/O signal connector	10314-52A0-008 (3M)	10114-3000PE (3M)	—

■ Optional cables

Ⓐ AC power cable

L : m (feet)	Part number
10 (32.81)	PM-C03P1000-05
5 (16.40)	PM-C03P0500-05
3 (9.84)	PM-C03P0300-05
1 (3.28)	PM-C03P0100-05

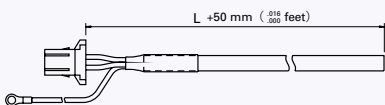

Leadwire	600V vinyl cab tire cable 3-core AWG16(1.25mm ²)
Housing	1-178128-2 (AMP)
Contact	1-175218-5 (AMP)
Round-type crimp contact	1.25M4 (J.S.T. Mfg Co.)

● Cables 10m (32.81 feet) or longer are available upon request.

Ⓑ Motor cable

L : m (feet)	Part number
10 (32.81)	PM-C06M1000-11
5 (16.40)	PM-C06M0500-11
3 (9.84)	PM-C06M0300-11
1 (3.28)	PM-C06M0100-11

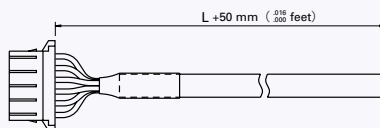

Leadwire	600V vinyl cab tire cable 6-core AWG16(0.75mm ²)
Housing	1-178128-6 (AMP)
Contact	1-175218-5 (AMP)

● Cables 10m (32.81 feet) or longer are available upon request.

Ⓒ I/O signal cable

L : m (feet)	Part number
2 (6.56)	PM-C14S0200-03
1 (3.28)	PM-C14S0100-03

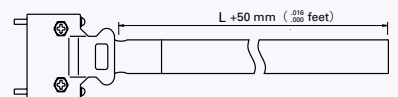

Leadwire	7-pair PVC shielded cable AWG28 (0.08mm ²)
Shell	10314-52A0-008 (3M)
Plug	10114-3000PE (3M)

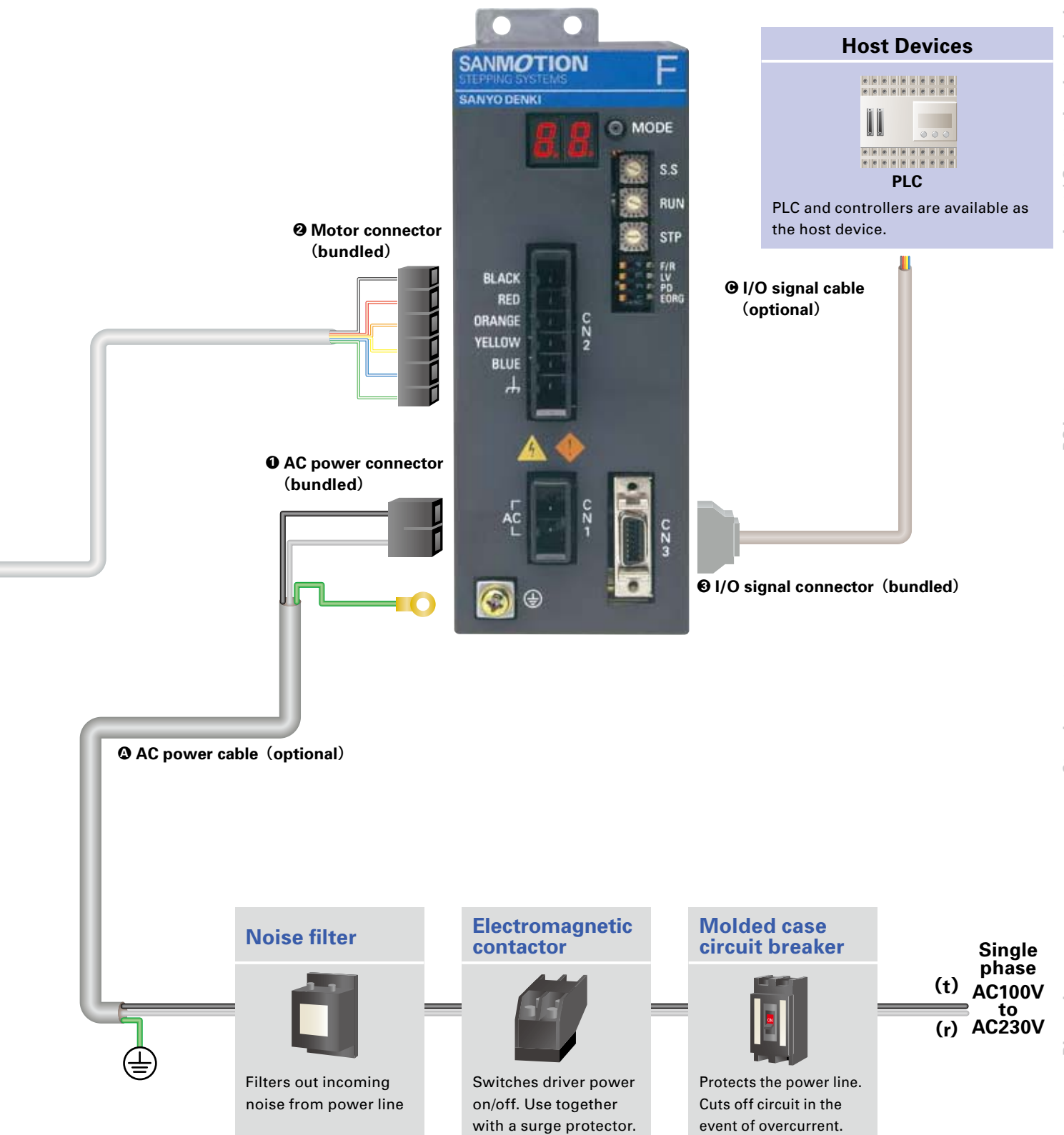

2 Motor connector (bundled)

1 AC power connector (bundled)

4 AC power cable (optional)

3 I/O signal cable (optional)

4 I/O signal connector (bundled)

Noise filter



Filters out incoming noise from power line

Electromagnetic contactor



Switches driver power on/off. Use together with a surge protector.

Molded case circuit breaker



Protects the power line. Cuts off circuit in the event of overcurrent.

Single phase AC100V to AC230V (t) (r)

With built-in positioning function

Flange side

Spur gear model

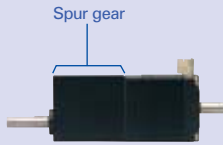

Motor flange size
□28 (□1.10inch)

Low-backlash gear model

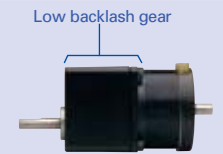

Motor flange size
□42mm (□1.65inch) / □60mm (□2.35inch) / *86mm (*3.39inch)

Harmonic gear model



Motor flange size
□28mm (□1.10inch) / □42mm (□1.65inch) / □60mm (□2.35inch) / *86mm (*3.39inch)

End - cap side

Damper



Magnetic dampers can be selected according to the required inertia.

Electromagnetic brake model

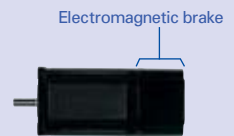

Motor flange size
□42mm (□1.65inch) / □60mm (□2.35inch) / *86mm (*3.39inch)



Standard model : F series motor
□28mm (□1.10inch) / □42mm (□1.65inch) / □60mm (□2.35inch) / *86mm (*3.39inch) / *106mm (*4.17inch)
CE / UL model : M series motor
□42mm (□1.65inch) / □60mm (□2.35inch) / *86mm (*3.39inch) / *106mm (*4.17inch)

● Motors are available in standard or vacuum types.

Ⓞ Option cable for motor

Encoder equipped model

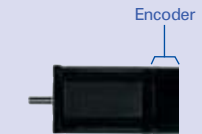

Optional

■ Bundled connectors (set models only)

Connector type	Housing	Contact	Applicable motor flange size
① AC power connector	1-178128-2 (AMP)	1-175218-5 (AMP)	—
	1-178128-6 (AMP)	1-175216-5 (AMP)	□28mm (□1.10inch), □42mm (□1.65inch)
② Motor connector	1-178128-6 (AMP)	1-175217-5 (AMP)	□60mm (□2.35inch), *86mm (*3.39inch)
	1-178128-6 (AMP)	1-175218-5 (AMP)	*106mm (*4.17inch)
③ I/O signal connector	10314-52A0-008 (3M)	10114-3000PE (3M)	—

■ Optional cables

Ⓜ AC power cable

L : m (feet)	Part number
10 (32.81)	PM-C03P1000-05
5 (16.40)	PM-C03P0500-05
3 (9.84)	PM-C03P0300-05
1 (3.28)	PM-C03P0100-05

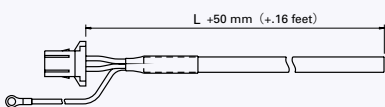

Leadwire	600V vinyl cab tire cable 3-core AWG16(1.25mm ²)
Housing	1-178128-2 (AMP)
Contact	1-175218-5 (AMP)
Round-type crimp tool	1.25M4 (J.S.T.)

● Cables 10 m (32.81 feet) or longer are available upon request.

Ⓞ Motor cable

L : m (feet)	Part number
10 (32.81)	PM-C06M1000-11
5 (16.40)	PM-C06M0500-11
3 (9.84)	PM-C06M0300-11
1 (3.28)	PM-C06M0100-11

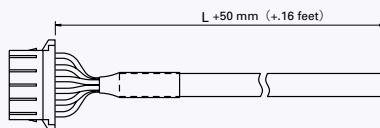

Leadwire	600V vinyl cab tire cable 6-core AWG16(0.75mm ²)
Housing	1-178128-6 (AMP)
Contact	1-175218-5 (AMP)

● Cables 10 m (32.81 feet) or longer are available upon request.

Ⓞ I/O signal cable

L : m (feet)	Part number
2 (6.56)	PM-C20S0200-01
1 (3.28)	PM-C20S0100-01

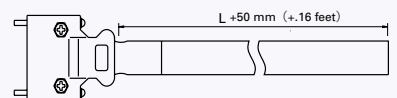

Leadwire	10-pair PVC shielded cable AWG28 (0.08mm ²)
Shell	10320-52A0-008 (3M)
Plug	10120-3000PE (3M)

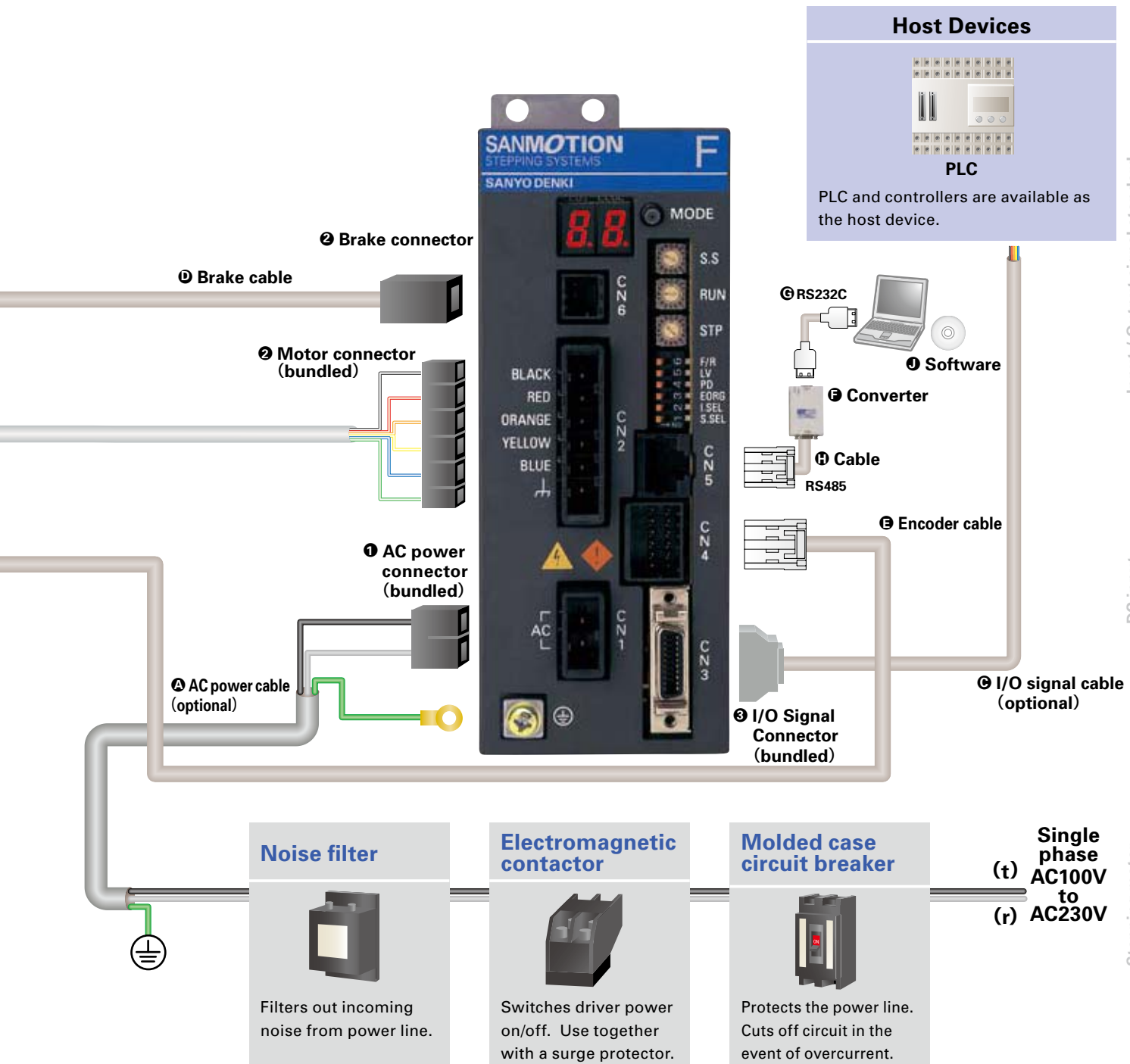

Host Devices

PLC

PLC and controllers are available as the host device.

Noise filter

Filters out incoming noise from power line.

Electromagnetic contactor

Switches driver power on/off. Use together with a surge protector.

Molded case circuit breaker

Protects the power line. Cuts off circuit in the event of overcurrent.

Single phase AC100V to AC230V (t) (r)

① Brake cable

L : m (feet)	Part number
10 (32.81)	PM-C03B1000-01
5 (16.40)	PM-C03B0500-01
3 (9.84)	PM-C03B0300-01
1 (3.28)	PM-C03B0100-01

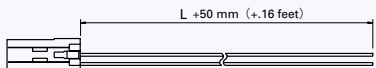

Leadwire	PVC cable AWG22 (0.3mm ²)
Housing	1-1318120-3 (AMP)
Contact	1318107-1 (AMP)

③ Cable for encoder use

L : m (feet)	Part number
10 (32.81)	PM-C12S1000-01
5 (16.40)	PM-C12S0500-01
3 (9.84)	PM-C12S0300-01
1 (3.28)	PM-C12S0100-01

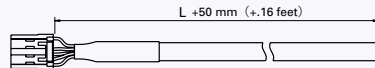

Leadwire	4-pair PVC shielded cable AWG22 (0.3mm ²)
Housing	1-1318118-6 (AMP)
Plug	1318107-1 (AMP)

⑦ Converter [unit : mm (inch)]

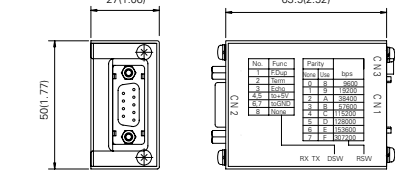

- ⑦ Part number for RS232C-RS485 converter : 232485CFP01-01
- ⑧ RS232 cable is supplied by user.
- ④ Part number for FP communications cable : PM-C08S0100-05
- ⑧ Part number for bundled software : SFP1W-01 (please download from website)

Part number convention

The following part number specifies a system with an F series driver (type code : FS1W075P) and a single shaft F series motor (type code : 103F7851-7041), □60mm (□2.36inch) square flange, and 46.5mm (1.83inch) motor length, equipped with low-backlash gear (reduction ratio of 1/3.6).

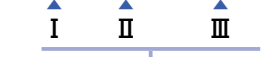

System spec

System type	I (Flange side)	II (End cap side)	III (Reduction ratio)
Spur gear	G	—	—
Low-backlash gear	C	—	—
Harmonic gear	H	—	—
No system at Flange side	X	—	—
Electromagnetic brake	—	B	—
No system at End cap side	—	X	—
Gear ratio	—	—	3.6 to 100

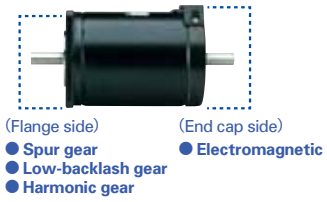

Stepping motor shaft spec
S : Single shaft D : Double shaft

Stepping motor total length

Code	Motor flange size									
	□28mm (□1.10inch)		□42mm (□1.65inch)		□60mm (□2.36inch)		φ86mm (φ3.39inch)		φ106mm (φ4.17inch)	
	Type code	Motor length : mm (inch)	Type code	Motor length : mm (inch)	Type code	Motor length : mm (inch)	Type code	Motor length : mm (inch)	Type code	Motor length : mm (inch)
1	3505	31 (1.22)	5505	34 (1.34)	7851	46.5 (1.83)	8581	62.2 (2.45)		
2			5508	40 (1.57)	7852	55 (2.17)	8582	92.2 (3.63)	89582	163.3 (6.43)
3					7853	87.5 (3.44)	8583	125.9(4.96)	89583	221.3(8.71)
4			5510	49 (1.93)						
6	3515	50.5 (1.99)								

Stepping motor flange size
35 : □28mm (□1.10inch) 85 : φ86mm (φ3.39inch)
55 : □42mm (□1.65inch) 89 : φ106mm (φ4.17inch)
78 : □60mm (□2.36inch)

Stepping motor series name
F : F series motor
M : M series motor (CE/UL)

FS : AC Power source Standard type
FP : AC Power positioning-function-included type

Combination list of 5-phase driver

System type	Motor flange size	Single shaft			Double shaft			
		Set part number		Combination stepping motor type code	Set part number		Combination stepping motor type code	
		S type	P type		S type	P type		
Standard model	□ 28mm (□ 1.10inch)	FSF351S	FPF351S	103F3505-7041	FSF351D	FPF351D	103F3505-7011	
		FSF356S	FPF356S	103F3515-7041	FSF356D	FPF356D	103F3515-7011	
		FSF551S	FPF551S	103F5505-7041	FSF551D	FPF551D	103F5505-7011	
	□ 42mm (□ 1.65inch)	FSF552S	FPF552S	103F5508-7041	FSF552D	FPF552D	103F5508-7011	
		FSF554S	FPF554S	103F5510-7041	FSF554D	FPF554D	103F5510-7011	
		FSF781S	FPF781S	103F7851-7041	FSF781D	FPF781D	103F7851-7011	
	□ 60mm (□ 2.36inch)	FSF782S	FPF782S	103F7852-7041	FSF782D	FPF782D	103F7852-7011	
		FSF783S	FPF783S	103F7853-7041	FSF783D	FPF783D	103F7853-7011	
		FSF851S	FPF851S	103F8581-7041	FSF851D	FPF851D	103F8581-7011	
	φ 86mm (φ 3.39inch)	FSF852S	FPF852S	103F8582-7041	FSF852D	FPF852D	103F8582-7011	
		FSF853S	FPF853S	103F8583-7041	FSF853D	FPF853D	103F8583-7011	
		FSF892S	FPF892S	103F89582-7041	FSF892D	FPF892D	103F89582-7011	
	φ 106mm (φ 4.17inch)	FSF893S	FPF893S	103F89583-7041	FSF893D	FPF893D	103F89583-7011	
	Low-backlash gear model	□ 42mm (□ 1.65inch)	FSF551S-CX3.6	FPF551S-CX3.6	103F5505-70CXA4	FSF551D-CX3.6	FPF551D-CX3.6	103F5505-70CXA1
			FSF551S-CX7.2	FPF551S-CX7.2	103F5505-70CXB4	FSF551D-CX7.2	FPF551D-CX7.2	103F5505-70CXB1
			FSF551S-CX10	FPF551S-CX10	103F5505-70CXE4	FSF551D-CX10	FPF551D-CX10	103F5505-70CXE1
FSF551S-CX20			FPF551S-CX20	103F5505-70CXG4	FSF551D-CX20	FPF551D-CX20	103F5505-70CXG1	
FSF551S-CX30			FPF551S-CX30	103F5505-70CXJ4	FSF551D-CX30	FPF551D-CX30	103F5505-70CXJ1	
FSF551S-CX36			FPF551S-CX36	103F5505-70CXX4	FSF551D-CX36	FPF551D-CX36	103F5505-70CXX1	
□ 60mm (□ 2.36inch)		FSF781S-CX3.6	FPF781S-CX3.6	103F7851-70CXA4	FSF781D-CX3.6	FPF781D-CX3.6	103F7851-70CXA1	
		FSF781S-CX7.2	FPF781S-CX7.2	103F7851-70CXB4	FSF781D-CX7.2	FPF781D-CX7.2	103F7851-70CXB1	
		FSF781S-CX10	FPF781S-CX10	103F7851-70CXE4	FSF781D-CX10	FPF781D-CX10	103F7851-70CXE1	
		FSF781S-CX20	FPF781S-CX20	103F7851-70CXG4	FSF781D-CX20	FPF781D-CX20	103F7851-70CXG1	
		FSF781S-CX30	FPF781S-CX30	103F7851-70CXJ4	FSF781D-CX30	FPF781D-CX30	103F7851-70CXJ1	
		FSF781S-CX36	FPF781S-CX36	103F7851-70CXX4	FSF781D-CX36	FPF781D-CX36	103F7851-70CXX1	
φ 86mm (φ 3.39inch)		FSF851S-CX3.6	FPF851S-CX3.6	103F8581-70CXA4	FSF851D-CX3.6	FPF851D-CX3.6	103F8581-70CXA1	
		FSF851S-CX7.2	FPF851S-CX7.2	103F8581-70CXB4	FSF851D-CX7.2	FPF851D-CX7.2	103F8581-70CXB1	
		FSF851S-CX10	FPF851S-CX10	103F8581-70CXE4	FSF851D-CX10	FPF851D-CX10	103F8581-70CXE1	
		FSF851S-CX20	FPF851S-CX20	103F8581-70CXG4	FSF851D-CX20	FPF851D-CX20	103F8581-70CXG1	
		FSF851S-CX30	FPF851S-CX30	103F8581-70CXJ4	FSF851D-CX30	FPF851D-CX30	103F8581-70CXJ1	
		FSF851S-CX36	FPF851S-CX36	103F8581-70CXX4	FSF851D-CX36	FPF851D-CX36	103F8581-70CXX1	
Spur gear model		□ 28mm (□ 1.10inch)	FSF351S-GX3.6	FPF351S-GX3.6	103F3505-70GXA4	FSF351D-GX3.6	FPF351D-GX3.6	103F3505-70GXA1
			FSF351S-GX7.2	FPF351S-GX7.2	103F3505-70GXB4	FSF351D-GX7.2	FPF351D-GX7.2	103F3505-70GXB1
			FSF351S-GX10	FPF351S-GX10	103F3505-70GXE4	FSF351D-GX10	FPF351D-GX10	103F3505-70GXE1
			FSF351S-GX20	FPF351S-GX20	103F3505-70GXG4	FSF351D-GX20	FPF351D-GX20	103F3505-70GXG1
			FSF351S-GX30	FPF351S-GX30	103F3505-70GXJ4	FSF351D-GX30	FPF351D-GX30	103F3505-70GXJ1
		FSF351S-GX50	FPF351S-GX50	103F3505-70GXL4	FSF351D-GX50	FPF351D-GX50	103F3505-70GXL1	
	□ 42mm (□ 1.65inch)	FSF551S-HX50	FPF551S-HX50	103F5505-70HXL4	FSF551D-HX50	FPF551D-HX50	103F5505-70HXL1	
		FSF551S-HX100	FPF551S-HX100	103F5505-70HXM4	FSF551D-HX100	FPF551D-HX100	103F5505-70HXM1	
		FSF551S-HX30	FPF551S-HX30	103F5505-70HXJ5	FSF551D-HX30	FPF551D-HX30	103F5505-70HXJ2	
		FSF551S-HX50	FPF551S-HX50	103F5505-70HXL5	FSF551D-HX50	FPF551D-HX50	103F5505-70HXL2	
FSF551S-HX100		FPF551S-HX100	103F5505-70HXM5	FSF551D-HX100	FPF551D-HX100	103F5505-70HXM2		
□ 60mm (□ 2.36inch)	FSF781S-HX50	FPF781S-HX50	103F7851-70HXL4	FSF781D-HX50	FPF781D-HX50	103F7851-70HXL1		
	FSF781S-HX100	FPF781S-HX100	103F7851-70HXM4	FSF781D-HX100	FPF781D-HX100	103F7851-70HXM1		
φ 86mm (φ 3.39inch)	FSF851S-HX50	FPF851S-HX50	103F8581-70HXL4	FSF851D-HX50	FPF851D-HX50	103F8581-70HXL1		
	FSF851S-HX100	FPF851S-HX100	103F8581-70HXM4	FSF851D-HX100	FPF851D-HX100	103F8581-70HXM1		
Electromagnetic brake model	□ 42mm (□ 1.65inch)	FSF551S-XB	FPF551S-XB	103F5505-70XB41	-	-	-	
		FSF552S-XB	FPF552S-XB	103F5508-70XB41	-	-	-	
		FSF554S-XB	FPF554S-XB	103F5510-70XB41	-	-	-	
	□ 60mm (□ 2.36inch)	FSF781S-XB	FPF781S-XB	103F7851-70XB41	-	-	-	
		FSF782S-XB	FPF782S-XB	103F7852-70XB41	-	-	-	
		FSF783S-XB	FPF783S-XB	103F7853-70XB41	-	-	-	
	φ 86mm (φ 3.39inch)	FSF851S-XB	FPF851S-XB	103F8581-70XB41	-	-	-	
		FSF852S-XB	FPF852S-XB	103F8582-70XB41	-	-	-	
		FSF853S-XB	FPF853S-XB	103F8583-70XB41	-	-	-	
CE/UL model	□ 42mm	FSM551S	FPM551S	103M5505-7041	FSM551D	FPM551D	103M5505-7011	
		FSM552S	FPM552S	103M5508-7041	FSM552D	FPM552D	103M5508-7011	
		FSM554S	FPM554S	103M5510-7041	FSM554D	FPM554D	103M5510-7011	
	□ 60mm	FSM781S	FPM781S	103M7851-7041	FSM781D	FPM781D	103M7851-7011	
		FSM782S	FPM782S	103M7852-7041	FSM782D	FPM782D	103M7852-7011	
		FSM783S	FPM783S	103M7853-7041	FSM783D	FPM783D	103M7853-7011	
	φ 86mm	FSM851S	FPM851S	103M8581-7041	FSM851D	FPM851D	103M8581-7011	
		FSM852S	FPM852S	103M8582-7041	FSM852D	FPM852D	103M8582-7011	
		FSM853S	FPM853S	103M8583-7041	FSM853D	FPM853D	103M8583-7011	
	φ 106mm	FSM892S	FPM892S	103M89582-7041	FSM892D	FPM892D	103M89582-7011	
		FSM893S	FPM893S	103M89583-7041	FSM893D	FPM893D	103M89583-7011	

AC input

Input / Output signal standard

DC input

Stepping motor

Dimensions

Standard model

F series driver + F series motor

Motor flange size



Size	Motor flange size	28mm (1.10inch)			
		31mm (1.22inch)		50.5mm (1.99inch)	
Set part number	Single shaft	FSF351S	FPF351S	FSF356S	FPF356S
	Double shaft	FSF351D	FPF351D	FSF356D	FPF356D
Holding torque	N·m(oz·in)	0.036 (5.10)		0.065 (9.20)	
Rotor inertia	$\times 10^{-4}$ kg·m ² (oz·in ²)	0.009 (0.05)		0.016 (0.09)	
Mass (Weight)	kg (lbs)	0.11 (0.22)		0.2 (0.44)	
Allowable thrust load	N (lbs)	3 (0.68)		3 (0.68)	
Allowable radial load ^(Note1)	N (lbs)	34 (7.65)		34 (7.65)	

(Note1) When load is applied at 1/3 length from output shaft edge.



AC100V

AC200V

Operating current:
0.75A/phase

- Pull-out torque
- - - Source current (load applied)
- · · Source current (no load)
- 1-division fs
- 2-division fs

Fs: Maximum self-start frequency when not loaded

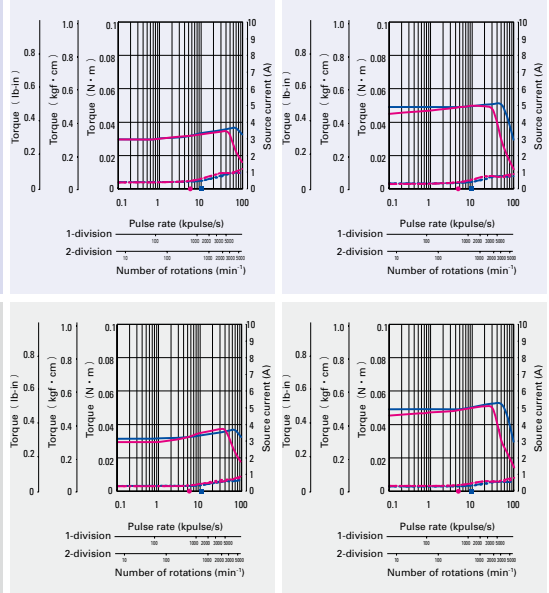

The data are measured under the drive condition of our company. The drive torque may very depending on the accuracy of customer-side equipment.

Size	Motor flange size	60mm (2.36inch)		86mm (3.39inch)					
		87.5mm (3.45inch)		62.15mm (2.47inch)		92.2mm (3.63inch)		125.85mm (4.95inch)	
Set part number	Single shaft	FSF783S	FPF783S	FSF851S	FPF851S	FSF852S	FPF852S	FSF853S	FPF853S
	Double shaft	FSF783D	FPF783D	FSF851D	FPF851D	FSF852D	FPF852D	FSF853D	FPF853D
Holding torque	N·m(oz·in)	1.79 (253.5)		2.06 (291.7)		4.02 (569.3)		6.17 (873.7)	
Rotor inertia	$\times 10^{-4}$ kg·m ² (oz·in ²)	0.84 (4.60)		1.45 (7.93)		2.9 (15.86)		4.4 (24.06)	
Mass (Weight)	kg (lbs)	1.36 (3.0)		1.5 (3.3)		2.5 (5.5)		3.5 (7.7)	
Allowable thrust load	N (lbs)	20 (4.5)		60 (13.5)		60 (13.5)		60 (13.5)	
Allowable radial load ^(Note1)	N (lbs)	80 (18)		220 (49.5)		220 (49.5)		220 (49.5)	

(Note1) When load is applied at 1/3 length from output shaft edge.

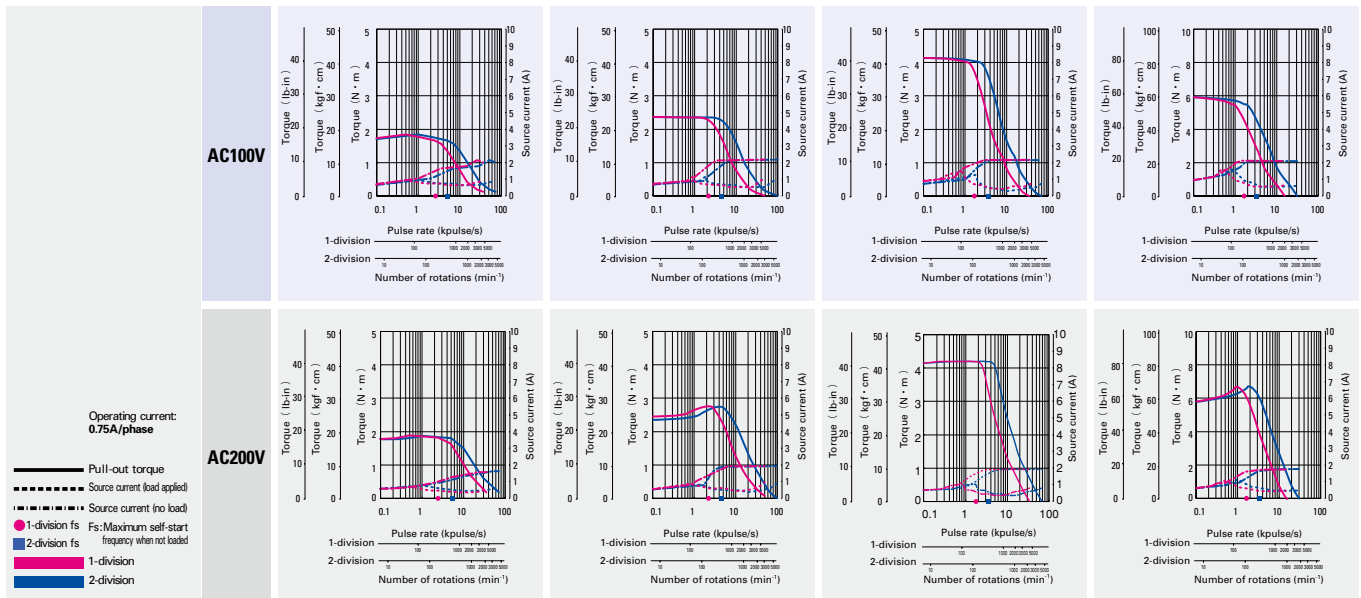

The data are measured under the drive condition of our company. The drive torque may very depending on the accuracy of customer-side equipment.

□ 42mm (□ 1.65inch)

□ 60mm (□ 2.36inch)

34mm (1.34inch)		40mm (1.57inch)		49mm (1.93inch)		46.5mm (1.83inch)		55mm (2.17inch)	
FSF551S	FPF551S	FSF552S	FPF552S	FSF554S	FPF554S	FSF781S	FPF781S	FSF782S	FPF782S
FSF551D	FPF551D	FSF552D	FPF552D	FSF554D	FPF554D	FSF781D	FPF781D	FSF782D	FPF782D
0.13 (18.41)		0.18 (25.49)		0.26 (36.82)		0.6 (85.0)		0.93 (131.7)	
0.03 (0.16)		0.053 (0.29)		0.065 (0.36)		0.275 (1.50)		0.4 (2.19)	
0.23 (0.50)		0.28 (0.62)		0.37 (0.81)		0.6 (1.32)		0.78 (1.72)	
10 (2.25)		10 (2.25)		10 (2.25)		20 (4.5)		20 (4.5)	
35 (8.75)		35 (8.75)		35 (8.75)		80 (18)		80 (18)	

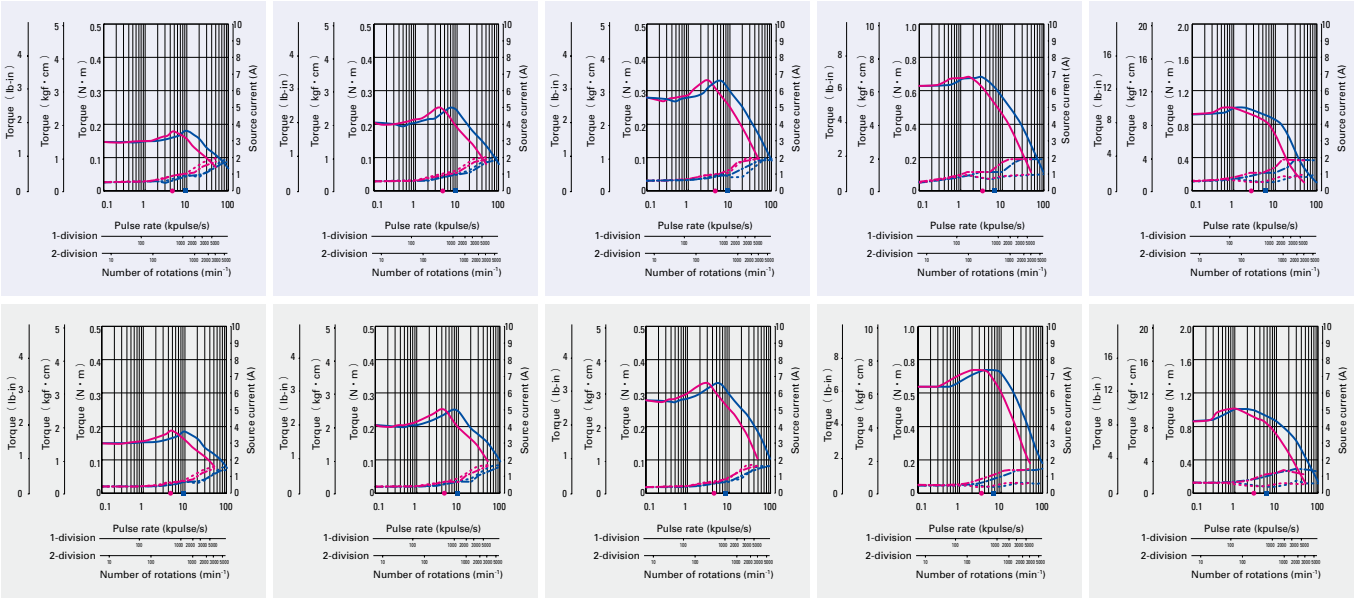

φ 106mm (φ 4.17inch)

163.3mm (6.43inch)		221.3mm (8.71inch)	
FSF892S	FPF892S	FSF893S	FPF893S
FSF892D	FPF892D	FSF893D	FPF893D
10.8 (1529.4)		16 (2265.7)	
14.6 (79.83)		22 (120.28)	
7.5 (16.5)		10.5 (23.1)	
100 (22.5)		100 (22.5)	
360 (81)		360 (81)	

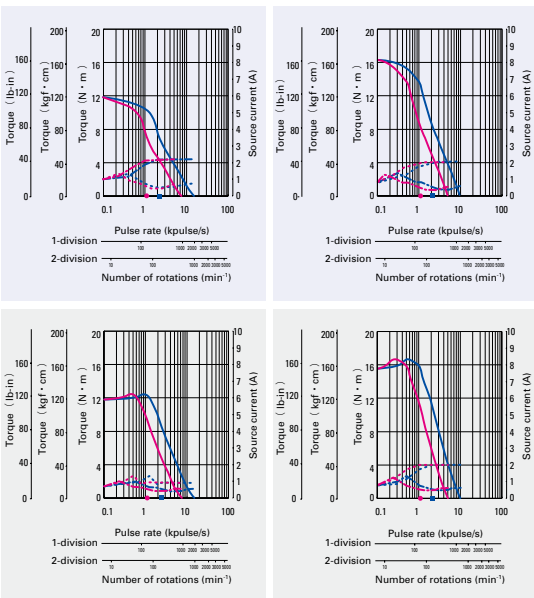

CE / UL model

F series driver + M series motor

Motor flange size



Size	Motor flange size	42mm (1.65inch)			
		31mm (1.22inch)		50.5mm (1.99inch)	
Set part number	Single shaft	F5M551S	F5P551S	F5M552S	F5P552S
	Double shaft	F5M551D	F5P551D	F5M552D	F5P552D
Holding torque	N·m(oz·in)	0.13 (18.41)		0.18 (25.49)	
Rotor inertia	$\times 10^{-4}$ kg·m ² (oz·in ²)	0.03 (0.16)		0.053 (0.29)	
Mass (Weight)	kg (lbs)	0.23 (0.51)		0.28 (0.62)	
Allowable thrust load	N (lbs)	10 (2.25)		10 (2.25)	
Allowable radial load (Note1)	N (lbs)	35 (8.75)		35 (8.75)	

(Note1) When load is applied at 1/3 length from output shaft edge.



AC100V

AC200V

Operating current:
0.75A/phase

- Pull-out torque
- Source current (load applied)
- Source current (no load)
- 1-division fs
- 2-division fs

Fs: Maximum self-start frequency when not loaded

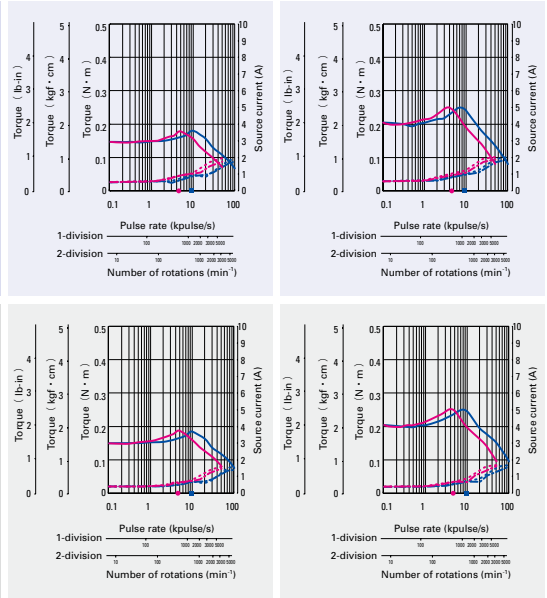

The data are measured under the drive condition of our company. The drive torque may very depending on the accuracy of customer-side equipment.

Size	Motor flange size	86mm (3.39inch)				106mm (4.17inch)			
		92.2mm (3.63inch)		125.85mm (4.95inch)		163.3mm (6.43inch)		221.3mm (8.71inch)	
Set part number	Single shaft	F5M852S	F5P852S	F5M853S	F5P853S	F5M892S	F5P892S	F5M893S	F5P893S
	Double shaft	F5M852D	F5P852D	F5M853D	F5P853D	F5M892D	F5P892D	F5M893D	F5P893D
Holding torque	N·m(oz·in)	4.02 (569.3)		6.17 (873.7)		10.8 (1529.4)		16 (2265.7)	
Rotor inertia	$\times 10^{-4}$ kg·m ² (oz·in ²)	2.9 (15.86)		4.4 (24.06)		14.6 (79.83)		22 (120.28)	
Mass (Weight)	kg (lbs)	2.5 (5.5)		3.5 (7.7)		7.5 (16.5)		10.5 (23.1)	
Allowable thrust load	N (lbs)	60 (13.5)		60 (13.5)		100 (22.5)		100 (22.5)	
Allowable radial load (Note1)	N (lbs)	220 (49.5)		220 (49.5)		360 (81)		360 (81)	

(Note1) When load is applied at 1/3 length from output shaft edge.

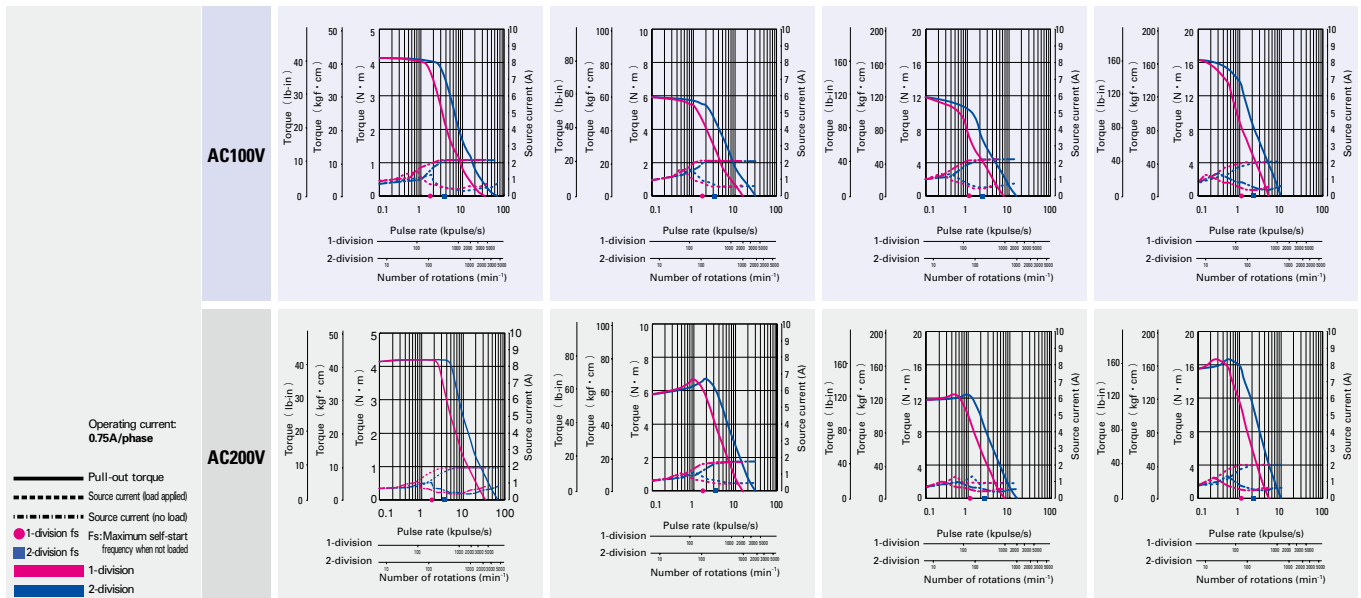

The data are measured under the drive condition of our company. The drive torque may very depending on the accuracy of customer-side equipment.

□ 42mm (□ 1.65inch)		□ 60mm (□ 2.36inch)				φ 86mm (φ 3.39inch)			
49mm (1.93inch)		46.5mm (1.83inch)		55mm (2.17inch)		87.5mm (3.44inch)		62.15mm (2.47inch)	
FSM554S	FPM554S	FSM781S	FPM781S	FSM782S	FPM782S	FSM783S	FPM783S	FSM851S	FPM851S
FSM554D	FPM554D	FSM781D	FPM781D	FSM782D	FPM782D	FSM783D	FPM783D	FSM851D	FPM851D
0.26 (36.82)		0.6 (85.0)		0.065 (9.20)		1.79 (253.5)		2.06 (291.7)	
0.065 (0.36)		0.275 (1.50)		0.016 (0.09)		0.84 (4.59)		1.45 (7.93)	
0.37 (0.81)		0.6 (1.32)		0.2 (0.44)		1.36 (3.0)		1.5 (3.3)	
10 (2.25)		20 (4.5)		3 (0.68)		20 (4.5)		60 (13.5)	
35 (8.75)		80 (18)		34 (7.65)		80 (18)		220 (49.5)	

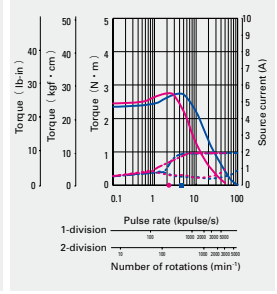
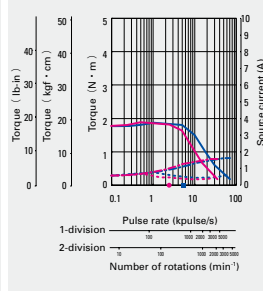
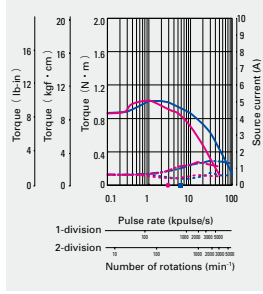
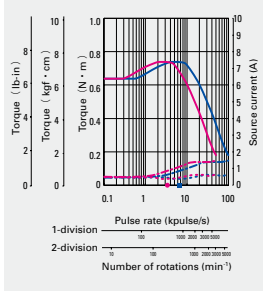
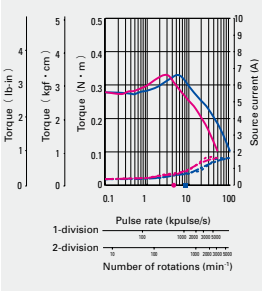
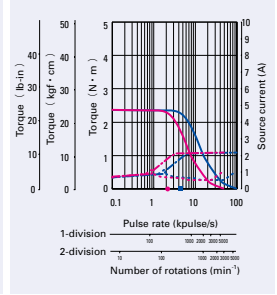
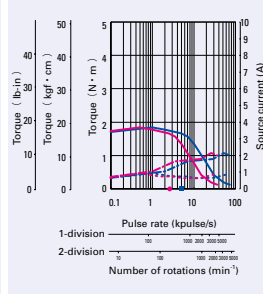
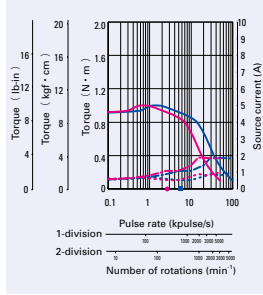
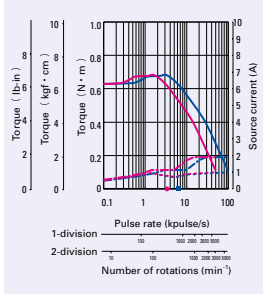
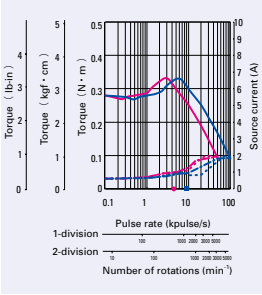

Low-backlash gear model

F series driver +
F series motor with low-backlash gear

Motor flange size



Size	Motor flange size	□ 42mm (□ 1.65inch)			
	Motor + gear length	64.5mm (2.54inch)		64.5mm (2.54inch)	
Set part number	Single shaft	FSF551S-CX3.6	FPF551S-CX3.6	FSF551S-CX7.2	FPF551S-CX7.2
	Double shaft	FSF551D-CX3.6	FPF551D-CX3.6	FSF551D-CX7.2	FPF551D-CX7.2
Allowable torque	N·m(oz·in)	0.35 (44.6)		0.7 (99.1)	
Rotor inertia	×10 ⁻⁴ kg·m ² (oz·in ²)	0.03 (0.16)		0.03 (0.16)	
Basic step angle		0.2		0.1	
Gear ratio		1 : 3.6		1 : 7.2	
Backlash	DEG	0.6		0.4	
Allowable speed	min ⁻¹	500		250	
Mass (Weight)	kg (lbs)	0.36 (0.79)		0.36 (0.79)	
Allowable thrust load	N (lbs)	15 (3.38)		15 (3.38)	
Allowable radial load ^(Note 1)	N (lbs)	20 (4.5)		20 (4.5)	

Directions of motor rotation and gear output shaft are the same for models with reduction ratio 1 : 3.6, 1 : 7.2, and 1 : 10 opposite for reduction ratio 1 : 20, 1 : 30, and 1 : 36.

(Note1) When load is applied at 1/3 length from output shaft edge.



AC100V

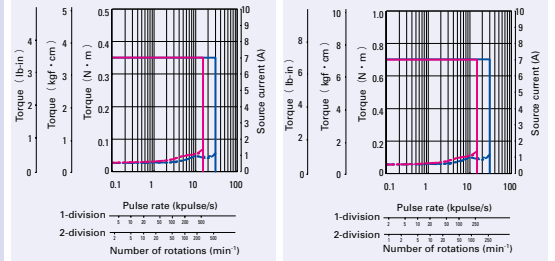

AC200V

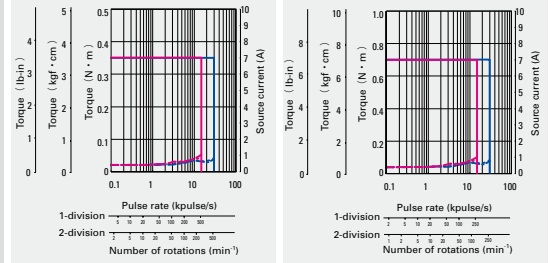

Operating current: 0.75A/phase

— Allowable torque
- - - Source current (load applied)
- · - · - Source current (no load)

— 1-division
— 2-division

The data are measured under the drive condition of our company. The drive torque may very depending on the accuracy of customer-side equipment.

Size	Motor flange size	□ 60mm (□ 2.36inch)							
	Motor + gear length	92mm (3.62inch)		92mm (3.62inch)		92mm (3.62inch)		92mm (3.62inch)	
Set part number	Single shaft	FSF781S-CX7.2	FPF781S-CX7.2	FSF781S-CX10	FPF781S-CX10	FSF781S-CX20	FPF781S-CX20	FSF781S-CX30	FPF781S-CX30
	Double shaft	FSF781D-CX7.2	FPF781D-CX7.2	FSF781D-CX10	FPF781D-CX10	FSF781D-CX20	FPF781D-CX20	FSF781D-CX30	FPF781D-CX30
Allowable torque	N·m(oz·in)	2.5 (354.0)		3 (424.8)		3.5 (495.6)		4 (566.4)	
Rotor inertia	×10 ⁻⁴ kg·m ² (oz·in ²)	0.275 (1.5)		0.275 (1.5)		0.275 (1.5)		0.275 (1.5)	
Basic step angle		0.1		0.072		0.036		0.024	
Gear ratio		1 : 7.2		1 : 10		1 : 20		1 : 30	
Backlash	DEG	0.25		0.25		0.17		0.17	
Allowable speed	min ⁻¹	250		180		90		60	
Mass (Weight)	kg (lbs)	0.97 (2.13)		0.97 (2.13)		0.97 (2.13)		0.97 (2.13)	
Allowable thrust load	N (lbs)	30 (6.75)		30 (6.75)		30 (6.75)		30 (6.75)	
Allowable radial load ^(Note 1)	N (lbs)	100 (22.5)		100 (22.5)		100 (22.5)		100 (22.5)	

Directions of motor rotation and gear output shaft are the same for models with reduction ratio 1 : 3.6 and 1:7.2, opposite for reduction ratio 1 : 10, 1 : 20 and 1 : 30.

(Note1) When load is applied at 1/3 length from output shaft edge.

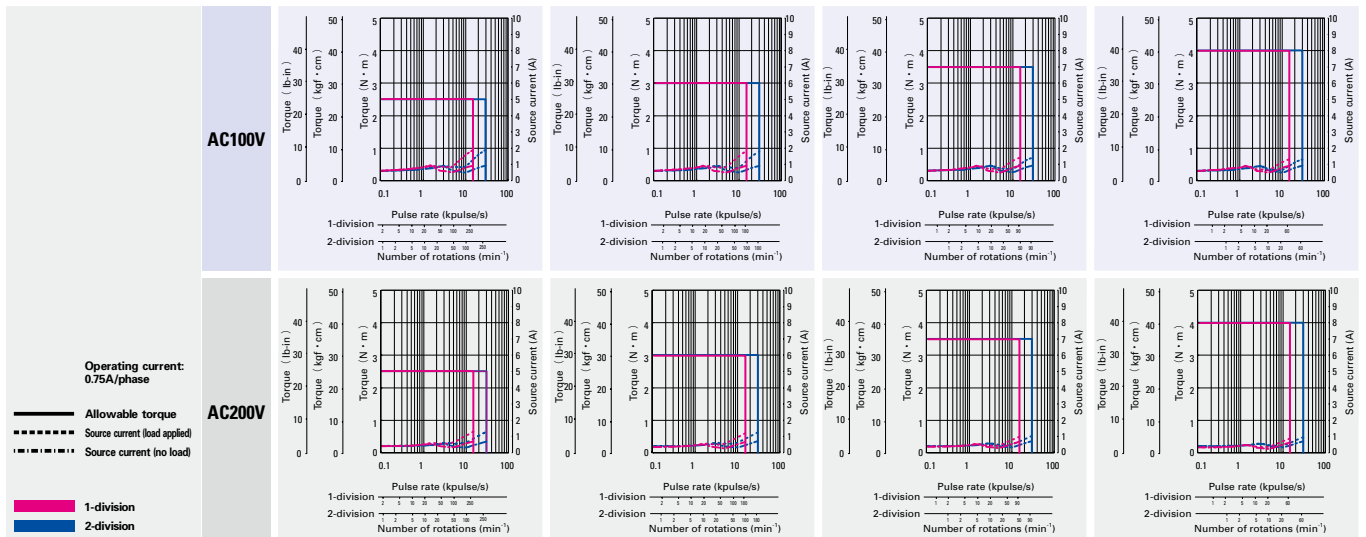

The data are measured under the drive condition of our company. The drive torque may very depending on the accuracy of customer-side equipment.

□ 42mm (□ 1.65inch)

□ 60mm (□ 2.36inch)

64.5mm (2.54inch)		64.5mm (2.54inch)		64.5mm (2.54inch)		64.5mm (2.54inch)		92mm (3.62inch)	
FSF551S-CX10	FPF551S-CX10	FSF551S-CX20	FPF551S-CX20	FSF551S-CX30	FPF551S-CX30	FSF551S-CX36	FPF551S-CX36	FSF781S-CX3.6	FPF781S-CX3.6
FSF551D-CX10	FPF551D-CX10	FSF551D-CX20	FPF551D-CX20	FSF551D-CX30	FPF551D-CX30	FSF551D-CX36	FPF551D-CX36	FSF781D-CX3.6	FPF781D-CX3.6
1 (141.6)		1.5 (212.4)		1.5 (212.4)		1.5 (212.4)		1.25 (177.0)	
0.03 (0.16)		0.03 (0.16)		0.03 (0.16)		0.03 (0.16)		0.275 (1.5)	
0.072		0.036		0.024		0.02		0.2	
1 : 10		1 : 20		1 : 30		1 : 36		1 : 3.6	
0.35		0.25		0.25		0.25		0.55	
180		90		60		50		500	
0.36 (0.79)		0.36 (0.79)		0.36 (0.79)		0.36 (0.79)		0.97 (2.13)	
15 (3.38)		15 (3.38)		15 (3.38)		15 (3.38)		30 (6.75)	
20 (4.5)		20 (4.5)		20 (4.5)		20 (4.5)		100 (22.5)	

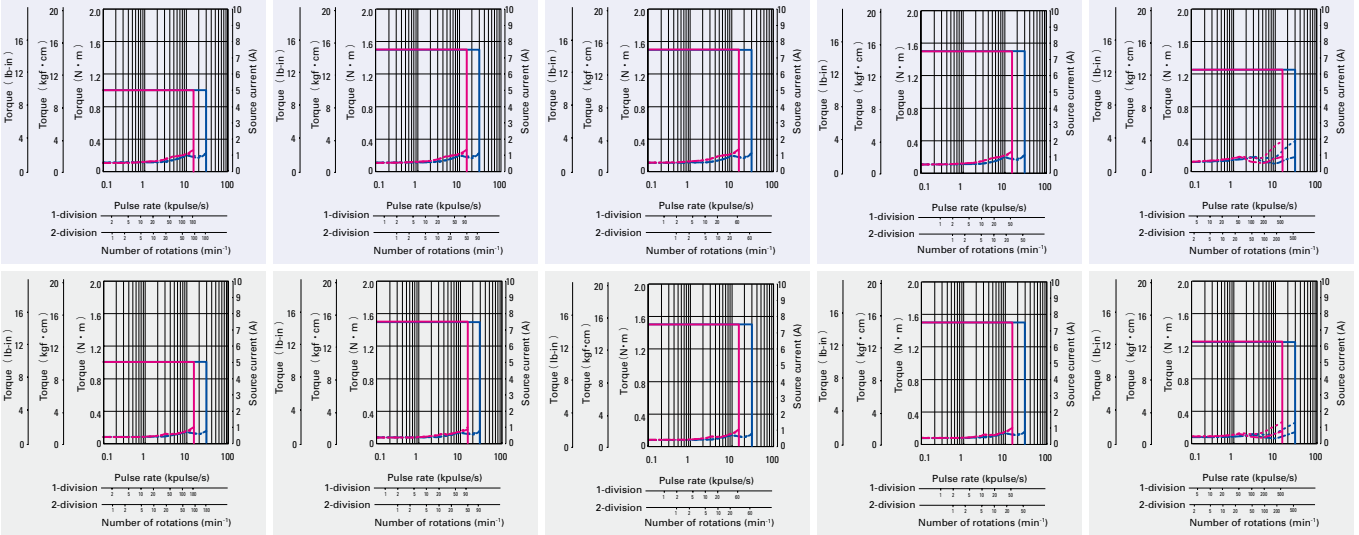

□ 60mm (□ 2.36inch)

φ 86mm (φ 3.39inch)

92mm (3.62inch)		127.3mm (5.01inch)		127.3mm (5.01inch)		127.3mm (5.01inch)		127.3mm (5.01inch)	
FSF781S-CX36	FPF781S-CX36	FSF851S-CX3.6	FPF851S-CX3.6	FSF851S-CX7.2	FPF851S-CX7.2	FSF851S-CX10	FPF851S-CX10	FSF851S-CX20	FPF851S-CX20
FSF781D-CX36	FPF781D-CX36	FSF851D-CX3.6	FPF851D-CX3.6	FSF851D-CX7.2	FPF851D-CX7.2	FSF851D-CX10	FPF851D-CX10	FSF851D-CX20	FPF851D-CX20
4 (566.4)		4.5 (637.2)		9 (1274.5)		9 (1274.5)		12 (1699.3)	
0.275 (1.5)		1.45 (7.93)		1.45 (7.93)		1.45 (7.93)		1.45 (7.93)	
0.02		0.2		0.1		0.072		0.036	
1 : 36		1 : 3.6		1 : 7.2		1 : 10		1 : 20	
0.17		0.4		0.25		0.25		0.17	
50		500		250		180		90	
0.97 (2.13)		2.7 (5.94)		2.7 (5.94)		2.7 (5.94)		2.7 (5.94)	
30 (6.75)		30 (6.75)		30 (6.75)		30 (6.75)		30 (6.75)	
100 (22.5)		100 (22.5)		100 (22.5)		100 (22.5)		100 (22.5)	

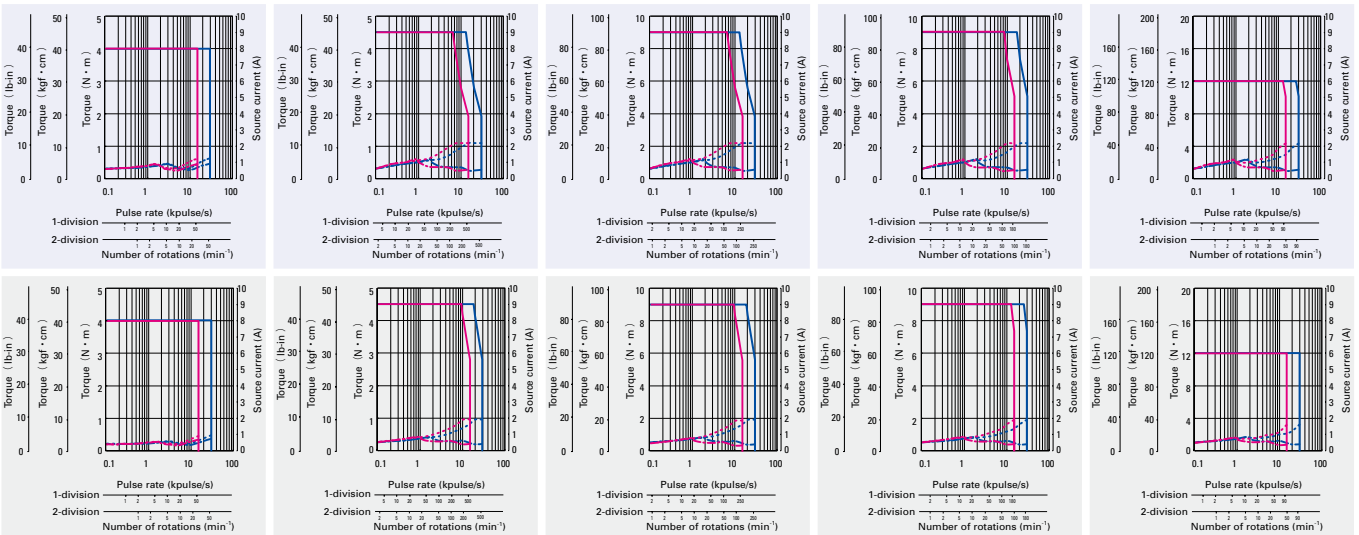

Low-backlash gear model

F series driver +
F series motor with low-backlash gear

Size	Motor flange size	φ 86mm (φ 3.39inch)			
		127.3mm (5.01inch)		127.3mm (5.01inch)	
Set part number	Motor + gear length				
	Single shaft	FSF851S-CX30	FPF851S-CX30	FSF851S-CX36	FPF851S-CX36
Allowable torque	Double shaft	FSF851D-CX30	FPF851D-CX30	FSF851D-CX36	FPF851D-CX36
	N·m(oz·in)	12 (1699.3)		12 (1699.3)	
Rotor inertia	×10 ⁴ kg·m ² (oz·in ²)	1.45 (7.93)		1.45 (7.93)	
Basic step angle		0.024		0.02	
Gear ratio		1 : 30		1 : 36	
Backlash	DEG	0.17		0.15	
Allowable speed	min ⁻¹	60		50	
Mass (Weight)	kg (lbs)	2.7 (5.94)		2.7 (5.94)	
Allowable thrust load	N (lbs)	60 (13.5)		60 (13.5)	
Allowable radial load (Note 1)	N (lbs)	300 (67.5)		300 (67.5)	

Directions of motor rotation and gear output shaft are the same for models with reduction ratio 1 : 3.6 and 1:7.2, opposite for reduction ratio 1 : 10, 1 : 20, 1 : 30, and 1 : 36.
(Note1) When load is applied at 1/3 length from output shaft edge.

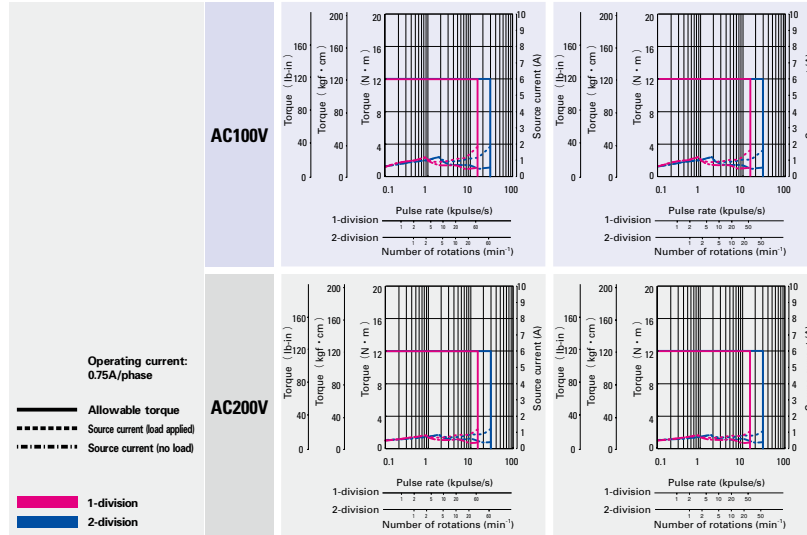

The data are measured under the drive condition of our company. The drive torque may vary depending on the accuracy of customer-side equipment.

Spur gear model

F series driver + F series motor with spur gear

Motor flange size

□28
(-1.10inch)



Size	Motor flange size	□28mm (□1.10inch)			
	Motor + gear length	60.3mm (2.37inch)		60.3mm (2.37inch)	
Set part number	Single shaft	FSF351S-GX3.6	FPF351S-GX3.6	FSF351S-GX7.2	FPF351S-GX7.2
	Double shaft	FSF351D-GX3.6	FPF351D-GX3.6	FSF351D-GX7.2	FPF351D-GX7.2
Allowable torque	N·m(oz·in)	0.1 (14.16)		0.15 (21.24)	
Rotor inertia	$\times 10^{-4}$ kg·m ² (oz·in ²)	0.009 (0.05)		0.009 (0.05)	
Basic step angle		0.2		0.1	
Gear ratio		1 : 3.6		1 : 7.2	
Backlash	DEG	2		2	
Allowable speed	min ⁻¹	800		400	
Mass (Weight)	kg (lbs)	0.17 (0.37)		0.17 (0.37)	
Allowable thrust load	N (lbs)	10 (2.25)		10 (2.25)	
Allowable radial load (Note 1)	N (lbs)	15 (3.38)		15 (3.38)	

Directions of motor rotation and gear output shaft are the same for models with reduction ratio 1 : 3.6, 1 : 7.2, 1 : 20, 1 : 30, and 1:50 opposite for reduction ratio 1 : 10.

(Note1) When load is applied at 1/3 length from output shaft edge.

AC100V

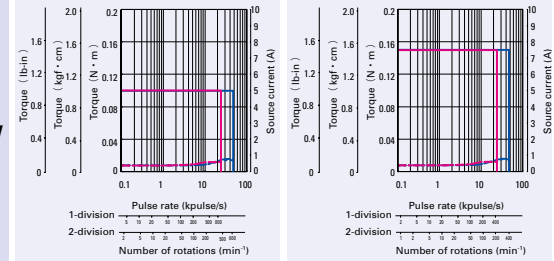

AC200V

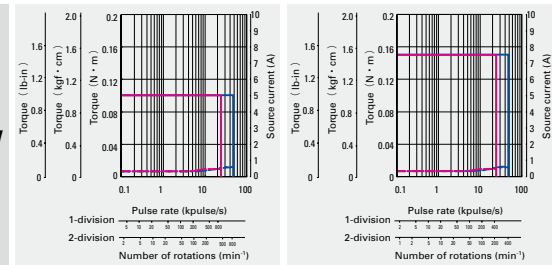

Operating current:
0.75A/phase

— Allowable torque
- - - Source current (load applied)
- · - · - Source current (no load)

■ 1-division
■ 2-division

The data are measured under the drive condition of our company. The drive torque may very depending on the accuracy of customer-side equipment.

Size	Motor flange size	□28mm (□1.10inch)							
	Motor + gear length	60.3mm (2.37inch)		60.3mm (2.37inch)		60.3mm (2.37inch)		60.3mm (2.37inch)	
Set part number	Single shaft	FSF351S-GX10	FPF351S-GX10	FSF351S-GX20	FPF351S-GX20	FSF351S-GX30	FPF351S-GX30	FSF351S-GX50	FPF351S-GX50
	Double shaft	FSF351D-GX10	FPF351D-GX10	FSF351D-GX20	FPF351D-GX20	FSF351D-GX30	FPF351D-GX30	FSF351D-GX50	FPF351D-GX50
Allowable torque	N·m(oz·in)	0.2 (28.32)		0.35 (49.6)		0.5 (70.80)		0.5 (70.80)	
Rotor inertia	$\times 10^{-4}$ kg·m ² (oz·in ²)	0.009 (0.05)		0.009 (0.05)		0.009 (0.05)		0.009 (0.05)	
Basic step angle		0.072		0.036		0.024		0.0144	
Gear ratio		1 : 10		1 : 20		1 : 30		1 : 50	
Backlash	DEG	2		1.5		1.5		1.5	
Allowable speed	min ⁻¹	300		150		100		60	
Mass (Weight)	kg (lbs)	0.17 (0.37)		0.17 (0.37)		0.17 (0.37)		0.17 (0.37)	
Allowable thrust load	N (lbs)	10 (2.25)		10 (2.25)		10 (2.25)		10 (2.25)	
Allowable radial load (Note 1)	N (lbs)	15 (3.38)		15 (3.38)		15 (3.38)		15 (3.38)	

Directions of motor rotation and gear output shaft are the same for models with reduction ratio 1 : 3.6, 1 : 7.2, 1 : 20, 1 : 30, and 1:50 opposite for reduction ratio 1 : 10.

(Note1) When load is applied at 1/3 length from output shaft edge.

AC100V

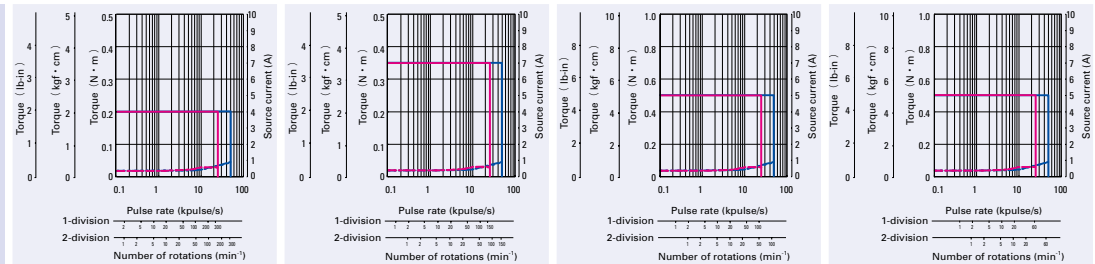

AC200V

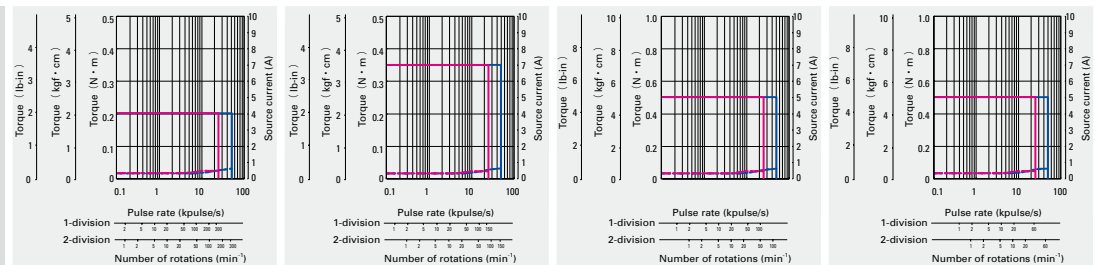

Operating current:
0.75A/phase

— Allowable torque
- - - Source current (load applied)
- · - · - Source current (no load)

■ 1-division
■ 2-division

The data are measured under the drive condition of our company. The drive torque may very depending on the accuracy of customer-side equipment.

AC input

Input / Output signal standard

DC input

Stepping motor

Dimensions

Harmonic gear model

F series driver +
F series motor with harmonic gear

Motor flange size

- 28
(1.10inch)
- 42
(1.65inch)
- 60
(2.35inch)
- φ86
(3.39inch)



Size	Motor flange size		□28mm (□1.10inch)			
	Motor + gear length		69.5mm (2.74inch)		69.5mm (2.74inch)	
Set part number	Single shaft		FSF351S-HX50	FPF351S-HX50	FSF351S-HX100	FPF351S-HX100
	Double shaft		FSF351D-HX50	FPF351D-HX50	FSF351D-HX100	FPF351D-HX100
Allowable torque	N·m(oz·in)		1.5 (212.4)		2 (283.2)	
Momentary allowable torque	N·m(oz·in)		2.7 (382.4)		3.6 (509.8)	
Rotor inertia	×10 ⁻⁴ kg·m ² (oz·in ²)		0.012 (0.065)		0.012 (0.065)	
Basic step angle			0.0144		0.0072	
Gear ratio			1 : 50		1 : 100	
Lost motion	Minute		0.4 to 3 ± 0.006N·m (0.85oz·in)		0.4 to 3 ± 0.008N·m (1.133oz·in)	
Allowable speed	min ⁻¹		70		35	
Mass (Weight)	kg(lbs)		0.22 (0.48)		0.22 (0.48)	
Allowable thrust load	N(lbs)		100 (22.5)		100 (22.5)	
Allowable radial load ^(Note 1)	N(lbs)		160 (36)		160 (36)	

Directions of gear output shaft are the opposite.
(Note1) When load is applied at 1/3 length from output shaft edge.

AC100V

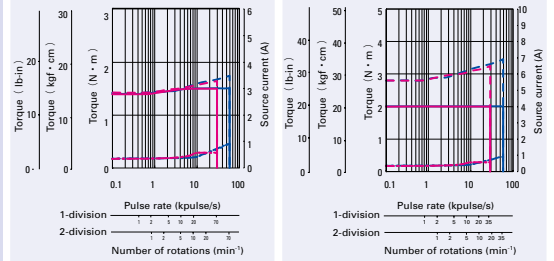

AC200V

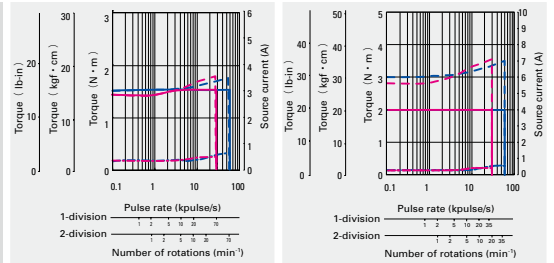

- Operating current: 0.75A/phase
- Momentary allowable torque
 - Allowable torque
 - Source current (load applied)
 - Source current (no load)
 - █ 1-division
 - █ 2-division

The data are measured under the drive condition of our company. The drive torque may very depending on the accuracy of customer-side equipment.

Size	Motor flange size		□60mm (□2.36inch)				φ86mm (φ3.39inch)			
	Motor + gear length		113.5mm (4.47inch)		113.5mm (4.47inch)		113.5mm (4.47inch)		113.5mm (4.47inch)	
Set part number	Single shaft		FSF781S-HX50	FPF781S-HX50	FSF781S-HX100	FPF781S-HX100	FSF851S-HX50	FPF851S-HX50	FSF851S-HX100	FPF851S-HX100
	Double shaft		FSF781D-HX50	FPF781D-HX50	FSF781D-HX100	FPF781D-HX100	FSF851D-HX50	FPF851D-HX50	FSF851D-HX100	FPF851D-HX100
Allowable torque	N·m(oz·in)		5.5 (778.8)		8 (1132.9)		25 (3540.2)		41 (5805.9)	
Momentary allowable torque	N·m(oz·in)		14 (1982.6)		20 (2832.2)		34 (4814.8)		59 (8355.1)	
Rotor inertia	×10 ⁻⁴ kg·m ² (oz·in ²)		0.31 (1.695)		0.31 (1.695)		1.65 (9.021)		1.65 (9.021)	
Basic step angle			0.0144		0.0072		0.0144		0.0072	
Gear ratio			1 : 50		1 : 100		1 : 50		1 : 100	
Lost motion	Minute		0.4 to 3 ± 0.028N·m (3.965oz·in)		0.4 to 3 ± 0.4N·m (56.645oz·in)		0.4 to 3 ± 1N·m (141.612oz·in)		0.4 to 3 ± 1.2N·m (169.934oz·in)	
Allowable speed	min ⁻¹		70		35		70		35	
Mass (Weight)	kg(lbs)		1.2 (2.64)		1.2 (2.64)		3.3 (7.26)		3.3 (7.26)	
Allowable thrust load	N(lbs)		400 (90)		400 (90)		1400 (315)		1400 (315)	
Allowable radial load ^(Note 1)	N(lbs)		360 (81)		360 (81)		1380 (310.5)		1380 (310.5)	

Directions of gear output shaft are the opposite.
(Note1) When load is applied at 1/3 length from output shaft edge.

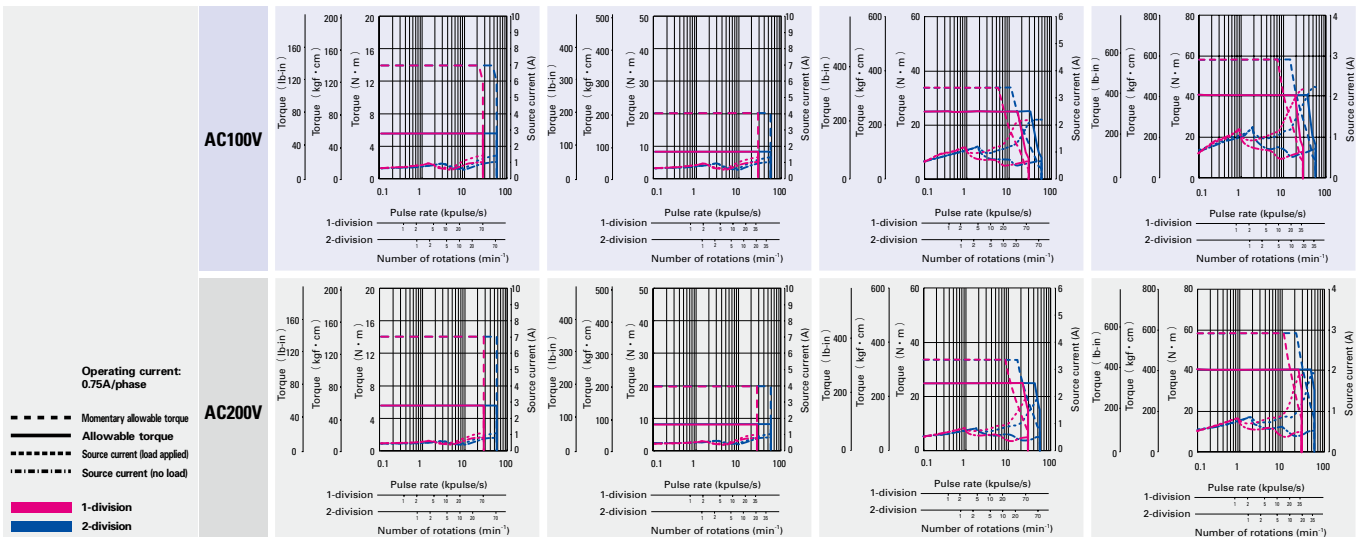

The data are measured under the drive condition of our company. The drive torque may very depending on the accuracy of customer-side equipment.

Size	Motor flange size	□ 42mm (□ 1.65inch)					
	Motor + gear length	73.5mm (2.89inch)		73.5mm (2.89inch)		73.5mm (2.89inch)	
Set part number	Single shaft	FSF551S-HX30	FPF551S-HX30	FSF551S-HX50	FPF551S-HX50	FSF551S-HX100	FPF551S-HX100
	Double shaft	FSF551D-HX30	FPF551D-HX30	FSF551D-HX50	FPF551D-HX50	FSF551D-HX100	FPF551D-HX100
Allowable torque	N·m(oz·in)	2.2 (311.5)		3.5 (495.6)		5 (708.1)	
Momentary allowable torque	N·m(oz·in)	4.5 (637.3)		8.3 (1175.4)		11 (1557.7)	
Rotor inertia	$\times 10^{-4} \text{kg}\cdot\text{m}^2(\text{oz}\cdot\text{in}^2)$	0.042 (0.23)		0.042 (0.23)		0.042 (0.23)	
Basic step angle		0.024		0.0144		0.0072	
Gear ratio		1:30		1:50		1:100	
Hysteresis loss	Minute	3.6		2.4		2.4	
Allowable speed	min^{-1}	116		70		35	
Mass (Weight)	kg (lbs)	0.42 (0.92)		0.42 (0.92)		0.42 (0.92)	
Allowable thrust load	N (lbs)	1150 (258.75)		1150 (258.75)		1150 (258.75)	
Allowable radial load ^(Note 1)	N (lbs)	209 (46.98)		209 (46.98)		209 (46.98)	

Directions of gear output shaft are the opposite.
 (Note1) The load point is an output axis point.

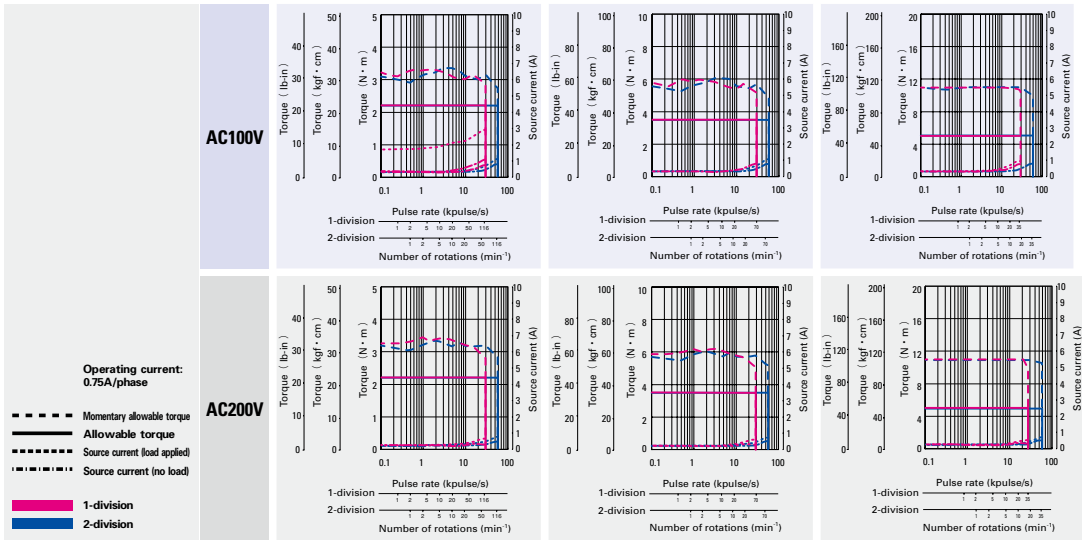

Electromagnetic brake model

F series driver + F series motor with electromagnetic brake

Motor flange size



Size	Motor flange size		42mm (1.65inch)			
	Motor + brake length		64.5mm (2.54inch)		70.5mm (2.78inch)	
Set part number	Single shaft		FSF551S-XB	FPF551S-XB	FSF552S-XB	FPF552S-XB
Holding torque	N·m(oz·in)		0.13 (8.4)		0.18 (25.49)	
Rotor inertia	$\times 10^{-4}$ kg·m ² (oz·in ²)		0.045 (0.246)		0.068 (0.372)	
Mass (Weight)	kg (lbs)		0.38 (0.84)		0.43 (0.95)	
Allowable thrust load	N (lbs)		10 (2.25)		10 (2.25)	
Allowable radial load ^(Note 1)	N (lbs)		35 (8.75)		35 (8.75)	
Brake type			No excitation actuating type		No excitation actuating type	
Electromagnetic brake	Power supply input	V	DC24V \pm 5%		DC24V \pm 5%	
	Excitation current	A	0.08		0.08	
	Power consumption	W	2		2	
	Static fiction torque	N·m(oz·in)	0.22 (31.15)		0.22 (31.15)	
	Brake operating time	ms	30		30	
	Brake release time	ms	20		20	

(Note1) When load is applied at 1/3 length from output shaft edge.



AC100V

AC200V

Operating current:
0.75A/phase

- Pull-out torque
- - - Source current (load applied)
- · - · - Source current (no load)
- 1-division fs
- 2-division fs
- Fs: Maximum self-start frequency when not loaded
- 1-division
- 2-division

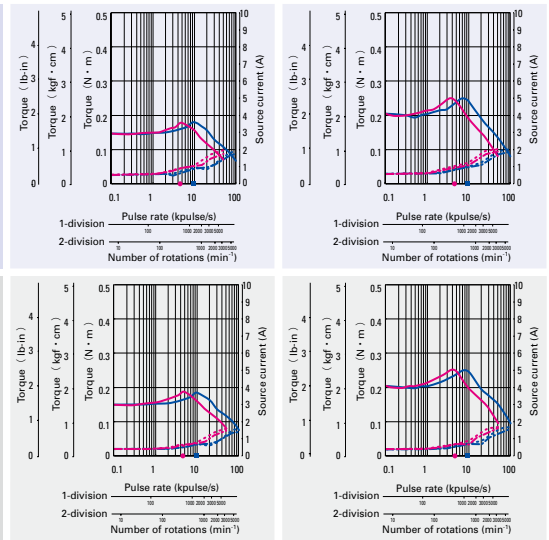

The data are measured under the drive condition of our company. The drive torque may very depending on the accuracy of customer-side equipment.

Size	Motor flange size		86mm (3.39inch)			
	Motor + brake length		146.8mm (5.78mm)		180.4mm (7.10mm)	
Set part number	Single shaft		FSF852S-XB	FPF852S-XB	FSF853S-XB	FPF853S-XB
Holding torque	N·m(oz·in)		4.02 (569.3)		6.17 (873.7)	
Rotor inertia	$\times 10^{-4}$ kg·m ² (oz·in ²)		3.69 (20.175)		5.19 (28.376)	
Mass (Weight)	kg (lbs)		4.5 (9.9)		5.5 (12.1)	
Allowable thrust load	N (lbs)		60 (13.5)		60 (13.5)	
Allowable radial load ^(Note 1)	N (lbs)		220 (49.5)		220 (49.5)	
Brake type			No excitation actuating type		No excitation actuating type	
Electromagnetic brake	Power supply input	V	DC24V \pm 5%		DC24V \pm 5%	
	Excitation current	A	0.42		0.42	
	Power consumption	W	10		10	
	Static fiction torque	N·m(oz·in)	4 (566.45)		4 (566.45)	
	Brake operating time	ms	50		50	
	Brake release time	ms	20		20	

(Note1) When load is applied at 1/3 length from output shaft edge.

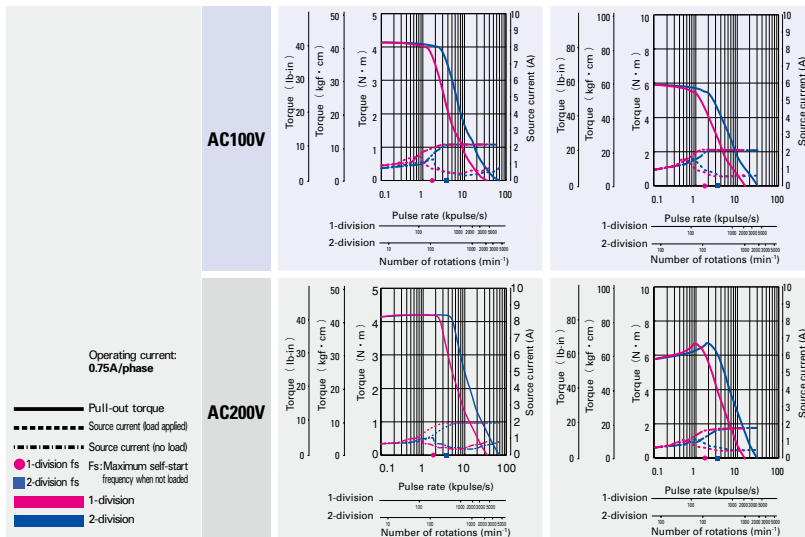

Operating current:
0.75A/phase

- Pull-out torque
- - - Source current (load applied)
- · - · - Source current (no load)
- 1-division fs
- 2-division fs
- Fs: Maximum self-start frequency when not loaded
- 1-division
- 2-division

The data are measured under the drive condition of our company. The drive torque may very depending on the accuracy of customer-side equipment.

□ 42mm (□ 1.65inch)		□ 60mm (□ 2.36inch)				φ 86mm (φ 3.39inch)			
79.5mm (3.13inch)		85.8mm (3.38inch)		94.5mm (3.72inch)		126.7mm (4.99inch)		116.7mm (4.59inch)	
FSF554S-XB	PPF554S-XB	FSF781S-XB	PPF781S-XB	FSF782S-XB	PPF782S-XB	FSF783S-XB	PPF783S-XB	FSF851S-XB	PPF851S-XB
0.26 (36.82)		0.6 (85.0)		0.98 (138.8)		1.79 (253.5)		2.06 (291.7)	
0.08 (0.437)		0.43 (2.351)		0.56 (3.062)		1 (5.468)		2.24 (12.247)	
0.52 (1.14)		0.94 (2.07)		1.12 (2.46)		1.7 (3.74)		3.5 (7.7)	
10 (2.25)		20 (4.5)		20 (4.5)		20 (4.5)		60 (13.5)	
35 (8.75)		80 (18)		80 (18)		80 (18)		220 (49.5)	
No excitation actuating type		No excitation actuating type		No excitation actuating type		No excitation actuating type		No excitation actuating type	
DC24V ± 5%		DC24V ± 5%		DC24V ± 5%		DC24V ± 5%		DC24V ± 5%	
0.08		0.25		0.25		0.25		0.42	
2		6		6		6		10	
0.22 (31.15)		0.8 (113.29)		0.8 (113.29)		0.8 (113.29)		4 (566.45)	
30		30		30		30		50	
20		20		20		20		20	

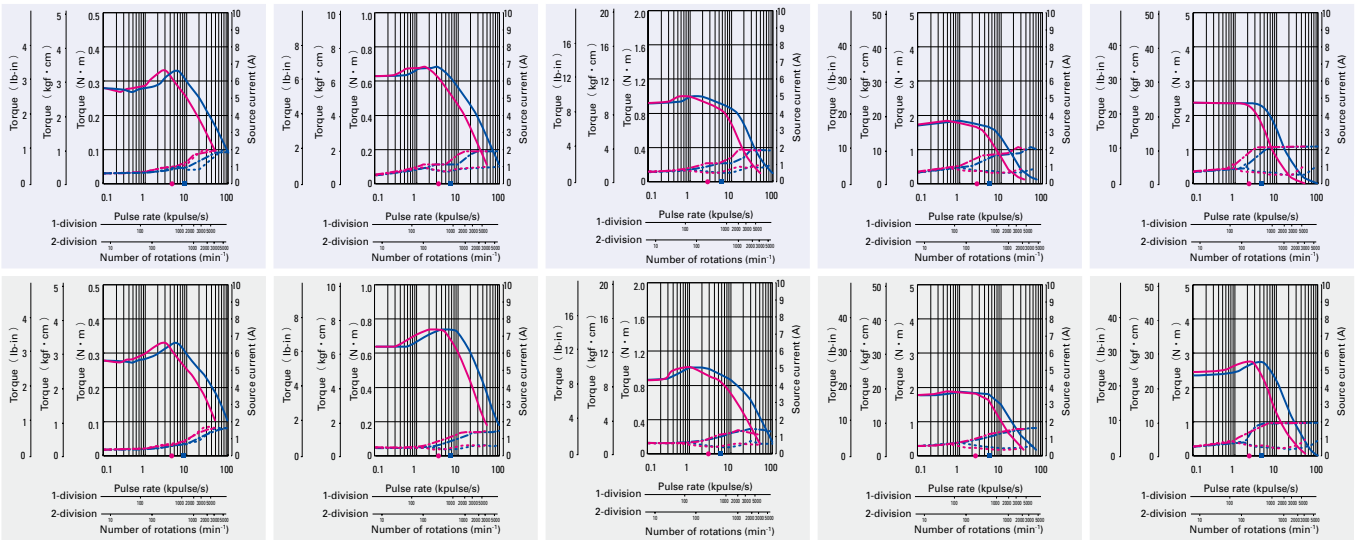

Common specifications

F series driver

Basic specifications	Type code	FS1W075S	
	Power supply	Single phase AC100V to 230V +10, -15% 50/60/Hz	
	Source current	4 A MAX.	
	Environment	Protection class	Class I
		Operation environment	Installation category (over-voltage category) : II , pollution degree: 2
		Applied standards	EN50178, UL508C
		Ambient operation temperature	0 to 50°C
		Storage temperature	-20 to +70°C
		Ambient operation humidity	35 to 85%RH (no condensation)
		Storage humidity	10 to 90%RH (no condensation)
		Operation altitude	1000 m (3280 feet) MAX. above sea level
		Vibration resistance	Tested under the following conditions ; 4.9m/s ² , frequency range 10 to 55Hz, direction along X, Y and Z axes, for 2 hours each
		Impact resistance	Not influenced at NDS-C-0110 standard section 3.2.2 division "C" .
	Withstand voltage	Not influenced when 1500V AC is applied between power input terminal and cabinet for one minute.	
Insulation resistance	10M ohm MIN. when measured with 500V DC megohmmeter between input terminal and cabinet.		
Mass (Weight)	0.8kg (1.77lbs)		
Functions	Protection functions	Driver overheating, main circuit power supply error, and over-current	
	LED indication	Power monitor, phase origin monitor, pulse monitor, alarm	
CN3	Input signal	Photo-coupler input system ; input resistance: 220 Ω ; input-signal "H" level : 4.0 to 5.5V ; input-signal "L" level : 0 to 0.5V	
	Output signal	From the photo coupler by the open collector output Output specification : V _{ceo} = 30V MAX., I _c = 5mA	

F series motor / M series motor

Stepping motor type	F series motor	M series motor
Motor Type	103F35 □□ /103F55 □□ /103F785 □ /103F858 □ /103F8958 □	103M55 □□ /103M785 □ /103M858 □ /103M8958 □
Type	—	S1 (continuous operation)
Insulation class	Class B (+130°C)	Class B (+130°C) [UL class A (+105°C)]
Operation altitude	1000m (3280 feet) MAX. above sea level	
Withstand voltage	□28mm (□1.10inch) : AC1000V 50/60Hz for 1 minute, □42mm (□1.65inch) , □60mm (□2.36inch) , °86mm (°3.39inch) , °106mm (°4.17inch) : AC1500V 50/60Hz for 1 minute	
Insulation resistance	100M ohm MIN. against DC500V	
Protection grade	IP40	
Vibration resistance	Amplitude of 1.52mm (0.06inch) (P-P) at frequency range 10 to 500Hz for 15 minutes sweep time along X, Y, and Z axes for 12 times.	
Impact resistance	490m/s ² of acceleration for 11 ms with half-sine wave applying three times for X, Y, and Z axes each, 18 times in total.	
Ambient operation temperature	-10 to +50°C (0 to +40°C for harmonic gear model)	
Ambient operation humidity	90% MAX. at less than 40°C, 57% MAX. at less than 50°C , 35% MAX. at 60°C (no condensation)	

External wiring diagram : FS type

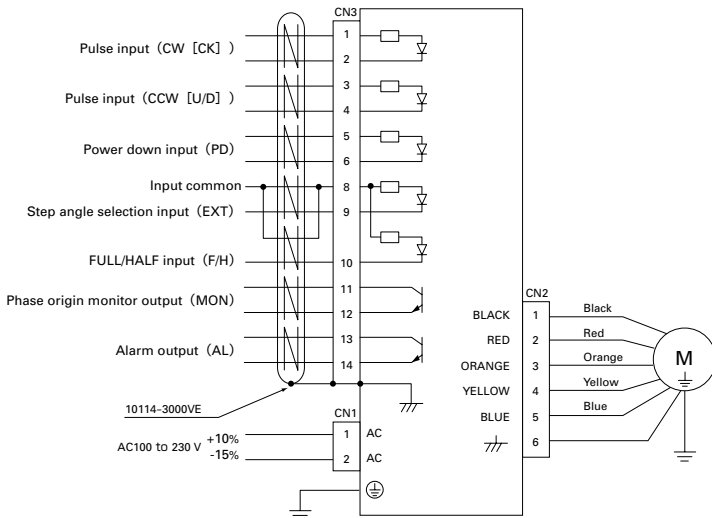

- * Marking : 1 red marking / pitch
 - ◎ Marking : 1 black marking / pitch
 - △ Marking : 2 red markings / pitch
 - ☆ Marking : 2 black markings / pitch
- * Marking size : width : 1mm,
space : 1mm,
pitch : 12mm

Specification summary of CN3 I/O signal

Signal name	CN3 Pin number	Function
CW pulse input (standard)	1	When using "2-input mode"
	2	Drive pulse for the CW direction rotation is input.
Pulse column input	1	When using "Pulse and direction mode"
	2	Drive pulse train for the stepping motor rotation is input.
CCW pulse input (standard)	3	When using "2-input mode"
	4	Drive pulse for the CCW direction rotation is input.
Rotation direction input	3	The rotation direction signal of stepping motor is input for the "Pulse and direction mode".
	4	Internal photocoupler ON...CW direction Internal photocoupler OFF...CCW direction
Power down input	5	Inputting the PD signal cuts OFF the current flowing through the stepping motor (turns OFF the power) . (The power down input can be changed to the power low function by selecting dipswitches.)
	6	PD input signal ON (internal photocoupler ON) ...PD function enabled PD input signal OFF (internal photocoupler OFF) ...PD function disabled
Step angle selection input	8	Inputting the EXT signal enables the FULL/HALF selection input.
	9	EXT input signal ON (internal photocoupler ON) ...External input signal F/H enabled EXT input signal OFF (internal photocoupler OFF) ...Main unit rotary switch S. S enabled
FULL/HALF selection input	8	When the EXT input signal is ON (internal photocoupler ON).
	10	F/H input signal ON (internal photocoupler ON) ...HALF step F/H input signal OFF (internal photocoupler OFF) ...FULL step
Phase origin monitor output	11	It is turned ON when the excitation phase is at the origin (in the state when the power is turned ON)
	12	It is turned ON once per 10 pulses when setting to HALF step. It is turned ON once per 20 pulses when setting to FULL step.
Alarm output	13	The signal is externally output when one of several alarm circuits operates in the PM driver. At this time, the stepping motor is in the unexcited state.
	14	

(Note) The CW rotation direction of stepping motor means the clockwise direction rotation as viewed from the output shaft side (flange side) . The CCW rotation direction means the counterclockwise direction rotation as viewed from the output shaft side (flange side) .

Driver part name

2-digit LED indication

	Indication	Description
Status	88	Internal power is established.
	88	Excitation phase is origin status at power on.
	88	Command pulse is under status at input.
Alarm	01	Over-current.
	02	Overheat.
	03	Low voltage power.
	04	Over-voltage power.
	05 08	Hardware fault



Display switch Alarm history of 10 previous alarms can be displayed on 2-digit LED.

- ① Step angle selection switch
- ② Current selection switch
- ③ 0-speed current adjustment switch
- ④ Function selection DIP switch

Motor interface connector

Power connector

Earth

⑤ **Input/output signal interface connector**

① Step angle selection switch

Basic step angle divisor (up to 250 divisions) .

Indication	0	1	2	3	4	5	6	7
Number of divisions	1	2	2.5	4	5	8	10	20
Indication	8	9	A	B	C	D	E	F
Number of divisions	25	40	50	80	100	125	200	250

Initial configuration of factory shipment is set to 1 (Half steps) .

② Operation current selection switch

Motor current during operation can be selected from 100 to 25%.

Indication	0	1	2	3	4	5	6	7
Motor current (%)	100 (Rated value)	95	90	85	80	75	70	65
Indication	8	9	A	B	C	D	E	F
Motor current (%)	60	55	50	45	40	35	30	25

Initial configuration of factory shipment is set to 0 (rated value) .

③ Current adjustment at operation halt switch

Motor current at 0-speed can be selected from 100 to 25%.

Indication	0	1	2	3	4	5	6	7
Motor current (%)	100 (Rated value)	95	90	85	80	75	70	65
Indication	8	9	A	B	C	D	E	F
Motor current (%)	60	55	50	45	40	35	30	25

Initial configuration of factory shipment is set to A (50% of rated value) .
Driver and motor should be operated at around 50% of rated value to reduce heat.

⑤ Input/output signal interface connector

Input signal connector is used for interface with upper level controller, etc. Driver side connector is 10214-52A2JL. (Sumitomo 3M)

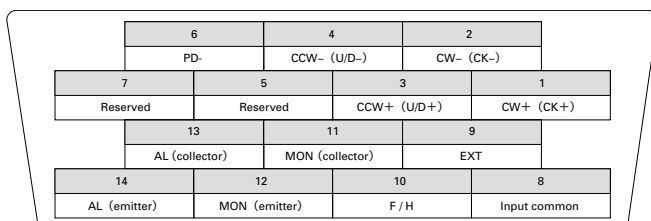

Terminal arrangement of CN3 connector

④ Function selection DIP switch

Selects an appropriate function for specification. Check that the ex-factory settings are as follows.

	OFF	ON
F/R	<input type="checkbox"/>	<input type="checkbox"/>
LV	<input type="checkbox"/>	<input type="checkbox"/>
PD	<input type="checkbox"/>	<input type="checkbox"/>
EORG	<input type="checkbox"/>	<input type="checkbox"/>

OFF Input method select
OFF Low-vibration mode select
OFF Power down select
OFF Excitation select

Input method select (F/R)

Selects input pulse type.

F/R	Input pulse type
ON	1 input (Pulse&direction)
OFF	2 input (CW, CCW)

Low-vibration mode select (LV)

Provides low-vibration, smooth operation even if resolution is rough (1-division, 2-division, etc)

LV	Operation
ON	Auto-micro function
OFF	Micro-step

Power down select (PD)

Selects current for power down signal input.

PD	Motor current
ON	Current by rotary switch STP (power low)
OFF	0A (power off)

Excitation select (EORG)

The excitation phase when the power supply is turned on is selected.

EORG	Original excitation phase
ON	Excitation phase at power shut off
OFF	Phase origin

By turning on the EORG, excitation phase when power OFF will be saved. Therefore, there will be no shaft displacement when turning the power ON.

Common specifications

F series driver

Basic specifications	Type code	FP1W075P		
	Power supply	Single phase AC100V to 230V +10, -15% 50/60/Hz		
	Source current	4 A MAX.		
	Environment	Protection class	Class I	
		Operation environment	Installation category (over-voltage category) : II , pollution degree: 2	
		Applied standards	EN50178, UL508C	
		Ambient operation temperature	0 to 50°C	
		Storage temperature	-20 to +70°C	
		Ambient operation humidity	35 to 85% RH (no condensation)	
		Storage humidity	10 to 90% RH (no condensation)	
		Operation altitude	1000m (3280feet) MAX. above sea level	
		Vibration resistance	Tested under the following conditions ; 4.9m/s ² , frequency range 10 to 55Hz, direction along X, Y and Z axes, for 2 hours each	
		Impact resistance	Not influenced at NDS-C-0110 standard section 3.2.2 division "C" .	
	Withstand voltage	Not influenced when 1500V AC is applied between power input terminal and cabinet for one minute.		
Insulation resistance	10M ohm MIN. when measured with 500V DC megohmmeter between input terminal and cabinet.			
Mass (Weight)	0.8kg (1.77lbs)			
Functions	Protection functions	Driver overheating, main circuit power supply error, and over-current		
	LED indication	Power monitor, phase origin monitor, pulse monitor, alarm		
CN3	Input signal	Photo-coupler input system ; input resistance: 220 Ω ; input-signal "H" level : 4.0 to 5.5V ; input-signal "L" level : 0 to 0.5V		
	Output signal	From the photo coupler by the open collector output	Output specification : Vceo = 30V MAX., Ic = 5mA	

F series motor / M series motor

Stepping motor type	F series motor	M series motor
Motor Type	103F35□□ / 103F55□□ / 103F785 □ / 103F858□ / 103F8958□	103M55□ / 103M785□ / 103M858□ / 103M8958 □
Type	—	S1 (continuous operation)
Insulation class	Class B (+130°C)	Class B (+130°C) [UL class A (+105°C)]
Operation altitude	1000m (3280 feet) MAX. above sea level	
Withstand voltage	□28mm (□1.10inch) : AC1000V 50/60Hz for 1 minute, □42mm (□1.65inch) , □60mm (□2.36inch) , □86mm (□3.39inch) , □106mm (□4.17inch) : AC1500V 50/60Hz for 1 minute	
Insulation resistance	100M ohm MIN. against DC500V	
Protection grade	IP40	
Vibration resistance	Amplitude of 1.52mm (0.06inch) (P-P) at frequency range 10 to 500Hz for 15 minutes sweep time along X, Y, and Z axes for 12 times.	
Impact resistance	490m/s ² of acceleration for 11 ms with half-sine wave applying three times for X, Y, and Z axes each, 18 times in total.	
Ambient operation temperature	-10 to +50°C (0 to +40°C for harmonic gear model)	
Ambient operation humidity	90% MAX. at less than 40°Cs, 57% MAX. at less than 50°C , 35% MAX. at 60°C (no condensation)	

The □ symbol in the motor model number indicates the length of the motor.

External wiring diagram : FP type

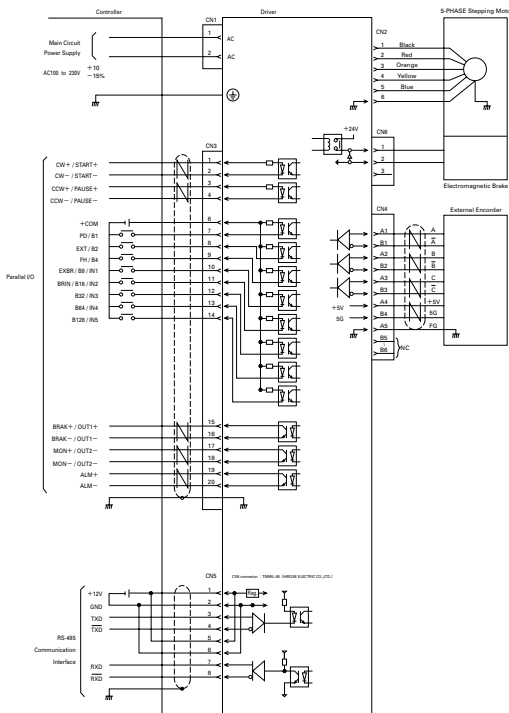

- * Marking : 1 red marking / pitch
- Marking : 1 black marking / pitch
- △ Marking : 2 red markings / pitch
- ☆ Marking : 2 black markings / pitch
- ※ Marking size : width : 1mm, space : 1mm, pitch : 12mm

Specification summary of CN3 I/O signal (Pulse train I/F mode)

Signal name	Pin number	Function
CW pulse input (standard)	1	When using "2-input mode" Drive pulse for the CW direction rotation is input.
Pulse column input	2	Drive pulse train for the stepping motor rotation is input.
CCW pulse input (standard)	3	When using "2-input mode" Drive pulse for the CCW direction rotation is input.
Rotation direction input	4	The rotation direction signal of stepping motor is input for the "Pulse and direction mode". Internal photocoupler ON...CW direction Internal photocoupler OFF...CCW direction
General-purpose input common	6	Input signal common of the 7 to 14 pins DC5V to DC24V is input.
Power down input	7	Inputting the PD signal cuts OFF the current flowing through the stepping motor (turns OFF the power). (The power down input can be changed to the power low function by selecting dipswitches.) PD input signal ON (internal photocoupler ON) ...PD function enabled PD input signal OFF (internal photocoupler OFF) ...PD function disabled
Step angle selection input	8	Inputting the EXT signal enables the FULL/HALF selection input. EXT input signal ON (internal photocoupler ON) ...HALF step signal F/H enabled EXT input signal OFF (internal photocoupler OFF) ...Main unit rotary switch S. S enabled
FULL/HALF selection input	9	When the EXT input signal is ON (internal photocoupler ON) . F/H input signal ON (internal photocoupler ON) ...HALF step F/H input signal OFF (internal photocoupler OFF) ...FULL step
Brake control select input	10	Brake retention/release timing can be controlled by the BRIN signal by inputting the EXBR signal. EXBR input signal ON (internal photo coupler ON) ...External input signal BRIN effective EXBR input signal OFF (internal photo coupler OFF) ...The driver controls the brake automatically
Brake control input	11	When the EXBR input signal on (internal photo coupler on) BRIN input signal ON (internal photo coupler on) ...Brake release BRIN input signal OFF (internal photo coupler off) ...Brake retention
Brake status output	15, 16	When the brake is released it turns ON, when the brake is retained it turns OFF.
Phase origin monitor output	17, 18	It is turned ON when the excitation phase is at the origin (in the state when the power is turned ON) It is turned ON once per 10 pulses when setting to HALF step. It is turned ON once per 20 pulses when setting to FULL step.
Alarm output	19, 20	The signal is externally output when one of several alarm circuits operates in the PM driver. At this time, the stepping motor is in the unexcited state.

(Note) The CW rotation direction of stepping motor means the clockwise direction rotation as viewed from the output shaft side (flange side) . The CCW rotation direction means the counterclockwise direction rotation as viewed from the output shaft side (flange side) .

Driver part name

2-digit LED indication

	Indication	Description
Status	88	Internal power is established.
	88	Excitation phase is origin status at power on.
	88	Command pulse is under status at input.
Alarm	01	Over-current.
	02	Overheat.
	03	Low voltage power.
	04	Over-voltage power.
	05 08	Hardware fault



Display switch Alarm history of 10 previous alarms can be displayed on 2-digit LED.

- ① Step angle selection switch
- ② Current selection switch
- ③ 0-speed current adjustment switch
- ④ Function selection DIP switch

Serial (RS-485)

Encoder

- ⑤ Input/output signal interface connector

Brake connector

Motor interface connector

Power connector

Earth

① Step angle selection switch

Basic step angle divisor (up to 250 divisions).

Indication	0	1	2	3	4	5	6	7
Number of divisions	1	2	2.5	4	5	8	10	20
Indication	8	9	A	B	C	D	E	F
Number of divisions	25	40	50	80	100	125	200	250

Initial configuration of factory shipment is set to 1 (Half steps)

② Operation current selection switch

Motor current during operation can be selected from 100 to 25%.

Indication	0	1	2	3	4	5	6	7
Motor current (%)	100 (Rated value)	95	90	85	80	75	70	65
Indication	8	9	A	B	C	D	E	F
Motor current (%)	60	55	50	45	40	35	30	25

Initial configuration of factory shipment is set to 0 (rated value).

③ Current adjustment at operation halt switch

Motor current at 0-speed can be selected from 100 to 25%.

Indication	0	1	2	3	4	5	6	7
Motor current (%)	100 (Rated value)	95	90	85	80	75	70	65
Indication	8	9	A	B	C	D	E	F
Motor current (%)	60	55	50	45	40	35	30	25

Initial configuration of factory shipment is set to A (50% of rated value).

Driver and motor should be operated at around 50% of rated value to reduce heat.

⑤ Input/output signal interface connector

Input signal connector is used for interface with upper level controller, etc. Driver side connector is 10214-52A2JL. (Sumitomo 3M)

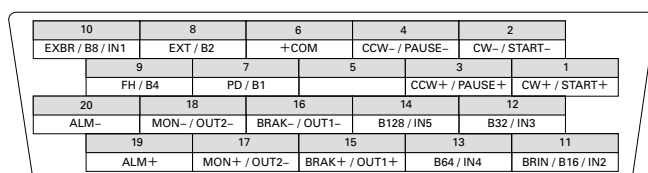

Terminal arrangement of CN3 connector

④ Function selection DIP switch

Selects an appropriate function for specification. Check that the ex-factory settings are as follows.

	OFF	ON	
F/R	<input type="checkbox"/>	<input type="checkbox"/>	OFF Input method select
LV	<input type="checkbox"/>	<input type="checkbox"/>	OFF Low-vibration mode select
PD	<input type="checkbox"/>	<input type="checkbox"/>	OFF Power down select
EORG	<input type="checkbox"/>	<input type="checkbox"/>	OFF Excitation select
I.SEL	<input type="checkbox"/>	<input type="checkbox"/>	OFF
S.SEL	<input type="checkbox"/>	<input type="checkbox"/>	OFF

Input method select (F/R)

Selects input pulse type.

F/R	Input pulse type
ON	1 input (Pulse&direction)
OFF	2 input (CW, CCW)

Low-vibration mode select (LV)

Provides low-vibration, smooth operation even if resolution is rough (1-division, 2-division, etc)

LV	Operation
ON	Auto-micro function
OFF	Micro-step

Power down select (PD)

Selects current for power down signal input.

PD	Motor current
ON	Current by rotary switch STP (power low)
OFF	0A (power off)

Excitation select (EORG)

The excitation phase when the power supply is turned on is selected.

EORG	Original excitation phase
ON	Excitation phase at power shut off
OFF	Phase origin

By turning on the EORG, excitation phase when power OFF will be saved. Therefore, there will be no shaft displacement when turning the power ON.

(I.SEL)

The operation mode is selected.

I.SEL	
ON	Selects S.SEL-setting operation mode
OFF	Pulse-train I/F mode

(S.SEL)

The operation mode is selected.

S.SEL	
ON	Serial I/F mode
OFF	Parallel I/F mode

(Note) Function descriptions for switches 1 to 4 apply to pulse-train I/F mode. See the user's manual for settings in serial-I/F and parallel-I/F modes.

Input circuit configuration of CW (CK), CCW (U/D)

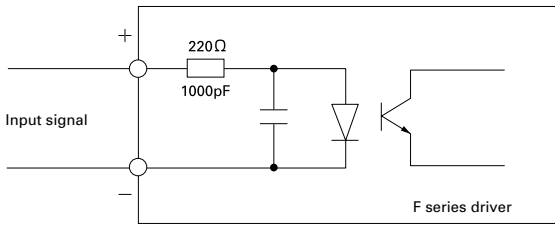

- Pulse duty 50% MAX.
- Maximum input frequency: 250kpulse/s
- When the crest value of the input signal exceeds 5V, use the external limit resistance R to limit the input current to approximately 15mA.

Input signal specification

(Photo coupler)

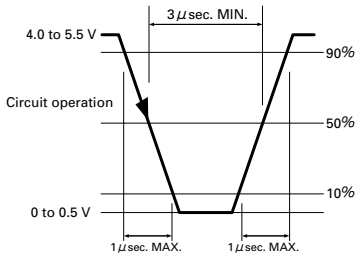

Timing of command pulse

2 input type (CW, CCW)

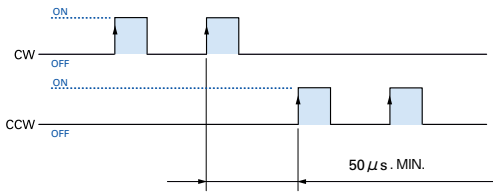

- Shaded area indicates internal photo coupler "ON". Internal circuit (motor) starts operating at leading edge of the photo coupler "ON".
- To apply pulse to CW, set CCW side internal photo coupler to "OFF".
- To apply pulse to CCW, set CW side internal photo coupler to "OFF".

1 input type (CW, CCW)

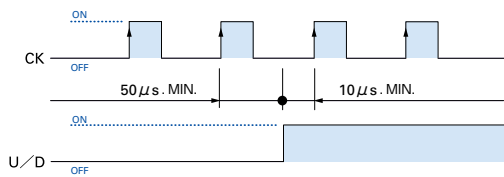

- Shaded area indicates internal photo coupler "ON". Internal circuit (motor) starts operating at leading edge of CK side photo coupler "ON".
- Switching of U/D input signal must be done while CK side internal photo coupler is "OFF".

Input circuit configuration of PD, EXT, F/H

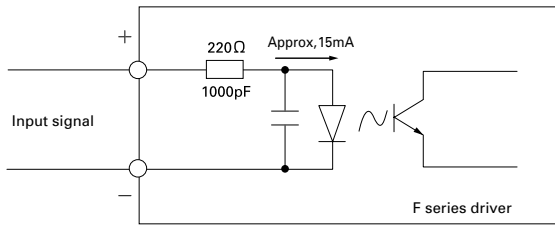

• If the peak value exceeds 5V, set the input current to approx. 15mA using the external limit resistance R.

AC input

Output signal configuration of MON, AL

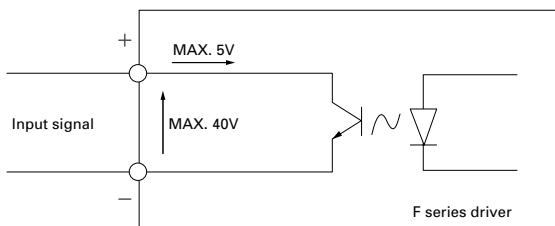

MON output

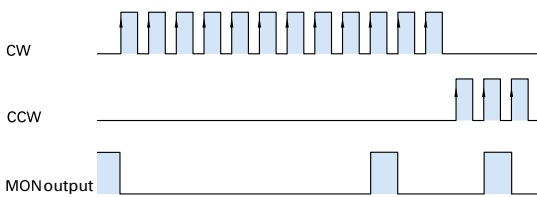

- Photo coupler at phase origin of motor excitation (status at power on) is set to "ON" (setting when number of divisions is 1).
- Output from MON is set to on at every 7.2 degrees of motor output shaft from phase origin.

Input / Output signal standard

DC input

Internal wire connection and direction of motor rotate

Internal wire connection

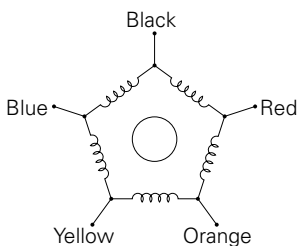

Direction of motor rotate

The direction of motor rotate is counterclockwise when viewed from the output shaft side at the direct current energization in the following order.

Type	Exciting order									
	1	2	3	4	5	6	7	8	9	10
Color of leads	Black	-	-	-	-	+	+	+	+	-
	Red	+	+	+	+	-	-	-	-	+
	Orange	-	-	-	-	+	+	+	+	-
	Yellow	+	+	+	+	-	-	-	-	+

Stepping motor

Dimensions

Flange side

Spur gear model

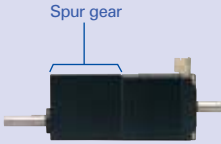

Motor flange size
□28 (□1.10inch)

Low-backlash gear model

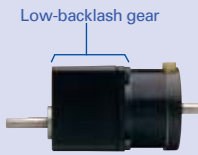

Motor flange size
□42mm (□1.65inch) / □60mm (□2.35inch) / ø86mm (ø3.39inch)

Harmonic gear model



Motor flange size
□28mm (□1.10inch) / □42mm (□1.65inch) / □60mm (□2.35inch) / ø86mm (ø3.39inch)

End cap side

Damper



Magnetic dampers can be selected according to required inertia.

Electromagnetic brake model

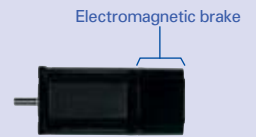

Motor flange size
□42mm (□1.65inch) / □60mm (□2.35inch) / ø86mm (ø3.39inch)

Brake power source (DC24V)

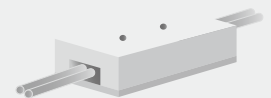

Required for brake-equipped stepping motor models.



Standard model : F series motor
□28mm (□1.10inch) / □42mm (□1.65inch) / □60mm (□2.35inch) / ø86mm (ø3.39inch)

Motor cable

Single phase
AC100V
to
AC230V

(t)
(r)

Molded case circuit breaker



Protects the power line. Cuts off circuit in the event of overcurrent.

Electromagnetic contactor

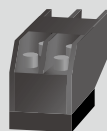

Switches driver power on/off. Use together with a surge protector.

Noise filter



Filters out incoming noise from power line.

Switching power supply



Converts AC power to DC power.

DC24V/
DC36V

Host Devices

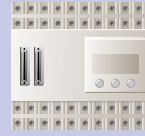

PLC

PLC and controllers are available as the host device.



To motor

I/O signal cable

To DC power source

I/O signal connector

Part number convention

The following part number specifies a system with an F series driver (type code : FS1D140P) and a single shaft F series motor (type code : 103F7851-8421) , □ 60mm (□ 2.36inch) square flange, and 46.5mm (1.83inch) motor length, equipped with low-backlash gear (reduction ratio of 1/3.6).

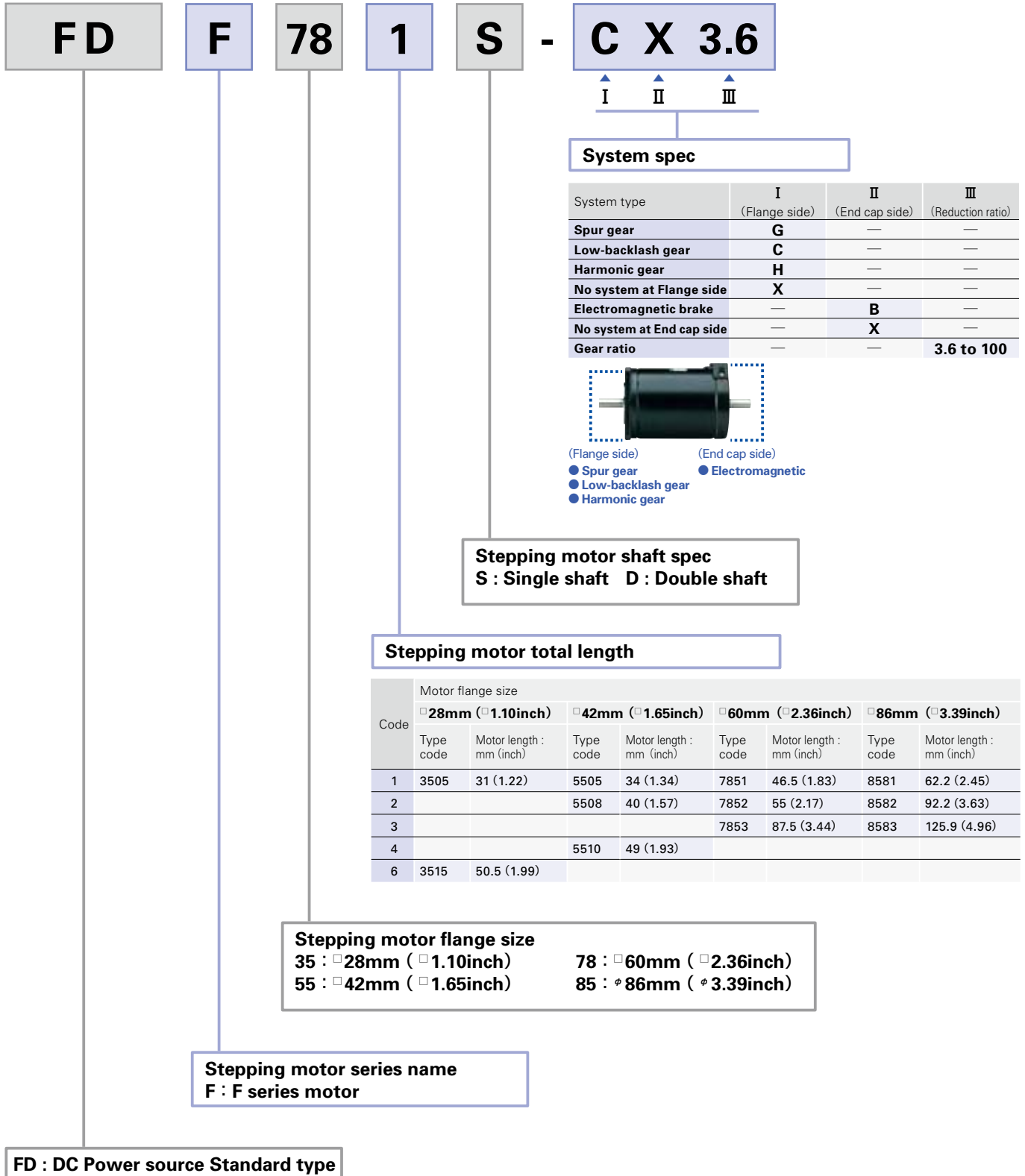

Combination list of 5-phase driver

Combination	Motor flange size	Set part number		Motor model number		Rated current	
		Single shaft	Double shaft	Single shaft	Double shaft		
Standard model	□ 28mm (□ 1.10inch)	FDf351S	FDf351D	103F3505-7441	103F3505-7411	0.75A	
		FDf356S	FDf356D	103F3515-7441	103F3515-7411	0.75A	
	□ 42mm (□ 1.65inch)	FDf551S	FDf551D	103F5505-8241	103F5505-8211	1.4A	
		FDf552S	FDf552D	103F5508-8241	103F5508-8211	1.4A	
	FDf554S	FDf554D	103F5510-8241	103F5510-8211	1.4A	1.4A	
		FDf781S	FDf781D	103F7851-8241	103F7851-8211	1.4A	1.4A
	□ 60mm (□ 2.36inch)	FDf782S	FDf782D	103F7852-8241	103F7852-8211	1.4A	1.4A
		FDf783S	FDf783D	103F7853-8241	103F7853-8211	1.4A	1.4A
	φ 86mm (φ 3.39inch)	FDf851S	FDf851D	103F8581-8241	103F8581-8211	1.4A	1.4A
		FDf852S	FDf852D	103F8582-8241	103F8582-8211	1.4A	1.4A
	Low-backlash gear model	□ 42mm (□ 1.65inch)	FDf551S-CX3.6	FDf551D-CX3.6	103F5505-82CXA4	103F5505-82CXA1	1.4A
			FDf551S-CX7.2	FDf551D-CX7.2	103F5505-82CXB4	103F5505-82CXB1	1.4A
FDf551S-CX10			FDf551D-CX10	103F5505-82CXE4	103F5505-82CXE1	1.4A	1.4A
FDf551S-CX20			FDf551D-CX20	103F5505-82CXG4	103F5505-82CXG1	1.4A	1.4A
FDf551S-CX30			FDf551D-CX30	103F5505-82CXJ4	103F5505-82CXJ1	1.4A	1.4A
FDf551S-CX36			FDf551D-CX36	103F5505-82CXX4	103F5505-82CXX1	1.4A	1.4A
FDf781S-CX3.6			FDf781D-CX3.6	103F7851-82CXA4	103F7851-82CXA1	1.4A	1.4A
FDf781S-CX7.2			FDf781D-CX7.2	103F7851-82CXB4	103F7851-82CXB1	1.4A	1.4A
□ 60mm (□ 2.36inch)		FDf781S-CX10	FDf781D-CX10	103F7851-82CXE4	103F7851-82CXE1	1.4A	1.4A
		FDf781S-CX20	FDf781D-CX20	103F7851-82CXG4	103F7851-82CXG1	1.4A	1.4A
		FDf781S-CX30	FDf781D-CX30	103F7851-82CXJ4	103F7851-82CXJ1	1.4A	1.4A
		FDf781S-CX36	FDf781D-CX36	103F7851-82CXX4	103F7851-82CXX1	1.4A	1.4A
		FDf851S-CX3.6	FDf851D-CX3.6	103F8581-82CXA4	103F8581-82CXA1	1.4A	1.4A
		FDf851S-CX7.2	FDf851D-CX7.2	103F8581-82CXB4	103F8581-82CXB1	1.4A	1.4A
φ 86mm (φ 3.39inch)		FDf851S-CX10	FDf851D-CX10	103F8581-82CXE4	103F8581-82CXE1	1.4A	1.4A
		FDf851S-CX20	FDf851D-CX20	103F8581-82CXG4	103F8581-82CXG1	1.4A	1.4A
		FDf851S-CX30	FDf851D-CX30	103F8581-82CXJ4	103F8581-82CXJ1	1.4A	1.4A
		FDf851S-CX36	FDf851D-CX36	103F8581-82CXX4	103F8581-82CXX1	1.4A	1.4A
		FDf351S-GX3.6	FDf351D-GX3.6	103F3505-74GXA4	103F3505-74GXA1	0.75A	0.75A
		FDf351S-GX7.2	FDf351D-GX7.2	103F3505-74GXB4	103F3505-74GXB1	0.75A	0.75A
Spur gear model		□ 28mm (□ 1.10inch)	FDf351S-GX10	FDf351D-GX10	103F3505-74GXE4	103F3505-74GXE1	0.75A
			FDf351S-GX20	FDf351D-GX20	103F3505-74GXG4	103F3505-74GXG1	0.75A
			FDf351S-GX30	FDf351D-GX30	103F3505-74GXJ4	103F3505-74GXJ1	0.75A
			FDf351S-GX50	FDf351D-GX50	103F3505-74GXL4	103F3505-74GXL1	0.75A
	FDf351S-HX50		FDf351D-HX50	103F3505-74HXL4	103F3505-74HXL1	0.75A	
	FDf351S-HX100		FDf351D-HX100	103F3505-74HXM4	103F3505-74HXM1	0.75A	
Harmonic gear model	□ 28mm (□ 1.10inch)	FDf5515S-HX30	FDf551D-HX30	103F5505-82HXJ5	103F5505-82HXJ2	1.4A	
		FDf5515S-HX50	FDf551D-HX50	103F5505-82HXL5	103F5505-82HXL2	1.4A	
	□ 42mm (□ 1.65inch)	FDf5515S-HX100	FDf551D-HX100	103F5505-82HXM5	103F5505-82HXM2	1.4A	
		FDf781S-HX50	FDf781D-HX50	103F7851-82HXL4	103F7851-82HXL1	1.4A	
	□ 60mm (□ 2.36inch)	FDf781S-HX100	FDf781D-HX100	103F7851-82HXM4	103F7851-82HXM1	1.4A	
		FDf851S-HX50	FDf851D-HX50	103F8581-82HXL4	103F8581-82HXL1	1.4A	
	φ 86mm (φ 3.39inch)	FDf851S-HX100	FDf851D-HX100	103F8581-82HXM4	103F8581-82HXM1	1.4A	
		FDf551S-XB	-	103F5505-82XB41	-	1.4A	
Electromagnetic brake model	□ 42mm (□ 1.65inch)	FDf552S-XB	-	103F5508-82XB41	-	1.4A	
		FDf554S-XB	-	103F5510-82XB41	-	1.4A	
		FDf781S-XB	-	103F7851-82XB41	-	1.4A	
	□ 60mm (□ 2.36inch)	FDf782S-XB	-	103F7852-82XB41	-	1.4A	
		FDf783S-XB	-	103F7853-82XB41	-	1.4A	
	φ 86mm (φ 3.39inch)	FDf851S-XB	-	103F8581-82XB41	-	1.4A	
		FDf852S-XB	-	103F8582-82XB41	-	1.4A	

AC input

Input / Output signal standard

DC input

Stepping motor

Dimensions

Standard model

F series driver + F series motor

Motor flange size



Size	Motor flange size	□ 28mm (□ 1.10inch)	
		31mm (1.22inch)	50.5mm (1.99inch)
Set part number	Single shaft	FD351S	FD356S
	Double shaft	FD351D	FD356D
Holding torque	N·m(oz·in)	0.036 (5.10)	0.065 (9.20)
Rotor inertia	$\times 10^{-4}$ kg·m ² (oz·in ²)	0.009 (0.05)	0.016 (0.09)
Mass (Weight)	kg (lbs)	0.11 (0.22)	0.2 (0.44)
Allowable thrust load	N (lbs)	3 (0.68)	3 (0.68)
Allowable radial load ^(Note 1)	N (lbs)	34 (7.65)	34 (7.65)

(Note1) When load is applied at 1/3 length from output shaft edge.



DC24V

DC36V

Operating current:
0.75A/phase

- Pull-out torque
- - - Source current (load applied)
- - - Source current (no load)
- 1-division fs
- 2-division fs
- Fs: Maximum self-start frequency when not loaded
- 1-division
- 2-division

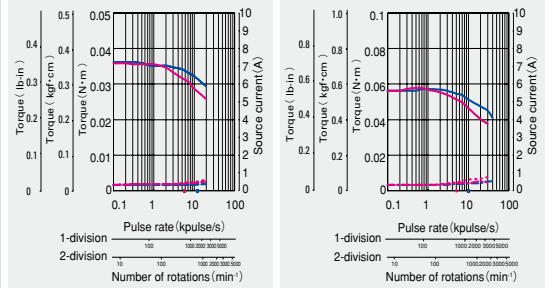
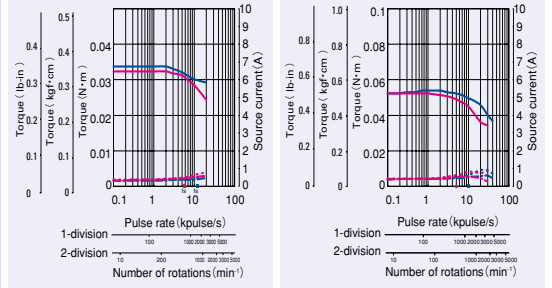

The data are measured under the drive condition of our company. The drive torque may vary depending on the accuracy of customer-side equipment.

Size	Motor flange size	□ 60mm (□ 2.36inch)		
		46.5mm (1.83inch)	55mm (2.17inch)	55mm (2.17inch)
Set part number	Single shaft	FD781S	FD782S	FD783S
	Double shaft	FD781D	FD782D	FD783D
Holding torque	N·m(oz·in)	0.6 (85.0)	0.98 (38.8)	1.79 (253.5)
Rotor inertia	$\times 10^{-4}$ kg·m ² (oz·in ²)	0.275 (1.50)	0.4 (2.19)	0.84 (4.59)
Mass (Weight)	kg (lbs)	0.6 (1.32)	0.78 (1.72)	1.36 (3.0)
Allowable thrust load	N (lbs)	20 (4.5)	20 (4.5)	20 (4.5)
Allowable radial load ^(Note 1)	N (lbs)	80 (18)	80 (18)	80 (18)

(Note1) When load is applied at 1/3 length from output shaft edge.

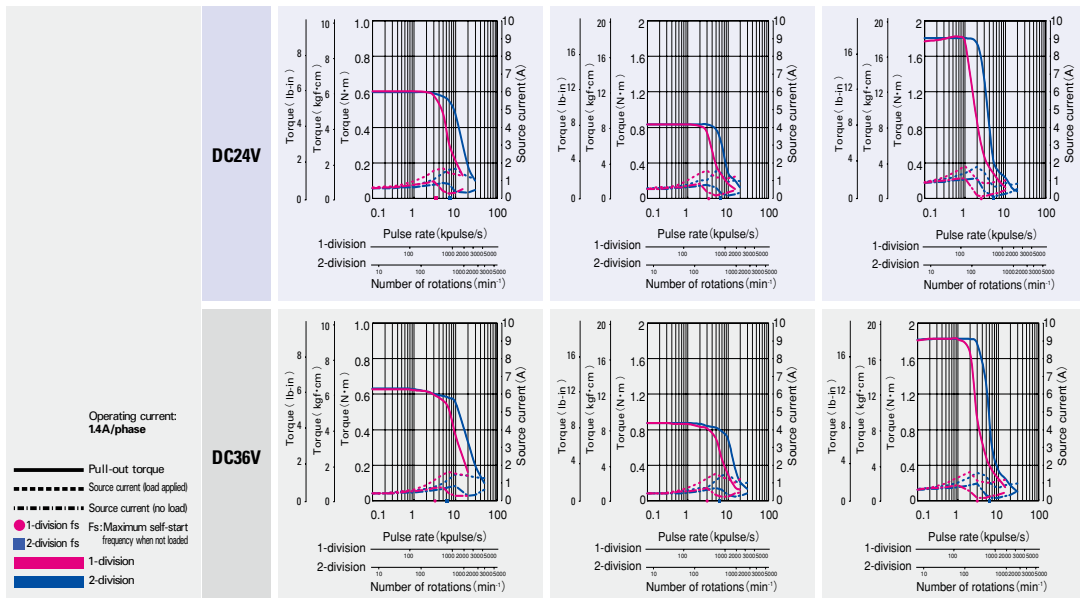

Operating current:
1.4A/phase

- Pull-out torque
- - - Source current (load applied)
- - - Source current (no load)
- 1-division fs
- 2-division fs
- Fs: Maximum self-start frequency when not loaded
- 1-division
- 2-division

The data are measured under the drive condition of our company. The drive torque may vary depending on the accuracy of customer-side equipment.

Size	Motor flange size	□ 42mm (□ 1.65inch)		
	Motor length	34mm (1.34inch)	40mm (1.57inch)	49mm (1.93inch)
Set part number	Single shaft	FD551S	FD552S	FD554S
	Double shaft	FD551D	FD552D	FD554D
Holding torque	N·m(oz·in)	0.13 (18.41)	0.18 (25.49)	0.26 (36.82)
Rotor inertia	$\times 10^{-4}$ kg·m ² (oz·in ²)	0.03 (0.16)	0.053 (0.29)	0.065 (0.36)
Mass (Weight)	kg (lbs)	0.23 (0.50)	0.28 (0.62)	0.37 (0.81)
Allowable thrust load	N (lbs)	10 (2.25)	10 (2.25)	10 (2.25)
Allowable radial load ^(Note 1)	N (lbs)	35 (8.75)	35 (8.75)	35 (8.75)

(Note1) When load is applied at 1/3 length from output shaft edge.

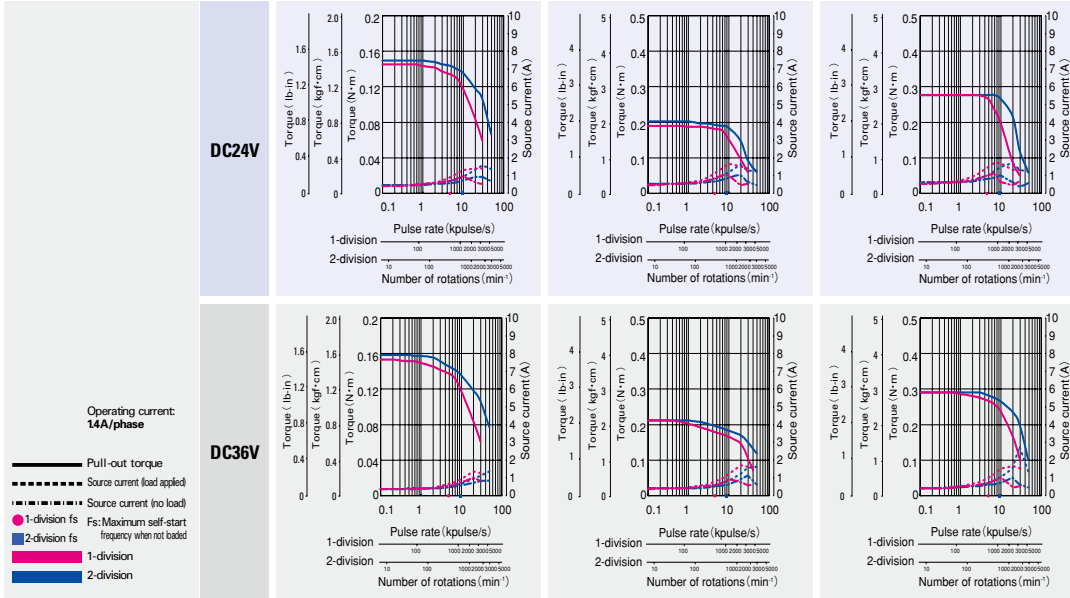

The data are measured under the drive condition of our company. The drive torque may vary depending on the accuracy of customer-side equipment.

Size	Motor flange size	φ 86mm (φ 3.39inch)	
	Motor length	62.15mm (2.47inch)	92.2mm (3.63inch)
Set part number	Single shaft	FD851S	FD852S
	Double shaft	FD851D	FD852D
Holding torque	N·m(oz·in)	2.06 (291.7)	4.02 (569.3)
Rotor inertia	$\times 10^{-4}$ kg·m ² (oz·in ²)	1.45 (7.93)	2.9 (15.86)
Mass (Weight)	kg (lbs)	1.5 (3.3)	2.5 (5.5)
Allowable thrust load	N (lbs)	60 (13.5)	60 (13.5)
Allowable radial load ^(Note 1)	N (lbs)	220 (49.5)	220 (49.5)

(Note1) When load is applied at 1/3 length from output shaft edge.

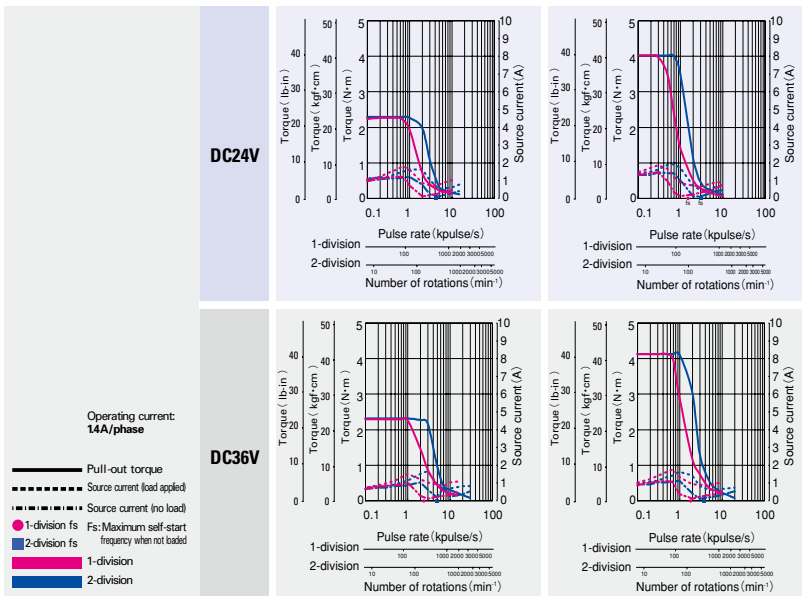

The data are measured under the drive condition of our company. The drive torque may vary depending on the accuracy of customer-side equipment.

Low-backlash gear model

F series driver +
F series motor with low-backlash gear

Motor flange size



Size	Motor flange size	42mm (1.65inch)	
	Motor + gear length	64.5mm (2.54inch)	64.5mm (2.54inch)
Set part number	Single shaft	FD551S-CX3.6	FD551S-CX7.2
	Double shaft	FD551D-CX3.6	FD551D-CX7.2
Allowable torque	N·m(oz·in)	0.35 (44.6)	0.7 (99.1)
Rotor inertia	$\times 10^{-4}$ kg·m ² (oz·in ²)	0.03 (0.16)	0.03 (0.16)
Basic step angle		0.2	0.1
Gear ratio		1 : 3.6	1 : 7.2
Backlash	DEG	0.6	0.4
Allowable speed	min ⁻¹	500	250
Mass (Weight)	kg (lbs)	0.36 (0.79)	0.36 (0.79)
Allowable thrust load	N (lbs)	15 (3.38)	15 (3.38)
Allowable radial load ^(Note 1)	N (lbs)	20 (4.5)	20 (4.5)

Directions of motor rotation and gear output shaft are the same for models with reduction ratio 1 : 3.6, 1 : 7.2 and 1 : 10 opposite for reduction ratio 1 : 20, 1 : 30, and 1 : 36.

(Note1) When load is applied at 1/3 length from output shaft edge.

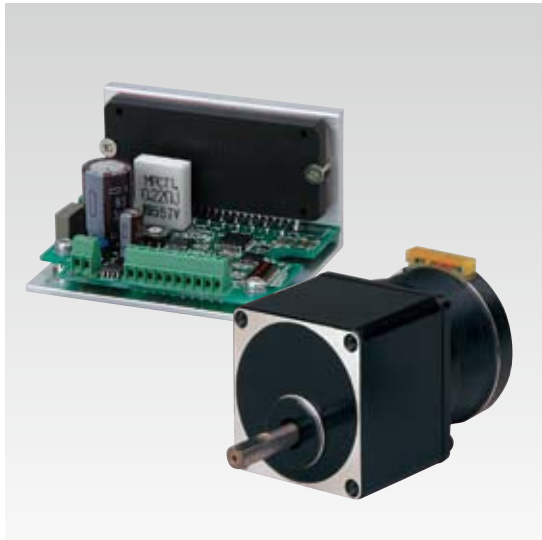

DC24V

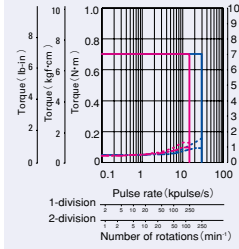
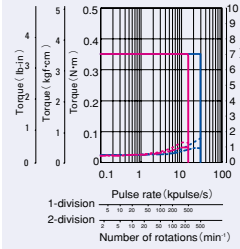

DC36V

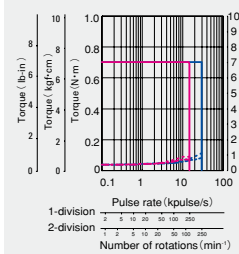
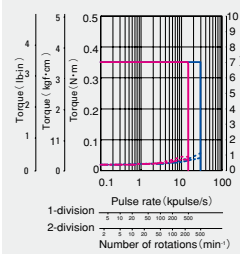

Operating current:
14A/phase

— Allowable torque
- - - Source current (load applied)
- · - · - Source current (no load)

1-division
2-division

The data are measured under the drive condition of our company. The drive torque may very depending on the accuracy of customer-side equipment.

Size	Motor flange size	60mm (2.36inch)			
	Motor + gear length	92mm (3.62inch)	92mm (3.62inch)	92mm (3.62inch)	92mm (3.62inch)
Set part number	Single shaft	FD781S-CX7.2	FD781S-CX10	FD781S-CX20	FD781S-CX30
	Double shaft	FD781D-CX7.2	FD781D-CX10	FD781D-CX20	FD781D-CX30
Allowable torque	N·m(oz·in)	2.5 (354.0)	3 (424.8)	3.5 (495.6)	4 (566.4)
Rotor inertia	$\times 10^{-4}$ kg·m ² (oz·in ²)	0.275 (1.5)	0.275 (1.5)	0.275 (1.5)	0.275 (1.5)
Basic step angle		0.1	0.072	0.036	0.024
Gear ratio		1 : 7.2	1 : 10	1 : 20	1 : 30
Backlash	DEG	0.25	0.25	0.17	0.10
Allowable speed	min ⁻¹	250	180	90	60
Mass (Weight)	kg (lbs)	0.97 (2.13)	0.97 (2.13)	0.97 (2.13)	0.97 (2.13)
Allowable thrust load	N (lbs)	30 (6.75)	30 (6.75)	30 (6.75)	30 (6.75)
Allowable radial load ^(Note 1)	N (lbs)	100 (22.5)	100 (22.5)	100 (22.5)	100 (22.5)

Directions of motor rotation and gear output shaft are the same for models with reduction ratio 1 : 3.6 and 1:7.2, opposite for reduction ratio 1 : 10, 1 : 20 and 1 : 30. (Note1) When load is applied at 1/3 length from output shaft edge.

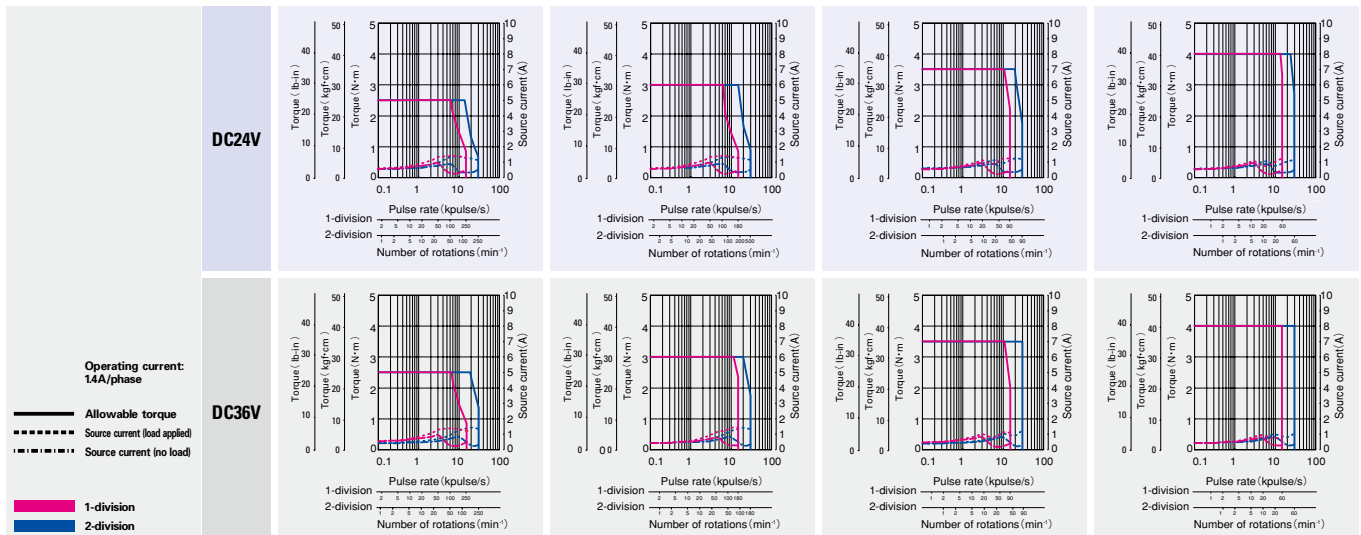

The data are measured under the drive condition of our company. The drive torque may very depending on the accuracy of customer-side equipment.

□ 42mm (□ 1.65inch)

□ 60mm (□ 2.36inch)

64.5mm (2.54inch)	64.5mm (2.54inch)	64.5mm (2.54inch)	64.5mm (2.54inch)	92mm (3.62inch)
DFD551S-CX10	DFD551S-CX20	DFD551S-CX30	DFD551S-CX36	DFD781S-CX3.6
DFD551D-CX10	DFD551D-CX20	DFD551D-CX30	DFD551D-CX36	DFD781D-CX3.6
1 (141.6)	1.5 (212.4)	1.5 (212.4)	1.5 (212.4)	1.25 (177.0)
0.03 (0.16)	0.03 (0.16)	0.03 (0.16)	0.03 (1.5)	0.275
0.072	0.036	0.024	0.02	0.2
1 : 10	1 : 20	1 : 30	1 : 36	1 : 3.6
0.35	0.25	0.25	0.25	0.55
180	90	60	50	500
0.36 (0.79)	0.36 (0.79)	0.36 (0.79)	0.36 (0.79)	0.97 (2.13)
15 (3.38)	15 (3.38)	15 (3.38)	15 (3.38)	30 (6.75)
20 (4.5)	20 (4.5)	20 (4.5)	20 (4.5)	100 (22.5)

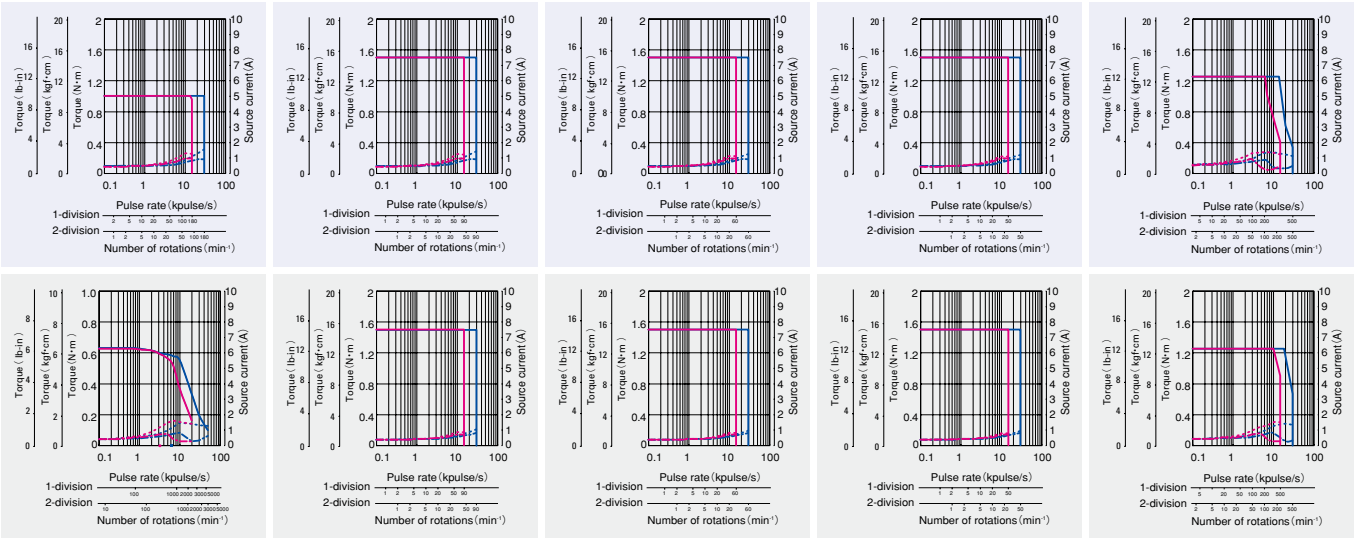

□ 60mm (□ 2.36inch)

φ 86mm (φ 3.39inch)

92mm (3.62inch)	127.3mm (5.01inch)	127.3mm (5.01inch)	127.3mm (5.01inch)	127.3mm (5.01inch)
DFD781S-CX36	DFD851S-CX3.6	DFD851S-CX7.2	DFD851S-CX10	DFD851S-CX20
DFD781D-CX36	DFD851D-CX3.6	DFD851D-CX7.2	DFD851D-CX10	DFD851D-CX20
4 (566.4)	4.5 (637.2)	9 (1274.5)	9 (1274.5)	12 (1699.3)
0.275 (1.51)	1.45 (7.93)	1.45 (7.93)	1.45 (7.93)	1.45 (7.93)
0.02	0.2	0.1	0.072	0.036
1 : 36	1 : 3.6	1 : 7.2	1 : 10	1 : 20
0.17	0.4	0.25	0.25	0.17
50	500	250	180	90
0.97 (2.13)	2.7 (5.94)	2.7 (5.94)	2.7 (5.94)	2.7 (5.94)
30 (6.75)	60 (13.5)	60 (13.5)	60 (13.5)	60 (13.5)
100 (22.5)	300 (67.5)	300 (67.5)	300 (67.5)	300 (67.5)

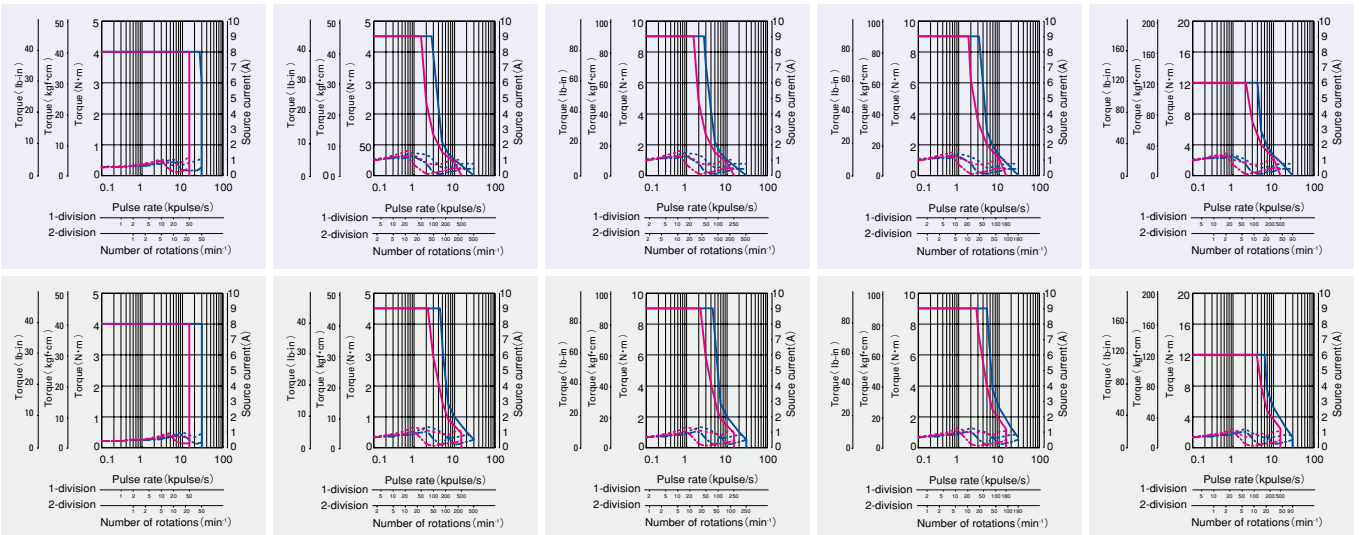

AC input

Input / Output signal standard

DC input

Stepping motor

Dimensions

Low-backlash gear model

F series driver +
F series motor with low-backlash gear

Size	Motor flange size	φ 86mm (φ 3.39inch)	
		127.3mm (5.01inch)	127.3mm (5.01inch)
Set part number	Motor + gear length	127.3mm (5.01inch)	127.3mm (5.01inch)
	Single shaft	FD851S-CX30	FD851S-CX36
Set part number	Double shaft	FD851D-CX30	FD851D-CX36
	Allowable torque	N·m(oz·in)	12 (1699.3)
Rotor inertia	×10 ⁻⁴ kg·m ² (oz·in ²)	1.45 (7.93)	1.45 (7.93)
Basic step angle		0.024	0.02
Gear ratio		1 : 30	1 : 36
Backlash	DEG	0.17	0.15
Allowable speed	min ⁻¹	60	50
Mass (Weight)	kg (lbs)	2.7 (5.94)	2.7 (5.94)
Allowable thrust load	N (lbs)	60 (13.5)	60 (13.5)
Allowable radial load ^(Note 1)	N (lbs)	300 (67.5)	300 (67.5)

Directions of motor rotation and gear output shaft are the same for models with reduction ratio 1 : 3.6, opposite for reduction ratio 1 : 10, 1 : 20, 1 : 30, and 1 : 36.
(Note1) When load is applied at 1/3 length from output shaft edge.

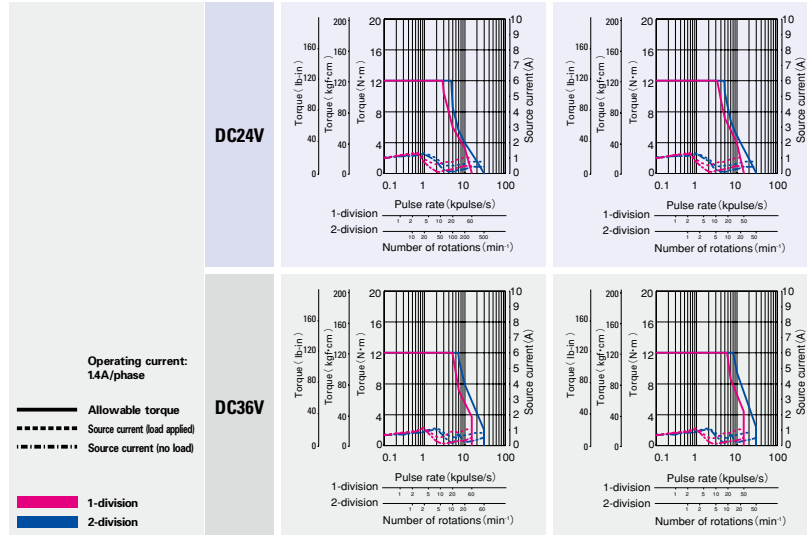

The data are measured under the drive condition of our company. The drive torque may vary depending on the accuracy of customer-side equipment.

Spur gear model

F series driver + F series motor with spur gear

Motor flange size

□28
(~1.10inch)

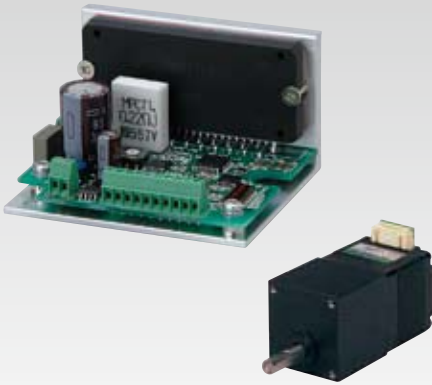

Size	Motor flange size	□28mm (□1.10inch)	
	Motor + gear length	60.3mm (2.37inch)	60.3mm (2.37inch)
Set part number	Single shaft	FD351S-GX3.6	FD351S-GX7.2
	Double shaft	FD351D-GX3.6	FD351D-GX7.2
Allowable torque	N·m(oz·in)	0.1 (14.16)	0.15 (21.24)
Rotor inertia	$\times 10^{-4}$ kg·m ² (oz·in ²)	0.009 (0.05)	0.009 (0.05)
Basic step angle		0.2	0.1
Gear ratio		1 : 3.6	1 : 7.2
Backlash	DEG	2	2
Allowable speed	min ⁻¹	800	400
Mass (Weight)	kg (lbs)	0.17 (0.37)	0.17 (0.37)
Allowable thrust load	N (lbs)	10 (2.25)	10 (2.25)
Allowable radial load ^(Note 1)	N (lbs)	15 (3.38)	15 (3.38)

Directions of motor rotation and gear output shaft are the same for models with reduction ratio 1 : 3.6, 1 : 7.2, 1 : 30 and 1 : 50 opposite for reduction ratio 1 : 10.
(Note1) When load is applied at 1/3 length from output shaft edge.

DC24V

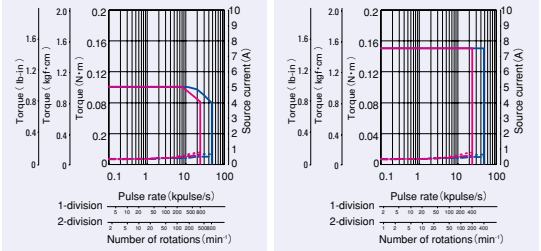

DC36V

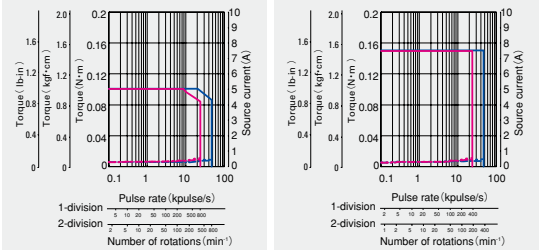

Operating current:
0.75A/phase

— Allowable torque
- - - Source current (load applied)
- · - · - Source current (no load)

■ 1-division
■ 2-division

The data are measured under the drive condition of our company. The drive torque may very depending on the accuracy of customer-side equipment.

Size	Motor flange size	□28mm (□1.10inch)			
	Motor + gear length	60.3mm (2.37inch)	60.3mm (2.37inch)	60.3mm (2.37inch)	60.3mm (2.37inch)
Set part number	Single shaft	FD351S-CX10	FD351S-CX20	FD351S-CX30	FD351S-CX50
	Double shaft	FD351D-CX10	FD351D-CX20	FD351D-CX30	FD351D-CX50
Allowable torque	N·m(oz·in)	0.2 (28.32)	0.35 (49.6)	0.5 (70.80)	0.5 (70.80)
Rotor inertia	$\times 10^{-4}$ kg·m ² (oz·in ²)	0.009 (0.05)	0.009 (0.05)	0.009 (0.05)	0.009 (0.05)
Basic step angle		0.072	0.036	0.024	0.0144
Gear ratio		1 : 10	1 : 20	1 : 30	1 : 50
Backlash	DEG	2	1.5	1.5	1.5
Allowable speed	min ⁻¹	300	150	100	60
Mass (Weight)	kg (lbs)	0.17 (0.37)	0.17 (0.37)	0.17 (0.37)	0.17 (0.37)
Allowable thrust load	N (lbs)	10 (2.25)	10 (2.25)	10 (2.25)	10 (2.25)
Allowable radial load ^(Note 1)	N (lbs)	15 (3.38)	15 (3.38)	15 (3.38)	15 (3.38)

Directions of motor rotation and gear output shaft are the same for models with reduction ratio 1 : 3.6, 1 : 7.2, 1 : 30, and 1 : 50 opposite for reduction ratio 1 : 10.
(Note1) When load is applied at 1/3 length from output shaft edge.

DC24V

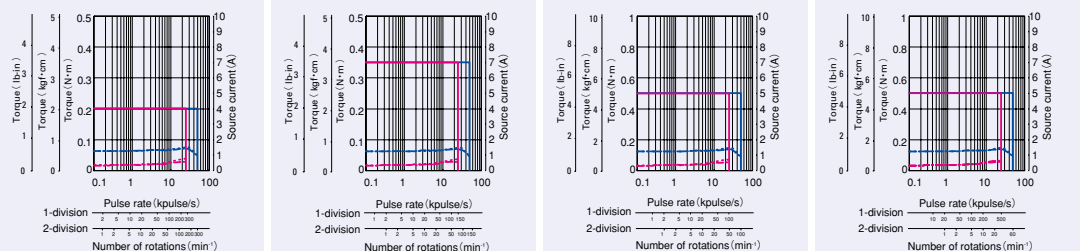

DC36V

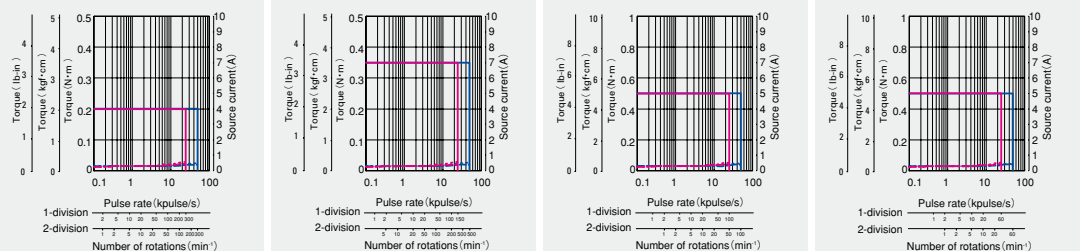

The data are measured under the drive condition of our company. The drive torque may very depending on the accuracy of customer-side equipment.

Harmonic gear model

F series driver +
F series motor with harmonic gear

Motor flange size

- 28 (1.10inch)
- 42 (1.65inch)
- 60 (2.35inch)
- φ86 (3.39inch)

Size	Motor flange size		□28mm (□1.10inch)	
	Motor + gear length		69.5mm (2.74inch)	69.5mm (2.74inch)
Set part number	Single shaft		FD F351S-HX50	FD F351S-HX100
	Double shaft		FD F351D-HX50	FD F351D-HX100
Allowable torque	N·m(oz·in)		1.5 (212.4)	2 (283.2)
Momentary allowable torque	N·m(oz·in)		2.7 (382.4)	3.6 (509.8)
Rotor inertia	×10 ⁻⁴ kg·m ² (oz·in ²)		0.012 (0.066)	0.012 (0.066)
Basic step angle			0.0144	0.0072
Gear ratio			1 : 50	1 : 100
Lost motion	Minute		0.4 to 3 ± 0.006N · m (0.85oz · in)	0.4 to 3 ± 0.008N · m (1.133oz · in)
Allowable speed	min ⁻¹		70	35
Mass (Weight)	kg (lbs)		0.22 (0.48)	0.22 (0.48)
Allowable thrust load	N (lbs)		100 (22.5)	100 (22.5)
Allowable radial load ^(Note 1)	N (lbs)		160 (36)	160 (36)

Directions of gear output shaft are the opposite.
(Note1) When load is applied at 1/3 length from output shaft edge.



DC24V

DC36V

Operating current:
0.75A/phase

- Allowable torque
- - - Source current (load applied)
- · · · · Source current (no load)
- 1-division
- 2-division

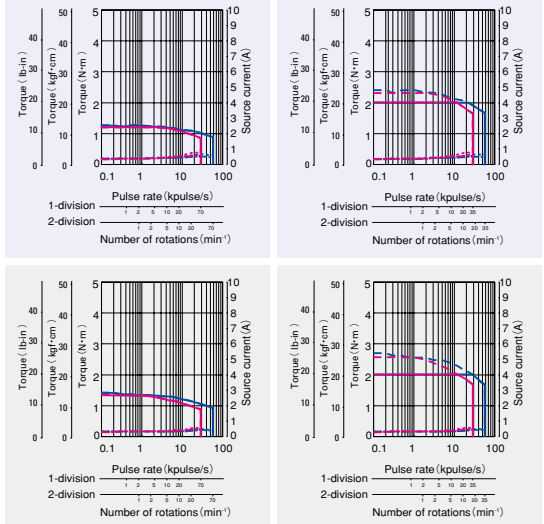

The data are measured under the drive condition of our company. The drive torque may very depending on the accuracy of customer-side equipment.

Size	Motor flange size		□60mm (□2.36inch)		φ86mm (φ3.39inch)	
	Motor + gear length		113.5mm (4.47inch)	113.5mm (4.47inch)	144.15mm (5.68inch)	144.15mm (5.68inch)
Set part number	Single shaft		FD F781S-HX50	FD F781S-HX100	FD F851S-HX50	FD F851S-HX100
	Double shaft		FD F781D-HX50	FD F781D-HX100	FD F851D-HX50	FD F851D-HX100
Allowable torque	N·m(oz·in)		5.5 (778.8)	8 (1132.9)	25 (3540.2)	41 (5805.9)
Momentary allowable torque	N·m(oz·in)		14 (1982.6)	20 (2832.2)	34 (4814.8)	59 (8355.1)
Rotor inertia	×10 ⁻⁴ kg·m ² (oz·in ²)		0.31 (1.695)	0.31 (1.695)	1.65 (9.02)	1.65 (9.02)
Basic step angle			0.0144	0.0072	0.0144	0.0072
Gear ratio			1 : 50	1 : 100	1 : 50	1 : 100
Lost motion	Minute		0.4 to 3 ± 0.28N · m (3.965oz · in)	0.4 to 3 ± 0.4N · m (56.645oz · in)	0.4 to 3 ± 1N · m (141.612oz · in)	0.4 to 3 ± 1.2N · m (169.934oz · in)
Allowable speed	min ⁻¹		70	35	70	35
Mass (Weight)	kg (lbs)		1.2 (2.64)	1.2 (2.64)	3.3 (7.26)	3.3 (7.26)
Allowable thrust load	N (lbs)		400 (90)	400 (90)	1400 (315)	1400 (315)
Allowable radial load ^(Note 1)	N (lbs)		360 (81)	360 (81)	1380 (310.5)	1380 (310.5)

Directions of gear output shaft are the opposite.
(Note1) When load is applied at 1/3 length from output shaft edge.

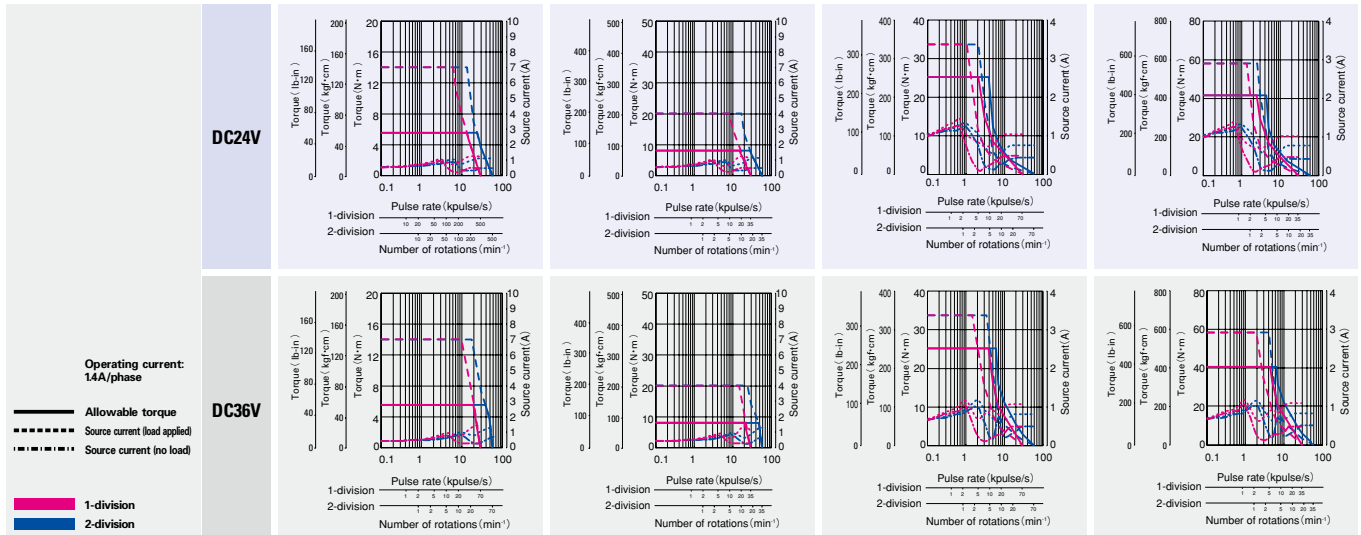

The data are measured under the drive condition of our company. The drive torque may very depending on the accuracy of customer-side equipment.

Size	Motor flange size	□ 42mm (□ 1.65inch)		
	Motor + gear length	73.5mm (2.89inch)	73.5mm (2.89inch)	73.5mm (2.89inch)
Set part number	Single shaft	FDF551S-HX30	FDF551S-HX50	FDF551S-HX100
	Double shaft	FDF551D-HX30	FDF551D-HX50	FDF551D-HX100
Allowable torque	N·m(oz·in)	2.2 (311.547)	3.5 (495.643)	5 (708.061)
Momentary allowable torque	N·m(oz·in)	4.5 (637.3)	8.3 (1175.4)	11 (1557.7)
Rotor inertia	$\times 10^4 \text{kg}\cdot\text{m}^2(\text{oz}\cdot\text{in}^2)$	0.042 (0.23)	0.042 (0.23)	0.072 (0.39)
Basic step angle		0.024	0.0144	0.0144
Gear ratio		1 : 30	1 : 50	1 : 100
Lost motion	Minute	0.4 to 1.5 ± 0.16N · m (22.658oz · in) *reference	0.4 to 1.5 ± 0.16N · m (22.658oz · in) *reference	0.4 to 1.5 ± 0.2N · m (28.322oz · in) *reference
Hysteresis loss	Minute	3.6	2.4	2.4
Allowable speed	min ⁻¹	116	70	35
Mass (Weight)	kg (lbs)	0.42 (0.92)	0.42 (0.92)	0.42 (0.92)
Allowable thrust load	N (lbs)	1150 (258.75)	1150 (258.75)	1150 (258.75)
Allowable radial load ^(Note 1)	N (lbs)	275 (61.88)	275 (61.88)	275 (61.88)

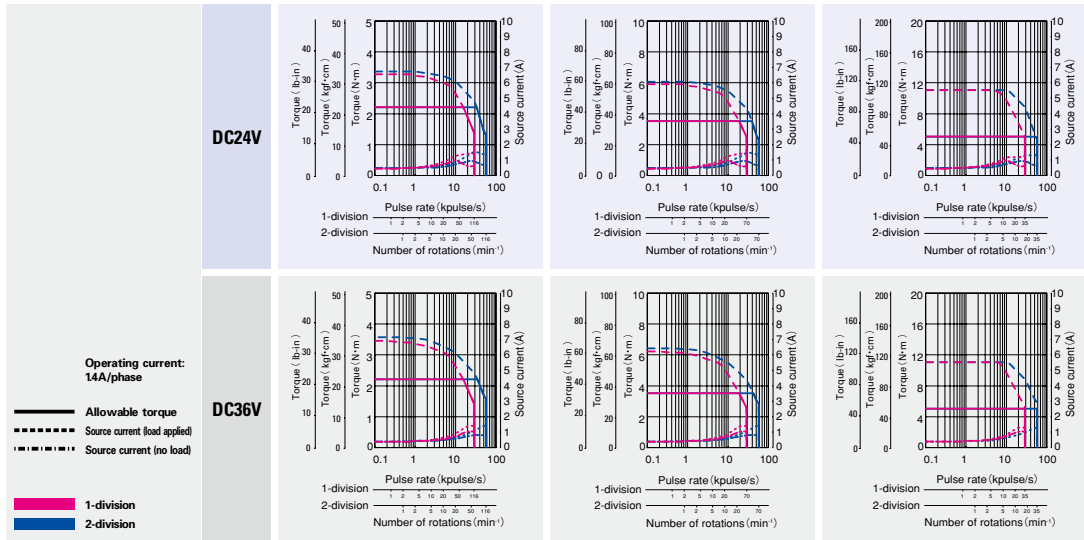

Electromagnetic brake model

F series driver +
F series motor with electromagnetic brake

Motor flange size



Size		□ 42mm (□ 1.65inch)	
Motor flange size		64.5mm (2.54inch)	70.5mm (2.78inch)
Motor + brake length		64.5mm (2.54inch)	70.5mm (2.78inch)
Set part number	Single shaft	FD551S-XB	FD552S-XB
		FD551D-XB	FD552D-XB
Holding torque	N·m(oz·in)	0.13 (8.4)	0.18 (25.49)
Rotor inertia	$\times 10^{-4}$ kg·m ² (oz·in ²)	0.045 (0.25)	0.068 (0.37)
Mass (Weight)	kg (lbs)	0.38 (0.84)	0.43 (0.95)
Allowable thrust load	N (lbs)	10 (2.25)	10 (2.25)
Allowable radial load ^(Note 1)	N (lbs)	35 (8.75)	35 (8.75)
Brake type		No excitation actuating type	No excitation actuating type
Electromagnetic brake	Power supply input	V	DC24V \pm 5%
	Excitation current	A	0.08
	Power consumption	W	2
	Static friction torque	N·m(oz·in)	0.22 (31.15)
	Brake operating time	ms	30
Brake release time	ms	20	

(Note1) When load is applied at 1/3 length from output shaft edge.

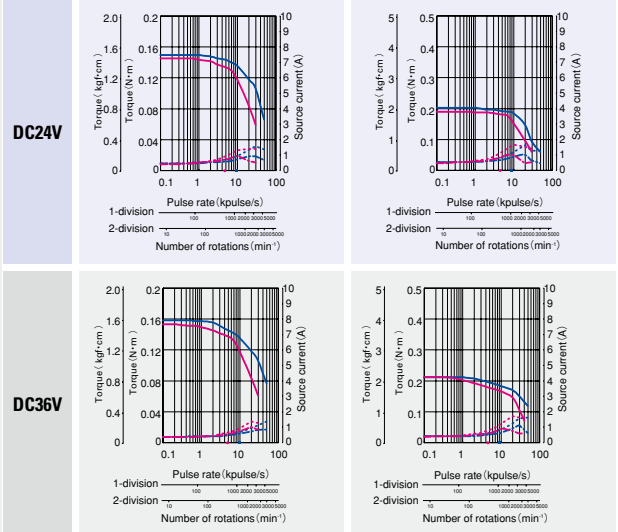

The data are measured under the drive condition of our company. The drive torque may very depending on the accuracy of customer-side equipment.

Size		φ 86mm (φ 3.39inch)	
Motor flange size		146.8mm (5.78mm)	
Motor + brake length		146.8mm (5.78mm)	
Set part number	Single shaft	FD852S-XB	FD852D-XB
		FD852S-XB	FD852D-XB
Holding torque	N·m(oz·in)	4.02 (569.3)	
Rotor inertia	$\times 10^{-4}$ kg·m ² (oz·in ²)	3.69 (20.18)	
Mass (Weight)	kg (lbs)	4.5 (9.9)	
Allowable thrust load	N (lbs)	60 (13.5)	
Allowable radial load ^(Note 1)	N (lbs)	220 (49.5)	
Brake type		No excitation actuating type	
Electromagnetic brake	Power supply input	V	DC24V \pm 5%
	Excitation current	A	0.42
	Power consumption	W	10
	Static friction torque	N·m(oz·in)	4 (566.45)
	Brake operating time	ms	50
Brake release time	ms	20	

(Note1) When load is applied at 1/3 length from output shaft edge.

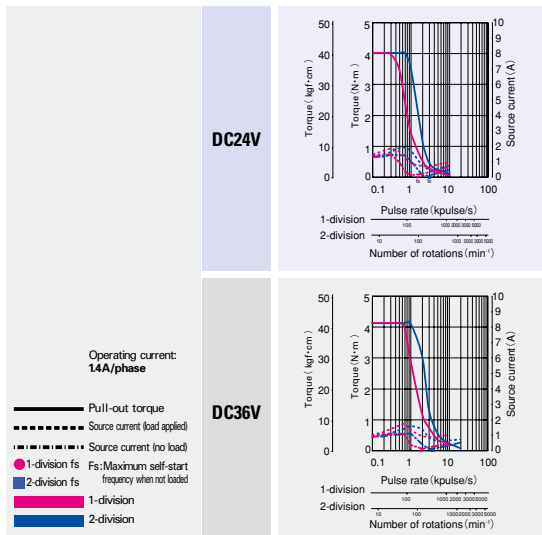

□ 42mm (□ 1.65inch)	□ 60mm (□ 2.36inch)			φ 86mm (φ 3.39inch)
79.5mm (3.13inch)	85.8mm (3.38inch)	94.5mm (3.72inch)	126.7mm (4.99inch)	116.7mm (4.59inch)
FD554S-XB	FD781S-XB	FD782S-XB	FD783S-XB	FD851S-XB
FD552D-XB	FD781D-XB	FD782D-XB	FD783D-XB	FD851D-XB
0.26 (36.82)	0.6 (85.0)	0.98 (138.8)	1.79 (253.5)	2.06 (291.7)
0.08 (0.44)	0.43 (2.35)	0.56 (3.06)	1 (5.47)	2.24 (12.25)
0.52 (1.14)	0.94 (2.07)	1.12 (2.46)	1.7 (3.74)	3.5 (7.7)
10 (2.25)	20 (4.5)	20 (4.5)	20 (4.5)	60 (13.5)
35 (8.75)	80 (18)	80 (18)	80 (18)	220 (49.5)
No excitation actuating type	No excitation actuating type	No excitation actuating type	No excitation actuating type	No excitation actuating type
DC24V ± 5%	DC24V ± 5%	DC24V ± 5%	DC24V ± 5%	DC24V ± 5%
0.08	0.25	0.25	0.25	0.42
2	6	6	6	10
0.22 (31.15)	0.8 (113.29)	0.8 (113.29)	0.8 (113.29)	4 (566.45)
30	30	30	30	50
20	20	20	20	20

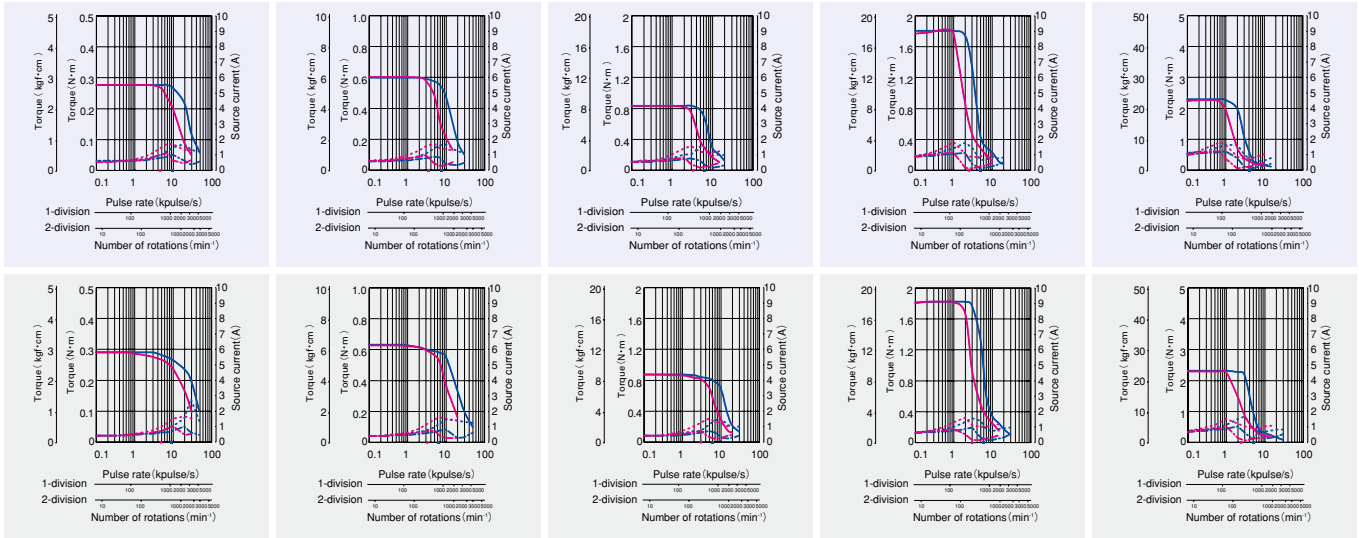

Common specifications

F series driver

Basic specifications	Item	FS1D140P □□	
	Power supply	DC24 V / 36 V ±10 %	
	Source current	3 A MAX.	
	Environment	Protection class	Class III
		Operation environment	Installation category (over-voltage category) : I , pollution degree: 2
		Applied standards	EN61010-1, UL508C
		Ambient operation temperature	0 to 50°C
		Storage temperature	-20 to +70°C
		Ambient operation humidity	35 to 85%RH (no condensation)
		Storage humidity	10 to 90%RH (no condensation)
		Operation altitude	1000 m (3280 feet) or less above sea level
		Vibration resistance	Tested under the following conditions ; 4.9m/s ² , frequency range 10 to 55Hz, direction along X, Y and Z axes, for 2 hours each
		Impact resistance	Not influenced at NDS-C-0110 standard section 3.2.2 division "C" .
Withstand voltage	Not influenced when 1500V AC is applied between power input terminal and cabinet for one minute.		
Insulation resistance	10M ohm MIN. when measured with 500V DC megohmmeter between input terminal and cabinet.		
Mass (Weight)	0.1kg (0.05lbs)		
Functions	Selection function	Step angle, pulse input method, step current, non-operating current, and operating current	
	Protection functions	Open phase protection	
	LED indication	Power monitor, alarm	
I/O signals	Command pulse input signal	Photo-coupler input system ; input resistance: 220 Ω ; input-signal "H" level : 4.0 to 5.5V ; input-signal "L" level : 0 to 0.5V, MAX. input frequency : 35kpulse/s	
	Power down input signal	Photo-coupler input system ; input resistance: 220 Ω ; input-signal "H" level : 4.0 to 5.5V ; input-signal "L" level : 0 to 0.5V	
	Input signal	Open collector output by photo coupler, output signal standard, V _{ceo} = 40V MAX., I _c = 10 mA MAX.	
	Output signal	Open collector output by photo coupler, output signal standard, V _{ceo} = 40V MAX., I _c = 10 mA MAX.	

F series motor

Stepping motor type	F series motor
Motor Type	103F35□□ /103F55□□ /103F785□ /103F858□ /103F8958□
Type	—
Insulation class	Class B (+130°C)
Operation altitude	1000m (3280 feet) or less above sea level
Withstand voltage	□ 28mm (□ 1.10inch) : AC1000V 50/60Hz for 1 minute, □ 42mm (□ 1.65inch) , □ 60mm (□ 2.36inch) , ° 86mm (° 3.39inch) , ° 106mm (° 4.17inch) : AC1500V 50/60Hz for 1 minute
Insulation resistance	100Mohm MIN. against DC500V
Protection grade	IP40
Vibration resistance	Amplitude of 1.52mm (0.06inch) (P-P) at frequency range 10 to 500Hz for 15 minutes sweep time along X, Y, and Z axes for 12 times.
Impact resistance	490m/s ² of acceleration for 11 ms with half-sine wave applying three times for X, Y, and Z axes each, 18 times in total.
Ambient operation temperature	-10 to +50°C (0 to +40°C for harmonic gear model)
Ambient operation humidity	90% MAX. at less than 40°C, 57% MAX. at less than 50°C , 35% MAX. at 60°C (no condensation)

External wiring diagram

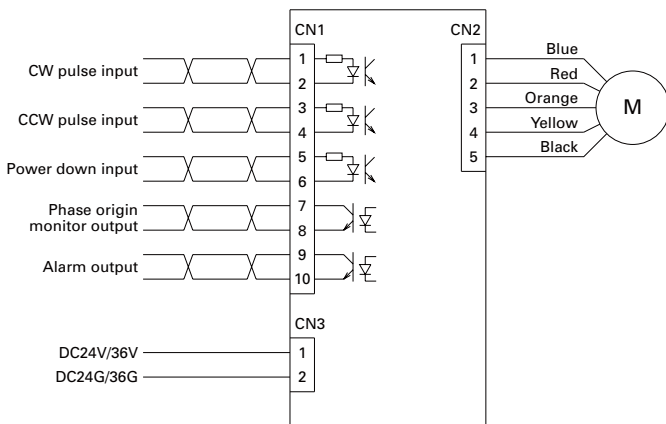

Specification summary of CN1 I/O signal

Signal name	CN1 Pin number	Function
CW pulse input (standard)	1	When using "2-input mode"
	2	Drive pulse for the CW direction rotation is input.
Pulse column input	1	When using "Pulse and direction mode"
	2	Drive pulse train for the stepping motor rotation is input.
CCW pulse input (standard)	3	When using "2-input mode"
	4	Drive pulse for the CCW direction rotation is input.
Rotation direction input	3	The rotation direction signal of stepping motor is input for the "Pulse and direction mode".
	4	Internal photocoupler ON...CW direction Internal photocoupler OFF...CCW direction
Power down input	5	Inputting the PD signal cuts OFF the current flowing through the stepping motor.
	6	internal photocoupler ON...PD function enabled internal photocoupler OFF...PD function disabled
Phase origin monitor output	7	It is turned ON when the excitation phase is at the origin (in the state when the power is turned ON)
	8	It is turned ON once per 10 pulses when setting to HALF step.
		It is turned ON once per 20 pulses when setting to FULL step.
Alarm output	9	The signal is externally output when one of several alarm circuits operates in the PM driver. At this time, the stepping motor is in the unexcited state.
	10	

The CW rotation direction of stepping motor means the clockwise direction rotation as viewed from the output shaft side (flange side) . The CCW rotation direction means the counterclockwise direction rotation as viewed from the output shaft side (flange side) .

Applicable wire sizes

Part	size	Allowable wire length
Power supply	AWG22(0.3mm ²)	2m MAX.
Input/output signal	AWG24(0.2mm ²) to AWG22(0.3mm ²)	photo coupler type : 2m MAX.
Motor	AWG22(0.3mm ²)	3m MIN.

Driver part name

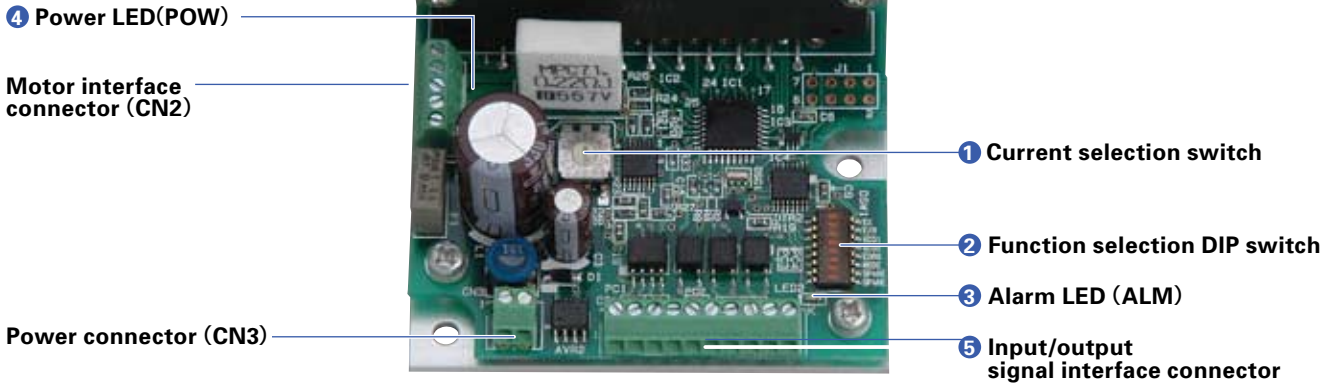

1 Current selection switch (RUN)

Enable to select operating current value to stepping motor.

Dial	0	1	2	3	4	5	6	7
Stepping motor current (A)	1.4	1.35	1.3	1.25	1.2	1.15	1.1	1.05
Dial	8	9	A	B	C	D	E	F
Stepping motor current (A)	1.0	0.95	0.9	0.85	0.8	0.75	0.7	0.65

3 Power LED (POW)

Lights up when main circuit power supply is switched on.

Indicator	Explanation
"POW" is displayed.	Main circuit power supply is switched on.

2 Function selection DIP switch

Selects an appropriate function for specification. Check that the ex-factory settings are as follows.

	OFF	ON	
EX	<input type="checkbox"/>	<input type="checkbox"/>	Half step
F/R	<input type="checkbox"/>	<input type="checkbox"/>	2-input mode (CW, CCW pulse-input method)
ACD1	<input type="checkbox"/>	<input type="checkbox"/>	Stopping current : 40% of driving current
ACD2	<input type="checkbox"/>	<input type="checkbox"/>	
EORG	<input type="checkbox"/>	<input type="checkbox"/>	Phase crigin
MODE	<input type="checkbox"/>	<input type="checkbox"/>	Reservation : Don't turn it ON.
SPARE	<input type="checkbox"/>	<input type="checkbox"/>	
SPARE	<input type="checkbox"/>	<input type="checkbox"/>	

4 Alarm LED (ALM)

Lights up during alarm conditions.

Indicator	Explanation
"ALM" is displayed.	Motor cable is broken, or switching element in driver is faulty. The main circuit voltage is out of specifications range (Less than DC19V).

When "ALM" is displayed, the winding current of the stepping motor is cut off and it is in a "non-excitation" state. At the same time, an output signal is transmitted from the alarm output terminal (AL) to an external source. When the alarm circuit is operating, this state is maintained until it is reset by switching on the power supply again. When an alarm condition has occurred, please take corrective actions to rectify the cause of the alarm before switching on the power supply again.

Step angle selection (EX)

Selects the basic step angle.

EX	Exciting mode
ON	Full step (0.72° /pulse)
OFF	Half step (0.36° /pulse)

Input method select (F/R)

Selects input pulse type.

F/R	Input pulse type
ON	1 input (pulse & direction)
OFF	2 input (CW, CCW)

Current adjustment at operation halt (ACD1, ACD2)

Selects the value of the motor current during stand-still.

ACD2	ACD1	Motor current
ON	ON	100% of driving current
ON	OFF	60% of driving current
OFF	ON	50% of driving current
OFF	OFF	40% of driving current

Initial configuration of factory shipment is set to A(50% of rated value). Driver and motor should be operated at around 50% of rated value to reduce heat.

Excitation select (EORG)

The excitation phasse when the power supply is turned on is selected.

EORG	Original excitation phase
ON	Excitation phase at power shut off
OFF	Phase origin

By turning on the EORG, excitation phase when power OFF will be saved. Therefore, there will be no shaft displacement when turning the power ON.

Input circuit configuration of CW (CK), CCW (U/D)

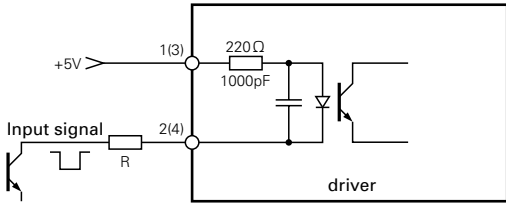

- Pulse duty 50% MAX.
- Maximum input frequency: 35kpulse/s
- When the crest value of the input signal exceeds 5V, use the external limit resistance R to limit the input current to approximately 15mA.

Input signal specification

(Photo coupler)

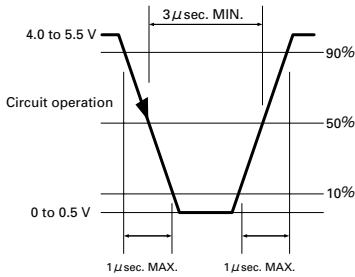

Timing of command pulse

2 input type (CW, CCW)

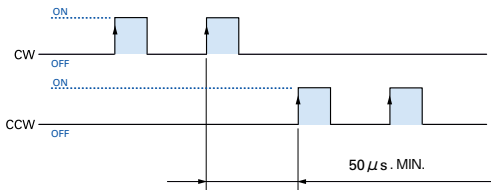

- Shaded area indicates internal photo coupler "ON". Internal circuit (motor) starts operating at leading edge of the photo coupler "ON".
- To apply pulse to CW, set CCW side internal photo coupler to "OFF".
- To apply pulse to CCW, set CW side internal photo coupler to "OFF".

1 input type (CW, U/D)

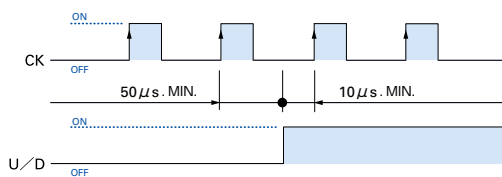

- Shaded area indicates internal photo coupler "ON". Internal circuit (motor) starts operating at leading edge of CK side photo coupler "ON".
- Switching of U/D input signal must be done while CK side internal photo coupler is "OFF".

Input circuit configuration of PD

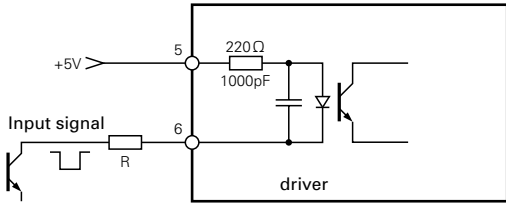

- If the peak value exceeds 5V, set the input current to approx. 15mA using the external limit resistance R.

AC input

Output signal configuration of MON, AL

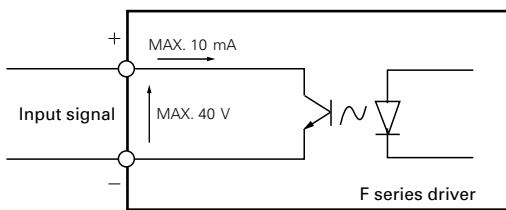

MON output

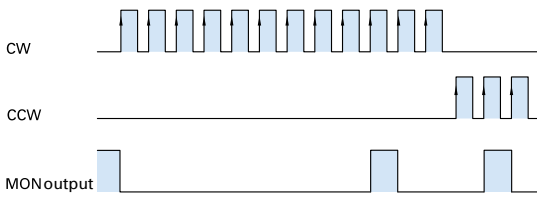

- Photo coupler at phase origin of motor excitation (status at power on) is set to "ON" (setting when number of divisions is 1).
- Output from MON is set to on at every 7.2 degrees of motor output shaft from phase origin.

Input / Output signal standard

DC input

Internal wire connection and direction of motor rotate

Internal wire connection

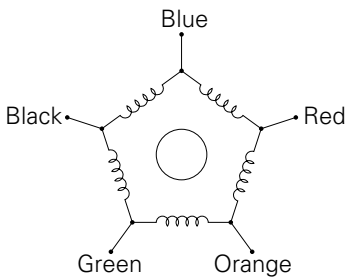

Direction of motor rotate

The direction of motor rotate is counterclockwise when viewed from the output shaft side at the direct current energization in the following order.

Type	Exciting order										
	1	2	3	4	5	6	7	8	9	10	
Color of leads	Blue			+	+	+					
	Red	-	+				+	+			
	Orange			-	-			+	+	+	
	Green	+				-	-			+	+
	Black	+	+	+				-	-		

Stepping motor

Dimensions

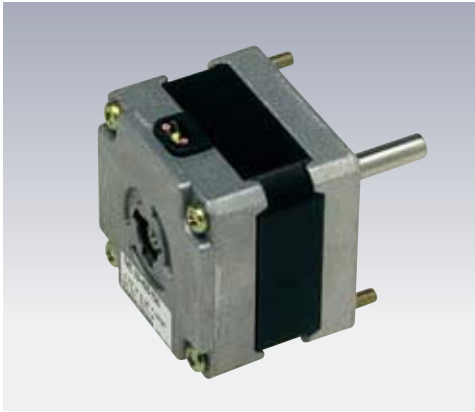

5-phase stepping motor

39mm sq. (1.54inch sq.)

103-45 □□ -70 □□
0.36° /step

Model		Holding torque at 5-phase energization	Rated current	Wiring resistance	Winding inductance	Rotor inertia	Mass (Weight)
Single shaft	Double shafts	[N · m (oz · in) MIN.]	A/phase	Ω /phase	mH/phase	[×10 ⁻⁴ kg · m ² (oz · in ²)]	[kg (lbs)]
103-4505-7040	-7010	0.078 (11.05)	0.75	2	1.97	0.0182 (0.10)	0.0182 (0.10)
103-4507-7040	-7010	0.108 (15.29)	0.75	2.35	3.8	0.024 (0.13)	0.024 (0.13)
103-4510-7040	-7010	0.167 (23.65)	0.75	3	6.2	0.036 (0.20)	0.036 (0.20)

Pulse rate-torque characteristics

■ 103-4505-70 □□

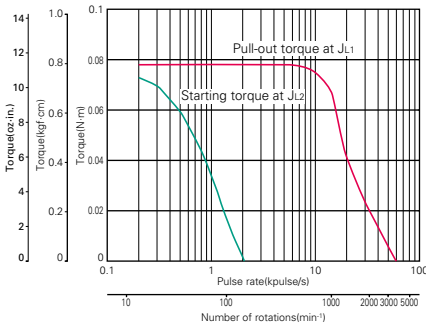

Constant current circuit
Source voltage : DC24V · operating current : 0.75A/phase,
5-phase excitation (full step)
 $J_{L1} = [0.33 \times 10^{-4} \text{kg} \cdot \text{m}^2 (1.80 \text{oz} \cdot \text{in}^2)$ use the rubber coupling]
 $J_{L2} = [0.18 \times 10^{-4} \text{kg} \cdot \text{m}^2 (0.98 \text{oz} \cdot \text{in}^2)$ use the direct coupling]

■ 103-4507-70 □□

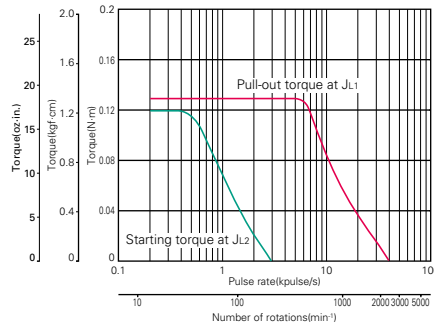

Constant current circuit
Source voltage : DC24V · operating current : 0.75A/phase,
5-phase excitation (full step)
 $J_{L1} = [0.33 \times 10^{-4} \text{kg} \cdot \text{m}^2 (1.80 \text{oz} \cdot \text{in}^2)$ use the rubber coupling]
 $J_{L2} = [0.18 \times 10^{-4} \text{kg} \cdot \text{m}^2 (0.98 \text{oz} \cdot \text{in}^2)$ use the direct coupling]

■ 103-4510-70 □□

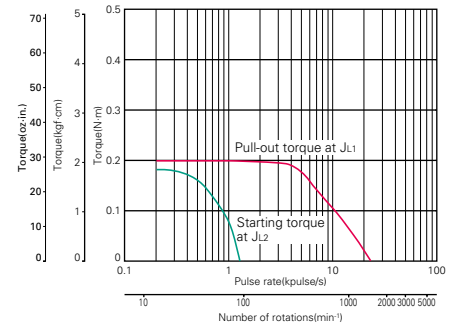

Constant current circuit
Source voltage : DC24V · operating current : 0.75A/phase,
5-phase excitation (full step)
 $J_{L1} = [0.94 \times 10^{-4} \text{kg} \cdot \text{m}^2 (5.14 \text{oz} \cdot \text{in}^2)$ use the rubber coupling]
 $J_{L2} = [0.8 \times 10^{-4} \text{kg} \cdot \text{m}^2 (4.37 \text{oz} \cdot \text{in}^2)$ use the direct coupling]



5-phase stepping motor

60mm cir. (2.36inch cir.)

103-7566-70 □□
0.45° /step

Model		Holding torque at 5-phase energization	Rated current	Wiring resistance	Winding inductance	Rotor inertia	Mass (Weight)
Single shaft	Double shafts	[N · m (oz · in) MIN.]	A/phase	Ω /phase	mH/phase	[$\times 10^{-4}$ kg · m ² (oz · in ²)]	[kg (lbs)]
103-7566-7041	-7011	0.91 (128.9)	0.75	4.8	23	0.235 (1.28)	1.1 (2.43)

Pulse rate-torque characteristics

■ 103-7566-70 □□

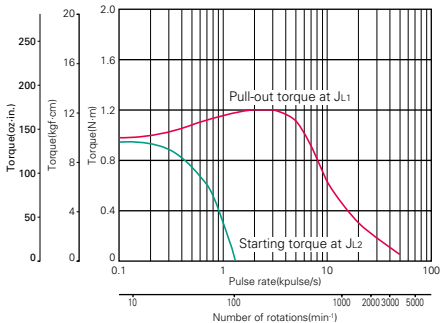

Constant current circuit
 Source voltage : AC100V · operating current : 0.75A/phase,
 5-phase excitation (full step)
 $J_{1.1}$ = [2.6x10⁻⁴kg · m² (14.22oz · in²) use the rubber coupling]
 $J_{1.2}$ = [2.6x10⁻⁴kg · m² (14.22oz · in²) use the direct coupling]

AC input

Input / Output signal standard

DC input

Stepping motor

Dimensions



5-phase stepping motor

28mm sq. (1.10inch sq.)

103H35 □□ -70 □□
0.72° /step

■ Motor with leads

Model		Holding torque at 5-phase energization	Rated current	Wiring resistance	Winding inductance	Rotor inertia	Mass (Weight)
Single shaft	Double shafts	[N · m (oz · in) MIN.]	A/phase	Ω /phase	mH/phase	[×10 ⁻⁴ kg · m ² (oz · in ²)]	[kg (lbs)]
103H3505-7070	-7020	0.026 (3.68)	0.75	1.2	0.32	0.009 (0.05)	0.11 (0.24)
103H3515-7070	-7020	0.052 (7.36)	0.75	1.5	0.4	0.016 (0.09)	0.2 (0.44)

■ Motor with connector

Model		Holding torque at 5-phase energization	Rated current	Wiring resistance	Winding inductance	Rotor inertia	Mass (Weight)
Single shaft	Double shafts	[N · m (oz · in) MIN.]	A/phase	Ω /phase	mH/phase	[×10 ⁻⁴ kg · m ² (oz · in ²)]	[kg (lbs)]
103H3505-7040	-7010	0.026 (3.68)	0.75	1.1	0.32	0.009 (0.05)	0.11 (0.24)
103H3515-7040	-7010	0.052 (7.36)	0.75	1.4	0.4	0.016 (0.09)	0.2 (0.44)

Pulse rate-torque characteristics

■ 103H3505-70 □□

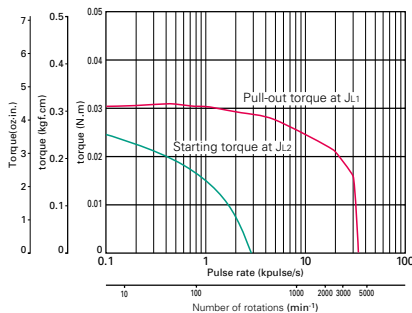

Constant current circuit
Source voltage : DC24V · operating current : 0.75A/phase,
5-phase excitation (full step)
J₁ = [0.01×10⁻⁴kg · m² (0.05oz · in²) pulley balancer system]
J₂ = [0.01×10⁻⁴kg · m² (0.05oz · in²) pulley balancer system]

■ 103H3515-70 □□

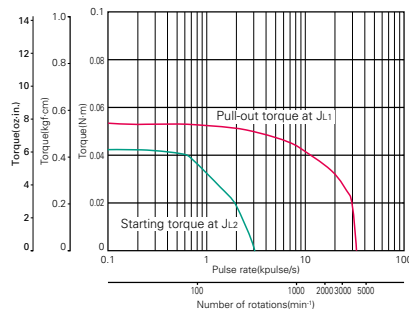

Constant current circuit
Source voltage : DC24V · operating current : 0.75A/phase,
5-phase excitation (full step)
J₁ = [0.01×10⁻⁴kg · m² (0.05oz · in²) pulley balancer system]
J₂ = [0.01×10⁻⁴kg · m² (0.05oz · in²) pulley balancer system]

5-phase stepping motor

42mm sq. (1.65inch sq.)

103H55 -70
 0.72° /step



AC input

Input / Output signal standard

DC input

Stepping motor

Dimensions

Model		Holding torque at 5-phase energization	Rated current	Wiring resistance	Winding inductance	Rotor inertia	Mass (Weight)
Single shaft	Double shafts	[N · m (oz · in) MIN.]	A/phase	Ω /phase	mH/phase	[×10 ⁻⁴ kg · m ² (oz · in ²)]	[kg (lbs)]
103H5505-7040	-7010	0.127 (17.98)	0.75	1.45	1.2	0.03 (0.16)	0.23 (0.50)
103H5508-7040	-7010	0.176 (24.92)	0.75	1.6	1.8	0.053 (0.29)	0.28 (0.62)
103H5510-7040	-7010	0.255 (36.11)	0.75	2.2	2.2	0.065 (0.36)	0.37 (0.82)

Pulse rate-torque characteristics

■ 103H5505-70

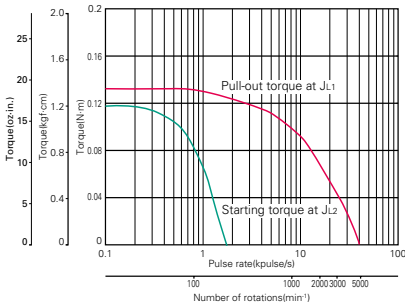

Constant current circuit
 Source voltage : DC24V · operating current:0.75A/phase,
 5-phase excitation (full step)
 $J_{L1} = [0.94 \times 10^{-4} \text{kg} \cdot \text{m}^2 (5.14 \text{oz} \cdot \text{in}^2)$ use the rubber coupling]
 $J_{L2} = [0.8 \times 10^{-4} \text{kg} \cdot \text{m}^2 (4.37 \text{oz} \cdot \text{in}^2)$ use the direct coupling]

■ 103H5508-70

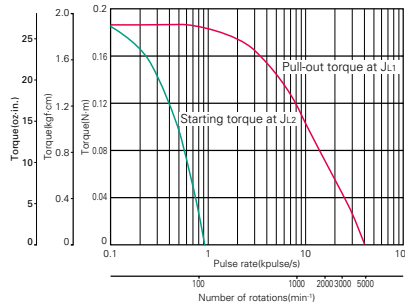

Constant current circuit
 Source voltage : DC24V · operating current:0.75A/phase,
 5-phase excitation (full step)
 $J_{L1} = [0.94 \times 10^{-4} \text{kg} \cdot \text{m}^2 (5.14 \text{oz} \cdot \text{in}^2)$ use the rubber coupling]
 $J_{L2} = [0.8 \times 10^{-4} \text{kg} \cdot \text{m}^2 (4.37 \text{oz} \cdot \text{in}^2)$ use the direct coupling]

■ 103H5510-70

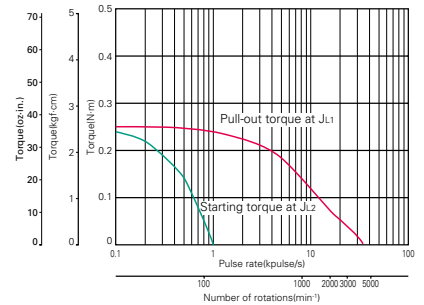

Constant current circuit
 Source voltage : DC24V · operating current:0.75A/phase,
 5-phase excitation (full step)
 $J_{L1} = [0.94 \times 10^{-4} \text{kg} \cdot \text{m}^2 (5.14 \text{oz} \cdot \text{in}^2)$ use the rubber coupling]
 $J_{L2} = [0.8 \times 10^{-4} \text{kg} \cdot \text{m}^2 (4.37 \text{oz} \cdot \text{in}^2)$ use the direct coupling]



5-phase stepping motor

50mm sq. (1.97inch sq.)

103H650 □ - □□□□
0.72° /step

Model		Holding torque at 5-phase energization	Rated current	Wiring resistance	Winding inductance	Rotor inertia	Mass (Weight)
Single shaft	Double shafts	[N · m (oz · in) MIN.]	A/phase	Ω /phase	mH/phase	[$\times 10^{-4}$ kg · m ² (oz · in ²)]	[kg (lbs)]
103H6500-7041	-7011	0.235 (33.28)	0.75	2	4	0.057 (0.31)	0.38 (0.84)
103H6500-8041	-8011	0.225 (31.86)	1.5	0.47	0.85	0.057 (0.31)	0.38 (0.84)
103H6501-7041	-7011	0.39 (55.23)	0.75	2.6	5.6	0.105 (0.57)	0.44 (0.97)
103H6501-8041	-8011	0.39 (55.23)	1.5	0.65	1.45	0.105 (0.57)	0.44 (0.97)

Pulse rate-torque characteristics

103H6500-70 □□

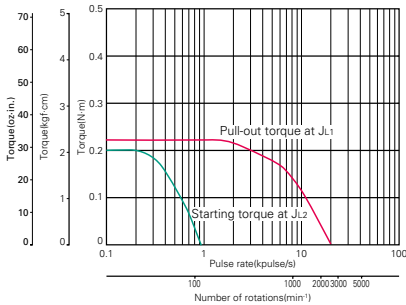

Constant current circuit
Source voltage : DC24V · operating current : 0.75A/phase, 5-phase excitation (full step)
 $J_{11} = [0.94 \times 10^{-4} \text{kg} \cdot \text{m}^2 (5.14 \text{oz} \cdot \text{in}^2)]$ use the rubber coupling]
 $J_{12} = [0.8 \times 10^{-4} \text{kg} \cdot \text{m}^2 (4.37 \text{oz} \cdot \text{in}^2)]$ use the direct coupling]

103H6500-80 □□

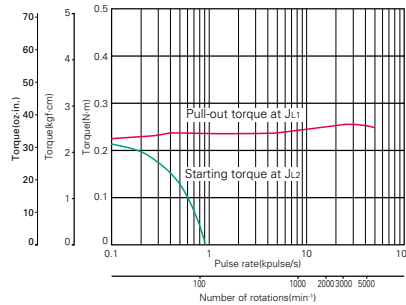

Constant current circuit
Source voltage : AC100V · operating current : 1.5A/phase, 5-phase excitation (full step)
 $J_{11} = [0.94 \times 10^{-4} \text{kg} \cdot \text{m}^2 (5.14 \text{oz} \cdot \text{in}^2)]$ use the rubber coupling]
 $J_{12} = [0.8 \times 10^{-4} \text{kg} \cdot \text{m}^2 (4.37 \text{oz} \cdot \text{in}^2)]$ use the direct coupling]

103H6501-70 □□

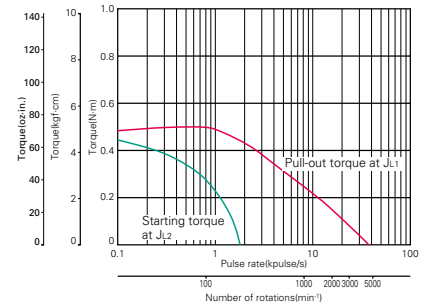

Constant current circuit
Source voltage : DC24V · operating current : 0.75A/phase, 5-phase excitation (full step)
 $J_{11} = [0.94 \times 10^{-4} \text{kg} \cdot \text{m}^2 (5.14 \text{oz} \cdot \text{in}^2)]$ use the rubber coupling]
 $J_{12} = [0.105 \times 10^{-4} \text{kg} \cdot \text{m}^2 (4.37 \text{oz} \cdot \text{in}^2)]$ pulley balancer system]

103H6501-80 □□

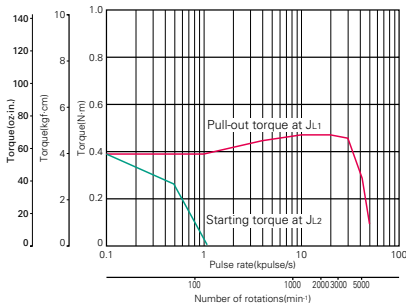

Constant current circuit
Source voltage : AC100V · operating current : 1.5A/phase, 5-phase excitation (full step)
 $J_{11} = [0.94 \times 10^{-4} \text{kg} \cdot \text{m}^2 (5.14 \text{oz} \cdot \text{in}^2)]$ use the rubber coupling]
 $J_{12} = [0.8 \times 10^{-4} \text{kg} \cdot \text{m}^2 (4.37 \text{oz} \cdot \text{in}^2)]$ use the direct coupling]



5-phase stepping motor

60mm sq. (2.36inch sq.)

103H785 □ - □□□□
0.72° /step

Model		Holding torque at 5-phase energization	Rated current	Wiring resistance	Winding inductance	Rotor inertia	Mass (Weight)
Single shaft	Double shafts	[N · m (oz · in) MIN.]	A/phase	Ω /phase	mH/phase	[$\times 10^{-4}$ kg · m ² (oz · in ²)]	[kg (lbs)]
103H7851-7051	-7021	0.65 (92.0)	0.75	2.75	4.75	0.275 (1.50)	0.6 (1.32)
103H7851-8051	-8021	0.65 (92.0)	1.5	0.64	1.2	0.275 (1.50)	0.6 (1.32)
103H7852-7051	-7021	0.98 (138.8)	0.75	3.4	7.75	0.4 (2.19)	0.78 (1.72)
103H7852-8051	-8021	0.98 (138.8)	1.5	0.8	2	0.4 (2.19)	0.78 (1.72)
103H7853-7051	-7021	1.86 (263.4)	0.75	5.5	15	0.84 (4.59)	1.36 (3.00)
103H7853-8051	-8021	1.86 (263.4)	1.5	1.28	3.85	0.84 (4.59)	1.36 (3.00)

Pulse rate-torque characteristics

103H7851-70 □□

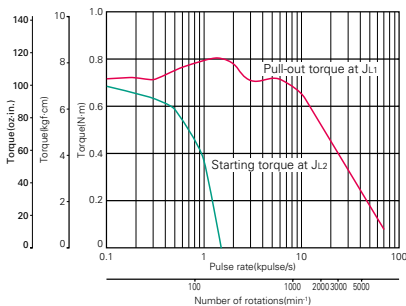

Constant current circuit
Source voltage : AC100V·operating current : 0.75A/phase,
5-phase excitation (full step)
J_{L1}=[0.94x10⁻⁴kg · m² (5.14oz · in²) use the rubber coupling]
J_{L2}=[0.8x10⁻⁴kg · m² (4.37oz · in²) use the direct coupling]

103H7852-70 □□

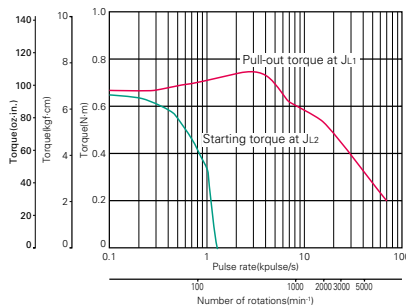

Constant current circuit
Source voltage : AC100V·operating current : 0.75A/phase,
5-phase excitation (full step)
J_{L1}=[0.94x10⁻⁴kg · m² (5.14oz · in²) use the rubber coupling]
J_{L2}=[0.8x10⁻⁴kg · m² (4.37oz · in²) use the direct coupling]

103H7853-70 □□

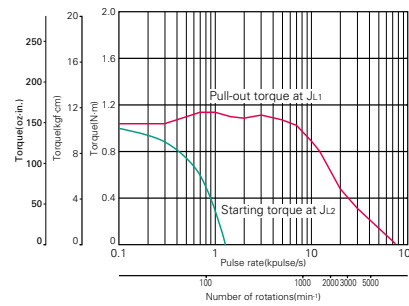

Constant current circuit
Source voltage : AC100V·operating current : 0.75A/phase,
5-phase excitation (full step)
J_{L1}=[7.4x10⁻⁴kg · m² (40.46oz · in²) use the rubber coupling]
J_{L2}=[7.4x10⁻⁴kg · m² (40.46oz · in²) use the direct coupling]

103H7851-80 □□

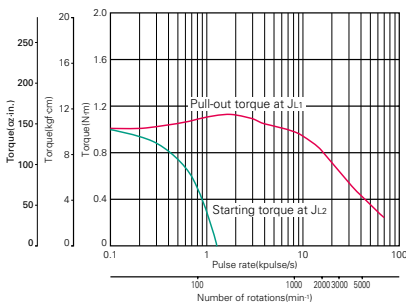

Constant current circuit
Source voltage : AC100V·operating current : 1.5A/phase,
5-phase excitation (full step)
J_{L1}=[0.94x10⁻⁴kg · m² (5.14oz · in²) use the rubber coupling]
J_{L2}=[0.8x10⁻⁴kg · m² (4.37oz · in²) use the direct coupling]

103H7852-80 □□

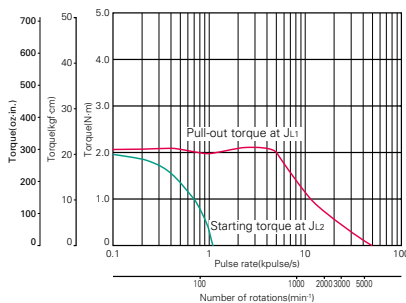

Constant current circuit
Source voltage : AC100V · operating current : 1.5A/phase,
5-phase excitation (full step)
J_{L1}=[2.6x10⁻⁴kg · m² (14.22oz · in²) use the rubber coupling]
J_{L2}=[2.6x10⁻⁴kg · m² (14.22oz · in²) use the direct coupling]

103H7853-80 □□

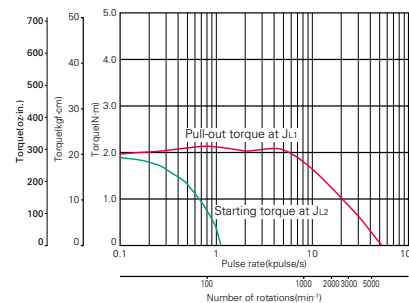

Constant current circuit
Source voltage : AC100V·operating current : 1.5A/phase,
5-phase excitation (full step)
J_{L1}=[7.4x10⁻⁴kg · m² (40.46oz · in²) use the rubber coupling]
J_{L2}=[7.4x10⁻⁴kg · m² (40.46oz · in²) use the direct coupling]



5-phase stepping motor

60mm cir. (2.36inch cir.)

103H752 □ - □□□□
0.72° /step

Model		Holding torque at 5-phase energization	Rated current	Wiring resistance	Winding inductance	Rotor inertia	Mass (Weight)
Single shaft	Double shafts	[N · m (oz · in) MIN.]	A/phase	Ω /phase	mH/phase	[×10 ⁻⁴ kg · m ² (oz · in ²)]	[kg (lbs)]
103H7521-7051	-7021	0.46 (65.1)	0.75	2.4	4.3	0.148 (0.81)	0.51 (1.12)
103H7521-8051	-8021	0.46 (65.1)	1.5	0.6	1.1	0.148 (0.81)	0.51 (1.12)
103H7522-7051	-7021	0.735 (104.1)	0.75	3.3	7.5	0.18 (0.98)	0.6 (1.32)
103H7522-8051	-8021	0.735 (104.1)	1.5	0.75	2	0.18 (0.98)	0.6 (1.32)
103H7523-7051	-7021	1.568 (222.0)	0.75	5.2	21	0.423 (2.31)	1.1 (2.43)
103H7523-8051	-8021	1.568 (222.0)	1.5	1.4	5.4	0.423 (2.31)	1.1 (2.43)

Pulse rate-torque characteristics

■ 103H7521-70 □□

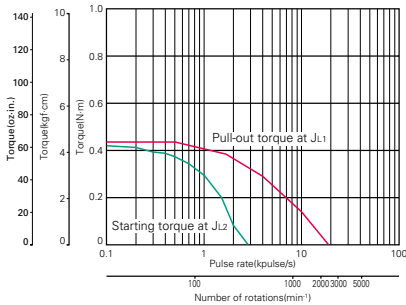

Constant current circuit
Source voltage: DC24V·operating current : 0.75A/phase,
5-phase excitation (full step)
J₁=[0.94×10⁻⁴kg·m²(5.14oz·in²) use the rubber coupling]
J₂=[0.51×10⁻⁴kg·m²(2.79oz·in²) pulley balancer system]

■ 103H7521-80 □□

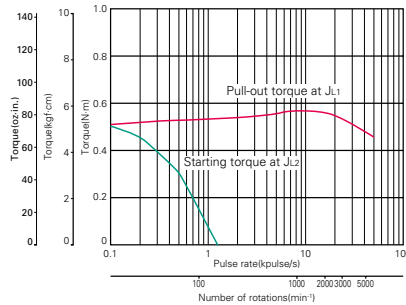

Constant current circuit
Source voltage: AC100V·operating current : 1.5A/phase,
5-phase excitation (full step)
J₁=[0.94×10⁻⁴kg·m²(5.14oz·in²) use the rubber coupling]
J₂=[0.8×10⁻⁴kg·m²(4.37oz·in²) use the direct coupling]

■ 103H7522-70 □□

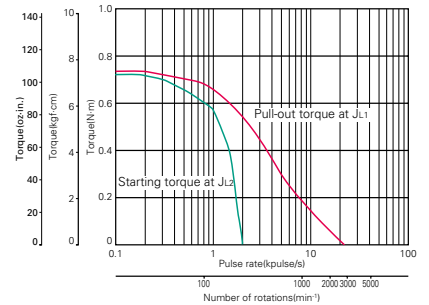

Constant current circuit
Source voltage: DC24V·operating current : 0.75A/phase,
5-phase excitation (full step)
J₁=[2.6×10⁻⁴kg·m²(14.22oz·in²) use the rubber coupling]
J₂=[0.6×10⁻⁴kg·m²(3.28oz·in²) pulley balancer system]

■ 103H7522-80 □□

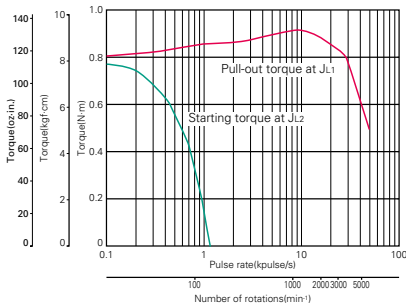

Constant current circuit
Source voltage: AC100V·operating current : 1.5A/phase,
5-phase excitation (full step)
J₁=[2.6×10⁻⁴kg·m²(14.22oz·in²) use the rubber coupling]
J₂=[2.6×10⁻⁴kg·m²(14.22oz·in²) use the direct coupling]

■ 103H7523-70 □□

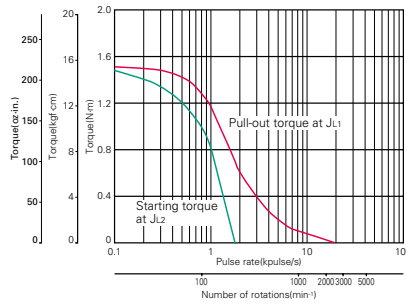

Constant current circuit
Source voltage: DC24V·operating current : 0.75A/phase,
5-phase excitation (full step)
J₁=[7.4×10⁻⁴kg·m²(40.46oz·in²) use the rubber coupling]
J₂=[1.1×10⁻⁴kg·m²(6.01oz·in²) pulley balancer system]

■ 103H7523-80 □□

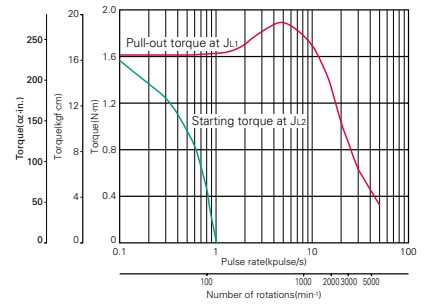

Constant current circuit
Source voltage: AC100V·operating current : 1.5A/phase,
5-phase excitation (full step)
J₁=[7.4×10⁻⁴kg·m²(40.46oz·in²) use the rubber coupling]
J₂=[7.4×10⁻⁴kg·m²(40.46oz·in²) use the direct coupling]



5-phase stepping motor

86mm cir. (3.39inch cir.)

103H858 □ - □□□□

0.72° /step

Model		Holding torque at 5-phase energization	Rated current	Wiring resistance	Winding inductance	Rotor inertia	Mass (Weight)
Single shaft	Double shafts	[N · m (oz · in) MIN.]	A/phase	Ω /phase	mH/phase	[×10 ⁻⁴ kg · m ² (oz · in ²)]	[kg (lbs)]
103H8581-7041	-7011	2.06 (291.7)	0.75	5.7	25	1.45 (7.93)	1.5 (3.31)
103H8581-8041	-8011	2.06 (291.7)	1.5	1.5	5.6	1.45 (7.93)	1.5 (3.31)
103H8582-7041	-7011	4.02 (569.3)	0.75	8.6	41	2.9 (15.86)	2.5 (5.51)
103H8582-8041	-8011	4.02 (569.3)	1.5	2	10.6	2.9 (15.86)	2.5 (5.51)
103H8583-7041	-7011	6.17 (873.7)	0.75	10.5	59	4.4 (24.06)	3.5 (7.72)
103H8583-8041	-8011	6.17 (873.7)	1.5	2.5	15	4.4 (24.06)	3.5 (7.72)

Pulse rate-torque characteristics

■ 103H8581-70 □□

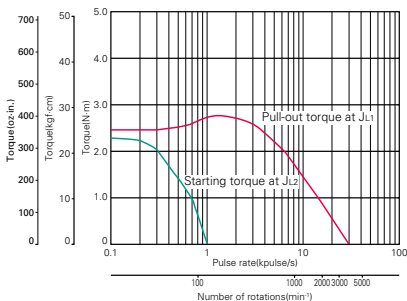

Constant current circuit
 Source voltage : AC100V·operating current : 0.75A/phase,
 5-phase excitation (full step)
 $J_{L1} = [7.4 \times 10^{-4} \text{kg} \cdot \text{m}^2 (40.46 \text{oz} \cdot \text{in}^2)]$ use the rubber coupling]
 $J_{L2} = [1.45 \times 10^{-4} \text{kg} \cdot \text{m}^2 (7.93 \text{oz} \cdot \text{in}^2)]$ pulley balancer system]

■ 103H8581-80 □□

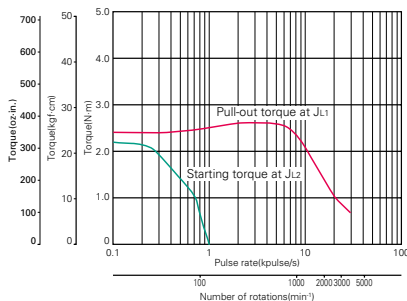

Constant current circuit
 Source voltage : AC100V·operating current : 1.5A/phase,
 5-phase excitation (full step)
 $J_{L1} = [7.4 \times 10^{-4} \text{kg} \cdot \text{m}^2 (40.46 \text{oz} \cdot \text{in}^2)]$ use the rubber coupling]
 $J_{L2} = [1.45 \times 10^{-4} \text{kg} \cdot \text{m}^2 (7.93 \text{oz} \cdot \text{in}^2)]$ pulley balancer system]

■ 103H8582-70 □□

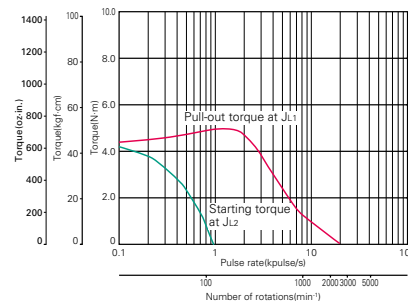

Constant current circuit
 Source voltage : AC100V·operating current : 0.75A/phase,
 5-phase excitation (full step)
 $J_{L1} = [15.3 \times 10^{-4} \text{kg} \cdot \text{m}^2 (83.65 \text{oz} \cdot \text{in}^2)]$ use the rubber coupling]
 $J_{L2} = [2.9 \times 10^{-4} \text{kg} \cdot \text{m}^2 (15.86 \text{oz} \cdot \text{in}^2)]$ pulley balancer system]

■ 103H8582-80 □□

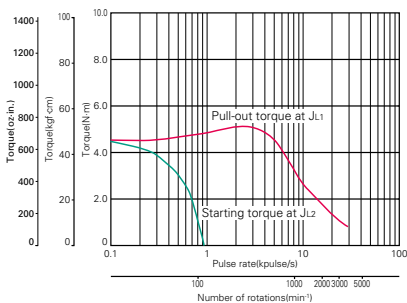

Constant current circuit
 Source voltage : AC100V·operating current : 1.5A/phase,
 5-phase excitation (full step)
 $J_{L1} = [15.3 \times 10^{-4} \text{kg} \cdot \text{m}^2 (83.65 \text{oz} \cdot \text{in}^2)]$ use the rubber coupling]
 $J_{L2} = [2.9 \times 10^{-4} \text{kg} \cdot \text{m}^2 (15.86 \text{oz} \cdot \text{in}^2)]$ pulley balancer system]

■ 103H8583-70 □□

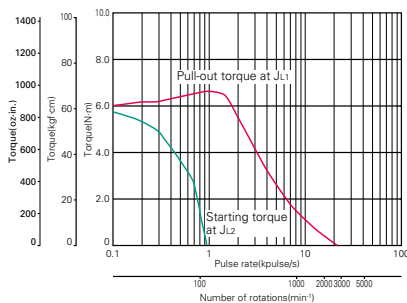

Constant current circuit
 Source voltage : AC100V·operating current : 0.75A/phase,
 5-phase excitation (full step)
 $J_{L1} = [43 \times 10^{-4} \text{kg} \cdot \text{m}^2 (235.10 \text{oz} \cdot \text{in}^2)]$ use the rubber coupling]
 $J_{L2} = [4.4 \times 10^{-4} \text{kg} \cdot \text{m}^2 (24.06 \text{oz} \cdot \text{in}^2)]$ pulley balancer system]

■ 103H8583-80 □□

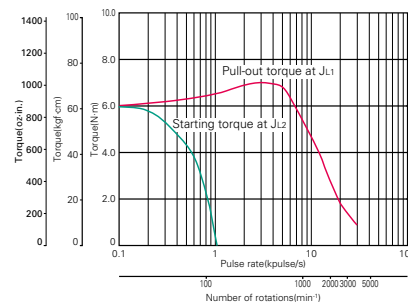

Constant current circuit
 Source voltage : AC100V·operating current : 1.5A/phase,
 5-phase excitation (full step)
 $J_{L1} = [43 \times 10^{-4} \text{kg} \cdot \text{m}^2 (235.10 \text{oz} \cdot \text{in}^2)]$ use the rubber coupling]
 $J_{L2} = [4.4 \times 10^{-4} \text{kg} \cdot \text{m}^2 (24.06 \text{oz} \cdot \text{in}^2)]$ pulley balancer system]



5-phase stepping motor

106mm cir. (4.17inch cir.)

103H8958 □ - □□□□
0.72° /step

Model		Holding torque at 5-phase energization	Rated current	Wiring resistance	Winding inductance	Rotor inertia	Mass (Weight)
Single shaft	Double shafts	[N · m (oz · in) MIN.]	A/phase	Ω /phase	mH/phase	[×10 ⁻⁴ kg · m ² (oz · in ²)]	[kg (lbs)]
103H89582-7041	-7011	10.8 (1529.4)	0.75	9	90	14.6 (79.83)	7.5 (16.53)
103H89582-8041	-8011	10.8 (1529.4)	1.5	2	26	14.6 (79.83)	7.5 (16.53)
103H89583-7041	-7011	16 (2265.7)	0.75	12.5	125	22 (120.28)	10.5 (23.15)
103H89583-8041	-8011	16 (2265.7)	1.5	2.9	33.4	22 (120.28)	10.5 (23.15)

Pulse rate-torque characteristics

103H89582-70 □□

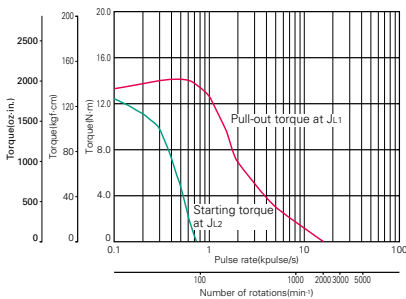

Constant current circuit
Source voltage: AC100V·operating current: 0.75A/phase, 5-phase excitation (full step)
J₁=[43x10⁻⁴kg·m²(235.10oz·in²) use the rubber coupling]
J₂=[43x10⁻⁴kg·m²(235.10oz·in²) use the rubber coupling]

103H89582-80 □□

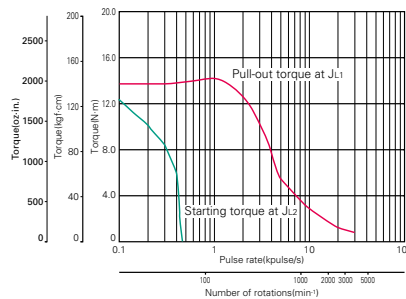

Constant current circuit
Source voltage: AC100V·operating current: 1.5A/phase, 5-phase excitation (full step)
J₁=[43x10⁻⁴kg·m²(235.10oz·in²) use the rubber coupling]
J₂=[43x10⁻⁴kg·m²(235.10oz·in²) use the rubber coupling]

103H89583-70 □□

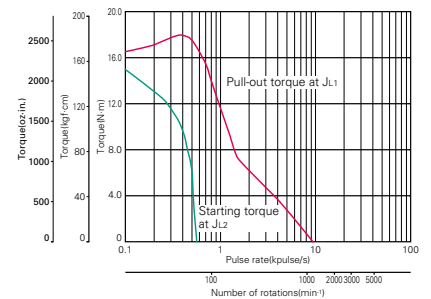

Constant current circuit
Source voltage: AC100V·operating current: 0.75A/phase, 5-phase excitation (full step)
J₁=[43x10⁻⁴kg·m²(235.10oz·in²) use the rubber coupling]
J₂=[43x10⁻⁴kg·m²(235.10oz·in²) use the rubber coupling]

103H89583-80 □□

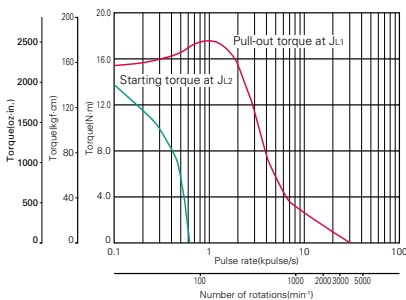

Constant current circuit
Source voltage: AC100V·operating current: 1.5A/phase, 5-phase excitation (full step)
J₁=[43x10⁻⁴kg·m²(235.10oz·in²) use the rubber coupling]
J₂=[43x10⁻⁴kg·m²(235.10oz·in²) use the rubber coupling]



5-phase stepping motor

60mm cir. (2.36inch cir.)

103H752 -6

CE marked

0.72° /step



AC input

Input / Output signal standard

Model		Holding torque at 5-phase energization	Rated current	Wiring resistance	Winding inductance	Rotor inertia	Mass (Weight)
Single shaft	Double shafts	[N · m (oz · in) MIN.]	A/phase	Ω /phase	mH/phase	[×10 ⁻⁴ kg · m ² (oz · in ²)]	[kg (lbs)]
103H7521-6050	-6020	0.46 (65.1)	0.75	2.4	4.3	0.148 (0.81)	0.51 (1.12)
103H7521-6250	-6220	0.46 (65.1)	1.5	0.6	1.1	0.148 (0.81)	0.51 (1.12)
103H7522-6050	-6020	0.735 (104.1)	0.75	3.3	7.5	0.18 (0.98)	0.6 (1.32)
103H7522-6250	-6220	0.735 (104.1)	1.5	0.75	2	0.18 (0.98)	0.6 (1.32)
103H7523-6050	-6020	1.568 (222.0)	0.75	5.2	21	0.423 (2.31)	1.1 (2.43)
103H7523-6250	-6220	1.568 (222.0)	1.5	1.4	5.4	0.423 (2.31)	1.1 (2.43)

Pulse rate-torque characteristics

103H7521-60

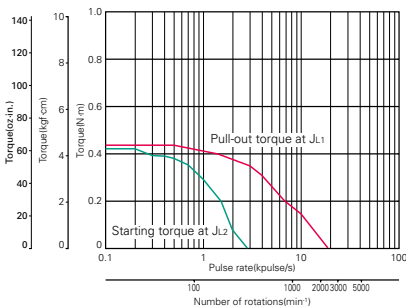

Constant current circuit
 Source voltage : DC24V · operating current : 0.75A/phase,
 5-phase excitation (full step)
 $J_{11} = [0.94 \times 10^{-4} \text{kg} \cdot \text{m}^2 (5.14 \text{oz} \cdot \text{in}^2)]$ use the rubber coupling]
 $J_{12} = [0.51 \times 10^{-4} \text{kg} \cdot \text{m}^2 (2.79 \text{oz} \cdot \text{in}^2)]$ pulley balancer system]

103H7521-62

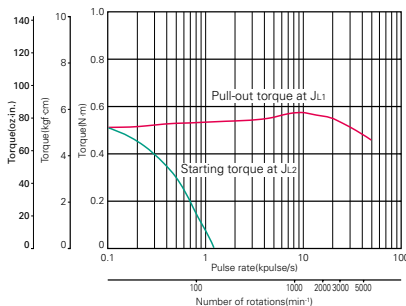

Constant current circuit
 Source voltage : AC100V · operating current : 1.5A/phase,
 5-phase excitation (full step)
 $J_{11} = [0.94 \times 10^{-4} \text{kg} \cdot \text{m}^2 (5.14 \text{oz} \cdot \text{in}^2)]$ use the rubber coupling]
 $J_{12} = [0.8 \times 10^{-4} \text{kg} \cdot \text{m}^2 (4.37 \text{oz} \cdot \text{in}^2)]$ use the direct coupling]

103H7522-60

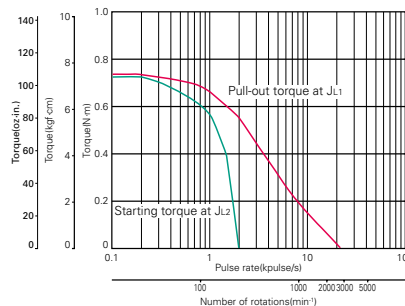

Constant current circuit
 Source voltage : DC24V · operating current : 0.75A/phase,
 5-phase excitation (full step)
 $J_{11} = [2.6 \times 10^{-4} \text{kg} \cdot \text{m}^2 (14.22 \text{oz} \cdot \text{in}^2)]$ use the rubber coupling]
 $J_{12} = [0.6 \times 10^{-4} \text{kg} \cdot \text{m}^2 (3.28 \text{oz} \cdot \text{in}^2)]$ pulley balancer system]

103H7522-62

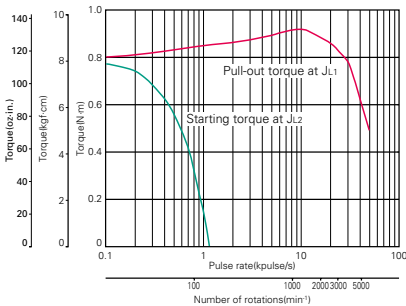

Constant current circuit
 Source voltage : AC100V · operating current : 1.5A/phase,
 5-phase excitation (full step)
 $J_{11} = [2.6 \times 10^{-4} \text{kg} \cdot \text{m}^2 (14.22 \text{oz} \cdot \text{in}^2)]$ use the rubber coupling]
 $J_{12} = [2.6 \times 10^{-4} \text{kg} \cdot \text{m}^2 (14.22 \text{oz} \cdot \text{in}^2)]$ use the direct coupling]

103H7523-60

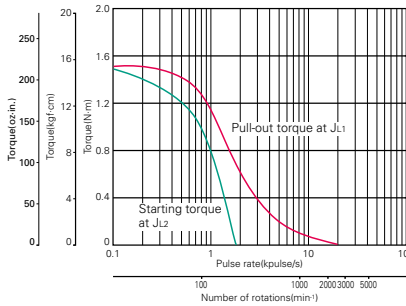

Constant current circuit
 Source voltage : DC24V · operating current : 0.75A/phase,
 5-phase excitation (full step)
 $J_{11} = [7.4 \times 10^{-4} \text{kg} \cdot \text{m}^2 (40.46 \text{oz} \cdot \text{in}^2)]$ use the rubber coupling]
 $J_{12} = [1.1 \times 10^{-4} \text{kg} \cdot \text{m}^2 (6.01 \text{oz} \cdot \text{in}^2)]$ pulley balancer system]

103H7523-62

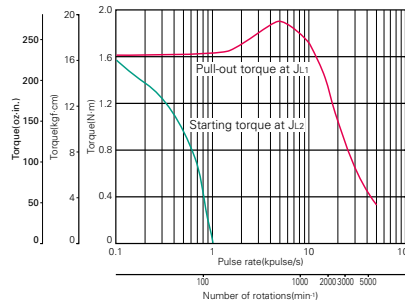

Constant current circuit
 Source voltage : AC100V · operating current : 1.5A/phase,
 5-phase excitation (full step)
 $J_{11} = [7.4 \times 10^{-4} \text{kg} \cdot \text{m}^2 (40.46 \text{oz} \cdot \text{in}^2)]$ use the rubber coupling]
 $J_{12} = [7.4 \times 10^{-4} \text{kg} \cdot \text{m}^2 (40.46 \text{oz} \cdot \text{in}^2)]$ use the direct coupling]

DC input

Stepping motor

Dimensions



5-phase stepping motor

86mm cir. (3.39inch cir.)

103H858 □ -6 □□□

CE marked

0.72° /step



Model	Holding torque at 5-phase energization	Rated current	Wiring resistance	Winding inductance	Rotor inertia	Mass (Weight)
Single shaft	Double shafts	[N · m (oz · in) MIN.]	A/phase	Ω /phase	mH/phase	[×10 ⁻⁴ kg · m ² (oz · in ²)] [kg (lbs)]
103H8581-6050	-6020	2.06 (291.7)	0.75	5.7	25	1.45 (7.93) 1.5 (3.31)
103H8581-6250	-6220	2.06 (291.7)	1.5	1.5	5.6	1.45 (7.93) 1.5 (3.31)
103H8582-6050	-6020	4.02 (569.3)	0.75	8.6	41	2.9 (15.86) 2.5 (5.51)
103H8582-6250	-6220	4.02 (569.3)	1.5	2	10.6	2.9 (15.86) 2.5 (5.51)
103H8583-6050	-6020	6.17 (873.7)	0.75	10.5	59	4.4 (24.06) 3.5 (7.72)
103H8583-6250	-6220	6.17 (873.7)	1.5	2.5	15	4.4 (24.06) 3.5 (7.72)

Pulse rate-torque characteristics

103H8581-60 □□

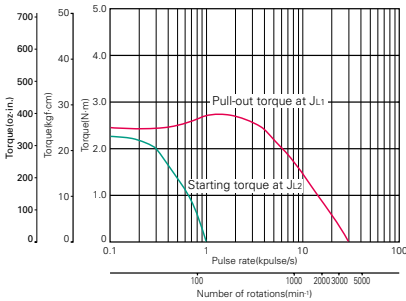

Constant current circuit
Source voltage : AC100V·operating current:0.75A/phase, 5-phase excitation (full step)
J₁=[7.4×10⁻⁴kg·m²(40.46oz·in²) use the rubber coupling]
J₂=[1.45×10⁻⁴kg·m²(7.93oz·in²) pulley balancer system]

103H8581-62 □□

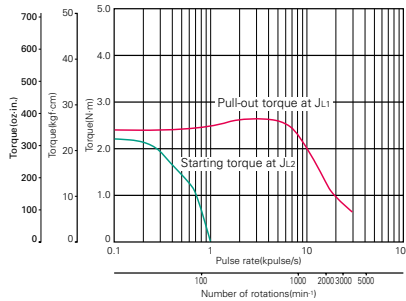

Constant current circuit
Source voltage : AC100V·operating current :1.5A/phase, 5-phase excitation (full step)
J₁=[7.4×10⁻⁴kg·m²(40.46oz·in²) use the rubber coupling]
J₂=[1.45×10⁻⁴kg·m²(7.93oz·in²) pulley balancer system]

103H8582-60 □□

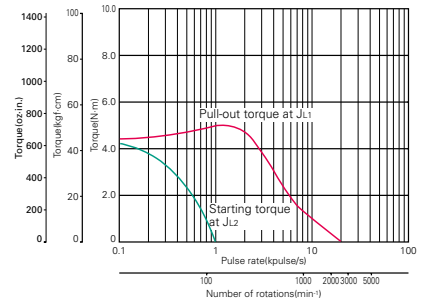

Constant current circuit
Source voltage : AC100V·operating current :0.75A/phase, 5-phase excitation (full step)
J₁=[15.3×10⁻⁴kg·m²(83.65oz·in²) use the rubber coupling]
J₂=[2.9×10⁻⁴kg·m²(15.86oz·in²) pulley balancer system]

103H8582-62 □□

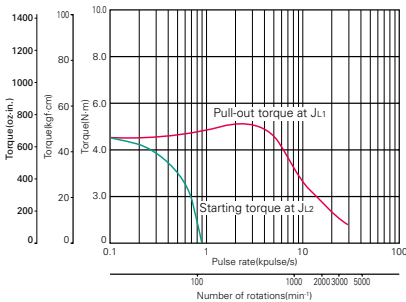

Constant current circuit
Source voltage : AC100V · operating current :1.5A/phase, 5-phase excitation (full step)
J₁=[15.3×10⁻⁴kg·m²(83.65oz·in²) use the rubber coupling]
J₂=[2.9×10⁻⁴kg·m²(15.86oz·in²) pulley balancer system]

103H8583-60 □□

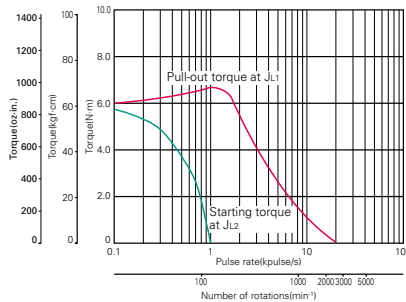

Constant current circuit
Source voltage : AC100V·operating current :0.75A/phase, 5-phase excitation (full step)
J₁=[43×10⁻⁴kg·m²(235.10oz·in²) use the rubber coupling]
J₂=[4.4×10⁻⁴kg·m²(24.06oz·in²) pulley balancer system]

103H8583-62 □□

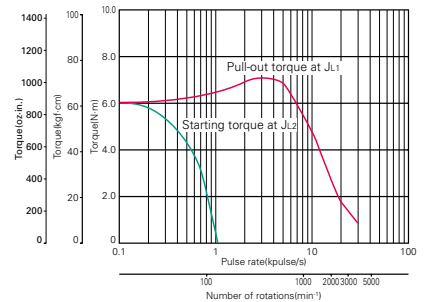

Constant current circuit
Source voltage : AC100V·operating current :1.5A/phase, 5-phase excitation (full step)
J₁=[43×10⁻⁴kg·m²(235.10oz·in²) use the rubber coupling]
J₂=[4.4×10⁻⁴kg·m²(24.06oz·in²) pulley balancer system]

5-phase stepping motor

106mm cir. (4.17inch cir.)

103H8958 □ -6 □ □ □

CE marked

0.72° /step



AC input

Input / Output signal standard

Model		Holding torque at 5-phase energization	Rated current	Wiring resistance	Winding inductance	Rotor inertia	Mass (Weight)
Single shaft	Double shafts	[N · m (oz · in) MIN.]	A/phase	Ω /phase	mH/phase	[×10 ⁻⁴ kg · m ² (oz · in ²)]	[kg (lbs)]
103H89582-6050	-6020	10.8 (1529.4)	0.75	9	90	14.6 (79.83)	7.5 (16.53)
103H89582-6250	-6220	10.8 (1529.4)	1.5	2	26	14.6 (79.83)	7.5 (16.53)
103H89583-6050	-6020	16 (2265.7)	0.75	12.5	125	22 (120.28)	10.5 (23.15)
103H89583-6250	-6220	16 (2265.7)	1.5	2.9	33.4	22 (120.28)	10.5 (23.15)

Pulse rate-torque characteristics

103H89582-60 □ □ □

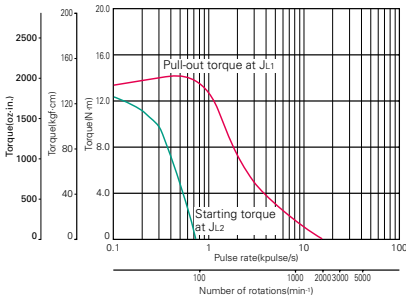

Constant current circuit
 Source voltage : AC100V·operating current : 0.75A/phase,
 5-phase excitation (full step)
 $J_{1.1} = [43 \times 10^{-4} \text{kg} \cdot \text{m}^2 (235.10 \text{oz} \cdot \text{in}^2)]$ use the rubber coupling]
 $J_{1.2} = [43 \times 10^{-4} \text{kg} \cdot \text{m}^2 (235.10 \text{oz} \cdot \text{in}^2)]$ use the rubber coupling]

103H89582-62 □ □ □

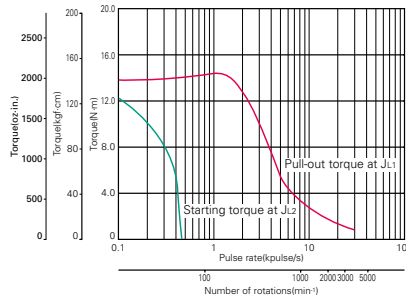

Constant current circuit
 Source voltage : AC100V·operating current : 1.5A/phase,
 5-phase excitation (full step)
 $J_{1.1} = [43 \times 10^{-4} \text{kg} \cdot \text{m}^2 (235.10 \text{oz} \cdot \text{in}^2)]$ use the rubber coupling]
 $J_{1.2} = [43 \times 10^{-4} \text{kg} \cdot \text{m}^2 (235.10 \text{oz} \cdot \text{in}^2)]$ use the rubber coupling]

103H89583-60 □ □ □

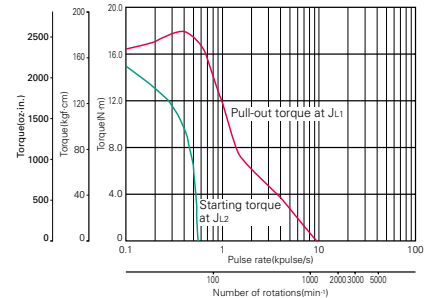

Constant current circuit
 Source voltage : AC100V·operating current : 0.75A/phase,
 5-phase excitation (full step)
 $J_{1.1} = [43 \times 10^{-4} \text{kg} \cdot \text{m}^2 (235.10 \text{oz} \cdot \text{in}^2)]$ use the rubber coupling]
 $J_{1.2} = [43 \times 10^{-4} \text{kg} \cdot \text{m}^2 (235.10 \text{oz} \cdot \text{in}^2)]$ use the rubber coupling]

103H89583-62 □ □ □

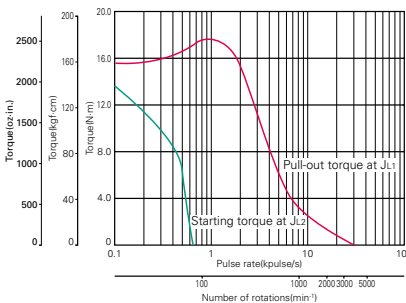

Constant current circuit
 Source voltage : AC100V·operating current : 1.5A/phase,
 5-phase excitation (full step)
 $J_{1.1} = [43 \times 10^{-4} \text{kg} \cdot \text{m}^2 (235.10 \text{oz} \cdot \text{in}^2)]$ use the rubber coupling]
 $J_{1.2} = [43 \times 10^{-4} \text{kg} \cdot \text{m}^2 (235.10 \text{oz} \cdot \text{in}^2)]$ use the rubber coupling]

DC input

Stepping motor

Dimensions

Allowable radial / thrust load

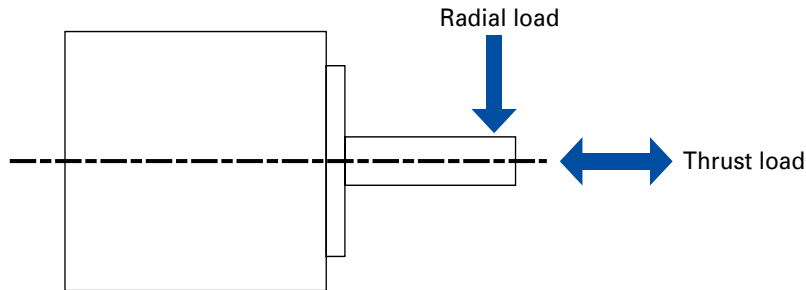

unit = upper section : N / lower berth : lbs

Frange size	Model number	Distance from end of shaft : mm (inch)				Thrust load : N (lbs)
		0 (0)	5 (0.2)	10 (2.25)	15 (3.38)	
		Radial load : N (lbs)				
□ 28mm (□ 1.10 inch)	103H35 □□ (3515-7040)	30 (1.18)	39 (1.54)	53 (2.09)	84 (3.31)	3 (0.12)
		6 (0.24)	8 (0.31)	11 (0.43)	18 (0.71)	0.67 (0.03)
□ 28mm (□ 1.10 inch)	103F35 □□ (3515-7041)	39 (1.54)	53 (2.09)	84 (3.31)	—	3 (0.12)
		8 (0.31)	11 (0.43)	18 (0.71)	—	0.67 (0.03)
□ 39mm (□ 1.54 inch)	103-45 □□ (4510-7040)	26 (1.02)	33 (1.3)	42 (1.65)	60 (2.36)	10 (2.25)
		5 (0.2)	7 (0.28)	9 (0.35)	13 (0.51)	2.25 (0.09)
□ 42mm (□ 1.65 inch)	103H55 □□ 103F55 □□ (F5510-7041)	29 (1.14)	36 (1.42)	49 (1.93)	52 (2.05)	10 (2.25)
		6 (0.24)	8 (0.31)	11 (0.43)	11 (0.43)	2.25 (0.09)
□ 50mm (□ 1.97 inch)	103H65 □□	71 (2.8)	87 (3.43)	115 (4.53)	167 (6.57)	15 (3.38)
		15 (0.59)	19 (0.75)	25 (0.98)	37 (1.46)	3.37 (0.13)
φ 60mm (φ 2.36 inch)	103H75 □□ 103-75 □□	94 (3.7)	116 (4.57)	153 (6.02)	222 (8.74)	15 (3.38)
		21 (0.83)	26 (1.02)	34 (1.34)	49 (1.93)	3.37 (0.13)
		68 (2.68)	85 (3.35)	113 (4.45)	166 (6.54)	15 (3.38)
□ 60mm (□ 2.36 inch)	103H78 □□ 103F78 □□ 103M78 □□	15 (0.59)	19 (0.75)	25 (0.98)	37 (1.46)	3.37 (0.13)
		70 (2.76)	87 (3.43)	114 (4.49)	165 (6.5)	20 (0.79)
		62 (2.44)	75 (2.95)	94 (3.7)	127 (5)	20 (0.79)
φ 86mm (φ 3.39 inch)	103H85 □□ 103F85 □□ 103M85 □□	13 (0.51)	16 (0.63)	21 (0.83)	28 (1.1)	4.50 (0.18)
		191 (7.52)	234 (9.21)	301 (11.85)	421 (16.57)	60 (2.36)
		42 (1.65)	52 (2.05)	67 (2.64)	94 (3.7)	13.488 (0.53)
		350 (13.78)	424 (16.69)	535 (21.06)	726 (28.58)	60 (2.36)
φ 106mm (φ 4.17 inch)	103H895 □□ 103F895 □□ 103M895 □□	78 (3.07)	95 (3.74)	120 (4.72)	163 (6.42)	13.488 (0.53)
		321 (12.64)	356 (14.02)	401 (15.79)	457 (18)	100 (3.94)
		72 (2.83)	80 (3.15)	90 (3.54)	102 (4.02)	22.48 (0.89)
		—	—	—	—	—

General specifications

	103H35 □□	103H55 □□	103H650 □	103H752 □	103H785 □	103H858 □	103H8958 □	103-45 □□	103-7556
Insulation class	Class B (130°C)								
Insulation resistance	Not less than 100M Ω between winding and frame by DC500V megger at normal temperature and humidity.								
Withstand voltage	Without abnormality when applying 50/60Hz,1000V AC (500V AC for 103H35 □□ and 103H55 □□) for 1 minute (leakage current 1mA) between winding and frame at normal temperature and humidity.				Without abnormality when applying 50/60Hz,1000V AC (500V AC for 103-45 □□) for 1 minute (leakage current 1mA) between winding and frame at normal temperature and humidity.				
Operating environment	Ambient temperature -10°C to +50°C								
	Ambient humidity 20% to 90%								
Wiring temperature increase	80K MAX. (based on Sanyo Denki standard)								
Standing angle error	± 0.09°	± 0.09°	± 0.09°	± 0.09°	± 0.09°	± 0.09°	± 0.09°	± 0.04°	± 0.09°
Axial play	0.075mm (0.002952inch)	0.075mm (0.002952inch)	0.075mm (0.002952inch)	0.075mm (0.002952inch)	0.075mm (0.002952inch)	0.075mm (0.002952inch)	0.075mm (0.002952inch)	0.075mm (0.002952inch)	0.075mm (0.002952inch)
	MAX., Load 4.4N (1lbs)	MAX., Load 4.4N (1lbs)	MAX., Load 9N (2lbs)	MAX., Load 9N (2lbs)	MAX., Load 9N (2lbs)	MAX., Load 9N (2lbs)	MAX., Load 9N (2lbs)	MAX., Load 9N (2lbs)	MAX., Load 4.4N (1lbs)
Radial play (Note 1)	0.025mm (0.00098inch) MAX., Load 4.4N (1lbs)								
Shaft runout	0.025mm (0.00098inch)								
Inserted part concentricity against shaft	*0.05mm (0.00197inch)	*0.05mm (0.00197inch)	*0.075mm (0.00295inch)	*0.075mm (0.00295inch)	*0.075mm (0.00295inch)	*0.075mm (0.00295inch)	*0.075mm (0.00295inch)	*0.05mm (0.00197inch)	*0.075mm (0.00295inch)
Fitted surface angularity against shaft	0.1mm (0.00394inch)	0.1mm (0.00394inch)	0.075mm (0.00295inch)	0.075mm (0.00295inch)	0.075mm (0.00295inch)	0.075mm (0.00295inch)	0.075mm (0.00295inch)	0.075mm (0.00295inch)	0.075mm (0.00295inch)

(Note1) When load is applied at 1/3 length from output shaft edge.

General specifications (models to CE marking)

	103H752 □	103H858 □	103H8958 □
Rated voltage	DC12-200V	DC12-300V	
Applied standards (Low voltage directive)	EN60034-1, IEC34-5 (EN60034-5), EN60204-1, EN60950, EN61010-1		
Specification type	S1 (continuous running duty type)		
Protection grade	IP43		
Protection class	Class I		
Operating environment	Pollution degree 2		
Insulation class	Class B (130°C)		
Insulation resistance	Not less than 100M Ω between winding and frame by DC500V megger at normal temperature and humidity.		
Withstand voltage	Without abnormality when applying 50/60Hz, 1600V AC (1500kV AC for 103H752 □) for 1 minute (leakage current 10mA) between winding and frame at normal temperature and humidity.		
Operating environment	Ambient temperature -10°C to +50°C		
	Ambient humidity 20% to 90% (no condensation)		
Wiring temperature increase	80K MAX. (Based on Sanyo Denki standard)		
Standing angle error	± 0.09°	± 0.09°	± 0.09°
Axial play	0.075mm (0.002952inch) MAX., Load 9N (2lbs)		
Radial play (Note 1)	0.075mm (0.002952inch) MAX., Load 4.4N (1lbs)		
Shaft runout	0.025mm (0.00098inch)		
Inserted part concentricity against shaft	*0.075 mm (0.00295inch)	*0.075 mm (0.00295inch)	*0.075 mm (0.00295inch)
Fitted surface angularity against shaft	0.075 mm (0.00295inch)	0.075 mm (0.00295inch)	0.075 mm (0.00295inch)

(Note 1) When load is applied at 1/3 length from output shaft edge.

Internal wire connection and direction of motor rotate

Internal wire connection

Connector pin number in the parentheses

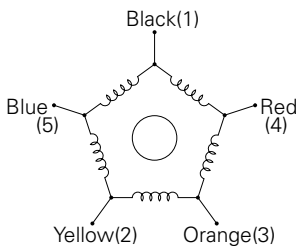

Direction of motor rotate

The direction of motor rotate is counterclockwise when viewed from the output shaft side at the direct current energization in the following order.

Type	Exciting order									
	1	2	3	4	5	6	7	8	9	10
Color of leads	Black	(1)	-	-	-	-	+	+	+	+
	Red	(4)	-	+	+	+	-	-	-	-
	Orange	(3)	+	-	-	-	-	+	+	+
	Yellow	(2)	-	-	+	+	+	+	-	-
	Blue	(5)	+	+	+	-	-	-	-	+

Standard model / CE/UL model

[Unit : mm (inch)]

□ 28mm (□ 1.10inch)

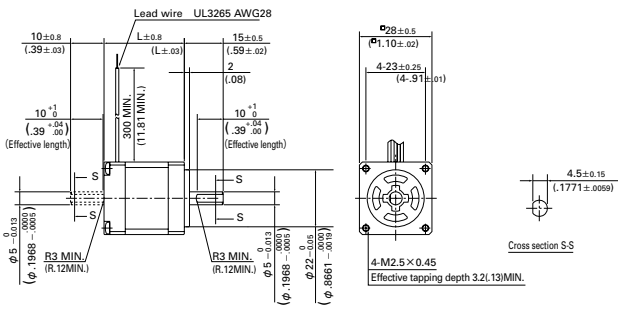

Set part number	Motor model number	Motor length (L) : mm (inch)
F □ F351 △	103F3505-70 △ 1	31 (1.22)
F □ F356 △	103F3515-70 △ 1	50.5 (1.99)
FD F351 △	103F3505-74 △ 1	31 (1.22)
FD F356 △	103F3515-74 △ 1	50.5 (1.99)

□ : Driver specifications

Motor shaft spec	Set type code
AC Power source Standard type	S
AC Power source Positioning function included type	P
DC Power source Standard type	D

■ : Motor specifications

Motor shaft spec	Set type code
F Series motor	F
M Series motor (CE · UL)	M

△ : Motor shaft specification code

Motor shaft spec	Set type code	Motor type code
Single shaft	S	4
Double shaft	D	1

▲ : Motor shaft specification code

Motor shaft spec	Set type code	Motor type code
Single shaft	S	7
Double shaft	D	2

▼ : Motor shaft specification code

Motor shaft spec	Set type code	Motor type code
Single shaft	S	5
Double shaft	D	2

◆ : Rated current

0.75A	0
1.5A	2

◇ : Motor shaft specification code

Motor shaft spec	Set type code	Motor type code
Single shaft	S	5
Double shaft	D	2

● : Rated current

0.75A	7
1.5A	8

□ 28mm (Lead wire type)

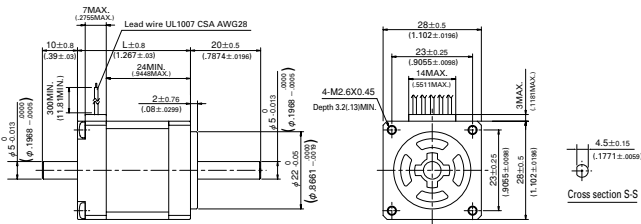

Set part number	Motor model number	Motor length (L) : mm (inch)
—	103H3505-70 ▲ 0	32.2 (1.27)
—	103H3515-70 ▲ 0	51.4 (2.02)

□ 28mm (Connector type)

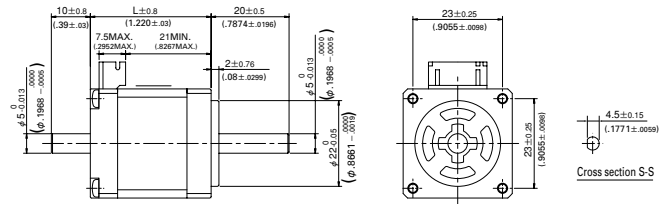

Set part number	Motor model number	Motor length (L) : mm (inch)
—	103H3505-70 △ 0	31 (1.22)
—	103H3515-70 △ 0	50.2 (1.98)

□ 39mm (□ 1.54inch)

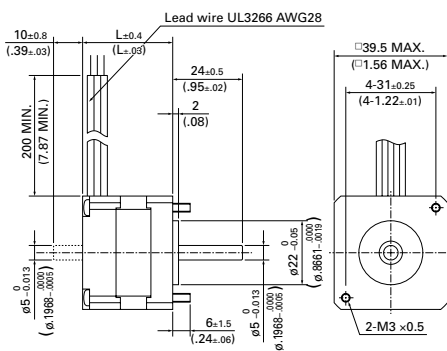

Set part number	Motor model number	Motor length : mm (inch)
—	103-4505-70 △ 0	31 (1.22)
—	103-4507-70 △ 0	35.2 (1.39)
—	103-4510-70 △ 0	44.3 (1.74)

42mm (1.65inch)

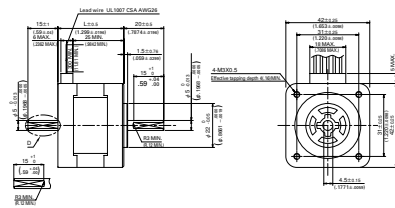
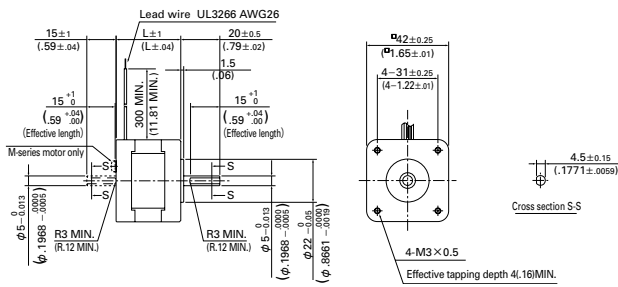

Set part number	Motor model number	Motor length (L) : mm (inch)
F □ F551 △	103 ■ 5505-70 △ 1	34 (1.34)
F □ F552 △	103 ■ 5508-70 △ 1	40 (1.57)
F □ F554 △	103 ■ 5510-70 △ 1	49 (1.93)
FD F551 △	103 F5505-82 △ 1	34 (1.34)
FD F552 △	103 F5508-82 △ 1	40 (1.57)
FD F554 △	103 F5510-82 △ 1	49 (1.93)

Set part number	Motor model number	Motor length (L) : mm (inch)
—	103H5505-70 △ 0	33 (1.3)
—	103H5508-70 △ 0	39 (1.54)
—	103H5510-70 △ 0	48 (1.89)

60mm (2.36inch)

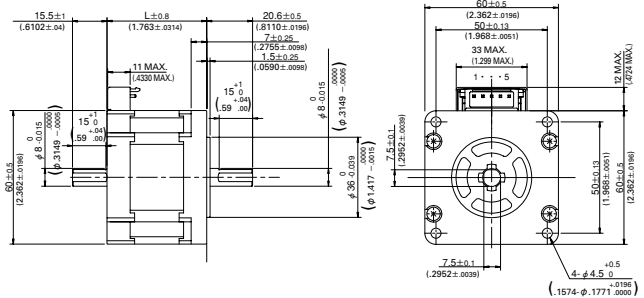
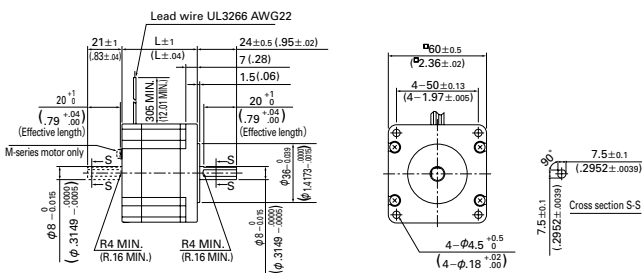

Set part number	Motor model number	Motor length (L) : mm (inch)
F □ F781 △	103 ■ 7851-70 △ 1	46.5 (1.83)
F □ F782 △	103 ■ 7852-70 △ 1	55 (2.17)
F □ F783 △	103 ■ 7853-70 △ 1	87.5 (3.44)
FD F781 △	103 F7851-82 △ 1	46.5 (1.83)
FD F782 △	103 F7852-82 △ 1	55 (2.17)
FD F783 △	103 F7853-82 △ 1	87.5 (3.44)

Set part number	Motor model number	Motor length (L) : mm (inch)
—	103H7851-● 0 △ 1	44.8 (1.76)
—	103H7852-● 0 △ 1	53.8 (2.1)
—	103H7853-● 0 △ 1	85.8 (3.38)

φ 60mm (φ 2.36inch)

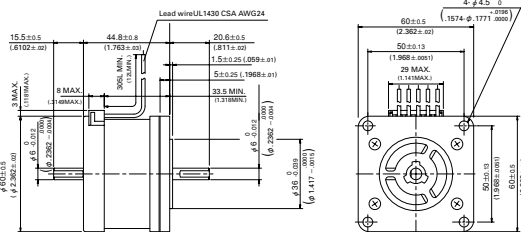
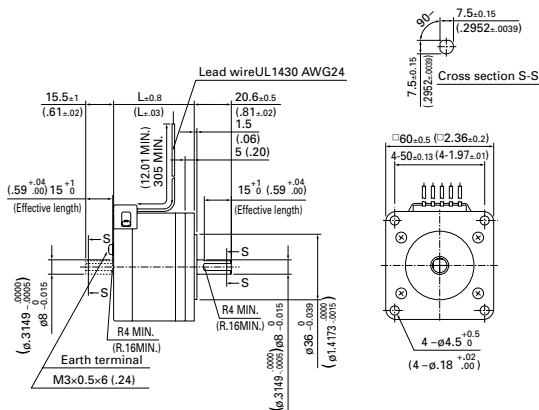

Set part number	Motor model number	Motor length : mm (inch)
—	103H7521-6 ◆▼ 0	44.8 (1.76)
—	103H7522-6 ◆▼ 0	53.8 (2.12)
—	103H7523-6 ◆▼ 0	85.8 (3.38)

Set part number	Motor model number	Motor length : mm (inch)
—	103H7521-● 0 ▼ 1	44.8 (1.76)
—	103H7522-● 0 ▼ 1	53.8 (2.12)
—	103H7523-● 0 ▼ 1	85.8 (3.38)

Dimensions

φ 86mm (φ 3.39inch)

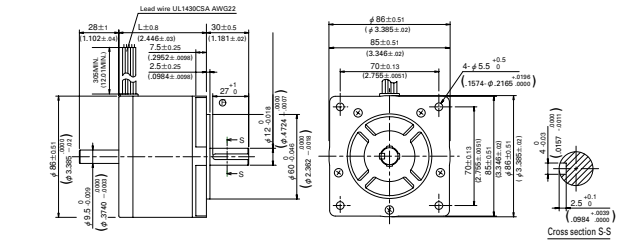
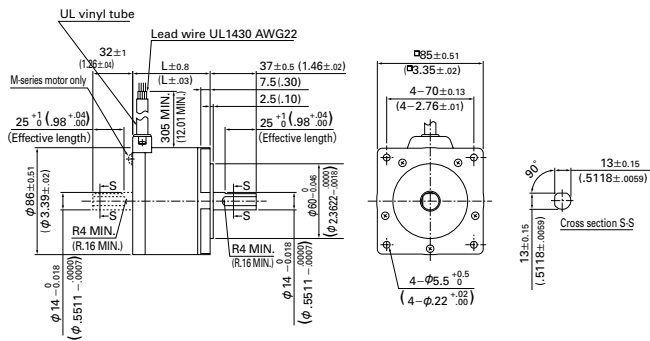

Set part number	Motor model number	Motor length (L): mm (inch)
F □ F851 △	103 ■ 8581-70 △ 1	62.15 (2.45)
F □ F852 △	103 ■ 8582-70 △ 1	92.2 (3.63)
F □ F853 △	103 ■ 8583-70 △ 1	125.85 (4.95)
FD F851 △	103F8581-82 △ 1	62.15 (2.45)
FD F852 △	103F8582-82 △ 1	92.2 (3.63)

Set part number	Motor model number	Motor length (L): mm (inch)
-	103H8581-● 0 △ 1	62.15 (2.45)
-	103H8582-● 0 △ 1	92.2 (3.63)
-	103H8583-● 0 △ 1	125.85 (4.95)

φ 106mm (φ 4.17inch)

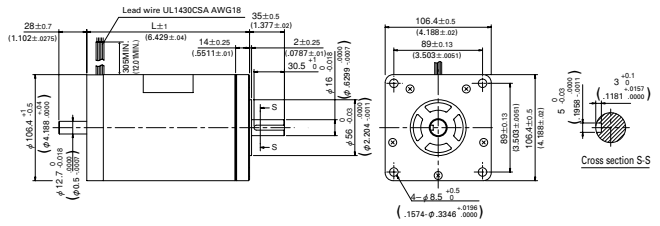
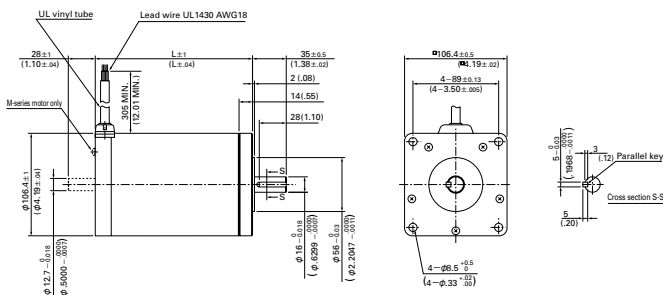

Set part number	Motor model number	Motor length (L) : mm (inch)
F □ F892 △	103 ■ 89582-70 △ 1	163.3 (6.43)
F □ F893 △	103 ■ 89583-70 △ 1	221.3 (8.71)

Set part number	Motor model number	Motor length (L) : mm (inch)
-	103H89582-● 0 △ 1	163.3 (6.43)
-	103H89583-● 0 △ 1	221.3 (8.71)

□ : Driver specifications

Motor shaft spec	Set type code
AC Power source Standard type	S
AC Power source Positioning function included type	P
DC Power source Standard type	D

■ : Motor specifications

Motor shaft spec	Set type code
F Series motor	F
M Series motor (CE · UL)	M

△ : Motor shaft specification code

Motor shaft spec	Set type code	Motor type code
Single shaft	S	4
Double shaft	D	1

● : Rated current

0.75A	7
1.5A	8

Low-backlash gear model

[Unit : mm (inch)]

□ 42mm (□ 1.65inch)

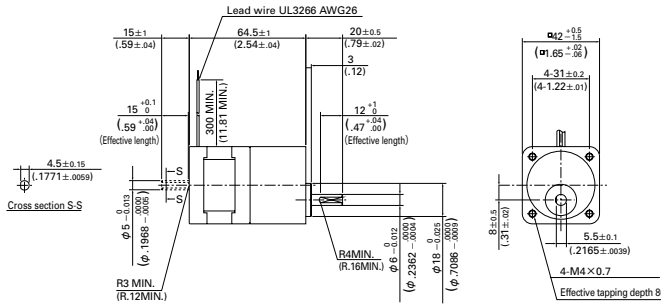

Set part number	Motor model number
FSF551 Δ -CX3.6	103F5505-70CXA Δ
FSF551 Δ -CX7.2	103F5505-70CXB Δ
FSF551 Δ -CX10	103F5505-70CXE Δ
FSF551 Δ -CX20	103F5505-70CXG Δ
FSF551 Δ -CX30	103F5505-70CXJ Δ
FSF551 Δ -CX36	103F5505-70CXX Δ

□ 60mm (□ 2.36inch)

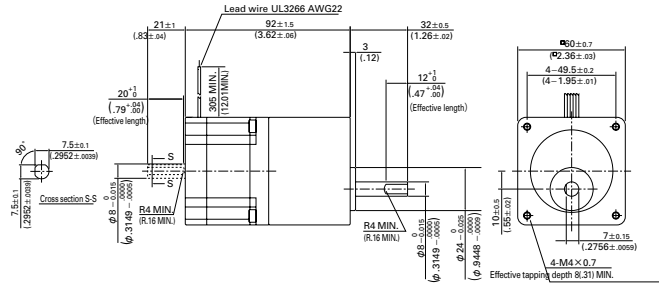

Set part number	Motor model number
FSF781 Δ -CX3.6	103F7851-70CXA Δ
FSF781 Δ -CX7.2	103F7851-70CXB Δ
FSF781 Δ -CX10	103F7851-70CXE Δ
FSF781 Δ -CX20	103F7851-70CXG Δ
FSF781 Δ -CX30	103F7851-70CXJ Δ
FSF781 Δ -CX36	103F7851-70CXX Δ

φ 86mm (φ 3.39inch)

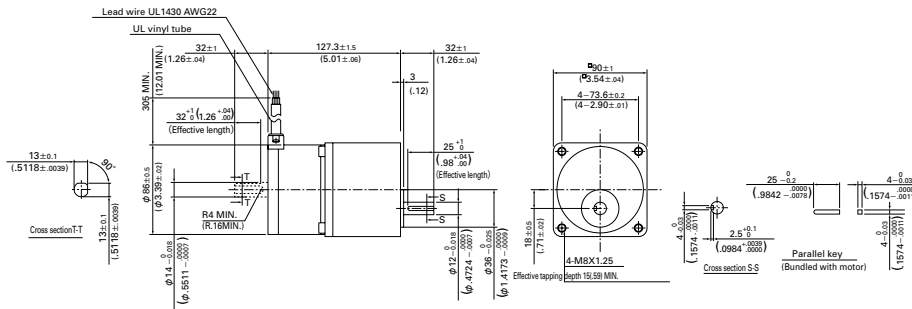

Set part number	Motor model number
FSF851 Δ -CX3.6	103F8581-70CXA Δ
FSF851 Δ -CX7.2	103F8581-70CXB Δ
FSF851 Δ -CX10	103F8581-70CXE Δ
FSF851 Δ -CX20	103F8581-70CXG Δ
FSF851 Δ -CX30	103F8581-70CXJ Δ
FSF851 Δ -CX36	103F8581-70CXX Δ

Δ : Motor shaft specification code

Motor shaft spec	Set type code	Motor type code
Single shaft	S	4
Double shaft	D	1

Spur gear model

[Unit : mm (inch)]

□ 28mm (□ 1.10inch)

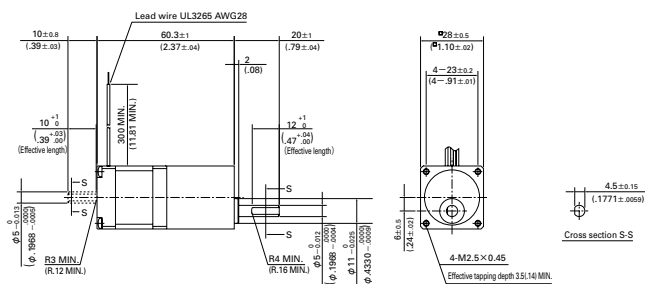

Set part number	Motor model number
FSF351 Δ -GX3.6	103F3505-70GXA Δ
FSF351 Δ -GX7.2	103F3505-70GXB Δ
FSF351 Δ -GX10	103F3505-70GXE Δ
FSF351 Δ -GX20	103F3505-70GXG Δ
FSF351 Δ -GX30	103F3505-70GXJ Δ
FSF351 Δ -GX50	103F3505-70GXL Δ

Δ : Motor shaft specification code

Motor shaft spec	Set type code	Motor type code
Single shaft	S	4
Double shaft	D	1

AC input

Input / Output signal standard

DC input

Stepping motor

Dimensions

Electromagnetic brake model

[Unit : mm (inch)]

□ 42mm (□ 1.65inch)

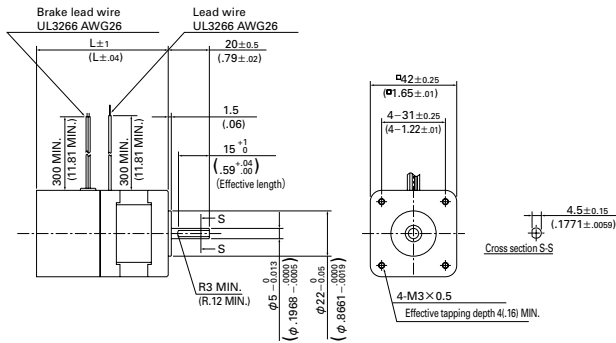

Set part number	Motor model number	Motor + brake length : mm (inch)
FSF551S-XB	103F5505-70XB41	64.5 (2.54)
FSF552S-XB	103F5508-70XB41	70.5 (2.78)
FSF554S-XB	103F5510-70XB41	79.5 (3.13)

□ 60mm (□ 2.36inch)

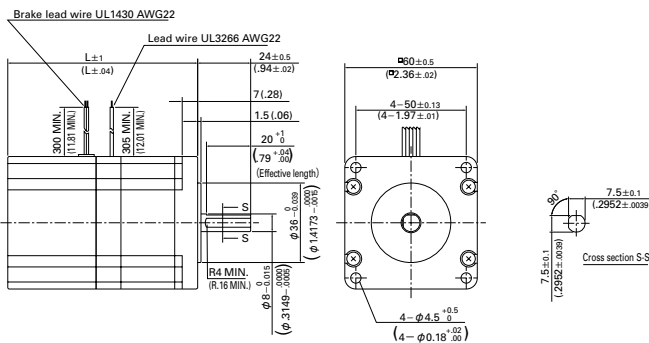

Set part number	Motor model number	Motor + brake length : mm (inch)
FSF781S-XB	103F7851-70XB41	85.8 (3.38)
FSF782S-XB	103F7852-70XB41	94.5 (3.72)
FSF783S-XB	103F7853-70XB41	126.7 (4.99)

φ 86mm (φ 3.39inch)

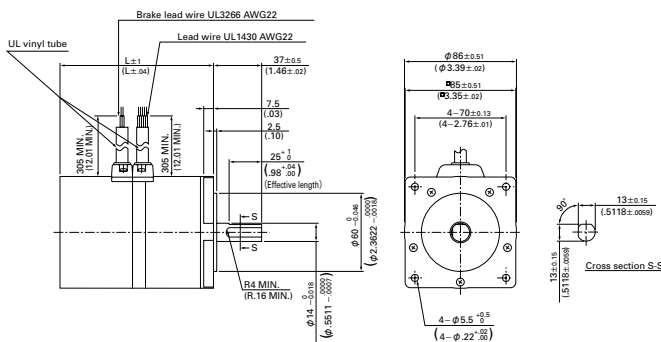

Set part number	Motor model number	Motor + brake length : mm (inch)
FSF851S-XB	103F8581-70XB41	116.7 (4.59)
FSF852S-XB	103F8582-70XB41	146.8 (5.78)
FSF853S-XB	103F8583-70XB41	180.4 (7.10)

AC input

Input / Output signal standard

DC input

Stepping motor

Dimensions

F series driver (CE [TÜV] • UL)

[Unit : mm (inch)]

AC input

FS type

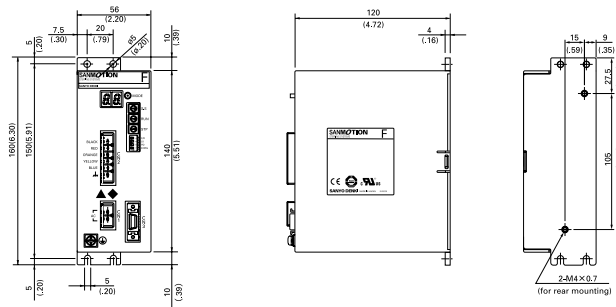

FP type

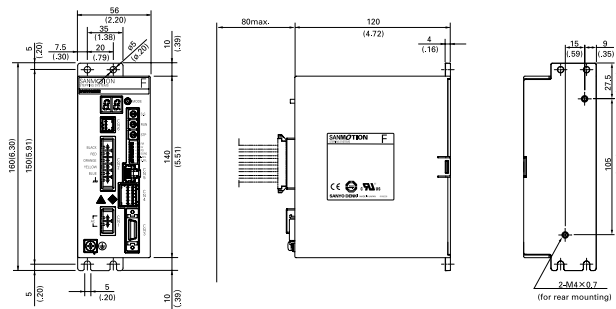

DC input

FD type

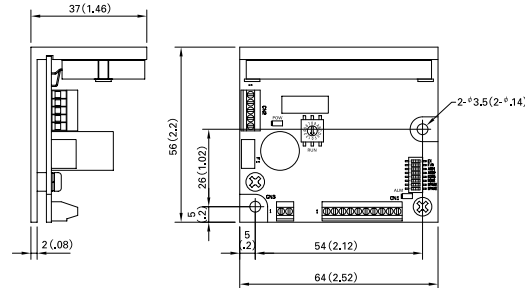

Safety standards

F series AC driver

UL	Acquired standards		File No.	Standard part	
	UL		E179775	UL508C	
UL for Canada					
CE (TÜV)	Directives	Category	Name	Standard part	
	Low-voltage directives	-	-	EN50178	
	EMC directives	Emission	Terminal disturbance voltage		EN55011-A
			Electromagnetic radiation disturbance		EN55011-A
			ESD (Electrostatic discharge)		EN61000-4-2
			RS (Radio-frequency amplitude modulated electromagnetic field)		EN61000-4-3
		Immunity	Fast transients		EN61000-4-4
			Surges		EN61000-4-6
			CS (Radio-frequency common mode)		EN61000-4-5
			Voltage dips, Voltage interruptions		EN61000-4-11

F series AC driver

UL	Acquired standards		File No.	Standard part	
	UL		E179775	UL508C	
UL for Canada					
CE (TÜV)	Directives	Category	Name	Standard part	
	Low-voltage directives	-	-	EN61010-1	
	EMC directives	Emission	Terminal disturbance voltage		EN55011-A
			Electromagnetic radiation disturbance		EN55011-A
			ESD (Electrostatic discharge)		EN61000-4-2
			RS (Radio-frequency amplitude modulated electromagnetic field)		EN61000-4-3
		Immunity	Fast transients		EN61000-4-4
			Surges		EN61000-4-6

● EMC characteristics may vary depending on the configuration of the users' control panel, which contains the driver or stepping motor, or the arrangement and wiring of other electrical devices.

● Validation test of F series driver has been performed for low-voltage EMC directives at TÜV (TÜV SUD Japan) for self-declaration of CE marking.

M series motor

UL	Acquired standards		File No.
	UL		E208878
UL for Canada			
CE	Standard category		Standard part
	Low-voltage directives		EN-60034-1
			IEC34-5 (EN-60034-5)

Safety Consideration

The drivers and stepping motors are the products designed to be used for the general industrial devices.

When using those, pay enough attention to the following points.

- Read thoroughly the Operation Manual prior to placement, assembly and/or operation in order to use the product properly.
- Refrain from modifying or processing the product in any way.
- Consult with the distributor or professional experts for placement or maintenance services of the product.
- In case of the following uses of the product, contact with us for the special care required to the operation, maintenance and management such as multiplexing the system, installing an emergency electric generator set, or so forth.

- 1 Use for the medical devices concerned with a fatal accident.
- 2 Use for trains, elevators, and so forth that are likely to cause an accident resulting in injury, damage or death.
- 3 Use in the computer system highly influential to the social life or the public systems.
- 4 Use in other devices highly influential to maintaining the human safety or the public functions.

In addition to the above, consult with us for use in such a vibration environment as automobile or transportation.

Read the Operation Manual thoroughly prior to the use (placement, operation, maintenance and inspection) to put the product in use properly.

Make yourself knowledgeable and familiarize with the devices, safety issues and cautions before handling the product.

After reading the Operation Manual or the like, keep it in the place where the users can refer to whenever necessary.

Indication by (Warning Label) on the product

Either or all of the following indications are given by the Warning Labels depending on the type of the driver or stepping motor.



This label is stuck near the high voltage part such as the electrically charged or cover-protected section, warning that the place where it is likely to cause an electric shock.



This label is stuck on the place where the driver or stepping motor body should be easily acknowledged, warning that it is likely to cause burns from high temperature.



必ずアース線を
接続して下さい
Use proper
grounding
techniques.

This label is stuck near the GND terminals of the driver or stepping motor for which grounding is required, suggesting that the terminals should be actually grounded.



危険
WARNING
感電注意
May Cause
electric shock

This label is stuck for the driver or stepping motor to which the power source is applied in the voltage exceeding the safety standard, drawing attention against the electric shock.

Safety ranks of the cautions

Following four ranks are provided.



DANGER Improper operations or use is most likely to result in serious injury or death.



CAUTION Improper operations or use is likely to result in average or minor injury, or in property damage.

In spite of the cautions with the $\Delta_{CAUTION}$ CAUTION label, it may cause serious results. Either the contents of the labels is describing important cautions to be followed inevitably.



PROHIBITED Indicates what shall not be done.



COMPULSORY Indicates what shall be done.

DANGER

< General matters >

1. Do not use the product in an explosive, flammable or corrosive atmosphere, watery place or near a combustible material. Doing so may cause injury or fire.
2. Have a person with expert knowledge for performing the transportation, placement, wiring, operation, maintenance or inspection of the product. Without such knowledge, it may cause an electric shock, injury or fire.
3. Do not work for wiring, maintenance servicing or inspection with the electric power on. Perform either of those five minutes after turning the power off, or otherwise, it may cause an electric shock.
4. When the protective functions of the product is activated, turn the power off immediately and eliminate the cause. If continuing the operation without eliminating the cause, the product may operate improperly and cause injury or a breakdown of the system devices.
5. Stepping motor may run out of order at the operating and stopping occasions, depending on the magnitude of the load. Put the product into use after confirming with the adequate trial test operation in the maximum load conditions that the product performs reliable operation. Doing otherwise may cause a breakdown of the system. (Should the product run out of order in the use to drive upward/downward, it may cause a fall of the load.)
6. Do not touch the internal parts of the driver. Doing so may cause an electric shock.

< Wiring >

7. Do not connect the stepping motor directly with the commercial power outlet. Doing so may cause an electric shock, injury or fire. The power shall be supplied to the stepping motor through the driving circuit.
8. Use the electric power source within the rated input voltage. Using otherwise may cause fire or an electric shock.
9. Connect the driver and stepping motor to the ground. Using without grounding may cause an electric shock.
10. Do not harm, forcibly put a stress, or load a heavy article on the cable or get it caught between the articles. Doing so may cause an electric shock.
11. Perform wiring with the power cable as instructed by the wiring diagram or the Operation Manual. Doing otherwise may cause an electric shock or fire.

< Operation >

12. Be sure not to touch the rotating part of the stepping motor during its operation. Touching it may cause injury.
13. Neither reach or touch the electric terminals while electric power is on. Doing so may cause an electric shock.
14. Never disconnect any of the connectors while electric power is on. Doing so may cause an electric shock and corruption.

< General matters >

1. Prior to placement, operation, maintenance servicing or inspection, be sure to read the Operation Manual and follow the instructions to perform those. Failure to follow the instructions may cause an electric shock, injury or fire.
2. Do not use the driver or the stepping motor outside the specified conditions. Doing so may cause an electric shock, injury or fire.
3. Do not insert a finger or a thing into the opening of the product. Doing so may cause an electric shock, injury or fire.
4. Do not use the damaged driver or stepping motor. Doing so may cause injury, fire or the like.
5. Use the driver and stepping motor in the designated combination. Using otherwise may cause fire or a trouble.
6. Be careful that the temperature rises in the operating driver, stepping motor or peripheral devices. Failure to be careful may cause a burn.

< Unpacking >

7. Unpack while confirming the ceiling. Failure to do so may cause injury.
8. Confirm if the product is the one having been ordered. Installing an incorrect product may cause a breakdown.

< Wiring >

9. Do not perform measurement of the insulation resistance or withstand insulation voltage of the product. Doing so may cause a breakdown. Instead, contact with us for such inspection.
10. Perform wiring conforming to the technical standards of electric facility or the internal rule. Doing otherwise may cause burning or fire.
11. Ensure that wiring has been correctly done. Operating without correct wiring may cause the stepping motor to run out of control and result in injury.
12. Take insulation process for the attached condenser or the external resistance connection terminals. Failure to do so may cause an electric shock.

< Placement >

13. Do not climb or attach a heavy article on the product. Doing so may cause injury.
14. Neither block nor stuff the aspiration/exhaust vent with a foreign particle. Doing so may cause fire.
15. Follow the instructions for the direction to place. Failure to do so may cause a trouble.
16. Keep a distance as instructed by the Operation Manual for the driver from the inner surface of the control console or other devices. Failure to do so may cause a trouble.
17. Place the product with a great care so as to prevent from the danger such as a tumble or a turnover.

CAUTION

18. Mount the product on an incombustible material such as metal. Doing otherwise may cause fire.
19. Confirm the rotating direction before connecting with the mechanical device. Failure to do so may cause injury or a breakdown.
20. Do not touch the motor output spindle (including the key slot and gears) with a bare hand. Doing so may cause injury.

< Operation >

21. The stepping motor is not equipped with any protective device. Take protective measures using an over-current protective relay, a ground fault interrupter, a protective device from excess temperature, and an emergency stopping device. Failure to do so may cause injury or fire.
22. Do not touch the product for a period after the power is on or has been turned off, since the driver and stepping motor remain in the high temperature. Doing so may cause burns. Especially the temperature rises considerably of the stepping motor depending on the operating conditions. Use the motor on the condition so that its surface temperature becomes 100°C or under.
23. Stop the operation immediately when an emergency occurs. Failure to do so may cause an electric shock, injury or fire.
24. Do not change adjustment to an extreme, for such a change results in the unstable operation. Doing so may cause injury.
25. When conducting the trial operation, make the stepping motor fixed firmly, and confirm the operation by disconnecting with the mechanical system before connecting with it. Failure to do so may cause injury.
26. When the alarm has been activated, eliminate the cause and ensure the safety to resume operation. Failure to do so may cause injury.
27. When the electric power recovers after the momentary interruption, do not approach the devices because the system may re-start operation by itself. (Set the system so as to secure the safety even when it re-start on such occasion.) Failure to do so may cause injury.
28. Confirm that the electric power supply is all proper conforming to the specifications. Failure to do so may cause a trouble.
29. The brake mechanism of the motor with the electro-magnetic brake is to hold the movable section and the motor position. Do not use it as a safety measure, or doing so may cause the breakdown of the system.
30. Fix the key firmly when operating the motor with key individually. Failure to do so may cause injury.

< Maintenance services >

31. Be careful when performing maintenance services or inspection about the temperature which rises highly in the driver and stepping motor frame. Failure to do so may cause burns.
32. It is recommended to replace the electrolytic condenser of the driver with a new one for securing the preventive measure after using for 5 years, the expected life in the average 40°C. The expected life of the fuse and cooling fan motor is 10 years in the average 40°C. Thus, the periodical replacement is recommended.
33. Contact with us for repair. If the product is disassembled by the user, it may put it out of action.

< Transportation >

34. Handle the product with care during transportation so as to prevent from the danger such as a tumble or a turnover.
35. Do not hold with the cable or the motor spindle. Doing so may cause a trouble or injury.

< Retirement >

36. When scrapping the driver or stepping motor, treat it for the general industrial waste.

PROHIBITED

< Storage >

1. Avoid the place exposed to rain or water drops, or in an environment with hazardous gas or liquid for storing the product. Failure to do so may cause a trouble.

< Maintenance services >

2. Do not assemble or repair the product. Doing so may cause fire or an electric shock.

< General matters >

3. Do not remove the rating plate.

COMPULSORY

< Storage >

1. Store the product within the specified conservation temperature and humidity in the place not exposed to the sun beam.

2. If the driver has been stored for a long period (3 years or longer for a guide), consult with us. The capacitance may have decreased with the electrolytic condenser due to the long period storage, and it may cause a trouble.

< Operation >

3. Install an external emergency stop circuit to turn the power off for the instant halt of operation.
4. Put the product into operation in the specified ambient temperature and humidity.

< Transportation >

5. Excess loading of the product on the carrier may cause the load to fall in pieces. Follow the instructions given outside the package.

Inquiry Check Sheet

Please provide the following information when placing an order or making an inquiry.
Also feel free to include any questions that require our attention.

Company Name: _____
 Department: _____
 Telephone : _____
 Fax: _____
 1) Application: _____
 2) Name of Machinery: _____
 3) Number of Units: _____

Date: _____
 To contact us: _____
 Phone: +81 3 3917 5157
 Fax: +81 3 3917 0643

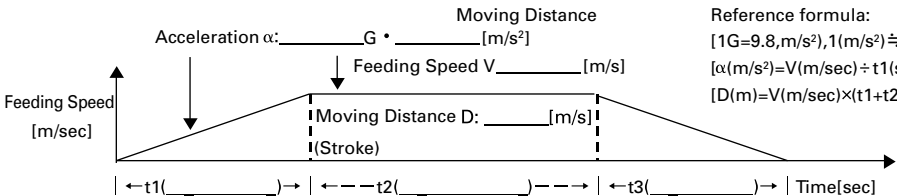
Item	Contents																																																																																																						
①	Name of target equipment Equipment name, category (transport, processing, test, other)																																																																																																						
②	Name of servo axis Axis name, axial mechanism (horizontal/vertical), brake mechanism (yes/no)																																																																																																						
③	Current condition of above axis Manufacturer Name () Series Name () Motor Capacity () Hydraulic, Mechanical, or New System ()																																																																																																						
④	Positioning accuracy ± mm / ± μm																																																																																																						
⑤	Operation pattern  <p>Reference formula: $[1G=9.8, m/s^2], 1(m/s^2) \approx 0.1G]$ $[\alpha(m/s^2)=V(m/sec) \div t1(sec)]$ $[D(m)=V(m/sec) \times (t1+t2)(sec)]$</p>																																																																																																						
⑥	Mechanism Ball-screw/screw-rotation type (horizontal), ball-screw/nut-rotation type (horizontal), rack and pinion (horizontal), belt/chain (horizontal), rotary table, roll feed, instability																																																																																																						
⑦	Mechanical structure <table border="0" style="width:100%; border-collapse: collapse;"> <tr> <td style="width:33%;">WT (table mass)</td> <td style="width:10%;">kg</td> <td style="width:33%;">WL (work mass)</td> <td style="width:10%;">kg</td> <td style="width:14%;">WA (mass of other drive parts)</td> <td style="width:10%;">kg</td> </tr> <tr> <td>WR (rack mass)</td> <td>kg</td> <td>WB (belt/chain mass)</td> <td>kg</td> <td>WC (counterbalance mass)</td> <td>kg</td> </tr> <tr> <td>Fa (external force in axial direction)</td> <td>N</td> <td>Fb (ball-screw preload)</td> <td>N</td> <td>T (roll pushing force)</td> <td>N</td> </tr> <tr> <td>Dr1 (drive-side roll diameter)</td> <td>mm</td> <td>Dr2 (follower-side roll diameter)</td> <td>mm</td> <td></td> <td></td> </tr> <tr> <td>Lr1 (drive-side roll length)</td> <td>mm</td> <td>Lr2 (follower-side roll length)</td> <td>mm</td> <td>G (reduction ratio)</td> <td></td> </tr> <tr> <td>JG (speed-reducer inertia)</td> <td>kg·m²</td> <td>JC (coupling inertia)</td> <td>kg·m²</td> <td></td> <td></td> </tr> <tr> <td>JN (nut inertia)</td> <td>kg·m²</td> <td>JO (other motor-axis conversion inertia)</td> <td>kg·m²</td> <td></td> <td></td> </tr> <tr> <td>Db (ball-screw diameter)</td> <td>mm</td> <td>Lb (ball-screw axial length)</td> <td>mm</td> <td>Pb (ball-screw lead)</td> <td>mm</td> </tr> <tr> <td>Dp (pinion/pulley diameter)</td> <td>mm</td> <td>Lp (pinion axial length)</td> <td>mm</td> <td>Tp (pulley thickness)</td> <td>mm</td> </tr> <tr> <td>Dt (table diameter)</td> <td>mm</td> <td>Dh (table-support diameter)</td> <td>mm</td> <td>LW (load shift from axis)</td> <td>mm</td> </tr> <tr> <td>Ds (table shaft diameter)</td> <td>mm</td> <td>Ls (table shaft length)</td> <td>mm</td> <td></td> <td></td> </tr> <tr> <td colspan="2">ρ (specific gravity of ball-screw/pinion/pulley/table-shaft material)</td> <td colspan="2"></td> <td></td> <td>kg/cm³</td> </tr> <tr> <td colspan="2">μ (friction coefficient between sheet and sliding-surface/support-section/roll)</td> <td colspan="2">ρ1 (specific gravity of roll-1 material)</td> <td colspan="2">kg/cm³</td> </tr> <tr> <td colspan="2">ρ2 (specific gravity of roll-2 material)</td> <td colspan="2">kg/cm³</td> <td colspan="2">κ (internal friction coefficient of preload nut)</td> </tr> <tr> <td colspan="2">η (mechanical efficiency)</td> <td colspan="2">JL (load inertia of motor-axis conversion)</td> <td colspan="2">kg·m²</td> </tr> <tr> <td colspan="2">TF (friction torque of motor axis conversion)</td> <td colspan="2">N·m</td> <td colspan="2">TU (imbalance torque of motor axis conversion)</td> </tr> <tr> <td colspan="2"></td> <td colspan="2"></td> <td colspan="2">N·m</td> </tr> </table>	WT (table mass)	kg	WL (work mass)	kg	WA (mass of other drive parts)	kg	WR (rack mass)	kg	WB (belt/chain mass)	kg	WC (counterbalance mass)	kg	Fa (external force in axial direction)	N	Fb (ball-screw preload)	N	T (roll pushing force)	N	Dr1 (drive-side roll diameter)	mm	Dr2 (follower-side roll diameter)	mm			Lr1 (drive-side roll length)	mm	Lr2 (follower-side roll length)	mm	G (reduction ratio)		JG (speed-reducer inertia)	kg·m ²	JC (coupling inertia)	kg·m ²			JN (nut inertia)	kg·m ²	JO (other motor-axis conversion inertia)	kg·m ²			Db (ball-screw diameter)	mm	Lb (ball-screw axial length)	mm	Pb (ball-screw lead)	mm	Dp (pinion/pulley diameter)	mm	Lp (pinion axial length)	mm	Tp (pulley thickness)	mm	Dt (table diameter)	mm	Dh (table-support diameter)	mm	LW (load shift from axis)	mm	Ds (table shaft diameter)	mm	Ls (table shaft length)	mm			ρ (specific gravity of ball-screw/pinion/pulley/table-shaft material)					kg/cm ³	μ (friction coefficient between sheet and sliding-surface/support-section/roll)		ρ1 (specific gravity of roll-1 material)		kg/cm ³		ρ2 (specific gravity of roll-2 material)		kg/cm ³		κ (internal friction coefficient of preload nut)		η (mechanical efficiency)		JL (load inertia of motor-axis conversion)		kg·m ²		TF (friction torque of motor axis conversion)		N·m		TU (imbalance torque of motor axis conversion)						N·m	
WT (table mass)	kg	WL (work mass)	kg	WA (mass of other drive parts)	kg																																																																																																		
WR (rack mass)	kg	WB (belt/chain mass)	kg	WC (counterbalance mass)	kg																																																																																																		
Fa (external force in axial direction)	N	Fb (ball-screw preload)	N	T (roll pushing force)	N																																																																																																		
Dr1 (drive-side roll diameter)	mm	Dr2 (follower-side roll diameter)	mm																																																																																																				
Lr1 (drive-side roll length)	mm	Lr2 (follower-side roll length)	mm	G (reduction ratio)																																																																																																			
JG (speed-reducer inertia)	kg·m ²	JC (coupling inertia)	kg·m ²																																																																																																				
JN (nut inertia)	kg·m ²	JO (other motor-axis conversion inertia)	kg·m ²																																																																																																				
Db (ball-screw diameter)	mm	Lb (ball-screw axial length)	mm	Pb (ball-screw lead)	mm																																																																																																		
Dp (pinion/pulley diameter)	mm	Lp (pinion axial length)	mm	Tp (pulley thickness)	mm																																																																																																		
Dt (table diameter)	mm	Dh (table-support diameter)	mm	LW (load shift from axis)	mm																																																																																																		
Ds (table shaft diameter)	mm	Ls (table shaft length)	mm																																																																																																				
ρ (specific gravity of ball-screw/pinion/pulley/table-shaft material)					kg/cm ³																																																																																																		
μ (friction coefficient between sheet and sliding-surface/support-section/roll)		ρ1 (specific gravity of roll-1 material)		kg/cm ³																																																																																																			
ρ2 (specific gravity of roll-2 material)		kg/cm ³		κ (internal friction coefficient of preload nut)																																																																																																			
η (mechanical efficiency)		JL (load inertia of motor-axis conversion)		kg·m ²																																																																																																			
TF (friction torque of motor axis conversion)		N·m		TU (imbalance torque of motor axis conversion)																																																																																																			
				N·m																																																																																																			
⑧	Speed reducer Customer-provided (/); Sanyo standard (planet/spur/no-backlash-planet:: /); other (/)																																																																																																						
⑨	Sensor type Sensor type specified (yes / no) Yes: (incremental , optical absolute , optical absolute [resolver absolute with incremental function]) Resolution ()																																																																																																						
⑩	Input format Position , speed, torque, communications (SERCOS / CAN / DeviceNet) other ()																																																																																																						
⑪	Upper-level equipment (controller) Sequencer , laptop , customer-developed product , Sanyo-provided , other ()																																																																																																						
⑫	Usage environment and other requirements Cutting , clean-room use , anti-dust measures , other ()																																																																																																						
⑬	Estimated production Single product: () units/month () units/year																																																																																																						
⑭	Development schedule Prototype period: ()Year ()Month Production period: ()Year ()Month																																																																																																						
⑮	Various measures Related documentation (already submitted ; send later by mail) Visit/PR desired (yes / no) Meeting desired (yes / no)																																																																																																						
⑯	Miscellaneous (questions, pending problems, unresolved issues, etc.)																																																																																																						

■ Precautions For Adoption



Failure to follow the precautions on the right may cause moderate injury and property damage, or in some circumstances, could lead to a serious accident.
Always follow all listed precautions.

Cautions

- Read the accompanying Instruction Manual carefully prior to using the product.
- If applying to medical devices and other equipment affecting people's lives, please contact us beforehand and take appropriate safety measures.
- If applying to equipment that can have significant effects on society and the general public, please contact us beforehand.
- Do not use this product in an environment where vibration is present, such as in a moving vehicle or shipping vessel.
- Do not perform any retrofitting, re-engineering, or modification to this equipment.
- The drivers and motors presented in this catalog are meant to be used for general industrial applications. If using for special applications related to aviation and space, nuclear power, electric power, submarine repeaters, etc., please contact us beforehand.

* For any question or inquiry regarding the above, contact our Sales Department.

SANYO DENKI CO., LTD.

1-15-1, Kita-Otsuka, Toshima-ku, Tokyo 170-8451, Japan

<http://www.sanyodenki.co.jp>

Phone: +81 3 3917 5157

SANYO DENKI AMERICA, INC.

468 Amapola Avenue Torrance, CA 90501 U.S.A.

Phone: +1 310 783 5400

SANYO DENKI EUROPE SA.

P.A. Paris Nord II 48 Allée des Erables-VILLEPINTE BP.57286 F-95958 ROISSY CDG Cedex France

Phone: +33 1 48 63 26 61

SANYO DENKI GERMANY GmbH

Frankfurter Strasse 63-69 65760 Eschborn Germany

Phone: +49 6196 76113 0

SANYO DENKI KOREA CO., LTD.

9F 5-2, Sunwha-dong Jung-gu Seoul, 100-130, Korea

Phone: +82 2 773 5623

SANYO DENKI SHANGHAI CO., LTD.

Room 2116, Bldg B, FAR EAST INTERNATIONAL PLAZA, No.317 XianXia Rd., Shanghai 200051 China

Phone: +86 21 6235 1107

SANYO DENKI TAIWAN CO., LTD.

Room 1208, 12F, No.96 Chung Shan N, Rd., Sec.2, Taipei 104, Taiwan, R.O.C.

Phone: +886 2 2511 3938

SANYO DENKI (H.K.) CO., LIMITED

Room 2305, 23/F, South Tower, Concordia Plaza, 1 Science Museum Rd., TST East, Kowloon, Hong Kong

Phone: +852 2312 6250

SANYO DENKI SINGAPORE PTE. LTD.

10 Hoe Chiang Road #14-03A/04 Keppel Towers Singapore 089315

Phone: +65 6223 1071

The names of companies and/or their products specified in this catalogue are the trade names, and/or trademarks and/or registered trademarks of such respective companies.
*Remarks : Specifications Are Subject To Change Without Notice.

CATALOG No. 833-3 '07.11.C

SANMOTION

5-PHASE STEPPING SYSTEMS

F5



Ver.2

SANYO DENKI

Extensive lineup

F series driver features

1

Lower vibration

AC input

DC input

AC input

- Automicro function and microstepping system enables further reduction of vibration compared to current models.

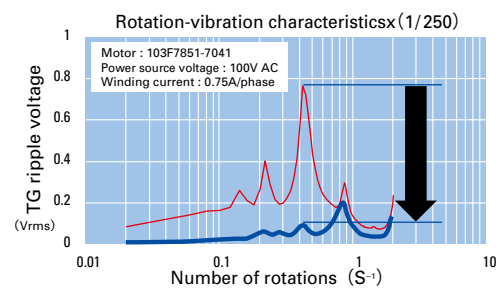
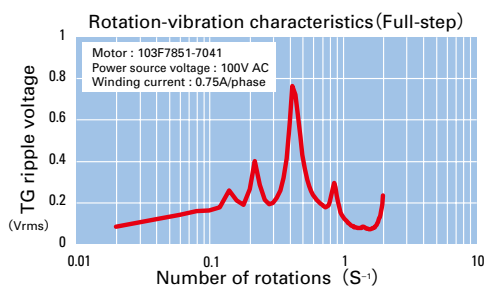

Automicro function

Vibration suppression is executed internally and independently from the controller.

Microstepping system

The basic step angle is divided by a maximum of 1/250 using 16 selectable resolution levels to enable smooth and vibration-free operation.

$$\frac{0.72}{1 \text{ to } 250 \text{ divisions}} = 0.72 \text{ to } 0.00288 \text{ degrees/pulse}$$

DC input

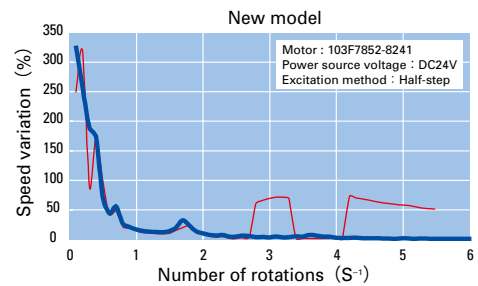
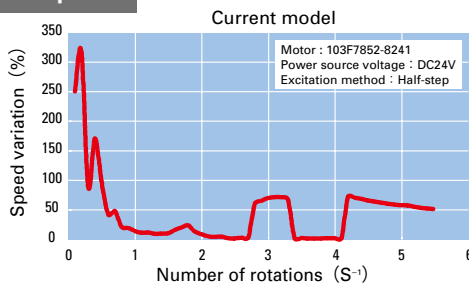

2

Shorter cycle time

AC input

- Improved response (up to 10% compared to current models) shortens the machine cycle time for repetitive operations.

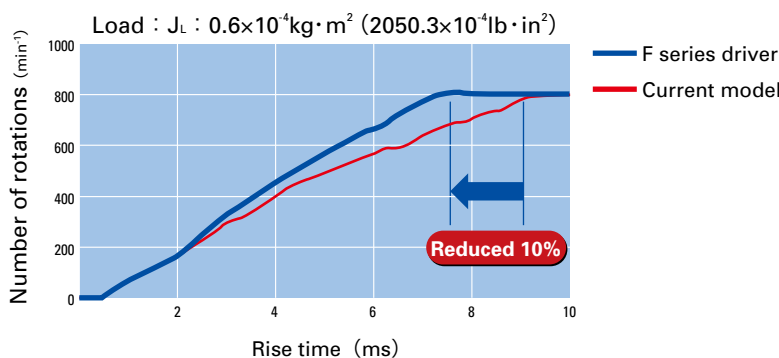

3

Control panel space is reduced

AC input
DC input

Volume is reduced by up to 50% for AC input types and 45% for DC input types compared to current models.

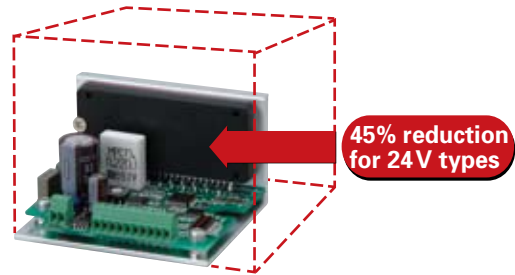
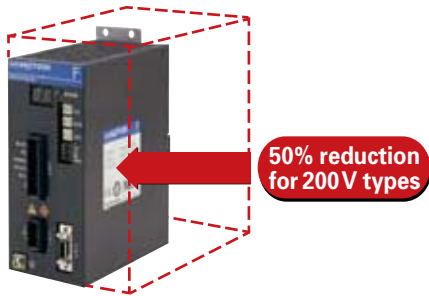

4

Easy maintenance

AC input

2-digit 7-segment LED displays operating status and alarm for easy troubleshooting and faster system recovery.



Test run function (JOG)

AC input

With built-in positioning function

On-board JOG operation function is available for testing motor and amplifier connection without the need to connect to host device.

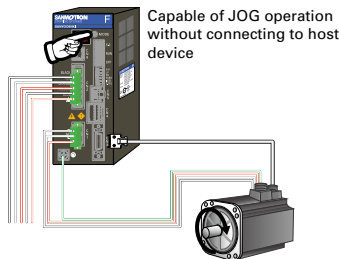

General-purpose I/O input for positioning

AC input

With built-in positioning function

System positioning is easily executed by using general-purpose I/O from an upper-level controller (PLC) to designate preset program numbers.

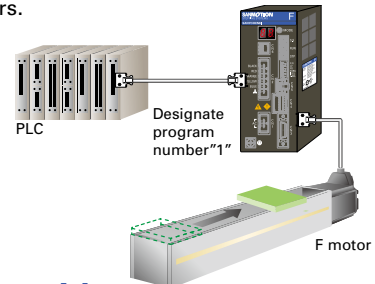

Encoder I/F Control

AC input

With built-in positioning function

Motor stall detection is possible by connecting a motor encoder. 500P/R (1000/2000 multiplier function) line driver method.

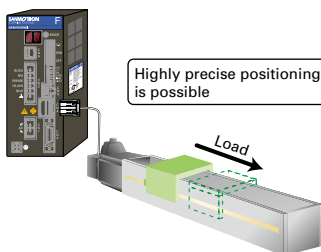

Compliance with international standards

AC input

DC input

The standard specification SANMOTION F series stepping driver complies with UL and EN safety standards. Stepping motors complying with UL and EN standards are available upon request. EMC filters are also available to comply with the EMC directive.



PC-based setup monitor

AC input

With built-in positioning function

Parameter and program settings can be made from the bundled setup software.

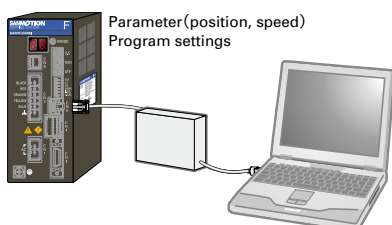

Brake control

AC input

Automatic brake activation timing control is available when using electromagnetic brake motors.

• Internal power source for brake (FP type)

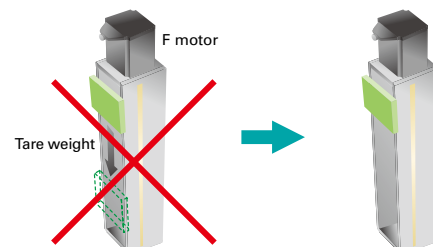

Control method

How do you want to control the equipment ?
 The F series offers the choice of 3 different control methods

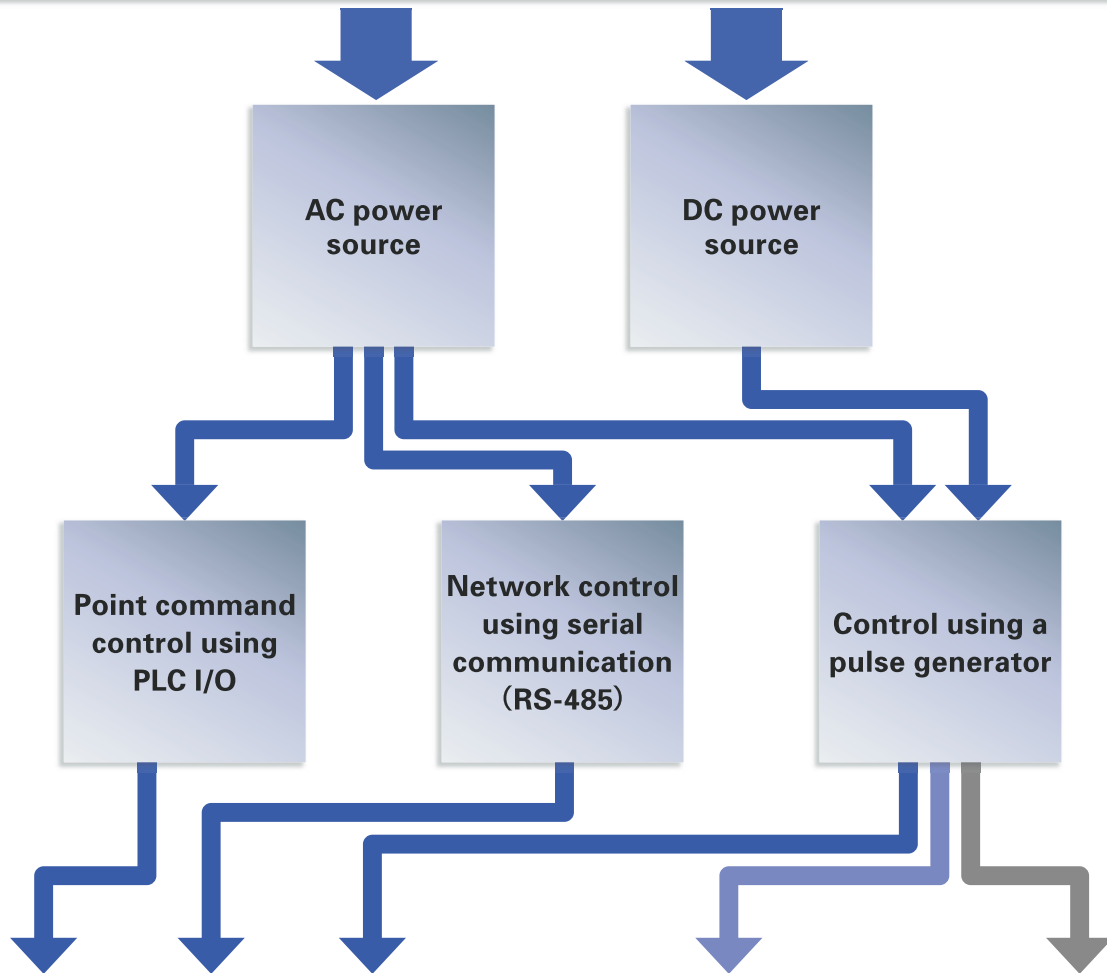

AC input with built-in positioning function



Startup via I/O : Initiate program containing speed, acceleration/deceleration, and travel distance commands stored in the driver via the I/O.	Startup via serial communication: Control by sending data for speed, acceleration/deceleration, and travel distance commands via serial communication.
System configuration diagram	P7
Set part number nomenclature	P9
Motor specifications	P47 to 58
General specifications	P25·26, 60
Motor dimension drawing	P61 to 64
Driver dimension drawing	P65

AC input standard type



Motion is generated by pulse input commands from an upper-level controller.	
System configuration diagram	P5
Set part number nomenclature	P9
Motor specifications	P47 to 58
General specifications	P23·24, 60
Motor dimension drawing	P59 to 62
Driver dimension drawing	P63

DC input



Motion is generated by pulse input commands from an upper-level controller.	
System configuration diagram	P31
Set part number nomenclature	P32
Motor specifications	P47 to 58
General specifications	P43·44, 60
Motor dimension drawing	P59 to 62
Driver dimension drawing	P63

Set model

AC input

Standard model P.11

The standard set includes a F series driver and a F series motor.



Motor flange size
 □28 (1.10inch) □42 (1.65inch) □60 (2.35inch) Ø86 (3.39inch) Ø106 (4.17inch)

CE / UL model P.13

The UL/CE set includes a F Series driver and a M Series motor.



Motor flange size
 □42 (1.65inch) □60 (2.35inch) Ø86 (3.39inch) Ø106 (4.17inch)

Low-backlash gear model P.15

This set includes a low backlash gear that uses tapered hobbled gears to engage the final stage of the speed reduction mechanism.



Motor flange size
 □42 (1.65inch) □60 (2.35inch) Ø86 (3.39inch)

Reduction gear ratios
 1/3.6, 1/7.2, 1/10, 1/20, 1/30, 1/36

Spur gear model P.18

This set utilizes a spur gear in the speed reduction mechanism.



Motor flange size
 □28 (1.10inch)

Reduction gear ratios
 1/3.6, 1/7.2, 1/10, 1/20, 1/30, 1/50

Harmonic gear model P.19

This set utilizes a harmonic gear.



Motor flange size
 □28 (1.10inch) □42 (1.65inch) □60 (2.35inch) Ø86 (3.39inch)

Reduction gear ratios
 1/36, 1/50, 1/100

Electromagnetic brake model P.21

This set utilizes a non-excitation electromagnetic brake to maintain position in vertical load applications and hold load even during power off.



Motor flange size
 □42 (1.65inch) □60 (2.35inch) Ø86 (3.39inch)

DC input

Standard model P.33

The standard set includes a F series driver and a F series motor.



Motor flange size
 □28 (1.10inch) □42 (1.65inch) □60 (2.35inch) Ø86 (3.39inch)

Low-backlash gear model P.35

This set includes a low backlash gear that uses tapered hobbled gears to engage the final stage of the speed reduction mechanism.



Motor flange size
 □42 (1.65inch) □60 (2.35inch) Ø86 (3.39inch)

Reduction gear ratios
 1/3.6, 1/7.2, 1/10, 1/20, 1/30, 1/36

Spur gear model P.38

This set utilizes a spur gear in the speed reduction mechanism.



Motor flange size
 □28 (1.10inch)

Reduction gear ratios
 1/3.6, 1/7.2, 1/10, 1/20, 1/30, 1/50

Harmonic gear model P.39

This set utilizes a harmonic gear.



Motor flange size
 □28 (1.10inch) □42 (1.65inch) □60 (2.35inch) Ø86 (3.39inch)

Reduction gear ratios
 1/30, 1/50, 1/100

Electromagnetic brake model P.41

This set utilizes a non-excitation electromagnetic brake to maintain position in vertical load applications and hold load even during power off.



Motor flange size
 □42 (1.65inch) □60 (2.35inch) Ø86 (3.39inch)

Standard type

Flange side

Spur gear model

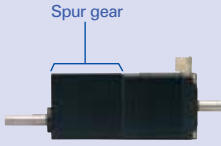

Motor flange size
□28 (□1.10inch)

Low-backlash gear model

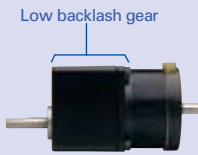

Motor flange size
□42mm (□1.65inch) / □60mm (□2.35inch) / *86mm (*3.39inch)

Harmonic gear model



Motor flange size
□28mm (□1.10inch) / □42mm (□1.65inch) / □60mm (□2.35inch) / *86mm (*3.39inch)



Standard model : F series motor
□28mm (□1.10inch) / □42mm (□1.65inch) / □60mm (□2.35inch) / *86mm (*3.39inch) / *106mm (*4.17inch)

CE / UL model : M series motor
□42mm (□1.65inch) / □60mm (□2.35inch) / *86mm (*3.39inch) / *106mm (*4.17inch)

● Motors are available in standard or vacuum types.

End-cap side

Damper



Magnetic dampers can be selected according to the required inertia.

Electromagnetic brake model

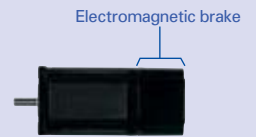

Motor flange size
□42mm (□1.65inch) / □60mm (□2.35inch) / *86mm (*3.39inch)

Brake power source (DC24V)

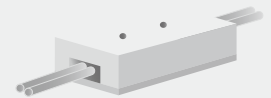

Required for brake-equipped stepping motor models.

Ⓢ Motor cable (optional)

■ Bundled connectors (set models only)

Connector type	Housing	Contact	Applicable motor flange size
① AC power connector	1-178128-2 (AMP)	1-175218-5 (AMP)	—
② Motor connector	1-178128-6 (AMP)	1-175216-5 (AMP)	□28mm (□1.10inch), □42mm (□1.65inch)
	1-178128-6 (AMP)	1-175217-5 (AMP)	□60mm (□2.35inch), *86mm (*3.39inch)
	1-178128-6 (AMP)	1-175218-5 (AMP)	*106mm (*4.17inch)
③ I/O signal connector	10314-52A0-008 (3M)	10114-3000PE (3M)	—

■ Optional cables

Ⓐ AC power cable

L : m (feet)	Part number
10 (32.81)	PM-C03P1000-05
5 (16.40)	PM-C03P0500-05
3 (9.84)	PM-C03P0300-05
1 (3.28)	PM-C03P0100-05

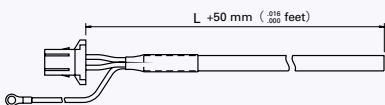

Leadwire	600V vinyl cab tire cable 3-core AWG16(1.25mm ²)
Housing	1-178128-2 (AMP)
Contact	1-175218-5 (AMP)
Round-type crimp contact	1.25M4 (J.S.T. Mfg Co.)

● Cables 10m (32.81 feet) or longer are available upon request.

Ⓑ Motor cable

L : m (feet)	Part number
10 (32.81)	PM-C06M1000-11
5 (16.40)	PM-C06M0500-11
3 (9.84)	PM-C06M0300-11
1 (3.28)	PM-C06M0100-11

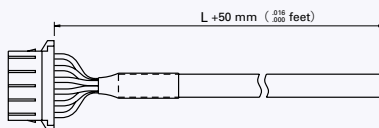

Leadwire	600V vinyl cab tire cable 6-core AWG16(0.75mm ²)
Housing	1-178128-6 (AMP)
Contact	1-175218-5 (AMP)

● Cables 10m (32.81 feet) or longer are available upon request.

Ⓒ I/O signal cable

L : m (feet)	Part number
2 (6.56)	PM-C14S0200-03
1 (3.28)	PM-C14S0100-03

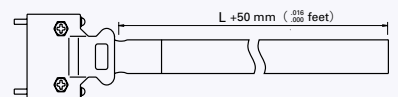

Leadwire	7-pair PVC shielded cable AWG28 (0.08mm ²)
Shell	10314-52A0-008 (3M)
Plug	10114-3000PE (3M)

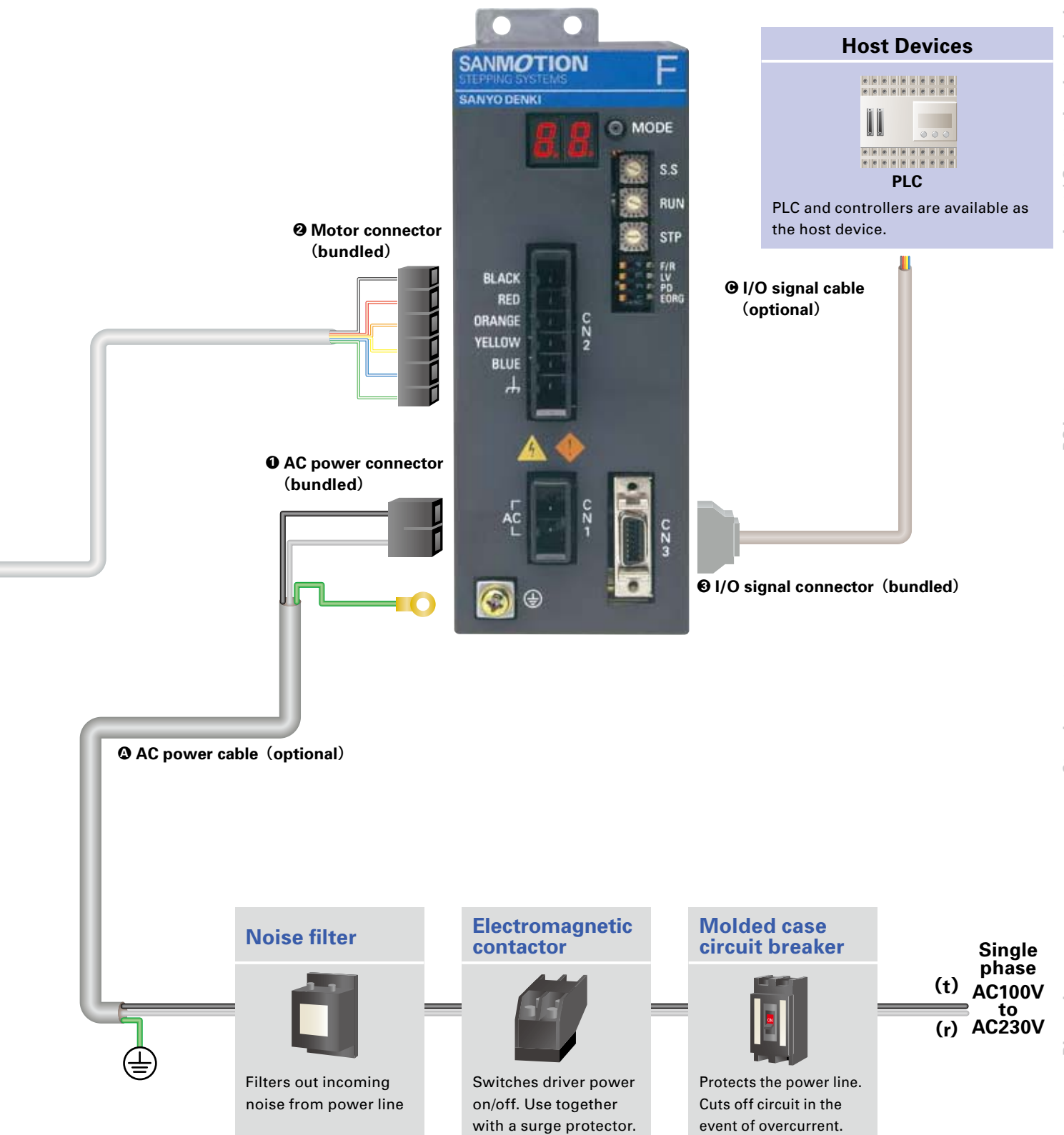

② Motor connector (bundled)

① AC power connector (bundled)

Ⓐ AC power cable (optional)

Ⓞ I/O signal cable (optional)

Ⓢ I/O signal connector (bundled)

Noise filter



Filters out incoming noise from power line

Electromagnetic contactor



Switches driver power on/off. Use together with a surge protector.

Molded case circuit breaker



Protects the power line. Cuts off circuit in the event of overcurrent.

Single phase
(t) AC100V
to
(r) AC230V

With built-in positioning function

Flange side

Spur gear model

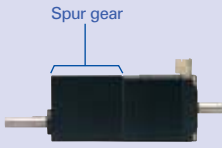

Motor flange size
□28 (□1.10inch)

Low-backlash gear model

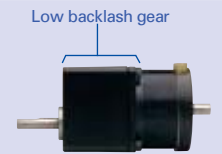

Motor flange size
□42mm (□1.65inch) / □60mm (□2.35inch) / *86mm (*3.39inch)

Harmonic gear model



Motor flange size
□28mm (□1.10inch) / □42mm (□1.65inch) / □60mm (□2.35inch) / *86mm (*3.39inch)

End - cap side

Damper



Magnetic dampers can be selected according to the required inertia.

Electromagnetic brake model

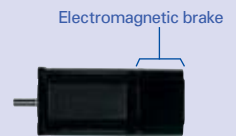

Motor flange size
□42mm (□1.65inch) / □60mm (□2.35inch) / *86mm (*3.39inch)



Standard model : F series motor
□28mm (□1.10inch) / □42mm (□1.65inch) / □60mm (□2.35inch) / *86mm (*3.39inch) / *106mm (*4.17inch)
CE / UL model : M series motor
□42mm (□1.65inch) / □60mm (□2.35inch) / *86mm (*3.39inch) / *106mm (*4.17inch)

● Motors are available in standard or vacuum types.

Ⓞ Option cable for motor

Encoder equipped model

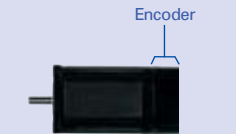

Optional

■ Bundled connectors (set models only)

Connector type	Housing	Contact	Applicable motor flange size
① AC power connector	1-178128-2 (AMP)	1-175218-5 (AMP)	—
	1-178128-6 (AMP)	1-175216-5 (AMP)	□28mm (□1.10inch), □42mm (□1.65inch)
② Motor connector	1-178128-6 (AMP)	1-175217-5 (AMP)	□60mm (□2.35inch), *86mm (*3.39inch)
	1-178128-6 (AMP)	1-175218-5 (AMP)	*106mm (*4.17inch)
③ I/O signal connector	10314-52A0-008 (3M)	10114-3000PE (3M)	—

■ Optional cables

Ⓜ AC power cable

L : m (feet)	Part number
10 (32.81)	PM-C03P1000-05
5 (16.40)	PM-C03P0500-05
3 (9.84)	PM-C03P0300-05
1 (3.28)	PM-C03P0100-05

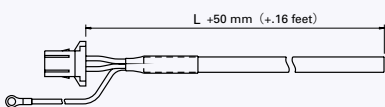

Leadwire	600V vinyl cab tire cable 3-core AWG16(1.25mm ²)
Housing	1-178128-2 (AMP)
Contact	1-175218-5 (AMP)
Round-type crimp tool	1.25M4 (J.S.T.)

● Cables 10 m (32.81 feet) or longer are available upon request.

Ⓞ Motor cable

L : m (feet)	Part number
10 (32.81)	PM-C06M1000-11
5 (16.40)	PM-C06M0500-11
3 (9.84)	PM-C06M0300-11
1 (3.28)	PM-C06M0100-11

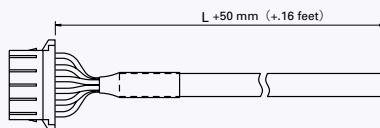

Leadwire	600V vinyl cab tire cable 6-core AWG16(0.75mm ²)
Housing	1-178128-6 (AMP)
Contact	1-175218-5 (AMP)

● Cables 10 m (32.81 feet) or longer are available upon request.

Ⓞ I/O signal cable

L : m (feet)	Part number
2 (6.56)	PM-C20S0200-01
1 (3.28)	PM-C20S0100-01

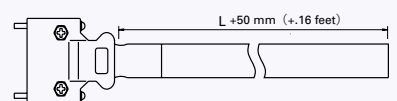

Leadwire	10-pair PVC shielded cable AWG28 (0.08mm ²)
Shell	10320-52A0-008 (3M)
Plug	10120-3000PE (3M)

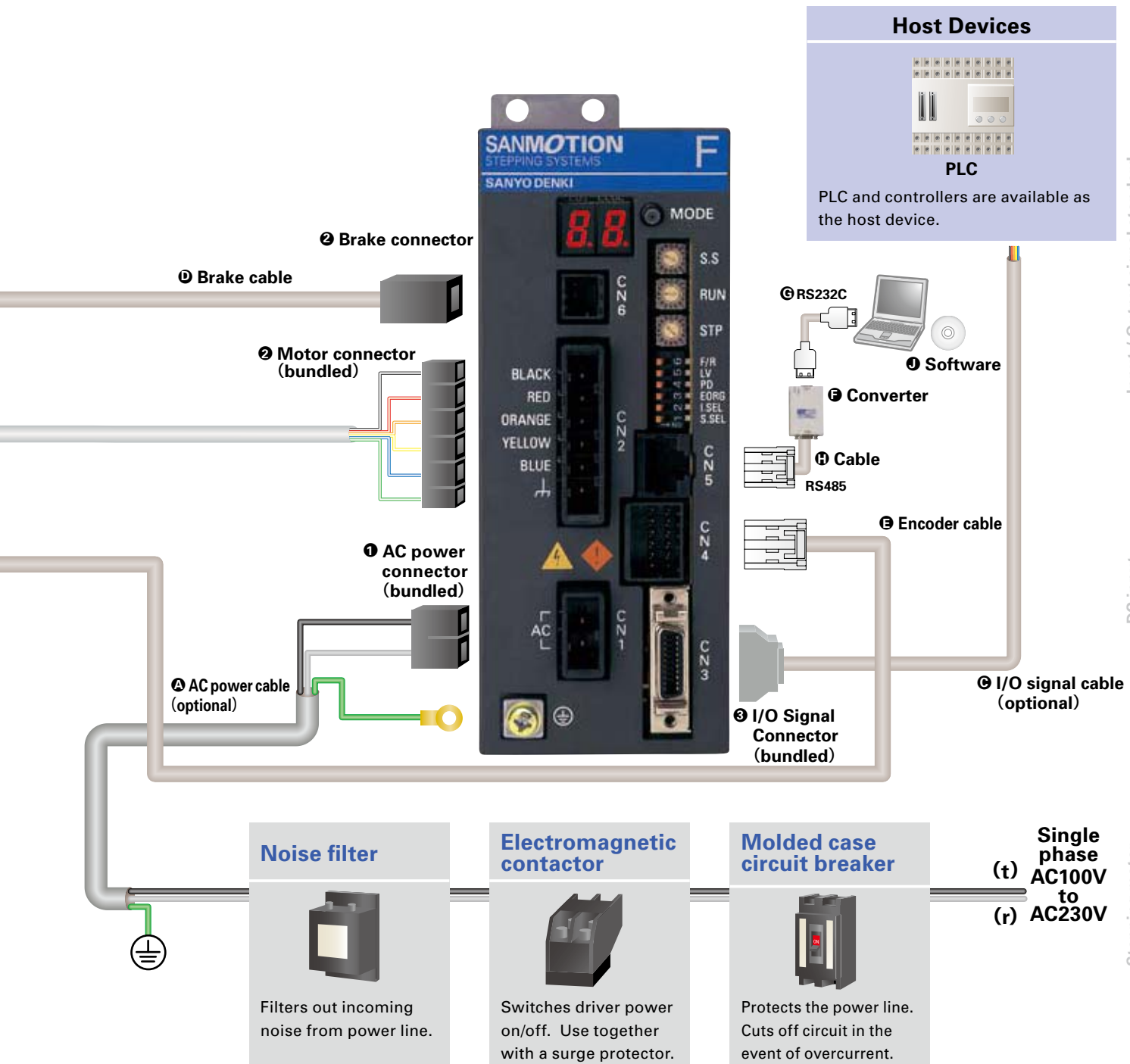

Host Devices

PLC

PLC and controllers are available as the host device.

Noise filter

Filters out incoming noise from power line.

Electromagnetic contactor

Switches driver power on/off. Use together with a surge protector.

Molded case circuit breaker

Protects the power line. Cuts off circuit in the event of overcurrent.

Single phase
AC100V
to
AC230V

② Brake cable

L : m (feet)	Part number
10 (32.81)	PM-C03B1000-01
5 (16.40)	PM-C03B0500-01
3 (9.84)	PM-C03B0300-01
1 (3.28)	PM-C03B0100-01

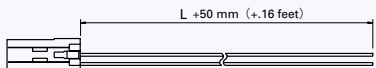

Leadwire	PVC cable AWG22 (0.3mm ²)
Housing	1-1318120-3 (AMP)
Contact	1318107-1 (AMP)

④ Cable for encoder use

L : m (feet)	Part number
10 (32.81)	PM-C12S1000-01
5 (16.40)	PM-C12S0500-01
3 (9.84)	PM-C12S0300-01
1 (3.28)	PM-C12S0100-01

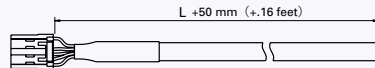

Leadwire	4-pair PVC shielded cable AWG22 (0.3mm ²)
Housing	1-1318118-6 (AMP)
Plug	1318107-1 (AMP)

⑦ Converter [unit : mm (inch)]

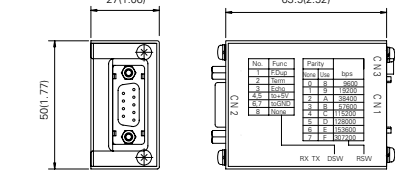

- ⑦ Part number for RS232C-RS485 converter : 232485CFP01-01
- ⑧ RS232 cable is supplied by user.
- ④ Part number for FP communications cable : PM-C08S0100-05
- ① Part number for bundled software : SFP1W-01 (please download from website)

Part number convention

The following part number specifies a system with an F series driver (type code : FS1W075P) and a single shaft F series motor (type code : 103F7851-7041), □60mm (□2.36inch) square flange, and 46.5mm (1.83inch) motor length, equipped with low-backlash gear (reduction ratio of 1/3.6).

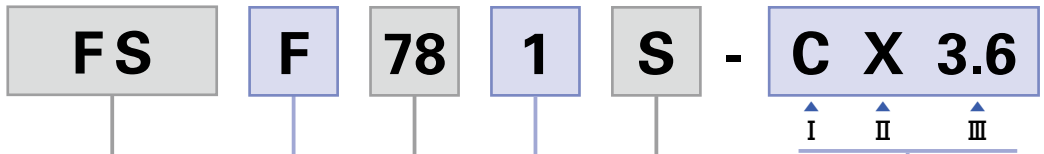

System spec

System type	I (Flange side)	II (End cap side)	III (Reduction ratio)
Spur gear	G	—	—
Low-backlash gear	C	—	—
Harmonic gear	H	—	—
No system at Flange side	X	—	—
Electromagnetic brake	—	B	—
No system at End cap side	—	X	—
Gear ratio	—	—	3.6 to 100



Stepping motor shaft spec
S : Single shaft D : Double shaft

Stepping motor total length

Code	Motor flange size									
	□28mm (□1.10inch)		□42mm (□1.65inch)		□60mm (□2.36inch)		φ86mm (φ3.39inch)		φ106mm (φ4.17inch)	
	Type code	Motor length : mm (inch)	Type code	Motor length : mm (inch)	Type code	Motor length : mm (inch)	Type code	Motor length : mm (inch)	Type code	Motor length : mm (inch)
1	3505	31 (1.22)	5505	34 (1.34)	7851	46.5 (1.83)	8581	62.2 (2.45)		
2			5508	40 (1.57)	7852	55 (2.17)	8582	92.2 (3.63)	89582	163.3 (6.43)
3					7853	87.5 (3.44)	8583	125.9(4.96)	89583	221.3(8.71)
4			5510	49 (1.93)						
6	3515	50.5 (1.99)								

Stepping motor flange size
 35 : □28mm (□1.10inch) 85 : φ86mm (φ3.39inch)
 55 : □42mm (□1.65inch) 89 : φ106mm (φ4.17inch)
 78 : □60mm (□2.36inch)

Stepping motor series name
 F : F series motor
 M : M series motor (CE/UL)

FS : AC Power source Standard type
 FP : AC Power positioning-function-included type

Combination list of 5-phase driver

System type	Motor flange size	Single shaft			Double shaft			
		Set part number		Combination stepping motor type code	Set part number		Combination stepping motor type code	
		S type	P type		S type	P type		
Standard model	□ 28mm (□ 1.10inch)	FSF351S	FPF351S	103F3505-7041	FSF351D	FPF351D	103F3505-7011	
		FSF356S	FPF356S	103F3515-7041	FSF356D	FPF356D	103F3515-7011	
		FSF551S	FPF551S	103F5505-7041	FSF551D	FPF551D	103F5505-7011	
	□ 42mm (□ 1.65inch)	FSF552S	FPF552S	103F5508-7041	FSF552D	FPF552D	103F5508-7011	
		FSF554S	FPF554S	103F5510-7041	FSF554D	FPF554D	103F5510-7011	
		FSF781S	FPF781S	103F7851-7041	FSF781D	FPF781D	103F7851-7011	
	□ 60mm (□ 2.36inch)	FSF782S	FPF782S	103F7852-7041	FSF782D	FPF782D	103F7852-7011	
		FSF783S	FPF783S	103F7853-7041	FSF783D	FPF783D	103F7853-7011	
		FSF851S	FPF851S	103F8581-7041	FSF851D	FPF851D	103F8581-7011	
	φ 86mm (φ 3.39inch)	FSF852S	FPF852S	103F8582-7041	FSF852D	FPF852D	103F8582-7011	
		FSF853S	FPF853S	103F8583-7041	FSF853D	FPF853D	103F8583-7011	
		FSF892S	FPF892S	103F89582-7041	FSF892D	FPF892D	103F89582-7011	
	φ 106mm (φ 4.17inch)	FSF893S	FPF893S	103F89583-7041	FSF893D	FPF893D	103F89583-7011	
	Low-backlash gear model	□ 42mm (□ 1.65inch)	FSF551S-CX3.6	FPF551S-CX3.6	103F5505-70CXA4	FSF551D-CX3.6	FPF551D-CX3.6	103F5505-70CXA1
			FSF551S-CX7.2	FPF551S-CX7.2	103F5505-70CXB4	FSF551D-CX7.2	FPF551D-CX7.2	103F5505-70CXB1
			FSF551S-CX10	FPF551S-CX10	103F5505-70CXE4	FSF551D-CX10	FPF551D-CX10	103F5505-70CXE1
FSF551S-CX20			FPF551S-CX20	103F5505-70CXG4	FSF551D-CX20	FPF551D-CX20	103F5505-70CXG1	
FSF551S-CX30			FPF551S-CX30	103F5505-70CXJ4	FSF551D-CX30	FPF551D-CX30	103F5505-70CXJ1	
FSF551S-CX36			FPF551S-CX36	103F5505-70CXX4	FSF551D-CX36	FPF551D-CX36	103F5505-70CXX1	
□ 60mm (□ 2.36inch)		FSF781S-CX3.6	FPF781S-CX3.6	103F7851-70CXA4	FSF781D-CX3.6	FPF781D-CX3.6	103F7851-70CXA1	
		FSF781S-CX7.2	FPF781S-CX7.2	103F7851-70CXB4	FSF781D-CX7.2	FPF781D-CX7.2	103F7851-70CXB1	
		FSF781S-CX10	FPF781S-CX10	103F7851-70CXE4	FSF781D-CX10	FPF781D-CX10	103F7851-70CXE1	
		FSF781S-CX20	FPF781S-CX20	103F7851-70CXG4	FSF781D-CX20	FPF781D-CX20	103F7851-70CXG1	
		FSF781S-CX30	FPF781S-CX30	103F7851-70CXJ4	FSF781D-CX30	FPF781D-CX30	103F7851-70CXJ1	
		FSF781S-CX36	FPF781S-CX36	103F7851-70CXX4	FSF781D-CX36	FPF781D-CX36	103F7851-70CXX1	
φ 86mm (φ 3.39inch)		FSF851S-CX3.6	FPF851S-CX3.6	103F8581-70CXA4	FSF851D-CX3.6	FPF851D-CX3.6	103F8581-70CXA1	
		FSF851S-CX7.2	FPF851S-CX7.2	103F8581-70CXB4	FSF851D-CX7.2	FPF851D-CX7.2	103F8581-70CXB1	
		FSF851S-CX10	FPF851S-CX10	103F8581-70CXE4	FSF851D-CX10	FPF851D-CX10	103F8581-70CXE1	
		FSF851S-CX20	FPF851S-CX20	103F8581-70CXG4	FSF851D-CX20	FPF851D-CX20	103F8581-70CXG1	
		FSF851S-CX30	FPF851S-CX30	103F8581-70CXJ4	FSF851D-CX30	FPF851D-CX30	103F8581-70CXJ1	
		FSF851S-CX36	FPF851S-CX36	103F8581-70CXX4	FSF851D-CX36	FPF851D-CX36	103F8581-70CXX1	
Spur gear model		□ 28mm (□ 1.10inch)	FSF351S-GX3.6	FPF351S-GX3.6	103F3505-70GXA4	FSF351D-GX3.6	FPF351D-GX3.6	103F3505-70GXA1
			FSF351S-GX7.2	FPF351S-GX7.2	103F3505-70GXB4	FSF351D-GX7.2	FPF351D-GX7.2	103F3505-70GXB1
			FSF351S-GX10	FPF351S-GX10	103F3505-70GXE4	FSF351D-GX10	FPF351D-GX10	103F3505-70GXE1
			FSF351S-GX20	FPF351S-GX20	103F3505-70GXG4	FSF351D-GX20	FPF351D-GX20	103F3505-70GXG1
			FSF351S-GX30	FPF351S-GX30	103F3505-70GXJ4	FSF351D-GX30	FPF351D-GX30	103F3505-70GXJ1
		FSF351S-GX50	FPF351S-GX50	103F3505-70GXL4	FSF351D-GX50	FPF351D-GX50	103F3505-70GXL1	
	□ 42mm (□ 1.65inch)	FSF551S-HX50	FPF551S-HX50	103F5505-70HXL4	FSF551D-HX50	FPF551D-HX50	103F5505-70HXL1	
		FSF551S-HX100	FPF551S-HX100	103F5505-70HXM4	FSF551D-HX100	FPF551D-HX100	103F5505-70HXM1	
		FSF551S-HX30	FPF551S-HX30	103F5505-70HXJ5	FSF551D-HX30	FPF551D-HX30	103F5505-70HXJ2	
		FSF551S-HX50	FPF551S-HX50	103F5505-70HXL5	FSF551D-HX50	FPF551D-HX50	103F5505-70HXL2	
FSF551S-HX100		FPF551S-HX100	103F5505-70HXM5	FSF551D-HX100	FPF551D-HX100	103F5505-70HXM2		
□ 60mm (□ 2.36inch)	FSF781S-HX50	FPF781S-HX50	103F7851-70HXL4	FSF781D-HX50	FPF781D-HX50	103F7851-70HXL1		
	FSF781S-HX100	FPF781S-HX100	103F7851-70HXM4	FSF781D-HX100	FPF781D-HX100	103F7851-70HXM1		
φ 86mm (φ 3.39inch)	FSF851S-HX50	FPF851S-HX50	103F8581-70HXL4	FSF851D-HX50	FPF851D-HX50	103F8581-70HXL1		
	FSF851S-HX100	FPF851S-HX100	103F8581-70HXM4	FSF851D-HX100	FPF851D-HX100	103F8581-70HXM1		
Electromagnetic brake model	□ 42mm (□ 1.65inch)	FSF551S-XB	FPF551S-XB	103F5505-70XB41	-	-	-	
		FSF552S-XB	FPF552S-XB	103F5508-70XB41	-	-	-	
		FSF554S-XB	FPF554S-XB	103F5510-70XB41	-	-	-	
	□ 60mm (□ 2.36inch)	FSF781S-XB	FPF781S-XB	103F7851-70XB41	-	-	-	
		FSF782S-XB	FPF782S-XB	103F7852-70XB41	-	-	-	
		FSF783S-XB	FPF783S-XB	103F7853-70XB41	-	-	-	
	φ 86mm (φ 3.39inch)	FSF851S-XB	FPF851S-XB	103F8581-70XB41	-	-	-	
		FSF852S-XB	FPF852S-XB	103F8582-70XB41	-	-	-	
		FSF853S-XB	FPF853S-XB	103F8583-70XB41	-	-	-	
CE/UL model	□ 42mm	FSM551S	FPM551S	103M5505-7041	FSM551D	FPM551D	103M5505-7011	
		FSM552S	FPM552S	103M5508-7041	FSM552D	FPM552D	103M5508-7011	
		FSM554S	FPM554S	103M5510-7041	FSM554D	FPM554D	103M5510-7011	
	□ 60mm	FSM781S	FPM781S	103M7851-7041	FSM781D	FPM781D	103M7851-7011	
		FSM782S	FPM782S	103M7852-7041	FSM782D	FPM782D	103M7852-7011	
		FSM783S	FPM783S	103M7853-7041	FSM783D	FPM783D	103M7853-7011	
	φ 86mm	FSM851S	FPM851S	103M8581-7041	FSM851D	FPM851D	103M8581-7011	
		FSM852S	FPM852S	103M8582-7041	FSM852D	FPM852D	103M8582-7011	
		FSM853S	FPM853S	103M8583-7041	FSM853D	FPM853D	103M8583-7011	
	φ 106mm	FSM892S	FPM892S	103M89582-7041	FSM892D	FPM892D	103M89582-7011	
		FSM893S	FPM893S	103M89583-7041	FSM893D	FPM893D	103M89583-7011	

AC input

Input / Output signal standard

DC input

Stepping motor

Dimensions

Standard model

F series driver + F series motor

Motor flange size



Size	Motor flange size	28mm (1.10inch)			
		31mm (1.22inch)		50.5mm (1.99inch)	
Set part number	Single shaft	FSF351S	FPF351S	FSF356S	FPF356S
	Double shaft	FSF351D	FPF351D	FSF356D	FPF356D
Holding torque	N·m(oz·in)	0.036 (5.10)		0.065 (9.20)	
Rotor inertia	$\times 10^{-4}$ kg·m ² (oz·in ²)	0.009 (0.05)		0.016 (0.09)	
Mass (Weight)	kg (lbs)	0.11 (0.22)		0.2 (0.44)	
Allowable thrust load	N (lbs)	3 (0.68)		3 (0.68)	
Allowable radial load ^(Note1)	N (lbs)	34 (7.65)		34 (7.65)	

(Note1) When load is applied at 1/3 length from output shaft edge.



AC100V

AC200V

Operating current:
0.75A/phase

- Pull-out torque
- - - Source current (load applied)
- · · Source current (no load)
- 1-division fs
- 2-division fs
- Fs: Maximum self-start frequency when not loaded
- 1-division
- 2-division

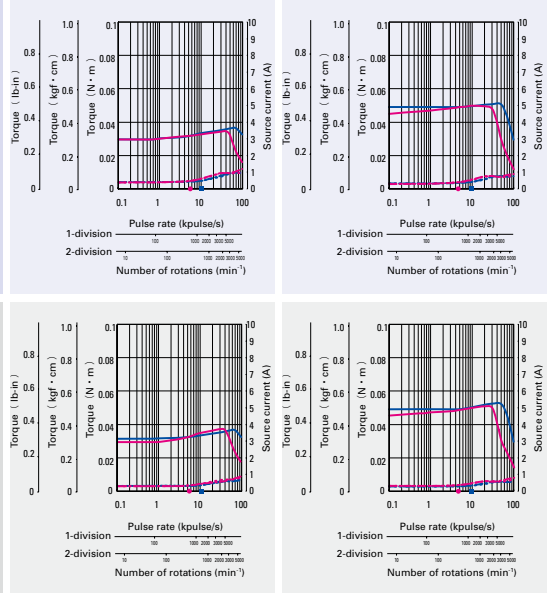

The data are measured under the drive condition of our company. The drive torque may very depending on the accuracy of customer-side equipment.

Size	Motor flange size	60mm (2.36inch)		86mm (3.39inch)		92.2mm (3.63inch)		125.85mm (4.95inch)	
		87.5mm (3.45inch)		62.15mm (2.47inch)		92.2mm (3.63inch)		125.85mm (4.95inch)	
Set part number	Single shaft	FSF783S	FPF783S	FSF851S	FPF851S	FSF852S	FPF852S	FSF853S	FPF853S
	Double shaft	FSF783D	FPF783D	FSF851D	FPF851D	FSF852D	FPF852D	FSF853D	FPF853D
Holding torque	N·m(oz·in)	1.79 (253.5)		2.06 (291.7)		4.02 (569.3)		6.17 (873.7)	
Rotor inertia	$\times 10^{-4}$ kg·m ² (oz·in ²)	0.84 (4.60)		1.45 (7.93)		2.9 (15.86)		4.4 (24.06)	
Mass (Weight)	kg (lbs)	1.36 (3.0)		1.5 (3.3)		2.5 (5.5)		3.5 (7.7)	
Allowable thrust load	N (lbs)	20 (4.5)		60 (13.5)		60 (13.5)		60 (13.5)	
Allowable radial load ^(Note1)	N (lbs)	80 (18)		220 (49.5)		220 (49.5)		220 (49.5)	

(Note1) When load is applied at 1/3 length from output shaft edge.

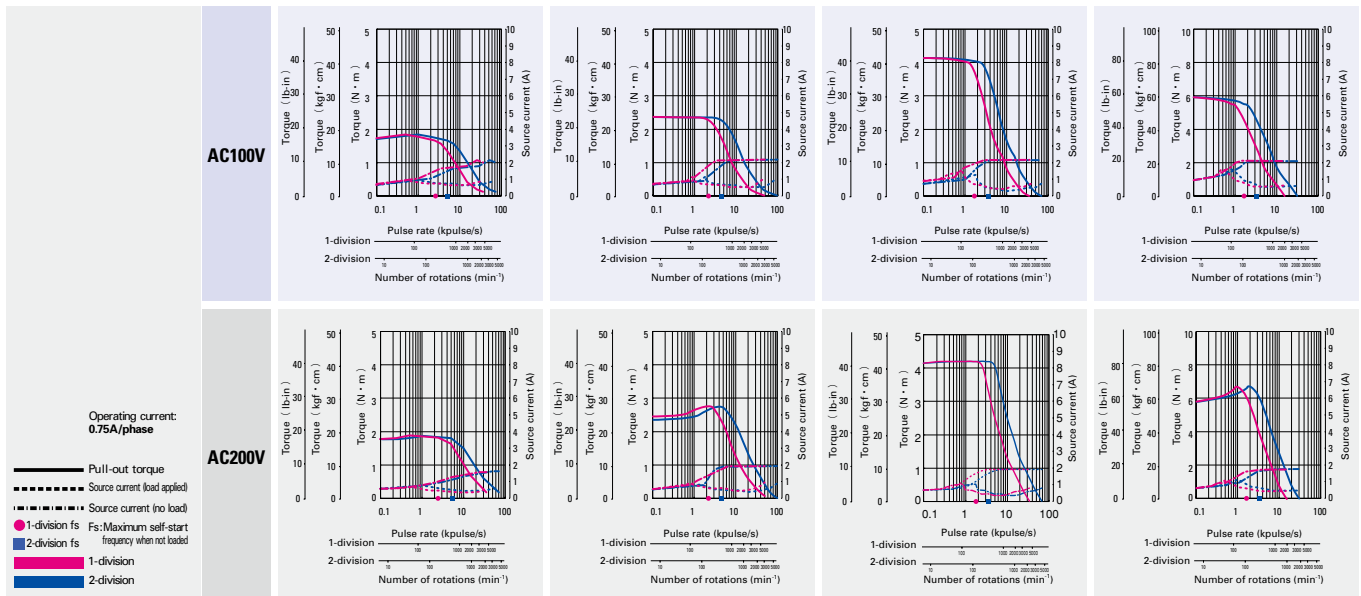

Operating current:
0.75A/phase

- Pull-out torque
- - - Source current (load applied)
- · · Source current (no load)
- 1-division fs
- 2-division fs
- Fs: Maximum self-start frequency when not loaded
- 1-division
- 2-division

The data are measured under the drive condition of our company. The drive torque may very depending on the accuracy of customer-side equipment.

□ 42mm (□ 1.65inch)

□ 60mm (□ 2.36inch)

34mm (1.34inch)		40mm (1.57inch)		49mm (1.93inch)		46.5mm (1.83inch)		55mm (2.17inch)	
FSF551S	FPF551S	FSF552S	FPF552S	FSF554S	FPF554S	FSF781S	FPF781S	FSF782S	FPF782S
FSF551D	FPF551D	FSF552D	FPF552D	FSF554D	FPF554D	FSF781D	FPF781D	FSF782D	FPF782D
0.13 (18.41)		0.18 (25.49)		0.26 (36.82)		0.6 (85.0)		0.93 (131.7)	
0.03 (0.16)		0.053 (0.29)		0.065 (0.36)		0.275 (1.50)		0.4 (2.19)	
0.23 (0.50)		0.28 (0.62)		0.37 (0.81)		0.6 (1.32)		0.78 (1.72)	
10 (2.25)		10 (2.25)		10 (2.25)		20 (4.5)		20 (4.5)	
35 (8.75)		35 (8.75)		35 (8.75)		80 (18)		80 (18)	

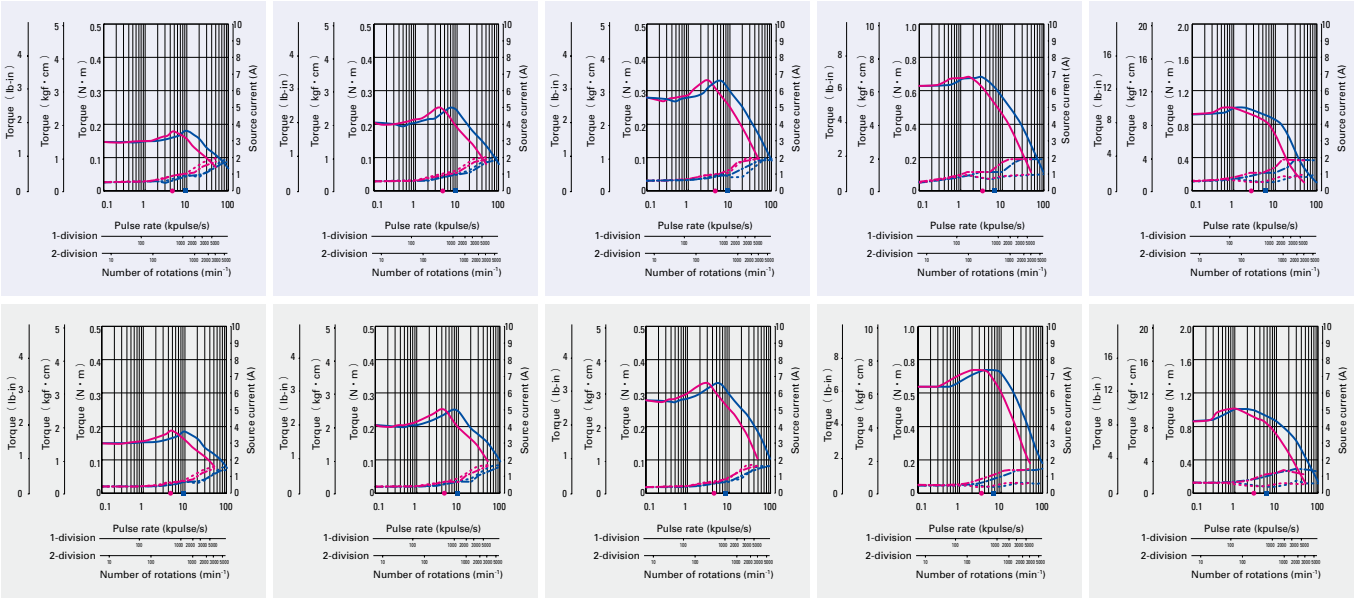

φ 106mm (φ 4.17inch)

163.3mm (6.43inch)		221.3mm (8.71inch)	
FSF892S	FPF892S	FSF893S	FPF893S
FSF892D	FPF892D	FSF893D	FPF893D
10.8 (1529.4)		16 (2265.7)	
14.6 (79.83)		22 (120.28)	
7.5 (16.5)		10.5 (23.1)	
100 (22.5)		100 (22.5)	
360 (81)		360 (81)	

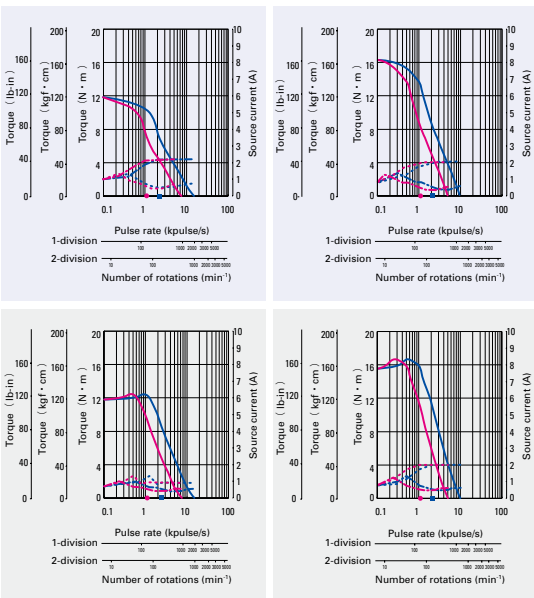

CE / UL model

F series driver + M series motor

Motor flange size



Size	Motor flange size	42mm (1.65inch)			
		31mm (1.22inch)		50.5mm (1.99inch)	
Set part number	Single shaft	F5M51S	F5M51S	F5M52S	F5M52S
	Double shaft	F5M51D	F5M51D	F5M52D	F5M52D
Holding torque	N·m(oz·in)	0.13 (18.41)		0.18 (25.49)	
Rotor inertia	$\times 10^{-4}$ kg·m ² (oz·in ²)	0.03 (0.16)		0.053 (0.29)	
Mass (Weight)	kg (lbs)	0.23 (0.51)		0.28 (0.62)	
Allowable thrust load	N (lbs)	10 (2.25)		10 (2.25)	
Allowable radial load (Note1)	N (lbs)	35 (8.75)		35 (8.75)	

(Note1) When load is applied at 1/3 length from output shaft edge.



AC100V

AC200V

Operating current:
0.75A/phase

- Pull-out torque
- Source current (load applied)
- Source current (no load)
- 1-division fs
- 2-division fs
- Fs: Maximum self-start frequency when not loaded
- 1-division
- 2-division

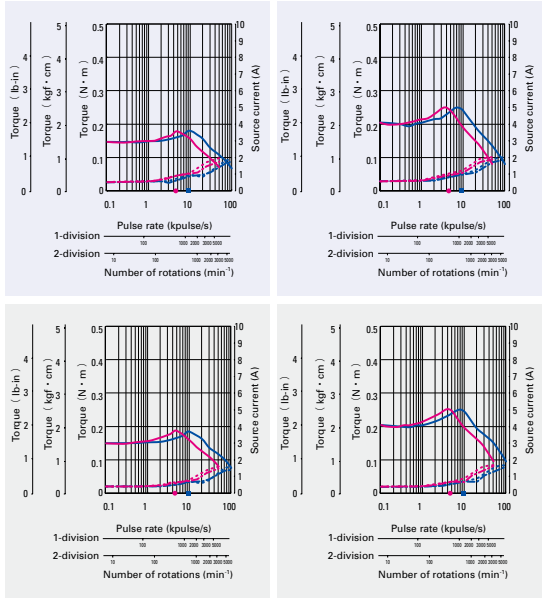

The data are measured under the drive condition of our company. The drive torque may very depending on the accuracy of customer-side equipment.

Size	Motor flange size	86mm (3.39inch)				106mm (4.17inch)			
		92.2mm (3.63inch)		125.85mm (4.95inch)		163.3mm (6.43inch)		221.3mm (8.71inch)	
Set part number	Single shaft	F5M852S	F5M852S	F5M853S	F5M853S	F5M892S	F5M892S	F5M893S	F5M893S
	Double shaft	F5M852D	F5M852D	F5M853D	F5M853D	F5M892D	F5M892D	F5M893D	F5M893D
Holding torque	N·m(oz·in)	4.02 (569.3)		6.17 (873.7)		10.8 (1529.4)		16 (2265.7)	
Rotor inertia	$\times 10^{-4}$ kg·m ² (oz·in ²)	2.9 (15.86)		4.4 (24.06)		14.6 (79.83)		22 (120.28)	
Mass (Weight)	kg (lbs)	2.5 (5.5)		3.5 (7.7)		7.5 (16.5)		10.5 (23.1)	
Allowable thrust load	N (lbs)	60 (13.5)		60 (13.5)		100 (22.5)		100 (22.5)	
Allowable radial load (Note1)	N (lbs)	220 (49.5)		220 (49.5)		360 (81)		360 (81)	

(Note1) When load is applied at 1/3 length from output shaft edge.

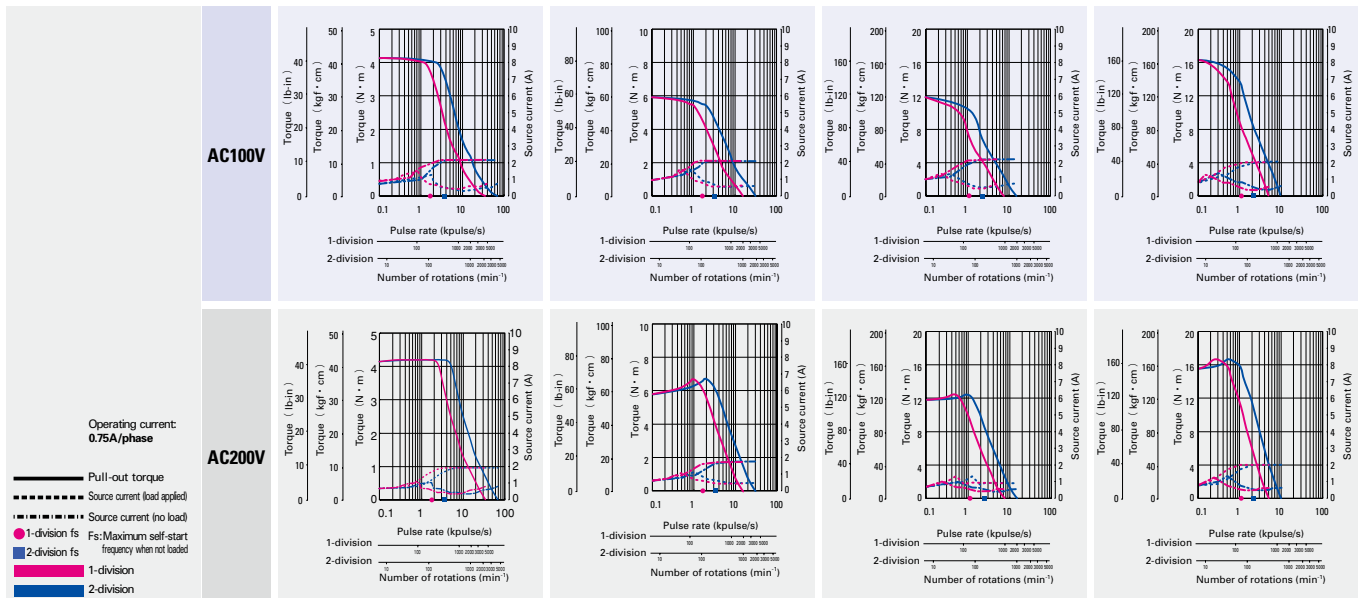

Operating current:
0.75A/phase

- Pull-out torque
- Source current (load applied)
- Source current (no load)
- 1-division fs
- 2-division fs
- Fs: Maximum self-start frequency when not loaded
- 1-division
- 2-division

The data are measured under the drive condition of our company. The drive torque may very depending on the accuracy of customer-side equipment.

□ 42mm (□ 1.65inch)		□ 60mm (□ 2.36inch)				φ 86mm (φ 3.39inch)			
49mm (1.93inch)		46.5mm (1.83inch)		55mm (2.17inch)		87.5mm (3.44inch)		62.15mm (2.47inch)	
FSM554S	FPM554S	FSM781S	FPM781S	FSM782S	FPM782S	FSM783S	FPM783S	FSM851S	FPM851S
FSM554D	FPM554D	FSM781D	FPM781D	FSM782D	FPM782D	FSM783D	FPM783D	FSM851D	FPM851D
0.26 (36.82)		0.6 (85.0)		0.065 (9.20)		1.79 (253.5)		2.06 (291.7)	
0.065 (0.36)		0.275 (1.50)		0.016 (0.09)		0.84 (4.59)		1.45 (7.93)	
0.37 (0.81)		0.6 (1.32)		0.2 (0.44)		1.36 (3.0)		1.5 (3.3)	
10 (2.25)		20 (4.5)		3 (0.68)		20 (4.5)		60 (13.5)	
35 (8.75)		80 (18)		34 (7.65)		80 (18)		220 (49.5)	

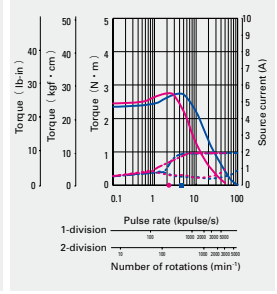
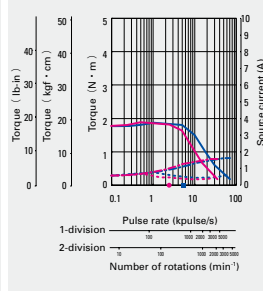
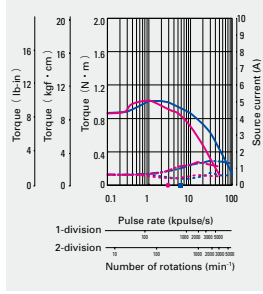
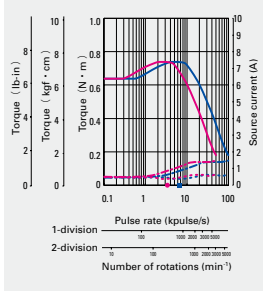
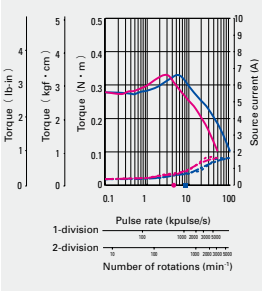
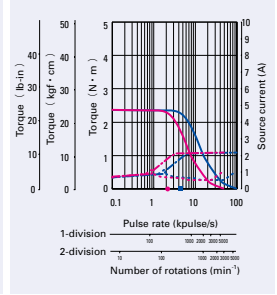
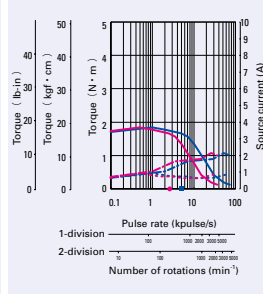
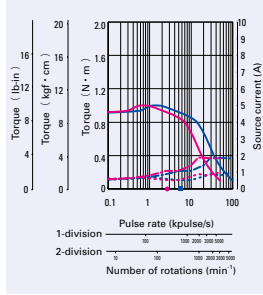
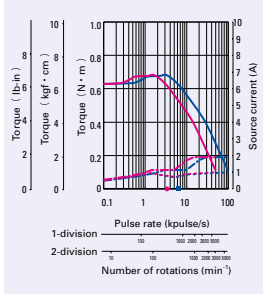
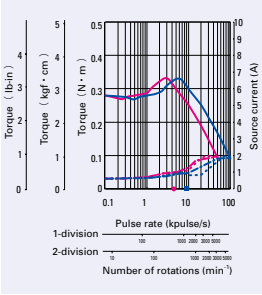

Low-backlash gear model

F series driver +
F series motor with low-backlash gear

Motor flange size



Size	Motor flange size	42mm (1.65inch)			
		64.5mm (2.54inch)		64.5mm (2.54inch)	
Set part number	Single shaft	FSF551S-CX3.6	FPF551S-CX3.6	FSF551S-CX7.2	FPF551S-CX7.2
	Double shaft	FSF551D-CX3.6	FPF551D-CX3.6	FSF551D-CX7.2	FPF551D-CX7.2
Allowable torque	N·m(oz·in)	0.35 (44.6)		0.7 (99.1)	
Rotor inertia	$\times 10^{-4}$ kg·m ² (oz·in ²)	0.03 (0.16)		0.03 (0.16)	
Basic step angle		0.2		0.1	
Gear ratio		1 : 3.6		1 : 7.2	
Backlash	DEG	0.6		0.4	
Allowable speed	min ⁻¹	500		250	
Mass (Weight)	kg (lbs)	0.36 (0.79)		0.36 (0.79)	
Allowable thrust load	N (lbs)	15 (3.38)		15 (3.38)	
Allowable radial load (Note 1)	N (lbs)	20 (4.5)		20 (4.5)	

Directions of motor rotation and gear output shaft are the same for models with reduction ratio 1 : 3.6, 1 : 7.2, and 1 : 10 opposite for reduction ratio 1 : 20, 1 : 30, and 1 : 36.

(Note1) When load is applied at 1/3 length from output shaft edge.



AC100V

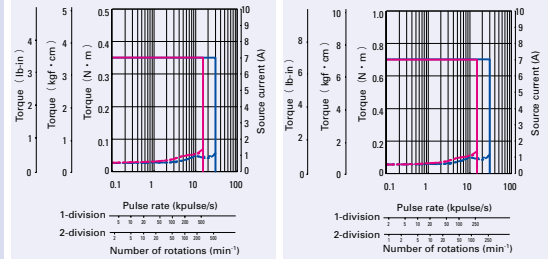

AC200V

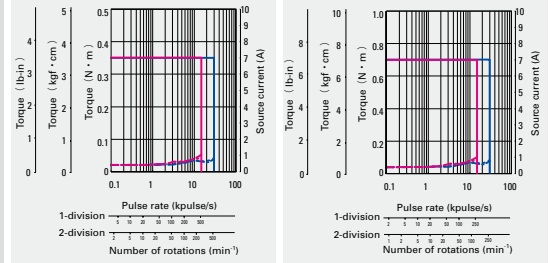

Operating current:
0.75A/phase

— Allowable torque
- - - Source current (load applied)
- · - · - Source current (no load)

— 1-division
— 2-division

The data are measured under the drive condition of our company. The drive torque may very depending on the accuracy of customer-side equipment.

Size	Motor flange size	60mm (2.36inch)							
		92mm (3.62inch)		92mm (3.62inch)		92mm (3.62inch)		92mm (3.62inch)	
Set part number	Single shaft	FSF781S-CX7.2	FPF781S-CX7.2	FSF781S-CX10	FPF781S-CX10	FSF781S-CX20	FPF781S-CX20	FSF781S-CX30	FPF781S-CX30
	Double shaft	FSF781D-CX7.2	FPF781D-CX7.2	FSF781D-CX10	FPF781D-CX10	FSF781D-CX20	FPF781D-CX20	FSF781D-CX30	FPF781D-CX30
Allowable torque	N·m(oz·in)	2.5 (354.0)		3 (424.8)		3.5 (495.6)		4 (566.4)	
Rotor inertia	$\times 10^{-4}$ kg·m ² (oz·in ²)	0.275 (1.5)		0.275 (1.5)		0.275 (1.5)		0.275 (1.5)	
Basic step angle		0.1		0.072		0.036		0.024	
Gear ratio		1 : 7.2		1 : 10		1 : 20		1 : 30	
Backlash	DEG	0.25		0.25		0.17		0.17	
Allowable speed	min ⁻¹	250		180		90		60	
Mass (Weight)	kg (lbs)	0.97 (2.13)		0.97 (2.13)		0.97 (2.13)		0.97 (2.13)	
Allowable thrust load	N (lbs)	30 (6.75)		30 (6.75)		30 (6.75)		30 (6.75)	
Allowable radial load (Note 1)	N (lbs)	100 (22.5)		100 (22.5)		100 (22.5)		100 (22.5)	

Directions of motor rotation and gear output shaft are the same for models with reduction ratio 1 : 3.6 and 1:7.2, opposite for reduction ratio 1 : 10, 1 : 20 and 1 : 30.

(Note1) When load is applied at 1/3 length from output shaft edge.

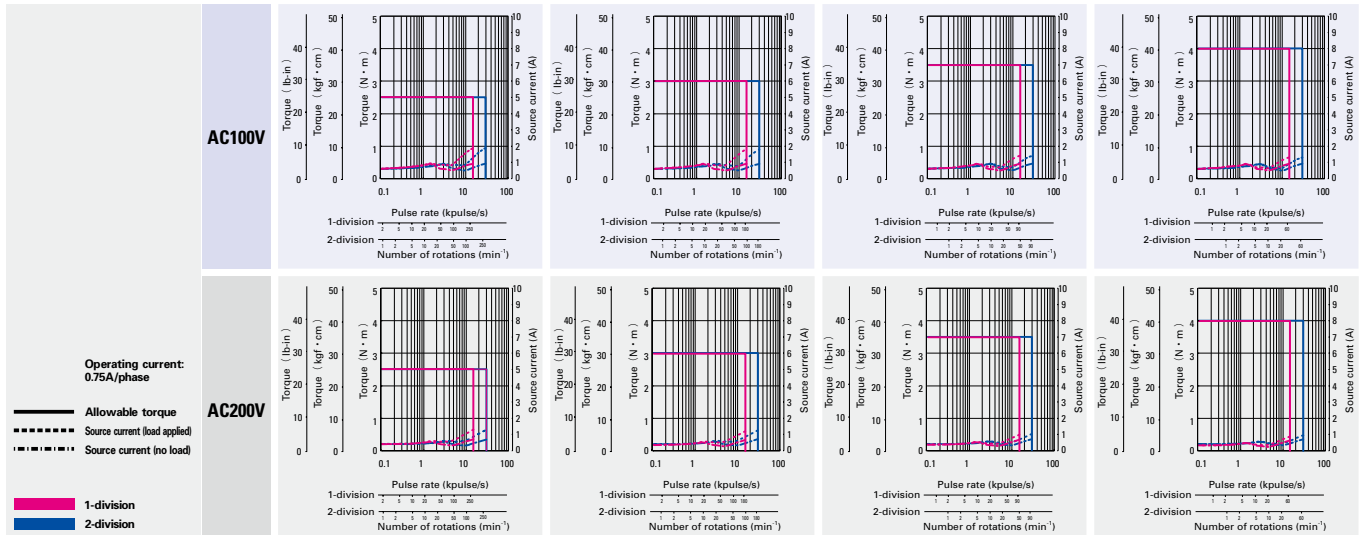

The data are measured under the drive condition of our company. The drive torque may very depending on the accuracy of customer-side equipment.

□ 42mm (□ 1.65inch)

□ 60mm (□ 2.36inch)

64.5mm (2.54inch)		64.5mm (2.54inch)		64.5mm (2.54inch)		64.5mm (2.54inch)		92mm (3.62inch)	
FSF551S-CX10	FPF551S-CX10	FSF551S-CX20	FPF551S-CX20	FSF551S-CX30	FPF551S-CX30	FSF551S-CX36	FPF551S-CX36	FSF781S-CX3.6	FPF781S-CX3.6
FSF551D-CX10	FPF551D-CX10	FSF551D-CX20	FPF551D-CX20	FSF551D-CX30	FPF551D-CX30	FSF551D-CX36	FPF551D-CX36	FSF781D-CX3.6	FPF781D-CX3.6
1 (141.6)		1.5 (212.4)		1.5 (212.4)		1.5 (212.4)		1.25 (177.0)	
0.03 (0.16)		0.03 (0.16)		0.03 (0.16)		0.03 (0.16)		0.275 (1.5)	
0.072		0.036		0.024		0.02		0.2	
1 : 10		1 : 20		1 : 30		1 : 36		1 : 3.6	
0.35		0.25		0.25		0.25		0.55	
180		90		60		50		500	
0.36 (0.79)		0.36 (0.79)		0.36 (0.79)		0.36 (0.79)		0.97 (2.13)	
15 (3.38)		15 (3.38)		15 (3.38)		15 (3.38)		30 (6.75)	
20 (4.5)		20 (4.5)		20 (4.5)		20 (4.5)		100 (22.5)	

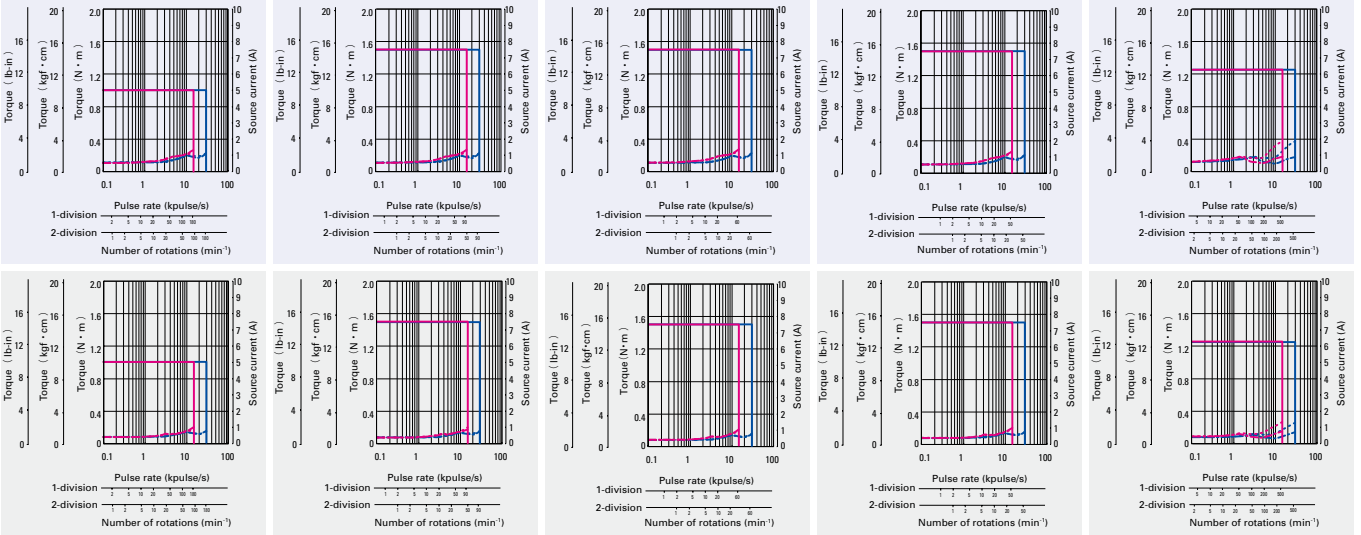

□ 60mm (□ 2.36inch)

φ 86mm (φ 3.39inch)

92mm (3.62inch)		127.3mm (5.01inch)		127.3mm (5.01inch)		127.3mm (5.01inch)		127.3mm (5.01inch)	
FSF781S-CX36	FPF781S-CX36	FSF851S-CX3.6	FPF851S-CX3.6	FSF851S-CX7.2	FPF851S-CX7.2	FSF851S-CX10	FPF851S-CX10	FSF851S-CX20	FPF851S-CX20
FSF781D-CX36	FPF781D-CX36	FSF851D-CX3.6	FPF851D-CX3.6	FSF851D-CX7.2	FPF851D-CX7.2	FSF851D-CX10	FPF851D-CX10	FSF851D-CX20	FPF851D-CX20
4 (566.4)		4.5 (637.2)		9 (1274.5)		9 (1274.5)		12 (1699.3)	
0.275 (1.5)		1.45 (7.93)		1.45 (7.93)		1.45 (7.93)		1.45 (7.93)	
0.02		0.2		0.1		0.072		0.036	
1 : 36		1 : 3.6		1 : 7.2		1 : 10		1 : 20	
0.17		0.4		0.25		0.25		0.17	
50		500		250		180		90	
0.97 (2.13)		2.7 (5.94)		2.7 (5.94)		2.7 (5.94)		2.7 (5.94)	
30 (6.75)		30 (6.75)		30 (6.75)		30 (6.75)		30 (6.75)	
100 (22.5)		100 (22.5)		100 (22.5)		100 (22.5)		100 (22.5)	

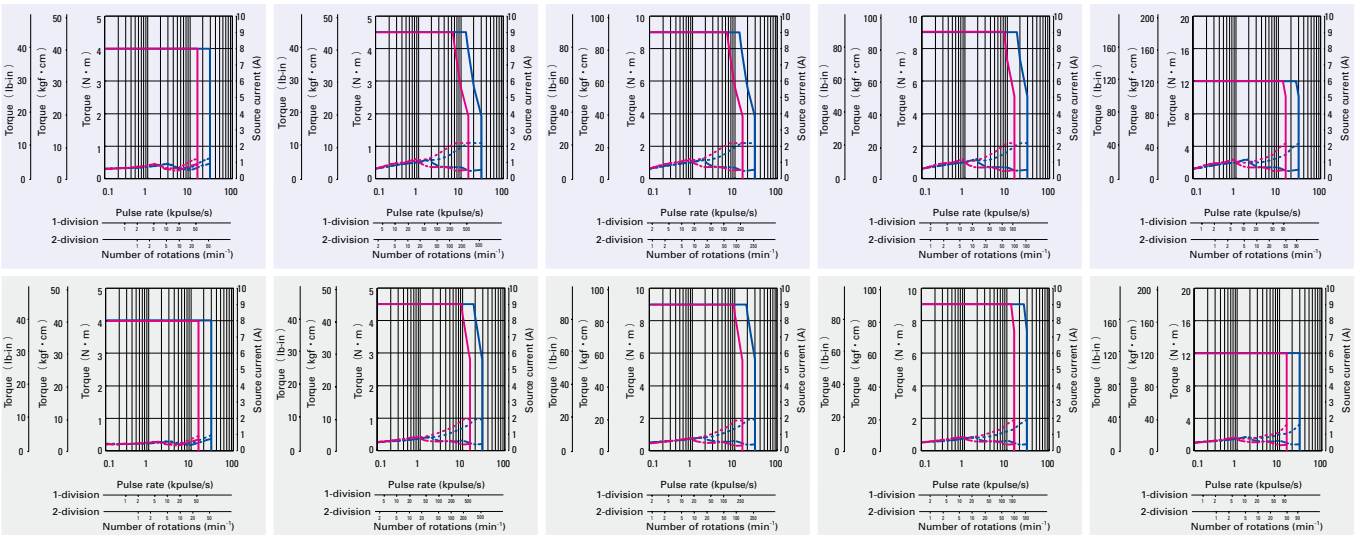

Low-backlash gear model

F series driver +
F series motor with low-backlash gear

Size	Motor flange size	φ 86mm (φ 3.39inch)			
		127.3mm (5.01inch)		127.3mm (5.01inch)	
Set part number	Motor + gear length				
	Single shaft	FSF851S-CX30	FPF851S-CX30	FSF851S-CX36	FPF851S-CX36
Allowable torque	Double shaft	FSF851D-CX30	FPF851D-CX30	FSF851D-CX36	FPF851D-CX36
	N·m(oz·in)	12 (1699.3)		12 (1699.3)	
Rotor inertia	×10 ⁴ kg·m ² (oz·in ²)	1.45 (7.93)		1.45 (7.93)	
Basic step angle		0.024		0.02	
Gear ratio		1 : 30		1 : 36	
Backlash	DEG	0.17		0.15	
Allowable speed	min ⁻¹	60		50	
Mass (Weight)	kg (lbs)	2.7 (5.94)		2.7 (5.94)	
Allowable thrust load	N (lbs)	60 (13.5)		60 (13.5)	
Allowableradialload (Note 1)	N (lbs)	300 (67.5)		300 (67.5)	

Directions of motor rotation and gear output shaft are the same for models with reduction ratio 1 : 3.6 and 1:7.2, opposite for reduction ratio 1 : 10, 1 : 20, 1 : 30, and 1 : 36.
(Note1) When load is applied at 1/3 length from output shaft edge.

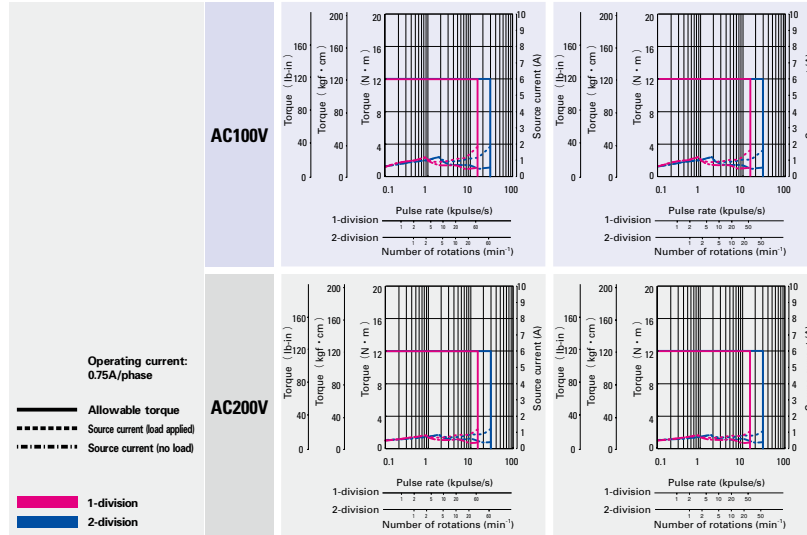

The data are measured under the drive condition of our company. The drive torque may vary depending on the accuracy of customer-side equipment.

Spur gear model

F series driver + F series motor with spur gear

Motor flange size

□28
(-1.10inch)

Size	Motor flange size	□28mm (□1.10inch)			
	Motor + gear length	60.3mm (2.37inch)		60.3mm (2.37inch)	
Set part number	Single shaft	FSF351S-GX3.6	FPF351S-GX3.6	FSF351S-GX7.2	FPF351S-GX7.2
	Double shaft	FSF351D-GX3.6	FPF351D-GX3.6	FSF351D-GX7.2	FPF351D-GX7.2
Allowable torque	N·m(oz·in)	0.1 (14.16)		0.15 (21.24)	
Rotor inertia	$\times 10^{-4}$ kg·m ² (oz·in ²)	0.009 (0.05)		0.009 (0.05)	
Basic step angle		0.2		0.1	
Gear ratio		1 : 3.6		1 : 7.2	
Backlash	DEG	2		2	
Allowable speed	min ⁻¹	800		400	
Mass (Weight)	kg (lbs)	0.17 (0.37)		0.17 (0.37)	
Allowable thrust load	N (lbs)	10 (2.25)		10 (2.25)	
Allowable radial load (Note 1)	N (lbs)	15 (3.38)		15 (3.38)	

Directions of motor rotation and gear output shaft are the same for models with reduction ratio 1 : 3.6, 1 : 7.2, 1 : 20, 1 : 30, and 1:50 opposite for reduction ratio 1 : 10.
(Note1) When load is applied at 1/3 length from output shaft edge.

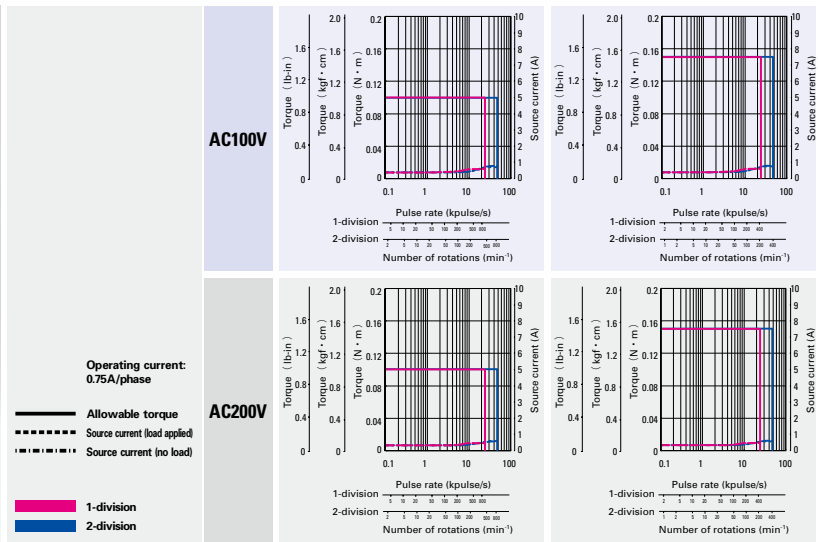

The data are measured under the drive condition of our company. The drive torque may very depending on the accuracy of customer-side equipment.

Size	Motor flange size	□28mm (□1.10inch)							
	Motor + gear length	60.3mm (2.37inch)		60.3mm (2.37inch)		60.3mm (2.37inch)		60.3mm (2.37inch)	
Set part number	Single shaft	FSF351S-GX10	FPF351S-GX10	FSF351S-GX20	FPF351S-GX20	FSF351S-GX30	FPF351S-GX30	FSF351S-GX50	FPF351S-GX50
	Double shaft	FSF351D-GX10	FPF351D-GX10	FSF351D-GX20	FPF351D-GX20	FSF351D-GX30	FPF351D-GX30	FSF351D-GX50	FPF351D-GX50
Allowable torque	N·m(oz·in)	0.2 (28.32)		0.35 (49.6)		0.5 (70.80)		0.5 (70.80)	
Rotor inertia	$\times 10^{-4}$ kg·m ² (oz·in ²)	0.009 (0.05)		0.009 (0.05)		0.009 (0.05)		0.009 (0.05)	
Basic step angle		0.072		0.036		0.024		0.0144	
Gear ratio		1 : 10		1 : 20		1 : 30		1 : 50	
Backlash	DEG	2		1.5		1.5		1.5	
Allowable speed	min ⁻¹	300		150		100		60	
Mass (Weight)	kg (lbs)	0.17 (0.37)		0.17 (0.37)		0.17 (0.37)		0.17 (0.37)	
Allowable thrust load	N (lbs)	10 (2.25)		10 (2.25)		10 (2.25)		10 (2.25)	
Allowable radial load (Note 1)	N (lbs)	15 (3.38)		15 (3.38)		15 (3.38)		15 (3.38)	

Directions of motor rotation and gear output shaft are the same for models with reduction ratio 1 : 3.6, 1 : 7.2, 1 : 20, 1 : 30, and 1:50 opposite for reduction ratio 1 : 10.
(Note1) When load is applied at 1/3 length from output shaft edge.

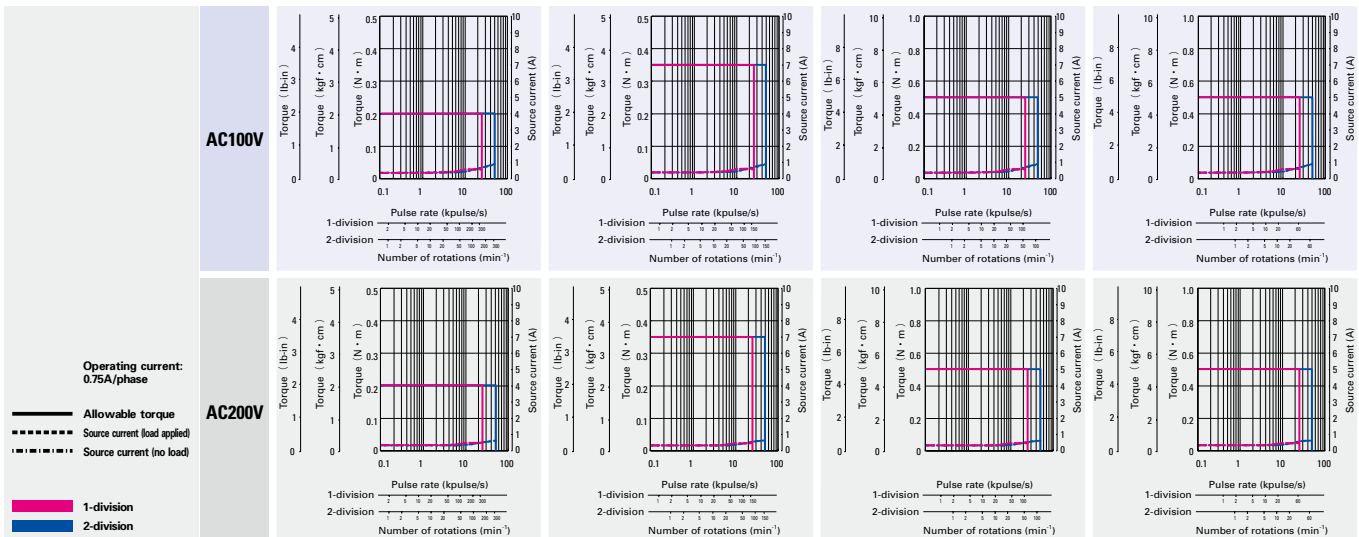

The data are measured under the drive condition of our company. The drive torque may very depending on the accuracy of customer-side equipment.

AC input

Input / Output signal standard

DC input

Stepping motor

Dimensions

Harmonic gear model

F series driver +
F series motor with harmonic gear

Motor flange size

- 28 (≈1.10inch)
- 42 (≈1.65inch)
- 60 (≈2.35inch)
- φ86 (≈3.39inch)



Size	□28mm (□1.10inch)				
	69.5mm (2.74inch)		69.5mm (2.74inch)		
Set part number	Single shaft	FSF351S-HX50	FPF351S-HX50	FSF351S-HX100	FPF351S-HX100
	Double shaft	FSF351D-HX50	FPF351D-HX50	FSF351D-HX100	FPF351D-HX100
Allowable torque	N·m(oz·in)	1.5 (212.4)		2 (283.2)	
Momentary allowable torque	N·m(oz·in)	2.7 (382.4)		3.6 (509.8)	
Rotor inertia	×10 ⁻⁴ kg·m ² (oz·in ²)	0.012 (0.065)		0.012 (0.065)	
Basic step angle		0.0144		0.0072	
Gear ratio		1 : 50		1 : 100	
Lost motion	Minute	0.4 to 3 ± 0.006N·m (0.85oz·in)		0.4 to 3 ± 0.008N·m (1.133oz·in)	
Allowable speed	min ⁻¹	70		35	
Mass (Weight)	kg(lbs)	0.22 (0.48)		0.22 (0.48)	
Allowable thrust load	N(lbs)	100 (22.5)		100 (22.5)	
Allowable radial load (Note 1)	N(lbs)	160 (36)		160 (36)	

Directions of gear output shaft are the opposite.
(Note1) When load is applied at 1/3 length from output shaft edge.

AC100V

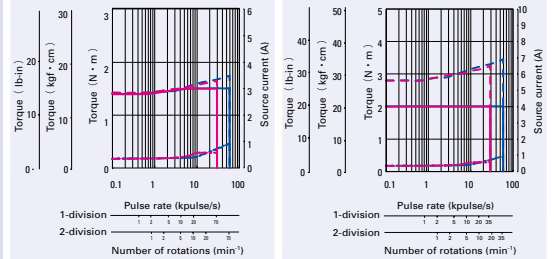

AC200V

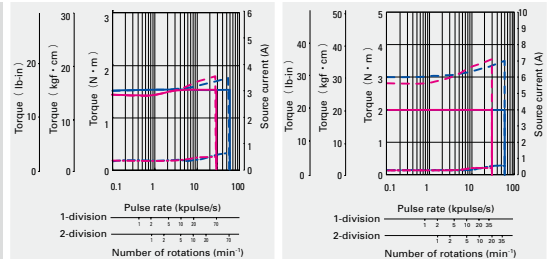

- Operating current: 0.75A/phase
- Momentary allowable torque
 - Allowable torque
 - Source current (load applied)
 - Source current (no load)
 - █ 1-division
 - █ 2-division

The data are measured under the drive condition of our company. The drive torque may very depending on the accuracy of customer-side equipment.

Size	□60mm (□2.36inch)				φ86mm (φ3.39inch)				
	113.5mm (4.47inch)		113.5mm (4.47inch)		113.5mm (4.47inch)		113.5mm (4.47inch)		
Set part number	Single shaft	FSF781S-HX50	FPF781S-HX50	FSF781S-HX100	FPF781S-HX100	FSF851S-HX50	FPF851S-HX50	FSF851S-HX100	FPF851S-HX100
	Double shaft	FSF781D-HX50	FPF781D-HX50	FSF781D-HX100	FPF781D-HX100	FSF851D-HX50	FPF851D-HX50	FSF851D-HX100	FPF851D-HX100
Allowable torque	N·m(oz·in)	5.5 (778.8)		8 (1132.9)		25 (3540.2)		41 (5805.9)	
Momentary allowable torque	N·m(oz·in)	14 (1982.6)		20 (2832.2)		34 (4814.8)		59 (8355.1)	
Rotor inertia	×10 ⁻⁴ kg·m ² (oz·in ²)	0.31 (1.695)		0.31 (1.695)		1.65 (9.021)		1.65 (9.021)	
Basic step angle		0.0144		0.0072		0.0144		0.0072	
Gear ratio		1 : 50		1 : 100		1 : 50		1 : 100	
Lost motion	Minute	0.4 to 3 ± 0.028N·m (3.965oz·in)		0.4 to 3 ± 0.4N·m (56.645oz·in)		0.4 to 3 ± 1N·m (141.612oz·in)		0.4 to 3 ± 1.2N·m (169.934oz·in)	
Allowable speed	min ⁻¹	70		35		70		35	
Mass (Weight)	kg(lbs)	1.2 (2.64)		1.2 (2.64)		3.3 (7.26)		3.3 (7.26)	
Allowable thrust load	N(lbs)	400 (90)		400 (90)		1400 (315)		1400 (315)	
Allowable radial load (Note 1)	N(lbs)	360 (81)		360 (81)		1380 (310.5)		1380 (310.5)	

Directions of gear output shaft are the opposite.
(Note1) When load is applied at 1/3 length from output shaft edge.

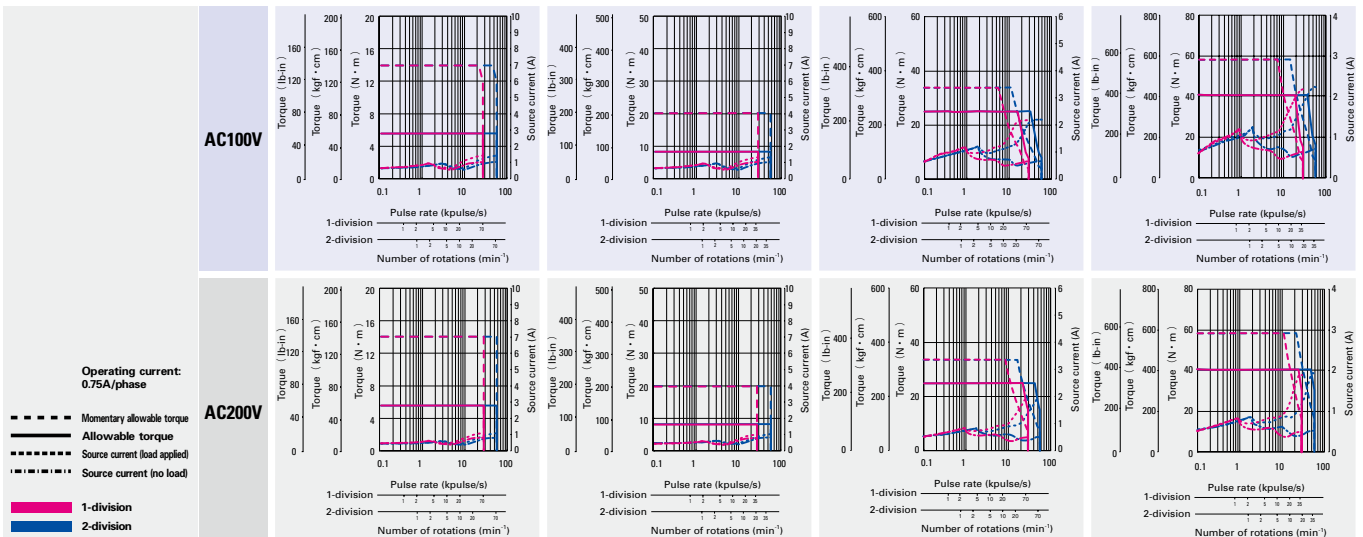

- Operating current: 0.75A/phase
- Momentary allowable torque
 - Allowable torque
 - Source current (load applied)
 - Source current (no load)
 - █ 1-division
 - █ 2-division

The data are measured under the drive condition of our company. The drive torque may very depending on the accuracy of customer-side equipment.

Size	Motor flange size	□ 42mm (□ 1.65inch)					
	Motor + gear length	73.5mm (2.89inch)		73.5mm (2.89inch)		73.5mm (2.89inch)	
Set part number	Single shaft	FSF551S-HX30	FPF551S-HX30	FSF551S-HX50	FPF551S-HX50	FSF551S-HX100	FPF551S-HX100
	Double shaft	FSF551D-HX30	FPF551D-HX30	FSF551D-HX50	FPF551D-HX50	FSF551D-HX100	FPF551D-HX100
Allowable torque	N·m(oz·in)	2.2 (311.5)		3.5 (495.6)		5 (708.1)	
Momentary allowable torque	N·m(oz·in)	4.5 (637.3)		8.3 (1175.4)		11 (1557.7)	
Rotor inertia	$\times 10^{-4} \text{kg}\cdot\text{m}^2(\text{oz}\cdot\text{in}^2)$	0.042 (0.23)		0.042 (0.23)		0.042 (0.23)	
Basic step angle		0.024		0.0144		0.0072	
Gear ratio		1:30		1:50		1:100	
Hysteresis loss	Minute	3.6		2.4		2.4	
Allowable speed	min^{-1}	116		70		35	
Mass (Weight)	kg (lbs)	0.42 (0.92)		0.42 (0.92)		0.42 (0.92)	
Allowable thrust load	N (lbs)	1150 (258.75)		1150 (258.75)		1150 (258.75)	
Allowable radial load ^(Note 1)	N (lbs)	209 (46.98)		209 (46.98)		209 (46.98)	

Directions of gear output shaft are the opposite.
 (Note1) The load point is an output axis point.

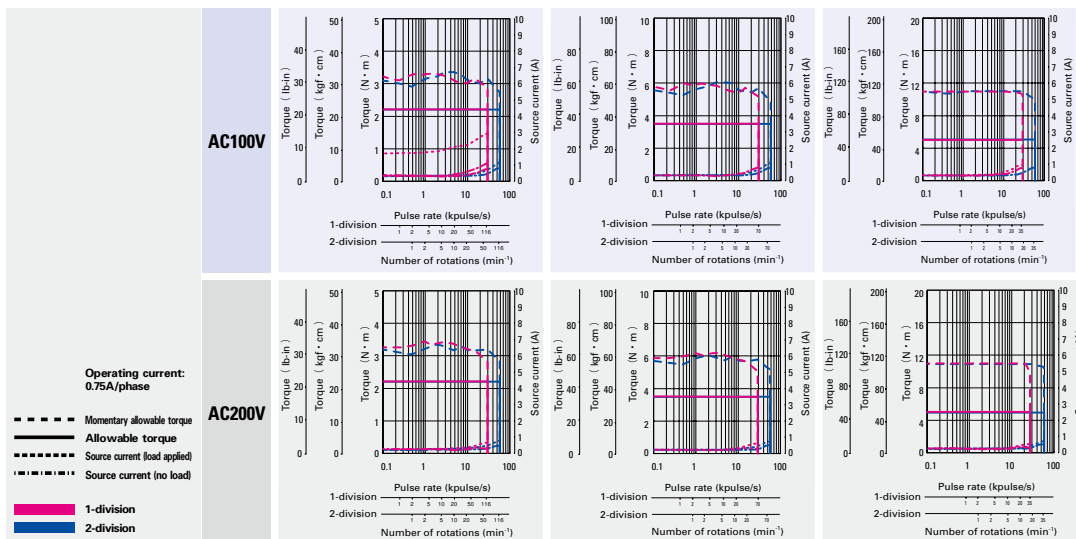

Electromagnetic brake model

F series driver + F series motor with electromagnetic brake

Motor flange size



Size	Motor flange size		42mm (1.65inch)			
	Motor + brake length		64.5mm (2.54inch)		70.5mm (2.78inch)	
Set part number	Single shaft		FSF551S-XB	FPF551S-XB	FSF552S-XB	FPF552S-XB
Holding torque	N·m(oz·in)		0.13 (8.4)		0.18 (25.49)	
Rotor inertia	$\times 10^{-4}$ kg·m ² (oz·in ²)		0.045 (0.246)		0.068 (0.372)	
Mass (Weight)	kg (lbs)		0.38 (0.84)		0.43 (0.95)	
Allowable thrust load	N (lbs)		10 (2.25)		10 (2.25)	
Allowable radial load ^(Note 1)	N (lbs)		35 (8.75)		35 (8.75)	
Brake type			No excitation actuating type		No excitation actuating type	
Electromagnetic brake	Power supply input	V	DC24V ± 5%		DC24V ± 5%	
	Excitation current	A	0.08		0.08	
	Power consumption	W	2		2	
	Static fiction torque	N·m(oz·in)	0.22 (31.15)		0.22 (31.15)	
	Brake operating time	ms	30		30	
	Brake release time	ms	20		20	

(Note1) When load is applied at 1/3 length from output shaft edge.



AC100V

AC200V

Operating current:
0.75A/phase

- Pull-out torque
 - - - Source current (load applied)
 - · - · - Source current (no load)
 - 1-division fs
 - 2-division fs
 - 1-division
 - 2-division
- Fs: Maximum self-start frequency when not loaded

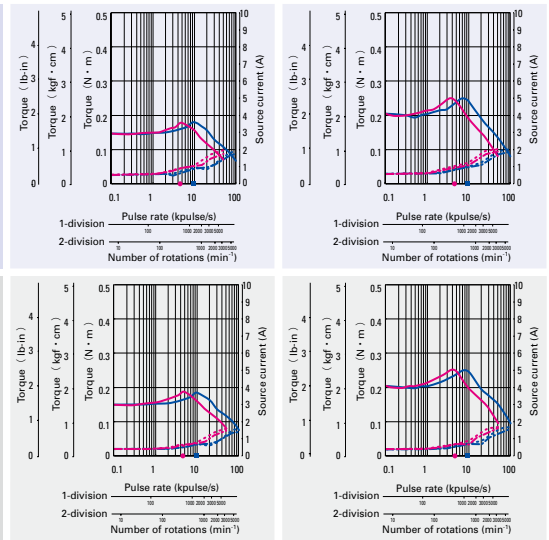

The data are measured under the drive condition of our company. The drive torque may very depending on the accuracy of customer-side equipment.

Size	Motor flange size		86mm (3.39inch)			
	Motor + brake length		146.8mm (5.78mm)		180.4mm (7.10mm)	
Set part number	Single shaft		FSF852S-XB	FPF852S-XB	FSF853S-XB	FPF853S-XB
Holding torque	N·m(oz·in)		4.02 (569.3)		6.17 (873.7)	
Rotor inertia	$\times 10^{-4}$ kg·m ² (oz·in ²)		3.69 (20.175)		5.19 (28.376)	
Mass (Weight)	kg (lbs)		4.5 (9.9)		5.5 (12.1)	
Allowable thrust load	N (lbs)		60 (13.5)		60 (13.5)	
Allowable radial load ^(Note 1)	N (lbs)		220 (49.5)		220 (49.5)	
Brake type			No excitation actuating type		No excitation actuating type	
Electromagnetic brake	Power supply input	V	DC24V ± 5%		DC24V ± 5%	
	Excitation current	A	0.42		0.42	
	Power consumption	W	10		10	
	Static fiction torque	N·m(oz·in)	4 (566.45)		4 (566.45)	
	Brake operating time	ms	50		50	
	Brake release time	ms	20		20	

(Note1) When load is applied at 1/3 length from output shaft edge.

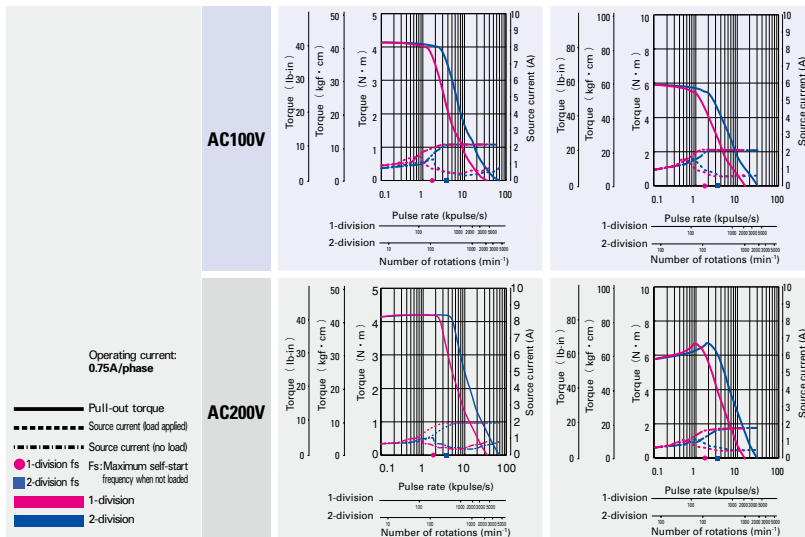

□ 42mm (□ 1.65inch)		□ 60mm (□ 2.36inch)				φ 86mm (φ 3.39inch)			
79.5mm (3.13inch)		85.8mm (3.38inch)		94.5mm (3.72inch)		126.7mm (4.99inch)		116.7mm (4.59inch)	
FSF554S-XB	PPF554S-XB	FSF781S-XB	PPF781S-XB	FSF782S-XB	PPF782S-XB	FSF783S-XB	PPF783S-XB	FSF851S-XB	PPF851S-XB
0.26 (36.82)		0.6 (85.0)		0.98 (138.8)		1.79 (253.5)		2.06 (291.7)	
0.08 (0.437)		0.43 (2.351)		0.56 (3.062)		1 (5.468)		2.24 (12.247)	
0.52 (1.14)		0.94 (2.07)		1.12 (2.46)		1.7 (3.74)		3.5 (7.7)	
10 (2.25)		20 (4.5)		20 (4.5)		20 (4.5)		60 (13.5)	
35 (8.75)		80 (18)		80 (18)		80 (18)		220 (49.5)	
No excitation actuating type		No excitation actuating type		No excitation actuating type		No excitation actuating type		No excitation actuating type	
DC24V ± 5%		DC24V ± 5%		DC24V ± 5%		DC24V ± 5%		DC24V ± 5%	
0.08		0.25		0.25		0.25		0.42	
2		6		6		6		10	
0.22 (31.15)		0.8 (113.29)		0.8 (113.29)		0.8 (113.29)		4 (566.45)	
30		30		30		30		50	
20		20		20		20		20	

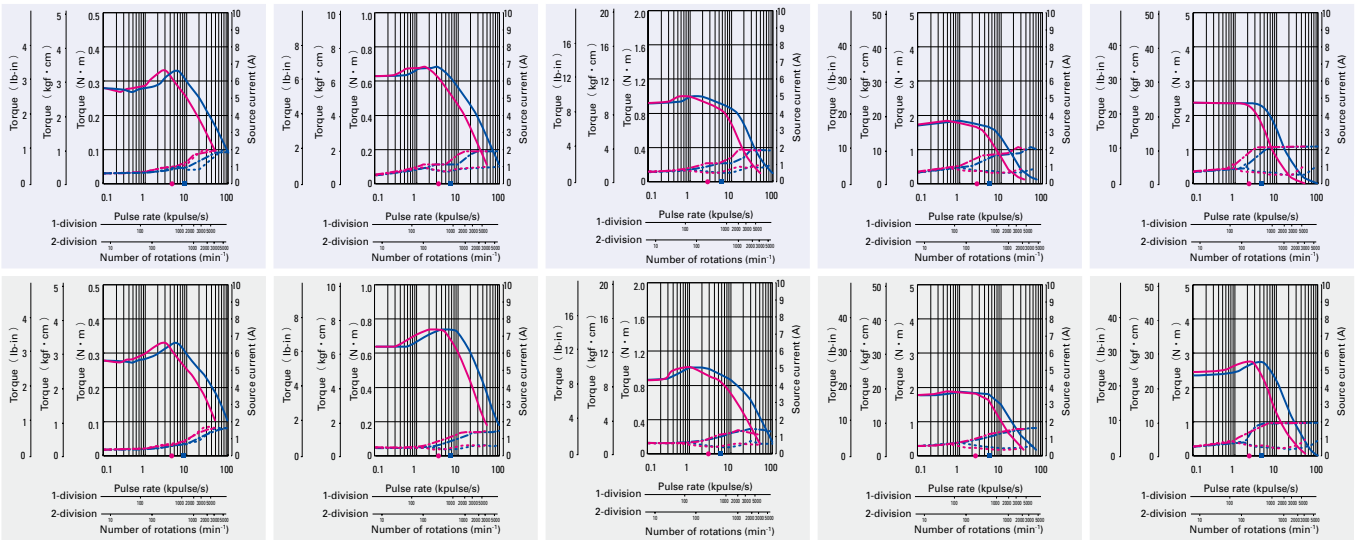

Common specifications

F series driver

Basic specifications	Type code	FS1W075S	
	Power supply	Single phase AC100V to 230V +10, -15% 50/60/Hz	
	Source current	4 A MAX.	
	Environment	Protection class	Class I
		Operation environment	Installation category (over-voltage category) : II , pollution degree: 2
		Applied standards	EN50178, UL508C
		Ambient operation temperature	0 to 50°C
		Storage temperature	-20 to +70°C
		Ambient operation humidity	35 to 85%RH (no condensation)
		Storage humidity	10 to 90%RH (no condensation)
		Operation altitude	1000 m (3280 feet) MAX. above sea level
		Vibration resistance	Tested under the following conditions ; 4.9m/s ² , frequency range 10 to 55Hz, direction along X, Y and Z axes, for 2 hours each
		Impact resistance	Not influenced at NDS-C-0110 standard section 3.2.2 division "C" .
	Withstand voltage	Not influenced when 1500V AC is applied between power input terminal and cabinet for one minute.	
Insulation resistance	10M ohm MIN. when measured with 500V DC megohmmeter between input terminal and cabinet.		
Mass (Weight)	0.8kg (1.77lbs)		
Functions	Protection functions	Driver overheating, main circuit power supply error, and over-current	
	LED indication	Power monitor, phase origin monitor, pulse monitor, alarm	
CN3	Input signal	Photo-coupler input system ; input resistance: 220 Ω ; input-signal "H" level : 4.0 to 5.5V ; input-signal "L" level : 0 to 0.5V	
	Output signal	From the photo coupler by the open collector output Output specification : Vceo = 30V MAX., Ic = 5mA	

F series motor / M series motor

Stepping motor type	F series motor	M series motor
Motor Type	103F35 □□ /103F55 □□ /103F785 □ /103F858 □ /103F8958 □	103M55 □□ /103M785 □ /103M858 □ /103M8958 □
Type	—	S1 (continuous operation)
Insulation class	Class B (+130°C)	Class B (+130°C) [UL class A (+105°C)]
Operation altitude	1000m (3280 feet) MAX. above sea level	
Withstand voltage	□28mm (□1.10inch) : AC1000V 50/60Hz for 1 minute, □42mm (□1.65inch) , □60mm (□2.36inch) , °86mm (°3.39inch) , °106mm (°4.17inch) : AC1500V 50/60Hz for 1 minute	
Insulation resistance	100M ohm MIN. against DC500V	
Protection grade	IP40	
Vibration resistance	Amplitude of 1.52mm (0.06inch) (P-P) at frequency range 10 to 500Hz for 15 minutes sweep time along X, Y, and Z axes for 12 times.	
Impact resistance	490m/s ² of acceleration for 11 ms with half-sine wave applying three times for X, Y, and Z axes each, 18 times in total.	
Ambient operation temperature	-10 to +50°C (0 to +40°C for harmonic gear model)	
Ambient operation humidity	90% MAX. at less than 40°C, 57% MAX. at less than 50°C , 35% MAX. at 60°C (no condensation)	

External wiring diagram : FS type

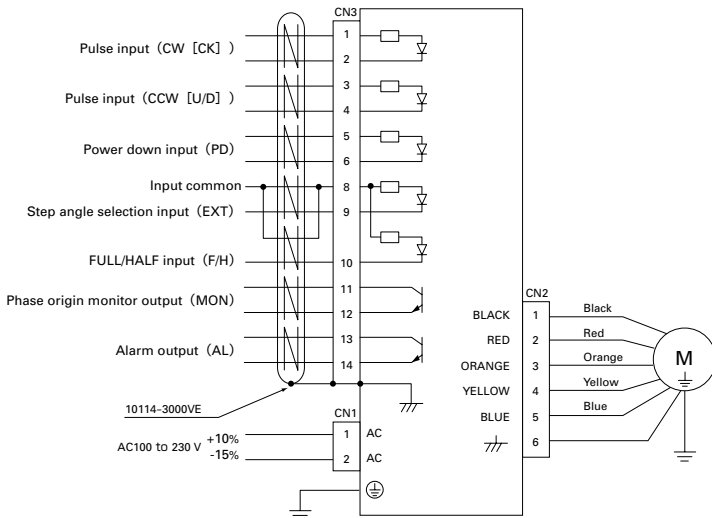

- * Marking : 1 red marking / pitch
 - ◎ Marking : 1 black marking / pitch
 - △ Marking : 2 red markings / pitch
 - ☆ Marking : 2 black markings / pitch
- * Marking size : width : 1mm,
space : 1mm,
pitch : 12mm

Specification summary of CN3 I/O signal

Signal name	CN3 Pin number	Function
CW pulse input (standard)	1	When using "2-input mode"
	2	Drive pulse for the CW direction rotation is input.
Pulse column input	1	When using "Pulse and direction mode"
	2	Drive pulse train for the stepping motor rotation is input.
CCW pulse input (standard)	3	When using "2-input mode"
	4	Drive pulse for the CCW direction rotation is input.
Rotation direction input	3	The rotation direction signal of stepping motor is input for the "Pulse and direction mode".
	4	Internal photocoupler ON...CW direction Internal photocoupler OFF...CCW direction
Power down input	5	Inputting the PD signal cuts OFF the current flowing through the stepping motor (turns OFF the power) . (The power down input can be changed to the power low function by selecting dipswitches.)
	6	PD input signal ON (internal photocoupler ON) ...PD function enabled PD input signal OFF (internal photocoupler OFF) ...PD function disabled
Step angle selection input	8	Inputting the EXT signal enables the FULL/HALF selection input.
	9	EXT input signal ON (internal photocoupler ON) ...External input signal F/H enabled EXT input signal OFF (internal photocoupler OFF) ...Main unit rotary switch S. S enabled
FULL/HALF selection input	8	When the EXT input signal is ON (internal photocoupler ON).
	10	F/H input signal ON (internal photocoupler ON) ...HALF step F/H input signal OFF (internal photocoupler OFF) ...FULL step
Phase origin monitor output	11	It is turned ON when the excitation phase is at the origin (in the state when the power is turned ON)
	12	It is turned ON once per 10 pulses when setting to HALF step. It is turned ON once per 20 pulses when setting to FULL step.
Alarm output	13	The signal is externally output when one of several alarm circuits operates in the PM driver. At this time, the stepping motor is in the unexcited state.
	14	

(Note) The CW rotation direction of stepping motor means the clockwise direction rotation as viewed from the output shaft side (flange side) . The CCW rotation direction means the counterclockwise direction rotation as viewed from the output shaft side (flange side) .

Driver part name

2-digit LED indication

	Indication	Description
Status	88	Internal power is established.
	88	Excitation phase is origin status at power on.
	88	Command pulse is under status at input.
Alarm	01	Over-current.
	02	Overheat.
	03	Low voltage power.
	04	Over-voltage power.
	05 08	Hardware fault



Display switch Alarm history of 10 previous alarms can be displayed on 2-digit LED.

- ① Step angle selection switch
- ② Current selection switch
- ③ 0-speed current adjustment switch
- ④ Function selection DIP switch

Motor interface connector

Power connector

Earth

⑤ **Input/output signal interface connector**

① Step angle selection switch

Basic step angle divisor (up to 250 divisions) .

Indication	0	1	2	3	4	5	6	7
Number of divisions	1	2	2.5	4	5	8	10	20
Indication	8	9	A	B	C	D	E	F
Number of divisions	25	40	50	80	100	125	200	250

Initial configuration of factory shipment is set to 1 (Half steps) .

② Operation current selection switch

Motor current during operation can be selected from 100 to 25%.

Indication	0	1	2	3	4	5	6	7
Motor current (%)	100 (Rated value)	95	90	85	80	75	70	65
Indication	8	9	A	B	C	D	E	F
Motor current (%)	60	55	50	45	40	35	30	25

Initial configuration of factory shipment is set to 0 (rated value) .

③ Current adjustment at operation halt switch

Motor current at 0-speed can be selected from 100 to 25%.

Indication	0	1	2	3	4	5	6	7
Motor current (%)	100 (Rated value)	95	90	85	80	75	70	65
Indication	8	9	A	B	C	D	E	F
Motor current (%)	60	55	50	45	40	35	30	25

Initial configuration of factory shipment is set to A (50% of rated value) .
Driver and motor should be operated at around 50% of rated value to reduce heat.

⑤ Input/output signal interface connector

Input signal connector is used for interface with upper level controller, etc. Driver side connector is 10214-52A2JL. (Sumitomo 3M)

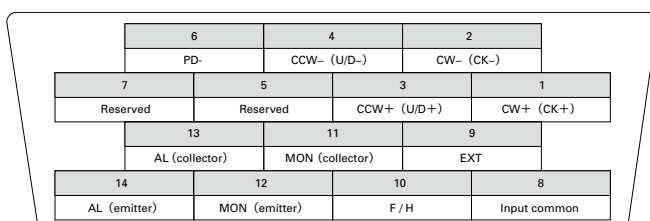

Terminal arrangement of CN3 connector

④ Function selection DIP switch

Selects an appropriate function for specification. Check that the ex-factory settings are as follows.

	OFF	ON	
F/R	<input type="checkbox"/>	<input type="checkbox"/>	OFF Input method select
LV	<input type="checkbox"/>	<input type="checkbox"/>	OFF Low-vibration mode select
PD	<input type="checkbox"/>	<input type="checkbox"/>	OFF Power down select
EORG	<input type="checkbox"/>	<input type="checkbox"/>	OFF Excitation select

Input method select (F/R)

Selects input pulse type.

F/R	Input pulse type
ON	1 input (Pulse&direction)
OFF	2 input (CW, CCW)

Low-vibration mode select (LV)

Provides low-vibration, smooth operation even if resolution is rough (1-division, 2-division, etc)

LV	Operation
ON	Auto-micro function
OFF	Micro-step

Power down select (PD)

Selects current for power down signal input.

PD	Motor current
ON	Current by rotary switch STP (power low)
OFF	0A (power off)

Excitation select (EORG)

The excitation phase when the power supply is turned on is selected.

EORG	Original excitation phase
ON	Excitation phase at power shut off
OFF	Phase origin

By turning on the EORG, excitation phase when power OFF will be saved. Therefore, there will be no shaft displacement when turning the power ON.

Common specifications

F series driver

Basic specifications	Type code	FP1W075P		
	Power supply	Single phase AC100V to 230V +10, -15% 50/60/Hz		
	Source current	4 A MAX.		
	Environment	Protection class	Class I	
		Operation environment	Installation category (over-voltage category) : II , pollution degree: 2	
		Applied standards	EN50178, UL508C	
		Ambient operation temperature	0 to 50°C	
		Storage temperature	-20 to +70°C	
		Ambient operation humidity	35 to 85% RH (no condensation)	
		Storage humidity	10 to 90% RH (no condensation)	
		Operation altitude	1000m (3280feet) MAX. above sea level	
		Vibration resistance	Tested under the following conditions ; 4.9m/s ² , frequency range 10 to 55Hz, direction along X, Y and Z axes, for 2 hours each	
		Impact resistance	Not influenced at NDS-C-0110 standard section 3.2.2 division "C" .	
	Withstand voltage	Not influenced when 1500V AC is applied between power input terminal and cabinet for one minute.		
Insulation resistance	10M ohm MIN. when measured with 500V DC megohmmeter between input terminal and cabinet.			
Mass (Weight)	0.8kg (1.77lbs)			
Functions	Protection functions	Driver overheating, main circuit power supply error, and over-current		
	LED indication	Power monitor, phase origin monitor, pulse monitor, alarm		
CN3	Input signal	Photo-coupler input system ; input resistance: 220 Ω ; input-signal "H" level : 4.0 to 5.5V ; input-signal "L" level : 0 to 0.5V		
	Output signal	From the photo coupler by the open collector output	Output specification : Vceo = 30V MAX., Ic = 5mA	

F series motor / M series motor

Stepping motor type	F series motor	M series motor
Motor Type	103F35□□ / 103F55□□ / 103F785 □ / 103F858□ / 103F8958□	103M55□ / 103M785□ / 103M858□ / 103M8958 □
Type	—	S1 (continuous operation)
Insulation class	Class B (+130°C)	Class B (+130°C) [UL class A (+105°C)]
Operation altitude	1000m (3280 feet) MAX. above sea level	
Withstand voltage	□28mm (□1.10inch) : AC1000V 50/60Hz for 1 minute, □42mm (□1.65inch) , □60mm (□2.36inch) , □86mm (□3.39inch) , □106mm (□4.17inch) : AC1500V 50/60Hz for 1 minute	
Insulation resistance	100M ohm MIN. against DC500V	
Protection grade	IP40	
Vibration resistance	Amplitude of 1.52mm (0.06inch) (P-P) at frequency range 10 to 500Hz for 15 minutes sweep time along X, Y, and Z axes for 12 times.	
Impact resistance	490m/s ² of acceleration for 11 ms with half-sine wave applying three times for X, Y, and Z axes each, 18 times in total.	
Ambient operation temperature	-10 to +50°C (0 to +40°C for harmonic gear model)	
Ambient operation humidity	90% MAX. at less than 40°Cs, 57% MAX. at less than 50°C , 35% MAX. at 60°C (no condensation)	

The □ symbol in the motor model number indicates the length of the motor.

External wiring diagram : FP type

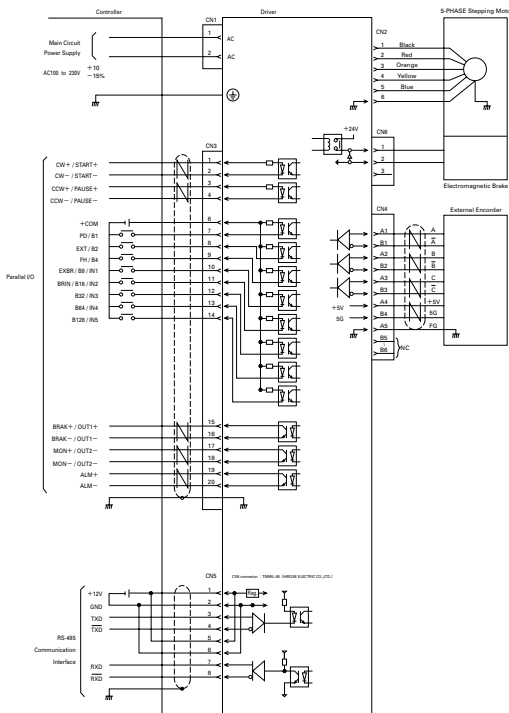

- * Marking : 1 red marking / pitch
- Marking : 1 black marking / pitch
- △ Marking : 2 red markings / pitch
- ☆ Marking : 2 black markings / pitch
- ※ Marking size : width : 1mm, space : 1mm, pitch : 12mm

Specification summary of CN3 I/O signal (Pulse train I/F mode)

Signal name	Pin number	Function
CW pulse input (standard)	1	When using "2-input mode" Drive pulse for the CW direction rotation is input.
Pulse column input	2	Drive pulse train for the stepping motor rotation is input.
CCW pulse input (standard)	3	When using "2-input mode" Drive pulse for the CCW direction rotation is input.
Rotation direction input	4	The rotation direction signal of stepping motor is input for the "Pulse and direction mode". Internal photocoupler ON...CW direction Internal photocoupler OFF...CCW direction
General-purpose input common	6	Input signal common of the 7 to 14 pins DC5V to DC24V is input.
Power down input	7	Inputting the PD signal cuts OFF the current flowing through the stepping motor (turns OFF the power). (The power down input can be changed to the power low function by selecting dipswitches.) PD input signal ON (internal photocoupler ON) ...PD function enabled PD input signal OFF (internal photocoupler OFF) ...PD function disabled
Step angle selection input	8	Inputting the EXT signal enables the FULL/HALF selection input. EXT input signal ON (internal photocoupler ON) ...HALF step signal F/H enabled EXT input signal OFF (internal photocoupler OFF) ...Main unit rotary switch S. S enabled
FULL/HALF selection input	9	When the EXT input signal is ON (internal photocoupler ON) . F/H input signal ON (internal photocoupler ON) ...HALF step F/H input signal OFF (internal photocoupler OFF) ...FULL step
Brake control select input	10	Brake retention/release timing can be controlled by the BRIN signal by inputting the EXBR signal. EXBR input signal ON (internal photo coupler ON) ...External input signal BRIN effective EXBR input signal OFF (internal photo coupler OFF) ...The driver controls the brake automatically
Brake control input	11	When the EXBR input signal on (internal photo coupler on) BRIN input signal ON (internal photo coupler on) ...Brake release BRIN input signal OFF (internal photo coupler off) ...Brake retention
Brake status output	15, 16	When the brake is released it turns ON, when the brake is retained it turns OFF.
Phase origin monitor output	17, 18	It is turned ON when the excitation phase is at the origin (in the state when the power is turned ON) It is turned ON once per 10 pulses when setting to HALF step. It is turned ON once per 20 pulses when setting to FULL step.
Alarm output	19, 20	The signal is externally output when one of several alarm circuits operates in the PM driver. At this time, the stepping motor is in the unexcited state.

(Note) The CW rotation direction of stepping motor means the clockwise direction rotation as viewed from the output shaft side (flange side) . The CCW rotation direction means the counterclockwise direction rotation as viewed from the output shaft side (flange side) .

Driver part name

2-digit LED indication

	Indication	Description
Status	88	Internal power is established.
	88	Excitation phase is origin status at power on.
	88	Command pulse is under status at input.
Alarm	01	Over-current.
	02	Overheat.
	03	Low voltage power.
	04	Over-voltage power.
	05 08	Hardware fault



Display switch Alarm history of 10 previous alarms can be displayed on 2-digit LED.

- ① Step angle selection switch
- ② Current selection switch
- ③ 0-speed current adjustment switch
- ④ Function selection DIP switch

Serial (RS-485)

Encoder

- ⑤ Input/output signal interface connector

Brake connector

Motor interface connector

Power connector

Earth

① Step angle selection switch

Basic step angle divisor (up to 250 divisions).

Indication	0	1	2	3	4	5	6	7
Number of divisions	1	2	2.5	4	5	8	10	20
Indication	8	9	A	B	C	D	E	F
Number of divisions	25	40	50	80	100	125	200	250

Initial configuration of factory shipment is set to 1 (Half steps)

② Operation current selection switch

Motor current during operation can be selected from 100 to 25%.

Indication	0	1	2	3	4	5	6	7
Motor current (%)	100 (Rated value)	95	90	85	80	75	70	65
Indication	8	9	A	B	C	D	E	F
Motor current (%)	60	55	50	45	40	35	30	25

Initial configuration of factory shipment is set to 0 (rated value).

③ Current adjustment at operation halt switch

Motor current at 0-speed can be selected from 100 to 25%.

Indication	0	1	2	3	4	5	6	7
Motor current (%)	100 (Rated value)	95	90	85	80	75	70	65
Indication	8	9	A	B	C	D	E	F
Motor current (%)	60	55	50	45	40	35	30	25

Initial configuration of factory shipment is set to A (50% of rated value).

Driver and motor should be operated at around 50% of rated value to reduce heat.

⑤ Input/output signal interface connector

Input signal connector is used for interface with upper level controller, etc. Driver side connector is 10214-52A2JL. (Sumitomo 3M)

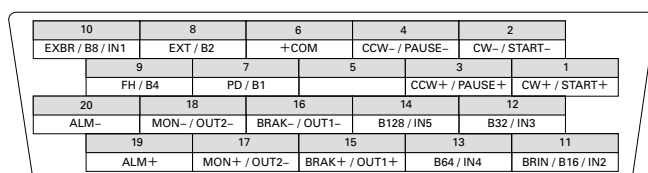

Terminal arrangement of CN3 connector

④ Function selection DIP switch

Selects an appropriate function for specification. Check that the ex-factory settings are as follows.

	OFF	ON	
F/R	<input type="checkbox"/>	<input type="checkbox"/>	OFF Input method select
LV	<input type="checkbox"/>	<input type="checkbox"/>	OFF Low-vibration mode select
PD	<input type="checkbox"/>	<input type="checkbox"/>	OFF Power down select
EORG	<input type="checkbox"/>	<input type="checkbox"/>	OFF Excitation select
I.SEL	<input type="checkbox"/>	<input type="checkbox"/>	OFF
S.SEL	<input type="checkbox"/>	<input type="checkbox"/>	OFF

Input method select (F/R)

Selects input pulse type.

F/R	Input pulse type
ON	1 input (Pulse&direction)
OFF	2 input (CW, CCW)

Low-vibration mode select (LV)

Provides low-vibration, smooth operation even if resolution is rough (1-division, 2-division, etc)

LV	Operation
ON	Auto-micro function
OFF	Micro-step

Power down select (PD)

Selects current for power down signal input.

PD	Motor current
ON	Current by rotary switch STP (power low)
OFF	0A (power off)

Excitation select (EORG)

The excitation phase when the power supply is turned on is selected.

EORG	Original excitation phase
ON	Excitation phase at power shut off
OFF	Phase origin

By turning on the EORG, excitation phase when power OFF will be saved. Therefore, there will be no shaft displacement when turning the power ON.

(I.SEL)

The operation mode is selected.

I.SEL	
ON	Selects S.SEL-setting operation mode
OFF	Pulse-train I/F mode

(S.SEL)

The operation mode is selected.

S.SEL	
ON	Serial I/F mode
OFF	Parallel I/F mode

(Note) Function descriptions for switches 1 to 4 apply to pulse-train I/F mode. See the user's manual for settings in serial-I/F and parallel-I/F modes.

Input circuit configuration of CW (CK), CCW (U/D)

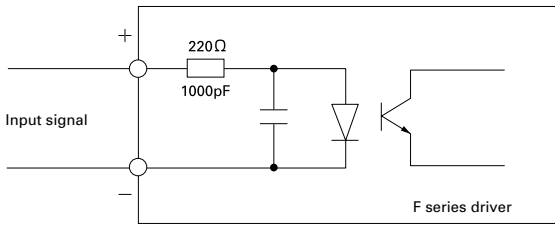

- Pulse duty 50% MAX.
- Maximum input frequency: 250kpulse/s
- When the crest value of the input signal exceeds 5V, use the external limit resistance R to limit the input current to approximately 15mA.

Input signal specification

(Photo coupler)

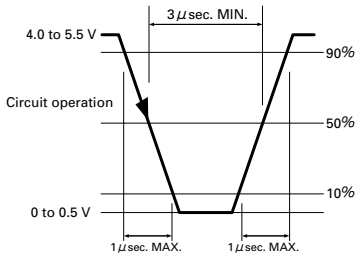

Timing of command pulse

2 input type (CW, CCW)

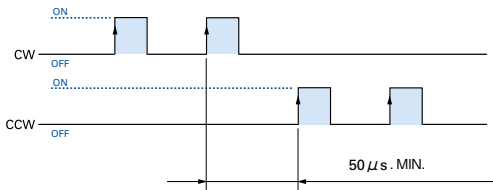

- Shaded area indicates internal photo coupler "ON". Internal circuit (motor) starts operating at leading edge of the photo coupler "ON".
- To apply pulse to CW, set CCW side internal photo coupler to "OFF".
- To apply pulse to CCW, set CW side internal photo coupler to "OFF".

1 input type (CW, CCW)

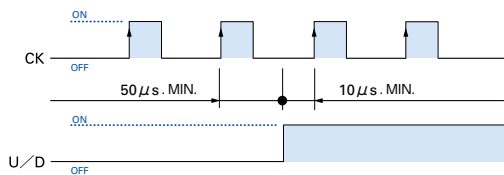

- Shaded area indicates internal photo coupler "ON". Internal circuit (motor) starts operating at leading edge of CK side photo coupler "ON".
- Switching of U/D input signal must be done while CK side internal photo coupler is "OFF".

Input circuit configuration of PD, EXT, F/H

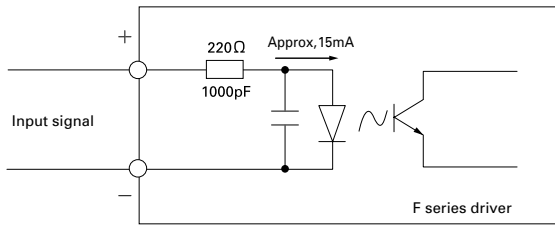

• If the peak value exceeds 5V, set the input current to approx. 15mA using the external limit resistance R.

AC input

Output signal configuration of MON, AL

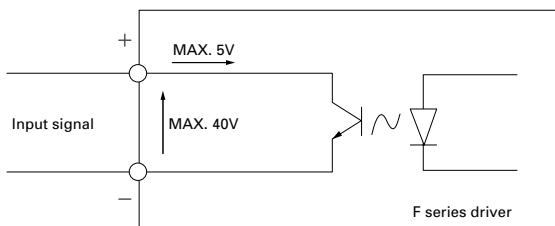

MON output

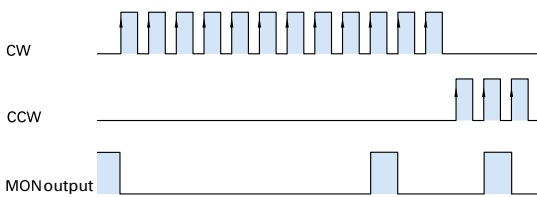

- Photo coupler at phase origin of motor excitation (status at power on) is set to "ON" (setting when number of divisions is 1).
- Output from MON is set to on at every 7.2 degrees of motor output shaft from phase origin.

Input / Output signal standard

DC input

Internal wire connection and direction of motor rotate

Internal wire connection

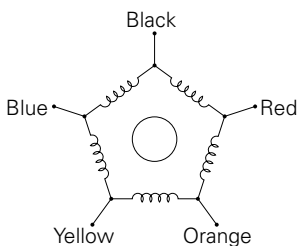

Direction of motor rotate

The direction of motor rotate is counterclockwise when viewed from the output shaft side at the direct current energization in the following order.

Type	Exciting order									
	1	2	3	4	5	6	7	8	9	10
Color of leads	Black	-	-	-	-	+	+	+	+	-
	Red	+	+	+	+	-	-	-	-	+
	Orange	-	-	-	-	+	+	+	+	-
	Yellow	+	+	+	+	-	-	-	-	+
Blue	-	-	-	-	+	+	+	+	-	+

Stepping motor

Dimensions

Flange side

Spur gear model

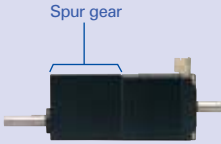

Motor flange size
□28 (□1.10inch)

Low-backlash gear model

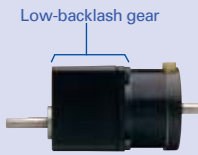

Motor flange size
□42mm (□1.65inch) / □60mm (□2.35inch) / ∅86mm (∅3.39inch)

Harmonic gear model



Motor flange size
□28mm (□1.10inch) / □42mm (□1.65inch) / □60mm (□2.35inch) / ∅86mm (∅3.39inch)

End cap side

Damper



Magnetic dampers can be selected according to required inertia.

Electromagnetic brake model

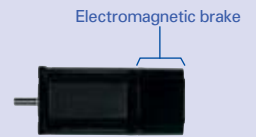

Motor flange size
□42mm (□1.65inch) / □60mm (□2.35inch) / ∅86mm (∅3.39inch)

Brake power source (DC24V)

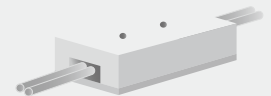

Required for brake-equipped stepping motor models.



Standard model : F series motor
□28mm (□1.10inch) / □42mm (□1.65inch) / □60mm (□2.35inch) / ∅86mm (∅3.39inch)

Motor cable

Single phase
AC100V
to
AC230V

(t)
(r)

Molded case circuit breaker



Protects the power line. Cuts off circuit in the event of overcurrent.

Electromagnetic contactor

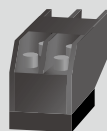

Switches driver power on/off. Use together with a surge protector.

Noise filter



Filters out incoming noise from power line.

Switching power supply



Converts AC power to DC power.

DC24V/
DC36V

Host Devices

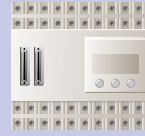

PLC

PLC and controllers are available as the host device.



To motor

I/O signal cable

To DC power source

I/O signal connector

Part number convention

The following part number specifies a system with an F series driver (type code : FS1D140P) and a single shaft F series motor (type code : 103F7851-8421) , □ 60mm (□ 2.36inch) square flange, and 46.5mm (1.83inch) motor length, equipped with low-backlash gear (reduction ratio of 1/3.6).

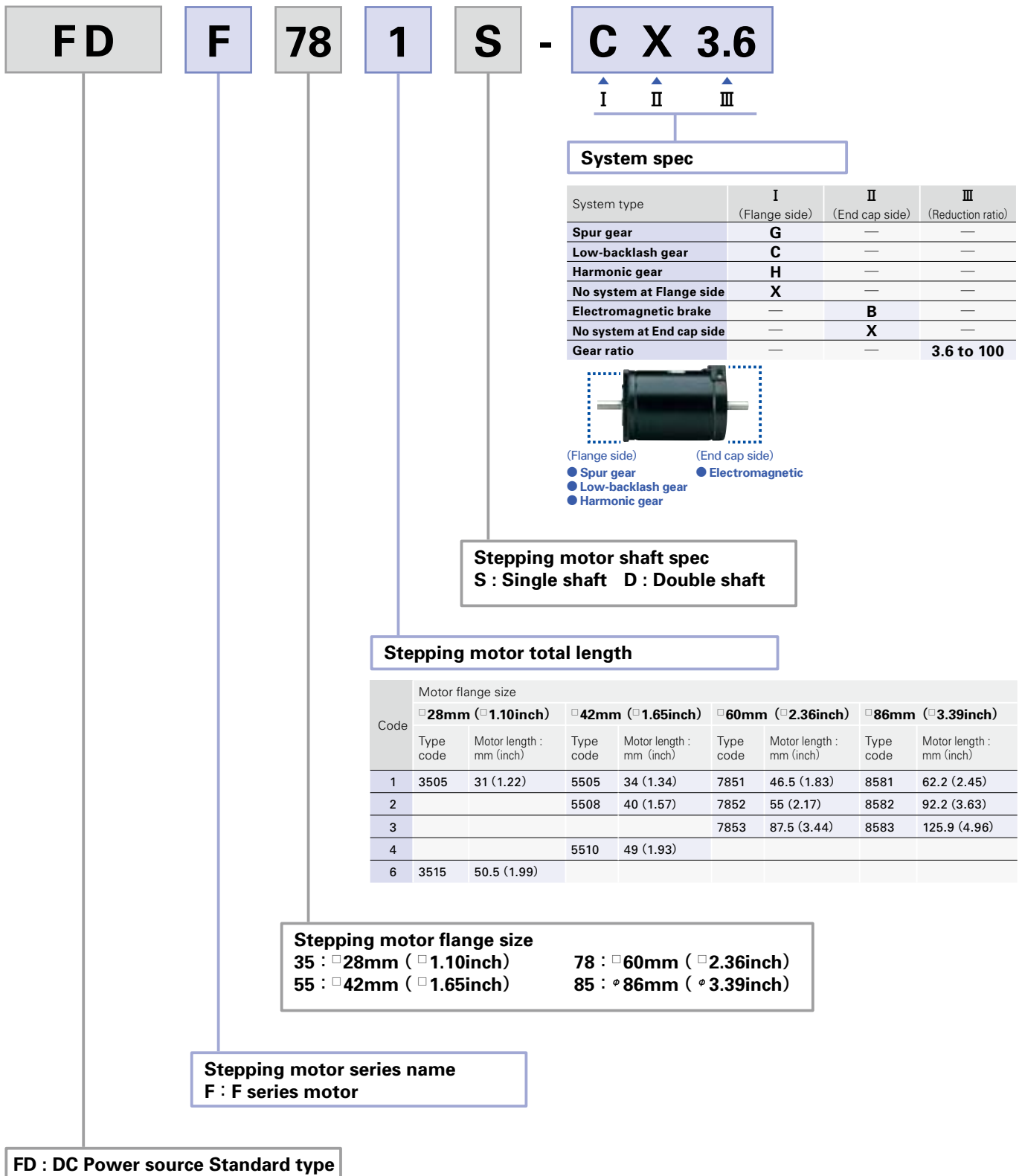

Combination list of 5-phase driver

Combination	Motor flange size	Set part number		Motor model number		Rated current	
		Single shaft	Double shaft	Single shaft	Double shaft		
Standard model	□ 28mm (□ 1.10inch)	FDf351S	FDf351D	103F3505-7441	103F3505-7411	0.75A	
		FDf356S	FDf356D	103F3515-7441	103F3515-7411	0.75A	
	□ 42mm (□ 1.65inch)	FDf551S	FDf551D	103F5505-8241	103F5505-8211	1.4A	
		FDf552S	FDf552D	103F5508-8241	103F5508-8211	1.4A	
	□ 60mm (□ 2.36inch)	FDf554S	FDf554D	103F5510-8241	103F5510-8211	1.4A	
		FDf781S	FDf781D	103F7851-8241	103F7851-8211	1.4A	
	φ 86mm (φ 3.39inch)	FDf782S	FDf782D	103F7852-8241	103F7852-8211	1.4A	
		FDf783S	FDf783D	103F7853-8241	103F7853-8211	1.4A	
	φ 86mm (φ 3.39inch)	FDf851S	FDf851D	103F8581-8241	103F8581-8211	1.4A	
		FDf852S	FDf852D	103F8582-8241	103F8582-8211	1.4A	
	Low-backlash gear model	□ 42mm (□ 1.65inch)	FDf551S-CX3.6	FDf551D-CX3.6	103F5505-82CXA4	103F5505-82CXA1	1.4A
			FDf551S-CX7.2	FDf551D-CX7.2	103F5505-82CXB4	103F5505-82CXB1	1.4A
FDf551S-CX10			FDf551D-CX10	103F5505-82CXE4	103F5505-82CXE1	1.4A	
FDf551S-CX20			FDf551D-CX20	103F5505-82CXG4	103F5505-82CXG1	1.4A	
FDf551S-CX30			FDf551D-CX30	103F5505-82CXJ4	103F5505-82CXJ1	1.4A	
FDf551S-CX36			FDf551D-CX36	103F5505-82CXX4	103F5505-82CXX1	1.4A	
□ 60mm (□ 2.36inch)		FDf781S-CX3.6	FDf781D-CX3.6	103F7851-82CXA4	103F7851-82CXA1	1.4A	
		FDf781S-CX7.2	FDf781D-CX7.2	103F7851-82CXB4	103F7851-82CXB1	1.4A	
		FDf781S-CX10	FDf781D-CX10	103F7851-82CXE4	103F7851-82CXE1	1.4A	
		FDf781S-CX20	FDf781D-CX20	103F7851-82CXG4	103F7851-82CXG1	1.4A	
		FDf781S-CX30	FDf781D-CX30	103F7851-82CXJ4	103F7851-82CXJ1	1.4A	
		FDf781S-CX36	FDf781D-CX36	103F7851-82CXX4	103F7851-82CXX1	1.4A	
φ 86mm (φ 3.39inch)		FDf851S-CX3.6	FDf851D-CX3.6	103F8581-82CXA4	103F8581-82CXA1	1.4A	
		FDf851S-CX7.2	FDf851D-CX7.2	103F8581-82CXB4	103F8581-82CXB1	1.4A	
		FDf851S-CX10	FDf851D-CX10	103F8581-82CXE4	103F8581-82CXE1	1.4A	
		FDf851S-CX20	FDf851D-CX20	103F8581-82CXG4	103F8581-82CXG1	1.4A	
		FDf851S-CX30	FDf851D-CX30	103F8581-82CXJ4	103F8581-82CXJ1	1.4A	
		FDf851S-CX36	FDf851D-CX36	103F8581-82CXX4	103F8581-82CXX1	1.4A	
Spur gear model		□ 28mm (□ 1.10inch)	FDf351S-GX3.6	FDf351D-GX3.6	103F3505-74GXA4	103F3505-74GXA1	0.75A
			FDf351S-GX7.2	FDf351D-GX7.2	103F3505-74GXB4	103F3505-74GXB1	0.75A
			FDf351S-GX10	FDf351D-GX10	103F3505-74GXE4	103F3505-74GXE1	0.75A
			FDf351S-GX20	FDf351D-GX20	103F3505-74GXG4	103F3505-74GXG1	0.75A
			FDf351S-GX30	FDf351D-GX30	103F3505-74GXJ4	103F3505-74GXJ1	0.75A
			FDf351S-GX50	FDf351D-GX50	103F3505-74GXL4	103F3505-74GXL1	0.75A
Harmonic gear model	□ 28mm (□ 1.10inch)	FDf351S-HX50	FDf351D-HX50	103F3505-74HXL4	103F3505-74HXL1	0.75A	
		FDf351S-HX100	FDf351D-HX100	103F3505-74HXM4	103F3505-74HXM1	0.75A	
	□ 42mm (□ 1.65inch)	FDf5515S-HX30	FDf551D-HX30	103F5505-82HXJ5	103F5505-82HXJ2	1.4A	
		FDf5515S-HX50	FDf551D-HX50	103F5505-82HXL5	103F5505-82HXL2	1.4A	
	□ 60mm (□ 2.36inch)	FDf5515S-HX100	FDf551D-HX100	103F5505-82HXM5	103F5505-82HXM2	1.4A	
		FDf781S-HX50	FDf781D-HX50	103F7851-82HXL4	103F7851-82HXL1	1.4A	
	φ 86mm (φ 3.39inch)	FDf781S-HX100	FDf781D-HX100	103F7851-82HXM4	103F7851-82HXM1	1.4A	
		FDf851S-HX50	FDf851D-HX50	103F8581-82HXL4	103F8581-82HXL1	1.4A	
φ 86mm (φ 3.39inch)	FDf851S-HX100	FDf851D-HX100	103F8581-82HXM4	103F8581-82HXM1	1.4A		
	FDf551S-XB	—	103F5505-82XB41	—	1.4A		
Electromagnetic brake model	□ 42mm (□ 1.65inch)	FDf552S-XB	—	103F5508-82XB41	—	1.4A	
		FDf554S-XB	—	103F5510-82XB41	—	1.4A	
		FDf781S-XB	—	103F7851-82XB41	—	1.4A	
	□ 60mm (□ 2.36inch)	FDf782S-XB	—	103F7852-82XB41	—	1.4A	
		FDf783S-XB	—	103F7853-82XB41	—	1.4A	
	φ 86mm (φ 3.39inch)	FDf851S-XB	—	103F8581-82XB41	—	1.4A	
		FDf852S-XB	—	103F8582-82XB41	—	1.4A	

AC input

Input / Output signal standard

DC input

Stepping motor

Dimensions

Standard model

F series driver + F series motor

Motor flange size



Size	Motor flange size	□ 28mm (□ 1.10inch)	
		31mm (1.22inch)	50.5mm (1.99inch)
Set part number	Single shaft	FD351S	FD356S
	Double shaft	FD351D	FD356D
Holding torque	N·m(oz·in)	0.036 (5.10)	0.065 (9.20)
Rotor inertia	$\times 10^{-4}$ kg·m ² (oz·in ²)	0.009 (0.05)	0.016 (0.09)
Mass (Weight)	kg (lbs)	0.11 (0.22)	0.2 (0.44)
Allowable thrust load	N (lbs)	3 (0.68)	3 (0.68)
Allowable radial load ^(Note 1)	N (lbs)	34 (7.65)	34 (7.65)

(Note1) When load is applied at 1/3 length from output shaft edge.



DC24V

DC36V

Operating current:
0.75A/phase

- Pull-out torque
- - - Source current (load applied)
- - - Source current (no load)
- 1-division fs
- 2-division fs
- Fs: Maximum self-start frequency when not loaded
- 1-division
- 2-division

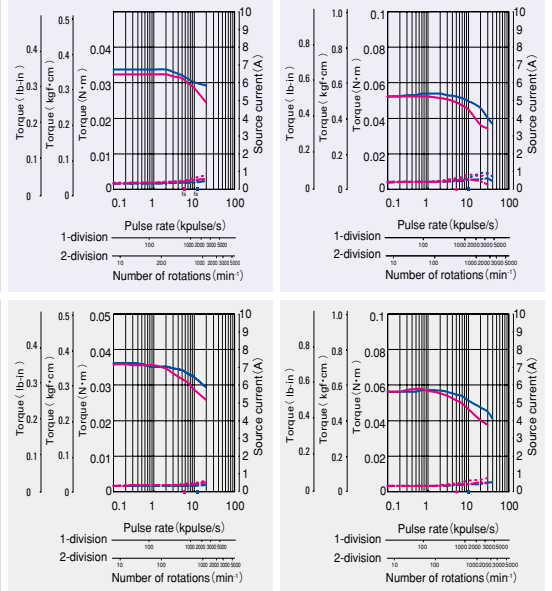

The data are measured under the drive condition of our company. The drive torque may vary depending on the accuracy of customer-side equipment.

Size	Motor flange size	□ 60mm (□ 2.36inch)		
		46.5mm (1.83inch)	55mm (2.17inch)	55mm (2.17inch)
Set part number	Single shaft	FD781S	FD782S	FD783S
	Double shaft	FD781D	FD782D	FD783D
Holding torque	N·m(oz·in)	0.6 (85.0)	0.98 (38.8)	1.79 (253.5)
Rotor inertia	$\times 10^{-4}$ kg·m ² (oz·in ²)	0.275 (1.50)	0.4 (2.19)	0.84 (4.59)
Mass (Weight)	kg (lbs)	0.6 (1.32)	0.78 (1.72)	1.36 (3.0)
Allowable thrust load	N (lbs)	20 (4.5)	20 (4.5)	20 (4.5)
Allowable radial load ^(Note 1)	N (lbs)	80 (18)	80 (18)	80 (18)

(Note1) When load is applied at 1/3 length from output shaft edge.

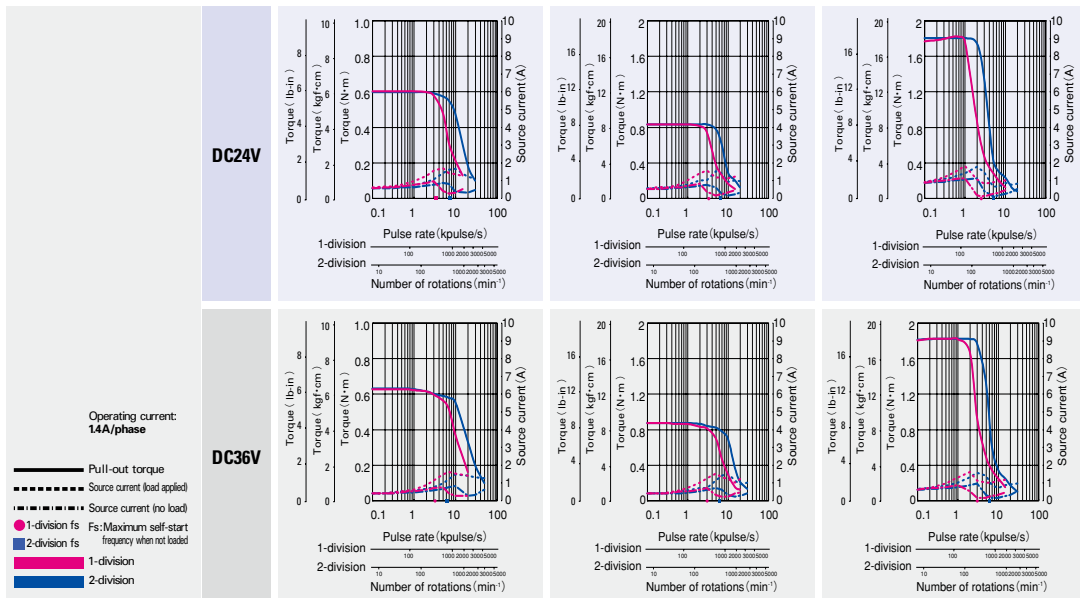

The data are measured under the drive condition of our company. The drive torque may vary depending on the accuracy of customer-side equipment.

Size	Motor flange size	□ 42mm (□ 1.65inch)		
	Motor length	34mm (1.34inch)	40mm (1.57inch)	49mm (1.93inch)
Set part number	Single shaft	FD551S	FD552S	FD554S
	Double shaft	FD551D	FD552D	FD554D
Holding torque	N·m(oz·in)	0.13 (18.41)	0.18 (25.49)	0.26 (36.82)
Rotor inertia	$\times 10^{-4}$ kg·m ² (oz·in ²)	0.03 (0.16)	0.053 (0.29)	0.065 (0.36)
Mass (Weight)	kg (lbs)	0.23 (0.50)	0.28 (0.62)	0.37 (0.81)
Allowable thrust load	N (lbs)	10 (2.25)	10 (2.25)	10 (2.25)
Allowable radial load ^(Note 1)	N (lbs)	35 (8.75)	35 (8.75)	35 (8.75)

(Note1) When load is applied at 1/3 length from output shaft edge.

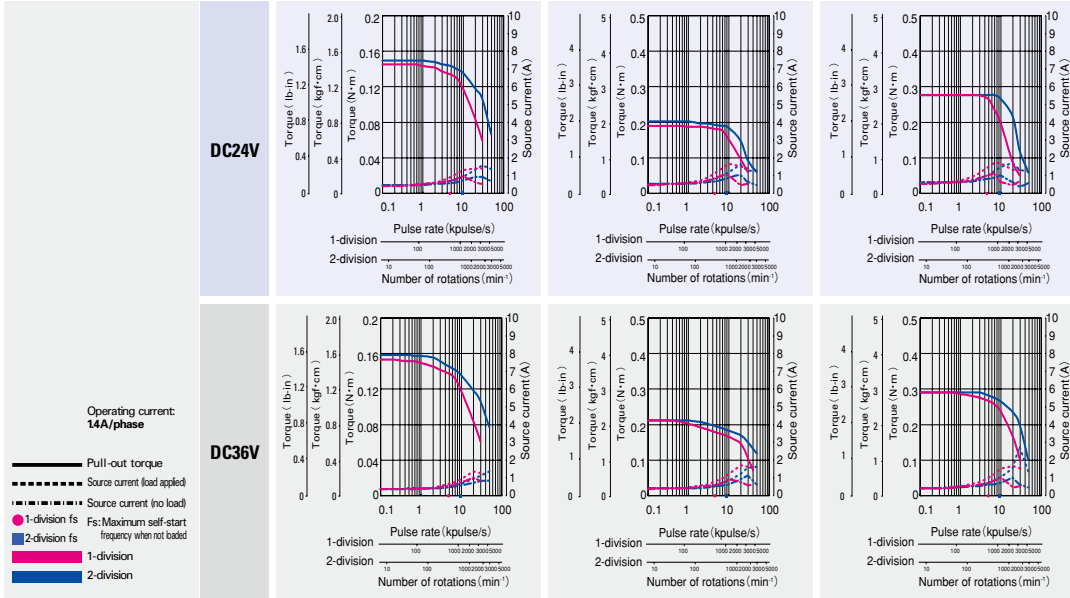

The data are measured under the drive condition of our company. The drive torque may vary depending on the accuracy of customer-side equipment.

Size	Motor flange size	φ 86mm (φ 3.39inch)	
	Motor length	62.15mm (2.47inch)	92.2mm (3.63inch)
Set part number	Single shaft	FD851S	FD852S
	Double shaft	FD851D	FD852D
Holding torque	N·m(oz·in)	2.06 (291.7)	4.02 (569.3)
Rotor inertia	$\times 10^{-4}$ kg·m ² (oz·in ²)	1.45 (7.93)	2.9 (15.86)
Mass (Weight)	kg (lbs)	1.5 (3.3)	2.5 (5.5)
Allowable thrust load	N (lbs)	60 (13.5)	60 (13.5)
Allowable radial load ^(Note 1)	N (lbs)	220 (49.5)	220 (49.5)

(Note1) When load is applied at 1/3 length from output shaft edge.

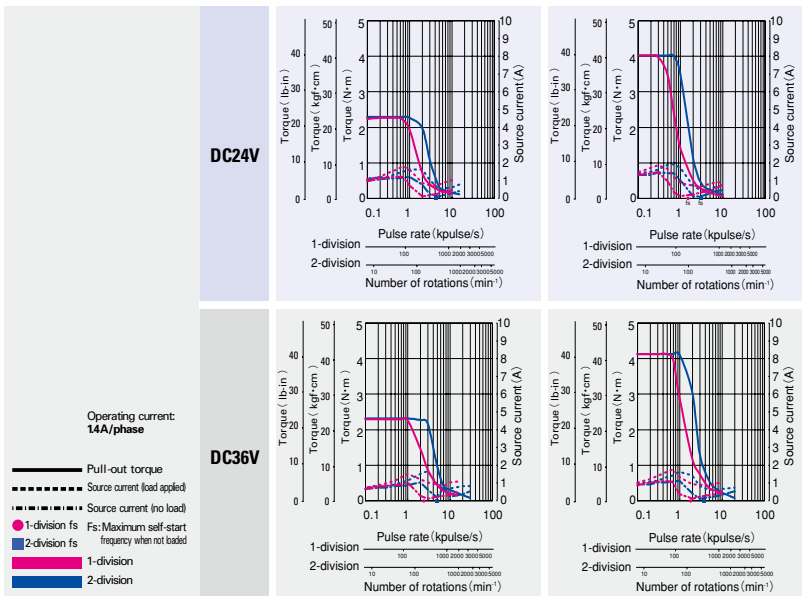

The data are measured under the drive condition of our company. The drive torque may vary depending on the accuracy of customer-side equipment.

Low-backlash gear model

F series driver +
F series motor with low-backlash gear

Motor flange size



Size	Motor flange size	□ 42mm (□ 1.65inch)	
	Motor + gear length	64.5mm (2.54inch)	64.5mm (2.54inch)
Set part number	Single shaft	FD551S-CX3.6	FD551S-CX7.2
	Double shaft	FD551D-CX3.6	FD551D-CX7.2
Allowable torque	N·m(oz·in)	0.35 (44.6)	0.7 (99.1)
Rotor inertia	×10 ⁻⁴ kg·m ² (oz·in ²)	0.03 (0.16)	0.03 (0.16)
Basic step angle		0.2	0.1
Gear ratio		1 : 3.6	1 : 7.2
Backlash	DEG	0.6	0.4
Allowable speed	min ⁻¹	500	250
Mass (Weight)	kg (lbs)	0.36 (0.79)	0.36 (0.79)
Allowable thrust load	N (lbs)	15 (3.38)	15 (3.38)
Allowable radial load ^(Note 1)	N (lbs)	20 (4.5)	20 (4.5)

Directions of motor rotation and gear output shaft are the same for models with reduction ratio 1 : 3.6, 1 : 7.2 and 1 : 10 opposite for reduction ratio 1 : 20, 1 : 30, and 1 : 36.

(Note1) When load is applied at 1/3 length from output shaft edge.

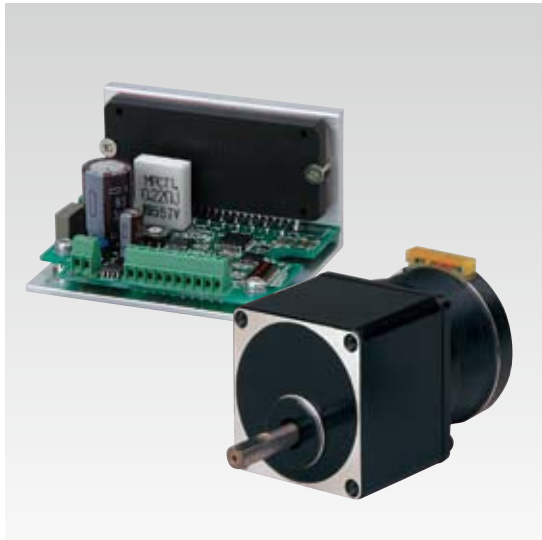

DC24V

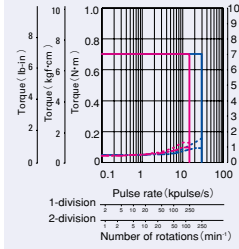
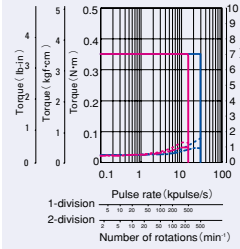

DC36V

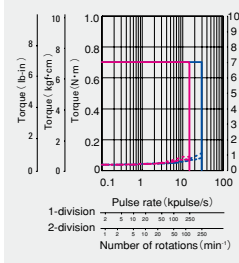
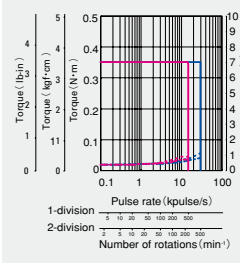

Operating current:
14A/phase

— Allowable torque
- - - Source current (load applied)
- · - · - Source current (no load)

■ 1-division
■ 2-division

The data are measured under the drive condition of our company. The drive torque may very depending on the accuracy of customer-side equipment.

Size	Motor flange size	□ 60mm (□ 2.36inch)			
	Motor + gear length	92mm (3.62inch)	92mm (3.62inch)	92mm (3.62inch)	92mm (3.62inch)
Set part number	Single shaft	FD781S-CX7.2	FD781S-CX10	FD781S-CX20	FD781S-CX30
	Double shaft	FD781D-CX7.2	FD781D-CX10	FD781D-CX20	FD781D-CX30
Allowable torque	N·m(oz·in)	2.5 (354.0)	3 (424.8)	3.5 (495.6)	4 (566.4)
Rotor inertia	×10 ⁻⁴ kg·m ² (oz·in ²)	0.275 (1.5)	0.275 (1.5)	0.275 (1.5)	0.275 (1.5)
Basic step angle		0.1	0.072	0.036	0.024
Gear ratio		1 : 7.2	1 : 10	1 : 20	1 : 30
Backlash	DEG	0.25	0.25	0.17	0.30
Allowable speed	min ⁻¹	250	180	90	60
Mass (Weight)	kg (lbs)	0.97 (2.13)	0.97 (2.13)	0.97 (2.13)	0.97 (2.13)
Allowable thrust load	N (lbs)	30 (6.75)	30 (6.75)	30 (6.75)	30 (6.75)
Allowable radial load ^(Note 1)	N (lbs)	100 (22.5)	100 (22.5)	100 (22.5)	100 (22.5)

Directions of motor rotation and gear output shaft are the same for models with reduction ratio 1 : 3.6 and 1:7.2, opposite for reduction ratio 1 : 10, 1 : 20 and 1 : 30. (Note1) When load is applied at 1/3 length from output shaft edge.

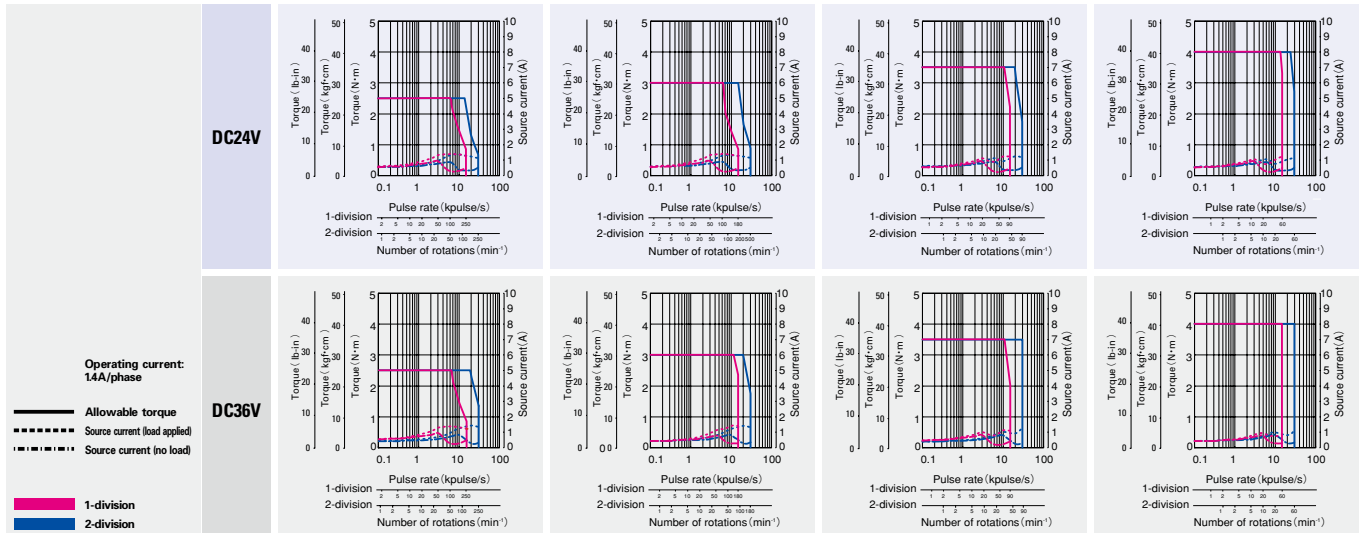

The data are measured under the drive condition of our company. The drive torque may very depending on the accuracy of customer-side equipment.

□ 42mm (□ 1.65inch)

□ 60mm (□ 2.36inch)

64.5mm (2.54inch)	64.5mm (2.54inch)	64.5mm (2.54inch)	64.5mm (2.54inch)	92mm (3.62inch)
DFD551S-CX10	DFD551S-CX20	DFD551S-CX30	DFD551S-CX36	DFD781S-CX3.6
DFD551D-CX10	DFD551D-CX20	DFD551D-CX30	DFD551D-CX36	DFD781D-CX3.6
1 (141.6)	1.5 (212.4)	1.5 (212.4)	1.5 (212.4)	1.25 (177.0)
0.03 (0.16)	0.03 (0.16)	0.03 (0.16)	0.03 (1.5)	0.275
0.072	0.036	0.024	0.02	0.2
1 : 10	1 : 20	1 : 30	1 : 36	1 : 3.6
0.35	0.25	0.25	0.25	0.55
180	90	60	50	500
0.36 (0.79)	0.36 (0.79)	0.36 (0.79)	0.36 (0.79)	0.97 (2.13)
15 (3.38)	15 (3.38)	15 (3.38)	15 (3.38)	30 (6.75)
20 (4.5)	20 (4.5)	20 (4.5)	20 (4.5)	100 (22.5)

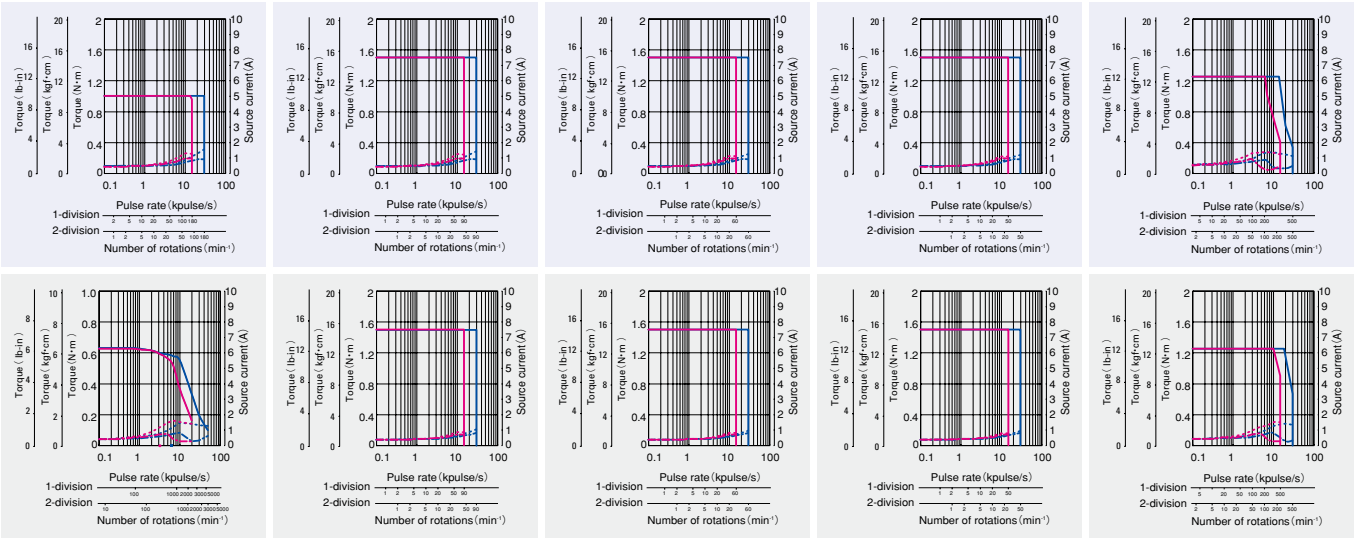

□ 60mm (□ 2.36inch)

φ 86mm (φ 3.39inch)

92mm (3.62inch)	127.3mm (5.01inch)	127.3mm (5.01inch)	127.3mm (5.01inch)	127.3mm (5.01inch)
DFD781S-CX36	DFD851S-CX3.6	DFD851S-CX7.2	DFD851S-CX10	DFD851S-CX20
DFD781D-CX36	DFD851D-CX3.6	DFD851D-CX7.2	DFD851D-CX10	DFD851D-CX20
4 (566.4)	4.5 (637.2)	9 (1274.5)	9 (1274.5)	12 (1699.3)
0.275 (1.51)	1.45 (7.93)	1.45 (7.93)	1.45 (7.93)	1.45 (7.93)
0.02	0.2	0.1	0.072	0.036
1 : 36	1 : 3.6	1 : 7.2	1 : 10	1 : 20
0.17	0.4	0.25	0.25	0.17
50	500	250	180	90
0.97 (2.13)	2.7 (5.94)	2.7 (5.94)	2.7 (5.94)	2.7 (5.94)
30 (6.75)	60 (13.5)	60 (13.5)	60 (13.5)	60 (13.5)
100 (22.5)	300 (67.5)	300 (67.5)	300 (67.5)	300 (67.5)

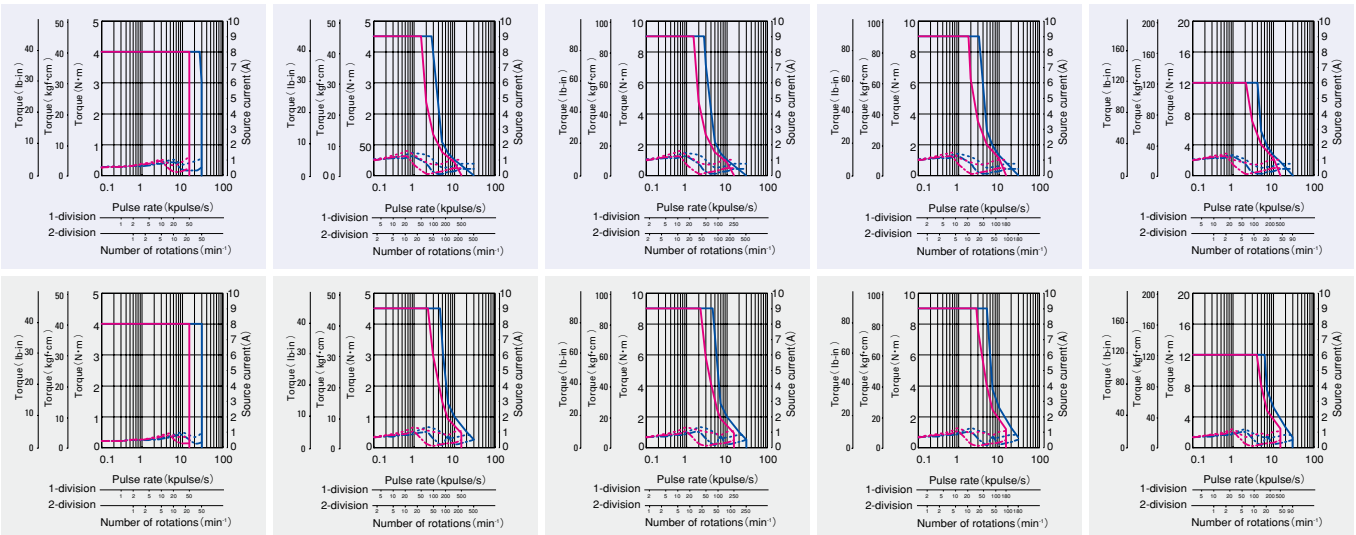

AC input

Input / Output signal standard

DC input

Stepping motor

Dimensions

Low-backlash gear model

F series driver +
F series motor with low-backlash gear

Size	Motor flange size	φ 86mm (φ 3.39inch)	
		127.3mm (5.01inch)	127.3mm (5.01inch)
Set part number	Motor + gear length	127.3mm (5.01inch)	127.3mm (5.01inch)
	Single shaft	FD851S-CX30	FD851S-CX36
Allowable torque	Double shaft	FD851D-CX30	FD851D-CX36
	N·m(oz·in)	12 (1699.3)	12 (1699.3)
Rotor inertia	×10 ⁻⁴ kg·m ² (oz·in ²)	1.45 (7.93)	1.45 (7.93)
Basic step angle		0.024	0.02
Gear ratio		1 : 30	1 : 36
Backlash	DEG	0.17	0.15
Allowable speed	min ⁻¹	60	50
Mass (Weight)	kg (lbs)	2.7 (5.94)	2.7 (5.94)
Allowable thrust load	N (lbs)	60 (13.5)	60 (13.5)
Allowable radial load ^(Note 1)	N (lbs)	300 (67.5)	300 (67.5)

Directions of motor rotation and gear output shaft are the same for models with reduction ratio 1 : 3.6, opposite for reduction ratio 1 : 10, 1 : 20, 1 : 30, and 1 : 36.
(Note1) When load is applied at 1/3 length from output shaft edge.

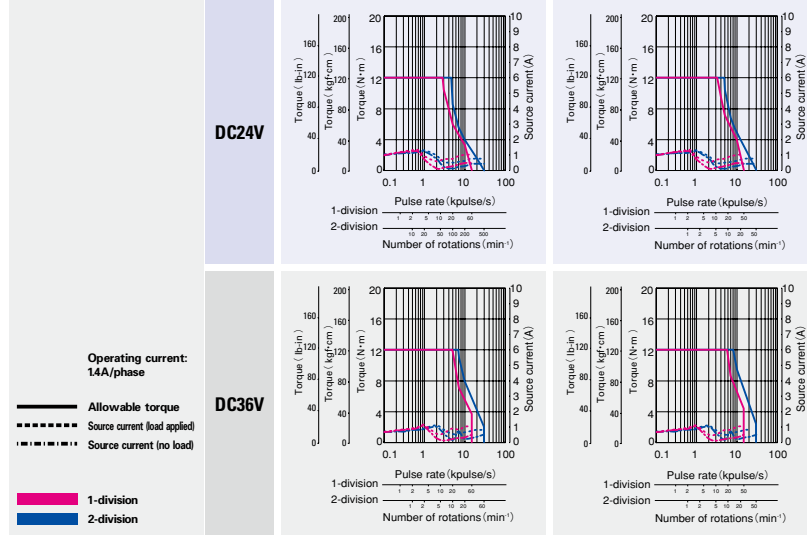

The data are measured under the drive condition of our company. The drive torque may vary depending on the accuracy of customer-side equipment.

Spur gear model

F series driver + F series motor with spur gear

Motor flange size

□28
(~1.10inch)

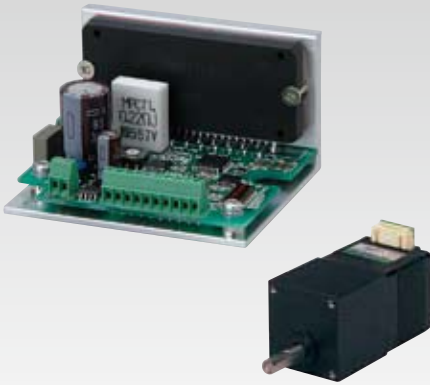

Size	Motor flange size	□28mm (□1.10inch)	
	Motor + gear length	60.3mm (2.37inch)	60.3mm (2.37inch)
Set part number	Single shaft	FD351S-GX3.6	FD351S-GX7.2
	Double shaft	FD351D-GX3.6	FD351D-GX7.2
Allowable torque	N·m(oz·in)	0.1 (14.16)	0.15 (21.24)
Rotor inertia	$\times 10^{-4}$ kg·m ² (oz·in ²)	0.009 (0.05)	0.009 (0.05)
Basic step angle		0.2	0.1
Gear ratio		1 : 3.6	1 : 7.2
Backlash	DEG	2	2
Allowable speed	min ⁻¹	800	400
Mass (Weight)	kg (lbs)	0.17 (0.37)	0.17 (0.37)
Allowable thrust load	N (lbs)	10 (2.25)	10 (2.25)
Allowable radial load ^(Note 1)	N (lbs)	15 (3.38)	15 (3.38)

Directions of motor rotation and gear output shaft are the same for models with reduction ratio 1 : 3.6, 1 : 7.2, 1 : 30 and 1 : 50 opposite for reduction ratio 1 : 10.
(Note1) When load is applied at 1/3 length from output shaft edge.

DC24V

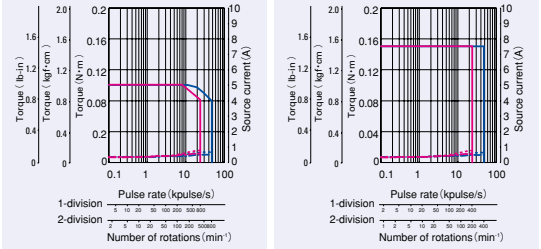

DC36V

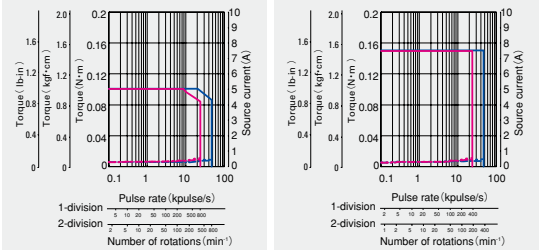

Operating current:
0.75A/phase

— Allowable torque
- - - Source current (load applied)
- · - · - Source current (no load)

■ 1-division
■ 2-division

The data are measured under the drive condition of our company. The drive torque may very depending on the accuracy of customer-side equipment.

Size	Motor flange size	□28mm (□1.10inch)			
	Motor + gear length	60.3mm (2.37inch)	60.3mm (2.37inch)	60.3mm (2.37inch)	60.3mm (2.37inch)
Set part number	Single shaft	FD351S-CX10	FD351S-CX20	FD351S-CX30	FD351S-CX50
	Double shaft	FD351D-CX10	FD351D-CX20	FD351D-CX30	FD351D-CX50
Allowable torque	N·m(oz·in)	0.2 (28.32)	0.35 (49.6)	0.5 (70.80)	0.5 (70.80)
Rotor inertia	$\times 10^{-4}$ kg·m ² (oz·in ²)	0.009 (0.05)	0.009 (0.05)	0.009 (0.05)	0.009 (0.05)
Basic step angle		0.072	0.036	0.024	0.0144
Gear ratio		1 : 10	1 : 20	1 : 30	1 : 50
Backlash	DEG	2	1.5	1.5	1.5
Allowable speed	min ⁻¹	300	150	100	60
Mass (Weight)	kg (lbs)	0.17 (0.37)	0.17 (0.37)	0.17 (0.37)	0.17 (0.37)
Allowable thrust load	N (lbs)	10 (2.25)	10 (2.25)	10 (2.25)	10 (2.25)
Allowable radial load ^(Note 1)	N (lbs)	15 (3.38)	15 (3.38)	15 (3.38)	15 (3.38)

Directions of motor rotation and gear output shaft are the same for models with reduction ratio 1 : 3.6, 1 : 7.2, 1 : 30, and 1 : 50 opposite for reduction ratio 1 : 10.
(Note1) When load is applied at 1/3 length from output shaft edge.

DC24V

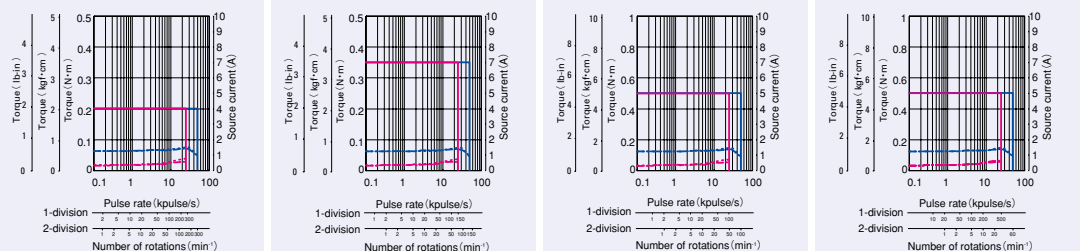

DC36V

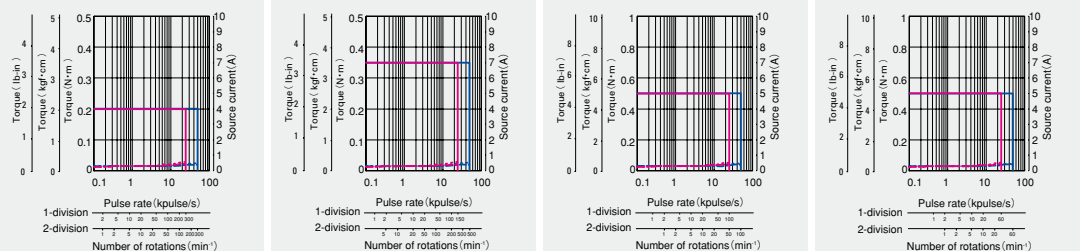

The data are measured under the drive condition of our company. The drive torque may very depending on the accuracy of customer-side equipment.

Harmonic gear model

F series driver +
F series motor with harmonic gear

Motor flange size



Size	Motor flange size		
	Motor + gear length	□ 28mm (□ 1.10inch)	
Set part number	Single shaft	69.5mm (2.74inch)	69.5mm (2.74inch)
	Double shaft	FD F351S-HX50	FD F351S-HX100
Allowable torque	N·m(oz·in)	1.5 (212.4)	2 (283.2)
	Momentary allowable torque N·m(oz·in)	2.7 (382.4)	3.6 (509.8)
Rotor inertia	×10 ⁻⁴ kg·m ² (oz·in ²)	0.012 (0.066)	0.012 (0.066)
Basic step angle		0.0144	0.0072
Gear ratio		1 : 50	1 : 100
Lost motion	Minute	0.4 to 3 ± 0.006N · m (0.85oz · in)	0.4 to 3 ± 0.008N · m (1.133oz · in)
Allowable speed	min ⁻¹	70	35
Mass (Weight)	kg (lbs)	0.22 (0.48)	0.22 (0.48)
Allowable thrust load	N (lbs)	100 (22.5)	100 (22.5)
Allowable radial load ^(Note 1)	N (lbs)	160 (36)	160 (36)

Directions of gear output shaft are the opposite.
(Note1) When load is applied at 1/3 length from output shaft edge.



DC24V

DC36V

Operating current:
0.75A/phase

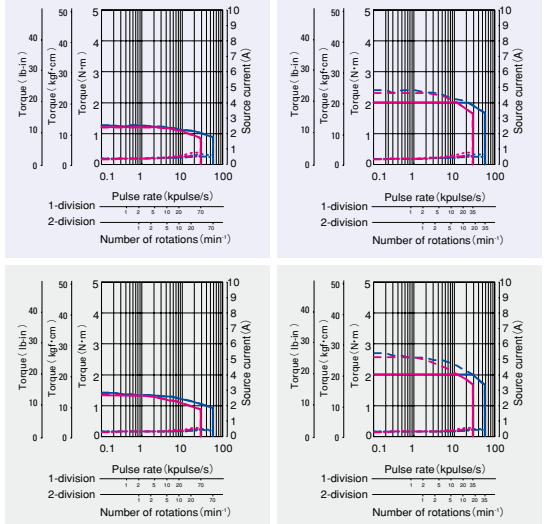
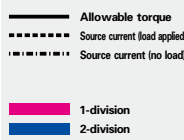

The data are measured under the drive condition of our company. The drive torque may very depending on the accuracy of customer-side equipment.

Size	Motor flange size		□ 60mm (□ 2.36inch)		φ 86mm (φ 3.39inch)	
	Motor + gear length		113.5mm (4.47inch)	113.5mm (4.47inch)	144.15mm (5.68inch)	144.15mm (5.68inch)
Set part number	Single shaft		FD F781S-HX50	FD F781S-HX100	FD F851S-HX50	FD F851S-HX100
	Double shaft		FD F781D-HX50	FD F781D-HX100	FD F851D-HX50	FD F851D-HX100
Allowable torque	N·m(oz·in)		5.5 (778.8)	8 (1132.9)	25 (3540.2)	41 (5805.9)
	Momentary allowable torque N·m(oz·in)		14 (1982.6)	20 (2832.2)	34 (4814.8)	59 (8355.1)
Rotor inertia	×10 ⁻⁴ kg·m ² (oz·in ²)		0.31 (1.695)	0.31 (1.695)	1.65 (9.02)	1.65 (9.02)
Basic step angle			0.0144	0.0072	0.0144	0.0072
Gear ratio			1 : 50	1 : 100	1 : 50	1 : 100
Lost motion	Minute		0.4 to 3 ± 0.28N · m (3.965oz · in)	0.4 to 3 ± 0.4N · m (56.645oz · in)	0.4 to 3 ± 1N · m (141.612oz · in)	0.4 to 3 ± 1.2N · m (169.934oz · in)
Allowable speed	min ⁻¹		70	35	70	35
Mass (Weight)	kg (lbs)		1.2 (2.64)	1.2 (2.64)	3.3 (7.26)	3.3 (7.26)
Allowable thrust load	N (lbs)		400 (90)	400 (90)	1400 (315)	1400 (315)
Allowable radial load ^(Note 1)	N (lbs)		360 (81)	360 (81)	1380 (310.5)	1380 (310.5)

Directions of gear output shaft are the opposite.
(Note1) When load is applied at 1/3 length from output shaft edge.

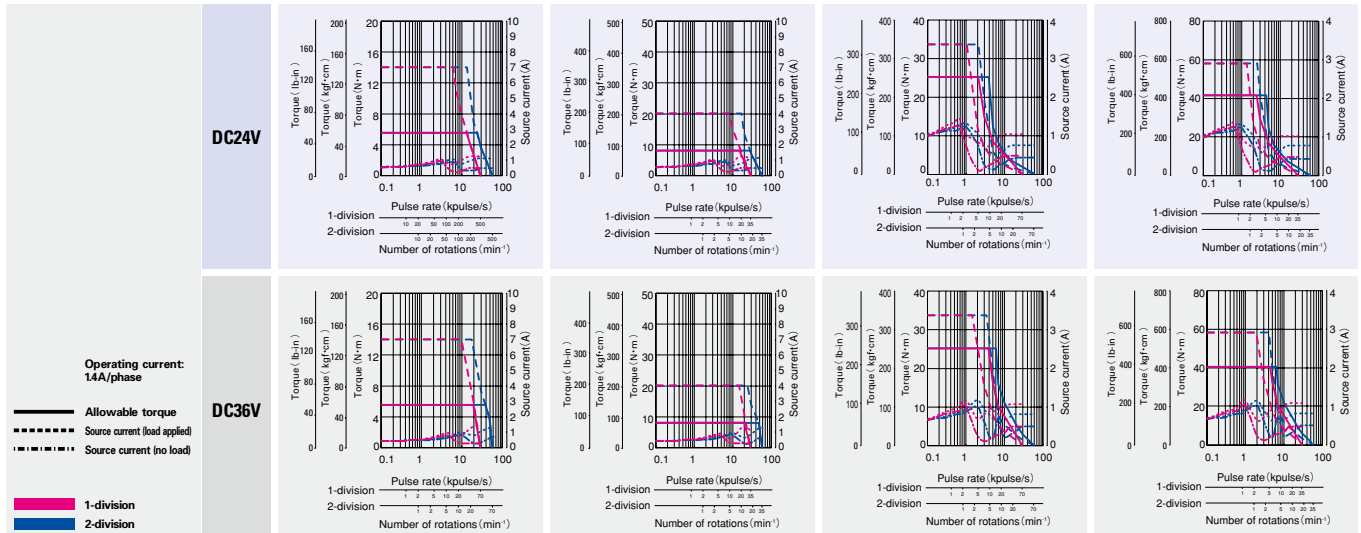

The data are measured under the drive condition of our company. The drive torque may very depending on the accuracy of customer-side equipment.

Size	Motor flange size	□ 42mm (□ 1.65inch)		
	Motor + gear length	73.5mm (2.89inch)	73.5mm (2.89inch)	73.5mm (2.89inch)
Set part number	Single shaft	FDF551S-HX30	FDF551S-HX50	FDF551S-HX100
	Double shaft	FDF551D-HX30	FDF551D-HX50	FDF551D-HX100
Allowable torque	N·m(oz·in)	2.2 (311.547)	3.5 (495.643)	5 (708.061)
Momentary allowable torque	N·m(oz·in)	4.5 (637.3)	8.3 (1175.4)	11 (1557.7)
Rotor inertia	$\times 10^4 \text{kg}\cdot\text{m}^2(\text{oz}\cdot\text{in}^2)$	0.042 (0.23)	0.042 (0.23)	0.072 (0.39)
Basic step angle		0.024	0.0144	0.0144
Gear ratio		1 : 30	1 : 50	1 : 100
Lost motion	Minute	0.4 to 1.5 ± 0.16N·m (22.658oz·in) *reference	0.4 to 1.5 ± 0.16N·m (22.658oz·in) *reference	0.4 to 1.5 ± 0.2N·m (28.322oz·in) *reference
Hysteresis loss	Minute	3.6	2.4	2.4
Allowable speed	min ⁻¹	116	70	35
Mass (Weight)	kg (lbs)	0.42 (0.92)	0.42 (0.92)	0.42 (0.92)
Allowable thrust load	N (lbs)	1150 (258.75)	1150 (258.75)	1150 (258.75)
Allowable radial load ^(Note 1)	N (lbs)	275 (61.88)	275 (61.88)	275 (61.88)

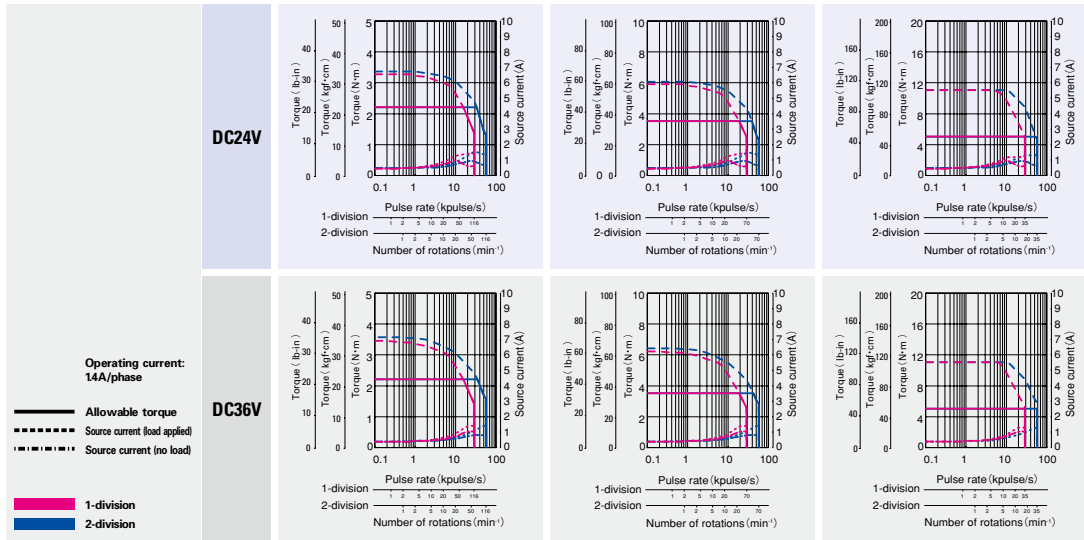

Electromagnetic brake model

F series driver +
F series motor with electromagnetic brake

Motor flange size



Size	Motor flange size	□ 42mm (□ 1.65inch)		
	Motor + brake length	64.5mm (2.54inch)	70.5mm (2.78inch)	
Set part number	Single shaft	FD551S-XB	FD552S-XB	
		FD551D-XB	FD552D-XB	
Holding torque	N·m(oz·in)	0.13 (8.4)	0.18 (25.49)	
Rotor inertia	×10 ⁻⁴ kg·m ² (oz·in ²)	0.045 (0.25)	0.068 (0.37)	
Mass (Weight)	kg (lbs)	0.38 (0.84)	0.43 (0.95)	
Allowable thrust load	N (lbs)	10 (2.25)	10 (2.25)	
Allowable radial load ^(Note 1)	N (lbs)	35 (8.75)	35 (8.75)	
Brake type		No excitation actuating type	No excitation actuating type	
Electromagnetic brake	Power supply input	V	DC24V ± 5%	
	Excitation current	A	0.08	
	Power consumption	W	2	
	Static friction torque	N·m(oz·in)	0.22 (31.15)	0.22 (31.15)
	Brake operating time	ms	30	30
Brake release time	ms	20	20	

(Note1) When load is applied at 1/3 length from output shaft edge.

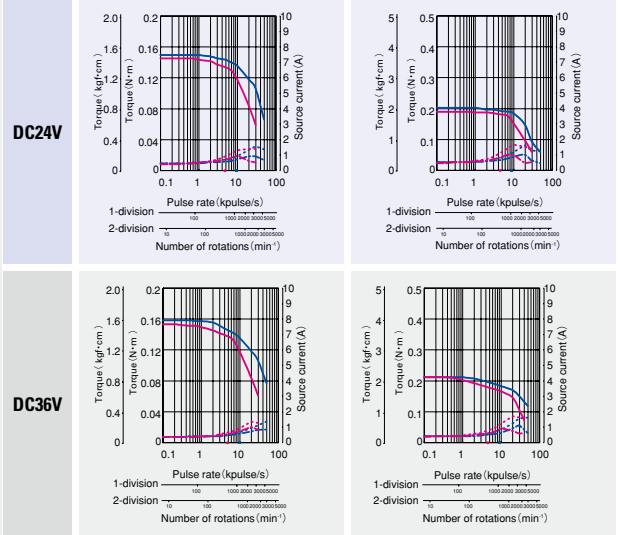
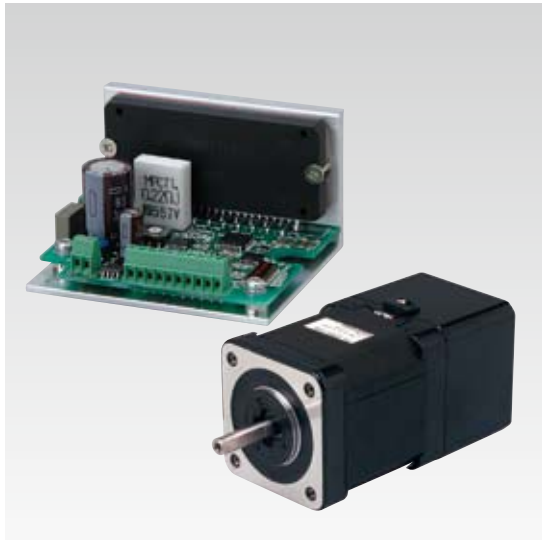

The data are measured under the drive condition of our company. The drive torque may very depending on the accuracy of customer-side equipment.

Size	Motor flange size	φ 86mm (φ 3.39inch)	
	Motor + brake length	146.8mm (5.78mm)	
Set part number	Single shaft	FD852S-XB	
		FD852D-XB	
Holding torque	N·m(oz·in)	4.02 (569.3)	
Rotor inertia	×10 ⁻⁴ kg·m ² (oz·in ²)	3.69 (20.18)	
Mass (Weight)	kg (lbs)	4.5 (9.9)	
Allowable thrust load	N (lbs)	60 (13.5)	
Allowable radial load ^(Note 1)	N (lbs)	220 (49.5)	
Brake type		No excitation actuating type	
Electromagnetic brake	Power supply input	V	DC24V ± 5%
	Excitation current	A	0.42
	Power consumption	W	10
	Static friction torque	N·m(oz·in)	4 (566.45)
	Brake operating time	ms	50
Brake release time	ms	20	

(Note1) When load is applied at 1/3 length from output shaft edge.

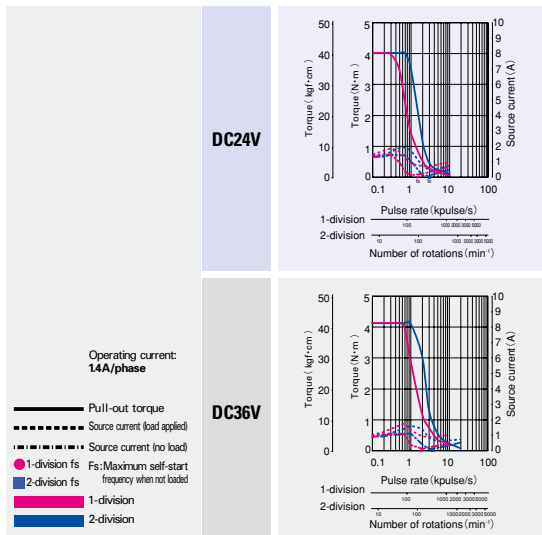

□ 42mm (□ 1.65inch)	□ 60mm (□ 2.36inch)			φ 86mm (φ 3.39inch)
79.5mm (3.13inch)	85.8mm (3.38inch)	94.5mm (3.72inch)	126.7mm (4.99inch)	116.7mm (4.59inch)
FD554S-XB	FD781S-XB	FD782S-XB	FD783S-XB	FD851S-XB
FD552D-XB	FD781D-XB	FD782D-XB	FD783D-XB	FD851D-XB
0.26 (36.82)	0.6 (85.0)	0.98 (138.8)	1.79 (253.5)	2.06 (291.7)
0.08 (0.44)	0.43 (2.35)	0.56 (3.06)	1 (5.47)	2.24 (12.25)
0.52 (1.14)	0.94 (2.07)	1.12 (2.46)	1.7 (3.74)	3.5 (7.7)
10 (2.25)	20 (4.5)	20 (4.5)	20 (4.5)	60 (13.5)
35 (8.75)	80 (18)	80 (18)	80 (18)	220 (49.5)
No excitation actuating type	No excitation actuating type	No excitation actuating type	No excitation actuating type	No excitation actuating type
DC24V ± 5%	DC24V ± 5%	DC24V ± 5%	DC24V ± 5%	DC24V ± 5%
0.08	0.25	0.25	0.25	0.42
2	6	6	6	10
0.22 (31.15)	0.8 (113.29)	0.8 (113.29)	0.8 (113.29)	4 (566.45)
30	30	30	30	50
20	20	20	20	20

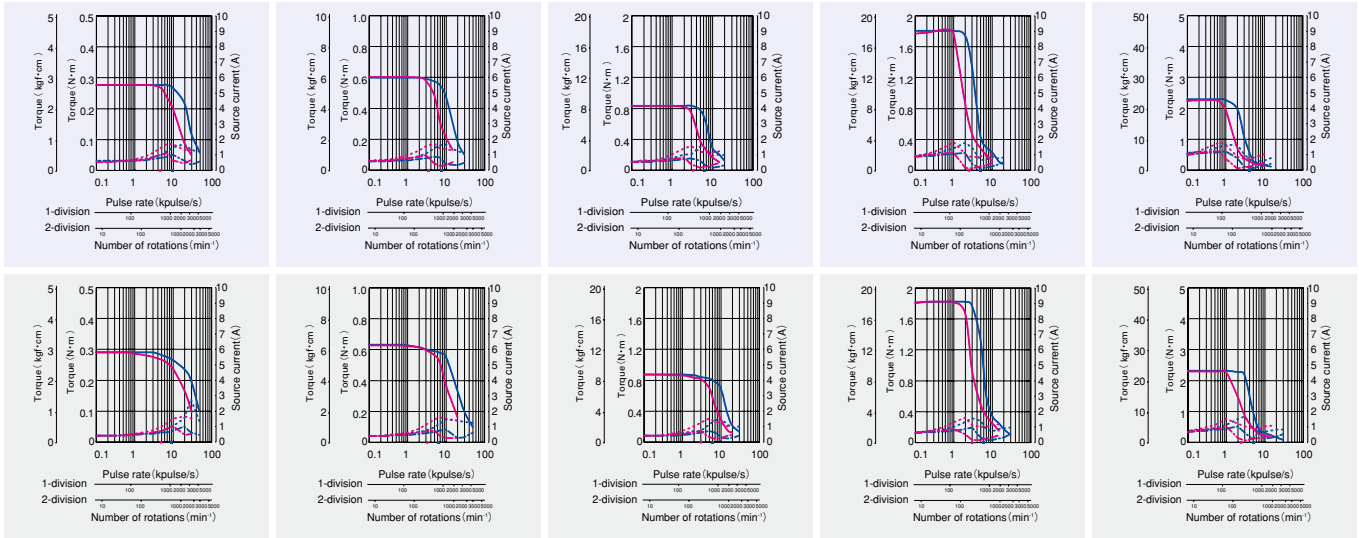

Common specifications

F series driver

Basic specifications	Item	FS1D140P □□	
	Power supply	DC24 V / 36 V ±10 %	
	Source current	3 A MAX.	
	Environment	Protection class	Class III
		Operation environment	Installation category (over-voltage category) : I , pollution degree: 2
		Applied standards	EN61010-1, UL508C
		Ambient operation temperature	0 to 50°C
		Storage temperature	-20 to +70°C
		Ambient operation humidity	35 to 85%RH (no condensation)
		Storage humidity	10 to 90%RH (no condensation)
		Operation altitude	1000 m (3280 feet) or less above sea level
		Vibration resistance	Tested under the following conditions ; 4.9m/s ² , frequency range 10 to 55Hz, direction along X, Y and Z axes, for 2 hours each
		Impact resistance	Not influenced at NDS-C-0110 standard section 3.2.2 division "C" .
Withstand voltage	Not influenced when 1500V AC is applied between power input terminal and cabinet for one minute.		
Insulation resistance	10M ohm MIN. when measured with 500V DC megohmmeter between input terminal and cabinet.		
Mass (Weight)	0.1kg (0.05lbs)		
Functions	Selection function	Step angle, pulse input method, step current, non-operating current, and operating current	
	Protection functions	Open phase protection	
	LED indication	Power monitor, alarm	
I/O signals	Command pulse input signal	Photo-coupler input system ; input resistance: 220 Ω ; input-signal "H" level : 4.0 to 5.5V ; input-signal "L" level : 0 to 0.5V, MAX. input frequency : 35kpulse/s	
	Power down input signal	Photo-coupler input system ; input resistance: 220 Ω ; input-signal "H" level : 4.0 to 5.5V ; input-signal "L" level : 0 to 0.5V	
	Input signal	Open collector output by photo coupler, output signal standard, V _{ceo} = 40V MAX., I _c = 10 mA MAX.	
	Output signal	Open collector output by photo coupler, output signal standard, V _{ceo} = 40V MAX., I _c = 10 mA MAX.	

F series motor

Stepping motor type	F series motor
Motor Type	103F35□□ /103F55□□ /103F785□ /103F858□ /103F8958□
Type	—
Insulation class	Class B (+130°C)
Operation altitude	1000m (3280 feet) or less above sea level
Withstand voltage	□ 28mm (□ 1.10inch) : AC1000V 50/60Hz for 1 minute, □ 42mm (□ 1.65inch) , □ 60mm (□ 2.36inch) , ° 86mm (° 3.39inch) , ° 106mm (° 4.17inch) : AC1500V 50/60Hz for 1 minute
Insulation resistance	100Mohm MIN. against DC500V
Protection grade	IP40
Vibration resistance	Amplitude of 1.52mm (0.06inch) (P-P) at frequency range 10 to 500Hz for 15 minutes sweep time along X, Y, and Z axes for 12 times.
Impact resistance	490m/s ² of acceleration for 11 ms with half-sine wave applying three times for X, Y, and Z axes each, 18 times in total.
Ambient operation temperature	-10 to +50°C (0 to +40°C for harmonic gear model)
Ambient operation humidity	90% MAX. at less than 40°C, 57% MAX. at less than 50°C , 35% MAX. at 60°C (no condensation)

External wiring diagram

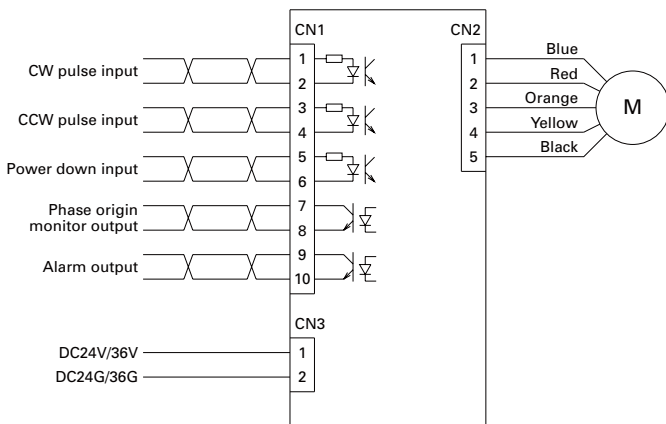

Specification summary of CN1 I/O signal

Signal name	CN1 Pin number	Function
CW pulse input (standard)	1	When using "2-input mode"
	2	Drive pulse for the CW direction rotation is input.
Pulse column input	1	When using "Pulse and direction mode"
	2	Drive pulse train for the stepping motor rotation is input.
CCW pulse input (standard)	3	When using "2-input mode"
	4	Drive pulse for the CCW direction rotation is input.
Rotation direction input	3	The rotation direction signal of stepping motor is input for the "Pulse and direction mode".
	4	Internal photocoupler ON...CW direction Internal photocoupler OFF...CCW direction
Power down input	5	Inputting the PD signal cuts OFF the current flowing through the stepping motor.
	6	internal photocoupler ON...PD function enabled internal photocoupler OFF...PD function disabled
Phase origin monitor output	7	It is turned ON when the excitation phase is at the origin (in the state when the power is turned ON)
	8	It is turned ON once per 10 pulses when setting to HALF step.
	8	It is turned ON once per 20 pulses when setting to FULL step.
Alarm output	9	The signal is externally output when one of several alarm circuits operates in the PM driver. At this time, the stepping motor is in the unexcited state.
	10	

The CW rotation direction of stepping motor means the clockwise direction rotation as viewed from the output shaft side (flange side) . The CCW rotation direction means the counterclockwise direction rotation as viewed from the output shaft side (flange side) .

Applicable wire sizes

Part	size	Allowable wire length
Power supply	AWG22(0.3mm ²)	2m MAX.
Input/output signal	AWG24(0.2mm ²) to AWG22(0.3mm ²)	photo coupler type : 2m MAX.
Motor	AWG22(0.3mm ²)	3m MIN.

Driver part name

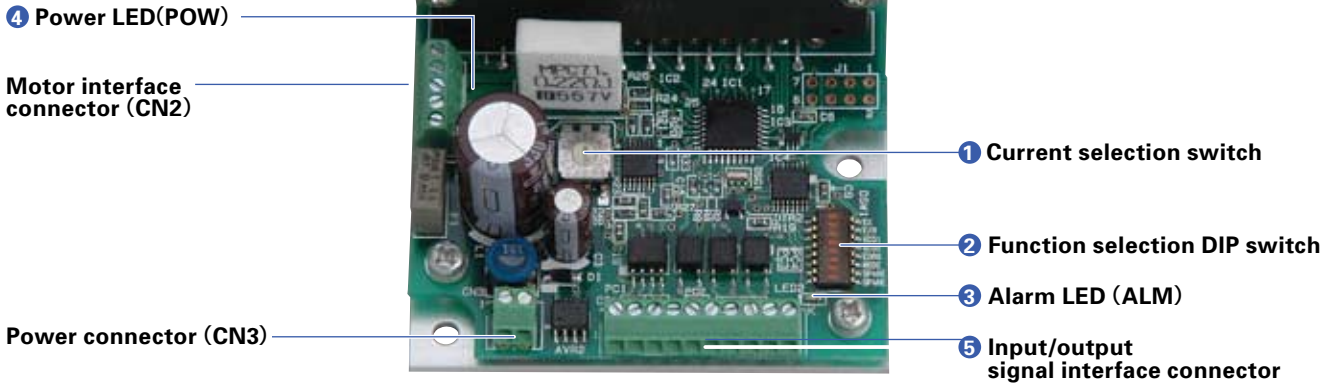

1 Current selection switch (RUN)

Enable to select operating current value to stepping motor.

Dial	0	1	2	3	4	5	6	7
Stepping motor current (A)	1.4	1.35	1.3	1.25	1.2	1.15	1.1	1.05
Dial	8	9	A	B	C	D	E	F
Stepping motor current (A)	1.0	0.95	0.9	0.85	0.8	0.75	0.7	0.65

3 Power LED (POW)

Lights up when main circuit power supply is switched on.

Indicator	Explanation
"POW" is displayed.	Main circuit power supply is switched on.

2 Function selection DIP switch

Selects an appropriate function for specification. Check that the ex-factory settings are as follows.

	OFF	ON	
EX	<input type="checkbox"/>	<input type="checkbox"/>	Half step
F/R	<input type="checkbox"/>	<input type="checkbox"/>	2-input mode (CW, CCW pulse-input method)
ACD1	<input type="checkbox"/>	<input type="checkbox"/>	Stopping current : 40% of driving current
ACD2	<input type="checkbox"/>	<input type="checkbox"/>	
EORG	<input type="checkbox"/>	<input type="checkbox"/>	Phase crigin
MODE	<input type="checkbox"/>	<input type="checkbox"/>	Reservation : Don't turn it ON.
SPARE	<input type="checkbox"/>	<input type="checkbox"/>	
SPARE	<input type="checkbox"/>	<input type="checkbox"/>	

4 Alarm LED (ALM)

Lights up during alarm conditions.

Indicator	Explanation
"ALM" is displayed.	Motor cable is broken, or switching element in driver is faulty. The main circuit voltage is out of specifications range (Less than DC19V).

When "ALM" is displayed, the winding current of the stepping motor is cut off and it is in a "non-excitation" state. At the same time, an output signal is transmitted from the alarm output terminal (AL) to an external source. When the alarm circuit is operating, this state is maintained until it is reset by switching on the power supply again. When an alarm condition has occurred, please take corrective actions to rectify the cause of the alarm before switching on the power supply again.

Step angle selection (EX)

Selects the basic step angle.

EX	Exciting mode
ON	Full step (0.72° /pulse)
OFF	Half step (0.36° /pulse)

Input method select (F/R)

Selects input pulse type.

F/R	Input pulse type
ON	1 input (pulse & direction)
OFF	2 input (CW, CCW)

Current adjustment at operation halt (ACD1, ACD2)

Selects the value of the motor current during stand-still.

ACD2	ACD1	Motor current
ON	ON	100% of driving current
ON	OFF	60% of driving current
OFF	ON	50% of driving current
OFF	OFF	40% of driving current

Initial configuration of factory shipment is set to A(50% of rated value). Driver and motor should be operated at around 50% of rated value to reduce heat.

Excitation select (EORG)

The excitation phasse when the power supply is turned on is selected.

EORG	Original excitation phase
ON	Excitation phase at power shut off
OFF	Phase origin

By turning on the EORG, excitation phase when power OFF will be saved. Therefore, there will be no shaft displacement when turning the power ON.

Input circuit configuration of CW (CK), CCW (U/D)

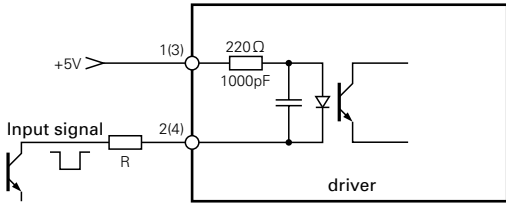

- Pulse duty 50% MAX.
- Maximum input frequency: 35kpulse/s
- When the crest value of the input signal exceeds 5V, use the external limit resistance R to limit the input current to approximately 15mA.

Input signal specification

(Photo coupler)

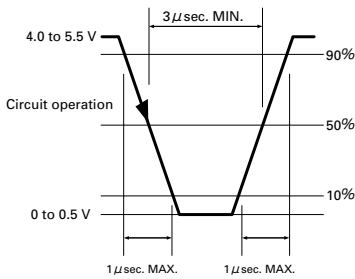

Timing of command pulse

2 input type (CW, CCW)

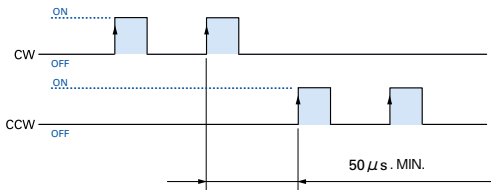

- Shaded area indicates internal photo coupler "ON". Internal circuit (motor) starts operating at leading edge of the photo coupler "ON".
- To apply pulse to CW, set CCW side internal photo coupler to "OFF".
- To apply pulse to CCW, set CW side internal photo coupler to "OFF".

1 input type (CW, U/D)

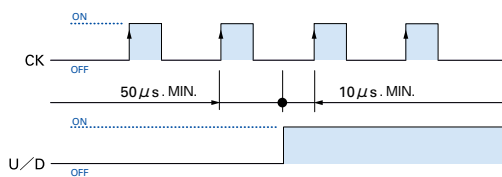

- Shaded area indicates internal photo coupler "ON". Internal circuit (motor) starts operating at leading edge of CK side photo coupler "ON".
- Switching of U/D input signal must be done while CK side internal photo coupler is "OFF".

Input circuit configuration of PD

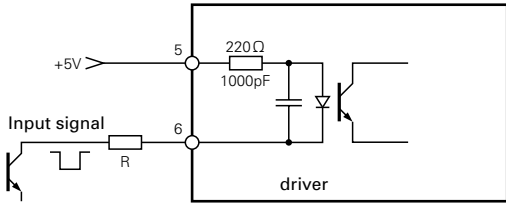

- If the peak value exceeds 5V, set the input current to approx. 15mA using the external limit resistance R.

AC input

Output signal configuration of MON, AL

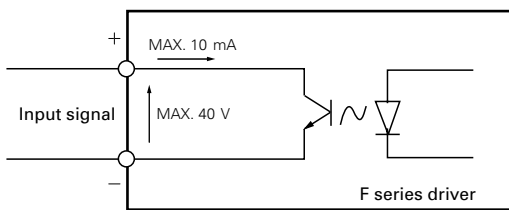

MON output

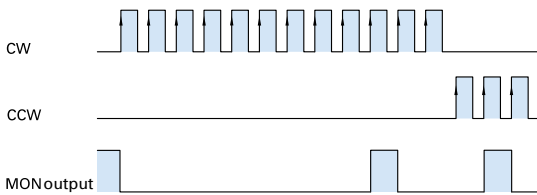

- Photo coupler at phase origin of motor excitation (status at power on) is set to "ON" (setting when number of divisions is 1).
- Output from MON is set to on at every 7.2 degrees of motor output shaft from phase origin.

Input / Output signal standard

DC input

Internal wire connection and direction of motor rotate

Internal wire connection

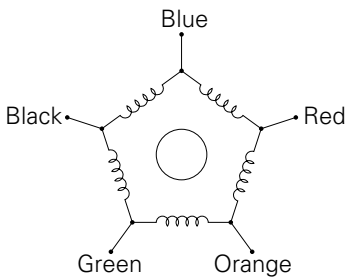

Direction of motor rotate

The direction of motor rotate is counterclockwise when viewed from the output shaft side at the direct current energization in the following order.

Type	Exciting order										
	1	2	3	4	5	6	7	8	9	10	
Color of leads	Blue			+	+	+			-	-	-
	Red	-	+				+	+			
	Orange			-	-			+	+	+	
	Green	+				-	-			+	+
	Black	+	+	+				-	-		

Stepping motor

Dimensions

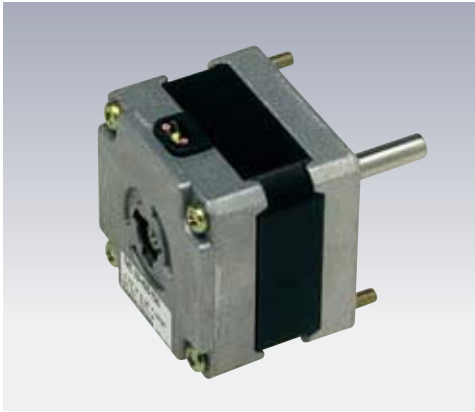

5-phase stepping motor

39mm sq. (1.54inch sq.)

103-45 □□ -70 □□
0.36° /step

Model		Holding torque at 5-phase energization	Rated current	Wiring resistance	Winding inductance	Rotor inertia	Mass (Weight)
Single shaft	Double shafts	[N · m (oz · in) MIN.]	A/phase	Ω /phase	mH/phase	[×10 ⁻⁴ kg · m ² (oz · in ²)]	[kg (lbs)]
103-4505-7040	-7010	0.078 (11.05)	0.75	2	1.97	0.0182 (0.10)	0.0182 (0.10)
103-4507-7040	-7010	0.108 (15.29)	0.75	2.35	3.8	0.024 (0.13)	0.024 (0.13)
103-4510-7040	-7010	0.167 (23.65)	0.75	3	6.2	0.036 (0.20)	0.036 (0.20)

Pulse rate-torque characteristics

■ 103-4505-70 □□

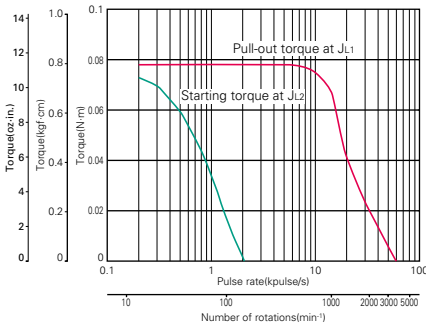

Constant current circuit
Source voltage : DC24V · operating current : 0.75A/phase, 5-phase excitation (full step)
J_{L1} = [0.33×10⁻⁴kg · m² (1.80oz · in²) use the rubber coupling]
J_{L2} = [0.18×10⁻⁴kg · m² (0.98oz · in²) use the direct coupling]

■ 103-4507-70 □□

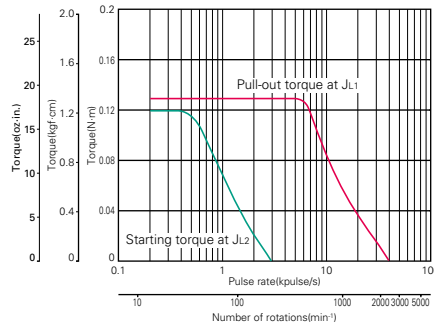

Constant current circuit
Source voltage : DC24V · operating current : 0.75A/phase, 5-phase excitation (full step)
J_{L1} = [0.33×10⁻⁴kg · m² (1.80oz · in²) use the rubber coupling]
J_{L2} = [0.18×10⁻⁴kg · m² (0.98oz · in²) use the direct coupling]

■ 103-4510-70 □□

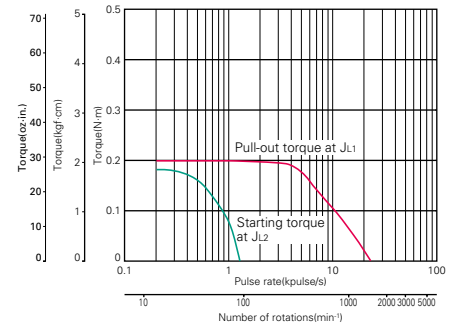

Constant current circuit
Source voltage : DC24V · operating current : 0.75A/phase, 5-phase excitation (full step)
J_{L1} = [0.94×10⁻⁴kg · m² (5.14oz · in²) use the rubber coupling]
J_{L2} = [0.8×10⁻⁴kg · m² (4.37oz · in²) use the direct coupling]



5-phase stepping motor

60mm cir. (2.36inch cir.)

103-7566-70 □□
0.45° /step

Model		Holding torque at 5-phase energization	Rated current	Wiring resistance	Winding inductance	Rotor inertia	Mass (Weight)
Single shaft	Double shafts	[N · m (oz · in) MIN.]	A/phase	Ω /phase	mH/phase	[$\times 10^{-4}$ kg · m ² (oz · in ²)]	[kg (lbs)]
103-7566-7041	-7011	0.91 (128.9)	0.75	4.8	23	0.235 (1.28)	1.1 (2.43)

Pulse rate-torque characteristics

■ 103-7566-70 □□

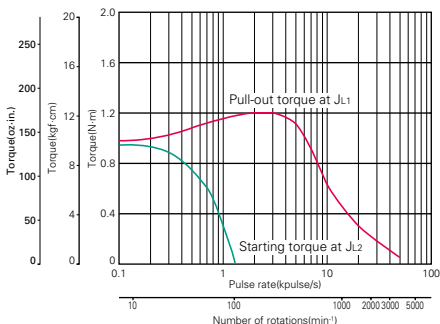

Constant current circuit
 Source voltage : AC100V · operating current : 0.75A/phase,
 5-phase excitation (full step)
 $J_{11} = [2.6 \times 10^{-4} \text{kg} \cdot \text{m}^2 (14.22 \text{oz} \cdot \text{in}^2)$ use the rubber coupling]
 $J_{12} = [2.6 \times 10^{-4} \text{kg} \cdot \text{m}^2 (14.22 \text{oz} \cdot \text{in}^2)$ use the direct coupling]

AC input

Input / Output signal standard

DC input

Stepping motor

Dimensions



5-phase stepping motor

28mm sq. (1.10inch sq.)

103H35 □□ -70 □□
0.72° /step

■ Motor with leads

Model		Holding torque at 5-phase energization	Rated current	Wiring resistance	Winding inductance	Rotor inertia	Mass (Weight)
Single shaft	Double shafts	[N · m (oz · in) MIN.]	A/phase	Ω /phase	mH/phase	[×10 ⁻⁴ kg · m ² (oz · in ²)]	[kg (lbs)]
103H3505-7070	-7020	0.026 (3.68)	0.75	1.2	0.32	0.009 (0.05)	0.11 (0.24)
103H3515-7070	-7020	0.052 (7.36)	0.75	1.5	0.4	0.016 (0.09)	0.2 (0.44)

■ Motor with connector

Model		Holding torque at 5-phase energization	Rated current	Wiring resistance	Winding inductance	Rotor inertia	Mass (Weight)
Single shaft	Double shafts	[N · m (oz · in) MIN.]	A/phase	Ω /phase	mH/phase	[×10 ⁻⁴ kg · m ² (oz · in ²)]	[kg (lbs)]
103H3505-7040	-7010	0.026 (3.68)	0.75	1.1	0.32	0.009 (0.05)	0.11 (0.24)
103H3515-7040	-7010	0.052 (7.36)	0.75	1.4	0.4	0.016 (0.09)	0.2 (0.44)

Pulse rate-torque characteristics

■ 103H3505-70 □□

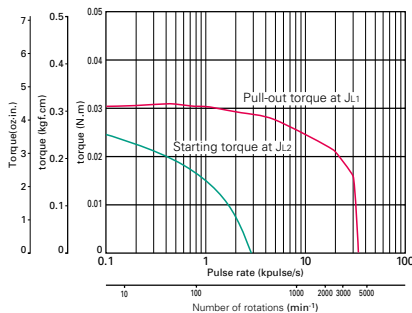

Constant current circuit
Source voltage : DC24V · operating current : 0.75A/phase,
5-phase excitation (full step)
J₁ = [0.01×10⁻⁴kg · m² (0.05oz · in²) pulley balancer system]
J₂ = [0.01×10⁻⁴kg · m² (0.05oz · in²) pulley balancer system]

■ 103H3515-70 □□

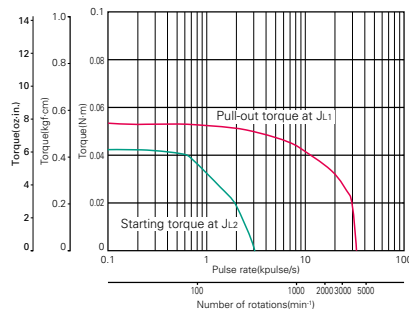

Constant current circuit
Source voltage : DC24V · operating current : 0.75A/phase,
5-phase excitation (full step)
J₁ = [0.01×10⁻⁴kg · m² (0.05oz · in²) pulley balancer system]
J₂ = [0.01×10⁻⁴kg · m² (0.05oz · in²) pulley balancer system]

5-phase stepping motor

42mm sq. (1.65inch sq.)

103H55 -70
 0.72° /step



AC input

Input / Output signal standard

DC input

Stepping motor

Dimensions

Model		Holding torque at 5-phase energization [N · m (oz · in) MIN.]	Rated current A/phase	Wiring resistance Ω /phase	Winding inductance mH/phase	Rotor inertia [×10 ⁻⁴ kg · m ² (oz · in ²)]	Mass (Weight) [kg (lbs)]
Single shaft	Double shafts						
103H5505-7040	-7010	0.127 (17.98)	0.75	1.45	1.2	0.03 (0.16)	0.23 (0.50)
103H5508-7040	-7010	0.176 (24.92)	0.75	1.6	1.8	0.053 (0.29)	0.28 (0.62)
103H5510-7040	-7010	0.255 (36.11)	0.75	2.2	2.2	0.065 (0.36)	0.37 (0.82)

Pulse rate-torque characteristics

■ 103H5505-70

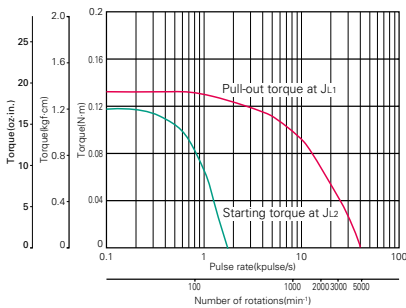

Constant current circuit
 Source voltage : DC24V · operating current:0.75A/phase,
 5-phase excitation (full step)
 $J_{L1} = [0.94 \times 10^{-4} \text{kg} \cdot \text{m}^2 (5.14 \text{oz} \cdot \text{in}^2)$ use the rubber coupling]
 $J_{L2} = [0.8 \times 10^{-4} \text{kg} \cdot \text{m}^2 (4.37 \text{oz} \cdot \text{in}^2)$ use the direct coupling]

■ 103H5508-70

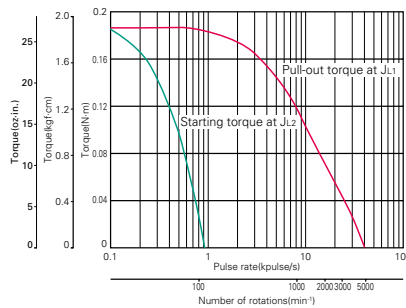

Constant current circuit
 Source voltage : DC24V · operating current:0.75A/phase,
 5-phase excitation (full step)
 $J_{L1} = [0.94 \times 10^{-4} \text{kg} \cdot \text{m}^2 (5.14 \text{oz} \cdot \text{in}^2)$ use the rubber coupling]
 $J_{L2} = [0.8 \times 10^{-4} \text{kg} \cdot \text{m}^2 (4.37 \text{oz} \cdot \text{in}^2)$ use the direct coupling]

■ 103H5510-70

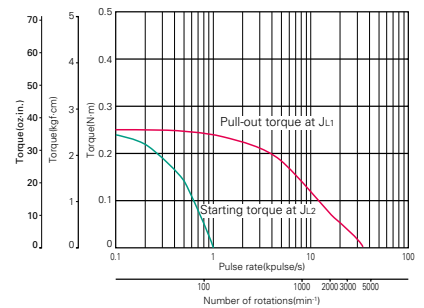

Constant current circuit
 Source voltage : DC24V · operating current:0.75A/phase,
 5-phase excitation (full step)
 $J_{L1} = [0.94 \times 10^{-4} \text{kg} \cdot \text{m}^2 (5.14 \text{oz} \cdot \text{in}^2)$ use the rubber coupling]
 $J_{L2} = [0.8 \times 10^{-4} \text{kg} \cdot \text{m}^2 (4.37 \text{oz} \cdot \text{in}^2)$ use the direct coupling]



5-phase stepping motor

50mm sq. (1.97inch sq.)

103H650 □ - □□□□
0.72° /step

Model		Holding torque at 5-phase energization	Rated current	Wiring resistance	Winding inductance	Rotor inertia	Mass (Weight)
Single shaft	Double shafts	[N · m (oz · in) MIN.]	A/phase	Ω /phase	mH/phase	[$\times 10^{-4}$ kg · m ² (oz · in ²)]	[kg (lbs)]
103H6500-7041	-7011	0.235 (33.28)	0.75	2	4	0.057 (0.31)	0.38 (0.84)
103H6500-8041	-8011	0.225 (31.86)	1.5	0.47	0.85	0.057 (0.31)	0.38 (0.84)
103H6501-7041	-7011	0.39 (55.23)	0.75	2.6	5.6	0.105 (0.57)	0.44 (0.97)
103H6501-8041	-8011	0.39 (55.23)	1.5	0.65	1.45	0.105 (0.57)	0.44 (0.97)

Pulse rate-torque characteristics

103H6500-70 □□

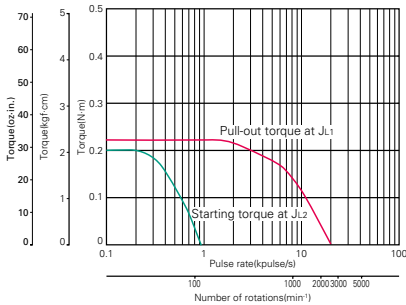

Constant current circuit
Source voltage : DC24V · operating current : 0.75A/phase, 5-phase excitation (full step)
 $J_{11} = [0.94 \times 10^{-4} \text{kg} \cdot \text{m}^2 (5.14 \text{oz} \cdot \text{in}^2)]$ use the rubber coupling]
 $J_{12} = [0.8 \times 10^{-4} \text{kg} \cdot \text{m}^2 (4.37 \text{oz} \cdot \text{in}^2)]$ use the direct coupling]

103H6500-80 □□

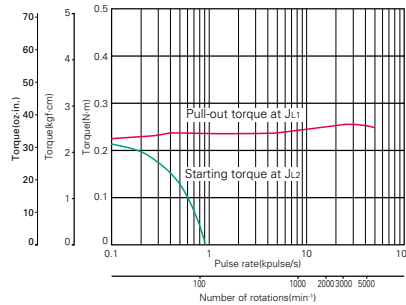

Constant current circuit
Source voltage : AC100V · operating current : 1.5A/phase, 5-phase excitation (full step)
 $J_{11} = [0.94 \times 10^{-4} \text{kg} \cdot \text{m}^2 (5.14 \text{oz} \cdot \text{in}^2)]$ use the rubber coupling]
 $J_{12} = [0.8 \times 10^{-4} \text{kg} \cdot \text{m}^2 (4.37 \text{oz} \cdot \text{in}^2)]$ use the direct coupling]

103H6501-70 □□

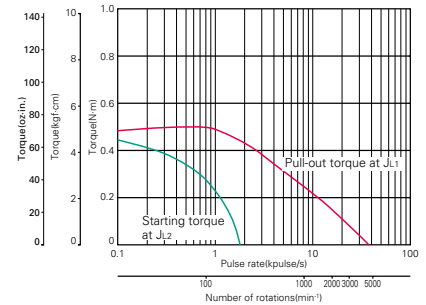

Constant current circuit
Source voltage : DC24V · operating current : 0.75A/phase, 5-phase excitation (full step)
 $J_{11} = [0.94 \times 10^{-4} \text{kg} \cdot \text{m}^2 (5.14 \text{oz} \cdot \text{in}^2)]$ use the rubber coupling]
 $J_{12} = [0.105 \times 10^{-4} \text{kg} \cdot \text{m}^2 (4.37 \text{oz} \cdot \text{in}^2)]$ pulley balancer system]

103H6501-80 □□

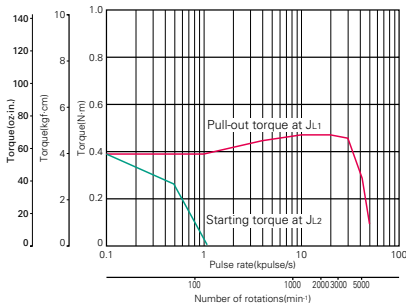

Constant current circuit
Source voltage : AC100V · operating current : 1.5A/phase, 5-phase excitation (full step)
 $J_{11} = [0.94 \times 10^{-4} \text{kg} \cdot \text{m}^2 (5.14 \text{oz} \cdot \text{in}^2)]$ use the rubber coupling]
 $J_{12} = [0.8 \times 10^{-4} \text{kg} \cdot \text{m}^2 (4.37 \text{oz} \cdot \text{in}^2)]$ use the direct coupling]



5-phase stepping motor

60mm sq. (2.36inch sq.)

103H785 □ - □□□□

0.72° /step

Model		Holding torque at 5-phase energization	Rated current	Wiring resistance	Winding inductance	Rotor inertia	Mass (Weight)
Single shaft	Double shafts	[N · m (oz · in) MIN.]	A/phase	Ω /phase	mH/phase	[×10 ⁻⁴ kg · m ² (oz · in ²)]	[kg (lbs)]
103H7851-7051	-7021	0.65 (92.0)	0.75	2.75	4.75	0.275 (1.50)	0.6 (1.32)
103H7851-8051	-8021	0.65 (92.0)	1.5	0.64	1.2	0.275 (1.50)	0.6 (1.32)
103H7852-7051	-7021	0.98 (138.8)	0.75	3.4	7.75	0.4 (2.19)	0.78 (1.72)
103H7852-8051	-8021	0.98 (138.8)	1.5	0.8	2	0.4 (2.19)	0.78 (1.72)
103H7853-7051	-7021	1.86 (263.4)	0.75	5.5	15	0.84 (4.59)	1.36 (3.00)
103H7853-8051	-8021	1.86 (263.4)	1.5	1.28	3.85	0.84 (4.59)	1.36 (3.00)

Pulse rate-torque characteristics

103H7851-70 □□

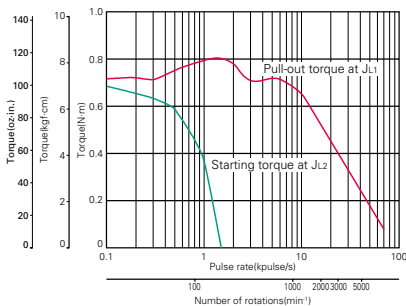

Constant current circuit
 Source voltage : AC100V·operating current : 0.75A/phase,
 5-phase excitation (full step)
 $J_{L1} = [0.94 \times 10^{-4} \text{kg} \cdot \text{m}^2 (5.14 \text{oz} \cdot \text{in}^2)]$ use the rubber coupling]
 $J_{L2} = [0.8 \times 10^{-4} \text{kg} \cdot \text{m}^2 (4.37 \text{oz} \cdot \text{in}^2)]$ use the direct coupling]

103H7852-70 □□

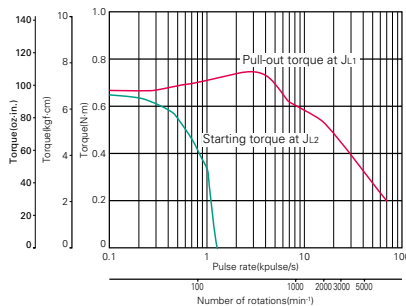

Constant current circuit
 Source voltage : AC100V·operating current : 0.75A/phase,
 5-phase excitation (full step)
 $J_{L1} = [0.94 \times 10^{-4} \text{kg} \cdot \text{m}^2 (5.14 \text{oz} \cdot \text{in}^2)]$ use the rubber coupling]
 $J_{L2} = [0.8 \times 10^{-4} \text{kg} \cdot \text{m}^2 (4.37 \text{oz} \cdot \text{in}^2)]$ use the direct coupling]

103H7853-70 □□

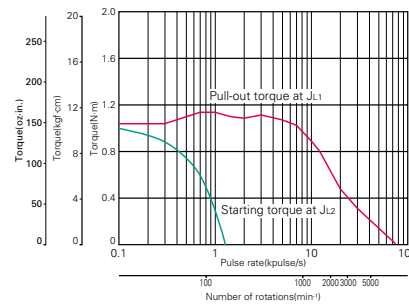

Constant current circuit
 Source voltage : AC100V·operating current : 0.75A/phase,
 5-phase excitation (full step)
 $J_{L1} = [7.4 \times 10^{-4} \text{kg} \cdot \text{m}^2 (40.46 \text{oz} \cdot \text{in}^2)]$ use the rubber coupling]
 $J_{L2} = [7.4 \times 10^{-4} \text{kg} \cdot \text{m}^2 (40.46 \text{oz} \cdot \text{in}^2)]$ use the direct coupling]

103H7851-80 □□

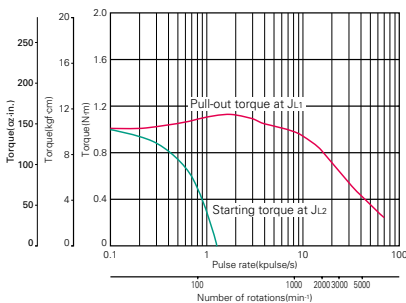

Constant current circuit
 Source voltage : AC100V·operating current : 1.5A/phase,
 5-phase excitation (full step)
 $J_{L1} = [0.94 \times 10^{-4} \text{kg} \cdot \text{m}^2 (5.14 \text{oz} \cdot \text{in}^2)]$ use the rubber coupling]
 $J_{L2} = [0.8 \times 10^{-4} \text{kg} \cdot \text{m}^2 (4.37 \text{oz} \cdot \text{in}^2)]$ use the direct coupling]

103H7852-80 □□

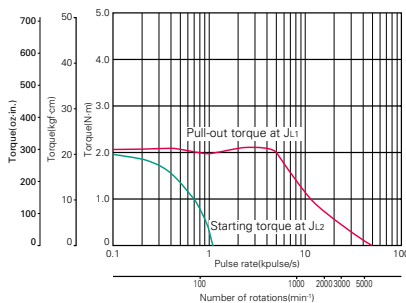

Constant current circuit
 Source voltage : AC100V·operating current : 1.5A/phase,
 5-phase excitation (full step)
 $J_{L1} = [2.6 \times 10^{-4} \text{kg} \cdot \text{m}^2 (14.22 \text{oz} \cdot \text{in}^2)]$ use the rubber coupling]
 $J_{L2} = [2.6 \times 10^{-4} \text{kg} \cdot \text{m}^2 (14.22 \text{oz} \cdot \text{in}^2)]$ use the direct coupling]

103H7853-80 □□

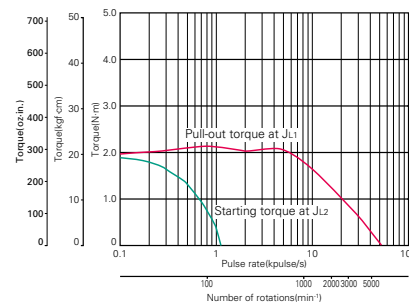

Constant current circuit
 Source voltage : AC100V·operating current : 1.5A/phase,
 5-phase excitation (full step)
 $J_{L1} = [7.4 \times 10^{-4} \text{kg} \cdot \text{m}^2 (40.46 \text{oz} \cdot \text{in}^2)]$ use the rubber coupling]
 $J_{L2} = [7.4 \times 10^{-4} \text{kg} \cdot \text{m}^2 (40.46 \text{oz} \cdot \text{in}^2)]$ use the direct coupling]



5-phase stepping motor

60mm cir. (2.36inch cir.)

103H752 □ - □□□□
0.72° /step

Model		Holding torque at 5-phase energization	Rated current	Wiring resistance	Winding inductance	Rotor inertia	Mass (Weight)
Single shaft	Double shafts	[N · m (oz · in) MIN.]	A/phase	Ω /phase	mH/phase	[×10 ⁻⁴ kg · m ² (oz · in ²)]	[kg (lbs)]
103H7521-7051	-7021	0.46 (65.1)	0.75	2.4	4.3	0.148 (0.81)	0.51 (1.12)
103H7521-8051	-8021	0.46 (65.1)	1.5	0.6	1.1	0.148 (0.81)	0.51 (1.12)
103H7522-7051	-7021	0.735 (104.1)	0.75	3.3	7.5	0.18 (0.98)	0.6 (1.32)
103H7522-8051	-8021	0.735 (104.1)	1.5	0.75	2	0.18 (0.98)	0.6 (1.32)
103H7523-7051	-7021	1.568 (222.0)	0.75	5.2	21	0.423 (2.31)	1.1 (2.43)
103H7523-8051	-8021	1.568 (222.0)	1.5	1.4	5.4	0.423 (2.31)	1.1 (2.43)

Pulse rate-torque characteristics

■ 103H7521-70 □□

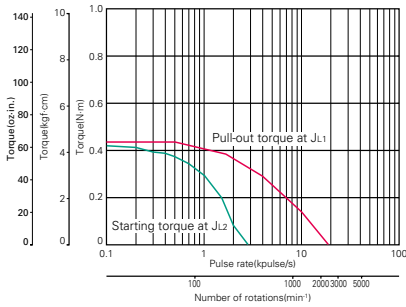

Constant current circuit
Source voltage: DC24V·operating current : 0.75A/phase,
5-phase excitation (full step)
J₁=[0.94×10⁻⁴kg · m² (5.14oz · in²) use the rubber coupling]
J₂=[0.51×10⁻⁴kg · m² (2.79oz · in²) pulley balancer system]

■ 103H7521-80 □□

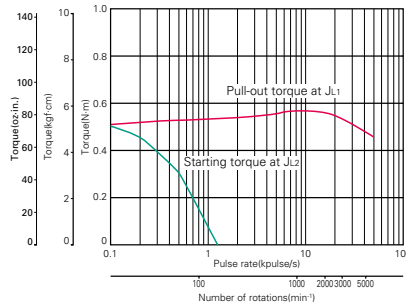

Constant current circuit
Source voltage: AC100V·operating current : 1.5A/phase,
5-phase excitation (full step)
J₁=[0.94×10⁻⁴kg · m² (5.14oz · in²) use the rubber coupling]
J₂=[0.8×10⁻⁴kg · m² (4.37oz · in²) use the direct coupling]

■ 103H7522-70 □□

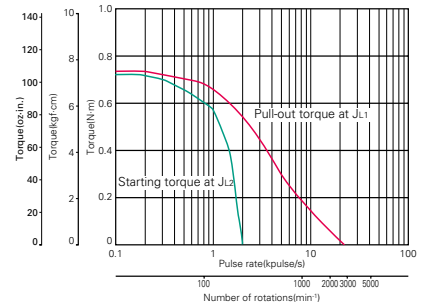

Constant current circuit
Source voltage: DC24V·operating current : 0.75A/phase,
5-phase excitation (full step)
J₁=[2.6×10⁻⁴kg · m² (14.22oz · in²) use the rubber coupling]
J₂=[0.6×10⁻⁴kg · m² (3.28oz · in²) pulley balancer system]

■ 103H7522-80 □□

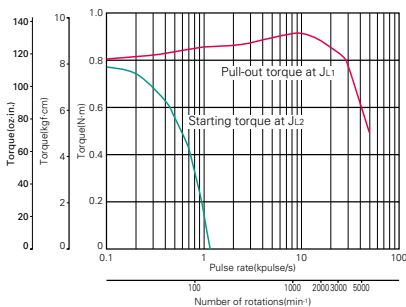

Constant current circuit
Source voltage: AC100V·operating current : 1.5A/phase,
5-phase excitation (full step)
J₁=[2.6×10⁻⁴kg · m² (14.22oz · in²) use the rubber coupling]
J₂=[2.6×10⁻⁴kg · m² (14.22oz · in²) use the direct coupling]

■ 103H7523-70 □□

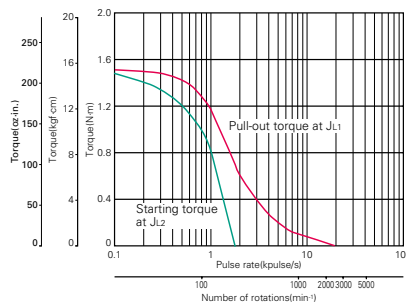

Constant current circuit
Source voltage: DC24V·operating current : 0.75A/phase,
5-phase excitation (full step)
J₁=[7.4×10⁻⁴kg · m² (40.46oz · in²) use the rubber coupling]
J₂=[1.1×10⁻⁴kg · m² (6.01oz · in²) pulley balancer system]

■ 103H7523-80 □□

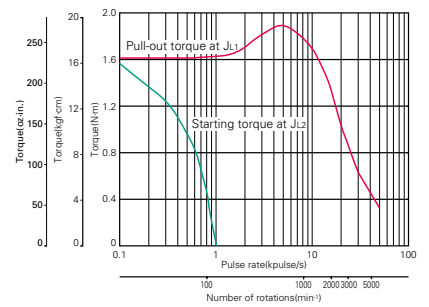

Constant current circuit
Source voltage: AC100V·operating current : 1.5A/phase,
5-phase excitation (full step)
J₁=[7.4×10⁻⁴kg · m² (40.46oz · in²) use the rubber coupling]
J₂=[7.4×10⁻⁴kg · m² (40.46oz · in²) use the direct coupling]



5-phase stepping motor

86mm cir. (3.39inch cir.)

103H858 □ - □□□□

0.72° /step

Model	Single shaft	Double shafts	Holding torque at 5-phase energization [N · m (oz · in) MIN.]	Rated current A/phase	Wiring resistance Ω /phase	Winding inductance mH/phase	Rotor inertia [×10 ⁻⁴ kg · m ² (oz · in ²)]	Mass (Weight) [kg (lbs)]
103H8581-7041		-7011	2.06 (291.7)	0.75	5.7	25	1.45 (7.93)	1.5 (3.31)
103H8581-8041		-8011	2.06 (291.7)	1.5	1.5	5.6	1.45 (7.93)	1.5 (3.31)
103H8582-7041		-7011	4.02 (569.3)	0.75	8.6	41	2.9 (15.86)	2.5 (5.51)
103H8582-8041		-8011	4.02 (569.3)	1.5	2	10.6	2.9 (15.86)	2.5 (5.51)
103H8583-7041		-7011	6.17 (873.7)	0.75	10.5	59	4.4 (24.06)	3.5 (7.72)
103H8583-8041		-8011	6.17 (873.7)	1.5	2.5	15	4.4 (24.06)	3.5 (7.72)

Pulse rate-torque characteristics

103H8581-70 □□

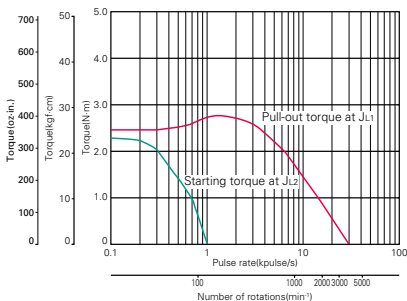

Constant current circuit
Source voltage: AC100V·operating current: 0.75A/phase,
5-phase excitation (full step)
J₁ = [7.4×10⁻⁴kg · m² (40.46oz · in²) use the rubber coupling]
J₂ = [1.45×10⁻⁴kg · m² (7.93oz · in²) pulley balancer system]

103H8581-80 □□

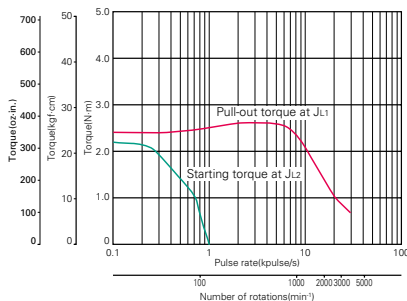

Constant current circuit
Source voltage: AC100V·operating current: 1.5A/phase,
5-phase excitation (full step)
J₁ = [7.4×10⁻⁴kg · m² (40.46oz · in²) use the rubber coupling]
J₂ = [1.45×10⁻⁴kg · m² (7.93oz · in²) pulley balancer system]

103H8582-70 □□

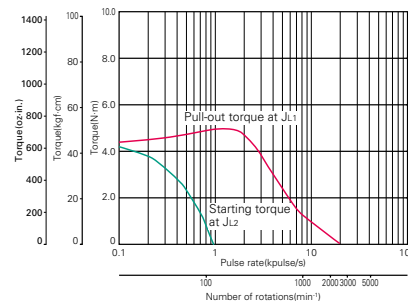

Constant current circuit
Source voltage: AC100V·operating current: 0.75A/phase,
5-phase excitation (full step)
J₁ = [15.3×10⁻⁴kg · m² (83.65oz · in²) use the rubber coupling]
J₂ = [2.9×10⁻⁴kg · m² (15.86oz · in²) pulley balancer system]

103H8582-80 □□

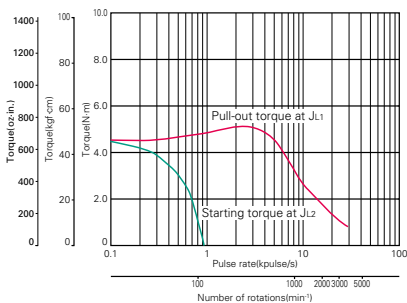

Constant current circuit
Source voltage: AC100V·operating current: 1.5A/phase,
5-phase excitation (full step)
J₁ = [15.3×10⁻⁴kg · m² (83.65oz · in²) use the rubber coupling]
J₂ = [2.9×10⁻⁴kg · m² (15.86oz · in²) pulley balancer system]

103H8583-70 □□

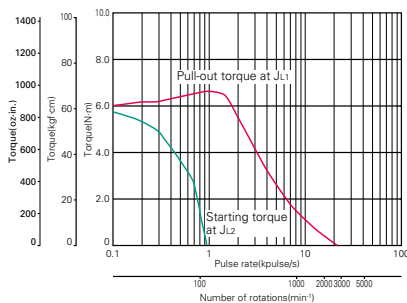

Constant current circuit
Source voltage: AC100V·operating current: 0.75A/phase,
5-phase excitation (full step)
J₁ = [43×10⁻⁴kg · m² (235.10oz · in²) use the rubber coupling]
J₂ = [4.4×10⁻⁴kg · m² (24.06oz · in²) pulley balancer system]

103H8583-80 □□

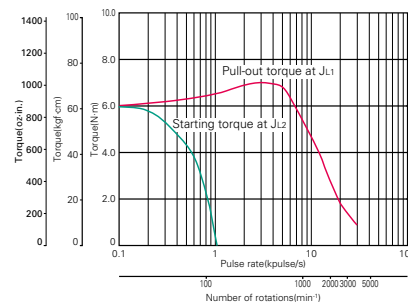

Constant current circuit
Source voltage: AC100V·operating current: 1.5A/phase,
5-phase excitation (full step)
J₁ = [43×10⁻⁴kg · m² (235.10oz · in²) use the rubber coupling]
J₂ = [4.4×10⁻⁴kg · m² (24.06oz · in²) pulley balancer system]



5-phase stepping motor

106mm cir. (4.17inch cir.)

103H8958 □ - □□□□
0.72° /step

Model		Holding torque at 5-phase energization	Rated current	Wiring resistance	Winding inductance	Rotor inertia	Mass (Weight)
Single shaft	Double shafts	[N · m (oz · in) MIN.]	A/phase	Ω /phase	mH/phase	[×10 ⁻⁴ kg · m ² (oz · in ²)]	[kg (lbs)]
103H89582-7041	-7011	10.8 (1529.4)	0.75	9	90	14.6 (79.83)	7.5 (16.53)
103H89582-8041	-8011	10.8 (1529.4)	1.5	2	26	14.6 (79.83)	7.5 (16.53)
103H89583-7041	-7011	16 (2265.7)	0.75	12.5	125	22 (120.28)	10.5 (23.15)
103H89583-8041	-8011	16 (2265.7)	1.5	2.9	33.4	22 (120.28)	10.5 (23.15)

Pulse rate-torque characteristics

103H89582-70 □□

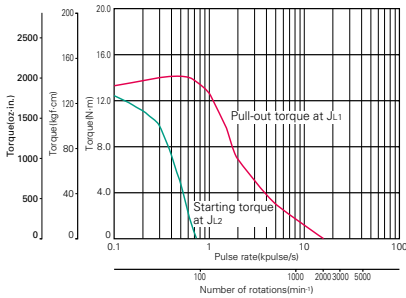

Constant current circuit
Source voltage: AC100V·operating current: 0.75A/phase, 5-phase excitation (full step)
J_{1.1}=[43×10⁻⁴kg·m²(235.10oz·in²) use the rubber coupling]
J_{1.2}=[43×10⁻⁴kg·m²(235.10oz·in²) use the rubber coupling]

103H89582-80 □□

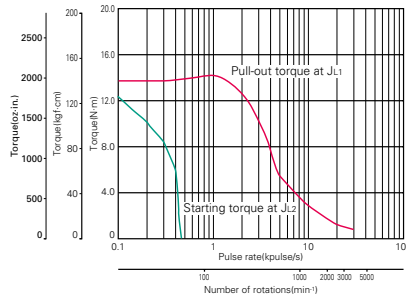

Constant current circuit
Source voltage: AC100V·operating current: 1.5A/phase, 5-phase excitation (full step)
J_{1.1}=[43×10⁻⁴kg·m²(235.10oz·in²) use the rubber coupling]
J_{1.2}=[43×10⁻⁴kg·m²(235.10oz·in²) use the rubber coupling]

103H89583-70 □□

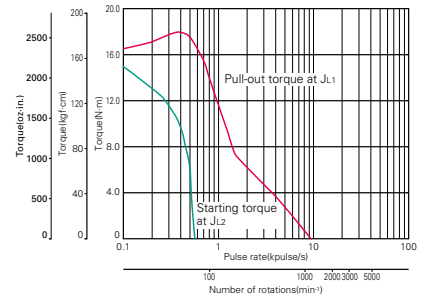

Constant current circuit
Source voltage: AC100V·operating current: 0.75A/phase, 5-phase excitation (full step)
J_{1.1}=[43×10⁻⁴kg·m²(235.10oz·in²) use the rubber coupling]
J_{1.2}=[43×10⁻⁴kg·m²(235.10oz·in²) use the rubber coupling]

103H89583-80 □□

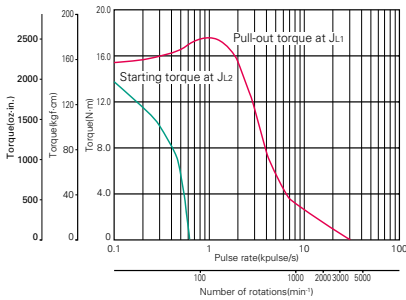

Constant current circuit
Source voltage: AC100V·operating current: 1.5A/phase, 5-phase excitation (full step)
J_{1.1}=[43×10⁻⁴kg·m²(235.10oz·in²) use the rubber coupling]
J_{1.2}=[43×10⁻⁴kg·m²(235.10oz·in²) use the rubber coupling]



5-phase stepping motor

60mm cir. (2.36inch cir.)

103H752 -6

CE marked

0.72° /step



AC input

Input / Output signal standard

Model		Holding torque at 5-phase energization	Rated current	Wiring resistance	Winding inductance	Rotor inertia	Mass (Weight)
Single shaft	Double shafts	[N · m (oz · in) MIN.]	A/phase	Ω /phase	mH/phase	[×10 ⁻⁴ kg · m ² (oz · in ²)]	[kg (lbs)]
103H7521-6050	-6020	0.46 (65.1)	0.75	2.4	4.3	0.148 (0.81)	0.51 (1.12)
103H7521-6250	-6220	0.46 (65.1)	1.5	0.6	1.1	0.148 (0.81)	0.51 (1.12)
103H7522-6050	-6020	0.735 (104.1)	0.75	3.3	7.5	0.18 (0.98)	0.6 (1.32)
103H7522-6250	-6220	0.735 (104.1)	1.5	0.75	2	0.18 (0.98)	0.6 (1.32)
103H7523-6050	-6020	1.568 (222.0)	0.75	5.2	21	0.423 (2.31)	1.1 (2.43)
103H7523-6250	-6220	1.568 (222.0)	1.5	1.4	5.4	0.423 (2.31)	1.1 (2.43)

Pulse rate-torque characteristics

103H7521-60

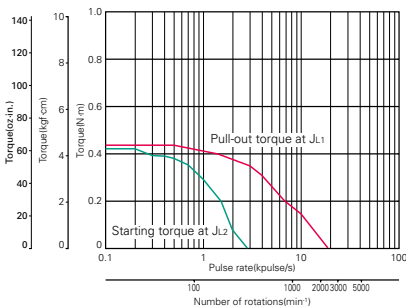

Constant current circuit
 Source voltage : DC24V · operating current : 0.75A/phase,
 5-phase excitation (full step)
 $J_{11} = [0.94 \times 10^{-4} \text{kg} \cdot \text{m}^2 (5.14 \text{oz} \cdot \text{in}^2)]$ use the rubber coupling]
 $J_{12} = [0.51 \times 10^{-4} \text{kg} \cdot \text{m}^2 (2.79 \text{oz} \cdot \text{in}^2)]$ pulley balancer system]

103H7521-62

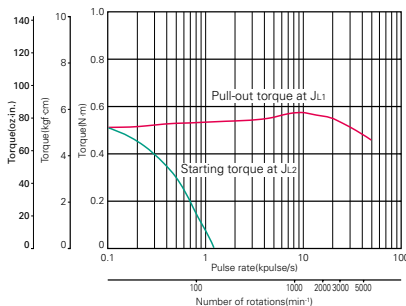

Constant current circuit
 Source voltage : AC100V · operating current : 1.5A/phase,
 5-phase excitation (full step)
 $J_{11} = [0.94 \times 10^{-4} \text{kg} \cdot \text{m}^2 (5.14 \text{oz} \cdot \text{in}^2)]$ use the rubber coupling]
 $J_{12} = [0.8 \times 10^{-4} \text{kg} \cdot \text{m}^2 (4.37 \text{oz} \cdot \text{in}^2)]$ use the direct coupling]

103H7522-60

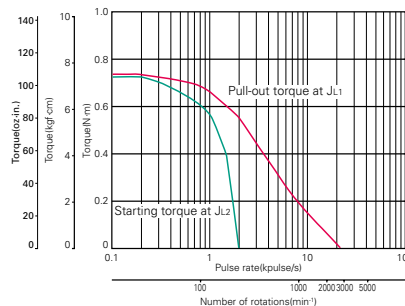

Constant current circuit
 Source voltage : DC24V · operating current : 0.75A/phase,
 5-phase excitation (full step)
 $J_{11} = [2.6 \times 10^{-4} \text{kg} \cdot \text{m}^2 (14.22 \text{oz} \cdot \text{in}^2)]$ use the rubber coupling]
 $J_{12} = [0.6 \times 10^{-4} \text{kg} \cdot \text{m}^2 (3.28 \text{oz} \cdot \text{in}^2)]$ pulley balancer system]

103H7522-62

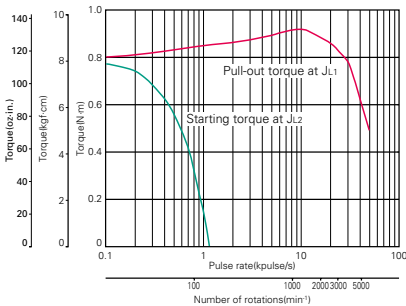

Constant current circuit
 Source voltage : AC100V · operating current : 1.5A/phase,
 5-phase excitation (full step)
 $J_{11} = [2.6 \times 10^{-4} \text{kg} \cdot \text{m}^2 (14.22 \text{oz} \cdot \text{in}^2)]$ use the rubber coupling]
 $J_{12} = [2.6 \times 10^{-4} \text{kg} \cdot \text{m}^2 (14.22 \text{oz} \cdot \text{in}^2)]$ use the direct coupling]

103H7523-60

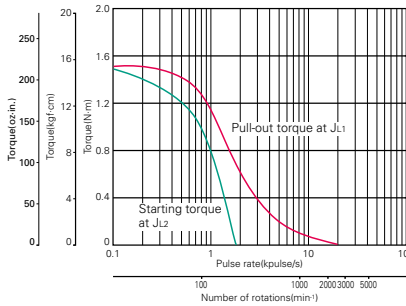

Constant current circuit
 Source voltage : DC24V · operating current : 0.75A/phase,
 5-phase excitation (full step)
 $J_{11} = [7.4 \times 10^{-4} \text{kg} \cdot \text{m}^2 (40.46 \text{oz} \cdot \text{in}^2)]$ use the rubber coupling]
 $J_{12} = [1.1 \times 10^{-4} \text{kg} \cdot \text{m}^2 (6.01 \text{oz} \cdot \text{in}^2)]$ pulley balancer system]

103H7523-62

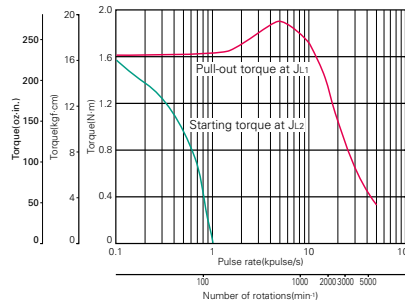

Constant current circuit
 Source voltage : AC100V · operating current : 1.5A/phase,
 5-phase excitation (full step)
 $J_{11} = [7.4 \times 10^{-4} \text{kg} \cdot \text{m}^2 (40.46 \text{oz} \cdot \text{in}^2)]$ use the rubber coupling]
 $J_{12} = [7.4 \times 10^{-4} \text{kg} \cdot \text{m}^2 (40.46 \text{oz} \cdot \text{in}^2)]$ use the direct coupling]

DC input

Stepping motor

Dimensions



5-phase stepping motor

86mm cir. (3.39inch cir.)

103H858 □ -6 □ □ □

CE marked

0.72° /step



Model		Holding torque at 5-phase energization	Rated current	Wiring resistance	Winding inductance	Rotor inertia	Mass (Weight)
Single shaft	Double shafts	[N · m (oz · in) MIN.]	A/phase	Ω /phase	mH/phase	[×10 ⁻⁴ kg · m ² (oz · in ²)]	[kg (lbs)]
103H8581-6050	-6020	2.06 (291.7)	0.75	5.7	25	1.45 (7.93)	1.5 (3.31)
103H8581-6250	-6220	2.06 (291.7)	1.5	1.5	5.6	1.45 (7.93)	1.5 (3.31)
103H8582-6050	-6020	4.02 (569.3)	0.75	8.6	41	2.9 (15.86)	2.5 (5.51)
103H8582-6250	-6220	4.02 (569.3)	1.5	2	10.6	2.9 (15.86)	2.5 (5.51)
103H8583-6050	-6020	6.17 (873.7)	0.75	10.5	59	4.4 (24.06)	3.5 (7.72)
103H8583-6250	-6220	6.17 (873.7)	1.5	2.5	15	4.4 (24.06)	3.5 (7.72)

Pulse rate-torque characteristics

103H8581-60 □ □

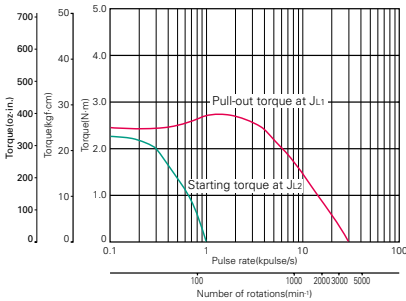

Constant current circuit
Source voltage : AC100V·operating current:0.75A/phase,
5-phase excitation (full step)
J₁=[7.4×10⁻⁴kg·m²(40.46oz·in²) use the rubber coupling]
J₂=[1.45×10⁻⁴kg·m²(7.93oz·in²) pulley balancer system]

103H8581-62 □ □

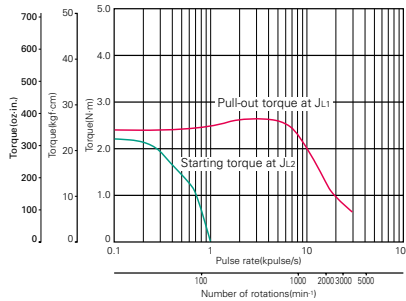

Constant current circuit
Source voltage : AC100V·operating current :1.5A/phase,
5-phase excitation (full step)
J₁=[7.4×10⁻⁴kg·m²(40.46oz·in²) use the rubber coupling]
J₂=[1.45×10⁻⁴kg·m²(7.93oz·in²) pulley balancer system]

103H8582-60 □ □

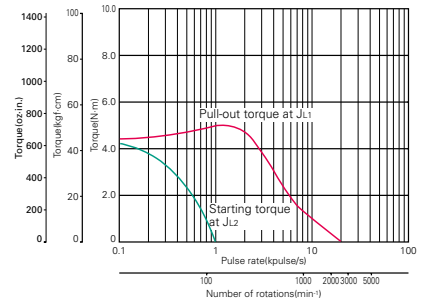

Constant current circuit
Source voltage : AC100V·operating current :0.75A/phase,
5-phase excitation (full step)
J₁=[15.3×10⁻⁴kg·m²(83.65oz·in²) use the rubber coupling]
J₂=[2.9×10⁻⁴kg·m²(15.86oz·in²) pulley balancer system]

103H8582-62 □ □

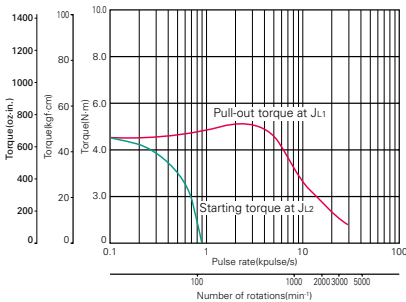

Constant current circuit
Source voltage : AC100V · operating current :1.5A/phase,
5-phase excitation (full step)
J₁=[15.3×10⁻⁴kg·m²(83.65oz·in²) use the rubber coupling]
J₂=[2.9×10⁻⁴kg·m²(15.86oz·in²) pulley balancer system]

103H8583-60 □ □

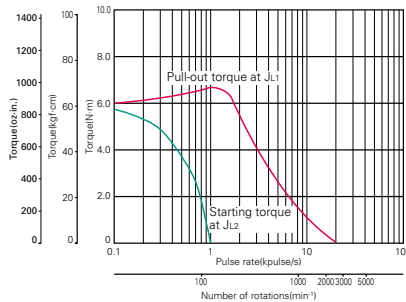

Constant current circuit
Source voltage : AC100V·operating current :0.75A/phase,
5-phase excitation (full step)
J₁=[43×10⁻⁴kg·m²(235.10oz·in²) use the rubber coupling]
J₂=[4.4×10⁻⁴kg·m²(24.06oz·in²) pulley balancer system]

103H8583-62 □ □

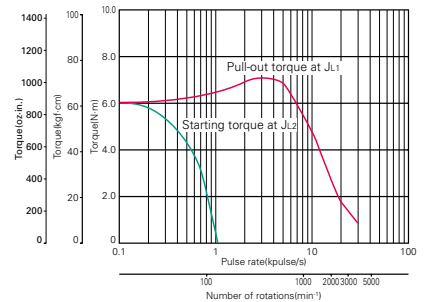

Constant current circuit
Source voltage : AC100V·operating current :1.5A/phase,
5-phase excitation (full step)
J₁=[43×10⁻⁴kg·m²(235.10oz·in²) use the rubber coupling]
J₂=[4.4×10⁻⁴kg·m²(24.06oz·in²) pulley balancer system]

5-phase stepping motor

106mm cir. (4.17inch cir.)

103H8958 □ -6 □ □ □

CE marked

0.72° /step



AC input

Input / Output signal standard

Model		Holding torque at 5-phase energization	Rated current	Wiring resistance	Winding inductance	Rotor inertia	Mass (Weight)
Single shaft	Double shafts	[N · m (oz · in) MIN.]	A/phase	Ω /phase	mH/phase	[×10 ⁻⁴ kg · m ² (oz · in ²)]	[kg (lbs)]
103H89582-6050	-6020	10.8 (1529.4)	0.75	9	90	14.6 (79.83)	7.5 (16.53)
103H89582-6250	-6220	10.8 (1529.4)	1.5	2	26	14.6 (79.83)	7.5 (16.53)
103H89583-6050	-6020	16 (2265.7)	0.75	12.5	125	22 (120.28)	10.5 (23.15)
103H89583-6250	-6220	16 (2265.7)	1.5	2.9	33.4	22 (120.28)	10.5 (23.15)

Pulse rate-torque characteristics

103H89582-60 □ □ □

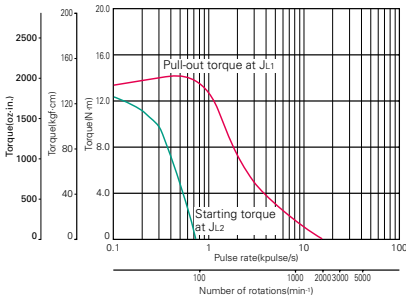

Constant current circuit
 Source voltage : AC100V·operating current : 0.75A/phase,
 5-phase excitation (full step)
 $J_{1.1} = [43 \times 10^{-4} \text{kg} \cdot \text{m}^2 (235.10 \text{oz} \cdot \text{in}^2)]$ use the rubber coupling]
 $J_{1.2} = [43 \times 10^{-4} \text{kg} \cdot \text{m}^2 (235.10 \text{oz} \cdot \text{in}^2)]$ use the rubber coupling]

103H89582-62 □ □ □

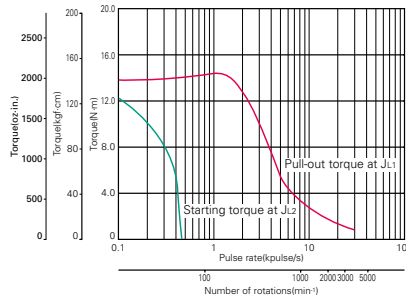

Constant current circuit
 Source voltage : AC100V·operating current : 1.5A/phase,
 5-phase excitation (full step)
 $J_{1.1} = [43 \times 10^{-4} \text{kg} \cdot \text{m}^2 (235.10 \text{oz} \cdot \text{in}^2)]$ use the rubber coupling]
 $J_{1.2} = [43 \times 10^{-4} \text{kg} \cdot \text{m}^2 (235.10 \text{oz} \cdot \text{in}^2)]$ use the rubber coupling]

103H89583-60 □ □ □

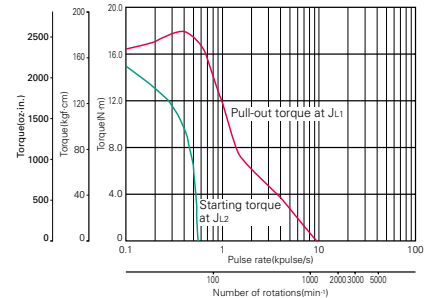

Constant current circuit
 Source voltage : AC100V·operating current : 0.75A/phase,
 5-phase excitation (full step)
 $J_{1.1} = [43 \times 10^{-4} \text{kg} \cdot \text{m}^2 (235.10 \text{oz} \cdot \text{in}^2)]$ use the rubber coupling]
 $J_{1.2} = [43 \times 10^{-4} \text{kg} \cdot \text{m}^2 (235.10 \text{oz} \cdot \text{in}^2)]$ use the rubber coupling]

103H89583-62 □ □ □

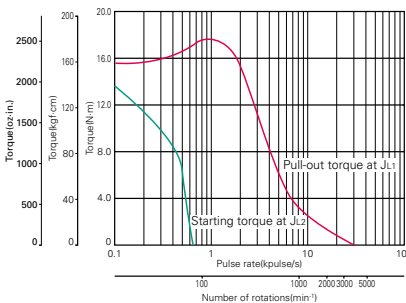

Constant current circuit
 Source voltage : AC100V·operating current : 1.5A/phase,
 5-phase excitation (full step)
 $J_{1.1} = [43 \times 10^{-4} \text{kg} \cdot \text{m}^2 (235.10 \text{oz} \cdot \text{in}^2)]$ use the rubber coupling]
 $J_{1.2} = [43 \times 10^{-4} \text{kg} \cdot \text{m}^2 (235.10 \text{oz} \cdot \text{in}^2)]$ use the rubber coupling]

DC input

Stepping motor

Dimensions

Allowable radial / thrust load

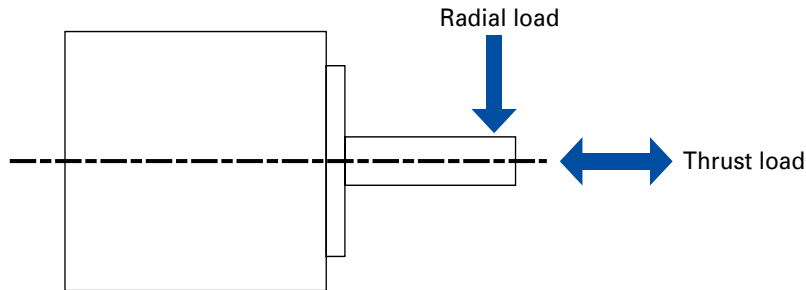

unit = upper section : N / lower berth : lbs

Frange size	Model number	Distance from end of shaft : mm (inch)				Thrust load : N (lbs)
		0 (0)	5 (0.2)	10 (2.25)	15 (3.38)	
		Radial load : N (lbs)				
□ 28mm (□ 1.10 inch)	103H35 □□ (3515-7040)	30 (1.18)	39 (1.54)	53 (2.09)	84 (3.31)	3 (0.12)
		6 (0.24)	8 (0.31)	11 (0.43)	18 (0.71)	0.67 (0.03)
□ 28mm (□ 1.10 inch)	103F35 □□ (3515-7041)	39 (1.54)	53 (2.09)	84 (3.31)	—	3 (0.12)
		8 (0.31)	11 (0.43)	18 (0.71)	—	0.67 (0.03)
□ 39mm (□ 1.54 inch)	103-45 □□ (4510-7040)	26 (1.02)	33 (1.3)	42 (1.65)	60 (2.36)	10 (2.25)
		5 (0.2)	7 (0.28)	9 (0.35)	13 (0.51)	2.25 (0.09)
□ 42mm (□ 1.65 inch)	103H55 □□ 103F55 □□ (F5510-7041)	29 (1.14)	36 (1.42)	49 (1.93)	52 (2.05)	10 (2.25)
		6 (0.24)	8 (0.31)	11 (0.43)	11 (0.43)	2.25 (0.09)
□ 50mm (□ 1.97 inch)	103H65 □□	71 (2.8)	87 (3.43)	115 (4.53)	167 (6.57)	15 (3.38)
		15 (0.59)	19 (0.75)	25 (0.98)	37 (1.46)	3.37 (0.13)
φ 60mm (φ 2.36 inch)	103H75 □□ 103-75 □□	94 (3.7)	116 (4.57)	153 (6.02)	222 (8.74)	15 (3.38)
		21 (0.83)	26 (1.02)	34 (1.34)	49 (1.93)	3.37 (0.13)
		68 (2.68)	85 (3.35)	113 (4.45)	166 (6.54)	15 (3.38)
□ 60mm (□ 2.36 inch)	103H78 □□ 103F78 □□ 103M78 □□	15 (0.59)	19 (0.75)	25 (0.98)	37 (1.46)	3.37 (0.13)
		70 (2.76)	87 (3.43)	114 (4.49)	165 (6.5)	20 (0.79)
		62 (2.44)	75 (2.95)	94 (3.7)	127 (5)	20 (0.79)
φ 86mm (φ 3.39 inch)	103H85 □□ 103F85 □□ 103M85 □□	13 (0.51)	16 (0.63)	21 (0.83)	28 (1.1)	4.50 (0.18)
		191 (7.52)	234 (9.21)	301 (11.85)	421 (16.57)	60 (2.36)
		42 (1.65)	52 (2.05)	67 (2.64)	94 (3.7)	13.488 (0.53)
		350 (13.78)	424 (16.69)	535 (21.06)	726 (28.58)	60 (2.36)
φ 106mm (φ 4.17 inch)	103H895 □□ 103F895 □□ 103M895 □□	78 (3.07)	95 (3.74)	120 (4.72)	163 (6.42)	13.488 (0.53)
		321 (12.64)	356 (14.02)	401 (15.79)	457 (18)	100 (3.94)
		72 (2.83)	80 (3.15)	90 (3.54)	102 (4.02)	22.48 (0.89)
		—	—	—	—	—

General specifications

	103H35 □□	103H55 □□	103H650 □	103H752 □	103H785 □	103H858 □	103H8958 □	103-45 □□	103-7556
Insulation class	Class B (130°C)								
Insulation resistance	Not less than 100M Ω between winding and frame by DC500V megger at normal temperature and humidity.								
Withstand voltage	Without abnormality when applying 50/60Hz,1000V AC (500V AC for 103H35 □□ and 103H55 □□) for 1 minute (leakage current 1mA) between winding and frame at normal temperature and humidity.				Without abnormality when applying 50/60Hz,1000V AC (500V AC for 103-45 □□) for 1 minute (leakage current 1mA) between winding and frame at normal temperature and humidity.				
Operating environment	Ambient temperature -10°C to +50°C								
	Ambient humidity 20% to 90%								
Wiring temperature increase	80K MAX. (based on Sanyo Denki standard)								
Standing angle error	± 0.09°	± 0.09°	± 0.09°	± 0.09°	± 0.09°	± 0.09°	± 0.09°	± 0.04°	± 0.09°
Axial play	0.075mm (0.002952inch)	0.075mm (0.002952inch)	0.075mm (0.002952inch)	0.075mm (0.002952inch)	0.075mm (0.002952inch)	0.075mm (0.002952inch)	0.075mm (0.002952inch)	0.075mm (0.002952inch)	0.075mm (0.002952inch)
	MAX., Load 4.4N (1lbs)	MAX., Load 4.4N (1lbs)	MAX., Load 9N (2lbs)	MAX., Load 9N (2lbs)	MAX., Load 9N (2lbs)	MAX., Load 9N (2lbs)	MAX., Load 9N (2lbs)	MAX., Load 9N (2lbs)	MAX., Load 4.4N (1lbs)
Radial play (Note 1)	0.025mm (0.00098inch) MAX., Load 4.4N (1lbs)								
Shaft runout	0.025mm (0.00098inch)								
Inserted part concentricity against shaft	*0.05mm (0.00197inch)	*0.05mm (0.00197inch)	*0.075mm (0.00295inch)	*0.075mm (0.00295inch)	*0.075mm (0.00295inch)	*0.075mm (0.00295inch)	*0.075mm (0.00295inch)	*0.05mm (0.00197inch)	*0.075mm (0.00295inch)
Fitted surface angularity against shaft	0.1mm (0.00394inch)	0.1mm (0.00394inch)	0.075mm (0.00295inch)	0.075mm (0.00295inch)	0.075mm (0.00295inch)	0.075mm (0.00295inch)	0.075mm (0.00295inch)	0.075mm (0.00295inch)	0.075mm (0.00295inch)

(Note1) When load is applied at 1/3 length from output shaft edge.

General specifications (models to CE marking)

	103H752 □	103H858 □	103H8958 □
Rated voltage	DC12-200V	DC12-300V	
Applied standards (Low voltage directive)	EN60034-1, IEC34-5 (EN60034-5) , EN60204-1, EN60950, EN61010-1		
Specification type	S1 (continuous running duty type)		
Protection grade	IP43		
Protection class	Class I		
Operating environment	Pollution degree 2		
Insulation class	Class B (130°C)		
Insulation resistance	Not less than 100M Ω between winding and frame by DC500V megger at normal temperature and humidity.		
Withstand voltage	Without abnormality when applying 50/60Hz, 1600V AC (1500kV AC for 103H752 □) for 1 minute (leakage current 10mA) between winding and frame at normal temperature and humidity.		
Operating environment	Ambient temperature -10°C to +50°C		
	Ambient humidity 20% to 90% (no condensation)		
Wiring temperature increase	80K MAX. (Based on Sanyo Denki standard)		
Standing angle error	± 0.09°	± 0.09°	± 0.09°
Axial play	0.075mm (0.002952inch) MAX., Load 9N (2lbs)		
Radial play (Note 1)	0.075mm (0.002952inch) MAX., Load 4.4N (1lbs)		
Shaft runout	0.025mm (0.00098inch)		
Inserted part concentricity against shaft	*0.075 mm (0.00295inch)	*0.075 mm (0.00295inch)	*0.075 mm (0.00295inch)
Fitted surface angularity against shaft	0.075 mm (0.00295inch)	0.075 mm (0.00295inch)	0.075 mm (0.00295inch)

(Note 1) When load is applied at 1/3 length from output shaft edge.

Internal wire connection and direction of motor rotate

Internal wire connection

Connector pin number in the parentheses

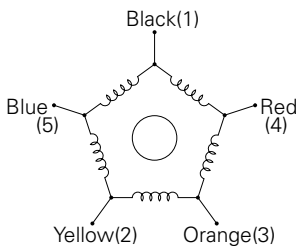

Direction of motor rotate

The direction of motor rotate is counterclockwise when viewed from the output shaft side at the direct current energization in the following order.

Type	Exciting order									
	1	2	3	4	5	6	7	8	9	10
Color of leads	Black	(1)	-	-	-	-	+	+	+	+
	Red	(4)	-	+	+	+	-	-	-	-
	Orange	(3)	+	-	-	-	-	+	+	+
	Yellow	(2)	-	-	+	+	+	+	-	-
	Blue	(5)	+	+	+	-	-	-	-	+

Standard model / CE/UL model

[Unit : mm (inch)]

□ 28mm (□ 1.10inch)

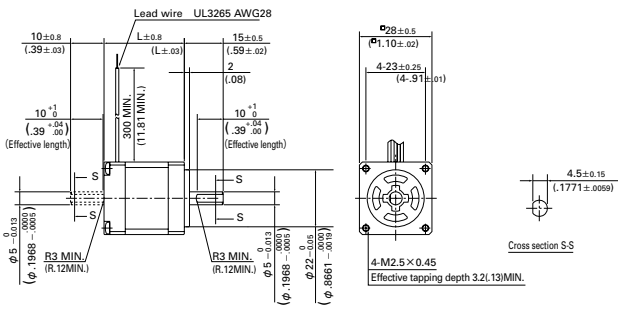

Set part number	Motor model number	Motor length (L) : mm (inch)
F □ F351 △	103F3505-70 △ 1	31 (1.22)
F □ F356 △	103F3515-70 △ 1	50.5 (1.99)
FD F351 △	103F3505-74 △ 1	31 (1.22)
FD F356 △	103F3515-74 △ 1	50.5 (1.99)

□ : Driver specifications

Motor shaft spec	Set type code
AC Power source Standard type	S
AC Power source Positioning function included type	P
DC Power source Standard type	D

■ : Motor specifications

Motor shaft spec	Set type code
F Series motor	F
M Series motor (CE · UL)	M

△ : Motor shaft specification code

Motor shaft spec	Set type code	Motor type code
Single shaft	S	4
Double shaft	D	1

▲ : Motor shaft specification code

Motor shaft spec	Set type code	Motor type code
Single shaft	S	7
Double shaft	D	2

▼ : Motor shaft specification code

Motor shaft spec	Set type code	Motor type code
Single shaft	S	5
Double shaft	D	2

◆ : Rated current

0.75A	0
1.5A	2

◇ : Motor shaft specification code

Motor shaft spec	Set type code	Motor type code
Single shaft	S	5
Double shaft	D	2

● : Rated current

0.75A	7
1.5A	8

□ 28mm (Lead wire type)

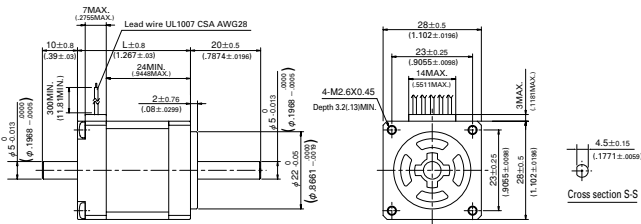

Set part number	Motor model number	Motor length (L) : mm (inch)
—	103H3505-70 ▲ 0	32.2 (1.27)
—	103H3515-70 ▲ 0	51.4 (2.02)

□ 28mm (Connector type)

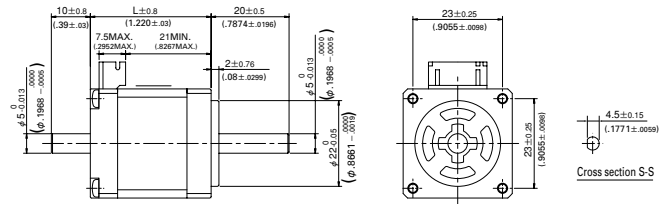

Set part number	Motor model number	Motor length (L) : mm (inch)
—	103H3505-70 △ 0	31 (1.22)
—	103H3515-70 △ 0	50.2 (1.98)

□ 39mm (□ 1.54inch)

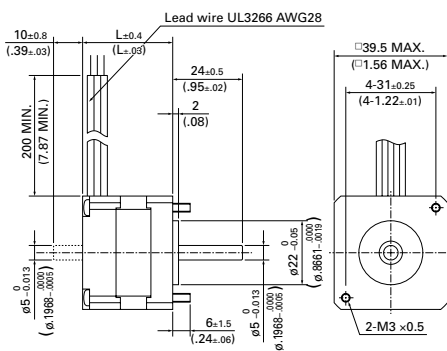

Set part number	Motor model number	Motor length : mm (inch)
—	103-4505-70 △ 0	31 (1.22)
—	103-4507-70 △ 0	35.2 (1.39)
—	103-4510-70 △ 0	44.3 (1.74)

□ 42mm (□ 1.65inch)

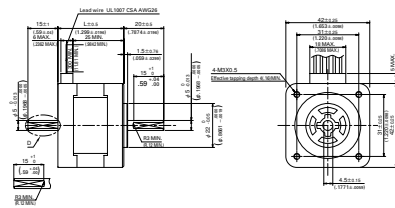
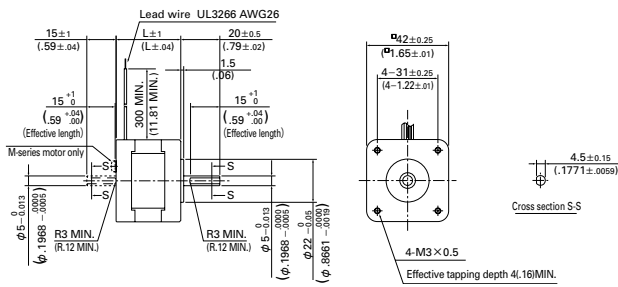

Set part number	Motor model number	Motor length (L) : mm (inch)
F □ F551 △	103 ■ 5505-70 △ 1	34 (1.34)
F □ F552 △	103 ■ 5508-70 △ 1	40 (1.57)
F □ F554 △	103 ■ 5510-70 △ 1	49 (1.93)
FD F551 △	103 F5505-82 △ 1	34 (1.34)
FD F552 △	103 F5508-82 △ 1	40 (1.57)
FD F554 △	103 F5510-82 △ 1	49 (1.93)

Set part number	Motor model number	Motor length (L) : mm (inch)
—	103H5505-70 △ 0	33 (1.3)
—	103H5508-70 △ 0	39 (1.54)
—	103H5510-70 △ 0	48 (1.89)

□ 60mm (□ 2.36inch)

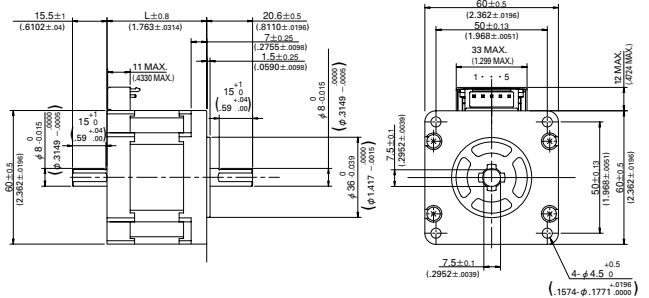
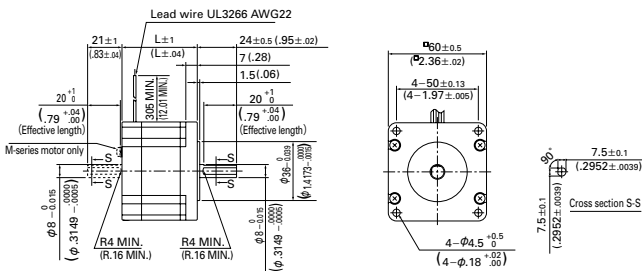

Set part number	Motor model number	Motor length (L) : mm (inch)
F □ F781 △	103 ■ 7851-70 △ 1	46.5 (1.83)
F □ F782 △	103 ■ 7852-70 △ 1	55 (2.17)
F □ F783 △	103 ■ 7853-70 △ 1	87.5 (3.44)
FD F781 △	103 F7851-82 △ 1	46.5 (1.83)
FD F782 △	103 F7852-82 △ 1	55 (2.17)
FD F783 △	103 F7853-82 △ 1	87.5 (3.44)

Set part number	Motor model number	Motor length (L) : mm (inch)
—	103H7851-● 0 △ 1	44.8 (1.76)
—	103H7852-● 0 △ 1	53.8 (2.1)
—	103H7853-● 0 △ 1	85.8 (3.38)

φ 60mm (φ 2.36inch)

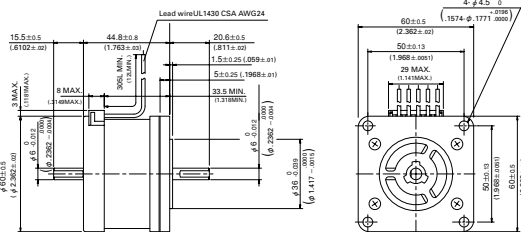
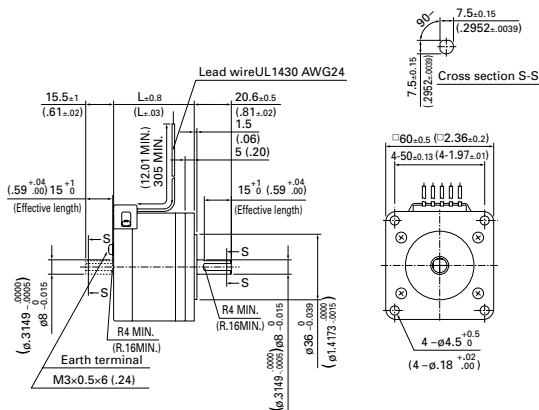

Set part number	Motor model number	Motor length : mm (inch)
—	103H7521-6 ◆▼ 0	44.8 (1.76)
—	103H7522-6 ◆▼ 0	53.8 (2.12)
—	103H7523-6 ◆▼ 0	85.8 (3.38)

Set part number	Motor model number	Motor length : mm (inch)
—	103H7521-● 0 ▼ 1	44.8 (1.76)
—	103H7522-● 0 ▼ 1	53.8 (2.12)
—	103H7523-● 0 ▼ 1	85.8 (3.38)

Dimensions

φ 86mm (φ 3.39inch)

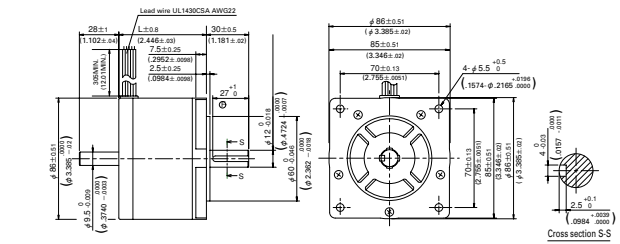
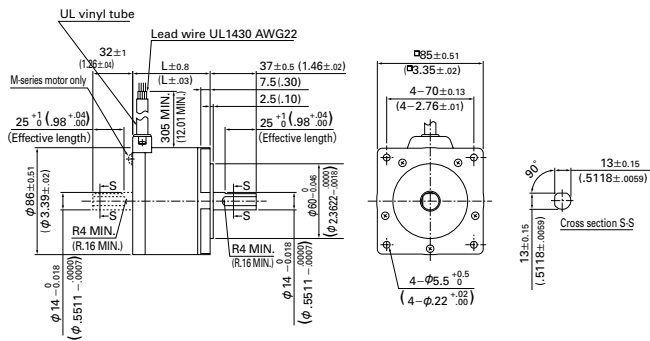

Set part number	Motor model number	Motor length (L): mm (inch)
F □ F851 △	103 ■ 8581-70 △ 1	62.15 (2.45)
F □ F852 △	103 ■ 8582-70 △ 1	92.2 (3.63)
F □ F853 △	103 ■ 8583-70 △ 1	125.85 (4.95)
FD F851 △	103F8581-82 △ 1	62.15 (2.45)
FD F852 △	103F8582-82 △ 1	92.2 (3.63)

Set part number	Motor model number	Motor length (L): mm (inch)
-	103H8581-● 0 △ 1	62.15 (2.45)
-	103H8582-● 0 △ 1	92.2 (3.63)
-	103H8583-● 0 △ 1	125.85 (4.95)

φ 106mm (φ 4.17inch)

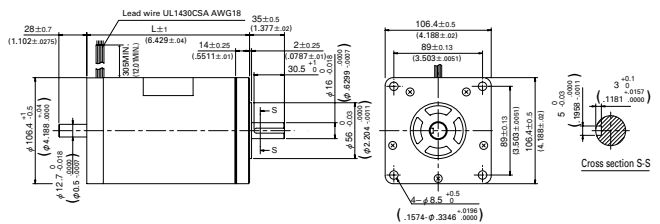
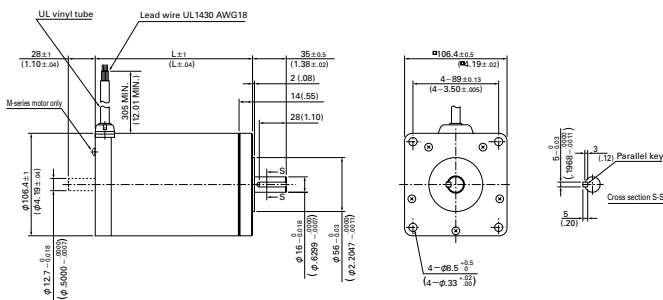

Set part number	Motor model number	Motor length (L) : mm (inch)
F □ F892 △	103 ■ 89582-70 △ 1	163.3 (6.43)
F □ F893 △	103 ■ 89583-70 △ 1	221.3 (8.71)

Set part number	Motor model number	Motor length (L) : mm (inch)
-	103H89582-● 0 △ 1	163.3 (6.43)
-	103H89583-● 0 △ 1	221.3 (8.71)

□ : Driver specifications

Motor shaft spec	Set type code
AC Power source Standard type	S
AC Power source Positioning function included type	P
DC Power source Standard type	D

△ : Motor shaft specification code

Motor shaft spec	Set type code	Motor type code
Single shaft	S	4
Double shaft	D	1

● : Rated current

0.75A	7
1.5A	8

■ : Motor specifications

Motor shaft spec	Set type code
F Series motor	F
M Series motor (CE · UL)	M

Low-backlash gear model

[Unit : mm (inch)]

□ 42mm (□ 1.65inch)

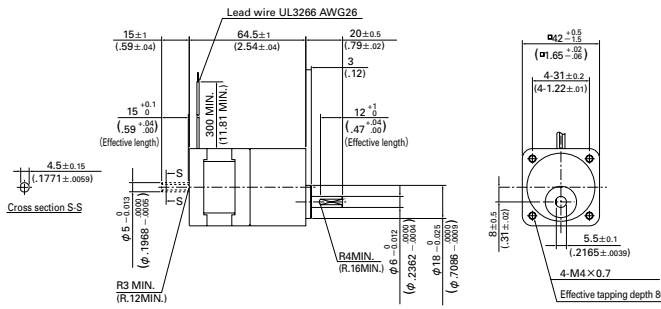

Set part number	Motor model number
FSF551 Δ -CX3.6	103F5505-70CXA Δ
FSF551 Δ -CX7.2	103F5505-70CXB Δ
FSF551 Δ -CX10	103F5505-70CXE Δ
FSF551 Δ -CX20	103F5505-70CXG Δ
FSF551 Δ -CX30	103F5505-70CXJ Δ
FSF551 Δ -CX36	103F5505-70CXX Δ

□ 60mm (□ 2.36inch)

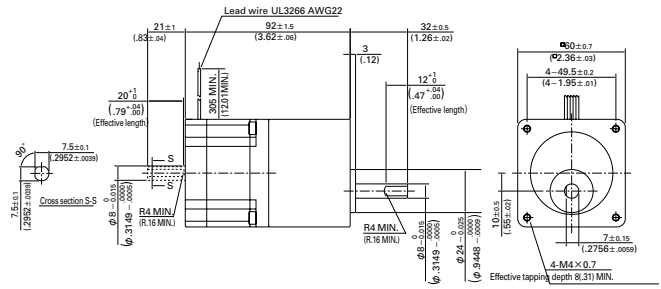

Set part number	Motor model number
FSF781 Δ -CX3.6	103F7851-70CXA Δ
FSF781 Δ -CX7.2	103F7851-70CXB Δ
FSF781 Δ -CX10	103F7851-70CXE Δ
FSF781 Δ -CX20	103F7851-70CXG Δ
FSF781 Δ -CX30	103F7851-70CXJ Δ
FSF781 Δ -CX36	103F7851-70CXX Δ

φ 86mm (φ 3.39inch)

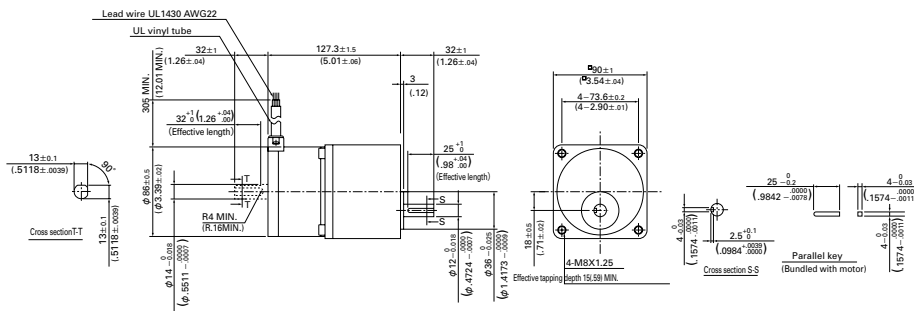

Set part number	Motor model number
FSF851 Δ -CX3.6	103F8581-70CXA Δ
FSF851 Δ -CX7.2	103F8581-70CXB Δ
FSF851 Δ -CX10	103F8581-70CXE Δ
FSF851 Δ -CX20	103F8581-70CXG Δ
FSF851 Δ -CX30	103F8581-70CXJ Δ
FSF851 Δ -CX36	103F8581-70CXX Δ

Δ : Motor shaft specification code

Motor shaft spec	Set type code	Motor type code
Single shaft	S	4
Double shaft	D	1

Spur gear model

[Unit : mm (inch)]

□ 28mm (□ 1.10inch)

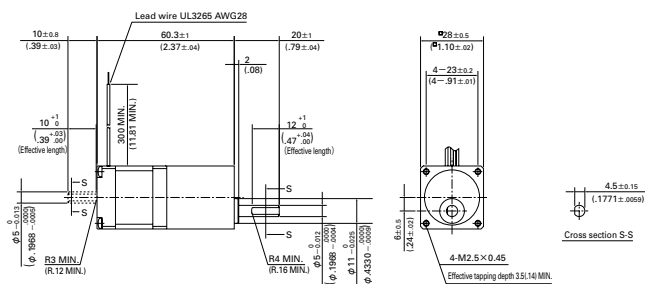

Set part number	Motor model number
FSF351 Δ -GX3.6	103F3505-70GXA Δ
FSF351 Δ -GX7.2	103F3505-70GXB Δ
FSF351 Δ -GX10	103F3505-70GXE Δ
FSF351 Δ -GX20	103F3505-70GXG Δ
FSF351 Δ -GX30	103F3505-70GXJ Δ
FSF351 Δ -GX50	103F3505-70GXL Δ

Δ : Motor shaft specification code

Motor shaft spec	Set type code	Motor type code
Single shaft	S	4
Double shaft	D	1

AC input

Input / Output signal standard

DC input

Stepping motor

Dimensions

Electromagnetic brake model

[Unit : mm (inch)]

□ 42mm (□ 1.65inch)

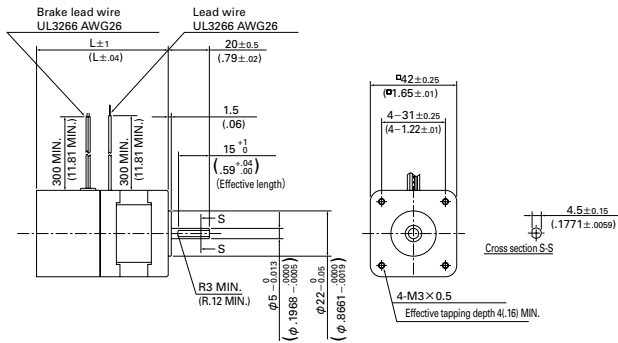

Set part number	Motor model number	Motor + brake length : mm (inch)
FSF551S-XB	103F5505-70XB41	64.5 (2.54)
FSF552S-XB	103F5508-70XB41	70.5 (2.78)
FSF554S-XB	103F5510-70XB41	79.5 (3.13)

□ 60mm (□ 2.36inch)

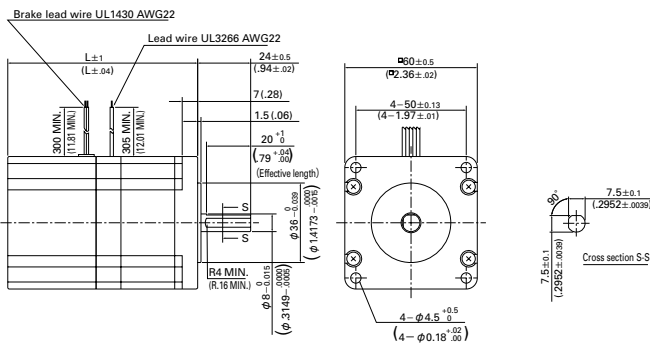

Set part number	Motor model number	Motor + brake length : mm (inch)
FSF781S-XB	103F7851-70XB41	85.8 (3.38)
FSF782S-XB	103F7852-70XB41	94.5 (3.72)
FSF783S-XB	103F7853-70XB41	126.7 (4.99)

φ 86mm (φ 3.39inch)

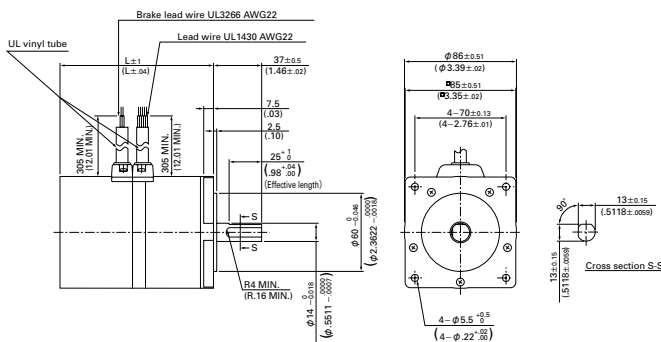

Set part number	Motor model number	Motor + brake length : mm (inch)
FSF851S-XB	103F8581-70XB41	116.7 (4.59)
FSF852S-XB	103F8582-70XB41	146.8 (5.78)
FSF853S-XB	103F8583-70XB41	180.4 (7.10)

AC input

Input / Output signal standard

DC input

Stepping motor

Dimensions

F series driver (CE [TÜV] • UL)

[Unit : mm (inch)]

AC input

FS type

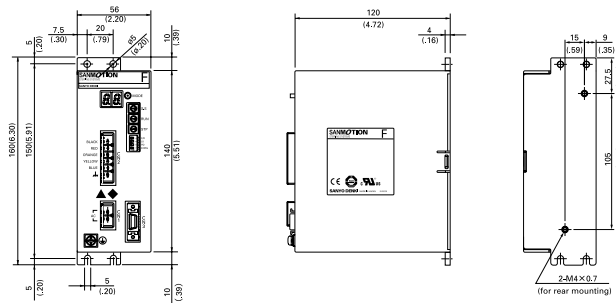

FP type

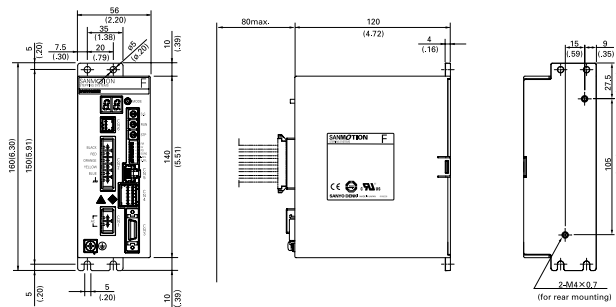

DC input

FD type

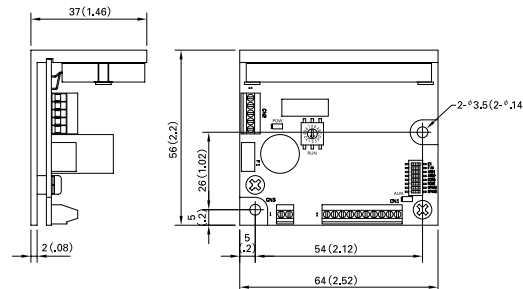

Safety standards

F series AC driver

UL	Acquired standards		File No.	Standard part
	UL			E179775
UL for Canada				
CE (TÜV)	Directives	Category	Name	Standard part
	Low-voltage directives	-	-	EN50178
	EMC directives	Emission	Terminal disturbance voltage	EN55011-A
			Electromagnetic radiation disturbance	EN55011-A
			ESD (Electrostatic discharge)	EN61000-4-2
		Immunity	RS (Radio-frequency amplitude modulated electromagnetic field)	EN61000-4-3
			Fast transients	EN61000-4-4
			Surges	EN61000-4-6
			CS (Radio-frequency common mode)	EN61000-4-5
Voltage dips, Voltage interruptions	EN61000-4-11			

F series AC driver

UL	Acquired standards		File No.	Standard part
	UL			E179775
UL for Canada				
CE (TÜV)	Directives	Category	Name	Standard part
	Low-voltage directives	-	-	EN61010-1
	EMC directives	Emission	Terminal disturbance voltage	EN55011-A
			Electromagnetic radiation disturbance	EN55011-A
			ESD (Electrostatic discharge)	EN61000-4-2
		Immunity	RS (Radio-frequency amplitude modulated electromagnetic field)	EN61000-4-3
			Fast transients	EN61000-4-4
			Surges	EN61000-4-6

● EMC characteristics may vary depending on the configuration of the users' control panel, which contains the driver or stepping motor, or the arrangement and wiring of other electrical devices.

● Validation test of F series driver has been performed for low-voltage EMC directives at TÜV (TÜV SUD Japan) for self-declaration of CE marking.

M series motor

UL	Acquired standards		File No.	Standard part
	UL			E208878
UL for Canada				
CE	Standard category			Standard part
				EN-60034-1
	Low-voltage directives			IEC34-5 (EN-60034-5)

Safety Consideration

The drivers and stepping motors are the products designed to be used for the general industrial devices.

When using those, pay enough attention to the following points.

- Read thoroughly the Operation Manual prior to placement, assembly and/or operation in order to use the product properly.
- Refrain from modifying or processing the product in any way.
- Consult with the distributor or professional experts for placement or maintenance services of the product.
- In case of the following uses of the product, contact with us for the special care required to the operation, maintenance and management such as multiplexing the system, installing an emergency electric generator set, or so forth.

- 1 Use for the medical devices concerned with a fatal accident.
- 2 Use for trains, elevators, and so forth that are likely to cause an accident resulting in injury, damage or death.
- 3 Use in the computer system highly influential to the social life or the public systems.
- 4 Use in other devices highly influential to maintaining the human safety or the public functions.

In addition to the above, consult with us for use in such a vibration environment as automobile or transportation.

Read the Operation Manual thoroughly prior to the use (placement, operation, maintenance and inspection) to put the product in use properly.

Make yourself knowledgeable and familiarize with the devices, safety issues and cautions before handling the product.

After reading the Operation Manual or the like, keep it in the place where the users can refer to whenever necessary.

Indication by (Warning Label) on the product

Either or all of the following indications are given by the Warning Labels depending on the type of the driver or stepping motor.



This label is stuck near the high voltage part such as the electrically charged or cover-protected section, warning that the place where it is likely to cause an electric shock.



This label is stuck on the place where the driver or stepping motor body should be easily acknowledged, warning that it is likely to cause burns from high temperature.



This label is stuck near the GND terminals of the driver or stepping motor for which grounding is required, suggesting that the terminals should be actually grounded.



This label is stuck for the driver or stepping motor to which the power source is applied in the voltage exceeding the safety standard, drawing attention against the electric shock.

Safety ranks of the cautions

Following four ranks are provided.



DANGER Improper operations or use is most likely to result in serious injury or death.



CAUTION Improper operations or use is likely to result in average or minor injury, or in property damage.

In spite of the cautions with the Δ_{CAUTION} CAUTION label, it may cause serious results. Either the contents of the labels is describing important cautions to be followed inevitably.



PROHIBITED Indicates what shall not be done.



COMPULSORY Indicates what shall be done.

DANGER

< General matters >

1. Do not use the product in an explosive, flammable or corrosive atmosphere, watery place or near a combustible material. Doing so may cause injury or fire.
2. Have a person with expert knowledge for performing the transportation, placement, wiring, operation, maintenance or inspection of the product. Without such knowledge, it may cause an electric shock, injury or fire.
3. Do not work for wiring, maintenance servicing or inspection with the electric power on. Perform either of those five minutes after turning the power off, or otherwise, it may cause an electric shock.
4. When the protective functions of the product is activated, turn the power off immediately and eliminate the cause. If continuing the operation without eliminating the cause, the product may operate improperly and cause injury or a breakdown of the system devices.
5. Stepping motor may run out of order at the operating and stopping occasions, depending on the magnitude of the load. Put the product into use after confirming with the adequate trial test operation in the maximum load conditions that the product performs reliable operation. Doing otherwise may cause a breakdown of the system. (Should the product run out of order in the use to drive upward/downward, it may cause a fall of the load.)
6. Do not touch the internal parts of the driver. Doing so may cause an electric shock.

< Wiring >

7. Do not connect the stepping motor directly with the commercial power outlet. Doing so may cause an electric shock, injury or fire. The power shall be supplied to the stepping motor through the driving circuit.
8. Use the electric power source within the rated input voltage. Using otherwise may cause fire or an electric shock.
9. Connect the driver and stepping motor to the ground. Using without grounding may cause an electric shock.
10. Do not harm, forcibly put a stress, or load a heavy article on the cable or get it caught between the articles. Doing so may cause an electric shock.
11. Perform wiring with the power cable as instructed by the wiring diagram or the Operation Manual. Doing otherwise may cause an electric shock or fire.

< Operation >

12. Be sure not to touch the rotating part of the stepping motor during its operation. Touching it may cause injury.
13. Neither reach or touch the electric terminals while electric power is on. Doing so may cause an electric shock.
14. Never disconnect any of the connectors while electric power is on. Doing so may cause an electric shock and corruption.

< General matters >

1. Prior to placement, operation, maintenance servicing or inspection, be sure to read the Operation Manual and follow the instructions to perform those. Failure to follow the instructions may cause an electric shock, injury or fire.
2. Do not use the driver or the stepping motor outside the specified conditions. Doing so may cause an electric shock, injury or fire.
3. Do not insert a finger or a thing into the opening of the product. Doing so may cause an electric shock, injury or fire.
4. Do not use the damaged driver or stepping motor. Doing so may cause injury, fire or the like.
5. Use the driver and stepping motor in the designated combination. Using otherwise may cause fire or a trouble.
6. Be careful that the temperature rises in the operating driver, stepping motor or peripheral devices. Failure to be careful may cause a burn.

< Unpacking >

7. Unpack while confirming the ceiling. Failure to do so may cause injury.
8. Confirm if the product is the one having been ordered. Installing an incorrect product may cause a breakdown.

< Wiring >

9. Do not perform measurement of the insulation resistance or withstand insulation voltage of the product. Doing so may cause a breakdown. Instead, contact with us for such inspection.
10. Perform wiring conforming to the technical standards of electric facility or the internal rule. Doing otherwise may cause burning or fire.
11. Ensure that wiring has been correctly done. Operating without correct wiring may cause the stepping motor to run out of control and result in injury.

12. Take insulation process for the attached condenser or the external resistance connection terminals. Failure to do so may cause an electric shock.

< Placement >

13. Do not climb or attach a heavy article on the product. Doing so may cause injury.
14. Neither block nor stuff the aspiration/exhaust vent with a foreign particle. Doing so may cause fire.
15. Follow the instructions for the direction to place. Failure to do so may cause a trouble.
16. Keep a distance as instructed by the Operation Manual for the driver from the inner surface of the control console or other devices. Failure to do so may cause a trouble.
17. Place the product with a great care so as to prevent from the danger such as a tumble or a turnover.

CAUTION

18. Mount the product on an incombustible material such as metal. Doing otherwise may cause fire.
19. Confirm the rotating direction before connecting with the mechanical device. Failure to do so may cause injury or a breakdown.
20. Do not touch the motor output spindle (including the key slot and gears) with a bare hand. Doing so may cause injury.

< Operation >

21. The stepping motor is not equipped with any protective device. Take protective measures using an over-current protective relay, a ground fault interrupter, a protective device from excess temperature, and an emergency stopping device. Failure to do so may cause injury or fire.
22. Do not touch the product for a period after the power is on or has been turned off, since the driver and stepping motor remain in the high temperature. Doing so may cause burns. Especially the temperature rises considerably of the stepping motor depending on the operating conditions. Use the motor on the condition so that its surface temperature becomes 100°C or under.
23. Stop the operation immediately when an emergency occurs. Failure to do so may cause an electric shock, injury or fire.
24. Do not change adjustment to an extreme, for such a change results in the unstable operation. Doing so may cause injury.
25. When conducting the trial operation, make the stepping motor fixed firmly, and confirm the operation by disconnecting with the mechanical system before connecting with it. Failure to do so may cause injury.
26. When the alarm has been activated, eliminate the cause and ensure the safety to resume operation. Failure to do so may cause injury.
27. When the electric power recovers after the momentary interruption, do not approach the devices because the system may re-start operation by itself. (Set the system so as to secure the safety even when it re-start on such occasion.) Failure to do so may cause injury.
28. Confirm that the electric power supply is all proper conforming to the specifications. Failure to do so may cause a trouble.
29. The brake mechanism of the motor with the electro-magnetic brake is to hold the movable section and the motor position. Do not use it as a safety measure, or doing so may cause the breakdown of the system.
30. Fix the key firmly when operating the motor with key individually. Failure to do so may cause injury.

< Maintenance services >

31. Be careful when performing maintenance services or inspection about the temperature which rises highly in the driver and stepping motor frame. Failure to do so may cause burns.
32. It is recommended to replace the electrolytic condenser of the driver with a new one for securing the preventive measure after using for 5 years, the expected life in the average 40°C. The expected life of the fuse and cooling fan motor is 10 years in the average 40°C. Thus, the periodical replacement is recommended.

33. Contact with us for repair. If the product is disassembled by the user, it may put it out of action.

< Transportation >

34. Handle the product with care during transportation so as to prevent from the danger such as a tumble or a turnover.
35. Do not hold with the cable or the motor spindle. Doing so may cause a trouble or injury.

< Retirement >

36. When scrapping the driver or stepping motor, treat it for the general industrial waste.

PROHIBITED

< Storage >

1. Avoid the place exposed to rain or water drops, or in an environment with hazardous gas or liquid for storing the product. Failure to do so may cause a trouble.

< Maintenance services >

2. Do not assemble or repair the product. Doing so may cause fire or an electric shock.

< General matters >

3. Do not remove the rating plate.

COMPULSORY

< Storage >

1. Store the product within the specified conservation temperature and humidity in the place not exposed to the sun beam.

2. If the driver has been stored for a long period (3 years or longer for a guide), consult with us. The capacitance may have decreased with the electrolytic condenser due to the long period storage, and it may cause a trouble.

< Operation >

3. Install an external emergency stop circuit to turn the power off for the instant halt of operation.
4. Put the product into operation in the specified ambient temperature and humidity.

< Transportation >

5. Excess loading of the product on the carrier may cause the load to fall in pieces. Follow the instructions given outside the package.

Inquiry Check Sheet

Please provide the following information when placing an order or making an inquiry.
Also feel free to include any questions that require our attention.

Company Name: _____
 Department: _____
 Telephone : _____
 Fax: _____
 1) Application: _____
 2) Name of Machinery: _____
 3) Number of Units: _____

Date: _____
 To contact us: _____
 Phone: +81 3 3917 5157
 Fax: +81 3 3917 0643

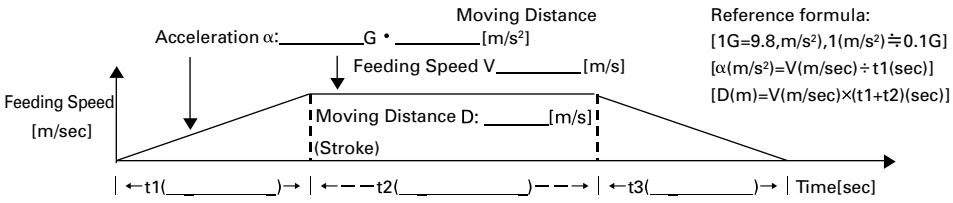
Item	Contents																																																																																																						
①	Name of target equipment Equipment name, category (transport, processing, test, other)																																																																																																						
②	Name of servo axis Axis name, axial mechanism (horizontal/vertical), brake mechanism (yes/no)																																																																																																						
③	Current condition of above axis Manufacturer Name () Series Name () Motor Capacity () Hydraulic, Mechanical, or New System ()																																																																																																						
④	Positioning accuracy ± mm / ± μm																																																																																																						
⑤	Operation pattern  <p>Reference formula: $[1G=9.8, m/s^2], 1(m/s^2) \approx 0.1G]$ $[\alpha(m/s^2)=V(m/sec) \div t1(sec)]$ $[D(m)=V(m/sec) \times (t1+t2)(sec)]$</p>																																																																																																						
⑥	Mechanism Ball-screw/screw-rotation type (horizontal), ball-screw/nut-rotation type (horizontal), rack and pinion (horizontal), belt/chain (horizontal), rotary table, roll feed, instability																																																																																																						
⑦	Mechanical structure <table border="0" style="width:100%; border-collapse: collapse;"> <tr> <td style="width:33%;">WT (table mass)</td> <td style="width:10%;">kg</td> <td style="width:33%;">WL (work mass)</td> <td style="width:10%;">kg</td> <td style="width:14%;">WA (mass of other drive parts)</td> <td style="width:10%;">kg</td> </tr> <tr> <td>WR (rack mass)</td> <td>kg</td> <td>WB (belt/chain mass)</td> <td>kg</td> <td>WC (counterbalance mass)</td> <td>kg</td> </tr> <tr> <td>Fa (external force in axial direction)</td> <td>N</td> <td>Fb (ball-screw preload)</td> <td>N</td> <td>T (roll pushing force)</td> <td>N</td> </tr> <tr> <td>Dr1 (drive-side roll diameter)</td> <td>mm</td> <td>Dr2 (follower-side roll diameter)</td> <td>mm</td> <td></td> <td></td> </tr> <tr> <td>Lr1 (drive-side roll length)</td> <td>mm</td> <td>Lr2 (follower-side roll length)</td> <td>mm</td> <td>G (reduction ratio)</td> <td></td> </tr> <tr> <td>JG (speed-reducer inertia)</td> <td>kg·m²</td> <td>JC (coupling inertia)</td> <td>kg·m²</td> <td></td> <td></td> </tr> <tr> <td>JN (nut inertia)</td> <td>kg·m²</td> <td>JO (other motor-axis conversion inertia)</td> <td>kg·m²</td> <td></td> <td></td> </tr> <tr> <td>Db (ball-screw diameter)</td> <td>mm</td> <td>Lb (ball-screw axial length)</td> <td>mm</td> <td>Pb (ball-screw lead)</td> <td>mm</td> </tr> <tr> <td>Dp (pinion/pulley diameter)</td> <td>mm</td> <td>Lp (pinion axial length)</td> <td>mm</td> <td>Tp (pulley thickness)</td> <td>mm</td> </tr> <tr> <td>Dt (table diameter)</td> <td>mm</td> <td>Dh (table-support diameter)</td> <td>mm</td> <td>LW (load shift from axis)</td> <td>mm</td> </tr> <tr> <td>Ds (table shaft diameter)</td> <td>mm</td> <td>Ls (table shaft length)</td> <td>mm</td> <td></td> <td></td> </tr> <tr> <td colspan="2">ρ (specific gravity of ball-screw/pinion/pulley/table-shaft material)</td> <td colspan="2"></td> <td></td> <td>kg/cm³</td> </tr> <tr> <td colspan="2">μ (friction coefficient between sheet and sliding-surface/support-section/roll)</td> <td colspan="2">ρ1 (specific gravity of roll-1 material)</td> <td colspan="2">kg/cm³</td> </tr> <tr> <td colspan="2">ρ2 (specific gravity of roll-2 material)</td> <td colspan="2">kg/cm³</td> <td colspan="2">κ (internal friction coefficient of preload nut)</td> </tr> <tr> <td colspan="2">η (mechanical efficiency)</td> <td colspan="2">JL (load inertia of motor-axis conversion)</td> <td colspan="2">kg·m²</td> </tr> <tr> <td colspan="2">TF (friction torque of motor axis conversion)</td> <td colspan="2">N·m</td> <td colspan="2">TU (imbalance torque of motor axis conversion)</td> </tr> <tr> <td colspan="2"></td> <td colspan="2"></td> <td colspan="2">N·m</td> </tr> </table>	WT (table mass)	kg	WL (work mass)	kg	WA (mass of other drive parts)	kg	WR (rack mass)	kg	WB (belt/chain mass)	kg	WC (counterbalance mass)	kg	Fa (external force in axial direction)	N	Fb (ball-screw preload)	N	T (roll pushing force)	N	Dr1 (drive-side roll diameter)	mm	Dr2 (follower-side roll diameter)	mm			Lr1 (drive-side roll length)	mm	Lr2 (follower-side roll length)	mm	G (reduction ratio)		JG (speed-reducer inertia)	kg·m ²	JC (coupling inertia)	kg·m ²			JN (nut inertia)	kg·m ²	JO (other motor-axis conversion inertia)	kg·m ²			Db (ball-screw diameter)	mm	Lb (ball-screw axial length)	mm	Pb (ball-screw lead)	mm	Dp (pinion/pulley diameter)	mm	Lp (pinion axial length)	mm	Tp (pulley thickness)	mm	Dt (table diameter)	mm	Dh (table-support diameter)	mm	LW (load shift from axis)	mm	Ds (table shaft diameter)	mm	Ls (table shaft length)	mm			ρ (specific gravity of ball-screw/pinion/pulley/table-shaft material)					kg/cm ³	μ (friction coefficient between sheet and sliding-surface/support-section/roll)		ρ1 (specific gravity of roll-1 material)		kg/cm ³		ρ2 (specific gravity of roll-2 material)		kg/cm ³		κ (internal friction coefficient of preload nut)		η (mechanical efficiency)		JL (load inertia of motor-axis conversion)		kg·m ²		TF (friction torque of motor axis conversion)		N·m		TU (imbalance torque of motor axis conversion)						N·m	
WT (table mass)	kg	WL (work mass)	kg	WA (mass of other drive parts)	kg																																																																																																		
WR (rack mass)	kg	WB (belt/chain mass)	kg	WC (counterbalance mass)	kg																																																																																																		
Fa (external force in axial direction)	N	Fb (ball-screw preload)	N	T (roll pushing force)	N																																																																																																		
Dr1 (drive-side roll diameter)	mm	Dr2 (follower-side roll diameter)	mm																																																																																																				
Lr1 (drive-side roll length)	mm	Lr2 (follower-side roll length)	mm	G (reduction ratio)																																																																																																			
JG (speed-reducer inertia)	kg·m ²	JC (coupling inertia)	kg·m ²																																																																																																				
JN (nut inertia)	kg·m ²	JO (other motor-axis conversion inertia)	kg·m ²																																																																																																				
Db (ball-screw diameter)	mm	Lb (ball-screw axial length)	mm	Pb (ball-screw lead)	mm																																																																																																		
Dp (pinion/pulley diameter)	mm	Lp (pinion axial length)	mm	Tp (pulley thickness)	mm																																																																																																		
Dt (table diameter)	mm	Dh (table-support diameter)	mm	LW (load shift from axis)	mm																																																																																																		
Ds (table shaft diameter)	mm	Ls (table shaft length)	mm																																																																																																				
ρ (specific gravity of ball-screw/pinion/pulley/table-shaft material)					kg/cm ³																																																																																																		
μ (friction coefficient between sheet and sliding-surface/support-section/roll)		ρ1 (specific gravity of roll-1 material)		kg/cm ³																																																																																																			
ρ2 (specific gravity of roll-2 material)		kg/cm ³		κ (internal friction coefficient of preload nut)																																																																																																			
η (mechanical efficiency)		JL (load inertia of motor-axis conversion)		kg·m ²																																																																																																			
TF (friction torque of motor axis conversion)		N·m		TU (imbalance torque of motor axis conversion)																																																																																																			
				N·m																																																																																																			
⑧	Speed reducer Customer-provided (/); Sanyo standard (planet/spur/no-backlash-planet: /); other (/)																																																																																																						
⑨	Sensor type Sensor type specified (yes / no) Yes: (incremental , optical absolute , optical absolute [resolver absolute with incremental function]) Resolution ()																																																																																																						
⑩	Input format Position , speed, torque, communications (SERCOS / CAN / DeviceNet) other ()																																																																																																						
⑪	Upper-level equipment (controller) Sequencer , laptop , customer-developed product , Sanyo-provided , other ()																																																																																																						
⑫	Usage environment and other requirements Cutting , clean-room use , anti-dust measures , other ()																																																																																																						
⑬	Estimated production Single product: () units/month () units/year																																																																																																						
⑭	Development schedule Prototype period: ()Year ()Month Production period: ()Year ()Month																																																																																																						
⑮	Various measures Related documentation (already submitted ; send later by mail) Visit/PR desired (yes / no) Meeting desired (yes / no)																																																																																																						
⑯	Miscellaneous (questions, pending problems, unresolved issues, etc.)																																																																																																						

■ Precautions For Adoption



Failure to follow the precautions on the right may cause moderate injury and property damage, or in some circumstances, could lead to a serious accident.
Always follow all listed precautions.

Cautions

- Read the accompanying Instruction Manual carefully prior to using the product.
- If applying to medical devices and other equipment affecting people's lives, please contact us beforehand and take appropriate safety measures.
- If applying to equipment that can have significant effects on society and the general public, please contact us beforehand.
- Do not use this product in an environment where vibration is present, such as in a moving vehicle or shipping vessel.
- Do not perform any retrofitting, re-engineering, or modification to this equipment.
- The drivers and motors presented in this catalog are meant to be used for general industrial applications. If using for special applications related to aviation and space, nuclear power, electric power, submarine repeaters, etc., please contact us beforehand.

* For any question or inquiry regarding the above, contact our Sales Department.

SANYO DENKI CO., LTD.

1-15-1, Kita-Otsuka, Toshima-ku, Tokyo 170-8451, Japan

<http://www.sanyodenki.co.jp>

Phone: +81 3 3917 5157

SANYO DENKI AMERICA, INC.

468 Amapola Avenue Torrance, CA 90501 U.S.A.

Phone: +1 310 783 5400

SANYO DENKI EUROPE SA.

P.A. Paris Nord II 48 Allée des Erables-VILLEPINTE BP.57286 F-95958 ROISSY CDG Cedex France

Phone: +33 1 48 63 26 61

SANYO DENKI GERMANY GmbH

Frankfurter Strasse 63-69 65760 Eschborn Germany

Phone: +49 6196 76113 0

SANYO DENKI KOREA CO., LTD.

9F 5-2, Sunwha-dong Jung-gu Seoul, 100-130, Korea

Phone: +82 2 773 5623

SANYO DENKI SHANGHAI CO., LTD.

Room 2116, Bldg B, FAR EAST INTERNATIONAL PLAZA, No.317 XianXia Rd., Shanghai 200051 China

Phone: +86 21 6235 1107

SANYO DENKI TAIWAN CO., LTD.

Room 1208, 12F, No.96 Chung Shan N, Rd., Sec.2, Taipei 104, Taiwan, R.O.C.

Phone: +886 2 2511 3938

SANYO DENKI (H.K.) CO., LIMITED

Room 2305, 23/F, South Tower, Concordia Plaza, 1 Science Museum Rd., TST East, Kowloon, Hong Kong

Phone: +852 2312 6250

SANYO DENKI SINGAPORE PTE. LTD.

10 Hoe Chiang Road #14-03A/04 Keppel Towers Singapore 089315

Phone: +65 6223 1071

The names of companies and/or their products specified in this catalogue are the trade names, and/or trademarks and/or registered trademarks of such respective companies.
*Remarks : Specifications Are Subject To Change Without Notice.

CATALOG No. 833-3 '07.11.C