



# Studies of the Laboulbeniomycetes: Diversity, Evolution, and Patterns of Speciation

## Permanent link

<http://nrs.harvard.edu/urn-3:HUL.InstRepos:40049989>

## Terms of Use

This article was downloaded from Harvard University's DASH repository, and is made available under the terms and conditions applicable to Other Posted Material, as set forth at <http://nrs.harvard.edu/urn-3:HUL.InstRepos:dash.current.terms-of-use#LAA>

## Share Your Story

The Harvard community has made this article openly available.  
Please share how this access benefits you. [Submit a story](#).

[Accessibility](#)

STUDIES OF THE LABOULBENIOMYCETES: DIVERSITY, EVOLUTION, AND  
PATTERNS OF SPECIATION

A dissertation presented

by

DANNY HAELEWATERS

to

THE DEPARTMENT OF ORGANISMIC AND EVOLUTIONARY BIOLOGY

in partial fulfillment of the requirements

for the degree of

Doctor of Philosophy

in the subject of

Biology

HARVARD UNIVERSITY

Cambridge, Massachusetts

April 2018

© 2018 – Danny Haelewaters

All rights reserved.

STUDIES OF THE LABOULBENIOMYCETES: DIVERSITY, EVOLUTION, AND  
PATTERNS OF SPECIATION

**ABSTRACT**

CHAPTER 1: Laboulbeniales is one of the most morphologically and ecologically distinct orders of Ascomycota. These microscopic fungi are characterized by an ectoparasitic lifestyle on arthropods, determinate growth, lack of asexual state, high species richness and intractability to culture. DNA extraction and PCR amplification have proven difficult for multiple reasons. DNA isolation techniques and commercially available kits are tested enabling efficient and rapid genetic analysis of Laboulbeniales fungi. Success rates for the different techniques on different taxa are presented and discussed in the light of difficulties with micromanipulation, preservation techniques and negative results.

CHAPTER 2: The class Laboulbeniomycetes comprises biotrophic parasites associated with arthropods and fungi. Two orders have been recognized, Laboulbeniales and Pyxidiophorales. The phylogenetic reconstruction of a large three-gene dataset reveals a third order, Herpomycetales nom. prov., containing the single genus *Herpomyces*, which now comprises 26 species. Species of *Herpomyces* exclusively parasitize cockroaches (Blattodea). A new species, *H. shelfordellae* nom. prov., is described based on morphology and analysis of the ITS ribosomal DNA. The new rankless taxon ‘Laboulbeniomyceta’ is used for the well-resolved node that describes the most recent common ancestor of Laboulbeniomycetes and sister class Sordariomycetes.

CHAPTER 3: Using the morphological species concept, *Hesperomyces virescens*

(Laboulbeniales) has been recognized as a single species with an almost global distribution and a host range encompassing 30 ladybird hosts (Coccinellidae). Using sequence data from three gene regions – SSU, ITS and LSU rDNA, evidence is presented for distinct clades within *Hesperomyces virescens*, each clade restricted to a single host species. Species delimitation methods confirm that the lineages within *H. virescens* sensu lato correspond to species. The combination of morphometric, molecular phylogenetic and ecological data provides support for an integrative taxonomy approach.

CHAPTER 4: *Arthrorhynchus*, *Gloeandromyces* and *Nycteromyces* (Laboulbeniales), are ectoparasitic on bat flies (Diptera), which are ectoparasitic on bats (Chiroptera). Sequence data from two genes reveal that parasitism of bat flies by Laboulbeniales independently arose three times. Of seven morphologically distinct taxa of *Gloeandromyces*, four are delimited as separate species by molecular methods. *Gloeandromyces dickii* nom. prov. is described and illustrated. Both *G. pageanus* and *G. streblae* show divergence correlated with host specialization. Position-induced morphological adaptations are observed and discussed. Parasite-host associations between bat flies and Laboulbeniales are explained by roosting ecology of the bat hosts.

CHAPTER 5: Owing to difficulties in DNA extraction and amplification of phylogenetically informative genes, the phylogeny of the class Laboulbeniomycetes has been severely understudied. Here, based on a dataset of 83 small subunit ribosomal DNA sequences, a preliminary class-wide phylogeny is presented. The three orders Herpomycetales, Laboulbeniales and Pyxidiophorales are strongly supported, but several current higher taxa (subtribes, tribes, subfamilies) are polyphyletic. Earliest diverging genera in the Laboulbeniales tree are those that have aquatic hosts. Compound antheridia have arisen multiple times independently. Structurally based classification needs revision.

**TABLE OF CONTENTS**

ABSTRACT..... iii

TABLE OF CONTENTS..... v

ACKNOWLEDGEMENTS..... ix

INTRODUCTION TO LABOULBENIALES .....1

    FUNGAL PARASITES .....2

    OVERVIEW OF LABOULBENIOMYCETES .....3

    SOME HISTORICAL NOTES.....7

    A MODEL TO STUDY SYMBIOTIC RELATIONSHIPS .....11

    MORPHOLOGY OF LABOULBENIALES.....13

    ASSOCIATIONS WITH THEIR HOSTS .....19

    OBJECTIVES OF THE DISSERTATION .....27

    LITERATURE CITED .....29

CHAPTER 1: Bringing Laboulbeniales into the 21st century: enhanced techniques for extraction and PCR amplification of DNA from minute ectoparasitic fungi .....41

    Abstract .....44

    INTRODUCTION .....44

MATERIAL AND METHODS .....	48
RESULTS .....	53
DISCUSSION .....	56
CONCLUSIONS.....	62
ACKNOWLEDGEMENTS.....	63
LITERATURE CITED.....	64
CHAPTER 2: Birth of an order: comprehensive phylogenetic study excludes <i>Herpomyces</i> (Fungi, Laboulbeniomycetes) from Laboulbeniales .....	70
Abstract.....	72
INTRODUCTION .....	73
MATERIAL AND METHODS.....	76
RESULTS .....	85
TAXONOMY .....	99
Herpomycetales nom. prov. ....	99
<i>Herpomyces shelfordellae</i> nom. prov. ....	100
DISCUSSION.....	103
ACKNOWLEDGEMENTS.....	112
LITERATURE CITED.....	113

CHAPTER 3: Integrative taxonomy reveals hidden species within <i>Hesperomyces virescens</i> (Fungi, Laboulbeniales), a parasite of ladybirds (Coleoptera, Coccinellidae) .....	120
Abstract .....	121
INTRODUCTION .....	121
MATERIAL AND METHODS .....	126
RESULTS .....	137
DISCUSSION .....	157
CONCLUSIONS.....	168
LITERATURE CITED .....	168
CHAPTER 4: Hyperparasites: morphological and molecular diversity of Laboulbeniales fungi associated with ectoparasitic bat flies (Diptera: Nycteribiidae, Streblidae) .....	177
Abstract .....	179
INTRODUCTION .....	180
MATERIAL AND METHODS .....	190
RESULTS .....	204
TAXONOMY .....	215
<i>Gloeandromyces dickii</i> nom. prov. ....	216
<i>Gloeandromyces pageanus</i> .....	220
Morphotype <i>alarum</i> .....	223



Morphotype <i>polymorphus</i> .....	225
<i>Gloeandromyces streblae</i> .....	227
Morphotype <i>sigmomorphus</i> .....	228
DISCUSSION .....	230
CONCLUSIONS.....	244
ACKNOWLEDGEMENTS.....	244
LITERATURE CITED .....	245
CHAPTER 5: A preliminary phylogeny of Laboulbeniomyces: pre-molecular classifications subject to revision .....	257
Abstract .....	258
INTRODUCTION .....	259
MATERIAL AND METHODS .....	266
RESULTS .....	270
DISCUSSION.....	274
CONCLUSIONS.....	280
LITERATURE CITED.....	280
CONCLUSIONS AND RECOMMENDATIONS FOR FUTURE RESEARCH .....	284

## ACKNOWLEDGEMENTS

The past six years have been an amazing adventure. Looking back at the opportunities I have had, the things I have done during my time at Harvard, I only feel gratitude. I am so thankful to many people who have helped me with different aspects of this project, from sending me specimens, helping me with multi-gene molecular clock analyses in BEAST, to bringing me a late-night latte. I honestly don't know where to start, so let's start at the beginning.

I am eternally indebted to my parents, Anita Smeulders and Luc Haelewaters, who believed in me since I was a little kid and supported me to follow my dreams. I may be exaggerating this memory, but I remember my mum planting her fist on the headmaster's desk – I was 12 at the time – yelling that I was good enough for the curriculum I was in. Consequently, nothing changed for me that year and that turned out to be a good thing. No-one's ever stood up for me like that. Mum, I don't know where you are, but I will always love you and I miss you every day.

My mycological “career” started at Ghent University, Belgium, with Annemieke Verbeken's warm personality, optimism and a more than healthy dose of enthusiasm for fungi. If it weren't for her, I might not be here. Thank you, Mieke, for your support and friendship! Back in 2008 (10 years, really?!), Mieke introduced me to André De Kesel who would be co-advisor for my master's project. The primer for my further studies on the Laboulbeniales was laid during my time with him. André, it is fair to say we've had ups and downs (I have not necessarily been the easiest student), but I have thoroughly enjoyed working with you, you taught me valuable lessons, and I hope we will keep collaborating on projects.

I had almost lost the will to finish my master's research when I contacted Paul van Wielink. What I felt was a final straw truly was a rebirth. Paul, you opened up your home for me

(and for Sarah) and you facilitated collecting data for my master's thesis and ever since. Thank you for your collaboration and for your friendship. I wish *De Kaaistoep* many years of exciting research to come. Also thank you to your wonderful wife, Gea. While studying at Ghent University, I lived at a Bed & Breakfast. Little did I know that the family that I was living with would feel like real family years later. Frederik Byttebier, thank you for all your support. I know how much you wanted this for me.

In those early days as a budding mycologist back in 2009, I contacted Meredith Blackwell with, looking back at it, a stupid question (which I should have been able to solve myself, sorry Meredith). However, how big was my surprise that she responded and reached out to solve my problem. Today, still, I truly appreciate that about you, Meredith. I've noticed you doing the same to other young, aspiring researchers. You go far and beyond in helping them, and for that, you are an inspiration. I feel lucky to have had your support and mentorship during my thesis work.

I did not envision coming to the United States as a master's student, or perhaps it was a looming dream. My first brief adventure on the North American continent happened on invitation by Alex Weir, for which I have been very indebted to him. He invited me to visit his lab and to join him during fieldwork in Costa Rica. That trip made me realize what could be possible. Before I knew, I was emailing with the eminent Donald H. Pfister, until he urged me to "just apply," which I ended up doing. One moment, I thought I was living the life in rural South of France, and the next I was on a plane to Boston, Massachusetts. Don, I can never express how happy I have been with you as a mentor. I've never really felt like a student with you, although you have taught me so many things, not just about doing mycological research and writing papers. *You lead by example*, says it all.

I would like to thank several people that helped me on several fronts: Nichola Hill, thank you so much for helping me with BEAST. You make things so easy to understand. You're a great teacher, and a fantastic friend. Heidi Hopkins, thank you for all your knowledge on roaches. You're an amazing person. Ted E. Cottrell, David S. Ilan-Shapiro, and lab assistant Emily A. Kemp, my project would have been a lot more meager, if it weren't for the collections at the USDA-ARS ground in Byron, Georgia. Thank you for collaborating with me. Let's finish some manuscripts! Helen E. Roy, thank you for inviting me to co-author your 2016 paper in *Biological Invasions*. Our meeting on Bornholm and that manuscript really have opened many doors, and your work and dedication to citizen science is an inspiration. Tina A. Hofmann, Rosa V. Villarreal Saucedo, Juan A. Bernal Vega, y los estudiantes de la Universidad Autónoma de Chiriquí, gracias por su colaboración, espero regresar pronto. Timothy Y. James, your and your lab's hospitality and kindness during my visit have made me so humble. Thank you for sharing information and knowledge. Your lab represents the kind of lab I'd like to build myself one day, an open environment to share data and knowledge with each other and with visitors. Rachel A. Page, working at STRI has been a fantastic opportunity and I have you to thank for supporting me. I will be back for more bats. Thomas Hiller, I saw your poster at Barro Colorado Island, you happened to be on the island, and before I knew we were capturing bats and started collaborating on more than a few exciting projects. Let's continue doing so. Oh, and thank you for sharing some of your R magic! Marc Albert, I have loved working with you, it has been a treat. Studying Boston Harbor Islands biodiversity has been rewarding on so many levels, most for the wonderful people I've met, students and interns included (a huge shout-out to Lara A. Kappler and Alden C. Dirks). I am very thankful to my OEB thesis committee members, Charles C. Davis and Brian D. Farrell. Both have been influential in the directions this project has taken.

Charles provided detailed lessons on methodological approaches, whereas Brian helped me to learn to take a step back and see the big picture.

Since the start of my studies of the Laboulbeniales and Laboulbeniomycetes, I have invested in exchanging ideas and experiences with others. Several researchers in the field other than the ones I mention elsewhere on these pages have visited the Pfister Lab or worked with me on projects one way or another. It's been a real pleasure, Michał Gorczak, Walter P. Pfliegler, Ana Sofia P.S. Reboleira, Walter Rossi and Sergi Santamaria. Several people have helped me extensively during fieldwork. Being with other people 24/7 can be hard sometimes, but you all made it so easy for me. You're all wonderful people and I hope to be able to work with you again one day: Jasmin J. Camacho, Annabel Dorrestein, Lauren A. Meckler, Kirk A. Silas, Melissa J. Walker, Tristan W. Wang. Jasmin, by presenting me with a silly little bat fly back in 2014, you have given one of my thesis chapters direction. It was infected with *Gloeandromyces* and that single fly turned into a project for which we now have looked at close to ten thousand bat flies. When we started out at Harvard, we were friends just because we happened to end up sharing an apartment on Belmont Street. But we clicked and even though we have not reached the seven-year milestone, you have become a wonderful friend. I will miss you so much. Who will I have my regular latte with now?

Many researchers and citizen scientists (!) have made my work so much easier by collecting insects infected with Laboulbeniales or by helping me with the identification of insect hosts. All the names of these people are given in the acknowledgements of the individual chapters. I have had countless useful discussions (and from time to time, "pizza parties") with lab mates: Rosanne A. Healy, Teresa Iturriaga, Jason M. Karakehian, Katherine F. Lobuglio, James K. Mitchell, Luis Quijada, and Feng Xu. The Harvard University Herbaria do not just

form the third largest herbarium collection in the United States. They are housed by a family of warm, helpful, incredible people. Thank you to: Ingrid McDonough, Melinda Peterson, Jeannette Everitt for help with financial and departmental matters; Donna Gadbois for giving me one of the best laughs I've ever had; Claire Gallagher for a constant supply of hot coco; Genevieve E. Tocci, Michaela Schnull, Hannah Merchant for all the support a graduate student can use; Julie Shapiro-McIntosh for your friendship and lending a house now and then.

A PhD isn't something one does and finishes on one's own. It really takes an entire village. Looking at the number of people I thanked thus far, I think that saying comes close to the truth. However, there is really one person missing from the endless list of people to thank. Sarah Verhaeghen has not only been my wife and wonderful mother of our beautiful daughter Luna, she has supported me in any way possible, and more. She has gone beyond her comfort zone to assist me in the field, to take care of our ever-awake daughter while I was in the field for several months, to proofread materials even though the words don't always mean everything to her, etc. I can only say this: you are my rock and I dedicate this dissertation to you. This is not my work, it is ours.

# **INTRODUCTION TO LABOULBENIOMYCETES**

## FUNGAL PARASITES

Peter W. Price (1980) begins his *Evolutionary Biology of Parasites*, by arguing that “[it] has not been generally realized that the most extraordinary adaptive radiations on the earth have been among parasitic organisms.” A decade later, Windsor (1990, 1995) made a case to have “equal rights for parasites.” He argued that parasites should be recognized as a legitimate part of the earth’s biodiversity instead of being either ignored or seen as a threat for conservation. Indeed, interactions between trophic levels may be an important driver of speciation, as is competition between organisms within the same trophic level (Thompson, 2014). Well-studied examples include plant-feeding insects: different populations have adapted to different plant species (Drès & Mallet, 2002). Another example is the African indigobirds that are host-specific brood parasites whose nestlings are reared with the host nestlings. The nestlings mimic mouth markings of the host, the adult males mimic host song and adult females use songs to select mates and nests to parasitize. Sorenson *et al.* (2003) found that host shifting leads to sympatric speciation in indigobirds.

Before discussing how we can use parasites to understand evolutionary biology and ecological phenomena, we must define what is a “parasite.” As is often the case in science, many definitions exist – perhaps in this case as many definitions as there are books on parasitism, according to Price (1980). In this dissertation we will discuss multicellular organisms living at the expense of a single host that do not directly cause death of the host (Vinson & Iwantsch, 1980; van den Bosch *et al.*, 1982; Godfray, 1994; Federici, 2009).

There is scientific consensus over the idea that the number of fungal parasites is highly underestimated (Hawksworth, 1991; Rossman, 1994; Weir & Hammond, 1997; Mueller & Schmit, 2007; Schmit & Mueller, 2007; Blackwell, 2011). If we consider insect-specific fungi,



only 1.5 percent are estimated to be known (Schmit & Mueller, 2007). These include necrotrophic and biotrophic parasites (Benjamin *et al.*, 2004). Necrotrophs kill their hosts and use dead host cells as a source for nutrition. Examples can be found in the Clavicipitaceae (*Cordyceps*, *Ophiocordyceps*, *Gibellula*, *Hirsutella*), Hypocreales (e.g., *Beauveria*, *Fusarium*, *Metarhizium*, *Tolypocladium*), among other groups. Biotrophic parasites require a living host. Known groups of fungal biotrophs are the Harpellales and Asellariales (Zoopagomycota, Kickxellomycotina, formerly Trichomycetes, which describes a polyphyletic group), Laboulbeniomycetes (Ascomycota) and Septobasidiales (Basidiomycota, Uredinomycetes) (Benjamin *et al.*, 2004; Hibbett *et al.*, 2007; Spatafora *et al.*, 2016). Certain phytopathogens can be hemibiotrophic parasites, which means that they require a living host, which they kill at later stages of infection. An example of this type of parasite is *Magnaporthe grisea* (Sordariomycetes, Magnaporthales). This dissertation will focus on Laboulbeniomycetes (Ascomycota), in particular on their diversity and patterns of speciation.

## OVERVIEW OF LABOULBENIOMYCETES

The class Laboulbeniomycetes comprises fungi that are obligately associated with arthropods for dispersal or as biotrophs (Weir & Blackwell, 2001b). Two orders are currently recognized, Pyxidiophorales and Laboulbeniales; a third order, Herpomycetales nom. prov., is described in this dissertation (CHAPTER 2). Pyxidiophorales is comprised of fungi that are associated with arthropods in their dispersal phase. They are mycoparasites, that is, they parasitize and feed on the hyphae and sporocarp tissues of other fungi (species of *Ascobolus*, *Asterophora*, *Fusarium*, *Inonotus*, *Lasiobolus*) and their single-septate ascospores directly develop a phoretic *Thaxteriola* asexual state (Blackwell & Malloch, 1989; Doveri & Coué, 2006). These asexual states produce

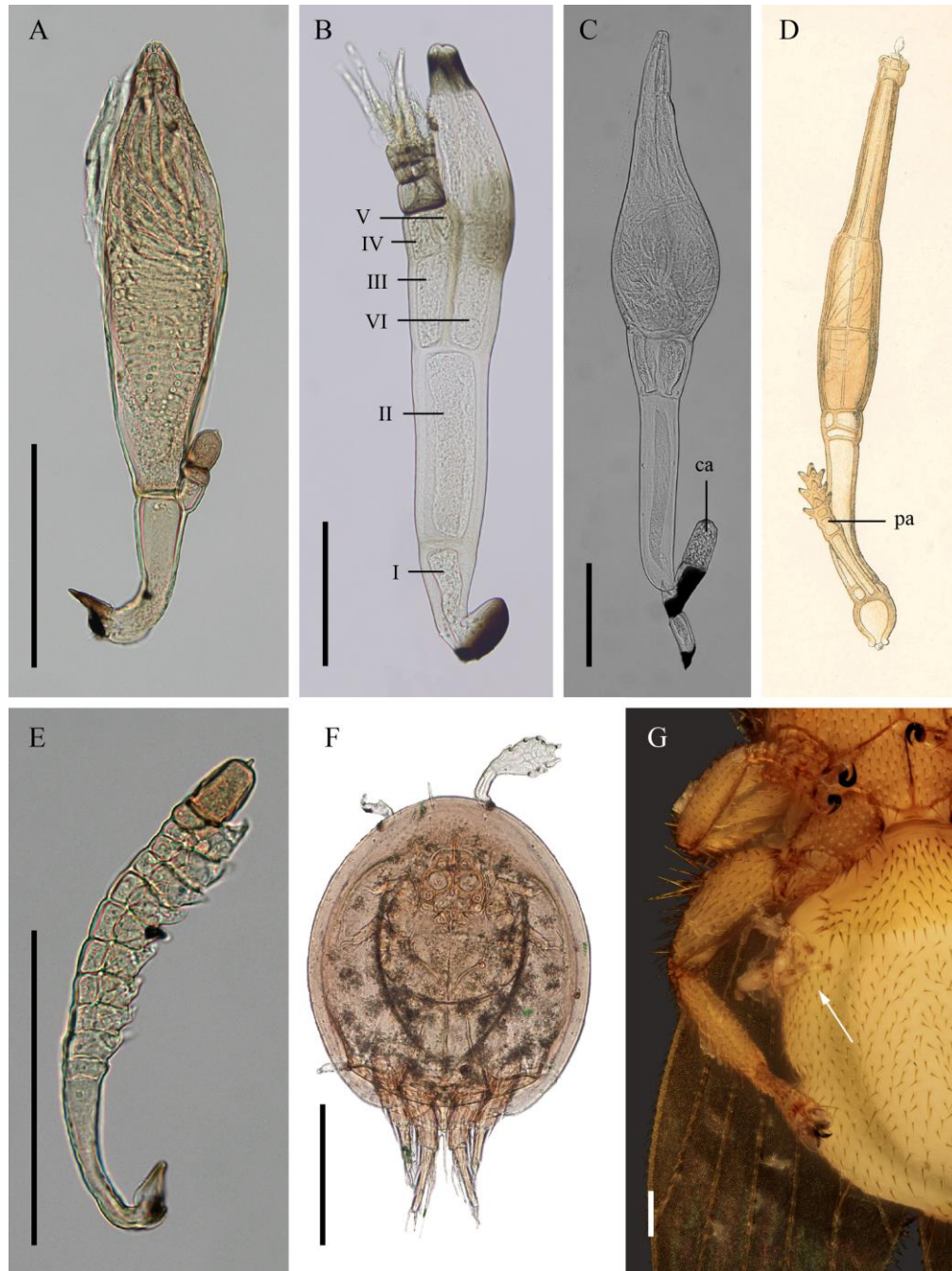
phialoconidia, which are transported to new substrates via phoretic mites. The yeast-like conidia of the *Thaxteriella* anamorph germinate by germ tubes to form a mycelium that may produce conidia and eventually perithecia. Sexual reproduction unknown for several members of the order. For example, the asexual fungus *Gliocephalis hyalina* was placed within Pyxidiophorales based on phylogenetic analysis (Jacobs *et al.*, 2005). Monoxenic cultures of this fungus failed; only co-culturing with a *Fusarium* species was successful (Barron, 1968; Jacobs *et al.*, 2005).

Laboulbeniales are obligate, microscopic ectoparasites of arthropods. Around 2200 species in 141 genera are known to infect various groups in three arthropod subphyla (Chelicerata, Hexapoda, Myriapoda) and they are known from all continents except Antarctica (Weir & Hammond, 1997; Weir & Blackwell, 2005; Santamaria *et al.*, 2017). Laboulbeniales never form mycelia; the ascospores do not form germ tubes but rather divide mitotically after attachment to the host to form thalli of up to thousands of cells by determinate growth. At maturity, structures are produced that form spermatia (antheridia) and ascospores (perithecia) (Tavares, 1985). Antheridia and perithecia may be housed on the same individual (in monoecious taxa) or less often on separate individuals (in dioecious taxa). Only sexual states are known. Most Laboulbeniales are strictly host specific (to the genus or even species level) (Thaxter, 1896; Scheloske, 1969; Majewski, 1994; De Kesel, 1996). Several species do occur on unrelated hosts, which upon close inspection seem to co-occur in the same microhabitat (Blum, 1924; Benjamin, 1971; De Kesel & Haelewaters, 2014; Pfliegler *et al.*, 2016; Reboleira *et al.*, 2017; Figure intro-1F). The phenomenon of position specificity, in which a species is found only on a particular portion of the host integument, is another interesting part of the biology of some species (Benjamin & Shanor, 1952; Rossi & Weir, 1998; Goldmann & Weir, 2012; Figure intro-1G).

The newly proposed order Herpomycetales includes a single genus, *Herpomyces*. Currently, 26 species of *Herpomyces* are known (CHAPTER 2). Hosts are exclusively cockroaches (order Blattodea). The genus *Herpomyces* has always been considered an early diverging group of the Laboulbeniales because of morphological features. However, molecular phylogenetic data in combination with morphological, developmental and host usage traits strongly support its separation from Laboulbeniales, which comprises the overwhelming majority of diversity in Laboulbeniomycetes. Important diagnostic features for the three recognized orders of the class Laboulbeniomycetes are summarized in Table intro-1. Note that the *Pyxidiophora* perithecium is developmentally different from that of most pyrenomycetes because it consists of only a single layer of wall cells. It shares this unusual character with *Kathistes* (Sordariomycetes, Ophiostomatales), a genus of coprophilous fungi with long-necked perithecia and quickly disintegrating asci (Malloch & Blackwell, 1990). This type of perithecium apparently arose independently twice.

**Table intro-1.** A comparison of traits between the orders of Laboulbeniomycetes.

	<b>Herpomycetales</b>	<b>Laboulbeniales</b>	<b>Pyxidiophorales</b>
No. species	26	2200	22
Haustoria	Always multiple	Single, if present	Never observed
Hosts	Order Blattodea	Arthropods (3 subphyla)	Fungi
Perithecium wall	2-layered	2-layered	1-layered
No. ascospores/ascus	8	4	mostly 3 (2–8)
Perithecium origin	From thallus derived from ascospore	From thallus derived from ascospore	From mycelium
Ascospores	1-septate (in center)	1-septate (near lower end)	1-septate (near lower end)
Ascus formation	Alternately, sequentially	In single series, sequentially	In single series, sequentially



**Figure intro-1.** A, E. *Nycteromyces streblidinus*, a dioecious species, with female thallus (forming a perithecium) in A and male thallus (forming multiple antheridia) in E. B. *Laboulbenia clivinalis*. Annotated are cells I through V of the receptacle, and the perithecial stalk cell (VI). C. *Haplomyces texanus*, with compound antheridium (ca). D. *Arthrorhynchus nycteribiae*, with a primary appendage (pa) carrying a complex of simple antheridia. Drawing reproduced from Peyritsch (1871). F. Ant nest-inhabiting Acaridae deutonymph with immature thalli of *Rickia wasmannii*. Image provided by Walter P. Pfliegler. G. Thalli of *Gloeandromyces dickii* nom. prov. occur only on the abdomen, ventrally, right side, of *Trichobius joblingi* bat flies. This is an example of position specificity. Image provided by André De Kesel. Scale bars = 100  $\mu$ m.

## SOME HISTORICAL NOTES

In the 1840s, two French entomologists, Joseph A. Laboulbène and Auguste Rouget, independently made the earliest observations of Laboulbeniales. First, Rouget thought that the structures he observed on a *Brachinus* ground beetle (Coleoptera, Carabidae) were antennal segments but later he (Rouget, 1850) recognized these structures as living organisms.

Apparently, an earlier account in the literature can be found in the *Illyrisches Blatt* no. 60 (Anonymous, 1849). In this summary of the seventh meeting of the “Wissenschaftsfreunde” from 20 July 1849, Ferdinand J. Schmidt was reported to have found clusters of bristles on a specimen of *Nebria* “*stentzii*” (Coleoptera, Carabidae), which he had identified as parasitic plants.

Soon after, Gustav L. Mayr mentioned hairlike structures but thought these were outgrowths of the insect integument. Mayr (1853) described differences between the structures on younger and older *Nebria* hosts. On older individuals, a swelling of variable shape was present at the lower portion of the hair, whereas no such swelling was present on younger beetles. The recognition of these organisms as fungi came from Robin (1852, 1853) who placed his newly erected genus *Laboulbenia* in the “familia Pyrenomycetum.” Interestingly, the valid descriptions of the bat fly-associated species *Arthrorhynchus diesingii* and *A. westrumbii* were as parasitic acanthocephalean worms (Kolenati, 1857). Johann J. Peyritsch (1871) made extensive observations on the development and morphology of *Laboulbenia muscae*, which he described. This species was later reclassified under *Stigmatomyces* and synonymized with *Stigmatomyces baeri*, known from *Musca domestica* (Diptera, Muscidae) (see, Tavares, 1985; Majewski, 1994). Peyritsch (1873) established the family Laboulbeniaceae within the ascomycetes; this family is still accepted in the latest published classification of the order by Tavares (1985). Our

understanding of the biology of Laboulbeniales began with Peyritsch's (1875) studies, based on laboratory colonies of houseflies (*M. domestica*). Among other things, he determined that maturation of *Stigmatomyces thalli* requires two weeks and that development does not occur on larvae or pupae.

It was not until the work of Harvard professor Roland Thaxter (1858–1932) that a systematic study of the Laboulbeniales was initiated. Pfister (1984) remarked that Thaxter started out in the first of his “preliminary” papers on Laboulbeniales referring to the group as “small.” By the end of his studies he had written 21 non-illustrated papers (published between 1890 and 1920 in the *Proceedings of the American Academy of Arts and Sciences*) and five illustrated monographic volumes (Thaxter, 1896, 1908, 1924, 1926, 1931), in which he described hundreds of new species. He died in 1932 before publishing his sixth monographic volume, intended as a treatment of the genus *Laboulbenia* (Benjamin, 1971). As a result, none of the *Laboulbenia* species described post-1908 have been illustrated until recently (e.g., Haelewaters & Rossi, 2015; Haelewaters *et al.*, 2017a). During his career, Thaxter described 103 genera and around 1,260 species (Benjamin, 1971). In other words, during 44 years, he must have described one new species every other week. Thaxter's first monographic volume (1896) provided an extensive treatment of Laboulbeniales development, morphology, geographic distribution and host diversity. His contributions stimulated others to start studying these fungi. Among those who made important contributions were Joseph H. Faull (1876–1961), René C.J.E. Maire (1878–1949), François Picard (1879–1939) and Carlos L. Spegazzini (1858–1926).

A revival of Laboulbeniales studies in the USA occurred under the impetus of Richard K. Benjamin (1922–2002). Benjamin & Shanor (1950a, 1950b) described the dioecious nature of *Laboulbenia formicarum* on North American *Lasius* spp. (Hymenoptera, Formicidae). They

subsequently studied position specificity in *Laboulbenia* species on *Bembidion picipes* (Coleoptera, Carabidae) and made the argument that sexual transmission was the mechanism driving this phenomenon. Benjamin gained an interest in Laboulbeniales of semiaquatic bugs (Hemiptera) and made important taxonomic contributions in this area; he established two new genera *Monandromyces* and *Prolixandromyces* and described new species of *Autophagomyces*, *Laboulbenia*, *Rhizopodomyces*, *Tavaresiella* and *Triceromyces* (Benjamin, 1967, 1970, 1979, 1981, 1986, 1993, 1998, 1999). Benjamin (1971) also wrote an informative *Introduction and Supplement to Roland Thaxter's Contribution Towards a Monograph of the Laboulbeniaceae* to the reprint of the five-volume Thaxter monograph. In this work he provided a review of previous work done in the group and gave detailed instructions for their study.

Apart from detailed contributions by Benjamin, after Thaxter's death the majority of publications on Laboulbeniales were regional studies reporting on specific geographic areas. Although most of these have been short, when considered together they provide extensive data on the distribution of Laboulbeniales, both in terms of geography and host usage. Of certain geographic areas, detailed mycota of the Laboulbeniales have been published, with descriptions and illustrations for all taxa: Germany (Scheloske, 1969), Japan (Sugiyama, 1973), Finland (Huldén, 1983), Poland (Majewski, 1994), Belgium (De Kesel, 1997) and the Iberian Peninsula (Santamaria, 1998, 2003). Even today, the kind of work that Thaxter did with his extensive collections of insects, visiting museum insect collections and gifts from correspondents, results in discoveries that expand our knowledge on the group. For example, based on specimens preserved at the Natural History Museum in Denmark, nine new species of *Rickia* recently were described and a new genus was erected for thalli on *Dicranolasma* harvestmen (Arachnida, Opiliones), presenting a new host order for the Laboulbeniales (Santamaria *et al.*, 2016, 2017).

Screening of the insect collection at the American Museum of Natural History (New York) brought to light seven undescribed species in the genera *Corethromyces*, *Diphymyces* and *Rodaucea* (Haelewaters & Rossi, 2017). Finally, extensive fieldwork in Ecuador has allowed Walter Rossi and colleagues to publish a series of contributions presenting a new genus, new species and many new records (e.g. Rossi & Santamaria, 2012; Rossi *et al.*, 2016).

Early on, the systematic position and evolutionary origins of the Laboulbeniales were questioned. Some researchers suggested a relationship between floridean algae and Laboulbeniales, proposing that Dikarya (Ascomycota and Basidiomycota) were derived from red algae, the Laboulbeniales being an intermediate step (Karsten, 1869; Sachs, 1874). This hypothesis was an attempt to explain the combination of unique morphological features of the Laboulbeniales – including the absence of hyphae and a mycelium, morphology of the sexual reproductive structures and a highly differentiated trichogyne, which resemble features of red algae (Denison & Carroll, 1966). Cépède (1914) placed the Laboulbeniales in the Phycascomycetes, a name that he proposed because of the superficial similarities to both Ascomycetes and red algae. A large number of competent mycologists espoused the idea of a floridean origin of fungi, including into the late 20th century (Denison & Carroll, 1966; Demoulin, 1985). Weir & Beakes (1995) thought the link of Laboulbeniales to hyphal ascomycetes through *Pyxidiophora* to be well supported but wanted more information, which certainly has arrived with PCR and the application of phylogenetic analyses.

Based on a six-gene dataset, James *et al.* (2006) were able to show that fungi in the Ascomycota derived from multiple flagellate Chytridiomycota-like ancestors. Although Barr (1983) had used cladistics logic in her opposition to the floridean hypothesis, the analysis of James *et al.* (2006) nailed the coffin shut with overwhelming evidence that fungi and red algae



(Rhodophyta) are not closely related. Cavalier-Smith (1998) placed the orders Laboulbeniales and Pyxidiophorales in the phylum Archemycota, class Zoomycetes, subclass Pedomycetidae, superorder Pyxomycetalia. The Pedomycetidae subclass included the orders Asellariales, Harpellales, Laboulbeniales and Pyxidiophorales, with the rationale that these fungi are all parasites attaching to the host by a similar holdfasts (foot). Cavalier-Smith (1998) himself mentioned that his classification system emphasized homogeneity of morphology and that it “[did] not slavishly follow rRNA trees,” disregarding Blackwell (1994), who had shown that *Pyxidiophora* and *Rickia* (Laboulbeniales) formed a monophyletic lineage within Ascomycota. We now consider many morphological traits to be the result of convergent evolution. Using small subunit ribosomal DNA, Weir & Blackwell (2001b) established the position of the Laboulbeniomycetes clade within Ascomycota and Schoch *et al.* (2009) confirmed the sister relationship of the class with Sordariomycetes.

#### A MODEL TO STUDY SYMBIOTIC RELATIONSHIPS

To date, only about 135,000 fungi have been described (Hibbett *et al.*, 2016), compared to the estimated number species, somewhere between 1.5 million (Hawksworth, 1991) and 6 million (Taylor *et al.*, 2014). This gap of knowledge leads to problems in the interpretation of biogeographical patterns (Ge *et al.*, 2014). This is especially true for largely neglected groups, such as the group Laboulbeniales. Ironically, several characteristics make the Laboulbeniales well suited as model organisms for studying parasite and invasion biology. They are microscopic in size (40  $\mu\text{m}$ –4 mm), have a short life cycle and exhibit different types of specificity (ecological specificity, host specificity, position specificity). Laboulbeniales can be easily observed on the integument of their insect hosts by trained mycologists visiting museum

collections. Because these external parasites remain attached to dead individuals, insect collections can reveal previously undescribed species of Laboulbeniales (Santamaria *et al.*, 2016; Haelewaters & Rossi, 2017), interesting geographic records (Báthori *et al.*, 2014; Haelewaters *et al.*, 2015c) and species distributions (thus geographic spread) over time (Haelewaters *et al.*, 2017b).

The drawback that Laboulbeniales cannot be grown in axenic culture (Benjamin, 1971; Weir & Blackwell, 2001a) is overcome by the relative ease with which their hosts can be artificially reared under standard laboratory conditions (De Kesel, 1996; Cottrell & Riddick, 2012). During our studies at Harvard, we maintained for several years colonies of cockroaches (*Periplaneta americana*) and ladybirds (*Harmonia axyridis*, *Olla v-nigrum*). Another major drawback has been the lack of sequence data. However, several research groups have published a number of different DNA extraction protocols in recent years. Weir & Blackwell (2001a, 2001b) were the first to propose a protocol to routinely generate sequence data. Their protocol using dry ice was further developed by Goldmann & Weir (2012) and Goldmann *et al.* (2013). Haelewaters *et al.* (2015b) evaluated a number of commercially evaluated kits and custom protocols for DNA isolation, discussing efficiency, influence of pre-treatments and the role of preservation (CHAPTER 1). Sundberg *et al.* (2018) developed a mechanical protocol for the extraction of DNA from single thalli and generated the first mitochondrial SSU sequences for Laboulbeniales. In this dissertation (CHAPTERS 2 and 3), we present a modified commercially available protocol for the isolation and whole-genome amplification (WGA) of DNA from single thalli.

The study of parasites, pathogens and parasitoids, together with their hosts in natural populations provides insight into the factors affecting historical biogeography and community structure. Parasites of vertebrate and invertebrate fauna provide a new level of information

regarding ecological interactions, patterns of distributions and complex co-evolutionary history (Hoberg, 1997). Ecologists emphasize the role of the environment as a factor driving speciation (for examples in Laboulbeniales see De Kesel, 1996; De Kesel & Haelewaters, 2014). The current anthropogenic changes to the earth's climate, land, oceans and biosphere facilitate invasions, geographically rearranging hosts and parasites and creating opportunities for host shifts and subsequent population divergences. This situation provides an unprecedented challenge for biologists to unravel the history of these host-parasite relationships. The development of new host-parasite systems that can be manipulated in the laboratory will help in this endeavor.

#### MORPHOLOGY OF LABOULBENIALES

The thalli of all species of Laboulbeniales develop from a bicellular ascospore, by a defined number of mitotic divisions. As a result, the thallus is a multicellular unit with restricted number of cells. A primary septum separates the larger cell of the ascospore from the smaller one. This septum is often visible by its thickness and color, even in mature thalli. The main axis of the thallus is formed by the receptacle, which is the part of the multicellular unit that is connected to the host by means of a foot. The receptacle and foot are derived from the larger cell of the ascospore, which emerges first. Additional divisions of particular cells of the receptacle produce the perithecium or perithecia. The perithecium is the only spore-forming structure of the Laboulbeniales; there are no asexual spores. The smaller cell of the ascospore produces the primary appendage system, which carries the spermatia-producing antheridia. The entire ontogeny, from ascospore to mature thallus, was studied for *Herpomyces ectobiae* and a few *Laboulbenia* species (Tavares, 1985; De Kesel, 1989).

In terms of orientation, the anterior side is the one on which the perithecium is located, whereas the posterior side is the side away from the perithecium. Other authors use ventral and dorsal for anterior and posterior, respectively.

*Receptacle.* — The primary receptacle forms the base for all parts of the thallus. Its shape and structure are extremely variable within the order, and this variability is an important criterion in generic delimitation. Apparently, the lower cell of the ascospore generally divides into 3 cells denoted by Roman numerals I, II and III. Further divisions in different planes may take place, depending on the genus. Many genera, those in the subtribe Stigmatomycetinae, have only those three cells in the receptacle but their positions are variable with respect to one another. Cell I is the basal cell, forming the connection with the host's integument. Multiple divisions of cell I can occur, for example in female thalli of *Dimeromyces*. These secondary cells will further give rise to perithecia or sterile appendages. Cell II, the suprabasal cell, generates the perithecium by successive divisions. Cell II undergoes multiple divisions in many genera, forming an elongate uniseriate receptacle. Example of genera with this structure are *Chaetomyces*, *Ecteinomyces*, *Filariomyces* and *Ormomyces*. Secondary divisions of cell III can occur. For example, in the genus *Laboulbenia*, these divisions form cells IV and V. The entire complex of cells III to V is called androstichum (Figure intro-1B). Some species of *Laboulbenia* have an undivided cell III+IV or cell III+IV+V (e.g., *L. nisotrae*, *L. obesa*, *L. richardiana*).

*Perithecium.* — The perithecium is derived from the receptacle, in species without secondarily divided receptacle cells, it arises from divisions of cell II. Benjamin (1971: 41–43) described three types of perithecial development. In the first type, a single cell arises laterally from the receptacle to divide into a lower and upper cell. The lower cell, by continued divisions, gives rise

to the perithecial stalk cell (VI), secondary stalk cell (VII) and basal cells m, n and n'. The upper cell will give rise to the female sexual organ, which initially is comprised of three cells: basal carpogenic cell, trichophoric cell and terminal trichogyne. The trichogyne is a thin appendage-like outgrowth of the young perithecium. It may or may not develop into a multicellular simple or branched structure, depending on the species. Its function is to receive spermatia. Before the perithecium is mature, the trichogyne will deteriorate, often leaving a visible scar. This "carpogonial upgrowth" is enveloped by the perithecial walls, which arise from cells m (forming a single vertical row of wall cells) and n and n' (forming three rows).

After interception by the trichogyne, the male nucleus from a spermatium will migrate to the carpogenic cell, thus resulting in the formation of an ascogenous cell (or multiple ones by mitotic divisions), in which both the male and female nuclei are present. This is the dikaryotic phase of the Laboulbeniales life cycle. Asci are produced by mitotic divisions of the ascogenous cells in multiple planes (as observed in *Herpomyces*; Hill, 1977). Upon fusion of the two nuclei, the diploid ascus mothercell is formed, which after meiosis gives rise to an ascus with 4 ascospores. This developmental type was described and illustrated by Thaxter (1896) for *Laboulbenia elongata*, *Peyritschiella geminata* and *Stigmatomyces baeri*. However, according to Benjamin (1971) there is only one genus of Laboulbeniales that does not follow this type of development. *Coreomyces* forms what Thaxter (1908) named a pseudoperithecium.

The perithecium is more or less elongated and narrowed distally. Sometimes there is a clear differentiation into a rounded or ovoidal venter and a narrow neck, terminating in an ostiole. The perithecial wall cells surrounding the ostiole often form distinct lips (e.g., in *Hesperomyces*) or (sub)apical outgrowths (e.g., in *Diphymyces*). The perithecium consists of a well-defined number of cells, except in Ceratomycetaceae and Herpomycetales. The perithecial

wall cells appear in two layers; the external wall cells are clearly visible and provide important taxonomic importance (Tavares, 1985; Majewski, 1994). The most ancestral perithecium is the one in which each of the four vertical rows of outer wall cells consists of many cells that are equal in height, as in Ceratomycetaceae and Herpomycetales. This was stated by Tavares (1985) and supported by use of sequence data by Goldmann & Weir (2018) and in this dissertation (CHAPTER 5). Morphological studies of the genera *Nycteromyces* and *Polyandromyces* (Dimorphomycetaceae) failed to distinguish perithecial cell walls (Thaxter, 1920, 1924; D. Haelewaters, unpubl.). Presumably this represents a highly derived situation (Tavares, 1985).

*A note on Herpomyces.* — The dioecious genus *Herpomyces*, now classified in its own order (CHAPTER 2), has a differently structured receptacle compared to Laboulbeniales genera. The primary receptacle of female thalli is small, typically consisting of four cells. The suprabasal cell gives rise to a secondary axis that consists of a series of narrow cells perforating the integument of the host with small haustoria. Male thalli are similar in that they have a primary axis, usually consisting of four superposed cells, and that the suprabasal cell may produce a secondary axis; both the third and fourth cell give may rise to a single cell or branch carrying antheridia (Figure 2-6). Also the development of the perithecium is entirely different from the general type in Laboulbeniales. The entire perithecium of *Herpomyces* develops from an outgrowth of the suprabasal cell of the 4-celled primary receptacle, by subsequent transverse and longitudinal divisions (Tavares, 1965, 1966). The carpogonial upgrowth(s) and inner rows of wall cells are initiated by specific outer wall cell. Also, in the *Herpomyces* ascus mothercell, mitosis will take place after meiosis, forming an ascus with 8 ascospores, as do most of the other species in Ascomycota.

*Appendage and antheridia.* — The primary appendage usually is a direct continuation of the receptacle axis. It is produced by divisions of the upper, smaller cell of the ascospore. In some genera, the primary appendage is very simple, consisting of one or two cells only. Examples are *Filariomyces* and *Dioicomyces*. In very few species the appendage can even become aborted (Tavares, 1985). Well-developed primary appendage systems exist in many species of, e.g., *Corecthromyces* and *Laboulbenia*. Sometimes, the original spore apex remains visible at maturity as a spinose process because the branches are formed at a level below the apex. This process is an important feature to identify species in the genera *Acompsomyces*, *Eucantharomyces*, *Ilyomyces* (Santamaria, 2003, 2006; Haelewaters, 2013). The primary appendage system of *Laboulbenia* deserves extra attention. Its basal cell, called insertion cell or cell e, is flattened and usually obscure and carries the inner and outer appendages. The inner appendage bears flask-shaped, simple antheridia. The outer appendage is usually longer, simple or branched and always sterile.

The primary appendages of *Chitonomyces* and *Hydraeomyces* break off early right above the constricted black septum (Tavares, 1985). The primary appendages of *Columnomyces* and *Diphymyces* are usually partly or completely broken off (Benjamin, 1955; Thaxter, 1918, 1931; Haelewaters *et al.*, 2014). This damage has been linked to the behavior of the host insects, Cholevinae (Coleoptera, Leiodidae). Cholevine beetles have evolved a largely underground lifestyle and make extensive use of narrow channels and tunnels in the soil, which may account for breakage of parts of Laboulbeniales thalli on these hosts (Sokolowski, 1942). Also the extensive appendage system of *Laboulbenia clivinalis* regularly breaks off (and regenerates; A. De Kesel, pers. comm.). Similar to cholevines, its host, *Clivina fossor*, has a partly subterranean lifestyle (De Kesel, 1995a).

When sterile or antheridial branches are derived from the lower cell of the ascospore, they are referred to as secondary appendages. All appendages of *Scepastocarpus* and *Zodiomyces* are secondary in origin. Little is known about the function of sterile appendages, whether primary or secondary. Cavara (1899) was the first to hint that thalli could retrieve nutrients from its environment by means of their sterile appendages. De Kesel (1996) showed experimentally that the successful establishment of *Laboulbenia slackensis* requires not only a suitable host but also favorable environmental conditions, which could be linked to the extensive appendage system of that species. Recently, Tragust *et al.* (2016) found no visible penetration damage at the host integument using light and electron microscopy techniques in four species of Laboulbeniales, revealing the necessity for alternative explanations to the hypothesis that Laboulbeniales may only receive nutrients through a haustorium. Further experimental work might be directed toward the function of the sterile appendages.

Spermatia are produced either exogeneously or endogeneously within simple or compound antheridia. Exogenous spermatial formation has mainly been observed in species that have aquatic hosts (Weir & Blackwell, 2005), such as *Ceratomyces* and *Zodiomyces*. In these genera, spermatia may be borne on intercalary cells or terminally on a short branchlet (Majewski, 1994). Simple antheridia are flask-shaped, with the neck serving as a discharge tube. Sometimes, old antheridia can proliferate into sterile branches, this is often the case in *Laboulbenia* taxa. In some genera, corner cells or intercalary cells of the appendage serve as antheridia with only the discharge tube being free. Most Laboulbeniales possess simple antheridia. Compound antheridia only occur in taxa of Monoicomycetoideae and Peyritschelloideae. Antheridial cells are structurally united and release their spermatia into a chamber that has a single opening. In the subfamily Monoicomycetoideae, compound antheridia are distally rounded and lack a discharge



tube. Compound antheridia with an elongated neck occur in the Peyritschielloideae. This observation led Faull (1911) to suggest that compound antheridia had arisen independently more than once. Antheridial characters were important to Thaxter's (1896, 1908) classification.

*Ascospores.* — The ascospores of Laboulbeniales are two-celled, hyaline, elongate and spindle-shaped. They are typically surrounded by a mucilaginous envelope, which provides adhesiveness. The ascospores are almost exclusively transferred by the activities of the host (De Kesel, 1995b; Cottrell & Riddick, 2012). Ascospores are produced in perithecia such that their larger cell, that which attached to the host, is directed upwards, the first to be released and potentially make contact.

#### ASSOCIATIONS WITH THEIR HOSTS

Even though researchers have known and studied Laboulbeniales fungi for 170 years, we still are only at the beginning of understanding their associations with their hosts. Whereas we know that Laboulbeniales need a living host for development and survival, we do not know what their nutritional requirements are. We do not know why they are often strictly specific, which is particularly intriguing in the light of findings by Tavares (1979) and Tragust *et al.* (2016) who showed that there was no penetration of hosts by *Laboulbenia borealis*, *L. camponoti*, *L. formicarum*, *Rickia lenoirii* and *R. wasmannii*. If there is no penetration by a haustorial apparatus, then how is the one-on-one relationship between parasite and host maintained? Even though we assume they are parasites, we do not have the data to support this statement. Are they truly parasites? In what way do they affect their host? And do they all affect their hosts in the same way, or is there a continuum from strong to weak parasitic tendencies in the order?

*Host specificity.* — The host spectrum of the Laboulbeniales includes three subphyla of Arthropoda: Chelicerata, Myriapoda and Hexapoda (Table intro-2). The majority, about 80% of all described taxa, occur on beetles (Weir & Hammond, 1997). Despite this wide host distribution, most Laboulbeniales exhibit great host specificity. This is illustrated by many parasite-host lists (Scheloske, 1969; Tavares, 1979; Huldén, 1983; Santamaria *et al.* 1991; De Kesel & Rammeloo, 1992; Majewski, 1994, 2003). Species of Laboulbeniales can range from univorous to plurivorous. Univorous taxa have one or two congeneric hosts. For example, *Laboulbenia hyalopoda* has only been reported from *Dromius linearis* (Coleoptera, Carabidae) (De Kesel, 1998; Haelewaters *et al.*, 2015a), whereas *Triainomyces hollowayanus* only parasitizes the pill-millipede *Procyliosoma tuberculatum* (Sphaerotheriida, Procyliosomatidae) (Rossi & Weir, 1998).

Plurivorous taxa can occur on phylogenetically distant host species. For example, *Euzodiomyces lathrobii* has been found on beetles in two families: Carabidae (*Patrobis*, *Pterostichus*) and Staphylinidae (*Achenium*, *Homeotarsus*, *Lathrobium*) (Weir & Rossi, 2001; Rossi *et al.*, 2010; De Kesel & Gerstmans, 2011; Bernardi *et al.*, 2014). However, there are main hosts, occasional hosts (“Nebenwirten”) and accidental hosts (“Zufallswirten”; Scheloske, 1969). The occurrence of thalli on occasional and accidental hosts can be explained by overlapping niches of the main host species with other arthropods occurring in the same micro-habitat. The fungus may not persist on these alternative hosts, but accidental transmission probably has played an important role in speciation processes of Laboulbeniales (De Kesel & Haelewaters, 2014; also see Rossi, 2011). Accidental transmissions have been reported several times in the literature (e.g., De Kesel, 2011; Haelewaters & Yaakop, 2014; Pfliegler *et al.*, 2016).

**Table intro-2.** Distribution of arthropod hosts parasitized by Laboulbeniales, annotated with common names where applicable.

PHYLUM ARTHROPODA	
Subphylum Chelicerata	
Class Arachnida	Subclass Acari, mites Order Opiliones, harvestmen
Subphylum Myriapoda	
Class Diplopoda, millipedes	
Subclass Chilognatha	Order Callipodida Order Julida Order Sphaerotheriida Order Spirostriptida
Subphylum Hexapoda	
Class Insecta	
Subclass Pterygota, winged insects	Order Blattodea, cockroaches and termites Order Coleoptera, beetles Order Dermaptera, earwigs Order Diptera, flies Order Hemiptera, true bugs Order Hymenoptera (family Formicidae, ants) Order Orthoptera, crickets and allies Order Psocodea, lice Order Thysanoptera, thrips

*Haustorium*. — The thallus attaches to the host integument at the foot cell (cell I), and at least some species form haustoria. These are rhizoidal structures that can be simple or branched and penetrate the host's integument to provide additional holdfast and increase surface area presumably for nutrient uptake (Benjamin, 1971; Gäumann & Dodge, 1928; Thaxter, 1896, 1908). Although only observed in some genera, some authors believe that all Laboulbeniales produce haustoria whether simple and minute or well developed (Scheloske, 1969; Benjamin, 1971). In *Arthrorhynchus* (Blackwell, 1980), *Gloeandromyces* (D. Haelewaters, unpubl.), *Herpomyces* (Richards & Smith, 1956), *Hesperomyces* (Kamburov *et al.*, 1967; Weir & Beakes, 1996), *Laboulbenia* (Thaxter, 1901; Rossi & Kirk-Spriggs, 2011), *Microsomyces* (Thaxter, 1931), *Rhizomyces* (Thaxter, 1896, 1908) and *Trenomyces* (Meola & Tavares, 1982), extensive

haustoria are produced. Interestingly, in the genera *Gloeandromyces*, *Laboulbenia* and *Rhizomyces*, the presence of a haustorium is not a generic characteristic – the majority of species in these genera form a simple foot. The haustorium of *A. nycteribiae* is non-septate, branched and extends into the host skeletal muscles (Blackwell, 1980). The haustorial apparatus of *H. virescens* consists of rhizoids of 3 µm in width, again non-septate and branched (Weir & Beakes, 1996). The haustorium in *Trenomycetes histophthorus* is enucleate and continuous with the cytoplasm of cell I, similar to the situation in *H. virescens* (Meola & Tavares, 1982; Weir & Beakes, 1996). In addition, Meola & Tavares (1982) reported that host cells invaded by haustorial rhizoids undergo degenerative ultrastructural changes.

*Nutrition.* — Currently, the most accepted hypothesis is that Laboulbeniales obtain their nutrition from their host either by the haustorium in contact with the body cavity (haemocoel) or by absorption through the pore canals in the host cuticle (Scheloske, 1969; Benjamin, 1971; Tavares, 1985). The rationale behind this is that Laboulbeniales never grow separately from their hosts and attempts to grow them on axenic culture have failed (Whisler, 1968). Evidence for this hypothesis was provided by Scheloske (1969) who observed Nile blue sulfate dye flowing from elytral tissues to attached thalli of *Laboulbenia*. Some authors criticize the nutrition-by-haustorium hypothesis, because not all species develop a haustorial apparatus. This was recently shown using a combination of light and electron microscopy both *in situ* and on sections of parasitized hosts (Tragust *et al.*, 2016). The authors were unable to find penetration pores or penetration structures beneath removed thalli of four species of ant-associated Laboulbeniales species. Another hypothesis (*sensu* Cavara, 1899; De Kesel, 1996) is that Laboulbeniales receive nutrients from the environment by uptake through (sterile) appendages. In his description of

*Rickia wasmannii*, growing on *Myrmica* ants, Cavara (1899) mentioned that the foot purely has an attachment function and the sterile appendages or (ephemeral) trichogyne are the absorbing structures of the thallus. Thaxter (1908) rejected his claim that appendages play a role in nutrition, because many species of Laboulbeniales lack appendages. After almost 100 years, Tragust *et al.* (2016) provide some support for Cavara's statement about the non-penetrating foot. Spegazzini (1917), inspired by the absence of visible damage on the host cuticle, stated that Laboulbeniales, with or without appendages, can take up nutrients from the environment.

But what are exactly the nutritional substances that Laboulbeniales depend on for successful development to maturation? Different ideas have been put forward: degradation of chitin, secretions from exocrine glands and the absorption of resources present at the cuticle: waxy substances, components from plants, substrate, microbiota, host fecal materials. Locke (1974) pointed out that waxy lipids, produced by the epidermal cells, are not inert but move to the surface presumably because of surface tension. Apparently, this is visible at the pore canals, which provides further support for the idea that Laboulbeniales, those without (visible) haustoria, may take up nutrients by the absorption of waxes through the pore canals. It is clear that more is unknown than is known about the nutritional modes of Laboulbeniales. Future work in Laboulbeniales should initiate studies in this regard, photospectrometry analyses may give more insights into the nutritional relationships between Laboulbeniales and their hosts. Finally, it may be very well possible that there are different modes of nutrition, depending on the presence or absence of haustoria and sterile appendages.

*Pathogenicity.* — Gäumann & Dodge (1928) wrote that the “very existence of [Laboulbeniales] parasites seems to depend on the fact that the host is not destroyed, since their own life ends with

that of the insect.” This statement summarizes the main idea of being a Laboulbeniales taxon: there is no development, growth, or survival without association with a living host.

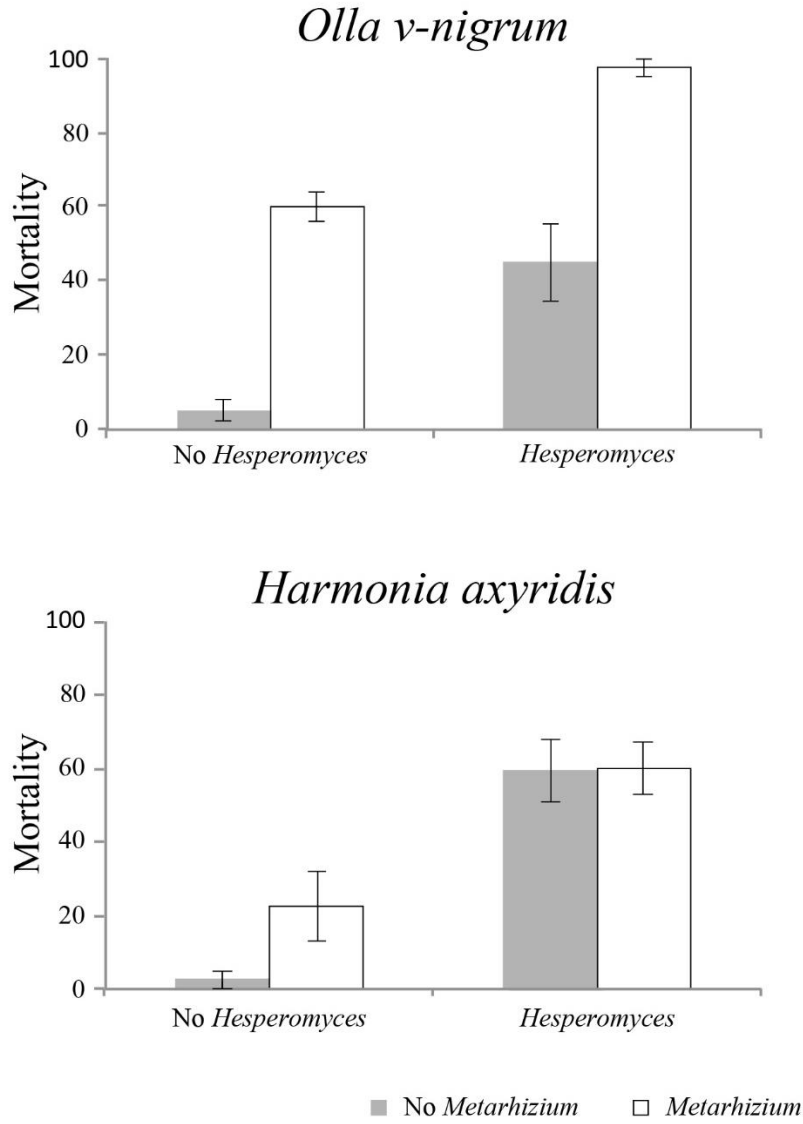
Laboulbeniales can cause observable injuries to host appendages, the cuticle and body tissues, caused by attachment to the host, or penetration inside the host by haustorial species (Thaxter, 1908; Benjamin, 1971; Gemeno *et al.*, 2004). Apparently, Laboulbeniales can alter reproductive behaviors of infected hosts, such as oviposition patterns (Strandberg & Tucker, 1974). Some authors suggested that heavily infected hosts with large numbers of thalli on the head, eyes, antennae, mouthparts, legs and/or elytra could be reduced in their ability to detect food, mate, predate, or hide from predators of their own (Scheloske, 1969; Nalepa & Weir, 2007). In recent years, several studies were published that used experimental data to reveal interesting details with regard to the presumed pathogenicity of Laboulbeniales.

The research group of András Tartally (University of Debrecen, Hungary) uses *Rickia wasmannii* on *Myrmica scabrinodis* (Hymenoptera, Formicidae) as a system to study interactions between Laboulbeniales and their hosts. In one study, the survival rate of *M. scabrinodis* was compared between infected and uninfected ants, under deprivation of food and water (Báthori *et al.*, 2015). The authors found that the survival of *R. wasmannii*-infected ants was significantly lower than uninfected specimens and that infected ants spent more time on consumption of water. During another study, wild-collected ants were subjected to a boldness test and an aggression test. In the boldness test, the time was measured that it took for the ants to leave the nest shelter after removal of a plug. The aggression test described the behavior of a pair of ants, one infected and one uninfected, when put into close proximity. Infected workers were significantly less bold and less aggressive (Báthori *et al.*, 2017). These studies seem to point to behavioral effects of *R. wasmannii* on its ant host. Also, the group of Bálint Marko (Babes-

Bolyai University, Romania) is performing experimental work with *R. wasmannii*. In a series of papers, they described the following effects of infection: reduction in lifespan, higher frequency of allogrooming and reduced aggressive behavior towards non-nestmates and unrelated queens; but no effect on locomotory behavior (Csata *et al.*, 2014, 2017a, 2017b).

Another study system that is being explored to investigate parasite-host interactions is *Hesperomyces virescens* and its ladybird hosts (Coleoptera, Coccinellidae). This fungus has attracted recent interest because it is known to infect *Harmonia axyridis*, a globally invasive pest species, in a rapidly increasing number of countries, locally with very high parasite prevalences, (see Roy *et al.*, 2016; Haelewaters *et al.*, 2017b). Nalepa & Weir (2007) reported a decrease in mating frequency of infected female ladybirds. Riddick (2010) measured winter survival under simulated conditions and found that survival decreased in infected individuals, especially males. Interestingly, Kamburov *et al.* (1967) linked *H. virescens* infection with premature mortality of *Chilocorus bipustulatus* ladybird populations (103 of 120 infected ladybirds died within 10 days). This reported so-called epizootic is contrary to current ideas.

We conducted an experiment at the USDA-ARS facility in Byron, Georgia, in collaboration with Ted. E. Cottrell and his research group, to study the effects of *H. virescens* upon two of its hosts (Figure intro-2). *Olla v-nigrum* and *H. axyridis* ladybirds were tested for mortality over a period of 18 days under the following treatments: (1) no infection (control), (2) *Hesperomyces virescens* infection, (3) *Beauveria bassiana* infection, (4) *Metarhizium anisopliae* infection, (5) *H. virescens* and *B. bassiana* co-infection (6) *H. virescens* and *M. anisopliae* co-infection. We were interested in the effects of *H. virescens* on its hosts, if any, but also in potential additive effects between *H. virescens* and two entomopathogenic fungi (*Beauveria bassiana* and *Metarhizium anisopliae*).



**Figure intro-2.** Mortality (mean  $\pm$  SEM) for *Olla v-nigrum* and *Harmonia axyridis* (D. Haelewaters, D.I. Shapiro-Ilan & T.E. Cottrell, unpubl.). Number of ladybirds per treatment was  $10 \times 4$  replicates. Treatments presented here are: no infection (control); *Hesperomyces virescens* infection; *Metarhizium anisopliae* infection; and *H. virescens* and *M. anisopliae* co-infection. The treatments with *Beauveria bassiana* yielded similar results.

The effect of *H. virescens*-alone infection was similar for both host species; there was a high mortality rate (45% in *O. v-nigrum*, 59% in *H. axyridis*). What is striking is the difference in the effect of the entomopathogen. *Metarhizium anisopliae* caused 60% mortality in *O. v-nigrum*, whereas in *H. axyridis* we only reported 23% mortality. In the co-infection treatment,



mortality was 98% in *O. v-nigrum* but still 60% in *H. axyridis*. In *O. v-nigrum* there is a clear positive synergistic effect of co-infection on mortality. For *H. axyridis*, however, *H. virescens* alone and *H. virescens*-*M. anisopliae* resulted in the same mortality. Perhaps this is evidence for the Enemy Release Hypothesis, which predicts that an invasive species experiences reduced pressure from natural enemies compared to native species. This will lead to population increase of the alien species in its invasive range. Indeed, it is possible that *H. axyridis* is less susceptible to *M. anisopliae* compared to the American-native *O. v-nigrum*.

## OBJECTIVES OF THE DISSERTATION

Since the application of molecular techniques have become standard, thousands of characters have become available for the study of Laboulbeniales, which do not have many morphological features and do not grow in axenic culture. Previous research in this group, even though limited, has shown that morphology *on its own* is inadequate in species delimitation studies. Without having molecular data available, *Hesperomyces coleomegillae* and *H. palustris* might have been described as four different species. Fortunately, using the internal transcribed spacer region of the ribosomal DNA, it has become clear that these are two species, each with two position-specific morphotypes (Goldmann *et al.*, 2013). Another example, using ribosomal DNA sequence data, Goldmann & Weir (2012) neatly placed 13 species into six pairs of morphotypes (one morphotype is a triplet). The combination with ecological data led to the revelation that these morphotypes are located at positions that come in contact during mating of the host. The main goal of this dissertation was to add a molecular phylogenetic component to other lines of evidence, morphological and ecological data, to better understand the diversity and speciation in the Laboulbeniomycetes.

*Objectives.* — The DNA extraction protocols proposed by Weir & Blackwell (2001a, 2001b) are time-consuming, require substantial input material and have led to limited success rates (“at least 1 of the 3 replicates” per extraction, Weir & Blackwell, 2001a; 25%, Weir & Blackwell, 2001b). In addition, DNA isolation protocols have often been unsuccessful for Laboulbeniales or resulted in contaminant DNA fragments (Haelewaters, 2011). Consequently, our first objective was to develop a reliable protocol for the isolation of DNA from as little material as possible (preferably single thalli). We then used these newly developed techniques to generate sequence data for Laboulbeniomycetes taxa of three distinct host groups, with the objective to evaluate the use of molecular data in higher-level taxonomy (at the ordinal level) and in the delimitation of species. The selected host-parasite groups were: (1) cockroaches (Blattodea) and the genus *Herpomyces* (CHAPTER 2); (2) ladybirds (Coleoptera, Coccinellidae) hosting the nearly cosmopolitan *Hesperomyces virescens* (CHAPTER 3); and (3) bat flies (Diptera, Hippoboscoidea, Nycteribiidae & Streblidae) and three genera of Laboulbeniales, *Arthrorhynchus*, *Gloeandromyces* and *Nycteromyces* (CHAPTER 4). Our final objective was to present a preliminary phylogenetic reconstruction of the class Laboulbeniomycetes using all available small subunit ribosomal DNA sequences (CHAPTER 5).

*Structure of the chapters.* — In CHAPTER 1, “Bringing Laboulbeniales into the 21st century: enhanced techniques for extraction and PCR amplification of DNA from minute ectoparasitic fungi,” details are provided of DNA isolation techniques and the application of commercially available kits enabling efficient and quick genetic analysis of Laboulbeniales fungi. Success rates for the different techniques on different genera are presented and discussed in the light of difficulties with micromanipulation, preservation techniques and negative results. In CHAPTER

2, “Birth of an order: comprehensive phylogenetic study excludes *Herpomycetes* (Fungi, Laboulbeniomycetes) from Laboulbeniales,” a new order is proposed based on phylogenetic analyses of three gene regions. Herpomycetales is discussed and a new species is recognized based upon morphological and molecular phylogenetic study. The new taxon is described and illustrated. Some sequences were generated using a standard DNA isolation protocol, edited for use with Laboulbeniomycetes. CHAPTER 3, “Integrative taxonomy reveals hidden species within *Hesperomyces virescens* (Fungi, Laboulbeniales), a parasite of ladybirds (Coleoptera, Coccinellidae),” presents evidence for the existence of multiple genetic clades within *H. virescens*, which is recognized as a species complex. A case is made for the use of the large subunit as a barcode and for a unified species concept, incorporating all available independent lineages of support. CHAPTER 4, “Hyperparasites: Morphological and molecular diversity of Laboulbeniales fungi associated with ectoparasitic bat flies (Diptera: Nycteribiidae, Streblidae),” presents and discusses a molecular phylogeny incorporating the three genera of Laboulbeniales associated with bat flies. The chapter builds on the previous chapter and uses LSU as a barcode for species delimitation in *Gloeandromyces*. The results of these analyses emphasize the need for molecular data in order to evaluate diversity. In CHAPTER 5, “A preliminary phylogeny of Laboulbeniomycetes: pre-molecular classifications subject to revision,” a broad phylogenetic overview of the class Laboulbeniomycetes based on analyses of small subunit DNA sequences is presented. Relationships between clades and the relevance of pre-molecular classification are discussed.

#### LITERATURE CITED

Anonymous (1849) Wissenschaftliches. Siebente Zusammenkunft der Wissenschaftsfreunde. In: *Illyrisches Blatt* (Hladnik J, ed) **60**: 240. Klagenfurt, Kleinmayr.

- Barr ME (1983) The ascomycete connection. *Mycologia* **75**: 1–13.
- Barron GL (1968) *The genera of hyphomycetes from soil*. Baltimore: William and Wilkins.
- Báthori F, Csata E, Tartally A (2015) *Rickia wasmannii* increases the need for water in *Myrmica scabrinodis* (Ascomycota: Laboulbeniales; Hymenoptera: Formicidae). *Journal of Invertebrate Pathology* **126**: 78–82.
- Báthori F, Pfliegler WP, Tartally A (2014) First records of the myrmecophilous fungus *Laboulbenia camponoti* Batra (Ascomycetes: Laboulbeniales) from Austria and Romania. *Sociobiology* **61**: 338–340.
- Báthori F, Rádai Z, Tartally A (2017) The effect of *Rickia wasmannii* (Ascomycota, Laboulbeniales) on the aggression and boldness of *Myrmica scabrinodis* (Hymenoptera, Formicidae). *Journal of Hymenoptera Research* **58**: 41–52.
- Benjamin RK (1955) New genera of Laboulbeniales. *El Aliso* **3**: 183–197.
- Benjamin RK (1967) Laboulbeniales on semi-aquatic Hemiptera. *Laboulbenia. Aliso* **6**: 111–136.
- Benjamin RK (1970) Laboulbeniales on semiaquatic Hemiptera. II. *Autophagomyces*, *Dioicomycetes*, and *Prolixandromyces* gen. nov. *Aliso* **7**: 165–182.
- Benjamin RK (1971) Introduction and supplement to Roland Thaxter's contribution towards a monograph of the Laboulbeniaceae. *Bibliotheca Mycologica* **30**: 1–155.
- Benjamin RK (1979) Laboulbeniales on semiaquatic Hemiptera. III. *Rhizopodomyces*. *Aliso* **9**: 379–409.
- Benjamin RK (1981) Laboulbeniales on semiaquatic Hemiptera. IV. Addenda to *Prolixandromyces*. *Aliso* **10**: 1–17.
- Benjamin RK (1986) Laboulbeniales on semiaquatic Hemiptera. V. *Triceromyces*: with a description of monoecious-dioecious dimorphism in the genus. *Aliso* **11**: 245–278.
- Benjamin RK (1993) Laboulbeniales on semiaquatic Hemiptera. VI. The genus *Tavaresiella*. *Aliso* **13**: 559–576.
- Benjamin RK (1998) Laboulbeniales on semiaquatic Hemiptera. VII. Addenda to *Triceromyces* on Hydrometridae and further observations on dioecism in the order. *Aliso* **17**: 1–21.
- Benjamin RK (1999) Laboulbeniales on semiaquatic Hemiptera. VIII. *Monandromyces*, a new genus based on *Autophagomyces microveliae* (Laboulbeniales), *Aliso* **18**: 71–91.
- Benjamin RK, Blackwell M, Chapella I, Humber RA, Jones KG, Klepzig KA, Lichtwardt RW, Malloch D, Noda H, Roeper RA, Spatafora JW, Weir A (2004) The search for diversity of insects and other arthropod associated fungi. In: *Biodiversity of fungi: Inventory and*

- monitoring methods* (Mueller GM, Bills GF, Foster MS, eds): 395–433. New York: Elsevier Academic Press.
- Benjamin RK, Shanor L (1950a) Discovery of dioecism in *Laboulbenia formicarum*. *Science* **111**: 33–34.
- Benjamin RK, Shanor L (1950b) The development of male and female individuals in the dioecious species *Laboulbenia formicarum* Thaxter. *American Journal of Botany* **37**: 471–476.
- Benjamin RK, Shanor L (1952) Sex of host specificity and position specificity of certain species of *Laboulbenia* on *Bembidion picipes*. *American Journal of Botany* **39**: 125–131.
- Bernardi M, Barragán A, Rossi W (2014) New records of Laboulbeniales (Fungi: Ascomycota) from Ecuador and other countries. *Webbia: Journal of Plant Taxonomy and Geography* **69**: 281–290.
- Blackwell M (1980) Developmental morphology and taxonomic characters of *Arthrorhynchus nycteribiae* and *A. eucampsipodae* (Laboulbeniomycetes). *Mycologia* **72**: 159–168.
- Blackwell M (1994) Minute mycological mysteries: the influence of arthropods on the lives of fungi. *Mycologia* **86**: 1–17.
- Blackwell M (2011) The Fungi: 1, 2, 3... 5.1 million species? *American Journal of Botany* **98**: 426–438.
- Blackwell M, Malloch D (1989) *Pyxidiophora*: life histories and arthropod associations of two species. *Canadian Journal of Botany* **67**: 2552–2562.
- Blum G (1924) Zwei neue Laboulbenien aus Brasilien. *Centralblatt für Bakteriologie, Parasitenkunde und Infektionskrankheiten, Zweite Abteilung* **62**: 300–302.
- Cavalier-Smith T (1998) A revised six-kingdom system of life. *Biological Reviews* **73**: 203–266.
- Cavara F (1899) Di una nuova Laboulbeniacea *Rickia Wasmannii* nov. gen. e nov. spec. *Malpighia* **13**: 173–188.
- Cépède C (1914) Étude des Laboulbéniciacées Européennes. *Laboulbenia Blanchardi* n. sp. et son parasite *Fusarium Laboulbeniae* n. sp. *Archives de Parasitologie* **16**: 373–403.
- Cottrell TE, Riddick EW (2012) Limited transmission of the ectoparasitic fungus *Hesperomyces virescens* between ladybirds. *Psyche* 2012: article ID 814378.
- Csata E, Bernadou A, Rákossy-Tican E, Heinze J, Markó B (2017a) The effects of fungal infection and physiological condition on the locomotory behaviour of the ant *Myrmica scabrinodis*. *Journal of Insect Physiology* **98**: 167–172.

- Csata E, Erős K, Markó B (2014) Effects of the ectoparasitic fungus *Rickia wasmannii* on its ant host *Myrmica scabrinodis*: changes in host mortality and behavior. *Insectes Sociaux* **61**: 247–252.
- Csata E, Timuş N, Witek M, Casacci LP, Lucas C, Bagnères AG, Sztencel-Jabłonka A, Barbero F, Bonelli S, Rákosy L, Markó B (2017b) Lock-picks: fungal infection facilitates the intrusion of strangers into ant colonies. *Scientific Reports* **7**: 46323.
- De Kesel A (1989) Ontogeny of *Laboulbenia slackensis* Picard & Cépède (Ascomycetes). *Bulletin de la Société Royale de Botanique de Belgique* **122**: 37–46.
- De Kesel A (1995a) Population dynamics of *Laboulbenia clivinalis* Thaxter (Ascomycetes, Laboulbeniales) and sex-related thallus distribution on its host *Clivina fossor* (Linnaeus, 1758) (Coleoptera, Carabidae).
- De Kesel A (1995b) Relative importance of direct and indirect infection in the transmission of *Laboulbenia slackensis* (Ascomycetes, Laboulbeniales). *Belgian Journal of Botany* **128**: 124–130. *Bulletin de la Société Royale de Botanique de Belgique* **131**: 335–348.
- De Kesel A (1996) Host specificity and habitat preference of *Laboulbenia slackensis*. *Mycologia* **88**: 565–573.
- De Kesel (1997) *Flora van de Laboulbeniales van België. Appendix bij het proefschrift: Bijdrage tot de studie van de specificiteit van Laboulbeniales (Fungi, Ascomycetes), met bijzondere aandacht voor de transmissie, de voorkeurshabitat en het gastheerspectrum van Laboulbenia slackensis*. Doctoral dissertation. University of Antwerp, Belgium.
- De Kesel A (1998) Identificatie en gastheerspectrum van het genus *Laboulbenia* in België (Ascomycetes, Laboulbeniales). *Sterbeeckia* **18**: 13–31.
- De Kesel A (2011) *Hesperomyces* (Laboulbeniales) and coccinellid hosts. *Sterbeeckia* **30**: 32–37.
- De Kesel A, Gerstmans C (2011) Laboulbeniales (Ascomycetes). *Scripta Botanica Belgica* **47**: 171–180.
- De Kesel A, Haelewaters D (2014) *Laboulbenia slackensis* and *L. littoralis* sp. nov. (Ascomycota, Laboulbeniales), two sibling species as a result of ecological speciation. *Mycologia* **106**: 407–414.
- De Kesel A, Rammeloo J (1992) Checklist of the Laboulbeniales (Ascomycetes) of Belgium. *Belgian Journal of Botany* **124**: 204–214.
- Demoulin V (1985) The red algal-higher fungi phylogenetic link: the last ten years. *BioSystems* **18**: 347–356.
- Denison WC, Carroll GC (1966) The primitive Ascomycete: a new look at an old problem. *Mycologia* **58**: 249–269.

- Doveri F, Coué B (2006) *Pyxidiophora badiorostris*, first record from France. *Documents Mycologiques* **34**: 33–41.
- Drès M, Mallet J (2002) Host races in plant–feeding insects and their importance in sympatric speciation. *Philosophical Transactions of the Royal Society B* **357**: 471–492.
- Faull JH (1911) The cytology of the Laboulbeniales. *Annals of Botany* **25**: 649–654.
- Federici BA (2009) Pathogens of Insects. In: *Encyclopedia of insects* (Resh VH, Cadré RT, eds): 757–765. Amsterdam: Academic Press.
- Gäumann EA, Dodge CW (1928) *Comparative morphology of fungi*. New York: McGraw-Hill Book Company, Inc.
- Ge Z-W, Yang ZL, Pfister DH, Carbone M, Bau T, Smith ME. (2014) Multigene molecular phylogeny and biogeographic diversification of the earth tongue fungi in the genera *Cudonia* and *Spathularia* (Rhytismatales, Ascomycota). *Plos One* **9**: e103457.
- Gemeno C, Zurek L, Schal C (2004) Control of *Herpomyces* spp. (Ascomycetes: Laboulbeniales) infection in the wood cockroach, *Parcoblatta lata* (Blattodea: Blattellidae), with benomyl. *Journal of Invertebrate Pathology* **85**: 132–135.
- Godfray HCJ (1994) *Parasitoids. Behavioral and evolutionary ecology*. Princeton, New Jersey: Princeton University Press.
- Goldmann L, Weir A (2012) Position specificity in *Chitonomyces* (Ascomycota, Laboulbeniomycetes) on *Laccophilus* (Coleoptera, Dytiscidae): a molecular approach resolves a century-old debate. *Mycologia* **104**: 1143–1158.
- Goldmann L, Weir A (2018) Molecular phylogeny of the Laboulbeniomycetes (Ascomycota). *Fungal Biology* **122**: 87–100.
- Goldmann L, Weir A, Rossi W (2013) Molecular analysis reveals two new dimorphic species of *Hesperomyces* (Ascomycota, Laboulbeniomycetes) parasitic on the ladybird *Coleomegilla maculata* (Coleoptera, Coccinellidae). *Fungal Biology* **117**: 807–813.
- Haelewaters D (2011) *Laboulbeniales: Exploring and testing DNA extraction protocols, carrion beetle hosts and species in 'De Kaaistoep' (The Netherlands)*. Master's thesis. Ghent University, Belgium.
- Haelewaters D (2013) First record of the genus *Ilyomyces* for North America, parasitizing *Stenus clavicornis*. *Bulletin of Insectology* **66**: 269–272.
- Haelewaters D, De Kock G, Van Wielink P (2015a) Nieuwe Laboulbeniales in De Kaaistoep: In: *Natuurstudie in De Kaaistoep. Verslag 2014, 20e onderzoeksjaar* (Peeters T, Van Eck A, Cramer T, eds.): 11–18. TWM Gronden BV, Natuurmuseum Brabant & KNNV-afdeling Tilburg.

- Haelewaters D, Gorczak M, Pfliegler WP, Tartally A, Tischer M, Wrzosek M, Pfister DH (2015b) Bringing Laboulbeniales into the 21st century: enhanced techniques for extraction and PCR amplification of DNA from minute ectoparasitic fungi. *IMA Fungus* **6**: 363–372.
- Haelewaters D, Rossi W (2015) Three new species of Laboulbenia from Roland Thaxter's backlog of slides and a brief review of Laboulbeniales associated with Chrysomelidae. *Mycologia* **107**: 142–148.
- Haelewaters D, Rossi W (2017) Laboulbeniales parasitic on American small carrion beetles: new species of *Corethromyces*, *Diphymyces*, and *Rodaucea*. *Mycologia* **109**: 655–666.
- Haelewaters D, Schilthuizen M, Pfister DH. 2014. On *Diphymyces* (Laboulbeniales, Ascomycota) in Malaysian Borneo. *Plant Ecology and Evolution* **147**: 93–100.
- Haelewaters D, Verhaeghen SJC, Ríos Gonzáles TA, Bernal Vega JA, Villarreal Saucedo RV (2017a) New and interesting Laboulbeniales from Panama and neighboring areas. *Nova Hedwigia* **105**: 267–299.
- Haelewaters D, Yaakop S (2014) New and interesting Laboulbeniales from southern and southeastern Asia. *Mycotaxon* **129**: 439–454.
- Haelewaters D, Zhao SY, Clusella-Trullas S, Cottrell TE, De Kesel A, Fiedler L, Herz A, Hesketh H, Hui C, Kleespies RG, Losey JE, Minnaar IA, Murray KM, Nedvěd O, Pfliegler WP, Raak-van den Berg CL, Riddick EW, Shapiro-Ilan DI, Smyth RR, Steenberg T, van Wielink PS, Vigišová S, Zhao Z, Ceryngier P, Roy HE (2017b) Parasites of *Harmonia axyridis*: current research and perspectives. *BioControl* **62**: 355–371.
- Haelewaters, D, Zhao SY, De Kesel A, Handlin RE, Royer IR, Farrell BD, and Pfister DH (2015c) Laboulbeniales (Ascomycota) of the Boston Harbor Islands I: species parasitizing Coccinellidae and Staphylinidae, with comments on typification. *Northeastern Naturalist* **22**: 459–477.
- Hawksworth DL (1991) The fungal dimension of biodiversity: Magnitude, significance, and conservation. *Mycological Research* **95**: 641–655.
- Hibbett DS, Binder M, Bischoff JF, Blackwell M, Cannon PF, Eriksson OE, Huhndorf S, James T, Kirk PM, Lücking R, Lumbsch HT, Lutzoni F, Matheny PB, McLaughlin DJ, Powell MJ, Redhead S, Schoch CL, Spatafora JW, Stalpers JA, Vilgalys R, Aime MC, Aptroot A, Bauer R, Begerow D, Benny GL, Castlebury LA, Crous PW, Dai Y-C, Gams W, Geiser DM, Griffith GW, Gueidan C, Hawksworth DL, Hestmark G, Hosaka K, Humber RA, Hyde KD, Ironside JE, Kõljalg U, Kurtzman CP, Larsson K-H, Lichtwardt R, Longcore J, Miadlikowska J, Miller A, Moncalvo J-M, Mozley-Standridge S, Oberwinkler F, Parmasto E, Reeb V, Rogers JD, Roux C, Ryvarden L, Sampaio JP, Schüßler A, Sugiyama J, Thorn RG, Tibell L, Untereiner WA, Walker C, Wang Z, Weir A, Weiss M, White MM, Winka K, Yao Y-J, Zhang N (2007) A higher-level phylogenetic classification of the Fungi. *Mycological Research* **111**: 509–547.



- Hibbett D, Abarenkov K, Kõljalg U, Öpik M, Chai B, Cole J, Wang Q, Crous P, Robert V, Helgason T, Herr JR, Kirk P, Lueschow S, O'Donnell K, Nilsson RH, Oono R, Schoch C, Smyth C, Walker DM, Porras-Alfaro A, Taylor JW, Geiser DM (2016) Sequence-based classification and identification of Fungi. *Mycologia* **108**: 1049–1068.
- Hill TW (1977) Ascocarp ultrastructure of *Herpomyces* sp. (Laboulbeniales) and its phylogenetic implications. *Canadian Journal of Botany* **55**: 2015–2032.
- Hoberg EP (1997) Phylogeny and historical reconstruction: host parasite systems as keystones in biogeography and ecology. In: *Biodiversity II: understanding and protecting our resources* (Wilson EO, Wilson D, eds): 243–261. Washington, DC: Joseph Henry Press, National Academy of Sciences.
- Huldén L (1983) Laboulbeniales (Ascomycetes) of Finland and adjacent parts of the U.S.S.R. *Karstenia* **23**: 31–136
- Jacobs K, Holtzman K, Seifert KA (2005) Morphology, phylogeny and biology of *Gliocephalis hyalina*, a biotrophic contact mycoparasite of *Fusarium* species. *Mycologia* **97**: 111–120.
- James TY, Kauff F, Schoch CL, Matheny PB, Hofstetter V, Cox CJ, Celio G, Gueidan C, Fraker E, Miadlikowska J, Lumbsch HT, Rauhut A, Reeb V, Arnold AE, Amtoft A, Stajich JE, Hosaka K, Sung G-H, Johnson D, O'rourke B, Crockett M, Binder M, Curtis JM, Slot JC, Wang Z, Wilson AW, Schüßler A, Longcore JE, O'Donnell K, Mozley-Standridge S, Porter D, Letcher PM, Powell MJ, Taylor JW, White MM, Griffith GW, Davies DR, Humber RA, Morton JB, Sugiyama J, Rossman AY, Rogers JD, Pfister DH, Hewitt D, Hansen K, Hambleton S, Shoemaker RA, Kohlmeyer J, Volkmann-Kohlmeyer B, Spotts RA, Serdani M, Crous PW, Hughes KW, Matsuura K, Langer E, Langer G, Untereiner WA, Lücking R, Büdel B, Geiser DM, Aptroot A, Diederich P, Schmitt I, Schultz M, Yahr R, Hibbett DS, Lutzoni F, McLaughlin DJ, Spatafora JW, Vilgalys R (2006) Reconstructing the early evolution of Fungi using a six-gene phylogeny. *Nature* **443**: 818–822.
- Kamburov SS, Nadel DJ, Kenneth R. Observations on *Hesperomyces virescens* Thaxter (Laboulbeniales, a fungus associated with premature mortality of *Chilocorus bipustulatus* L. in Israel. *Israel Journal of Agricultural Research* **17**: 131–134
- Karsten H (1869) *Chemismus der Pflanzenzelle. Eine morphologisch-chemische Untersuchung der Hefe*. Vienna: W. Braumüller.
- Kolenati FA (1857) Epizoa der Nycteribien. *Wiener entomologische Monatschrift* **1**: 66–69.
- Locke M (1974) The structure and formation of the integument in insects. In: *Physiology of insecta, vol. VI* (Rockstein M, ed): 123–213. New York: Academic Press.
- Majewski T (1994) The Laboulbeniales of Poland. *Polish Botanical Studies* **7**: 1–466.
- Majewski T (2003) Distribution and ecology of Laboulbeniales (Fungi, Ascomycetes) in the Białowieża forest and its western foreland. *Phytocoenosis* **15**, *Supplementum Cartographiae Geobotanicae* **16**: 1–144.

- Malloch D, Blackwell M (1990) *Kathistes*, a new genus of pleomorphic ascomycetes. *Canadian Journal of Botany* **68**: 1712–1721.
- Mayr G (1853) Abnorme Haargebilde an Nebrien und einige Pflanzen Krains. *Verhandlungen der Zoologisch-Botanischen Gesellschaft in Wien* **2**: 75–77.
- Meola S, Tavares II (1982) Ultrastructure of the haustorium of *Trenomyces histophthorus* and adjacent host cells. *Journal of Invertebrate Pathology* **40**: 205–215.
- Mueller GM, Schmit JP (2007) Fungal biodiversity: What do we know? What can we predict? *Biodiversity and Conservation* **16**: 1–5.
- Nalepa CA, Weir A (2007) Infection of *Harmonia axyridis* (Coleoptera: Coccinellidae) by *Hesperomyces virescens* (Ascomycetes: Laboulbeniales): Role of mating status and aggregation behavior. *Journal of Invertebrate Pathology* **94**: 96–203.
- Peyritsch J (1871) Über einige Pilze aus der Familie der Laboulbenien. *Sitzungsberichte der Kaiserlichen Akademie der Wissenschaft (Wien), Mathematisch-naturwissenschaftliche Classe* **64**: 441–458.
- Peyritsch J (1873) Beiträge zur Kenntniss der Laboulbenien. *Sitzungsberichte der Kaiserlichen Akademie der Wissenschaft (Wien), Mathematisch-naturwissenschaftliche Classe* **68**: 227–254.
- Peyritsch J (1875) Über Vorkommen und Biologie von Laboulbeniaceen. *Sitzungsberichte der Kaiserlichen Akademie der Wissenschaft (Wien), Mathematisch-naturwissenschaftliche Classe* **72**: 377–385.
- Pfister DH (1984) Roland Thaxter: mycologist and entomologist. In: *Fungus-insect relationships. Perspectives in ecology and evolution* (Wheeler Q, Blackwell M, eds): 211–221. New York: Columbia University Press.
- Pfliegler WP, Báthori F, Haelewaters D, Tartally A (2016) Studies of Laboulbeniales on *Myrmica* ants (III): myrmecophilous arthropods as alternative hosts of *Rickia wasmannii*. *Parasite* **23**: 50.
- Price PW (1980) *Evolutionary biology of parasites*. Princeton, New Jersey: Princeton University Press.
- Reboleira ASP, Fresnada J, Salgado JM (2017) A new species of *Speonemadus* from Portugal, with the revision of the *escalerai*-group (Coleoptera, Leiodidae). *European Journal of Taxonomy* **261**: 1–23.
- Richards AG, Smith MN (1956) Infection of cockroaches with *Herpomyces* (Laboulbeniales) II. Histology and histopathology. *Annals of the Entomological Society of America* **49**: 85–93
- Riddick EW (2010) Ectoparasitic mite and fungus on an invasive lady beetle: parasite coexistence and influence on host survival. *Bulletin of Insectology* **63**: 13–20.

- Robin CP (1852) Végétaux parasites sur une insecte du genre *Brachynus*. *Comptes Rendus des Séances de la Société de Biologie (sér. 1)* **4**: 11.
- Robin CP (1853) *Histoire naturelle des végétaux parasites qui croissent sur l'homme et sur les animaux vivants*. Paris: J.-B. Baillière.
- Rossi W (2011) New species of *Laboulbenia* from Ecuador, with evidence for host switch in the Laboulbeniales. *Mycologia* **103**: 184–194.
- Rossi W, Bernardi M, Torres JA (2016) New species of *Laboulbenia* parasitic on leaf beetles. *Mycological Progress* **15**: 4.
- Rossi W, Kirk-Spriggs AH (2011) A new species of *Laboulbenia* (Ascomycota) parasitic on an African fly (Diptera: Curtonotidae), with a brief review of Diptera-associated species of the genus. *African Invertebrates* **52**: 211–216.
- Rossi W, Máca J & Vávra J (2010) New records of Laboulbeniales (Ascomycota) from the Czech Republic and Slovakia. *Polish Botanical Journal* **55**: 343–351.
- Rossi W, Santamaria S (2012) *Rodaucea*, a new genus of the Laboulbeniales. *Mycologia* **104**: 785–788.
- Rossi W, Weir A (1998) *Triainomyces*, a new genus of Laboulbeniales on the pill-millipede *Procyliosoma tuberculatum* from New Zealand. *Mycologia* **90**: 282–289.
- Rossmann A (1994) A strategy for an all-taxa inventory of fungal biodiversity. In: *Biodiversity and terrestrial ecosystems* (Peng CI, Chou CH, eds): 169–194. Taipei, Taiwan: Academia Sinica Monograph Series 14.
- Rouget A (1850) Notice sur une production parasite observée sur le *Brachinus crepitans*. *Annales de la Société Entomologique de France (Paris)* **8**: 21–24.
- Roy HE, Brown PMJ, Adriaens T, Berkvens N, Borges I, Clusella-Trullas S, Comont RF, De Clercq P, Eschen R, Estoup A, Evans EW, Facon B, Gardiner MM, Gil A, Grez AA, Guillemaud T, Haelewaters D, Herz A, Honek A, Howe AG, Hui C, Hutchison WD, Kenis M, Koch RL, Kulfan J, Lawson Handley L, Lombaert E, Loomans A, Losey J, Lukashuk AO, Maes D, Magro A, Murray KM, San Martín G, Martinkova Z, Minnaar IA, Nedvěd O, Orlova-Bienkowskaja MJ, Osawa N, Rabitsch W, Ravn HP, Rondoni G, Rorke SL, Ryndevich SK, Saethre M-G, Sloggett JJ, Soares AO, Stals R, Tinsley MC, Vandereycken A, van Wielink P, Vigišová S, Zach P, Zakharov IA, Zaviezo T, Zhao Z (2016) The harlequin ladybird, *Harmonia axyridis*: global perspectives on invasion history and ecology. *Biological Invasions* **18**: 997–1044.
- Sachs J (1874) *Lehrbuch der Botanik. 4th ed.* Leipzig, Germany: Wilhelm Engelmann.
- Santamaria S (1998) Laboulbeniales, I. *Laboulbenia*. *Flora Mycologia Iberica* **4**: 1–186.

- Santamaria S (2003) Laboulbeniales, II. *Acompsomyces–Ilyomyces*. *Flora Mycologia Iberica* **5**: 1–344.
- Santamaria S (2006) New or interesting Laboulbeniales (Fungi, Ascomycota) from Spain, V. *Nova Hedwigia* **82**: 349–363.
- Santamaria S, Balazuc J, Tavares II (1991) Distribution of the European Laboulbeniales (Fungi, Ascomycotina). Ann annotated list of species. *Treballs de l'Institut Botanic de Barcelona* **14**: 5–123.
- Santamaria S, Enghoff H, Gruber J, Reboleira ASP (2017) First Laboulbeniales from harvestmen: the new genus *Opilionomyces*. *Phytotaxa* **305**: 285–292.
- Santamaria S, Enghoff H, Reboleira ASP (2016) Hidden biodiversity revealed by collection-based research—Laboulbeniales in millipedes: genus *Rickia*. *Phytotaxa* **243**: 101–127.
- Scheloske H-W (1969) Beiträge zur Biologie, Ökologie und Systematik der Laboulbeniales (Ascomycetes) unter besondere Berücksichtigung des Parasit-Wirt-Verhältnisses. *Parasitologische Schriftenreihe* **19**: 1–176.
- Schmit JP, Mueller GM (2007) An estimate of the lower limit of global fungal diversity. *Biodiversity and Conservation* **16**: 99–111.
- Schoch CL, Sung GH, López-Giráldez F, Townsend JP, Miadlikowska J, Hofstetter V, Robbertse B, Matheny PB, Kauff F, Wang Z, Gueidan C, Andrie RM, Trippe K, Ciufetti LM, Wynns A, Fraker E, Hodkinson BP, Bonito G, Groenewald JZ, Arzanlou M, de Hoog GS, Crous PW, Hewitt D, Pfister DH, Peterson K, Gryzenhout M, Wingfield MJ, Aptroot A, Suh SO, Blackwell M, Hillis DM, Griffith GW, Castlebury LA, Rossman AY, Lumbsch HT, Lücking R, Büdel B, Rauhut A, Diederich P, Ertz D, Geiser DM, Hosaka K, Inderbitzin P, Kohlmeyer J, Volkman-Kohlmeyer B, Mostert L, O'Donnell K, Sipman H, Rogers JD, Shoemaker RA, Sugiyama J, Summerbell RC, Untereiner W, Johnston PR, Stenroos S, Zuccaro A, Dyer PS, Crittenden PD, Cole MS, Hansen K, Trappe JM, Yahr R, Lutzoni F, Spatafora JW (2009) The Ascomycota tree of life: A phylum-wide phylogeny clarifies the origin and evolution of fundamental reproductive and ecological traits. *Systematic Biology* **58**: 224–239.
- Sokolowski K (1942) Die Catopiden der Nordmark. *Entomologische Blätter* **38**: 173–211.
- Sorenson MD, Sefc KM, Payne RB (2003) Speciation by host switch in brood parasitic indigobirds. *Nature* **424**: 928.
- Spatafora JW, Chang Y, Benny GL, Lazarus K, Smith ME, Berbee ML, Bonito G, Corradi N, Grigoriev I, Gryganskyi A, James TY, O'Donnell K, Roberson RW, Taylor TN, Uehling J, Vilgalys R, White MM, Stajich JE (2016) A phylum-level phylogenetic classification of zygomycete fungi based on genome-scale data. *Mycologia* **108**: 1028–1046.
- Spegazzini C (1917) Revisión de las Laboulbeniales argentinas. *Anales del Museo Nacional de Historia Natural de Buenos Aires* **29**: 445–688.

- Strandberg JO, Tucker LC (1974) *Filariomyces forficulae*: Occurrence and effects on the predatory earwig, *Labidura riparia*. *Journal of Invertebrate Pathology* **24**: 357–364.
- Sundberg H, Ekman S, Kruys Å (2018) A crush on small fungi: An efficient and quick method for obtaining DNA from minute ascomycetes. *Methods in Ecology and Evolution* **9**: 148–158.
- Sugiyama K (1973) Species and genera of the Laboulbeniales (Ascomycetes) in Japan. *Ginkgoana* **2**: 1–97, Pl. 11–27.
- Tavares II (1965) Thallus development in *Herpomyces paranensis* (Laboulbeniales). *Mycologia* **52**: 704–721.
- Tavares II (1966) Structure and development of *Herpomyces stylopygae* (Laboulbeniales). *American Journal of Botany* **53**: 311–318.
- Tavares II (1979) The Laboulbeniales and their arthropod hosts. In: *Insect-fungus symbiosis, nutrition, mutualist, and commensalism* (Batra LR, ed.): 229–258. New York: John Wiley & Sons.
- Tavares II (1985) Laboulbeniales (Fungi, Ascomycetes). *Mycologia Memoir* **9**: 1–627.
- Taylor DL, Hollingsworth TN, McFarland JW, Lennon NJ, Nusbaum C, Ruess RW (2014) A first comprehensive census of fungi in soil reveals both hyperdiversity and fine-scale niche partitioning. *Ecological Monographs* **84**:3–20.
- Thaxter R (1896) Contribution towards a monograph of the Laboulbeniaceae. *Memoirs of the American Academy of Arts and Sciences* **12**: 187–429, Pl. I–XXVI.
- Thaxter R (1901) Preliminary diagnoses of new species of Laboulbeniaceae. III. *Proceedings of the American Academy of Arts and Sciences* **36**: 397–414.
- Thaxter R (1908) Contribution toward a monograph of the Laboulbeniaceae. Part II. *Memoirs of the American Academy of Arts and Sciences* **13**: 217–469, Pl. XXVIII–LXXI.
- Thaxter R (1918) New Laboulbeniales from Chile and New Zealand. *Proceedings of the American Academy of Arts and Sciences* **54**: 207–232.
- Thaxter R (1920) New Dimorphomyceteae. *Proceedings of the American Academy of Arts and Sciences* **55**: 211–282.
- Thaxter R (1924) Contribution toward a monograph of the Laboulbeniaceae III. *Memoirs of the American Academy of Arts and Sciences* **14**: 309–426, Pl. I–XII.
- Thaxter R (1926) Contribution toward a monograph of the Laboulbeniaceae IV. *Memoirs of the American Academy of Arts and Sciences* **15**: 427–580, Pl. I–XXIV.

- Thaxter R (1931) Contribution toward a monograph of the Laboulbeniaceae V. *Memoirs of the American Academy of Arts and Sciences* **16**: 1–435, Pl. I–LX.
- Thompson JN (2014) Coevolution and speciation. In: *The Princeton guide to evolution* (Losos J, ed): 535–548. Princeton, New Jersey: Princeton University Press.
- Tragust S, Tartally A, Espadaler X, Billen J (2016) Histopathology of Laboulbeniales (Ascomycota: Laboulbeniales): ectoparasitic fungi on ants (Hymenoptera: Formicidae). *Myrmecological News* **23**: 81–89.
- van den Bosch R, Messenger PS, Gettier AP (1982) An introduction to biological control. New York: Plenum.
- Vinson SB, Iwantsch GF (1980) Host suitability for insect parasitoids. *Annual Review of Entomology* **25**: 397–419.
- Weir A, Beakes GW (1995) An introduction to the Laboulbeniales: a fascinating group of entomogenous fungi. *Mycologist* **9**: 6–10.
- Weir A, Beakes GW (1996) Correlative light- and scanning electron microscope studies on the developmental morphology of *Hesperomyces virescens*. *Mycologia* **88**: 677–693.
- Weir A, Blackwell M (2001a) Extraction and PCR amplification of DNA from minute ectoparasitic fungi. *Mycologia* **93**: 802–806
- Weir A, Blackwell M (2001b) Molecular data support the Laboulbeniales as a separate class of Ascomycota, Laboulbeniomycetes. *Mycological Research* **105**: 1182–1190.
- Weir A, Blackwell M (2005) Fungal biotrophic parasites of insects and other arthropods. In: *Insect-fungal associations: ecology and evolution* (Vega FE, Blackwell M, eds): 119–145. New York: Oxford University Press.
- Weir A, Hammond PM (1997) Laboulbeniales on beetles: Host utilization patterns and species richness of the parasites. *Biodiversity and Conservation* **6**: 701–719.
- Weir A, Rossi W (2001) New and interesting Bolivian Laboulbeniales. *Mycologia* **93**: 171–180.
- Whisler HC (1968) Experimental studies with a new species of *Stigmatomyces* (Laboulbeniales). *Mycologia* **60**: 65–75.
- Windsor DA (1990) Heavenly hosts. *Nature* **348**: 104.
- Windsor DA (1995) Equal rights for parasites. *Conservation Biology* **9**: 1–2.

## CHAPTER 1

### **Bringing Laboulbeniales into the 21st century: enhanced techniques for extraction and PCR amplification of DNA from minute ectoparasitic fungi**

Published in 2015:

Haelewaters D, Gorczak M, Pfliegler WP, Tartally A, Tischler M, Wrzosek M, Pfister DH.

*IMA Fungus* 6: 363-372.

*Author's contribution.* — D.H. evaluated the commercially available QIAamp DNA Micro Kit and Extract-N-Amp Plant PCR Kit, and generated the majority of nuclear ribosomal molecular sequence data. D.H. also did extensive literature review on methodologies and preservation techniques and wrote the manuscript with input from the co-authors.



**Bringing Laboulbeniales into the 21st century: enhanced techniques for extraction and PCR amplification of DNA from minute ectoparasitic fungi**

Danny Haelewaters<sup>1,2</sup>

Michał Gorczak<sup>3</sup>

Walter P. Pfliegler<sup>4,5,6</sup>

András Tartally<sup>7</sup>

Marta Tischer<sup>3</sup>

Marta Wrzosek<sup>3</sup>

Donald H. Pfister<sup>2</sup>

<sup>1</sup>Department of Organismic and Evolutionary Biology, Harvard University, 22 Divinity Avenue, Cambridge, MA 02138, United States; <sup>2</sup>Farlow Reference Library and Herbarium of Cryptogamic Botany, Harvard University, 22 Divinity Avenue, Cambridge, Massachusetts 02138, United States; <sup>3</sup>Department of Molecular Phylogenetics and Evolution, University of Warsaw, Aleje Ujazdowskie 4, Warsaw, Poland; <sup>4</sup>Department of Genetics and Applied Microbiology, University of Debrecen, Egyetem tér 1, 4032 Debrecen, Hungary; <sup>5</sup>Department of Biotechnology and Microbiology, University of Debrecen, Egyetem tér 1, 4032 Debrecen, Hungary; <sup>6</sup>Postdoctoral Fellowship Programme of the Hungarian Academy of Sciences (MTA), Hungary; <sup>7</sup>Department of Evolutionary Zoology and Human Biology, University of Debrecen, Egyetem tér 1, 4032 Debrecen, Hungary

**Abstract.** Laboulbeniales is one of the most peculiar orders of Ascomycota. these fungi are characterized by an ectoparasitic lifestyle on arthropods, determinate growth, lack of an asexual stage, high species richness and intractability in culture. The order Laboulbeniales, sister to Pyxidiophorales, has only recently been assigned a separate class, the Laboulbeniomycetes, based on very few ribosomal DNA sequences. So far, DNA isolations and PCR amplifications have proven difficult. Here, we provide details of isolation techniques and the application of commercially available kits that enable efficient and quick genetic analyses of these fungi. We provide 43 newly generated Laboulbeniales ribosomal DNA sequences, among which the first published sequences for species in the genera *Gloeandromyces*, *Herpomyces*, *Laboulbenia*, *Monoicomyces* and *Polyandromyces*. DNA extractions were possible using 1 to 30 thalli from hosts preserved in ethanol (70-100%). In two cases, we successfully isolated DNA from thalli on dried insect collections. Laboulbeniales molecular systematics could be substantially enhanced through these improved methods by allowing more complete sampling of both taxa and gene regions.

**Key words:** Ascomycota, DNA isolation, insect collections, Laboulbeniales-specific primers, ribosomal DNA, unculturable fungi

## INTRODUCTION

Laboulbeniales are obligate ectoparasitic Ascomycota on arthropods. Over 2100 species in 140 genera are described, but many more species await discovery (Weir & Hammond, 1997; Haelewaters & Yaakop, 2014). Laboulbeniales differ from most other non-yeast Ascomycota in that they do not form hyphae but instead form discrete microscopic and multicellular thalli. Their

only form of reproduction is sexual, during which they generate sticky ascospores that are usually transmitted directly from infected to uninfected hosts during mating or other contact (De Kesel, 1996a). They are moderately to highly host specific; most species are associated with a particular host species (but see De Kesel & Haelewaters, 2014). It was experimentally shown that this specificity is driven by several factors: the characteristics of the integument and living conditions of the arthropod host, as well as the nature and availability of nutrients in the habitat chosen by the host (De Kesel, 1996b). Study of these fungi also needs some expertise in entomology. Correct identification of a host often facilitates identification of its associated fungi, but since fortuitous infections of hosts occur, it is best to identify these fungi based on their morphology or DNA sequence comparisons. Host-parasite lists are available for some countries (Scheloske, 1969; Huldén, 1983; Majewski, 1994; De Kesel, 1998; Santamaria, 1998, 2003) and regions (Santamaria *et al.*, 1991). Useful advice about general methodology and identification of Laboulbeniales can be found in Thaxter (1896), Scheloske (1969), Benjamin (1971), Majewski (1994) and Santamaria (1998).

It was only recently that the order Laboulbeniales was recognized as a well-supported lineage in Ascomycota, as the class Laboulbeniomycetes that includes both Laboulbeniales and Pyxidiophorales (Weir & Blackwell, 2001a). This phylogenetic determination was based on four (partial) SSU ribosomal DNA (rDNA) sequences (*Pyxidiophora* sp.1, *Stigmatomyces limnophorae*, *Hesperomyces coccinelloides* and *Zodiomyces vorticellarius*). Weir & Blackwell's (2001a) phylogeny suggested a close relationship with Sordariomycetes. High bootstrap support for this hypothesis was later achieved by Schoch *et al.* (2009) based on a six-gene phylogeny. The order Laboulbeniales was represented in that dataset by only SSU and LSU sequences for two species (*Hesperomyces virescens* and *Stigmatomyces protrudens*).

Molecular studies of Laboulbeniales have proven difficult for several reasons. The thalli are microscopic, on average 200-300  $\mu\text{m}$  in length. Among the smallest species known are *Rickia euxesti* (total length 40–68  $\mu\text{m}$ ), *R. lenoirii* (45– 67  $\mu\text{m}$ ) and *Siemaszkoa annae* (47–54  $\mu\text{m}$ ) (Thaxter, 1896, 1926; Majewski, 1994; Santamaría & Espadaler, 2015). At the other end of the size spectrum are *Zodiomyces vorticellarius* (to 2.75 mm) and *Laboulbenia kunkelii* (2–4 mm) (Giard, 1892; Sugiyama & Phanichapol, 1984; Rossi *et al.*, 2016). For study and extraction of DNA, thalli need to be removed from their host, which requires micro-manipulation techniques and specific tools. Hosts may bear only a few thalli but certain hosts carry multiple, often position-specific species, e.g., *Chitonomyces* spp. (De Kesel & Haelewaters, 2012; Goldmann & Weir, 2012) and *Hesperomyces coleomegillae* and *H. palustris* (Goldmann *et al.*, 2013). Many species are heavily pigmented with melanin in their cell walls, providing rigidity (Weir & Beakes, 1996). This pigment interferes with PCR amplification by binding to the DNA polymerase (Eckhart *et al.*, 2000). Thalli are relatively long-lasting and their form is such that they absorb impacts and friction during their entire existence on the hosts' integument. These tough and resilient cells are difficult to break. Because Laboulbeniales have not been grown in culture to more than a few cells, obtaining DNA from cultured material has been impossible. Only Whisler (1968) was partly successful in this with *Stigmatomyces ceratophorus*, obtaining 20-celled thalli onto sterile fly wings on brain-heart infusion agar, but perithecia were not produced.

Laboulbeniales are a remarkable clade for their: (1) obligate biotrophy; (2) strictly determinate growth, with development from a two-celled ascospore to a thallus of up to several thousand cells; (3) bilateral symmetry; and (4) loss of germ tubes, hyphae and conidia. Despite these special features, the order and the class were not included in studies dealing with “major

lineages in Ascomycota” (Prieto & Wedin, 2013) or the subphylum Pezizomycotina, to which they belong (Spatafora *et al.*, 2006).

Extraction of DNA using a variety of methods and protocols have given poor results or failed. These include prolonged boiling of thalli (Henson, 1992), microwave treatment (Goodwin & Lee, 1993), immersion in liquid nitrogen (Haugland *et al.*, 1999) and direct addition of entire thalli to PCR master mix (Haelewaters, 2011). Also, the use of commercial kits (Puregene Kit A, DNeasy Plant Mini Kit, Qiagen; Haelewaters, 2011) has so far proven unsuccessful.

The first successful published extraction protocol involved transferring thalli to double distilled (dd) H<sub>2</sub>O, air drying and manually crushing thalli between microscope slides (Weir & Blackwell, 2001a). The success rate for this protocol was 25%. Weir & Blackwell (2001b) developed an improved technique in which thalli were manually crushed on a microscope slide and picked up with a micropipette facilitated by the use of a bed of dry ice, a modification from previous endeavors based on Conger & Fairchild (1953) and Lee & Taylor (1990). The technique from Weir & Blackwell (2001b) was successful only when hosts were preserved in 95% ethanol for not more than six months. Thalli taken from dried insect specimens have not been available for molecular phylogenetic analyses because extractions have been unsuccessful with this type of material (Weir & Blackwell, 2001b). This technical difficulty limits both the taxonomical and geographical diversity of species that can be included in phylogenetic studies (e.g., Thaxter, 1899, 1900, 1901a, 1901b, 1902, 1905; Weir & Hammond, 1997; Haelewaters *et al.*, 2014, 2015a, 2015b).

Owing to the difficulties in DNA isolation and amplification of phylogenetically informative genes, the molecular phylogenetic relationships within this group have been understudied. Weir & Hughes (2002) constructed a partial SSU rDNA phylogeny of ten species

of Laboulbeniales, representing three subfamilies (Ceratomycetoideae, Laboulbenioideae, Peyritschelloideae). A combined dataset of the partial SSU and ITS rDNA regions was used to study the phenomenon of position specificity in 13 species of *Chitonomyces* on *Laccophilus maculosus* (Coleoptera: Dytiscidae; Goldmann & Weir, 2012). Goldmann *et al.* (2013) described two position specific species of *Hesperomyces* on *Coleomegilla maculata* (Coleoptera: Coccinellidae), again based on partial SSU+ITS rDNA. All these studies used the extraction methodology of Weir & Blackwell (2001b). We tested more generalized techniques that could be adapted to sample the thalli of Laboulbeniales.

## MATERIAL AND METHODS

*Collection of Laboulbeniales.* — Insects were collected around the world by ourselves or collaborators using standard entomological methods (sticky traps, light trap, entomological net and hand collecting) or obtained from the pet store (*Shelfordella lateralis*). Insects were killed in 70-100% ethanol, ethyl acetate vapors, or simply by freezing. Screening for Laboulbeniales was done using a dissecting microscope at 50×.

*Morphological studies.* — Individual thalli were removed from the host using an entomological pin (self-made, sometimes flattened) or the tip of a scalpel. Slide mounts followed techniques for permanent microscope slides (Benjamin, 1971; Haelewaters *et al.*, 2015b). Identification of Laboulbeniales followed Thaxter (1908, 1931), Majewski (1994) and De Kesel (2011). Voucher slides are deposited at BP (Botanical Department, Hungarian Natural History Museum), FH (Farlow Herbarium, Harvard University) and WA (Faculty of Biology, University of Warsaw).

*DNA extraction protocols.* — Between one and thirty thalli were removed from each host specimen. In this study we wanted to test the efficacy of different commercial and noncommercial DNA extraction protocols. The following were used: (1) QIAamp DNA Micro Kit (Qiagen, Stanford, California); (2) Extract-N-Amp Plant PCR Kit (Sigma-Aldrich, St. Louis, Missouri); (3) a heat-extraction protocol; and (4) ISOLATE II Plant DNA Kit (Bioline Reagents Limited, London).

(1) *QIAamp DNA Micro Kit*: DNA was isolated from two to sixteen thalli for each extraction, following the manufacturer's instructions. Some extracts received pre-treatment with liquid nitrogen or two cycles of heating to 95 °C and freezing on liquid nitrogen.

(2) *Modified Extract-N-Amp Plant PCR Kit*: The manufacturer's instructions were followed but with 20 µL of Extraction Solution (EX) and 60 µL of Dilution Solution. One to 20 thalli were removed from the host with the help of a tiny drop of Hoyer's medium (30 g arabic gum, 200 g chloral hydrate, 16 mL glycerol, 50 mL ddH<sub>2</sub>O) or glycerine at the very end of a micropipette and then added to EX-filled 0.5 µL tubes. When hosts were preserved in dried collections, 16-30 thalli were used. Again, the pre-treatment described above was applied for some extracts.

(3) *Heat-extraction protocol*: This method was adapted from a protocol for single-spore extractions and subsequent PCR reactions (Ferreira & Glass, 1996; based on Goodwin & Lee, 1993). Thalli were removed from the host (3 thalli of *Hesperomyces virescens*, 20–30 thalli of *Rickia wasmannii*) or a ~5 mm portion of a heavily infected *Shelfordella lateralis* antenna with *Herpomycetes* sp. nov. thalli was removed, placed in 0.5 mL PCR tubes and microwave-treated (750 W for 5 min). Then 50 µL ddH<sub>2</sub>O was added to the individual tubes and the thalli (or antennal parts) were manually crushed using a sterile pipette tip under a dissecting microscope.

Some loss of material did occur by capillary effect, but it was minimal. The PCR tubes were incubated at -20 °C for 10 min. Strong pressure was applied to the ice inside the PCR tubes to further break apart thalli using a sterile pipette tip.

(4) *ISOLATE II Plant DNA Kit*: Up to twenty thalli were removed and transferred to 1.5 mL Eppendorf tubes with 20–50 µL 95% ethanol. Alternatively, in the case of *Herpomyces ectobiae* on *Blattella germanica*, a piece of an antenna was isolated and transferred altogether. The 1.5 mL tubes were vacuum-dried at room temperature. Thalli were subsequently crushed in liquid nitrogen, using a sterile pipette with melted-closed tip. CTAB-based isolation buffer (PA1, *ISOLATE II Plant DNA Kit*) was added to the tubes and incubation took place in liquid nitrogen for 3 min, followed by incubation in a heat block set at 65–90 °C for 3 min. This cycle of freezing/heating was repeated twice. Further steps were performed following the *ISOLATE II Plant DNA Kit* manufacturer's protocol.

*PCR amplification and DNA sequencing.* — Three gene loci were amplified: partial rDNA SSU (*ca* 1100 bp), rDNA ITS (including ITS1, 5.8S and ITS2; *ca* 500 bp) and partial rDNA LSU (*ca* 1300 bp). PCR amplification was performed using both previously published and newly designed primers (Table 1-1). Laboulbeniales-specific primers were designed for the SSU region based on existing sequences in GenBank. PCR reactions were performed according to the protocols listed in the respective reference for mentioned primers, or, in the case of the Extract-N-Amp Plant PCR Kit, according to the suggested protocol in the manufacturer's instructions. When PCR reactions did not produce clear bands on agarose gel, conditions were optimized to include a two-step (60 °C, 55 °C) "touch-down" annealing phase (Sohrabi *et al.*, 2010). In some cases, a semi-nested "touch-down" PCR was performed, using the product of the first,



**Table 1-1.** List of primers used for PCR amplification of small subunit (SSU), internal transcribed spacer (ITS) and large subunit (LSU) rDNA.

Locus	Primer name	Direction	Sequence	Reference
SSU rDNA	NS1	forward	GTA GTC ATA TGC TTG TCT C	White <i>et al.</i> , (1990)
SSU rDNA	NS2	reverse	GGC TGC TGG CAC CAG ACT TGC	White <i>et al.</i> (1990)
SSU rDNA	NS4	reverse	CTT CCG TCA ATT CCT TTA AG	White <i>et al.</i> (1990)
SSU rDNA	SL344	forward	GGT CGC AAG GCT GAA ACT TA	Landvik <i>et al.</i> (1997)
SSU rDNA	NS6	reverse	GCA TCA CAG ACC TGT TAT TGC CTC	White <i>et al.</i> (1990)
SSU rDNA	SL122	forward	AGG CGC GCA AAT TAC CCA AT	Landvik <i>et al.</i> (1997)
SSU rDNA	SR4	reverse	AAA CCA ACA AAA TAG AA	R. Vilgalys (unpubl.)
SSU rDNA	NSL1	forward	GTA GTG TCC TCr CAT GCT TTT GAC	Present study
SSU rDNA	NSL2	reverse	AAT Cya AGA ATT TCA CCT CTG AC	Present study
SSU rDNA	L	forward	AAC CTG GTT GAT CCT GCC AGT	Wrzosek (2000)
SSU rDNA	402	forward	GCT ACC ACA TCC AAG GAA GGC A	Wrzosek (2000)
SSU rDNA	416	reverse	ATT TGC GCG CCT GCT GCC TTC C	Wrzosek (2000)
SSU rDNA	895	forward	GTC AGA GGT GAA ATT CTT GGA T	Wrzosek (2000)
SSU rDNA	898	reverse	TAA ATC CAA GAA TTT CAC CTC T	Wrzosek (2000)
SSU rDNA	1144	forward	GCC TGC GGC TTA ATT TGA CTC AAC A	Wrzosek (2000)
SSU rDNA	1308	reverse	CTC GTT CGT TAA CCG AAT TAA CC	Wrzosek (2000)
SSU rDNA	R	reverse	TGA TCC TTC TGC AGG TTC ACC TAC G	Wrzosek (2000)
ITS rDNA	ITS1f	forward	CTT GGT CAT TTA GAG GAA GTA A	Gardes & Bruns (1993)
ITS rDNA	ITS4	reverse	TCC TCC GCT TAT TGA TAT GC	White <i>et al.</i> (1990)
ITS rDNA	ITS4_kyo1	reverse	TCC TCC GCT TWT TGW TWT GC	Toju <i>et al.</i> (2012)
ITS rDNA	ITS5	forward	GGA AGT AAA AGT CGT AAC AAG G	White <i>et al.</i> (1990)
ITS rDNA	ITS2	reverse	GCT GCG TTC TTC ATCG ATG C	White <i>et al.</i> (1990)
LSU rDNA	LR0R	forward	ACC CGC TGA ACT TAA GC	R. Vilgalys (unpubl.)
LSU rDNA	LR1R	forward	AGG AAA AGA AAC CAA CC	Moncalvo <i>et al.</i> (1993)

**Table 1-1.** (Continued).

Locus	Primer name	Direction	Sequence	Reference
LSU rDNA	LIC24R	forward	GAA ACC AAC AGG GAT TG	Miadlikowska & Lutzoni (2000)
LSU rDNA	LR3	reverse	GGT CCG TGT TTC AAG AC	Vilgalys & Hester (1990)
LSU rDNA	LR5	reverse	ATC CTG AGG GAA ACT TC	Vilgalys & Hester (1990)
LSU rDNA	LR7	reverse	TAC TAC CAC CAA GAT CT	Vilgalys & Hester (1990)

unsuccessful PCR reaction (e.g., PCR 1 using primers LR0R and LR5, semi-nested PCR using the product of PCR 1 with primers LR0R and LR3).

Products that showed clear bands on agarose gel were cleaned with Qiaquick PCR Purification Kit (Qiagen) or ExtractMe DNA Gel-out Kit (Blirt S.A., Gdańsk, Poland) and subsequently sequenced. We prepared 10 µL sequencing reactions containing the same primers and 1 µL of purified PCR product. The sequencing reactions were performed using the Big Dye® Terminator v3.1 Cycle Sequencing Kit (Life Technologies, Carlsbad, California).

Sequences were trimmed, edited and assembled in Sequencher v. 4.10.1 (Gene Codes Corporation, Ann Arbor, Michigan). We performed Nucleotide BLAST searches on all of our sequences at [ncbi.nlm.nih.gov/blast/Blast.cgi](http://ncbi.nlm.nih.gov/blast/Blast.cgi) for similar sequences. For genera not yet represented in GenBank we compared sequences with our personal database, which is accessible at the Harvard University Herbaria internal server.

## RESULTS

Our study shows that some simple, general DNA extraction protocols work. The commercial kits we tested are widely available.

Table 1-2 shows the success rates of the individual protocols, per genus extracted. Extractions using the QIAamp DNA Micro Kit yielded the lowest rates of success among the tested protocols, with seemingly no effect of pre-treatment. The overall success was 22% (n=27 extractions total), for *Hesperomyces virescens* extractions the success rate was 35% (n=17). Overall success of the Extract-N-Amp Plant PCR Kit was 64% (n=66), with 92% success for *Herpomyces* spp. (n=13) and 66% for *H. virescens* (n=35). For the third, heat-extraction protocol the success rate was 83% for *Herpomyces ectobiae* (n=6) and 100% for *H. virescens* (n=3). The

**Table 1-2.** Success rates per DNA extraction protocol used in this study, for all tested genera. Laboulbenales from dried host insects were only extracted using the Extract-N-Amp Plant PCR Kit.

Genus	QIAamp DNA Micro Kit			Extract-N-Amp Plant PCR Kit		
	# extractions	# success	% success	# extractions	# success	% success
<i>Aphanandromyces</i>						
<i>Chitonomyces</i>	4	0	0%			
<i>Gloeandromyces</i>				1	1	100%
<i>Haplomyces</i>	2	0	0%	2	0	0%
<i>Herpomyces</i>				13	12	92%
<i>Hesperomyces</i>	17	6	35%	35	23	66%
<i>Laboulbenia</i>	4	0	0%	5	1	20%
<i>Monoicomycetes</i>						
<i>Polyandromyces</i>				2	2	100%
<i>Rhachomyces</i>						
<i>Rickia</i>						
<i>Zodiomyces</i>						
<i>Herpomyces</i> (dried)				2	0	0%
<i>Hesperomyces</i> (dried)				5	3	60%
<i>Rodaucea</i> (dried)				1	0	0%

**Table 1-2.** (Continued).

Genus	Heat-extraction protocol			ISOLATE II Plant DNA Kit		
	# extractions	# success	% success	# extractions	# success	% success
<i>Aphanandromyces</i>				1	0	0%
<i>Chitonomyces</i>						
<i>Gloeandromyces</i>						
<i>Haplomyces</i>						
<i>Herpomyces</i>	6	5	83%	5	5	100%
<i>Hesperomyces</i>	3	3	100%	7	6	86%
<i>Laboulbenia</i>				10	1	10%
<i>Monoicoomyces</i>				6	4	67%
<i>Polyandromyces</i>						
<i>Rhachomyces</i>				2	1	50%
<i>Rickia</i>	11	5	45%			
<i>Zodiomyces</i>				3	3	100%

ISOLATE II Plant DNA Kit gave an overall success rate of 59% (n=34), with a 100% success rate for *H. ectobiae* (n=5) and 86% for *H. virescens* (n=7). Interestingly, extracting DNA of *Laboulbenia* species was only successful 20% of the time with the Extract-N-Am Plant PCR Kit and 10% with the ISOLATE II Plant DNA Kit. Four extraction attempts of *Laboulbenia* species with the QIAamp DNA Micro Kit were unsuccessful.

We generated 43 sequences (SSU, ITS and/or LSU rDNA) for 18 isolates of the following species: *Gloeandromyces* sp., *Herpomyces chaetophilus*, *H. ectobiae*, *H. periplanetae*, *Herpomyces* sp. nov., *Hesperomyces virescens*, *Laboulbenia diopsidis*, *Monoicomycetes invisibilis*, *Polyandromyces coptosomalis*, *Rhachomyces philonthinus*, *Rickia wasmannii* and *Zodiomyces vorticellarius* (Table 1-3). *Rhachomyces philonthinus* was removed from a specimen of *Philonthinus* that had been collected by Tomasz Majewski in August 2004. The host specimen was preserved for 11 years in 70% ethanol.

We were able to extract DNA from thalli of *Hesperomyces virescens* from dried insect specimens (with the Extract-N-Amp Plant PCR Kit); on *Cycloneda sanguinea sanguinea* from Guatemala collected in May 2013 and on *Harmonia axyridis* from Massachusetts collected in August 2006 (details in Haelewaters *et al.* 2015b). Extractions were performed of *H. paranensis* on a dried *Archimandrita tessellata* (Blattodea, Blaberidae) collected in 2001 and from *Rodaucea* sp. on a dried Cholevinae sp. (Coleoptera, Leiodidae) collected in 1991 but no bands were noted on agarose gel after PCR.

## DISCUSSION

*Micromanipulation practices.* — Laboulbeniales are more problematic to work with than many other groups of fungi. One of the main difficulties is their small size, which requires sterile

**Table 1-3.** Detailed collecting data, method of preservation, number of thalli used in extraction, DNA extraction protocol and GenBank accession numbers for SSU, ITS and LSU rDNA sequences of 18 isolates. Extraction protocol (1) = QIAamp DNA Micro Kit, (2) = Extract-N-Amp Plant PCR Kit, (3) = Heat-extraction and (4) = ISOLATE II Plant DNA Kit.

Species	Isolate	Collecting data			
		Host	Country	Date	Preservation
<i>Gloeandromyces</i> sp.	D. Haelew. 619a	Streblidae sp.	Trinidad	2014	95% EtOH
<i>Herpomyces chaetophilus</i>	D. Haelew. 602b	<i>Periplaneta americana</i>	USA	2014	95% EtOH
<i>Herpomyces ectobiae</i>	MG001	<i>Blattella germanica</i>	Poland	2015	95% EtOH
<i>Herpomyces periplanetae</i>	D. Haelew. 602c	<i>Periplaneta americana</i>	USA	2014	95% EtOH
<i>Herpomyces</i> sp. nov.	DE_HerpBL1	<i>Shelfordella lateralis</i>	Hungary	2014	80% EtOH
<i>Hesperomyces virescens</i>	D. Haelew. 167e	<i>Cycloneda sanguinea sanguinea</i>	Guatemala	2013	Dried
<i>Hesperomyces virescens</i>	JP353a	<i>Olla v-nigrum</i>	USA	2014	95% EtOH
<i>Hesperomyces virescens</i>	D. Haelew. 486c	<i>Harmonia axyridis</i>	USA	2006	Dried
<i>Hesperomyces virescens</i>	D. Haelew. 646c	<i>Harmonia axyridis</i>	Germany	2013	95% EtOH
<i>Hesperomyces virescens</i>	HM497c	<i>Harmonia axyridis</i>	USA	2014	95% EtOH
<i>Hesperomyces virescens</i>	DE_HV01	<i>Harmonia axyridis</i>	Hungary	2014	80% EtOH
<i>Hesperomyces virescens</i>	MT001	<i>Harmonia axyridis</i>	Poland	2015	95% EtOH
<i>Laboulbenia diopsidis</i>	D. Haelew. 468a	<i>Diopsidae</i> sp.	Sierra Leone	2013	100% EtOH
<i>Monoicomyces invisibilis</i>	MT004	<i>Anotylus sculturatus</i>	Poland	2015	95% EtOH
<i>Polyandromyces coptosomalis</i>	D. Haelew. 313f	<i>Phoecacia</i> sp. nov.	Ecuador	2009	95% EtOH
<i>Rhachomyces philonthinus</i>	TM10446	<i>Philonthus</i> sp.	Poland	2004	70% EtOH
<i>Rickia wasmannii</i>	DE_Rak4	<i>Myrmica scabrinodis</i>	Hungary	2014	80% EtOH
<i>Zodiomyces vorticellarius</i>	MG003	<i>Helochares obscurus</i>	Poland	2015	95% EtOH

**Table 1-3.** (Continued).

Species	Extractions		Sequences			
	Number of thalli used	Protocol used	SSU	ITS	LSU	
<i>Gloeandromyces</i> sp.	12 thalli	(2) with glycerine			KT800008	
<i>Herpomyces chaetophilus</i>	10 female thalli	(2) with glycerine	KT800023	KT800039	KT800009	
<i>Herpomyces ectobiae</i>	± 20 adult thalli on antenna	(4) without freeze/thaw	KT800024	KT800040		
<i>Herpomyces periplanetae</i>	11 female thalli	(2) with glycerine	KT800025	KT800041	KT800010	
<i>Herpomyces</i> sp. nov.	± 30 adult thalli on antenna	(3)	KT800026	KT800042	KT800011	
<i>Hesperomyces virescens</i>	18 adult thalli	(2)	KT800027		KT800012	
<i>Hesperomyces virescens</i>	10 adult thalli	(1)	KT800028	KT800043	KT800013	
<i>Hesperomyces virescens</i>	16 adult thalli	(2) with glycerine	KT800029	KT800044	KT800014	
<i>Hesperomyces virescens</i>	2 adult thalli	(2)		KT800045	KT800015	
<i>Hesperomyces virescens</i>	15 adult thalli	(2) (with Hoyer's)	KT800030	KT800046	KT800016	
<i>Hesperomyces virescens</i>	9 adult thalli	(3)	KT800031	KT800047	KT800017	
<i>Hesperomyces virescens</i>	1 adult thallus	(4)	KT800032	KT800048	KT800018	
<i>Laboulbenia diopsidis</i>	12 adult thalli	(2)	KT800033	KT800049	KT800019	
<i>Monoicomycetes invisibilis</i>	1 adult thallus	(4)	KT800034			
<i>Polyandromyces coptosomalis</i>	7 female and 2 male thalli	(2)	KT800035		KT800020	
<i>Rhachomyces philonthinus</i>	± 15 adult thalli	(4)	KT800036			
<i>Rickia wasmannii</i>	30 adult thalli	(3)	KT800037	KT800050	KT800021	
<i>Zodiomyces vorticellarius</i>	1 adult thallus	(4)	KT800038		KT800022	



micromanipulation with precise micropip handling.

It is preferable to separate thalli from the host's body, but minute thalli of *Rickia*, *Herpomyces* or *Siemaszkoa* are hard to detach. Using whole infected body parts in an extraction makes the procedure faster and easier. Most of the primers used in this study do not amplify the host insect's DNA, However, amplification of insect DNA by some primers may happen (as with LR0R/LR7 and the sets of SSU primers used in Wrzosek, 2000). Prominent appendages, such as those in many species of *Laboulbenia* or *Rhachomyces*, pose another difficulty; debris is often observed to stick to the appendages and is very hard to impossible to wash away. In this case contamination with fungal propagules may be inevitable. Laboulbeniales-specific primers will serve to reduce the chance of amplifying non-target DNA. Another option is to simply excise the appendage system prior to extraction.

*Preservation techniques.* — One of the most important concerns regarding successful molecular research is the method employed for preservation of material. The most effective option for extraction of Laboulbeniales DNA involves using freshly collected material preferably stored in  $\geq 95\%$  ethanol. These two factors certainly contribute to most of our DNA isolation positive results. Storage in  $\geq 95\%$  ethanol generally provides good DNA preservation for a prolonged period of time. Our DNA extraction protocols enabled us to amplify DNA and generate sequences from Laboulbeniales material that was on average 1–2 years old (one specimen was 11 years old), which is a novel development. Conditions that consistently yielded good results included: freshly collected specimens of larger species of Laboulbeniales, which provide ample DNA concentration even from a single thallus (e.g., *Zodiomyces vorticellarius*) and mature ascospore-containing thalli, which provide a higher concentration of DNA compared to

immature or old thalli (always without ascospores). Many entomological practices involve preservation methods that interfere with successful DNA extraction of either the host or its associated fungi: most insect specimens are pinned in museum collections or preserved on 70% ethanol.

For morphological study of Laboulbeniales, researchers are able to make use of the many excellent systematic insect collections in natural history museums around the world. Such collections of dried pinned insects give relatively easy access to data (e.g., Weir & Hammond, 1997; Haelewaters *et al.*, 2014). However, to date, extracting DNA from dried specimens has resulted in a 100% failure rate (Weir & Blackwell, 2001b). We present sequences obtained from two collections of *H. virescens* from dried ladybirds (D. Haelew. 167e and 486c) collected in 2013 and 2006, respectively. Often thalli acquired from dried hosts are in poor condition and both identification based on morphological characters and DNA extraction may be a challenge.

Many insects in entomological collections are preserved in 70% ethanol. This decreases the DNA quality of the insect and its associates – especially after an extended period of storage (e.g., A'Hara *et al.*, 1998). Some studies have generated short segments of mitochondrial DNA (< 300 bp) from material in 70% ethanol (e.g., Colgan *et al.*, 2002). For phylogenetic studies, however, longer segments are needed, and these need to be acquired from non-degraded DNA. Non-degraded DNA is also required for PCR amplification of low copy-number nuclear genes commonly used in modern fungal phylogenies (e.g., Hibbett *et al.*, 2007; Hansen, *et al.*, 2013; Wang *et al.*, 2014). If 70% ethanol was used to preserve insect hosts, it comes as no surprise that the DNA of Laboulbeniales harvested from them is adversely affected. When working with Laboulbeniales from dried collections, another challenge is that information about the habitat or methods of collection and preservation is typically sparse. The extraction of DNA from insects

can be drastically affected by using certain media (such as killing agents in pitfall traps) that degrade DNA. Some commonly used materials such as ethylene glycol or formalin have been linked to considerable DNA degradation (e.g., Dillon *et al.*, 1996; Stoeckle *et al.*, 2010).

*Negative results.* — Our negative results can be explained based on protocols employed and/or the nature of the fungi that were under investigation. The 100% failure rate of the QIAamp DNA Micro Kit for *Chitonomyces*, *Haplomyces* and *Laboulbenia* is largely due to the fact that no pre-treatments were carried out for these extracts. However, for one *Laboulbenia* extraction using this protocol a pre-treatment was done involving two cycles of heating to 95 °C and freezing on liquid nitrogen. Then why was this extraction unsuccessful? *Laboulbenia* species are generally heavily melanized and this melanin pigment seems to hinder PCR amplification reactions (Eckhart *et al.*, 2000). Also in the Extract-N-Amp Plant PCR Kit and the ISOLATE II Plant DNA Kit the success of extracting DNA and subsequent PCR amplification of *Laboulbenia* species is considerably lower compared to other genera. This observation shows that variables other than isolation techniques, such as the presence of pigments, are important to the success of DNA extraction and amplification. The 0% success rate of *Haplomyces* using both the QIAamp DNA Micro Kit and the Extract-N-Amp Plant PCR Kit probably is due to the combination of two factors: (1) the extract received no pre-treatment; and (2) host insects were collected and preserved (for four to five years) in 70 % ethanol. The relatively low success rate with *Rickia*, with the heat-extraction protocol, may be explained by the fact that these small but very rigid thalli are difficult to break during the treatments that were applied; visual inspection after performing the entire protocol shows many intact thalli. Thus, the amount of DNA available for

the *Taq* polymerase during PCR was limited, despite the high number of thalli (20–30) per reaction.

We can only hint at the low success rate of extractions from dried material. The extraction of *Rodaucea* sp. received no pre-treatment and the thalli were removed from a cholevine specimen collected in 1991. It might have been too old for successful DNA extraction. The same may be true for the unsuccessful attempts to extract DNA of *Herpomyces paranensis* from a pinned specimen of *Archimandrita tessallata* from 2001.

## CONCLUSIONS

Even with fresh thalli available, successful extraction of DNA has been one of the greatest obstacles in applying molecular methods to research on Laboulbeniales. Their minute size, the difficulty in fracturing thalli to release DNA and the fact that (to date) they remain resistant to isolation into culture makes molecular protocols applied to Laboulbeniales difficult. This is the reason “laboulbeniologists” need: (1) colleagues (entomologists) or museums to provide high-quality, properly prepared samples; and (2) DNA isolation protocols that focus heavily on deep homogenization of the material. Microwave heating, submersion in liquid nitrogen, freeze/thaw cycles and simple yet effective crushing with pipette tips are all means of destroying the tough cell walls without damaging the DNA.

As stated in previous studies, both the SSU and ITS portions of rDNA are suited for molecular phylogenetics of the Laboulbeniales and universal fungal primers for these regions work well for most of the species (Weir & Blackwell, 2001b; Goldmann & Weir, 2012; Weir & Hughes, 2002; Goldmann *et al.*, 2013). We have found that LSU sequences are also easily to obtain. Designing specific primers often facilitates the work. Well-designed primers specific for

Laboulbeniales may perform better and their specificity helps to avoid contamination. As the number of genes being used in fungal phylogenetic studies increases it will be important that these new genes/regions/markers be explored in the Laboulbeniales as well.

We hope that sharing our experience with various techniques for extraction and PCR amplification of Laboulbeniales DNA will have a positive effect on present and future molecular biology research of Laboulbeniomycetes – the only class among the Ascomycota without a reliable multi-gene phylogeny.

#### ACKNOWLEDGEMENTS

D.H. acknowledges funding from the Harvard University Graduate School of Arts and Sciences, the American Museum of Natural History (Theodore Roosevelt Memorial Grant) and the National Park Service. A.T. was supported by the 'AntLab' Marie Curie Career Integration Grant within the 7th European Community Framework Programme and by a 'Bolyai János' scholarship of the Hungarian Academy of Sciences (MTA). This manuscript would not have come together without the various contributions of the following researchers, collaborators and friends. For collecting and/or identifying host specimens used in this study: Elizabeth Brooks Thompson, Jasmin C. Camacho, André De Kesel, Dimitri Forero, Thereza de A. Garbelotto, Louis S. Hesler, Heidi Hopkins, Walter Rossi, Jessica J. Rykken, Tristan W. Wang and Richard S. Zack. For confirming Laboulbeniales identifications: Tomasz Majewski. For advice and helpful discussions: Rosanne A. Healy, Katherine F. LoBuglio and Feng Xu. For assisting in the molecular lab: Harvard undergraduates Hamidah Mahmud, Julie Park and Tristan W. Wang. For general support: André De Kesel, István Pócsi, Matthias Sipiczki and Tomasz Majewski. For

reviewing an earlier draft of the manuscript: André De Kesel, Tomasz Majewski and Walter Rossi.

#### LITERATURE CITED

- A'Hara S, Harling R, McKinlay RG, Topping CJ (1998) RAPD profiling of spider (Araneae) DNA. *Journal of Arachnology* **26**: 397–400.
- Benjamin RK (1971) Introduction and supplement to Roland Thaxter's contribution towards a monograph of the Laboulbeniaceae. *Bibliotheca Mycologica* **30**: 1–155.
- Colgan DJ, Brown S, Major RE, Christie F, Gray MR, Cassis G (2002) Population genetics of wolf spiders of fragmented habitat in the wheat belt of New South Wales. *Molecular Ecology* **11**: 2295–2305.
- Conger AD, Fairchild LM (1953) A quick-freeze method for making smear slides permanent. *Stain Technology* **28**: 281–283.
- De Kesel A (1996a) Relative importance of direct and indirect infection in the transmission of *Laboulbenia slackensis* (Ascomycetes, Laboulbeniales). *Belgian Journal of Botany* **128**: 124–130.
- De Kesel A (1996b) Host specificity and habitat preference of *Laboulbenia slackensis*. *Mycologia* **88**: 565–573.
- De Kesel A (1998) Identification and host-range of the genus *Laboulbenia* in Belgium. *Sterbeekia* **18**: 13–31.
- De Kesel A (2011) *Hesperomyces* (Laboulbeniales) and coccinellid hosts. *Sterbeekia* **30**: 32–37.
- De Kesel A, Haelewaters D (2012) Belgian records of Laboulbeniales from aquatic insects (2) – *Chitonomyces aculeifer*. *Sterbeekia* **31**: 16–18.
- De Kesel A, Haelewaters D (2014) *Laboulbenia slackensis* and *L. littoralis* sp. nov. (Ascomycota, Laboulbeniales), two sibling species as a result of ecological speciation. *Mycologia* **106**: 407–414.
- Dillon N, Austin AD, Bartowsky E (1996) Comparison of preservation techniques for DNA extraction from hymenopterous insects. *Insect Molecular Biology* **5**: 21–24.
- Eckhart L, Bach J, Ban J, Tschachler E (2000) Melanin binds reversibly to thermostable DNA polymerase and inhibits its activity. *Biochemical and Biophysical Research Communications* **271**: 726–730.

- Ferreira AVB, Glass NL (1996) PCR from fungal spores after microwave treatment. *Fungal Genetics Newsletter* **43**: 25–26.
- Gardes M, Bruns TD (1993) ITS Primers with enhanced specificity for Basidiomycetes – application to the identification of mycorrhizae and rusts. *Molecular Ecology* **2**: 113–118.
- Giard A (1892) Sur une Laboulbéniciacée (*Thaxteria künckeli* nov. gen. et sp.), parasite de *Mormolyce phyllodes* Hagenbach. *Comptes Rendus Hebdomadaires des Séances et Mémoires de la Société de Biologie* **4**: 156–158.
- Goldmann L, Weir A (2012) Position specificity in *Chitonomyces* (Ascomycota, Laboulbeniomyces) on *Laccophilus* (Coleoptera, Dytiscidae): a molecular approach resolves a century-old debate. *Mycologia* **104**: 1143–1158.
- Goldmann L, Weir A, Rossi W (2013) Molecular analysis reveals two new dimorphic species of *Hesperomyces* (Ascomycota, Laboulbeniomyces) parasitic on the ladybird *Coleomegilla maculata* (Coleoptera, Coccinellidae). *Fungal Biology* **117**: 807–813.
- Goodwin DC, Lee SB (1993) Microwave miniprep of total genomic DNA from fungi, plants, protists and animals for PCR. *BioTechniques* **15**: 438–441.
- Haelewaters D (2011) *Laboulbeniales: Exploring and testing DNA extraction protocols, carrion beetle hosts and species in 'De Kaaistoep' (Netherlands)*. Master's thesis. Ghent University, Belgium.
- Haelewaters D, Comont RF, Zhao SY, Pfister DH (2014) *Hesperomyces virescens* (Fungi, Ascomycota, Laboulbeniales) attacking *Harmonia axyridis* (Coleoptera, Coccinellidae) in its native range. *Chinese Science Bulletin* **59**: 528–532.
- Haelewaters D, De Kock G, van Wielink P (2015a) Nieuwe Laboulbeniales in De Kaaistoep. In: *Natuurstudie in De Kaaistoep. Verslag 2014, 20e onderzoeksjaar* (Peeters T, van Eck A, Cramer T, eds): 11–18. TWM Gronden BV, Natuurmuseum Brabant & KNNV-afdeling Tilburg, The Netherlands.
- Haelewaters D, Yaakop S (2014) New and interesting Laboulbeniales from southern and southeastern Asia. *Mycotaxon* **129**: 439–454.
- Haelewaters D, Zhao SY, De Kesel A, Handlin RE, Royer IR, Farrell BD, Pfister DH (2015b) Laboulbeniales (Ascomycota) of the Boston Harbor Islands I: species parasitizing Coccinellidae and Staphylinidae. *Northeastern Naturalist* **22**: 459–477.
- Hansen K, Perry BA, Dranginis AW, Pfister DH (2013) A phylogeny of the highly diverse cup-fungus family Pyronemataceae (Pezizomycetes, Ascomycota) clarifies relationships and evolution of selected life history traits. *Molecular Phylogenetics and Evolution* **67**: 311–335.
- Haugland RA, Heckman JL, Wymer LJ (1999) Evaluation of different methods for the extraction of DNA from fungal conidia by quantitative competitive PCR analysis. *Journal of Microbiological Methods* **37**: 165–176.

- Henson JM (1992) DNA hybridization and polymerase chain reaction (PCR) tests for identification of *Gaeumannomyces*, *Phialophora* and *Magnaporthe* isolates. *Mycological Research* **96**: 629–636.
- Hibbett DS, Binder M, Bischoff JF, Blackwell M, Cannon PF, Eriksson OE, Huhndorf S, James T, Kirk PM, Lücking R, Lumbsch HT, Lutzoni F, Matheny PB, McLaughlin DJ, Powell MJ, Redhead S, Schoch CL, Spatafora JW, Stalpers JA, Vilgalys R, Aime MC, Aptroot A, Bauer R, Begerow D, Benny GL, Castlebury LA, Crous PW, Dai Y-C, Gams W, Geiser DM, Griffith GW, Gueidan C, Hawksworth DL, Hestmark G, Hosaka K, Humber RA, Hyde KD, Ironside JE, Kõljalg U, Kurtzman CP, Larsson K-H, Lichtwardt R, Longcore J, Miadlikowska J, Miller A, Moncalvo J-M, Mozley-Standridge S, Oberwinkler F, Parmasto E, Reeb V, Rogers JD, Roux C, Ryvarden L, Sampaio JP, Schüßler A, Sugiyama J, Thorn RG, Tibell L, Untereiner WA, Walker C, Wang Z, Weir A, Weiss M, White MM, Winka K, Yao Y-J, Zhang N (2007) A higher-level phylogenetic classification of the Fungi. *Mycological Research* **3**: 509–547.
- Huldén L (1983) Laboulbeniales (Ascomycetes) of Finland and adjacent parts of the U.S.S.R. *Karstenia* **23**: 31–136.
- Landvik S, Egger KN, Schumacher T (1997) Towards a subordinal classification of the Pezizales. *Nordic Journal of Botany* **17**: 403–418.
- Lee SB, Taylor JM (1990) Isolation of total DNA from fungi for amplification by the polymerase chain reaction. In: *PCR protocols: a guide to methods and applications* (Innis MA, Gelfand DH, Sninsky JJ, White TJ, eds): 315–322. Academic Press, New York.
- Majewski T (1994) The Laboulbeniales of Poland. *Polish Botanical Studies* **7**: 1-466.
- Miadlikowska J, Lutzoni F (2000) Phylogenetic revision of the genus *Peltigera* (lichen-forming Ascomycota) based on morphological, chemical, and large subunit nuclear ribosomal DNA data. *International Journal of Plant Sciences* **161**: 925–958.
- Moncalvo J-M, Rehner SA, Vilgalys R (1993) Systematics of *Lyophyllum* section *Difformia* based on evidence from culture studies and ribosomal DNA sequences. *Mycologia* **85**: 788–794.
- Prieto M & Wedin M (2013) Dating the diversification of the major lineages of Ascomycota (Fungi). *PLoS One* **8**: e65576.
- Rossi W, Haelewaters D, Pfister DH (2016) Fireworks under the microscope: a spectacular new species of *Zodiomyces* from the Thaxter collection. *Mycologia* **108**: 709–715.
- Santamaria S (1998) Laboulbeniales, I. *Laboulbenia*. *Flora Mycologica Iberica* **4**: 1–186.
- Santamaria S (2003) Laboulbeniales, II. *Acompsomyces-Ilyomyces*. *Flora Mycologica Iberica* **5**: 1–344.



- Santamaria S, Balazuc J, Tavares II (1991) Distribution of the European Laboulbeniales (Fungi, Ascomycotina). Ann annotated list of species. *Treballs de l'Institut Botanic de Barcelona* **14**: 5–123.
- Santamaria S, Espadaler X (2015) *Rickia lenoirii*, a new ectoparasitic species, with comments on world Laboulbeniales associated with ants. *Mycoscience* **56**: 224–229.
- Scheloske H-W (1969) Beiträge zur Biologie, Ökologie und Systematik der Laboulbeniales (Ascomycetes) unter besondere Berücksichtigung des Parasit-Wirt-Verhältnisses. *Parasitologische Schriftenreihe* **19**: 1–176.
- Schoch CL, Sung GH, López-Giráldez F, Townsend JP, Miadlikowska J, Hofstetter V, Robbertse B, Matheny PB, Kauff F, Wang Z, Gueidan C, Andrie RM, Trippe K, Ciufetti LM, Wynns A, Fraker E, Hodkinson BP, Bonito G, Groenewald JZ, Arzanlou M, de Hoog GS, Crous PW, Hewitt D, Pfister DH, Peterson K, Gryzenhout M, Wingfield MJ, Aptroot A, Suh SO, Blackwell M, Hillis DM, Griffith GW, Castlebury LA, Rossman AY, Lumbsch HT, Lücking R, Büdel B, Rauhut A, Diederich P, Ertz D, Geiser DM, Hosaka K, Inderbitzin P, Kohlmeyer J, Volkmann-Kohlmeyer B, Mostert L, O'Donnell K, Sipman H, Rogers JD, Shoemaker RA, Sugiyama J, Summerbell RC, Untereiner W, Johnston PR, Stenroos S, Zuccaro A, Dyer PS, Crittenden PD, Cole MS, Hansen K, Trappe JM, Yahr R, Lutzoni F, Spatafora JW (2009) The Ascomycota tree of life: A phylum-wide phylogeny clarifies the origin and evolution of fundamental reproductive and ecological traits. *Systematic Biology* **58**: 224–239.
- Sohrabi M, Myllys L, Stenroos S (2010) Successful DNA sequencing of a 75 year-old herbarium specimen of *Aspicilia aschabadensis* (J. Steiner) Mereschk. *Lichenologist* **42**: 626–628.
- Spatafora JW, Sung GH, Johnson D, Hesse C, O'Rourke B, Serdani M, Spotts R, Lutzoni F, Hofstetter V, Miadlikowska J, Reeb V, Gueidan C, Fraker E, Lumbsch T, Lücking R, Schmitt I, Hosaka K, Aptroot A, Roux C, Miller AN, Geiser DM, Hafellner J, Hestmark G, Arnold AE, Büdel B, Rauhut A, Hewitt D, Untereiner WA, Cole MS, Scheidegger C, Schultz M, Sipman H, Schoch CL (2006) A five-gene phylogeny of Pezizomycotina. *Mycologia* **98**: 1018–1028.
- Stoeckle BC, Dworschak K, Gossner MM, Kuehn R (2010) Influence of arthropod sampling solutions on insect genotyping reliability. *Entomologia Experimentalis et Applicata* **135**: 217–223.1
- Sugiyama K, Phanichapol D (1984) Laboulbeniomycetes (Ascomycotina) in Thailand, I. *Natural History Bulletin of the Siam Society* **31**: 47–88.
- Thaxter R (1896) Contribution towards a monograph of the Laboulbeniaceae. *Memoirs of the American Academy of Arts and Sciences* **12**: 187–429, Pl. I–XXVI.
- Thaxter R (1899) Diagnosis of new species of Laboulbeniaceae. I. *Proceedings of the American Academy of Arts and Sciences* **35**: 153–209.

- Thaxter R (1900) Preliminary diagnosis of new species of Laboulbeniaceae. II. *Proceedings of the American Academy of Arts and Sciences* **35**: 409–450.
- Thaxter R (1901a) Preliminary diagnosis of new species of Laboulbeniaceae. III. *Proceedings of the American Academy of Arts and Sciences* **36**: 397–414.
- Thaxter R (1901b) Preliminary diagnosis of new species of Laboulbeniaceae. IV. *Proceedings of the American Academy of Arts and Sciences* **37**: 21–45.
- Thaxter R (1902) Preliminary diagnosis of new species of Laboulbeniaceae. V. *Proceedings of the American Academy of Arts and Sciences* **38**: 9–57.
- Thaxter R (1905) Preliminary diagnoses of new species of Laboulbeniaceae. VI. *Proceedings of the American Academy of Arts and Sciences* **41**: 303–318.
- Thaxter R (1908) Contribution toward a monograph of the Laboulbeniaceae. Part II. *Memoirs of the American Academy of Arts and Sciences* **13**: 217–469, Pl. XXVIII–LXXI.
- Thaxter R (1926) Contribution toward a monograph of the Laboulbeniaceae IV. *Memoirs of the American Academy of Arts and Sciences* **15**: 427–580, Pl. I–XXIV.
- Toju H, Tanabe AS, Yamamoto S, Sato H (2012) High-coverage ITS primers for the DNA-based identification of ascomycetes and basidiomycetes in environmental samples. *PLoS One* **7**: e40863.
- Vilgalys R, Hester M (1990) Rapid genetic identification and mapping of enzymatically amplified ribosomal DNA from several *Cryptococcus* species. *Journal of Bacteriology* **172**: 4238–4246.
- Wang Y, Tretter ED, Johnson EM, Kandel P, Lichtwardt RW, Novak SJ, Smith JF, White MM (2014) Using a five-gene phylogeny to test morphology-based hypotheses of *Smittium* and allies, endosymbiotic gut fungi (Harpellales) associated with arthropods. *Molecular Phylogenetics and Evolution* **79**: 23–41.
- Weir A, Beakes GW (1996) Correlative light- and scanning electron microscope studies on the developmental morphology of *Hesperomyces virescens*. *Mycologia* **88**: 677–693.
- Weir A, Blackwell M (2001a) Molecular data support the Laboulbeniales as a separate class of Ascomycota, Laboulbeniomycetes. *Mycological Research* **105**: 1182–1190.
- Weir A, Blackwell M (2001b) Extraction and PCR amplification of DNA from minute ectoparasitic fungi. *Mycologia* **93**: 802–806.
- Weir A, Hammond PM (1997) Laboulbeniales on beetles: Host utilization patterns and species richness of the parasites. *Biodiversity and Conservation* **6**: 701–719.

- Weir A, Hughes M (2002) The taxonomic status of *Corethromyces bicolor* from New Zealand, as inferred from morphological, developmental, and molecular studies. *Mycologia* **94**: 483–493.
- Whisler HC (1968) Experimental studies with a new species of *Stigmatomyces* (Laboulbeniales). *Mycologia* **60**: 65–75.
- White TJ, Bruns TD, Lee SB, Taylor JW (1990) Analysis of phylogenetic relationships by amplification and direct sequencing of ribosomal RNA genes. In: *PCR Protocols: a guide to methods and applications* (Innis MA, Gelfand DH, Sninsky JJ, White TJ, eds): 315–322. San Diego: Academic Press.
- Wrzosek M (2000) *Taksonomia i filogeneza Mucorales (Zygomycetes) w świetle analiz morfometrycznych oraz wybranych markerów molekularnych*. [Taxonomy and phylogeny of Mucorales (Zygomycetes) in the light of morphometrical and selected molecular markers analyses]. Doctoral dissertation. University of Warsaw, Poland.

## CHAPTER 2

### **Birth of an order: comprehensive phylogenetic study excludes *Herpomyces* (Fungi, Laboulbeniomycetes) from Laboulbeniales**

Manuscript in review:

Haelewaters D, Pfliegler WP, Gorczak M, Pfister DH. *Molecular Phylogenetics and Evolution*.

*Author's contribution.* — D.H. initiated the project, generated the majority of nuclear ribosomal molecular sequence data, performed all molecular phylogenetic and molecular clock analyses, prepared all figures, co-described the new species, and wrote the manuscript with input from the co-authors.

**Birth of an order: comprehensive phylogenetic study excludes *Herpomyces* (Fungi, Laboulbeniomycetes) from Laboulbeniales**

Danny Haelewaters<sup>1</sup>

Walter P. Pfliegler<sup>2</sup>

Michał Gorczak<sup>3</sup>

Donald H. Pfister<sup>1</sup>

<sup>1</sup>Department of Organismic and Evolutionary Biology, Harvard University, 22 Divinity Avenue, Cambridge, MA 02138, United States; <sup>2</sup>Department of Biotechnology and Microbiology, University of Debrecen, Egyetem tér 1, 4032 Debrecen, Hungary; <sup>3</sup>Department of Molecular Phylogenetics and Evolution, University of Warsaw, Aleje Ujazdowskie 4, Warsaw, Poland

**Abstract.** The class Laboulbeniomycetes comprises biotrophic parasites associated with arthropods and fungi. Two orders are currently recognized, Pyxidiophorales and Laboulbeniales. *Herpomyces*, a genus within Laboulbeniales, has 25 species that exclusively parasitize cockroaches (Blattodea). Here we evaluate 40 Laboulbeniomycetes taxa with a three-gene phylogeny (nrSSU, ITS, nrLSU) and propose a new order in the class. Herpomycetales contains a single genus, *Herpomyces*. We also build on the six-gene dataset from Schoch *et al.* (2009) to confirm that Laboulbeniomycetes and Sordariomycetes are sister orders and apply ‘Laboulbeniomyceta’ as a rankless taxon for the now well-resolved node that describes the most recent common ancestor of both classes.

**Key words:** Cockroaches, divergence times, ectoparasitic fungi, Laboulbeniomycetes, phylogeny, taxonomy

## INTRODUCTION

Laboulbeniomycetes is a class of perithecial fungi that are associated with arthropods as obligate biotrophs or for dispersal. The class is comprised of two orders, Laboulbeniales and Pyxidiophorales, and several unclassified organisms (e.g., *Laboulbeniopsis termitarius* and *Coreomycetopsis oedipus* on termites; Blackwell, 1994; Henk *et al.*, 2003). Pyxidiophorales contains species associated with arthropods in their dispersal phase. Most *Pyxidiophora* species parasitize other fungi and their two-celled ascospores directly divide to develop a *Thaxteriola* asexual state (Blackwell & Malloch, 1989b; Kirschner, 2003; Weir & Blackwell, 2005), which is dependent on arthropods for dispersal. The *Thaxteriola* asexual state produces yeast-like cells that inoculate new substrates. A phylogenetic study using partial nuclear small subunit ribosomal DNA sequences placed the asexual fungus *Gliocephalis hyalina* within Pyxidiophorales (Jacobs *et al.*, 2005). Culturing of this fungus failed using standard monoxenic techniques but was successful when co-cultured with *Fusarium* species (Barron, 1968; Jacobs *et al.*, 2005).

Laboulbeniales are obligate biotrophs of arthropods. About 2200 species are known to infect various groups in three subphyla – Chelicerata, Hexapoda, Myriapoda – and are known from all continents except Antarctica. Among the insects, the most basal host order (Blattodea) includes the cockroaches and termites. To date, 27 species of Laboulbeniales in three genera have been reported on cockroaches (Wang *et al.*, 2016): *Herpomyces* (25 species), *Laboulbenia* (1) and *Rickia* (1). Although *Laboulbenia* and *Rickia* have a broad host range with the majority

of species occurring on other host groups (e.g., Santamaria *et al.*, 1991; Pfliegler *et al.*, 2016), species of the genus *Herpomyces* occur only on cockroaches (order Blattodea).

*Herpomyces* is the only genus in the family Herpomycetaceae I.I. Tav., and this is the only family in the suborder Herpomycetinae (Thaxt.) I.I. Tav. (Tavares, 1981). The genus was described by Thaxter (1902) and now includes 25 species, all of which are parasites of cockroaches (Richards & Smith, 1954). *Herpomyces* is arguably the best-studied genus of the Laboulbeniales in terms of biology and thallus ontogeny. *Herpomyces*-infected cockroaches are easily reared and maintained; A. Glenn Richards and Myrtle N. Smith used laboratory colonies to perform exhaustive studies on the life history of these fungi, development, histopathology and host specificity (Richards & Smith, 1954, 1955a, 1955b, 1956). In addition to their investigations, Hill (1977) and Tavares (1965, 1966, 1980, 1985) contributed to our current knowledge of *Herpomyces* with detailed ultrastructural and developmental studies.

In his early efforts to organize the Laboulbeniales, Thaxter (1908) created two suborders based on antheridial characters, Laboulbeniineae and Ceratomycetinae, 2 families and 22 tribes to accommodate the (at that time) 55 genera in the order. One of these tribes was Herpomycetaceae, with a single genus, in the suborder Laboulbeniineae, family Laboulbeniaceae. Later, based on perithecium morphology and characters of ascus development, Tavares (1981) erected the suborder Herpomycetinae to accommodate Thaxter's tribe Herpomycetaceae and to indicate the isolated position of these species. In this classification system (Tavares, 1981, 1985), *Herpomyces* species were considered sister to all other members of Laboulbeniales, which were placed in the suborder Laboulbeniineae. One important characteristic of Laboulbeniales is that their perithecia have an outer and inner wall. In most members of the Laboulbeniales, the wall arises from the perithecial basal cells (Tavares, 1985). However, in *Herpomyces*, the rows of



inner wall cells start at the level of the fourth or fifth tier of the outer wall. As such, they may be comparable to periphyses, sterile elements that line the perithecial neck in many pyrenomycetes (Tavares, 1985). A further difference is marked in the number of ascospores per ascus. The asci of Laboulbeniales generally contain four two-celled ascospores. Asci of *Herpomyces* species, on the other hand, contain eight two-celled ascospores (Thaxter, 1908; Richards & Smith, 1955a; Tavares, 1985). Eight-spored asci predominate in the Ascomycota and this condition might be considered ancestral in the Laboulbeniomycetes.

Blackwell & Malloch (1989a) proposed these *Herpomyces* species as intermediate forms linking filamentous ascomycetes and other Laboulbeniales. The flask-shaped perithecia of *Herpomyces* species closely resemble those of *Pyxidiophora*. This view of the relationship and position of the genus *Herpomyces* was further supported by molecular phylogenetic reconstruction (Weir & Blackwell, 2001). Their phylogeny supported a sister relationship between Laboulbeniales and Pyxidiophorales, although no sequences of *Herpomyces* species were used in their study. Tavares (1985) also suggested that the ancestral position of the genus might be related to the basal position of its hosts among the Hexapoda. Tavares (1985) presented a hypothesis that stated an origin of the group through the infection of cockroaches in the Carboniferous and a subsequent transition to Coleoptera (beetles). Laboulbeniomycetes fossils are rarely reported. Only three reports are known: *Stigmatomyces succini* from a fly in Bitterfeld amber (35 million years old, Myo; Rossi *et al.*, 2005), an undescribed species of *Columnomyces* from Dominican amber (16 Myo; M. Perreau & D. Haelewaters, unpubl.) and a report we consider spurious by Poinar (2016) of an amber inclusion from Myanmar (around 100 Myo). The hypothesized evolutionary history of these fungi may be inferred from phylogenetic molecular investigations incorporating a molecular clock approach. Here we present phylogenetic

molecular data providing insight into the position of the genus *Herpomyces* within the Laboulbeniomycetes as well as into the relationships among several species in the genus.

## MATERIAL AND METHODS

*Collection of host specimens.* — Cockroaches were obtained from pet supply companies and laboratory colonies. Screening for Laboulbeniales was done using a binocular microscope at 50×. Fresh specimens of *Periplaneta americana* were hand-collected in Burbank, California; Cambridge, Massachusetts; New York City, New York; and during fieldwork in Panama (in Ancón and Gamboa). Long-term preservation was obtained by storing material in 95% ethanol at -20 °C. To present a more complete phylogeny of Laboulbeniomycetes, also other insect groups were collected and screened for Laboulbeniales. Hosts were collected by hand, using pyramid traps with killing agent, on an illuminated white screen at night, by fumigation, or using an entomological net. In addition, bats were captured with mist nets and their bat flies were collected using paintbrush and forceps.

*Morphology.* — We removed entire antennae from highly infected cockroaches using forceps. These were washed 3 times in 70% ethanol and stored in 85% ethanol at -20 °C prior to identification of thalli or isolation of fungal DNA. In other cases, individual thalli were removed from the host at the point of attachment (foot or haustoria), using Minuten pins (BioQuip #1208SA, Rancho Dominguez, California) inserted into wooden rods. Thalli were directly mounted in Amann's solution (Benjamin, 1971) with modifications as follows.

We placed a droplet of Hoyer's medium on the slide with the tip of a Minuten pin and deposited thalli in the droplet. The thalli were positioned on the slide by taking them out of the

Hoyer's one by one and placing them in a single row, each thallus in a minute amount of the Hoyer's. The specimens were dried briefly, then a small drop of Amann's solution was placed on the cover glass before lowering the latter (drop facing down) sideways onto the Hoyer's medium. In this way, the moderately fixed thalli remained in place when the cover glass was added. To seal, the cover glass was ringed with nail polish or B-72 in acetone (Gaylord #AB72, Syracuse, New York). We viewed mounted specimens at 400–1000x magnification. For identification we used relevant systematic and taxonomic descriptions (listed in LITERATURE CITED). Most species of *Herpomyces* were identified using the descriptions in Thaxter (1908, 1931) and Santamaria (2003). Voucher slides are deposited at the Farlow Herbarium (FH; Harvard University, Cambridge, Massachusetts).

*DNA isolation, PCR amplification and sequencing.* — DNA was isolated from 1–18 thalli following a modified Extract-N-Amp Plant PCR Kit (Sigma-Aldrich, St. Louis, Missouri), a so-called “heat-extraction” protocol and a modified REPLI-g Single Cell Kit (Qiagen, Stanford, California). Using the Extract-N-Amp PCR Kit, 1.5 mL Eppendorf tubes were filled with 40  $\mu$ L of Extraction Solution. A Minuten pin was submerged in glycerin to allow the thalli to stick to the pin and prevent them from being lost during transfer. Thalli were removed from the host using this Minuten pin and placed in a droplet of glycerin on a microscopic slide. Thalli were then taken out of the droplet with the Minuten pin and put into the Extraction Solution-filled tube. The sample was crushed with a pestle and incubated at room temperature for 10+ min and then at 95 °C for 20 min on a standard heating block (VWR Scientific catalog #13259-030, Franklin, Massachusetts). Finally, 60  $\mu$ L of Dilution Solution (3% BSA) was added to the tubes. DNA extractions were stored at -20 °C. Some samples in the 40  $\mu$ L Extraction Solution received

pre-treatment with overnight incubation in a Shake 'N Bake Hybridization Oven (Boekel Scientific model #136400-2, Feasterville, Pennsylvania) at 56 °C.

Samples from Hungary were subjected to a heat-extraction protocol. A portion of a heavily infected antenna, around 5 mm in length, was removed from a cockroach, placed in 0.2 mL PCR tubes and incubated in a microwave at 750 W for 5 min. Then 50 µL ddH<sub>2</sub>O was added and the submerged tissue (fungal material or section of highly infected antenna) was crushed using a sterile pipette tip under a dissecting microscope. Some loss of material occurred by capillary action, but it was minimal. PCR tubes were incubated at -20 °C for 10 min. Forceful pressure was applied to the ice inside the PCR tubes to further break apart thalli using a sterile pipette tip.

In addition, we developed a modified protocol for the REPLI-g Single Cell Kit (Qiagen). This protocol was used for isolation and whole-genome amplification (WGA) of DNA from single thalli of Laboulbeniales. A Minuten pin was submerged in glycerin and a single thallus was removed from the host and placed in a droplet of glycerin on a microscope slide. The thallus was then placed in a 0.2 mL PCR tube with 2 µl of phosphate-buffered saline (PBS). After adding 1.5 mL of prepared D2 buffer, the tube was incubated at 65 °C for 20 min. Subsequent steps followed the manufacturer's instructions.

Three non-protein coding DNA fragments were amplified, including nrSSU, ITS (ITS1 – 5.8S – ITS2) and nrLSU. Primer pairs used are given in Table 2-1. For ITS, initial attempts to amplify using previously published primers designed for fungi often resulted in weak or non-specific amplification. To improve our success rate, new primers were designed: ITShespL (5'–CTCCTGTAGAACCTACACATC–3') and ITShespR (5'–CAAATTTAAGCTTTTGCCGC–3'), both of which are *Hesperomyces*-specific; and the Laboulbeniomycetes-specific LabITS1

**Table 2-1.** Primer pairs used in this study, including the targeted product and reference(s).

Forward	Reverse	Product	Reference(s)
NS1	NS4	nrSSU	White <i>et al.</i> (1990)
NS1	NS2	nrSSU	White <i>et al.</i> (1990)
NS1	NS6	nrSSU	White <i>et al.</i> (1990)
NS1	R	nrSSU	Wrzosek (2000)
NSL1	NSL2	nrSSU	Haelewaters <i>et al.</i> (2015a)
SL122	NSL2	nrSSU	Landvik <i>et al.</i> (1997), Haelewaters <i>et al.</i> (2015a)
ITS1f	ITS4	ITS	Gardes & Bruns (1993), White <i>et al.</i> (1990)
ITS1f	ITS4_kyo1	ITS	Gardes & Bruns (1993), Toju <i>et al.</i> (2012)
ITS1f	ITS4A	ITS	Gardes & Bruns (1993), Larena <i>et al.</i> (1999)
ITS1f	ITS-u4	ITS	Gardes & Bruns (1993), Cheng <i>et al.</i> (2016)
ITShespL	ITShespR	ITS	This study
ITS5	ITS2	ITS1 – 5.8S	White <i>et al.</i> (1990)
5.8Shs2	ITS4	5.8S – ITS2	Sundberg <i>et al.</i> (2018), White <i>et al.</i> (1990)
ITS9mun	LR3	ITS – nrLSU	Egger (1995), Vilgalys & Hester (1990)
LabITS1	LR3	5.8S – nrLSU	This study, Vilgalys & Hester (1990)
LR0R	LR5	nrLSU	R. Vilgalys (unpubl.), Vilgalys & Hester (1990)
LIC24R	LR3	nrLSU	Miadlikowska & Lutzoni (2000), Vilgalys & Hester (1990)

(5'–ATkGCrCTyTyTGGyAwTCC–3'). The PCR reactions were conducted on a Mastercycler ep gradient Thermal Cycler (Eppendorf model #5341, Hauppauge, New York) and consisted of 13.3 µL of Extract-N-Amp PCR ReadyMix (Sigma-Aldrich), 2.5 µL of each 10 µM primer, 5.7 µL of H<sub>2</sub>O and 1 µL of template DNA. The amplification reactions were run under the following profiles: pre-denaturing at 94 °C for 3:00 min; 35 cycles of denaturing at 94 °C for 1:00 min, annealing at 50 °C for 0:45 min, extension at 72 °C for 1:30 min; and a final extension step of 72 °C for 10:00 min.

PCR products were cleaned using the QIAquick PCR Purification Kit (Qiagen) and sequenced. We prepared 10 µL sequencing reactions containing the same primers and 1 µL of purified PCR product. Sequencing reactions were performed using the Big Dye® Terminator v3.1 Cycle Sequencing Kit (Life Technologies, Carlsbad, California). Generated sequences were

assembled, trimmed and edited in Sequencher 4.10.1 (Gene Codes Corporation, Ann Arbor, Michigan).

*Sequence alignment and phylogenetic analyses.* — We compiled two datasets, the ITS sequences matrix and a concatenated dataset (nrSSU, ITS, nrLSU) to investigate the phylogeny within the genus *Herpomyces* and its position among Laboulbeniomycetes. For all three available DNA regions in the combined dataset, we aligned sequences using Muscle v3.7 (Edgar, 2004) as implemented on the Cipres Science Gateway version 3.3 (Miller *et al.*, 2010). Ambiguously aligned regions and uninformative positions were detected and removed using trimAl v1.3 (Capella-Gutiérrez *et al.*, 2009) with 60% gap threshold and minimal coverage of 50%. The data for each region were concatenated in MEGA7 (Kumar *et al.*, 2016) to create a super matrix of 1891 bp with phylogenetic data for 41 species.

Our ITS dataset consisting of 23 Laboulbeniomycetes sequences was complemented by four *Herpomyces* sequences that we retrieved from GenBank ([ncbi.nlm.nih.gov/genbank/](http://ncbi.nlm.nih.gov/genbank/)) and three taxa belonging to other classes: *Neurospora crassa* (Sordariomycetes, Sordariales), *Capnodium coffeae*, *C. salicinum* (Dothideomycetes, Capnodiales). All sequences were aligned using Muscle 3.7 and trimmed using trimAl v1.3 with 60% gap threshold and minimal coverage of 50%. Alignments generated during this study are available for download in NEXUS format from the figshare online repository (Haelewaters, 2017).

Phylogenetic analyses were performed using RAxML v8.2.X (Stamatakis, 2014) available on the Cipres web portal (Miller *et al.*, 2010). Maximum likelihood (ML) was inferred under a GTRCAT model, with 1000 bootstrapping replicates. Nucleotide substitution models were selected statistically with the help of jModelTest 2.1 (Darriba *et al.*, 2012) by considering

the Akaike Information Criterion (AIC). For the combined nrSSU+ITS+nrLSU dataset, the lowest -lnL value (12483.7340) was assigned to the General Time Reversible substitution model (Tavaré, 1986) with estimation of invariant sites and the assumption of a gamma distribution with six rate categories (GTR+I+G) had the lowest -lnL value. Bayesian analyses were done with a Markov chain Monte Carlo (MCMC) coalescent approach implemented in BEAST v1.8.4 (Drummond *et al.*, 2012), with an uncorrelated lognormal relaxed molecular clock allowing for rate variation across the tree. We selected a Speciation Yule Process tree prior with the GTR+G+I nucleotide substitution model. Five runs were performed from a random starting tree for 80 million generations, with a sampling frequency of 8000. All prior settings were entered in BEAUti v.1.8.4 to generate an XML file, which was run in BEAST on the Cipres web portal. The resulting log files of the five independent runs were entered in Tracer v1.6 (Rambaut *et al.*, 2014) to check trace plots and effective sample size (ESS). Burn-in values were adjusted to achieve an overall ESS of  $\geq 200$ . Upon removal of a portion of each run as burn-in, log files and trees files were combined in LogCombiner v.1.8.4. TreeAnnotator v1.8.4 was used to generate consensus trees with 0% burn-in value and to infer the maximum clade credibility tree, with the highest product of individual clade posterior probabilities. BEAUti, LogCombiner and TreeAnnotator are part of the BEAST package. Final trees with bootstraps (BS) and posterior probabilities (pp) were visualized in FigTree v1.4.3 ([tree.bio.ed.ac.uk/software/figtree/](http://tree.bio.ed.ac.uk/software/figtree/)).

*Molecular clock: dataset, initial phylogenetic analyses, calibration strategies and divergence time estimates.* — Our molecular clock analysis was based on the six-gene data matrix (nrSSU, nrLSU, mitSSU, *RPB1*, *RPB2*, *TEF1*) available from TreeBASE under study ID #2137 (Schoch *et al.* 2009a). Both the nrSSU and nrLSU regions were extracted from the matrix separately and

sequences of Laboulbeniomycetes were added to the respective dataset. Alignment of DNA sequences was done for both genes separately using Muscle v3.7 on the Cipres Science Gateway version 3.3. The sequences of both genes were concatenated in MEGA7 and trimmed with trimAl v1.3 as implemented in the Phylemon 2.0 web resource (Sánchez *et al.*, 2011), selecting the heuristic method automated1 (Capella-Gutiérrez *et al.*, 2009). The resulting nrSSU+LSU data matrix then was complemented with Schoch *et al.*'s (2009a) four other loci, which were present as two-gene datasets in the downloaded NEXUS file (*RPB1*+mitSSU and *TEF1*+*RPB2*).

Maximum likelihood analysis of the six-gene data matrix was inferred under a GTRCAT model with 1000 BS replicates (using RAxML v8.2.X on the CIPRES web portal). In preparation for the molecular clock analysis in BEAST v1.8.4, best fitting substitution models were chosen for each gene separately and for the six-gene data matrix as a whole from 88 candidate models included in jModeltest 2.1. The Bayesian Information Criterion was employed (BIC; Schwarz, 1978). For all genes as well as the concatenated data matrix, the GTR+G+I model was selected by the Bayesian Information Criterion. Bayesian analyses were done using MCMC to check whether our selected priors were optimized for the data matrix prior to including fossil calibration points. First trials using the entire dataset with 345 taxa failed to converge, and thus we decided to continue working with a pruned data matrix (making sure that each class was represented and supported in the resulting tree). Two independent runs of 40 million generations each were made, with the following priors: GTR+G+I substitution model, uncorrelated lognormal relaxed clock, Speciation Birth-Death tree prior with incomplete sampling (Stadler, 2009), normal prior distribution on the ucl.d.mean hyperparameter and sampling frequency of 4000. Trace plots and ESS values were checked in Tracer v1.6, and the burn-in of each run was adjusted to achieve an ESS of  $\geq 200$  (20% for run 1, 10% for run 2).



TreeAnnotator v1.8.4 was used to generate consensus trees with 0% burn-in value and to infer the maximum clade credibility tree, with the highest product of individual clade posterior probabilities. Final trees with bootstrap values (BS) and posterior probabilities (pp) were visualized in FigTree v1.4.3.

For fossil calibration, we used five ascomycetes fossils: *Paleopyrenomycites devonicus*, *Aspergillus collembolorum*, *Parmelia ambra*/*P. isidiiveteris* and *Stigmatomyces succini*. Ages are adopted from Beimforde *et al.* (2014). *Paleopyrenomycites devonicus* (Taylor *et al.*, 2005) is from Devonian Rhynie Chert (410 Myo) and represents the oldest known ascomycete fossil. It has an uncertain position but was estimated to be best placed between Pezizomycotina divergence (= stem base) and Pezizomycotina crown (= Pezizomycetes stem base) by Lücking *et al.* (2009). We followed Beimforde *et al.*'s (2014) view and placed *Paleopyrenomycites* on the node giving rise to all Pezizomycotina, as “common ancestor of all filamentous, sporocarp-producing Ascomycota.” The Baltic amber fossil *Aspergillus collembolorum* was used to constrain the most recent common ancestor (MRCA) of *Aspergillus protuberus*, *Penicillium freii*, *Eupenicillium limosum* and *E. javanicum* to 50-35 Myo. The fossil Metacapnodiaceae sp. (Schmidt *et al.*, 2014) from Early Cretaceous Charentes amber (100 Myo) was placed on the node representing the MRCA of *Scorias spongiosa*, *Capnodium coffeae* and *C. salicinum*. The fourth calibration point is represented by two species of *Parmelia* (*P. ambra*, *P. isidiiveteris*) from Dominican amber (17 Myo). Reassessment by Beimforde *et al.* (2014), evaluating the use of these materials as calibration points in molecular phylogenetic models, led to the insight that both are Parmeliaceae but do not belong to *Parmelia sensu stricto*. As a result, we used them as MRCA of the family Parmeliaceae (including genera *Canoparmelia*, *Flavocetraria*, *Flavoparmelia*, *Hypogymnia* and *Usnea*). Finally, *Stigmatomyces succini*, a member of the order

Laboulbeniales, was described as an ectoparasite of a diopsid fly in Bitterfeld amber (Rossi *et al.*, 2005). It was used to constrain the common ancestor of *Stigmatomyces gregarius*, *S. limnophorae*, *S. protrudens*, *S. rugosus* and *S. scaptomyzae* to be 35 Myo.

Divergence times were estimated with BEAST v1.8.4 using an uncorrelated log-normally distributed clock model, allowing for rate variation across the tree. The XML input file for BEAST was constructed with BEAUti v1.8.4 (Drummond *et al.*, 2012) by importing the NEXUS file of the concatenated, pruned data matrix. The substitution model GTR+G+I was used. Five taxon sets were created and constrained to be monophyletic in BEAUti for fossil calibration: Pezizomycotina, *Aspergillus*, Capnodiales, Parmeliaceae and *Stigmatomyces*. Tree Prior was set to Speciation: Birth-Death Incomplete Sampling (Stadler, 2009). The prior on the ucl.d.mean hyperparameter was lognormally distributed. For fossil node calibrations, we used normally distributed priors (mean = 410 for Pezizomycotina; mean = 35 for *Aspergillus*; mean = 100 for Capnodiales; mean = 17 for Parmeliaceae; mean = 23 for *Stigmatomyces*; standard deviations were kept at 1). Four independent Markov chain Monte Carlo (MCMC) chains of 80,000,000 generations and sampling frequency of 8,000 were run from random starting trees. Convergence was assessed by checking the resulting log files in Tracer v1.6 (Rambaut *et al.*, 2014). Of each run the burn-in was adjusted such that most of the combined ESS values were  $\geq 200$ . A maximum clade credibility tree with mean and 95% Highest Posterior Density (HPD) node ages and per-clade posterior probabilities was inferred using TreeAnnotator v1.8.4. All XML files generated during this study are available for download from the figshare online repository (Haelewaters, 2017).

## RESULTS

*Nucleotide alignment datasets.* — The concatenated nrSSU+ITS+nrLSU dataset included 61 isolates representing 41 species and 1891 characters (GenBank accession numbers in Table 2-2). Of these characters, 1058 were constant and 620 were parsimony-informative. Taxonomic sampling covered 17 genera in the Laboulbeniomycetes. *Capnodium coffeae* and *C. salicinum* (Dothideomycetes, Capnodiales) served as outgroup taxa. *Neurospora crassa* was included in the dataset to confirm the sister relationship between Laboulbeniomycetes and Sordariomycetes. The ITS dataset included 30 isolates from 11 species and 1098 characters, of which 305 were constant and 494 were parsimony-informative. Taxonomic sampling covered 7 species in the genus *Herpomyces* in addition to *Pyxidiophora microspora* (Laboulbeniomycetes, Pyxidiophorales), *Neurospora crassa* and as outgroup taxa *Capnodium coffeae* and *C. salicinum*. The six-gene data matrix included 345 isolates from 335 species and 16754 characters, of which 5354 were constant and 8262 were parsimony-informative. Taxonomic sampling covered 16 classes of Ascomycota. The class Laboulbeniomycetes was represented by the genera *Arthrorhynchus* (1 isolate), *Hesperomyces* (3), *Polyandromyces* (1) and *Stigmatomyces* (5) (Laboulbeniales); *Gliocephalis* (1) and *Pyxidiophora* (4) (Pyxidiophorales); and the genus of interest, *Herpomyces* (9). The pruned six-gene data matrix included the same number of characters but only 120 taxa representing 114 species. Compared to the original dataset with 345 taxa, coverage did not change (16 classes of Ascomycota); as to the Laboulbeniomycetes, *Arthrorhynchus nycteribiae* and *Herpomyces leurolestis* were removed.

*Phylogenetic inferences.* — All three resulting phylogenies (ITS, three-gene, six-gene) confirm the placement of Laboulbeniomycetes as sister to the Sordariomycetes with a high level of

**Table 2-2.** Overview of all Laboulbeniomyces sequences used in this study, with indication of in which datasets isolates were used (ITS, three-gene, six-gene). All isolates of which sequences were generated are listed, with geographic information and GenBank accession numbers. Sequences in bold were newly generated during this study.

Species	Isolate	Country	SSU	ITS	LSU	ITS	3-gene	6-gene
<b>DOTIDEOMYCETES, CAPNODIALES</b>								
<i>Capnodium salicinum</i>	CBS 131.34	Indonesia	NG016491	AJ244240	DQ678050	X	X	X
<i>Capnodium coffeae</i>	CBS 147.52	DR Congo	DQ247808	DQ491515	NG027576	X	X	X
<b>SORDARIOMYCETES, SORDARIALES</b>								
<i>Neurospora crassa</i>	FGSC 987			AF388914		X		
<i>Neurospora crassa</i>	OR74A		NW011929459	NW011929459	NW011929459		X	
<b>LABOULBENIOMYCETES, HERPOMYCETALES</b>								
<i>Herpomyces chaetophilus</i>	DH435b	USA: Massachusetts	<b>MG438318</b>	<b>MG438292</b>		X	X	
<i>Herpomyces chaetophilus</i>	DH483b	USA: Massachusetts	<b>MG438319</b>	<b>MG438293</b>	<b>MG438350</b>	X	X	X
<i>Herpomyces chaetophilus</i>	DH483c	USA: Massachusetts	<b>MG438320</b>	<b>MG438296</b>	<b>MG438351</b>	X	X	
<i>Herpomyces chaetophilus</i>	DH602b	USA: Massachusetts	KT800023	KT800039	KT800009	X	X	
<i>Herpomyces chaetophilus</i>	DH1097b	Panama	<b>MG438321</b>	<b>MG438294</b>	<b>MG438352</b>	X		
<i>Herpomyces chaetophilus</i>	DH1097c	Panama	<b>MG438322</b>	<b>MG438295</b>	<b>MG438353</b>	X	X	X
<i>Herpomyces ectobiae</i>	TW793a	USA: California		<b>MG438296</b>		X	X	
<i>Herpomyces ectobiae</i>	MG001	Poland	KT800024	KT800040		X	X	
<i>Herpomyces leurolestis</i>	DH1417b	Hungary		<b>MG438297</b>		X		
<i>Herpomyces leurolestis</i>	Debr_Ppal	Hungary	<b>MG438323</b>	<b>MG438298</b>	<b>MG438354</b>	X	X	X
<i>Herpomyces leurolestis</i>	2017/0199	Hungary		<b>MG438299</b>		X		
<i>Herpomyces paranensis</i>	DH1365a	Panama		<b>MG438300</b>		X		
<i>Herpomyces paranensis</i>	DH1365b	Panama		<b>MG438301</b>		X		
<i>Herpomyces periplanetae</i>	TW437c	USA: Massachusetts	<b>MG438324</b>	<b>MG438302</b>	<b>MG438355</b>	X	X	
<i>Herpomyces periplanetae</i>	TW448b	USA: Massachusetts	<b>MG438325</b>	<b>MG438303</b>	<b>MG438356</b>	X	X	X
<i>Herpomyces periplanetae</i>	DH602a	USA: Massachusetts	<b>MG438326</b>	<b>MG438304</b>		X	X	
<i>Herpomyces periplanetae</i>	DH602c	USA: Massachusetts	KT800025	KT800041	KT800010	X	X	X
<i>Herpomyces periplanetae</i>	DH602d	USA: Massachusetts	<b>MG438327</b>	<b>MG438305</b>	<b>MG438357</b>	X	X	
<i>Herpomyces periplanetae</i>	DH620a	USA: New York	<b>MG438328</b>	<b>MG438306</b>	<b>MG438358</b>	X	X	
<i>Herpomyces periplanetae</i>	DH654b	Panama	<b>MG438329</b>	<b>MG438307</b>		X		
<i>Herpomyces periplanetae</i>	DH654c	Panama	<b>MG438330</b>	<b>MG438308</b>	<b>MG438308</b>	X		
<i>Herpomyces periplanetae</i>	DH1187d	USA: Massachusetts	<b>MG438331</b>	<b>MG438309</b>	<b>MG438359</b>	X		X

**Table 2-2. (Continued).**

Species	Isolate	Country	SSU	ITS	LSU	ITS	3-gene	6-gene
<i>Herpomyces stylopygae</i>	Bud_Bori	Hungary	<b>MG438332</b>	<b>MG438310</b>	<b>MG438360</b>	X	X	X
<i>Herpomyces stylopygae</i>	Bud_Bori_2	Hungary		<b>MG438311</b>		X		
<i>Herpomyces shelfordellae</i>	DE_HerpBL1	Hungary	KT800026	KT800042	KT800011	X	X	X
<i>Herpomyces shelfordellae</i>	Bud_Slat	Hungary	<b>MG438333</b>	<b>MG438312</b>	<b>MG438361</b>	X	X	X
<i>Herpomyces shelfordellae</i>	DH1415a	Hungary		<b>MG438313</b>		X		
LABOULBENIOMYCETES, PYXIDIOPHORALES								
<i>Gliocephalis hyalina</i>	DAOM 229465	Canada	AH012810				X	X
<i>Pyxidiophora arvernensis</i>	CBS 657.82		FJ176839		FJ176894		X	X
<i>Pyxidiophora cf. microspora</i>	MG200	Poland	<b>MG438334</b>	<b>MG438314</b>	<b>MG438362</b>	X		X
<i>Pyxidiophora</i> sp.	IMI-1989	Canada	AF313769				X	
<i>Pyxidiophora</i> sp. 03			AY212811				X	
LABOULBENIOMYCETES, LABOULBENIALES								
<i>Aphanandromyces audisioi</i>	MG060	Poland	<b>MG438335</b>				X	
<i>Arthrorhynchus nycteribiae</i>	DH1015d	Hungary	<b>MG438336</b>		<b>MG438363</b>		X	X
<i>Chitonomyces hyalinus</i>		USA: New York	JN127393	JN127405			X	
<i>Chitonomyces marginatus</i>		USA: New York	JN127391	JN127404			X	
<i>Corethromyces</i> sp.	AW2001		AF431761				X	
<i>Gloeandromyces streblae</i>	DH1011a	Mexico	<b>MG438337</b>				X	
<i>Gloeandromyces streblae</i>	DH1018a	Nicaragua	<b>MG438338</b>				X	
<i>Hesperomyces coccinelloides</i>	AW820	USA: Louisiana	AF407575				X	
<i>Hesperomyces coleomegillae</i>	635A	Ecuador	KF266890	KF192897			X	
<i>Hesperomyces coleomegillae</i>	637	Ecuador	KF266893	KF192901			X	
<i>Hesperomyces palustris</i>	631K	Ecuador	KF266902	KF192902			X	
<i>Hesperomyces palustris</i>	632B	Ecuador	KF266891	KF192899			X	
<i>Hesperomyces virescens</i>	DH316a	USA: Georgia	<b>MG438339</b>	<b>MG438315</b>	<b>KJ842339</b>		X	X
<i>Hesperomyces virescens</i>	DH334b	Netherlands	<b>MG438340</b>	<b>MG438316</b>	<b>MG438364</b>		X	X
<i>Hesperomyces virescens</i>	DH646c	Germany		KT800045	KT800015		X	
<i>Hesperomyces virescens</i>	DH1188g	USA: Massachusetts	<b>MG438341</b>	<b>MG438317</b>	<b>MG438365</b>			X
<i>Hesperomyces virescens</i>	MT001	Poland	KT800032	KT800048	KT800018		X	
<i>Laboulbenia calathi</i>	DH1007a	Netherlands	<b>MG438342</b>				X	
<i>Laboulbenia flagellata</i>	DH1030a	USA: Massachusetts	<b>MG438343</b>				X	

**Table 2-2. (Continued).**

Species	Isolate	Country	SSU	ITS	LSU	ITS	3-gene	6-gene
<i>Laboulbenia pheropsophi</i>	DH1009b	Sierra Leone	<b>MG438344</b>				X	
<i>Laboulbenia</i> sp.	DH971a	Panama	<b>MG438345</b>				X	
<i>Monoicomyces homalotae</i>	DH1014c	USA: California	<b>MG438346</b>				X	
<i>Monoicomyces invisibilis</i>	MT004	Poland	KT800034				X	
<i>Polyandromyces coptosomalis</i>	DH313f	Ecuador	KT800035		KT800020		X	X
<i>Polyandromyces coptosomalis</i>	HM499a	Canary Islands	<b>MG438347</b>				X	
<i>Prolixandromyces triandrus</i>	HNHM1079	Hungary	LT158294	LT158296	LT158295		X	
<i>Rhachomyces philonthinus</i>	TM10446	Poland	KT800036				X	
<i>Rhadinomyces pallidus</i>			AF431763				X	
<i>Rickia passalina</i>			AF432129				X	
<i>Stigmatomyces borealis</i>	AW797	USA: Louisiana	JN835186				X	
<i>Stigmatomyces gregarius</i>	DH1008a	Sierra Leone	<b>MG438348</b>				X	X
<i>Stigmatomyces limnophorae</i>	AW785	USA: Louisiana	AF407576				X	X
<i>Stigmatomyces protrudens</i>			AF298232		AF298234		X	X
<i>Stigmatomyces rugosus</i>			AF431759				X	X
<i>Stigmatomyces scaptomyzae</i>			AF431758				X	X
<i>Zodiomyces vorticellarius</i>	AW819	USA: Louisiana	AF407577				X	X
<i>Zodiomyces vorticellarius</i>	MG003	Poland	KT800038		KT800022		X	X

certainty. Support was lacking or moderate for the relationships among orders in the Laboulbeniomycetes. In all multi-gene phylogenetic analyses, the three orders are highly supported (Figures 2-1 and 2-2). The *Herpomyces* clade and Pyxidiophorales are supported with maximum bootstrap values and posterior probabilities. Laboulbeniales is supported with BS = 87 and pp = 1.0 in the three-gene phylogeny and with BS = 94 in the six-gene phylogeny. In the pruned six-gene phylogeny, Pyxidiophorales (pp = 1.0) is basal, with the *Herpomyces* clade (pp = 1.0) and Laboulbeniales (pp = 1.0) sharing a most recent common ancestor (Figure 2-2). The support for this sister relationship is moderately high: pp = 0.8.

The ITS phylogeny supported existing species of *Herpomyces* and brought to light an undescribed species (Figure 2-3). The new species is associated with *Shelfordella lateralis* (Blattodea, Blattidae, Blattinae) from commercially available sources in Hungary. To confirm its molecular identity, we generated ITS sequences for multiple isolates from cockroaches purchased in different pet stores. In addition, we applied two DNA isolation techniques in two laboratories (Debrecen & Harvard). The ITS sequences match for 100% (over 721 bp), but isolate DE\_HerpBL1 has an extra G in position 650 (isolate Bud\_Slat has a gap).

Ascomycota diverged from Basidiomycota in the Neoproterozoic (664 Mya). Subphylum Pezizomycotina split from Saccharomycotina in the early Cambrian, around 583 Mya. Within the Pezizomycotina, the unranked taxon ‘Sordariomyceta’ (= Leotiomycetes and Laboulbeniomycetes and Sordariomycetes, Schoch *et al.* 2009a) diverged in the Triassic (231 Mya). Laboulbeniomycetes and Sordariomycetes diverged around the Triassic-Jurassic boundary (206 Mya). Within Laboulbeniomycetes, the earliest split occurred around 160 Mya (divergence of Pyxidiophorales). Finally, the *Herpomyces* clade and Laboulbeniales diverged around 143 Mya. Dating estimates are shown in Figure 2-4.

**Figure 2-1.** Phylogeny of Laboulbeniomyces, reconstructed from the concatenated three-gene dataset (nrSSU+ITS+nrLSU). The topology is the result of maximum likelihood inference performed with RAxML. For each node, the ML bootstraps (if > 70) and posterior probabilities (if > 0.7) are presented above/below the branch leading to that node. An asterisk (\*) indicates maximum support (BS = 100, pp = 1.0). The arrow indicates the Laboulbeniomyces class.



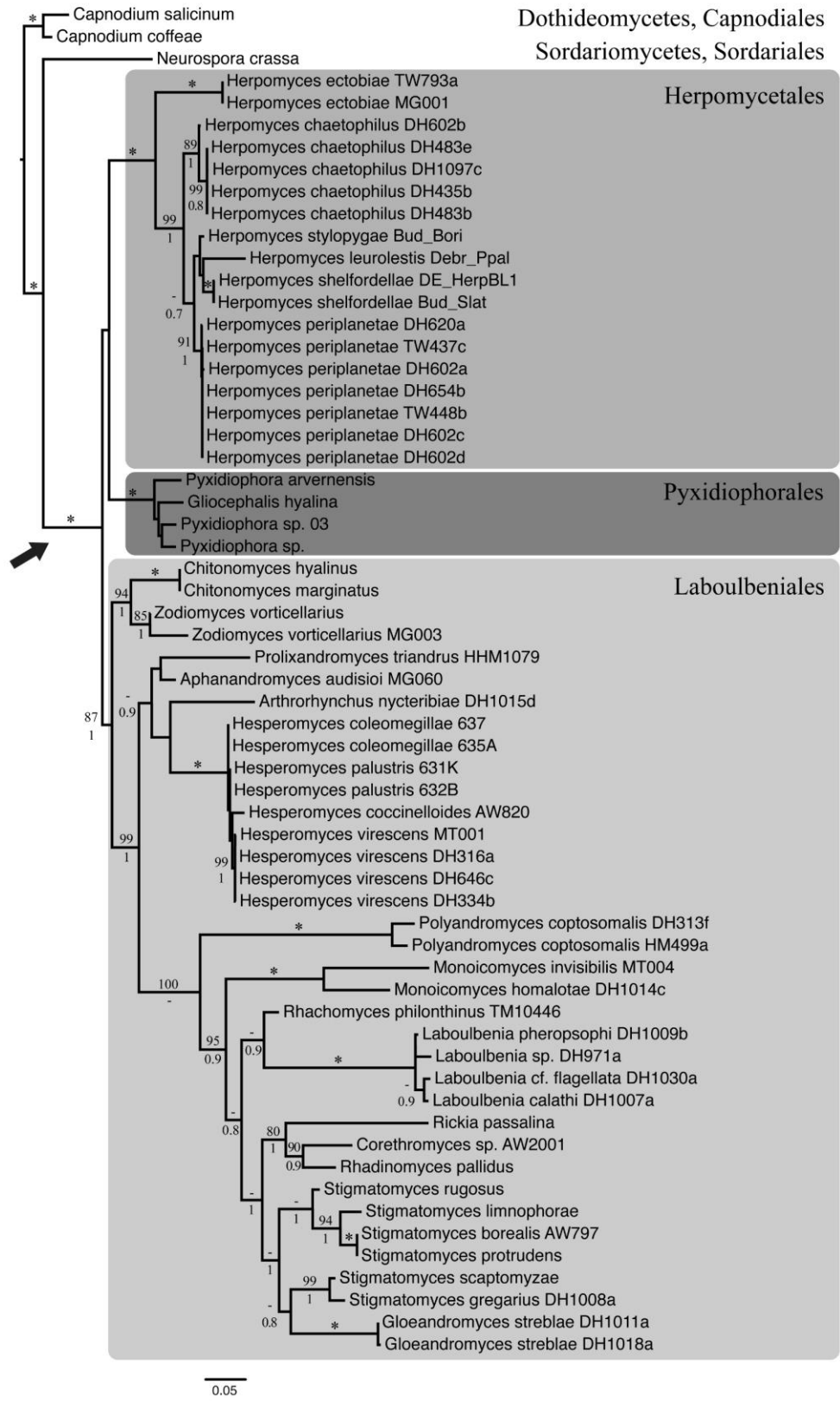


Figure 2-1. (Continued).

**Figure 2-2.** Complete Ascomycota phylogeny, reconstructed from a six-gene data matrix. The topology is the result of maximum likelihood inference performed with RAxML with all lineages collapsed to class level and to order level within Laboulbeniomycetes. For each node, the ML bootstraps (if > 70) and posterior probabilities (if > 0.7) are presented above/below the branch leading to that node. An asterisk (\*) indicates maximum support (BS = 100, pp = 1.0). The arrow indicates the Laboulbeniomycetes class.

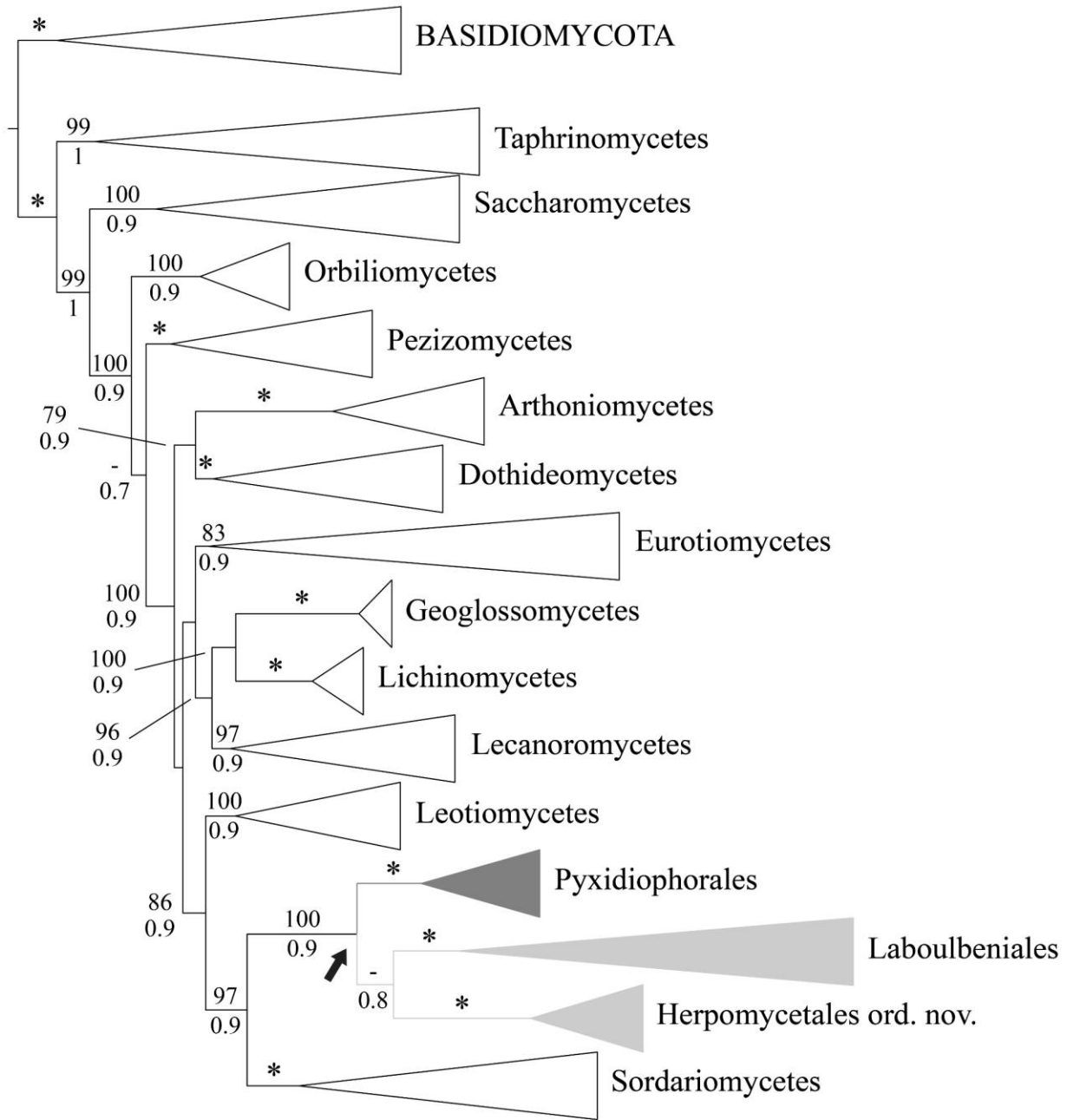
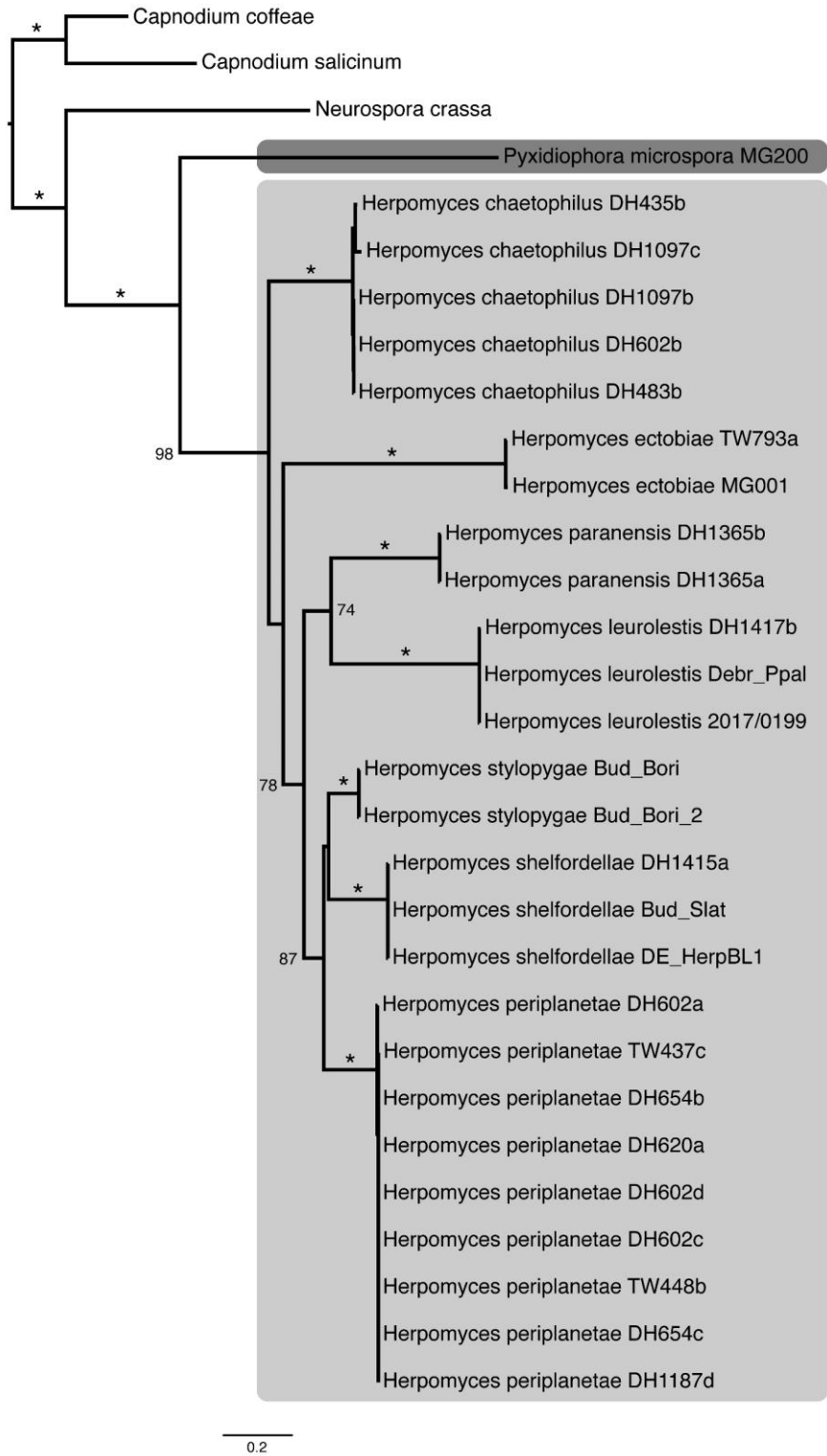


Figure 2-2. (Continued)



**Figure 2-3.** Phylogeny of *Herpomyces* species, reconstructed from the ITS dataset. The topology is the result of maximum likelihood inference performed with RAxML. For each node, the ML bootstraps (if > 70) are presented next to the branch leading to that node. An asterisk above the branch (\*) indicates maximum support (BS = 100)

**Figure 2-4.** Maximum clade credibility tree with divergence times estimates for main groups of Ascomycota and orders within Laboulbeniomycetes, reconstructed from the pruned six-gene data matrix. The tree is the result of a Bayesian analysis performed in BEAST, using five fossil calibration constraints. For each node, the posterior probabilities (if > 0.7) are presented next to the branch leading to that node. Assignments in the tree of the fossil calibration points are marked with black stars. Fossil calibrations are *Paleopyrenomycites devonicus* (Pezizomycotina-crown, basal-most position), Metacapnodiaceae sp. (in Dothideomycetes), *Aspergillus collemboforum* (in Eurotiomycetes), *Parmelia ambr/P. isidiiveteris* (in Lecanoromycetes) and *Stigmatomyces succini* (in Laboulbeniomycetes).

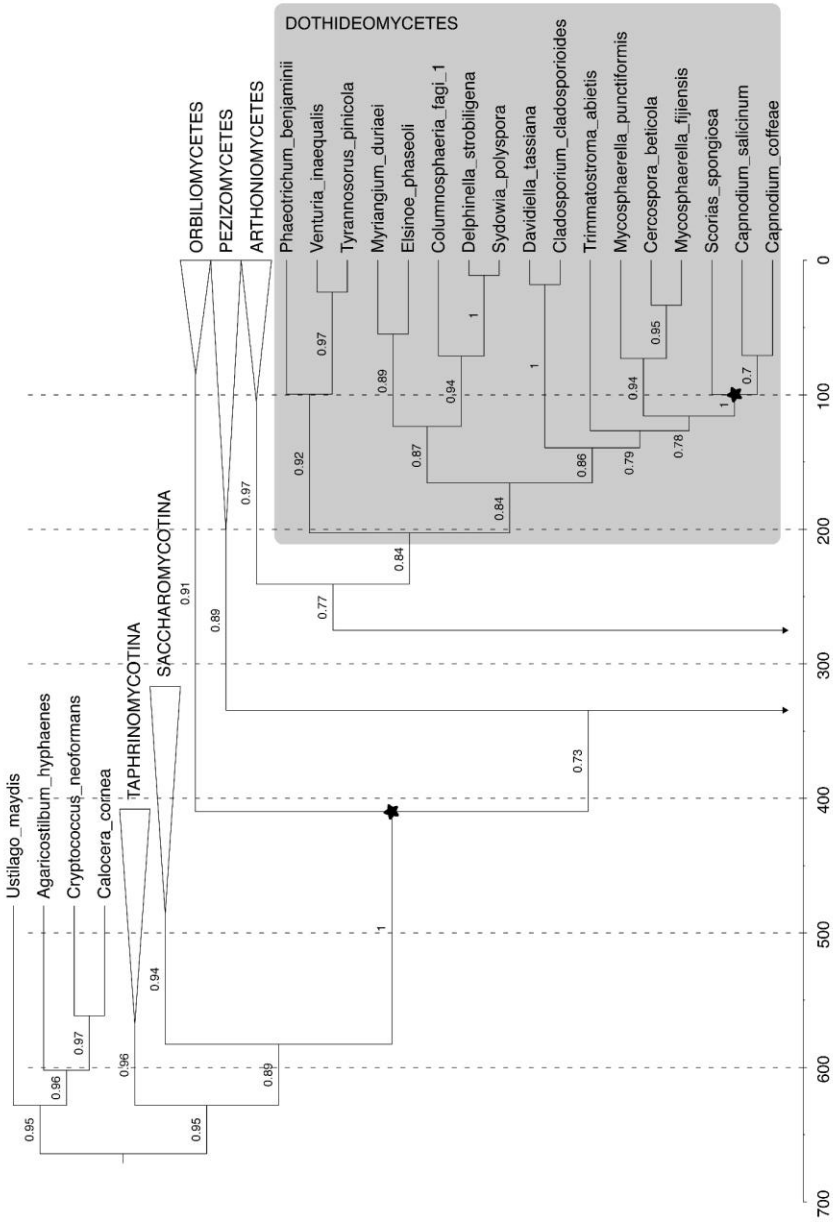


Figure 2-4. (Continued).

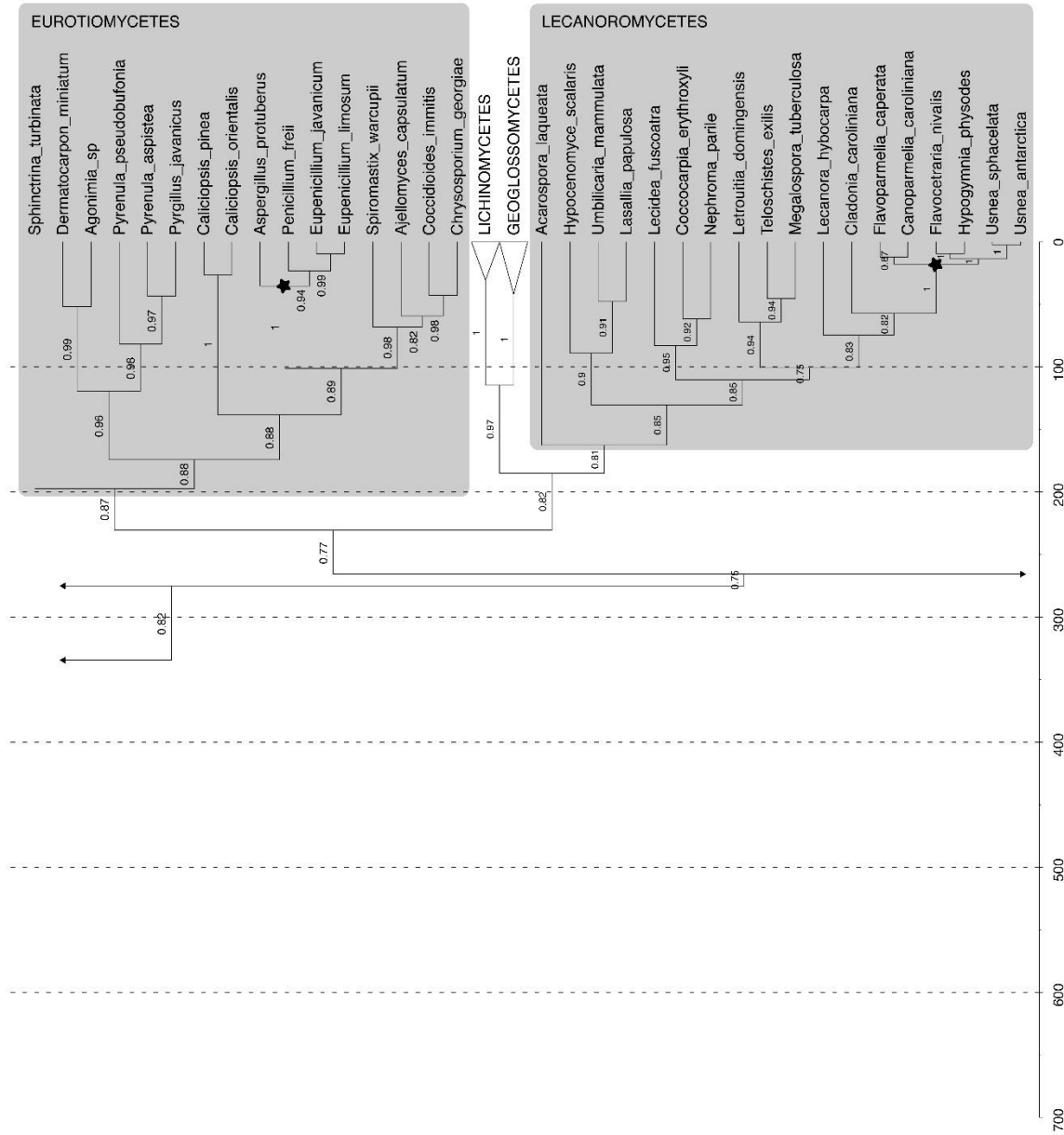
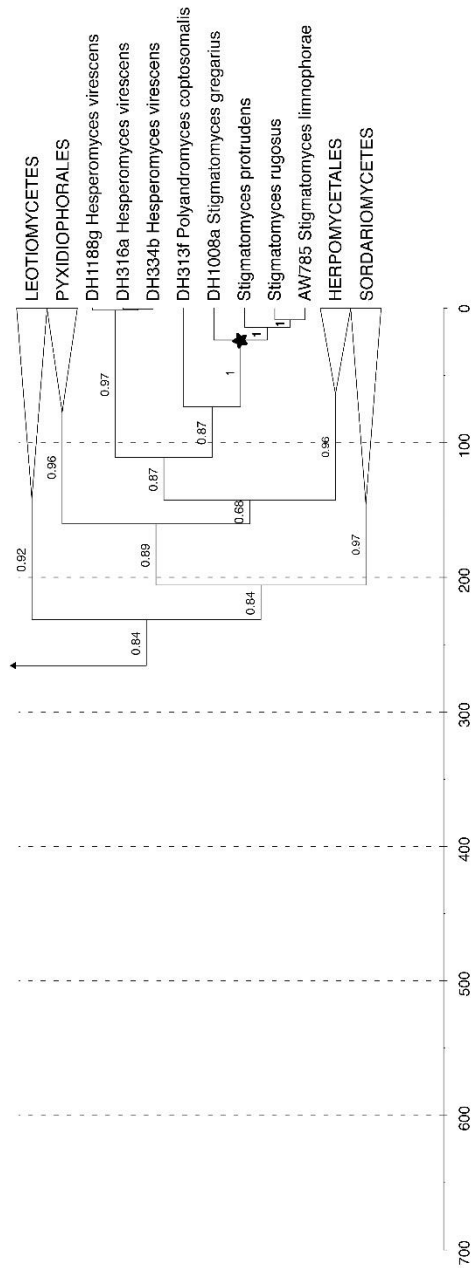


Figure 2-4. (Continued).



**Figure 2-4. (Continued).**



## TAXONOMY

To formally recognize the *Herpomyces* clade in the Laboulbeniomycetes we propose a new order. This is based on its highly supported phylogenetic placement, distinct from Laboulbeniales and Pyxidiophorales (Figures 2-1, 2-2 and 2-4), in combination with evidence from developmental, morphological and host usage data (DISCUSSION).

***Herpomycetales* nom. prov.** Haelew. & Pfister

*Type family:* Herpomycetaceae I.I. Tav., Mycotaxon 13:469 (1981).

*Type genus:* *Herpomyces* Thaxt., Proceedings of the American Academy of Arts and Sciences 38:11 (1902).

*Etymology:* Derived from its single genus, *Herpomyces*.

*Description:* Dioecious; 4-celled primary axis of thallus developing directly from ascospore; suprabasal cell in female thallus giving rise to secondary axis (or axes), producing perithecia and connecting directly with integument of the host; perithecia multi-tiered, outer wall rows consisting of many cells equal in height; ascospores 8 per ascus with median septum. On Blattodea (cockroaches).

*Note:* There is a single family Herpomycetaceae with a single genus, *Herpomyces* Thaxt. (1902).

The type species of the genus is *Herpomyces chaetophilus* Thaxt. (1902). Currently, 26 species are accepted in the Herpomycetales (Table 2-3). Acceptance is based on the combination of morphological characteristics (Thaxter, 1902, 1905, 1908, 1915, 1918, 1931; Spegazzini, 1917) and molecular data (this study).

**Table 2-3.** All 26 species of *Herpomyces* described thus far on cockroaches (order Blattodea) are listed (Thaxter, 1902, 1905, 1915, 1931; Spegazzini, 1917; this study). Species in bold are included in our phylogenetic analyses. Species with an asterisk (\*) are only known from the type collection.

<i>amazonicus</i> Thaxt.*	<b><i>ectobiae</i> Thaxt.</b>	<i>nyctoborae</i> Thaxt.*	<b><i>shelfordellae</i> nom. prov.</b>
<i>anaplectae</i> Thaxt.	<i>forficularis</i> Thaxt.	<i>panchlorae</i> Thaxt.*	<b><i>stylopygae</i> Speg.</b>
<i>appendiculatus</i> Thaxt.*	<i>gracilis</i> Thaxt.*	<i>panesthiae</i> Thaxt.*	<i>supellae</i> Thaxt.*
<i>arietinus</i> Thaxt.	<i>grenadinus</i> Thaxt.*	<i>paranensis</i> Thaxt.	<i>tricuspidatus</i> Thaxt.
<b><i>chaetophilus</i> Thaxt.</b>	<b><i>leurolestis</i> Thaxt.</b>	<b><i>periplanetae</i> Thaxt.</b>	<i>zanzibarinus</i> Thaxt.
<i>chilensis</i> Thaxt.*	<i>lobopterae</i> Thaxt.*	<i>phyllodromiae</i> Thaxt.*	
<i>diplopterae</i> Thaxt.	<i>macropus</i> Speg.	<i>platyzosteriae</i> Thaxt.*	

***Herpomyces shelfordellae* nom. prov.** Pfliegler & Haelew.

Mycobank number MB823130.

*Etymology:* Referring to the host genus of the holotype, *Shelfordella*.

*Description:* Male thallus hyaline, consisting of four superposed cells; second cell conspicuously flattened. Third and fourth cell each giving rise to an elongated cell at the upper-lateral corner, carrying a single, slender antheridium. Fourth cell ending in a short-pointed axis, which laterally carries a minuscule blackish disc.

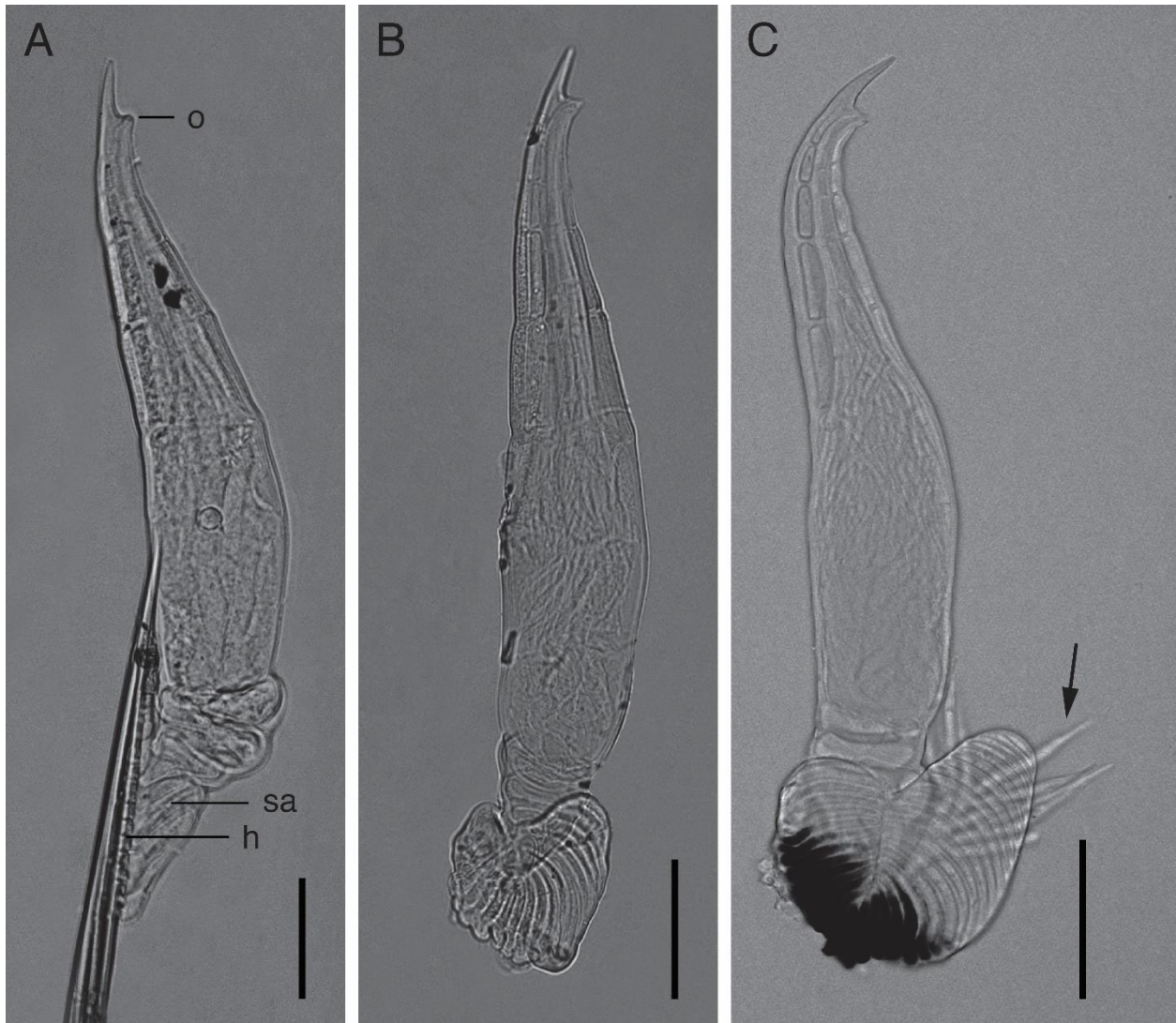
Female thallus hyaline. Primary axis of the receptacle four-celled, the proximal cell with a short and pointed apex. *Thalli from antennal setae* have a secondary axis with obliquely superposed cells. *Thalli growing on the host surface* possess a compact secondary axis, forming a single-lobed shield, 0.8–1.3× higher than wide, usually symmetrical, asymmetrical in some thalli, and usually asymmetrical in thalli possessing two perithecia, with a single lobe (rarely the basal part of the shield extending laterally, but not forming a distinct lobe with rounded apex), with broad and blunt apex; shield ornamented with concentric ridges extending between lateral edges, apical ridges slightly curved, basal ridges strongly curved to inverted U-shaped. The apex of the single lobe is broad and blunt. Perithecial basal cells flattened. Thalli usually with one

perithecium, occasionally two. Perithecium slightly bent, asymmetric, fusiform; broadest in the lower third, then gradually tapering upwards to a well-differentiated, bent neck; perithecial apex strongly asymmetrical, with the pointed ostiole positioned sideways, distally ending in an elongated, tooth-like projection. Upper fourth and fifth tier of outer wall cells conspicuously thickened, resulting in the abrupt narrowing of the inner mass at the perithecial neck.

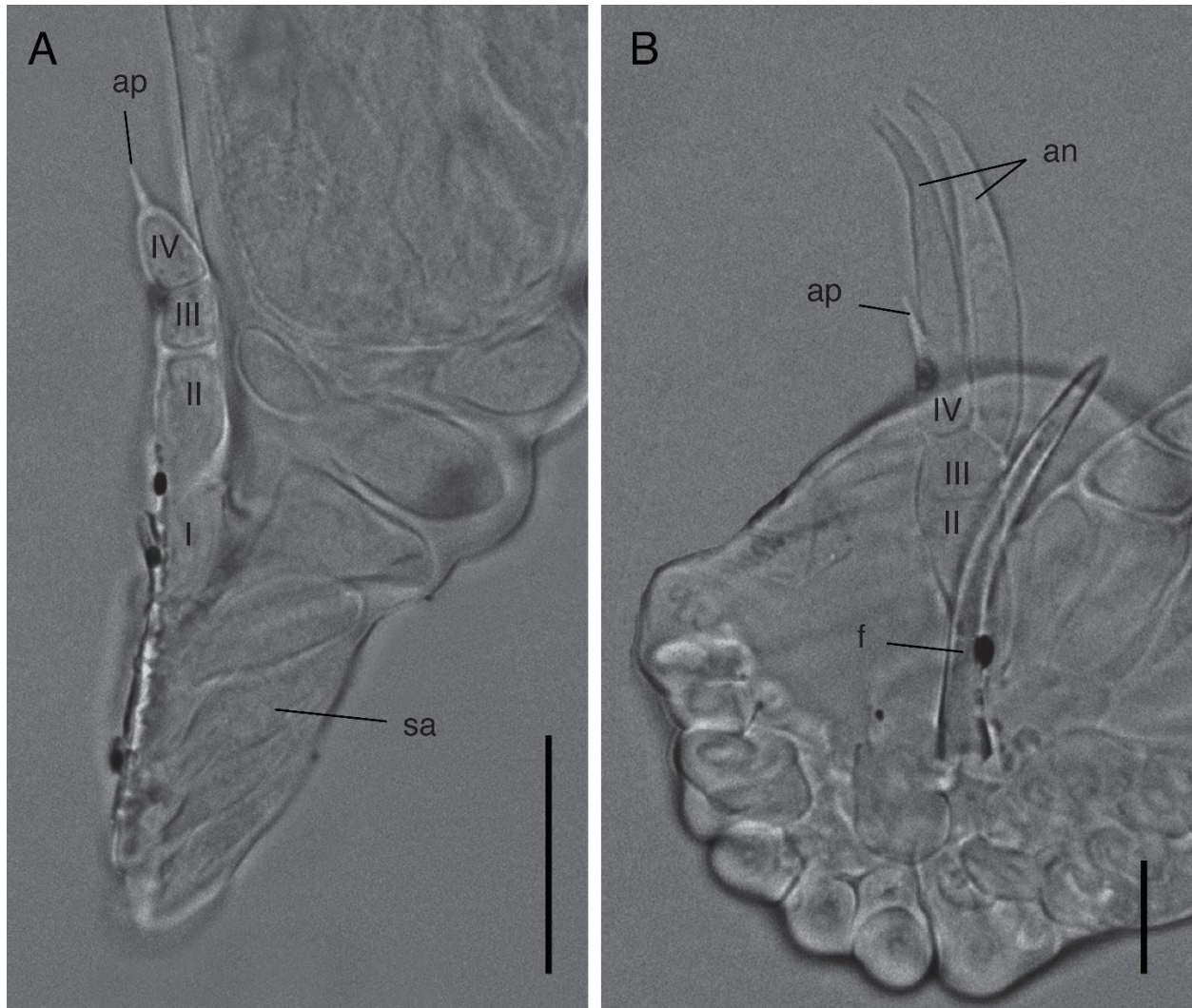
*Measurements:* Male thallus 33–40 µm in length. Female thallus 214–282 µm in length. Shield: 26–56 × 28–54 µm (height × width). Perithecia: 156–224 × 33–45 µm (without basal cells). Ascospores 24–28 × 2–3 µm.

*Material examined:* HUNGARY, Northern Great Plain Region, Hajdú-Bihar County, Debrecen, November 2014, *W.P. Pfliegler*, on antenna of *Shelfordella lateralis*, slide D. Haelew. 1414c (FH 00313669, **holotype**; Figures 2-5A,B and 2-6A). HUNGARY, Central Hungary Region, Budapest, 10 March 2015, *W.P. Pfliegler*, on antenna of *S. lateralis*, slide D. Haelew. 1415b (FH 00313670, **paratype**; Figure 2-6B). All host specimens for this species were purchased from pet stores in Hungary (Budapest, Debrecen) and subsequently kept in escape-proof terrariums at the University of Debrecen under the following conditions: 25 ± 1 °C and 14:10 [L:D] h.

*Material examined of Herpomyces stylopygae:* CANADA, Québec, 20 September 1963, *A. Francoeur*, on left antenna of male *Blatta orientalis* Linnaeus, 1758, in Collection d'insectes du Québec (CIQ), slides D. Haelew. 570a (FH 00313663), 570b (FH 00313664) and 570c (FH 00313665). HUNGARY, Central Hungary Region, Budapest, May 2015, *J. Schmidt*, on antenna of *B. orientalis*, slide D. Haelew. 951a (FH 00313666). Same data, slides D. Haelew. 952a (FH 00313667; Figure 2-5C) and 952b (FH 00313668). Hungarian host specimens for this species originated from a toxicological laboratory in Budapest.



**Figure 2-5.** *Herpomyces shelfordellae* nom. prov. (A-B) and *H. stylopygae* (C). **A.** Female thallus growing on antennal seta. Indicated are the oblique cells of the secondary axis (sa), which are attached to the host's haemocoel by haustoria (h) and the perithecial ostiole (o). **B.** Female thallus growing on host surface with a compact secondary axis forming a single-lobed shield, ornamented with concentric ridges. **C.** Female thallus of *H. stylopygae* removed from the host's integument. The most conspicuous difference from *H. shelfordellae* is its bilobed shield that is basally blackened. In addition, the male thallus of *H. stylopygae* is comparatively more developed (arrow). Scale bars = 40  $\mu$ m.



**Figure 2-6.** *Herpomyces shelfordellae* nom. prov. **A.** Detail of the four-celled primary axis of a female thallus, which has been removed from its host's spine. Annotated are cells I through IV, the pointed apex (ap) at the distal end of the fourth cell and the secondary axis of the receptacle (sa). **B.** A male thallus, attached to a spine by a small foot (f). Shown are cells II through IV, the pointed apex and two slender antheridia (an). Scale bars = 20  $\mu\text{m}$ .

## DISCUSSION

*Placement within 'Sordariomyceta'.* — Schoch *et al.* (2009a, 2009b) used the unranked taxon 'Sordariomyceta' to circumscribe the classes Leotiomyces, Laboulbeniomyces and Sordariomyces. The placement of Laboulbeniomyces within Ascomycota was shown by Weir & Blackwell (2001) based on nrSSU sequences. The sister relationship of this class with

Sordariomycetes was established from a six-gene Ascomycota-wide phylogeny that included 4 isolates of Laboulbeniomyces (Schoch *et al.*, 2009a). Our analyses are in agreement with Schoch *et al.* (2009a). Taxonomic sampling of Laboulbeniomyces is more complete in our study, with the inclusion 23 isolates from the three supported orders. These isolates represent 16 species in Herpomyetales (5 species, 9 isolates), Laboulbeniales (8 species, 10 isolates) and Pyxidiophorales (4 species, 4 isolates).

In keeping with Schoch *et al.* (2009b), who applied -myceta rankless taxa to define well-supported clades above the class level, we apply ‘Laboulbeniomyceta’ as a rankless taxon to contain all the fungi with perithecial ascomata (*pyrenomycetes*). ‘Laboulbeniomyceta’ excludes the earliest diverging class of ‘Sordariomyceta’ (the apothecial Leotiomyces). Included in this clade are the two classes Sordariomycetes and Laboulbeniomyces and perhaps some unclassified genera (“extralimital” pyrenomycetes; Samuels & Blackwell, 2001). It is clear from all analyses (Schoch *et al.*, 2009a; this study) that perithecial fungi have a single origin. Within in the various groups that produce perithecia there are different developmental pathways. This is the case within the three orders of the Laboulbeniomyces (Malloch, 1981; Parguey-Leduc & Janex-Favre, 1981; Samuels & Blackwell, 2001; Eriksson *et al.*, 2003; Schoch *et al.*, 2009b). Malloch (1981) and Samuels & Blackwell (2001) described multiple steps towards evolutionary simplification of taxa, such as the loss of the ostiole and loss of the arrangement of asci in a hymenium. In the case of Laboulbeniomyces, the simplification extends to reductions in the assimilative phase and loss of asexual states in Herpomyetales and Laboulbeniales. Along with these life history simplifications, there is a reduction to the point that thallus development is restricted to a series of highly organized, determinate mitotic divisions. There are no hyphae.

*Relationships within Laboulbeniomyces.* — The three orders within Laboulbeniomyces form an unresolved trichotomy. Only in the pruned six-gene phylogeny is there moderate support for the basal position of Pyxidiophorales (BS = 68, pp = 0.8). Blackwell (1994) put forward two potential reasons to support Pyxidiophorales as the basal-most or early diverging branch of Laboulbeniomyces. First, a switch from mycoparasitic Pyxidiophorales with arthropod dispersal to a single arthropod host in Herpomycetales and Laboulbeniales is a significant simplification of life history. Second, for *Pyxidiophora* spp., successful completion of the life cycle requires an ephemeral substrate such as herbivorous dung onto which an appropriate fungus host must grow. The shift to an arthropod-only dependency has freed Herpomycetales and Laboulbeniales from this “patchiness” (Blackwell, 1994). Although arthropod hosts themselves can be considered patchy substrates, these hosts are often long-lived as adult and they have many contacts with individuals of their own species but also other species, thus providing good conditions for Herpomycetales and Laboulbeniales fungi to be transmitted, develop and mature. These associations maintain populations. In time, divergent isolated populations have emerged, leading to microevolutionary changes and ultimately speciation. The radiation of Laboulbeniales is remarkable, given the currently 2200 described species and estimates up to 75000 (Weir & Hammond, 1997) but it may be expected considering the high diversity of a principle host group, the beetles.

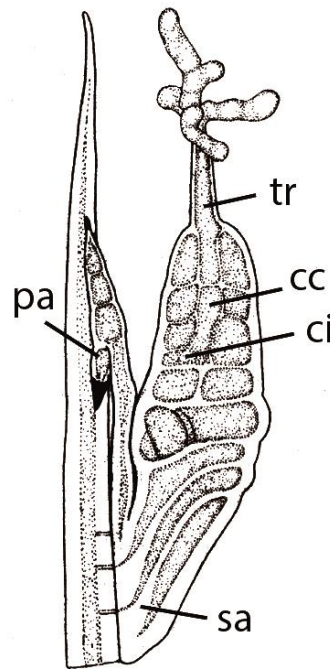
Molecular, developmental, morphological and host usage data provide ample evidence to support formally elevating the suborder Herpomycetineae to the order level. Our molecular data consistently point to three strongly supported clades within Laboulbeniomyces. In one analysis (the pruned six-gene phylogeny), there is support for within-class relationships. There is no doubt that more data of various types will resolve relationships. First, more taxa should be



represented in the phylogenetic reconstructions of the class. Many families and genera are still highly undersampled, which we believe accounts for low support among clades and long branches in our phylogenetic analyses. Second, in addition to taxon sampling, effort needs to be made to develop additional gene markers to better resolve evolutionary relationships within Laboulbeniomycetes. Genomic studies, too, will be critical. Pyxidiophorales are separated from Herpomycetales and Laboulbeniales by their more complex life cycle with two asexual states and a sexual state. In addition, their perithecia are produced from a mycelium, are composed of single-layered cell walls and most species have reduced numbers of ascospores per ascus (Blackwell & Malloch, 1989b; Kirschner, 2003; Doveri & Coué, 2005; Weir & Blackwell, 2005). Thalli of Herpomycetales and Laboulbeniales differ because they develop from an ascospore and the perithecia have two-layered walls (Weir & Blackwell, 2005). These features support the sister relationship of these two orders. The way in which these two-layered wall cells are formed, however, differs between the two orders. In Herpomycetales, the perithecial walls develop before carpogonial upgrowth, which extends between the outer wall cells (Figure 2-7). By contrast, in Laboulbeniales, the rows of outer wall cells grow upwards around and after carpogonial extension (Tavares, 1980). Ascus development differs between Herpomycetales and Laboulbeniales (Tavares, 1980, 1985). (1) The asci of Herpomycetales produce 8 ascospores; those of Laboulbeniales produce 4 ascospores. (2) In Herpomycetales, a primary septum divides the ascospore in two equal cells; in Laboulbeniales this septum is positioned near the lower end, dividing the ascospore in a smaller (directed downward) and larger cell (directed upwards). (3) Two series of ascogonic cells produce asci sequentially, first on one side, then the other, in Herpomycetales; in Laboulbeniales the asci form in a single series. Other evidence for the separation of Herpomycetales and Laboulbeniales comes from their host usage differences. All



26 species of *Herpomyces* are restricted to cockroaches. The order Laboulbeniales, on the other hand, is composed of around 2200 species and these have a wide variety of hosts in three subphyla: Cheliceriformes (subclass Acari, mites; order Opiliones, harvestmen), Myriapoda (class Diplopoda, millipedes) and Hexapoda (class Insecta, true insects). Among the Insecta, representatives of 9 orders are hosts to Laboulbeniales: Blattodea (cockroaches and termites), Coleoptera (beetles), Dermaptera (earwigs), Diptera (flies), Hemiptera (true bugs), Hymenoptera: Formicidae (ants), Orthoptera (crickets and allies), Psocodea (lice) and Thysanoptera (thrips). It is not clear why Laboulbeniales has undergone such a successful radiation while Herpomycetales has not.



**Figure 2-7.** *Herpomyces appendiculatus*. Developing female thallus attached to a single antennal spine of a *Platyzosteria scabra* cockroach. This is an enlargement of Thaxter's (1931) drawing Plate XIV, Figure 24. Indicated are: the primary axis of the receptacle (pa), secondary axis (sa) with haustoria penetrating the host's integument, the carpogonium-initiating cell (ci), the carpogenic cell (cc) and the trichogyne (tr), which receives spermata. The carpogenic cell and trichogyne are surrounded by three tiers of perithecial outer wall cells. Image courtesy of the Archives of the Farlow Herbarium of Cryptogamic Botany.

*Evolution and species delimitation within Herpomycetales.* — In our ITS phylogeny, seven species of *Herpomyces* are included. All species are highly supported, indicating the utility of the ITS region as barcode for these fungi. There does not seem to be any geographical signal in conspecific isolates. For example, the two isolates of *H. ectobiae* were collected in California (TW793a) and Poland (MG001). The wide distribution of the hosts is of course relatively recent and clearly associated with human activity. The taxonomic status of *H. stylopygae* as a separate species is confirmed. In the second volume of his monograph, Thaxter (1908) included this as a form on *Blatta orientalis* in his circumscription of *H. periplanetae*. It was Spegazzini (1917) who considered this form as a separate species, but Thaxter (1931) doubted its validity. Based on our work, we not only find that *H. stylopygae* is a well-defined species, but also that it may be highly host specific. When we found *Herpomyces* thalli on *Shelfordella lateralis*, we initially had identified them as *H. stylopygae* based on the host identification. The host species has a complex taxonomic history, contributing to our confusion. It was first described by Walker (1868) as *Periplaneta lateralis* and then transferred by Princis (1966) to *Blatta (Shelfordella) lateralis*. Later, Bohn (1985) raised *Shelfordella* to genus level. To date, the phylogenetic relationships between *Blatta* and *Shelfordella* remain elusive (Djernæs *et al.*, 2012). After careful morphological examination, it was clear that the thalli examined from this host represented an undescribed species. This was supported by our ITS phylogeny. *Herpomyces shelfordellae* and *H. stylopygae* are retrieved as sister species, but support for this sister relationship is low (BS = 53). It may be that both taxa are part of a complex of species parasitic on closely related cockroach hosts. The most distinctive morphological character of *H. shelfordellae* is its secondary axis, which forms a completely hyaline shield. In comparison, the basal tip of this shield is blackened in *H. stylopygae* (Spegazzini, 1917; Thaxter, 1931). Also *H. periplanetae* has

a hyaline shield, but female thalli of this species usually carry five perithecia (Thaxter, 1908). The combination of molecular data and morphology has been key to the recognition of *H. shelfordellae*. To date, blackening of cells and structures has been referred to as an unsatisfying character in Laboulbeniomycetes taxonomy, since variations of color are not uncommon (e.g., Thaxter, 1931; Rossi, 1991; Weir, 1998; Haelewaters *et al.*, 2015b). We find the difference in pigmentation to be significant in this case.

One interesting observation was that two of our sampled species, *H. chaetophilus* and *H. periplanetae*, co-occur on the same host individuals (*Periplaneta americana*). To test their status as separate taxa, we removed thalli of both species from a single host specimen, isolated and amplified their DNA and included the ITS sequences in our phylogeny. The isolates are D. Haelew. 602b for *H. chaetophilus* and D. Haelew. 602a, 602c and 602d for *H. periplanetae*. In this case, *H. chaetophilus* thalli were removed from the left posterior leg and those of *H. periplanetae* from the antennae. Often thalli of both species occur on antennae in close proximity of each other. Wang (2016) found that *H. periplanetae* almost exclusively occurs on the antennae, but *H. chaetophilus* occurs on antennae, coxae, femora, tibiae and tarsi. What drives this strict specificity of *H. periplanetae* is unknown.

Thaxter (1931) designated four groups, that he referred to as forms, in the genus *Herpomyces*, depending on characters of the perithecial apex. Form I includes those species with a simple apex (no projections), such as *H. chaetophilus* and *H. ectobiae* in our dataset; form II circumscribes those species with an apex subtended by a single projection, such as *H. periplanetae*, *H. shelfordellae* and *H. stylopygae*; form III is represented by *H. forficularis* (not in our dataset), in which the perithecial apex has two projections at opposite sides; and form IV includes those species with three apical projections, such as *H. leurolestis* and *H. paranensis*.

Interestingly, the species from forms II and IV form two supported clades in our ITS phylogeny. Tavares (1985) suggested that structural form I is ancestral based on three pieces of evidence: 1) Simple morphology with normally blackened foot but without shield; 2) Ectobiidae is the earliest diverging lineage of Herpomycetales-associated cockroaches (confirmed by molecular phylogenetic studies; e.g., Legendre *et al.*, 2015) and 3) the species of form I occur on cockroaches of different lineages. Our three-gene phylogeny shows that also *H. ectobiae*, parasitic on *Blattella germanica* (Ectobiidae, Blattellinae), is the earliest diverging clade, sister to all other species in the dataset.

*Origins of Blattodea and Herpomycetales.* — The host range of Laboulbeniomyces species is undeniably diverse. *Herpomycetes* species are parasites of cockroaches (Thaxter, 1908, 1931); *Laboulbeniopsis termitarius*, a member of the class with unconfirmed position, is associated with termites (Henk *et al.*, 2003); most *Pyxidiophora* species are associated with various fungal hosts in decaying substrates, and beetle and phoretic mite dispersers (Blackwell *et al.*, 1986); and the Laboulbeniales have hosts in three subphyla of Arthropoda (Weir & Hammond, 1997). Comparing the phylogeny of Laboulbeniomyces with their arthropod hosts may enable us to speculate on the evolutionary history of these fungi. However, this comparison is arguably only informative when we exclude Pyxidiophorales, because these fungi are associated with organisms across multiple kingdoms and host relationships are largely unknown. Species in Herpomycetales have cockroaches (Blattodea) as hosts. Blattodea and Mantodea (mantises) form a well-established lineage, superorder Dictyoptera, with a rich fossil record and established phylogeny (Legendre *et al.*, 2015). Recently, termites were shown to be part of Blattodea and they should be treated as an epifamily, Termitoidae, most closely related to the extant wood-

feeding cockroach *Cryptocercus* (Inward *et al.*, 2007; Eggleton *et al.*, 2007; Djernæs *et al.*, 2015; Legendre *et al.*, 2015). Estimated dates for the split between Mantodea and Blattodea vary from 315.1 to 204.3 Mya. The most recent common ancestor of the two subfamilies Blaberoidea and Blattoidea is thought to have appeared in the Late Permian—Middle Jurassic (Djernæs *et al.*, 2015; Legendre *et al.*, 2015; Wang *et al.*, 2017; Table 2-4). The only other study that constructed a molecular clock analysis of a cockroach phylogeny estimated these dates much younger (Che *et al.*, 2017), but their findings were based on a single mitochondrial marker and thus should be treated with caution.

**Table 2-4.** Molecular phylogenetic studies, including molecular dating of cockroach phylogenies based on fossil calibrations. For each reference are given: estimated dates for the split of crown-Dictyoptera into mantises and cockroaches (M-C) and the split between superfamilies Blaberoidea and Blattoidea (B-B), as well as the genes and the number of fossil calibration points used.

Reference	Split M-C	Split B-B	(Number of) genes	Fossils
Djernæs <i>et al.</i> (2015)	273±15 Mya	~ 250 Mya	(6) 12S, 16S, COII, 18S, 28S, H3	3
Legendre <i>et al.</i> (2015)	293.7–315.1 Mya	283.2–263.6 Mya	(6) 12S, 16S, COI, COII, 18S, 28S	17
Che <i>et al.</i> (2017)	145.0–185.09 Mya	125–167.4 Mya	(1) COI	6
Wang <i>et al.</i> (2017)	204.3–289.1 Mya	173.1–229.1 Mya	(5) 12S, 16S, COII, 28S, H3	8

An interesting question regarding the Blattodea-associated Herpomycetales clade is whether its divergence happened simultaneously or later than that of its hosts. In our molecular clock analysis, the split between Leotiomycetes and Sordariomycetes is at 250.93 Mya. Beimforde *et al.* (2014) did not include Laboulbeniomycetes into their analyses but dated this split around 309 Mya (267-430 Mya). The two analyses are comparable, with estimates in the (Middle to) Late Paleozoic. Further, we estimate the split between Laboulbeniomycetes and

Sordariomycetes around 223.88 Mya. Surprisingly, the Laboulbeniales lineage is much older (125.15 Mya) compared to the Herpomycetales lineage (60.52 Mya). The genera *Chitonomyces* and *Zodiomyces* are highly supported as sister clades at the base of the Laboulbeniales phylogeny. The species of these two genera occur on aquatic hosts (Tavares, 1985; Santamaria, 2004; Goldmann & Weir, 2012). It is very well possible that Laboulbeniales-like ancestors were aquatic. The Paleocene origin of the Herpomycetales clade is plausible given the divergence time estimates provided for their hosts (Djernæs *et al.*, 2015; Legendre *et al.*, 2015; Wang *et al.*, 2017). This later origin compared to Laboulbeniales points to either a host shift from a laboulbenialean ancestor on a host living in close proximity to cockroaches or divergence among populations of laboulbenialean ancestors on a cockroach host.

#### ACKNOWLEDGEMENTS

This work would not have been possible without the support of many researchers, collaborators and friends. We specifically thank: Berend Aukema, Ferenc Báthori, Ted E. Cottrell, Carl W. Dick, Dimitri Forero, Thereza de A. Garbelotto, Vladimir Gusarov, Walter Rossi, József Schmidt, Henk Spijkers, Tamara Szentiványi, András Tartally, Simon Tragust, Paul S. van Wielink, Sarah J.C. Verhaeghen, Remco Vos and James and Tristan W. Wang for collecting and/or providing host specimens; Lee H. Herman, Ruth Salass (American Museum of Natural History), Hannah Merchant, Michaela Schnull and Genevieve Tocci (Farlow Herbarium) for curatorial support; Nichola J. Hill for stimulating discussions; Timothy Y. James and his lab members for their hospitality and kindness to D.H. during his lab visit; Zurenayka Alaín, Michelle Nowak and Rachel A. Page for facilitating fieldwork in Panama. We acknowledge funding from the following sources: David Rockefeller Center for Latin American Studies

(D.H.), Mycological Society of America (D.H., Robert W Lichtwardt Student Research Award and Graduate Research Fellowship), Smithsonian Tropical Research Institute (D.H., Short-Term Research Fellowship), New York Hungarian Scientific Society (W.P.P.), ÚNKP-16-4-IV New National Excellence Program of the Hungarian Ministry of Human Capacities (W.P.P.), Polish Ministry of Science and Higher Education (M.G., grant number DI2014012344). Fieldwork in Panama was licensed and approved by the Smithsonian Tropical Research Institute (IACUC protocol: 2017-0102-2020-A5) and the government of Panama (Ministerio de Ambiente de Panamá: SE/AH-2-16, SC/AH-1-17).

#### LITERATURE CITED

- Barron GL (1968) *The genera of hyphomycetes from soil*. Baltimore: William and Wilkins.
- Beimforde C, Feldberg K, Nylinder S, Rikkinen J, Tuovila H, Dörfelt H, Gube M, Jackson DJ, Reitner J, Seyfullah LJ, Schmidt AR (2014) Estimating the Phanerozoic history of the Ascomycota lineages: combining fossil and molecular data. *Molecular Phylogenetics and Evolution* **78**: 386–398.
- Blackwell M (1994) Minute mycological mysteries: the influence of arthropods on the lives of fungi. *Mycologia* **86**: 1–17.
- Blackwell M, Bridges JR, Moser JC, Perry TJ (1986) Hyperphoretic dispersal of a *Pyxidiophora* anamorph. *Science* **232**: 993–995.
- Blackwell M, Malloch D (1989a) *Pyxidiophora*: a link between the Laboulbeniales and hyphal ascomycetes. *Memoirs of the New York Botanic Garden* **49**: 23–32.
- Blackwell M, Malloch D (1989b) *Pyxidiophora*: life histories and arthropod associations of two species. *Canadian Journal of Botany* **67**: 2552–2562.
- Bohn H (1985) *Blatta furcata* (Karny), the nearest relative of the Oriental cockroach (*Blatta orientalis* L.) (Insecta: Blattodea: Blattidae). *Israel Journal of Zoology* **33**: 39–50.
- Capella-Gutiérrez S, Silla-Martínez JM, Gabaldón T (2009) TrimAl: a tool for automated alignment trimming in large-scale phylogenetic analyses. *Bioinformatics* **25**: 1972–1973.
- Che Y, Gui S, Lo N, Ritchie A, Wang Z (2017) Species delimitation and phylogenetic relationships in ectobiid cockroaches (Dictyoptera, Blattodea) from China. *Plos One* **12**: e0169006.

- Cheng T, Xu C, Lei L, Li C, Zhang Y, Zhou S (2016) Barcoding the kingdom Plantae: new PCR primers for ITS regions of plants with improved universality and specificity. *Molecular Ecology Resources* **16**: 138–149.
- Darriba D, Taboada GL, Doallo R, Posada D (2012) jModelTest 2: more models, new heuristics and parallel computing. *Nature Methods* **9**: 772.
- Djernæs M, Klass K-D, Eggleton P (2015) Identifying possible sister groups of Cryptocercidae+Isoptera: A combined molecular and morphological phylogeny of Dictyoptera. *Molecular Phylogenetics and Evolution* **84**: 284–303.
- Djernæs M, Klass K-D, Picker MD, Damgaard J (2012) Phylogeny of cockroaches (Insecta, Dictyoptera, Blattodea), with placement of aberrant taxa and exploration of out-group sampling. *Systematic Entomology* **37**: 65–83.
- Doveri F, Coué B (2006) *Pyxidiophora badiorostris*, first record from France. *Documents Mycologiques* **34**: 33–41.
- Drummond AJ, Suchard MA, Xie D, Rambaut A (2012) Bayesian phylogenetics with BEAUti and the BEAST 1.7. *Molecular Biology and Evolution* **29**: 1969–1973.
- Edgar RC (2004) MUSCLE: multiple sequence alignment with high accuracy and high throughput. *Nucleic Acids Research* **32**: 1792–1797.
- Egger KN (1995) Molecular analysis of ectomycorrhizal fungal communities. *Canadian Journal of Botany* **73**: S1415–S1422.
- Eggleton P, Beccaloni G, Inward D (2007) Response to Lo et al. *Biology Letters* **3**: 564–565.
- Eriksson OE, Baral H-O, Currah RS, Hansen K, Kurtzman CP, Rambold G, Laessøe T (2003) Outline of Ascomycota—2003. *Myconet* **9**: 1–89,
- Gardes M, Bruns TD (1993) ITS Primers with enhanced specificity for Basidiomycetes – application to the identification of mycorrhizae and rusts. *Molecular Ecology* **2**: 113–118.
- Goldmann L, Weir A (2012) Position specificity in *Chitonomyces* (Ascomycota, Laboulbeniomyces) on *Laccophilus* (Coleoptera, Dytiscidae): a molecular approach resolves a century-old debate. *Mycologia* **104**: 1143–1158.
- Haelewaters D 2017. *Data from "Birth of an order: comprehensive phylogenetic study excludes Herpomyces (Fungi, Laboulbeniomyces) from Laboulbeniales"*. Available at <https://figshare.com/s/73c82e9df56415d08311> (accessed 31 October 2017).
- Haelewaters D, Gorczak M, Pfliegler WP, Tartally A, Tischer M, Wrzosek M, Pfister DH (2015a) Bringing Laboulbeniales into the 21st century: enhanced techniques for extraction and PCR amplification of DNA from minute ectoparasitic fungi. *IMA Fungus* **6**: 363–372.



- Haelewaters D, Zhao SY, De Kesel A, Handlin RE, Royer IR, Farrell BD, Pfister DH (2015b) Laboulbeniales (Ascomycota) of the Boston Harbor Islands I: species parasitizing Coccinellidae and Staphylinidae, with comments on typification. *Northeastern Naturalist* **22**: 459–477.
- Henk DA, Weir A, Blackwell M (2003) *Laboulbeniopsis termitarius*, an ectoparasite of termites newly recognized as a member of the Laboulbeniomycetes. *Mycologia* **95**: 561–564.
- Hill TW (1977) Ascocarp ultrastructure of *Herpomycetes* sp. (Laboulbeniales) and its phylogenetic implications. *Canadian Journal of Botany* **55**: 2015–2032.
- Inward D, Beccaloni G, Eggleton P (2007) Death of an order: a comprehensive molecular phylogenetic study confirms that termites are eusocial cockroaches. *Biology Letters* **3**: 331–335.
- Jacobs K, Holtzman K, Seifert KA (2005) Morphology, phylogeny and biology of *Gliocephalis hyalina*, a biotrophic contact mycoparasite of *Fusarium* species. *Mycologia* **97**: 111–120.
- Kirschner R (2003) Two new species of *Pyxidiophora* associated with bark beetles in Europe. *Mycological Progress* **2**: 209–218.
- Kumar S, Stecher G, Tamura K (2016) MEGA7: Molecular Evolutionary Genetics Analysis version 7.0 for bigger datasets. *Molecular Biology and Evolution* **33**: 1870–1874.
- Landvik S, Egger KN, Schumacher T (1997) Towards a subordinal classification of the Pezizales. *Nordic Journal of Botany* **17**: 403–418.
- Larena I, Salazar O, González V, Julián MC, Rubio V (1999) Design of a primer for ribosomal DNA internal transcribed spacer with enhanced specificity for ascomycetes. *Journal of Biotechnology* **75**: 187–194.
- Legendre F, Nel A, Svenson GJ, Robillard T, Pellens R, Grandcolas P (2015) Phylogeny of Dictyoptera: Dating the origin of cockroaches, praying mantises and termites with molecular data and controlled fossil evidence. *Plos One* **10**: e0130127.
- Lücking R, Huhndorf S, Pfister DH, Plata ER, Lumbsch HT (2009) Fungi evolved right on track. *Mycologia* **101**: 810–822.
- Malloch D (1981) The plectomycete centrum. In: *Ascomycete systematics* (Reynold DR, ed): 73–91. New York: Springer-Verlag.
- Miadlikowska J, Lutzoni F (2000) Phylogenetic revision of the genus *Peltigera* (lichen-forming Ascomycota) based on morphological, chemical, and large subunit nuclear ribosomal DNA data. *International Journal of Plant Sciences* **161**: 925–958.
- Miller MA, Pfeiffer W, Schwartz T (2010) Creating the CIPRES Science Gateway for inference of large phylogenetic trees. *Proceedings of the Gateway Computing Environments Workshop (GCE)* **14 Nov. 2010**: 1–8. New Orleans, Louisiana.

- Parguey-Leduc A, Janex-Favre MC (1981) The ascocarps of ascohymenial pyrenomycetes. In: *Ascomycete systematics* (Reynold DR, ed): 102–123. New York: Springer-Verlag.
- Pfliegler WP, Báthori F, Haelewaters D, Tartally A (2016) Studies of Laboulbeniales on *Myrmica* ants (III): myrmecophilous arthropods as alternative hosts of *Rickia wasmannii*. *Parasite* **23**: 50.
- Poinar Jr. G (2016) A mid-Cretaceous ectoparasitic fungus, *Spheciophila adercia* gen et sp. nov. attached to a wasp in Myanmar amber. *Fungal Genomics and Biology* **6**: 2.
- Princis K (1966) Blattariae: Suborbo Blattoidea. Fam.: Blattidae, Nocticolidae. *Orthopterorum Catalogus* **8**: 402–614.
- Rambaut A, Suchard MA, Xie D, Drummond AJ (2014) *Tracer v1.6*. Available at <http://tree.bio.ed.ac.uk/software/tracer/> (accessed 02 November 2017).
- Richards AG, Smith MN (1954) Infection of cockroaches with *Herpomyces* (Laboulbeniales). III. Experimental studies on host specificity. *Botanical Gazette* **116**: 195–198.
- Richards AG, Smith MN (1955a) Infection of cockroaches with *Herpomyces* (Laboulbeniales). I. Life history studies. *Biological Bulletin* **108**: 206–218.
- Richards AG, Smith MN (1955b) Infection of cockroaches with *Herpomyces* (Laboulbeniales). IV. Development of *H. stylopygae* Spegazzini. *Biological Bulletin* **109**: 306–315.
- Richards AG, Smith MN (1956) Infection of cockroaches with *Herpomyces* (Laboulbeniales) II. Histology and Histopathology. *Annals of the Entomological Society of America* **49**: 85–93.
- Rossi W (1991) A new species and a new record of Laboulbeniales (Ascomycetes) parasitic on myrmecophilous Staphylinidae. *Sociobiology* **18**: 197–202.
- Rossi W, Kotrba M, Triebel D (2005) A new species of *Stigmatomyces* from Baltic amber, the first fossil record of Laboulbeniomycetes. *Mycological Research* **109**: 271–274.
- Samuels GJ, Blackwell M (2001) Pyrenomycetes—fungi with perithecia. In: *The Mycota, VII. Part A. Systematics and evolution* (McLaughlin D, McLaughlin E, eds.): 221–255. Berlin: Springer.
- Sánchez R, Serra F, Tárraga J, Medina I, Carbonell J, Pulido L, de María A, Capella-Gutiérrez S, Huerta-Cepas J, Gabaldón T, Dopazo J, Dopazo H (2011) Phylemon 2.0: a suite of web-tools for molecular evolution, phylogenetics, phylogenomics and hypotheses testing. *Nucleic Acids Research* **39**: W470–W474.
- Santamaria S (2003) Laboulbeniales. II. *Acompsomyces–Ilyomyces*. *Flora Mycologia Iberica* **5**: 1–344.
- Santamaria S (2004) Two new genera of Laboulbeniales allied to *Zodiomyces*. *Mycologia* **96**: 761–772.

- Santamaria S, Balazuc J, Tavares II (1991) Distribution of the European Laboulbeniales (Fungi, Ascomycotina). An annotated list of species. *Treballs de l'Institut Botanic de Barcelona* **14**: 1–123.
- Schmidt AR, Beimforde C, Seyfullah LJ, Wege SE, Dörfelt H, Girard V, Grabenhorst H, Gube M, Heinrichs J, Nel A, Nel P, Perrichot V, Reitner J, Rikkinen J (2014) Amber fossils of sooty moulds. *Review of Palaeobotany and Palynology* **200**: 53–64.
- Schoch CL, Sung GH, López-Giráldez F, Townsend JP, Miadlikowska J, Hofstetter V, Robbertse B, Matheny PB, Kauff F, Wang Z, Gueidan C, Andrie RM, Trippe K, Ciufetti LM, Wynns A, Fraker E, Hodkinson BP, Bonito G, Groenewald JZ, Arzanlou M, de Hoog GS, Crous PW, Hewitt D, Pfister DH, Peterson K, Gryzenhout M, Wingfield MJ, Aptroot A, Suh SO, Blackwell M, Hillis DM, Griffith GW, Castlebury LA, Rossman AY, Lumbsch HT, Lücking R, Büdel B, Rauhut A, Diederich P, Ertz D, Geiser DM, Hosaka K, Inderbitzin P, Kohlmeyer J, Volkmann-Kohlmeyer B, Mostert L, O'Donnell K, Sipman H, Rogers JD, Shoemaker RA, Sugiyama J, Summerbell RC, Untereiner W, Johnston PR, Stenroos S, Zuccaro A, Dyer PS, Crittenden PD, Cole MS, Hansen K, Trappe JM, Yahr R, Lutzoni F, Spatafora JW (2009a) The Ascomycota Tree of Life: A phylum-wide phylogeny clarifies the origin and evolution of fundamental reproductive and ecological traits. *Systematic Biology* **58**: 224–239.
- Schoch CL, Wang Z, Townsend JP, Spatafora JW (2009b) Geoglossomycetes cl. nov., Geoglossales ord. nov. and taxa above class rank in the Ascomycota Tree of Life. *Persoonia* **22**: 129–138.
- Schwarz G (1978) Estimating the dimension of a model. *Annals of Statistics* **6**: 461–464.
- Spegazzini C (1917) Revisión de las Laboulbeniales argentinas. *Anales del Museo Nacional de Historia Natural de Buenos Aires* **29**: 445–688.
- Stadler T (2009) On incomplete sampling under birth-death models and connections to the sampling-based coalescent. *Journal of Theoretical Biology* **261**: 58–66.
- Stamatakis A (2014) RAxML Version 8: A tool for Phylogenetic Analysis and Post-Analysis of Large Phylogenies. *Bioinformatics* **30**: 1312–1313.
- Sundberg H, Ekman S, Kruys Å (2018) A crush on small fungi: An efficient and quick method for obtaining DNA from minute ascomycetes. *Methods in Ecology and Evolution* **9**: 148–158.
- Tavare S (1986) Some probabilistic and statistical problems in the analysis of DNA sequences. *American Mathematical Society: Lectures on Mathematics in the Life Sciences* **17**: 57–86.
- Tavares II (1965) Thallus development in *Herpomyces paranensis* (Laboulbeniales). *Mycologia* **57**: 704–721.
- Tavares II (1966) Structure and development of *Herpomyces stylopygae* (Laboulbeniales). *American Journal of Botany* **53**: 311–318.

- Tavares II (1980) Notes on perithecial development in the Euceratomycetaceae fam. nov. (Laboulbeniales, Laboulbeniineae) and *Herpomyces* (Herpomycetinae). *Mycotaxon* **11**: 485–492.
- Tavares II (1981) Validation of the Herpomycetinae and Herpomycetaceae in the Laboulbeniales. *Mycotaxon* **13**: 469–470.
- Tavares II (1985) Laboulbeniales (Fungi, Ascomycetes). *Mycological Memoir* **9**: 1–627.
- Taylor TN, Hass H, Kerp H, Krings M, Hanlin RT (2005) Perithecial ascomycetes from the 400 million year old Rhynie chert: an example of ancestral polymorphism. *Mycologia* **97**: 269–285.
- Thaxter R (1902) Preliminary diagnoses of new species of Laboulbeniaceae. V. *Proceedings of the American Academy of Arts and Sciences* **38**: 9–57.
- Thaxter R (1905) Preliminary diagnoses of new species of Laboulbeniaceae. VI. *Proceedings of the American Academy of Arts and Sciences* **41**: 303–318.
- Thaxter R (1908) Contribution toward a monograph of the Laboulbeniaceae. Part II. *Memoirs of the American Academy of Arts and Sciences* **13**: 217–469, Pl. XXVIII–LXXI.
- Thaxter R (1915) New Indo-Malayan Laboulbeniales. *Proceedings of the American Academy of Arts and Sciences* **51**: 3–51.
- Thaxter R (1918) New Laboulbeniales from Chile and New Zealand. *Proceedings of the American Academy of Arts and Sciences* **54**: 207–232.
- Thaxter R (1931) Contribution toward a monograph of the Laboulbeniaceae V. *Memoirs of the American Academy of Arts and Sciences* **16**: 1–435, Pl. I–LX.
- Toju H, Tanabe AS, Yamamoto S, Sato H (2012) High-coverage ITS primers for the DNA-based identification of ascomycetes and basidiomycetes in environmental samples. *Plos One* **7**: e40863.
- Vilgalys R, Hester M (1990) Rapid genetic identification and mapping of enzymatically amplified ribosomal DNA from several *Cryptococcus* species. *Journal of Bacteriology* **172**: 4238–4246.
- Walker F (1868) *Catalogue of the specimens of Blattariae in the collection of the British Museum*. Trustees of the British Museum. London.
- Wang TW, De Kesel A, Haelewaters D, Pfister DH (2016) Farlow Herbarium cockroach hosts new record of Laboulbeniales for North America. *Rhodora* **118**: 26–31.
- Wang Z, Shi Y, Qiu Z, Che Y, Lo N (2017) Reconstructing the phylogeny of Blattodea: robust support for interfamilial relationships and major clades. *Scientific Reports* **7**: 3903.

- Weir A (1998) Notes on the Laboulbeniales of Sulawesi. The genus *Rickia*. *Mycologia* **102**: 327–343.
- Weir A, Blackwell M (2001) Molecular data support the Laboulbeniales as a separate class of Ascomycota, Laboulbeniomycetes. *Mycological Research* **105**: 1182–1190.
- Weir A, Blackwell M (2005) Fungal biotrophic parasites of insects and other arthropods. In: *Insect-fungal associations: Ecology and evolution* (Vega FE, Blackwell M, eds): 119–145. New York: Oxford University Press.
- Weir A, Hammond PM (1997) Laboulbeniales on beetles: host utilization patterns and species richness of the parasites. *Biodiversity and Conservation* **6**: 701–719.
- White TJ, Bruns TD, Lee SB, Taylor JW (1990) Analysis of phylogenetic relationships by amplification and direct sequencing of ribosomal RNA genes. In: *PCR Protocols: a guide to methods and applications* (Innis MA, Gelfand DH, Sninsky JJ, White TJ, eds): 315–322. San Diego: Academic Press.
- Wrzosek M (2000) *Taksonomia i filogeneza Mucorales (Zygomycetes) w świetle analiz morfometrycznych oraz wybranych markerów molekularnych*. [Taxonomy and phylogeny of Mucorales (Zygomycetes) in the light of morphometrical and selected molecular markers analyses]. Doctoral dissertation. University of Warsaw, Poland.

## CHAPTER 3

**Integrative taxonomy reveals hidden species within *Hesperomyces virescens* (Fungi, Laboulbeniales), a parasite of ladybirds (Coleoptera, Coccinellidae)**

**Integrative taxonomy reveals hidden species within *Hesperomyces virescens* (Fungi, Laboulbeniales), a parasite of ladybirds (Coleoptera, Coccinellidae)**

**Abstract.** Our understanding of fungal diversity is far from complete. Fungal species descriptions generally focus on the morphological features, but this approach may underestimate species diversity. Using the morphological species concept, *Hesperomyces virescens* (Ascomycota, Laboulbeniales) is a single species with a characteristic morphology, a global distribution and a wide host range. Since its description 120 years ago, this fungal parasite has been reported from 30 ladybird hosts on all continents except Antarctica. This broad distribution area and wide host range suggest that *H. virescens* could be made up of many different species, each adapted to individual host species. Using sequence data from three gene regions, we found evidence for distinct clades within *Hesperomyces virescens*, each clade corresponding to isolates from a single host species. We propose that these lineages represent separate species, driven by adaptation to different ladybird hosts. Our combined morphometric, molecular phylogenetic and ecological data provide support for a unified species concept and an integrative taxonomy approach.

**Key words:** Divergence times, host specificity, molecular phylogenetic analysis, species complex, species delimitation analysis, unified species concept

## INTRODUCTION

*What is a species?* This is a perennial question in evolutionary biology. The answer is complex and has been intensely argued for decades. Different species concepts corresponding to multiple

biological properties provide a means to recognize, delineate and describe species. These properties include differences in morphological traits, nucleotide divergence and monophyly, reproductive isolation, ecological niches or adaptive zones, mate recognition or mating systems, geographic range, exclusive coalescence of alleles, etc. However, biologists from various research fields have advocated different and sometimes incompatible species concepts, leading to varying conclusions regarding delimitation of species and their numbers (de Queiroz, 2007). Rather than disagreeing on the conceptual agreement of what is a species (a separately evolving metapopulation lineage; Simpson, 1961), de Queiroz (1998, 2007) argues that each species concept emphasizes different properties. In evolutionary biology, “species” are hypotheses for which evidence can be sought by the study of multiple properties. The absence of a certain property does not provide evidence contradicting any given species hypothesis. This is the unifying species concept as proposed by de Queiroz (2007).

Fungi have essential functions in ecosystems, they are virtually everywhere, even in the most extreme habitats and associate with many diverse organisms (algae, plants, invertebrates and other fungi). Currently, about 135000 species of fungi have been described (Hibbett *et al.*, 2016), still many localities, habitats and taxonomic groups remain poorly sampled. In the pre-molecular era, Hawksworth (1991) estimated the number of fungal species to be 1.5 million, based on the ratio of vascular plants and fungi on the British Isles, which he accepted as 1:6. An ITS-based evaluation of soil fungal diversity of two temperate plots and the vascular plant richness in those plots led O’Brien *et al.* (2004) to extrapolate global (soil) fungal species richness estimates as ranging from 3.5 to 5.1 million. Taylor *et al.* (2014), using a large fungal dataset from a boreal ecosystem with well-established plant diversity, suggested up to 6 million species of fungi as a global estimate. Understanding how these millions of fungal species have



come to existence has stimulated widespread interest. The challenges of diversity studies are posed especially for fungi, which produce propagules that are microscopic in size, have sometimes worldwide distributions and use a multitude of host species. Pringle *et al.* (2005) postulated that morphology is a poor means to distinguish species of this magnitude given these dispersal potentials and patterns of host usage. As a result, species hypotheses about microscopic organisms with global distributions or multiple host ranges should be treated with care.

Many fungal species have been described based on morphological traits; representatives of any given species share a set of morphological characteristics. However, this morphological species concept is a poor means of species delimitation when phenotypic plasticity allows for overlapping morphologies in distinct species or when morphological traits have not yet arisen in the process of speciation (*sensu* de Queiroz, 2007). For example, the genus *Protoparmelia* *sensu stricto* (Ascomycota, Lecanorales) consists of 12 species based on morphological and chemical features but a phylogenetic-coalescent approach recognizes 23 species (Singh *et al.*, 2015). Another widely cited example is that of *Dictyonema glabratum* (Basidiomycota, Agaricales), a single morphological species that constitutes 126 species using a Generalized Mixed Yule Coalescent (GMYC) analysis of a large dataset of the internal transcribed spacer (ITS) DNA region, and even more than 400 species based on a predictive model (Lücking *et al.*, 2014).

Many species of fungi form associations with other organisms and these associations may be critical in species recognition. As a result, fungal species may be circumscribed based on the property of host associations. Host specificity represents an ecological condition; it entails resource availability and niche specialization. The concept of “ecological species” generally refers to reproductive isolation evolved through adaptation to different environments. The micro-evolutionary process of natural selection among diverging populations or subsets of a single

population acts in contrasting directions between environments and leads to the fixation of alleles, which may be advantageous in one environment but not in others (Schluter, 2000, 2001; Rundle & Nosil, 2005). The ecological species concept dates from the 1940s, when Dobzhansky (1946) wrote that “[s]peciation in *Drosophila* proceeds mainly through evolving physiological complexes which are successful each in its environment.” An interesting case study is the one where den Bakker *et al.* (2004b) investigated *Leccinum* (Basidiomycota, Boletales), a genus of ectomycorrhizal fungi forming associations with many plant hosts. Based on a *Gadph* dataset, the authors found high host specificity in all species included, except for the generalist *L. aurantiacum*. In addition, they reported niche specialization to soil conditions in the Scabra section. The authors raised the point that ecological information on its own (“the ability to grow on a new host”) does not a priori provide evidence for a species hypothesis. More recently, Araújo *et al.* (2015) described three species within the ant-parasitic *Ophiocordyceps unilateralis* species complex (Ascomycota, Hypocreales) based on the combination of molecular, micro-morphological and ecological (host specificity) data. All this is in line with de Queiroz’s (2007) view that multiple properties provide evidence for lineage separation, that is, divergence of populations and, thus, speciation.

In this paper, we explore species limits in an enigmatic group of microscopic fungi, the Laboulbeniales. *Hesperomyces virescens* has been reported to parasitize over 30 species of ladybirds (Coleoptera, Coccinellidae) in all continents but Antarctica. It grows exclusively on adult ladybird hosts in 21 genera in 5 subfamilies (Haelewaters & De Kesel, 2017; Table 3-1). Since its discovery on the invasive ladybird *Harmonia axyridis*, biologists have discussed *H. virescens* as a candidate model for studying host-parasite co-evolution and biological control programs (Haelewaters *et al.*, 2017b). Based on intra- and interspecific transmission

**Table 3-1.** All ladybird genera that have been reported as hosts for the ectoparasitic fungus *Hesperomyces virescens*, with subfamily and reference of first report. † = these genera are included in the phylogenetic analyses of this study.

Genus	Subfamily	Reference
<i>Adalia</i> †	Coccinellinae	Iperti (1964)
<i>Azya</i> †	Coccidulinae	Haelewaters <i>et al.</i> (2017a)
<i>Brachiacantha</i>	Scymninae	Harwood <i>et al.</i> (2006a)
<i>Cheilomenes</i> †	Coccinellinae	Haelewaters <i>et al.</i> (2016)
<i>Chilocorus</i>	Chilocorinae	Thaxter (1931)
<i>Coccinella</i>	Coccinellinae	Harwood <i>et al.</i> (2006b)
<i>Coccinula</i>	Coccinellinae	Castaldo <i>et al.</i> (2004)
<i>Cycloneda</i> †	Coccinellinae	Tavares (1979)
<i>Epilachna</i>	Epilachninae	Haelewaters <i>et al.</i> (2017a)
<i>Eriopis</i>	Coccinellinae	Thaxter (1931)
<i>Erythroneda</i>	Coccinellinae	Bernardi <i>et al.</i> (2014)
<i>Exochomus</i>	Coccinellinae	Castaldo <i>et al.</i> (2004)
<i>Halyzia</i> †	Coccinellinae	Haelewaters & van Wielink (2016)
<i>Harmonia</i> †	Coccinellinae	Garcés & Williams (2004)
<i>Hippodamia</i>	Coccinellinae	Thaxter (1931)
<i>Hyperaspis</i>	Scymninae	Thaxter (1931, as <i>H. hyperaspidis</i> ), Bernardi <i>et al.</i> (2014)
<i>Olla</i> †	Coccinellinae	Weir & Beakes (1996)
<i>Propylea</i>	Coccinellinae	Santamaria (1989)
<i>Psyllobora</i> †	Coccinellinae	Balazuc (1974)
<i>Tytthaspis</i>	Coccinellinae	Castaldo <i>et al.</i> (2004)

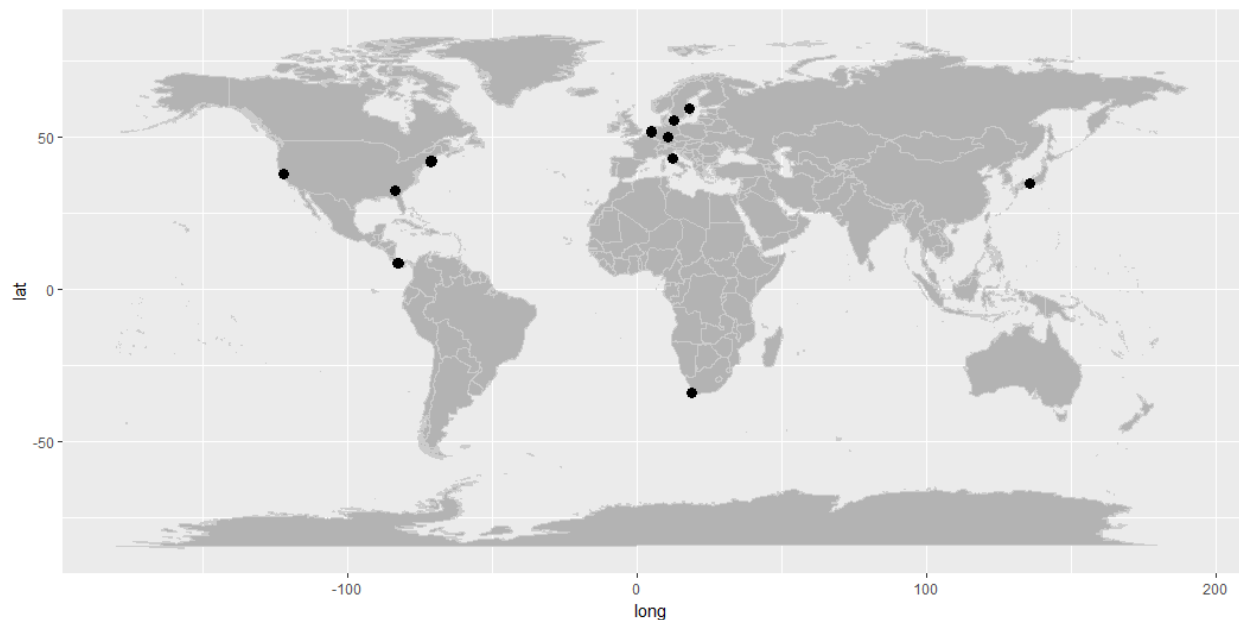
experiments, Cottrell & Riddick (2012) suggested that different lineages of *H. virescens* exist and that each of these lineages may have a high degree of host specificity. The question whether *H. virescens* truly is a single species or an assemblage of morphologically similar species has provided the starting point for the present research study. Knowing species delimitations of or within *H. virescens* will enable us to better assess species interactions or to potentially develop highly specific biological control agents. To identify *H. virescens*, mycologists have used morphological characters that can be compared across a range of different host species. Here, we combine morphological, molecular and ecological data as independent lines of evidence to infer the number of species within *H. virescens*, following the unified species concept proposed by de Queiroz (1998, 2007).

## MATERIAL AND METHODS

*Collection of host specimens.* — Our main field site for the collection of ladybirds was the 480-ha land of the USDA Southeastern Fruit and Tree Nut Research Laboratory in Georgia, USA (Riddick & Cottrell, 2010), where we collected specimens of *Harmonia axyridis* and *Olla v-nigrum* in 2014–2015. In addition, ladybirds were by the first author or collaborators at different sites in four continents: Africa, Asia, Europe and North and South America (Figure 3-1).

Sampling of ladybirds was done using a variety of standard entomological methods: Tedders pyramidal traps (Kemp & Cottrell, 2015), light traps, hand collecting and sweeping in stands of weedy vegetation along the banks of swamps and small lakes and at the sides of roadways.

Long-time preservation of ladybird specimens was in 95% ethanol at -20 °C. In addition to field-collected material, pinned ladybirds in dried insect collections were screened for the presence of

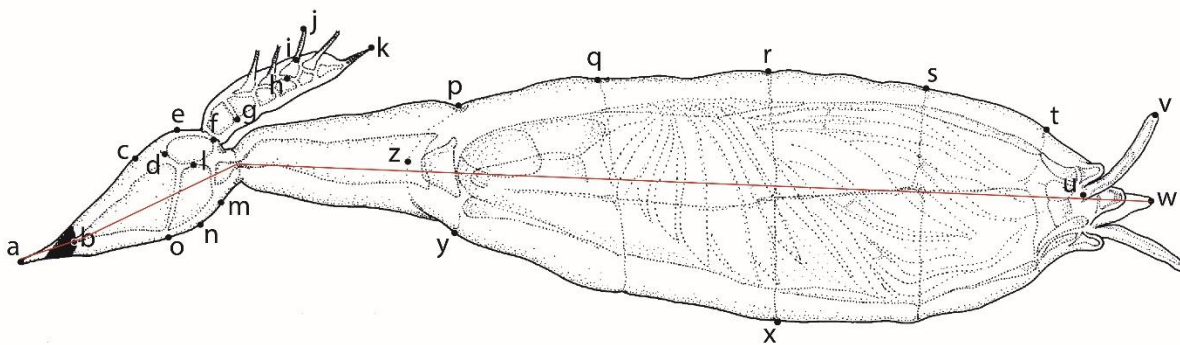


**Figure 3-1.** Ladybird hosts were collected for this project from four continents: USA and Panama in North America; Denmark, Germany, Italy, the Netherlands and Sweden in Europe; South Africa in Africa; and Japan in Asia.

Laboulbeniales. The Coccinellidae collection of the Boston Harbor Islands All Taxa Biodiversity Inventory project at the Harvard Museum of Comparative Zoology (Cambridge, Massachusetts), the Division of Invertebrate Zoology at American Museum of Natural History (New York City, New York) and the Florida State Collection of Arthropods (Gainesville, Florida) were primary sources for infected ladybirds.

*Collection of Laboulbeniales.* — Preserved insects were examined for the presence of Laboulbeniales under a dissecting microscope at 10–50× magnification. *Hesperomyces* thalli were removed from their hosts using Minutens pins (BioQuip #1208SA, Rancho Dominguez, California) inserted onto wooden rods. Following Benjamin's (1971) procedure, we removed thalli or groups of thalli and mounted them in Amann's medium, a liquid solution. Before applying Amann's medium and to facilitate microscopic observations, thalli first had to be arranged and fixed onto the microscope slide. To make thalli a bit sticky, they were first placed in a droplet of Hoyer's medium (30 g arabic gum, 200 g chloral hydrate, 16 mL glycerol, 50 mL ddH<sub>2</sub>O). Next, thalli were individually picked up and arranged in one or two rows. After a brief period of drying, the slide was closed using a cover slip with a drop of Amann's medium (drop facing downward) and subsequently sealed with nail polish or B-72 in acetone (Gaylord #AB72, Syracuse, New York). We viewed mounted specimens at 400–1000× magnification using an Olympus BX40 microscope equipped with an XC50 camera (Olympus, Waltham, Massachusetts). Identification was done using Thaxter (1896; as *Stigmatomyces virescens*), Santamaria (2003) and De Kesel (2011). Slides are deposited at Farlow Herbarium (FH; Harvard University, Cambridge, Massachusetts).

*Morphological studies.* — To assess morphological variation in thalli we took measurements of 22 parameters per thallus (Figure 3-2): total length of the thallus including haustorium (total L foot, point a—point x in Figure 3-2), total length of the thallus (total L, b—x), length of cell I (L cell I, b—d), width of cell I (W cell I, c—o), length of cell II (L cell II, m—o), width of cell II (W cell II, l—n), length of cell III (L cell III, d—f), width of cell III (W cell III, e—l), total length of receptacle (total L rec., b—f), length of basal cell of the appendage (L bas. app., f—g), total length of appendage (total L app., f—k), length of longest antheridium (L lngst. anth., h—j), length of longest antheridial neck (L anth. neck, i—j), length of cell VI (L cell VI, m—z), width of cell VI (W cell VI, p—y), perithecium length (L perith., w—z), perithecium width (W perith., r—x), length of second tier of perithecial wall cells (tier II, q—r), third tier (tier III, r—s), fourth tier (tier IV, s—t), length of lobes (lobes, t—w) and length of longest projection (lngst. proj., u—v). To correct for natural variation in length and width, these ratios were calculated: L/W cell I, L/W cell II, L/W cell III, total L rec./total L, total L app./total L, L/W cell VI, tier II/L perith., tier III/L perith., tier IV/L perith., lobes/L perith., L/W perith., L perith./total L and lngst. proj./L perith.



**Figure 3-2.** Adult thallus of *Hesperomyces virescens*, taken from a specimen of *Psyllobora vigintiduopunctata* (ADK763b, Zwin Nature Park, Belgium). Letters a through z refer to begin and end points (landmarks) for measurements taken of 22 parameters. Details in text. Drawing provided by André De Kesel.

Measurements were made at 400–1000× magnification with cellSens Standard 1.14 software (Olympus) using the Polyline measuring tool. We measured at least 30 adult thalli from each host populations. Maturity was judged by the presence of ascospores within the perithecium. To exclude potential position-induced morphological variation, only thalli from the elytra were measured and used in this study.

We analyzed variation in morphology of thalli from different host species and populations using generalized linear mixed linear models (GLMM), implemented in the R package ‘lme4’ (Bates *et al.*, 2015). Random effects for insect specimen were included, because we measured several thalli from the same host individuals. Hypothesis testing was done using likelihood ratio tests, with *P*-values calculated based on chi-squared distributions, declaring an effect significant when  $P \leq 0.05$ . Two models were compared for each variable, the null model (mod0) and the model with host species as explaining variable (mod1). Model selection happened using the Akaike Information Criterion (Akaike, 1974). For a selection of variables with significant differences between host species in the GLMMs, principal component analysis (PCA) followed by exploratory biplots were made. PCA was only done for ratios to visualize variation in shape and structure independent of size. PCA and biplots were obtained using the R package ‘factoextra’ (Kassambara, 2015).

*DNA extraction methods.* — We extracted DNA from 1–18 *Hesperomyces* thalli either using the QIAamp DNA Micro Kit (Qiagen, Stanford, California), a modified Extract-N-Amp Plant PCR kit (Sigma-Aldrich, St. Louis, Missouri) procedure (Haelewaters *et al.*, 2015), or a modified REPLI-g Single Cell Kit (Qiagen) protocol (Haelewaters *et al.*, in review). The QIAamp DNA Micro Kit protocol was followed as per the manufacturer’s instructions. One major change we

implemented was the increase of the incubation time at 56 °C for complete lysis to several days. With the Extract-N-Amp Plant PCR kit, 1–22 thalli were removed at the foot with a tiny drop of Hoyer's medium or glycerin at the tip of a Minuten Pin and placed in a 0.5 µL PCR tube with 20 µL of Extraction Solution. The tube was incubated at room temperature for 10–30 min and then at 95 °C for 20 min. The extract was diluted with 60 µL of Dilution Solution (3% Bovine Serum Albumin). The REPLI-g Single Cell Kit is different from the previous protocols because it adds a whole-genome amplification (WGA) step to the DNA isolation, thus providing a considerable benefit when material is scarce. A Minuten Pin was submerged in glycerin to remove a single thallus from its host and place it in a droplet of glycerin on a microscope slide. The thallus was carefully placed in a 0.2 mL PCR tube with 2 µL of phosphate-buffered saline (PBS). These steps were done at 40× magnification under a stereomicroscope. After adding 1.5 µL of prepared D2 buffer, the tube was incubated at 65 °C for 20 min. Subsequent steps followed the manufacturer's instructions. All steps of this procedure were performed under a laminar flow hood to ensure sterile conditions.

For a majority of our isolates, we applied pre-treatments to increase the likelihood of successful isolation and subsequent PCR amplification. These pre-treatments included subsequent cycles of freezing on liquid nitrogen and heating to 95 °C, prolonged incubation at 56 °C in 180 µL ATL buffer + 20 µL proteinase K or in 20 µL Extraction Solution using a Shake 'N Bake Hybridization Oven (Boekel Scientific model #136400-2, Feasterville, Pennsylvania) and homogenization in a FastPrep FP120 Cell Disrupter at 5.0 m/sec for 15s (Thermo Fisher Scientific, Waltham, Massachusetts). For both the QIAamp DNA Micro Kit and the Extract-N-Amp Plant PCR kit, we often manually crushed thalli in 1.5 mL tubes using a 1.5 mL pellet pestle (Kimble Chase #749521-1500, Vineland, New Jersey). In the REPLI-g Single Cell Kit, the



single thallus was often cut in half through the perithecium using a sterile no. 10 surgical blade on a disposable Bard-Parker handle (Aspen Surgical, Caledonia, Michigan) before placing it in the 0.2 mL PCR tube.

*PCR amplification and DNA sequencing.* — We amplified the nuclear small and large ribosomal subunits (SSU and LSU) and the internal transcribed spacer region of the ribosomal DNA (ITS). Primer combinations used were NS1/NS2, NS1/NS4, SL122/SR4, NSL1/NSL2, SL122/NSL2 and SL344/NS6 (White *et al.*, 1990; Landvik *et al.*, 1997; Haelewaters *et al.*, 2015; R. Vilgalys, unpubl.) for SSU; ITS1f/ITS4, ITS1f/ITS4A, ITSshesPL/ITSshesPR (White *et al.*, 1990; Gardes & Bruns, 1993; Larena *et al.*, 1999; Haelewaters *et al.*, in review) for ITS; and LIC24R/LR3 and LR0R/LR5 (Vilgalys & Hester, 1990; Miadlikowska & Lutzoni, 2000; R. Vilgalys, unpubl.) for LSU. PCR reactions consisted of 2.5  $\mu$ L of each 10  $\mu$ M primer, 13.3  $\mu$ L of RedExtract Taq polymerase (Sigma-Aldrich), 5.7  $\mu$ L of ddH<sub>2</sub>O and 1  $\mu$ L of DNA extract. For all amplifications an Eppendorf Mastercycler ep gradient thermocycler was used with initial denaturation at 94 °C for 3:00 min; followed by 35 cycles of denaturing at 94 °C for 1:00 min, annealing at 50 °C for 0:45 min, extension at 72 °C for 1:30 min; and a final extension step of 72 °C for 10:00 min. When PCR reactions were unsuccessful, we optimized PCR conditions to include multiple annealing temperatures: initial denaturation at 95 °C for 10 min; followed by 30 cycles at 95 °C for 1 min, 62 °C for 1 min (decreasing 1 °C every 3 cycles) and 72 °C for 1:30 min; then 30 cycles at 95 °C for 30 s, 55 °C for 30 s and 72 °C for 1 min; and a final extension step of 72 °C for 7 min (modified from Don *et al.*, 1991). PCR products that showed clear bands on agarose gel were purified using the QIAquick PCR Purification Kit (Qiagen) and subsequently sequenced. We prepared 10  $\mu$ L reactions with the same primers and 3–5.5  $\mu$ L of purified PCR

product. The sequencing reactions were performed using the Big Dye® Terminator v3.1 Cycle Sequencing Kit (Life Technologies, Carlsbad, California). Generated sequences were assembled, trimmed and edited in Sequencher 4.10.1 (Gene Codes Corporation, Ann Arbor, Michigan). All sequences have been deposited to GenBank.

*Sequence alignment and phylogenetic analyses.* — We constructed 3 datasets, ITS, LSU and a concatenated SSU+ITS+LSU dataset, to investigate phylogenetic structure within *H. virescens*. We aligned sequences of each region separately using Muscle v3.7 (Edgar, 2004), implemented on the Cipres Science Gateway version 3.3 (Miller *et al.*, 2010). For SSU and LSU, ambiguously aligned regions and uninformative positions were detected and removed using trimAl v1.3 (Capella-Gutiérrez *et al.*, 2009) with 60% gap threshold and minimal coverage of 50%. In the ITS dataset, we manually removed the ITS1 (positions 1—525) and ITS2 (687—1067) spacer regions for those sequences other than *Hesperomyces*, because they were too variable to align. The data for each region were concatenated in MEGA7 (Kumar *et al.*, 2016) to create a matrix of 4274 bp with phylogenetic data for 50 isolates. Alignments generated during this study are available for download in NEXUS format from the figshare online repository (Haelewaters, 2018).

Maximum likelihood (ML) analyses were run using the PAUP on XSEDE 4.0b tool (Swofford 1991) available on the Cipres web portal (Miller *et al.*, 2010). Nucleotide substitution models were selected statistically with the help of jModelTest 2.1 (Darriba *et al.*, 2012) by considering the Akaike Information Criterion (AIC). For the ITS dataset, the TVM+G model was selected (lowest  $-\ln L = 3566.8229$ ). For the LSU dataset, the TIM1+G model gave the best scoring tree ( $-\ln L = 3151.3620$ ). For the combined SSU+ITS+LSU dataset, the lowest  $-\ln L$  value

(10888.0688) was assigned to the GTR+I+G model of nucleotide substitution. ML was inferred for each dataset under the appropriate model; rapid bootstrap (BS) analysis was implemented with 100 replicates.

In addition to ML, we performed maximum parsimony (MP) and Bayesian analyses for the SSU+ITS+LSU dataset. MP was estimated with heuristic searches consisting of 500 stepwise-addition trees obtained using random sequence addition replicates followed by tree bisection-reconnection (TBR) branch swapping, MulTrees in effect and saving all equally most parsimonious trees (MPTs). Robustness of individual branches was estimated by maximum parsimony bootstrap (BS) proportions, using 1000 replicates, with TBR branch swapping, a rearrangement limit of 1000 and MaxTrees set at 100. Bayesian analyses were done with a Markov chain Monte Carlo (MCMC) coalescent approach implemented in BEAST v1.8.4 (Drummond *et al.*, 2012), with an uncorrelated lognormal relaxed molecular clock allowing for rate variation across the tree. We selected the Birth-Death Incomplete Sampling speciation model (Stadler, 2009) as tree prior with the GTR+I+G nucleotide substitution model (considering the Bayesian Information Criterion from jModelTest 2.1) and a lognormal ucl.d.mean (mean = 5.0, stdev = 1.0). Four independent runs were performed from a random starting tree for 80 million generations, with a sampling frequency of 8000. Prior settings were entered in BEAUti v.1.8.4 to generate an XML file, which was run using the BEAST on XSEDE tool in Cipres. The resulting log files of the four runs were entered in Tracer v1.6 (Rambaut *et al.*, 2014) to check trace plots for convergence (= straight hairy-caterpillar profile, Drummond *et al.*, 2007) and effective sample size (ESS). Burn-in was adjusted to achieve ESS values of  $\geq 200$  for the majority of sampled parameters (*sensu* Drummond *et al.*, 2007). While removing a portion of each run as burn-in, log files and trees files were combined in LogCombiner v.1.8.4.

TreeAnnotator v1.8.4 was used to generate consensus trees with 0% burn-in and to infer the maximum clade credibility tree, with the highest product of individual clade posterior probabilities. Final trees with bootstrap values (BS) and posterior probabilities (pp) were visualized in FigTree v1.4.3 ([tree.bio.ed.ac.uk/software/figtree/](http://tree.bio.ed.ac.uk/software/figtree/)).

*Species delimitation analyses.* — Morphology-based identification of *H. virescens* thalli (Thaxter, 1896; Weir & Beakes, 1996; Santamaria, 2003; De Kesel, 2011) may mask multiple species within a geographical context or with strict host specificity. Therefore, we used 3 species delimitation methods to validate species hypotheses: the Automatic Barcode Gap Discovery (ABGD; Puillandre *et al.*, 2012) and General Mixed Yule Coalescent methods (GMYC, Pons *et al.*, 2006) and the Poisson tree processes (PTP) model approach (Zhang *et al.*, 2013).

ABGD is based on the detection of a “barcode gap,” which is observed when nucleotide divergence among isolates of the same species is smaller than divergence among isolates of different species in a given multiple alignment. Gaps are identified and used to partition (or: split) the data into the maximum number of groups, which represent species hypotheses (Puillandre *et al.*, 2012). We used the web version of ABGD (at [wwwabi.snv.jussieu.fr/public/abgd/abgdweb.html](http://wwwabi.snv.jussieu.fr/public/abgd/abgdweb.html)) to identify barcode gaps in the SSU+ITS+LSU dataset. Genetic distances were calculated using both available distance metrics JC69 (Jukes & Cantor, 1969) and K80 (Kimura, 1980), applying the following parameters:  $P_{min} = 0.001$ ,  $P_{max} = 0.01$  (*sensu* Puillandre *et al.*, 2012), steps = 10 and Nb bins = 20. To assess consistency of the species recognized by ABGD, we evaluated results for four gap width values (X): 0.1, 0.5, 1.0 and 1.5.

In the PTP model approach, the number of nucleotide substitutions is directly used to model speciation rate. The underlying assumption is that the number of substitutions between species is significantly higher than the number of substitutions within species (Zhang *et al.*, 2013). Compared with GMYC, Zhang *et al.* (2013) found that PTP performs best, especially when the evolutionary distances between species are small. PTP is intended for the delimitation of species in single-gene trees. As a result, we applied this method to both the ITS and LSU phylogenetic reconstructions separately. As input for the PTP model approach, we used phylogenetic trees generated by Bayesian analyses for the two datasets. The MCMC analyses were done under a strict molecular clock, with the Yule speciation tree prior and the appropriate nucleotide substitution model, as selected by the Bayesian Information Criterion from jModelTest 2.1. For the ITS dataset, the TVM2uf+G model was selected (lowest  $-\ln L = 3573.5434$ ). For the LSU dataset, the K80+I model gave the best scoring tree ( $-\ln L = 1672.9035$ ). Two independent runs were performed from a random starting tree for 10 million generations, with a sampling frequency of 1000. The two resulting log files were combined in LogCombiner v1.8.4 with 1% burn-in. Consensus trees with 0% burn-in were generated and the maximum clade credibility tree was constructed in TreeAnnotator v.1.8.4. We used the bPTP web server ([species.h-its.org](http://species.h-its.org)). The “b” in bPTP stands for the Bayesian support values that are added to delimited species. The different parameters were set as default (number of MCMC generations, thinning, burn-in, seed). For both analyses the outgroups were removed from the dataset prior to constructing the phylogenetic tree.

GMYC uses a fully-resolved ultrametric tree inferred from a single marker to model processes at the population level (coalescence) and processes at the species level (speciation). As input we used the ITS and LSU maximum clade credibility trees generated for PTP. In addition,

we reconstructed a maximum clade credibility tree in BEAST v1.8.4 using the concatenated SSU+ITS+LSU dataset. For this analysis we removed the outgroups (*Arthrorhynchus nycteribiae*, *Prolixandromyces triandrus*), because the inclusion of distantly related species makes it more difficult for GMYC to detect closely related species. As above, the MCMC analysis was done under an uncorrelated lognormal relaxed molecular clock, with the Birth-Death Incomplete Sampling speciation model (Stadler, 2009) tree prior, the GTR+I+G nucleotide substitution model and a lognormal ucl.d.mean (mean = 5.0, stdev = 1.0). Two independent runs were performed from a random starting tree for 80 million generations, with a sampling frequency of 8000. The two resulting log files were combined in LogCombiner v1.8.4 with 10% burn-in. The maximum clade credibility tree was constructed in TreeAnnotator v.1.8.4. Species were delimited based on this generated ultrametric tree with the GMYC method in R (R Core Team 2013) using packages ‘rnc1’ (Michonneau *et al.*, 2015) and ‘SPLITS’ (Ezard *et al.*, 2009). R code used is available for download from the figshare online repository (Haelewaters, 2018).

*Divergence time estimates.* — To estimate ages for the individual branches within the *H. virescens* complex, we constructed a multi-gene dataset (SSU, LSU, *TEF1*, mitSSU, *RPB2*, ITS) that we could use in a molecular clock analysis based on two fossil calibration points. These were *Metacapnodiaceae* sp. (Dothideomycetes, Capnodiales) from Early Cretaceous Charentes amber (100 My) and *Stigmatomyces succini* (Laboulbeniomycetes, Laboulbeniales) from Bitterfeld amber (35 My). We downloaded SSU, LSU, *TEF1*, mitSSU and *RPB2* sequences of Arthoniomycetes, Dothideomycetes, Sordariomycetes and Laboulbeniomycetes from GenBank

(ncbi.nlm.nih.gov/genbank/). ITS sequences of Laboulbeniomycetes were included in this dataset to ensure maximum support at the tips.

## RESULTS

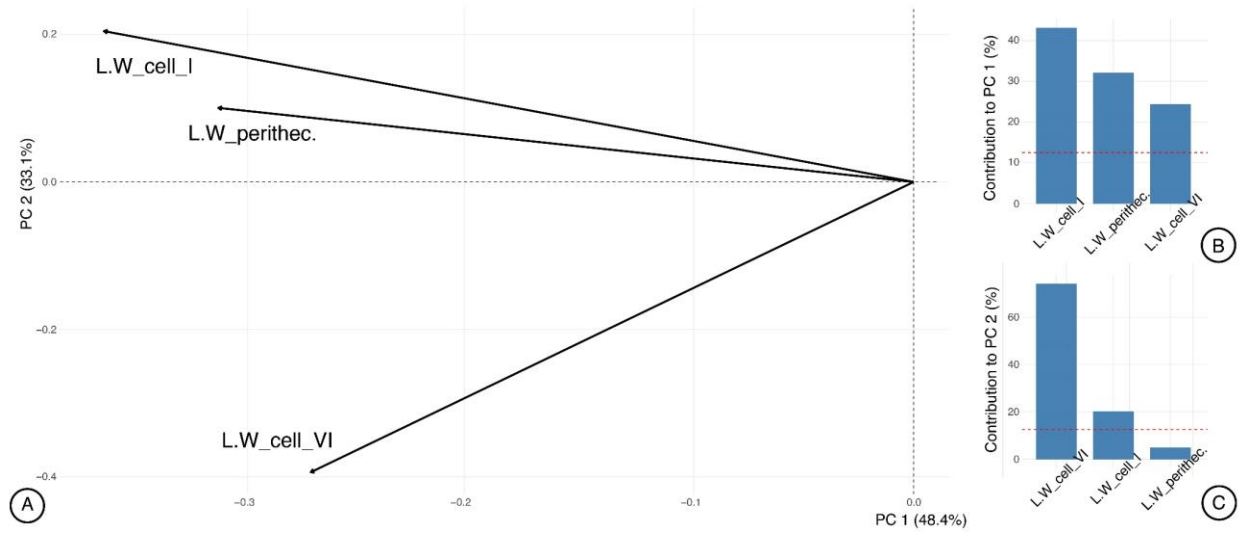
*Morphometric approach.* — Detailed measurements and ratios for 181 thalli were included in the analysis. For a majority of variables, the best model to explain differences in measurements contained host species (Mod1 in Table 3-2). Inclusion of host species as an explanatory variable considerably improved model performance. Of the 35 studied variables, 10 did not differ significantly between host species: W cell I, L cell II, W cell II, L cell VI, lngst. proj., L/W cell II, total L rec./total L, tier II/L perith., tier III/L perith. and lngst. proj./L perith.

We only considered ratios for PCA to focus on shape rather than natural variation in absolute size. Significant differences were observed for the following ratios: L/W cell I, L/W cell III, total L app./total L, L/W cell VI, tier IV/L perith., lobes/L perith., L/W perith. and L perith./total L. Statistical processing of these ratios revealed two principal components (PCs) that together accounted for 81.54% of the observed variation in thallus morphology of *H. virescens* between *C. propinqua*, *H. axyridis* *O. v-nigrum*. PC1, 48.39% variation explained, represents L/W cell I, L/W perith. and L/W cell VI (Figure 3-3). PC2, 33.15% variation explained, represents L/W cell VI and L/W cell I (Figure 3-3). In the morphospace formed by the two first PCs, clouds of individuals from the 3 different host species overlap partly, but they also occupy a considerable part of the morphospace without overlap (Figure 3-4).

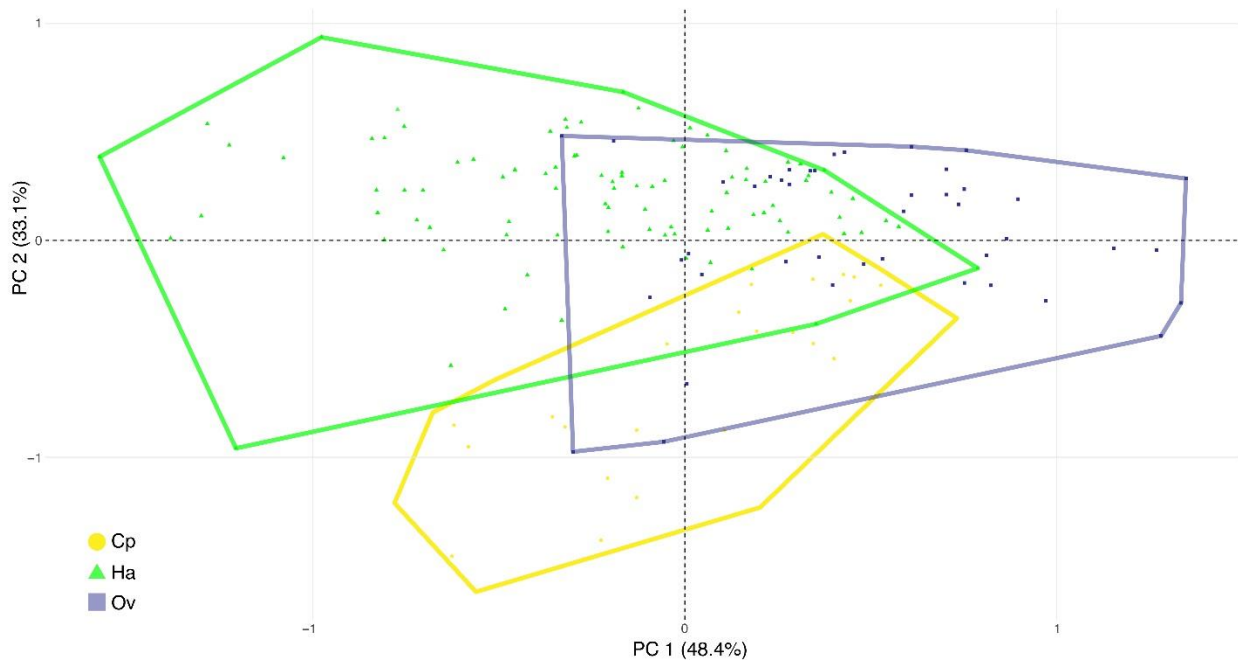
**Table 3-2.** Comparison of the generalized linear mixed models (GLMMs) for all variables (measured parameters and ratios) of *Hesperomyces virescens* thalli removed from different host species.  $\Delta$ AIC is calculated as the AIC for each model with host species as explaining variable (mod1) minus the AIC of the null model (mod0). \*Variables that are significantly different among thalli from different host species. (\*)L cell II is marginally significant ( $0.05 < P < 0.1$ ).

Parameter	Mean	St. d.	Mod0	Mod1	$\Delta$ AIC	Chi-sq.	P
MEASUREMENTS							
total L w foot*	388.24	66.50	1457.4	1448.5	-8.9	12.904	0.0016
total L*	374.33	66.50	1857.9	1849.4	-8.5	12.522	0.0019
L cell I*	59.44	9.66	1103.4	1088.1	-15.3	19.24	0.0000
W cell I	22.14	3.27	901.42	901.22	-0.2	4.1979	0.1226
L cell II(*)	28.41	5.35	1023.4	1021.5	-1.9	5.8435	0.0538
W cell II	18.45	3.56	884.89	884.41	-0.48	4.4752	0.1067
L cell III*	13.70	3.05	812.53	804.39	-8.14	12.142	0.0023
W cell III*	16.33	3.13	861.48	856.72	-4.76	8.7583	0.0125
total L rec.*	73.79	11.29	1149.8	1138.2	-11.6	15.634	0.0004
L bas. app.*	18.40	2.59	674.38	660.79	-13.59	17.587	0.0002
total L app.*	70.97	7.83	1066.0	1039.2	-26.8	30.768	0.0000
L lngst. anth.*	25.39	2.83	769.99	754.72	-15.27	19.277	0.0000
L anth. neck*	15.18	1.74	621.59	597.66	-23.93	27.93	0.0000
L cell VI	46.91	13.78	1395.6	1396.3	0.7	3.3397	0.1883
W cell VI*	28.43	6.28	1026.5	1018.1	-8.4	12.313	0.0021
L perith.*	262.69	49.57	1733.1	1722.5	-10.6	14.536	0.0007
W perith.*	68.96	10.02	1234.7	1223.8	-10.9	14.901	0.0006
tier II*	65.86	13.91	1325.6	1319.3	-6.3	10.241	0.0060
tier III*	59.97	12.69	1256.3	1245.8	-10.5	14.573	0.0007
tier IV*	40.35	10.14	1159.6	1136.5	-23.1	27.104	0.0000
lobes*	47.62	4.19	905.45	892.02	-13.43	17.431	0.0002
lngst. proj.	31.37	8.21	1200.0	1200.9	0.9	3.0464	0.2180
RATIOS							
L/W cell I*	2.71	0.45	173.88	156.21*	-17.67	21.67	0.0000
L/W cell II	1.57	0.30	54.933	55.249	0.316	3.6841	0.1585
L/W cell III*	0.85	0.16	-178.84	-189.19	-10.35	14.355	0.0007
total L rec./total L	0.20	0.03	-959.95	-956.78	3.17	0.8295	0.6605
total L app./total L*	0.19	0.04	-829.88	-838.57	-8.69	12.69	0.0018
L/W cell VI*	1.68	0.49	155.81	136.72	-19.09	23.09	0.0000
tier II/L perith.	0.25	0.02	-1002.85	-999.05	3.8	0.2047	0.9027
tier III/L perith.	0.23	0.01	-1056.7	-1056.5	0.2	3.8681	0.1446
tier IV/L perith.*	0.15	0.02	-1014.9	-1043.2	-28.3	32.374	0.0000
lobes/L perith.*	0.19	0.03	-880.54	-885.27	-4.73	8.7339	0.0127
L/W perith.*	3.80	0.40	93.579	82.962	-10.617	14.617	0.0007
L perith./total L*	0.70	0.03	-866.06	-873.16	-7.1	11.091	0.0039
lngst. proj./L perith.	0.12	0.04	-752.50	-750.19	2.31	1.6866	0.4303





**Figure 3-3.** A. Morphospace formed by the first two PCs of the PCA showing the importance of ratios. B, C. Contributions of included ratios to PC1 (B) and PC2 (C) separately. The dashed line is a reference corresponding to the expected value if the contributions were uniform. Contributions above the reference line are considered as important.



**Figure 3-4.** Principal component analysis (PCA) using morphometric variables showing variation in thallus shape. Each symbol represents an individual thallus in the two-dimensional morphospace formed by the first two PCs. Thalli are colored by host species (yellow circles *Cheilomenes propinqua*, green triangles *Harmonia axyridis*, purple squares *Olla v-nigrum*).

*Nucleotide alignment datasets.* — We generated 93 *Hesperomyces* sequences during this study, of the SSU (31), ITS (37) and LSU (25) regions. Our ITS dataset comprised 1068 characters, of which 769 were constant and 229 were parsimony-informative. A total of 41 ITS sequences were included, of which 35 have been newly generated during the course of this study, complemented by 16 sequences that we retrieved from GenBank ([ncbi.nlm.nih.gov/genbank/](http://ncbi.nlm.nih.gov/genbank/)): 43 sequences of *H. virescens*, 2 of *H. coleomegillae*, 2 of *H. palustris* and 4 of *Herpomyces* spp. (outgroup). Isolates of *H. virescens* originated from 9 host species: *Adalia bipunctata* (5 isolates), *A. decempunctata* (2), *Azya orbiger*a (1), *Cheilomenes propinqua* (5), *Cycloneda sanguinea* (2), *Halyzia sedecimguttata* (1), *Harmonia axyridis* (16), *Olla v-nigrum* (8) and *Psyllobora vigintimaculata* (3). Our LSU dataset consisted of 25 newly generated sequences (22 of *H. virescens*, 2 of *H. coleomegillae* and 1 of *H. palustris*) complemented by 14 sequences downloaded from GenBank (9 of *H. virescens*, 4 of *Herpomyces* spp. and 1 of *Pyxidiophora* cf. *microspora* as outgroup) and 1051 characters, of which 769 were constant and 222 were parsimony-informative. Isolates of *H. virescens* originated from 7 host species: *Adalia bipunctata* (5 isolates), *A. decempunctata* (1), *Azya orbiger*a (1), *Cheilomenes propinqua* (2), *Harmonia axyridis* (13), *Olla v-nigrum* (6) and *Psyllobora vigintimaculata* (3).

Our concatenated SSU+ITS+LSU dataset included 4274 characters and 50 isolates representing 5 species (GenBank accession numbers in Table 3-3). Of all characters, 3471 were constant and 346 were parsimony-informative. Taxonomic sampling covered 3 genera in the Laboulbeniales: *Arthrorhynchus*, *Hesperomyces* and *Prolixandromyces*. In addition to 44 isolates of *H. virescens*, we included *Arthrorhynchus nycteribiae*, *Prolixandromyces triandrus* (outgroup), *Hesperomyces coleomegillae* and *H. palustris*. Isolates of *H. virescens* originated from 9 different host species: *Adalia bipunctata* (6 isolates), *A. decempunctata* (2), *Azya*

**Table 3-3.** Overview of Laboulbeniomyces sequences used in this study, with indication of in which datasets isolates were used (ITS, LSU, SSU+ITS+LSU). All isolates of which sequences were generated are listed, with country and host species information as well as GenBank accession numbers. Sequences in bold were generated during the course of this study.

Species	Isolate, voucher	Geography	Host species	SSU	ITS	LSU	Dataset(s)	
							ITS	LSU
<i>Pyxidiphora</i> cf. <i>microspora</i>	MG200	Poland		MG438334	MG438314	MG438362		X
<i>Herpomyces chaetophilus</i>	D. Haelew. 483b	USA, Massachusetts	<i>Periplaneta americana</i>	MG438319	MG438293	MG438350	X	X
<i>Herpomyces chaetophilus</i>	D. Haelew. 602b	USA, Massachusetts	<i>Periplaneta americana</i>	KT800023	KT800039	KT800009	X	X
<i>Herpomyces periplanetae</i>	D. Haelew. 602d	USA, Massachusetts	<i>Periplaneta americana</i>	MG438327	MG438305	MG438357	X	X
<i>Herpomyces periplanetae</i>	D. Haelew. 1187d	USA, Massachusetts	<i>Periplaneta americana</i>	MG438331	MG438309	MG438359	X	X
<i>Arthrorhynchus nycteribiae</i>	Edeleny_13.xi.2014	Hungary	<i>Penicillidia conspiciua</i>	KY094496		KY094497		X
<i>Prolixandromyces triandrus</i>	HNHM107914	Hungary	<i>Velia saulii</i>	LT158294	LT158296	LT158295		X
<i>Hesperomyces coleomegillae</i>	631C	Ecuador	<i>Coleomegilla maculata</i>	KF266882	KF192892		X	X
<i>Hesperomyces coleomegillae</i>	632A	Ecuador	<i>Coleomegilla maculata</i>	KF266880	KF192888		X	X
<i>Hesperomyces coleomegillae</i>	D. Haelew. 1287b	Panama	<i>Coleomegilla maculata</i>			<b>MG745334</b>		X
<i>Hesperomyces coleomegillae</i>	D. Haelew. 1291c	Panama	<i>Coleomegilla maculata</i>			<b>MG745335</b>		X
<i>Hesperomyces palustris</i>	631K	Ecuador	<i>Coleomegilla maculata</i>	KF266902	KF192902		X	X
<i>Hesperomyces palustris</i>	632B	Ecuador	<i>Coleomegilla maculata</i>	KF266891	KF192899		X	X
<i>Hesperomyces palustris</i>	D. Haelew. 1325a	Panama	<i>Coleomegilla maculata</i>		<b>MG745336</b>	<b>MG745336</b>		X
<i>Hesperomyces virescens</i>	D. Haelew. 316a	USA, Georgia	<i>Harmonia axyridis</i>	MG438339	MG438315	KJ842339	X	X
<i>Hesperomyces virescens</i>	D. Haelew. 334b	Netherlands	<i>Harmonia axyridis</i>	MG438340	MG438316	MG438364	X	X

**Table 3-3. (Continued).**

Species	Isolate, voucher	Geography	Host species	SSU	ITS	LSU	Dataset(s)		
							ITS	LSU	3-gene
<i>Hesperomyces virescens</i>	JP352b	USA, Georgia	<i>Olla v-nigrum</i>	<b>MG760581</b>	<b>MG757798</b>	<b>MG745337</b>	X	X	X
<i>Hesperomyces virescens</i>	JP353a	USA, Georgia	<i>Olla v-nigrum</i>	KT800028	KT800043	KT800013	X	X	X
<i>Hesperomyces virescens</i>	JP353b	USA, Georgia	<i>Olla v-nigrum</i>	<b>MG760582</b>	<b>MG757799</b>	<b>MG745338</b>	X	X	X
<i>Hesperomyces virescens</i>	JP354b	USA, Georgia	<i>Olla v-nigrum</i>	<b>MG760583</b>	<b>MG757800</b>	<b>MG745339</b>	X	X	X
<i>Hesperomyces virescens</i>	D. Haelew. 361a	Netherlands	<i>Harmonia axyridis</i>	<b>MG760584</b>	<b>MG757801</b>		X		X
<i>Hesperomyces virescens</i>	D. Haelew. 486c	USA, Massachusetts	<i>Harmonia axyridis</i>	<b>MG760585</b>	KT800044	KT800014	X	X	X
<i>Hesperomyces virescens</i>	HM497c	USA, Georgia	<i>Harmonia axyridis</i>	KT800030	KT800046	KT800016	X	X	X
<i>Hesperomyces virescens</i>	D. Haelew. 516a	USA, Massachusetts	<i>Harmonia axyridis</i>	<b>MG760586</b>	<b>MG757802</b>	<b>MG745340</b>	X	X	X
<i>Hesperomyces virescens</i>	D. Haelew. 646a	Germany	<i>Harmonia axyridis</i>	<b>MG760587</b>	<b>MG745341</b>	<b>MG745341</b>	X	X	X
<i>Hesperomyces virescens</i>	D. Haelew. 646c	Germany	<i>Harmonia axyridis</i>	<b>MG760588</b>	KT800045	KT800015	X	X	X
<i>Hesperomyces virescens</i>	D. Haelew. 648c	South Africa	<i>Harmonia axyridis</i>	KU574863	KU574864	KU574865	X	X	X
<i>Hesperomyces virescens</i>	D. Haelew. 653a	South Africa	<i>Cheilomenes propinqua</i>	<b>MG760589</b>	<b>MG757803</b>		X		X
<i>Hesperomyces virescens</i>	D. Haelew. 655c	South Africa	<i>Cheilomenes propinqua</i>	KU574866	<b>MG757804</b>	KU574867	X	X	X
<i>Hesperomyces virescens</i>	D. Haelew. 659b	South Africa	<i>Cheilomenes propinqua</i>	<b>MG760590 (659a)</b>	<b>MG757805</b>	<b>MG745342</b>	X	X	X
<i>Hesperomyces virescens</i>	D. Haelew. 659d	South Africa	<i>Cheilomenes propinqua</i>	<b>MG760591</b>	<b>MG757806</b>		X		X
<i>Hesperomyces virescens</i>	D. Haelew. 669a	South Africa	<i>Harmonia axyridis</i>		<b>MG757807</b>				X
<i>Hesperomyces virescens</i>	D. Haelew. 924a	Panama	<i>Cycloneda sanguinea</i>	KX533512 (929a)	<b>MG757808</b>		X		X

**Table 3-3. (Continued).**

Species	Isolate, voucher	Geography	Host species	SSU	ITS	LSU	Dataset(s)		
							ITS	LSU	3-gene
<i>Hesperomyces virescens</i>	D. Haelew. 928g	Panama	<i>Azya orbigera</i>	<b>MG760592</b>	<b>MG745343</b>	<b>MG745343</b>	X	X	X
<i>Hesperomyces virescens</i>	D. Haelew. 943a	South Africa	<i>Harmonia axyridis</i>	<b>MG760593</b>	<b>MG757809</b>		X		X
<i>Hesperomyces virescens</i>	D. Haelew. 943b	South Africa	<i>Harmonia axyridis</i>	<b>MG760594</b>	<b>MG757810</b>	<b>MG745344</b>	X	X	X
<i>Hesperomyces virescens</i>	D. Haelew. 954d	USA, Georgia	<i>Olla v-nigrum</i>	<b>MG760595</b>	<b>MG757811</b>		X		X
<i>Hesperomyces virescens</i>	D. Haelew. 954e	USA, Georgia	<i>Olla v-nigrum</i>	<b>MG760596</b>	<b>MG757812</b>		X		X
<i>Hesperomyces virescens</i>	D. Haelew. 955b	Netherlands	<i>Halysia sedecimguttata</i>		<b>MG757813</b>		X		X
<i>Hesperomyces virescens</i>	D. Haelew. 1005c	South Africa	<i>Harmonia axyridis</i>	<b>MG760597</b>	<b>MG757814</b>		X		X
<i>Hesperomyces virescens</i>	D. Haelew. 1174a	Netherlands	<i>Harmonia axyridis</i>	<b>MG760598</b>	<b>MG757815</b>	<b>MG745345</b>	X	X	X
<i>Hesperomyces virescens</i>	D. Haelew. 1188g	USA, Massachusetts	<i>Harmonia axyridis</i>	MG438341	MG438317	MG438365	X	X	X
<i>Hesperomyces virescens</i>	D. Haelew. 1193a	Denmark	<i>Adalia bipunctata</i>		<b>MG757816</b>		X		X
<i>Hesperomyces virescens</i>	D. Haelew. 1193g	Denmark	<i>Adalia bipunctata</i>	<b>MG760599</b>	<b>MG757817</b>	<b>MG745346</b>	X	X	X
<i>Hesperomyces virescens</i>	D. Haelew. 1199h	Sweden	<i>Adalia bipunctata</i>	<b>MG760600</b>	<b>MG757818</b>	<b>MG745347</b>	X	X	X
<i>Hesperomyces virescens</i>	D. Haelew. 1200h	USA, Georgia	<i>Adalia bipunctata</i>	<b>MG760601</b>	<b>MG757819</b>	<b>MG745348</b>	X	X	X
<i>Hesperomyces virescens</i>	D. Haelew. 1200i	USA, Georgia	<i>Olla v-nigrum</i>	<b>MG760602</b>	<b>MG757820</b>	<b>MG745349</b>	X	X	X
<i>Hesperomyces virescens</i>	D. Haelew. 1231a	Italy	<i>Adalia bipunctata</i>	<b>MG760603</b>	<b>MG757821</b>	<b>MG745350</b>	X	X	X
<i>Hesperomyces virescens</i>	D. Haelew. 1232a	Italy	<i>Adalia bipunctata</i>	<b>MG760604</b>	<b>MG757822</b>	<b>MG745351</b>	X	X	X
<i>Hesperomyces virescens</i>	D. Haelew. 1247a	Italy	<i>Adalia bipunctata</i>	<b>MG760605</b>	<b>MG745352</b>	<b>MG745352</b>	X	X	X

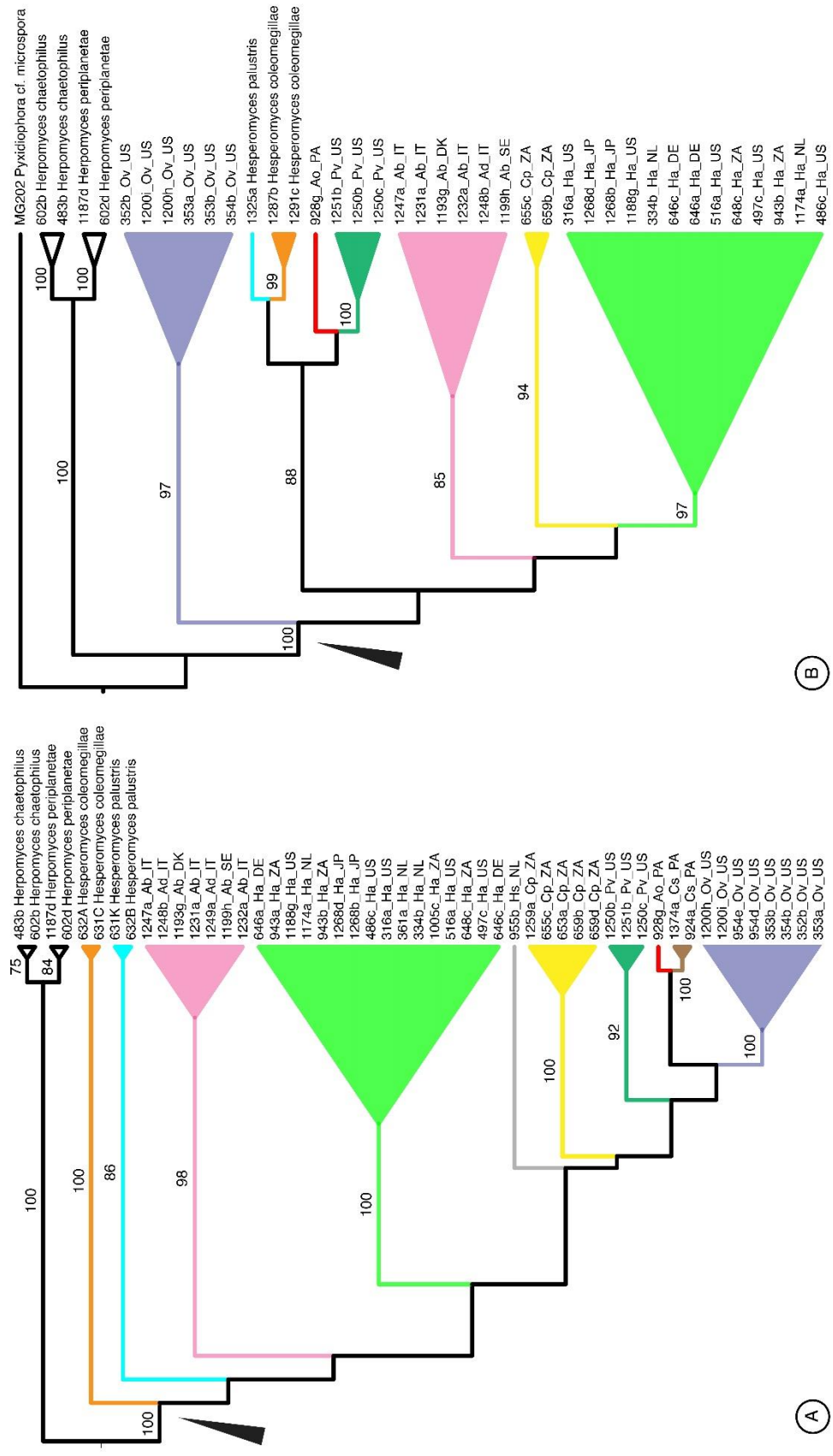
**Table 3-3. (Continued).**

Species	Isolate, voucher	Geography	Host species	SSU	ITS	LSU	Dataset(s)		
							ITS	LSU	3-gene
<i>Hesperomyces virescens</i>	D. Haelew. 1248b	Italy	<i>Adalia decempunctata</i>	<b>MG760606</b>	<b>MG757823</b>	<b>MG745353</b>	X	X	X
<i>Hesperomyces virescens</i>	D. Haelew. 1249a	Italy	<i>Adalia decempunctata</i>		<b>MG757824</b>		X		X
<i>Hesperomyces virescens</i>	D. Haelew. 1250b	USA, California	<i>Psyllobora vigintimaculata</i>	<b>MG760607</b>	<b>MG757825</b>	<b>MG745354</b>	X	X	X
<i>Hesperomyces virescens</i>	D. Haelew. 1250c	USA, California	<i>Psyllobora vigintimaculata</i>	<b>MG760608</b>	<b>MG757826</b>	<b>MG745355</b>	X	X	X
<i>Hesperomyces virescens</i>	D. Haelew. 1251b	USA, California	<i>Psyllobora vigintimaculata</i>	<b>MG760609</b>	<b>MG757827</b>	<b>MG745356</b>	X	X	X
<i>Hesperomyces virescens</i>	D. Haelew. 1259a	South Africa	<i>Cheilomenes propinqua</i>		<b>MG757828</b>		X		
<i>Hesperomyces virescens</i>	D. Haelew. 1268b	Japan	<i>Harmonia axyridis</i>	<b>MG760610</b>	<b>MG757829</b>	<b>MG745357</b>	X	X	X
<i>Hesperomyces virescens</i>	D. Haelew. 1268d	Japan	<i>Harmonia axyridis</i>	<b>MG760611</b>	<b>MG757830</b>	<b>MG745358</b>	X	X	X
<i>Hesperomyces virescens</i>	D. Haelew. 1374a	Panama	<i>Cycloneda sanguinea</i>		<b>MG757831</b>		X		X

*orbiger*a (1), *Cheilomenes propinqua* (4), *Cycloneda sanguinea* (2), *Halyzia sedecimguttata* (1), *Harmonia axyridis* (17), *Olla v-nigrum* (8) and *Psyllobora vigintimaculata* (3).

*Phylogenetic inferences.* — The *Hesperomyces* clade has maximum support in the ITS and LSU datasets. In both datasets, each monophyletic clade within the *H. virescens* complex consists of isolates from thalli removed from a single host species. There is one exception: the clade consisting of isolates from two host species in the same genus, *Adalia bipunctata* and *A. decempunctata*. We will refer to these distinct clades by the first letters of the host genus and species names. For example, clade Ov is composed of *H. virescens* isolates taken from *Olla v-nigrum* ladybirds. In the ITS dataset, 8 clades are recognized, in addition to *H. coleomegillae* and *H. palustris*, which are positioned basally compared to the other clades (Figure 3-5A). Of the 8 clades, 6 are strongly supported (BS  $\geq$  92): Ab+Ad, Cp, Cs, Ha, Ov and Pv. In the LSU dataset, 6 clades are recognized in addition to *H. coleomegillae* and *H. palustris*, which are nested within the *H. virescens* complex (Figure 3-5B). Of the 6 clades, 5 have strong support (BS  $\geq$  85). The sister relationship between (*H. coleomegillae*, *H. palustris*) and (Ao, Pv) is supported by BS = 88.

In the 3-gene dataset, again, the *Hesperomyces* clade has strong support and consists of 10 clades (Figure 3-6). Of these, nine have high support (MP BS  $\geq$  88, ML BS  $\geq$  84, pp  $\geq$  0.8). Only the Hs clade is unsupported, but this clade consists of only a single isolate. MP and ML inferences do not agree with the Bayesian analysis regarding the position of the Ao clade and sister species *H. coleomegillae* and *H. palustris*. In the Bayesian analysis, they are basal to the other lineages. In both the MP and ML analysis, *H. coleomegillae* and *H. palustris* are part of a medium supported branch (MP BS = 71, ML BS = 75) including the Pv and Ao clades.



**Figure 3-5.** Phylogeny of *Hesperomyces* isolates, with *Hesperomyces* species as outgroup taxa, reconstructed from the ITS (A) and LSU (B) datasets. The topology is the result of maximum likelihood inference performed with Paup. For each node, the ML bootstraps (if > 70) are presented above the branch leading to that node. The arrowhead in both reconstructions points at the node leading to the *Hesperomyces* clade. Monophyletic clades are color-coded by host species (Ab+Ad, Ao, Cp, Cs, Ha, Hs, Ov, Pv) or parasite species (*H. coleomegilliae*, *H. palustris*).



*Species delimitation analyses.* — Results of the sequence-based methods for species delimitation are summarized in Table 3-4 and Figure 3-6. The ABGD analysis resulted in 10 distinct groups, irrespective of distance metrics or gap width values. Ten species were identified within the *Hesperomyces* clade from the bPTP analysis of the ITS topology. The bPTP analysis of the LSU topology resulted in 8 species (no LSU sequences were generated for isolates from *Cycloneda sanguinea* and *Halyzia sedecimguttata*). Support was lacking for the Cp clade in this analysis. The GMYC analyses of the ITS and concatenated trees resulted in ten species, all with high support except for clades Ao and Hs (which comprised a single isolate only). The GMYC analysis of the LSU tree resulted in 8 recognized species, without support for Ao, Hs, *H. palustris* (each comprising a single isolate), and Cp and Ha.

*Molecular clock.* — Our multi-gene dataset included 6947 characters and 107 isolates representing 60 species in 4 classes (GenBank accession numbers in Table 3-5). Of all characters, 3143 were constant and 2820 were parsimony-informative. Taxonomic sampling covered 10 genera in the Laboulbeniales: *Arthrorhynchus*, *Chitonomyces*, *Gloeandromyces*, *Hesperomyces*, *Laboulbenia*, *Polyandromyces*, *Prolixandromyces*, *Rickia*, *Stigmatomyces* and *Zodiomyces*. Isolates of *H. virescens* originated from 7 host species: *Adalia bipunctata* (5 isolates), *A. decempunctata* (1), *Azya orbigera* (1), *Cheilomenes propinqua* (4), *Harmonia axyridis* (9), *Olla v-nigrum* (8) and *Psyllobora vigintimaculata* (3).

Dating estimates are shown in Figure 3-7. The earliest split in Dothideomycetes (crown Dothideomycetes) occurred around 152.58 million years ago (Mya). Laboulbeniomycetes and Sordariomycetes diverged in the early Cretaceous, around 138.84 Mya. The earliest split in Sordariomycetes (crown Sordariomycetes) occurred around 120.43 Mya. Within

**Table 3-4.** Summary of results of MP, ML, Bayesian and species delimitation analyses (ABGD, bPTP, GMYC). Explanation of symbols and values used: — indicates no support; + under ABGD represents supported clades; numbers under bPTP are Bayesian support values for the delimited clades, no value indicates that a clade was absent from the analysis.

Putative species	MP BS	ML BS	pp	ABGD	bPTP	bPTP	GMYC	bPTP	GMYC	GMYC	GMYC
				3 genes	ITS	LSU	ITS	3 genes	LSU	ITS	3 genes
Ao clade	100	100	0.8	+	1.00	1.00	0.00	1.00	0.02	0.00	0.00
<i>H. palustris</i>	100	100	1.0	+	0.76	1.00	1.00	0.44	0.02	1.00	1.00
<i>H. coleomegillae</i>	97	98	1.0	+	1.00	0.97	1.00	0.47	0.91	1.00	1.00
Pv clade	100	99	1.0	+	0.92	0.84	1.00	0.34	0.77	1.00	1.00
Cs clade	98	100	1.0	+	0.99		1.00	0.49		1.00	1.00
Ov clade	92	84	1.0	+	0.98	0.83	1.00	0.20	0.69	1.00	1.00
Cp clade	91	93	1.0	+	0.99	0.00	1.00	0.52	0.18	1.00	1.00
Ab+Ad clade	96	98	1.0	+	0.72	0.71	1.00	0.20	0.61	1.00	1.00
Hs clade	—	—	0.6	+	1.00		0.00	0.99		0.00	0.00
Ha clade	88	97	1.0	+	0.91	0.56	1.00	0.02	0.41	1.00	0.67

**Table 3-5.** Overview of sequences used in the multi-gene molecular clock analysis.

Species	Isolate	SSU	ITS	LSU	RPB1	RPB2	TEF1	mitSSU
<b>LABOULBENIOMYCETES, HERPOMYCETALES</b>								
<i>Herpomyces chaetophilus</i>	D. Haelew. 483b	MG438319	MG438293	MG438350				
<i>Herpomyces chaetophilus</i>	D. Haelew. 602b	KT800023	KT800039	KT800009				
<i>Herpomyces periplanetae</i>	D. Haelew. 602d	MG438327	MG438305	MG438357				
<i>Herpomyces periplanetae</i>	D. Haelew. 1187d	MG438331	MG438309	MG438359				
<b>LABOULBENIOMYCETES, LABOULBENIALES</b>								
<i>Arthrorynchus nycteribiae</i>		KY094496		KY094497				
<i>Chitonomyces hyalinus</i>		JN127393	JN127405					
<i>Chitonomyces marginatus</i>		JN127391	JN127404					
<i>Gloeandromyces pageanus</i>	D. Haelew. 1091b			MG906798				
<i>Gloeandromyces</i> sp. nov.	D. Haelew. 1323b	MG958011						
<i>Gloeandromyces streblae</i>	D. Haelew. 1306c	MG958012						
<i>Hesperomyces coleomegillae</i>	631C	KF266882	KF192892					
<i>Hesperomyces coleomegillae</i>	632A	KF266880	KF192888					
<i>Hesperomyces palustris</i>	631K	KF266902	KF192902					
<i>Hesperomyces palustris</i>	632K	KF266891	KF192899					
<i>Hesperomyces virescens</i>	D. Haelew. 316a	MG438339	MG438315	KJ842339				
<i>Hesperomyces virescens</i>	D. Haelew. 334b	MG438340	MG438316	MG438364				
<i>Hesperomyces virescens</i>	JP352b	MG760581	MG757798	MG745337				
<i>Hesperomyces virescens</i>	JP353a	KT800028	KT800043	KT800013				
<i>Hesperomyces virescens</i>	JP353b	MG760582	MG757799	MG745338				
<i>Hesperomyces virescens</i>	JP354b	MG760583	MG757800	MG745339				
<i>Hesperomyces virescens</i>	D. Haelew. 361a	MG760584	MG757801					
<i>Hesperomyces virescens</i>	D. Haelew. 486c		KT800044	KT800014				
<i>Hesperomyces virescens</i>	D. Haelew. 497c	KT800030	KT800046	KT800016				
<i>Hesperomyces virescens</i>	D. Haelew. 516a	MG760586	MG757802	MG745340				
<i>Hesperomyces virescens</i>	D. Haelew. 646a	MG760587	MG745341	MG745341				
<i>Hesperomyces virescens</i>	D. Haelew. 646c	MG760588	KT800045	KT800015				
<i>Hesperomyces virescens</i>	D. Haelew. 648c	KU574863	KU574864	KU574865				

**Table 3-5. (Continued).**

Species	Isolate	SSU	ITS	LSU	RPB1	RPB2	TEF1	mitSSU
<i>Hesperomyces virescens</i>	D. Haelew. 653a	MG760589	MG757803					
<i>Hesperomyces virescens</i>	D. Haelew. 655c	KU574866	MG757804	KU574867				
<i>Hesperomyces virescens</i>	D. Haelew. 659b	MG760590 (659a)	MG757805	MG745342				
<i>Hesperomyces virescens</i>	D. Haelew. 659d	MG760591	MG757806					
<i>Hesperomyces virescens</i>	D. Haelew. 928g	MG760592	MG745343	MG745343				
<i>Hesperomyces virescens</i>	D. Haelew. 943a	MG760593	MG757809					
<i>Hesperomyces virescens</i>	D. Haelew. 943b	MG760594	MG757810	MG745344				
<i>Hesperomyces virescens</i>	D. Haelew. 954d	MG760595	MG757811					
<i>Hesperomyces virescens</i>	D. Haelew. 954e	MG760596	MG757812					
<i>Hesperomyces virescens</i>	D. Haelew. 1005c	MG760597	MG757814					
<i>Hesperomyces virescens</i>	D. Haelew. 1174a	MG760598	MG757815	MG745345				
<i>Hesperomyces virescens</i>	D. Haelew. 1188g	MG438341	MG438317	MG438365				
<i>Hesperomyces virescens</i>	D. Haelew. 1193g	MG760599	MG757817	MG745346				
<i>Hesperomyces virescens</i>	D. Haelew. 1199h	MG760600	MG757818	MG745347				
<i>Hesperomyces virescens</i>	D. Haelew. 1200h	MG760601	MG757819	MG745348				
<i>Hesperomyces virescens</i>	D. Haelew. 1200i	MG760602	MG757820	MG745349				
<i>Hesperomyces virescens</i>	D. Haelew. 1231a	MG760603	MG757821	MG745350				
<i>Hesperomyces virescens</i>	D. Haelew. 1232a	MG760604	MG757822	MG745351				
<i>Hesperomyces virescens</i>	D. Haelew. 1247a	MG760605	MG745352	MG745352				
<i>Hesperomyces virescens</i>	D. Haelew. 1248b	MG760606	MG757823	MG745353				
<i>Hesperomyces virescens</i>	D. Haelew. 1250b	MG760607	MG757825	MG745354				
<i>Hesperomyces virescens</i>	D. Haelew. 1250c	MG760608	MG757826	MG745355				
<i>Hesperomyces virescens</i>	D. Haelew. 1251b	MG760609	MG757827	MG745356				
<i>Hesperomyces virescens</i>	D. Haelew. 1268b	MG760610	MG757829	MG745357				
<i>Hesperomyces virescens</i>	D. Haelew. 1268d	MG760611	MG757830	MG745358				
<i>Laboulbenia calathi</i>	D. Haelew. 1007a	MG438342						
<i>Laboulbenia cf. flagellata</i>	D. Haelew. 1030a	MG438343						
<i>Laboulbenia pheropsophi</i>	D. Haelew. 1009b	MG438344						

**Table 3-5. (Continued).**

Species	Isolate	SSU	ITS	LSU	RPB1	RPB2	TEF1	mitSSU
<i>Laboulbenia</i> sp.	D. Haelew. 971a	MG438345						
<i>Polyandromyces coptosomalis</i> 1	D. Haelew. 313f	KT800035		KT800020				
<i>Polyandromyces coptosomalis</i> 2	HM499a	MG438347						
<i>Prolixandromyces triandrus</i>	Nagyvisnyo1	LT158294	LT158296	LT158295				
<i>Rickia wasmannii</i>	DE_Rak4	KT800037	KT800050	KT800021				
<i>Stigmatomyces borealis</i>	AW-797	JN835186						
<i>Stigmatomyces ceratophorus</i>	D. Haelew. 1136h	MG958013						
<i>Stigmatomyces entomophilus</i>	D. Haelew. 1062c	MG958014						
<i>Stigmatomyces gregarius</i>	D. Haelew. 1008a	MG438348						
<i>Stigmatomyces limnophorae</i>		AF407576						
<i>Stigmatomyces protrudens</i>		AF298232		AF298234				
<i>Stigmatomyces rugosus</i>		AF431759						
<i>Stigmatomyces scaptomyzae</i>		AF431758						
<i>Zodiomyces vorticellarius</i> 1	AW819	AF407577						
<i>Zodiomyces vorticellarius</i> 2	MG003	KT800038		KT800022				
<b>LABOULBENIOMYCETES, PYXIDIOPHORALES</b>								
<i>Pyxidiphora arvernensis</i>		FJ176839		FJ176894		FJ238377	FJ238412	
<i>Pyxidiphora</i> cf. <i>microspora</i>	MG200	MG438334	MG438314	MG438362				
<b>SORDARIOMYCETES</b>								
<i>Amphisphaeria umbrina</i>		FJ176809		FJ176863	FJ238431	FJ238348	FJ238394	FJ713609
<i>Chrysosporthe cubensis</i>		DQ862047		AF408338	JN989456	DQ862016	DQ862032	KT380885
<i>Coniochaete ostreum</i>		DQ471007		DQ470959	DQ471151	DQ470909	DQ471078	FJ190601
<i>Cryphonectria nitschkei</i>		DQ862046		AF408335		DQ862015	DQ862031	
<i>Cryptosporella hypoderma</i>		DQ862049		DQ862028		DQ862018	DQ862034	
<i>Diaporthe phaseolorum</i>		L36985		U47830	FJ238426	AY641036		AY779326
<i>Gelasinospora tetrasperma</i>		DQ471032		DQ470980	DQ471178	DQ470932	DQ471103	FJ190627
<i>Lulworthia grandispora</i>		DQ522855		DQ522856		DQ518181	DQ497608	FJ190595
<i>Lulworthia lignoarenaria</i>		FJ176848		FJ176903			FJ238417	FJ713612
<i>Magnaporthe grisea</i>		AB026819		AB026819	Genome	Genome	AY849694	

**Table 3-5. (Continued).**

Species	Isolate	SSU	ITS	LSU	RPBI	RPB2	TEFI	mitSSU
<i>Neurospora crassa</i>		X04971		AF286411	XM_959004	XM_324476	D45837	
<i>Sordaria fimicola</i>		AY545728		AY545724		DQ368647	DQ518175	
<i>Xylaria acuta</i>		AY544719		AY544676	DQ471118	DQ247797	DQ471048	AY544759
<i>Xylaria hypoxylon</i>		AY544692		AY544648	DQ471114	DQ470878	DQ471042	AY544760
DOTHIDEOMYCETES								
<i>Capnodium coffeae</i>		DQ247808		DQ247800	DQ471162	DQ247788	DQ471089	FJ190609
<i>Capnodium salicinum</i>		DQ677997		DQ678050		KT216553	DQ677889	
<i>Cercospora beticola</i>		DQ678039		DQ678091		KT216555	DQ677932	FJ190647
<i>Cladosporium cladosporioides</i>		DQ678004		DQ678057	EU186064	DQ677952	DQ677898	FJ190628
<i>Davidiella tassiana</i>		DQ678022		DQ678074	GU357793	DQ677971	DQ677918	EU514455
<i>Mycosphaerella fijiensis</i>		DQ767652		DQ678098		DQ677993		FJ190656
<i>Mycosphaerella punctiformis</i>		DQ471017		DQ470968	DQ471165	DQ470920	DQ471092	FJ190611
<i>Myrangium duriaei</i>		AY016347		DQ678059		DQ677954	DQ677900	AY571389
<i>Scortias spongiosa</i>		DQ678024		DQ678075		DQ677973	DQ677920	FJ190643
<i>Stylodothis puccinioides</i>		AY016353		AY004342	FJ238427		DQ677886	AF346428
<i>Sydowia polyspora</i>		DQ678005		DQ678058		DQ677953	DQ677899	FJ190631
<i>Trimmatostroma abietis</i>		DQ678040		DQ678092	GU357797	GU566747	DQ677933	FJ190648
ARTHONIOMYCETES								
<i>Roccella fuciformis</i>		AY584678		AY584654	DQ782825	DQ782866		EU704082
<i>Roccellographa cretacea</i>		DQ883705		DQ883696	DQ883716	DQ883713	DQ883733	FJ772240
<i>Schismatomma decolorans</i>		AY548809		AY548815	DQ883718	DQ883715	DQ883725	AY548816
<i>Simonyella variagata</i>		AY584669			DQ782819	DQ782861	DQ782891	AY584631

**Figure 3-6.** Maximum clade credibility tree of the *Hesperomyces virescens* complex, reconstructed from the concatenated SSU+ITS+LSU dataset. The tree is the result of a Bayesian analysis performed in BEAST. For each node, the MP/ML bootstraps (if > 70) and posterior probabilities (if > 0.7) are presented above/below the branch leading to that node. Thick branches have maximum support in the Bayesian analysis (pp = 1.0). Relationships retrieved by MP and ML different from the Bayesian inference are shown as dotted lines, including the Ao and Pv clades in addition to previously described species *H. coleomegillae* and *H. palustris*. Monophyletic clades are color-coded by host species (Ab+Ad, Ao, Cp, Cs, Ha, Hs, Ov, Pv) or parasite species (*H. coleomegillae*, *H. palustris*). To the right of the terminal labels of the phylogeny, the results of species delimitation analyses are summarized, from left to right: ABGD analysis of the SSU+ITS+LSU alignment, bPTP analysis of the ITS topology, bPTP analysis of the LSU topology and GMYC analysis of the ITS, LSU and SSU+ITS+LSU ultrametric trees (without outgroups) generated in BEAST. Shading implies lack of support, whereas no coloration means that clade was absent in that analysis.

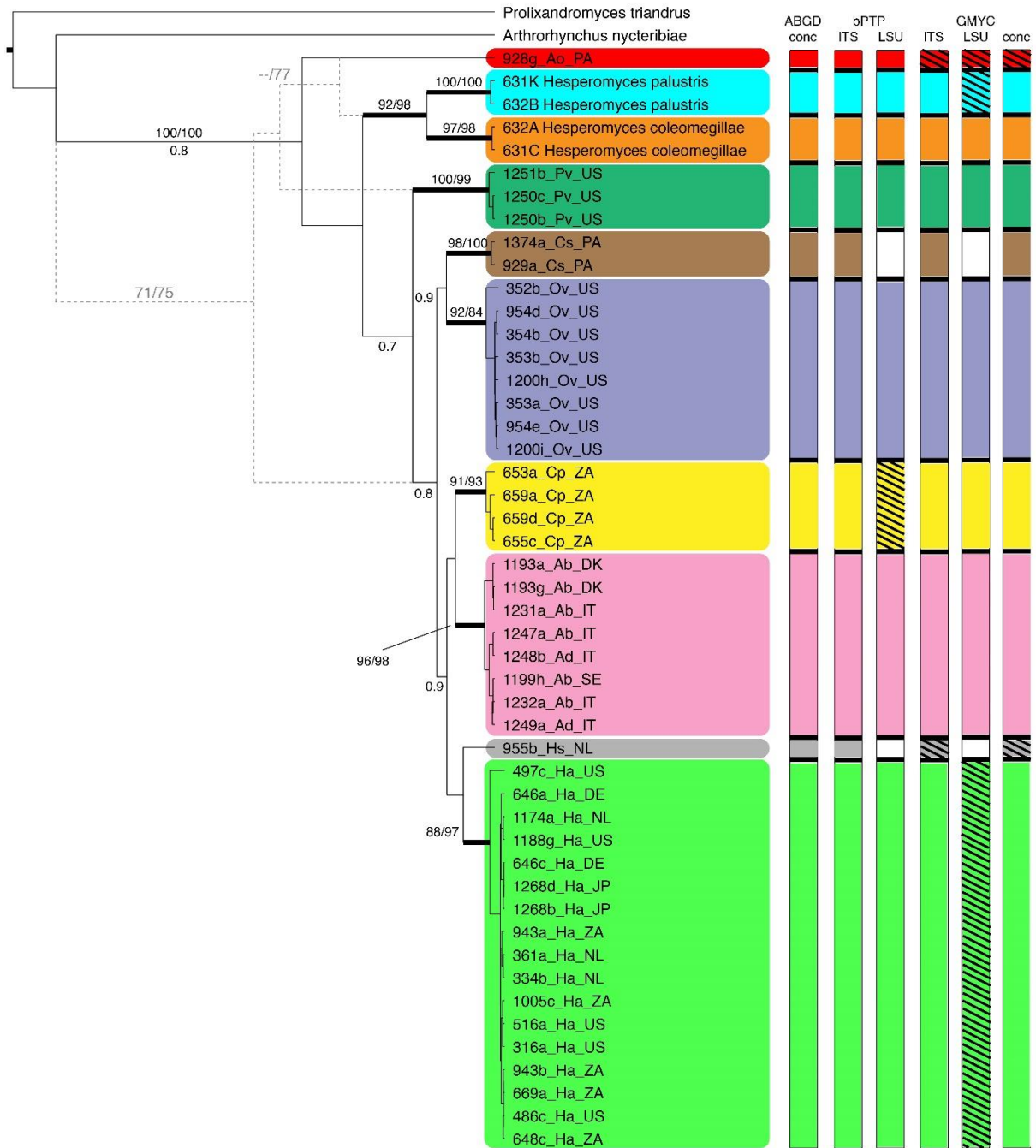


Figure 3-6. (Continued).



**Figure 3-7.** Maximum clade credibility tree with divergence times estimates for orders within Laboulbeniomycetes and members of the *Hesperomyces virescens* complex, reconstructed from a six-gene dataset. The tree is the result of a Bayesian analysis performed in BEAST using two fossil calibration constraints, Metacapnodiaceae sp. (in Dothideomycetes) and *Stigmatomyces succini* (in Laboulbeniomycetes). Assignments in the tree of the fossil calibration points are marked with black stars. For each final node in the *Hesperomyces* clade, the estimated divergence times are presented above the branch leading to that node.

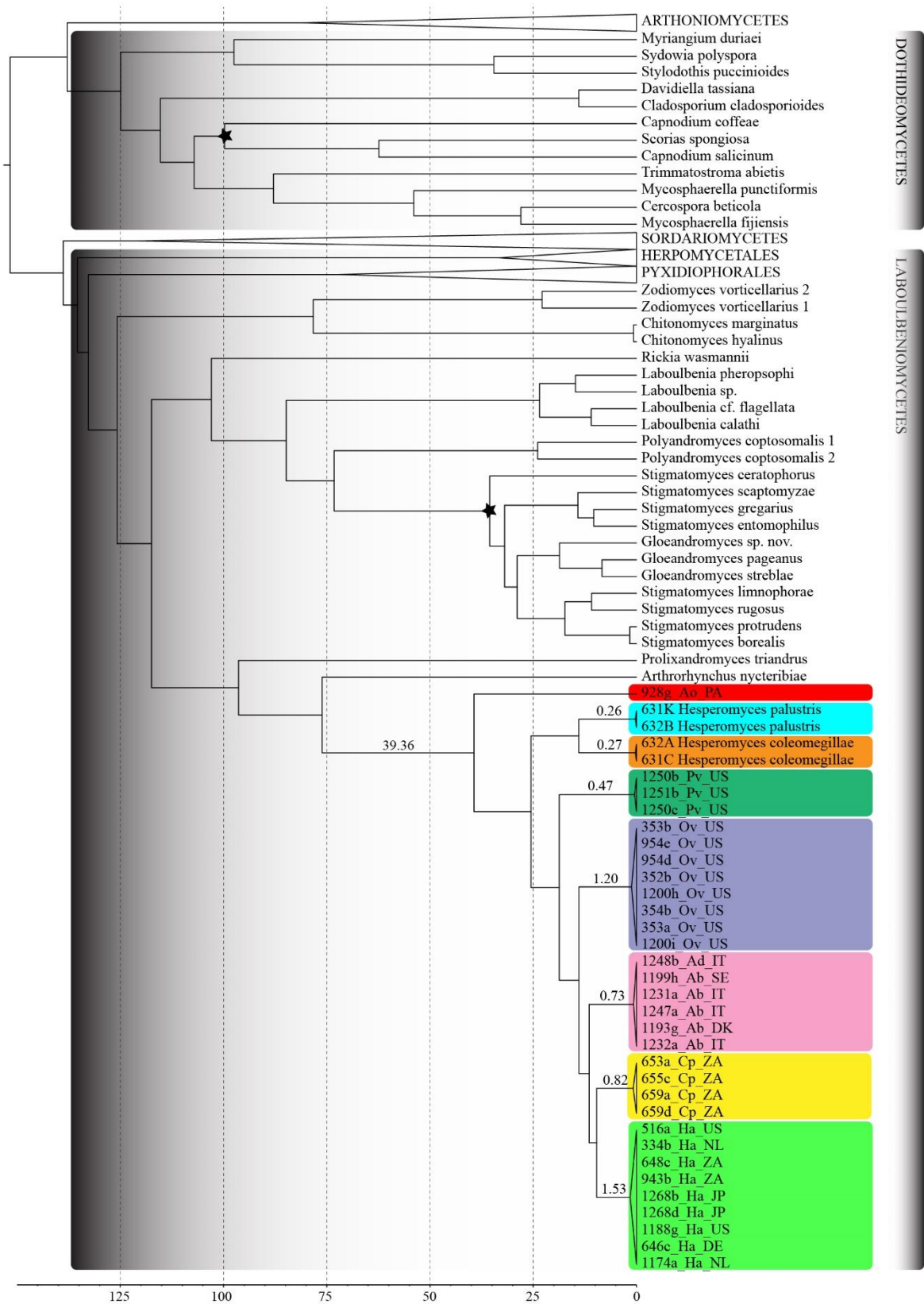


Figure 3-7. (Continued).

Laboulbeniomycetes, the earliest split occurred around 135.37 Mya (divergence of Herpomycetales). Finally, Laboulbeniales and Pyxidiophorales diverged around 132.75 Mya. The divergence of the *Hesperomyces* clade on *Azya orbigera* from other *Hesperomyces* lineages occurred in the middle Eocene, around 39.36 Mya. All other splits in the *H. virescens* complex happened during the Pleistocene, between 1.53 and 0.26 Mya.

## DISCUSSION

Our results illustrate that *H. virescens* encompasses several unique genetic lineages. Each of these lineages occurs on a single host species (or two host species, in the case of *Adalia*), regardless of geographic origin of the collection. Some of the clades in our phylogenies are unsupported but these are the clades for which only a single isolate is available (Ao, Hs and isolate D. Haelew. 1325a in the LSU dataset). Some ladybird species were only recently discovered as hosts and others are not frequently found. For example, during fieldwork in Panama in 2015 we found *Hesperomyces* thalli on *Azya orbigera*, which was previously not reported as a host. Out of 151 *A. orbigera* ladybirds, only 10 were infected, each individual carrying a single thallus (1 individual carried 3 thalli). We tried two extraction protocols, each with 1 thallus. The extraction using the Extract-N-Amp PCR Plant Kit failed; the one with the REPLI-g Single Cell Kit was successful and we were able to generate SSU, ITS and LSU sequences (928g\_Ao\_PA). In another case, a single *Hesperomyces*-infected individual of *Halysia sedecimguttata* was found in the Netherlands in 2015. It bore 13 adult and 4 juvenile thalli. We chose to use 10 adult thalli for DNA isolation with the Extract-N-Amp Plant PCR Kit (955b\_Hs\_NL). Since this report, no further infected *H. sedecimguttata* specimens have been collected. Finally, we only had 3 infected specimens of *Psyllobora vigintiduopunctata* available

for study, but these specimens carried sufficient thalli for both morphological study and molecular work.

Some of our host species were collected only from a single population. This is the case for *Cheilomenes propinqua*, *Olla v-nigrum* and *P. vigintimaculata*. However, specimens of *O. v-nigrum*, although originating from a single locality, were collected on multiple occasions in 2014, 2015 and 2016 (also from a laboratory colony for many generations). *Adalia bipunctata* and *H. axyridis* are the host species with the widest geographical range included in this study. Infected specimens of *A. bipunctata* were collected in Denmark, Italy and Sweden; specimens of *H. axyridis* were collected on different continents. Even so, both clades Ab+Ad and Ha form two monophyletic clades, in all datasets (ITS, LSU, SSU+ITS+LSU). In other words, there is no geographic signal. We conclude that phylogenetic structure is primarily determined by host specialization. Based on intra- and interspecific transmission experiments, Cottrell and Riddick (2012) proposed that “isolates/strains of *H. virescens* may exist under field conditions and only infect closely related Coccinellidae or even a single species.” Based on the results of our species delimitations analyses, we propose that these lineages (or clades, as we refer to them) represent distinct species.

*Comparison of species delimitation methods.* — Whereas molecular data provide a valuable tool to validate morphology-based species descriptions, the application of species delimitation methods can increase confidence if several methods offer congruent estimates of species diversity within a given dataset. Incongruences in results imply that multiple methods differ in their delimitation power. Alternatively, it is also possible that users make incorrect assumptions when employing a given species delimitation approach (Carstens *et al.*, 2013). In the event of

incongruent results, it is better to be conservative, rather than to designate entities that do not actually represent evolutionary metapopulation lineages as species. In any case, the multiple species delimitation analyses that we used in our study identified congruent species boundaries. The combination of BS, pp and species delimitation support provides strong evidence for *H. virescens* being a complex of multiple species.

In the bPTP analysis of the LSU topology, the Cp clade was not supported. PTP models speciation in terms of number of nucleotide substitutions (Zhang *et al.*, 2013). Upon manual inspection of the multiple alignment, for all clades it is the case that the number of nucleotide substitutions within the clade is zero. The only exception is the Cp clade, with 2 substitutions between the isolates of this clade. The number of substitutions between Cp and other clades ranges from 5 to 13. The PTP model did probably not interpret the Cp clade as a distinct species because of these *within-clade* substitutions for the Cp clade. Our PTP analyses based on single-gene trees are consistent with the results obtained by ABGD. We also performed a bPTP analysis on the concatenated SSU+ITS+LSU dataset (only Bayesian support values shown, Table 3-4). Although the number of species is the same as in the PTP analysis of single gene topology and the ABGD and GMYC approaches, the Bayesian support dropped significantly; none of the delimited clades have support higher than 0.52. We repeat the findings by Zhang *et al.* (2013) and Leavitt *et al.* (2015a) that PTP is most accurate with single gene trees.

Kekkonen & Hebert (2014) put forward that GMYC usually delimits more species compared to other methods. In our analysis, however, the results from GMYC are congruent with ABGD and bPTP of the ITS topology (and bPTP of the LSU topology, noting that two clades were missing in this analysis). Three clades that lack support – Ao, Hs and *H. palustris* in the LSU analysis – consist of single isolates only. GMYC looks at intraspecific branching versus

interspecific branching, and thus it is no surprise that these singleton clades have no support from this approach. The low support for the Ha clade in the GMYC analyses of the LSU and 3-gene topologies may be explained by the fact that for a number of isolates coming from *Harmonia axyridis*, sequences are incomplete (missing or only partial SSU, ITS, or LSU). Because this clade holds many isolates, missing sequence data may influence generating an ultrametric tree, which is a computationally intensive and error-prone process. Since GMYC is dependent on the accuracy of this input tree, any alterations will strongly influence species delimitation analyses.

Zhang *et al.* (2013), when introducing PTP, argued that delimited groups represent “putative” species. PTP uses phylogenetic reconstructions inferred from single gene datasets, which are gene trees rather than species trees. Also GMYC is based on a single-gene tree. As a consequence, more data should be collected to confirm and validate the species boundaries set by these delimitation approaches, in an integrative taxonomy framework across disciplines (Dayrat, 2005; Zamora, *et al.*, 2005; Padial *et al.*, 2010; Leavitt *et al.*, 2015b; Sousa *et al.*, 2017). Note that this framework is in line with the unified species concept, as proposed by de Queiroz (2007).

*Comparison of ITS and LSU as barcode markers.* — Molecular identification of fungi relies on the availability of good DNA barcode markers. Currently, DNA-based identifications focus on genes that code for ribosomal RNA (rDNA), because these regions have many copies in the genome and thus are well-suited target regions for PCR amplification. Schoch *et al.* (2012) proposed the ITS region as universal barcode for Fungi. This means that for a majority of fungi, the interspecific variation at this marker should exceed the intraspecific variation, and for over 70% of fungi the ITS is indeed effective in recognizing species. A number of considerations have been made since the acceptance of this barcode marker (Krüger *et al.*, 2012; Schoch *et al.* 2012;

Samson *et al.*, 2014; Crous *et al.*, 2015): (1) *RPB1* is actually better in discriminating species but its amplification success is much lower; (2) whereas ITS performs best overall across the fungal kingdom, its identification power is equal to LSU for subphyla Pezizomycotina and Saccharomycotina (Ascomycota); (3) ITS does not contain enough variation to discriminate between species for some groups of fungi, such as *Aspergillus* and economically important plant pathogens in the genera *Alternaria*, *Diaporthe*, *Fusarium* and others; (4) arbuscular mycorrhizal-forming species in Glomeromycota are multinucleate and extremely intraspecific divergent in their ribosomal DNA. These challenges have driven mycologists to developing other, lineage- or genus-specific barcodes. Secondary barcodes are often more difficult to amplify (because of the lack of universal primers) but have a better delimiting power than the ITS (Yahr *et al.*, 2016). Examples of secondary barcodes include calmodulin (*CaM*) for *Aspergillus*; the translation elongation factor (*TEF1*), topoisomerase I (*TOP1*) and phosphoglycerate kinase (*PGK*) for *Fusarium*; the LSU rDNA region for *Amanita*; and the *Apn2-Mat1-2* intergenic spacer and partial mating type (*Mat1-2*) gene (*ApMat*) and glutamine synthetase (*GS*) combined for *Colletotrichum* (Samson *et al.*, 2014; Liu *et al.*, 2015; Al-Hatmi *et al.*, 2016).

We experience low amplification success for the ITS region with the Laboulbeniales using general, fungal-specific primers. There are many possible reasons for failed ITS amplification, ranging from simple primer mismatch as is the case in the Archaeorhizomycetes (Rosling *et al.*, 2011) to significant intragenomic (Kovács *et al.*, 2011; Lindner *et al.*, 2013) or intraspecific variability (den Bakker *et al.*, 2004a). Although the 5.8S region is highly conserved, both spacer regions (especially ITS1) appear to be rapidly evolving (Nilsson *et al.*, 2008). Previously generated sequences of Laboulbeniales suggest that the ITS differs significantly among genera and we have currently no idea of the extent of this variability. Still, ITS may be

useful and important as a marker to study intrageneric relationships. During our studies of *Hesperomyces* we designed and are currently using primers that specifically target conserved regions of the ITS (ITShespL and ITShespR; Haelewaters *et al.*, in review).

During the course of this study, we constructed phylogenies based on single genes (SSU, ITS, LSU) and on a combined SSU+ITS+LSU dataset. The SSU gene is very conservative and has no discriminative power at the species level. But, both the ITS and LSU datasets result in high support for the individual clades of the *H. virescens* complex (Figure 3-5). In addition to its discrimination power, amplification of the LSU region poses virtually no problem within the Laboulbeniomycetes so far investigated. The commonly used fungal primers for the LSU region, such as LR0R/LR5 and LIC24R/LR3 (Vilgalys & Hester, 1990; Miadlikowska & Lutzoni, 2000; R. Vilgalys, unpubl.), generally work well for most species of Laboulbeniomycetes. Based on these results, the LSU region should be investigated as barcode for species delimitation in Laboulbeniomycetes.

*Hesperomyces virescens, a complex of cryptic species?* .— Recent molecular (phylogenetic) studies point at a dazzling diversity of the Kingdom Fungi. However, it is not always possible to infer this diversity from morphological features. Species that “have been classified as a single nominal species because they are at least superficially morphologically indistinguishable” are referred to as cryptic species (Bickford *et al.*, 2007). Many (or almost any; Hawksworth, 2004) species studied using molecular, incompatibility, secondary metabolites have been shown to “mask” several biological species. Examples are found in diverse groups of fungi – among Ascomycota: Eurotiales (*Aspergillus*; Pringle *et al.*, 2005), Helotiales (*Phialocephala*; Grünig *et al.*, 2008), Lecanorales (*Protoparmelia*; Singh *et al.*, 2015); among Basidiomycota: Agaricales



(*Cortinarius* and *Tricholomopsis*; Stefani *et al.* 2014; Olariaga *et al.*, 2015), Polyporales (*Ganoderma*; Hong & Jung, 2004), Russulales (*Lactifluus* and *Russula*; Adamcik *et al.*, 2016; van de Putte *et al.*, 2016), Ustilaginales (*Tranzscheliella*; Li *et al.*, 2017). In this study, we have observed at a superficial level cryptic species. Consequently, we employed landmark-based geometric morphometry (Zelditch *et al.*, 2012) followed by principal component analysis of shape variation, aimed at finding characters, if any, to circumscribe species with.

To date, morphometric methods in Laboulbeniales have only been applied in studies dealing with the genus *Laboulbenia*. Morphological plasticity of *L. flagellata* from different carabid hosts (Coleoptera, Carabidae) was studied by De Kesel & Van Den Neucker (2005). The general habitus of thalli was stable, but size was related to host species, habitat of the host and position of the fungus on the host integument. Subsequently, De Kesel & Haelewaters (2014) tested differences in thallus shape and dimension between two morphologically similar species of *Laboulbenia*. Most variables were significantly different between both species, particularly the shape of the receptacle was different regardless of size or growth position. In this study, we generated the largest morphometric dataset to date for any species of Laboulbeniales, including measurements and ratios of 181 thalli from 3 host species. Our PCA suggests that the shapes of cell I, cell VI and the perithecium contribute most to the observed variation within the dataset. If we were to formally describe clades Cp, Ha and Ov as separate species, we expect to find most descriptive features in cell I of the receptacle and in the perithecium and its basal cell (VI).

Interestingly, we found *H. coleomegillae* and *H. palustris* (on *Coleomegilla maculata*) within the highly supported branch that is sister to *Arthrorhynchus nycteribiae*. First, we thought both species had to be part of the *H. virescens* complex. This was because we believed also clade Ao belonged to the complex. However, the thalli on *Azya orbigera* are structurally quite different

compared to thalli from other host species upon detailed morphological study. For example, the appendage is only 3-celled with the third cell carrying two antheridia. This structure is completely different than thalli from any of the other hosts in our dataset and also than *H. coleomegillae* and *H. palustris* (De Kesel, 2011; Goldmann *et al.* 2013; Haelewaters & De Kesel, 2017; Figure 3-8). The appendage of these thalli consists of a single row of at least 4 cells, and every cell starting from the second carries an antheridium (the distal-most cell carries 2 antheridia). As a result, we believe clade Ao is a separate evolutionary lineage and deserves its own species designation, *H. coleomegillae* and *H. palustris* are 2 standalone position-specific species (Goldmann *et al.*, 2013), and only the clades Ab+Ad, Cp, Cs, Ha, Hs, Ov and Pv are part of the *H. virescens* complex, or *H. virescens* sensu lato. Given the strict host specificity detected by this study, we propose to restrict *H. virescens* sensu stricto to those thalli found on *Chilocorus stigma*, the host species on which the fungus was originally described (Thaxter, 1891).

Our molecular clock analysis provides additional support for clade Ao being a separate species. This clade seems to have diverged from all other *Hesperomyces* lineages/species in the middle Eocene, whereas the other lineages only diverged in the Pleistocene. The diversification within the *H. virescens* complex is the result of recent speciation events. Our clock analysis resulted in node ages younger compared to previous studies (Table 3-6). Also Haelewaters *et al.* (in review) found somewhat younger estimates for divergence events of major lineages. It is possible that this is the result of the inclusion of the Laboulbeniales fossil *Stigmatomyces succini* as a calibration point (at 35 Mya), which had not been used before in divergence time estimation analyses.

**Figure 3-8.** Adult thalli of *Hesperomyces* removed from different host species. Thalli are color-coded, using the same colors as those used for separate lineages in phylogenetic reconstructions. *Top row, from left to right:* a single thallus from *Cheilomenes propinqua* and three thalli from *Harmonia axyridis*, showing variation in size and in projections at the perithecial tip. *Middle row:* thalli from *Olla v-nigrum*, *Cycloneda sanguinea*, *Psyllobora vigintimaculata*, *Adalia bipunctata* and *Halyzia sedecimguttata*. *Bottom row:* morphotypes 1 and 3 of *Hesperomyces coleomegillae* from *Coleomegilla maculata*, morphotype 2 of *H. palustris* from the same host and a thallus from *Azya orbiger*a. Scale bar = 200  $\mu$ m. Drawings provided by André De Kesel.

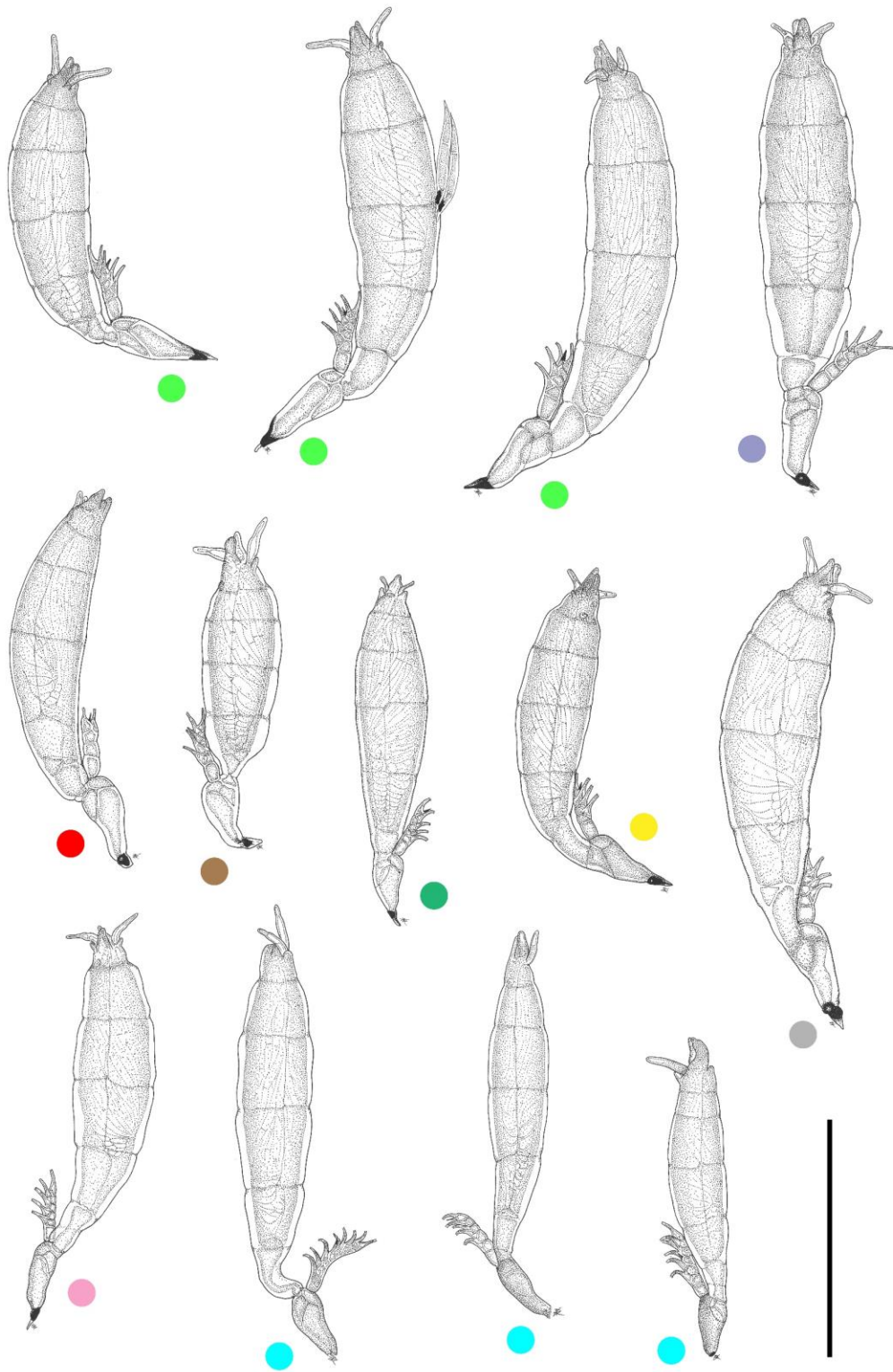


Figure 3-8. (Continued).

**Table 3-6.** Comparison of divergence time estimates from this study with previous studies, in millions of years ago (Mya), with annotation of the number of fossil calibrations used. Calibration points as follows: Haelewaters *et al.* (in review): 5 = *A. collembolorum*, Metacapnodiaceae sp., *Parmelia ambra*/*P. isidiveteris*, *P. devonicus*, *Stigmatomyces succini*. Beimforde *et al.* (2014): 1 = only *P. devonicus*; 5 = *Anzia electra*, *Aspergillus collembolorum*, *Calicium* sp., Metacapnodiaceae sp., *P. devonicus*. Prieto & Wedin (2013): 5 = *Alectoria succinica*, *Calicium* sp., *Chaenotheca* sp., *Chaenothecopsis* sp., *P. devonicus*. Taylor & Berbee (2006): 1 (P) = *Paleopyrenomycites devonicus* considered as Pezizomycotina; 1 (A) = *P. devonicus* considered as Ascomycota; 3 = *P. devonicus* (as Pezizomycotina), in addition to 2 non-fungal calibration points (fruit fly–mosquito, eudicots–monocots).

Nodes	This study		Haelewaters <i>et al.</i> (in review)		Beimforde <i>et al.</i> (2014)		Prieto & Wedin (2013)		Taylor & Berbee (2006)	
	2	5	5	1	5	5	5	1 (P)	1 (A)	3
Crown Dothideomycetes	152.58	202.60	321 [247–427]	350 [273–459]	174 [107–245]	—	—	—	—	—
Laboulbeniomycetes-Sordariomycetes	138.84	205.79	—	—	—	—	—	—	—	—
Crown Sordariomycetes	120.43	145.63	233 [182–316]	260 [207–339]	130 [77–181]	226	122	211	—	—
Crown Laboulbeniomycetes	135.37	160.27	—	—	—	—	—	—	—	—
Crown Laboulbeniales	125.80	110.78	—	—	—	—	—	—	—	—

## CONCLUSIONS

Through DNA isolation, PCR amplification, sequencing and analysis methods, thousands of characters became available for minute fungi that do not have many morphological features and do not grow in culture. These remarkable improvements in the collection of character data will help us answer questions about the validity of “worldwide” and “cosmopolitan” geographic distributions ascribed to many morphological forms of the Laboulbeniomycetes. Here, we provided answers in the case of *Hesperomyces virescens*, which we have shown to be a complex of many species, each with its own host (genus). We are only starting to unravel patterns of speciation in this group of fungi. The findings of this paper are not only promising for future studies, but they also emphasize the necessity for an integrative approach in taxonomic research (*sensu* De Queiroz, 2007). We hope with this contribution to include the Laboulbeniales ectoparasitic fungi in contemporary discussions considering molecular evolution and speciation patterns, rather than treating them as obscure fungi for specialists only.

## LITERATURE CITED

- Adamcik S, Cabon M, Eberhardt U, Saba M, Hampe F, Slovák M, Kleine J, Marxmüller H, Jancovicova S, Pfister DH, Khalid AN, Kolarik M, Marhold K, Verbeken A (2016) A molecular analysis reveals hidden species diversity within the current concept of *Russula maculata* (Russulaceae, Basidiomycota). *Phytotaxa* **270**: 71–88.
- Akaike H (1974) New look at statistical-model identification. *IEEE Transactions on Automatic Control* **19**: 716–723.
- Al-Hatmi AM, Van Den Ende AG, Stielow JB, Van Diepeningen AD, Seifert KA, McCormick W, Assabgui R, Gräfenhan T, De Hoog GS, Levesque CA (2016) Evaluation of two novel barcodes for species recognition of opportunistic pathogens in *Fusarium*. *Fungal Biology* **120**: 231–245.
- Araújo JPM, Evans HC, Geiser DM, Mackay WP, Hughes DP (2015) Unravelling the diversity behind the *Ophiocordyceps unilateralis* (Ophiocordycipitaceae) complex: Three new species of zombie-ant fungi from the Brazilian Amazon. *Phytotaxa* **220**: 224–238.

- Balazuc J (1974) Laboulbeniales de France (suite et fin). *Bulletin Mensuel de la Société Linnéenne et des Sociétés Botanique de Lyon* **43**: 346–368.
- Bates D, Maechler M, Bolker B, Walker S (2015) Fitting linear mixed-effects models using lme4. *Journal of Statistical Software* **67**: 1–48.
- Beimforde C, Feldberg K, Nylinder S, Rikkinen J, Tuovila H, Dörfelt H, Gube M, Jackson DJ, Reitner J, Seyfullah LJ, Schmidt AR (2014) Estimating the Phanerozoic history of the Ascomycota lineages: combining fossil and molecular data. *Molecular Phylogenetics and Evolution* **78**: 386–398.
- Benjamin RK (1971) Introduction and supplement to Roland Thaxter's contribution towards a monograph of the Laboulbeniaceae. *Bibliotheca Mycologica* **80**: 1–155.
- Bernardi M, Barragán A, Rossi W (2014) New records of Laboulbeniales (Fungi: Ascomycota) from Ecuador and other countries. *Webbia* **69**: 281–289.
- Bickford D, Lohman DJ, Sodhi NS, Ng PKL, Meier R, Winker K, Ingram KK, Das I (2007) Cryptic species as a window on diversity and conservation. *Trends in Ecology and Evolution* **22**: 148–155.
- Capella-Gutiérrez S, Silla-Martínez JM, Gabaldón T (2009) TrimAl: a tool for automated alignment trimming in large-scale phylogenetic analyses. *Bioinformatics* **25**: 1972–1973.
- Carstens BC, Pelletier TA, Reid NM, Satler JD (2013) How to fail at species delimitation. *Molecular Ecology* **22**: 4369–4383.
- Castaldo D, Rossi W, Sabatini F (2004) Contribution to the knowledge of the Laboulbeniales from Greece. *Plant Biosystems* **138**: 261–269.
- Cottrell TE, Riddick EW (2012) Limited transmission of the ectoparasitic fungus *Hesperomyces virescens* between ladybirds. *Psyche* **2012**: article ID 814378.
- Crous PW, Hawksworth DL, Wingfield MJ (2015) Identifying and naming plant-pathogenic fungi: past, present, and future. *Annual Review of Phytopathology* **53**: 247–267.
- Darriba D, Taboada GL, Doallo R, Posada D (2012) jModelTest 2: more models, new heuristics and parallel computing. *Nature Methods* **9**: 772.
- Dayrat B (2005) Towards integrative taxonomy. *Biological Journal of the Linnean Society* **85**: 407–415.
- De Kesel A (2011) *Hesperomyces* (Laboulbeniales) and coccinellid hosts. *Sterbeekia* **30**: 32–37.
- De Kesel A, Haelewaters D (2014) *Laboulbenia slackensis* and *L. littoralis* sp. nov. (Ascomycota, Laboulbeniales), two sibling species as a result of ecological speciation. *Mycologia* **106**: 407–414.

- De Kesel A, Van den Neucker T (2005) Morphological variation in *Laboulbenia flagellata* (Ascomycetes, Laboulbeniales). *Belgian Journal of Botany* **138**: 165–172.
- de Queiroz K (1998) The general lineage concept of species, species criteria, and the process of speciation: A conceptual unification and terminological recommendations. In: *Endless forms: Species and speciation* (Howard DJ, Berlocher SH, eds): 57–75. New York: Oxford University Press.
- de Queiroz K (2007) Species concepts and species delimitation. *Systems Biology* **56**: 879–886.
- den Bakker HC, Gravendeel B, Kuyper TW (2004a) An ITS phylogeny of *Leccinum* and an analysis of the evolution of minisatellite-like sequences within ITS1. *Mycologia* **96**: 102–118.
- den Bakker HC, Zuccarello GC, Kuyper TH, Noordeloos ME (2004b) Evolution and host specificity in the ectomycorrhizal genus *Leccinum*. *New Phytologist* **163**: 201–215.
- Dobzhansky T (1946) Complete reproductive isolation between two morphologically similar species of *Drosophila*. *Ecology* **27**: 205–211.
- Don RH, Cox PT, Wainwright BJ, Baker K, Mattick JS (1991) “Touchdown” PCR to circumvent spurious priming during gene amplification. *Nucleic Acids Research* **19**: 4008.
- Drummond AJ, Ho SYW, Rawlence N, Rambaut A (2007) *A rough guide to BEAST 1.4*. University Auckland, New Zealand. Available at <http://beast.bio.ed.ac.uk> (accessed 05 March 2018).
- Drummond AJ, Suchard MA, Xie D, Rambaut A (2012) Bayesian phylogenetics with BEAUti and the BEAST 1.7. *Molecular Biology and Evolution* **29**: 1969–1973.
- Edgar RC (2004) MUSCLE: multiple sequence alignment with high accuracy and high throughput. *Nucleic Acids Research* **32**: 1792–1797.
- Ezard T, Fujisawa T, Barraclough TG (2009) *splits: SPecies’ LLimits by Threshold Statistics*. R package version 1.0-14/r31. Available at <http://R-Forge.R-project.org/projects/splits/> (accessed 12 January 2018).
- Garcés S, Williams R (2004) First record of *Hesperomyces virescens* Thaxter (Laboulbeniales: Ascomycetes) on *Harmonia axyridis* (Pallas) (Coleoptera: Coccinellidae). *Journal of the Kansas Entomological Society* **77**: 156–158.
- Gardes M, Bruns TD (1993) ITS Primers with enhanced specificity for Basidiomycetes – application to the identification of mycorrhizae and rusts. *Molecular Ecology* **2**: 113–118.
- Goldmann L, Weir A, Rossi W (2013) Molecular analysis reveals two new dimorphic species of *Hesperomyces* (Ascomycota, Laboulbeniomycetes) parasitic on the ladybird *Coleomegilla maculata* (Coleoptera, Coccinellidae). *Fungal Biology* **117**: 807–813.



- Grünig CR, Duo A, Sieber TN, Holdenrieder O (2008) Assignment of species rank to six reproductively isolated cryptic species of the *Phialocephala fortinii* s.l.-*Acephala applanata* species complex. *Mycologia* **100**: 47–67.
- Haelewaters D (2018) *Data from "Integrative taxonomy reveals hidden species within Hesperomyces virescens (Fungi, Laboulbeniales), a parasite of ladybirds (Coleoptera, Coccinellidae)". Available at <https://doi.org/10.6084/m9.figshare.c.3944749.v1> (accessed 07 March 2018).*
- Haelewaters D, De Kesel A (2017) De schimmel *Hesperomyces virescens*, een natuurlijke vijand van lieveheersbeestjes. [The fungus *Hesperomyces virescens*, a natural enemy of ladybirds]. *Entomologische Berichten* **77**: 106–118.
- Haelewaters D, Gorczak M, Pfliegler WP, Tartally A, Tischer M, Wrzosek M, Pfister DH (2015) Bringing Laboulbeniales to the 21st century: enhanced techniques for extraction and PCR amplification of DNA from minute ectoparasitic fungi. *IMA Fungus* **6**: 363–372.
- Haelewaters D, Minnaar IA, Clusella-Trullas S (2016) A fungal parasite of native and invasive ladybirds (Coleoptera: Coccinellidae) newly reported from South Africa. *Parasite* **23**: 5.
- Haelewaters D, Pfliegler WP, Gorczak M, Pfister DH (in review) Birth of an order: phylogenetic study excludes *Herpomyces* (Fungi, Laboulbeniomycetes) from Laboulbeniales. *Molecular Phylogenetics and Evolution*.
- Haelewaters D, van Wielink P (2016) *Hesperomyces virescens* (Laboulbeniales) op een nieuwe gastheer. In: *Natuurstudie in De Kaaistoep. Verslag 2015, 21e onderzoeksjaar* (Peeters T, van Eck A, Cramer T, eds): 9–12. TWM Gronden BV, Natuurmuseum Brabant & KNNV-afdeling Tilburg.
- Haelewaters D, Verhaeghen SJC, Ríos González TA, Bernal Vega JA, Villarreal Saucedo RV (2017a) New and interesting Laboulbeniales from Panama and neighboring areas. *Nova Hedwigia* **105**: 267–299.
- Haelewaters D, Zhao SY, Clusella-Trullas S, Cottrell TE, De Kesel A, Fiedler L, Herz A, Hesketh H, Hui C, Kleespies RG, Losey JE, Minnaar IA, Murray KM, Nedvěd O, Pfliegler WP, Raak-van den Berg CL, Riddick EW, Shapiro-Ilan DI, Smyth RR, Steenberg T, van Wielink PS, Vigišová S, Zhao Z, Ceryngier P, Roy HE (2017b) Parasites of *Harmonia axyridis*: current research and perspectives. *BioControl* **62**: 355–371.
- Harwood JD, Ricci C, Romani R, Pitz KM, Weir A, Obrycki JJ (2006a) Prevalence and association of the laboulbenialean fungus *Hesperomyces virescens* (Laboulbeniales: Laboulbeniaceae) on coccinellid hosts (Coleoptera: Coccinellidae) in Kentucky, USA. *European Journal of Entomology* **103**: 799–804.
- Harwood JD, Ricci C, Romani R, Obrycki JJ (2006b) Historic prevalence of a laboulbenialean fungus infecting introduced coccinellids in the United States. *Antenna* **30**: 74–79.

- Hawksworth DL (1991) The fungal dimension of biodiversity: magnitude, significance, and conservation. *Mycological Research* **95**: 641–655.
- Hawksworth DL (2004) Fungal diversity and its implications for genetic resource collections. *Studies in Mycology* **50**: 9–18.
- Hibbett D, Abarenkov K, Kõljalg U, Öpik M, Chai B, Cole J, Wang Q, Crous P, Robert V, Helgason T, Herr JR, Kirk P, Lueschow S, O'Donnell K, Nilsson RH, Oono R, Schoch C, Smyth C, Walker DM, Porras-Alfaro A, Taylor JW, Geiser DM (2016) Sequence-based classification and identification of Fungi. *Mycologia* **108**: 1049–1068.
- Hong SG, Jung HS (2004) Phylogenetic analysis of *Ganoderma* based on nearly complete mitochondrial small-subunit ribosomal DNA sequences. *Mycologia* **96**: 742–755.
- Iperti G (1964) Les parasites des Coccinelles aphidiphages dans les Alpes-Maritimes et les Basses-Alpes. *Entomophaga* **9**: 153–180.
- Jukes TH, Cantor CR (1969) Evolution of protein molecules. In: *Mammalian protein metabolism* (Mumro NH, ed): 21–132. New York: Academic Press.
- Kassambara A (2015) *factoextra: Visualization of the outputs of a multivariate analysis*. R package version 1.0.1. Available at <https://cran.r-project.org/web/packages/factoextra/index.html> (accessed 28 November 2017).
- Kekkonen M, Hebert PDN (2014) DNA barcode-based delineation of putative species: efficient start for taxonomic workflows. *Molecular Ecology Resources* **14**: 706–715.
- Kemp EA, Cottrell TE (2015) Effect of lures and colors on capture of lady beetles (Coleoptera: Coccinellidae) in Tedders pyramidal traps. *Environmental Entomology* **44**: 1395–1406.
- Kimura M (1980) A simple method for estimating evolutionary rates of base substitutions through comparative studies of nucleotide sequences. *Journal of Molecular Evolution* **16**: 111–120.
- Kovács GM, Jankovics T, Kiss L (2011) Variation in the nrDNA ITS sequences of some powdery mildew species: do routine molecular identification procedures hide valuable information? *European Journal of Plant Pathology* **131**: 135.
- Krüger M, Krüger C, Walker C, Stockinger H, Schüßler A (2012) Phylogenetic reference data for systematics and phylotaxonomy of arbuscular mycorrhizal fungi from phylum to species level. *New Phytologist* **193**: 970–984.
- Kumar S, Stecher G, Tamura K (2016) MEGA7: molecular evolutionary genetics analysis version 7.0 for bigger datasets. *Molecular Biology and Evolution* **33**: 1870–1874.
- Landvik S, Egger KN, Schumacher T (1997) Towards a subordinal classification of the Pezizales. *Nordic Journal of Botany* **17**: 403–418.

- Larena I, Salazar O, González V, Julián MC, Rubio V (1999) Design of a primer for ribosomal DNA internal transcribed spacer with enhanced specificity for ascomycetes. *Journal of Biotechnology* **75**: 187–194.
- Leavitt SD, Divakar PK, Ohmura Y, Wang LS, Esslinger TL, Lumbsch HT (2015a) Who's getting around? Assessing species diversity and phylogeography in the widely distributed lichen-forming fungal genus *Montanelia* (Parmeliaceae, Ascomycota). *Molecular Phylogenetics and Evolution* **90**: 85–96.
- Leavitt SD, Moreau SD, Lumbsch HT (2015b) The dynamic discipline of species delimitation: progress toward effectively recognizing species boundaries in natural populations. In: *Recent advances in lichenology* (Upreti DK, Divakar PK, Shukla V, Bajapi R, eds): 11–44. Delhi: Springer.
- Li Y-M, Shivas RG, Cai L (2017) Cryptic diversity in *Tranzscheliella* spp. (Ustilaginales) is driven by host switches. *Scientific Reports* **7**: 43549.
- Lindner DL, Carlsen T, Henrik Nilsson R, Davey M, Schumacher T, Kauserud H (2013) Employing 454 amplicon pyrosequencing to reveal intragenomic divergence in the internal transcribed spacer rDNA region in fungi. *Ecology and Evolution* **3**: 1751–1764.
- Liu F, Weir BS, Damm U, Crous PW, Wang Y, Liu B, Wang M, Zhang M, Cai L (2015) Unravelling *Colletotrichum* species associated with *Camellia*: employing ApMat and GS loci to resolve species in the *C. gloeosporioides* complex. *Persoonia* **35**: 63–86.
- Lücking R, Dal-Forno M, Sikaroodi M, Gillevet PM, Bungartz F, Moncada B, Yáñez-Ayabaca A, Chaves JL, Coca LF, Lawrey JD (2014) A single microlichen constitutes hundreds of unrecognized species. *Proceedings of the National Academy of Sciences of the United States of America* **111**: 11091–11096.
- Miadlikowska J, Lutzoni F (2000) Phylogenetic revision of the genus *Peltigera* (lichen-forming Ascomycota) based on morphological, chemical, and large subunit nuclear ribosomal DNA data. *International Journal of Plant Sciences* **161**: 925–958.
- Michonneau F, Bolker B, Holder M, Lewis P, O'Meara B (2015) *rncl: an interface to the nexus class library*. R package version 0.6.0. Available at <http://CRAN.R-project.org/package=rncl> (accessed 08 February 2018).
- Miller MA, Pfeiffer W, Schwartz T (2010) Creating the CIPRES Science Gateway for inference of large phylogenetic trees. *Proceedings of the Gateway Computing Environments Workshop (GCE)* **14 Nov. 2010**: 1–8. New Orleans, Louisiana.
- Nilsson RH, Kristiansson E, Ryberg M, Hallenberg N, Larsson KH (2008) Intraspecific ITS variability in the kingdom Fungi as expressed in the international sequence databases and its implications for molecular species identification. *Evolutionary Bioinformatics* **4**: 193–201.

- O'Brien HE, Parrent JL, Jackson JA, Moncalvo JM, Vilgalys R (2005) Fungal community analysis by large-scale sequencing of environmental samples. *Applied and Environmental Microbiology* **71**: 5544–5550.
- Olariaga I, Laskibar X, Holec J (2015) Molecular data reveal cryptic speciation within *Tricholomopsis rutilans*: description of *T. pteridicola* sp. nov. associated with *Pteridium aquilinum*. *Mycological Progress* **14**: 21.
- Padial JM, Miralles A, De la Riva I, Vences M (2010) The integrative future of taxonomy. *Frontiers in Zoology* **7**: 16.
- Pons J, Barraclough TG, Gomez-Zurita J, Cardoso A, Duran DP, Hazell S, Kamoun S, Sumlin WD, Vogler AP (2006) Sequence-based species delimitation for the DNA taxonomy of undescribed insects. *Systems Biology* **55**: 595–609.
- Prieto M, Wedin M (2013) Dating the diversification of the major lineages of Ascomycota (Fungi). *Plos One* **8**: e65576.
- Pringle A, Baker DM, Platt JL, Wares JP, Latgé JP, Taylor JW (2005) Cryptic speciation in the cosmopolitan and clonal human pathogenic fungus *Aspergillus fumigatus*. *Evolution* **59**: 1886–1899.
- Puillandre N, Lambert A, Brouillet S, Achaz G (2012) ABGD, Automatic Barcode Gap Discovery for primary species delimitation. *Molecular Ecology* **21**: 1864–1877.
- R Core Team (2013) *R: a language and environment for statistical computing*. Vienna, Austria: R Foundation for Statistical Computing. Available at <http://www.R-project.org> (accessed 06 March 2018).
- Rambaut A, Suchard MA, Xie D, Drummond AJ (2014) *Tracer v1.6*. Available at <http://tree.bio.ed.ac.uk/software/tracer/> (accessed 02 November 2017).
- Riddick EW, Cottrell TE (2010) Is the prevalence and intensity of the ectoparasitic fungus *Hesperomyces virescens* related to the abundance of entomophagous coccinellids. *Bulletin of Insectology* **63**: 71–78.
- Rosling A, Cox F, Cruz-Martinez K, Ihrmark K, Grelet GA, Lindahl BD, Menkis A, James TY (2011) Archaeorhizomycetes: unearthing an ancient class of ubiquitous soil fungi. *Science* **333**: 876–879.
- Rundle HD, Nosil P (2005) Ecological speciation. *Ecology Letters* **8**: 336–352.
- Samson RA, Visagie CM, Houbraken J, Hong S-B, Hubka V, Klaassen CHW, Perrone G, Seifert KA, Susca A, Tanney JB, Varga T, Kocsubé S, Szigeti G, Yaguchi T, Frisvad JC (2014) Phylogeny, identification and nomenclature of the genus *Aspergillus*. *Studies in Mycology* **78**: 141–173.

- Santamaría S (1989) El orden Laboulbeniales (Fungi, Ascomycotina) en la Península Ibérica e Islas Baleares. *Edicions especials de la Societat Catalana de Micologia* **3**: 1–396.
- Santamaría S (2003) Laboulbeniales, II. *Acompsomyces–Ilyomyces*. *Flora Mycologica Iberica* **5**: 1–344.
- Schluter D (2000) *The ecology of adaptive radiation*. Oxford, UK: Oxford University Press.
- Schluter D (2001) Ecology and the origin of species. *Trends in Ecology and Evolution* **16**: 372–380.
- Schoch CL, Seifert KA, Huhndorf S, Robert V, Spouge JL, Levesque CA, Chen W, Fungal Barcoding Consortium (2012) Nuclear ribosomal internal transcribed spacer (ITS) region as a universal DNA barcode marker for Fungi. *Proceedings of the National Academy of Sciences of the United States of America* **109**: 6241–6246.
- Simpson GG (1961) *Principles of animal taxonomy*. New York: Columbia University Press.
- Singh G, Dal Grande F, Divakar PK, Otte J, Leavitt SD, Szczepanska K, Crespo A, Rico VJ, Aptroot A, da Silva Cáceres ME, Lumbsch HT, Schmitt I (2015) Coalescent-based species delimitation approach uncovers high cryptic diversity in the cosmopolitan lichen-forming fungal genus *Protoparmelia* (Lecanorales, Ascomycota). *Plos One* **10**: e0124625.
- Sousa JO, Suz LM, García MA, Alfredo DS, Conrado LM, Marinho P, Ainsworth AM, Baseia IG, Martín MP (2017) More than one fungus in the pepper pot: Integrative taxonomy unmasks hidden species within *Myriostoma coliforme* (Geastraceae, Basidiomycota). *Plos One* **12**: e0177873.
- Stadler T (2009) On incomplete sampling under birth–death models and connections to the sampling-based coalescent. *Journal of Theoretical Biology* **261**: 58–66.
- Stefani FOP, Jones RH, May TW (2014) Concordance of seven gene genealogies compared to phenotypic data reveals multiple cryptic species in Australian dermocyboid *Cortinarius* (Agaricales). *Molecular Phylogenetics and Evolution* **71**: 249–260.
- Swofford DL (1991) *PAUP: Phylogenetic Analysis Using Parsimony, Version 3.1*. Computer program distributed by the Illinois Natural History Survey, Champaign, Illinois.
- Tavares II (1979) The Laboulbeniales and their arthropod hosts. In: *Insect-fungus symbiosis, nutrition, mutualism, and commensalism* (Batra LR, ed): 229–258. Hoboken, New Jersey: John Wiley & Sons.
- Taylor JW, Berbee ML (2006) Dating divergences in the Fungal Tree of Life: review and new analyses. *Mycologia* **98**: 838–849.
- Taylor DL, Hollingsworth TN, McFarland JW, Lennon NJ, Nusbaum C, Ruess RW (2014) A first comprehensive census of fungi in soil reveals both hyperdiversity and fine-scale niche partitioning. *Ecological Monographs* **84**: 3–20.

- Thaxter R (1891) Supplementary note on North American Laboulbeniaceae. *Proceedings of the American Academy of Arts and Sciences* **25**: 261–270.
- Thaxter R (1896) Contribution towards a monograph of the Laboulbeniaceae. *Memoirs of the American Academy of Arts and Sciences* **12**: 187–429, Pl. I–XXVI.
- Thaxter R (1931) Contribution towards a monograph of the Laboulbeniaceae. Part V. *Memoirs of the American Academy of Arts and Sciences* **16**: 1–435, Pl. I–LX.
- van de Putte K, Nuytinck J, De Crop E, Verbeken A (2016) *Lactifluus volemus* in Europe: three species in one—revealed by a multilocus genealogical approach, Bayesian species delimitation and morphology. *Fungal Biology* **120**: 1–25.
- Vilgalys R, Hester M (1990) Rapid genetic identification and mapping of enzymatically amplified ribosomal DNA from several *Cryptococcus* species. *Journal of Bacteriology* **172**: 4238–4246.
- Weir A, Beakes GW (1996) Correlative light- and scanning electron microscope studies on the development morphology of *Hesperomyces virescens*. *Mycologia* **88**: 677–693.
- White TJ, Bruns TD, Lee SB, Taylor JW (1990) Analysis of phylogenetic relationships by amplification and direct sequencing of ribosomal RNA genes. In: *PCR Protocols: a guide to methods and applications* (Innis MA, Gelfand DH, Sninsky JJ, White TJ, eds): 315–322. San Diego: Academic Press.
- Yahr R, Schoch CL, Dentinger BT (2016) Scaling up discovery of hidden diversity in fungi: impacts of barcoding approaches. *Philosophical Transactions of the Royal Society B* **371**: 20150336.
- Zamora JC, Calonge FD, Martín MP (2015) Integrative taxonomy reveals an unexpected diversity in *Geastrum* section *Geastrum* (Geastrales, Basidiomycota). *Persoonia* **34**: 130–165.
- Zelditch ML, Swiderski DL, Sheets HD, Fink WL (2012) *Geometric morphometrics for biologists: A primer*. New York: Elsevier Academic Press.
- Zhang J, Kapli P, Pavlidis P, Stamatakis A (2013) A general species delimitation method with applications to phylogenetic placements. *Bioinformatics* **29**: 2869–2876.

## CHAPTER 4

### **Hyperparasites: Morphological and molecular diversity of Laboulbeniales fungi associated with ectoparasitic bat flies (Diptera: Nycteribiidae, Streblidae)**

Manuscript in review:

Haelewaters D, Page RA, Pfister DH. *Ecology and Evolution*.

*Author's contribution.* — D.H. initiated the project, generated all sequence data, performed molecular phylogenetic analyses, prepared all figures, described the new species and morphotypes, and wrote the manuscript with input from R.A.P. and D.H.P. R.A.P. contributed to fieldwork and facilitated research in Panama. D.H.P. provided expertise at all stages of research.



**Hyperparasites: Morphological and molecular diversity of Laboulbeniales fungi associated with ectoparasitic bat flies (Diptera: Nycteribiidae, Streblidae)**

Danny Haelewaters<sup>1,2</sup>

Rachel A. Page<sup>2</sup>

Donald H. Pfister<sup>1</sup>

<sup>1</sup>Department of Organismic and Evolutionary Biology & Farlow Reference Library and Herbarium of Cryptogramic Botany, Harvard University, 22 Divinity Avenue, Cambridge, MA 02138, United States; <sup>2</sup>Smithsonian Tropical Research Institute, Apartado Postal 0843-03092, Balboa, Panama

**Abstract.** The aim of this study was to explore the diversity of ectoparasitic fungi (Ascomycota, Laboulbeniales) that use bat flies (Diptera, Hippoboscoidea) as hosts. Bat flies themselves live as ectoparasites in the fur and on wing membranes of bats (Mammalia, Chiroptera); hence this is a tripartite parasite system. Here, we collected bats, bat flies and Laboulbeniales, and conducted phylogenetic analyses of Laboulbeniales to contrast morphology with sequence data. Parasitism of bat flies by Laboulbeniales arose three times independently, once in the Eastern Hemisphere (*Arthrorhynchus*) and twice in the Western Hemisphere (*Gloeandromyces*, *Nycteromyces*). We hypothesize that the genera *Arthrorhynchus* and *Nycteromyces* evolved independently from lineages of ectoparasites of true bugs (Hemiptera). Four species of *Gloeandromyces* are recognized by molecular-based species delimitation methods (ABGD, bPTP, GMYC). *Gloeandromyces dickii* nom. prov. from Nicaragua and Panama is described and illustrated. Both

*G. pageanus* and *G. streblae* show divergence by host specialization. In addition, we observed morphotypes that are position-specific and speculate that these are the consequence of morphological adaptations induced by growing in that specific position of the fly integument. In our assessment of coevolution, we only observe congruence between the Old World clades of bat flies and Laboulbeniales. The other associations are the result of the roosting ecology of the bat hosts.

**Key words:** Ascomycota, ectoparasites, host specialization, phenotypic plasticity, ribosomal DNA, taxonomy

## INTRODUCTION

*So naturalists observe, a flea*

*Hath smaller fleas that on him prey;*

*And these have smaller fleas to bite 'em.*

*And so proceeds ad infinitum.*

—Jonathan Swift (*On Poetry: A Rhapsody*, 1733)

Hyperparasitism, whereby parasites infect other parasites, is thought to be a common phenomenon in nature (Parratt & Laine, 2016). However, few examples of obligate hyperparasites among fungi have been well studied. Questions arise about what at first glance appears to be a risky lifestyle. How did such associations evolve? What population parameters are necessary to maintain these relationships? How strict are the species-level relationships? The examples studied here involve bats, their blood-sucking dipteran ectoparasites and the fungal

ectoparasites of the blood-sucking flies. An important question is whether this lifestyle could have arisen multiple times even though this seems tenuous. Another unexplored question is how diverse these fungal hyperparasites are, especially in the tropical regions (Arnold & Lutzoni, 2007).

Bats (Mammalia, Chiroptera) have received a great deal of attention due to their extraordinary morphological and ecological adaptations as well as their diversity in life history traits that make them ideal study organisms (longevity, large social structure, high mobility). Bats are parasitized by different groups of organisms, of which bat flies (Diptera, Hippoboscoidea, Nycteribiidae and Streblidae) are relatively well studied compared to other parasites. Published studies have focused on host specificity, apparent male-domination and population structure of bat flies (Dittmar *et al.*, 2006; Dick & Patterson, 2007, 2008; Olival *et al.*, 2013) and on associations between functional traits of bats and parasitism with bat flies (Patterson *et al.*, 2007). The addition of a second trophic level to the bat “microhabitat” is underexplored. Shockley & Murray (2006) reported two natural enemies of streblids (a hymenopteran parasitoid and a predaceous mirid bug). In addition, a handful of papers have discussed bacterial endosymbionts of bat flies in temperate and tropical regions (Hosokawa *et al.*, 2012; Morse *et al.*, 2012, 2013; Duron *et al.*, 2014; Wilkinson *et al.*, 2016).

In this study, we focus on the Laboulbeniales (Ascomycota, Laboulbeniomyces), microscopic fungi that are obligatory biotrophic on a wide range of arthropods, including bat flies. Prior to our current studies, the most recent papers dealing with Laboulbeniales on bat flies were published almost 40 years ago (Blackwell, 1980a, 1980b). For other papers on the same topic, we have to go back to the work of Harvard professor Roland Thaxter (1858–1932). Some of his publications presented species descriptions and new records for *Arthrorhynchus*, a genus

apparently restricted to Old World bat flies (Thaxter, 1896, 1901, 1908, 1915, 1931), and two genera that are restricted to neotropical bat flies, *Gloeandromyces* and *Nycteromyces* (Thaxter, 1917, 1924, 1931). Interestingly, until we initiated our studies on bat fly-associated Laboulbeniales, five species were only known from the type collections (Haelewaters *et al.*, 2017a, 2017b; Walker *et al.*, 2018). This illustrates how underexplored these hyperparasites are. Parasites are generally either ignored or seen as a threat for conservation of endangered organisms. However, they are a legitimate part of the earth's biodiversity and provide important ecosystem services (Windsor 1990, 1995; Dougherty *et al.*, 2015). In addition, parasites have the potential to alter food webs (Lafferty *et al.*, 2008). This applies as well to hyperparasites, since all organisms are almost sure to pick up a parasite during their lifetime, even parasites themselves.

*Bats and bat flies.* — With over 1300 described species, bats (Mammalia: Chiroptera) are the second-most diverse group of living mammals, after the rodents (Teeling *et al.*, 2005). Many bats have a wide assortment of food sources. Especially the New World leaf-nosed bats (family Phyllostomidae) encompass multiple feeding strategies associated with striking differences in craniofacial morphology. As a result, this is the most functionally diverse family in the Neotropics, where they occur throughout Central and South America and the Caribbean Islands (Dávalos, 2010). These bats have evolved diverse faces, skulls and teeth that are adapted for many different food types, including insects, small vertebrates, pollen, blood, fruit and nectar (Freeman, 1988; Nogueira *et al.*, 2009). Bats have also diverging preferences for roosting habits; some species such as *Platyrrhinus vittatus* make use of exposed and ephemeral structures whereas others such as *Vampyrum spectrum*, the false vampire bat, roost in more enclosed,

permanent structures (Kunz, 1982; Patterson *et al.*, 2007). Patterson *et al.* (2007) ranked bat roost structures according to roost duration and protection, with roosts of rolled leaves and foliage at one end of the spectrum and mines and caves at the other end. Bats act as indicator species to signal the conservation status of a given area, since they show species-specific sensitivity to habitat transformation (Meyer & Kalko, 2008; Jones *et al.*, 2009) and are species-rich (Kalko *et al.*, 1996; Churchill, 2008). Moreover, they provide important ecosystem services like insect predation, pollination and seed dispersal (Kunz *et al.*, 2011). For example, *Carollia perspicillata*, a frugivorous bat, prefers seeds of shrubs that are typical of early-succession forests with more canopy openness (e.g., Piperaceae, Solanaceae). As a result, this bat species is an indicator of early successional, secondary vegetation and an important vector for reforestation (Vleut *et al.*, 2013).

Bats are parasitized by many lineages of Arthropoda – including mites, ticks, true bugs, fleas and flies. Undoubtedly best studied are the bat flies. In contrast, as an example, the last study on ectoparasitic mites, ticks, true bugs and fleas in Panama was done in the 1960s (Wenzel & Tipton, 1966). Bat flies (Diptera: Hippoboscoidea: Nycteribiidae, Streblidae) are conspicuous and therefore more easily investigated. Bat flies have specialized to life in the fur and on the flight membranes of bats where they suck blood (Dick & Patterson, 2006). Bat flies are divided into two families, Nycteribiidae and Streblidae, but familial as well as sub-familial classifications are subject to revision (Dittmar *et al.*, 2006). Nycteribiid bat flies (275 species) are dorsoventrally flattened and wingless. They are most diverse in the Eastern Hemisphere. Streblid bat flies (230 species) have undergone diversification mainly in the Neotropics, and their body plans are highly variable, ranging from laterally to dorsoventrally flattened. Also the presence of

wings is variable among streblids. Most have wings, despite not always being functional, and a minority (3%) are wingless (Dick & Patterson, 2006).

*Bat fly life history.* — To understand their relationships with other organisms, both as parasites and as hosts to other parasites, it is important to understand the life history characteristics of bat flies. Eggs are fertilized inside the female bat fly and the larvae develop and molt within the female, feeding from intra-uterine milk glands. The female gives birth to a single, third instar larva. Larval deposition happens on the roosting substrate. The larva (pre-pupa) pupates immediately, forming a puparium that develops in 3–4 weeks. Then the adult fly emerges and must immediately find a bat host to parasitize (Theodor, 1967; Dick & Patterson, 2006). Sexual maturity is reached at six days after emergence for males and five days after emergence for females. It should be noted that these are data obtained for *Basilina hispida*, a species parasitic on bamboo bats (*Tylonycteris* spp., Vespertilionidae); this is the only nycteribiid bat fly for which the life cycle has been studied in such detail (Marshall, 1970). Deposition of pre-pupae occurs in nine-day intervals in *B. hispida*, but apparently this period can differ in other species; the majority of female *Eucampsipoda sunndaica* flies deposits pre-pupae in three-day-intervals (Leong & Marshall, 1968). After about 20–25 days, the adult fly emerges upon stimulation (e.g., a bat host in the neighborhood). The life span of adult *B. hispida* flies reaches 97 days for males and 156 days for females. Interestingly, bat flies die within 25 hours without their bat host (Marshall, 1970). We refer to them as semi-permanent parasites because they can leave their hosts, for example when they are disturbed or when females are ready to deposit a third instar larva.

Extensive fieldwork has led to a better understanding of parasite dynamics. Bat social structure, roost environment and species fidelity to roosting structures have been linked to

parasitism by bat flies (Lewis, 1995; Patterson *et al.*, 2007). Social bats that live in large groups roosting in permanent structures to which they return with high fidelity, display increased parasitism. Bat flies display various levels of specificity. They can exploit a single bat species or multiple species. Monoxenous bat flies are strongly associated with a single bat species. Oligoxenous bat flies occur on bat hosts belonging to the same genus. Polyxenous flies show no strict host preference; they can use bat host species in two or even more genera. Jobling (1949) suggested that the ability to fly may be an important factor in bat fly host specificity, with winged species being less specific. However, compared to streblid bat flies, Marshall (1980) found no higher specificity in nycteribiids, despite all of them being wingless. This was confirmed by ter Hofstede *et al.* (2004), who also found no evidence for ecological isolation affecting specificity. Apparently, the bat fly species from their study (773 specimens from 455 bats) followed phylogenetic lines, even when multiple bat species occupied the same roost sites, and the authors referred to physiological or behavioral features of bat hosts to explain the observed specificity. In addition to host specificity, bat flies can display position specificity, with preference for either fur or flight membranes. Host grooming behavior may be responsible for this phenomenon (ter Hofstede *et al.*, 2004). Species living in the fur have morphological adaptations, such as ctenidia (specialized setae) and elongated metalegs (e.g., *Megistopoda aranea* on *Artibeus* fruit bats).

*Laboulbeniales*. — Laboulbeniales are one of three orders in the class Laboulbeniomycetes, the two others being Herpomycetales and Pyxidiophorales. All members of the class are obligately associated with arthropods for dispersal (Pyxidiophorales) or as biotrophs (Herpomycetales, Laboulbeniales). What sets the Laboulbeniales apart is its diversity with 2200 described species

and many more awaiting discovery and its wide variety of arthropod hosts. Representatives of three subphyla serve as host to Laboulbeniales fungi: Chelicerata, with harvestmen (Opiliones) and mites (Acari); Myriapoda, with millipedes (Diplopoda); and Hexapoda, with cockroaches and termites (Blattodea), beetles (Coleoptera), earwigs (Dermaptera), flies (Diptera), true bugs (Hemiptera), ants (Hymenoptera, Formicidae), crickets and allies (Orthoptera), lice (Psocodea) and thrips (Thysanoptera). Laboulbeniales are ectoparasites; they are attached at the exoskeleton of the host where they form multicellular units of determinate growth, or thalli. They are developmentally unique among the fungi that usually have mycelia of unlimited growth. Laboulbeniales thalli are the result of subsequent divisions of a single two-celled ascospore. The ascospores are predominantly transmitted directly from infected to uninfected hosts (De Kesel, 1995).

Studying Laboulbeniales fungi has proven to be difficult: the average size of Laboulbeniales thalli is around 200  $\mu\text{m}$ , with extremes ranging from 35  $\mu\text{m}$  (*Rickia depauperata* on mites of the genus *Celaenopsis*) to 4 mm (*Laboulbenia kunkelii* on *Mormolyce phyllodes* beetles); because thalli are externally attached to a host, any study, morphological or molecular, requires micro-manipulation with sterile techniques; hosts may bear a large number of thalli, but often only a few thalli are available for study; in some cases, thalli of a given species or morphotype may be restricted to a particular position on the host body (Goldmann & Weir, 2012; Goldmann *et al.*, 2013); Laboulbeniales have not been grown in culture to more than a few cells (never reaching maturity) (Whisler, 1968). Isolation of DNA has often been unsuccessful because of the often heavily pigmented cell walls (Weir & Blackwell, 2001b). This pigment, melanin, interferes during the PCR step by binding to the polymerase enzyme (Eckhart *et al.*, 2000). In addition, the cells are resilient to absorb impacts and friction on the host's integument.



The combination of the melanized cell walls and resilient cells makes that the thalli are hard to break open.

Fungi of the order Laboulbeniales can display several types of specificity. Many species are host specific; they are associated with a single host species or species in the same genus. For example, *Rickia wasmannii* is specific to *Myrmica* ants and has been reported on ten different species in this genus thus far (Báthori *et al.*, 2017). Based on experimental work, De Kesel (1996) showed that this specificity is driven by characteristics of the integument and living conditions of the arthropod host, but also by the habitat chosen by that host. For a number of species, such as *Euzodiomyces lathrobii*, *Hesperomyces virescens*, *Laboulbenia flagellata* and *Rhachomyces lasiophorus*, many host species are known, often in more than one host family (Santamaria *et al.*, 1991). Our work with *H. virescens* has demonstrated that it is impossible to make accurate species-level delimitations without molecular data (CHAPTER 3). It could be that more generalistic parasite taxa are species complexes consisting of different species, whether or not cryptic, segregated by host. A different scenario is posed when hosts co-occur in a single micro-habitat. In this situation, opportunities exist for ascospores to transmit from a “typical” host to an “atypical” one. Micro-habitats can be ant nests (Pfliegler *et al.*, 2016), subterranean caves (Reboleira *et al.*, 2017), or seaweed and plant debris on beaches (De Kesel & Haelewaters, 2014).

Another type of specificity is displayed when a given fungus shows “a remarkable tendency to grow on very restricted portions of the host integument” (Benjamin & Shanor, 1952). This phenomenon is referred to as position specificity. For example, 13 species of *Chitonomyces* can be observed on restricted positions of the aquatic diving beetle *Laccophilus maculosus*. Based on the combination of molecular and ecological data, Goldmann & Weir

(2012) confirmed that sexual transmission was the mechanism behind the observed position specificity patterns, as suggested by Benjamin & Shanor (1952).

*Laboulbeniales on bat flies.* — Around 10% of Laboulbeniales parasitize flies (Diptera). Species of Laboulbeniales on flies belong to eight genera: *Arthrorhynchus*, *Dimeromyces*,

*Gloeandromyces*, *Ilytheomyces*, *Laboulbenia*, *Nycteromyces*, *Rhizomyces* and *Stigmatomyces*.

The genus *Laboulbenia* is by far the largest genus with close to 600 recognized species, but only 24 species of those are known from flies (Rossi & Kirk-Spriggs, 2011). *Stigmatomyces* is the second-largest genus in the order, with 144 described species, all on flies (Rossi & Leonardi, 2013). The genera *Arthrorhynchus*, *Gloeandromyces* and *Nycteromyces* are specific to bat flies, whereas none of the other genera have been recorded from bat flies.

*Arthrorhynchus* is restricted to Eastern Hemisphere species of Nycteribiidae. Kolenati (1857) was the first to report Laboulbeniales from bat flies; he described two species, *Arthrorhynchus diesingii* from *Nycteribia vexata* [as *Acrocholidia montguei (vexata)*] and *A. westrumbii* from *Penicillidia conspicua* [as *Megistopoda westwoodii*]. Peyritsch (1871) described *Laboulbenia nycteribiae* and suggested that Kolenati's species were synonyms of his newly described taxon. He later erected a new genus to accommodate his species: *Helminthophana nycteribiae* (Peyritsch 1873). Thaxter (1896) followed Peyritsch's opinion but later he (Thaxter 1901) retained *Arthrorhynchus* and described two additional species, *A. cyclopodiae* and *A. eucampsipodae*. A fourth species, *A. acrandros*, was described by Merola (1952) from the bat fly *Phthiridium biarticulatum* [as *Nycteribia (Celepries) biarticulata*]. The taxonomic status of all these species is unclear, because no sequence data exist for any of them. *Arthrorhynchus nycteribiae* has been reported from several host genera: *Nycteribia*, *Penicillidia*, *Phthiridium* (Blackwell, 1980b). Consequently, this taxon could be a complex of different

species, each specialized to a single bat fly host or several hosts in a single genus—as is the situation in *Hesperomyces virescens* sensu lato (CHAPTER 3).

The genera *Gloeandromyces* and *Nycteromyces* are restricted to growing on streblid bat flies in North and South America (Thaxter, 1917, 1931; Haelewaters *et al.*, 2017a). The diversity of both genera is thus far limited, as is knowledge of their distribution and biology. After their original description (Thaxter, 1917), *G. nycteribiidarum*, *G. streblae* [both described as *Stigmatomyces*] and *Nycteromyces streblidinus* were only reported again a century later by Haelewaters *et al.* (2017a). *Gloeandromyces nycteribiidarum* was described on *Megistopoda aranea* [as *Pterellipsis aranea*] from Grenada, and *G. streblae* on *Strebla wiedemanni* [as *S. vespertilionis*] from Venezuela. *Nycteromyces streblidinus* was described on the same individual of *S. wiedemanni* from which *G. streblae* had been described (Thaxter, 1917). Haelewaters *et al.* (2017a) described a third species of *Gloeandromyces*, *G. pageanus*, from *Trichobius dugesioides* bat flies collected in Gamboa, Panama.

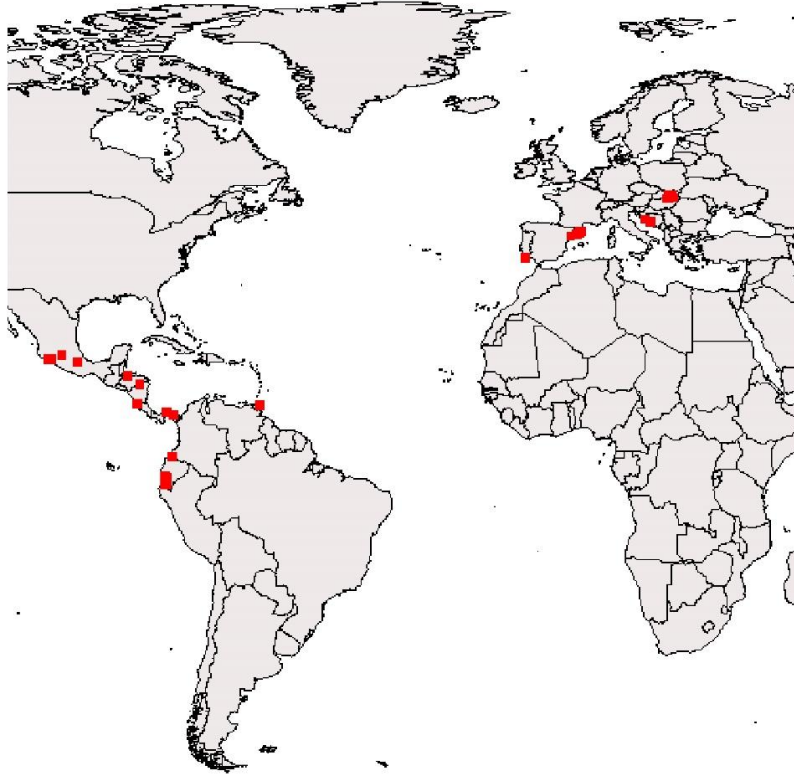
Except for a few disparate records of bat fly-associated Laboulbeniales, virtually nothing is known about this triparatite system. Bat flies are dependent on their bat hosts (Ramasindrazana *et al.*, 2017) and it has been shown that habitat disturbance affected parasitism of bats by bat flies (Pilosof *et al.*, 2012). The direction of the correlation (positive or negative) was reliant on the bat host species. Similarly, life history traits of both bats and bat flies may affect the ecology of Laboulbeniales species. If bat flies are affected by habitat disturbance, then Laboulbeniales species could be affected as well. For example, elevated population densities of bat flies would potentially increase transmission success of ascospores, if they co-occur on the same bat hosts or in the same roosts. However, for these sorts of data, hundreds or even thousands of bat flies need to be collected and screened for parasitic fungi. How life history traits and environmental factors

such as habitat modification can shape species responses remains poorly understood and requires a large, non-biased dataset.

With this contribution, our main intentions were to collect and screen large numbers of bat flies, both by fieldwork and expanding our network of collaborators who could provide us with collections of bat flies. Here, we present the results of increased sampling efforts and the employment of molecular phylogenetic methods. We discuss the phylogenetic position of bat fly-associated Laboulbeniales genera and evaluate the importance of morphological characters versus DNA characters for species delimitation in *Gloeandromyces*.

## MATERIAL AND METHODS

*Capture of bats and collection of bat flies.* — Bats were captured and screened for ectoparasites by D.H. with the help of collaborators and field assistants during several field trips to Panama between 2015 and 2017. Field sites were located at Isla Barro Colorado (Panamá Oeste Province), in Gamboa and Parque Nacional Soberanía in the Canal Zone (Colón Province), Chilibre (Panamá Province) and Reserva Natural Chucantí (Darién Province) (Figure 4-1). Bats were captured using three to four 6m 36mm mesh ground level mistnets with 4 shelves (Avinet, Portland, Maine, USA). Mistnets were set over trails that were presumably used by bats as flight pathways (Palmeirim & Etherdige, 1985). Nets were usually examined every 10 to 20 min between sunset and ~11 pm. Bats were disentangled and processed immediately or kept in clean cotton bags until processing. Bats were identified on site using dichotomous keys (Handley Jr., 1981; Timm & LaVal, 1998). Bats were again released at the vicinity of capture site immediately after processing. Bat taxonomy follows Simmons (2005). In this study, we considered *Artibeus intermedius* a junior synonym of *A. lituratus* (Guerrero *et al.*, 2008; Barquez *et al.*, 2015).



**Figure 4-1.** Field sites where bat flies for this project have been collected. Field sites are located in North America (Costa Rica, Honduras, Mexico, Nicaragua, Panama), South America (Ecuador, Trinidad) and Europe (Croatia, Hungary, Slovakia, Portugal, Spain).

To remove bat flies from their bat hosts, we first applied 99% ethanol using a paintbrush to reduce fly activity. Subsequently, the bat flies were carefully removed using a rigid Swiss Style Forceps #5 with superfine tip (BioQuip #4535, Rancho Dominguez, California) or a Featherweight Forceps with narrow tip (BioQuip #4748). Some bat flies were collected using forceps alone or simply by hand. Preservation and long-term storage of bat flies was in 99% ethanol in separate vials (one vial per bat host). Identification of bat flies to species level was based on published keys (Wenzel & Tipton, 1966; Wenzel, 1976; Guerrero, 1993–1998b) and complementary publications (Miller & Tschapka, 2001; Dick, 2013). Voucher specimens are deposited at the following locations: Museo de Peces de Agua e Invertebrados, David, Panamá (MUPADI) and Naturalis Biodiversity Center, Leiden, Netherlands (RMNH).

Additional bat fly specimens preserved in 70-99% ethanol were available from fieldwork by collaborators. Included in this study were bat flies from Costa Rica (T. Hiller, unpubl.), Ecuador, Mexico, Nicaragua (C.W. Dick, unpubl.), Honduras (Dick, 2013), Panama (Walker *et al.*, 2018) and Trinidad (J.J. Camacho, unpubl.) in Central and South America; and Croatia, Hungary, Portugal, Slovakia and Spain in Europe (Haelewaters *et al.*, 2017a; Szentiványi *et al.*, in review).

*Collection and identification of Laboulbeniales.* — Bat flies were screened for the presence of Laboulbeniales thalli under a Zeiss Stemi 508 stereomicroscope (Thornwood, New York). Thalli were removed from the host at the point of attachment (foot or haustorium) using Minuten Pins (BioQuip #1208SA, Rancho Dominguez, California) inserted onto wooden rods. We made slide mounts of thalli following procedures in CHAPTER 3. Mounted specimens were viewed at 400× to 1000× magnification under an Olympus BX53 compound microscope equipped with an Olympus DP73 digital camera (Waltham, Massachusetts). For detailed morphological study and descriptions at the Farlow Herbarium we used an Olympus BX40 microscope with XC50 camera. Fungal specimens were identified using Thaxter (1917, 1924, 1931) and Haelewaters *et al.* (2017b). Voucher slides are deposited at Farlow Herbarium (FH; Harvard University, Cambridge, Massachusetts) and Herbario de la Universidad Autónoma de Chiriquí (UCH; David, Panamá).

*DNA extraction, amplification, phylogenetic analysis.* — DNA was extracted from 1–14 Laboulbeniales thalli using the Extract-N-Amp Plant PCR Kit (Sigma-Aldrich, St. Louis, Missouri) (Haelewaters *et al.*, 2015) or the REPLI-g Single Cell Kit (Qiagen, Valencia,

California) (Haelewaters *et al.*, in review). Pre-treatments employed with the Extract-N-Amp method included a prolonged incubation period at 56 °C in 20 µL Extraction Solution up to 24 hours in a Shake 'N Bake Hybridization Oven (Boekel Scientific model #136400-2, Feasterville, Pennsylvania) and mechanically crushing fungal material in a FastPrep FP120 Cell Disrupter (Thermo Fisher Scientific, Waltham, Massachusetts) at 5.5 m/sec for 20s. For about two thirds of our extractions, and as a rule for later extractions, we manually cut thalli in 2 or 3 parts (usually through the perithecium) using a #10 surgical blade on disposable Bard-Parker handle (Aspen Surgical, Caledonia, Michigan) to ensure successful lysis.

We amplified the nuclear small and large ribosomal subunits of the ribosomal DNA (SSU and LSU rDNA). Primer pairs for SSU were NSL1 (5'–GTAGTGTCCCTCrCATGCTTTTGAC–3') and NSL2 (5'–AATCyAAGAATTTACCTCTGAC–3') or NSL1 and R (5'–TGATCCTTCTGCAGGTTACCTACG–3'). Primer pairs for LSU were LR0R (5'–ACCCGCTGAACTTAAGC–3') and LR5 (5'–ATCCTGAGGGAACTTC–3') or LIC24R (5'–GAAACCAACAGGGATTG–3') and LR3 (5'–GGTCCGTGTTTCAAGAC–3'). PCR reactions consisted of 13.3 µL of RedExtract Taq polymerase (Sigma-Aldrich), 2.5 µL of each 10 µM primer, 5.7 µL of H<sub>2</sub>O and 1.0 µL of template DNA. All amplifications were done in a 2720 Thermal Cycler (Applied Biosystems, Foster City, California) with initial denaturation at 94 °C for 3:00 min; followed by 35 cycles of denaturation at 94 °C for 1:00 min, annealing at 50 °C for 0:45 min and extension at 72 °C for 1:30 min; and final extension at 72 °C for 10:00 min.

Unsuccessful PCR reactions were re-run using the Q5 Host Start High-Fidelity DNA Polymerase (New England BioLabs, Ipswich, Massachusetts). PCR was done in 25 µL consisting of 5.0 µL of 5× Q5 Reaction Buffer, 0.5 µL of 10 mM dNTP Mix (Quantabio, Beverly, Massachusetts), 1.25 µL of each 10 µM primer, 0.25 µL of Q5 High-Fidelity DNA

Polymerase, 12.75  $\mu\text{L}$  of  $\text{H}_2\text{O}$  and 4.0  $\mu\text{L}$  of template DNA. Thermal cycling conditions were as follows: initial denaturation at 98 °C for 30 s; 35 cycles of denaturation at 98 °C for 10 s, annealing at 58-61.5 °C for 30 s and extension at 72 °C for 30 + 5/cycle s; followed by final extension at 72 °C for 2 min. The optimal annealing temperature ( $T_a$ ) was calculated for every primer combination using the New England BioLabs online  $T_m$  Calculator tool ([tmcalculator.neb.com/](http://tmcalculator.neb.com/)) selecting “Q5” as product group and “Q5 Hot Start High-Fidelity DNA Polymerase” as polymerase/kit, and with 500 mM for primer concentration. When smears or weak bands were observed on gel, we optimized PCR conditions to include multiple annealing temperatures (*sensu* CHAPTER 3): 98 °C for 3 min; 30 cycles at 98 °C for 10 s, 65-68.5 °C for 30 s (decreasing 1 °C every 3 cycles) and 72 °C for 1:30 min; then 30 cycles at 98 °C for 10 s, 58-61.5 °C for 30 s and 72 °C for 1:30 min; and a final extension step of 72 °C for 2 min.

Molecular work was done both at the Molecular Multi-User's Lab at the Naos Marine Laboratories (Smithsonian Tropical Research Institute, Panama) and at the Harvard University Herbaria (Cambridge, Massachusetts). The work routine was identical except for purification and sequencing. In Panama, we purified PCR products using the QIAquick PCR Purification Kit (Qiagen). We subsequently prepared 10  $\mu\text{L}$  reactions with the same primers and 3.0  $\mu\text{L}$  of purified PCR product. Sequencing reactions were performed using the Big Dye® Terminator v3.1 Cycle Sequencing Kit (Life Technologies, Carlsbad, California). In Cambridge, purification and sequencing steps were outsourced to Genewiz (South Plainfield, New Jersey). Generated sequences were assembled and edited in Sequencher 4.10.1 (Gene Codes Corporation, Ann Arbor, Michigan). All sequences are deposited in GenBank (accession numbers in Table 4-1).



**Table 4-1.** Overview of Laboulbeniomyces sequences used in this study. Species names are listed for all isolates, with their hosts and country. Also included are extraction protocols and numbers of thalli used per extraction for all isolates: 1% Triton 100-based protocol from Weir & Blackwell (2001a); 0.1×TE buffer + dry ice protocol from Weir & Blackwell (2001b); heat extraction protocol, Extract-N-Amp Plant PCR Kit (ExNA) and QIAamp DNA Micro Kit (QIAamp Micro) from Haelewaters *et al.* (2015); REPLI-g Single Cell Kit (REPLI-g) from Haelewaters *et al.* (in review). GenBank accession numbers are provided (newly generated sequences in bold).

Genus	Species	Host	Country	Isolate	Extraction protocol	# thalli used	SSU	LSU
<i>Arthrorhynchus</i>	<i>nycteribiae</i>	<i>Penicillidia conspicua</i>	Hungary	Edeleny_13.xi.2014	Heat extraction	4-5	KY094496	KY094497
<i>Arthrorhynchus</i>	<i>nycteribiae</i>	<i>Penicillidia conspicua</i>	Hungary	D. Haelew. 1015d	ExNA	7	MG438336	MG438363
<i>Camptomyces</i>	sp. nov.	<i>Astenus</i> sp.	Tanzania	D. Haelew. 1222d	REPLI-g	1	MF314140	MF314141
<i>Gloeandromyces</i>	<i>dickii</i>	<i>Trichobius joblingi</i>	Panama	D. Haelew. 1312b	REPLI-g, crushed	2	<b>MH040546</b>	<b>MH040580</b>
<i>Gloeandromyces</i>	<i>dickii</i>	<i>Trichobius joblingi</i>	Panama	D. Haelew. 1312c	REPLI-g	2	<b>MH040547</b>	<b>MH040581</b>
<i>Gloeandromyces</i>	<i>dickii</i>	<i>Trichobius joblingi</i>	Panama	D. Haelew. 1323b	REPLI-g, crushed	4	MG958011	<b>MH040582</b>
<i>Gloeandromyces</i>	<i>dickii</i>	<i>Trichobius joblingi</i>	Panama	D. Haelew. 1323c	REPLI-g, crushed	4	<b>MH040548</b>	<b>MH040583</b>
<i>Gloeandromyces</i>	<i>nycteribiidarum</i>	<i>Megistopoda aranea</i>	Panama	D. Haelew. 1319b	REPLI-g	2	<b>MH040533</b>	<b>MH040566</b>
<i>Gloeandromyces</i>	<i>nycteribiidarum</i>	<i>Megistopoda aranea</i>	Panama	D. Haelew. 1334c	REPLI-g, crushed	3	<b>MH040534</b>	<b>MH040567</b>
<i>Gloeandromyces</i>	<i>pageanus</i> morphotype <i>alarum</i>	<i>Trichobius joblingi</i>	Panama	D. Haelew. 1306b	REPLI-g	2	<b>MH040541</b>	<b>MH040574</b>
<i>Gloeandromyces</i>	<i>pageanus</i> morphotype <i>alarum</i>	<i>Trichobius joblingi</i>	Panama	D. Haelew. 1322a	REPLI-g, crushed	1	<b>MH040543</b>	<b>MH040577</b>
<i>Gloeandromyces</i>	<i>pageanus</i> morphotype <i>alarum</i>	<i>Trichobius joblingi</i>	Panama	D. Haelew. 1327a	REPLI-g, crushed	1	<b>MH040544</b>	<b>MH040578</b>
<i>Gloeandromyces</i>	<i>pageanus</i> morphotype <i>polymorphus</i>	<i>Trichobius joblingi</i>	Trinidad	D. Haelew. 619a	ExNA	12	<b>MH040537</b>	KT800008
<i>Gloeandromyces</i>	<i>pageanus</i> morphotype <i>polymorphus</i>	<i>Trichobius joblingi</i>	Panama	D. Haelew. 1073b	ExNA, prolonged, crushed	3	<b>MH040538</b>	<b>MH040570</b>
<i>Gloeandromyces</i>	<i>pageanus</i> morphotype <i>polymorphus</i>	<i>Trichobius joblingi</i>	Panama	D. Haelew. 1089a	ExNA, prolonged, crushed	4	<b>MH040539</b>	<b>MH040571</b>

Table 4-1. (Continued).

Genus	Species	Host	Country	Isolate	Extraction protocol	# thalli used	SSU	LSU
<i>Gloeandromyces</i>	<i>pageanus</i> morphotype <i>polymorphus</i>	<i>Trichobius joblingi</i>	Panama	D. Haelew. 1100b	ExNA, prolonged, crushed	7	MH040307	MH040572
<i>Gloeandromyces</i>	<i>pageanus</i> morphotype <i>polymorphus</i>	<i>Trichobius dugesioides</i>	Panama	D. Haelew. 1272a	REPLI-g, crushed	2	MH040540	MH040573
<i>Gloeandromyces</i>	<i>pageanus</i> morphotype <i>polymorphus</i>	<i>Trichobius joblingi</i>	Panama	D. Haelew. 1315a	REPLI-g, crushed	1	—	MH040575
<i>Gloeandromyces</i>	<i>pageanus</i> morphotype <i>polymorphus</i>	<i>Trichobius joblingi</i>	Panama	D. Haelew. 1315b	REPLI-g	2	MH040542	MH040576
<i>Gloeandromyces</i>	<i>pageanus</i> morphotype <i>pageanus</i>	<i>Trichobius dugesioides</i>	Panama	D. Haelew. 1091b	ExNA, prolonged, crushed	6	MH040535	MG906798
<i>Gloeandromyces</i>	<i>pageanus</i> morphotype <i>pageanus</i>	<i>Trichobius dugesioides</i>	Panama	D. Haelew. 1367b	EXNA, crushed, FastPrep	6	—	MH040568
<i>Gloeandromyces</i>	<i>pageanus</i> morphotype <i>pageanus</i>	<i>Trichobius dugesioides</i>	Panama	D. Haelew. 1425a	REPLI-g, crushed	4	MH040536	MH040569
<i>Gloeandromyces</i>	<i>streblae</i>	<i>Trichobius dugesioides</i>	Panama	D. Haelew. 1090a	ExNA, prolonged, crushed	7	—	MH040584
<i>Gloeandromyces</i>	<i>streblae</i>	<i>Trichobius joblingi</i>	Panama	D. Haelew. 1306c	REPLI-g	4	MG958012	MH040585
<i>Gloeandromyces</i>	<i>streblae</i>	<i>Trichobius dugesioides</i>	Panama	D. Haelew. 1308b	REPLI-g	2	MH040549	MH040586
<i>Gloeandromyces</i>	<i>streblae</i>	<i>Trichobius dugesioides</i>	Panama	D. Haelew. 1309a	REPLI-g	1	MH040550	MH040587
<i>Gloeandromyces</i>	<i>streblae</i>	<i>Trichobius joblingi</i>	Panama	D. Haelew. 1317a	REPLI-g	1	MH040551	MH040588
<i>Gloeandromyces</i>	<i>streblae</i>	<i>Trichobius joblingi</i>	Panama	D. Haelew. 1335c	REPLI-g, crushed	2	MH040552	MH040589
<i>Gloeandromyces</i>	<i>streblae</i> morphotype <i>sigmomorphus</i>	<i>Trichobius joblingi</i>	Panama	D. Haelew. 1320b	REPLI-g, crushed	1	MH040545	MH040579
<i>Herpomyces</i>	<i>chaetophilus</i>	<i>Periplaneta americana</i>	USA	D. Haelew. 483b	ExNA	11 fem	MG438319	MG438350
<i>Herpomyces</i>	<i>chaetophilus</i>	<i>Periplaneta americana</i>	USA	D. Haelew. 602b	ExNA	10 fem	KT800023	KT800009
<i>Herpomyces</i>	<i>periplanetae</i>	<i>Periplaneta americana</i>	USA	D. Haelew. 602d	ExNA	8 fem	MG438327	MG438357
<i>Herpomyces</i>	<i>periplanetae</i>	<i>Periplaneta americana</i>	USA	D. Haelew. 1187d	REPLI-g	1 fem	MG438331	MG438359

**Table 4-1. (Continued).**

Genus	Species	Host	Country	Isolate	Extraction protocol	# thalli used	SSU	LSU
<i>Herpomyces</i>	<i>shelfordellae</i>	<i>Shelfordella lateralis</i>	Hungary	DE_HerpBL1	Heat extraction	±30	KT800026	KT800011
<i>Herpomyces</i>	<i>shelfordellae</i>	<i>Shelfordella lateralis</i>	Hungary	Bud_Slat	Heat extraction	10-20	MG438333	MG438361
<i>Herpomyces</i>	<i>stylopygae</i>	<i>Blatta orientalis</i>	Hungary	Bud_Bori	Heat extraction	10-20	MG438332	MG438360
<i>Hesperomyces</i>	<i>coleomegillae</i>	<i>Coleomegilla maculata</i>	Ecuador	631C	0.1×TE buffer + dry ice	3-15	KF266882	—
<i>Hesperomyces</i>	<i>coleomegillae</i>	<i>Coleomegilla maculata</i>	Ecuador	632A	0.1×TE buffer + dry ice	3-15	KF266880	—
<i>Hesperomyces</i>	<i>palustris</i>	<i>Coleomegilla maculata</i>	Ecuador	631K	0.1×TE buffer + dry ice	3-15	KF266902	—
<i>Hesperomyces</i>	<i>palustris</i>	<i>Coleomegilla maculata</i>	Ecuador	632B	0.1×TE buffer + dry ice	3-15	KF266891	—
<i>Hesperomyces</i>	<i>virescens</i>	<i>Harmonia axyridis</i>	USA	D. Haelew. 316a	ExNA	10-12	MG438339	KJ842339
<i>Hesperomyces</i>	<i>virescens</i>	<i>Harmonia axyridis</i>	Netherlands	D. Haelew. 334b	ExNA	10	MG438340	MG438364
<i>Hesperomyces</i>	<i>virescens</i>	<i>Olla v-nigrum</i>	USA	JP352b	ExNA	11	MG760581	MG745337
<i>Hesperomyces</i>	<i>virescens</i>	<i>Olla v-nigrum</i>	USA	JP353a	QIAamp Micro	10	KT800028	KT800013
<i>Hesperomyces</i>	<i>virescens</i>	<i>Olla v-nigrum</i>	USA	JP354b	ExNA	10	MG760583	MG745339
<i>Hesperomyces</i>	<i>virescens</i>	<i>Harmonia axyridis</i>	South Africa	D. Haelew. 648c	ExNA	8-10	KU574863	KU574865
<i>Hesperomyces</i>	<i>virescens</i>	<i>Cheilomenes propinqua</i>	South Africa	D. Haelew. 655c	ExNA	11	KU574866	KU574867
<i>Hesperomyces</i>	<i>virescens</i>	<i>Cheilomenes propinqua</i>	South Africa	D. Haelew. 659a/b	ExNA	20	MG760590	MG745342
<i>Hesperomyces</i>	<i>virescens</i>	<i>Harmonia axyridis</i>	Netherlands	D. Haelew. 1174a	ExNA, crushed, prolonged	12	MG760598	MG745345
<i>Hesperomyces</i>	<i>virescens</i>	<i>Addia bipunctata</i>	Denmark	D. Haelew. 1193g	REPLI-g, crushed	1	MG760599	MG745346
<i>Hesperomyces</i>	<i>virescens</i>	<i>Addia bipunctata</i>	Sweden	D. Haelew. 1199h	REPLI-g, crushed	1	MG760600	MG745347
<i>Hesperomyces</i>	<i>virescens</i>	<i>Olla v-nigrum</i>	USA	D. Haelew. 1200i	REPLI-g, crushed	4	MG760602	MG745349

**Table 4-1. (Continued).**

<b>Genus</b>	<b>Species</b>	<b>Host</b>	<b>Country</b>	<b>Isolate</b>	<b>Extraction protocol</b>	<b># thalli used</b>	<b>SSU</b>	<b>LSU</b>
<i>Hesperomyces</i>	<i>virescens</i>	<i>Addalia bipunctata</i>	Italy	D. Haelew. 1231a	REPLI-g	2	MG760603	MG745350
<i>Hesperomyces</i>	<i>virescens</i>	<i>Psyllobora vigintimaculata</i>	USA	D. Haelew. 1250b	REPLI-g	5	MG760607	MG745354
<i>Hesperomyces</i>	<i>virescens</i>	<i>Psyllobora vigintimaculata</i>	USA	D. Haelew. 1250c	REPLI-g, crushed	2	MG760608	MG745355
<i>Hesperomyces</i>	<i>virescens</i>	<i>Psyllobora vigintimaculata</i>	USA	D. Haelew. 1251b	REPLI-g, crushed	1	MG760609	MG745356
<i>Hesperomyces</i>	<i>virescens</i>	<i>Harmonia axyridis</i>	Japan	D. Haelew. 1268b	REPLI-g, crushed	3	MG760610	MG745357
<i>Nycteromyces</i>	<i>streblidinus</i>	<i>Trichobius parasiticus</i>	Honduras	D. Haelew. 956a	ExNA	8 fem	<b>MH040553</b>	—
<i>Nycteromyces</i>	<i>streblidinus</i>	<i>Trichobius joblingi</i>	Panama	D. Haelew. 1324b	REPLI-g, crushed	4 m	<b>MH040554</b>	<b>MH040590</b>
<i>Nycteromyces</i>	<i>streblidinus</i>	<i>Trichobius joblingi</i>	Panama	D. Haelew. 1324c	REPLI-g, crushed	1 fem	<b>MH040555</b>	—
<i>Nycteromyces</i>	<i>streblidinus</i>	<i>Trichobius joblingi</i>	Panama	D. Haelew. 1324d	REPLI-g	1 fem	<b>MH040556</b>	<b>MH040591</b>
<i>Nycteromyces</i>	<i>streblidinus</i>	<i>Trichobius joblingi</i>	Panama	D. Haelew. 1324e	REPLI-g, crushed	1 m	<b>MH040557</b>	<b>MH040592</b>
<i>Polyandromyces</i>	<i>coptosomalis</i>	<i>Phoeacia</i> sp. nov.	Ecuador	D. Haelew. 313f	ExNA	7 fem, 2 m	KT800035	KT800020
<i>Polyandromyces</i>	<i>coptosomalis</i>	<i>Acrosternum</i> sp.	Canary Islands	HM499a	ExNA	15 fem, 3 m	MG438347	—
<i>Prolixandromyces</i>	<i>triandrus</i>	<i>Velia (Plesiovelia) saulii</i>	Hungary	Nagyvisnyo1	Heat extraction	5	LT158294	LT158295
<i>Rickia</i>	<i>laboulbentoides</i>	<i>Cyindroiulus punctatus</i>	Denmark	SR4s	ExNA, crushed	5	<b>MH040558</b>	<b>MH040593</b>
<i>Rickia</i>	<i>pachyuli</i>	<i>Pachyulus hungaricus</i>	Serbia	SR1s	ExNA, crushed	10-12	<b>MH040559</b>	<b>MH040594</b>
<i>Rickia</i>	<i>wasmannii</i>	<i>Myrmica scabrinodis</i>	Hungary	DE_Rak4	Heat extraction	30	KT800037	KT800021
<i>Rickia</i>	<i>wasmannii</i>	<i>Myrmica sabuleti</i>	Netherlands	D. Haelew. 1234a	REPLI-g	3	<b>MH040560</b>	<b>MH040595</b>
<i>Stigmatomyces</i>	<i>borealis</i>	<i>Parydra breviceps</i>	USA	AW-797	—	—	<b>JN835186</b>	—

Table 4-1. (Continued).

Genus	Species	Host	Country	Isolate	Extraction protocol	# thalli used	SSU	LSU
<i>Stigmatomyces</i>	<i>ceratophorus</i>	<i>Fannia canicularis</i>	USA	D. Haelew. 1136h	REPLI-g, crushed	8	MG958013	MH145384
<i>Stigmatomyces</i>	<i>entomophilus</i>	<i>Drosophila funebris</i>	Netherlands	D. Haelew. 1062c	ExNA, prolonged, crushed	6	MG958014	—
<i>Stigmatomyces</i>	<i>entomophilus</i>	<i>Drosophila funebris</i>	Netherlands	D. Haelew. 1063a	ExNA, prolonged, crushed	14	MH040561	—
<i>Stigmatomyces</i>	<i>gregarius</i>	Diopsidae sp.	Sierra Leone	D. Haelew. 1008a	ExNA	5	MG438348	—
<i>Stigmatomyces</i>	<i>gregarius</i>	Diopsidae sp.	Sierra Leone	D. Haelew. 1008b	ExNA	±10	MH040562	—
<i>Stigmatomyces</i>	<i>hydrelliae</i>	<i>Hydrellia</i> sp.			0.1×TE buffer + dry ice	4-10	AF431757	—
<i>Stigmatomyces</i>	<i>limnophorae</i>	Muscidae sp.	USA	AW-785	1% Triton 100	4-10	AF407576	—
<i>Stigmatomyces</i>	<i>protrudens</i>	Ephydriidae sp.	USA	AW-793	0.1×TE buffer + dry ice	4-10	AF298232	AF298234
<i>Stigmatomyces</i>	<i>rugosus</i>	<i>Psilopa</i> sp.			0.1×TE buffer + dry ice	4-10	AF431759	—
<i>Stigmatomyces</i>	<i>rugosus</i>	<i>Psilopa</i> sp.	Portugal	D. Haelew. 1138a	ExNA, prolonged, crushed	6	MH040563	—
<i>Stigmatomyces</i>	<i>scaptomyzae</i>	<i>Scaptomyza</i> sp.			0.1×TE buffer + dry ice	4-10	AF431758	—
<i>Stigmatomyces</i>	sp. nov.	cf. <i>Chamaemyia</i>	Portugal	D. Haelew. 1137a	ExNA, prolonged, crushed	8	MH040564	—
<i>Stigmatomyces</i>	sp. nov.	cf. <i>Chamaemyia</i>	Portugal	D. Haelew. 1137c	ExNA, prolonged, crushed	1	MH040565	—

*Sequence alignment and phylogenetic analyses.* — We constructed SSU and LSU rDNA datasets of newly generated sequences and sequences downloaded from GenBank to assess (1) the position of bat fly-associated genera among Laboulbeniales from other hosts and (2) species discrimination in the genus *Gloeandromyces*. Alignments were done using Muscle v3.7 (Edgar, 2004) on the Cipres Science Gateway version 3.3 (Miller *et al.*, 2010) and manually edited in BioEdit v7.2.6 (Hall, 1999). The SSU and LSU aligned data matrices were concatenated in MEGA v7.0.21 (Kumar *et al.*, 2016). Maximum likelihood (ML) analysis was run using PAUP on XSEDE 4.0b (Swofford, 1991), which is available on Cipres. The appropriate nucleotide substitution model was selected by considering the Akaike Information Criterion (AIC) in jModelTest 2.1 (Darriba *et al.*, 2012). The general time reversible model (GTR) with the assumption of a gamma distribution (+G) gave the best scoring tree (-lnL = 15262.1769). ML was inferred under this model and bootstrap (BS) values were calculated with 200 replicates. We ran Bayesian analyses using the BEAST on XSEDE tool in Cipres with a Markov chain Monte Carlo (MCMC) coalescent approach, under an uncorrelated lognormal relaxed molecular clock model allowing rates of evolution to vary across the tree. We selected the Birth-Death Incomplete Sampling speciation model (Stadler, 2009) as tree prior with the GTR+G nucleotide substitution model (considering the Bayesian Information Criterion, jModelTest 2.1) and a lognormal ucl.d.mean (mean = 5.0, stdev = 1.0). Three independent runs were performed from a random starting tree for 80 million generations, with a sampling frequency of 8000. Resulting log files of the individual runs were imported in Tracer v1.6 (Rambaut *et al.*, 2014) to check trace plots for convergence (= straight hairy-caterpillar profile; Drummond *et al.*, 2007) and effective sample size (ESS). ESS values were well  $\geq 200$  and so we took a minimum burn-in of 10% for all three runs. Log files and trees files were combined in LogCombiner v.1.8.4

(Drummond *et al.*, 2012) after removal of burn-in. TreeAnnotator v1.8.4 was used to generate consensus trees (0% burn-in) and to infer the Maximum Clade Credibility (MCC) tree, presenting the highest product of individual clade posterior probabilities. Final trees with bootstrap values (BS) and posterior probabilities (pp) were visualized in FigTree v1.4.3 ([tree.bio.ed.ac.uk/software/figtree/](http://tree.bio.ed.ac.uk/software/figtree/)).

*Species delimitation in Gloeandromyces.* — For species delimitation analyses within the genus *Gloeandromyces*, we used the LSU rDNA dataset. This region was put forward by previous studies to replace ITS as barcode for species delimitation in Laboulbeniomycetes (Walker *et al.*, 2018; CHAPTER 3). First, we calculated pairwise evolutionary distances between putative species using PAUP on XSEDE 4.0b. The p-distance was calculated as the number of nucleotide differences in a pairwise alignment divided by the number of nucleotides compared. We also calculated Jukes-Cantor (JC69) and Kimura 2-parameter (K80) distance metrics (Jukes & Cantor, 1969; Kimura, 1980). We performed neighbor-joining (NJ) analyses (Saitou & Nei, 1987) to cluster taxa based on distance matrices and compared the resulting NJ phenograms with the SH Test (Shimodaira & Hasegawa, 1999).

Next, we aimed to validate species identifications based on morphology by employing 3 species delimitation methods (SDMs). The Automatic Barcode Gap Discovery method (ABGD) partitions sequence data into a maximum number of groups based on nucleotide divergence among isolates (Puillandre *et al.*, 2012). We used the following parameters in the online version of ABGD ([wwwabi.snv.jussieu.fr/public/abgd/abgdweb.html](http://wwwabi.snv.jussieu.fr/public/abgd/abgdweb.html)): Pmin = 0.001, Pmax = 0.01 (*sensu* Puillandre *et al.*, 2012), steps = 10 and Nb bins = 20. To assess consistency in the recognition of species hypotheses by ABGD, we evaluated results for both available distance

metrics (JC69, K80) and for four gap width values (X): 0.1, 0.5, 1.0 and 1.5. The Poisson tree processes (PTP) model approach uses the number of nucleotide substitutions to infer speciation rate (Zhang *et al.*, 2013). We conducted two independent MCMC chains under a strict molecular clock, with a Yule speciation tree prior (Yule, 1925; Gernhard, 2008) and the TPM2uf+G model of nucleotide substitution as selected by the Bayesian Information Criterion from jModelTest 2.1.1. The runs were performed from a random starting tree for 40 million generations, with sampling of parameters and trees every 4,000 generations. The two resulting log files were combined in LogCombiner v1.8.4 with 10% burn-in. Consensus trees with 0% burn-in were generated and the MCC tree was constructed in TreeAnnotator v.1.8.4. We used the bPTP web server (<http://species.h-its.org>) with default values for number of MCMC generations, thinning, burn-in and seed. The General Mixed Yule Coalescent (GMYC) approach models processes at the population level (coalescence) and processes at the species level (speciation) based on a fully resolved ultrametric tree (Pons *et al.*, 2006). We conducted GMYC in R (R Core Team, 2013) using the packages ‘rnc1’ (Michonneau *et al.*, 2015) and ‘SPLITS’ (Ezard *et al.*, 2009). Input tree was the same MCC tree generated above for the PTP approach.

*Comparison of host and Laboulbeniales phylogenies.* — Sequence data for analyses were obtained by taking a single isolate per species for both the hosts and Laboulbeniales. For bat flies, mitochondrial cytochrome oxidase gene subunit I (COI) sequences were used. The bat fly dataset included: *Brachytarsina alluaudi* (outgroup); *Exastinion clovisi*, *Megistopoda aranea*, *Nycteribia schmidlii*, *Penicillidia conspicua*, *P. monoceros*, *Speiseria ambigua*, *Trichobius costalimai*, *Tri. dugesioides*, *Tri. joblingi*, *Tri. parasiticus*, *Tri. yunkerii* (hosts); *Mastoptera guimaraesi*, *Paratrachobius longicrus*, *Strebla wiedemanni* (to add structure and support to the



tree). *Penicillidia monoceros* is not a host to Laboulbeniales, but we selected this bat fly species as a substitute for *P. dufourii*, for which no sequences exist. For Laboulbeniales, we used large subunit ribosomal DNA (LSU rDNA) sequences, which we established earlier as a potential barcode region. The dataset of Laboulbeniales included the following species: *Herpomyses periplanetae* (outgroup); *Arthrorhynchus nycteribiae*, *Gloeandromyces dickii*, *G. nycteribiidarum*, *G. pageanus* morphotype *alarum*, *G. pageanus* morphotype *pageanus*, *G. pageanus* morphotype *polymorphus*, *G. streblae* Clade A, *G. streblae* Clade B, *G. streblae* morphotype *sigmomorphus*, *Nycteromyces streblidinus* (species associated with bat flies); *Hesperomyces virescens*, *Polyandromyces coptosomalis*, *Stigmatomyces protrudens* (to add structure and support to the tree). Sequences were aligned in Muscle v3.7 (Edgar, 2004) on Cipres. Alignments were visually inspected in BioEdit v7.2.6 (Hall, 1999). Maximum likelihood (ML) phylogenetic trees were generated using RAxML v8.2.X (Stamatakis, 2014) available on Cipres. ML was inferred under a GTRCAT model, with 1000 bootstrapping replicates. To visualize host–Laboulbeniales interactions, cladograms were generated from the best ML trees in FigTree v1.4.3 and saved as NEXUS files. The co-phylogeny plot was constructed in R (R Core Team, 2013) using the package ‘ape’ (Paradis *et al.*, 2004).

*Associations network.* — All presence/absence data of Laboulbeniales on bat flies and bat flies on bats were entered in a database. Data were partitioned to represent distinct climatic zones (temperate, neotropical). The bat–bat fly–Laboulbeniales associations were visualized with the help of the R package ‘bipartite’ (Dormann *et al.*, 2008). We used weighted data and the function *plotweb* to build a network showing host-dependencies and prevalence. Bats and bat flies that were not identified to genus level, bats without specimen label and infected bat flies with

unidentified Laboulbeniales were excluded from the analysis. Also excluded were bats and bat flies for which  $n < 10$ .

## RESULTS

*Nucleotide alignment datasets.* — We generated 54 sequences of bat fly-associated Laboulbeniales during this study, of which 26 SSU and 28 LSU sequences. Our SSU+LSU concatenated dataset comprised 3969 characters, of which 2962 were constant and 789 were parsimony-informative. A total of 84 isolates were included (Table 4-1): *Arthrorhynchus* (2), *Camptomyces* (1), *Fanniomyces* (1), *Gloeandromyces* (26), *Herpomycetes* (7, outgroup), *Hesperomyces* (22), *Nycteromyces* (5), *Polyandromyces* (2), *Prolixandromyces* (1), *Rickia* (4) and *Stigmatomyces* (13). Our LSU dataset consisted of 27 isolates (including 1 *Stigmatomyces* as outgroup) and 955 characters, of which 817 were constant and 110 were parsimony-informative.

*Phylogenetic inferences and species delimitation.* — The three genera of bat fly-associated Laboulbeniales occur in three disparate places of our phylogenetic reconstruction of the SSU+LSU dataset (Figure 4-2): *Arthrorhynchus nycteribiae* is placed in a sister relationship to *Prolixandromyces triandrus* with  $pp = 0.8$ ; *Nycteromyces streblidinus* is placed in a sister relationship to *Polyandromyces coptosomalis* with maximum support; and the genus *Gloeandromyces* is placed sister to the genus *Stigmatomyces*, with very strong support (ML BS = 99,  $pp = 1.0$ ). The subtribe Stigmatomycetinae, which holds several genera included in our dataset (Table 4-2), is a polyphyletic taxon.

In the LSU dataset, *Gloeandromyces* forms six distinct clades (Figure 4-3).

*Gloeandromyces nycteribiidarum* and *G. dickii* nom. prov. are sister species and have high

**Figure 4-2.** Maximum clade credibility tree, reconstructed from the concatenated SSU+LSU dataset. The tree is the result of a Bayesian analysis performed in BEAST. For each node, ML BS (if  $\geq 70$ )/Bayesian pp (if  $\geq 0.7$ ) are presented above to the branch leading to that node. The arrowheads and clades in blue denote the Stigmatomycetinae subtribe *sensu* Tavares (1985).

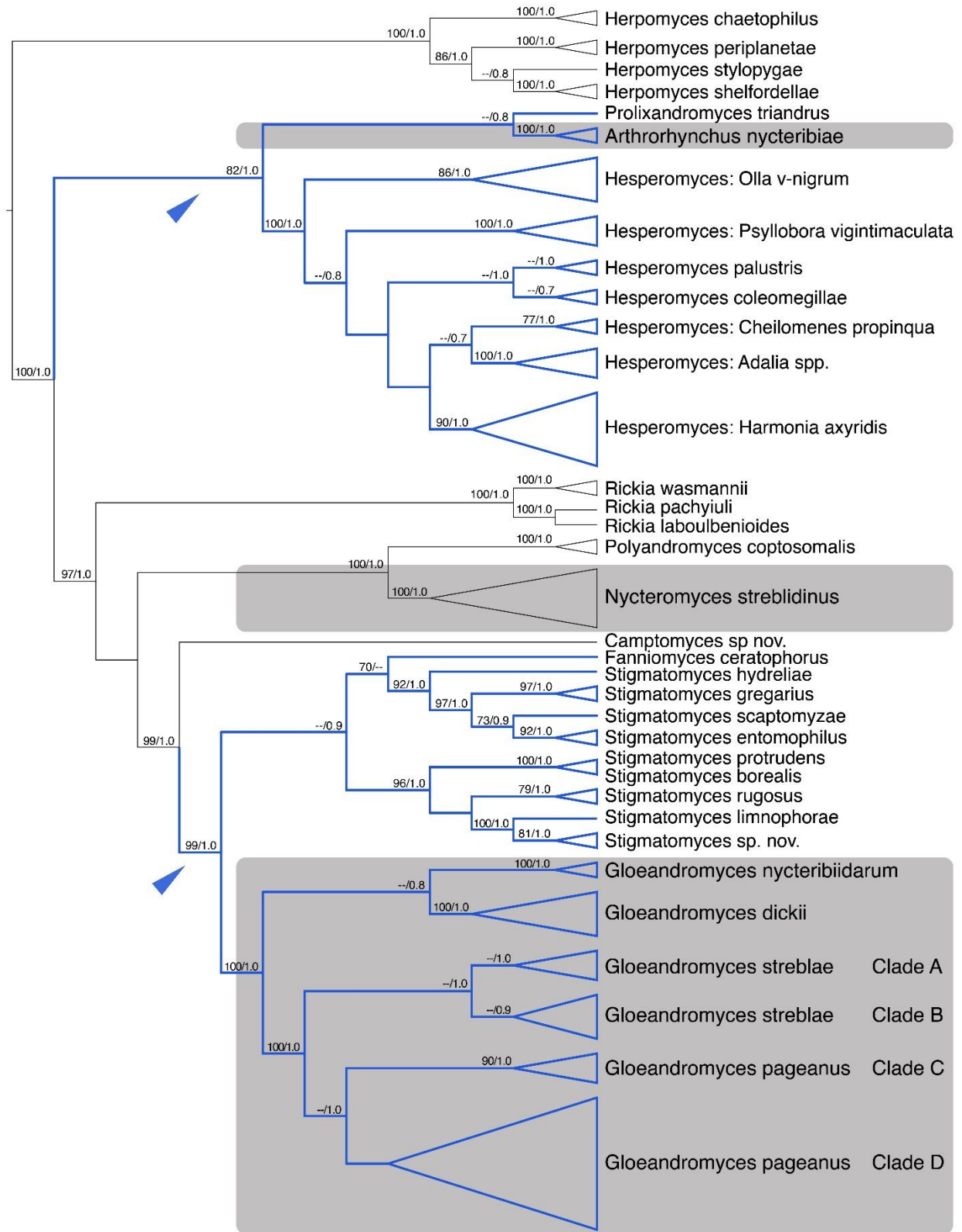


Figure 4-2. (Continued).

**Figure 4-3.** Maximum clade credibility tree showing species in the genus *Gloeandromyces*, with *Stigmatomyces protrudens* as outgroup. The tree is the result of a Bayesian analysis of the LSU dataset performed in BEAST. For each node, ML BS (if  $\geq 70$ )/Bayesian pp (if  $\geq 0.7$ ) are presented above the branch leading to that node. Symbols indicate hosts: (bat flies) ☆ = *Megistopoda aranea*, ● = *Trichobius dugesioides*, ○ = *Tri. joblingi*; (bats) ▨ = *Artibeus jamaicensis*, ☒ = *Carollia brevicauda*, □ = *C. perspicillata*, ■ = *Trachops cirrhosus*. Symbols behind fungus species names designate morphotypes: \*morphotype *sigmomorphus*, ^morphotype *alarum*, all other isolates in clade D: morphotype *polymorphus*. To the right of the terminal labels of the phylogeny, SDM results are summarized, from left to right: ABGD of the aligned LSU data matrix with prior intraspecific divergence (P) = 0.001 (Pmin), ABGD with P = 0.002783, ABGD with P = 0.01 (Pmax), bPTP of the LSU topology and GMYC of the LSU ultrametric tree generated in BEAST.

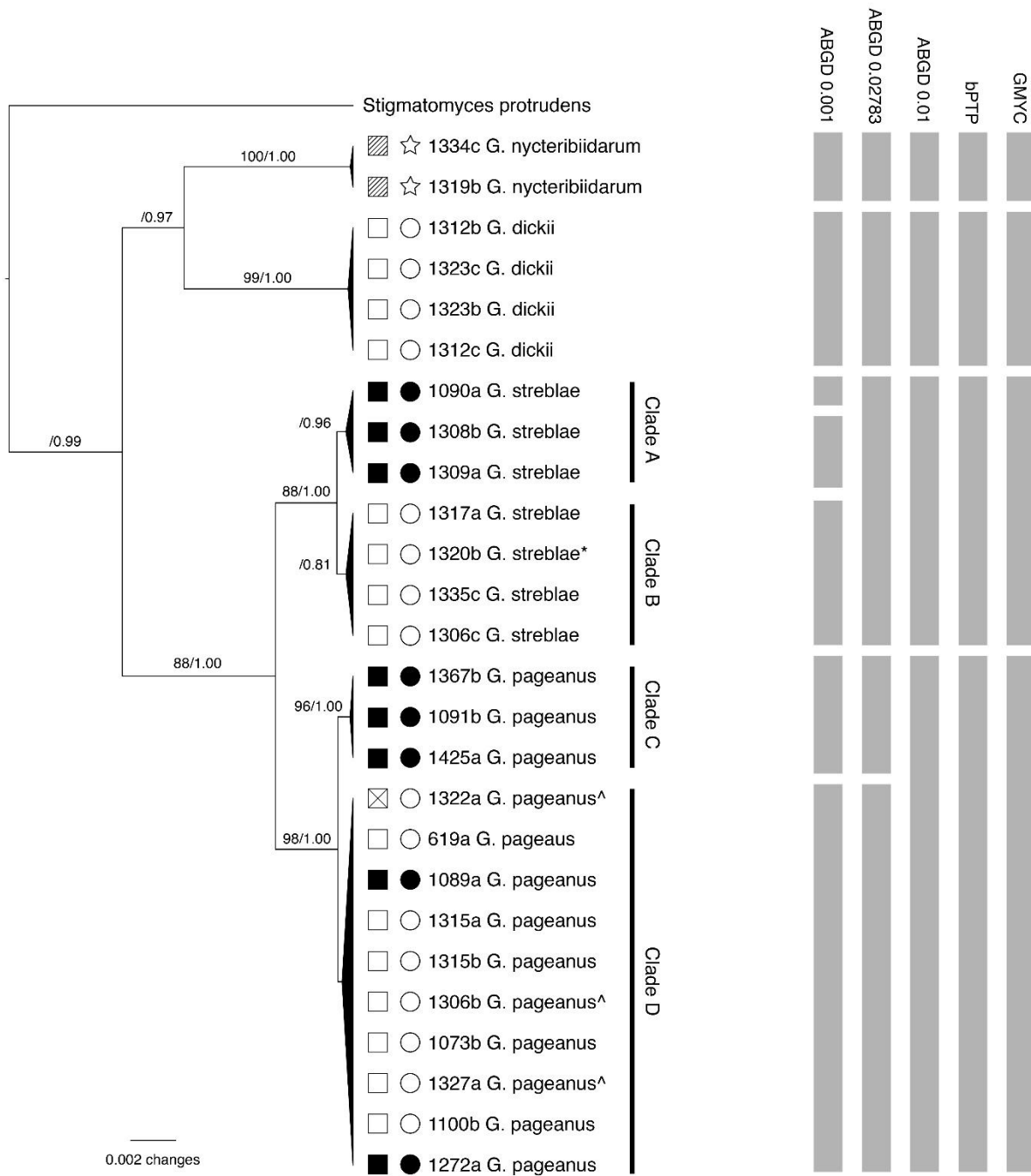


Figure 4-3. (Continued).

**Table 4-2.** Genera included in the concatenated SSU+LSU dataset, with classification up to ordinal level.

Order	Genus	Subtribus	Tribus	Subfamily
Herpomyetales	<i>Herpomyces</i>		Herpomycetaceae	
Laboulbeniales	<i>Arthrorhynchus</i>	Stigmatomycetinae	Laboulbeniaceae	Laboulbenioideae
Laboulbeniales	<i>Camptomyces</i>	Haplomycetinae	Haplomycetaceae	Peyritschielloideae
Laboulbeniales	<i>Fanniomyces</i>	Stigmatomycetinae	Laboulbeniaceae	Laboulbenioideae
Laboulbeniales	<i>Gloeandromyces</i>	Stigmatomycetinae	Laboulbeniaceae	Laboulbenioideae
Laboulbeniales	<i>Hesperomyces</i>	Stigmatomycetinae	Laboulbeniaceae	Laboulbenioideae
Laboulbeniales	<i>Nycteromyces</i>	N/A	Dimorphomyceteae	Peyritschielloideae
Laboulbeniales	<i>Polyandromyces</i>	N/A	Dimorphomyceteae	Peyritschielloideae
Laboulbeniales	<i>Prolixandromyces</i>	Stigmatomycetinae	Laboulbeniaceae	Laboulbenioideae
Laboulbeniales	<i>Rickia</i>	Peyritschiellinae	Peyritschielleae	Peyritschielloideae
Laboulbeniales	<i>Stigmatomyces</i>	Stigmatomycetinae	Laboulbeniaceae	Laboulbenioideae

**Table 4-3.** Summary of results of MP, ML, Bayesian and species delimitation analyses (ABGD, bPTP, GMYC). Explanation of symbols and values used: — indicates no support; + under ABGD represents supported clades; numbers under bPTP and GMYC are Bayesian support values for delimited species hypotheses. (+) The ABGD analysis found support for two clades within *Gloeandromyces streblae* clade A under prior maximum distance (P) = 0.001, 0.001292, 0.001668 and 0.002154.

Putative species	ML BS	pp	ABGD		ABGD		bPTP	GMYC
			P 0.001	P 0.002783	P 0.01	P 0.01		
<i>nycteribiidarum</i>	100	1.0	+	+	+	+	0.996	0.85
<i>dickii</i>	99	1.0	+	+	+	+	0.986	0.81
<i>streblae</i> clade A	68	1.0	(+)	+	+	+	0.856	0.33
<i>streblae</i> clade B	—	0.9	+	+	+	+		
<i>pageanus</i> clade C	96	1.0	+	+	+	+	0.906	0.41
<i>pageanus</i> clade D	—	0.3	+	+	+	+		

support. *Gloeandromyces streblae* falls apart into two clades A and B lacking ML BS support but with moderate to high pp support. Clades C and D include isolates of the recently described *G. pageanus*. Support for clade C is high (BS = 96, pp = 1.00) whereas support is lacking for its sister clade D. All isolates included in clade D are identical in their LSU. Out of the 955 nucleotides, three are different between the isolates in clade C and those in clade D. Results of the species delimitation methods are summarized in Figure 4-3 and Table 4-3. The number of putative species in *Gloeandromyces* varied from 4 to 7 with ABGD analyses, depending on the prior intraspecific divergence (Table 4-4). The relative gap width and used distance metrics (JC69, K80) had no influence on the results. The bPTP analysis of the LSU topology resulted in 4 highly supported species (the “b” in bPTP standing for Bayesian support calculated for putative species): *Gloeandromyces dickii*, *G. nycteribiidarum*, *G. pageanus* (clade C+D) and *G. streblae* (clade A+B). The GMYC model led to the same results (4 species delimited), but without strong support for *G. pageanus* and *G. streblae*.

*Bats, bat flies and Laboulbeniales.* — Our complete dataset, prior to excluding specimens and partitioning, was composed of 2599 bats and 7949 bat flies, of which 363 (= 4.6%) were infected by Laboulbeniales. Seven bat species were included in our final temperate dataset (Haelewaters *et al.*, 2017a; Szentiványi *et al.*, in review). The most abundantly parasitized bat species was *Miniopterus schreibersii* (n=414), followed by *Myotis daubentonii* (n=206). Eight species of bat flies were removed from bats: *Basilina natali* (n=10), *Nycteribia kolenatii* (n=899), *N. pedicularia* (n=24), *N. schmidlii* (n=607), *N. vexata* (n=13), *Penicillidia conspicua* (n=278), *P. dufourii* (n=134) and *Phthiridium biarticulatum* (n=36). The highest number of bat flies was found on *M. schreibersii* bats (n=942 bat flies altogether), closely followed by *M. daubentonii* (n=896 bat

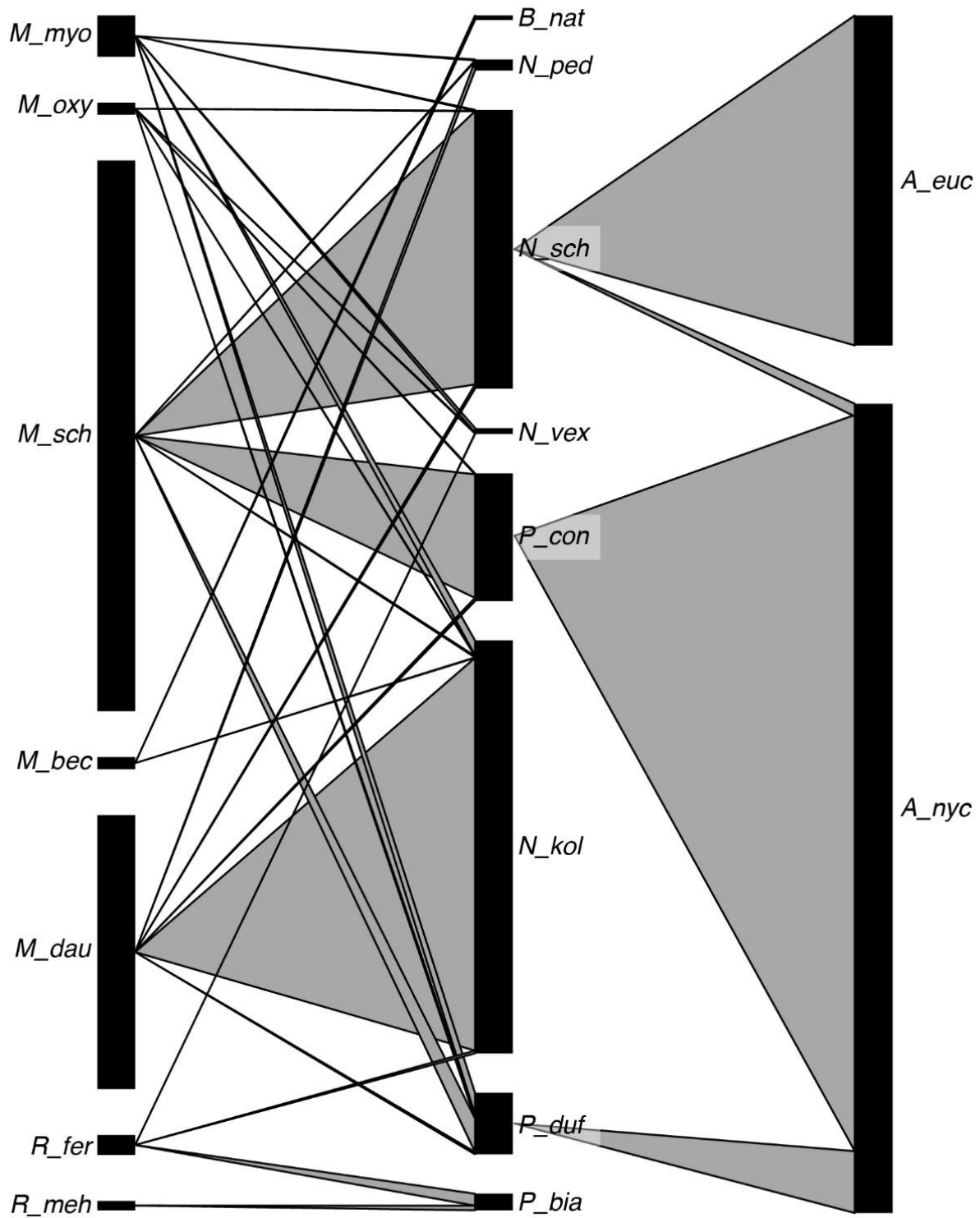


**Table 4-4.** Results of the Automatic Barcode Gap Discovery (ABGD) analyses. X, relative gap width; JC69, Jukes-Cantor substitution model; K80, Kimura 2-parameter substitution model.

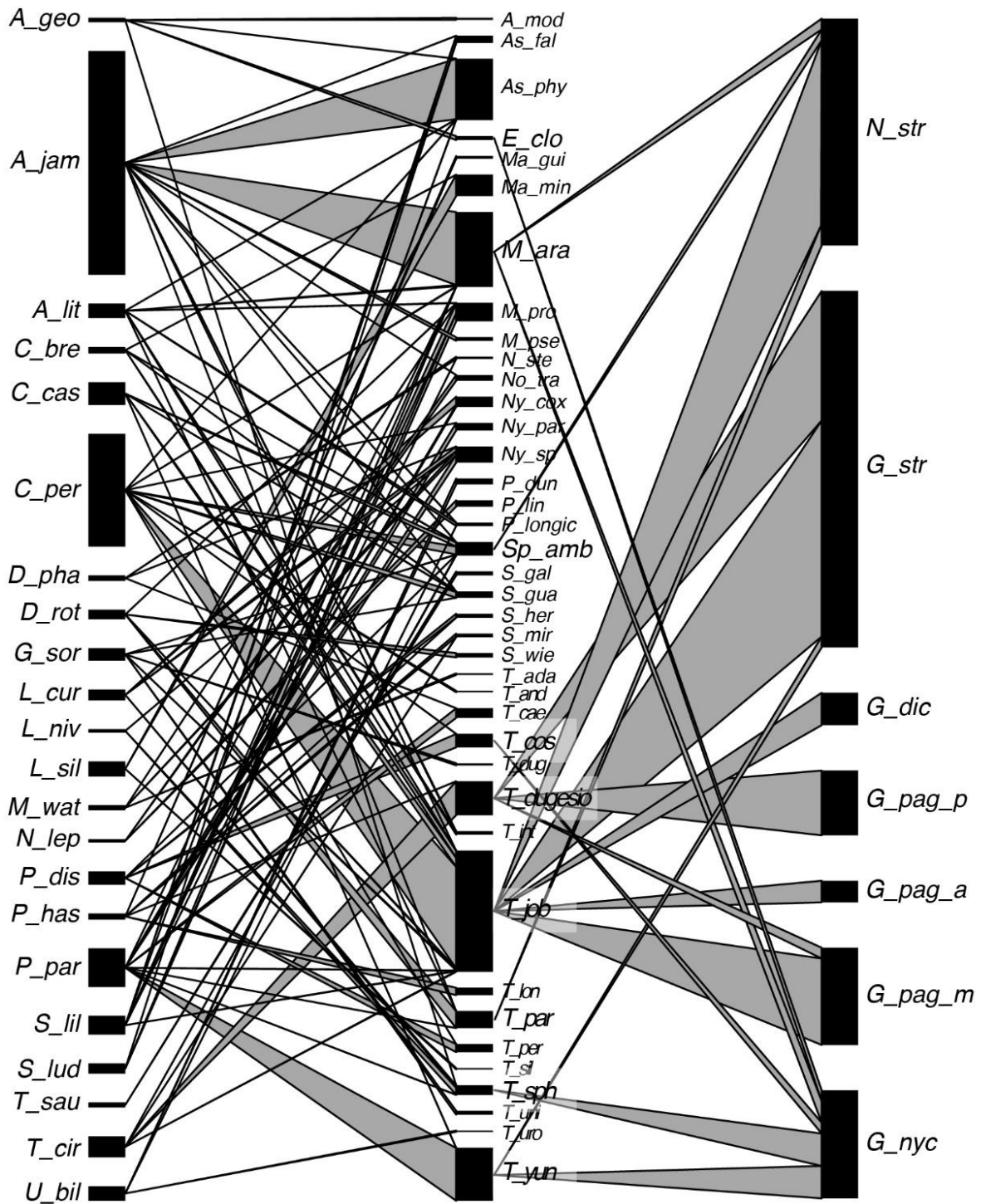
		<b>Prior intraspecific divergence (P)</b>										
<b>Distance</b>	<b>X</b>	0.001	0.001292	0.001668	0.002154	0.002783	0.003594	0.004642	0.005995	0.007743	0.01	
<b>JC69</b>	0.1	7	7	7	7	5	4	4	4	4	4	
	0.5	7	7	7	7	5	4	4	4	4	4	
	1.0	7	7	7	7	5	4	4	4	4	4	
	1.5	7	7	7	7	5	4	4	4	4	4	
<b>K80</b>	0.1	7	7	7	7	5	4	4	4	4	4	
	0.5	7	7	7	7	5	4	4	4	4	4	
	1.0	7	7	7	7	5	4	4	4	4	4	
	1.5	7	7	7	7	5	4	4	4	4	4	

flies). On the other bat species, less than 100 bat flies per species were found altogether. Laboulbeniales infection was found on three bat fly species: *Nycteribia schmidlii* (n=26+1), *Penicillidia conspicua* (n=59) and *P. dufourii* (n=6). The overall parasite prevalence of Laboulbeniales on temperate bat flies was 4.6%. *Nycteribia schmidlii* was host for two species of Laboulbeniales, *A. eucampsipodae* (n=26) and *A. nycteribiae* (n=1). Both *Penicillidia* host species only carried *A. nycteribiae* thalli. Associations are shown in Figure 4-4.

In our neotropical dataset (Figure 4-5), 1703 bats were present, *Artibeus jamaicensis* (n=660), *Carollia perspicillata* (n=333) and *Pteronotus parnellii* (n=114) being the most abundant in addition to 19 other species (with each < 70 individuals). The highest number of bat flies was found on *A. jamaicensis* bats (n=1309 bat flies altogether), followed by *C. perspicillata* (n=1102), *P. parnellii* (n=755) and *Trachops cirrhosus* (n=334). Of 39 sampled species of bat fly species, 9 carried Laboulbeniales thalli (in decreasing order): *Trichobius joblingi* (n=50 infected specimens), *Tri. dugesioides* (n=19), *Tri. yunkerii* (n=4), *Megistopoda aranea*, *Tri. sphaeronotus* (n=3), *Tri. parasiticus* (n=2), *Exastinion clovisi*, *Speiseria ambigua* and *Tri. costalimai* (n=1). The most frequently encountered species of Laboulbeniales was *Gloeandromyces streblae* (on 33 bat flies of 3 species), followed by *Nycteromyces streblidinus* (on 21 bat flies of 4 species). *Trichobius joblingi* was not only most often infected with Laboulbeniales, it also bore the highest number of Laboulbeniales taxa: *Gloeandromyces dickii*, *G. pageanus* morphotype *alarum*, *G. pageanus* morphotype *polymorphus*, *G. streblae* and *N. streblidinus*. *Gloeandromyces nycteribiidarum* had the highest number of host species: *E. clovisi*, *Megistopoda aranea*, *Strebla wiedemanni*, *Tri. sphaeronotus* and *Tri. yunkerii*.

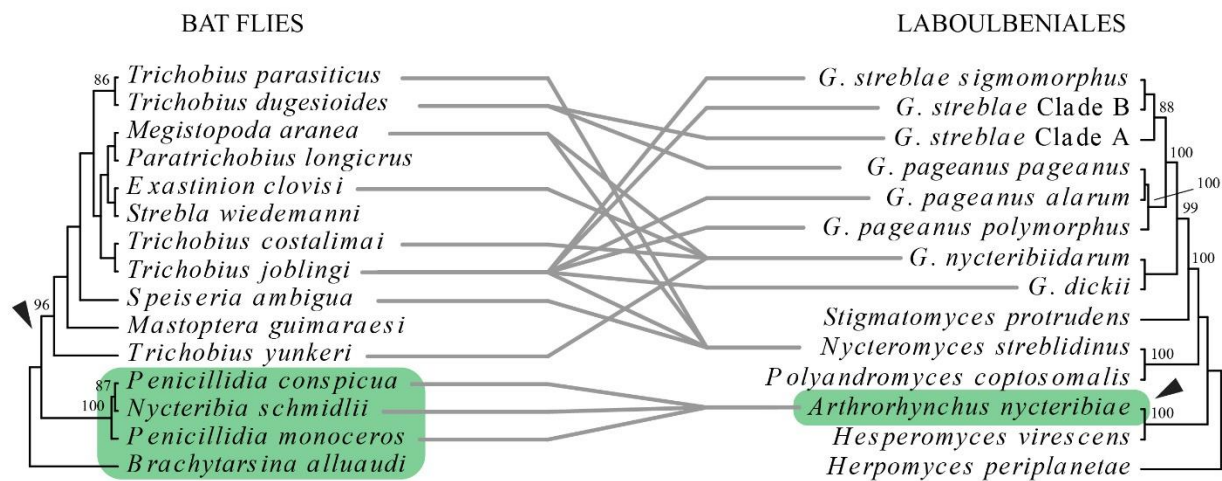


**Figure 4-4.** Host–parasite–parasite network of the final temperate dataset. Shown is the association of bat flies with their bat hosts as well as the association of Laboulbeniales and their bat fly hosts. Bar width represents the relative abundance of a species within each network level.



**Figure 4-5.** Host–parasite–parasite network of the final neotropical dataset. Shown is the association of bat flies with their bat hosts as well as the association of Laboulbeniales and their bat fly hosts. Bar width represents the relative abundance of a species within each network level.

*Co-phylogenetic relationships between bat flies and Laboulbeniales.* — Our COI dataset of bat flies consisted of 15 taxa (1 outgroup) and 677 characters, of which 410 were constant and 177 were parsimony-informative. Our LSU dataset of Laboulbeniales consisted of 14 taxa (1 outgroup) and 998 characters, of which 610 were constant and 217 were parsimony-informative. The co-phylogeny plot is shown in Figure 4-6. There is congruence between the (basal-most) Old World clades, otherwise the evidence for coevolution is lacking.



**Figure 4-6.** Co-phylogenetic relationships between bat flies and Laboulbeniales. Maximum likelihood phylogenies for bat flies (left) and their Laboulbeniales parasites (right). For each node, ML BS (if  $\geq 70$ ) are presented above the branch leading to that node. All associations are shown as gray connecting lines. Old World bat flies and Laboulbeniales are highlighted in green. *Penicillidia monoceros* substituted for *Penicillidia dufourii*.

## TAXONOMY

Genus *Gloeandromyces* Thaxt., *Memoirs of the American Academy of Arts and Sciences* 16:112 (1931).

*Type species: Gloeandromyces streblae* (Thaxt.) Thaxt., *Memoirs of the American Academy of Arts and Sciences* 16:113 (1931).

≡ *Stigmatomyces streblae* Thaxt., Proceedings of the American Academy of Arts and Sciences 52:700 (1917).

***Gloeandromyces dickii* nom. prov.** Haelew.

Figure 4-7A

MycoBank number MB 824616.

*Diagnosis:* Different from the other species in the genus by its single peculiar, slender outgrowth at the perithecial venter.

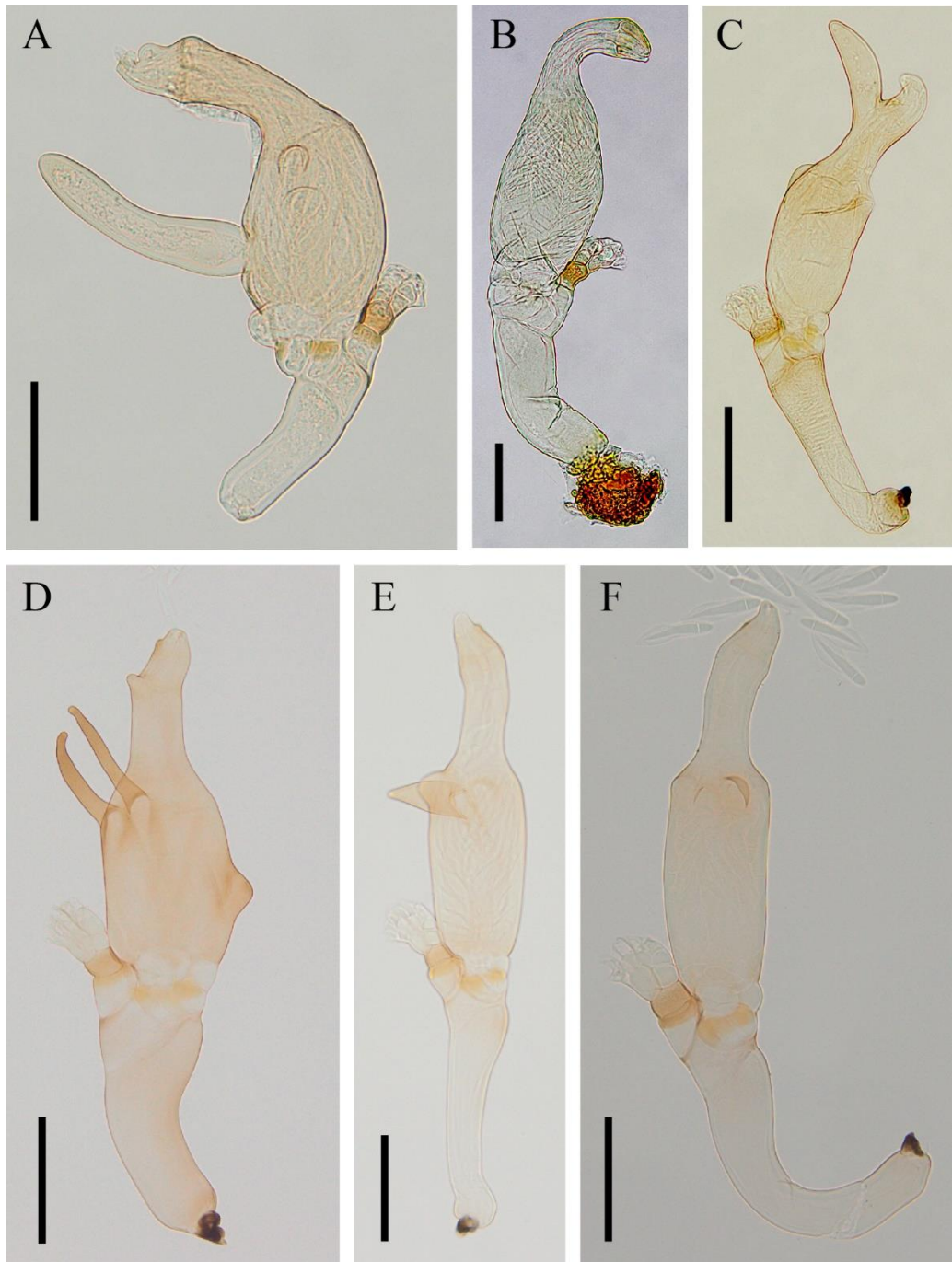
*Etymology:* Referring to Dr. Carl W. Dick, Associate Professor of Biology at Western Kentucky University, who provided 7,792 bat flies from Ecuador, Honduras, Mexico and Nicaragua for this study.

*Description:* Thallus irregularly pale yellowish, darker at the perithecial venter and neck; basal cell of the appendage bright orange. Cell I bent or kinked anteriorly, with parallel margins, 2.5–2.9× longer than broad, carrying cells II and VI. Cell II broadly rhomboidal, isodiametric or slightly longer than broad, separated from cell III by an oblique septum. Cell III broadly trapezoidal, distally narrowing, slightly longer than broad. Basal cell of the appendage pentagonal to dome-shaped, with the margins slightly broadening distally, carrying two short (up to 32 μm) branches of dichotomously dividing cells, final cells antheridial, the outer suprabasal cell always higher than the inner one. Cell VI strongly oblique, lens-shaped or flattened between cells II and VII, its posterior margin (= septum II/VI) convex. Cell VII next to cell VI, with convex outer margin, its proximal end in contact with cell I or almost so. Perithecium broadly ovoid; bearing three very different outgrowths, a short but conspicuous rounded bulge at the base, an elongate, finger-like protuberance directed anteriorly halfway along the venter, usually straight or slightly bent upwards, and a single bump (rarely two) positioned laterally at the distal

third of the venter; neck abruptly distinguished, strongly bent, with anterior margin concave and the posterior margin nearly straight, distally distinctly broader at its junction with the stout, tapering tip, ending with prominent rounded lips. Ascospores bicellular.

*Measurements:* Thallus 183–294  $\mu\text{m}$  in length from foot to perithecial tip. Cell I 58–88  $\times$  21–30  $\mu\text{m}$ . Basal cell of appendage 9–12  $\times$  10–16  $\mu\text{m}$ . Perithecium 123–176  $\times$  40–62  $\mu\text{m}$ . Finger-like projection up to 50–86  $\mu\text{m}$  long. Ascospores 31–36  $\times$  3–5  $\mu\text{m}$  (up to 10  $\mu\text{m}$  wide including slime sheath).

*Types:* NICARAGUA, Jinotega Department, Reserva Natural Bosawás, Mayangna Sauna Bu, Amak, at fork Rio Bocay and Rio Amak, secondary growth forest, 14.2396944 N 85.148 W, 30 May 2003, *M.R. Gannon*, on male *Trichobius joblingi* (collected from male *Carollia perspicillata*), slide D. Haelew. 1018c (FH, **holotype**, 2 juvenile & 6 mature thalli, abdominal sterna). PANAMA, Colón Province, Forest Fragment near El Giral, 9.2152675 N 79.7301492 W, 11 May 2015, *T. Hiller*, on *Tri. joblingi* (collected from female *C. perspicillata*), slide D. Haelew. 1069a (FH, **paratype**, 1 mature thallus, right-hand side abdomen). PANAMA, Darién Province, Reserva Natural Chucantí, field site Waterfall, young secondary succession forest, 8.7865167 N 78.4508333 W, 19 June 2017, *D. Haelewaters et al.*, on *Tri. joblingi* (collected from male *C. perspicillata*), slide D. Haelew. 1312a (FH, **paratype**, 3 mature thalli, right-hand side ventral abdomen). PANAMA, Darién Province, Reserva Natural Chucantí, field site Potrerito, old-growth broadleaf forest, 8.7909833 N 78.4510333 W, 22 June 2017, *D. Haelewaters et al.*, on *Tri. joblingi* (from male *C. perspicillata*), slide D. Haelew. 1323a (UCH, **paratype**, 3 mature thalli, right-hand side ventral abdomen).



**Figure 4-7.** Thalli of *Gloeandromyces*. A. *Gloeandromyces dickii* nom. prov. (slide D. Haelew. 1018c, holotype). B. *Gloeandromyces nycteribiidarum*, showing haustorial bulb (slide D. Haelew. 947a). C. *Gloeandromyces streblae* morphotype *sigmomorphus* (slide D. Haelew. 1099b). D. *Gloeandromyces pageanus* morphotype *pageanus* (slide D. Haelew. 1092a, paratype). E. *Gloeandromyces pageanus* morphotype *alarum* (slide D. Haelew. 1316a). F. *Gloeandromyces pageanus* morphotype *polymorphus* (slide D. Haelew. 1073a). Scale bars = 50  $\mu\text{m}$ .



*Material sequenced:* PANAMA, Darién Province, Reserva Natural Chucantí, field site Waterfall, young secondary succession forest, 8.7865167 N 78.4508333 W, 19 June 2017, *D. Haelewaters et al.*, on *Tri. joblingi* (collected from male *C. perspicillata*), isolate D. Haelew. 1312b (2 mature thalli, right-hand side ventral abdomen, SSU: MH040546, LSU: MH040580). Same data, isolate D. Haelew. 1312c (2 mature thalli, right-hand side ventral abdomen, SSU: MH040547, LSU: MH040581). PANAMA, Darién Province, Reserva Natural Chucantí, field site Potrerito, old-growth broadleaf forest, 8.7909833 N 78.4510333 W, 22 June 2017, *D. Haelewaters et al.*, on *Tri. joblingi* (from male *C. perspicillata*), isolate D. Haelew. 1323b (4 mature thalli, right-hand side ventral abdomen, SSU: MG958011, LSU: MH040582). Same data, isolate D. Haelew. 1323c (1 juvenile & 3 mature thalli, right-hand side ventral abdomen, SSU: MH040548, LSU: MH040583).

*Remarks:* The perithecium of thalli from slide D. Haelew. 1312a looks different from the typical form: the venter is slenderer in combination with a consistently shorter and tapering perithecial projection. These thalli were also removed from the same bat fly host, *Tri. joblingi*. The *G. dickii* clade in the LSU phylogeny comprises D. Haelew. 1323b and 1323c (“typical” *G. dickii*) and D. Haelew. 1312b and 1312c. This clade is strongly supported and our SDMs support *G. dickii* as a single species. In other words, the morphological differences described here seem to represent a range of phenotypic plasticity.

In addition to the Nicaraguan and Panamanian material, we also observed specimens from Ecuador: Esmeraldas Province, San Francisco de Bogota, 1.0877 N 78.6915 W, 6 August 2014, *C.W. Dick*, on female *Trichobius longipes* (collected from female *Phyllostomus hastatus*), slides D. Haelew. 1042a and 1043a (FH, 13 mature thalli total, anterior ventral abdomen). We did not include them as part of the type series, because they were removed from another host

species (*Tri. longipes*). We only performed DNA extractions of thalli taken from *Tri. joblingi*, and consequently, with the data in hand, we cannot rule out the possibility that there is some level of host specialization or (incipient) speciation. The Ecuadorian material is also different in the following morphological characters: cell I can be slightly bent anteriorly but is straight in the majority of observed thalli, the outer wall of cell VII is not convex/bulbous, the perithecial venter is less ovoidal, the bump at the base of the perithecium is less prominent and the perithecial projection is shorter and more tapered. Other features are in line with those in the description of *G. dickii* above, and thus the differences between populations may simply be due to natural variation. It is clear that the Ecuadorian thalli and those from Nicaragua and Panama represent taxa that are very closely related if not the same.

***Gloeandromyces pageanus*** Haelew., Nova Hedwigia 105:272 (2017).

Figure 4-7D

Mycobank number MB 819381.

*Diagnosis:* Different from the other species in the genus by its peculiar perithecial bulbous outgrowths and finger-like projections.

*Etymology:* Referring to Dr. Rachel Page (Smithsonian Tropical Research Institute), mammalogist, collaborator and Principal Investigator at the Bat Lab in Gamboa.

*Description:* Thallus irregularly colored reddish, darker at the basal cell of the appendage, the perithecial bulbous outgrowth and the finger-like projections; upper part of cell III and cells VI and VII tinged with orange. Cell I anteriorly curved, longer than broad, with divergent margins, carrying cells II and VI. Cell II trapezoidal, slightly broader than long. Cell III isodiametric, with rounded lower anterior margin. Basal cell of appendage pentagonal, with parallel anterior and posterior margins, carrying two very short branches of dichotomously dividing cells, the final

cells antheridial. Cell VI obliquely positioned between cells II and VII, broadly triangular, lower margin rounded, broader than long. Perithecium obclavate, anterior margin bearing a short and bulbous outgrowth at lower third, and two horn-like projections obliquely directed upwards on the posterior side just below the base of the well distinguished neck, bearing on the upper half of posterior side two very short bulbous outgrowths, the upper one slightly smaller and darkly pigmented; tip undifferentiated, blunt. Ascospores bicellular.

*Measurements:* Thallus 195–257  $\mu\text{m}$  in length from foot to perithecial tip. Cell I 45–74  $\times$  31–44  $\mu\text{m}$  (distally). Basal cell of appendage 7–10  $\times$  11–13  $\mu\text{m}$ . Perithecium 113–139  $\times$  43–52  $\mu\text{m}$  (not including bulbous outgrowth). Perithecial projections up to 46  $\mu\text{m}$  in length. Ascospores 30–35  $\times$  3–5  $\mu\text{m}$ .

*Types:* PANAMA, Colón Province, Gamboa, 26 June 2016, *R.A. Page et al.*, on female *Trichobius dugesioides* (collected from female *Trachops cirrhosus*), slide D. Haelew. 1093a (FH, **holotype**, 6 mature thalli, prescutum and scutum). PANAMA, Colón Province, Gamboa, 24 June 2016, *R.A. Page et al.*, on female *Tri. dugesioides* (collected from male *T. cirrhosus*), slide D. Haelew. 1092a (FH, **paratype**, 1 mature thallus, prescutum). Same data, slide D. Haelew. 1091a (FH, **paratype**, 1 mature thallus, right-hand side thorax). PANAMA, Colón Province, Gamboa, 2 July 2016, *R.A. Page et al.*, on male *Tri. dugesioides* (collected from *T. cirrhosus*), slide D. Haelew. 1094a (FH, **paratype**, 4 mature thalli, right prescutum). PANAMA, Panamá Province, Ocelot Pond, 9.1017 N 79.685 W, 2 July 2016, *R.A. Page et al.*, on female *Tri. dugesioides* (collected from *T. cirrhosus*), slide D. Haelew. 1098a (FH, **paratype**, 1 mature thallus, thorax).

*Other specimens examined:* PANAMA, Colón Province, Gamboa, 29 January 2017, *R.A. Page et al.*, on *Tri. dugesioides* (collected from female *T. cirrhosus*), slide D. Haelew. 1280b (UCH, 2

mature thalli, left mesoprescutum). PANAMA, Parque Nacional Soberanía, Pipeline Road, Tunnel 17, 28 July 2017, *R.A. Page et al.*, on female *Tri. dugesioides* (collected from female *T. cirrhosus*), slide D. Haelew. 1367a (FH, 5 mature thalli, left mesoprescutum). PANAMA, Darién Province, Reserva Natural Chucantí, field site Potrerito, old-growth broadleaf forest, 8.7909833 N 78.4510333 W, 22 June 2017, *D. Haelewaters et al.*, on male *Tri. dugesioides* (collected from male *T. cirrhosus*), slide D. Haelew. 1329a (UCH, 1 mature thallus, left prescutum).

*Material sequenced*: PANAMA, Colón Province, Gamboa, 24 June 2016, *R.A. Page et al.*, on female *Tri. dugesioides* (collected from male *T. cirrhosus*), isolate D. Haelew. 1091b (6 mature thalli, right-hand side thorax, SSU: MH040535, LSU: MG906798). PANAMA, Parque Nacional Soberanía, Pipeline Road, Tunnel 17, 28 July 2017, *R.A. Page et al.*, on female *Tri. dugesioides* (collected from female *T. cirrhosus*), isolate D. Haelew. 1367b (6 mature thalli, left mesoprescutum, LSU: MH040568). PANAMA, Colón Province, Parque Nacional Soberanía, Pipeline Road, Tunnel 1, 13 October 2016, *I. Geipel*, on *Tri. dugesioides* (collected from male *T. cirrhosus*), isolate D. Haelew. 1425a (4 mature thalli, right mesoprescutum, SSU: MH040536, LSU: MH040569).

*Remarks*: Its perithecial bulbous outgrowth and the two horn-like projections separate this species from the other species in the genus *Gloeandromyces* (Thaxter, 1917, 1931; Haelewaters *et al.*, 2017b). These characteristics are stable and have been observed in all studied specimens. *Gloeandromyces pageanus* shares with *G. streblae* a simple, blackened foot. The host for *G. pageanus*, *Tri. dugesioides*, is also reported for *G. streblae* in Panama. On most of the host specimens, we found thalli of both parasite species. *Gloeandromyces pageanus* was always found on the thorax, whereas *G. streblae* has no positional restrictions; we have observed this species on the thorax, legs and wings. On one bat fly (D. Haelew. 1094), both species co-

occurred on the right prescutum. Our phylogenetic analysis confirms that the two taxa are separate species.

The phylogenetic reconstruction based on the LSU rDNA region shows divergence by host species into clade C (on *Tri. dugesioides*) and clade D (on *Tri. joblingi*). However, clade D is unsupported by both ML and Bayesian inferences. In addition, all but one SDMs do not recognize clades C and D as separate species. As a result, we cannot describe the specimens represented by this clade as a separate species, even though their morphology is clearly different from *G. pageanus*. In fact, clade D represents two different morphological types, one that seems restricted to the base of the wings and a second that has no positional restrictions. To avoid confusion regarding these different forms, we will refer to them as morphotypes. The “true” *G. pageanus* (clade C) will from here on be referred to as morphotype *pageanus*. The forms from clade D will be referred to as morphotype *alarum* and morphotype *polymorphus* and are described below.

### **Morphotype *alarum***

Figure 4-7E

*Etymology*: From Latin, of the wings.

*Description*: Thallus irregularly yellowish-light brown; septum II/III, the area around the septum between cell III and the basal cell of the appendage, cells VI and VII, and the perithecial projection and bumps usually darker. Cell I straight, broadening upwards, especially at anterior side, 3.4–4.1× longer than broad, carrying cells II and VI. Cell II trapezoidal, slightly broader than long, obliquely positioned. Cell III broadly triangular, slightly longer than broad. Basal cell of appendage pentagonal, with parallel anterior and posterior margins, carrying two short (up to 25 µm) branches of dichotomously dividing cells, the outer suprabasal cell always higher than

the inner one, final cells antheridial. Cell VI broader than long, obliquely positioned, broadly lens-shaped or flattened between cells II and VII. Perithecium with nearly straight, parallel or very slightly diverging margins; venter ending in one to three conspicuous bumps and a subulate, almost horizontal projection directed posteriorly, up to 36  $\mu\text{m}$  in length; venter passing without abrupt transition into the neck; the latter with subparallel margins, somewhat curving towards posterior, tapering to the conical tip, with two minute preostiolar bumps at opposite sides.

Ascospores bicellular.

*Measurements:* Thallus 183–294  $\mu\text{m}$  in length from foot to perithecial tip. Cell I 58–102  $\times$  15–26  $\mu\text{m}$  (distally). Basal cell of appendage 8–11  $\times$  10–12  $\mu\text{m}$ . Perithecium 130–163  $\times$  28–45  $\mu\text{m}$ .

Ascospores 33–43  $\times$  4–6  $\mu\text{m}$  (with slime sheet up to 12  $\mu\text{m}$  wide).

*Material examined:* PANAMA, Colón Province, Gamboa, Harding Avenue past Building 183, 9.115876 N 79.696784 W, 17 July 2016, *D. Haelewaters*, on *Trichobius joblingi* (collected from female *Carollia perspicillata*), slide D. Haelew. 1100a (FH, 1 mature thallus, base of left wing).

PANAMA, Darién Province, Reserva Natural Chucantí, field site Waterfall, young secondary succession forest, 8.7865167 N 78.4508333 W, 18 June 2017, *D. Haelewaters et al.*, on *Tri.*

*joblingi* (collected from female *C. perspicillata*), slide 1306a (FH, 3 mature thalli, base of right wing). PANAMA, Darién Province, Reserva Natural Chucantí, field site Potrerito, old-growth

broadleaf forest, 8.7909833 N 78.4510333 W, 20 June 2017, *D. Haelewaters et al.*, on *Tri.*

*joblingi* (collected from female *C. perspicillata*), slide 1316a (FH, 1 mature thallus, base of right wing).

*Material sequenced:* PANAMA, Darién Province, Reserva Natural Chucantí, field site Waterfall, young secondary succession forest, 8.7865167 N 78.4508333 W, 18 June 2017, *D. Haelewaters et al.*, on *Tri. joblingi* (collected from female *C. perspicillata*), isolate 1306b (2 mature thalli,

base of right wing, SSU: MH040541, LSU: MH040574). PANAMA, Darién Province, Reserva Natural Chucantí, field site Camp Site, 8.7996833 N 78.45355 W, 21 June 2017, *D. Haelewaters et al.*, on *Tri. joblingi* (collected from female *C. brevicauda*), isolate 1322a (1 mature thallus, base of right wing R1 vein, SSU: MH040543, LSU: MH040577). PANAMA, Darién Province, Reserva Natural Chucantí, field site Potrerito, old-growth broadleaf forest, 8.7909833 N 78.4510333 W, 22 June 2017, *D. Haelewaters et al.*, on male *Tri. joblingi* (collected from male *C. perspicillata*), isolate D. Haelew. 1327a (1 mature thallus, base of right wing, SSU: MH040544, LSU: MH040578).

### **Morphotype *polymorphus***

Figure 4-7F

*Etymology*: From Greek (*poly* + *morphus*), existing in many forms.

*Description*: Thallus faintly yellowish, with distinctly darker upper half of cell III, basal cell of the appendage, and upper portions of cells VI and VII. Cell I 3.3–3.8× longer than broad, posteriorly curved, broadening upwards, carrying cells II and VI. Cell II irregularly trapezoidal, slightly broader than long, septum II/III very oblique. Cell III broader than long, usually with convex outer margins. Basal cell of appendage pentagonal, with parallel anterior and posterior margins, carrying two short (up to 20 µm) branches of dichotomously dividing cells, the final cells antheridial. Cell VI broader than long, obliquely positioned between cells II and VII, allantoid to broadly triangular, with rounded lower margin. Perithecial venter with slightly diverging margins, the anterior nearly straight, the posterior slightly convex, ending in four conspicuous bumps; neck abruptly distinguished, with subparallel margins, slightly curving towards anterior side, distinctly inflated at its junction with the tapering, subconical tip; ending with blunt apex directed upwards. Ascospores bicellular.

*Measurements:* Thallus 183–189(–311)  $\mu\text{m}$  in length from foot to perithecial tip. Cell I 66–69(–120)  $\times$  18–26  $\mu\text{m}$  (distally). Basal cell of appendage 5–7(–12)  $\times$  11–12(–15)  $\mu\text{m}$ . Perithecium 89–96(–152)  $\times$  31–35  $\mu\text{m}$ .

*Material examined:* PANAMA, Colón Province, Península Bohío, 9.2045036 N 79.8299767 W, 3 July 2015, *T. Hiller*, on male *Trichobius joblingi* (collected from female *Carollia perspicillata*), slide D. Haelew. 1073a (FH, 2 mature thalli, left-hand side abdomen). PANAMA, Colón Province, Parque Nacional Soberanía, Pipeline Road, Tunnel 10, 2 June 2017, *D.*

*Haelewaters & L.A. Meckler*, on *Tri. dugesioides* (collected from *T. cirrhosus*), slide D. Haelew. 1272b (FH, 3 mature thalli, right metatibia).

*Material sequenced:* PANAMA, Colón Province, Península Bohío, 9.2045036 N 79.8299767 W, 3 July 2015, *T. Hiller*, on male *Trichobius joblingi* (collected from female *Carollia perspicillata*), isolate D. Haelew. 1073b (3 mature thalli, left-hand side abdomen, SSU: MH040538, LSU: MH040570). PANAMA, Colón Province, Gamboa, 25 April 2016, *R.A. Page et al.*, on *Tri. dugesioides* (collected from female *Trachops cirrhosus*), isolate D. Haelew. 1089a (4 mature thalli, left-hand side abdomen, SSU: MH040539, LSU: MH040571). PANAMA, Colón Province, Gamboa, Harding Avenue past Building 183, 9.115876 N 79.696784 W, 17 July 2016, *D. Haelewaters*, on *Tri. joblingi*, (collected from female *Carollia perspicillata*), isolate D. Haelew. 1100b (2 submature & 5 mature thalli, right profemur & protibia, SSU: MH040307, LSU: MH040572). PANAMA, Colón Province, Parque Nacional Soberanía, Pipeline Road, Tunnel 10, 2 June 2017, *D. Haelewaters & L.A. Meckler*, on *Tri. dugesioides* (collected from *T. cirrhosus*), isolate D. Haelew. 1272a (2 mature thalli, left metafemur, SSU: MH040540, LSU: MH040573). PANAMA, Darién Province, Reserva Natural Chucantí, field site Waterfall, young secondary succession forest, 8.7865167 N 78.4508333 W, 19 June 2017, *D. Haelewaters et al.*,



on *Tri. joblingi* (collected from male *C. perspicillata*), isolate D. Haelew. 1315a (1 mature thallus, right sternopleuron, LSU: MH040575). Same data, isolate D. Haelew. 1315b (2 mature thalli, right profemur, SSU: MH040542, LSU: MH040576). TRINIDAD AND TOBAGO, Sangre Grande Regional Corporation, 10.4671389 N 61.2025833 W, 9 May 2014, *J.J. Camacho*, on *Tri. joblingi* (collected from female *C. perspicillata*), isolate D. Haelew. 619a (12 mature thalli, different body parts, SSU: MH040537, LSU: KT800008), erroneously identified as *G. nycteribiidarum* in Haelewaters *et al.* (2015).

*Remarks:* The thalli from Península Bohío are slenderer and somewhat darker colored compared to those from Soberanía. This is due to phenotypic plasticity because the DNA of the isolates from these localities is identical. The thalli from slide D. Haelew. 1308a were preliminarily thought to be identical to those described here, under morphotype *polymorphus*. Also these thalli show four conspicuous bumps at the distal end of the perithecial venter. However, isolate D. Haelew. 1308b is placed in the A clade, *G. streblae*. In addition, the host species are different: the bat fly host for *G. streblae* Clade A is *Tri. dugesioides*, whereas the (main) host species for morphotype *polymorphus* is *Tri. joblingi*. This might be a first case of cryptic diversity in the Laboulbeniales. It is more likely that this form falls under the phenotypic plasticity exhibited by *G. streblae* (see DISCUSSION).

***Gloeandromyces streblae*** (Thaxt.) Thaxt., *Memoirs of the American Academy of Arts and Sciences* 16:113 (1931).

≡ *Stigmatomyces streblae* Thaxt., *Proceedings of the American Academy of Arts and Sciences* 52:700 (1917).

*Remarks:* This species was described based on material from a single bat fly *Strebla wiedemanni* [as *S. vespertilionis*] (Diptera, Streblidae, Streblinae) from Venezuela. This poses a problem; our material of *G. streblae* was collected from *Tri. dugesioides* and *Tri. joblingi*. Although not recognized as separate species by our SDMs, we found evidence for two clades within *G. streblae* (Clades A and B), both clades correlating with isolates from a single host species. This points to divergence by host species, and because we do not have isolates available from *S. wiedemanni*, we do not know the “true” *G. streblae*. As a result, we refrain from formally re-describing or emending the description for this species.

Based on our molecular data, it is evident that the thalli that we had initially identified as a new species based on morphology (*Gloeandromyces* sp. nov. 2; Walker *et al.*, 2018), are part of the B clade, together with thalli of *G. streblae*. As is the case with *G. pageanus* morphotype *alarum*, this morphotype seems restricted to a precise position of the host’s integument. We have only observed thalli of this morphotype at the last sternite/tergite. Again, to avoid confusion when referring to these thalli, we will describe them as *G. streblae* morphotype *sigmomorphus*.

### **Morphotype sigmomorphus**

Figure 4-7C

*Etymology:* Referring to the general habitus of the fungus, which is curved like the letter s (sigma in Greek).

*Description:* Thallus pale yellowish, the upper portion of cell III and the basal cell of the appendage tinged with darker yellow. Cell I 3.0–4.1× longer than broad, basally anteriorly curved, otherwise straight, gradually broadening upwards, with outer wall longitudinally or radially striped, carrying cells II, VI and VII. Cell II rhomboidal, slightly broader than long, separated from cell III by an oblique septum. Cell III triangular and broader than long. Basal cell

of appendage broader than long, pentagonal, with parallel anterior and posterior margins, carrying two short (up to 19  $\mu\text{m}$ ) branches of dichotomously dividing cells, the outer suprabasal cell always higher than the inner one, final cells antheridial. Cell VI between cells II and VII, ovoidal to broadly triangular. Cell VII similar to cell VI. Cell n' inflated, its outer margin rounded, protruding between cell VII and the lower end of the perithecium. Perithecial venter with the margins slightly diverging upwards to the conspicuous rounded prominences of the wall cells; neck with a broad base, short and stout; apex blunt, distinctly bent posteriorly, subtended by a very large, sickle-shaped outgrowth at posterior side. Ascospores bicellular.

*Measurements:* Thallus 201–243  $\mu\text{m}$  in length from foot to perithecial tip. Cell I 65–85  $\times$  19–22  $\mu\text{m}$  (distally). Basal cell of appendage 6–8  $\times$  11–12  $\mu\text{m}$ . Perithecium 115–126  $\times$  27–30  $\mu\text{m}$ .

Horn-like perithecial appendage 36–44  $\mu\text{m}$  in length.

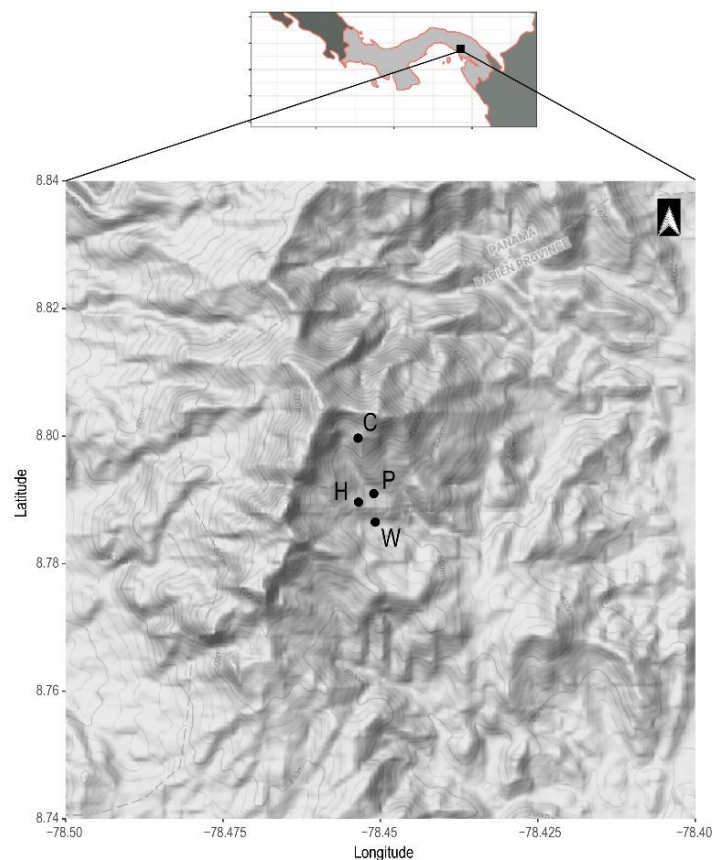
*Material examined:* PANAMA, Colón Province, Gamboa, Harding Avenue past Building 183, 9.115876 N 79.696784 W, 17 July 2016, *D. Haelewaters*, on *Trichobius joblingi* (collected from female *Carollia perspicillata*), slide D. Haelew. 1099b (FH, 5 mature thalli, tip of last sternite).

PANAMA, Darién Province, Reserva Natural Chucantí, field site Potrerito, old-growth broadleaf forest, 8.7909833 N 78.4510333 W, 20 June 2017, *D. Haelewaters et al.*, on *Tri. joblingi* (collected from female *C. perspicillata*), slide D. Haelew. 1320a (FH, 1 juvenile & 1 mature thallus, last sternite/tergite).

*Material sequenced:* PANAMA, Darién Province, Reserva Natural Chucantí, field site Potrerito, old-growth broadleaf forest, 8.7909833 N 78.4510333 W, 20 June 2017, *D. Haelewaters et al.*, on *Tri. joblingi* (collected from female *C. perspicillata*), isolate D. Haelew. 1320b (1 mature thallus, last sternite/tergite, SSU: MH040545, LSU: MH040579).

## DISCUSSION

*Bats and bat flies in Panama.* — Bats are the most diverse mammal group in Panama, with a total of 118 documented species (Samudio Jr. & Pino, 2014). Although species reports are numerous, many come from lowland research (Handley Jr., 1966; Samudio Jr., 2002). This implies that mammal inventories have not been conducted in many highland Panamanian regions such as Chiriquí and the unexplored Darién Gap. We chose to conduct intensive fieldwork in one such area, a private cloud-forested nature reserve in Darién, Reserva Natural Chucantí, managed by the NGO Adopt a Panama Rainforest (ADOPTA). Most of the bat flies infected by species of Laboulbeniales used in this study were collected in this reserve (Figure 4-8). With a team of six,



**Figure 4-8.** Map of the sampled field sites at Reserva Natural Chucantí, with its location in Panama. Field sites are labeled as follows: C = Camp Site, H = Helipad, P = Potrerito and W = Waterfall. Details in Walker *et al.* (2018).

we captured bats at Chucantí for seven nights, investing 68 mnh (mistnet hours, 1 mnh = a single 6m-wide mistnet open for 1 hour). We captured 227 bats representing 17 species. We captured *Micronycteris schmidtorum*, a species reported previously only from the Los Santos Province (Handley, 1966). In addition, we encountered the rarely collected *Platyrrhinus dorsalis*, representing the westernmost report of this species (Velazco, 2005). Of the captured bats, 148 carried bat flies (65 %). The number of sampled bat flies was 437, representing 16 species. One species was a new country record (*Trichobius anducei*) and five species represented first reports for Darién (*Basilia anceps*, *Anatrichobius scorzai*, *Nycterophilia parnelli*, *Tri. johnsonae*, *Tri. parasiticus*) (Guerrero, 1998a; Stamper, 2012; Lourenço *et al.*, 2016; Table 4-5). Of all screened bat flies, 30 bore species of Laboulbeniales (6.86 %). The results of the tripartite survey at Chucantí were published by Walker *et al.* (2018).

*Prevalences.* — A comprehensive study of nycteribiid bat fly-associated Laboulbeniales was conducted by Blackwell (1980b). She screened 2517 bat flies, of which 56 were infected with *Arthrorhynchus eucampsipodae* or *A. nycteribiae*, denoting a parasite prevalence of 2.2%. In our larger study, we screened 7949 bat flies of which 363 were infected by Laboulbeniales (4.6%). This includes both temperate and neotropical material. Taking only temperate flies into consideration (n=2001), parasite prevalence was again 4.6%. These low percentages can be explained by life history traits of the bat flies. Deposition of larvae happens on roosting substrates. Therein lies some risk, because flies need to return to their host within 25 hours. Since the flies are so closely tied to their bat host, we assume that transmission of ascospores of the fungi only happens on the bat itself, most likely through direct contact (De Kesel, 1995). Host grooming is the main cause of death for bat flies (Marshall, 1981). Apparently, this

**Table 4-5.** All species of bat flies reported in Panama to date. Bat flies reported as host to Laboulbeniales fungi are bolded, details are provided in the last column.

Bat fly species	Reference(s)	Reported Laboulbeniales taxa
<b>NYCTERIBIIDAE</b>		
<i>Basilia anceps</i>	Guimarães (1966), Walker <i>et al.</i> (2018)	
<i>Basilia dunni</i>	Guimarães (1966)	
<i>Basilia ferruginea</i>	Guimarães (1966)	
<i>Basilia handleyi</i>	Guimarães (1966)	
<i>Basilia myotis</i>	Guimarães (1966)	
<i>Basilia tiptonii</i>	Guimarães (1966)	
<i>Basilia wenzeli</i>	Guimarães (1966)	
<b>STREBLIDAE</b>		
<i>Anastrebla mattadani</i>	Wenzel & Tiptoni (1966)	
<i>Anastrebla modestini</i>	Wenzel & Tiptoni (1966)	
<i>Anastrebla nycteridis</i>	Wenzel & Tiptoni (1966)	
<i>Anatrachobius scorzai</i>	Wenzel & Tiptoni (1966), Walker <i>et al.</i> (2018)	
<i>Aspidoptera phyllostomatis</i>	González <i>et al.</i> (2004), Wenzel & Tiptoni (1966), Walker <i>et al.</i> (2018)	
<i>Aspidoptera delatorrei</i>	González <i>et al.</i> (2004), Wenzel & Tiptoni (1966)	
<i>Eldunnia breviceps</i>	Wenzel & Tiptoni (1966)	
<b><i>Exastinion clovisi</i></b>	Wenzel & Tiptoni (1966)	<b><i>Gloeandromyces nycteribiidarum</i></b> , Mexico (this study); Laboulbeniales gen. & sp. indet., Brazil (Bertola <i>et al.</i> , 2005)
<i>Joblingia schmidti</i>	Wenzel & Tiptoni (1966)	
<i>Mastoptera guimaraesi</i>	González <i>et al.</i> (2004), Wenzel & Tiptoni (1966)	
<i>Mastoptera minuta</i>	Wenzel & Tiptoni (1966)	

**Table 4-5.** (Continued).

Bat fly species	Reference(s)	Reported Laboulbeniales taxa
<b><i>Megistopoda aranea</i></b>	González <i>et al.</i> (2004), Wenzel & Tiptoni (1966), Walker <i>et al.</i> (2018)	<i>Gloeandromyces mycteribiidarum</i> , Grenada (Thaxter, 1917), Panama (Walker <i>et al.</i> , 2018); <i>G. streblae</i> & <i>Nycteromyces streblidinus</i> , Panama (Walker <i>et al.</i> , 2018); Laboulbeniales gen. & sp. indet., Brazil (Bertola <i>et al.</i> , 2005)
<b><i>Megistopoda proxima</i></b>	Wenzel & Tiptoni (1966), Walker <i>et al.</i> (2018)	Laboulbeniales gen. & sp. indet., Brazil (Bertola <i>et al.</i> , 2005)
<i>Megistopoda theodori</i>	Wenzel & Tiptoni (1966)	
<i>Metelasmus pseudopterus</i>	González <i>et al.</i> (2004), Wenzel & Tiptoni (1966)	
<i>Neotrichobius stenopterus</i>	González <i>et al.</i> (2004), Wenzel & Tiptoni (1966)	
<i>Noctiliostrebla maai</i>	Wenzel & Tiptoni (1966)	
<i>Noctiliostrebla traubi</i>	Wenzel & Tiptoni (1966)	
<i>Nycterophilina fairchildi</i>	Wenzel & Tiptoni (1966)	
<i>Nycterophilina natali</i>	Wenzel & Tiptoni (1966)	
<i>Nycterophilina parnelli</i>	Wenzel & Tiptoni (1966), Walker <i>et al.</i> (2018)	
<i>Paradyschiria lineata</i>	Wenzel & Tiptoni (1966)	
<i>Paradyschiria parvuloides</i>	Wenzel & Tiptoni (1966)	
<i>Parastrebla handleyi</i>	Wenzel & Tiptoni (1966)	
<i>Paratrachobius dumni</i>	González <i>et al.</i> (2004), Wenzel & Tiptoni (1966)	
<b><i>Paratrachobius longicrus</i></b>	Wenzel & Tiptoni (1966), Walker <i>et al.</i> (2018)	Laboulbeniales gen. & sp. indet., Brazil (Bertola <i>et al.</i> , 2005)
<i>Paratrachobius lowei</i>	Wenzel & Tiptoni (1966)	
<i>Paratrachobius salvini</i>	González <i>et al.</i> (2004), Wenzel & Tiptoni (1966)	
<i>Paratrachobius sanchezi</i>	Wenzel & Tiptoni (1966)	
<i>Paratrachobius</i> sp. ( <i>longicrus</i> complex)	Wenzel & Tiptoni (1966)	

**Table 4-5.** (Continued).

Bat fly species	Reference(s)	Reported Laboulbeniales taxa
<i>Pseudostrebla greenwelli</i>	Wenzel & Tiptoni (1966)	
<i>Pseudostrebla ribeiroi</i>	Wenzel & Tiptoni (1966)	
<b><i>Speiseria ambigua</i></b>	González <i>et al.</i> (2004), Wenzel & Tiptoni (1966), Walker <i>et al.</i> (2018)	<i>Gloeandromyces streblae</i> , Ecuador; <i>Nycteromyces streblidinus</i> , Honduras (this study); Laboulbeniales gen. & sp. indet., Costa Rica (Fritz, 1983)
<i>Strebla altmani</i>	Wenzel & Tiptoni (1966)	
<i>Strebla alvarezi</i>	Wenzel & Tiptoni (1966)	
<b><i>Strebla guajiro</i></b>	González <i>et al.</i> (2004), Wenzel & Tiptoni (1966), Walker <i>et al.</i> (2018)	Laboulbeniales gen. & sp. indet., Costa Rica (Fritz, 1983)
<i>Strebla christinae</i>	Wenzel & Tiptoni (1966)	
<i>Strebla diaemi</i>	Wenzel & Tiptoni (1966)	
<i>Strebla galindoi</i>	Wenzel & Tiptoni (1966)	
<i>Strebla hertigi</i>	Wenzel & Tiptoni (1966)	
<i>Strebla hoogstraali</i>	Wenzel & Tiptoni (1966)	
<i>Strebla kohlsi</i>	Wenzel & Tiptoni (1966)	
<i>Strebla mirabilis</i>	González <i>et al.</i> (2004), Wenzel & Tiptoni (1966)	
<b><i>Strebla wiedemanni</i></b>	Wenzel & Tiptoni (1966)	<i>Gloeandromyces streblae</i> & <i>Nycteromyces streblidinus</i> , Venezuela (Thaxter, 1917)
<i>Trichobioides perspicillatus</i>	Wenzel & Tiptoni (1966)	
<i>Trichobius anducei</i>	Walker <i>et al.</i> (2018)	
<i>Trichobius bequarti</i>	Wenzel & Tiptoni (1966)	
<i>Trichobius brennani</i>	Wenzel & Tiptoni (1966)	
<b><i>Trichobius costalimai</i></b>	Wenzel & Tiptoni (1966)	<i>Gloeandromyces nycteribiidarum</i> , Panama (this study)
<b><i>Trichobius dugesii</i></b>	Wenzel & Tiptoni (1966)	Laboulbeniales gen. & sp. indet., Brazil (Bertola <i>et al.</i> , 2005)
<b><i>Trichobius dugesioides</i></b>	Wenzel & Tiptoni (1966), Walker <i>et al.</i> (2018)	<i>Gloeandromyces pageanus</i> ( <i>pageanus</i> ) & <i>G. streblae</i> , Panama (Haelewaters <i>et al.</i> , 2017b, Walker <i>et al.</i> , 2018)
<i>Trichobius durni</i>	Wenzel & Tiptoni (1966)	



**Table 4-5.** (Continued).

Bat fly species	Reference(s)	Reported Laboulbeniales taxa
<i>Trichobius galei</i>	Wenzel & Tiptoni (1966)	
<b><i>Trichobius joblingi</i></b>	González <i>et al.</i> (2004), Wenzel & Tiptoni (1966), Walker <i>et al.</i> (2018)	<i>Gloeandromyces dickii</i> nom. prov. & <i>G. pageanus</i> ( <i>alarum</i> & <i>polymorphus</i> ) & <i>G. streblae</i> (incl. <i>sigmomorphus</i> ), Panama (Haelewaters <i>et al.</i> , 2017b, Walker <i>et al.</i> , 2018); Laboulbeniales gen. & sp. indet., Costa Rica (Fritz, 1983)
<i>Trichobius johnsonae</i>	Wenzel & Tiptoni (1966), Walker <i>et al.</i> (2018)	
<i>Trichobius keenani</i>	Wenzel & Tiptoni (1966)	
<i>Trichobius lionycteridis</i>	Wenzel & Tiptoni (1966)	
<i>Trichobius lonchophyllae</i>	Wenzel & Tiptoni (1966)	
<i>Trichobius longipes</i>	González <i>et al.</i> (2004), Wenzel & Tiptoni (1966)	
<i>Trichobius macrophylli</i>	Wenzel & Tiptoni (1966)	
<i>Trichobius mendezi</i>	Wenzel & Tiptoni (1966)	
<b><i>Trichobius parasiticus</i></b>	Wenzel & Tiptoni (1966), Walker <i>et al.</i> (2018)	<i>Nycteromyces streblidinus</i> , Honduras (this study)
<i>Trichobius sparsus</i>	González <i>et al.</i> (2004), Wenzel & Tiptoni (1966)	
<b><i>Trichobius uniformis</i></b>	Wenzel & Tiptoni (1966)	Laboulbeniales gen. & sp. indet., Brazil (Bertola <i>et al.</i> , 2005)
<i>Trichobius urodermae</i>	Wenzel & Tiptoni (1966)	
<i>Trichobius vampyropis</i>	Wenzel & Tiptoni (1966)	
<b><i>Trichobius yunkerii</i></b>	Wenzel & Tiptoni (1966), Walker <i>et al.</i> (2018)	<i>Gloeandromyces nycteribiidarum</i> , Costa Rica; <i>G. streblae</i> , Panama (Haelewaters <i>et al.</i> , 2017b)

behavior is an important selective factor driving evolution of host specific and even position specific parasites (ter Hofstede *et al.*, 2004) and may to some extent be an explanatory factor in the observed patterns of Laboulbeniales.

Several studies confirm that bats are often infected by several bat fly species (Wenzel *et al.*, 1966; Wenzel, 1976; Dick & Gettinger, 2005). At the same time, the average number of (nycteribiid) bat flies on their bat hosts is only 1.79 (Haelewaters *et al.*, 2017a). This number depends on bat host species and is much higher for, e.g., *Myotis daubentonii* (up to 21) and *Miniopterus schreibersii* (up to 13). A majority of Laboulbeniales species are strictly host specific. For those taxa occurring on several host species, such as *Arthrorhynchus nycteribiae*, caution is required in the assessment of their ecology—it is possible that these represent more than a single species (*sensu* CHAPTER 3). All in all, the numbers of times of contact between an infected bat fly and new potential hosts (of the same species) may be very low.

*Independent lineages of bat fly-associated Laboulbeniales.* — An intriguing finding in this study is that parasitism of bat flies by Laboulbeniales arose three times independently, once in the Eastern Hemisphere and twice in the Western Hemisphere. The genus *Gloeandromyces* is placed sister to the speciose genus *Stigmatomyces*, species of which infect only flies. The other two bat fly-associated genera form two separate clades, both sister to a genus that is associated with true bugs (Hemiptera). *Arthrorhynchus* and *Prolixandromyces* form a clade with moderate Bayesian support. The genus *Prolixandromyces* consists of eight species parasitizing taxa in the semi-aquatic family Veliidae (Weir, 2008). *Nycteromyces* forms a clade with *Polyandromyces*; the basal node of this clade received maximum support. *Polyandromyces* is a monotypic genus; its sole representative, *P. coptosomalis*, occurs on terrestrial species in the families Pentatomidae

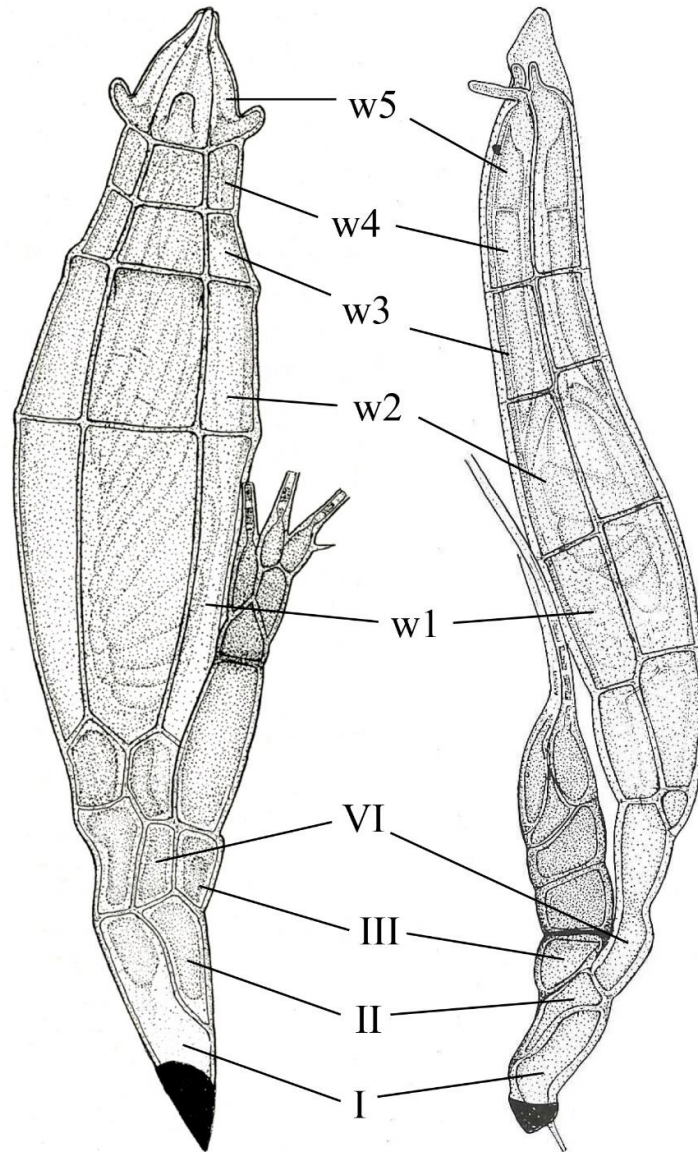
and Plataspidae. In other words, using the phylogenetic reconstruction of the SSU+LSU dataset, for the first time including molecular data from the rarely sampled bat fly-associated Laboulbeniales, we identified two inter-ordinal host shifts (true bugs to bat flies). We hypothesize that the two bat fly-associated lineages *Arthrorhynchus* and *Nycteromyces* have independently evolved from lineages of true bug ectoparasites. Tavares (1985) noted that bugs are secondary hosts to Laboulbeniales, and that their fungus parasites arose from taxa occurring on beetles (Coleoptera). We cannot confirm this suggestion because our phylogenetic reconstruction is far from complete and does not encompass many taxa with beetle hosts. However, it is clear that Laboulbeniales on beetle hosts are evolutionary very successful; 80% of known species are reported from beetles (Weir & Hammond, 1997). In contrast, the number of known species from bugs is 4%, whereas the number from bat flies is less than 1%.

Is it possible bat fly-associated lineages have evolved from bug-associated lineages? Representatives of both host groups make use of the bat microhabitat and roost environment. Two families of terrestrial bugs are known as obligatory hematophagous ectoparasites: Cimicidae and Polyctenidae (Schuh & Štys, 1991). Both families belong to the superfamily Cimicoidea, along with Anthocoridae, Lasiochilidae, Lyctocoridae and Plokiophilidae (Schuh & Štys, 1991; Jung *et al.*, 2010). One lasiochilid, *Lasiochilus pallidulus*, has been found as a host to *Cupulomyces lasiochili* in Grenada, a member of the Stigmatomycetinae subtribe (Benjamin, 1992a). Benjamin (1992a) used the family name Anthocoridae for the host but he probably used this in the broad sense, whereas Schuh & Štys (1991) proposed to split up this non-monophyletic family into three, Anthocoridae sensu stricto, Lasiochilidae and Lyctocoridae. Lasiochilids live on the ground, under bark and in vegetation (Schuh & Slater, 1995). It is probable that transmission of ascospores occurs now and then between bugs and bat flies and that this at some

point in time may have led to segregation of populations, microevolutionary changes and ultimately speciation.

We have not yet found Laboulbeniales other than *C. lasiochili* on those families of bugs, but the problem with Laboulbeniales is that the absence of reports on certain host groups is more a consequence of lack of sampling and screening efforts. We recommend that future studies focus on screening bugs for Laboulbeniales parasites and on generating molecular data for taxa that may be found on bugs. The phylogenetic placements of these taxa, including *C. lasiochili*, will add crucial data points in evaluating our hypothesis. *Cupulomyces* and *Prolixandromyces*, which is represented in our phylogeny by *P. triandrus*, have a similar receptacle structure (Figure 4-9): cell II is positioned posterior and next to cell I, separated by an oblique septum, and cell II carries cells III obliquely and VI distally (Benjamin, 1981, 1992a). In *Cupulomyces*, the perithecial wall cells are arranged in five tiers (Benjamin, 1992a). The situation has been described differently for *Prolixandromyces*, where in each vertical row of outer wall cells there are four tiers. However, Tavares (1985) mentioned that the fourth tier “may divide by maturity” even though the septa are extremely thin. Five tiers can also be observed in some of Benjamin’s drawings of mature thalli (Benjamin, 1981; Figure 13, reproduced here; Weir, 2008; Figure 10). Consequently, also the perithecial outer wall structure is similar between both genera. Incorporating sequence data for *Cupulomyces* into our phylogenetic reconstruction will help elucidate if contacts between insects within bat roost environment indeed may have mediated host jumps to and subsequent speciation of Laboulbeniales on bat flies.

*Polyphyly of subtribe Stigmatomycetinae.* — The subtribe Stigmatomycetinae is characterized by a simple receptacle consisting of three superposed cells, of which cell II carries the stalk cell of



**Figure 4-9.** Comparison of two species of Laboulbeniales. *Left.* Mature thallus of *Cupulomyces lasiochili*, revised from Benjamin (1992a: p. 358). *Right.* Mature thallus of *Prolixandromyces rhinoceralis*, revised from Benjamin (1981: p. 8). Annotated are cells I, II, III and VI, and tiers of perithecial outer wall cells ( $w^1$  to  $w^5$ ).

the perithecium (VI) and cell III carries the appendage. Taking synonymies and recent additions into consideration, Stigmatomycetinae now holds 40 genera (Tavares, 1985; Tavares & Balazuc, 1989; Benjamin, 1992a, 1992b, 2001; Santamaria, 1995). Our phylogenetic analysis shows that this subtribe is polyphyletic. We found two well-supported clades. One clade consists of

*Gloeandromyces* and *Stigmatomyces* (including its synonym, *Fanniomyces*), the second clade includes *Arthrorhynchus*, *Hesperomyces* and *Prolixandromyces*. Even Thaxter's (1908) original circumscription of what he called the "Stigmatomyceteae" tribe, including only five genera, *Acallomyces*, *Acompsomyces*, *Arthrorhynchus*, *Polyascomyces* and *Stigmatomyces*, is polyphyletic. These findings undermine classification systems of both Thaxter (1908) and Tavares (1985) and are in line with Goldmann & Weir (2018), who retrieved twelve genera of Stigmatomycetinae in three unrelated clades.

*Associations between bat flies and Laboulbeniales.* — Both the temperate bat flies and Laboulbeniales are geographically separated from their neotropical counterparts, so it is no surprise that we observe congruence of the Old World-clades. The other relationships are difficult to disentangle from an evolutionary point of view. *Nycteromyces streblidinus* is a plurivorous species, with hosts in the genera *Megistopoda*, *Speiseria* and *Trichobius*. All these are parasitic on phyllostomid bats that commonly roost in hollow trees (Wenzel *et al.*, 1966; Overal, 1980; Kunz & Lumsdem, 2003). Also *G. nycteribiidarum* is plurivorous, with hosts in the genera *Exastinion*, *Megistopoda* and *Trichobius*. The ecology of the bat hosts of these bat flies is similar. Mormoopidae (*Pteronotus parnellii*, host of *Tri. yunkerii*) almost always roost in caves or mines. *Anoura geoffroyi* (host of *Exastinion clovisi*) and *Phyllostomus discolor* (host of *Tri. costalimai*) preferably roost in caves. The morphospecies within *G. pageanus* and *G. streblae* are restricted to a single host species. We cannot provide an evolutionary explanation for the observed neotropical patterns in the co-phylogeny plot, instead we think the patterns can be linked to the roosting ecology of the bat hosts.

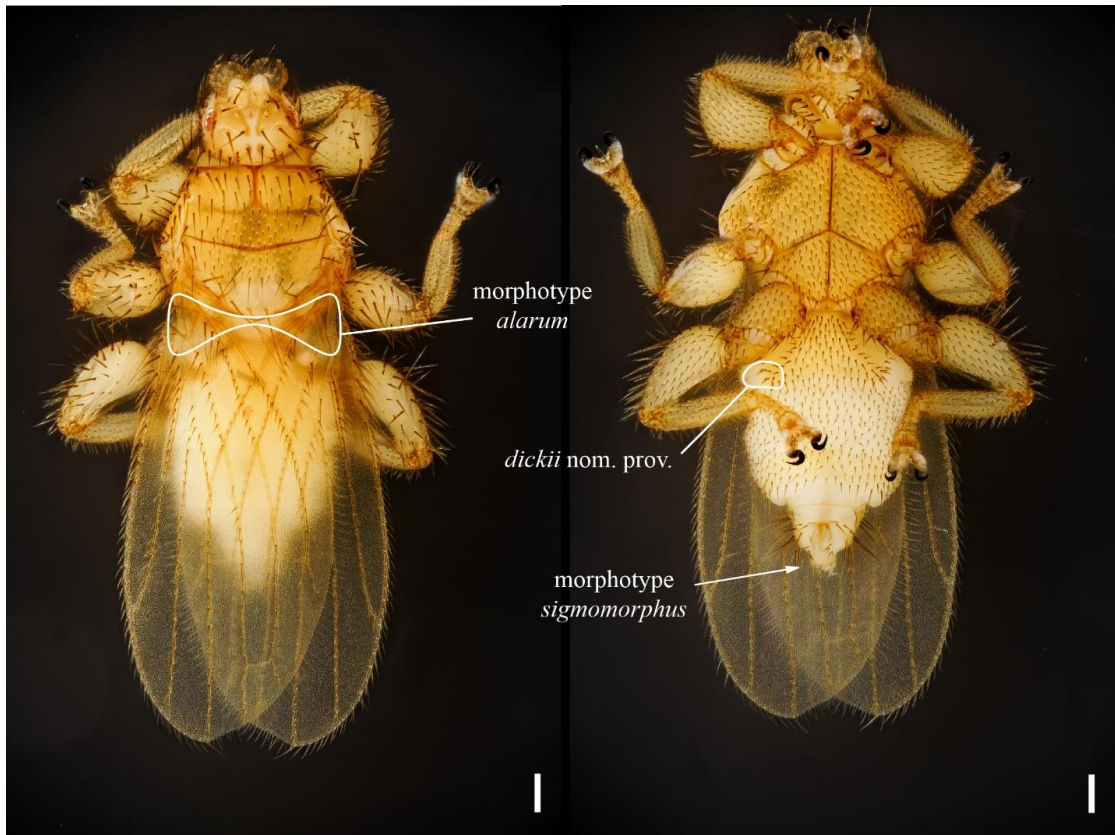
*Artibeus* and *Sturnira* are two genera of bats (Phyllostomidae, Stenodermatinae) that use hollow trees as main roosting sites, whereas most other stenodermatine bats roost in foliage or leaf tents (Evelyn & Stiles, 2003; Patterson *et al.*, 2007; Garbino & Tavares, 2018). As a consequence, different species of three genera of bat flies parasitize these two host genera. *Megistopoda proxima*, *Metelasmus wenzeli*, *Aspidoptera delatorrei* and *A. falcata* parasitize species of *Sturnira*; and *Megistopoda aranea*, *Metelasmus pseudopterus* and *Aspidoptera phyllostomatis* parasitize species of *Artibeus* (Graciolli & Dick, 2004). These patterns can be generalized: bats with similar roosting behaviors share similar parasite species. Upon adding another parasite level, it is not hard to imagine that these fungi can be on several, even distantly related species of bat flies, when their bat hosts share the same roosts.

*Morphological diversity vs. phylogenetic diversity.* — The application of species delimitation methods (SDM) increases confidence in the assessment of the biodiversity of a given dataset. Based on morphological study, we identified seven species of *Gloeandromyces*, but this morphological diversity is not reflected in molecular structuring based on the LSU rDNA region. Using SDMs resulted in four species. In the case of *G. pageanus* and *G. streblae*, however, we revealed specialization to host species. For *G. streblae*, no obvious morphological features are observed to distinguish between thalli from *Tri. dugesioides* and *Tri. joblingi*. In fact, *G. streblae* exhibits high phenotypic plasticity (West-Eberhard, 1989). In the case of *G. streblae*, this plasticity makes it hard to make morphologically based identifications. As mentioned before, some thalli are morphologically so similar to *G. pageanus* morphotype *polymorphus* that it is difficult to impossible separating these taxa without sequence data. We have observed and included in our molecular work a range of thalli, from short, stout and curved to elongate, some

with conspicuous bumps at the distal end of the perithecial venter. Even so, two clades were retrieved that are only segregated by host species. There is one exception: isolate D. Haelew. 1320b represents morphotype *sigmomorphus* (Figures 4-7C and 4-10). This morphotype was removed from the last sternite/tergite. We believe the sigmoid habitus of this morphotype is a consequence of morphological adaptations induced by that specific portion of the insect integument.

In *G. pageanus*, thalli from *Tri. dugesioides* are in line with the original description of the species by Haelewaters *et al.* (2017a). However, thalli on *Tri. joblingi* showed two distinct morphologies. One morphotype, *alarum*, was restricted to the base of the wings (Figure 4-10), whereas the other morphotype, *polymorphus*, was not restricted to a particular position on the host. In *G. pageanus*, two mechanisms drive diversity: 1) host specialization, resulting in the two clades segregating by host species, and 2) position-induced morphological adaptations, resulting in the wing-restricted morphotype *alarum*. Two isolates seem aberrant, D. Haelew. 1089a and 1272a; these isolates were removed from *Tri. dugesioides* but are present in clade D, which includes *Tri. joblingi* isolates. We think we can explain this by bat fly behaviors and interactions. Bat flies are usually strictly host specific, with non-primary associations being defined as host species with less than 5% of the total individuals of a parasite species (Dick, 2007). When Wenzel *et al.* (1966) described *Tri. dugesioides*, they reported it from *Trachops cirrhosus*, *Chrotopterus auratus* and *Carollia perspicillata*, all bats in the family Phyllostomidae. The main hosts are *T. cirrhosus* and *C. auratus*. Because *C. perspicillata* bats make use of the same roost environments, *Tri. dugesioides* can be “exchanged” between these bat species. Apparently, dynamics are different for *Tri. joblingi*, which is strictly restricted to *Carollia* species.





**Figure 4-10.** A specimen of a *Trichobius* bat fly, photographed *in situ* dorsally (*left*) and ventrally (*right*). Annotated (encircled or with arrow) are the positions of the bat fly cuticle at which some species of *Gloeandromyces* seem to be restricted to: *G. dickii* nom. prov. on the abdomen, ventrally, at the right side; *G. pageanus* morphotype *alarum* at the base of both wings; and *G. streblae* morphotype *sigmomorphus* at the last tergite/sternite. Scale bars = 100  $\mu$ m. Images provided by André De Kesel.

Finally, even though SDMs only recognize four species of *Gloeandromyces*, it is evident that in *G. pageanus* and *G. streblae*, there is divergence by host species. This host specialization may represent an important first step in a potential radiation process; our results suggest a case of sympatric speciation into two incipient species, both in *G. pageanus* and *G. streblae*. Rosenblum *et al.* (2012) proposed the “ephemeral speciation model,” in which they postulated that speciation is common and rapid, but the new species produced almost never persist. This could be due to extinction or changes in conditions that maintain reproductive isolation.

## CONCLUSIONS

This study has not only substantially increased our knowledge about bats and their ectoparasitic associates, but also shown the need to include molecular data in Laboulbeniales taxonomy.

Multiple phenomena come into play in the morphological and phylogenetic diversity of these parasites. Phenotypic plasticity and position-induced morphological adaptations go hand in hand. Position-induced morphotypes still belong to the same phylogenetic species. In *Chitonomyces*, transmission of ascospores during mating between host individuals seems to be the mechanism leading to position specific morphotypes (Goldmann & Weir, 2012). For bat fly-associated Laboulbeniales, it is unclear what is behind the morphotypes on the last sternite/tergite or on the base of the wings. Another important contributor to diversity, whether or not ephemeral or incipient, is host specialization. In CHAPTER 3 we have provided evidence for segregation by host species in *Hesperomyces virescens* sensu lato on ladybirds. Phylogenetic structuring with segregation by host species also seems to be the case for at least two bat fly-associated species. Our main recommendation for future taxonomy research in Laboulbeniales is to always include molecular data. The examples discussed in this study have made it clear that it has become impossible to assess diversity by morphology alone.

## ACKNOWLEDGEMENTS

We would like to thank Carl W. Dick (Western Kentucky University) for providing thousands of well-curated bat fly specimens for this study; Thomas Hiller (University of Ulm, Germany) for bat fly identifications; Jasmin J. Camacho, Annabel Dorrestein, Lauren A. Meckler, Kirk A. Silas and Melissa J. Walker for assistance in the field; Guido C. Berguido (Asociación Adopta el Bosque Panamá) and Rachel A. Page (Smithsonian Tropical Research Institute, Panama) for

generous logistical assistance during fieldwork; W. Owen McMillan (Smithsonian Tropical Research Institute, Panama) and Edilma Gomez (Molecular Multi-User's Lab, Panama) for facilitating molecular work in Panama; André De Kesel (Botanic Garden Meise, Belgium) for excellent *in situ* photography of bat flies; and Walter Rossi (University of L'Aquila, Italy) for reviewing and improving morphological descriptions. Funding for fieldwork was received from the following sources (to D.H.): Harvard University Herbaria (Fernald Fund), David Rockefeller Center for Latin American Studies (Summer Research Travel Grant), Smithsonian Tropical Research Institute (Short-Term Research Fellowship) and Mycological Society of America (Graduate Fellowship, Robert W. Lichtwardt Student Research Award).

#### LITERATURE CITED

- Arnold AE, Lutzoni F (2007) Diversity and host range of foliar fungal endophytes: are tropical leaves biodiversity hotspots? *Ecology* **88**: 541–549.
- Barquez RM, Perez S, Miller B, Diaz M (2015) *Artibeus lituratus*. The IUCN red list of threatened species 2015. Available at <http://www.iucnredlist.org/details/2136/0> (accessed 06 October 2017).
- Báthori F, Pfliegler WP, Zimmerman C-U, Tartally A (2017) Online image databases as multi-purpose resources: discovery of a new host ant of *Rickia wasmannii* Cavara (Ascomycota, Laboulbeniales) by screening AntWeb.org. *Journal of Hymenoptera Research* **61**: 85–94.
- Benjamin RK (1981) Laboulbeniales on semiaquatic Hemiptera. IV. Addenda to *Prolixandromyces*. *Aliso* **10**: 1–17.
- Benjamin RK (1992a) *Cupulomyces*, a new genus of Laboulbeniales (Ascomycetes) based on *Stigmatomyces lasiochili*. *Aliso* **13**: 355–364.
- Benjamin RK (1992b) A new genus of Laboulbeniales (Ascomycetes) on a species of *Phalacrichus* (Coleoptera: Dryopoidea; Limnichidae), with a note on mirror-image asymmetry in the order. *Aliso* **13**: 427–446.
- Benjamin RK (2001) *Autophagomyces*, *Bordea*, and a new genus, *Rossiomyces* (Laboulbeniales). *Aliso* **19**: 99–136.

- Benjamin RK, Shanor L (1952) Sex of host specificity and position specificity of certain species of *Laboulbenia* on *Bembidion picipes*. *American Journal of Botany* **39**: 125–131.
- Blackwell M (1980a) Developmental morphology and taxonomic characters of *Arthrorhynchus nycteribiae* and *A. eucampsipodae* (Laboulbeniomycetes). *Mycologia* **72**: 159–168.
- Blackwell M (1980b) Incidence, host specificity, distribution, and morphological variation in *Arthrorhynchus nycteribiae* and *A. eucampsipodae* (Laboulbeniomycetes). *Mycologia* **72**: 143–58.
- Churchill S (2008) Australian bats. Sydney: Allen and Unwin.
- Darriba D, Taboada GL, Doallo R, Posada D (2012) jModelTest 2: more models, new heuristics and parallel computing. *Nature Methods* **9**: 772.
- Dávalos LM (2010) Earth history and the evolution of Caribbean bats. In: *Island bats: Ecology, evolution, and conservation* (Fleming TH, Racey PA, eds): 96–115. Chicago: The University of Chicago Press.
- De Kesel A (1995) Relative importance of direct and indirect infection in the transmission of *Laboulbenia slackensis* (Ascomycetes, Laboulbeniales). *Belgian Journal of Botany* **128**: 124–130.
- De Kesel A (1996) Host specificity and habitat preference of *Laboulbenia slackensis*. *Mycologia* **88**: 565–573.
- De Kesel A, Haelewaters D (2014) *Laboulbenia slackensis* and *L. littoralis* sp. nov. (Ascomycota, Laboulbeniales), two sibling species as a result of ecological speciation. *Mycologia* **106**: 407–414.
- Dick CW (2007) High host specificity of obligate ectoparasites. *Ecological Entomology* **32**: 446–450.
- Dick CW (2013) Review of the bat flies of Honduras, Central America (Diptera: Streblidae). *Journal of Parasitology Research* **2013**: article ID 437696.
- Dick CW, Gettinger D (2005) A faunal survey of streblid flies (Diptera: Streblidae) associated with bats in Paraguay. *Journal of Parasitology* **91**: 1015–1024.
- Dick CW, Patterson BD (2006) Bat flies: Obligate ectoparasites of bats. In: *Micromammals and macroparasites: from evolutionary ecology to management* (Morand S, Krasnov B, Poulin R, eds): 179–194. Tokyo: Springer.
- Dick CW, Patterson BD (2007) Against all odds: explaining high host specificity in dispersal-prone parasites. *International Journal for Parasitology* **37**: 871–876.
- Dick CW, Patterson BD (2008) An excess of males: skewed sex ratios in bat flies (Diptera: Streblidae). *Evolutionary Ecology* **22**: 757–769.

- Dittmar K, Porter ML., Murray S, Whiting MF (2006) Molecular phylogenetic analysis of nycteribiid and streblid bat flies (Diptera: Brachycera, Calypttratae): implications for host associations and phylogeographic origins. *Molecular Phylogenetics and Evolution* **38**: 155–170.
- Dormann CF, Gruber B, Fründ J (2008) Introducing the bipartite package: Analysing ecological networks. *R News* **8**: 8–11.
- Dougherty ER, Carlson CJ, Bueno VM, Burgio KR, Cizauskas CA, Clements CF, Seidel DP, Harris NC (2016) Paradigms for parasite conservation. *Conservation Biology* **30**: 724–733.
- Drummond AJ, Ho SYW, Rawlence N, Rambaut A (2007) *A rough guide to BEAST 1.4*. University Auckland, New Zealand. Available at <http://beast.bio.ed.ac.uk> (accessed 05 March 2018).
- Drummond AJ, Suchard MA, Xie D, Rambaut A (2012) Bayesian phylogenetics with BEAUti and the BEAST 1.7. *Molecular Biology and Evolution* **29**: 1969–1973.
- Duron O, Schneppat UE, Berthomieu A, Goodman SM, Droz B, Paupy C, Obame Nkoghe J, Rahola N, Tortosa P (2014) Origin, acquisition and diversification of heritable bacterial endosymbionts in louse flies and bat flies. *Molecular Ecology* **23**:2105–2117.
- Eckhart L, Bach J, Ban J, Tschachler E (2000) Melanin binds reversibly to thermostable DNA polymerase and inhibits its activity. *Biochemical and Biophysical Research Communications* **271**: 726–730.
- Edgar RC (2004) MUSCLE: multiple sequence alignment with high accuracy and high throughput. *Nucleic Acids Research* **32**: 1792–1797.
- Evelyn MJ, Stiles DA (2003) Roosting requirements of two frugivorous bats (*Sturnira lilium* and *Arbeteus intermedius*) in fragmented Neotropical forest. *Biotropica* **35**: 405–418.
- Ezard T, Fujisawa T, Barraclough TG (2009) *splits: SPecies' LLimits by Threshold Statistics*. R package version 1.0-14/r31. Available at <http://R-Forge.R-project.org/projects/splits/> (accessed 12 January 2018).
- Freeman PW (1988) Frugivorous and animalivorous bats (Microchiroptera): dental and cranial adaptations. *Biological Journal of the Linnean Society* **33**: 249–272.
- Garbino GST, Tavares VC (2018) 2018. Roosting ecology of Stenodermatinae bats (Phyllostomidae): Evolution of foliage roosting and correlated phenotypes. *Mammal Review*, doi:10.1111/mam.12114.
- Gernhard T (2008) The conditioned reconstructed process. *Journal of Theoretical Biology* **253**: 769–778.

- Goldmann L, Weir A (2012) Position specificity in *Chitonomyces* (Ascomycota, Laboulbeniomyces) on *Laccophilus* (Coleoptera, Dytiscidae): a molecular approach resolves a century-old debate. *Mycologia* **104**: 1143–1158.
- Goldmann L, Weir A (2018) Molecular phylogeny of the Laboulbeniomyces (Ascomycota). *Fungal Biology* **122**: 87–100.
- Goldmann L, Weir A, Rossi W (2013) Molecular analysis reveals two new dimorphic species of *Hesperomyces* (Ascomycota, Laboulbeniomyces) parasitic on the ladybird *Coleomegilla maculata* (Coleoptera, Coccinellidae). *Fungal Biology* **117**: 807–813.
- González DP, Santos AM, Miranda JR (2004) Streblidae (Diptera: Pupipara) ectoparasitos de murciélagos, en las tierras bajas del Parque Nacional Darien, provincia de Darién, Panamá. *Tecnociencias* **6**: 1–12.
- Graciolli G, Dick CW (2004) A new species of *Metelasmus* (Diptera: Streblidae: Streblinae) from southern South America. *Zootaxa* **509**: 1–8.
- Guerrero R (1993) Catalogo de los Streblidae (Diptera: Pupipara) parasitos de murciélagos (Mammalia: Chiroptera) del Nuevo Mundo I. Clave para los géneros y Nycterophiliinae. *Acta Biologica Venezuelica* **14**: 61–75.
- Guerrero R (1994a) Catalogo de los Streblidae (Diptera: Pupipara) parasitos de murciélagos (Mammalia: Chiroptera) del Nuevo Mundo II. Los grupos: *pallidus*, *caecus*, *major*, *uniformis* y *longipes* del género *Trichobius* (Gervais, 1844). *Acta Biologica Venezuelica* **15**: 1–18.
- Guerrero R (1994b) Catalogo de los Streblidae (Diptera: Pupipara) parasitos de murciélagos (Mammalia: Chiroptera) del Nuevo Mundo IV. Trichobiinae con alas desarrolladas. *Boletín de Entomología Venezolana* **9**: 161–192.
- Guerrero R (1995a) Catalogo de los Streblidae (Diptera: Pupipara) parasitos de murciélagos (Mammalia: Chiroptera) del Nuevo Mundo III. Los grupos: *dugesii*, *dunni* y *phyllostomae* del género *Trichobius* (Gervais, 1844). *Acta Biologica Venezuelica* **15**: 1–27.
- Guerrero R (1995b) Catalogo de los Streblidae (Diptera: Pupipara) parasitos de murciélagos (Mammalia: Chiroptera) del Nuevo Mundo V. Trichobiinae con alas reducidas o ausentes y miscelaneos. *Boletín de Entomología Venezolana* **10**: 135–160.
- Guerrero R (1996) Catálogo de los Streblidae (Diptera: Pupipara) parásitos de murciélagos (Mammalia: Chiroptera) del Nuevo Mundo VI. Streblinae. *Acta Biologica Venezuelica* **16**: 1–26.
- Guerrero R (1997) Catálogo de los Streblidae (Diptera: Pupipara) parásitos de murciélagos (Mammalia: Chiroptera) del Nuevo Mundo VII. Lista de especies, hospedadores y países. *Acta Biologica Venezuelica* **17**: 9–24.

- Guerrero R (1998a) Notes on Neotropical batflies (Diptera, Streblidae). I. The genus *Trichobius*, with description of two new species and one new subspecies from Venezuela. *Acta Parasitologica* **43**: 86–93.
- Guerrero R (1998b) Notes on Neotropical bat flies (Diptera: Streblidae): II. Review of the genus *Xenotrichobius*. *Acta Parasitologica* **43**: 142–147.
- Guerrero JA, Ortega J, Gonzalez D, Maldonado JE, Lorenzo C, Espinoza E (2008) Molecular phylogenetics and taxonomy of the fruit-eating bats of the genus *Artibeus* (Chiroptera: Phyllostomidae). *Avances en el Estudio de los Mamíferos de México. Publicaciones Especiales* **2**: 125–146.
- Guimarães LR (1966) Nycteribiid batflies from Panama (Diptera: Nycteribiidae). In: *Ectoparasites of Panama* (Wenzel RL, Tipton VJ, eds): 393–404. Chicago: Field Museum of Natural History.
- Haelewaters D, Gorczak M, Pfliegler WP, Tartally A, Tischler M, Wrzosek M, Pfister DH (2015) Bringing Laboulbeniales into the 21st century: enhanced techniques for extraction and PCR amplification of DNA from minute ectoparasitic fungi. *IMA Fungus* **6**: 363–72.
- Haelewaters D, Pfliegler WP, Gorczak M, Pfister DH (in review) Birth of an order: comprehensive phylogenetic study excludes *Herpomycetes* (Fungi, Laboulbeniomycetes) from Laboulbeniales. *Molecular Phylogenetics and Evolution*.
- Haelewaters D, Pfliegler WP, Szentiványi T, Földvári M, Sándor AD, Barti L, Camacho JJ, Gort G, Estók P, Hiller T, Dick CW, Pfister DH (2017a) Parasites of parasites of bats: Laboulbeniales (Fungi: Ascomycota) on bat flies (Diptera: Nycteribiidae) in Central Europe. *Parasites & Vectors* **10**: 96.
- Haelewaters D, Verhaeghen SJC, Rios Gonzalez TA, Bernal Vega JA, Villarreal Saucedo RV (2017b) New and interesting Laboulbeniales from Panama and neighboring areas. *Nova Hedwigia* **105**: 267–299.
- Hall TA (1999) BioEdit: a user-friendly biological sequence alignment editor and analysis program for Windows 95/98/NT. *Nucleic Acids Symposium Series* **41**: 95–98.
- Handley Jr. CO (1966) Checklist of the mammals of Panama. In: *Ectoparasites of Panama* (Wenzel RL, Tipton VJ, eds): 753–795. Chicago: Field Museum of Natural History.
- Handley Jr. CO (1981) *Key to the bats of the lowlands of Panama*. Washington DC: National Museum of Natural History.
- Hosokawa T, Nikoh N, Koga R, Satô M, Tanahashi M, Meng XY, Fukatsu T (2012) Reductive genome evolution, host-symbiont co-speciation and uterine transmission of endosymbiotic bacteria in bat flies. *The ISME Journal* **6**: 577–587.

- Jobling B (1949) Host-parasite relationship between the American Streblidae and the bats, with a new key to the American genera and a record of the Streblidae from Trinidad, British West Indies (Diptera). *Parasitology* **39**: 315–329.
- Jones G, Jacobs DS, Kunz TH, Willig MR, Racey PA (2009) Carpe noctem: the importance of bats as bioindicators. *Endangered Species Research* **8**: 93–115.
- Jukes TH, Cantor CR (1969) Evolution of protein molecules. In: *Mammalian protein metabolism* (Munro NH, ed): 21–132. New York: Academic Press.
- Jung S, Kim H, Yamada K, Lee S (2010) Molecular phylogeny and evolutionary habitat transition of the flower bugs (Heteroptera: Anthocoridae). *Molecular Phylogenetics and Evolution* **57**: 1173–1183.
- Kalko EKV, Handley CO, Handley D (1996) Organization, diversity, and long-term dynamics of a neotropical bat community. In: *Long-term studies of vertebrate communities* (Cody ML, Smallwood JA, eds): 503–553. San Diego: Academic Press.
- Kimura M (1980) A simple method for estimating evolutionary rates of base substitutions through comparative studies of nucleotide sequences. *Journal of Molecular Evolution* **16**: 111–120.
- Kolenati FA (1857) Epizoa der Nycteribien. *Wiener Entomologische Monatsschrift* **1**: 66–69.
- Kumar S, Stecher G, Tamura K (2016) MEGA7: molecular evolutionary genetics analysis version 7.0 for bigger datasets. *Molecular Biology and Evolution* **33**: 1870–1874.
- Kunz TH (1982) Roosting ecology. In: *Ecology of bats* (Kunz TH, ed): 1–55. New York: Plenum Press.
- Kunz TH, Braun De Torrez E, Bauer D, Lobova T, Fleming TH (2011) Ecosystem services provided by bats. *Annals of the New York Academy of Sciences* **1223**: 1–38.
- Kunz TH, Lumsdem LF (2003) Ecology of cavity and foliage roosting bats. In: *Bat ecology* (Kunz TH, Fenton MB, eds): 3–90. Chicago: The University of Chicago Press.
- Lafferty KD, Allesina S, Arim M, Briggs CJ, De Leo G, Dobson AP, Dunne JA, Johnson PTJ, Kuris AM, Marcogliese DJ, Martinez ND, Memmott J, Marquet PA, McLaughlin JP, Mordecai EA, Pascual M, Poulin R, Thielgtes DW (2008) Parasites in food webs: the ultimate missing links. *Ecology Letters* **11**: 533–546.
- Leong MC, Marshall AG (1968) The breeding biology of the bat-fly *Eucampsipoda sunndaicum* Theodor, 1955 (Diptera: Nycteribiidae). *Malayan Nature Journal* **21**: 171–180.
- Lewis SE (1995) Roost fidelity of bats: A review. *Journal of Mammalogy* **76**: 481–496.



- Lourenço EC, Almeida JC, Famadas KM (2016) Richness of ectoparasitic flies (Diptera: Streblidae) of bats (Chiroptera)—a systematic review and meta-analysis of studies in Brazil. *Parasitology Research* **115**: 4379–4388.
- Marshall AG (1970) The life cycle of *Basilia hispida* Theodor 1957 (Diptera: Nycteribiidae) in Malaysia. *Parasitology* **61**: 1–18
- Marshall AG (1980) The comparative ecology of insects ectoparasitic upon bats in west Malaysia. In: *Proceedings. Fifth international bat research conference* (Wilson DE, Gardner AL, eds): 135–142. Lubbock, Texas: Texas Tech Press.
- Marshall AG (1981) *The ecology of ectoparasitic insects*. New York: Academic Press.
- Merola A (1952) Interessante ritrovamento di labulbeniologia cavernicola: *Arthrorhynchus acrandros* n. sp. (con considerazioni sul gen. *Arthrorhynchus*). *Bollettino della Società dei naturalisti in Napoli* **60**: 1–30.
- Meyer CFJ, Kalko EKV (2008) Assemblage-level responses of phyllostomid bats to tropical forest fragmentation: land-bridge islands as a model system. *Journal of Biogeography* **35**: 1711–1726.
- Michonneau F, Bolker B, Holder M, Lewis P, O’Meara B (2015) *rncl: an interface to the nexus class library*. R package version 0.6.0. Available at <http://CRAN.R-project.org/package=rncl> (accessed 08 February 2018).
- Miller J, Tschapka M (2001) *The bat flies of La Selva (Diptera: Nycteribiidae, Streblidae)*. Available at <http://www.biologie.uni-ulm.de/bio3/Batfly/index.html> (accessed 04 November 2017).
- Miller MA, Pfeiffer W, Schwartz T (2010) Creating the CIPRES Science Gateway for inference of large phylogenetic trees. *Proceedings of the Gateway Computing Environments Workshop (GCE)* **14 Nov. 2010**: 1–8. New Orleans, Louisiana.
- Morse SF, Dick CW, Patterson BD, Dittmar K (2012) Some like it hot—Evolution and ecology of novel endosymbionts in bat flies of cave-roosting bats (Hippoboscoidea, Nycterophiliinae). *Applied and Environmental Microbiology* **78**: 8639–8649.
- Morse SF, Bush SE, Patterson BD, Dick CW, Gruwell ME, Dittmar K (2013) Evolution, multiple acquisition, and localization of endosymbionts in bat flies (Diptera: Hippoboscoidea: Streblidae and Nycteribiidae). *Applied and Environmental Microbiology* **79**: 2952–2961.
- Nogueira MR, Peracchi AL, Monteiro LR (2009) Morphological correlates of bite force and diet in the skull and mandible of phyllostomid bats. *Functional Ecology* **23**: 715–723.
- Olival KJ, Dick CW, Simmons NB, Morales JC, Melnick DJ, Dittmar K, Perkins SL, Daszak P, DeSalle R (2013) Lack of population genetic structure and host specificity in the bat fly,

- Cyclopodia horsfieldi*, across species of Pteropus bats in Southeast Asia. *Parasites & Vectors* **6**: 231.
- Overall WL (1980) Host-relations of the batfly *Megistopoda aranea* (Diptera: Streblidae) in Panama. *University of Kansas Science Bulletin* **52**: 1–20.
- Palmeirim JM, Etherdige K (1985) The influence of man-made trails on foraging by tropical frugivorous bats. *Biotropica* **17**: 82–83.
- Paradis E, Claude J, Strimmer K (2004) APE: analyses of phylogenetics and evolution in R language. *Bioinformatics* **20**: 289–290.
- Parratt SR, Laine AL (2016) The role of hyperparasitism in microbial pathogen ecology and evolution. *The ISME Journal* **10**: 1815–1822.
- Patterson BD, Dick CW, Dittmar K (2007) Roosting habits of bats affect their parasitism by bat flies (Diptera: Streblidae). *Journal of Tropical Ecology* **23**: 177–189.
- Peyritsch J (1871) Über einige Pilze aus der Familie der Laboulbenien. *Sitzungsberichte der Kaiserlichen Akademie der Wissenschaften. Mathematisch-naturwissenschaftliche Classe* **64**: 441–458.
- Peyritsch J (1873) Beiträge zur Kenntniss der Laboulbenien. *Sitzungsberichte der Kaiserlichen Akademie der Wissenschaften. Mathematisch-naturwissenschaftliche Classe* **68**: 227–254
- Pfliegler WP, Báthori F, Haelewaters D & Tartally A (2016) Studies of Laboulbeniales on *Myrmica* ants (III): myrmecophilous arthropods as alternative hosts of *Rickia wasmannii*. *Parasite* **23**: 50.
- Pilosof S, Dick CW, Korine C, Patterson BD, Krasnov BR (2012) Effects of anthropogenic disturbance and climate on patterns of bat fly parasitism. *Plos One* **7**: e41487.
- Pons J, Barraclough TG, Gomez-Zurita J, Cardoso A, Duran DP, Hazell S, Kamoun S, Sumlin WD, Vogler AP (2006) Sequence-based species delimitation for the DNA taxonomy of undescribed insects. *Systematic Biology* **55**: 595–609.
- Puillandre N, Lambert A, Brouillet S, Achaz G (2012) ABGD, Automatic Barcode Gap Discovery for primary species delimitation. *Molecular Ecology* **21**: 1864–1877.
- R Core Team. 2013. *R: a language and environment for statistical computing*. Vienna, Austria: R Foundation for Statistical Computing. Available at <http://www.R-project.org> (accessed 06 March 2018).
- Ramasindrazana B, Goodman SM, Gomard Y, Dick CW, Tortosa P (2017) Hidden diversity of Nycteribiidae (Diptera) bat flies from the Malagasy region and insights on host-parasite interactions. *Parasites & Vectors* **10**: 630.

- Rambaut A, Suchard MA, Xie D, Drummond AJ (2014) *Tracer v1.6*. Available at <http://tree.bio.ed.ac.uk/software/tracer/> (accessed 02 November 2017).
- Reboleira ASPS, Fresneda J, Salgado JM (2017) A new species of *Speonemadus* from Portugal, with the revision of the *escalerai*-group (Coleoptera, Leiodidae). *European Journal of Taxonomy* **261**: 1–23.
- Rosenblum EB, Sarver BAJ, Brown JW, Des Roches S, Hardwick KM, Hether TD, Eastman JM, Pennell MW, Harmon LJ (2012) Goldilocks meets Santa Rosalia: an ephemeral speciation model explains patterns of diversification across time scales. *Evolutionary Biology* **39**: 255–261.
- Rossi W, Kirk-Spriggs AH (2011) A new species of *Laboulbenia* (Ascomycota) parasitic on an African fly (Diptera: Curtonotidae), with a brief review of Diptera-associated species of the genus. *African Invertebrates* **52**: 211–216.
- Rossi W, Leonardi M (2013) New species of *Stigmatomyces* (Laboulbeniomycetes) from Sierra Leone. *Plant Biosystems* **147**: 79–83.
- Saitou N, Nei M (1987) The neighbor-joining method: a new method for reconstructing phylogenetic trees. *Molecular Biology and Evolution* **4**: 406–425.
- Samudio Jr. R (2002) 77. *Patterns of diversity and ecology in Panamanian bats at two elevations*. Doctoral dissertation. University of Florida, Gainesville, Florida.
- Samudio Jr. R, Pino JL (2014) Historia de la Mastozoología en Panamá. In: *Historia de La Mastozoología En Latinoamérica, Las Guayanas Y El Caribe* (Ortega J, Martínez JL, Tirira DG, eds): 329–344. Quito, Ecuador: Editorial Murciélago Blanco y Asociación Ecuatoriana de Mastozoología.
- Santamaria S (1995) *Parvomyces*, a new genus of Laboulbeniales from Spain. *Mycological Research* **99**: 1071–1077.
- Santamaria S, Balazuc J, Tavares II (1991) Distribution of the European Laboulbeniales (Fungi, Ascomycotina). An annotated list of species. *Treballs de l'Institut Botanic de Barcelona* **14**: 1–123.
- Schuh RT, Slater JA (1995) True bugs of the world (Hemiptera: Heteroptera): classification and natural history. Ithaca, New York: Cornell University Press.
- Schuh RT, Štys P (1991) Phylogenetic analysis of cimicomorphan family relationships (Heteroptera). *Journal of the New York Entomological Society* **99**: 298–350.
- Shimodaira H, Hasegawa M (1999) Multiple comparisons of log-likelihoods with applications to phylogenetic inference. *Molecular Biology and Evolution* **16**: 1114–1116.
- Shockley FW, Murray KL (2006) Discovery of a parasitoid and a predator of bat flies (Diptera: Streblidae) at La Selva, Costa Rica. *Biotropica* **38**: 789–790.

- Simmons NB (2005) Order Chiroptera. In: *Mammal species of the world: a taxonomic and geographic reference. Third edition* (Wilson DE, Reeder DAM, eds): 312–529. Baltimore, Maryland: Johns Hopkins University Press.
- Stadler T (2009) On incomplete sampling under birth–death models and connections to the sampling-based coalescent. *Journal of Theoretical Biology* **261**: 58–66.
- Stamatakis A (2014) RAxML Version 8: A tool for phylogenetic analysis and post-analysis of large phylogenies. *Bioinformatics* **30**: 1312–1313.
- Stamper E (2012) *Host Specificity of Ecuadorian bat flies (Diptera: Streblidae)*. Honors College Capstone Experience/Thesis Projects. Paper 358. Available at [http://digitalcommons.wku.edu/stu\\_hon\\_theses/358](http://digitalcommons.wku.edu/stu_hon_theses/358) (accessed 17 October 2017).
- Swofford DL (1991) *PAUP: Phylogenetic Analysis Using Parsimony, Version 3.1*. Computer program distributed by the Illinois Natural History Survey, Champaign, Illinois.
- Szentiványi T, Haelewaters D, Pfliegler WP, Clément L, Christe P, Glaizot O (in review) Laboulbeniales (Fungi: Ascomycota) infection of bat flies (Diptera: Nycteribiidae) from *Miniopterus schreibersii* across Europe. *Parasites & Vectors*.
- Tavares II (1985) Laboulbeniales (Fungi, Ascomycetes). *Mycol Memoir* **9**: 1–627.
- Tavares II, Balazuc J (1989) *Sugiyamaemyces*, a new genus of Laboulbeniales (Ascomycetes) on Clidicus (Scydmaenidae). *Mycotaxon* **34**: 565–576.
- Teeling E, Springer M, Madsen O (2005) A molecular phylogeny for bats illuminates biogeography and the fossil record. *Science* **307**: 580–583.
- ter Hofstede HM, Fenton MB, Whitaker JO Jr. (2004) Host and host-site specificity of bat flies (Diptera: Streblidae and Nycteribiidae) on Neotropical bats (Chiroptera). *Canadian Journal of Zoology* **82**: 616–626.
- Thaxter R (1896) Contribution towards a monograph of the Laboulbeniaceae. *Memoirs of the American Academy of Arts and Sciences* **12**: 187–429, Pl. I–XXVI.
- Thaxter R (1901) Preliminary diagnosis of new species of Laboulbeniaceae. III. *Proceedings of the American Academy of Arts and Sciences* **36**: 397–414.
- Thaxter R (1908) Contribution toward a monograph of the Laboulbeniaceae. Part II. *Memoirs of the American Academy of Arts and Sciences* **13**: 217–469, Pl. XXVIII–LXXI.
- Thaxter R (1915) New Indo-Malayan Laboulbeniales. *Proceedings of the American Academy of Arts and Sciences* **51**: 3–51.
- Thaxter R (1917) New Laboulbeniales, chiefly dipterophilous American species. *Proceedings of the American Academy of Arts and Sciences* **52**: 649–721.

- Thaxter R (1924) Contribution toward a monograph of the Laboulbeniaceae III. *Memoirs of the American Academy of Arts and Sciences* **14**: 309–426, Pl. I–XII.
- Thaxter R (1931) Contribution toward a monograph of the Laboulbeniaceae V. *Memoirs of the American Academy of Arts and Sciences* **16**: 1–435, Pl. I–LX.
- Theodor O (1967) Illustrated catalogue of the Rothschild collection of Nycteribiidae (Diptera) in the British Museum (Natural History). London: British Museum of Natural History.
- Timm RM, LaVal RK (1998) A field key to the bats of Costa Rica. *Occasional Publication Series, University of Kansas Center of Latin American Studies* **22**: 1–30.
- Velazco PM (2005) Morphological phylogeny of the bat genus *Platyrrhinus* Saussure, 1860 (Chiroptera: Phyllostomidae) with the description of four new species. *Fieldiana: Zoology* **105**: 1–53.
- Vleut I, Levy-Tacher SI, de Boer WF, Galindo-González J, Vazquez L-B (2013) Tropical secondary forest management influences frugivorous bat composition, abundance and fruit consumption in Chiapas, Mexico. *Plos One* **8**: e77584.
- Walker MJ, Dorrestein A, Camacho JJ, Meckler LA, Silas KA, Hiller T, Haelewaters D (2018) A tripartite survey of hyperparasitic fungi associated with ectoparasitic flies on bats (Mammalia: Chiroptera) in a neotropical cloud forest in Panama. *Parasite* **25**: 19.
- Weir A (2008) The genus *Prolixandromyces* (Laboulbeniales) in the old world. *Aliso* **26**: 29–35.
- Weir A, Blackwell M (2001a) Molecular data support the Laboulbeniales as a separate class of Ascomycota, Laboulbeniomycetes. *Mycological Research* **105**: 1182–1190.
- Weir A, Blackwell M (2001b) Extraction and PCR amplification of DNA from minute ectoparasitic fungi. *Mycologia* **93**: 802–806.
- Weir A, Hammond PM (1997) Laboulbeniales on beetles: host utilization patterns and species richness of the parasites. *Biodiversity and Conservation* **6**: 701–719.
- Wenzel RL (1976) The streblid batflies of Venezuela (Diptera: Streblidae). *Brigham Young University Science Bulletin* **20**: 1–177.
- Wenzel RL, Tipton VJ (1966) *Ectoparasites of Panama*. Chicago: Field Museum of Natural History.
- Wenzel RL, Tipton VJ, Kiewlicz A (1966) The streblid batflies of Panama (Diptera Calypterae: Streblidae). In: *Ectoparasites of Panama* (Wenzel RL, Tipton VJ, eds): pp 405–676. Chicago: Field Museum of Natural History.
- West-Eberhard MJ (1989) Phenotypic plasticity and the origins of diversity. *Annual Review of Ecology, Evolution, and Systematics* **20**: 249–278.

- Whisler HC (1968) Experimental studies with a new species of *Stigmatomyces* (Laboulbeniales). *Mycologia* **60**: 65–75.
- Wilkinson DA, Duron O, Cordonin C, Gomard Y, Ramasindrazana B, Mavingui P, Goodman SM, Tortosa P (2016) The bacteriome of bat flies (Nycteribiidae) from the Malagasy region: a community shaped by host ecology, bacterial transmission mode, and host-vector specificity. *Applied and Environmental Microbiology* **82**: 1778–1788.
- Windsor DA (1990) Heavenly hosts. *Nature* **348**: 104.
- Windsor DA (1995) Equal rights for parasites. *Conservation Biology* **9**: 1–2.
- Yule GU (1925) A mathematical theory of evolution based on the conclusions of Dr. J. C. Willis. *Philosophical Transactions of the Royal Society B* **213**: 21–87.
- Zhang J, Kapli P, Pavlidis P, Stamatakis A (2013) A general species delimitation method with applications to phylogenetic placements. *Bioinformatics* **29**: 2869–2876.

## **CHAPTER 5**

**A preliminary phylogeny of Laboulbeniomyces: pre-molecular classifications subject to  
revision**

## **A preliminary phylogeny of Laboulbeniomycetes: pre-molecular classifications subject to revision**

**Abstract.** The class Laboulbeniomycetes comprises fungi that are obligately associated with Arthropoda as biotrophs or for dispersal. Three orders are recognized, Laboulbeniales, Pyxidiophorales and the recently described Herpomycetales. In addition, *Coreomycetopsis* and *Laboulbeniopsis* have not been placed in the classification scheme because lack of sequence data. Owing to difficulties in DNA isolation and PCR amplification, the molecular phylogenetic relationships within the class have been understudied. Moreover, the lack of sequence data has resulted in the group often having been excluded from major Ascomycota-wide investigations. Here, based on a dataset of 83 small subunit ribosomal DNA sequences we take a new direction in the inference of the relationships within the class. We find strong evidence for the three orders, but their interrelationships remain elusive. Several higher taxa that were described based on structural characters are polyphyletic. For example, subtribe Stigmatomycetinae, tribe Laboulbenieae and subfamilies Laboulbenioideae and Peyritschelloideae all are polyphyletic. *Ceratomyces*, *Chitonomyces*, *Coreomyces* and *Zodiomyces*, genera with species that have aquatic hosts, occupy a basal position in the Laboulbeniales clade, providing evidence for an ecological viewpoint, more than a structurally based one. Subfamily Peyritschelloideae being polyphyletic supports the view that compound antheridia have arisen multiple times independently (at least four times).

**Key words:** Ascomycota, Bayesian inference, ectoparasites, phylogeny, ribosomal DNA



## INTRODUCTION

The study of the Laboulbeniomycetes started with observations of *Laboulbenia* thalli on carabid beetles in the 1840s and early 1850s (Anonymous, 1849; Rouget, 1850; Mayr, 1853). Some authors thought that the structures they observed were insect parts (Mayr, 1853) whereas others recognized them as living organisms. In those days, researchers referred to Laboulbeniales as “parasitic plants” (Anonymous, 1849) or acanthocephalan worms (Kolenati, 1857). Robin (1852) recognized them as fungi and de Bary (1884) listed the family Laboulbeniaceae as ascomycetes with doubt.

The first to use the name “Laboulbeniaceae” was Peyritsch (1873). Five genera were recognized at that time – *Chitonomyces*, *Heimatomyces*, *Helmintophana* [= *Arthrorhynchus*], *Laboulbenia* and *Stigmatomyces* – and twelve species had been described, of which eight were in *Laboulbenia* (Benjamin, 1971). Upon the publication of Thaxter’s (1896) first monograph, there were 28 genera and 152 species, most of which had previously been published by Thaxter in a series of preliminary papers. Thaxter (1896) not only contributed significant taxonomic additions, he also proposed a classification system, which he updated in his subsequent volume (Thaxter, 1908). Thaxter (1896) separated what he called the family Laboulbeniaceae into two “groups,” the Exogenae and Endogenae. The ways of spermatia formation was the sole criterion for grouping of taxa. The Exogenae included genera with species that form spermatia exogeneously; spermatia are gametes produced on the appendages. They are borne on intercalary cells or terminally on short branchlets (Majewski, 1994). Only the genera *Ceratomyces* and *Zodiomyces* were part of the Exogenae group. The Endogenae comprised taxa in which spermatia are formed inside of antheridia. This group included two “orders”: Laboulbenieae (with simple antheridia, 15 genera) and Peyritschielleae (with compound antheridia, 11 genera).

In his second monographic volume, Thaxter (1908) accepted the ordinal name Laboulbeniales and replaced the terms Exogenae and Endogenae by the subordinal names Laboulbeniinae and Ceratomycetinae. The two subdivisions from the original “group” Endogenae were replaced by families Laboulbeniaceae and Peyritschiellaceae. Thaxter did not recognize a family within the Ceratomycetinae. The name Ceratomycetaceae, now widely accepted, was introduced for the first time by Maire (1916), as a *nomen nudum* and validly published by Colla (1934). This scheme of organizing taxa was widely accepted until Tavares (1967, 1985) introduced new characters for classification of the Laboulbeniales: perithecial development and perithecial wall structure. Thaxter’s (1908) two suborders, two families and twenty tribes were reorganized to two suborders, four families, six subfamilies, 13 tribes and 28 subtribes (Table 5-1).

Tavares (1985) recognized three families in the suborder Laboulbeniinae: Ceratomycetaceae, Euceratomycetaceae and Laboulbeniaceae (Majewski, 1994; Santamaria, 2003; Figure 5-1). Ceratomycetaceae comprises eleven genera: *Autoicomycetes*, *Ceratomyces*, *Drepanomyces*, *Eusynaptomyces*, *Helodiomyces*, *Phurmomyces*, *Plectomyces*, *Rhynchophoromyces*, *Synaptomyces*, *Tettigomyces*, *Thaumasiomyces* and *Thripomyces*. Synapomorphic characters are (1) the primary receptacle consisting of a single series of superposed cell and (2) cells VI and VII are successive, intercalary cells of the primary receptacle. In the Euceratomycetaceae, cells VI and VII are successive cells of the lateral secondary appendage coming from the primary appendage. The lateral appendage extends beyond the base of the perithecium (arising from cell VII). Depending on the genus, there may be a single perithecium or multiple ones. Genera included in the Euceratomycetaceae are *Cochliomyces*, *Colonomyces*, *Euceratomyces*, *Euzodiomyces* and *Pseudoecteinomyces*. Taxa in

**Table 5-1.** Comparison of classification systems by Thaxter (1908) and Tavares (1985).

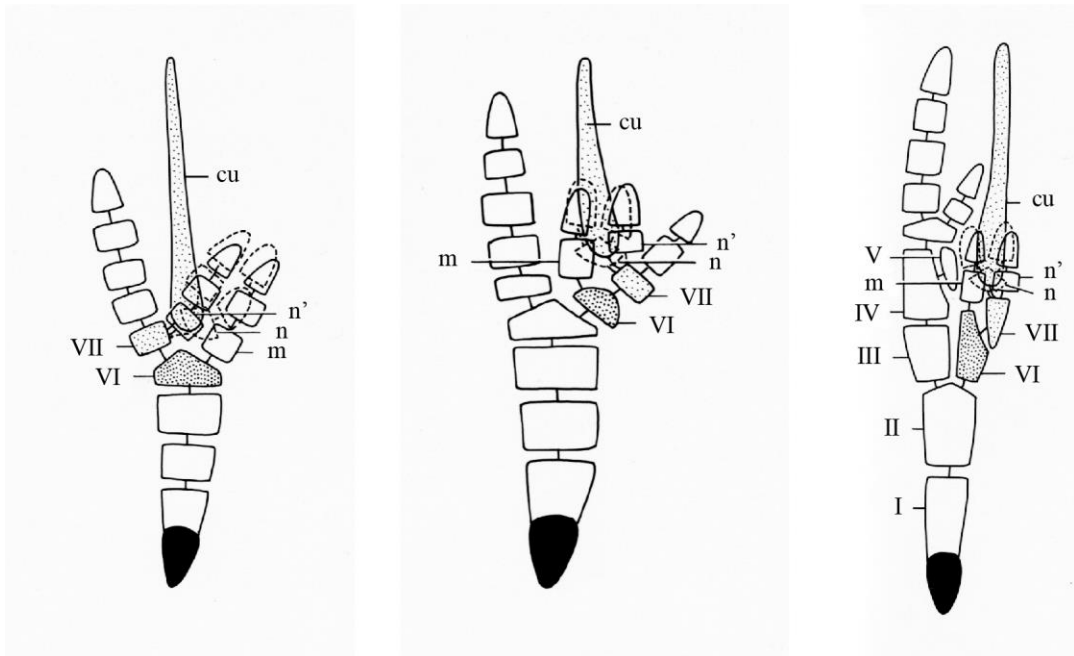
Thaxter (1908)	Tavares (1985)
<b>Suborder Ceratomycetinae</b>	<b>Suborder Herpomycetinae</b>
Tribe Ceratomycetaceae	Family Herpomycetaceae
Tribe Zodiomycetaceae	Tribe Herpomycetaceae
<b>Suborder Laboulbeniineae</b>	<b>Suborder Laboulbeniinae</b>
Family Laboulbeniaceae	Family Ceratomycetaceae
Tribe Amorphomycetaceae	Subfamily Ceratomycetoidaeae
Tribe Chaetomycetaceae	Tribe Ceratomycetaceae
Tribe Clematomycetaceae	Subtribe Ceratomycetinae
Tribe Compsomycetaceae	Subtribe Helodiomycetinae
Tribe Corethromycetaceae	Tribe Drepanomycetaceae
Tribe Ecteinomycetaceae	Tribe Thaumasiomycetaceae
Tribe Herpomycetaceae	Subfamily Tettigomycetoideae
Tribe Idiomycetaceae	Family Euceratomycetaceae
Tribe Laboulbenieae	Family Laboulbeniaceae
Tribe Misgomycetaceae	Subfamily Laboulbenioideae
Tribe Rhachomycetaceae	Tribe Compsomycetaceae
Tribe Stigmatomycetaceae	Subtribe Compsomycetinae
Tribe Teratomycetaceae	Subtribe Kainomycetinae
Family Peyritschiellaceae	Tribe Coreomycetaceae
Tribe Dimorphomycetaceae	Tribe Euphoriomycetaceae
Tribe Enarthromycetaceae	Subtribe Aporomycetinae
Tribe Haplomycetaceae	Subtribe Euphoriomycetinae
Tribe Peyritschielleae	Tribe Hydrophilomycetaceae
Tribe Rickieae	Tribe Laboulbenieae
	Subtribe Amorphomycetinae
	Subtribe Chaetarthriomycetinae
	Subtribe Chitonomycetinae
	Subtribe Laboulbeniinae
	Subtribe Misgmomycetinae
	Subtribe Stigmatomycetinae
	Tribe Teratomycetaceae
	Subtribe Amphimycetinae
	Subtribe Asaphomycetinae
	Subtribe Chaetomycetinae
	Subtribe Filariomycetinae
	Subtribe Histeridomycetinae
	Subtribe Rhachomycetinae
	Subtribe Rhipidiomycetinae
	Subtribe Scelophoromycetinae
	Subtribe Smeringomycetinae
	Subtribe Teratomycetinae

**Table 5-1.** (Continued).

---

Subfamily Monoicomycetoideae  
Subfamily Peyritschielloideae  
Tribe Dimorphomyceteae  
Tribe Haplomyceteae  
    Subtribe Haplomycetinae  
    Subtribe Kleidiomycetinae  
Tribe Peyritschielleae  
    Subtribe Diandromycetinae  
    Subtribe Enarthromycetinae  
    Subtribe Mimeomycetinae  
    Subtribe Peyritschiellinae

---



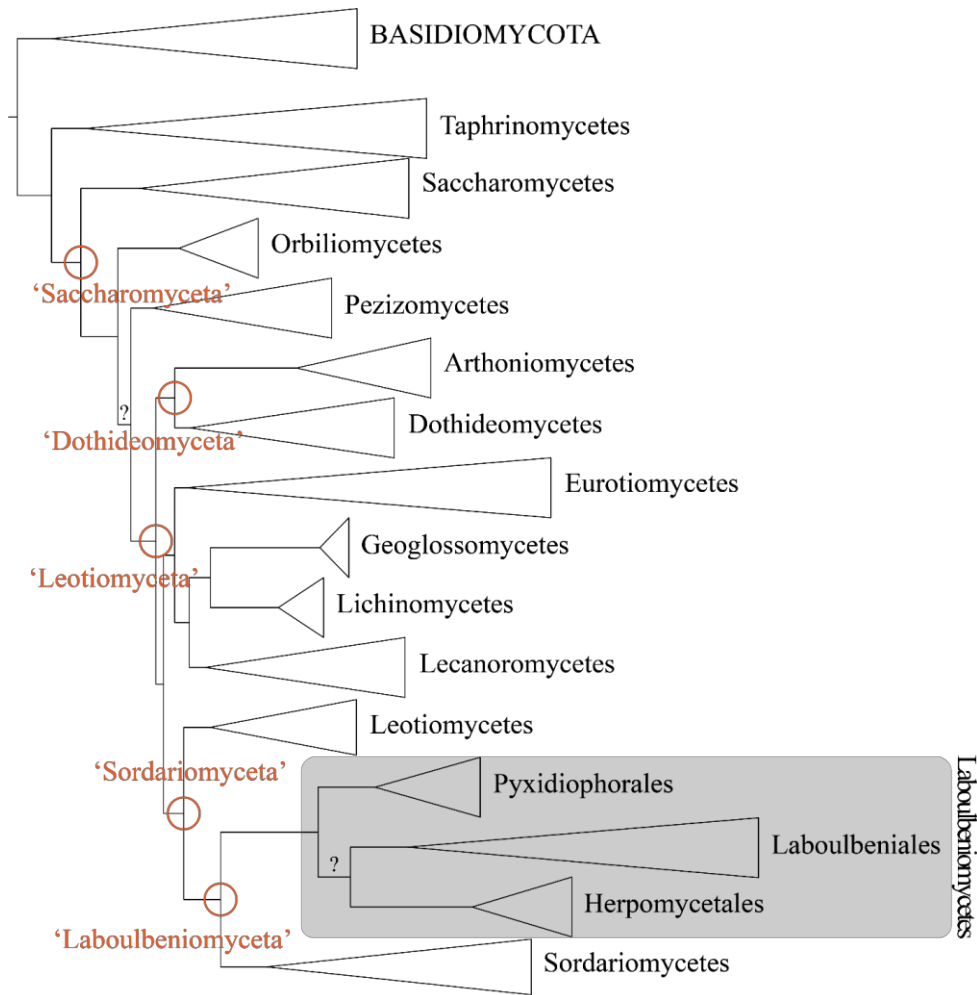
**Figure 5-1.** Schematic representation of Ceraotmycetaceae (*left*), Euceratomycetaceae (*middle*) and Laboulbeniaceae (*right*). Abbreviations: I-V cells of the receptacle; VI perithecial stalk cell; VII secondary stalk cell; m, n, n' basal cells of the perithecium; cu carpogonial upgrowth. Revised from Tavares (1985: p. 481).

Taxa in the genus *Euzodiomyces* are exceptional among Laboulbeniales in the construction of their primary receptacle, which is many-celled and pseudoparenchymatous (Tavares, 1985;

Santamaria, 2003). Other than in *Euzodiomyces*, this feature is only present in the genera *Columnomyces*, *Kainomyces*, *Scepastocarpus* and *Zodiomyces*, which are all classified in the Laboulbeniaceae (Rossi *et al.*, 2016). The genera in Ceratomycetaceae are associated with aquatic hosts, whereas those in Euceratomycetaceae have terrestrial hosts. Finally, the family Laboulbeniaceae is recognized by the tiers of perithecial outer wall cells, which are four or five in number and unequal in height. Although the genus *Zodiomyces* has perithecial outer wall cells that are arranged in eight tiers subequal in height, Tavares (1985) also placed this genus in Laboulbeniaceae, in its own subfamily Zodiomycetoideae. This is in stark contrast with Thaxter (1908) who placed *Zodiomyces* in the suborder Ceratomycetinae.

In addition to development and morphology, DNA characters have now provided useful insights into the evolutionary relationships of Laboulbeniomycetes. Based on sequence data of the small subunit (SSU) ribosomal DNA (rDNA), Weir & Blackwell (2001) retrieved Laboulbeniales and Pyxidiophorales as a strongly supported single clade within the Ascomycota. However, no assessment of the relationship among ascomycete classes was possible due to lack of support. Schoch *et al.* (2009) used a phylum-wide six-gene phylogenetic reconstruction and found strong support for the sister relationship of Laboulbeniomycetes and Sordariomycetes, suggesting a single origin of perithecial fungi (see CHAPTER 2 and Figure 5-2). Also, lesser known fungi have been sequenced and shown to belong in the Laboulbeniomycetes.

*Gliocephalis hyalina* was placed within the order Pyxidiophorales based on SSU rDNA. In addition, culturing attempts were only successful using slides onto which *Fusarium* was previously inoculated and grown (Jacobs *et al.*, 2005). These authors determined that *Gliocephalis hyalina* is a mycoparasite, which is in line with the life history traits for *Pyxidiophora* described by Blackwell & Malloch (1989). In another study, *Laboulbeniopsis*



**Figure 5-2.** Complete Ascomycota phylogeny, with lineages collapsed to class level or to order level in Laboulbeniomyces. Classes (-mycetes) and rankless taxa (-myceta) are indicated. Question marks (?) indicate unresolved nodes. The topology is the result of maximum likelihood analysis of a six-gene data matrix (Schoch *et al.*, 2009; revised from Haelewaters *et al.*, in review).

*termitaria*, an ectoparasite of termites, was retrieved in the Laboulbeniomyces with high support. Its placement had been previously unknown. This was again based on SSU rDNA (Henk *et al.*, 2003). *Laboulbeniopsis* was placed in a lineage sister to *Pyxidiophora* but this placement had no bootstrap support. The alternative scenario (*Laboulbeniopsis* sister to Laboulbeniales) would imply a single loss of germ tube germination and of conidial production as well as a single

origin of thallus development in the most recent common ancestor of *Laboulbeniopsis* and Laboulbeniales.

In keeping with Malloch (1981) and Samuels & Blackwell (2001), we expect in this case a simplification of the complex life cycle of Pyxidiophorales toward a reduction of the assimilative phase and loss of asexual states in Herpomycetales and Laboulbeniales. However, the relationships among orders within Laboulbeniomycetes are unresolved (CHAPTER 2). The three-gene analysis resulted in a sister relationship of Herpomycetales and Pyxidiophorales, although without support. In the six-gene analysis, Herpomycetales was retrieved as a sister clade to Laboulbeniales, with moderate support from Bayesian inference. Even though we have formulated ideas about the likely evolutionary relationships, the most parsimonious scenario is not always the right one.

Recently, Goldmann & Weir (2018) published a molecular phylogeny of the Laboulbeniomycetes based on SSU rDNA. They found support for the existence of several lineages within the class. Their single sequence of *Herpomyces* (an isolate from Haelewaters *et al.*, 2015) fell outside of the Laboulbeniales in an unresolved position (Bayesian inference) or in an unsupported clade with *Laboulbeniopsis* (maximum likelihood), which these authors took as support for the placement of *Herpomyces* in its own suborder Herpomycetinae (*sensu* Tavares, 1985; but see CHAPTER 2). The number of perithecial wall cells seems to be phylogenetically informative across the order Laboulbeniales. Goldmann & Weir (2018) described a progressive reduction of number of perithecial wall cells in the four vertical rows.

As we are becoming more confident in applying phylogenetic approaches in this group, confronting morphology-based classification systems with sequence data allows more precise correlation of characters. The most recent classification for the Laboulbeniales (Tavares, 1985)

was based on perithecial development, perithecial wall structure and the nature of antheridia. Unaware of Goldman & Weir's (2018) contribution and without access to their still unpublished sequences, we reconstructed a preliminary molecular phylogeny of the class Laboulbeniomycetes using sequences derived from material from various sources, including our own collections and those of others. Our objective was to assess the validity of the classification systems of Thaxter (1908) and Tavares (1985).

## MATERIAL AND METHODS

*Collection of Laboulbeniales.* — Insects were collected around the world by ourselves or collaborators using standard entomological methods (sticky traps, light trap, entomological net and hand collecting), obtained from the pet stores, or removed from captured bats (CHAPTER 4). Insects were killed in 70-100% ethanol, ethyl acetate vapors, or simply by freezing. Screening for Laboulbeniales was done using a dissecting microscope at 50×.

*Morphology and DNA extraction.* — Individual thalli were removed from the host using Minutepins (BioQuip #1208SA, Rancho Dominguez, California) inserted into wooden rods. We made slide mounts of thalli following procedures in CHAPTER 3. Mounted specimens were viewed at 400× to 1000× magnification under an Olympus BX40 microscope with XC50 camera. Fungal specimens were identified using Thaxter (1896, 1908, 1924, 1926, 1931), Majewski (1994), Santamaria (1998, 2003) and many recent publications, often describing a single new species. Voucher slides are deposited at Farlow Herbarium (FH; Harvard University, Cambridge, Massachusetts), Ghent University Herbarium (GENT, Belgium) and Herbario de la Universidad Autónoma de Chiriquí (UCH; David, Panamá).



We used the Extract-N-Amp Plant PCR protocol (Sigma-Aldrich, St. Louis, Missouri) or the REPLI-g Single Cell Kit (Qiagen, Stanford, California) with modifications for the isolation of DNA from thalli (Haelewaters *et al.*, 2015, in review). As starting material for Extract-N-Amp extractions, we used between five and twenty thalli. For the REPLI-g method we used one to five thalli. Protocols for PCR amplification of the small subunit ribosomal DNA (SSU rDNA) region followed those outlined in CHAPTER 3. Unsuccessful PCR reactions were re-run using the Q5 Host Start High-Fidelity DNA Polymerase (New England BioLabs, Ipswich, Massachusetts) following protocols outlined in CHAPTER 4. PCR purification and sequencing reactions were outsourced to Genewiz (South Plainfield, New Jersey). Generated sequences were assembled and edited in Sequencher 4.10.1 (Gene Codes Corporation, Ann Arbor, Michigan). All sequences are deposited in GenBank (accession numbers in Table 5-2).

*Sequence alignment and phylogenetic analysis.* — An SSU rDNA dataset was constructed by compiling our generated sequences and sequences downloaded from GenBank. We aligned sequences using MAFFT v7.305 (Kato & Standley, 2013) under default parameters. Visual inspection and manual edits were done in BioEdit v7.2.6 (Hall, 1999). The dataset was analyzed in jModelTest 2.1 (Darriba *et al.*, 2012) to determine the nucleotide substitution model that best described the data, by considering the Bayesian Information Criterion. The lowest -lnL value (11526.6774) was assigned to the transition (TIM) model (Rodríguez *et al.*, 1990) with the assumption of a gamma distribution (+G).

Four Markov chains were run independently for 80 million generations and sampled every 8000 generations. All analyses were performed under an uncorrelated lognormal relaxed molecular clock model, using a transitional (TIM) nucleotide substitution model with the

**Table 5-2.** All isolates included in the phylogenetic analysis, with GenBank accession number.

Species	Isolate	SSU acc. no.
<i>Aphanandromyces audisioi</i>	MG060	MG438335
<i>Arthrorhynchus nycteribiae</i>	D. Haelew. 1015d	MG438336
<i>Arthrorhynchus nycteribiae</i>	Edeleny_13.xi.2014	KY094496
<i>Botryandromyces ornatus</i>		AF431760
<i>Camptomyces</i> sp. nov.	D. Haelew. 1222d	MF314140
<i>Ceratomyces mirabilis</i>		AF431764
<i>Chitonomyces appendiculatus</i>		JN127399
<i>Chitonomyces dentifer</i>		JN127392
<i>Chitonomyces distortus</i>		JN127398
<i>Chitonomyces paradoxus</i>		JN127396
<i>Chitonomyces unciger</i>		JN127395
<i>Coreomyces</i> sp.	H73-1	KY523236
<i>Coreomyces</i> sp.	H81-1	KY523242
<i>Coreomyces</i> sp.	H82-1	KY523243
<i>Corethromyces bicolor</i>		AF431762
<i>Corethromyces</i> sp.		AF431761
<i>Diplopodomycetes lusitanipodos</i>	SR2	*****
<i>Diplopodomycetes veneris</i>	SR14s	*****
<i>Gloeandromyces pageanus pageanus</i>	D. Haelew. 1091b	MH040535
<i>Gloeandromyces pageanus pageanus</i>	D. Haelew. 1425a	MH040536
<i>Gloeandromyces streblae</i>	D. Haelew. 1011a	MG438337
<i>Gloeandromyces streblae</i>	D. Haelew. 1018a	MG438338
<i>Herpomyces chaetophilus</i>	D. Haelew. 1097b	MG438321
<i>Herpomyces chaetophilus</i>	D. Haelew. 483b	MG438319
<i>Herpomyces chaetophilus</i>	D. Haelew. 483e	MG438320
<i>Herpomyces ectobiae</i>	MG001	KT800024
<i>Herpomyces periplanetae</i>	D. Haelew. 1187d	MG438331
<i>Herpomyces periplanetae</i>	D. Haelew. 620a	MG438328
<i>Herpomyces periplanetae</i>	TW448b	MG438325
<i>Herpomyces shelfordellae</i>	DE_HerpBL1	KT800026
<i>Hesperomyces coccinelloides</i>		AF407575
<i>Hesperomyces coleomegillae</i>	637	KF266893
<i>Hesperomyces coleomegillae</i>	633B	KF266887
<i>Hesperomyces coleomegillae</i>	635B	KF266889
<i>Hesperomyces palustris</i>	631J	KF266899
<i>Hesperomyces palustris</i>	631K	KF266902
<i>Hesperomyces palustris</i>	632B	KF266891
<i>Hesperomyces virescens</i>	D. Haelew. 1188g	MG438341
<i>Hesperomyces virescens</i>	D. Haelew. 1250b	MG760607
<i>Hesperomyces virescens</i>	D. Haelew. 1251b	MG760609
<i>Hesperomyces virescens</i>	D. Haelew. 1443a	*****

**Table 5-2.** (Continued).

Species	Isolate	SSU acc. no.
<i>Hesperomyces virescens</i>	D. Haelew. 316a	MG438339
<i>Laboulbenia bruchii</i>	D. Haelew. 1346b	*****
<i>Laboulbenia calathi</i>	D. Haelew. 1007a	MG438342
<i>Laboulbenia</i> Chrysomelidae	D. Haelew. 967a	*****
<i>Laboulbenia diopsidis</i>	D. Haelew. 1254a	*****
<i>Laboulbenia eubradycelli</i>	D. Haelew. 1059d	*****
<i>Laboulbenia flagellata</i>	ADK6173a	*****
<i>Laboulbenia flagellata</i>	D. Haelew. 1030a	MG438343
<i>Laboulbenia fuliginosa</i>	D. Haelew. 972e	*****
<i>Laboulbenia gyrincola</i>	MG045	*****
<i>Laboulbenia idiostoma</i>	D. Haelew. 972a	*****
<i>Laboulbenia pheropsophi</i>	D. Haelew. 1009b	MG438344
<i>Laboulbenia philonthi</i>	MG155	*****
<i>Laboulbenia</i> sp.	D. Haelew. 971a	MG438345
<i>Laboulbeniopsis termitarius</i>	DAH18	AY212810
<i>Monoicomyces homalotae</i>	D. Haelew. 1014c	MG438346
<i>Monoicomyces invisibilis</i>	MT004	KT800034
<i>Nycteromyces streblidinus</i>	D. Haelew. 1324b	MH040554
<i>Nycteromyces streblidinus</i>	D. Haelew. 956a	MH040553
<i>Polyandromyces coptosomalis</i>	D. Haelew. 313f	KT800035
<i>Polyandromyces coptosomalis</i>	HM499a	MG438347
<i>Prolixandromyces triandrus</i>	Nagyvisnyo1	LT158294
<i>Pyxidiophora microspora</i>	MG200	MG438334
<i>Pyxidiophora</i> sp.	IMI-1989	AF313769
<i>Pyxidiophora</i> sp.		AY212811
<i>Rhachomyces philonthinus</i>	TM10446	KT800036
<i>Rhachomyces philonthinus</i>		AF431756
<i>Rhadinomyces pallidus</i>		AF431763
<i>Rickia laboulbenioides</i>	SR4s	*****
<i>Rickia pachyiuli</i>	SR1s	*****
<i>Rickia passalina</i>		AF432129
<i>Rickia wasmannii</i>	ADK6272a	*****
<i>Rickia wasmannii</i>	DE_Rak4	KT800037
<i>Stigmatomyces ceratophorus</i>	D. Haelew. 1136h	MG958013
<i>Stigmatomyces gregarius</i>	D. Haelew. 1008a	MG438348
<i>Stigmatomyces protrudens</i>		AF298232
<i>Stigmatomyces rugosus</i>	D. Haelew. 1138a	MH040563
<i>Stigmatomyces scaptomyzae</i>		AF431758
<i>Zodiomyces vorticellarius</i>	MG003	KT800038
<i>Zodiomyces vorticellarius</i>		AF407577

assumption of a gamma distribution (+G) and assuming a Birth-Death Incomplete Sampling speciation tree prior (Stadler, 2009). All settings were entered in BEAUti v1.8.4 to generate an XML file, which was run in BEAST v1.8.4 (Drummond *et al.*, 2012). Examination of the MCMC runs in Tracer v1.6 (Rambaut *et al.*, 2014) indicated convergence. Upon inspection in Tracer, we discarded an appropriate number of steps from each run as burn-in and combined the resulting MCMC samples in LogCombiner v1.8.4. The maximum clade credibility topology, presenting the highest product of individual clade posterior probabilities, was constructed in TreeAnnotator v1.8.4. The final tree with posterior probabilities (pp) was visualized in FigTree v1.4.3 ([tree.bio.ed.ac.uk/software/figtree/](http://tree.bio.ed.ac.uk/software/figtree/)). BEAUti, LogCombiner and TreeAnnotator are part of the BEAST v1.8.4 package. MAFFT, jModelTest and BEAST were run on the Cipres Science Gateway web portal (Miller *et al.*, 2010).

## RESULTS

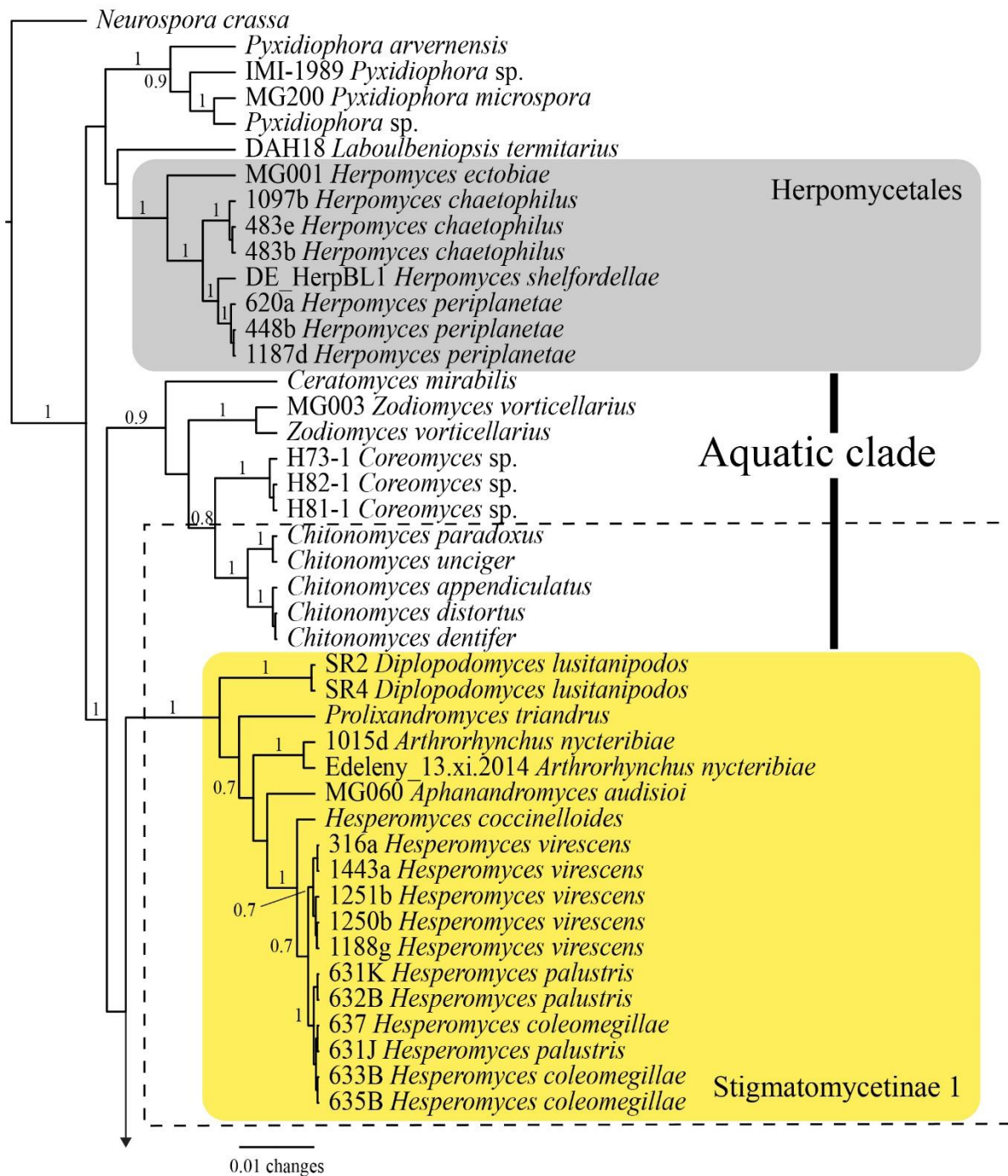
A total of 83 SSU sequences, of which 43 were generated in the Pfister Lab, were included in our dataset (Table 5-2). The number of characters was 1921, of which 1028 were constant and 449 were parsimony-informative. Taxonomic sampling covered 25 genera, belonging to four orders: *Neurospora* (Sordariomyces, Sordariales; outgroup), *Pyxidiophora* (Pyxidiophorales), *Herpomyces* (Herpomycetales), *Laboulbeniopsis* (unclassified) and 21 genera that belong to the large order Laboulbeniales. Detailed classification of the genera in Laboulbeniales is presented in Table 5-3. The three orders of the class were retrieved, all with maximum Bayesian support. Within Laboulbeniales, several higher taxa are polyphyletic (Figure 5-3). Subtribe Stigmatomycetinae is divided into four clades, tribe Laboulbenieae into six clades, subfamily Laboulbenioideae into seven clades and subfamily Peyritschelloideae into three clades.

**Table 5-3.** Overview of genera in Laboulbeniales with host group (CLASS or ORDER: Family), lifestyle (aquatic, semiaquatic, terrestrial, parasitic) and classification down to subtribe following Tavares (1985). † *Herpomycetes* is now placed in the order Herpomycetales.

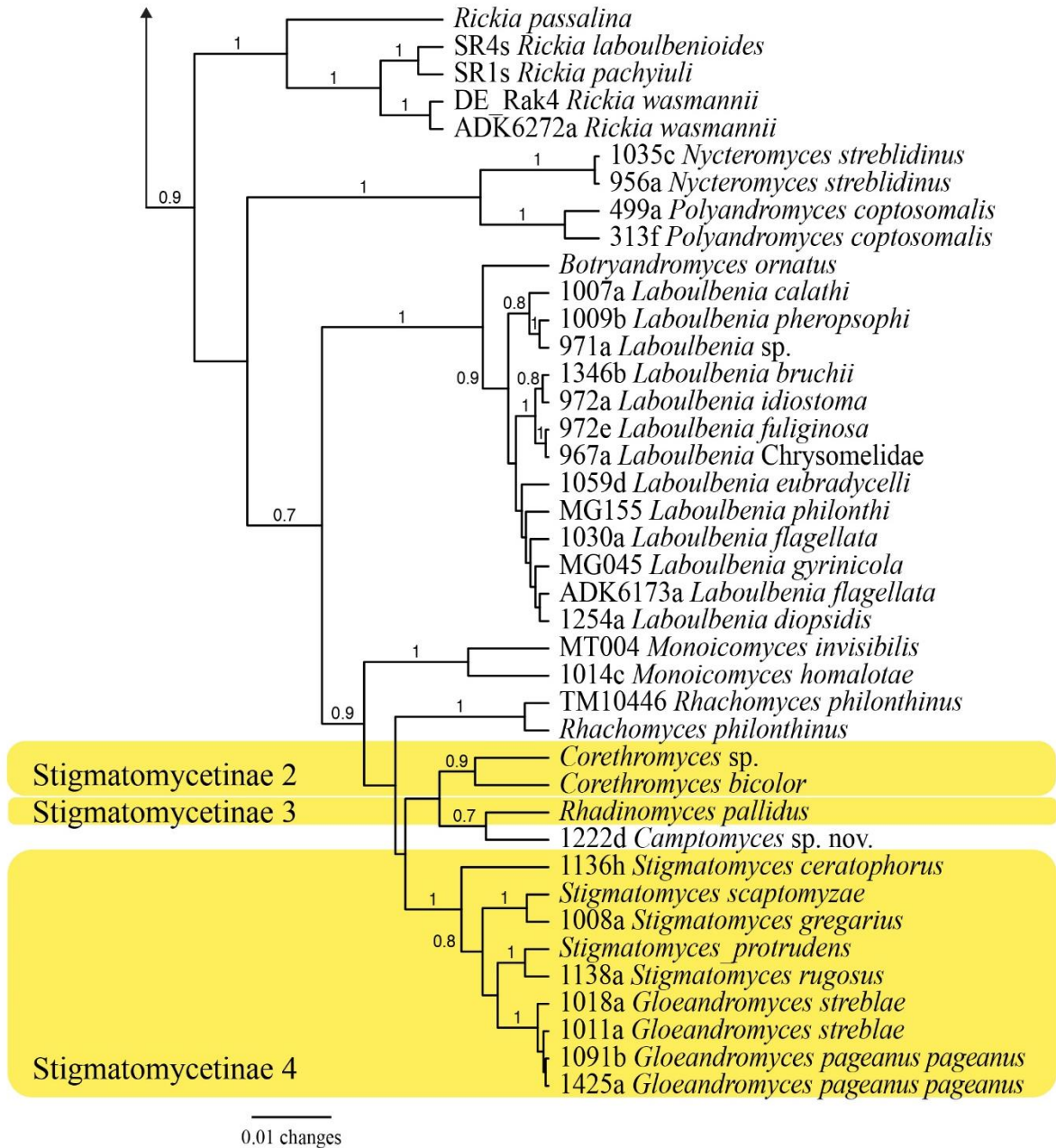
Genus	Host group	Lifestyle	Family	Subfamily	Tribe	Subtribe
<i>Aphanandromyces</i>	COLEOPTERA: Kateretidae	Terrestrial	Laboulbeniaceae	Laboulbenioideae	Laboulbenieae	Stigmatomycetinae
<i>Arthrorhynchus</i>	DIPTERA: Nycteriibiidae	Terrestrial, parasitic	Laboulbeniaceae	Laboulbenioideae	Laboulbenieae	Stigmatomycetinae
<i>Botryandromyces</i>	COLEOPTERA, Heteroceridae	Terrestrial	Laboulbeniaceae	Laboulbenioideae	Laboulbenieae	Laboulbeniinae
<i>Camptomycetes</i>	COLEOPTERA: Staphylinidae	Terrestrial	Laboulbeniaceae	Peyritschelloideae	Haplomyceteae	Haplomycetinae
<i>Ceratomyces</i>	COLEOPTERA: Hydrophilidae	Aquatic	Ceratomycetaceae	Ceratomycetoidae	Ceratomyceteeae	Ceratomycetinae
<i>Chitonomyces</i>	COLEOPTERA: Dytiscidae	Aquatic	Laboulbeniaceae	Laboulbenioideae	Laboulbenieae	Chitonomycetinae
<i>Coreomyces</i>	HEMIPTERA: Corixidae	Aquatic	Laboulbeniaceae	Laboulbenioideae	Coreomyceteeae	
<i>Corethromyces</i>	COLEOPTERA / HEMIPTERA	Terrestrial	Laboulbeniaceae	Laboulbenioideae	Laboulbenieae	Stigmatomycetinae
<i>Diplopodomycetes</i>	DIPLOPODA: Callipodida	Terrestrial	Laboulbeniaceae	Laboulbenioideae	Laboulbenieae	Stigmatomycetinae
<i>Gloeandromyces</i>	DIPTERA: Strebliidae	Terrestrial, parasitic	Laboulbeniaceae	Laboulbenioideae	Laboulbenieae	Stigmatomycetinae
<i>Herpomycetes</i> †	BLATTODEA	Terrestrial	Herpomycetaceae		Herpomycetaea	
<i>Hesperomyces</i>	COLEOPTERA: Coccinellidae	Terrestrial	Laboulbeniaceae	Laboulbenioideae	Laboulbenieae	Stigmatomycetinae
<i>Laboulbenia</i>	COLEOPTERA / DIPTERA / HEMIPTERA	Terrestrial, semiaquatic	Laboulbeniaceae	Laboulbenioideae	Laboulbenieae	Laboulbeniinae
<i>Monoicomycetes</i>	COLEOPTERA: Ptiliidae, Staphylinidae	Terrestrial	Laboulbeniaceae	Monoicomycetoideae		
<i>Nycteromyces</i>	DIPTERA: Strebliidae	Terrestrial, parasitic	Laboulbeniaceae	Peyritschelloideae	Dimorphomyceteae	Dimorphomyceteae
<i>Polyandromyces</i>	HEMIPTERA: Pentatomidae, Plataspidae	Terrestrial	Laboulbeniaceae	Peyritschelloideae	Dimorphomyceteae	Dimorphomyceteae

**Table 5-3. (Continued).**

Genus	Host group	Lifestyle	Family	Subfamily	Tribe	Subtribe
<i>Prolixandromyces</i>	HEMIPTERA: Veliidae	Semiaquatic	Laboulbeniaceae	Laboulbenioideae	Laboulbenieae	Stigmatomycetinae
<i>Rhachomyces</i>	COLEOPTERA: Carabidae, Leioidae, Staphylinidae	Terrestrial	Laboulbeniaceae	Laboulbenioideae	Teratomyceteae	Rhachomycetinae
<i>Rhadinomyces</i>	COLEOPTERA: Staphylinidae	Terrestrial	Laboulbeniaceae	Laboulbenioideae	Laboulbenieae	Stigmatomycetinae
<i>Rickia</i>	COLEOPTERA: Passalidae / HYMENOPTERA: Formicidae / DIPLOPODA DIPTERA	Terrestrial	Laboulbeniaceae	Peyritschiielloideae	Peyritschielleae	Peyritschiiellinae
<i>Stigmatomyces</i>	DIPTERA	Terrestrial	Laboulbeniaceae	Laboulbenioideae	Laboulbenieae	Stigmatomycetinae
<i>Zodiomyces</i>	COLEOPTERA: Hydrophilidae	Aquatic	Laboulbeniaceae	Zodiomyctoideae		



**Figure 5-3.** Maximum clade credibility tree of the Laboulbeniomycetes, reconstructed from the SSU dataset. The tree is the result of a Bayesian analysis performed in BEAST. For each node, the posterior probabilities (if  $\geq 0.7$ ) are presented above the branch leading to that node. Dashed rectangle indicates a portion of the family Laboulbeniaceae, showing polyphyly. Phylogeny continues on next page.



**Figure 5-3.** (Continued).

## DISCUSSION

*Interordinal relationships.* — The three orders within Laboulbeniomycetes are highly supported but their interrelationships remain elusive. In this phylogeny we also included *Laboulbeniopsis*, which is retrieved as sister lineage to Herpomycetales. However, this placement was not



supported (pp = 0.6). Haelewaters *et al.* (in review) came to the same results based on a combined SSU+ITS+LSU dataset. Pyxidiophorales in the basal-most position would make most sense from an evolutionary point of view; this would indicate a significant simplification in life history from dependency on two hosts to a single arthropod host-situation in Herpomycetales, Laboulbeniales and *Laboulbeniopsis*. This would also imply a single origin for the direct development of a thallus from an ascospore.

*Aquatic clade at the base of the Laboulbeniales.* This strongly supported clade provides evidence for an ecological viewpoint, more than a structurally based one. *Ceratomyces* is currently placed in the family Ceratomycetaceae. The other genera *Chitonomyces*, *Coreomyces* and *Zodiomyces* are members of the family Laboulbeniaceae, although in different subgroups. Goldmann & Weir (2018) recognized different clades at the base of their tree: they retrieved *Chitonomyces* and *Zodiomyces* in two separate clades. This is a rather unexpected outcome since we have always found high support for a close relationship between these two genera from different independent datasets (CHAPTER 2, CHAPTER 3, this chapter). We hypothesized previously that a Laboulbeniales-like ancestor may have been aquatic in lifestyle (CHAPTER 2).

As one of the characters for the family Laboulbeniaceae, Tavares (1985) listed: “outer wall cells mostly 4–5 in each vertical row, the cells usually unequal in height.” The perithecial outer wall cells in *Zodiomyces* are arranged in eight tiers and these are subequal in height. In addition, Tavares (1985) included the following descriptive character for Laboulbeniaceae: “spermatia exogenous or produced in phialides or compound antheridia.” The only genus in the family producing spermatia exogeneously is *Zodiomyces*. We are left to guess why Tavares (1985) included *Zodiomyces* in this family but it should be clear that based on the morphological

characters and the phylogenetic position, her placement of it in Laboulbeniaceae is incorrect. As more data become available, the circumscription of the large family Laboulbeniaceae will certainly continue to be revised and refined, as it has been since 1873.

*Polyphyly of higher taxa.* — A number of higher taxa included in this study are found to be polyphyletic. For example, subtribe Stigmatomycetinae consists of 40 genera (Tavares, 1985; Tavares & Balazuc, 1989; Benjamin, 1992a, 1992b, 2001; Santamaria, 1995). Of these, nine genera are included in our phylogenetic reconstruction, grouped in 4 clades (Figure 5-3). The genera *Aphanandromyces*, *Arthrorhynchus*, *Diplopodomycetes*, *Hesperomyces* and *Prolixandromyces* comprise the largest clade (Stigmatomycetinae 1). The other genera are *Corethromyces* (Stigmatomycetinae 2), *Rhadinomyces* (Stigmatomycetinae 3), *Gloeandromyces* and *Stigmatomyces* (Stigmatomycetinae 4). Similar results were found by Goldmann & Weir (2018). Convincing evidence for the polyphyly of Stigmatomycetinae was presented by Haelewaters *et al.* (in review, Figure 2-1) based on a multi-locus phylogeny.

The tribe Laboulbenieae is polyphyletic as well. Tavares (1985) considerably expanded Thaxter's (1908) Laboulbenieae, including several subtribes: Amorphomycetinae, Chaetarthriomycetinae, Chitonomycetinae, Laboulbeniinae, Misgomycetinae and Stigmatomycetinae. In our dataset, only three genera were included in addition to those in Stigmatomycetinae (*Chitonomyces*, *Botryandromyces*, *Laboulbenia*). However, *Botryandromyces*+*Laboulbenia* forms a stand-alone clade with maximum support and *Chitonomyces* is retrieved in an unrelated, highly supported clade with *Coreomyces*, *Zodiomyces* and *Ceratomyces* (Figure 5-3). This “aquatic clade” includes genera that are parasites of aquatic hosts. Another taxon, subfamily Peyritschilloideae, is divided into three clades. This subfamily

was circumscribed by Tavares (1985) to combine species with compound antheridia that have a discharge tube (as opposed to the Monoicomycetoideae). Even though the phylogenetic reconstruction is not robust, there is strong reason for the separation of *Rickia* from the other taxa in Peyritschielloideae, and of *Nycteromyces*+*Polyandromyces* from *Camptomyces*, thus reinforcing the idea that compound antheridia have arisen multiple times independently, even within the same structural group (Faull, 1911).

*Character-based classification.* — When higher taxa are found to be polyphyletic, the grounds of their recognition come into question. Tavares (1985) used perithecial development and wall structure as well as antheridial characters. In Figure 5-4, we annotated all genera in Herpomycetales and Laboulbeniales with antheridial and perithecial characters. We think that antheridial characters are not phylogenetically important. Exogeneous spermatial production occurs only at the base of the tree, genera *Ceratomyces* and *Zodiomyces*. In the Laboulbeniales tree, however, compound antheridia occur in several places. This implies that compound antheridia have arisen at least four times independently. The alternative, although less likely scenario is a single origin and subsequent reversal to simple antheridia in multiple clades. [Note that it is still unknown how spermatia are produced in *Chitonomyces*; Tavares, 1985.]

With regard to perithecial characters, Goldmann & Weir (2018) described a progressive reduction from the 5-5-5-5 arrangement (= number of wall cells in each of the four vertical rows) to an intermediate 5-5-4-4 arrangement and the most recent clades that have a 4-4-4-4 sequence. At first sight, this seems to be the case indeed. Our basal-most clade (“aquatic clade”) has many or eight walls cells in each of the four vertical rows, the next clade (“Stigmatomycetinae 1”) has 5-5-5-5 sequences and the other genera usually display a 4-4-4-4 arrangement. A few notes: For

**Figure 5-4.** Simplified maximum clade credibility tree of the Laboulbeniomycetes, with nodes collapsed to genus level. For each node, the posterior probabilities (if  $\geq 0.7$ ) are presented above the branch leading to that node. Bars at the right of the phylogeny indicate classification *sensu* Tavares (1985), with colored bars revealing higher taxa that are polyphyletic (Table 5-3 for details): ST = subtribe (yellow for Stigmatomycetinae), T = tribe (orange for Laboulbenieae), SF = subfamily (green for Laboulbenioideae, blue for Peyritschielloideae), F = family, O = order. To the right of each genus name, antheridial and perithecial characters are summarized. Antheridia:  $\times$  = no antheridia (exogeneous production of spermatia);  $\circ$  = simple;  $\square$  = compound. Perithecial: M = many cells in each vertical row of outer wall cells; 8, 5, 4 number = 8, 5, 4 cells in each vertical row; 3|4 = 3 cells in 2 vertical rows, 4 cells in the 2 other vertical rows; ? = unknown.

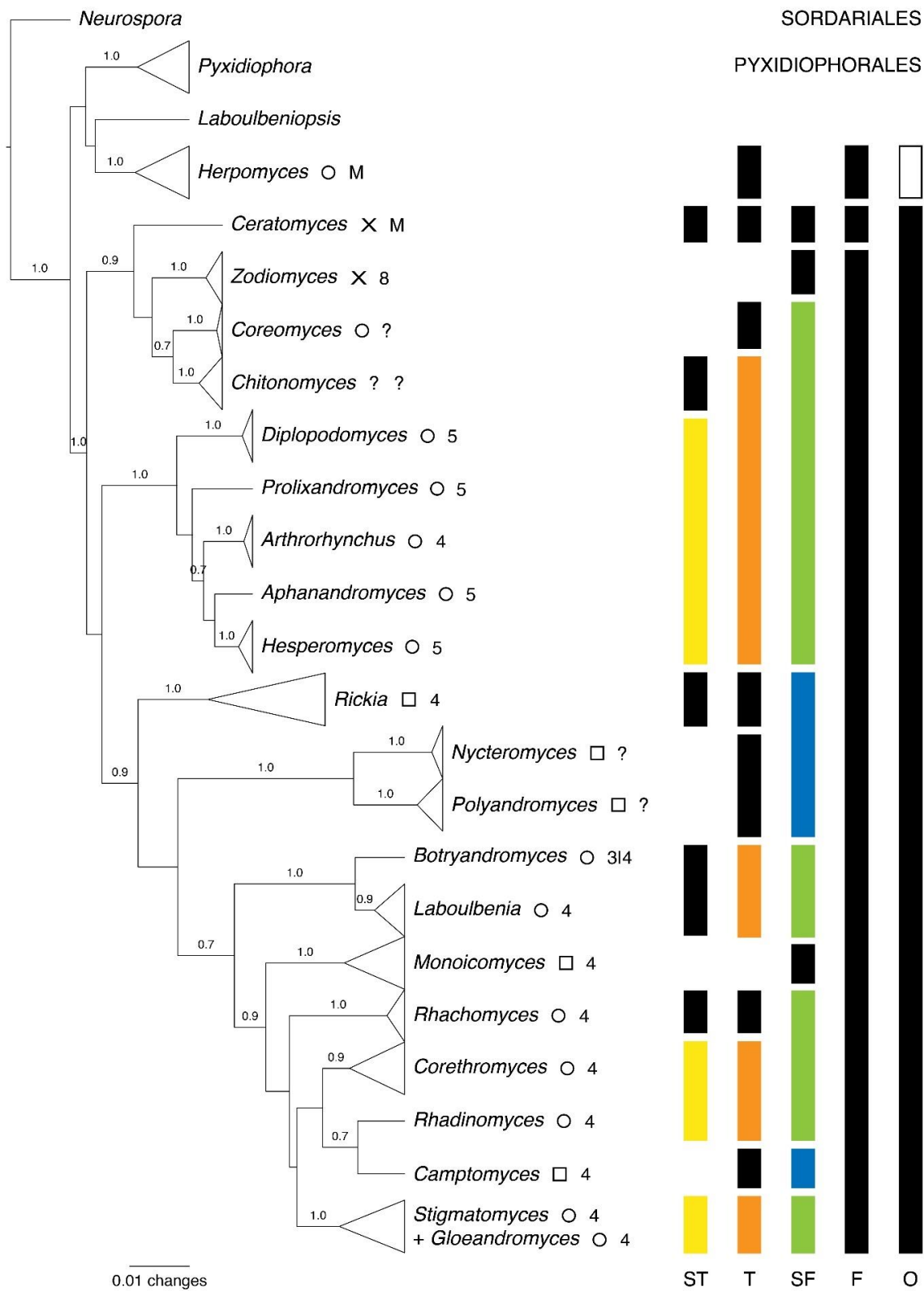


Figure 5-4. (Continued).

*Arthrorhynchus*, only four cells are reported per vertical row of outer wall cells. However, the apical lobes should be re-studied and perhaps recognized as fifth tier. In *Nyteromyces* and *Polyandromyces*, it has been impossible to detect perithecial wall cells at maturity (Thaxter, 1920, 1924, D. Haelewaters, unpubl.). In *Botryandromyces*, the outer perithecial wall is composed of two three-celled vertical rows and two four-celled ones (De Kesel, 2009).

## CONCLUSIONS

We are still far from a complete overview of the relationships among the members of the class Laboulbeniomycetes. Recent molecular phylogenetic studies have yielded sequences that will contribute to this greater aim. Our SSU rDNA phylogenetic reconstruction of the class confirms the presence of three orders in addition to an unclassified taxon, *Laboulbeniopsis termitarius*. The basal-most clade of Laboulbeniales includes taxa with aquatic hosts, leading us to speculate about an aquatic origin for the group. A number of previously described higher taxa have proven to be polyphyletic. Antheridial features are not phylogenetically informative, but perithecial wall structure seems to provide reliable characters for evolutionary inference.

## LITERATURE CITED

- Anonymous (1849) Wissenschaftliches. Siebente Zusammenkunft der Wissenschaftsfreunde. In: *Illyrisches Blatt* **60** (Hladnik J, ed): 240. Klagenfurt, Kleinmayr.
- Benjamin RK (1971) Introduction and supplement to Roland Thaxter's contribution towards a monograph of the Laboulbeniaceae. *Bibliotheca Mycologica* **30**: 1–155.
- Benjamin RK (1992a) *Cupulomyces*, a new genus of Laboulbeniales (Ascomycetes) based on *Stigmatomyces lasiochili*. *Aliso* **13**: 355–364.
- Benjamin RK (1992b) A new genus of Laboulbeniales (Ascomycetes) on a species of *Phalacrichus* (Coleoptera: Dryopoidea; Limnichidae), with a note on mirror-image asymmetry in the order. *Aliso* **13**: 427–446.

- Benjamin RK (2001) *Autophagomycetes, Bordea*, and a new genus, *Rossiomyces* (Laboulbeniales). *Aliso* **19**: 99–136.
- Blackwell M, Malloch D (1989) *Pyxidiophora*: life histories and arthropod associations of two species. *Canadian Journal of Botany* **67**: 2552–2562.
- Colla S (1934) Laboulbeniales, Peyritschellaceae, Dimorphomycetaceae, Laboulbeniaceae Heterothallicae, Laboulbeniaceae Homothallicae, Ceratomycetaceae. In: *Flora Italica Cryptogama, pars I: Fungi, Fasc. 16* (Saccardo PA, Costa HD, eds): 1–157. Firenze: Societa Botanica Italiana.
- Darriba D, Taboada GL, Doallo R, Posada D (2012) jModelTest 2: more models, new heuristics and parallel computing. *Nature Methods* **9**: 772.
- de Bary A (1884) *Vergleichende Morphologie und Biologie der Pilze, Mycetozoan und Bacterien*. Leipzig, W. Engelmann.
- De Kesel A (2009) *Botryandromyces* and *Ecteinomyces* (Laboulbeniales) in Belgium. *Sterbeekia* **29**: 23–26.
- Drummond AJ, Suchard MA, Xie D, Rambaut A (2012) Bayesian phylogenetics with BEAUti and the BEAST 1.7. *Molecular Biology and Evolution* **29**: 1969–1973.
- Faull JH (1911) The cytology of the Laboulbeniales. *Annals of Botany* **25**: 649–654.
- Goldmann L, Weir A (2018) Molecular phylogeny of the Laboulbeniomycetes (Ascomycota). *Fungal Biology* **122**: 87–100.
- Haelewaters, D, Gorczak M, Pfliegler WP, Tartally A, Tischer M, Wrzosek M, Pfister DH (2015) Bringing Laboulbeniales into the 21st century: enhanced techniques for extraction and PCR amplification of DNA from minute ectoparasitic fungi. *IMA Fungus* **6**: 363–372.
- Haelewaters D, Pfliegler WP, Gorczak M, Pfister DH (in review) Birth of an order: comprehensive phylogenetic study excludes *Herpomyces* (Fungi, Laboulbeniomycetes) from Laboulbeniales. *Molecular Phylogenetics and Evolution*.
- Hall TA (1999) BioEdit: a user-friendly biological sequence alignment editor and analysis program for Windows 95/98/NT. *Nucleic Acids Symposium Series* **41**: 95–98.
- Henk DA, Weir A, Blackwell M (2003) *Laboulbeniopsis termitarius*, an ectoparasite of termites newly recognized as a member of the Laboulbeniomycetes. *Mycologia* **95**: 561–564.
- Katoh K, Standley DM (2013) MAFFT multiple sequence alignment software version 7: improvements in performance and usability. *Molecular Biology and Evolution* **30**: 772–780.
- Kolenati FA (1857) Epizoa der Nycteribien. *Wiener entomologische Monatschrift* **1**: 66–69.

- Maire R (1916) Deuxième contribution à l'étude des Laboulbéniales de l'Afrique du Nord. *Bulletin de la Société d'Histoire Naturelle de l'Afrique du Nord* **7**: 6–39.
- Jacobs K, Holtzman K, Seifert KA (2005) Morphology, phylogeny and biology of *Gliocephalis hyalina*, a biotrophic contact mycoparasite of *Fusarium* species. *Mycologia* **97**: 111–120.
- Majewski T (1994) The Laboulbeniales of Poland. *Polish Botanical Studies* **7**: 1–466.
- Malloch D (1981) The plectomycete centrum. In: *Ascomycete systematics* (Reynold DR, ed): 73–91. New York: Springer-Verlag.
- Mayr G (1853) Abnorme Haargebilde an Nebrien und einige Pflanzen Krains. *Verhandlungen der Zoologisch-Botanischen Gesellschaft in Wien* **2**: 75–77.
- Miller MA, Pfeiffer W, Schwartz T (2010) Creating the CIPRES Science Gateway for inference of large phylogenetic trees. *Proceedings of the Gateway Computing Environments Workshop (GCE)* **14 Nov. 2010**: 1–8. New Orleans, Louisiana.
- Peyritsch J (1873) Beiträge zur Kenntniss der Laboulbenien. *Sitzungsberichte der Kaiserlichen Akademie der Wissenschaft (Wien), Mathematisch-naturwissenschaftliche Classe* **68**: 227–254.
- Rambaut A, Suchard MA, Xie D, Drummond AJ (2014) *Tracer v1.6*. Available at <http://tree.bio.ed.ac.uk/software/tracer/> (accessed 02 November 2017).
- Robin CP (1852) Végétaux parasites sur une insecte du genre *Brachynus*. *Comptes Rendus des Séances de la Société de Biologie (sér. 1)* **4**: 11.
- Rodríguez F, Oliver JF, Marín A, Medina JR (1990) The general stochastic model of nucleotide substitutions. *Journal of Theoretical Biology*, **142**: 485–501.
- Rossi W, Haelewaters D, Pfister DH (2016) Fireworks under the microscope: a spectacular new species of *Zodiomyces* from the Thaxter collection. *Mycologia* **108**: 709–715.
- Rouget A (1850) Notice sur une production parasite observée sur le *Brachinus crepitans*. *Annales de la Société Entomologique de France (Paris)* **8**: 21–24.
- Samuels GJ, Blackwell M (2001) Pyrenomycetes—fungi with perithecia. In: *The Mycota, VII. Part A. Systematics and evolution* (McLaughlin D, McLaughlin E, eds): 221–255. Berlin: Springer.
- Santamaria S (1995) *Parvomyces*, a new genus of Laboulbeniales from Spain. *Mycological Research* **99**: 1071–1077.
- Santamaria S (1998) Laboulbeniales, I. *Laboulbenia*. *Flora Mycologia Iberica* **4**: 1–186.
- Santamaria S (2003) Laboulbeniales, II. *Acompsomyces–Ilyomyces*. *Flora Mycologia Iberica* **5**: 1–344.



- Schoch CL, Sung GH, López-Giráldez F, Townsend JP, Miadlikowska J, Hofstetter V, Robbertse B, Matheny PB, Kauff F, Wang Z, Gueidan C, Andrie RM, Trippe K, Ciufetti LM, Wynns A, Fraker E, Hodkinson BP, Bonito G, Groenewald JZ, Arzanlou M, de Hoog GS, Crous PW, Hewitt D, Pfister DH, Peterson K, Gryzenhout M, Wingfield MJ, Aptroot A, Suh SO, Blackwell M, Hillis DM, Griffith GW, Castlebury LA, Rossman AY, Lumbsch HT, Lücking R, Büdel B, Rauhut A, Diederich P, Ertz D, Geiser DM, Hosaka K, Inderbitzin P, Kohlmeyer J, Volkmann-Kohlmeyer B, Mostert L, O'Donnell K, Sipman H, Rogers JD, Shoemaker RA, Sugiyama J, Summerbell RC, Untereiner W, Johnston PR, Stenroos S, Zuccaro A, Dyer PS, Crittenden PD, Cole MS, Hansen K, Trappe JM, Yahr R, Lutzoni F, Spatafora JW (2009) The Ascomycota Tree of Life: A phylum-wide phylogeny clarifies the origin and evolution of fundamental reproductive and ecological traits. *Systematic Biology* **58**: 224–239.
- Stadler T (2009) On incomplete sampling under birth-death models and connections to the sampling-based coalescent. *Journal of Theoretical Biology* **261**: 58–66.
- Tavares II (1967) A new basis for classification of the Laboulbeniales. *American Journal of Botany* **54**: 648.
- Tavares II (1985) Laboulbeniales (Fungi, Ascomycetes). *Mycologia Memoir* **9**: 1–627.
- Tavares II, Balazuc J (1989) *Sugiyamaemyces*, a new genus of Laboulbeniales (Ascomycetes) on *Clidicus* (Scydmaenidae). *Mycotaxon* **34**: 565–576.
- Thaxter R (1896) Contribution towards a monograph of the Laboulbeniaceae. *Memoirs of the American Academy of Arts and Sciences* **12**: 187–429.
- Thaxter R (1908) Contribution toward a monograph of the Laboulbeniaceae. Part II. *Memoirs of the American Academy of Arts and Sciences* **13**: 217–469.
- Thaxter R (1920) New Dimorphomyceteae. *Proceedings of the American Academy of Arts and Sciences* **55**: 211–282.
- Thaxter R (1924) Contribution toward a monograph of the Laboulbeniaceae III. *Memoirs of the American Academy of Arts and Sciences* **14**: 309–426, Pl. I–XII.
- Thaxter R (1926) Contribution toward a monograph of the Laboulbeniaceae IV. *Memoirs of the American Academy of Arts and Sciences* **15**: 427–580, Pl. I–XXIV.
- Thaxter R (1931) Contribution toward a monograph of the Laboulbeniaceae V. *Memoirs of the American Academy of Arts and Sciences* **16**: 1–435, Pl. I–LX.
- Weir A, Blackwell M (2001) Molecular data support the Laboulbeniales as a separate class of Ascomycota, Laboulbeniomycetes. *Mycological Research* **105**: 1182–1190.

## CONCLUSIONS AND RECOMMENDATIONS FOR FUTURE RESEARCH

In this dissertation we used molecular phylogenetic data to explore diversity in Laboulbeniomycetes and especially Laboulbeniales. A three-gene rDNA dataset provided strong support for the establishment of a new order, Herpomycetales. A two-gene rDNA dataset provided strong support for three independent origins of parasitism of bat flies by Laboulbeniales. The internal transcribed spacer as well as the large subunit ribosomal DNA regions revealed new species that we described. The application of species delimitation methods such as bPTP (Poisson tree processes model), GMYC (general mixed Yule coalescent approach) and ABGD (Automatic Barcode Gap Discovery), considerably improved efficiency in the delimitation of a species.

Undeniably an essential theme throughout the dissertation is that morphology does not always agree with molecular data. In addition, position-induced morphological adaptations and phenotypic plasticity, both of which we have observed throughout this project, may make morphology-based identification questionable. We make a strong case for host specialization (in *Gloeandromyces*) and even speciation by host species (within *Hesperomyces virescens* sensu lato). A shift in thinking is required since we have come to realize that diversity in Laboulbeniomycetes encompasses more than that which we can describe morphologically. Laboulbeniologists are moving toward significant improvements in their taxonomic studies, in that they will evaluate morphological data together with molecular phylogenetic results and other pieces of evidence such as development, ecology and host information – which we have referred to as an integrative taxonomic approach in CHAPTER 3. A similar reconsideration of species limits has been proposed for the Glomeromycota, which also have few morphological characters

and difficulties related to PCR amplification; in this group species are defined broadly with a low degree of host specificity.

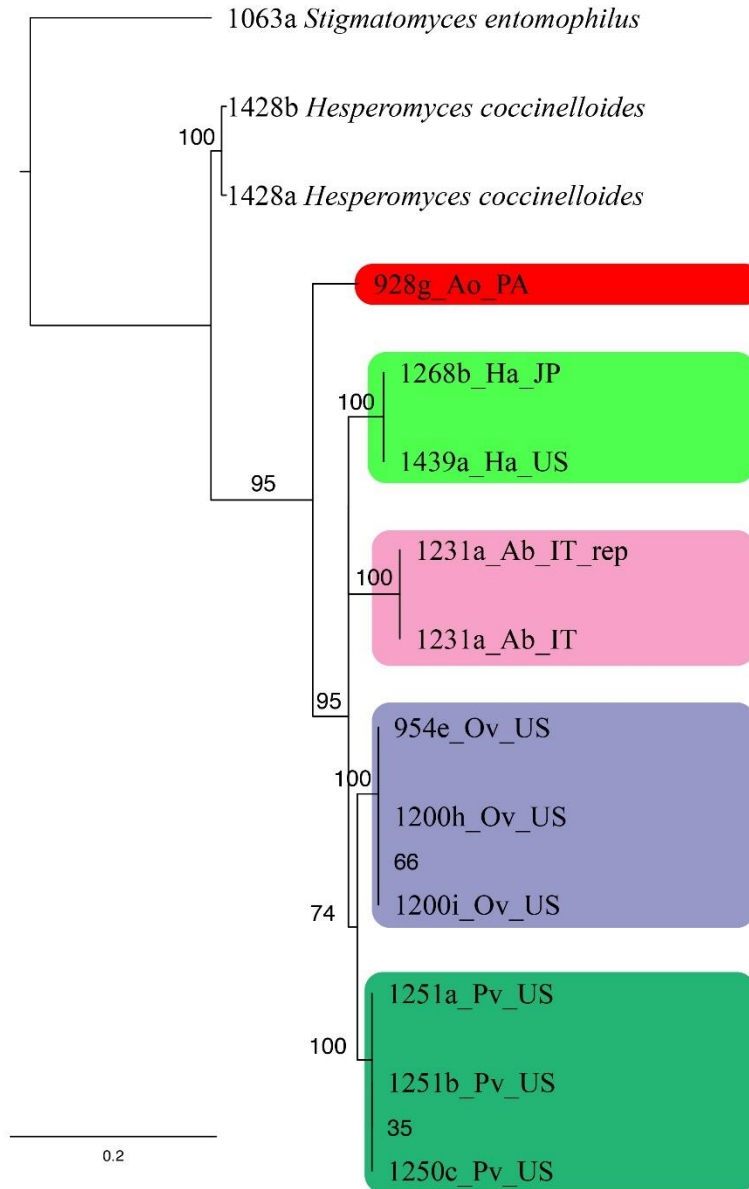
To date, phylogenetic reconstructions of Laboulbeniales/Laboulbeniomycetes have always been based on a single gene: the SSU rDNA (for deeper phylogeny). Indeed, sixty percent of all Laboulbeniomycetes sequences in NCBI GenBank (n=377, 10 May 2018) are SSU sequences. In CHAPTERS 2–4 we used two-gene (SSU+LSU) and three-gene (SSU+ITS+LSU) phylogenies to shed light on evolutionary relationships. The molecular phylogenetic results using multi-gene datasets presented in this dissertation are an improvement for Laboulbeniomycetes systematics research. Nuclear ribosomal RNA genes (rDNA) dominate Laboulbeniomycetes sequence data currently available in GenBank. These regions are relatively easy to amplify due to the many copies in the genome. However, we witness many failures in the amplification of the ITS region. The ITS differs significantly among genera and for most genera we do not know the extent of this variation. The difficulty encountered in the amplification of ITS combined with the ease by which LSU is amplified have led us to propose the LSU region as a barcode for Laboulbeniales in this dissertation and to even abandon the ITS barcode in CHAPTER 4.

In recent years we have seen an increase in resolution in phylogenies for other major groups of fungi. Good resolution always comes with the inclusion of multiple phylogenetically informative genes, especially protein-coding genes. Comprehensive multi-gene phylogenetic reconstructions have significantly improved our understanding of fungal systematics. Examples of single or low-copy nuclear protein-coding genes are *gapdh* (glyceraldehyde 3-phosphate dehydrogenase), *MCM7* (codes for a licensing factor required for initiation of DNA replication and cell proliferation), *RPB1* (the largest subunit of RNA polymerase II), *RPB2* (the second-largest subunit of RNA polymerase II), *TEF1* (translation elongation factor 1- $\alpha$ ) and  *$\beta$ -tubulin-*

coding genes. In Laboulbeniomycetes, there are no sequence data for protein-coding genes. The only exception is *Pyxidiophora arvernensis*, for which two protein-coding sequences are available in GenBank: one *RPB2* sequence (FJ238377) and one *TEF1* sequence (FJ238412). Contrary to species in the Herpomycetales and Laboulbeniales, species of *Pyxidiophora* can be grown in culture to yield adequate material for DNA extraction and subsequent amplification of single-copy genes.

Overcoming the problems of DNA extraction and PCR amplification has led researchers in the field to lag behind in generating the kinds of data that are being used in other groups. Recent developments look promising: we have been successful in generating *MCM7* sequences for members of *Hesperomyces virescens* sensu lato (Figure conclusions-1). Meanwhile, in other groups of fungi such as the zygomycetes, genomic data are being used to improve our understanding of deep diverging lineages. Initiatives should be undertaken to generate *de novo* Laboulbeniomycetes genome assemblies (using Illumina HiSeq sequencing technology and an assembly algorithm to piece together the sequence reads).

We recommend that field studies be directed toward better understanding mechanisms driving diversity, rather than toward solely describing the diversity. We need more collections, more molecular data and genome-scale data. Our understanding of the diversity of the class will only work when using a multidisciplinary approach – study the development, morphology, ecology and biogeography, in concordance with generating and analyzing sequence data. We have entered an exciting new era with the Laboulbeniomycetes, enabled by data and tools professor Roland Thaxter never imagined back in the early 20th century: the ability to collect widely by modern transportation and to use molecular phylogenetic methods to truly consider these elusive fungi in an evolutionary context.



**Figure conclusions-1.** Preliminary phylogenetic reconstruction of *Hesperomyces virescens* sensu lato, using *MCM7* sequences. The topology is the result of maximum likelihood inference performed with RaXML in Cipres. For each node, the ML bootstraps (if > 70) are presented above/below the branch leading to that node.