



**Estudis filogenètics i
filogeogràfics de la
tribu *Cardueae* i el
gènere *Euphorbia***

Laia Barres González
Tesi Doctoral, 2013



UNIVERSITAT DE BARCELONA
FACULTAT DE BIOLOGIA

PROGRAMA DE DOCTORAT BIODIVERSITAT 2008-2013

INSTITUT BOTÀNIC DE BARCELONA (IBB-CSIC-ICUB)

**Estudis filogenètics i filogeogràfics
de la tribu *Cardueae* i el gènere *Euphorbia***

Laia Barres González
Barcelona, 2013



UNIVERSITAT DE BARCELONA
FACULTAT DE BIOLOGIA

PROGRAMA DE DOCTORAT BIODIVERSITAT 2008-2013

INSTITUT BOTÀNIC DE BARCELONA (IBB-CSIC-ICUB)

**Estudis filogenètics i filogeogràfics
de la tribu *Cardueae* i el gènere *Euphorbia***

Memòria presentada per Laia Barres González per a optar al títol de Doctora per la
Universitat de Barcelona

Amb el vist-i-plau de les directores de tesi:

Dra. Roser Vilatersana Lluch
Institut Botànic de Barcelona
(IBB-CSIC-ICUB)

Dra. Mercè Galbany Casals
Facultat de Biociències
Universitat Autònoma de Barcelona

I del tutor de tesi: Dr. Xavier Font Castells

Laia Barres González
Barcelona, 2013



Agraïments

Els més sentits agraïments van cap a les meves directores, la Dra. Roser Vilatersana i la Dra. Mercè Galbany. Elles m'han guiat en aquest llarg camí, m'han animat en els moments més durs i m'han sabut escoltar i recolzar a l'hora de prendre decisions difícils. La veritat és que sense els seus esclats de riure aquesta tesi hauria estat molt menys divertida. En tot moment: al laboratori, davant de l'ordinador però sobretot durant les campanyes per les Canàries, Madeira i Catalunya han estat unes directores entusiastes i encoratjadores. Gràcies de tot cor!

Vull agrair molt especialment el Dr. Julià Molero pel seu suport en l'estudi de les *Euphorbia*, ell m'ha transmès la seva insaciable curiositat científica, la seva passió vers el món de les lleterasses i el seu afany per trobar-les per les Espanyes i arreu. Junt amb les meves directores, han format el trio de rialles més reconegut de l'Institut Botànic de Barcelona.

Agraeixo també el Dr. Alfonso Susanna i la Dra. Núria Garcia el compartir amb ells la discussió de nombroses investigacions, l'haver-me ofert la possibilitat de col·laborar amb ells en diferents articles; l'experiència ha estat molt enriquidora.

También quiero agradecer a la Dra. Isabel Sanmartín y a la Dra. Cajsja Lisa Anderson, del Real Jardín Botánico de Madrid, con quien durante 3 meses aprendí muchas de las cosas que he utilizado al largo de toda la tesis. La estancia en vuestro equipo me ha aportado muchos conociminetos sobre biogeografía y reloj molecular. La experiencia en Madrid no hubiera estado tan buena sin los compañeros de "la plaza de toros" del RJB. Andrea, Luís, Isabel, Edu, Almudena-LiFang: gracias por todos los momentos compartiendo cañas madrileñas!

María, Patri y Megara, gracias por acogerme en vuestro hogar y por hacerme pasar tan buena experiencia en Madrid. Que risas más buenas compartimos entre piratas en la calle Santiago ;)

I am very grateful to Dr. Andrew Hipp, who host me in the Morton Arboretum of Lisle, Illinois. There, I learned how to deal with AFLP and how to get through bad results. I really enjoyed the journal club sessions there. Also living inside the Arboretum was a great experience, having chickmunks and deers as neighbours. But the nicest experience was to share lab days with Marcial and Kyong-Sook, my experience in Chicago would have been very different without you! Thank you guys for sharing such great moments; like eating kimchi, visiting Oak Park with an emergency blanket or enjoying sports in the Arboretum. Also, I was very happy to meet Bethany, Alka and Carrie.

Molt efusivament, vull donar les gràcies als companys de l'Institut Botànic de Barcelona, que sempre han estat disposats a resoldre dubtes, discutir resultats o compartir estones de xerrameca. Sara (la més bona de les tècniques de lab i encara millor amiga!), Javi (company des del inici del màster fins al final), Andreas (el tirolés més català), Sergi (i el seu porquet), Almu, María, Dani, Isma, Kostya, Jordi, Núria (la millor compi de pis), Encarni, Eli, Sònia, Jaume, Teresa, Marisa, Juanjo, Juancho, Piotr, Cristina...I sobretot agrair els bons esmorzars amb el grupet de les 11h: Míriam, Tamara, Neus Nualart, Neus Ibañez, Noe, Diana, que bé m'ho he passat compartint pastissos, cafè i bones converses amb Barcelona de fons!

També vull agrair el suport de la meva gent, que sempre ha estat allà quan els he necessitat, i també per fer festa i gaudir.

Als meus companys de Nusos, per fer-ho tot molt fàcil alhora de compatibilitzar la feina al Museu amb la tesi, per motivar-me a ser creativa i per fer possible una ciència més accessible, didàctica i divertida. Sou la canya!

Anna Mo, Triu, Erola i Anna Rita, les amigues de tota la vida, gràcies a totes per ser-hi, i per haver-me fet més fàcil aquest camí, espero que encara compartim molts més moments juntes!

Mercè, Eva i Lula, del club de les manualitats. Gràcies pels viatges, pels sopars de nenes, per compartir juntes els diferents etapes de la tesi i per fer-me riure tant. Aviat totes doctores! Nenes, ja ho sabeu, sense vosaltres...Això seria una altra cosa ©.

I sobretot a la meva família, especialment als meus avis -l'avolo, la meme i la iaia- que en aquesta última etapa han estat molt presents i que tant m'han estimat i cuidat...

També als meus pares i el meu germà per fer-me estimar tant la natura, segur que sense ells no seria on sóc ara mateix!

ÍNDIX

1. INTRODUCCIÓ.....	5
1.1 EL GÈNERE <i>EUPHORBIA</i>.....	5
1.1.1. Marc sistemàtic	5
1.1.2. Estudis previs.....	9
1.1.3. El subgènere <i>Esula</i>	12
1.1.4.El grup <i>Pachycladae</i>	12
1.1.4.1. Marc sistemàtic.....	12
1.1.4.2 Biogeografia.....	16
1.2. LA TRIBU <i>CARDUEAE</i>.....	19
1.2.1. Marc sistemàtic	19
1.2.2. Estudis previs.....	22
1.2.3. Biogeografia	23
1.3. LA SISTEMÀTICA MOLECULAR.....	26
1.3.1. Mètodes de reconstrucció filogenètica	27
1.3.2. Mètodes de datació molecular.....	29
1.3.3. Mètodes de reconstrucció biogeogràfica	30
1.3.4. Mètodes de reconstrucció filogeogràfica	31
1.4. JUSTIFICACIÓ DEL PRESENT TREBALL.....	33
2. OBJECTIUS.....	39
3. INFORME DE LES DIRECTORES DE LA TESI DOCTORAL REFERENT AL FACTOR D'IMPACTE I A LA CONTRIBUCIÓ DEL DOCTORAND A CADASCUN DELS ARTICLES PUBLICATS	43
4. RESUM I DISCUSSIÓ DELS RESULTATS OBTINGUTS	49
4.1. DEL GÈNERE <i>EUPHORBIA</i>	49
4.1.1. Filogènia molecular.....	49
4.1.2. Filogeografia	53
4.2. DE LA TRIBU <i>CARDUEAE</i>	58
4.2.1. Filogènia molecular.....	58
4.2.2. Datació molecular i reconstrucció biogeogràfica	61

5. CONCLUSIONS FINALS.....	67
6. SUMMARY IN ENGLISH	75
7. BIBLIOGRAFIA	87
8. COMPENDI DE PUBLICACIONS.....	103
8.1. Publicació 1: Molecular phylogeny of <i>Euphorbia</i> subgen. <i>Esula</i> sect. <i>Aphyllis</i> (Euphorbiaceae) inferred from nrDNA and cpDNA markers with biogeographic insights	105
8.2. Publicació 2: Phylogeography and character evolution of <i>Euphorbia</i> sect. <i>Aphyllis</i> subsect. <i>Macaronesicae</i> (Euphorbiaceae)	123
8.3. Publicació 3: Reconstructing the evolution and biogeographic history of tribe Cardueae (Compositae).....	165
8.4. Publicació 4: Lessons from <i>Plectocephalus</i> (Compositae, Cardueae-Centaureinae) ITS disorientation in annuals and Beringian dispersal as revealed by molecular analyses	215

INTRODUCCIÓ

1. INTRODUCCIÓ

1.1. EL GÈNERE *EUPHORBIA*

1.1.1. Marc sistemàtic

El gènere *Euphorbia* L. pertany a les *Euphorbiaceae* Juss., família que comprèn uns 245 gèneres (Radcliffe-Smith, 2001) i unes 6300 espècies (Govaerts et al., 2000). La família *Euphorbiaceae* és de distribució cosmopolita, tot i que el seu centre de diversitat es troba a les regions tropicals i subtropicals. Dins les *Euphorbiaceae* trobem arbres, arbusts i plantes herbàcies amb tiges de vegades suculentes i que poden presentar làtex. Les fulles normalment són simples, poden ser alternes o oposades, perennes o caduques i normalment presenten estípules. La inflorescència és terminal o axil·lar, en general de tipus cimós. Les flors són solitàries, aclamídies o clamídies, hipògines, generalment actinomorfes i unisexuals. Sovint les flors són molt reduïdes i s'agrupen en un ciati, estructura que actua com a pseudant hermafrodita.

Les *Euphorbiaceae* comprenen cinc subfamílies (Webster, 1975): *Phyllanthoideae* Asch., *Oldfieldioideae* C. Kohler & G. L. Webster, *Acalyphoideae* Asch., *Crotonoideae* Pax i *Euphorbioideae* Boiss. Dins les *Euphorbioideae* trobem la tribu *Euphorbieae* Dumort. que inclou 11 gèneres i 2100 espècies, de les quals 2000 pertanyen al gènere *Euphorbia* (Oudejans, 1990). Els 11 gèneres es classifiquen en 3 subtribus: *Anthosteminae* (Baill.) G. L. Webster, *Neoguillauminiinae* Croizat i *Euphorbiinae* Hurusawa (Taula 1). La presència o absència de periant defineix aquestes subtribus: les *Anthosteminae* en presenten a les flors femenines i masculines; les *Neoguillauminiinae* només en tenen a les femenines i les *Euphorbiinae* no en presenten en cap del dos tipus de flors. S'observa una tendència cap a la reducció i la compactació d'estructures florals durant l'evolució floral de les *Euphorbieae*. Diferents autors coincideixen en definir la subtribu *Anthosteminae* com a grup ancestral de la tribu, ja que presenten les flors més rudimentàries (Steinmann & Porter, 2002). Són endèmiques de l'Àfrica i Madagascar i apareixen en posició basal en estudis moleculars (Park & Elisens, 2000; Steinmann & Porter, 2002; Bruyns et al., 2006). La següent clada més basal, la subtribu *Neoguillauminiinae*, es troba a Austràlia i Nova Caledònia, mentre que les *Euphorbiinae* són subcosmopolites. La distribució a l'hemisferi sud de les subtribus basals dins les *Euphorbieae* suggereix que l'origen de la tribu hauria

estat a l'Àfrica abans de la separació de Gondwana, fa 165 milions d'anys (Ma; Sanmartín & Ronquist, 2004).

Boissier (1862)	Bentham (1878)	Pax & Hoffmann (1931)	Wheeler (1943)	Webster (1994)
Tribu <i>Anthostemeae</i> <i>Anthostema</i>	Tribu <i>Euphorbieae</i> <i>Anthostema</i>	Tribu <i>Euphorbieae</i> <i>Anthostema</i>	Tribu <i>Euphorbieae</i> <i>Anthostema</i>	Subtribu <i>Anthosteminae</i> <i>Anthostema</i>
Tribu <i>Euphorbieae</i> <i>Euphorbia</i> <i>Pedilanthus</i>	<i>Calycopeplus</i> <i>Euphorbia</i> <i>Pedilanthus</i>	<i>Calycopeplus</i> <i>Diplocyathium</i> <i>Dichostema</i>	<i>Calycopeplus</i> <i>Dichostemma</i> <i>Elaeophorbia</i>	Subtribu <i>Neoguillaiminiinae</i> <i>Anthostema</i> <i>Dischostemma</i>
<i>Synadenium</i>	<i>Synadenium</i>	<i>Elaeophorbia</i> <i>Euphorbia</i> <i>Monadenium</i> <i>Pedilanthus</i> <i>Stenadenium</i> <i>Synadenium</i>	<i>Euphorbia</i> <i>Monadenium</i> <i>Neoguillauminia</i> <i>Pedilanthus</i> <i>Stenadenium</i> <i>Synadenium</i>	Subtribu <i>Euphorbiinae</i> <i>Calycopeplus</i> <i>Neoguillauminia</i> <i>Chamaesyce</i> <i>Cubanthus</i> <i>Endadenium</i> <i>Euphorbia</i> <i>Monadenium</i> <i>Pedilanthus</i> <i>Synadenium</i>

Taula 1. Principals classificacions taxonòmiques de la tribu *Euphorbieae* i tàxons afins.

El gènere *Euphorbia* és el segon gènere més nombrós d'Angiospermes després d'*Astragalus* L. (*Fabaceae* Lindl.). Fou descrit per Linné (1753) i té distribució subcosmopolita amb diversos centres de diversificació: les zones àrides d'Àfrica i Madagascar, el nord i centre de Mèxic i l'Àsia occidental. És absent en àrees subàrtiques i a les selves tropicals (Govaerts et al., 2000). Són, de manera general, plantes monoiques amb hàbits molt diversos incloent des de plantes herbàcies i arbusts fins a arbres (Fig. 1); de vegades són espinoses i/o suculentes. Presenten làtex a les tiges. Les fulles són simples, generalment alternes, encara que també n'hi ha amb fulles oposades o verticil·lades. De forma general no presenten estípules. És l'únic gènere conegut de plantes que inclou els tres sistemes fotosintètics que existeixen: CAM, C₃ i C₄. Les flors masculines es redueixen a un estam i les femenines a un ovari tricoc.

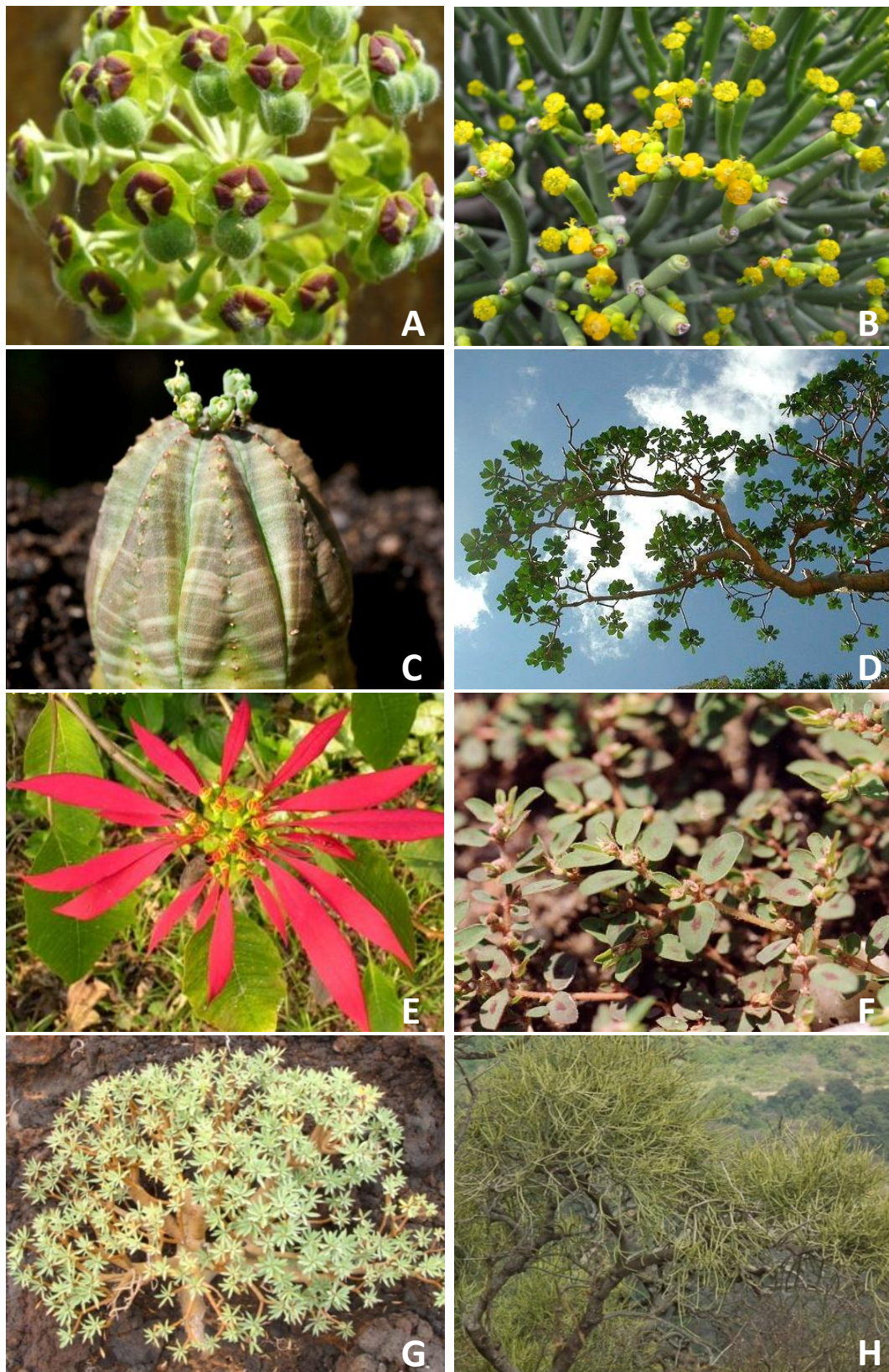

Fig. 1: Diversitat morfològica dins el gènere *Euphorbia*. Subgènere *Esula*, A: *Euphorbia characias* (L. Barres), B: *E. aphylla* (L. Barres); subgènere *Rhizanthium*, C: *E. obesa* Hook. f. (J. M. Barres), D: *E. socotrana* Balf. f. (L. Banfield); subgènere *Chamaesyce*, E: *E. pulcherrima* Willd. ex Klotzsch (asianplant.net), F: *E. maculata* L. (E. Dronnet); subgènere *Euphorbia*, G: *E. balsamifera* (L. Barres), H: *E. tirucalli* L. (commons.wikimedia.org).

Les flors masculines i femenines es reuneixen en una inflorescència anomenada ciati. El ciati està format per cinc flors masculines al voltant d'una única flor femenina i un involucre o exociati. Els ciatis són proterogínics i actuen com a un pseudant hermafrodita, ja que presenten de quatre a cinc glàndules nectaríferes situades al marge de l'involucre que tenen la funció d'oferir una recompensa ensucrada als insectes pol·linitzadors. Aquesta visió tradicional del ciati però, s'ha vist modificada recentment, ja que un estudi sobre el seu desenvolupament ontogènic revela que el gen LFY, associat amb la identitat floral en moltes Angiospermes, s'expressa alhora en òrgans de les flors i del ciati, difuminant així els límits entre flor i inflorescència (Prenner & Rudall, 2007; Prenner et al., 2011). Els ciatis es reuneixen en sinflorescències en forma de pleocasi o agregat d'inflorescències cimoses. Cada branca de la sinflorescència s'anomena radi pleocasi. Els radis pleocasials donen lloc a cimes bípares. Les seves bràctees s'anomenen bràctees dicasials i les seves branques, radis dicasials (Fig. 2). L'ovari és tricarpelar, quan es fecunda forma una càpsula esquizocàrpica de mericarps monosperms. La majoria de llavors presenten un eleosoma anomenat carúncula que té un paper fonamental en la seva dispersió mirmeccòcora.

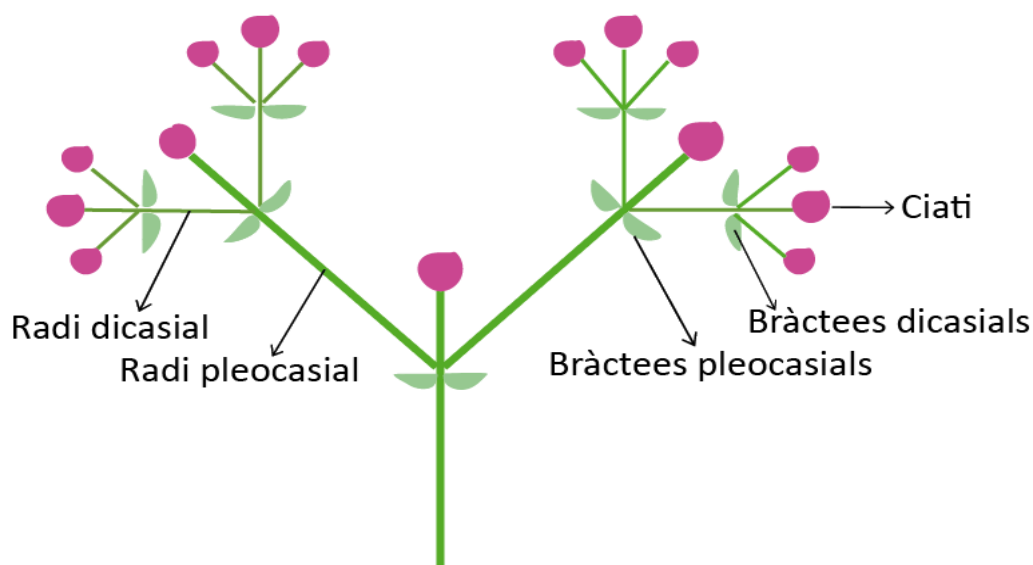

Fig. 2: Esquema simplificat de la sinflorescència característica del gènere *Euphorbia*.

Tot i l'existència de dos caràcters diagnòstics en la definició del gènere *Euphorbia* –la presència de ciati i de làtex a les fulles–, la seva delimitació ha estat sempre controvertida degut bàsicament a tres raons: (1) la seva àmplia distribució, (2) el gran nombre d'espècies que inclou i (3) l'extrema variabilitat morfològica que presenta (Fig.

1), que sovint ha dificultat l'establiment de classificacions naturals. Diversos gèneres reconeguts tradicionalment tals com *Chamaesyce* Gray, *Cubanthus* Millsp., *Elaeophorbia* Stapf, *Endadenium* L. C. Leach, *Monadenium* Pax, *Pedilanthus* Neck., *Poinsettia* Graham i *Synadenium* Boiss. (Taula 1) es consideren actualment dins la circumscripció d'*Euphorbia* ja que en recents estudis filogenètics (Steinman & Porter, 2002; Wurdack et al., 2004, Bruyns et al., 2006; Horn et al., 2012) apareixen compartint un ancestre comú. Tot i així, en alguns casos es conserva la seva entitat taxonòmica sota un rang diferent. En el cas del llinatge *Chamaesyce*, es recupera el seu tractament com a subgènere (*Euphorbia* subgènere *Chamaesyce* Raf.). El llinatge *Cubanthus* es reconeix actualment sota la categoria de secció (*Euphorbia* subgènere *Euphorbia* secció *Cubanthus* (Boiss.) V. W. Steinm. & P. E. Berry). El llinatge *Monadenium*, es manté també sota el rang de secció (*Euphorbia* subgènere *Euphorbia* secció *Monadenium* (Pax) Bruyns) incloent els antics gèneres *Endadenium* i *Synadenium*. Els demés tàxons no es reconeixen sota criteris moleculars i passen a formar part d'altres subgèneres.

1.1.2. Estudis previs

El tractament del gènere *Euphorbia* ha estat divers al llarg de la història (Taula 2) i ha inclòs de 27 (Boissier, 1862) a sis seccions (Bentham, 1878). Pax & Hoffman (1931) proposaren un tractament semblant al de Bentham (1878) però afegiren dues noves seccions (Taula 2). Wheeler (1943) fou el primer en proposar la categoria de subgènere com a rang infragèneric d'*Euphorbia* i en general acceptà la classificació de Bentham (1878). Finalment, autors més moderns han acabat de modificar la taxonomia clàssica d'*Euphorbia*, elevant categories menors al rang de subgènere: Carter (1985) reconegué els subgèneres *Tirucalli* (Boiss.) S. Carter i *Trichadenia* (Pax) S. Carter, i Gilbert (1987) el subgènere *Lacanthia* (Raf.) M. G. Gilbert (Taula 2), tàxons anteriorment considerats a nivell de secció.

Estudis filogenètics i filogeogràfics de la tribu *Cardueae* i el gènere *Euphorbia*

Boissier (1862)	Bentham (1878)	Pax & Hoffmann (1931)	Wheeler (1943)	Carter (1985)	Gilbert (1987)
Sect. <i>Alectoroxtonum</i>	Sect. <i>Adenopetalum</i>	Sect. <i>Adenopetalum</i>	Subg. <i>Agaloma</i>	Subg. <i>Agaloma</i>	Subg. <i>Agaloma</i>
Sect. <i>Anisophyllum</i>	Sect. <i>Anisophyllum</i>	Sect. <i>Anisophyllum</i>	Subg. <i>Chamaesyce</i>	Subg. <i>Chamaesyce</i>	Subg. <i>Chamaesyce</i>
Sect. <i>Arthrothamnus</i>	Sect. <i>Eremophyton</i>	Sect. <i>Eremophyton</i>	Subg. <i>Eremophyton</i>	Subg. <i>Eremophyton</i>	Subg. <i>Eremophyton</i>
Sect. <i>Calycopeplus</i>	Sect. <i>Euphorbium</i>	Sect. <i>Euphorbium</i>	Subg. <i>Esula</i>	Subg. <i>Esula</i>	Subg. <i>Esula</i>
Sect. <i>Caulanthium</i>	Sect. <i>Poinsettia</i>	Sect. <i>Lyciopsis</i>	Subg. <i>Euphorbia</i>	Subg. <i>Euphorbia</i>	Subg. <i>Euphorbia</i>
Sect. <i>Cheirolepidium</i>	Sect. <i>Tithymalus</i>	Sect. <i>Poinsettia</i>	Subg. <i>Lyciopsis</i>	Subg. <i>Lyciopsis</i>	Subg. <i>Lacanthis</i>
Sect. <i>Crossadenia</i>		Sect. <i>Pseudoeuphorbium</i>	Subg. <i>Poinsettia</i>	Subg. <i>Poinsettia</i>	Subg. <i>Lyciopsis</i>
Sect. <i>Cyttarospermum</i>		Sect. <i>Rhizanthium</i>	Subg. <i>Rhizanthium</i>	Subg. <i>Rhizanthium</i>	Subg. <i>Poinsettia</i>
Sect. <i>Diacanthium</i>		Sect. <i>Tithymalus</i>	Subg. <i>Tithymalus</i>	Subg. <i>Tirucalli</i>	Subg. <i>Rhizanthium</i>
Sect. <i>Dichilum</i>				Subg. <i>Tithymalus</i>	Subg. <i>Tirucalli</i>
Sect. <i>Eremophyton</i>				Subg. <i>Trichadenia</i>	Subg. <i>Tithymalus</i>
Sect. <i>Euphorbiastrum</i>					Subg. <i>Trichadenia</i>
Sect. <i>Euphorbium</i>					
Sect. <i>Goniostema</i>					
Sect. <i>Lyciopsis</i>					
Sect. <i>Nummulariopsis</i>					
Sect. <i>Petaloma</i>					
Sect. <i>Poinsettia</i>					
Sect. <i>Portulacastrum</i>					
Sect. <i>Pseudacalypha</i>					
Sect. <i>Rhizanthium</i>					
Sect. <i>Stachydium</i>					
Sect. <i>Tirucalli</i>					
Sect. <i>Tithymalopsis</i>					
Sect. <i>Tithymalus</i>					
Sect. <i>Tricherostigma</i>					
Sect. <i>Zygophyllidium</i>					

Taula 2. Principals classificacions taxonòmiques infragenèriques del gènere *Euphorbia*.

Els darrers anys, diversos estudis moleculars han establert noves classificacions sota criteris filogenètics que han simplificat el tractament taxonòmic del gènere en establir-ne quatre subgèneres corresponents a quatre clades: *Chamaesyce*, *Esula* Pers., *Euphorbia* L. i *Rhizanthium* (Boiss.) Wheeler (Fig. 3). Les quatre clades no comparteixen sinapomorfies morfològiques evidents però es defineixen prou bé per característiques estructurals del genoma mitocondrial i cloroplàstic (Wurdack & Zimmer, 2003). Estudis recents demostren que el subg. *Esula*, l'únic present a Europa, es troba a la base de tot el gènere (Fig. 3; Zimmermann et al., 2010; Horn et al., 2012). El subg. *Rhizanthium* és germà de la clada formada pel subg. *Chamaesyce* i el subg. *Euphorbia* (Fig. 3).

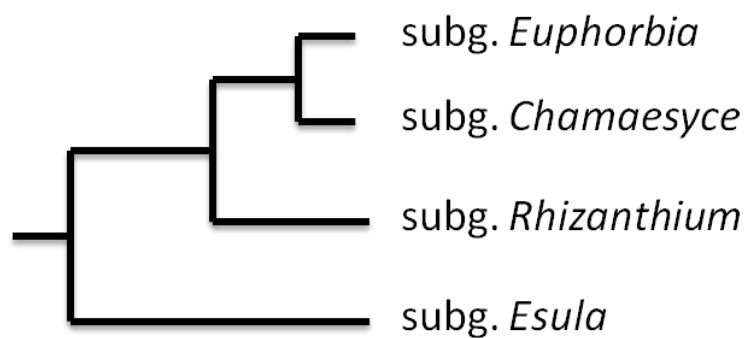

Fig. 3: Relacions filogenètiques entre els 4 subgèneres dins *Euphorbia* segons Horn et al. (2012).

El subg. *Esula* conté unes 500 espècies i correspon àmpliament a la secció *Tithymalus* Boiss. Inclou majoritàriament herbes anuals i perennes i arbusts, sense estípules, i és principalment mediterrani (Fig. 2: A, B). En ser el grup d'estudi serà tractat amb més detall en el següent apartat.

El subg. *Rhizanthium* inclou unes 200 espècies d'arbusts, geòfits i plantes suculentas distribuïdes majoritàriament a l'Àfrica i Madagascar, de fulles esparses, herbàcies o suculentas, i estípules absents (Fig. 2: C, D). Els ciatis normalment són solitaris, amb glàndules nectaríferes digitades. Les llavors majoritàriament no presenten carúncula.

El subg. *Chamaesyce* comprèn unes 600 espècies d'arbusts o herbes anuals no suculentas de fulles oposades, dístiques, sovint asimètriques a la base (Fig. 2: E, F). Les inflorescències presenten pocs ciatis terminals, amb quatre nectaris enters o amb apèndixs petaloides. Les llavors són de tuberculades a berrugoses i poden tenir o no

carúncula. La seva distribució és cosmopolita i, tot i que la majoria d'espècies són del Nou Món, els seus orígens es troben a Àfrica, Madagascar i el sud-oest asiàtic.

El subg. *Euphorbia* inclou al voltant de 700 espècies molt diverses. Trobem herbes, arbusts i arbres de tiges verdes i fotosintètiques, suculentes (Fig. 2: G, H). Les fulles són oposades, normalment molt reduïdes i les estípules s'han transformat en espines. Les inflorescències són cimoses axil·lars, amb bràctees reduïdes. Les llavors poden ser de llises a tuberculades, sense carúncula. És de distribució pantropical, tot i que els llinatges basals es troben a l'Àfrica i Madagascar.

Croizat (1940) suggerí que els subgèneres d'*Euphorbia* ja devien estar diferenciats al Cretaci mitjà (fa 100 Ma). El registre fòssil del gènere és escàs però hi ha evidències d'una diversificació ja notable a l'Eocè (de 55,8 a 33,9 Ma; Wurdack et al., 2005).

1.1.3. El subgènere *Esula*

El subg. *Esula* inclou aproximadament 400 espècies distribuïdes en zones temperades de l'hemisferi Nord, amb el centre de diversitat a la conca Mediterrània. Inclou espècies herbàcies, perennes o anuals, arbusts, petits arbres i plantes suculentes. Les seves fulles en general presenten disposició alterna i els ciatis es disposen en cima dicasial o pleocasial, amb bràctees a la base. En general, no presenten estípules. La majoria d'espècies presenten ciati, caràcter definitori del gènere. Les glàndules nectaríferes del ciati presenten morfologies diverses, des de truncades a tenir apèndixs en forma de mitja lluna o claviformes. Les llavors normalment són carunculades.

Segons estudis filogenètics recents, el subgènere *Esula* és monofilètic només si s'hi inclouen les espècies del subgènere *Tirucalli* afins a *E. mauritanica* L. (Steinmann & Porter, 2002; Bruyns et al., 2006; Frajman & Schönswetter, 2011).

1.1.4. El grup *Pachycladae*

1.1.4.1. Marc sistemàtic

Boissier (1862) definí dins la secció *Tithymalus* el grup *Pachycladae* (Taula 3), sense rang taxonòmic formal i que comprèn arbusts llenyosos de fulles alternes, enteres i aviat caduques. Les glàndules nectaríferes poden ser des de truncades fins a presentar

dos apèndixs en forma de mitja lluna, de marge enter. La càpsula presenta un pericarp endurit i les llavors són llises.

El grup *Pachycladae* tal com el va definir Boissier (1862) comprenia dues entitats (Taula 3): el grup *Canariensis et Mediterraneae*, que incloïa vuit espècies endèmiques de la Macaronèsia (*E. atropurpurea* Brouss. ex Willd., *E. berthelotii* Bolle ex Boiss. in DC., *E. bourgeana* Gay ex Boiss., *E. mellifera* Aiton, *E. piscatoria* Aiton, *E. regis-jubae* Webb & Berthel., *E. stygiana* H. C. Watson i *E. tuckeyana* Steud. ex Webb), una espècie àmpliament distribuïda a les illes Canàries i a l'Àfrica central des de la costa oest fins al Iemen (*E. balsamifera* Aiton) i una sola espècie de distribució Mediterrània (*E. dendroides* L.) i el grup *Polynesicae et Sundaieae-species anomalae*, que incloïa espècies de distribució australasiàtiques endèmiques de les illes Fiji (*E. fidjiana* Boiss.), Nova Zelanda (*E. glauca* G. Forst.), l'illa Norfolk (*E. norfolkiana* Boiss.) i Malèsia (*E. plumerioides* Teijsm. ex Hassk.).

Recentment s'ha demostrat que les espècies incloses dins el grup *Polynesicae et Sundaieae* no estan relacionades amb el grup *Pachycladae* i s'han inclòs dins el subgènere *Euphorbia* (Steinmann & Porter, 2002).

Les espècies incloses dins el grup *Canariensis et Mediterraneae* s'han investigat en diversos estudis filogenètics on s'ha demostrat el seu origen polifilètic. Molero et al. (2002), Steinmann & Porter (2002) i Bruyins et al. (2006) demostraren que el grup *Pachycladae* no és natural, ja que trobaren que les espècies tradicionalment considerades dins el grup *Pachycladae* s'inclouïen en quatre clades d'origen independent:

- 1) Grup troncal de les *Pachycladae*, que inclou *E. atropurpurea*, *E. bravoana* Svent., *E. piscatoria*, *E. regis-jubae* i *E. tuckeyana*;
- 2) *Euphorbia dendroides*, espècie que queda dins el subgènere *Esula* però fora del grup troncal *Pachycladae* i no es resol la seva posició filogenètica;
- 3) La clada d'arbres endèmics de la Macaronèsia *E. mellifera* i *E. stygiana*, dels quals tampoc es poden resoldre les seves afinitats però estan dins el subgènere *Esula*;
- 4) *Euphorbia balsamifera*, que apareix estretament relacionada amb *E. meuleniana* O. Schwartz, endèmica del Iemen, dins el subgènere *Rhizanthium* sect. *Somalica* S. Carter.

Tot i així, aquests treballs no arribaren a delimitar clarament la clada del grup troncal *Pachycladae*, ja que no van incloure totes les espècies del grup ni totes les espècies relacionades amb el grup *Pachycladae*, i tampoc van poder definir-ne el seu grup germà.

Per altra banda, estudis moleculars recents han demostrat que algunes espècies africanes i aràbigues del subgènere *Tirucalli* es troben emparentades amb espècies del grup troncal de les *Pachycladae* (Steinmann & Porter, 2002; Bruyns et al., 2006). Carter (1985) ja detectà per caràcters morfològics que el grup *Tirucalli* incloïa espècies de dos llinatges diferents (Taula 3). Per una banda inclou el grup troncal de les *Tirucalli*, espècies amb bràctees escarioses, inflorescències denses i estípules glandulars. Aquest grup s'inclou dins el subgènere *Euphorbia* en estudis moleculars (Steinmann & Porter, 2002; Bruyns et al., 2006; Horn et al., 2012) i constituïria les "veritable" *Tirucalli*. Per altra banda, el grup *Tirucalli* també comprèn un grup d'espècies amb bràctees folioses, pleocasis de tres a vuit radis i absència d'estípules glandulars, que Leach (1975) ja havia denominat complex d'*E. mauritanica* i que incloïa *E. bottae* Boiss., *E. consobrina* N. E. Br., *E. gossypina* Pax, *E. lateriflora* Schumach., *E. mauritanica*, *E. merkeri* N. E. Br., *E. nubica* N. E. Br. i *E. schimperi* C. Presl. Més tard, Carter (1992) confirmà que constituïen un segon llinatge dins el subgènere *Tirucalli* i afegí al grup *E. bariensis* S. Carter, *E. dhofarensis* S. Carter, *E. pachyclada* S. Carter i *E. papilionum* S. Carter. Algunes espècies d'aquest complex van aparèixer estretament relacionades amb les espècies de la clada de les veritable *Pachycladae* en estudis moleculars recents (Steinmann & Porter, 2002; Bruyns et al., 2006).

Alhora, altres espècies macaronèsiques considerades en tractaments clàssics fora del grup *Pachycladae* han aparegut filogenèticament relacionades amb la clada de les veritable *Pachycladae* (Molero et al., 2002). Aquestes espècies són *E. aphylla* Brouss. ex Willd, inclosa originàriament dins la secció monotípica *Aphyllis* Webb & Berthel. (Webb & Berthelot, 1842), i *E. lamarckii* Sweet. Totes dues espècies havien estat considerades per Boissier (1862) dins la secció *Tirucalli* (Taula 3).

Dins les espècies macaronèsiques considerades tradicionalment com a grup *Pachycladae*, hom pot distingir dos complexos diferenciats morfològic i ecològicament (Molero et al., 2002). El complex d'*E. atropurpurea* inclou *E. atropurpurea*, *E. bourgeana* i *E. bravoana*, endèmiques de les illes Canàries.

Webb & Berthelot (1842)	Boissier (1862)	Pax & Hoffmann (1931)	Leach (1975)	Carter (1985, 1992)
Sect. <i>Aphyllis</i> Webb & Berthel. <i>E. aphylla</i>	Sect. <i>Tirucalli</i> Boiss. <i>E. aphylla</i>	Sect. <i>Tithymalus</i> Boiss. Subsect. <i>Pachycladae</i> (Boiss.) Pax <i>E. atropurpurea</i>	Sect. <i>Tirucalli</i> Boiss. <i>E. berotica</i>	Subg. <i>Tirucalli</i> (Boiss.) S. Carter <i>E. bariensis</i>
Sect. <i>Balsamis</i> Webb & Berthel. <i>E. balsamifera</i>	<i>E. dregeana</i> <i>E. larica</i>	<i>E. balsamifera</i>	<i>E. bottae</i> <i>E. consobrina</i>	<i>E. calamiformis</i> <i>E. dhofarensis</i>
Sect. <i>Tithymalus</i> †† <i>Esula</i> Haw. * <i>Frustescens</i>	<i>E. lateriflora</i> <i>E. mauritanica</i> <i>E. obtusifolia</i> (= <i>E. lamarckii</i>) <i>E. schimperi</i>	<i>E. berthelotii</i> <i>E. bourgeana</i> <i>E. dendroides</i> <i>E. fidjiana</i>	<i>E. gossypina</i> <i>E. lateriflora</i> <i>E. mauritanica</i> <i>E. merkeri</i> (= <i>E. gossypina</i>)	<i>E. gossypina</i> <i>E. pachyclada</i> <i>E. papilionum</i>
<i>E. atropurpurea</i> <i>E. obtusifolia</i> (= <i>E. lamarckii</i>) <i>E. piscatoria</i>	<i>E. tirucalli</i>	<i>E. glauca</i> <i>E. mellifera</i>	<i>E. nubica</i> <i>E. schimperi</i>	
<i>E. regis-jubae</i> * <i>Arborescentes</i>	[§] <i>Pachycladae</i> Boiss. * <i>Canariensis et Mediterraneae</i> <i>E. atropurpurea</i> <i>E. balsamifera</i> <i>E. berthelotii</i> <i>E. bourgeana</i> <i>E. dendroides</i> <i>E. mellifera</i> <i>E. piscatoria</i> <i>E. regis-jubae</i> <i>E. stygiana</i> <i>E. tuckeyana</i> * <i>Polynesicae et Sundaicae – Species anomalae</i> <i>E. glauca</i> <i>E. fidjiana</i> <i>E. norfolkiana</i> <i>E. plumerioides</i>	<i>E. norfolkiana</i> <i>E. piscatoria</i> <i>E. plumerioides</i> <i>E. regis-jubae</i> <i>E. stygiana</i> <i>E. tuckeyana</i> Subsect. <i>Galarrhoei</i> (Boiss.) Pax <i>E. usambarica</i> Sect. <i>Euphorbium</i> Boiss. Subsect. <i>Tirucalli</i> (Boiss.) Pax <i>E. dregeana</i> <i>E. gummifera</i> <i>E. lateriflora</i> <i>E. mauritanica</i> <i>E. tirucalli</i>		
<i>E. mellifera</i>				

Taula 3. Principals classificacions taxonòmiques de les espècies relacionades amb el grup *Pachycladae*.

Presenten fulles perennes, inflorescències amb pleocasi doble i bràctees dicasials grans (10 - 20 mm), fusionades almenys a la seva base, i llavors marcadament ornamentades. *Euphorbia atropurpurea* i *E. bravoana* són espècies de distribució vicariant a Tenerife i La Gomera, respectivament i *E. bourgeana* es troba a ambdues illes a l'oest de l'arxipèlag canari. Ocupen ambients mesòfils i meso-higròfils típics de laurisilva.

D'altra banda, el complex d'*E. lamarckii* inclou *E. anachoreta* Svent., *E. berthelotii*, *E. lamarckii*, *E. pedroi* Molero & Rovira, *E. piscatoria*, *E. regis-jubae* i *E. tuckeyana*. Són espècies de fulla caduca, inflorescència pleocasal simple, bràctees petites i lliures a la base i llavors de llises a rugoses. Es troben distribuïdes a l'arxipèlag canari (*E. berthelotii*, *E. lamarckii* i *E. regis-jubae*), Cap Verd (*E. tuckeyana*), Madeira (*E. piscatoria*), les illes Selvages (*E. anachoreta*), Sesimbra a la costa de Portugal (*E. pedroi*) i la costa est del Marroc (*E. regis-jubae*). Ocupen hàbitats xèrics i mesòfils d'altituds baixes i mitges.

1.1.4.2. Biogeografia

Nombrosos grups de plantes presenten una distribució disjunta entre el nord-oest, l'est i el sud d'Àfrica, la península Aràbiga i la Macaronèsia. Aquesta distribució és un dels patrons biogeogràfics més intrigants en la fitogeografia i el conjunt de grups de plantes amb aquesta distribució es denominen col·lectivament *Rand Flora* (Christ, 1892; Le Houérou, 1995). El cas més conegut dins la *Rand Flora* és el del gènere *Dracaena* Vand., del qual trobem dues espècies a la Macaronèsia (*D. draco* L. i *D. tamaranae* Marrero Rodr., R. S. Almeida & Gonz.-Mart.), i diverses espècies morfològicament relacionades a l'est d'Àfrica (*D. cinnabari* Balf. f., endèmica de l'illa de Socotra, *D. schizantha* Baker, endèmica de Somàlia i *D. serrulata* Perr., d'Àrabia, Iemen i Oman), però molts altres grups de plantes segueixen aquesta distribució disjunta africano-macaronèsica (*Hypericum* sect. *Webbia* (Spach) R. Keller i sect. *Campylosporus* (Spach) R. Keller, *Adenocarpus* DC., *Micromeria* Benth., *Canarina* L., *Campanula* subgènere *Campanula* L., *Aeonium* Webb & Berthel., el grup d'*Euphorbia balsamifera*, *Campylanthus* Roth, *Erica arborea* L.; revisat a Bramwell, 1985 i Andrus et al., 2004).

Diversos autors han explicat l'origen de la Rand Flora mitjançant dues hipòtesis alternatives. Els estudis florístics i ecològics tradicionals (Quézel, 1978; Sunding, 1979;

Bramwell, 1985; Médail & Quézel, 1999) i alguns estudis filogenètics més recents (Park et al., 2001; Moore et al., 2002; Andrus et al., 2004; Thiv et al., 2010), proposen la vicariança com a origen de la disjunció. El procés d'aridificació que es va produir gradualment en el sud de la Mediterrània i el nord d'Àfrica a partir del Miocè tardà i que va originar el desert del Sàhara (Axelrod, 1975) hauria provocat l'aïllament de dos centres de distribució a est i oest de l'actual desert del Sàhara, que a partir d'aquest moment hauria actuat com a barrera ecològica, desfigurant el que havia estat una flora contínua en el nord d'Àfrica en períodes pre-pliocènics. És evident que en el cas de les illes que constitueixen la Macaronèsia, un o diversos esdeveniments de dispersió des del continent haurien estat l'origen de la colonització en aquestes illes d'origen oceànic, però es parla de vicariança perquè la flora anterior als canvis climàtics del Pliocè hauria ocupat una franja més o menys contínua des de la Macaronèsia fins la banya d'Àfrica.

Per contra, altres autors proposen la dispersió com a explicació d'aquesta distribució disjunta. Thulin (1994), Francisco-Ortega et al. (1999), Carine (2005), Galley & Linder (2006) i Sanmartín et al. (2008) proposaren que l'actual distribució de la Rand Flora hauria estat resultat d'esdeveniments de dispersió a llarga o mitja distància més recents en períodes posteriors a l'aridificació del Sàhara, i més tard radiacions *in situ* haurien contribuït a la ràpida diversificació de les espècies als extrems del Sàhara. Diverses cadenes muntanyoses situades entre els gran centres de distribució actual (la serralada del Drakensberg al sud d'Àfrica i els massissos de Jebel Marra, Tassili, Tibesti i Hoggar al nord d'Àfrica) haurien pogut actuar com a esglaons o parades intermèdies durant la dispersió.

La flora sud-africana també s'ha relacionat amb la *Rand Flora* mitjançant la via migratòria anomenada *African track*, proposada per Linder et al. (1992). Dues direccions alternatives de migració podrien explicar aquest patró de distribució. Una proposta seria la migració direcció nord, amb l'origen de dispersió al sud d'Àfrica i des d'aquí la colonització de la zona Mediterrània via l'est d'Àfrica i finalment la Macaronèsia (Bellstedt et al., 2008; Galbany-Casals et al., 2009). Segons aquesta hipòtesi, la flora temperada de l'est d'Àfrica tindria el seu origen en els llinatges endèmics de la regió del Cap sud-africana.

L'altra hipòtesi proposa una migració direcció sud, des de l'est d'Àfrica cap al sud d'Àfrica i també cap a l'oest, a la Macaronèsia (Levyns, 1964; Axelrod & Raven, 1978;

McGuire & Kron, 2005). Així, alguns autors proposen que la flora sud-africana prové de la flora present al Nord d'Àfrica i a la Mediterrània durant el Terciari, i que actualment quedaria relict a en els marges continentals.

Si es confirmen les relacions filogenètiques obtingudes en estudis moleculars recents, el grup *Pachycladae* presentaria una distribució disjunta entre la Macaronèsia i la banya d'Àfrica, el sud de la península Aràbiga i el sud d'Àfrica, seguint el patró fitogeogràfic de la denominada *Rand Flora*.

La Macaronèsia és una regió biogeogràfica que comprèn cinc arxipèlags atlàntics d'origen volcànic (Açores, Madeira, Cap Verd, illes Selvages i illes Canàries) situats entre els 39°45' N, 31°17' W i els 14°49' N, 13°20' W i dues localitats continentals costaneres al Marroc i Portugal. L'origen de les illes macaronèsiques s'ha datat amb mètodes geoquímics i s'esté en un rang que va des dels 27 Ma (Selvagem Grande a illes Selvages; Geldmacher et al., 2001) als 1,77 Ma (El Hierro a illes Canàries; Carracedo et al., 2002).

El clima de la Macaronèsia és de tipus subtropical però té una gran influència del vents alisis, que en xocar amb les altes muntanyes d'origen volcànic descarreguen la seva humitat i condicionen la distribució de les comunitats vegetals.

La flora macaronèsica es caracteritza per tenir un component paleoendèmic, originari de mar de Tetis, format pels arbres i falgueres típics de laurisilva, que haurien sobreviscut al refredament climàtic del Pliocè-Pleistocè; un segon component neoendèmic que provindria de colonitzacions sobretot des d'Àfrica i la conca Mediterrània i que hauria diversificat *in situ*, i un tercer component d'espècies pròpies del Mediterrani (Fernández-Palacios et al., 2011).

Pel que fa a l'origen de grups de plantes macaronèsiques endèmiques, nombrosos autors han demostrat mitjançant eines moleculars que la diversificació d'espècies a les illes macaronèsiques s'ha produït en alguns casos després d'un únic esdeveniment de colonització (Francisco-Ortega et al., 1997, 1999, 2001; Helfgott et al., 2000; Allan et al., 2004), mentre que d'altres han detectat processos de colonització múltiples per un mateix grup de plantes (Cuénoud et al., 2000; Hess et al., 2000; Park et al., 2001; Percy et Cronk, 2002). Tot i la diversitat de resultats, sembla que uns pocs processos de colonització haurien originat la majoria de grups endèmics (Fernández-Palacios et al., 2011).

Els principals factors han intervingut en la composició de la singular flora macaronèsica són:

- La diversitat de distàncies dels diferents arxipèlags al continent (dels 96 km de Fuerteventura, a Canàries, als 1900 km de Flores, a les Azores) i entre elles marca una certa singularitat florística a cada arxipèlag i cada illa. Tot i així, les distàncies s'haurien pogut escurçar en diversos períodes per la presència d'illots ara submergits que haurien permès la dispersió esglaonada de les espècies (Fernández-Palacios et al., 2011).
- El paper de les illes macaronèsiques com a refugi durant les glaciacions del pleistocè que posteriorment va permetre la recolonització d'Àfrica i la Península Ibèrica, actuant com a font de biodiversitat (Vargas, 2007).
- La diversitat ecològica trobada entre els arxipèlags i les diferents illes de la Macaronèsia explicaria la diversificació de múltiples llinatges macaronèsics.
- L'adquisició de l'hàbit arbori com a caràcter derivat en moltes espècies insulars relacionades amb espècies herbàcies al continent, fenomen observat en diferents llinatges de diversos arxipèlags d'origen volcànic (Carlquist, 1974).
- Les freqüents esllavissades producte de l'activitat volcànica de les illes, especialment les illes Canàries, haurien provocat extincions massives o haurien originat espècies vicariants a banda i banda de la pertorbació (De Nascimento et al., 2009).

1.2. LA TRIBU *CARDUEAE*

1.2.1. Marc sistemàtic

La tribu *Cardueae* Cass. pertany a les *Compositae* Giseke o *Asteraceae* Berscht. & J. Presl., la família més gran en nombre d'espècies que es coneix dins les Angiospermes, amb 24000 espècies repartides en 1600 - 1700 gèneres (Funk et al., 2009). Atès al gran nombre d'espècies que inclou, la família comprèn una gran diversitat de formes vitals. Tot i que la gran majoria de *Compositae* són herbes anuals o perennes, també inclou arbusts, lianes, arbres i plantes suculentes. Les *Compositae* ocupen tot tipus d'hàbitats,

des de selves i deserts fins a prats alpins, però són més comunes en regions montanes, àrides o semiàrides de latituds subtropicals o temperades. El tret morfològic més característic de les *Compositae* és la inflorescència en capítol. Aquesta estructura està formada per un receptacle protegit per un involucre de bràctees on s'hi poden inserir dos tipus diferents de flors: els flòsculs i les lígules (Fig. 4), tot i que també poden tenir-ne només un dels dos tipus. Altres trets comuns definitoris de la família són les anteres, que es troben fusionades en forma d'anell al voltant de l'estil, i la presència de fruits tipus aqueni o cípsela, sovint acompanyats d'un papus o vilà (Fig. 5) que afavoreix la dispersió principalment anemòcora. Aquests trets morfològics, junt amb caràcters moleculars, han definit la família de les *Compositae* com a monofilètica (Funk et al., 2009). Un gran nombre d'espècies de la família té un gran interès econòmic o importància ecològica i d'altres han esdevingut espècies invasores.

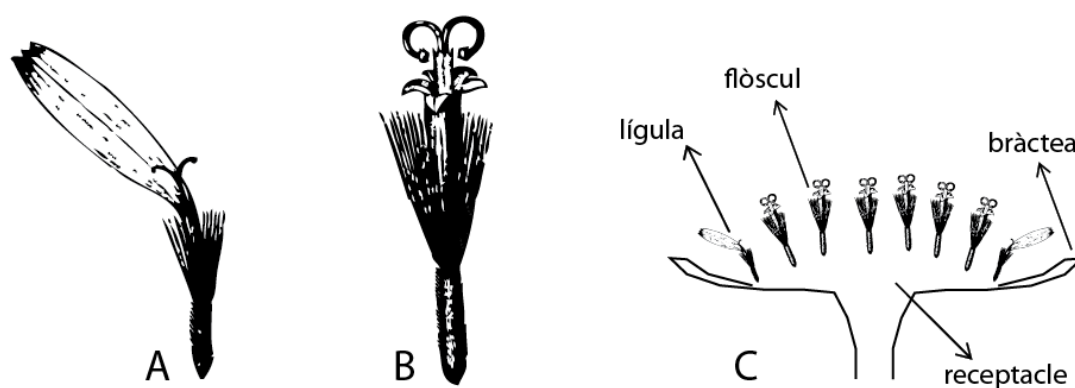

Fig. 4: Lígula (A), flòscul (B) i esquema de la disposició de les flors en un capítol típic d'una *Compositae* amb els dos tipus de flors (C), extret de Greenish (1920).

Cassini (1819) realitzà la primera classificació de les *Compositae* i establí 20 tribus. La classificació de Bentham (1873) sintetitzà les anteriors i establí 13 tribus. Carlquist (1976) i Wagenitz (1976) proposaren una reorganització en dues subfamílies (*Asteroideae* (Cass.) Lindl. i *Cichorioideae* (Juss.) Chevall.) i 16 tribus. Però la gran revolució en la sistemàtica i taxonomia de les *Compositae* no arribà fins a l'ús d'eines moleculars. Jansen & Palmer (1987) definiren una tercera subfamília (*Barnadesioideae* (D. Don) Bremer & Jansen), basal a la resta, gràcies a la presència d'una inversió en el DNA

cloroplàstic present a la resta de *Compositae* però absent en aquest grup i en altres plantes vasculares. Els estudis moleculars han anat modificant la classificació existent fins a les més recents publicacions de “metatrees” de les *Compositae* (Funk et al., 2005, 2009; Panero & Funk, 2008), una combinació d'arbres filogenètics parcials que ha mostrat que les tres subfamílies tradicionals són polifilètiques, establint 43 tribus repartides en 12 subfamílies monofilètiques.

La tribu *Cardueae* és un dels grups més nombrosos de les *Compositae*, ja que inclou unes 2400 espècies repartides en 73 gèneres (Susanna & Garcia-Jacas, 2009). Les *Cardueae* s'inclouen dins la subfamília *Carduoideae* Cass. ex Sweet junt amb les tribus *Dicomeae* Panero & V. A. Funk, *Oldenburgieae* S. Ortiz i *Tarchonantheae* Kostel. Aquestes tres tribus havien estat classificades de manera tradicional dins les *Mutiseae* Cass. però en van ser separades per criteris morfològics i moleculars (Panero & Funk, 2002). La tribu *Dicomeae* comprèn 7 gèneres que inclouen la majoria d'espècies d'Àfrica i Madagascar de les antigues *Mutiseae*. La tribu *Oldenburgieae* està formada per un únic gènere: *Oldenburgia* Less., endèmic de la regió sud-africana del Cap, mentre que la tribu *Tarchonantheae* comprèn dos gèneres: *Tarchonanthus* L. i *Brachylaena* R. Br., d'Àfrica tropical i la península Aràbiga.

Les relacions filogenètiques de les quatre tribus incloses dins les *Carduoideae* no s'han resolt en estudis moleculars recents, tot i que hi ha indicis que les tribus *Oldenburgieae* i *Tarchonantheae* constitueixen clades germanes (Ortiz, 2009).

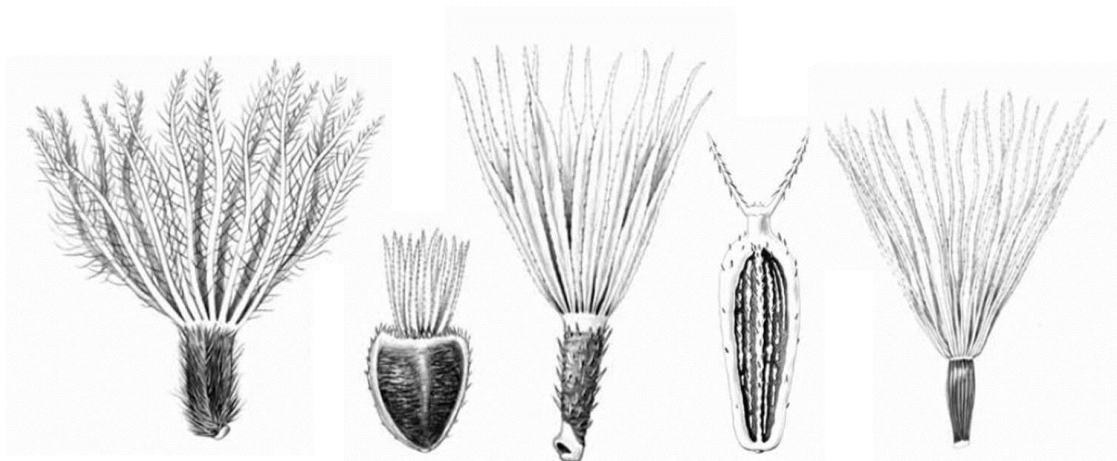

Fig. 5: Diversitat d'aquenis i papus característics de les *Compositae* (extret de Funk et al., 2005).

Les *Cardueae* són plantes herbàcies anuals, biennals o perennes, arbusts o més rarament arbres (Fig. 6). Són sovint espinescents, amb conductes resinífers a les arrels i

làtex a les parts aèries, en alguns casos. Les fulles presenten disposició alterna, les basals sovint agrupades en una roseta. Els capítols són solitaris o bé es disposen en inflorescències corimbiformes i rarament presenten una agregació en capítol de capítols. Les bràctees involucrals són multiseriades i sovint presenten apèndixs o espines. Els receptacles normalment contenen pàlees o pèls. Els capítols només presenten flòsculs i aquests normalment són tubulars i actinomorfs; rarament trobem lígules perifèriques als capítols (en els gèneres *Atractylis* L. i *Carlina* L.). Les anteres tenen la base caudada. L'estil presenta un engruiximent pilós característic sota la bifurcació. Els aquenís són molt variables, en general pilosos a les subtribus *Carlininae* (Cass.) Dumort., *Cardopatiinae* Less. i *Echinopsinae* (Cass.) Dumort, i glabres a les subtribus *Carduinae* Cass. i *Centaureinae* (Cass.) Dumort. Presenten papus d'esquames o setes, disposades en dues files en les *Centaureinae*. El pol·len és tricolporat, oblat, esfèric o prolat, espinós, verrucós, escàbrid o gairebé llis.

1.2.2. Estudis previs

La classificació subtribal de les *Cardueae* ha estat controvertida i revisada per diferents autors (Taula 4; Cassini, 1819; Bentham, 1873; Hoffman, 1894; Wagenitz, 1976; Dittrich, 1977). Cassini (1819) reconegué tres tribus independents: *Echinopseae* Cass., *Carlineae* Cass. i *Cardueae*. Aquesta última alhora comprenia les subtribus *Carduinae* i *Centaureinae*. Posteriorment, Bentham (1873) i Hoffman (1894) inclogueren les dues primeres dins les *Cardueae* com a subtribus *Echinopsidinae* i *Carlininae*. Aquests dos grups han estat considerats com a tribus independents de les *Cardueae* o com a subtribus dins d'aquestes, segons els autors (Wagenitz, 1976; Dittrich, 1977; Bremer, 1994; Petit, 1997).

Els estudis moleculars més recents estableixen les *Cardueae* com a grup monofilètic (Susanna et al., 1995, 2006; Garcia-Jacas et al., 2002) i reconeixen cinc subtribus dins les *Cardueae*: *Cardopatiinae*, *Carduinae*, *Carlininae*, *Centaureinae* i *Echinopsinae*. Les subtribus *Carduinae*-*Centaureinae* tenen un origen comú i es defineixen com a grup troncal i més derivat dins les *Cardueae*. Segons aquests resultats, les *Carduinae* constitueixen un grup parafilètic. Tot i així, es considera que una nova

circumscripció del grup *Carduinae-Centaureinae* prioritzant la monofília fóra impracticable pel gran nombre d'espècies que pertanyen a aquestes dues subtribus ja que representen el 90% de totes les *Cardueae* (Susanna et al., 2006).

Cassini (1819)	Bentham (1873) i Hoffman (1894)	Wagenitz (1976)	Susanna et al. (2006)
Tribu <i>Carlineae</i>	Tribu <i>Cardueae</i>	Tribu <i>Cardueae</i>	Tribu <i>Cardueae</i>
Tribu <i>Cardueae</i>	Subtribu <i>Carduinae</i>	Subtribu <i>Carlininae</i>	Subtribu <i>Cardopatiinae</i>
Subtribu <i>Carduinae</i>	Subtribu <i>Carlininae</i>	Subtribu <i>Carduinae</i>	Subtribu <i>Carduinae</i>
Subtribu <i>Centaureinae</i>	Subtribu <i>Centaureinae</i>	Tribu <i>Echinopsidae</i>	Subtribu <i>Carlininae</i>
Tribu <i>Echinopinae</i>	Subtribu <i>Echinopsidinae</i>		Subtribu <i>Centaureinae</i> Subtribu <i>Echinopinae</i>

Taula 4. Principals classificacions subtribals de les *Cardueae*.

Les relacions filogenètiques entre les subtribus basals (*Cardopatiinae*, *Carlininae* i *Echinopsinae*) no s'han pogut resoldre mitjançant mètodes filogenètics pel poc suport que presenten les clades basals.

En el treball més exhaustiu de la tribu *Cardueae* fins al moment (Susanna et al., 2006) es definiren grups informals útils per tractar grups monofilètics. Aquesta classificació serà utilitzada en aquest treball per la facilitat que dona a l'hora de tractar clades naturals que inclouen gèneres tan extensos com *Centaurea* L. (250 espècies), *Cirsium* Mill. (250 espècies), *Cousinia* Cass. (600 espècies), *Jurinea* Cass. (200 espècies) o *Saussurea* DC. (300 espècies). Dins les *Cardueae*, la subtribu *Centaureinae* és una de les més estudiades i un dels aspectes més controvertits ha estat la circumscripció del gènere *Centaurea*, que ha passat d'incloure de 700 a 400 espècies (Garcia-Jacas et al., 2001). Els mètodes moleculars finalment han donat llum a aquest i d'altres aspectes (Garcia-Jacas et al., 2001) tot i que les relacions filogenètiques entre els gèneres basals dins aquesta subtribu no s'han pogut resoldre.

1.2.3. Biogeografia

El reconeixement de la subfamília *Barnadesioideae*, endèmica del sud d'Amèrica del Sud, com a grup germà a la resta de *Compositae* (Jansen & Palmer, 1987, 1988; Kim &

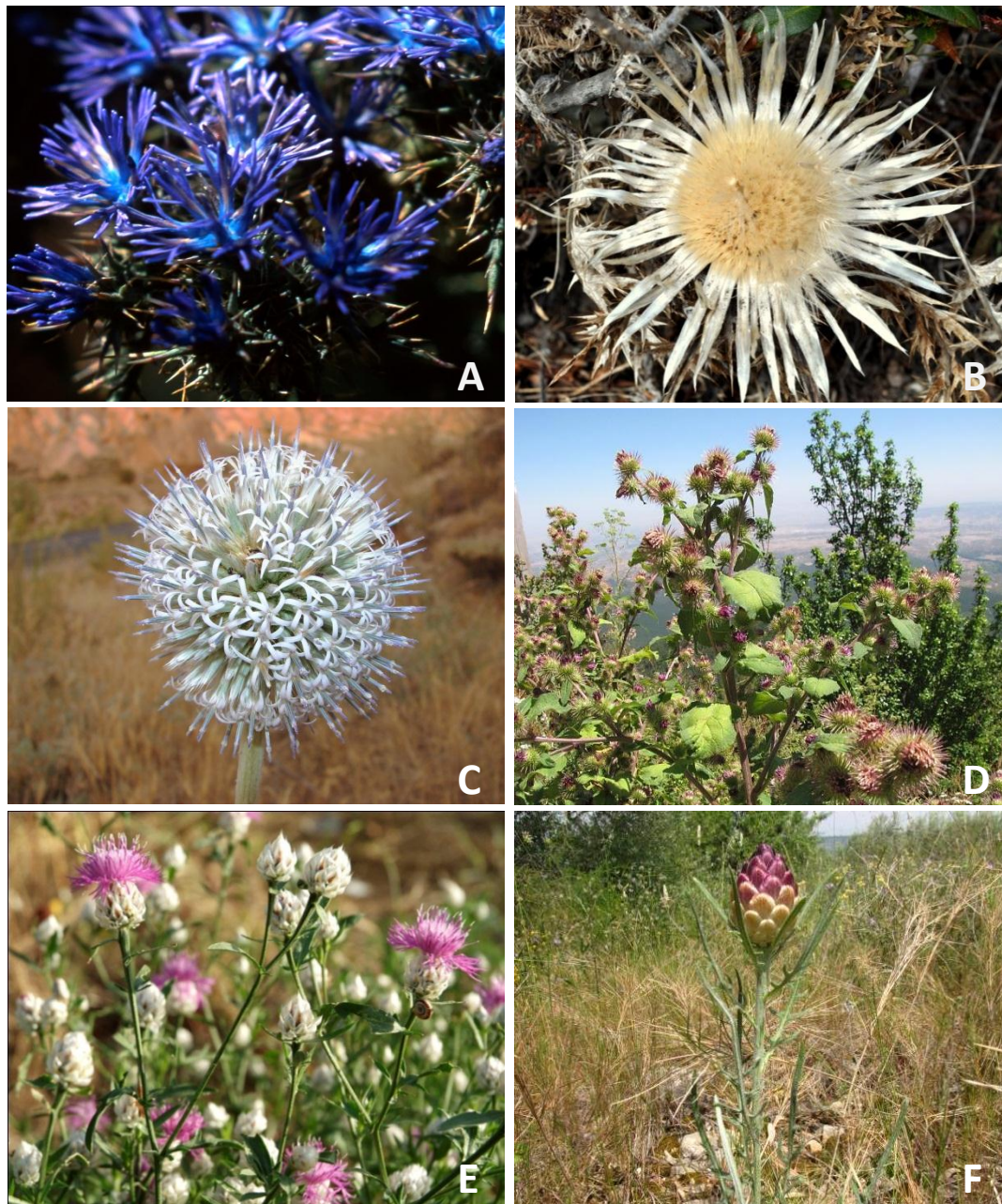

Fig. 6: Diversitat dins la tribu *Cardueae*. A: *Cardopatum corymbosum* Pers., subtribu *Cardopatiinae* (A. Susanna); B: *Carlina acanthifolia* All., subtribu *Carlininae* (L. Barres); C: *Echinops orientalis* Trautv., subtribu *Echinopinae* (L. Barres); D: *Arctium minus* Bernh., subtribu *Carduinae* (L. Barres) i E: *Centaurea deusta* Tem. i *Rhaponticum coniferum* (L.) Greuter, subtribu *Centaureinae* (L. Barres).

Jansen, 1995; Kim et al., 2002), va permetre situar l'origen de les *Compositae* a Amèrica del Sud. Aquesta hipòtesi es confirma pel fet que el grup germà de les *Compositae*, la família *Calyceraceae* R. Br. ex Rich., també es troba a Amèrica del Sud (Funk et al., 2009). L'origen africà de la majoria de tribus basals de les *Compositae* suggereix que des

d'Amèrica del Sud es va produir una radiació al continent africà, però com que les relacions filogenètiques entre aquestes clades no ha estat resolta, l'origen de la radiació africana no es pot confirmar (Funk et al., 2009). Posteriorment, les *Compositae* van colonitzar la resta de continents. La seva distribució és cosmopolita a excepció de l'Antàrtic, tot i que la seva diversitat es concentra a les àrees tropicals i subtropicals d'Amèrica el Nord, els Andes, Sud-Àfrica, Àsia central, el sud-oest de la Xina i la regió Mediterrània. Es considera que les *Compositae* es van originar fa uns 50 Ma i que la majoria de tribus actuals ja s'haurien originat cap al final de l'Oligocè (25-22 Ma). L'èxit evolutiu de les *Compositae* està relacionat amb alguns trets característics de la família: la presència de metabòlits secundaris, la plasticitat d'hàbit, la disposició en capítol de les flors i la poliploidia.

La subfamília *Carduoideae* presenta una distribució disjunta entre l'Àfrica i la conca Mediterrània. Les tribus ancestrals a les *Cardueae* (*Dicomeae*, *Tarchonantheae* i *Oldenburgieae*) són originàries de l'Àfrica però les *Cardueae* són de distribució asiàtica i circummediterrània. Les hipòtesis biogeogràfiques, però, no es poden contrastar amb una datació ja que l'origen de les *Cardueae* no s'ha datat mai mitjançant mètodes moleculars. Les *Cardueae* concentren la major diversitat d'espècies als extrems orientals i occidentals de la conca Mediterrània, l'oest de la regió Irano-Turaniana i el nord d'Àfrica. Tot i així, les *Cardueae* han colonitzat tots els continents. Els gèneres *Carduus* L., *Cirsium*, *Centaurea* i sobretot *Echinops* L. arriben a l'Àfrica tropical. *Cirsium*, *Plectocephalus* D. Don i *Saussurea* són nadius principalment d'Amèrica del Nord i *Plectocephalus* i *Centaurodendron* Johow principalment d'Amèrica del Sud. El gènere *Rhaponticum* Vaill. es troba a Austràlia. Alguns gèneres dins les *Cardueae* presenten distribucions disjunctes molt particulars: entre Austràlia i Euràsia (*Rhaponticum*), entre Àfrica-Euràsia i Amèrica del Nord (*Cirsium*) i entre l'est d'Àfrica i el continent americà (*Plectocephalus*).

Aquesta última disjunció, dins la subtribu de les *Centaureinae*, és força especial i ha despertat el nostre interès. El gènere *Plectocephalus* comprèn una espècie a Etiòpia (*P. varians* (A. Rich.) C. Jeffrey in Cufod.), dues a Amèrica del Nord (*P. americanus* D. Don i *P. rothrockii* (Greenm.) D. J. N. Hind) i una més a Amèrica del Sud (*P. chilensis* G. Don ex Loudon). Altres espècies de *Centaurea* d'Amèrica del Sud són morfològicament properes a *Plectocephalus* i cal investigar la seva relació filogenètica amb aquest gènere (*C. cachinalensis* Phil., *C. floccosa* Hook. & Arn. i *C. tweediei* Hook. & Arn.). Ahora,

Plectocephalus està considerat morfològicament i biogeogràficament proper al gènere *Centaurodendron* (Carlquist, 1958; Nordenstam & El-Ghazaly, 1977; Hellwig, 2004), l'únic gènere de les *Centaureinae* endèmic d'Amèrica, que comprèn tres espècies endèmiques de les illes Juan Fernández.

1.3. LA SISTEMÀTICA MOLECULAR

La sistemàtica és la ciència que estudia l'origen i la diversitat dels éssers vius al llarg del temps. L'objectiu de la sistemàtica és comprendre la història de la vida a la Terra i també classificar la diversitat d'organismes en grups que reflecteixin l'evolució de les espècies. La sistemàtica utilitza diverses eines per reconstruir les relacions evolutives entre les espècies com poden ser els caràcters morfològics, bioquímics, palinològics, citològics, biogeogràfics, etc. En les darreres dècades, l'ús d'eines moleculars ha provocat una revolució dins el camp de la sistemàtica, que ha vist com molts dels grups establerts mitjançant mètodes tradicionals es veien modificats.

La filogènia molecular reconstrueix l'evolució dels éssers vius mitjançant dades moleculars, com són les proteïnes, l'RNA o el DNA. Aquesta disciplina ha experimentat un progrés molt important gràcies al desenvolupament de la tecnologia, que ha permès obtenir seqüències del genoma de manera molt més ràpida i eficient i gràcies al desenvolupament d'eines informàtiques d'inferència filogenètica, que faciliten l'anàlisi i la interpretació d'aquestes dades moleculars.

Tot i així, les dades moleculars no són les úniques que ens permeten establir arbres evolutius; cal combinar-les amb l'estudi de dades morfològiques per reconstruir l'evolució de les espècies. L'ús exclusiu de caràcters moleculars pot portar a reconstruccions no naturals, ja que aquests poden ser objectes de fenòmens d'homoplàsia (convergències evolutives i paral·lelismes) o poden establir grups no naturals si enlloc de gens ortòlegs (aquells que provenen d'un procés d'especiació) s'utilitzen gens paràlegs (aquells que provenen d'un procés de duplicació gènica).

De totes maneres, el fenomen d'homoplàsia també pot enterbolir les classificacions establertes exclusivament mitjançant caràcters morfològics, i els caràcters moleculars ofereixen una sèrie d'avantatges que les eines tradicionals no tenen: (1) l'enorme quantitat dels quals disposem, (2) la facilitat d'interpretació de les dades

moleculares, (3) es poden utilitzar per comparar qualsevol tipus d'organisme degut a la pràctica universalitat del codi genètic i (4) normalment evolucionen de manera molt més regular que els caràcters morfològics (Graur & Li, 1999; Nei & Kumar, 2000).

1.3.1. Mètodes de reconstrucció filogenètica

Els marcadors moleculars que s'utilitzen per establir relacions evolutives entre plantes són bàsicament seqüències de DNA que poden provenir de diferents genomes: el DNA nuclear, el DNA cloroplàstic o el DNA mitocondrial. Els dos primers són els més utilitzats per reconstruir arbres filogenètics de grups de plantes ja que el mitocondrial presenta moltes reestructuracions (Palmer, 1992). El DNA nuclear és d'herència biparental, és a dir, inclou informació tant del pare com de la mare i per això els marcadors nuclears són els més populars a l'hora de resoldre filogènies a nivell interespecífic. La regió del genoma ribosòmic nuclear no codificant de l'ITS (*Internal Transcribed Spacer*) és la més utilitzada per inferir les relacions evolutives entre la majoria de gèneres d'Angiospermes (Baldwin et al., 1995) i també en les *Cardueae* (Susanna et al., 2006) i les *Euphorbiaceae* (Molero et al., 2002; Steinmann & Porter, 2002; Bruyns et al., 2006; Zimmermann et al., 2010; Horn et al., 2012). Aquesta regió ribosòmica presenta una sèrie d'avantatges davant d'altres marcadors: (1) s'amplifica fàcilment pel mètode de la PCR gràcies a l'elevat nombre de còpies en què es troba al genoma, (2) els encebadors que s'utilitzen per la seva amplificació són universals en plantes i fongs, (3) té molt poca variabilitat a nivell individual a causa de fenòmens d'evolució concertada, que homogeneïtzen les diferents còpies existents al genoma (Álvarez & Wendel, 2003) i (4) té la suficient variabilitat per inferir relacions evolutives a nivell genèric, específic o fins i tot a nivell de família (Baldwin, 1992).

El DNA cloroplàstic és d'herència uniparental i normalment és heretat per via materna. S'han utilitzat diverses regions cloroplàstiques codificants per inferir relacions a nivells taxonòmics supragenèrics ja que aquestes tenen una pressió selectiva major que les regions no codificants i són per tant més conservades. En el cas de les *Euphorbiaceae* s'han utilitzat les regions *ndhF*, *rbcL* i *trnL-trnF* (Steinmann & Porter, 2002; Wurdack et al., 2005; Bruyns et al., 2006; Park & Jansen, 2007; Zimmermann et al., 2010; Horn et al., 2012) i en el cas de les *Compositae* els marcadors cloroplàstics més utilitzats són *matK*,

ndhF i *rbcL* (Kim & Jansen, 1995; Panero & Funk, 2002, 2008; Susanna et al., 2006; Wagstaff et al., 2006).

Els mètodes d'anàlisi de seqüències de DNA per inferir relacions filogenètiques més usats actualment són la Màxima Parsimònia (MP) i la inferència Bayesiana (IB; Huelsenbeck & Ronquist, 2001). La MP es basa en el concepte de parsimònia: les hipòtesis més simples són preferibles a les hipòtesis que impliquin un gran nombre d'assumpcions. Les millors reconstruccions filogenètiques són doncs les que impliquen un nombre menor de processos evolutius per explicar una topologia concreta d'un arbre filogenètic. Aquest mètode selecciona l'arbre que presenti el menor nombre de canvis de caràcters per explicar les dades observades. La MP només utilitza els caràcters informatius de les seqüències de DNA, que són els canvis compartits per almenys dos individus. Amb tots els arbres més parsimoniosos obtinguts es construeix un arbre consens. Per calcular el suport estadístic de les branques de l'arbre consens s'utilitza sobretot la tècnica de remostreig bootstrap (BS; Felsenstein, 1985), que ens dóna informació sobre la fiabilitat de cada clada resultant. El remostreig es realitza per múltiples rèpliques i es mira en quin percentatge de rèpliques apareix cada clada obtinguda. La MP pot produir arbres de topologia esbiaixada a causa del fenomen de l'atracció de branques llargues, segons el qual les branques llargues tendeixen a aparèixer unides en els arbres tot i no estar relacionades filogenèticament.

La IB és un mètode probabilístic, és a dir que es basa en una funció que calcula la probabilitat d'obtenir una hipòtesi evolutiva concreta que expliqui les dades observades. Aquest mètode permet la incorporació de models probabilístics que estimen els processos d'evolució molecular mitjançant diferents models evolutius, que descriuen principalment les taxes de mutació entre nucleòtids i la freqüència de cada nucleòtid. El suport estadístic de les clades obtingudes es calcula a partir de la probabilitat posterior (PP) d'un arbre filogenètic, és a dir, la probabilitat que una hipòtesi evolutiva sigui la correcta donada una determinada matriu de dades i seguint un model evolutiu determinat. La IB cerca el grup d'arbres que presentin una PP més elevada mitjançant la fórmula matemàtica de Bayes, que combina l'algoritme de versemblança amb la PP. L'estima de la PP es calcula mitjançant el mètode Markov Chain Monte Carlo (MCMC), que realitza quatre cerques independents que exploren la distribució de la probabilitat posterior. La PP pot ser sobreestimada respecte als valors de BS (Suzuki et al., 2002).

1.3.2. Mètodes de datació molecular

La hipòtesi del rellotge molecular es basa en el fet que les diferències genètiques entre dues espècies augmenten al llarg del temps a partir de la seva separació com a llinatges independents. Així, el rellotge molecular permet establir una escala temporal pels processos evolutius del passat i es converteix en una eina imprescindible per establir la cronologia de processos d'especiació, dispersió i migració. A més, possibilita el càlcul de taxes d'especiació i extinció sobre un arbre de reconstrucció filogenètica. Els primers mètodes de datació molecular es basaven en la teoria del rellotge molecular per calcular l'edat de divergència entre tàxons mesurant les distàncies genètiques entre aquests, que es convertien en temps mitjançant l'ús d'una taxa de mutació (nombre de canvis esperats en les bases nucleotídiques per unitat de temps).

La hipòtesi del rellotge molecular va permetre datar els processos d'especiació sota l'assumpció que la taxa de mutació de les seqüències de DNA era constant al llarg del temps i que espècies properes tenien la mateixa taxa de mutació. Així, un sol punt de calibració sobre un arbre filogenètic (un fòssil o algun esdeveniment geològic com la separació de continents o l'aparició d'una illa oceànica o serralada) i una taxa de mutació per a la regió del DNA utilitzada eren suficients per realitzar una datació molecular i obtenir una data absoluta de l'aparició d'una espècie.

En els darrers anys, però, s'ha desenvolupat la teoria del rellotge molecular relaxat, que afirma que la taxa de mutació no és constant i pot canviar al llarg del temps, entre tàxons germans, entre diferents regions del DNA o fins i tot dins el mateix tàxon.

Els mètodes de datació molecular basats en la teoria del rellotge molecular relaxat assumeixen que la taxa de mutació varia al llarg del temps però que alhora s'hereta i per tant és semblant entre tàxons evolutivament propers (Gillespie, 1986). Actualment existeixen diversos mètodes de datació molecular que incorporen aquesta assumpció anomenada d'autocorrelació, que permet l'heterogeneïtat entre les taxes de mutació. Alguns dels mètodes de datació més usats són:

- PATHd8 (Britton et al., 2007): és un model no paramètric que minimitza la diferència de les taxes de mutació entre grups germans.

- *Penalized Likelihood* (PL) implementat a r8s (Sanderson, 2002): és un model de datació basat en el mètode estadístic de la màxima versemblança. Utilitza una aproximació semiparamètrica, ja que inclou models de substitució nucleotídica explícits per als canvis en les taxes de mutació però alhora penalitza els canvis bruscs entre branques properes.
- BEAST (Drummond et al., 2006): és un model bayesià que assumeix que no existeix cap correlació entre les taxes de mutació i les calcula de manera independent, a la vegada que infereix la tipologia de l'arbre filogenètic.

1.3.3. Mètodes de reconstrucció biogeogràfica

La biogeografia estudia la distribució de les espècies al llarg del temps i els processos que han intervingut en l'actual distribució dels organismes. Les aplicacions de la biogeografia són diverses, des d'identificar patrons generals de la distribució dels organismes, identificar àrees relictas de distribució d'un determinat llinatge fins a predir escenaris futurs de distribució.

Els primers mètodes de reconstrucció biogeogràfica es basaven en la biogeografia cladista, una disciplina que té l'objectiu de detectar patrons generals de distribució, sense explicar quins processos biogeogràfics els poden haver causat. Aquests mètodes es basen principalment en la vicariança per explicar distribucions disjunctes i no tenen en compte la dispersió o l'extinció en les seves reconstruccions. En els darrers anys han sorgit altres mètodes d'inferència biogeogràfica que incorporen aquests altres processos biogeogràfics per explicar la història de la distribució d'un grup d'espècies emparentades a partir de les àrees ancestrals de distribució d'aquell llinatge concret.

Un dels mètodes més àmpliament utilitzats per a la reconstrucció biogeogràfica ha estat l'anàlisi de dispersió - vicariança (Ronquist, 1997) implementat en el programa DIVA (Ronquist, 1996), un mètode basat en màxima parsimònia que estableix quin esdeveniment biogeogràfic (dispersió, vicariança o extinció) és més probable a cada node de l'arbre. El mètode DIVA requereix disposar d'un arbre filogenètic totalment resolt i això suposa una gran limitació per la gran proporció de filogènies amb alguna politomia en la seva tipologia. D'altra banda, DIVA presenta un problema en la

reconstrucció d'àrees ancestrals dels nodes basals dels arbres filogenètics i és que tendeix a inferir múltiples àrees ancestrals igualment probables quan hi ha clades amb espècies àmpliament distribuïdes. Les limitacions de DIVA han millorat amb programa Bayes - DIVA (Nylander et al., 2008) ja que aquest permet incorporar la incertesa de les relacions filogenètiques a la reconstrucció biogeogràfica. Bayes - DIVA utilitza una aproximació bayesiana a l'anàlisi de dispersió - vicariança inferint les àrees ancestrals de cada node d'especiació utilitzant DIVA sobre una distribució probabilística d'arbres, resultant de l'anàlisi MCMC filogenètica i que representen la distribució posterior de la filogènia, i així s'evita el problema de les politomies. D'aquesta manera, s'obté per a cada node de l'arbre filogenètic la probabilitat marginal de totes les possibles àrees ancestrals, integrant per una banda la incertesa de les relacions evolutives i per l'altra, la incertesa de la reconstrucció biogeogràfica.

Altres mètodes de reconstrucció biogeogràfica es basen en el mètode de la màxima versemblança, com és el cas de Lagrange (Ree et al., 2005; Ree & Smith, 2008), que permet reconstruir les àrees ancestrals de distribució de les espècies alhora que calcula les seves taxes de dispersió i extinció. Aquest mètode permet incorporar informació sobre la disponibilitat de connexió entre les àrees de distribució assignades a les espècies o sobre el temps de divergència entre espècies assignant probabilitats prèvies de presència en àrees ancestrals a l'anàlisi. L'avantatge d'aquest mètode és que permet afavorir la dispersió - vicariança d'espècies germanes distribuïdes per exemple en àrees contigües i penalitzar la dispersió entre àrees sense contacte durant el temps geològic d'evolució del llinatge o incorporar altres restriccions que tinguin en compte la història geològica de les espècies.

1.3.4. Mètodes de reconstrucció filogeogràfica

La filogeografia estudia la diversitat genètica de les poblacions o d'espècies molt properes amb l'objectiu de reconstruir la seva història evolutiva i explicar la distribució actual dels diversos llinatges genètics (Avise et al., 1987). L'estructura genètica de les poblacions ve determinada per factors genètics (deriva genètica i flux gènic) o bé per esdeveniments biogeogràfics (migració, dispersió, fragmentació de l'hàbitat, processos de colls d'ampolla, extinció de llinatges...). L'enfocament filogeogràfic permet incorporar

els processos biogeogràfics a la genètica de poblacions clàssica que es basa únicament en processos d'intercanvi genètic i així establir les causes dels processos de radiació i la distribució actual dels organismes.

El desenvolupament d'aquesta disciplina ha anat lligat a l'aparició de noves tècniques de seqüenciació i al desenvolupament de la teoria de coalescència, que explica la incorporació de nous al·lels a les poblacions per la teoria de la neutralitat. És a dir que en una població de mida constant hi ha alguns al·lels que apareixen per mutació i altres que desapareixen per deriva genètica però tots deriven d'un mateix al·lel ancestral. Així, la teoria de la coalescència estableix un marc conceptual que permet estudiar els processos evolutius a nivell poblacional mitjançant una genealogia de gens.

Per tal d'inferir la diversitat i l'estructura genètica de les poblacions en els estudis filogeogràfics és necessari utilitzar marcadors que presentin variabilitat molecular a nivell infraespecífic. Altres requisits dels marcadors moleculars utilitzats en el camp de la filogeografia és que no recombinin, per això la majoria d'estudis filogeogràfics utilitzen marcadors d'herència citoplasmàtica no mendeliana, com el DNA mitocondrial. Els primers estudis van ser en animals i aquesta regió del genoma tenia les característiques necessàries per establir l'estructura genètica a nivell poblacional: presenta una elevada variació intraespecífica, és d'herència uniparental i no presenta recombinació genètica. En plantes, però, el DNA mitocondrial no és útil per obtenir l'estructura genètica de les poblacions perquè evoluciona més lentament que les seqüències nucleotídiques que s'utilitzen per establir filogènies (Avice, 2000). En canvi, el DNA cloroplàstic presenta variació i és utilitzat de manera freqüent per establir xarxes d'haplotips d'aplicació en filogeografia. Tot i així té una taxa de substitució nucleotídica baixa i sovint no permet establir l'estructura genètica en grups de plantes amb una evolució ràpida i recent (Meudt & Clarke, 2007), com passa en grups d'illes oceàniques. Actualment, un dels marcadors més àmpliament utilitzats per conèixer l'estructura genètica de plantes a nivell infraespecífic són els AFLP (*Amplified Fragment Length Polymorphisms*). Els AFLP són fragments de DNA tallats a l'atzar per un parell d'enzims de restricció i amplificats després amb encebadors específics que proporcionen un perfil de fragments o petjada genètica diferent per a cada individu. El nombre de fragments generats és variable degut a la variabilitat genètica dels individus, marcada per la disponibilitat al genoma de llocs de restricció i de llocs d'unió dels encebadors específics. Cada fragment visualitzat en el

perfil de cada individu correspon a un locus. Els al·lels de cada locus corresponen a l'absència o presència de cada fragment i això fa que els AFLP siguin marcadors dominants, és a dir que podem conèixer l'absència o presència d'un al·lel però no podem distingir entre individus homozigots o heterozigots. S'assumeix que els fragments de la mateixa mida tenen la mateixa posició al genoma i que per tant són homòlegs i així podem obtenir informació sobre l'estructura i diversitat genètica de les poblacions. Tot i així, conceptualment els AFLP no són els més adients per estudiar la filogeografia d'un grup, ja que en no poder llegir les seqüències de DNA de cada fragment, no podem estar segurs de l'homologia entre individus. A més, tot i que els AFLP incorporen DNA de tots els orgànuls de la cèl·lula, el que predomina és el nuclear ja que és el més abundant i per tant no seguirien la teoria de la coalescència. De totes formes, són cada cop més nombrosos els estudis filogeogràfics de grups de plantes que utilitzen els AFLPs combinats amb marcadors del genoma cloroplàstic (Dixon et al., 2009, Calviño-Cancela et al., 2012; Galbany-Casals et al., 2012; Jiménez-Mejías et al., 2012), ja que sovint les seqüències cloroplàstiques no proporcionen prou informació (Mendelson & Shaw, 2005) i els AFLP aporten una gran variabilitat a nivell infraespecífic per l'enorme quantitat de loci que generen. A més, des del punt de vista de la metodologia, els AFLP són força rendibles, ja que no es necessita informació prèvia sobre la seqüència de DNA del grup per dissenyar els encebadors, es poden obtenir una gran quantitat de marcadors en un període curt de temps i la quantitat de DNA requerida és mínima.

A més d'utilitzar-se en filogeografia, els AFLP també tenen aplicació en estudis de taxonomia, de genètica de poblacions i de biologia de la conservació d'espècies amenaçades, entre d'altres.

1.4. JUSTIFICACIÓ DEL PRESENT TREBALL

La present tesi doctoral té la sistemàtica molecular, la biogeografia i la filogeografia moleculars com a eixos vertebradors. Pel que fa a la sistemàtica, tradicionalment s'han utilitzat caràcters molt diversos per establir classificacions dels éssers vius que reflectissin les relacions evolutives entre les espècies. Però en les darreres dècades, l'ús de caràcters moleculars, la generació de nous mètodes d'inferència filogenètica, i el perfeccionament de la bioinformàtica han provocat una

evolució dins d'aquesta disciplina, ja que molts dels grups establerts mitjançant mètodes tradicionals s'han vist modificats substancialment un cop s'han vist revelades les seves afinitats evolutives mitjançant aquesta nova aproximació. Tant seqüències del DNA, nuclear i cloroplàstic, com marcadors de tipus hipervariables com els AFLP, s'utilitzen actualment en aquesta disciplina, i han estat els marcadors triats per desenvolupar els objectius d'aquesta tesi.

L'estudi de la biogeografia ha experimentat també grans canvis en els darrers anys, basant-se de manera essencial en els mateixos tipus de marcadors moleculars. En aquest camp, el desenvolupament del concepte de rellotge molecular relaxat i la creació de nous mètodes d'anàlisi que l'incorporen ha marcat una fita important en la història d'aquesta disciplina, així com el desenvolupament de mètodes pròpiament de reconstrucció biogeogràfica cada vegada més complexos, com les anàlisis de Dispersió-Vicariància perfeccionades amb una aproximació Bayesiana.

A nivell infraspecífic, el recent naixement de la filogeografia ha permès incorporar els processos biogeogràfics –l'estudi de la història evolutiva i la distribució geogràfica dels llinatges genètics– a la genètica de poblacions clàssica, ampliant horitzons a l'hora d'interpretar l'origen i diversificació de grups d'espècies propers i determinar els processos que han intervingut en la seva distribució actual. Addicionalment, els marcadors hipervariables AFLP, molt utilitzats en plantes en aquest camp, ofereixen informació genotípica molt útil que, combinada amb dades morfològiques, permeten una nova reinterpretació de la taxonomia.

Per a aquesta tesi doctoral s'han seleccionat dos grups principals de plantes, que pertanyen a dues famílies diferents: una part del gènere *Euphorbia*, que pertany a la família de les *Euphorbiaceae*, i la tribu *Cardueae*, que pertany a la família de les *Compositae*. Aquests dos grups s'han triat perquè inclouen un gran nombre d'espècies i perquè presenten interessants qüestions a resoldre tant en el camp de la sistemàtica com en els de la biogeografia i filogeografia, i que ens permetran comprovar l'aplicabilitat dels mètodes més actuals i contrastar-ne els resultats amb les propostes més tradicionals.

En el cas del gènere *Euphorbia* s'ha escollit el subgènere *Esula*, i en concret un grup inclòs en aquest subgènere, el grup *Pachycladae*. Diversos treballs taxonòmics previs basats en caràcters morfològics i diversos estudis moleculars més recents

manifestaven que la circumscripció i les afinitats filogenètiques d'aquest grup i altres grups d'espècies relacionades, entre ells la secció *Tirucalli*, no eren clares. Tot i així, el mostreig representat era insuficient. Així, el primer article de la tesi té com a objectiu principal recircumscriure aquests grups incloent a l'estudi la majoria de representants i establir-ne una nova classificació taxonòmica que reflecteixi les relacions filogenètiques de les espècies implicades. Aquest treball s'ha realitzat mitjançant anàlisis filogenètiques de Màxima Parsimònia i d'Inferència Bayesiana de seqüències de DNA nuclear i cloroplàstic. El segon objectiu d'aquest primer article és, a partir de les relacions filogenètiques obtingudes, confirmar si el grup estudiat segueix el paradigmàtic patró fitogeogràfic de la denominada *Rand Flora*, que inclou grups molt diversos de plantes que presenten una distribució disjunta entre la Macaronèsia, la banya d'Àfrica, el sud de la península Aràbiga i el sud d'Àfrica, i explicar les possibles causes d'aquesta distribució.

El grup *Pachycladae* inclou nombroses espècies distribuïdes en quatre dels cinc arxipèlags macaronèsics i en les dues localitats continentals d'aquesta regió. S'ha estudiat l'origen d'aquest grup, i els processos de dispersió i patrons d'especiació implicats. Són nombrosos els estudis biogeogràfics que s'han centrat en grups de distribució principalment macaronèsica per les particularitats de la flora d'aquests arxipèlags. Tot i així, la majoria d'estudis se centren en un o pocs arxipèlags. És per això que s'ha escollit aquest grup d'espècies macaronèsiques per estudiar-ne la filogeografia amb l'ús de marcadors AFLP. A més, el fet que existeixin propostes taxonòmiques prèvies basades en morfologia permet contrastar-les amb els resultats obtinguts amb els AFLP.

En el cas de la tribu *Cardueae* ja existien diverses filogènies moleculars publicades, però aquestes, tot i que aportaven informació cabdal sobre la sistemàtica i l'evolució d'aquest gran grup de les Compostes, tenien encara algunes mancances pel que fa al mostreig i a la resolució dels grups basals. El tercer article de la tesi té com a un dels objectius construir una nova filogènia molecular basada en més marcadors moleculars, en aquest cas diverses regions del DNA cloroplàstic i nuclear, i un mostreig més exhaustiu que els treballs anteriors, per tal de respondre algunes de les qüestions sistemàtiques encara no resoltes. Però l'objectiu principal d'aquest treball és la reconstrucció biogeogràfica d'aquesta tribu, que presenta una distribució subcosmopolita i diversos exemples d'interessants disjuncions entre àrees llunyanes. Aquest treball inclou diverses novetats metodològiques, aplicades sobre la filogènia

molecular obtinguda, que el fan particularment valuós: l'ús de fòssils recentment descoberts i del concepte de rellotge molecular relaxat en la datació molecular de la tribu, i l'ús de mètodes bayesians en la reconstrucció biogeogràfica.

Dins de les *Cardueae* s'ha escollit també un grup d'espècies particular per al darrer treball inclòs a la tesi, perquè presenta problemes taxonòmics i també una distribució geogràfica excepcional. El grup inclou el gènere *Plectocephalus*, amb espècies a l'est d'Àfrica i Amèrica del Nord i del Sud, algunes espècies relacionades del gènere *Centaurea* d'Amèrica del Sud, i el gènere *Centaurodendron*, amb tres espècies endèmiques de les illes Juan Fernández. Els objectius són utilitzar una nova filogènia molecular generada per a aquest treball basada en seqüències de diverses regions del DNA nuclear i cloroplàstic per proporcionar una nova classificació taxonòmica per a aquest grup i conjuntament amb els resultats obtinguts en el tercer treball sobre una datació molecular, desenvolupar una proposta sobre el seu origen, diversificació i els processos que han determinat la seva distribució geogràfica actual.

OBJECTIUS

2. OBJECTIUS

Gènere *Euphorbia*

1. Comprovar la monofília i circumscripció de les principals seccions mediterrànies del subgènere *Esula*, utilitzant seqüències de la regió nuclear ribosòmica de l'ITS d'un ampli mostreig d'espècies del gènere *Euphorbia* que contempli la seva distribució global.
2. Estimar un context filogenètic general pel grup *Pachycladae* i les seves espècies emparentades.
3. Redefinir la circumscripció del grup *Pachycladae* i la secció *Tirucalli*.
4. Generar una hipòtesi biogeogràfica que expliqui l'actual distribució disjunta de la clada formada per espècies del grup *Pachycladae* i el grup afí a *E. mauritanica* de la secció *Tirucalli*, que en conjunt passem a anomenar secció *Aphyllis*.
5. Comprovar si els complexos morfològics descrits tradicionalment per les espècies macaronèsiques de la secció *Aphyllis*, el complex d'*E. atropurpurea* i el complex d'*E. lamarckii*, corresponen a grups naturals.
6. Reconstruir l'evolució dels caràcters morfològics en el llinatge macaronèsic d'*Euphorbia* secció *Aphyllis*.
7. Estudiar la distribució de la variabilitat genètica inter i intrapoblacional per conèixer l'estructura genètica de les espècies macaronèsiques de la secció *Aphyllis*.
8. Investigar l'origen de les espècies macaronèsiques de la secció *Aphyllis* i els fenòmens de colonització i diversificació d'aquest grup.

Tribu *Cardueae*

1. Obtenir una filogènia molecular de la tribu *Cardueae*, amb especial interès en resoldre les relacions filogenètiques entre les subtribus basals.
2. Estimar els temps de divergència dels principals esdeveniments de diversificació de la tribu *Cardueae*.
3. Reconstruir les àrees ancestrals de distribució i inferir els principals fenòmens biogeogràfics que expliquen l'actual distribució de la tribu *Cardueae*.
4. Comprovar la monofília i definir una nova circumscripció del gènere *Plectocephalus*, determinant la posició filogenètica de l'espècie africana *P. varians* i les espècies sud-americanes *P. chilensis*, *Centaurea cachinalensis*, *C. floccosa* i *C. tweediei*.
5. Esbrinar les relacions filogenètiques i la història biogeogràfica dels gèneres *Centaurodendron* i *Plectocephalus* i les seves afinitats amb els gèneres basals de la subtribu *Centaureinae*.
6. Investigar les relacions filogenètiques entre els membres basals de la subtribu *Centaureinae*, no resoltes anteriorment.

INFORME DE LES DIRECTORES

3. INFORME DE LES DIRECTORES DE LA TESI DOCTORAL REFERENT AL FACTOR D'IMPACTE I A LA CONTRIBUCIÓ DE LA DOCTORANDA A CADASCUN DELS ARTICLES ELABORATS

Roser Vilatersana Lluch, investigadora de l'Institut Botànic de Barcelona, i Mercè Galbany Casals, professora lectora de la Universitat Autònoma de Barcelona, directores de la Tesi Doctoral elaborada per Laia Barres González, amb el títol *Estudis filogenètics i filogeogràfics de la tribu Cardueae i el gènere Euphorbia*

INFORMEN

Que el treball de recerca dut a terme per Laia Barres González com a part de la seva formació predoctoral i inclòs a la seva Tesi Doctoral ha donat lloc a 3 publicacions i 1 manuscrit. A continuació es detalla la llista d'articles així com els índexs d'impacte de les corresponents revistes (segons el JCR de la ISI web of Knowledge), la categorització d'aquestes en el seu àmbit, i la participació de la doctoranda en cada article.

1. Barres, L., Vilatersana, R., Molero, J., Susanna, A. and Galbany-Casals, M. 2011. Molecular phylogeny of *Euphorbia* sect. *Aphyllis* (Euphorbiaceae) inferred from nrDNA and cpDNA markers with biogeographic insights. *Taxon* 60: 705-720.

L'índex d'impacte de *Taxon* del 2011 és 2,364, i es troba en la posició 46 d'un total de 188 revistes del seu àmbit, situada al primer quartil (Q1) de la categoria *Plant Sciences*. La responsabilitat i participació de la doctoranda en aquest treball han estat la recol·lecció al camp de part dels tàxons inclosos, la realització de totes les tasques de laboratori, les anàlisis filogenètiques, la co-discussió dels resultats i la redacció de l'article.

2. Barres, L., Vilatersana, R., Hipp, A., Molero, J. and Galbany-Casals, M. Phylogeography and character evolution of *Euphorbia* sect. *Aphyllis* (Euphorbiaceae) subsect. *Macaronesicae*.

Es preveu enviar aquest article a *Taxon*. L'índex d'impacte en l'actualitat és 2,703, i es troba en la posició 46 d'un total de 190 revistes del seu àmbit, situada al primer quartil (Q1) de la categoria *Plant Sciences*. La responsabilitat i participació de la doctoranda en aquest treball han estat la recol·lecció al camp de bona part dels tàxons inclosos, la realització de totes les tasques de laboratori i totes les anàlisis de dades, la co-discussió dels resultats i la redacció de l'article. La part experimental d'aquest treball s'ha realitzat durant una estada de tres mesos de la doctoranda al laboratori *Plant Systematics and Herbarium Department* del *Morton Arboretum* a Lisle i *The Field Museum* a Chicago sota la supervisió i en col·laboració amb el Dr. Hipp.

3. Barres, L., Sanmartín, I., Anderson, C.-L., Susanna, A., Buerki, S., Galbany-Casals, M. and Vilatersana, R. Acceptat. Reconstructing the evolution and biogeographic history of tribe *Cardueae* (Compositae). *American Journal of Botany*.

L'índex d'impacte d'*American Journal of Botany* en l'actualitat és 2,664, i es troba en la posició 47 d'un total de 190 revistes del seu àmbit, situada al primer quartil (Q1) de la categoria *Plant Sciences*. La responsabilitat i participació de la doctoranda en aquest treball ha estat la realització de totes les tasques de laboratori i de bona part de les anàlisis de dades, la co-discussió dels resultats i la redacció de l'article. L'anàlisi de les dades en aquest treball s'ha realitzat durant una estada de tres mesos de la doctoranda al *Real Jardín Botánico de Madrid* sota la supervisió i en col·laboració amb la Dra. I. Sanmartín.

4. Susanna, A., Galbany-Casals, M., Romaschenko, K., Barres, L., Martín, J. and Garcia-Jacas, N. 2011. Lessons from *Plectocephalus* (Compositae, Cardueae-Centaureinae): ITS disorientation in annuals and Beringian dispersal as revealed by molecular analyses. *Annals of Botany* 108: 263-277.

L'índex d'impacte d'*Annals of Botany* del 2011 és 3,388, i es troba en la posició 21 d'un total de 188 revistes del seu àmbit, situada al primer quartil (Q1) de la categoria *Plant Sciences*. La responsabilitat i participació de la doctoranda en aquest treball ha estat la

realització de part de les tasques de laboratori, part de les anàlisis de dades, i la co-discussió dels resultats i participació en la co-redacció final de l'article.

A més, **CERTIFIQUEN**:

que Laia Barres Gonzalez ha participat activament en el desenvolupament del treball de recerca associat a cadascun dels articles, així com en la seva elaboració. En concret, ha participat en les següents tasques:

- Plantejament inicial dels objectius dels treballs.
- Recol·leccions de bona part dels materials estudiats en els treballs corresponents.
- Tasques de laboratori: seqüenciació de diverses regions del DNA i desenvolupament i posada a punt dels marcadors AFLP.
- Anàlisis de dades.
- Discussió dels resultats, redacció dels articles i seguiment del procés de revisió dels mateixos.

Atentament,

Roser Vilatersana Lluçh

Mercè Galbany Casals

Barcelona, de de

RESUM I DISCUSSIÓ DELS RESULTATS OBTINGUTS

4. RESUM I DISCUSSIÓ DELS RESULTATS OBTINGUTS

4.1. DEL GÈNERE *EUPHORBIA*

4.1.1. Filogènia molecular

Les reconstruccions filogenètiques del gènere *Euphorbia* realitzades mitjançant el marcador ribosòmic nuclear ITS mostren quatre grans clades corresponents als quatre subgèneres (subgènere *Chamaesyce*, subgènere *Esula*, subgènere *Euphorbia* i subgènere *Rhizanthium*) ja establerts en anteriors publicacions (Steinmann & Porter, 2002; Bruyns et al., 2006; Park & Jansen, 2007; Zimmermann et al., 2010). El subgènere *Rhizanthium* és monofilètic amb un suport moderat (PP = 0,97). El subgènere *Chamaesyce* també és monofilètic (BS = 76%, PP = 1) i apareix com a clada germana del subgènere *Euphorbia*. Aquest últim subgènere no mostra suport estadístic en els nostres resultats. Tampoc recuperem suport estadístic per la monofília ni la posició filogenètica del subgènere *Esula*. Així doncs, les relacions filogenètiques entre els quatre subgèneres no es resolen en les nostres anàlisis, tot i que estudis més recents (Horn et al., 2012) han definit el subgènere *Esula* com a grup germà de la resta i el subgènere *Rhizanthium* com a successiu grup germà de la clada formada pels subgèneres *Euphorbia* i *Chamaesyce*. Pel que fa a la monofília del subgènere *Esula*, també ha estat prèviament demostrada amb anàlisis del genoma cloroplàstic (BS = 86%; Steinmann & Porter, 2002) o el genoma nuclear (PP = 1: Bruyns et al., 2006; PP = 1: Zimmermann et al., 2010).

La clada que centra el nostre interès dins el gènere *Euphorbia* correspon al subgènere *Esula*. Aquest presenta vuit grans clades amb elevat suport estadístic. Aquestes vuit clades no corresponen a la classificació seccional tradicional establerta mitjançant la morfologia de les espècies (Radcliffe-Smith & Tutin, 1968) excepte per la secció *Myrsinites* (Boiss.) Lojac. (BS = 100%, PP = 1). Aquesta secció inclou herbes perennes caracteritzades per presentar les glàndules nectaríferes acabades en apèndixs capitats. Comprèn endemismes de muntanya mediterrània d'àrea reduïda.

La posició filogenètica d'*E. lathyris* L., membre de la secció monotípica *Lathyris* (Dum.) Soják, no es resol en les nostres anàlisis, tot i que estudis moleculars posteriors (Horn et al., 2012) revelen que aquesta espècie és germana a la resta d'espècies del subgènere *Esula*.

Totes les espècies de la secció *Helioscopia* (Dum.) Soják incloses en el nostre treball apareixen en una clada sense suport estadístic, dins la qual recuperem una subclada (BS = 82%, PP = 1) que inclou totes les espècies de la secció *Helioscopia* menys *E. lagascae* Spreng. *Euphorbia isatidifolia* Lam., una espècie amb caràcters i ecologia poc comú entre la resta d'espècies de la secció *Helioscopia*, es resol com a espècie germana de la resta d'espècies de la secció. Es tracta d'una espècie típica d'ambients estèpics, amb el làtex groc o ataronjat i un rizoma tuberós. Aquests caràcters l'apropen a membres de la secció *Holophyllum* (Prok.) Prok., d'Àsia central, fet que es confirma per criteris moleculars (Riina et al., in press). En la clada de la secció *Helioscopia* també apareixen les espècies macaronèsiques *E. mellifera* i *E. stygiana*, arbres típics de laurisilva que s'havien relacionat tradicionalment amb el grup *Pachycladae* i del qual queden exclosos. Tot i la poca resolució dins la secció *Helioscopia*, podem deduir que les dues subseccions descrites per Radcliffe-Smith (1982), *Galarrhaei* (Boiss. in A. DC.) Pax in Engler & Prantl i *Helioscopia*, definides segons la forma vital (perennes o anuals, respectivament), no segueixen criteris monofilètics perquè trobem espècies anuals i perennes barrejades en les mateixes clades i veiem que aquest caràcter pot aparèixer diverses vegades en el mateix llinatge. Les espècies de la secció *Chylogala* (Fourr.) Soják *E. serrata* L. i *E. retusa* Forssk. apareixen també relacionades en una mateixa clada amb suport estadístic (BS = 95%, PP = 1), però la posició filogenètica d'*E. calyptrata* Coss. & Durieu, de la mateixa secció, no es resol. La secció *Paralias* (Dum.) Soják apareix clarament com a polifilètica, ja que les seves espècies incloses en aquest treball es troben repartides en tres clades no relacionades entre si i sense presentar cap caràcter morfològic distintiu. El mateix passa amb les espècies de la secció *Cymatospermum* (Prokh.) Prokh., que es troben repartides en diferents clades amb membres de les seccions *Paralias* i *Esula* Dumort. *Euphorbia amygdaloides* L. i *E. characias* L., tradicionalment classificades dins la secció *Esula*, apareixen en una clada ben recolzada (BS = 100%, PP = 1) no relacionada amb l'altra clada que inclou les altres espècies de la secció *Esula* analitzades. El grup troncal d'espècies macaronèsiques del grup *Pachycladae* i algunes espècies classificades tradicionalment dins la secció *Tirucalli* del subgènere *Euphorbia* configuren la darrera clada recolzada de les nostres anàlisis. Aquest grup monofilètic (BS = 76%, PP = 1) compren *E. aphylla*, 10 espècies macaronèsiques del grup *Pachycladae* i 11 espècies de

la secció *Tirucalli* relacionades morfològicament amb el complex *E. mauritanica* definit per Leach (1975) i Carter (1992): *Euphorbia stolonifera* Marloth ex A. C. White, R. A. Dyer & B. Sloane i *E. mauritanica*, de Sud-Àfrica; *E. orthoclada* Baker, endèmica de Madagascar i *E. berotica* N. E. Br., *E. calamiformis* P. R. O. Bally & S. Carter, *E. gossypina*, *E. lateriflora*, *E. nubica*, *E. papilionum*, *E. schimperi* i *E. usambarica* Pax, de l'est i centre d'Àfrica. Les espècies distribuïdes al centre i est d'Àfrica i el sud de la península Aràbiga constitueixen un grup monofilètic (PP = 1), germà a les espècies macaronèsiques d'aquesta clada. Així doncs, l'establiment d'aquest llinatge en el nostre treball ens porta a definir aquesta clada amb el nom de secció *Aphyllis* i així recircumscriure i recuperar el tàxon definit per Webber & Berthelot (1842; Taula 3). La recircumscripció d'aquesta secció s'ha seguit en posteriors treballs del gènere *Euphorbia* (Horn et al., 2012; Riina et al., in press), on alhora s'han definit dues subseccions dins la secció *Aphyllis*: la subsecció *Macaronesicae* Molero & Barres i la subsecció *Africanae* Molero & Barres.

Les altres espècies de la secció *Tirucalli*, incloses en les nostres anàlisis per comprovar la seva relació amb el grup *Pachycladae*, apareixen repartides en dos altres subgèneres d'*Euphorbia*. En primer lloc, *E. larica* Boiss. i *E. masirahensis* Ghaz., de l'Iran i la península Aràbiga, respectivament, apareixen formant una clada dins el subgènere *Rhizanthium*. Aquestes espècies s'inclouen alhora en un grup monofilètic relacionades amb *E. meuleniana*, del Iemen i *E. balsamifera*, distribuïda a les illes Canàries, l'oest d'Àfrica i el Iemen. *Euphorbia balsamifera* havia estat tradicionalment inclosa al grup *Canariensis et Mediterraneae* del grup *Pachycladae* de Boissier (1862). En segon lloc, les espècies *E. bariensis*, endèmica de Somàlia; *E. dhofarensis*, d'Oman i *E. uzumuk* S. Carter & J. R. I. Wood, del Iemen i Oman apareixen incloses al subgènere *Euphorbia*, junt amb la resta d'espècies que representen el grup central de la secció *Tirucalli* (*E. arbuscula* Balf. f., *E. gregaria* Marloth, *E. stenoclada* Baill., *E. tirucalli* L. i *E. xylophyloides* Brongn. ex Lem.).

El grup germà a la secció *Aphyllis* és una clada formada per espècies de diferents seccions (PP = 0,96). Per una banda inclou *E. dendroides*, espècie de distribució àmplia a la Mediterrània que havia estat inclosa tradicionalment al grup *Pachycladae* (Boissier, 1862) però que difereix de la resta d'espècies per la seva distribució, perquè les tiges joves no són fotosintètiques i presenten un ritidoma marró

i per les seves llavors, que són comprimides lateralment. També inclou *E. terracina* L., de la secció *Esula*, *E. biumbellata* Poir. i *E. megalatlantica* Ball, espècies perennes de la secció *Paralias*, i *E. medicaginea* Boiss. i *E. exigua* L., espècies anuals de la secció *Cymatospermum*. Aquesta clada és molt diversa morfològicament però ens suggereix que l'origen de la secció *Aphyllis* és al Mediterrani. En les anàlisis de la regió nuclear ITS no s'han pogut resoldre les relacions filogenètiques entre les espècies de la secció *Aphyllis* i per aquest motiu s'han seqüenciat vuit noves regions, una de nuclear (ETS) i set de cloroplàstiques (*trnL-trnF*, *psbA-trnH*, *ycf3-trnS*, *trnG*, *atpB-rbcL*, *trnK-matK* i *trnT-trnL*) per les espècies incloses dins la secció *Aphyllis*. Les incongruències detectades entre els arbres filogenètics inferits per les regions nuclears i les regions cloroplàstiques probablement són degudes a fenòmens d'hibridació, ja descrits anteriorment en espècies del grup (Molero & Rovira, 2005a). Aquestes incongruències no ens han permès combinar les seqüències dels genomes nuclears i cloroplàstics i realitzar una anàlisi conjunta. Tot i així, hi ha coincidències de topologia entre els dos arbres: la posició d'*E. tuckeyana* com a espècie basal a la resta, tot i que aquesta posició només està recolzada estadísticament en la filogènia basada en regions cloroplàstiques (BS = 80%, PP = 1). La clada que agrupa totes les espècies macaronèsiques (excepte *E. tuckeyana*), només recolzada estadísticament en l'arbre inferit de les regions cloroplàstiques serà estudiada en profunditat en un altre estudi.

Pel que fa a la biogeografia, els nostres estudis assenyalen que la colonització de les illes macaronèsiques per les espècies endèmiques del gènere *Euphorbia* es va produir en almenys cinc esdeveniments independents: dos per part de membres de la secció *Aphyllis* (*E. tuckeyana* per una banda i la resta d'espècies per una altra), una per part de membres de la secció *Helioscopia* (*E. mellifera* i *E. stygiana*), i dos més per part de membres del subgènere *Euphorbia* (*E. canariensis* L. i *E. handiensis* Burchard). La nova secció *Aphyllis* presenta una distribució disjunta entre la Macaronèsia, el sud i el centre d'Àfrica, Madagascar i la banya d'Àfrica, i per tant es confirma la seva pertinença a la *Rand Flora*. Finalment, es demostra que l'especiació a la Macaronèsia de les espècies de la secció *Aphyllis* s'ha produït per dos processos diferents. Per una banda, la radiació adaptativa explica la diversificació del grup en diferents tipus d'hàbitats i per l'altra, l'especiació al·lopàtrica també ha jugat un paper important en la

diversificació del grup ja que la majoria d'espècies ocupen només un arxipèlag, un grup d'illes o són endèmiques d'una única illa.

4.1.2. Filogeografia

L'estudi filogeogràfic del complex macaronèsic de la secció *Aphyllis* que es correspon a la recentment descrita subsecció *Macaronesicae* Molero & Barres (Riina et al., in press) ens dona informació taxonòmica, biogeogràfica i de la variabilitat i estructura genètica del grup.

Totes les anàlisis realitzades amb els AFLP confirmen quatre grups genètics dins la secció *Aphyllis*: el complex d'*E. lamarckii*, el complex d'*E. atropurpurea*, l'espècie *E. aphylla* i l'espècie *E. tuckeyana*.

Pel que fa a la biogeografia, es confirma que la colonització de les illes macaronèsiques per la subsecció *Macaronesicae* va ser produïda en dos esdeveniments independents: *E. tuckeyana*, per una banda, va colonitzar Cap Verd i per l'altra, la resta d'espècies macaronèsiques del grup van arribar a la Macaronèsia després d'un únic segon procés de colonització. Tot i que les llavors d'*Euphorbia* no presenten cap element adaptat per la dispersió endozoòcora o epizoòcora, la disseminació dels seus propàguls entre les illes macaronèsiques podria ser realitzat per les espècies de colom i tórtora *Columba livia canariensis* Gmelin i *Streptopelia turtur turtur* L. (Nogales, 1985; Berg, 1990), fet que explicaria els diversos fenòmens de dispersió en el grup entre illes i entre illes i continent.

La resta d'espècies macaronèsiques de la subsecció *Macaronesicae* haurien ocupat els arxipèlags de Canàries, Madeira i les illes Selvatges en un segona colonització que va permetre l'enorme radiació d'espècies a aquestes illes. Les anàlisis filogeogràfiques indiquen que la direcció d'aquest procés de colonització s'hauria pogut produir des de les illes Canàries cap al Nord, tal com indica la posició basal d'*E. aphylla*.

D'altra banda, es demostra que diverses poblacions han tornat a colonitzar el continent per un "efecte boomerang" (Caujapé-Castells, 2011), com s'explica més endavant. Així, els nostres resultats recolzen la idea de que la Macaronèsia podria

haver actuat com a refugi de biodiversitat durant l'últim màxim glacial i posteriorment hauria aportat diversitat cap a les poblacions continentals.

Euphorbia tuckeyana, que havia estat inclosa en el complex d'*E. lamarckii* pels caràcters morfològics (Molero et al., 2002), genèticament no forma part d'aquest complex i es resol en una posició independent a la resta d'espècies de la subsecció *Macaronesicae*. Segurament l'aïllament geogràfic ha fet que la distància genètica amb la resta d'espècies macaronèsiques de la secció augmentés i es mantingués com un llinatge independent. *Euphorbia tuckeyana* no presenta cap estructura genètica a les illes de Cap Verd. Això podria ser degut a la uniformitat ecològica d'aquest arxipèlag, que hauria evitat processos de radiació adaptativa. Considerant resultats anteriors (Barres et al., 2011), la història biogeogràfica de Cap Verd i la diferenciació genètica d'aquesta espècie, creiem que *E. tuckeyana* hauria de quedar exclosa del complex d'*E. lamarckii*.

Podem extreure diverses conclusions pel que fa a la taxonomia del grup. Pel que fa a *E. aphylla*, els resultats obtinguts revelen que no pertany a cap dels dos complexos, en concordança amb la classificació morfològica (Molero et al., 2002). Les seves característiques morfològiques, ben diferents a la resta d'espècies (Fig. 2B) –no presenta fulles, el pleocasi és simple i dens, les bràctees subciatials són petites (menys de 2 mm), lliures i caduques després de la fructificació i les llavors són llises o ruguloses–, la seva ecologia –és xeròfita i halòfita i viu en penya-segats exposats als vents marins– i el fet que anteriorment no s'hagués reconegut dins de cap dels dos complexos definits, concorden amb la seva posició basal, com a espècie germana a la resta.

D'altra banda, es demostra que els complexos d'*E. atropurpurea* i d'*E. lamarckii*, definits anteriorment sota criteris morfològics i ecològics (Molero et al., 2002), es troben diferenciats genèticament. El complex d'*E. atropurpurea* es caracteritza per presentar fulles semi-persistentes, pleocasi doble, bràctees subciatials grans (de 10 a 20 mm), perennes i soldades a la base i llavors reticulatoalveolades. Les espècies d'aquest complex són mesòfiles o mesohidròfiles i es troben dins la laurisilva o en la seva transició cap al *fayal-brezal*. Inclou *E. atropurpurea*, *E. bourgeana* i *E. bravoana*.

El complex d'*E. lamarckii* es caracteritza per presentar espècies de fulla caduca després de la fructificació, pleocasi simple i lax, bràctees subciatials petites (de menys de 10 mm), caduques i lliures a la base i llavors llises o rugoses. Les espècies d'aquest complex són xeròfiles i mesòfiles. Inclou *E. anachoreta*, *E. berthelotii*, *E. lamarckii* var. *lamarckii*, *E. lamarckii* var. *broussonetti*, *E. pedroi*, *E. piscatoria* i *E. regis-jubae*.

L'ancestre de les espècies macaronèsiques de la subsecció *Macaronesicae* hauria estat molt proper als membres del complex d'*E. lamarckii* i hauria presentat un pleocasi simple, glàndules nectaríferes truncades, bràctees subciatials caduques i lliures, llavors de llises a ruguloses i carúncula obnavicluar-truncada. Així, aquests resultats ens fan pensar que l'ancestre de la subsecció *Macaronesicae* hauria tingut els mateixos requeriments ecològics que els membres del complex d'*E. lamarckii*. Els canvis morfològics del complex d'espècies d'*E. atropurpurea* haurien afavorit la seva adaptació a ambients més humits.

Dins el complex d'*E. atropurpurea*, són destacables els resultats de l'espècie *E. bourgeana*, distribuïda a Tenerife i La Gomera, amb l'estructura genètica més ben marcada, en tres grups. El primer grup inclou les poblacions orientals de Tenerife (Anaga), el segon les poblacions occidentals de Tenerife (Teno) i el tercer les poblacions de La Gomera. Les poblacions de La Gomera de *E. bourgeana* han estat descrites com a *E. lambii* per Sventenius (1960) però la validesa d'aquest tàxon ha estat controvertida i discutida per diferents autors (Bramwell & Bramwell, 2001; Molero et al., 2002; Molero & Rovira, 2005b). Les nostres anàlisis detecten una diferenciació genètica elevada entre les dues poblacions ($\phi_{ST} = 0,83$) però creiem que no hi ha suficients caràcters morfològics per a diferenciar-les.

Les poblacions a Tenerife d'*E. bourgeana* mostren una estructura genètica molt particular, en dos grups diferenciats entre Anaga i Teno. Tot i així, una de les poblacions de Teno mostra una elevada barreja genètica amb les poblacions d'Anaga. Aquesta distribució disjunta entre Anaga i Teno es troba en altres organismes, tan plantes com animals (Juan et al., 2000). Diversos factors han afavorit l'aïllament de les poblacions als extrems orientals i occidentals de l'illa: (1) aquestes regions han estat dues illes independents fins fa només 3,5 Ma, quan es va formar l'actual illa de Tenerife; (2) les esclavissades són freqüents a la zona nord de l'illa de Tenerife (Carracedo et al., 1998) i aïllen els dos extrems de l'illa; (3) aquestes dues zones són les

úniques on trobem l'hàbitat de laurisilva i les espècies que prefereixen aquest hàbitat es poden haver restringit aquí per requeriments ecològics; (4) les activitats humanes poden haver causat una disminució de les poblacions a la zona central de l'illa fins a la reducció de les poblacions a dos refugis als extrems de Tenerife. Com a resultat de la nostra investigació, detectem la singularitat genètica d'una de les poblacions a la zona de Teno. Recomanem un estudi en profunditat d'aquesta població per tal de que passi a ser objecte de programes de conservació *in situ* i *ex situ* i així conservar el màxim de diversitat genètica d'*E. bourgeana*, espècie inclosa en la Llista Vermella de flora vascular espanyola sota la categoria de vulnerable (VU; Bañares, 2010).

Dins el complex d'*E. lamarckii*, les anàlisis detecten quatre clades diferenciades. La primera ens revela que *E. pedroi*, endèmica del Cap Espichel (Portugal) forma part del llinatge d'*E. regis-jubae*, de les illes orientals de la Macaronèsia i la costa de Marroc i comparteix gran part del seu patrimoni genètic. De fet, es mostra més distància genètica entre les poblacions de Gran Canaria i la resta de poblacions, que entre les poblacions d'*E. pedroi* i les poblacions d'*E. regis-jubae* de Marroc, Fuerteventura i Lanzarote. Tot i així, la presència de caràcters morfològics diferenciats (*E. pedroi* presenta la carúncula molt més allargada), el fort aïllament geogràfic i el fet que *E. pedroi* no presenta gens de barreja genètica amb les altres poblacions ens porten a seguir reconeixent *E. pedroi* com a espècie. *Euphorbia pedroi* podria tenir el seu origen en un efecte boomerang (o colonització posterior cap al continent) recent i haver sofert un procés de coll d'ampolla que va minvar la mida i la diversitat genètica de les seves poblacions a Portugal, ja que observem branques curtes al filograma reconstruït per NJ i uns nivells de diferenciació genètica entre poblacions elevats ($\Phi_{ST} = 0.69$) si els comparem amb altres espècies. Les poblacions marroquines d'*E. regis-jubae* probablement també hi haurien arribat per un fenomen de colonització posterior cap al continent.

La segona clada inclou les poblacions d'*E. piscatoria*, que formen dos grups diferenciats, un a Madeira i l'altre a Porto Santo. Caldrà veure en futurs estudis la posició que prenen les poblacions de les illes de les Desertes, també a l'arxipèlag de Madeira i que no han estat incloses en aquest treball.

La tercera clada inclou totes les poblacions d'*E. berthelotii*, de la qual no es detecta cap estructura genètica diferenciada. Tot i així, algunes de les anàlisis detecten

una barreja genètica entre un individu d'aquesta espècie i *E. lamarckii*. Aquestes espècies comparteixen hàbitat i distribució a l'illa de La Gomera (Fig. 4). Tot i que durant el treball de camp es va evitar recol·lectar en zones de contacte entre les dues espècies i els individus amb una morfologia intermèdia, la hibridació és un fenomen que s'ha observat al camp i que s'ha detectat entre diverses espècies macaronèsiques de la subsecció *Macaronesicae* (Molero & Rovira, 2005). Aquest fenomen podria explicar l'intercanvi genètic observat a les anàlisis.

I per últim, la quarta clada engloba les poblacions d'*E. anachoreta* i *E. lamarckii*. La primera es troba només a un dels illots que formen part de les illes Selvatges, arxipèlag a 280 km al sud de Madeira i 160 km al nord de Canàries. És una població molt reduïda (menys de 50 individus) i en perill crític d'extinció (CR) segons la UICN (Martín et al., 2008). Segons indica l'arbre de NJ, *E. anachoreta* s'hauria originat a partir d'un esdeveniment de dispersió des de l'arxipèlag canari i posterior aïllament geogràfic.

Al contrari, *E. lamarckii* és l'espècie que ha experimentat una radiació més gran a les illes Canàries. Trobem dues varietats repartides en les quatre illes més occidentals de l'arxipèlag (*E. lamarckii* var. *lamarckii* al sud de Tenerife i *E. lamarckii* var. *broussonetti* al Nord de Tenerife, La Gomera, El Hierro i la Palma). Les dues varietats apareixen en clades independents en les anàlisis filogeogràfiques i es confirma així un cert grau d'aïllament genètic. Alhora, també es detecta una incipient separació genètica entre les poblacions de La Palma i El Hierro, no detectables a nivell morfològic.

Pel que fa a patrons generals d'especiació i estructura genètica a les illes Canàries, es podria pensar que les illes orientals d'aquest arxipèlag (Lanzarote, Fuerteventura i Gran Canaria) haurien de presentar una alta freqüència d'endemismes degut a la seva edat (15,5, 20,6, 14,5 Ma respectivament), les més antigues del grup i per la seva distància menor al continent. Tot i així, la freqüència d'endemismes és major a les illes centrals (Gran Canaria, Tenerife i La Gomera). Aquesta distribució de la diversitat genètica segueix el model de Sanmartín & al. (2008), que proposa aquest grup d'illes com a centre de diversificació i de dispersió entre illes a les Canàries.

El grau d'estructura genètica és molt petit a les espècies distribuïdes en illes orientals (*E. regis-jubae*), probablement perquè aquestes illes són més planes i

ecològicament més homogènies i això hauria afavorit més intercanvi genètic entre les poblacions i una homogeneïtzació de les poblacions (Caujapé-Castells, 2011).

Per contra, en les illes més occidentals, a més d'haver-hi més nombre d'espècies endèmiques, aquestes solen presentar una major estructura genètica (Reyes-Betancort et al., 2008; Caujapé-Castells, 2011). En el nostre estudi és només el cas d'*E. bourgeana*. S'hipotetitzava que això és degut a que aquest últim grup d'illes presenta una diversitat d'hàbitats i una heterogeneïtat topogràfica més gran (Caujapé-Castells, 2011). Processos com el coll d'ampolla i l'efecte fundador, provocats per l'aïllament ecològic i geogràfic, haurien afavorit la diferenciació genètica entre les poblacions en aquestes illes més abruptes.

4.2. DE LA TRIBU CARDUEAE

4.2.1. Filogènia molecular

Els estudis filogenètics de la tribu *Cardueae* s'han fet a dos nivells que es corresponen a dos articles diferents. Per una banda s'ha analitzat la tribu de manera general, per tal d'establir les relacions filogenètiques entre els grans grups i per tal de poder realitzar la datació molecular i la reconstrucció biogeogràfica de la tribu i detectar grans patrons biogeogràfics. Per altra banda, s'ha realitzat un estudi filogenètic del gènere *Plectocephalus*, per tal d'esbrinar la seva posició filogenètica dins la subtribu *Centaureinae* i alhora resoldre les relacions entre els grups basals d'aquesta subtribu. A més es volia explorar l'origen de la distribució disjunta tan particular d'aquest gènere (trobem una espècie a l'est d'Àfrica, dues a Nord Amèrica i quatre a Sud Amèrica) i establir la seva relació amb el gènere *Centaurodendron*, que engloba tres espècies endèmiques de l'arxipèlag de Juan Fernández, a 670 km de la costa de Xile.

Pel que fa a la tribu *Cardueae*, la reconstrucció filogenètica realitzada combinant una regió nuclear (ITS) i quatre regions cloroplàstiques (*matK*, *ndhF*, *rbcL* i *trnL-trnF*) revela que la subtribu de les *Cardopatiinae* és el grup basal a totes les *Cardueae* i que les *Carlininae* i les *Echinopsinae* són, successivament, les subtribus germanes al clade *Carduinae-Centaureinae*. Així, la combinació d'aquestes regions permet resoldre per primer cop les relacions filogenètiques entre les subtribus basals.

Altres resultats nous extrets de les anàlisis filogenètiques d'aquest estudi mostren que *Dipterocome* Fisch. & C. A. Mey., un gènere distribuït al Pròxim Orient (Síria, Jordània, Armènia, Azerbaidjan, Iran i Afganistan) es troba a la base de la clada *Xeranthemum* L., grup basal de les *Carduinae*. També dins les *Carduinae*, es mostra que les espècies africanes de *Carduus* es troben niuades dins *Cirsium* i per tant la circumscripció d'aquests dos gèneres requereix més estudis.

Pel que fa a les novetats sistemàtiques del segon treball, les anàlisis realitzades amb la combinació de seqüències de regions del DNA nuclear (ITS i ETS) i cloroplàstic (*trnL-trnF*, *rpl32-trnL^{UAG}* i *ndhF*) mostren que els gèneres *Centaurodendron*, *Plectocephalus* i algunes espècies del gènere *Centaurea* tenen un origen comú i formen un grup monofilètic. A més, el gènere *Plectocephalus* tal com estava circumscribit fins ara seria parafilètic. Com a resultat de la nova circumscripció de la clada *Plectocephalus* es proposen les següents noves combinacions de les tres espècies de *Centaurea* incloses en aquest treball: *Centaurea cachinalensis* es combina com a *Plectocephalus cachinalensis* (Phil.) N. Garcia & Susanna; *Plectocephalus floccosus* (Hook. & Arn.) N. Garcia & Susanna per a *Centaurea floccosa* i *Plectocephalus tweediei* (Hook. & Arn.) N. Garcia & Susanna per a *Centaurea tweediei*.

D'altra banda, les diferències morfològiques entre *Plectocephalus*, del continent americà i *Centaurodendron*, endèmic de les illes Juan Fernández, recolzen el manteniment dels dos gèneres. *Centaurodendron* és un arbret perenne mentre que *Plectocephalus* és una herba i el pol·len de *Centaurodendron* i *Plectocephalus* és de tipus *Serratula* en ambdós casos però a *Plectocephalus* les espines són cònicoagudes i a *Centaurodendron* són cònicotruncades. L'aïllament geogràfic també dona suport a la separació dels dos gèneres. La proposta de mantenir els dos gèneres com a tàxons independents afavoreix també les polítiques de conservació de les espècies d'aquest gènere endèmic, dues d'elles (*C. dracaenoides* Johow i *C. palmiforme* Skottsbo.) incloses a la Llista Vermella d'espècies amenaçades de la IUCN (World Conservation Monitoring Centre, 1998) sota el rang en perill crític d'extinció (CR).

Dins la clada *Plectocephalus* es defineixen dues subclades: la primera inclou totes les espècies anuals del grup (*P. americanus*, *P. rothrockii*, *P. tweediei* i *P. varians*) i la segona inclou les espècies perennes: tres arbusts sud-americans (*P. cachinalensis*, *P. chilensis* i *P. floccosus*) i els arbrets pertanyents a *Centaurodendron*. La definició de

dues clades dins el complex *Centaurodendron-Plectocephalus* indicarien que hi ha hagut dos processos independents de colonització des d'Amèrica del Nord cap a Amèrica del Sud, el primer hauria originat *P. tweediei* i el segon la resta d'espècies sud-americanes. Tot i així, les diferents taxes de mutació entre anuals i perennes podrien haver agrupat les espècies de manera artificial, no reflectint els veritables grups naturals. El més parsimoniós és pensar que aquestes espècies van arribar a colonitzar Amèrica del Sud des d'Amèrica del Nord per un sol esdeveniment de dispersió. L'ITS és la regió estudiada més vulnerable dins el grup *Plectocephalus*, ja que és la que presenta una diferència més gran de taxa de mutació entre espècies anuals i perennes, a patir un fenomen d'atracció de branques llargues i per això s'ha extret de les anàlisis combinades. Almenys per les espècies estudiades, l'ITS s'hauria de combinar amb altres regions per minimitzar aquest efecte sempre que sigui possible.

La clada germana a *Plectocephalus* no es resol per les anàlisis filogenètiques però les afinitats morfològiques fan pensar que l'origen del gènere està probablement als gèneres basals de les *Centaureinae*, distribuïts a la Mediterrània oriental i la zona Iranoturànica, com són *Phalacrachena* Iljin, *Psephellus* Cass., *Rhaponticoides* Vaill. i *Zoega* L.

D'altra banda, l'estudi del gènere *Plectocephalus* ens revela relacions filogenètiques fins ara no resoltes a la base de les *Centaureinae*, subtribu principalment Mediterrània. En aquest estudi, es demostra que la clada basal dins les *Centaureinae* és el grup *Volutaria*, complex que inclou set gèneres (*Amberboa* (Pers.) Less., *Goniocaulon* Cass., *Mantiscalca* Cass., *Plagiobasis* Schrenk, *Russowia* C. Winkl., *Tricholepis* DC. i *Volutaria* Cass.) de distribució principalment mediterrània en el seu sentit més ampli (incloent també la zona Iranoturànica) però que també arriba a l'Índia (*Goniocaulon*) i a l'est d'Àsia (*Tricholepis*). Els estudis filogenètics anteriors mostraven que els gèneres basals de les *Centaureinae* eren els anuals *Schischkinia* Iljin, *Zoega* i *Stizolophus* Cass. (Garcia-Jacas et al., 2001). Probablement el comportament artificial d'aquestes espècies anuals hauria estat provocat per un fenomen d'atracció de branques llargues, que agrupa espècies amb una elevada taxa de mutació. Així, les relacions filogenètiques a la base de la clada de les *Centaureinae* en els estudis anteriors no reflectiria veritables grups monofilètics.

4.2.2. Datació molecular i reconstrucció biogeogràfica

La combinació de dades obtingudes amb les tècniques de datació molecular i reconstrucció biogeogràfica d'àrees ancestrals mostren que l'origen de les *Cardueae* és a la zona d'Anatòlia, el Càucas i Iran durant l'Eocè mitjà (40,26 Ma). Probablement, l'ancestre comú de totes les *Cardueae* va migrar des de l'est d'Àfrica, on es troben (junt amb el sud d'Àfrica) actualment les seves tribus germanes (*Oldenburgieae*, *Tarchonantheae* i *Dicomeae*). La migració dels ancestres de les *Cardueae* possiblement va seguir la via del nord d'Àfrica i després l'oest d'Àsia, ja que tots els grups de *Cardueae* actualment distribuïts al Mediterrani occidental tenen el seu origen a la zona del Càucas i Anatòlia. Les anàlisis de datació molecular ens revelen que la tribu *Cardueae* és un grup molt més antic del que es pensava, ja que en estudis anteriors el seu origen es va datar a l'Oligocè (29,24 Ma). La diferència d'edats probablement és deguda a l'ús de nous fòssils com a punts de calibració. Barreda et al. (2010) van descriure el que fins ara és el fòssil més antic de les *Compositae* i van situar l'origen d'aquesta família en el límit entre el Paleocè i l'Eocè (55,8 Ma).

La diversificació de la tribu *Cardueae* a la regió Mediterrània s'ha produït en totes quatre subtribus. A les subtribus *Carduinae* i *Carlininae* va començar a l'Oligocè - Miocè, associada amb els cicles d'unió i fragmentació de la microplaca d'Anatòlia amb la conca Mediterrània (Meulenkamp & Sissingh, 2003). La dispersió i aïllament d'espècies durant aquest període va permetre la radiació de les *Cardueae* per fenòmens d'especiació al·lopàtrica, que explicarien la gran diversificació d'aquest grup a la zona Mediterrània. Dins la subtribu *Centaureinae*, s'observa una gran diversificació durant el Miocè tardà, quan l'aridificació produïda durant la crisi del Messinià (Duggen et al., 2003) va connectar Ibèria amb Àfrica del Nord permetent la migració d'espècies entre àrees prèviament aïllades per barreres oceàniques. Alhora, l'aixecament de la serralada de l'Himàlaia durant diversos períodes del Miocè-Pliocè (Wang et al., 2009) va tenir un gran paper en l'evolució de la subtribu *Carduinae*, ja que els nostres resultats mostren que el grup va patir una gran radiació en aquesta zona, coincidint amb diversos períodes d'activitat orogènica.

Pel que fa a la colonització d'Àfrica, els representants africans de les *Cardueae* són espècies d'alta muntanya dels gèneres *Carduus* i *Echinops*. Aquestes espècies van

colonitzar l'Àfrica durant el Pleistocè, amb períodes freds que van permetre l'expansió geogràfica d'aquests grups que posteriorment, quan el clima es va tornar a aridificar i escalfar, es van quedar aïllats en aquestes zones d'alta muntanya.

Alhora, s'ha produït una gran radiació de les *Cardueae* a l'Àsia central, sobretot dins les *Carduinae*. Més concretament, algunes espècies de *Cirsium* van migrar cap a l'Àsia central i el Japó des de l'est d'Àsia durant el límit entre l'Eocè superior i l'Oligocè inferior, seguint la ruta nord a través del mar Caspi. Durant el Miocè mitjà, *Xanthopappus* C. Winkl. arribà a colonitzar la serralada dels Himàlaies i durant el Miocè inferior hi va haver una gran diversificació en els gèneres *Arctium* L. i *Cousinia*, coincidint amb un dels grans períodes d'aixecament de serralades al voltant de la placa iraniana degut a la formació de l'altiplà de Qinghai i el Tibet, després de la col·lisió entre les plaques indoaustraliana i eurasiàtica.

Trobem dues altres radiacions força remarcables també cap a l'est, en aquest cas dins les *Centaureinae*. *Goniocaulon* va migrar des de l'oest i centre d'Àsia cap al sud-est asiàtic i l'Índia durant el Miocè inferior, abans que l'aixecament dels Himàlaies tanquessin aquesta via i *Rhaponticum australe* (Gaudich.) Soskov va migrar des de l'est Mediterrani i l'oest asiàtic fins a Austràlia durant el Miocè mitjà, després de l'aridificació de la zona deguda a l'aixecament de serralades a Malàisia, el nord-est d'Austràlia i la serralada Central de Nova Guinea, provocat per la col·lisió de les plaques asiàtica i australiana durant el Miocè.

La colonització cap al Nou Món s'ha produït diverses vegades durant l'evolució de les *Cardueae*. El gènere *Plectocephalus* es va originar en la zona del Càucas i Anatòlia i va migrar per una banda cap a l'Àfrica oriental i per l'altra cap a Amèrica del Nord, seguint la ruta siberiana i travessant el pont terrestre de Bering durant el Miocè tardà-Pliocè (12-2,5 Ma). Aquesta hipòtesi es veu recolzada per l'existència d'altres gèneres de *Centaureinae* adaptats als ambients xèrics del centre i est d'Àsia, com *Phalacrachena*, que suggereix la possibilitat que l'hipotètic ancestre comú de *Plectocephalus* hagués arribat a colonitzar aquests ambients abans d'arribar a l'estret de Bering, extingint-se posteriorment en aquella zona.

A part de l'espectacular radiació de *Plectocephalus* cap al continent americà, algunes espècies de *Cirsium* va migrar cap a Amèrica del Nord en un sol esdeveniment de colonització probablement des de l'Àsia central a través del pont terrestre de Bering,

tot i que les nostres anàlisis no permeten confirmar aquesta ruta biogeogràfica degut al baix nivell de resolució obtingut en aquesta clada.

CONCLUSIONS FINALS

5. CONCLUSIONS FINALS

The genus *Euphorbia*

- The traditional sectional classification of *Euphorbia* subgenus *Esula* based on morphological characters does not have any correspondence with the clades resolved by phylogenetic reconstructions, except for section *Myrsinites*.
- The group *Pachycladae sensu* Boiss. is polyphyletic in its traditional circumscription as its members have at least four independent origins. First, *E. mellifera* and *E. stygiana*, two lauroid macaronesic trees are closely related to the Mediterranean section *Helioscopia*; second, the Mediterranean shrub *E. dendroides* is placed within the sister clade of section *Aphyllis*; third, *E. balsamifera*, a widely distributed shrub in West Africa, Yemen and the Canary Islands, falls in subgenus *Rhizanthium* section *Somalica*; and finally, a *Pachycladae* core clade is defined.
- Section *Tirucalli* is polyphyletic in its traditional circumscription because its members have three independent origins. First, the *E. mauritanica* complex is related to the Macaronesian species of the *Pachycladae* core clade; second, *E. larica* and *E. masirahensis* are merged in a clade within subgenus *Rhizanthium*, and are phylogenetically related to *E. balsamifera*; and finally the *Tirucalli* core clade is placed within subgenus *Euphorbia*.
- Section *Aphyllis* is redefined after our phylogenetic analyses to include 11 Africo-Arabian species traditionally classified in section *Tirucalli*, *E. aphylla* and 10 Macaronesian species from the *Pachycladae* core clade.
- Low resolution within section *Aphyllis* and incongruences between nuclear and chloroplast phylogenies may be due to hybridization processes.

- Section *Aphyllis* is part of the Rand Flora and its disjoint distribution is probably due to vicariance, resulting from fragmentation of a wider distribution area in North Africa caused by the aridification of the climate during the late Miocene-Pliocene.
- The Macaronesian endemic species of the genus *Euphorbia* colonized the oceanic islands from the mainland in at least five independent events: three involved species from subgenus *Esula* (two from section *Aphyllis* and one from section *Helioscopia*) and two involved species from subgenus *Euphorbia* (*E. canariensis* and *E. handiensis*, independently).
- Species from subsection *Macaronesicae* colonized the Macaronesia in at least two independent dispersal events: *E. tuckeyana* reached Cape Verde independently from the rest of species, that colonised all the other Macaronesian archipelagos, except for the Azores.
- The direction of dispersal within species in subsection *Macaronesicae* probably followed a South to North direction from the Canary Islands, as the basal position of *E. aphylla* suggests.
- The diversification of subsection *Macaronesicae* species followed two different speciation models: adaptive ecological radiation, as we detect that species from *E. atropurpurea* and *E. lamarckii* complexes have radiated in different ecological habitats, and allopatric speciation, which is detected especially within the *E. lamarckii* complex.
- Both *E. atropurpurea* and *E. lamarckii* taxonomic complexes are confirmed genetically from the AFLP analyses, with the exception of *E. tuckeyana*, that is excluded from the *E. lamarckii* complex. *Euphorbia aphylla* is not included in any of these complexes, as previously suggested by morphological analyses.

- No genetic structure is detected in *E. tuckeyana* because of the habitat homogeneity of Cape Verde islands.
- *Euphorbia pedroi*, an endemic species from Cape Espichel in Portugal, makes part of the genetic pool of *E. regis-jubae*, from the West Canary Islands and Morocco. Probably *E. pedroi* and *E. regis-jubae* reached the mainland by a back colonisation event.
- The populations of *E. bourgeana* from Tenerife and *E. bourgeana* from La Gomera (named *E. lambii* by some authors) are genetically differentiated but we do not observe enough morphological characters to recognise both species.
- The species diversity of subsection *Macaronesicae* in the Canary Islands is concentrated in the central islands (Gran Canaria, Tenerife and La Gomera). The level of genetic structure within the Canarian species is lower in eastern species due to high levels of gene flow among their populations, favored by the flat topology and the ecological homogeneity of the eastern islands.

The tribe *Cardueae*

- Subtribe *Cardopatiinae* is revealed in the phylogenetic analyses as basal to the rest of subtribes of tribe *Cardueae*, followed by *Carlininae*, *Echinopsinae* and the *Carduinae* – *Centaureinae* complex.
- Phylogenetic analyses show that *Dipterocome* is basal to the rest of species of the *Xeranthemum* group within subtribe *Carduinae*.
- The African species of *Carduus* are merged within the *Cirsium* clade, showing the polyphyly of this genus as currently circumscribed.
- The basal group of subtribe *Centaureinae* is the *Volutaria* group, and previous results on the phylogenetic relationships in the *Centaureinae* basal grade were probably due to a long branch attraction phenomena provoked by differences in mutation rates in species with different life cycles. Thus, DNA regions from different genomes should always be combined in phylogenetic reconstructions.
- *Plectocephalus* is paraphyletic as revealed by the phylogenetic reconstruction, and is recircumscribed to include *P. americanus*, *P. cachinalensis*, *P. chilensis*, *P. floccosus*, *P. rothrockii*, *P. tweediei* and *P. varians*.
- *Centaurodendron*, an endemic genus from the Juan Fernández Islands, is placed within the *Plectocephalus* clade but is maintained as an independent genus due to its geographical isolation and the morphological differences with *Plectocephalus*.
- The tribe *Cardueae* originated around the Mid Eocene in West Asia.

- Most diversification events within *Cardueae* are related to the continuous cycles of area connection and division between the Anatolian microplate and the Western Mediterranean Basin during the Oligocene-Miocene.
- The uplift of the Himalayan range from the Miocene onwards played a major role in the diversification of subtribed *Carduinae*.
- From the Mediterranean region and central Asia, tribe *Cardueae* has dispersed and colonized the rest of the continents (the New World, Africa, Australia and India) most likely during the colder Pliocene-Pleistocene period.
- The geographic disjunction of *Plectocephalus* in East Africa and the New World is explained as a consequence of dispersal from Caucasus and Anatolia along the Siberian route and then across the Bering Land Bridge during the Miocene–Pliocene.

SUMMARY IN ENGLISH

6. SUMMARY IN ENGLISH

The genus *Euphorbia*

The genus *Euphorbia* comprises around 2000 species and is the second largest genus after *Astragalus*. It has a subcosmopolitan distribution and it has several diversification centers in Africa, Madagascar, Mexico and western Asia. It presents a large diversity of habits, including herbs, shrubs, trees and also succulent species. They all produce latex. Leaves are simple and alternate. Generally, they do not have stipules. *Euphorbia* is the only known genus having the three photosynthetic systems: CAM, C3 and C4. Flowers are reduced and aggregated in a particular type of inflorescence or cluster of flowers, the cyathium. The cyathium acts as a hermaphrodite pseudanthium, attracting pollinators with a sweet reward offered in four to five nectariferous involucre glands. Cyathia are gathered in synflorescences called pleiochasium. The fruits of *Euphorbia* are capsules that typically open explosively when ripe. Seeds of some species have a fleshy appendage called caruncle, an elaiosome attracting dispersal ants. The classification of the genus *Euphorbia* has always been controversial due to its large size and distribution. Currently, the subgeneric classification follows the results of several molecular studies of the genus, that propose a subdivision in four subgenera: subg. *Esula*, mainly distributed in Europe, is the sister clade to the rest; subg. *Rhizanthium*, mainly African, is sister to the clade composed by subg. *Chamaesyce*, mainly from the New World, and subg. *Euphorbia*, from Africa and Madagascar.

Subgenus *Esula* comprises around 400 species and has been lately shown as monophyletic only if it includes some species of sect. *Tirucalli* related to the *E. mauritanica* complex.

The *Pachycladae* group was defined by Boissier to include Australasian species (in the group *Polynesicae et Sundaieae*) and woody spurges from the Macaronesia, Africa and the Mediterranean area (the group *Canarienses et Mediterraneae* including *E. atropurpurea*, *E. balsamifera*, *E. berthelotii*, *E. bourgeana*, *E. dendroides*, *E. mellifera*, *E. piscatoria*, *E. regis-jubae*, *E. stygiana* and *E. tuckeyana*). Recently, the group *Polynesicae et Sundaieae* has been classified in subg. *Euphorbia* based on the results of molecular phylogenies. The *Canarienses et Mediterraneae* group has been shown as polyphyletic in molecular phylogenies, that revealed four independent origins or clades: first, the

Pachycladae core clade, which includes *E. atropurpurea*, *E. bravoana*, *E. piscatoria*, *E. regis-jubae* and *E. tuckeyana*; second, *E. balsamifera*, related to other species from subg. *Lyciopsis* sect. *Somalica*; third, *E. stygiana* and *E. mellifera*, two lauroid trees from the Canary Islands, Madeira and Azores that are not closely related to the *Pachycladae* core clade; and finally, *E. dendroides*, also excluded from the *Pachycladae* core clade. However these works did not provide a complete delimitation of the *Pachycladae* core clade because they did not include all the related species, and they also failed in resolving the *Pachycladae* core clade sister group.

The East/South African and Arabian elements of sect. *Tirucalli* comprised in the *E. mauritanica* complex have been phylogenetically related to the *Pachycladae* core clade in some molecular phylogenies. Additionally, some Macaronesian species previously classified in other sections have also been related to the *Pachycladae* group in molecular works. These species are *E. aphylla*, which had been previously included in the monotypic sect. *Aphyllis*, and *E. lamarckii*, previously classified in sect. *Tirucalli*.

Two main complexes defined by morphological characters and ecological preferences have been detected within the *Pachycladae* group. The *E. atropurpurea* complex includes three endemic species from the Canary Islands (*E. atropurpurea*, *E. bourgeana* and *E. bravoana*); and the *E. lamarckii* complex includes species from the Canarian archipelago (*E. berthelotii*, *E. lamarckii* and *E. regis-jubae*), Cape Verde (*E. tuckeyana*), Madeira (*E. piscatoria*), Selvagens Islands (*E. anachoreta*), Portugal (*E. pedroi*) and Morocco (*E. regis-jubae*).

If the relationships between the Macaronesian *Pachycladae* core clade and sect. *Tirucalli* are confirmed, this clade would be another example of the phytogeographic pattern known as the Rand Flora, that includes many plant groups showing a disjoint distribution between East and West Africa, South Africa and the Arabian Peninsula. This disjoint distribution pattern has been explained alternatively by a vicariance event, resulting from fragmentation of a wider distribution area in North Africa caused by the aridification of the climate during the late Miocene-Pliocene, or by a more recent, post-aridification longdistance dispersal event between the Horn of Africa and the Macaronesian region, followed by fast diversification events in each of these regions.

The tribe Cardueae

The tribe Cardueae represents one of the largest tribes of the family Compositae, with over 2400 species distributed amongst 73 genera. Cardueae are classified in the subfamily Carduoideae, along with Dicomeae, Oldenburgieae and Tarchonantheae, mainly from Africa. Phylogenetic relationships within Carduoideae have not been yet resolved. Cardueae include perennial, biennial, or monocarpic herbs and shrubs and, less often, annual herbs or small trees. The style is characterized by having the stigmatic areas confined to the inner surfaces of the style arms and an articulation below the branches of the upper region, which is usually provided with a collar of hairs. Historically, subtribal classification has been controversial but in the most complete study to date, five monophyletic lineages within Cardueae were identified: subtribes Cardopatiinae, Carduinae, Carlininae, Centaureinae, and Echinopsinae, with Carduinae being paraphyletic. However, this study failed to solve basal relationships between these lineages.

Subtribe Centaureinae is one of the most complex and diversified group in tribe Cardueae and it has been recently recircumscribed by molecular methods. However, phylogenetic relationships within the Centaureinae basal grade have not been yet resolved.

Tribe Cardueae is mainly distributed in the Mediterranean region, with centers of endemism in the eastern and western Mediterranean basin, the western Irano-Turanian region, and North Africa. The eastern limits of many genera are found in central Asia, in the mountains of Tian Shan, Pamir, and the Himalayas. A few genera occur in even more distant areas like Japan (*Atractylodes*, *Cirsium*, *Synurus*), North America (*Cirsium*, *Plectocephalus* and *Saussurea*), South America (*Centaurodendron*), and Australia (*Rhaponticum*).

There are also some striking intercontinental disjunctions in tribe Cardueae. One example is *Plectocephalus* (Centaureinae), a genus distributed in East Africa, North America, and South America.

Molecular systematics

The systematics studies the origin and diversification of species along life history, trying to reveal the evolutionary relationships of species. Systematics has used different types of characters to reconstruct the history of taxa, but in the last decades the most useful ones have been the molecular characters from the nuclear, chloroplast or mitochondrial genomes. In plants, the most commonly used markers are the two first ones because mitochondrial genome has a lot of restructurations. The development of molecular phylogeny is related to advances in the technology associated to DNA sequencing and the bioinformatics tools needed for the analysis of data. The most commonly used methods to analyze DNA sequences are Maximum Parsimony and Bayesian Inference.

Molecular dating was born with the hypothesis of the molecular clock, based on the assumption that evolutionary changes increase over time from the moment of separation of two lineages. The relaxed molecular clock hypothesis provides a new framework, which assumes that the mutation rate is not constant within species or over time. The most commonly used methods of molecular dating are PATHd8, *Penalized Likelihood* (PL) and BEAST.

Currently, one of the most used biogeographic reconstruction method is Bayes – DIVA, based in the dispersal-vicariance analyses, a bayesian method that minimizes dispersal and extinction events and accounts for uncertainty in phylogenetic relationships.

Phylogeography studies the genetic diversity of populations or closely related species and the geographic distribution of their lineages with the aim of explaining the evolutionary history of genetic lineages. The most commonly used genetic markers in this field are chloroplastic DNA sequences and AFLP markers, which can also be used to obtain taxonomic conclusions.

The main objectives of this thesis are:

In genus *Euphorbia*

- To test the monophyly of traditional sections of subg. *Esula*, using DNA sequences of the nuclear ribosomal ITS region.

- To provide a general phylogenetic framework for the *Pachycladae* group and its relatives, including the *E. mauritanica* complex from sect. *Tirucalli*.
- To provide a robust biogeographic hypothesis for the *Pachycladae* group and its relatives based on the phylogenetic relationships obtained.
- To verify taxonomic entities within subsect. *Macaronesicae* based on morphological and genetic data.
- To improve our understanding of colonization events, and on genetic and morphological diversification mechanisms of this group of species in the Macaronesia.

In tribe Cardueae

- To provide a resolved molecular phylogeny of tribe Cardueae at the generic level, with a special focus on phylogenetic relationships among subtribes and major lineages.
- To estimate divergence times for the main diversification events within Cardueae.
- To infer the ancestral areas and main migration events within the tribe to explain how it attained such a widespread and disjoint distribution.
- To test the monophyly of *Plectocephalus* and to determine the systematic position of the African *P. varians*, and the South American *P. chilensis*, *Centaurea cachinalensis*, *C. floccosa* and *C. tweediei*.
- To verify the phylogenetic relationships of *Centaurodendron* and *Plectocephalus* and their affinities with the basal genera of the Centaureinae.

Results and Discussion

The genus *Euphorbia*

Molecular Phylogeny

The phylogenetic reconstructions for the genus *Euphorbia* resolve eight main clades within subg. *Esula*, which do not correspond to traditional sectional classification,

except for sect. *Mysrinites*. All members of sect. *Helioscopia*, except *E. lagascae*, constitute a supported clade, which also includes the Macaronesian lauroid trees *E. mellifera* and *E. stygiana*, previously included in the *Pachycladae* group. *Euphorbia serrata* and *E. retusa*, from sect. *Chylogala*, are resolved in a main clade but the phylogenetic position of *E. calyptrata* is unresolved. The *Pachycladae* core clade is resolved in a main clade including 10 Macaronesian species from the *Pachycladae* core clade, *E. aphyllis*, and 11 species of sect. *Tirucalli* related to the *E. mauritanica* complex distributed mainly in the Eritreo-Arabian region but also in West and South Africa and Madagascar (*E. stolonifera*, *E. mauritanica*, *E. orthoclada*, *E. berotica*, *E. calamiformis*, *E. gossypina*, *E. lateriflora*, *E. nubica*, *E. papilionum*, *E. schimperii* and *E. usambarica*). This clade is renamed as sect. *Aphyllis* in our work. More recently, other studies have validated this natural section and have defined two subsections within sect. *Aphyllis*: subsect. *Macaronesicae* and subsect. *Africanae*.

Section *Tirucalli* is revealed as polyphyletic in our study. The “true” *Tirucalli* are placed in subg. *Euphorbia*, constituting a clade composed by *E. tirucalli* and related species, like *E. bariensis* and *E. dhofarensis*. A second clade is comprised by the *E. mauritanica* complex and related species now members of sect. *Aphyllis*. Finally, *E. larica* and *E. masirahensis* are placed within subg. *Rhizanthium*, closely related to *E. balsamifera*, species traditionally included in the *Pachycladae* group because of its distribution in West Africa, Yemen and the Canary Islands.

The sister clade of sect. *Aphyllis* is constituted by species from several sections like *E. dendroides*, previously classified in the *Pachycladae* group; *E. biumbellata*, from sect. *Paralias* and *E. medicaginea*, from sect. *Cymatospermum*.

Low resolution within sect. *Aphyllis* and incongruences between nuclear and chloroplast phylogenies may be due to hybridization. The incongruences detected did not allow us to combine genomes from different origins but some results were consistent in both reconstructions, like the basal position of *E. tuckeyana*, which seems to have had an independent origin from the rest of species in sect. *Aphyllis*.

Two modes of speciation have occurred within species from sect. *Aphyllis*: adaptive ecological radiation and allopatric speciation. Radiation into different ecological habitats seems to have played a main role, given that species from the *E. lamarckii* complex mainly occupy xerophytic habitats in low and mid-altitude areas while members

of the *E. atropurpurea* complex mainly occur in mesophytic and sub-hygrophytic areas associated with evergreen laurisilva. Allopatric speciation among different archipelagos also seems to have occurred within members of the *E. lamarckii* complex, each endemic to one archipelago or Macaronesian enclave but with the same ecological preferences.

Section *Aphyllis* would have originated in the Mediterranean area; its disjunct distribution is probably due to vicariance, resulting from fragmentation of a wider distribution area in North Africa caused by the aridification of the climate during the late Miocene-Pliocene.

Phylogeography

All the analyses performed with the AFLP markers on the species from sect. *Aphyllis* subsect *Macaronesicae* confirm that *E. tuckeyana* has an independent origin from the rest of species of the group, thus it should be excluded from the *E. lamarckii* complex, where it had been classified by morphological characters. Within the main group in sect. *Aphyllis*, excluding *E. tuckeyana*, we obtained a clear genetic structure in two groups; with correspond to the two complexes *E. atropurpurea* and *E. lamarckii*. *Euphorbia aphylla* is basal to the two complexes, suggesting a northwards direction of dispersal of the group in the Macaronesia from the Canary Islands. Rock pigeons (*Columba livia canariensis*) and the migratory turtle doves (*Streptopelia turtur turtur*) have been recorded as *Euphorbia* seeds feeders and may be acting as long-distance *Euphorbia* seeds' dispersal agents' by accidental endozoochory.

Back-dispersal of Macaronesian organisms to the mainland has been reported for several plant groups. This phenomenon could have been acting especially during the Quaternary glaciations, when the Macaronesian islands could have acted as a biodiversity refuge acting as a source of biodiversity to the mainland rather than an end of dispersal routes from the continent. A back colonisation to the continent can explain the presence of *E. regis-jubae* in the Atlantic coast of Morocco, as this locality has the same ecological conditions than Fuerteventura and Lanzarote since the Pliocene. Also, a recent back colonisation to the continent from one of the islands where *E. regis-jubae* is found would explain the presence of *E. pedroi* in Portugal, as we detect very short branches in the NJ tree.

Regarding the *E. lamarckii* complex, four clusters are detected: one cluster including all the specimens of *E. regis-jubae* and *E. pedroi*; a second cluster with all the specimens of *E. piscatoria*; a third cluster including all the specimens of *E. berthelotii*; and finally the cluster composed by *E. anachoreta* and *E. lamarckii*. The inclusion of the *E. pedroi* populations within the *E. regis-jubae* cluster appears in all the AFLP analyses performed. These results reveal that *E. pedroi* makes part of the genetic pool of *E. regis-jubae*. However, *E. pedroi* is morphologically differentiated from *E. regis-jubae*, this differentiation could be further promoted by its geographical isolation. Moreover, it shows no genetic admixture with the rest of populations of this group. Thus, we support to maintain *E. pedroi* as a separate species. *Euphorbia anachoreta*, endemic to the Selvagens Islands and included in the Red List of threatened species as “critically endangered”, seems to have its origin in the Canary Islands as it is genetically related to *E. lamarckii*.

The presence of hybridization events between several species of sect. *Aphyllis* has been hypothesised in the literature on the basis of the existence of morphologically intermediate individuals between several pairs of species, but hybrids have been avoided in our sampling. However, some specimens with mixed ancestry have been detected in the genetic clustering analyses: *E. lamarckii* seems to present high admixture with *E. berthelotti* and *E. bravoana*. The same results are not obtained in the Neighbour-Net analysis, and the reliability of clustering analyses in detecting hybridization and introgression is doubtful in this cases, so we recommend to perform further analyses including intermediate individuals to detect the levels of hybridization in this group.

The tribe Cardueae

Molecular Phylogeny

The phylogenetic reconstruction combining a nuclear region (ITS) and four chloroplastic regions (*matK*, *ndhF*, *rbcL* and *trnL-trnF*) provides a good resolution of basal relationships within Cardueae. Cardopatiinae is reconstructed as sister-group to the other subtribes, with subtribe Carlininae diverging next, followed by Echinopsinae, although the phylogenetic position of the latter is not well supported. The last clade is

composed of the complex Carduinae-Centaureinae. Within subtribe Carduinae, *Dipterocome* is shown as sister-group to the remaining genera of the *Xeranthemum* group. Our analyses confirm the close relationships of *Carduus* species from tropical East Africa and the genus *Cirsium*, affinities also detected on the basis of morphological similarities. Within the Centaureinae subtribe, phylogenetic analyses show that *Plectocephalus* includes the African species *P. varians*, together with all the native North and South American species, some of them previously classified in *Centaurea*. *Centaurodendron*, an endemic tree from the Juan Fernández Islands, is placed within the *Plectocephalus* clade. However, we support to maintain *Centaurodendron* as an independent genus because of its morphological differences.

The *Volutaria* group is now defined as the basalmost group in the Centaureinae. This result diverges from previous phylogenies of subtribe Centaureinae, probably due to a long branch attraction phenomenon provoked by differences in mutation rates between species with different life cycles. ITS is the most sensible region to these differences among all the DNA regions used in this study. Thus, DNA regions from different genomes should be always combined in phylogenetic reconstructions.

Molecular dating and biogeographical reconstruction

The combination of molecular dating and biogeographical reconstruction reveals that Cardueae were originated in West Asia around the Middle Eocene. The ancestors of Cardueae dispersed from Africa to West Asia, probably across northeastern Africa. The date of Cardueae origin is much older than the one previously suggested in other molecular studies for the same tribe, probably due to new fossil evidence used in the present analyses. Indeed, our dating corresponds to the oldest age among tribes of Compositae.

Diversification of tribe Cardueae in the Mediterranean region is detected in the five subtribes. In subtribes Carduinae and Carlininae these events are dated to the Oligocene-Miocene period, when additions of microplates located between the Paratethys and Tethys formed a continuous landmass across the Mediterranean, which connected the West Mediterranean Basin with the West Asia-Eastern Mediterranean region. In subtribe Centaureinae we detect a large diversification in the late Miocene,

when the aridification produced by the Messinian Salinity Crisis would have allowed trans-Mediterranean dispersal and diversification.

Our analyses suggest that several *Cardueae* species (from *Carduus* and *Echinops*) migrated secondarily to the mountains of tropical Africa. This may indicate that these species colonized Africa during cool periods and found refuge in the mountain regions of tropical Africa when the climate started to become arid again.

Middle Asia has been a major area of diversification for the *Cardueae*, especially for subtribe *Carduinae*, for which the uplift of the Qinghai-Tibetan plateau (QTP) played a major role. Diversification of species is detected in our analyses in the five subtribes coinciding with four major periods of uplift of the QTP: 22–20, 15–13, 8–7 and 3.6–1.8 Ma.

The colonization of the New World has taken place several times in the *Cardueae*. *Plectocephalus* reached the New World after a dispersal event from East Africa to Caucasus and Anatolia along the Siberian route and then across the Bering Land Bridge during the Miocene–Pliocene.

Besides the striking dispersal of *Plectocephalus* to the American continent, a second migration event to North America during the Pliocene is shown in the clade formed by two eastern North American *Cirsium* species from Middle Asia, probably via the second BLB before its closure.

BIBLIOGRAFIA

7. BIBLIOGRAFIA

Allan, G.J., Francisco-Ortega, J., Santos-Guerra, A., Boerner, E. and E.A. Zimmer. 2004. Molecular phylogenetic evidence for the geographic origin and classification of Canary island *Lotus* (Fabaceae: Loteae). *Molecular Phylogenetics and Evolution* 32: 123–138.

Álvarez, I. and J.F. Wendel. 2003. Ribosomal ITS sequences and plant phylogenetic inference. *Molecular Phylogenetics and Evolution* 29: 417–434.

Andrus, N., Trusty, J., Santos-Guerra, A., Jansen, R.K. and J. Francisco-Ortega. 2004. Using molecular phylogenies to test phytogeographical links between east/south Africa-southern Arabia and the macaronesian islands - a review, and the case of *Vierea* and *Pulicaria* section *Vieraeopsis* (Asteraceae). *Taxon* 53: 333–346.

Avise, J.C. 2000. *Phylogeography: The history and formation of species*. Harvard University Press: Cambridge.

Avise, J.C., Arnold, J., Ball, R.M., Bermingham, E., Lamb, T., Neigel, J.E., Reeb, C.A. and N.C. Saunders. 1987. Intraspecific phylogeography: the mitochondrial DNA bridge between population-genetics and systematics. *Annual Review of Ecology and Systematics* 18: 489–522.

Axelrod, D.I. 1975. Evolution and biogeography of madrean-tethyan sclerophyll vegetation. *Annals of the Missouri Botanical Garden* 62: 280–334.

Axelrod, D.I. and P.H. Raven. 1978. Late cretaceous and tertiary vegetation history of Africa. Pp. 79–130 In: Werger, M.J.A. (ed.), *Biogeography and ecology of Southern Africa*. Junk: The Hague.

Baldwin, B.G. 1992. Phylogenetic utility of the internal transcribed spacers of nuclear ribosomal DNA in plants: an example from the Compositae. *Molecular Phylogenetics and Evolution* 1: 3–16.

Baldwin, B.G., Sanderson, M.J., Porter, J.M., Wojciechowski, M.F., Campbell, C.S. and M.J. Donoghue. 1995. The ITS region of nuclear ribosomal DNA: A valuable source of evidence on Angiosperm phylogeny. *Annals of the Missouri Botanical Garden* 82: 247–277.

Barreda, V.D., Palazzesi, L., Tellería, M.C., Katinas, L., Crisci, J.V., Bremer, K., Passalia, M.G., Corsolini, R., Brizuela, R.R. and F. Bechis. 2010. Eocene Patagonia fossils of the daisy family. *Science* 329: 1621–1621.

Bañares, Á., Blanca, G., Güemes, J., Moreno, J.C. and S. Ortiz, eds. 2010. *Atlas y Libro Rojo de la Flora Vasculare Amenazada de España. Adenda 2010*. Dirección General de Medio Natural y Política Forestal (Ministerio de Medio Ambiente, y Medio Rural y Marino) - Sociedad Española de Biología de la Conservación de Plantas: Madrid.

Bellstedt, D.U., Van Zyl, L., Marais, E.M., Bytebier, B., De Villiers, C.A., Dreyer, L.L., Galley, C., Pirie, M. and H.P. Linder. 2008. A molecular phylogeny reveals evidence of rapid and recent radiation in Cape and Australian members of the genus *Zygophyllum*. *South African Journal of Botany* 74: 361–361.

Bentham, G. 1873. Compositae. Pp. 162–533 In: Bentham, G. and J.D. Hooker (eds.), *Genera Plantarum*. Lovell Reeve: London.

Bentham, G. 1878. Notes on Euphorbiaceae. *Botanic Journal of the Linnean Society* 17: 185–267.

Berg, R.Y. 1990. Seed dispersal relative to population structure, reproductive capacity, seed predation, and distribution in *Euphorbia balsamifera* (Euphorbiaceae), with a note on sclerendochory. *Sommerfeltia* 11: 35–63.

Boissier, P.E. 1862. Euphorbiaceae. Pp. 3–188 In: De Candolle, A.P. (ed.), *Prodromus systematis naturalis regni vegetabilis* 15(2). Treuttel & Würtz : Paris.

Bramwell, D. 1985. Contribución a la biogeografía de las Islas Canarias. *Botánica Macaronésica* 14: 3–34.

Bramwell, D. and Z.I. Bramwell. 2001. *Flores silvestres de las islas Canarias*. Ed. Rueda: Madrid.

Bremer, K. 1994. *Asteraceae. Cladistics and classification*. Timber Press: Portland.

Britton, T., Anderson, C.L., Jacquet, D., Lundqvist, S. and K. Bremer. 2007. Estimating divergence times in large phylogenetic trees. *Systematic Biology* 56: 741–752.

Bruyns, P.V., Mapaya, R.J. and T. Hedderson. 2006. A new subgeneric classification for *Euphorbia* (Euphorbiaceae) in southern Africa based on ITS and *psbA-trnH* sequence data. *Taxon* 55: 397–420.

Calviño-Cancela, M., Escudero, M., Rodríguez-Perez, J., Cano, E., Vargas, P., Velo-Anton, G. and A. Traveset. 2012. The role of seed dispersal, pollination and

historical effects on genetic patterns of an insular plant that has lost its only seed disperser. *Journal of Biogeography* 39: 1996–2006.

Carine, M.A. 2005. Spatio-temporal relationships of the Macaronesian endemic flora: A relictual series or window of opportunity? *Taxon* 54: 895–903.

Carlquist, S. 1958. Anatomy and systematic position of *Centaurodendron* and *Yunquea* (Compositae). *Brittonia* 10: 78–93.

Carlquist, S. 1974. *Island Biology*. Columbia University Press: New York.

Carlquist, S. 1976. Tribal interrelationships and phylogeny of the Asteraceae. *Aliso* 8: 465–492.

Carracedo, J.C., Day, S., Guillou, H., Badiola, E.R., Canas, J.A. and F.J.P. Torrado. 1998. Hotspot volcanism close to a passive continental margin: The Canary Islands. *Geological Magazine* 135: 591–604.

Carracedo, J.C., Pérez, F.J., Ancochea, E., Meco, J., Hernán, F., Cubas, C.R., Casillas, R., Rodríguez, E. and A. Ahijado. 2002. Cenozoic volcanism. II: The Canary Islands. Pp. 439–472 In: Gibbons, W. and T. Moreno (eds.), *The Geology of Spain*. The Geological Society of London: London.

Carter, S. 1985. New species and taxonomic changes in *Euphorbia* from East and northeast tropical Africa and a new species from Oman. *Kew Bulletin* 40: 809–825.

Carter, S. 1992. New species of *Euphorbia* subgenus *Tirucalli* (Euphorbiaceae) from Somalia and Oman. *Nordic Journal of Botany* 12: 675–679.

Cassini, H. 1819. Sur la famille des Synanthérées, contenant les caractères des tribus. *Journal de Physique, de Chimie, d'Histoire Naturelle et des Arts* 88: 189–204.

Caujapé-Castells, J. 2011. Jesters, red queens, boomerangs and surfers: a molecular outlook on the diversity of the Canarian endemic flora. Pp. 284–324 In: Bramwell, D. and J. Caujapé-Castells (eds.), *The biology of Island Floras*. Cambridge University Press: London.

Christ, H. 1892. Exposé sur le rôle que joue dans le domaine de nos flores la “flore ancienne africaine”. *Archives des Sciences Physiques et Naturelles de Genève* 3 (XXVIII): 1–48 and 369–374.

Croizat, L. 1940. A significant new species from New Guinea: *Euphorbia euonymoclada* Croiz., sp. nov. *Bulletin of Botanic Gardens Buitenzorg, ser. III* 16: 351–357.

Cuénoud, P., Del Pero Martínez, M.A., Loizeau, P.A., Spichiger, R., Andrews, S. and J.F. Manen. 2000. Molecular phylogeny and biogeography of the genus *Ilex* L. (Aquifoliaceae). *Annals of Botany* 85: 111–122.

De Nascimento, L., Willis, K.J., Fernández-Palacios, J.M., Criado, C. and R.J. Whittaker. 2009. The long-term ecology of the lost forests of La Laguna, Tenerife (Canary Islands). *Journal of Biogeography* 36: 499–514.

Dittrich, M. 1977. Cynareae—systematic review. Pp. 999–1015 In: Heywood, V.H., Harborne, J.B. and B.L. Turner (eds.), *The Biology and Chemistry of the Compositae*. Academic Press: London–New York–San Francisco.

Dixon, C.J., Schoenswetter, P., Suda, J., Wiedermann, M.M. and G.M. Schneeweiss. 2009. Reciprocal Pleistocene origin and postglacial range formation of an allopolyploid and its sympatric ancestors (*Androsace adfinis* group, Primulaceae). *Molecular Phylogenetics and Evolution* 50: 74–83.

Drummond, A.J., Ho, S.Y.W., Phillips, M.J. and A. Rambaut. 2006. Relaxed phylogenetics and dating with confidence. *PLoS Biology* 4: 88.

Duggen, S., Hoernle, K., Van Den Bogaard, P., Rupke, L. and J.P. Morgan. 2003. Deep roots of the Messinian salinity crisis. *Nature* 422: 602–606.

Felsenstein, J. 1985. Confidence limits on phylogenies: An approach using the bootstrap. *Evolution* 39: 783–791.

Fernández-Palacios, J.M., de Nascimento, L., Otto, R., Delgado, J.D., García-del-Rey, E., Ramon Arévalo, J. and R.J. Whittaker. 2011. A reconstruction of Palaeo-Macaronesia, with particular reference to the long-term biogeography of the Atlantic island laurel forests. *Journal of Biogeography* 38: 226–246.

Frajman, B. and P. Schönswetter. 2011. Giants and dwarfs: molecular phylogenies reveal multiple origins of annual spurges within *Euphorbia* subg. *Esula*. *Molecular Phylogenetics and Evolution* 61: 413–424.

Francisco-Ortega, J., Barber, J.C., Santos-Guerra, A., Febles-Hernández, R. and R. K. Jansen. 2001. Origin and evolution of the endemic genera of *Gonosperminae* (Asteraceae: Anthemideae) from the Canary Islands: evidence from

nucleotide sequences of the internal transcribed spacers of the nuclear ribosomal DNA. *American Journal of Botany* 88: 161–169.

Francisco-Ortega, J., Fuertes-Aguilar, J., Gómez-Campo, C., Santos-Guerra, A. and R.K. Jansen. 1999. Internal transcribed spacer sequence phylogeny of *Crambe* L. (Brassicaceae): Molecular data reveal two Old World disjunctions. *Molecular Phylogenetics and Evolution* 11: 361–380.

Francisco-Ortega, J., Santos-Guerra, A., Hines, A. and R.K. Jansen. 1997. Molecular evidence for a mediterranean origin of the macaronesian endemic genus *Argyranthemum* (Asteraceae). *American Journal of Botany* 84: 1595–1613.

Funk, V.A., Bayer, R.J., Keeley, S., Chan, R., Watson, L., Gemeinholzer, B., Schilling, E., Panero, J.L., Baldwin, B.G., Garcia-Jacas, N., Susanna, A. and R.K. Jansen. 2005. Everywhere but Antarctica: Using a supertree to understand the diversity and distribution of the Compositae. *Biologiske Skrifter* 55: 343–374.

Funk, V.A., Susanna, A., Stuessy, T.F. and H. Robinson. 2009. Classification of Compositae. Pp. 171–189 In: Funk, V.A., Susanna, A., Stuessy, T.F. and R.J. Bayer (eds.), *Systematics, evolution, and biogeography of Compositae*. IAPT: Vienna.

Galbany-Casals, M., Carnicero-Campmany, P., Blanco-Moreno, J.M. and R.D. Smissen. 2012. Morphological and genetic evidence of contemporary intersectional hybridisation in Mediterranean *Helichrysum* (Asteraceae, Gnaphalieae). *Plant Biology* 14: 789–800.

Galbany-Casals, M., Garcia-Jacas, N., Sáez, L., Benedí, C. and A. Susanna. 2009. Phylogeny, biogeography, and character evolution in Mediterranean, Asiatic, and Macaronesian *Helichrysum* (Asteraceae, Gnaphalieae) inferred from nuclear phylogenetic analyses. *International Journal of Plant Sciences* 170: 365–380.

Galley, C. and H.P. Linder. 2006. Geographical affinities of the Cape flora, South Africa. *Journal of Biogeography* 33: 236–250.

Garcia-Jacas, N., Garnatje, T., Susanna, A. and R. Vilatersana. 2002. Tribal and subtribal delimitation and phylogeny of the *Cardueae* (Asteraceae): A combined nuclear and chloroplast DNA analysis. *Molecular Phylogenetics and Evolution* 22: 51–64.

Garcia-Jacas, N., Susanna, A., Garnatje, T. and R. Vilatersana. 2001. Generic delimitation and phylogeny of the subtribe *Centaureinae* (Asteraceae): A combined nuclear and chloroplast DNA analysis. *Annals of Botany* 87: 503–515.

Geldmacher, J., Hoernle, K., van den Bogaard, P., Zankl, G. and D. Garbe-Schönberg. 2001. Earlier history of the ≥ 70 -Ma-old Canary hotspot based on temporal and geochemical evolution of the Selvagens Archipelago and neighbouring seamounts in the eastern North Atlantic. *Journal of Volcanology and Geothermal Research* 111: 55–87.

Gilbert, M.G. 1987. Two new geophytic species of *Euphorbia* with comments on the subgeneric grouping of its African members. *Kew Bulletin* 42: 231–244.

Gillespie, J.H. 1986. Rates of molecular evolution. *Annual Review of Ecology, Evolution and Systematics* 17: 637–665.

Govaerts, R., Frodin, D.G. and A. Radcliffe-Smith. 2000. *World checklist and bibliography of Euphorbiaceae (with Pandaceae)*, vol. 4. Royal Botanic Gardens: Kew.

Graur, D. and W.H. Li. 1999. *Fundamentals of molecular evolution*. Sinauer Associates: Sunderland.

Greenish, H.G. 1920. *Text book of materia medica, being an account of the more important crude drugs of vegetable and animal origin, designed for students of pharmacy and medicine*. Churchill: London.

Helfgott, D.M., Francisco-Ortega, J., Santos-Guerra, A., Jansen, R.K. and B.B. Simpson. 2000. Biogeography and breeding system evolution of the woody *Becomia* alliance (*Rosaceae*) in Macaronesia based on its sequence data. *Systematic Botany* 25: 82–97.

Hellwig, F.H. 2004. *Centaureinae* (Asteraceae) in the Mediterranean – history of ecogeographical radiation. *Plant Systematics and Evolution* 246: 137–162.

Hess, J., Kadereit, J.W. and P. Vargas. 2000. The colonization history of *Olea europaea* L. in Macaronesia based on internal transcribed spacer 1 (ITS-1) sequences, randomly amplified polymorphic DNAs (RAPD), and intersimple sequence repeats (ISSR). *Molecular Ecology* 9: 857–868.

Hoffmann, O. 1894. Compositae. Pp. 324–333 In: Engler, A. and K. Prantl (eds.), *Die natürlichen Pflanzenfamilien*. Wilhelm Engelmann: Leipzig.

Horn, J.W., van Ee, B.W., Morawetz, J.J., Riina, R., Steinmann, V.W., Berry, P.E. and K.J. Wurdack. 2012. Phylogenetics and the evolution of major structural characters in the giant genus *Euphorbia* L. (Euphorbiaceae). *Molecular Phylogenetics and Evolution* 63: 305–326.

Huelsenbeck, P. and F. Ronquist. 2001. MRBAYES: Bayesian inference of phylogenetic trees. *Bioinformatics* 17: 754–755.

Jansen, R.K. and J.D. Palmer. 1987. A chloroplast DNA inversion marks an ancient evolutionary split in the sunflower family (Asteraceae). *Proceedings of the National Academy of Sciences, USA* 84: 5818–5822.

Jansen, R.K. and J.D. Palmer. 1988. Phylogenetic implications of chloroplast DNA restriction site variation in the Mutisieae (Asteraceae). *American Journal of Botany* 75: 753–766.

Jiménez-Mejías, P., Luceño, M., Lye, K.A., Brochmann, C. and G. Gussarova. 2012. Genetically diverse but with surprisingly little geographical structure: the complex history of the widespread herb *Carex nigra* (Cyperaceae). *Journal of Biogeography* 39: 2279–2291.

Juan, C., Emerson, B.C., Oromí, P. and G.M. Hewitt. 2000. Colonisation and diversification: towards a phylogeographic synthesis for the Canary Islands. *Trends in Ecology and Evolution* 15: 104–109.

Kim, H.-G., Loockerman, D.J. and R.K. Jansen. 2002. Systematic implications of *ndhF* sequence variation in the Mutisieae (Asteraceae). *Systematic Botany* 27: 598–609.

Kim, K.J. and R.K. Jansen. 1995. *NdhF* sequence evolution and the major clades in the sunflower family. *Proceedings of the National Academy of Sciences, USA* 92: 10379–10383.

Le Houérou, H.-N. 1995. *Bioclimatologie et biogéographie des steppes arides du Nord de l'Afrique: diversité biologique, développement durable et désertisation*. CIHEAM-IAMM (Options Méditerranéennes Séries B): Montpellier-Paris.

Leach, L.C. 1975. Notes on *Euphorbia mauritanica*, *E. gossypina* and some related species with an amplified description of *E. berotica*. *Bothalia* 11: 505–510.

Levyens, M.R. 1964. Migrations and origin of the Cape flora. *Transactions of the Royal Society of South Africa* 37: 85–107.

Linder, H.P., Meadows, M.E. and R.M. Cowling. 1992. History of the Cape flora. Pp. 113–134 In: Cowling, R.M. (ed.), *The ecology of fynbos: Nutrients, fire and diversity*. Oxford University Press: Cape Town.

Linné, C. 1753. *Species Plantarum*. Impensis Laurentii Salvii: Stockholm.

Martín, J.L., Arechavaleta, M., Borges, P.A.V. and B. Faria (eds.). 2008. *TOP 100 - As cem espécies ameaçadas prioritárias em termos de gestão na região europeia biogeográfica da Macaronésia*. Consejería de Medio Ambiente y Ordenación Territorial, Gobierno de Canarias: Las Palmas de Gran Canaria.

McGuire, A.F. and K.A. Kron. 2005. Phylogenetic relationships of European and African Ericas. *International Journal of Plant Sciences* 166: 311–318.

Médail, F. and P. Quézel. 1999. The phytogeographical significance of S.W. Morocco compared to the Canary Islands. *Plant Ecology* 140: 221–244.

Mendelson, T.C. and K.L. Shaw. 2005. Use of AFLP markers in surveys of arthropod diversity. *Methods in Enzimology* 395: 161–177.

Meudt, H.M. and A.C. Clarke. 2007. Almost forgotten or latest practice? AFLP applications, analyses and advances. *Trends in Plant Sciences*. 12: 106–117.

Meulenkamp, J.E. and W. Sissingh. 2003. Tertiary palaeogeography and tectonostratigraphic evolution of the Northern and Southern Peri-Tethys platforms and the intermediate domains of the African-Eurasian convergent plate boundary zone. *Palaeogeography, Palaeoclimatology, Palaeoecology* 196: 209–228.

Molero, J., Garnatje, T., Rovira, A., Garcia-Jacas, N. and A. Susanna. 2002. Karyological evolution and molecular phylogeny in macaronesian spurges (*Euphorbia* subsect. *Pachycladae*). *Plant Systematics and Evolution* 231: 109–132.

Molero, J. and A.M. Rovira. 2005a. Natural hybrids in endemic Canarian dendroid spurges (*Euphorbia* subsect. *Pachycladae*). *Willdenowia* 35: 271–280.

Molero, J. and A.M. Rovira. 2005b. Typification of some Macaronesian and Mediterranean dendroid spurges. *Taxon* 54: 472–474.

Moore, M.J., Francisco-Ortega, J., Santos-Guerra, A. and R.K. Jansen. 2002. Chloroplast DNA evidence for the roles of island colonization and extinction in *Tolpis* (Asteraceae: Lactuceae). *American Journal of Botany* 89: 518–526.

Moreno, J.C. 2011. *Lista Roja de la flora vascular española 2008. Actualización con los datos del Adenda 2010 al Atlas y Libro rojo de la flora vascular amenazada*. Dirección General de Conservación de la Naturaleza y Sociedad Española de Biología de la Conservación de Plantas: Madrid.

Nei, M. and S. Kumar. 2000. *Molecular evolution and phylogenetics*. Oxford University Press: New York.

Nogales, M. 1985. *Contribución al estudio de la flora y fauna en los montes de Pajonales, Ojeda e Inagua (Gran Canaria)*. PhD Thesis. Universidad de la Laguna: La Laguna.

Nordenstam, B. and G. El-Ghazaly. 1977. Floral micromorphology and pollen ultrastructure in some *Centaureinae* (Compositae) mainly from Egypt. *Publications from Cairo University Herbarium* 7–8: 143–155.

Nylander, J.A.A., Olsson, U., Alström, P. and I. Sanmartín. 2008. Accounting for phylogenetic uncertainty in biogeography: A Bayesian approach to dispersal-vicariance analysis of the thrushes (Aves: *Turdus*). *Systematic Biology* 57: 257–268.

Ortiz, S. 2009. *Oldenburgieae* (Carduoideae). Pp. 287–291 In: Funk, V.A., Susanna, A., Stuessy, T.F. and R.J. Bayer (eds.), *Systematics, evolution, and biogeography of Compositae*. IAPT: Vienna.

Oudejans, R.C.H.M. 1990. *World catalogue of species names published in the Euphorbieae (Euphorbiaceae) with their geographical distribution*. Published by the author: Utrecht.

Palmer, J.D. 1992. Mitochondrial DNA in plant systematics: Applications and limitations. Pp. 36–48 In: Soltis, P.S., Soltis, J.E. and J.J. Doyle (eds.), *Molecular systematics of plants*. Chapman and Hall: New York.

Panero, J.L. and V.A. Funk. 2002. Toward a phylogenetic subfamilial classification for the Compositae (Asteraceae). *Proceedings of the Biological Society of Washington* 115: 909–922.

Panero, J.L. and V.A. Funk. 2008. The value of sampling anomalous taxa in phylogenetic studies: Major clades of the Asteraceae revealed. *Molecular Phylogenetics and Evolution* 47: 757–782.

Park, K.R. and W.J. Elisens. 2000. A phylogenetic study of tribe Euphorbieae (Euphorbiaceae). *International Journal of Plant Sciences* 161: 425–434.

Park, K.R. and R.K. Jansen. 2007. A phylogeny of *Euphorbieae* subtribe *Euphorbiinae* (Euphorbiaceae) based on molecular data. *Journal of Plant Biology* 50: 644–649.

Park, S.J., Korompai, E.J., Francisco-Ortega, J., Santos-Guerra, A. and R.K. Jansen. 2001. Phylogenetic relationships of *Tolpis* (Asteraceae: Lactuceae) based on *ndhF* sequence data. *Plant Systematics and Evolution* 226: 23–33.

Pax, F. and U. Hoffman. 1931. Euphorbiaceae. Pp. 11–233 In: Engler, A. and K. Prantl (eds.), *Die Natürlichen Pflanzenfamilien 2*, 19C. Engelmann: Leipzig.

Percy, D.M. and Q.C.B. Cronk. 2002. Different fates of island brooms: contrasting evolution in *Adenocarpus*, *Genista*, and *Teline* (*Genisteae*, *Fabaceae*) in the Canary Islands and Madeira. *American Journal of Botany* 89: 854–864.

Petit, D.P. 1997. Generic interrelationships of the *Cardueae* (Compositae): A cladistic analysis of morphological data. *Plant Systematics and Evolution* 207: 173–203.

Prenner, G., Cacho, G.I., Baum, D. and P.J. Rudall. 2011. Is LEAFY a useful marker gene for the flower-inflorescence boundary in the *Euphorbia* cyathium? *Journal of Experimental Botany* 62: 345–350.

Prenner, G. and P.J. Rudall. 2007. Comparative ontogeny of the cyathium in *Euphorbia* (Euphorbiaceae) and its allies: exploring the organ-flower-inflorescence boundary. *American Journal of Botany* 94: 1612–1629.

Quézel, P. 1978. Analysis of the flora of Mediterranean and Saharan Africa. *Annals of the Missouri Botanical Garden* 65: 479–534.

Radcliffe-Smith, A. 1982. *Euphorbia* L. Pp. 571–630 In: Davis, P. (ed.), *Flora of Turkey and the East Aegean Islands*, vol. 7. Edinburgh University Press: Edinburgh.

Radcliffe-Smith, A. 2001. *Genera Euphorbiacearum*. Royal Botanic Gardens: Kew.

Radcliffe-Smith, A. and T.G. Tutin. 1968. *Euphorbia* L. Pp. 213–226 In: Tutin, T.G., Heywood, V.H., Burges, N.A., Moore, D.M., Walters, S.M. and D.A. Webb (eds.), *Flora Europaea*, vol. 2. Cambridge University Press: Cambridge.

Ree, R.H., Moore, B.R., Webb, C.O. and M.J. Donoghue. 2005. A likelihood framework for inferring the evolution of geographic range on phylogenetic trees. *Evolution* 59: 2299–2311.

Ree, R.H. and S.A. Smith. 2008. Maximum likelihood inference of geographic range evolution by dispersal, local extinction, and cladogenesis. *Systematic Biology* 57: 4–14.

Riina, R., Peirson, J. A., Geltman, D.V., Molero, J., Frajman, B., Pahlevani, A., Barres, L., Morawetz, J.J., Salmaki, Y., Zarre, S., Kryukov, A., Bruyns, P.V. and P.E. Berry. In press. A worldwide molecular phylogeny and classification of the leafy spurge, *Euphorbia* subgenus *Esula* (Euphorbiaceae). *Taxon*.

Ronquist, F. 1996. *DIVA, version 1.1*. Computer program available by anonymous ftp. Uppsala University: Uppsala.

Ronquist, F. 1997. Dispersal-vicariance analysis: A new approach to the quantification of historical biogeography. *Systematic Biology* 46: 195–203.

Sanderson, M.J. 2002. Estimating absolute rates of molecular evolution and divergence times: a Penalized Likelihood approach. *Molecular Biology and Evolution* 19: 101–109.

Sanmartín, I. and F. Ronquist. 2004. Southern hemisphere biogeography inferred by event-based models: plant versus animal patterns. *Systematic Biology* 53: 1–28.

Sanmartín, I., Van der Mark, P. and F. Ronquist. 2008. Inferring dispersal: A Bayesian approach to phylogeny-based island biogeography, with special reference to the Canary Islands. *Journal of Biogeography* 35: 428–449.

Steinmann, V.W. and J.M. Porter. 2002. Phylogenetic relationships in *Euphorbieae* (Euphorbiaceae) based on ITS and *ndhF* sequence data. *Annals of the Missouri Botanical Garden* 89: 453–490.

Sunding, P. 1979. Origins of the Macaronesian flora. Pp. 13–40 In: Bramwell, D. (ed.), *Plants and Islands*. Academic Press: London.

Susanna, A., Garcia-Jacas, N., Hidalgo, O., Vilatersana, R. and T. Garnatje. 2006. The *Cardueae* (Compositae) revisited: Insights from ITS, *trnL-trnF*, and *matK* nuclear and chloroplast DNA analysis. *Annals of the Missouri Botanical Garden* 93: 150–171.

Susanna, A. and N. Garcia-Jacas. 2009. *Cardueae* (Carduoideae). Pp. 293–313 In: Funk, V.A., Susanna, A., Stuessy, T.F. and R.J. Bayer (eds.), *Systematics, evolution, and biogeography of Compositae*. IAPT: Vienna.

Susanna, A., Garcia-Jacas, N., Soltis, D.E. and P.S. Soltis. 1995. Phylogenetic relationships in tribe *Cardueae* (Asteraceae) based on ITS sequences. *American Journal of Botany* 82: 1056–1068.

Suzuki, Y., Glazko, G.V. and M. Nei. 2002. Overcredibility of molecular phylogenies obtained by Bayesian phylogenetics. *Proceedings of the National Academy of Sciences of the United States of America* 99: 16138–16143.

Thiv, M., Thulin, M., Hjertson, M., Kropf, M. and H.P. Linder. 2010. Evidence for a vicariant origin of Macaronesian-Eritreo/Arabian disjunctions in *Campylanthus* Roth (Plantaginaceae). *Molecular Phylogenetics and Evolution* 54: 607–616.

Thulin, M. 1994. Aspects of disjunct distributions and endemism in the arid parts of the Horn of Africa, particularly Somalia. Pp. 1105– 1119 In: Seyani, J.H. and A.C. Chikuni (eds.), *Proceedings of the XIIIth Plenary Meeting of AETFAT*. National Herbarium and Botanic Gardens of Malawi: Malawi.

Vargas, P. 2007. Are Macaronesian islands refugia or relict plant lineages?: a molecular survey. Pp. 297–314 In: Weiss, S.J. and N. Ferrand (eds.), *Phylogeography in southern european refugia: Evolutionary perspectives on the origins and conservation of european biodiversity*. Kluwer Academic Publishers: Dordrecht.

Wagenitz, G. 1976. Systematics and phylogeny of Compositae (Asteraceae). *Plant Systematics and Evolution* 125: 29–46.

Wagstaff, S.J., Breitwieser, I. and U. Swenson. 2006. Origin and relationships of the austral genus *Abrotanella* (Asteraceae) inferred from DNA sequences. *Taxon* 55: 95–106.

Wang, Y.J., Susanna, A., von Raab-Straube, E., Milne, R. and J.Q. Liu. 2009. Island-like radiation of *Saussurea* (Asteraceae: *Cardueae*) triggered by uplifts of the Qinghai-Tibetan Plateau. *Biological Journal of the Linnean Society* 97: 893–903.

Webber, P.B. and S. Berthelot. 1842. *Histoire naturelle des Îles Canaries, vol. 3(2, 3), Phytographia Canariensis*. Béthune: Paris.

Webster, G.L. 1975. Conspectus of a new classification of the Euphorbiaceae. *Taxon* 24: 593–601.

Webster, G.L. 1994. Synopsis of the genera and suprageneric taxa of *Euphorbiaceae*. *Annals of the Missouri Botanical Garden* 81: 33–144.

Wheeler, L.C. 1943. The genera of the living Euphorbiaceae. *The American Midland Naturalist* 30: 456–503.

World Conservation Monitoring Centre. 1998. *Centaurodendron palmiforme* In: IUCN 2012. *IUCN red list of threatened species. Version 2012.1*. <www.iucnredlist.org>. Downloaded on 30 July 2012.

Wurdack, K.J., Hoffmann, P. and M.W. Chase. 2005. Molecular phylogenetic analysis of uniovulate Euphorbiaceae (Euphorbiaceae sensu stricto) using plastid *rbcL* and *trnL-F* sequences. *American Journal of Botany* 92: 1397–1420.

Wurdack, K.J., Hoffmann, P., Samuel, R., de Bruijn, A., van der Bank, M. and M.W. Chase. 2004. Molecular phylogenetic analysis of *Phyllanthaceae* (Phyllanthoideae pro parte, Euphorbiaceae sensu lato) using plastid *rbcL* DNA sequences. *American Journal of Botany* 91: 1882–1900.

Wurdack, K.J. and E.A. Zimmer. 2003. *CoxI* intron evolution in *Euphorbia* s.l. (*Euphorbiaceae* s.s.). Botany 2003 meetings, Mobile, AL. Abstracts.

Zimmermann, N.F.A., Ritz, C.M. and F.H. Hellwig. 2010. Further support for the phylogenetic relationships within *Euphorbia* L. (Euphorbiaceae) from nrITS and *trnL-trnF* IGS sequence data. *Plant Systematics and Evolution* 286: 39–58.

COMPENDI DE PUBLICACIONS

1.COMPENDI DE PUBLICACIONS

- 1.1. Publicació 1: Molecular phylogeny of *Euphorbia* subgen. *Esula* sect. *Aphyllis* (Euphorbiaceae) inferred from nrDNA and cpDNA markers with biogeographic insights**
- 1.2. Publicació 2: Phylogeography and character evolution of *Euphorbia* sect. *Aphyllis* subsect. *Macaronesicae* (Euphorbiaceae)**
- 1.3. Publicació 3: Reconstructing the evolution and biogeographic history of tribe Cardueae (Compositae)**
- 1.4. Publicació 4: Lessons from *Plectocephalus* (Compositae, Cardueae-Centaureinae): ITS disorientation in annuals and Beringian dispersal as revealed by molecular analyses**

8.1. Publicació 1: Molecular phylogeny of *Euphorbia* subgen. *Esula* sect. *Aphyllis* (Euphorbiaceae) inferred from nrDNA and cpDNA markers with biogeographic insights

Taxon 60: 705-720 (2011)

Filogènia molecular d'*Euphorbia* subgen. *Esula* sect. *Aphyllis* (*Euphorbiaceae*) inferida amb marcadors nuclears i cloroplàstics, amb claus sobre la seva biogeografia.

Laia Barres, Roser Vilatersana, Julià Molero, Alfonso Susanna & Mercè Galbany-Casals

Resum

El subgènere *Esula* del gènere *Euphorbia* inclou, com s'ha demostrat recentment, una clada de distribució disjunta entre la Macaronèsia, l'Àfrica del sud i la regió Eritreoaràbiga, que conté majoritàriament membres del grup *Pachycladae* i de la secció *Tirucalli*. Per tal de delimitar aquest grup de distribució disjunta, hem analitzat les seqüències de l'espaiador intern transcrit ribosòmic nuclear ITS d'un mostreig ampli del subgènere *Esula*. Posteriorment i per tal de resoldre les relacions filogenètiques dins el grup i reconstruir la seva història biogeogràfica, hem realitzat anàlisis filogenètiques de la clada del nostre interès amb les seqüències nuclears ITS i ETS i les seqüències cloroplàstiques *trnL-trnF*, *psbA-trnH*, *ycf3-trnS*, *trnG*, *atpB-rbcL*, *trnK-matK* i *trnT-trnL*. Els nostres resultats demostren que el grup *Pachycladae* i la secció *Tirucalli* tal com es reconeixen de manera tradicional són grups polifilètics. En aquest treball hem recircumscrit la secció *Aphyllis*, incloent-hi la clada troncal del grup *Pachycladae* i alguns membres de la secció *Tirucalli*. La baixa resolució i les incongruències detectades entre les filogènies establertes a partir del genoma cloroplàstic i nuclear dins la secció *Aphyllis* poden ser degudes a fenòmens d'hibridació. La secció *Aphyllis* s'hauria originat a la regió Mediterrània i la seva distribució disjunta probablement és deguda a un procés de vicariança produït per la fragmentació de la flora anteriorment distribuïda al llarg del nord d'Àfrica a causa de l'aridificació climàtica del Miocè-Pliocè.

Molecular phylogeny of *Euphorbia* subg. *Esula* sect. *Aphyllis* (Euphorbiaceae) inferred from nrDNA and cpDNA markers with biogeographic insights

Laia Barres,¹ Roser Vilatersana,¹ Julià Molero,² Alfonso Susanna¹ & Mercè Galbany-Casals³

¹ Institut Botànic de Barcelona (CSIC–ICUB), Pg. del Migdia s.n., 08038 Barcelona, Spain

² Laboratori de Botànica, Facultat de Farmàcia, Universitat de Barcelona, Avda. Joan XXIII s.n., 08028 Barcelona, Spain

³ Unitat de Botànica, Facultat de Biociències, Universitat Autònoma de Barcelona, 08193 Barcelona, Spain

Author for correspondence: Laia Barres, lbarres@ibb.csic.es, laia.barres@gmail.com

Abstract *Euphorbia* subg. *Esula* (Euphorbiaceae) has recently been shown, using molecular analyses, to contain a clade with a disjunct distribution in Macaronesia, South Africa and the Eritreo-Arabian region, and being primarily made up of members of sect. *Tithymalus* subsect. *Pachycladae* and sect. *Tirucalli*. To delimitate this disjoint group, we carried out phylogenetic analyses of the internal transcribed spacer (nrITS) using a broad sampling, with emphasis on subg. *Esula*. Subsequently, we carried out phylogenetic analyses focused on this clade using nuclear (ITS, ETS) and chloroplast (*trnL-trnF*, *psbA-trnH*, *ycf3-trnS*, *trnG*, *atpB-rbcL*, *trnK-matK*, *trnT-trnL*) markers, with the aim of resolving the phylogenetic relationships within the group and reconstructing its biogeographic history. Our results showed that sect. *Tithymalus* subsect. *Pachycladae* and sect. *Tirucalli* are polyphyletic. Section *Aphyllis* is recircumscribed to comprise the *Pachycladae* core clade and part of sect. *Tirucalli*. Low resolution within sect. *Aphyllis* and incongruences between nuclear and chloroplast phylogenies may be due to hybridization. Section *Aphyllis* should have originated in the Mediterranean area; its disjunct distribution is probably due to vicariance, resulting from fragmentation of a wider distribution area in North Africa caused by the aridification of the climate during the late Miocene-Pliocene.

Keywords Eritreo-Arabian region; *Euphorbia*; Macaronesian region; *Pachycladae*; Rand Flora; South Africa; *Tirucalli*

■ INTRODUCTION

Euphorbia L. (Euphorbiaceae, Euphorbioideae) is considered the second largest genus in the angiosperms, including ca. 2000 species (Oudejans, 1990). It comprises a large diversity of life forms, including annual and perennial herbs, trees, spiny succulents and non-spiny pencil-like succulents, mainly distributed in temperate and tropical habitats. *Euphorbia* can be easily recognised by the presence of latex in the stems and the organisation of the reduced flowers in a structure named the cyathium, which acts as a pseudanthium. Recent molecular studies have shown that the traditional infrageneric classification does not agree with the natural circumscription of monophyletic lineages and have detected four clades within *Euphorbia* s.l. (A–D; Steinmann & Porter, 2002), which correspond to four newly circumscribed subgenera: subg. *Rhizanthium* (Boiss.) Wheeler, subg. *Chamaesyce* Raf., subg. *Euphorbia* and subg. *Esula* Pers. (Bruyns & al., 2006).

Subgenus *Esula* comprises approximately 400 herbaceous and shrubby species primarily distributed in temperate regions of the Northern Hemisphere. Most of the species have cyathia with nectariferous involucre glands, as well as a caruncle on their seeds. Subgenus *Esula* (formerly referred to as clade B; Steinmann & Porter, 2002; Bruyns & al., 2006) is the sister clade to the rest of *Euphorbia* (Horn & al., 2009; Zimmermann & al., 2010).

This new delineation of subg. *Esula* largely corresponds to section *Tithymalus* Boiss. (Steinmann & Porter, 2002). Boissier

(1862) created within sect. *Tithymalus* the unranked category *Pachycladae* Boiss. and divided it into two groups (Table 1). The first group, *Canarienses et Mediterraneae*, comprises woody spurges; eight species endemic to the Macaronesian region; one species mainly distributed in the Canary Islands but also found in West Africa and Yemen (*E. balsamifera* Aiton) and one Mediterranean species (*E. dendroides* L.). The second group, *Polynesicae et Sundaicae*, comprises Australasian species from the Fiji Islands, New Zealand, Norfolk Island and Malaysia.

The group *Canarienses et Mediterraneae* has undergone notable changes throughout history with regard to its rank and circumscription (Table 1). Pax & Hoffmann (1931) considered the species in this group as subsect. *Pachycladae* (Boiss.) Pax within sect. *Tithymalus*. In several regional floristic treatments, the group is described within several taxonomic ranks (Vindt, 1953; Radcliffe-Smith & Tutin, 1968; Radcliffe-Smith, 1982; Benedí & al., 1997).

Molecular phylogenies have determined that sect. *Tithymalus* subsect. *Pachycladae* is polyphyletic, as the species traditionally included in this group belong to several independent clades (Molero & al., 2002; Steinmann & Porter, 2002; Bruyns & al., 2006): (1) the *Pachycladae* core clade, which includes some species from sect. *Tithymalus* subsect. *Pachycladae* – *Euphorbia atropurpurea* Brouss. ex Willd., *E. bravoana* Svent., *E. piscatoria* Aiton, *E. regis-jubae* J. Gay and *E. tuckeyana* Steud. ex Webb; (2) *Euphorbia balsamifera*, related with other species from subg. *Lyciopsis* (Boiss.) Wheeler sect. *Somalica*

S. Carter; (3) *Euphorbia stygiana* H.C. Watson and *E. mellifera* Aiton, two lauroid trees from the Canary Islands, Madeira and Azores that are not closely related to the *Pachycladae* core clade; and finally (4) *Euphorbia dendroides*, also excluded from the *Pachycladae* core clade. These four clades of species previously classified in sect. *Tithymalus* subsect. *Pachycladae* are scattered throughout subg. *Esula* and subg. *Rhizanthium*.

Section *Tirucalli* Boiss., which was later defined at the subgeneric level by Carter (1985), was first described to include a group of “pencil-like” species, defined as subsucculent shrubs with cylindrical photosynthetic stems and reduced deciduous leaves. The East/South African and Arabian elements of sect. *Tirucalli* comprise two morphologically well-differentiated groups. First, the *Euphorbia mauritanica* L. complex, described by Leach (1975) and later confirmed by Carter (1992), includes species with foliar bracts, absence of glandular stipules and pleiochasia with 3–8 rays. The members of this complex appeared related to the aforementioned *Pachycladae* core clade in molecular phylogenies (Steinmann & Porter,

2002; Bruyns & al., 2006). Second, *E. tirucalli* L. and related species would constitute the “true” *Tirucalli*. This group, characterised by the presence of scarious bracts, glandular stipules and congested synflorescences, is placed in subg. *Euphorbia* (Steinmann & Porter, 2002; Bruyns & al., 2006). Boissier (1862) also included two Macaronesian species within sect. *Tirucalli*: *Euphorbia aphylla* Brouss. ex Willd., which was originally classified in the monotypic section *Aphyllis* Webb & Berthel. (Webb & Berthelot, 1842); and *E. lamarckii* Sweet. However, both species also belong to the *Pachycladae* core clade (Molero & al., 2002).

Despite these findings, many species traditionally classified in sect. *Tithymalus* subsect. *Pachycladae* and sect. *Tirucalli* have never been included in any comprehensive molecular phylogenetic analysis and their closest relatives remain unknown.

The disjunct geographic distribution of sect. *Tithymalus* subsect. *Pachycladae* and allies in Macaronesia and eastern/southern Africa, southern Arabia and Socotra represents an

Table 1. Historical sectional classifications of the most relevant species included in this study.

Webb & Berthelot (1842)	Boissier (1862)	Pax & Hoffmann (1931)
Sect. <i>Aphyllis</i> Webb & Berthel.	Sect. <i>Tirucalli</i> Boiss.	Sect. <i>Tithymalus</i> Boiss.
<i>E. aphylla</i>	<i>E. aphylla</i>	Subsect. <i>Pachycladae</i> (Boiss.) Pax
Sect. <i>Balsamis</i> Webb & Berthel.	<i>E. dregeana</i>	<i>E. atropurpurea</i>
<i>E. balsamifera</i>	<i>E. larica</i>	<i>E. balsamifera</i>
Sect. <i>Tithymalus</i> Tourn.^a	<i>E. lateriflora</i>	<i>E. berthelotii</i>
†† <i>Esula</i> Haw. ^a	<i>E. mauritanica</i>	<i>E. bourgeana</i>
* <i>Frutescentes</i>	<i>E. obtusifolia</i> (= <i>E. lamarckii</i>)	<i>E. dendroides</i>
<i>E. atropurpurea</i>	<i>E. schimperi</i>	<i>E. fidjiana</i>
<i>E. obtusifolia</i> (= <i>E. lamarckii</i>)	<i>E. tirucalli</i>	<i>E. glauca</i>
<i>E. piscatoria</i>	Sect. <i>Tithymalus</i> Boiss.	<i>E. mellifera</i>
<i>E. regis-jubae</i>	[§] <i>Pachycladae</i> Boiss.	<i>E. norfolkiana</i>
* <i>Arborescentes</i>	* <i>Canariensis et Mediterraneae</i>	<i>E. piscatoria</i>
<i>E. mellifera</i>	<i>E. atropurpurea</i>	<i>E. plumerioides</i>
	<i>E. balsamifera</i>	<i>E. regis-jubae</i>
	<i>E. berthelotii</i>	<i>E. stygiana</i>
	<i>E. bourgeana</i>	<i>E. tuckeyana</i>
	<i>E. dendroides</i>	Subsect. <i>Galarrhoei</i> (Boiss.) Pax
	<i>E. mellifera</i>	<i>E. usambarica</i>
	<i>E. piscatoria</i>	Sect. <i>Euphorbium</i> Boiss.
	<i>E. regis-jubae</i>	Subsect. <i>Tirucalli</i> (Boiss.) Pax
	<i>E. stygiana</i>	<i>E. dregeana</i>
	<i>E. tuckeyana</i>	<i>E. gummifera</i>
	* <i>Polynesiaca et Sundaicae – Species anomale</i>	<i>E. lateriflora</i>
	<i>E. glauca</i>	<i>E. mauritanica</i>
	<i>E. fidjiana</i>	<i>E. tirucalli</i>
	<i>E. norfolkiana</i>	
	<i>E. plumerioides</i>	

^aThis name was not validly used in this work.

example of a phylogeographic pattern found in other plant groups (reviewed by Andrus & al., 2004), collectively known as the Rand Flora (Christ, 1892; Le Houérou, 1995). This disjunct distributional pattern has been explained by two alternative hypotheses. Based on ecological and floristic studies (Quézel, 1978; Sunding, 1979; Bramwell, 1985; Médail & Quézel, 1999) as well as recent phylogenetic studies (Park & al., 2001; Moore & al., 2002; Andrus & al., 2004; Thiv & al., 2010), vicariance has been proposed as the most reliable explanation. Aridification of the Mediterranean basin during the Upper Miocene and Pliocene (Axelrod, 1975) would have resulted in two refugial distribution centres, one in the eastern and one in the western part of northern Africa, for the flora that previously occupied a continuous strip in this area. In contrast, Thulin (1994), Francisco-Ortega & al. (1999), Carine (2005), Galley & Linder (2006) and Sanmartín & al. (2008) postulated that the disjunct distribution could be due to more recent, post-aridification long-distance dispersal events between the Horn of Africa and the Macaronesian region, followed by fast diversification events in each of these regions. The southern African Flora has also been considered part of the Rand Flora, following the “African track” proposed by Linder & al. (1992). This route connects southern Africa with East Africa and, via the Sahara, with Macaronesia and the Mediterranean region. Two directions of this migration route have been proposed for different plant groups: northwards from southern Africa to the Horn of Africa and then the Macaronesian and Mediterranean areas (Bellstedt & al., 2008; Galbany-Casals & al., 2009) or southwards from the Mediterranean area and the Horn of Africa to southern Africa (Levyns, 1964; Axelrod & Raven, 1978; McGuire & Kron, 2005).

Throughout this paper, the Macaronesian biogeographic region is meant to include five archipelagos in the Atlantic Ocean (Azores, Madeira, Cape Verde, Selvagens Islands, and Canary Islands), one continental enclave in Morocco (Sunding, 1979; Barbero & al., 1992; García-Verdugo & al., 2010) and Cape Espichel in Portugal (Pedro, 1942; Carine & al., 2004). The origin of the Macaronesian archipelagos is volcanic and their age ranges from 20.6 Ma for Lanzarote Island to 1.77 Ma for El Hierro Island (Geldmacher & al., 2001; Carracedo & al., 1998; Holm & al., 2006). Several groups of plants seem to have diversified in the Macaronesian archipelagos following a single colonization event (Francisco-Ortega & al., 1997, 1999, 2001; Helfgott & al., 2000; Allan & al., 2004) while others have reached these archipelagos multiple times (Cuenoud & al., 2000; Hess & al., 2000; Park & al., 2001; Percy & Cronk, 2002; Kilian & al., 2010).

The aims of our study were twofold: first, to provide a general phylogenetic framework for sect. *Tithymalus* subsect. *Pachycladae* and its relatives based on a broad sampling of *Euphorbia* species and using sequences of the nrITS region, widely employed for inferring *Euphorbia* phylogenies (Molero & al., 2002; Steinmann & Porter, 2002; Bruyns & al., 2006; Zimmermann & al., 2010); second, to provide a robust hypothesis of relationships in the disjunct clade of subg. *Esula* using a subset of taxa, with focused sampling in sect. *Tithymalus* subsect. *Pachycladae* and sect. *Tirucalli*, and explore

its biogeographic history. To achieve our second aim, we expanded upon our ITS dataset by adding sequences from the nrDNA ETS region and seven non-coding chloroplast markers. In addition, we investigated the sectional classification within subg. *Esula*, with particular focus on the western Mediterranean species.

■ MATERIALS AND METHODS

Plant material. — A general sampling of the genus *Euphorbia* included the four subgenera previously identified in *Euphorbia* (Steinmann & Porter, 2002; Bruyns & al., 2006) and a representation of African, American and Asian species. In addition, a wide sampling of Mediterranean species of subg. *Esula* was done. A total of 154 taxa were included, of which 95 were newly sequenced and 59 downloaded from GenBank. As to the main group of study, all members of *Euphorbia* sect. *Tithymalus* subsect. *Pachycladae* were included (11 species) as well as 21 species from sect. *Tirucalli*, including members of the *E. mauritanica* complex and some morphologically similar ones of unknown phylogenetic position. Accession numbers and sources of material are given in the Appendix. Nomenclature follows Govaerts (2010).

DNA extraction, amplification and sequencing. — Total genomic DNA, from fresh or silica gel-dried leaf tissues, taken from field collections or herbarium specimens (in the herbaria BCN, K, W), was extracted using the DNeasy Plant Mini extraction kit (Qiagen, Hilden, Germany) modified by adding 5 µl of proteinase K at 20 mg/ml (Pereira, pers. comm.) in order to avoid the interference of secondary compounds that occur in *Euphorbia*.

Plant material from the Kew herbarium (K) was extracted following the CTAB method from Saghai-Marooof & al. (1984) as modified by Doyle & Dickson (1987) and Palmer & al. (1989). The DNA from old herbarium specimens was highly degraded and the extractions were concentrated with the commercial kit DNA Clean Concentrator-5 (Zymo Research Group, Orange, California, U.S.A.), following the manufacturer’s instructions.

Two nrDNA regions—the internal transcribed spacer (ITS1, 5.8S, ITS2) and the external transcribed spacer (ETS)—and seven cpDNA regions (the *trnL-trnF* non-coding region, including the *trnL* intron and the *trnL-trnF* intergenic spacer; the *psbA-trnH* intergenic spacer; the non-coding *ycf3-trnS* region; the non-coding *trnG* region; the region between the *atpB* and *rbcl* genes and the first codons of the *rbcl* gene; the *trnK-matK* spacer; and the *trnT-trnL* non-coding region) were amplified using the universal primers indicated in Table 2.

Polymerase chain reactions (PCR) were performed in 25 µl volumes composed of 10% 10× AmpliTaq buffer, 10% 25 mM MgCl₂, 10% 2 mM dNTPs mix, 4% primers at 5 µM, 1 U AmpliTaq DNA polymerase (Applied Biosystems, Foster City, California, U.S.A.) and 2 µl of template DNA of an unknown concentration. This was filled up to 25 µl with distilled sterilised water. We added 0.5 µl DMSO (dimethyl sulfoxide; Sigma-Aldrich, Schnellendorf, Germany) in nrDNA regions and 2.5 µl BSA (bovine serum albumin; New England Biolabs,

Ipswich, Massachusetts, U.S.A.) at 400 ng/μl in cpDNA regions to enhance the PCR reaction.

The PCR conditions varied for each DNA region and consisted of a preheat for 1 min 35 s to 5 min at 94°C–96°C, followed by 30 to 35 cycles of the following steps: 30 s to 1 min at 94°C, 30 s to 1 min 30 s at 52°C–58°C and 30 s to 3 min at 72°C. A final extension phase of 10 to 15 min at 72°C was conducted. Annealing temperatures for each primer pair are given in Table 2.

PCR products were purified with either QIAquick Purification Kit (Qiagen, Valencia, California, U.S.A.) or DNA Clean & Concentrator-5.

Direct sequencing of the amplified DNA segments was performed with a Big Dye Terminator v.3.1 kit (Applied Biosystems) following the protocol recommended by the manufacturer. Nucleotide sequencing was carried out at the Serveis Científic-Tècnics of the University of Barcelona on an ABI PRISM 3700 DNA analyser (Applied Biosystems).

Alignments and phylogenetic analyses. — Sequences were edited visually with BioEdit v.7.0.9.0 (Hall, 1999) and aligned

by hand or with the T-Coffee software (Notredame & al., 2000) and refined by hand. In all datasets, several areas of ambiguous alignment and/or autapomorphic indels were excluded. Alignments are available upon request from the corresponding author.

Dataset 1 included ITS sequences of 152 *Euphorbia* taxa and two related genera coded as outgroups (*Dichostemma glaucescens* Pierre and *Triadica sebifera* (L.) Small), selected following Steinmann & Porter (2002). Dataset 2 included sequences of nine markers (the two nrDNA regions and the seven cpDNA regions mentioned above) of 26 species, 22 of them recovered as clade 1 (Fig. 1) in the analysis of the first dataset, and four additional species coded as outgroups based on the analysis of dataset 1: *E. biumbellata* Poir., *E. dendroides*, *E. megalatlantica* Ball and *E. terracina* L. DNA of *Euphorbia lateriflora* Schumacher and *E. calamiformis* P.R.O. Bally & S. Carter was highly degraded and it could not be amplified for the *trnK-matK* marker. We coded the sequences of these species as missing data for this region in the combined matrix of dataset 2.

We carried out a partition homogeneity test (incongruence length difference, ILD; Farris & al., 1995a, b) to test the

Table 2. Primers description and amplification conditions used in this study.

Region	Primer	Direction	Sequences 5' → 3'	Reference	T (°C)
ITS	ITS1 ^a	F	TCCGTAGGTGAACCTGCGG	White & al., 1990	57
	ITS2 ^{a,b}	R	GCTGCGTTCTTCATCGATGC		
	ITS3 ^a	F	GCATCGATGAAGAACGCAGC	Nickrent & al., 1994	
	ITS4 ^{a,b}	R	TCCTCCGCTTATTGATATGC		
	1460F ^a	F	TGTACACACCCGCCCGT		
	307R ^{a,b}	R	TTGGGCTGCATTCCCA		
ETS	18SIGS ^a	R	GAGACAAGCATATGACTACTGGCAGGATCAACCAG	Baldwin & Markos, 1998	54
	ETSR38 ^{a,b}	F	GGYGGTGCATGAGTGGTGTATWY	Yang & al., pers. comm.	
<i>trnL</i> intron and <i>trnL-trnF</i> spacer	trnL-c ^a	F	CGAAATCGGTAGACGCTACG	Taberlet & al., 1991	58
	trnL-d ^{a,b}	R	GGGGATAGAGGGACTTGAAC		
	trnL-e ^a	F	GTTCAAGTCCCTCTATCCC		
	trnL-f ^{a,b}	R	ATTGAACTGGTGAACGAG		
<i>psbA-trnH</i>	psbAF ^a	F	GTTATGCATGAACGTAATGCTC	Sang & al., 1997	53
	trnHR ^{a,b}	R	CGCGCATGGTGGATTACAAAATC		
<i>trnT-trnL</i>	A2 ^{a,b}	F	CAAATGCGATGCTTAACCT	Cronn & al., 2002	52
	trnB ^{a,b}	R	TCTACCGATTTCGCCATATC		
<i>ycf3-trnS</i>	SP43122F ^a	F	ATTGGCYACAAYTGAAAAGG	Hershkovitz, 2006	54
	SP44097R ^{a,b}	R	ATTCGAACCCTCGGTAAACA		
<i>trnG</i>	5' trnG-2G ^{a,b}	F	GCGGGTATAGTTTGTAGTGGTAAAA	Shaw & al., 2005	54
	3' trnGUUC ^{a,b}	R	GTAGCGGGAATCGAACCCGCATC		
<i>trnK-matK</i>	trnK-3914F ^{a,b}	F	TGGGTTGCTAACCTCAATGG	Johnson & Soltis, 1995	52
	matK-1168R ^{a,b}	R	ATTGAATGAATTGATCGTA		
<i>atpB-rbcL</i>	2 ^{a,b}	F	GAAGTAGTAGGATTGATTCTC	Savolainen & al., 1994	52
	5 ^{a,b}	R	TACAGTTGTCCATGTACCAG		

F, Forward; R, Reverse; T (°C), annealing temperature.

^aPrimer used for amplifications.

^bPrimer used for sequencing.

heterogeneity of phylogenetic signals between the nuclear and chloroplast markers on dataset 2. ILD significance values were calculated in TNT v.1.1 (Goloboff & al., 2008) with the INCTST script (kindly provided by the authors of the program) using 1000 replicates.

Two matrices were used for the analyses of dataset 2: the first matrix was composed of the two nrDNA markers combined, and the second matrix was composed of the seven cpDNA markers combined.

For the three total matrices generated from both datasets, maximum parsimony (MP) and Bayesian inference (BI) analyses were conducted. Phylogenetic trees were constructed with PAUP* v.4.0b10 (Swofford, 2002) employing MP with heuristic searches consisting of 1000 replicates of random taxon addition with MULPARS in effect and tree bisection reconnection (TBR) branch swapping, and saving all the most parsimonious trees, except for dataset 1 where we used 1000 iterations with the constraint of saving no more than 1000 trees with a length ≥ 3085 due to memory restrictions. Parsimony-uninformative positions were excluded. In the case of dataset 2, MP analyses used indels as additional characters. Indel codification was done with IndelCoder v.1.0 (Müller, 2006) using the Modified Complex Indel Coding (MCIC) algorithm. After computing the strict consensus tree, bootstrap analyses (BS; Felsenstein, 1985) were performed using 1000 replicates of heuristic search with the default options except for dataset 1, where we used 1000 iterations with random taxa addition and no swapping. Nodes with BS ≥ 75 were considered as significantly supported.

Bayesian inference estimation was calculated with MrBayes v.3.1.2 (Huelsenbeck & Ronquist, 2001; Ronquist & Huelsenbeck, 2003). In order to select the best-fit model of substitution for each region, the Akaike information criterion (Akaike, 1973) was used as implemented in the MrModeltest v.2.3 program (Nylander, 2004). Best-fit models of substitution chosen by each region are detailed in Table 3. For the Bayesian analyses of dataset 2, we set up a partitioned analysis to apply the parameters of the most appropriate model to each region. We ran two independent analyses with 12 million generations sampling every 1000 generations, in the case of dataset 1, and two independent analyses with 3 million generations sampling every 1000 generations for dataset 2 until they reached stationary frequencies (final split frequency between the two runs, $P < 0.01$). The first 25% of the total trees generated (3000 for dataset 1 and 750 trees for dataset 2) were eliminated before summarising the posterior distribution and computing a 50% majority-rule consensus tree. Nodes with posterior probability (PP) ≥ 0.95 were considered statistically supported.

■ RESULTS

The main characteristics and statistics of both datasets are summarised in Table 3. Parsimony and Bayesian analyses were congruent in topology and generally showed the same supported clades. For this reason, only the 50% majority-rule consensus tree from Bayesian analyses of dataset 1 (Fig. 1)

and one of the most parsimonious phylograms from the MP analyses of dataset 2 (Fig. 2) are shown.

Phylogenetic analyses of dataset 1 (Fig. 1). — The four main clades correspond to the four lineages (subg. *Rhizanthium*, subg. *Chamaesyce*, subg. *Euphorbia*, subg. *Esula*) previously identified by other authors (Steinmann & Porter, 2002; Bruyns & al., 2006; Zimmermann & al., 2010). Subgenus *Esula* is recovered as a clade but without statistical support. Eight main supported clades are recovered within subg. *Esula* (clades 1–8). Clade 1 (BS = 76%, PP = 1) includes the *Pachycladae* core clade and 11 species from sect. *Tirucalli*. *Euphorbia dendroides* and other West Mediterranean species constitute the sister clade to clade 1 (PP = 0.98). Most of the remaining clades (2 to 8) include a mix of species from different taxonomic sections and will be further commented on in the discussion.

Subgenus *Euphorbia* is not statistically supported in our analyses. *Euphorbia tirucalli* and its closest relatives are included in subg. *Euphorbia*, constituting the “true” *Tirucalli* clade (clade 9; BS = 98%, PP = 1). *Euphorbia bariensis* S. Carter, *E. dhofarensis* S. Carter and *E. uzumuk* S. Carter & J.R.I. Wood appear as part of the “true” *Tirucalli* clade. The succulent species endemic to Macaronesia (*E. canariensis* L., *E. handiensis* Burchard) and from West Morocco (*E. resinifera* O. Berg) are included in subg. *Euphorbia*, constituting a robust clade with *E. drupifera* Thonn. and *E. meenae* S. Carter, from Tropical Africa and India, respectively (clade 10; BS = 100%, PP = 1).

Subg. *Chamaesyce* (BS = 76%, PP = 1) is sister to subg. *Euphorbia*. Subg. *Rhizanthium* (PP = 0.97) includes some species traditionally classified in sect. *Tirucalli* (*E. larica* Boiss., *E. masirahensis* Ghaz.) that appear closely related to *E. balsamifera* (clade 11; PP = 0.98).

Phylogenetic analyses of dataset 2 (Fig. 2). — The results of the ILD test ($P = 0.001$) and several hard incongruities detected in the topologies, obtained with the independent analyses, did not support the possibility of combining the nrDNA markers with the cpDNA markers.

nrDNA analyses (Fig. 2A). — A main clade constituted by the eastern/southern African, Arabian and Madagascan species traditionally classified in sect. *Tirucalli* is strongly supported (BS = 93%, PP = 1). Within this clade, *E. stolonifera* Marloth ex A.C. White, R.A. Dyer & B. Sloane, endemic to the Cape Floristic Region, is shown in a clade also including *E. berotica* N.E. Br., *E. calamiformis*, *E. gossypina* Pax, *E. nubica* N.E. Br., *E. papilionum* S. Carter and *E. schimperi* C. Presl, species from East and central Africa and Arabia (BS = 86%, PP = 1). Within this clade, *E. nubica* and *E. schimperi* appear closely related to each other (BS = 95%, PP = 1) and are included in a clade supported only by Bayesian analyses (PP = 1) together with *E. calamiformis* and *E. gossypina*.

Regarding the Macaronesian species, two main supported clades are detected: the first one includes *E. anachoreta* Svent., *E. berthelotii* Bolle ex Boiss., *E. pedroi* Molero & Rovira and *E. piscatoria* (PP = 0.95) and the second one is composed of *E. lamarckii* and *E. regis-jubae* (BS = 82%, PP = 1). The position of the other species is unresolved.

cpDNA analyses (Fig. 2B). — The analyses of cpDNA recover *E. tuckeyana* as sister to the rest of the species (BS =

Table 3. Main characteristics of each DNA region used in the phylogenetic analyses.

	Dataset 1				Dataset 2							
	ITS	ETS	nrDNA combined	ITS	trnL-trnF	trnT-trnL	ycf3-trnS	psbA-trnH	trnG	atpB-rbcL	trnK-matK	cpDNA combined
Number of taxa	154	26	26	26	26	26	26	26	26	26	24	26
Alignment length	634	342	978	1152	435	483	593	638	638	959	980	5240
Length range	531–581	337–342	968–974	874–1091	387–412	340–480	449–524	620–630	896–934	963–976	4653–4934	
Variable characters (%)	344 (54.26)	78 (22.80)	230 (23.52)	181 (15.71)	33 (7.58)	47 (9.73)	58 (9.78)	36 (5.64)	86 (8.97)	65 (6.63)	506 (9.65)	
Parsimony-informative characters (%)	97 (15.30)	39 (11.40)	107 (10.94)	118 (10.24)	25 (5.74)	39 (8.07)	46 (7.75)	18 (2.82)	29 (3.02)	37 (3.77)	279 (5.32)	
Indel length	1–39	1–2	1–2	1–39	1–13	1–39	1–20	1–19	1–13	1–22	1–39	
Informative indels	–	11	17	37	2	9	5	6	5	3	67	
Tree length	3085	56	167	150	39	70	72	22	40	58	272	
No. of most parsimonious trees	104	27	122	647020	23509	802	2398	254	1	94	54	
Consistency index	0.26	0.82	0.75	0.81	0.64	0.57	0.69	0.82	0.78	0.71	0.75	
Retention index	0.74	0.87	0.83	0.85	0.79	0.74	0.83	0.90	0.87	0.83	0.82	
Homoplasy index	0.74	0.18	0.25	0.19	0.36	0.43	0.31	0.18	0.23	0.29	0.25	
Maximum sequence divergence within ingroup (%)	35.03	3.03	4.73	9.40	3.19	4.59	4.79	2.30	4.77	1.42	3.31	
Model of evolution (Akaike criterion)	SYM+I+G	GTR+G	GTR+G	GTR+G	F81+I	HKY+G	GTR+G	GTR+I	F81+G	GTR+I	GTR+I	

100%, PP = 1), which are grouped in two main clades. One of them is constituted by the species traditionally classified in sect. *Tirucalli* (BS = 85%, PP = 1), and the other is constituted by the Macaronesian species (BS = 93%). Two main clades are resolved in the African and Arabian group: one is constituted by *E. calamiformis*, *E. lateriflora*, *E. nubica* and *E. usambarica* Pax (BS = 97%, PP = 1) and a second one is constituted by the rest of species (PP = 1). Within the first clade, *E. usambarica* is sister to the rest of the species. *Euphorbia calamiformis* and *E. lateriflora* constitute a strongly supported clade within this group (BS = 94%). Within the second clade, two main clades are also resolved: one constituted by *E. berotica*, *E. gossypina*, *E. papilionum* and *E. schimperi* (PP = 1) and the other one is composed of species from South Africa and Madagascar (*E. mauritanica*, *E. orthoclada* Baker and *E. stolonifera*; PP = 0.96). *Euphorbia gossypina* and *E. berotica* constitute a strongly supported clade (BS = 100%, PP = 1) within the first clade and *E. mauritanica* and *E. stolonifera* constitute a clade only supported by Bayesian analyses (PP = 1) within the second clade.

Among the Macaronesian species, two main clades are recovered. The first clade (PP = 0.97) shows *E. piscatoria* as sister species to a clade including *E. anachoreta*, *E. aphylla*, *E. bourgeana* J. Gay ex Boiss., *E. bravoana*, *E. pedroi* and *E. regis-jubae* (BS = 75%, PP = 1). Within this clade, two additional clades are recovered. One consists of *E. anachoreta*, *E. pedroi* and *E. regis-jubae* (PP = 1) and the other clade includes *E. bourgeana* and *E. bravoana* (BS = 91%, PP = 1). The second main clade within the Macaronesian species is constituted of *E. atropurpurea* and *E. lamarckii* (BS = 96%, PP = 1).

Some notable differences are found between nrDNA and cpDNA analyses. Among the Macaronesian species, the position of *E. berthelotii*, *E. lamarckii* and *E. regis-jubae* is incongruent between the nrDNA and the cpDNA analyses, and among the African-Arabian species, the position of *E. calamiformis*, *E. nubica* and *E. schimperi* is also inconsistent.

Fig. 1. 50% majority-rule consensus tree derived from Bayesian analyses of ITS sequences for 154 taxa (dataset 1). Bayesian posterior probabilities (≥ 0.95) and bootstrap values ($\geq 75\%$) are indicated above branches. Sectional classification follows Boissier (1862). Species marked with a star are not included in subg. *Esula* but are commented in the discussion.

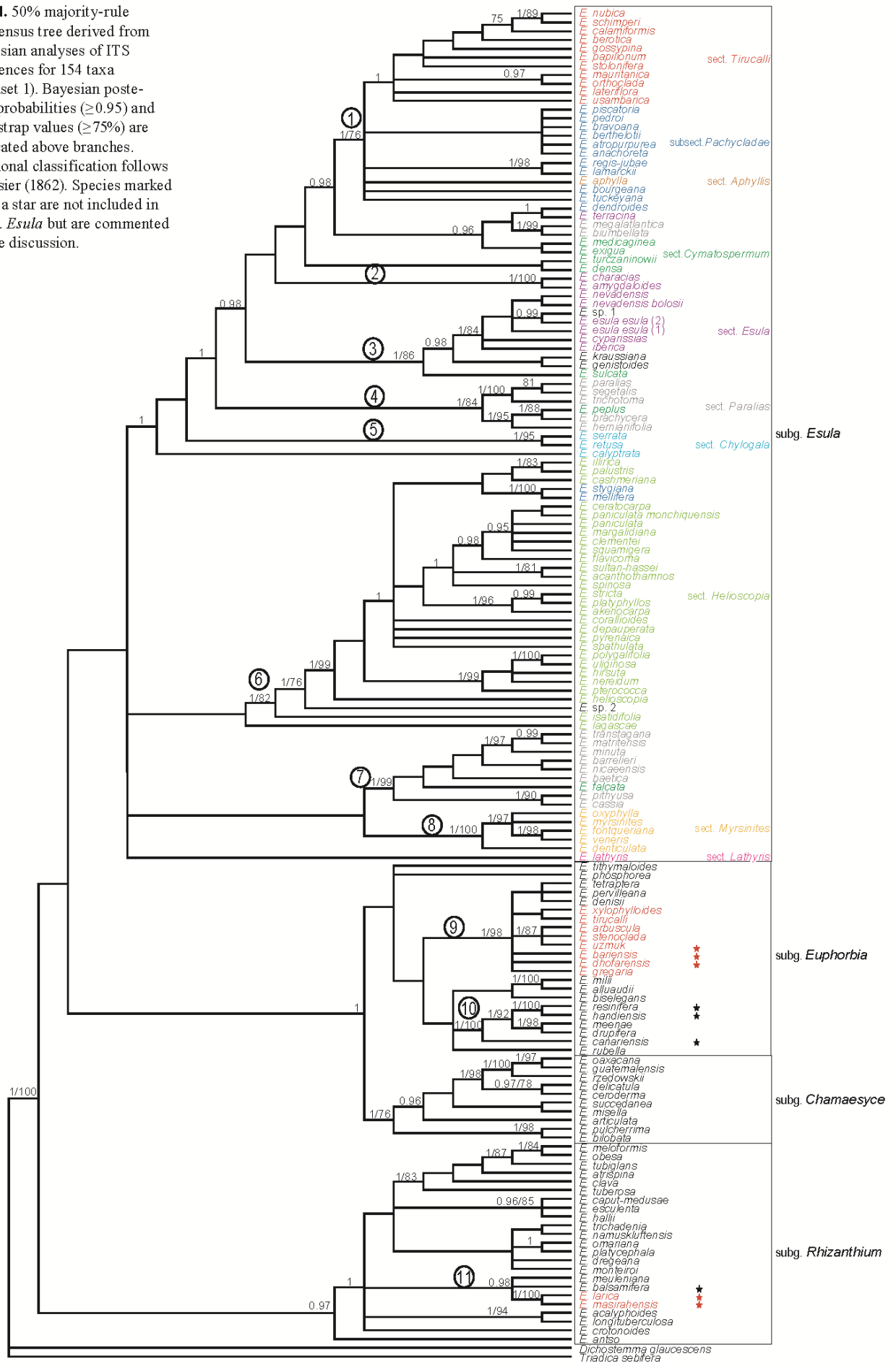



Fig. 2. Phylogram of one of the most parsimonious trees from the maximum parsimony analyses of combined nuclear (A) and chloroplast sequences (B) for dataset 2. Discontinuous branches do not appear in the topology of the strict consensus tree. Bayesian posterior probabilities (≥ 0.95) and bootstrap values ($\geq 75\%$) are indicated above branches. The traditional groups previously considered within sect. *Aphyllis* as currently circumscribed, are indicated as: circle, sect. *Tirucalli*; square, subsect. *Pachycladae*, *Euphorbia lamarckii* complex; rhombus, subsect. *Pachycladae*, *Euphorbia atropurpurea* complex; star, sect. *Aphyllis* sensu Webb & Berthelot (1842).

DISCUSSION

Phylogenetic relationships in *Euphorbia* and taxonomic implications. — Our analyses based on ITS sequences provide no statistical support for subg. *Esula* (Fig. 1). Monophyly of subg. *Esula* has been demonstrated in the past based on analyses of chloroplast regions receiving moderate bootstrap support (BS = 86% in Steinmann & Porter, 2002) or based on analyses of nuclear regions with strong support of Bayesian PP (PP = 1 in Bruyns & al., 2006; PP = 1 in Zimmermann & al., 2010). The lack of statistical support for subg. *Esula* in our analysis could be explained by the high substitution rate known for ITS and by the sampling differences, since 13, 38 and 39 taxa from subg. *Esula* were sampled in the last three works mentioned, respectively, compared to the 97 taxa included in our analyses.

Although the existence of the *Pachycladae* core clade (Fig. 1, clade 1) within subg. *Esula* was already known from previous phylogenies (Steinmann & Porter, 2002; Bruyns & al., 2006), we demonstrate for the first time that several additional

species from sect. *Tirucalli*, previously classified in the *E. mauritanica* complex based on morphologic studies (*E. berotica*, *E. gossypina*, *E. lateriflora* [Leach, 1975], and *E. papilionum* [Carter, 1992]) belong to this clade. In the present study, the affinities with the *E. mauritanica* complex are newly confirmed by molecular analyses and the phylogenetic relationships for *E. calamiformis*, *E. nubica* and *E. orthoclada* are established for the first time.

The first available name for members of clade 1 (Fig. 1) at the sectional level is sect. *Aphyllis* (Table 1). Based on our results, we propose sect. *Aphyllis* to include *E. aphylla* and the members of the traditional sect. *Tithymalus* subsect. *Pachycladae* and sect. *Tirucalli* included in clade 1. Species of this newly circumscribed sect. *Aphyllis* share some morphological characters (Fig. 3A–L): they are dendroid shrubs with green succulent young stems (except for *E. usambarica*, which has non-succulent stems); leaves can be absent (in *E. aphylla*) or persistent until fructification, but in most cases they are soon deciduous and leave prominent and callose scars in the stem;

stipules are absent; synflorescences are pseudo-umbellate with equal or sub-equal radii length and leafy sub-cyathial bracts; 4–5 rounded, truncate, emarginate or two-horned cyathium glands are always present; capsules are smooth (rarely granulate) and wider than high; and seeds are carunculate.

Euphorbia dendroides, traditionally classified in sect. *Tithymalus* subsect. *Pachycladae* (Table 1), is placed in the sister clade to sect. *Aphyllis*. This taxon differs from the species of sect. *Aphyllis* in having non-photosynthetic subsucculent young stems covered by a brown rhytidome and laterally compressed seeds.

The incongruities between nuclear and chloroplast markers that precluded a combined analysis (see results) could be due to incomplete lineage sorting or hybridisation events, though the last explanation is more probable in this case as hybridisation processes have been reported between several Macaronesian species of this group (Molero & Rovira, 2005). No evidence of hybridisation has been reported for the African species of sect. *Aphyllis*, but it could be feasible since incongruities are also found on this part of the tree.

Our phylogenies based on nrDNA and cpDNA sequences (Fig. 2) show some correspondence with morphological

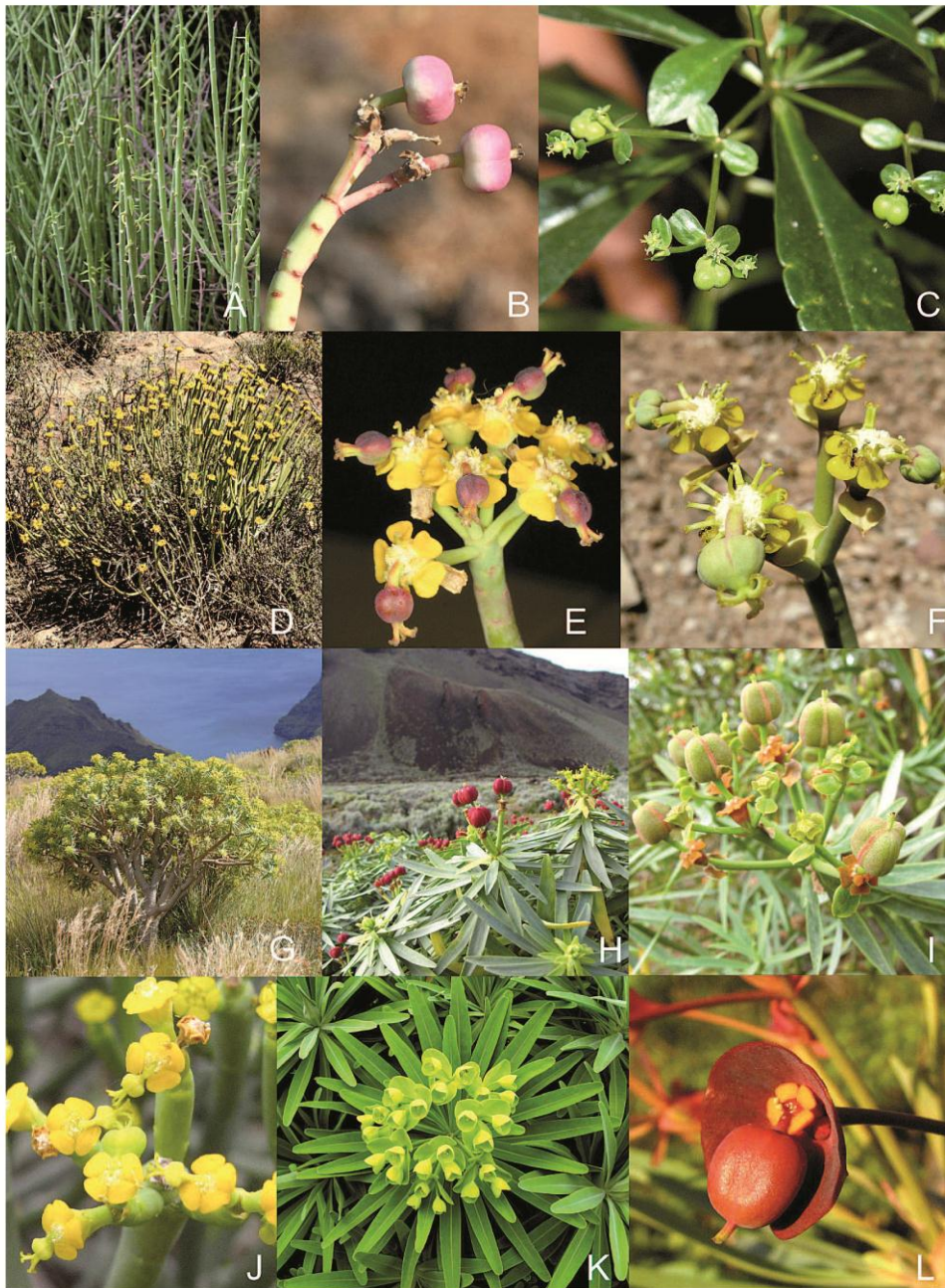

Fig. 3. Morphology and habit of some members of *Euphorbia* sect. *Aphyllis*, as currently circumscribed. **A–B**, habit and capsules of *E. gossypina*, from Kenya; **C**, synflorescence of *E. usambarica* from Kenya; **D–E**, habit and synflorescence of *E. stolonifera*, from the Cape Province, South Africa; **F**, synflorescence of *E. schimperi* from Yemen; **G**, habit of *E. berthelotii* from La Gomera, Canary Islands, Spain; **H**, habit of *E. lamarekii* from El Hierro, Canary Islands, Spain; **I**, synflorescence of *E. piscatoria*, from Madeira, Portugal; **J**, synflorescence of *E. aphylla* from Tenerife, Canary Islands, Spain; **K**, synflorescence of *E. bourgeana* from Tenerife, Canary Islands, Spain; **L**, capsule of *E. atropurpurea* from Tenerife, Canary Islands, Spain. Photographs by J. Morawetz (A–C), A. Moller (D–E), A. Susanna (F), J. Molero (G) and L. Barres (H–L).

characters. Two main groups can be distinguished within sect. *Aphyllis*. First, the African-Arabian group, constituting a strongly supported clade in both trees and characterized by xerophilous plants with patent or erecto-patent lateral ramification of the stems, small and deciduous loosely distributed leaves, small deciduous bracts and pseudovericillate synflorescences congested on the apex of the stems with undivided radii (Fig. 3A–F). Secondly, the Macaronesian group, only supported in the cpDNA analyses, characterized by xerophilous and mesophylous plants with a pseudumbellate ramification of the stems, wide deciduous leaves (when present) arranged spirally on young branches and leaving conspicuous leaf scars, persistent bracts, and lax pleiochasial synflorescences divided 1–2 times (Fig. 3G–L). *Euphorbia tuckeyana*, which is suggested to be sister to the rest of the species of sect. *Aphyllis* only by the cpDNA analyses (BS = 100%, PP = 1; Fig. 2B), resembles the species of the African-Arabian clade in its type of ramification but it has pleiochasial synflorescences like the other Macaronesian species. *Euphorbia aphylla* (Fig. 3J) also shares some characters with the African species, like the presence of small deciduous bracts and CAM photosynthesis (Mies & al., 1996). However, the chromosome number ($2n = 20$) and karyotype characteristics tie this species to the rest of Macaronesian species (Molero & al., 2002). *Euphorbia usambarica* has wide lanceolate leaves and two horned nectariferous glands (Fig. 3C), like most of the Macaronesian species. Wide leaves are also present in *E. lateriflora* and *E. orthoclada*, while the rest of the African-Arabian species have narrow leaves. However, variations of this character are probably more influenced by ecological factors than by phylogenetic signal. The long branch lengths recovered for *E. gossypina* and *E. berotica* in the cpDNA analyses (Fig. 2B) indicate that those two species have accumulated a high number of mutations, and would probably have diverged more anciently than the other lineages.

Macaronesian species have been classified in two complexes according to morphological characteristics (Molero & al., 2002): the *E. lamarckii* complex and the *E. atropurpurea* complex (Figs. 2 and 4). Species belonging to the *E. lamarckii* complex are *E. anachoreta*, *E. berthelotii*, *E. lamarckii*, *E. pedroi*, *E. piscatoria*, *E. regis-jubae* and *E. tuckeyana*. They all have deciduous leaves, simple pleiochasial synflorescences with small and free sub-cyathial bracts (Fig. 3H–I) and smooth to rugulose seeds. In contrast, the *E. atropurpurea* complex includes *E. atropurpurea*, *E. bourgeana* and *E. bravoana*, all possessing persistent leaves, double pleiochasial synflorescences with large and fused sub-cyathial bracts, at least at the base (Fig. 3K–L), and strongly ornamented seeds. The two complexes are not supported as monophyletic groups. However, in the nrDNA tree there is no incongruence of this morphological classification and the phylogenetic relationships obtained, since the two statistically supported clades are exclusively composed of members of the *E. lamarckii* complex (Fig. 2A). On the contrary, in the cpDNA-based phylogeny (Fig. 2B) we found strong support for *E. atropurpurea* and *E. lamarckii*, each belonging to a different complex, to be sister species (BS = 96%, PP = 1). A mix of species from both complexes is recovered in another well-supported clade (BS = 75%, PP = 1).

With regard to other groups in subg. *Esula*, our results show that most of the traditional sections do not correspond to monophyletic groups (Fig. 1). *Euphorbia amygdaloides* L. and *E. characias* L. are members of clade 2 (BS = 100%, PP = 1), but they are not placed in the main clade of sect. *Esula* Dumort. (clade 3; BS = 86%, PP = 1), where they are traditionally classified. Clade 3 also includes *E. kraussiana* Bernh. ex Krauss and *E. genistoides* P.J. Bergius, to our knowledge not previously classified in any section and *E. sulcata* Lens ex Loisel., from sect. *Cymatospermum* (Prokh.) Prokh. *Euphorbia falcata* L. and *E. peplus* L., also from sect. *Cymatospermum*, appear instead in two different clades, clade 4 (BS = 84%, PP = 1) and clade 7 (BS = 99%, PP = 1), respectively; both clade 4 and clade 7 are composed of members of sect. *Paralias* Dumort. Clade 5 encompasses two species from sect. *Chylogala* (Fourr.) Prokh. (BS = 95%, PP = 1), but the phylogenetic position of *E. calyptata* Coss. & Kralik is unresolved. All members of sect. *Helioscopia* Dumort., except *E. lagascae* Spreng., constitute clade 6 (BS = 82%, PP = 1), which also includes the Macaronesian lauroid trees *E. mellifera* and *E. stygiana*, previously included in sect. *Tithymalus* subsect. *Pachycladae*. Distinctive characters define this Macaronesian clade within sect. *Helioscopia*, such as the tree habit condition, lauroid leaves, paniculate cymose synflorescence, tuberculate capsule, smooth seeds and an exclusive chromosome and base chromosome number ($2n = 44$, $x = 11$; Molero & al., 2002). Monophyletic groups in clade 6 cannot be delimited based on the presence of smooth or tuberculate ovaries (or capsules), as Steinmann & Porter (2002) suggested. *Euphorbia isatidifolia* Lam. is the sister species to the rest of the species of clade 6. This species possesses some exclusive characteristics in the group, like the presence of tubers, yellow latex and non-horned nectariferous glands. Its related species probably lie among species from sect. *Holophyllum* (Prok.) Prok., from central Asia. The position of *E. lagascae* remains unresolved, though a relationship with sect. *Helioscopia* in the tree topology is detected. With the available data, sect. *Myrsinites* (Boiss.) Lojac. (clade 8, BS = 100%, PP = 1) is the only monophyletic section and is populated by orophyte narrow endemics from the Mediterranean basin, characterised by the presence of nectariferous glands with dilatated horns. The phylogenetic position of *E. lathyris* L., the only member of sect. *Lathyris* Dumort., is not resolved in our results, though it is recovered as sister species to the rest of subg. *Esula* in another study including many genes from all three genomic compartments (Horn & al., 2009).

Molecular evidence demonstrates that sect. *Tirucalli* is polyphyletic. Carter (1992) already suggested the division of this section into two different groups on the basis on morphological characteristics, but our study reveals that this group has at least three different origins (Fig. 1). The first group (clade 9; BS = 98%, PP = 1) was named the “*Tirucalli* alliance” by Bruyns & al. (2006) and is placed in subg. *Euphorbia*. *Euphorbia tirucalli* and related species populate this clade; these species are related to other species from Madagascar and southwestern Africa. *Euphorbia bariensis* and *E. dhofarensis*, from Somalia and Oman, are shown to be members of this alliance for the first time. The second group, as described

above, is comprised of the *E. mauritanica* complex and related species (clade 1; BS = 76%, PP = 1), now members of sect. *Aphyllis*. Finally, *E. larica* and *E. masirahensis*, from Iran and the Arabian Peninsula, are placed within subg. *Rhizanthium* and constitute clade 11 (PP = 0.98) along with *E. balsamifera*, a widely distributed species in West Africa, Yemen and the Canary Islands, and *E. meuleniana* O. Schwartz from Yemen.

Biogeographical implications. — The origin of Macaronesian endemic plant lineages has been studied by many authors. The oceanic origin of the islands implies long-distance dispersal as the more reliable hypothesis to explain the source of colonisation. Sister groups of several endemic Macaronesian taxa proposed by molecular and morphological approaches populate a range of areas like Eurosiberia (Vargas & al., 1999), East Africa (reviewed by Andrus & al., 2004) or South Africa (Sunding, 1979), but the origin of the Macaronesian flora is mostly the West Mediterranean basin (see examples in Kim & al., 2008).

Our phylogenetic reconstruction suggests that the Macaronesian species of sect. *Aphyllis* have their closest relatives on the Horn of Africa, southern Africa and the southern Arabian Peninsula, and thus are part of the Rand Flora (Fig. 4). Recent molecular dating of genus *Euphorbia* estimates the split between the African-Arabian and Macaronesian species to be 5 Ma old (Horn & al., in prep.). This agrees with a vicariance scenario as the aridification process, which occurred in the late Miocene-Pliocene (Axelrod, 1975) in northern Africa, acted as an important ecological barrier. The arid belt would have fragmented the continuous subtropical flora in this area and left two relict distribution centres in refugia areas, explaining the present disjunct distribution of sect. *Aphyllis*. This process should always be associated to a long-distance dispersal event to the oceanic islands. Since most of the Afro-Arabian species of sect. *Aphyllis* are distributed in the Horn of Africa (Fig. 4), a migration from this area to southern Africa could have taken place following the African track (Linder & al., 1992). A

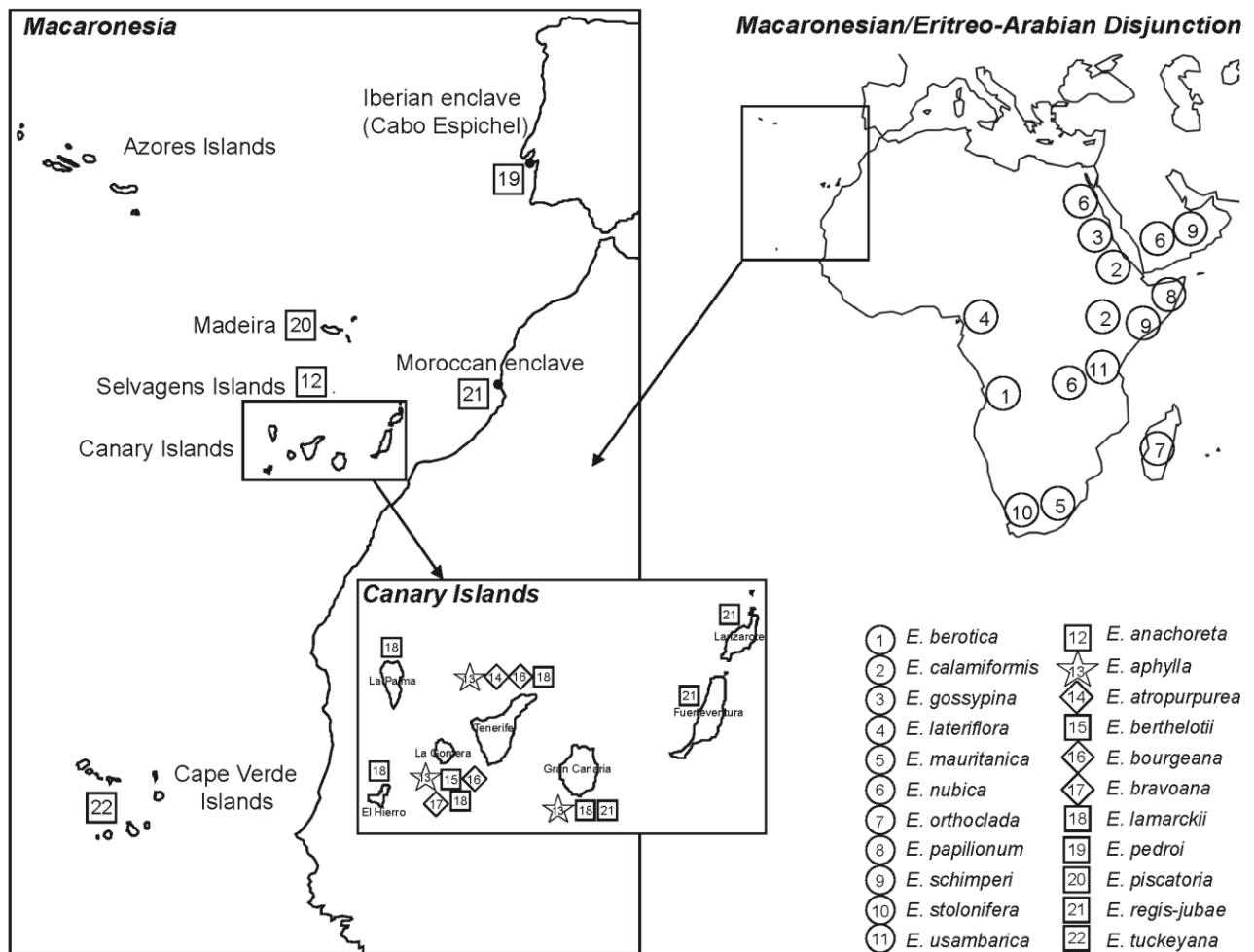

Fig. 4. Geographical distribution of the species belonging to sect. *Aphyllis* as currently circumscribed. The traditional groups previously considered within sect. *Aphyllis* are indicated as: circle, sect. *Tirucalli*; square, subsect. *Pachycladae*, *Euphorbia lamarckii* complex; rhombus, subsect. *Pachycladae*, *Euphorbia atropurpurea* complex; star, sect. *Aphyllis* sensu Webb & Berthelot (1842).

long-distance dispersal event from southern Africa to Madagascar would have originated the endemic *E. orthoclada*. In this case, vicariance seems improbable since the isolation of Madagascar from other Gondwana landmasses is estimated to be 120 Ma (Rabinowitz & al., 1983).

From our results (Fig. 2) it is unclear whether members of sect. *Aphyllis* dispersed to Macaronesia from continental masses once or more than once. Although the isolated position of *E. tuckeyana* in both nuclear and chloroplastic analyses could suggest at least an independent colonisation of Cape Verde Archipelago, the rest of the species could have diversified after a unique dispersion event from the continent, since they are shown as monophyletic in cpDNA based analyses (Fig. 2B). Moreover, hybridisation, which seems to be recurrent in this group (Molero & Rovira, 2005), is common in plant groups presenting a single colonisation event (Carine & al., 2004). The phylogenetic position of the endemic *E. pedroi* from Cape Espichel (Figs. 2 and 4) could be explained through two hypotheses: (1) a back-colonisation from Macaronesia, probably from the closest archipelago, Madeira; or (2) the permanence of this species as a relict from the subtropical flora existing in the Mediterranean basin during the Miocene. The same two hypotheses could explain the presence of *E. regis-jubae* in the west coast of Morocco (Figs. 2 and 4). However, the short branches observed in the phylogram in both species (Fig. 2), and the short distance between the two distribution areas in the case of *E. regis-jubae* (Fig. 4), could make back-colonisation the most probable hypothesis for both cases.

An independent colonisation of Macaronesia by other members of subg. *Esula* is evident from our results (Fig. 1, clade 6). A Mediterranean herbaceous ancestor from sect. *Helioscopia* would have given origin to the lauroid trees *E. stygiana*, endemic to the Azores Islands, and *E. mellifera*, distributed in the Canary Islands and Madeira. The present distribution of these species could be explained either by independent dispersal events from the Mediterranean area to the different archipelagos, as has been reported for other plant groups (Carine & al., 2004), or a step-stone colonisation via Madeira. The acquisition of a woody habit in the ancestor of *E. mellifera* and *E. stygiana* provides another example of derived insular woodiness, a phenomenon also detected in subg. *Chamaesyce* in Hawaii (Koutnik, 1999). The acquisition of woodiness in islands was first reported by Carlquist (1974) and has been widely documented in different plant groups from several volcanic archipelagos (e.g., Jorgensen & Olesen, 2001; Helfgott & al., 2000; García-Maroto & al., 2009, among others).

The presence of the succulents *E. canariensis* and *E. handiensis* from subg. *Euphorbia*, both endemic to the Canary Islands, in clade 10 (Fig. 1) and their grouping with species from Morocco, tropical Africa and India suggests at least two additional independent colonisations of the Macaronesian region by *Euphorbia*.

In summary, the Macaronesian endemic *Euphorbia* have originated from at least five independent colonisation events: three in subg. *Esula* (two independent events in sect. *Aphyllis* and one additional event in sect. *Helioscopia*—*E. mellifera* and

E. stygiana) and two in subg. *Euphorbia* (*E. canariensis* and *E. handiensis*, independently).

Finally, two modes of speciation have been postulated to occur in endemic lineages of oceanic islands (Whittaker & Fernández-Palacios, 2007; Carine & Schaefer, 2010): adaptive ecological radiation and allopatric speciation. Within sect. *Aphyllis*, the pattern found is very complex and both types seem to have occurred. The fact that members of the *E. lamarckii* complex mainly occupy xerophytic habitats in low- and mid-altitude areas while members of the *E. atropurpurea* complex mainly occur in mesophytic and sub-hygrophytic areas associated with evergreen laurisilva suggests a role for radiation into different ecological habitats. However, allopatric speciation among different archipelagos also seems to have occurred within members of the *E. lamarckii* complex, each endemic to one archipelago or Macaronesian enclave (Fig. 4) but with the same ecological preferences. Furthermore, dispersal among islands must have occurred repeatedly within the group because most species are present in more than one island. Also, the low divergence among sequences of different species suggests recent radiation of the group, hybridisation events, or both. Population genetic studies using more variable molecular markers (i.e., fingerprinting markers) on a complete sampling of the different species across their whole distributions are needed for a better understanding of the origin and evolution of this group in Macaronesia.

■ ACKNOWLEDGEMENTS

This work was supported by the Ministry of Education and Science, Spanish Government (project CGL2006-01765/BOS, CGL2009-13322-C03-03 and BES-2007-14260 Ph.D. grant to L. Barres) and the Catalan Government ('Ajuts a grups consolidats' 2009/SGR/00439). We acknowledge the Euphorbia Planetary Biodiversity Inventory Project, which provided material and strongly supports our research. Special thanks are due to A. Moller and J. Morawetz, who kindly provided some photographs for Figure 3. The National Science Foundation Planetary Biodiversity Inventory Grant (DEB-0616533) additionally supported this work. Also thanks are due to the curators of all herbaria that provided material (K, LISC, W), and also to J. Aldasoro, C. Benedí, A. Hilpold, N. Montes-Moreno, J. Morawetz, R. Riina, Ll. Sáez and all the people who offered material from their own collections. Three anonymous reviewers provided helpful comments that improved the manuscript.

■ LITERATURE CITED

- Akaike, H. 1973. Information theory and an extension of the maximum likelihood principle. Pp. 267–281 in: Petrov, B.N. & Csáki, F. (eds.), *Second International Symposium on Information Theory*. Budapest: Akadémiai Kiadó.
- Allan, G.J., Francisco-Ortega, J., Santos-Guerra, A., Boerner, E. & Zimmer, E.A. 2004. Molecular phylogenetic evidence for the geographic origin and classification of Canary Island *Lotus* (Fabaceae: Loteae). *Molec. Phylog. Evol.* 32: 123–138.
- Andrus, N., Trusty, J., Santos-Guerra, A., Jansen, R.K. &

- Francisco-Ortega, J. 2004. Using molecular phylogenies to test phytogeographical links between East/South Africa-Southern Arabia and the Macaronesian islands—a review, and the case of *Vierea* and *Pulicaria* section *Vieraeopsis* (Asteraceae). *Taxon* 53: 333–346.
- Axelrod, D.I. 1975. Evolution and biogeography of Madrean-Tethyan sclerophyll vegetation. *Ann. Missouri Bot. Gard.* 62: 280–334.
- Axelrod, D.I. & Raven, P.H. 1978. Late Cretaceous and Tertiary vegetation history of Africa. Pp. 79–130 in: Werger, M.J.A. (ed.), *Biogeography and ecology of Africa*. The Hague: Junk.
- Baldwin, B.G. & Markos, S. 1998. Phylogenetic utility of the external transcribed spacer (ETS) of 18S-26S rDNA: Congruence of ETS and ITS trees of *Calycadenia* (Compositae). *Molec. Phylog. Evol.* 10: 449–463.
- Barbero, M., Loisel, R. & Quézel, P. 1992. Biogeography, ecology and history of Mediterranean *Quercus ilex* ecosystems. *Vegetatio* 100: 19–34.
- Bellstedt, D.U., Van Zyl, L., Marais, E.M., Bytebier, B., De Villiers, C.A., Dreyer, L.L., Galley, C., Pirie, M. & Linder, H.P. 2008. A molecular phylogeny reveals evidence of rapid and recent radiation in Cape and Australian members of the genus *Zygophyllum*. *S. African J. Bot.* 74: 361–361.
- Benedí, C., Molero, J., Simon, J. & Vicens, J. 1997. *Euphorbia* L. Pp. 210–286 in: Castroviejo, S., Aedo, C., Benedí, C., Lainz, M., Muñoz Garmendia, F., Nieto Feliner, G. & Paiva, J. (eds.), *Flora Iberica*, vol. 8. Madrid: CSIC.
- Boissier, P.E. 1862. Euphorbiaceae subordo Euphorbieae. Pp. 3–188 in: Candolle, A.P. de (ed.), *Prodromus systematis naturalis regni vegetabilis*, vol. 15(2). Paris: Treuttel & Würtz.
- Bramwell, D. 1985. Contribución a la biogeografía de las Islas Canarias. *Bot. Macaronés.* 14: 3–34.
- Bruyns, P.V., Mapaya, R.J. & Hedderson, T. 2006. A new subgeneric classification for *Euphorbia* (Euphorbiaceae) in southern Africa based on ITS and *psbA-trnH* sequence data. *Taxon* 55: 397–420.
- Carine, M.A. 2005. Spatio-temporal relationships of the Macaronesian endemic flora: A relictual series or window of opportunity? *Taxon* 54: 895–903.
- Carine, M.A., Russell, S.J., Santos-Guerra, A. & Francisco-Ortega, J. 2004. Relationships of the Macaronesian and Mediterranean floras: Molecular evidence for multiple colonizations into Macaronesia and back-colonization of the continent in *Convolvulus* (Convolvulaceae). *Amer. J. Bot.* 91: 1070–1085.
- Carine, M.A. & Schaefer, H. 2010. The Azores diversity enigma: Why are there so few Azorean endemic flowering plants and why are they so widespread? *J. Biogeogr.* 37: 77–89.
- Carlquist, S.J. 1974. *Island biology*. New York: Columbia University Press.
- Carracedo, J.C., Day, S., Guillou, H., Badiola, E.R., Canas, J.A. & Torrado, F.J.P. 1998. Hotspot volcanism close to a passive continental margin: The Canary Islands. *Geol. Mag.* 135: 591–604.
- Carter, S. 1985. New species and taxonomic changes in *Euphorbia* from east and northeast tropical Africa and a new species from Oman. *Kew Bull.* 40: 809–825.
- Carter, S. 1992. New species of *Euphorbia* subgenus *Tirucalli* (Euphorbiaceae) from Somalia and Oman. *Nordic J. Bot.* 12: 675–679.
- Christ, H. 1892. Exposé sur le rôle que joue dans le domaine de nos flores la “flore ancienne africaine”. *Arch. Sci. Phys. Nat. Genève* 3 (XXVIII): 1–48 & 369–374.
- Cronn, R.C., Small, R.L., Haselkorn, T. & Wendel, J.F. 2002. Rapid diversification of the cotton genus (*Gossypium*: Malvaceae) revealed by analysis of sixteen nuclear and chloroplast genes. *Amer. J. Bot.* 89: 707–725.
- Cuenoud, P., Martínez, M.A.D., Loizeau, P.A., Spichiger, R., Andrews, S. & Manen, J.F. 2000. Molecular phylogeny and biogeography of the genus *Ilex* L. (Aquifoliaceae). *Ann. Bot. (Oxford)* 85: 111–122.
- Doyle, J.J. & Dickson, E.E. 1987. Preservation of plant-samples for DNA restriction endonuclease analysis. *Taxon* 36: 715–722.
- Farris, J.S., Källersjö, M., Kluge, A.G. & Bult, C. 1995a. Testing significance of incongruence. *Cladistics* 10: 315–319.
- Farris, J.S., Källersjö, M., Kluge, A.G. & Bult, C. 1995b. Constructing a significance test for incongruence. *Syst. Biol.* 44: 570–572.
- Felsenstein, J. 1985. Confidence limits on phylogenies: An approach using the bootstrap. *Evolution* 39: 783–791.
- Francisco-Ortega, J., Barber, J.C., Santos-Guerra, A., Febles-Hernández, R. & Jansen, R.K. 2001. Origin and evolution of the endemic genera of *Gonosperminae* (Asteraceae: Anthemideae) from the Canary Islands: Evidence from nucleotide sequences of the internal transcribed spacers of the nuclear ribosomal DNA. *Amer. J. Bot.* 88: 161–169.
- Francisco-Ortega, J., Fuertes-Aguilar, J., Gómez-Campo, C., Santos-Guerra, A. & Jansen, R.K. 1999. Internal transcribed spacer sequence phylogeny of *Crambe* L. (Brassicaceae): Molecular data reveal two Old World disjunctions. *Molec. Phylog. Evol.* 11: 361–380.
- Francisco-Ortega, J., Santos-Guerra, A., Hines, A. & Jansen, R.K. 1997. Molecular evidence for a Mediterranean origin of the Macaronesian endemic genus *Argyranthemum* (Asteraceae). *Amer. J. Bot.* 84: 1595–1613.
- Galbany-Casals, M., Garcia-Jacas, N., Sáez, L., Benedí, C. & Susanna, A. 2009. Phylogeny, biogeography, and character evolution in Mediterranean, Asiatic, and Macaronesian *Helichrysum* (Asteraceae, Gnaphalieae) inferred from nuclear phylogenetic analyses. *Int. J. Pl. Sci.* 170: 365–380.
- Galley, C. & Linder, H.P. 2006. Geographical affinities of the Cape flora, South Africa. *J. Biogeogr.* 33: 236–250.
- García-Maroto, F., Manas-Fernández, A., Garrido-Cárdenas, J.A., Alonso, D.L., Guil-Guerrero, J.L., Guzmán, B. & Vargas, P. 2009. Delta(6)-Desaturase sequence evidence for explosive Pliocene radiations within the adaptive radiation of Macaronesian *Echium* (Boraginaceae). *Molec. Phylog. Evol.* 52: 563–574.
- García-Verdugo, C., Forrest, A.D., Balaguer, L., Fay, M.F. & Vargas, P. 2010. Parallel evolution of insular *Olea europaea* subspecies based on geographical structuring of plastid DNA variation and phenotypic similarity in leaf traits. *Bot. J. Linn. Soc.* 162: 54–63.
- Geldmacher, J., Hoernle, K., Van den Bogaard, P., Zankl, G. & Garbe-Schönberg, D. 2001. Earlier history of the ≥ 70-Ma-old Canary hotspot based on the temporal and geochemical evolution of the Selvagen Archipelago and neighboring seamounts in the eastern North Atlantic. *J. Volcanol. Geothermal Res.* 111: 55–87.
- Goloboff, P.A., Farris, J.S. & Nixon, K. 2008. TNT, a free program for phylogenetic analysis. *Cladistics* 24: 774–786.
- Govaerts, R., Fernández Casas, F.J., Barker, C., Carter, S., Davies, S., Esser, H.-J., Gilbert, M., Hoffmann, P., Radcliffe-Smith, A., Steinmann, V., Van Welzen, P. & Whitmore, T. 2010. World checklist of Euphorbiaceae. The Board of Trustees of the Royal Botanic Gardens, Kew. <http://www.kew.org/wcps/> (accessed 30 Dec. 2010).
- Hall, T.A. 1999. BioEdit: A user-friendly biological sequence alignment editor and analysis program for Windows 95/98/NT. *Nucleic Acids Symp. Ser.* 41: 95–98.
- Helfgott, D.M., Francisco-Ortega, J., Santos-Guerra, A., Jansen, R.K. & Simpson, B.B. 2000. Biogeography and breeding system evolution of the woody *Bencomia* alliance (Rosaceae) in Macaronesia based on ITS sequence data. *Syst. Bot.* 25: 82–97.
- Hershkovitz, M.A. 2006. Ribosomal and chloroplast DNA evidence for diversification of western American Portulacaceae in the Andean region. *Gayana, Bot.* 63: 13–74.
- Hess, J., Kadereit, J.W. & Vargas, P. 2000. The colonization history of *Olea europaea* L. in Macaronesia based on internal transcribed spacer 1 (ITS-1) sequences, randomly amplified polymorphic DNAs (RAPD), and intersimple sequence repeats (ISSR). *Molec. Ecol.* 9: 857–868.
- Holm, P.M., Wilson, J.R., Christensen, B.P., Hansen, L., Hansen, S.L., Hein, K.M., Mortensen, A.K., Pedersen, R., Plesner, S.

- & Runge, M.K. 2006. Sampling the Cape Verde mantle plume: Evolution of melt compositions on Santo Antão, Cape Verde Islands. *J. Petrol.* 47: 145–189.
- Horn, J.W., Van Ee, B., Morawetz, J.J., Riina, R., Berry, P.E., Steinmann, V.W. & Wurdack, K. 2009. Phylogeny and evolution of growth forms in the giant genus *Euphorbia* (Euphorbiaceae). Botany and Micology Conference, Snowbird, Utah. <http://2009.botanyconference.org/engine/search/index.php?func=detail&aid=679>.
- Huelsenbeck, P. & Ronquist, F. 2001. MRBAYES: Bayesian inference of phylogenetic trees. *Bioinformatics* 17: 754–755.
- Johnson, L.A. & Soltis, D.E. 1995. Phylogenetic inference in Saxifragaceae sensu stricto and *Gilia* (Polemoniaceae) using *matK* sequences. *Ann. Missouri Bot. Gard.* 82: 149–175.
- Jorgensen, T.H. & Olesen, J.M. 2001. Adaptive radiation of island plants: Evidence from *Aeonium* (Crassulaceae) of the Canary Islands. *Perspect. Pl. Ecol. Evol. Syst.* 4: 29–42.
- Kilian, N., Galbany-Casals, M. & Oberprieler, C. 2010. *Helichrysum nicolai* (Compositae, Gnaphaliales), a dwarf local endemic of the Cape Verde Islands, W Africa. *Folia Geobot.* 45: 183–199.
- Kim, S.-C., McGowen, M.R., Lubinsky, P., Barber, J.C., Mort, M.E. & Santos-Guerra, A. 2008. Timing and tempo of early and successive adaptive radiations in Macaronesia. *PLoS ONE* 3(5): e2139. DOI: 10.1371/journal.pone.0002139.
- Koutnik, D.L. 1999. *Chamaesyce* S.F. Gray. Pp. 602–617 in: Wagner, W.L., Herbst, D.R. & Sohmer, S.H. (eds.), *Manual of flowering plants of Hawaii*, rev. ed. Honolulu: University of Hawaii Press and Bishop Museum Press.
- Le Houérou, H.N. 1995. Bioclimatologie et biogéographie des steppes arides du Nord de l'Afrique. *Options Médit.*, ser. B, 10: 1–396.
- Leach, L.C. 1975. Notes on *Euphorbia mauritanica*, *E. gossypina* and some related species with an amplified description of *E. berotica*. *Bothalia* 11: 505–510.
- Levyns, M.R. 1964. Migrations and origin of the Cape flora. *Trans. Roy. Soc. South Africa* 37: 85–107.
- Linder, H.P., Meadows, M.E. & Cowling, R.M. 1992. History of the Cape flora. Pp. 113–134 in: Cowling, R.M. (ed.), *The ecology of fynbos: Nutrients, fire and diversity*. Cape Town: Oxford University Press.
- McGuire, A.F. & Kron, K.A. 2005. Phylogenetic relationships of European and African Ericas. *Int. J. Pl. Sci.* 166: 311–318.
- Médail, F. & Quézel, P. 1999. The phytogeographical significance of S.W. Morocco compared to the Canary Islands. *Pl. Ecol.* 140: 221–244.
- Mies, B., Jiménez, M.S. & Morales, D. 1996. Ecophysiology and distribution of the endemic leafless spurge *Euphorbia aphylla* and the introduced *E. tirucalli* (Euphorbiaceae, *Euphorbia* sect. *Tirucalli*) in the Canary Islands. *Pl. Syst. Evol.* 202: 27–36.
- Molero, J., Garnatje, T., Rovira, A., García-Jacas, N. & Susanna, A. 2002. Karyological evolution and molecular phylogeny in Macaronesian dendroid spurges (*Euphorbia* subsect. *Pachycladae*). *Pl. Syst. Evol.* 231: 109–132.
- Molero, J. & Rovira, A.M. 2005. Natural hybrids in endemic Canarian dendroid spurges (*Euphorbia* subsect. *Pachycladae*). *Willdenowia* 35: 271–280.
- Moore, M.J., Francisco-Ortega, J., Santos-Guerra, A. & Jansen, R.K. 2002. Chloroplast DNA evidence for the roles of island colonization and extinction in *Tolpis* (Asteraceae: Lactuceae). *Amer. J. Bot.* 89: 518–526.
- Müller, K. 2006. Incorporating information from length-mutational events into phylogenetic analysis. *Molec. Phylog. Evol.* 38: 667–676.
- Nickrent, D.L., Schuetz, K.P. & Starr, E.M. 1994. A molecular phylogeny of *Arceuthobium* (Viscaceae) based on nuclear ribosomal DNA internal transcribed spacer sequences. *Amer. J. Bot.* 81: 1149–1160.
- Notredame, C., Higgins, D.G. & Heringa, J. 2000. T-Coffee: A novel method for fast and accurate multiple sequence alignment. *J. Molec. Biol.* 302: 205–217.
- Nylander, J.A.A. 2004. MrModeltest, version 2. Program distributed by the author. Uppsala: Evolutionary Biology Centre, Uppsala University.
- Oudejans, R.C.H.M. 1990. *World catalogue of species names published in the Euphorbieae (Euphorbiaceae) with their geographical distribution*. Utrecht: published by the author.
- Palmer, J.D., Jansen, R.K., Michaels, H.J., Chase, M.W. & Manhart, J.R. 1989. Chloroplast DNA variation and plant phylogeny. *Ann. Missouri Bot. Gard.* 75: 1180–1206.
- Park, S.J., Korompai, E.J., Francisco-Ortega, J., Santos-Guerra, A. & Jansen, R.K. 2001. Phylogenetic relationships of *Tolpis* (Asteraceae: Lactuceae) based on *ndhF* sequence data. *Pl. Syst. Evol.* 226: 23–33.
- Pax, F.A. & Hoffmann, K. 1931. Euphorbiaceae. Pp. 11–233 in: Engler, A. & Prantl, K. (eds.), *Die natürlichen Pflanzenfamilien*, ed. 2, vol. 19C. Leipzig: Engelmann.
- Pedro, J.G. 1942. Estudo geobotânico da Serra da Arrábida. I. Reconhecimento geral. *Agron. Lusit.* 4: 101–136.
- Percy, D.M. & Cronk, Q.C.B. 2002. Different fates of island brooms: Contrasting evolution in *Adenocarpus*, *Genista*, and *Teline* (Genisteae, Fabaceae) in the Canary Islands and Madeira. *Amer. J. Bot.* 89: 854–864.
- Quézel, P. 1978. Analysis of the flora of Mediterranean and Saharan Africa. *Ann. Missouri Bot. Gard.* 65: 479–534.
- Rabinowitz, P.D., Coffin, M.F. & Falvey, D. 1983. The separation of Madagascar and Africa. *Science* 220: 67–69.
- Radcliffe-Smith, A. 1982. *Euphorbia* L. Pp. 571–630 in: Davis, P. (ed.), *Flora of Turkey and the East Aegean Islands*, vol. 7. Edinburgh: Edinburgh University Press.
- Radcliffe-Smith, A. & Tutin, T.G. 1968. *Euphorbia* L. Pp. 213–226 in: Tutin, T.G., Heywood, V.H., Burges, N.A., Moore, D.M., Walters, S.M. & Webb, D.A. (eds.), *Flora Europaea*, vol. 2. Cambridge: Cambridge University Press.
- Ronquist, F. & Huelsenbeck, J.P. 2003. MrBAYES 3: Bayesian phylogenetic inference under mixed models. *Bioinformatics* 19: 1572–1574.
- Saghai-Marouf, M.A., Soliman, K.M., Jorgensen, R.A. & Allard, R.W. 1984. Ribosomal DNA spacer length polymorphisms in barley: Mendelian inheritance, chromosomal location, and population dynamics. *Proc. Natl. Acad. Sci. U.S.A.* 81: 8014–8018.
- Sang, T., Crawford, D.J. & Stuessy, T.F. 1997. Chloroplast DNA phylogeny, reticulate evolution, and biogeography of *Paeonia* (Paeoniaceae). *Amer. J. Bot.* 84: 1120–1136.
- Sanmartín, I., Van der Mark, P. & Ronquist, F. 2008. Inferring dispersal: A Bayesian approach to phylogeny-based island biogeography, with special reference to the Canary Islands. *J. Biogeogr.* 35: 428–449.
- Savolainen, V., Manen, J.F., Douzery, E. & Spichiger, R. 1994. Molecular phylogeny of families related to Celastrales based on *rbcL* 5' flanking sequences. *Molec. Phylog. Evol.* 3: 27–37.
- Shaw, J., Lickey, E.B., Beck, J.T., Farmer, S.B., Liu, W.S., Miller, J., Siripun, K.C., Winder, C.T., Schilling, E.E. & Small, R.L. 2005. The tortoise and the hare II: Relative utility of 21 noncoding chloroplast DNA sequences for phylogenetic analysis. *Amer. J. Bot.* 92: 142–166.
- Steinmann, V.W. & Porter, J.M. 2002. Phylogenetic relationships in Euphorbieae (Euphorbiaceae) based on ITS and *ndhF* sequence data. *Ann. Missouri Bot. Gard.* 89: 453–490.
- Sunding, P. 1979. Origins of the Macaronesian flora. Pp. 13–40 in: Bramwell, D. (ed.), *Plants and islands*. London: Academic Press.
- Swofford, D.L. 2002. PAUP*: Phylogenetic analysis using parsimony (*and other methods), version 4.0b10. Sunderland, Massachusetts: Sinauer.
- Taberlet, P., Gielly, L., Pautou, G. & Bouvet, J. 1991. Universal primers for amplification of 3 noncoding regions of chloroplast DNA. *Pl. Molec. Biol.* 17: 1105–1109.

- Thiv, M., Thulin, M., Hjertson, M., Kropf, M. & Linder, H.P. 2010. Evidence for a vicariant origin of Macaronesian-Eritreo/Arabian disjunctions in *Campylanthus* Roth (Plantaginaceae). *Molec. Phylog. Evol.* 54: 607–616.
- Thulin, M. 1994. Aspects of disjunct distributions and endemism in the arid parts of the Horn of Africa, particularly Somalia. Pp. 1105–1119 in Seyani, J.H. & Chikuni, A.C. (eds.), *Proceedings of the XIIIth Plenary Meeting of AETFAT*. Malawi: National Herbarium and Botanic Gardens of Malawi.
- Vargas, P., Morton, C.M. & Jury, S.L. 1999. Biogeographic patterns in Mediterranean and Macaronesian species of *Saxifraga* (Saxifragaceae) inferred from phylogenetic analyses of ITS sequences. *Amer. J. Bot.* 86: 724–734.
- Vindt, J. 1953. Monographie des Euphorbiacées du Maroc. Part 1: Révision et systématique. *Trav. Inst. Sci. Chérifien, Sér. Bot.* 2: 1–228.
- Webb, P.B. & Berthelot, S. 1842. *Histoire naturelle des Îles Canaries*, vol. 3(2, 3), *Phytographia Canariensis*. Paris: Béthune.
- White, T.J., Bruns, T., Lee, S. & Taylor, J.W. 1990. Amplification and direct sequencing of fungal ribosomal RNA genes for phylogenetics. Pp. 315–322 in: Innis, M.A., Gelfand, D.H., Sminsky, J.J. & White, T.J. (eds.), *PCR protocols: A guide to methods and applications*. New York: Academic Press.
- Whittaker, R.J. & Fernández-Palacios, J.M. 2007. *Island biogeography: Ecology, evolution, and conservation*. Oxford: Oxford University Press.
- Zimmermann, N.F.A., Ritz, C.M. & Hellwig, F.H. 2010. Further support for the phylogenetic relationships within *Euphorbia* L. (Euphorbiaceae) from nrITS and *trnL-trnF* IGS sequence data. *Pl. Syst. Evol.* 286: 39–58.

Appendix. Taxa, voucher information and GenBank accession numbers employed in molecular analyses. GenBank accession numbers marked with super-index were already published (¹Molero & al., 2002; ²Steinmann & Porter, 2002; ³Bruyns & al., 2006). GenBank accession numbers for new sequences are in the following order: ITS, ETS, *trnL-trnF*, *psbA-trnH*, *ycf3-trnS*, *trnG*, *atpB-rbcL*, *trnK-matK*, *trnT-trnL*. When only one accession number is indicated, it corresponds to ITS.

Dichostemma glaucescens Pierre, Gabon, AF537584². *Euphorbia acalyphoides* Hochst. ex Boiss., Kenya, AF537576². *E. acanthothannos* Heldr. ex Sart., Greece, Crete, Melindaou Peak, *Riina 1562* (MICH), HQ900573. *E. akenocarpa* Guss., Spain, Cádiz, Vejer de la Frontera, Barres & al. s.n. (BCN 53041), HQ900574. *E. aliuauudii* Drake, Madagascar, AF537468². *E. amygdaloides* L., Spain, Barcelona, Sant Iscle de Vallalta, *Molero 19/2007* (BCN 48887), HQ900575. *E. anachoreta* Svent., Portugal, Selvagens Islands, Pequeño Pitón (cultivated) (BC), HQ900576, HQ900393, HQ900495, HQ900419, HQ900547, HQ900445, HQ900367, HQ900471, HQ900521. *E. antso* Denis, Madagascar (cultivated), AF537579². *E. aphylla* Brouss. ex Willd., Spain, Canary Islands, Tenerife, Montaña del Taco, *Molero 2/2007* (BCN), HQ900577, HQ900394, HQ900496, HQ900420, HQ900548, HQ900446, HQ900368, HQ900472, HQ900522. *E. arbuscula* Balf. f., Socotra (cultivated), AF537496². *E. atrispina* N.E. Br., Republic of South Africa (cultivated), AF537568². *E. articulata* Burm., Virgin Islands, AF537446². *E. atropurpurea* Brouss. ex Willd., Spain, Canary Islands, Tenerife, Masca, Los Carrizales, *Molero 5/2007* (BCN), HQ900579, HQ900395, HQ900497, HQ900421, HQ900549, HQ900447, HQ900369, HQ900473, HQ900523. *E. baetica* Boiss., Spain, Cádiz, Parque Natural de Breña y Marismas de Barbate, *Molero 18/2007* (BCN), HQ900580. *E. balsamifera* Aiton subsp. *balsamifera*, Spain, Canary Islands (cultivated) (BC), HQ900581. *E. bariensis* S. Carter, Somalia, *Osman & al. 10500* (K), HQ900582. *E. barrelieri* Savi, Italy, Toscana, Grosseto, Castiglione della Pescaia, *Vilatersana 1235 & al.* (BC), HQ900583. *E. berotica* N.E. Br., Angola, Huila, between Pocolo and Quihita, *Gonveia & Barbosa 10720* (LISC 2247), HQ900584, HQ900396, HQ900498, HQ900422, HQ900550, HQ900448, HQ900370, HQ900474, HQ900524. *E. berthelotii* Bolle ex Boiss., Spain, Canary Islands, La Gomera, San Sebastián de la Gomera, near Santiago Beach, *Molero 25/2007* (BCN), HQ900585, HQ900397, HQ900499, HQ900423, HQ900551, HQ900449, HQ900371, HQ900475, HQ900525. *E. bilobata* Engelm., U.S.A., AF537435². *E. biselegans* Bruyns, Tanzania (cultivated), AF537470². *E. biumbellata* Poir., Spain, Barcelona, Sant Pol de Mar, *Molero 26/2007* (BCN), HQ900586, HQ900398, HQ900500, HQ900424, HQ900552, HQ900450, HQ900372, HQ900476, HQ900526. *E. bourgeana* J. Gay ex Boiss., Spain, Canary Islands, La Gomera, Parque Nacional de Garajonay, Los Noruegos, *Molero 11/2007* (BCN), HQ900587, HQ900399, HQ900501, HQ900425, HQ900553, HQ900451, HQ900373, HQ900477, HQ900527. *E. brachyera* Engelm., U.S.A., AF537533². *E. bravonia* Svent., Spain, Canary Islands, La Gomera, Punta de la Sardinia, *Fernández-López 08/2007* (BCN), HQ900588, HQ900400, HQ900502, HQ900426, HQ900554, HQ900452, HQ900374, HQ900478, HQ900528. *E. calamiformis* P.R.O. Bally & S. Carter, Kenya, *Carter & Stannard 558* (K), HQ900589, HQ900401, HQ900503, HQ900427, HQ900555, HQ900453, HQ900375, –, HQ900529. *E. calyptata* Coss. & Kralik, Morocco, Tarfaya, near Tan-Tan, *Batriu & al. s.n.* (BCN 49739), HQ900590. *E. canariensis* L., Spain, Canary Islands (cultivated) (BC), HQ900591. *E. caput-medusae* L., Republic of South Africa (cultivated), AF537574². *E. cashmeriana* Royle, Afghanistan, Nuristan, Nishei, *Edelberg 781* (W 1964–14520), HQ900592. *E. cassia* Boiss., Cyprus, road B8 from Lemesos to Trimiklini, *Galbany 2035 & al.* (BC), HQ900593. *E. ceratocarpa* Ten., Italy, Sicily, Messina, Santo Stefano di Camastra, *Vilatersana 1141 & al.* (BC), HQ900594. *E. ceroderma* I.M. Johnst., Mexico, AF537389². *E. characias* L., Spain, Barcelona, Parc de Montjuïc, Barres 21 (BC), HQ900595. *E. clava* Jacq., Republic of Sotuh Africa (cultivated), AF537569². *E. clementei* Boiss. subsp. *clementei*, Morocco, Midelt, Jebel Ayachi, *Molero s.n.* (BCN 49327), HQ900596. *E. coralitoides* L., Italy, Sicily, Agrigento, south shore of Lake Arancio, *Vilatersana 1161 & al.* (BC), HQ900597. *E. crotonoides* Boiss., Tanzania, AF537578². *E. cyparissias* L., Spain, Girona, Olot, Barres 37 (BC), HQ900598. *E. delicatula* Boiss., Mexico, AF537393². *E. dendroides* L., Italy, Sardinia, Capo Caccia, Barres 26 & Mameli (BC), HQ900599, HQ900402, HQ900504, HQ900428, HQ900556, HQ900454, HQ900376, HQ900479, HQ900530. *E. denisii* Oudejans, Madagascar (cultivated), AF537497². *E. densa* Schrenk, Pakistan, Quetta, Yaro near Bostan, 40 km NNE Quetta versus Pishin, *Rechinger 28952* (W 1984–11717), HQ900600. *E. denticulata* Lam., Iran, Luristan, Baghbanan, SE Khorrarnabad, *Rechinger 47845* (W 1981–05279), HQ900601. *E. depauperata* Hochst. ex A. Rich., Malawi, AF537556². *E. dhofarensis* S. Carter, Oman, Dhofar, 30 km past Mugsail on Sarfait Rd. 2 km past police checkpoint, *Morawetz 324* (MICH), HQ900602. *E. dregana* E. Mey. ex Boiss., South Africa, *Becker 897* (MICH), HQ900603. *E. drupifera* Thonn., Africa (cultivated), AF537480². *E. esculenta* Marloth, Republic of South Africa (cultivated), AF537575². *E. esula* L. subsp. *esula* (1), Spain, Granada, Sierra Nevada Natural Park, Campos de Otero, *Vilatersana 1831 & al.* (BC), HQ900605. *E. esula* L. subsp. *esula* (2), Spain, Tarragona, Falset, *Molero & Vallverdú s.n.* (BCN), HQ900604. *E. exigua* L., Spain, Girona, L'Escala, Mas Vilanera, Barres 44 & al. (BC), HQ900606. *E. falcata* L., Spain, Girona, El Far de l'Empordà, Barres 42 & al. (BC), HQ900607. *E. flavicomada* DC. subsp. *flavicomada*, Spain, Alacant, Torremanzanas, Puerto del Restonar, *Molero s.n.* (BCN 53024), HQ900608. *E. fontqueriana* Greuter, Spain, Balearic Islands, *Sáez s.n.* (BCB), HQ900609. *E. gentioides* P.J. Bergius, South Africa, AM040770³. *E. gossypina* Pax, Tanzania, *Richards 23502* (K), HQ900610, HQ900403, HQ900505, HQ900429, HQ900557, HQ900455, HQ900377, HQ900480, HQ900531. *E. gregaria* Marloth, Republic of South Africa (cultivated), AF537527². *E. guatemalensis* Standl. & Steyerl., Mexico, AF537408². *E. hallii* R.A. Dyer, Republic of South Africa (cultivated), AF537573². *E. handiensis* Burchard, Spain, Canary Islands, Fuerteventura (cultivated) (BC), HQ900611. *E. helioscopia* L. subsp. *helioscopia*, Spain, Barcelona, Montserrat Mountain, near Santa Cecilia, Barres 6 & al. (BC), HQ900612. *E. herniariifolia* Willd., Greece, Crete, Pachnes Peak, 20 km from Aradena, *Riina 1571* (MICH), HQ900613. *E. hirsuta* L., Spain, Cádiz, Tarifa, *Molero 21/2007 & Rovira* (BCN), HQ900614. *E. iberica* Boiss., Armenia, Tavush province, N area of Berd, *Vitek 05–0912* (W 2008–06796), HQ900615. *E. ilirica* Lam., Spain, Girona, Olot, near Ravell, Barres 39 (BC), HQ900616. *E. isatidifolia* Lam., Spain, Lleida, La Sentiu de Sió, Serra de les Guineus, Barres 30 & al. (BC), HQ900617. *E. kraussiana* Bernh. ex Krauss, South Africa, AF537548². *E. lagascae* Spreng., Spain, Murcia, Puerto Lumbreras, *Molero 18/2008 & al.* (BCN 53042), HQ900618. *E. lamarckii* Sweet, Spain, Canary Islands, Tenerife, Barranco del Infierno, *Molero 6/2007* (BCN), HQ900619, HQ900404, HQ900506, HQ900430, HQ900558, HQ900456, HQ900378, HQ900481, HQ900532. *E. larica* Boiss., Oman, Al-Dakhiliyah, Jebel Akhdar, *Morawetz 350* (MICH), HQ900620. *E. lateriflora* Schumach., Ghana, *Hall 46017* (K), HQ900621, HQ900405, HQ900507, HQ900431, HQ900559, HQ900457, HQ900379, –, HQ900533. *E. lathyris* L., Spain, Girona, Olot, Barres 36 (BC), HQ900622. *E. longituberculosa* Hochst.

Appendix. Continued.

ex Boiss., East tropical Africa (cultivated), AF537577². *E. margalitana* Kubbier & Lewej., Spain, AF334252¹; AF334267¹. *E. mastrahensis* Ghaz., Oman, Sharqiyah, Masirah Island, NE part of island, *Morawetz 348* (MICH), HQ900623. *E. matritensis* Boiss., Spain, Toledo, Santa Cruz del Retamar, *Molero 11/2008* & al. (BCN 53037), HQ900624. *E. mauritanica* L., South Africa, Western Cape, N12 from De Rust to Oudtshoorn, *Becker & al. 857* (MICH277), HQ900625, HQ900406, HQ900508, HQ900432, HQ900560, HQ900458, HQ900380, HQ900482, HQ900534. *E. medicaginea* Boiss., Spain, Cádiz, Algeciras, *Molero 22/2007* & *Rovira* (BCN), HQ900626. *E. meenae* S. Carter, India, AF537483². *E. megalatlantica* Ball, Morocco, Midelt, Jebel Ayachi, *Molero 07/2007* (BCN), HQ900627, HQ900407, HQ900509, HQ900433, HQ900561, HQ900459, HQ900381, HQ900483, HQ900535. *E. mellifera* Aiton, Spain, Canary Islands, La Gomera, Parque nacional de Garajonay, *Molero 12/2007* (BCN), HQ900628. *E. meloformis* Ait., Republic of South Africa (cultivated), AF537565². *E. menliana* O. Schwartz, Yemen (cultivated), AF537572². *E. miltif* Des Moul., Madagascar (cultivated), AF537461². *E. minuta* Loscos & J. Pardo, Spain, Lleida, Llardecans, *Barres 33 & al.* (BC), HQ900629. *E. misella* S. Watson, Mexico, AF537384². *E. monteiroi* Hook., Botswana, AF537563². *E. myrsinites* L., Italy, Basilicata, Potenza, Pollino National Park, *Vilatersana 1132 & al.* (BC), HQ900630. *E. namuskluftensis* L.C. Leach, Namibia (cultivated), AF537562². *E. nereidum* Jahand. & Maire, Morocco, Beni-Mellal, *Montserrat s.n.* (BC), HQ900631. *E. nevadensis* Boiss. & Reut., Spain, Granada, Sierra Nevada, *Molero s.n.* (BCN 34062), JF279604. *E. nevadensis* subsp. *bolosii* Molero & Rovira, Spain, Barcelona, Montserrat Mountain, *Hilpold s.n. & Pramsohler* (BC), HQ900632. *E. nicaeensis* All., Spain, Barcelona, near Monistrol de Montserrat, *Barres 3 & al.* (BC), HQ900633. *E. nubica* N.E. Br., Ethiopia, *Friis & al.* 8288 (K), HQ900634, HQ900408, HQ900510, HQ900434, HQ900562, HQ900460, HQ900382, HQ900484, HQ900536. *E. oaxacana* B.L. Rob. & Greenm., Mexico, AF537373². *E. obesa* Hook.f., Republic of South Africa (cultivated), AF537566². *E. omariana* M.G. Gilbert, Ethiopia, AF537560². *E. orthoclada* Baker, Madagascar, *Riina 1739* (MICH), HQ900635, HQ900409, HQ900511, HQ900435, HQ900563, HQ900461, HQ900383, HQ900485, HQ900537. *E. oxyphylla* Boiss., Spain, Toledo, El Real de San Martín, *Molero 12/2008 & al.* (BCN 53036), HQ900636. *E. palustris* L., Spain, Girona, L'Escala, Cinclaus, *Barres 34 & al.* (BC), HQ900637. *E. paniculata* Desf. subsp. *paniculata*, Spain, Huelva, between Los Marines and Fuenteheridos, *Molero 16/2008 & al.* (BCN 53039), HQ900639. *E. paniculata* subsp. *monchiquensis* (Franco & P. Silva) Vicens, Molero & C. Blanché, Portugal, Algarve, Nave Redonda, *Molero 14/2008 & al.* (BCN), HQ900638. *E. papilionum* S. Carter, Somalia, *Thulin & al.* 9415 (K), HQ900640, HQ900410, HQ900512, HQ900436, HQ900564, HQ900462, HQ900384, HQ900486, HQ900538. *E. paraitis* L., Spain, Tarragona, Torredembarra Beach, *Molero 6/2008* (BCN), HQ900641. *E. pedroi* Molero & Rovira, Portugal, Sesimbra, *Riina 1585* (MICH), HQ900642, HQ900411, HQ900513, HQ900437, HQ900565, HQ900463, HQ900385, HQ900487, HQ900539. *E. pepiul* L., Spain, Barcelona, Parc de Montjuïc, *Barres 16* (BC), HQ900643. *E. pervilleana* Baill., Madagascar (cultivated), AF537518². *E. phosphorea* Mart., Brazil (cultivated), AF537512². *E. piscatoria* Aiton, Portugal, Madeira (cultivated) (BC), HQ900644, HQ900412, HQ900514, HQ900438, HQ900566, HQ900464, HQ900386, HQ900488, HQ900540. *E. pithyusa* L. subsp. *pithyusa*, Spain, Balearic Islands, Minorca, Fornells, *Benedi & Montes s.n.* (BC 869609), HQ900645. *E. platycephala* Pax, Tanzania, AF537561². *E. platyphyllos* L., Spain, Tarragona, Cornudella de Montsant, La Venta d'en Pubil, *Molero s.n.* (BCN), HQ900646. *E. polygalifolia* Boiss. & Reut., Spain, Cantabria, Puerto del Escudo, *Molero & Rovira s.n.* (BCN 53621), HQ900647. *E. pterococca* Brot., Spain, Cádiz, Tarifa, *Molero 20/2007 & Rovira* (BCN), HQ900648. *E. pulcherrima* Willd. ex Klotzsch, Mexico, AF537432². *E. pyrenaica* Jord., Spain, Cantabria, Fuente Dé, Peña Vieja, *Molero & Rovira s.n.* (BCN 53619), HQ900649. *E. regis-jubae* J. Gay, Morocco, Sous-Massa-Drâa, Tiznit, Sidi Daoud, *Batriu & al. s.n.* (BCN), HQ900650, HQ900413, HQ900515, HQ900439, HQ900567, HQ900465, HQ900387, HQ900489, HQ900541. *E. resinifera* O. Berg, Morocco, Beni-Mellal, road to Azilal, *Molero s.n.* (BC), HQ900651. *E. retusa* Forssk., Morocco, Guelmin-Es-Smsa, Guelmin, between Targwa m-Mayt and Mansoura, Ahmed, *Batriu & al. s.n.* (BCN), HQ900652. *E. rubella* Pax, East Tropical Africa (cultivated), AF537487². *E. rzedowskii* McVaugh, Mexico, AF537399². *E. schimperi* C. Presl, Ethiopia, *Riina 1675* (MICH), HQ900653, HQ900414, HQ900516, HQ900440, HQ900568, HQ900466, HQ900388, HQ900490, HQ900542. *E. segetalis* L., Spain, Barcelona, Montserrat Mountain, *Barres 5 & al.* (BC), HQ900654. *E. serrata* L., Spain, Barcelona, Montserrat Mountain, *Barres 9 & al.* (BC), HQ900655. *E. sp. 1*, Russia, AF537545². *E. sp. 2*, Armenia, SE of Yerevan Province, *Vitek 05-1171* (W 2008-06492), HQ900578. *E. spathulata* Lam., U.S.A., AF537552². *E. spinosa* L., Italy, Basilicata, Potenza, road from Maratea to Trecchina, *Vilatersana 1121 & al.* (BC), HQ900656. *E. squamigera* Loisel., Spain, Valencia, La Safor, *Molero & Rovira s.n.* (BCN 53020), HQ900657. *E. stenoclada* Baill., Madagascar, AM040791¹. *E. stolonifera* Marloth ex A.C. White, R.A. Dyer & B. Sloane, voucher 1: South Africa, AM040792¹; voucher 2: South Africa, Karoo National Park, *Becker 1109* (MICH), –, HQ900415, HQ900517, HQ900441, HQ900569, HQ900467, HQ900389, HQ900491, HQ900543. *E. stricta* L., Austria, AF537559². *E. stygiana* H.C. Watson, Portugal, Azores Islands, AF334247¹; AF334262¹. *E. succedanea* L.C. Wheeler, Mexico, AF537403². *E. sulcata* Lens ex Loisel., Spain, Lleida, La Sentiu de Sió, Serra Gran, *Barres 32 & al.* (BC), HQ900659. *E. sultan-hassei* Á. Strid et al., Greece, Crete, Gorges d'Aradena, *Riina 1568* (MICH), HQ900660. *E. terracina* L., Spain, Sevilla, *Molero 23/2007 & Rovira* (BCN), HQ900661, HQ900416, HQ900518, HQ900442, HQ900570, HQ900468, HQ900390, HQ900492, HQ900544. *E. tetraptera* Baker, Madagascar, AF537526². *E. tirucalli* L., Africa and Madagascar (cultivated), AF537479². *E. tithymaloides* L., Guatemala, AF537494². *E. transtagana* Boiss., Portugal, Lisbon, Fernão Ferro, *Molero 13/2008 & al.* (BCN 53035), HQ900662. *E. trichadenia* Pax, Zimbabwe and Angola (cultivated), AF537564². *E. trichotoma* Kunth, Belize, AF537534². *E. tuberosa* L., Republic of South Africa (cultivated), AF537570². *E. tubiglans* Marloth ex R.A. Dyer, Republic of South Africa (cultivated), AF537567². *E. tuckeyana* Steud. ex Webb, Portugal, Cape Verde, Santiago Island (cultivated) (BC), HQ900663, HQ900417, HQ900519, HQ900443, HQ900571, HQ900469, HQ900391, HQ900493, HQ900545. *E. turczaninowii* Kar. & Kir., China, AF537543². *E. uliginosa* Welw. ex Boiss., Spain, Galicia, A Coruña, Zas, *Molero & Rovira s.n.* (BCN 53605), HQ900664. *E. usambarica* Pax subsp. *usambarica*, Tanzania, *Gereau & Lovett 3021* (K), HQ900665, HQ900418, HQ900520, HQ900444, HQ900572, HQ900470, HQ900392, HQ900494, HQ900546. *E. uzumuk* S. Carter & J.R.I. Wood, Yemen, Nashima, *Aldasoro 14569 & Susanna* (BCN), HQ900666. *E. veneris* M.S. Khan, Cyprus, near Prodromos road to Platres, *Galbany 2039 & al.* (BC), HQ900667. *E. xylophylloides* Brongn. ex Lem., Madagascar (cultivated), AF537467². *Triadica sebifera* (L.) Small, China (cultivated), AF537586².

8.2. Publicació 2: Phylogeography and character evolution of *Euphorbia* sect. *Aphyllis* subsect. *Macaronesicae* (Euphorbiaceae)

S'enviarà a *Taxon*.

Filogeografia i evolució de caràcters d'*Euphorbia* sect. *Aphyllis* subsect. *Macaronesicae* (Euphorbiaceae).

Laia Barres, Roser Vilatersana, Andrew Hipp, Julià Molero & Mercè Galbany-Casals

Resum

Les espècies macaronèsiques de la secció *Aphyllis* subsecció *Macaronesicae* del gènere *Euphorbia* es troben distribuïdes en quatre dels cinc arxipèlags de la regió biogeogràfica de la Macaronèsia. Els objectius d'aquest estudi són investigar la sistemàtica, l'evolució i la filogeografia d'aquest grup mitjançant la tècnica molecular dels AFLP i la reconstrucció de caràcters ancestrals. Les nostres anàlisis revelen que *Euphorbia tuckeyana* va tenir un origen independent a la resta d'espècies de la subsecció *Macaronesicae*, les quals comparteixen un mateix ancestre. A part d'aquests dos processos independents de colonització de la Macaronèsia, es revelen múltiples esdeveniments de dispersió entre illes i almenys dues recolonitzacions cap al continent. Les espècies del grup es troben ben delimitades genèticament i es van originar de la combinació de fenòmens d'especiació al·lopàtrica i ecològica, amb posteriors processos de dispersió entre illes, que explicarien l'actual distribució d'algunes espècies, disseminades en diverses illes. La clada principal, que deixa fora *E. tuckeyana*, mostra *E. aphylla* a la base del grup i la resta d'espècies distribuïdes en dos grans grups genètics que corresponen als complexos reconeguts de manera tradicional per caràcters morfològics d'*E. lamarckii* i *E. atropurpurea*. La reconstrucció de caràcters ancestrals suggereix que l'ancestre de tot el grup hauria estat una espècies adaptada a ambients xeròfils o mesòfils i que posteriorment hauria adquirit els caràcters morfològics més ben adaptats a les condicions hidròfiles. Les anàlisis ens mostren que *E. pedroi*, endèmica del Cap Espichel a Portugal, comparteix el mateix patrimoni genètic que *E. regis-jubae*, de les illes Canàries orientals i la costa de Marroc, cosa que ens revela que la diferenciació morfològica no sempre coincideix amb la diferenciació genètica. En les anàlisis

d'estructura genètica del grup s'obtenen evidències de fenòmens d'hibridació entre diverses espècies.

Phylogeography and character evolution of *Euphorbia* sect. *Aphyllis* subsect.

***Macaronesicae* (Euphorbiaceae)**

Laia Barres¹, Roser Vilatersana¹, Andrew Hipp², Julià Molero³ & Mercè Galbany-Casals⁴

¹ Institut Botànic de Barcelona (IBB - CSIC - ICUB), Pg. del Migdia s.n., E-08038 Barcelona, Spain.

² The Morton Arboretum, 4100 Illinois Route 53, 60532 Lisle, U.S.A.

³ Laboratori de Botànica, Facultat de Farmàcia, Universitat de Barcelona, Avgda. Joan XXIII s.n., E-08028 Barcelona, Spain.

⁴ Unitat de Botànica, Dept. Biologia Animal, Biologia Vegetal i Ecologia, Facultat de Biociències, Universitat Autònoma de Barcelona, E-08193 Bellaterra, Spain.

Abstract

The Macaronesian species of *Euphorbia* sect. *Aphyllis* subsect. *Macaronesicae* are distributed in four of the five archipelagos of the Macaronesia. The aims of this study are to investigate the systematics, evolution and phylogeography of this group with AFLP markers and ancestral character state reconstruction. Our analyses show that members of subsect. *Macaronesicae* had a common origin except for *Euphorbia tuckeyana*, which had an independent origin from the rest. Apart from these two independent colonisation events of the Macaronesia, our results suggest that there have been repeated inter-island dispersion and at least two back-colonisation events to the mainland. Species are genetically well delimited and have originated from a combination of allopatric and ecological speciation, followed by more recent inter-islands dispersal events, that explain the present scattered distribution of some species in several islands. Within the main group excluding *E. tuckeyana*, *E. aphylla* is at the base, and the rest of species are distributed in two clearly differentiated genetic groups, which correspond to the two formerly recognised *E. atropurpurea* and *E. lamarckii* complexes based on morphological characters. Ancestral character state reconstruction suggests that the ancestor of the group would have been adapted to xerophilous or mesophilous conditions, and would have later acquired the morphological characters linked to adaptation to hygrophilous conditions. The taxonomical status of *E. lambii* and *E. pedroi* is evaluated.

Keywords

AFLP; ancestral character reconstruction; boomerang effect; genetic diversity; hybridization; island biogeography; Macaronesia; morphological diversity

INTRODUCTION

The Macaronesian biogeographic region comprises five volcanic archipelagos situated between 14.5°N and 39.5°N in latitude in the Atlantic Ocean: Azores, Canary Islands, Cape Verde, Madeira and Selvagens Islands; and two continental enclaves, one in the Atlantic coast of Morocco and the other in Cape Espichel in Portugal (Sunding, 1979). The Macaronesian archipelagos, like all the oceanic islands, are considered a biogeographical and evolutionary model system to study speciation, migration and extinction processes (Whittaker & Fernández-Palacios, 2007) due to their endemic species richness and diversity. The Macaronesian flora shelter a large quantity of endemic plants ranging from the 7% estimated for the Azores to the 45% for the Canary Islands (Caujapé-Castells & al., 2010).

Euphorbia sect. *Aphyllis* Webb & Berthel. has been defined as a monophyletic taxon in recent molecular studies (Barres & al., 2011; Riina & al., in press). Two subsections have been defined within sect. *Aphyllis* (Riina & al., in press) according to the two clades resolved (Barres & al., 2011; Riina & al., in press): subsect. *Macaronesicae* Molero & Barres comprises the Macaronesian species and subsect. *Africanae* Molero & Barres comprises the east/south African and South Arabian species. *Euphorbia tuckeyana* Steud., endemic to Cape Verde, was suggested as sister species to the rest in Barres & al. (2011). In previous studies, phylogenetic relationships within the two main clades were poorly resolved and incongruences between chloroplast and nuclear markers were detected, which were mainly explained by hybridization processes and a recent and rapid radiation (Barres & al., 2011).

In the present study, we focus our interest on subsect. *Macaronesicae*, with species distributed in four of the five oceanic archipelagos in the Atlantic Ocean that constitute the Macaronesia: Canary Islands, Cape Verde, Madeira and Selvagens Islands, and in the two continental enclaves (Fig. 1).

Regarding the taxonomy, Molero & al. (2002) defined two complexes within subsect. *Macaronesicae* under morphological and ecological criteria: the *E. atropurpurea*

complex, which included *E. atropurpurea* Brouss. ex Willd., *E. bourgeana* J. Gay ex Boiss. and *E. bravoana* Svent.; and the *E. lamarckii* complex, which included *E. anachoreta* Svent., *E. berthelotii* Bolle ex Boiss., *E. lamarckii* Sweet. var. *lamarckii*, *Euphorbia lamarckii* var. *broussonetii* (Willd. ex Link) Molero & Rovira, *E. pedroi* Molero & Rovira, *E. piscatoria* Aiton, *E. regis-jubae* J. Gay and *E. tuckeyana*. *Euphorbia aphylla* Brouss. ex Willd. was not included in any of these two complexes but is known to be included within subsect. *Macaronesicae* clade (Barres & al., 2011; Riina & al., in press). A summary of main diagnostic morphological characters of both complexes is provided in Table 1. Molecular markers used in Molero & al. (2002) and in Barres & al. (2011) were not able to confirm or reject the monophyly of each of these two complexes, probably because phylogenetic uncertainty and low resolution of DNA sequences are common in groups of species that have rapidly diversified in oceanic islands.

In a biogeographical context, species from subsect. *Macaronesicae* were suggested to have reached Macaronesia at least twice (Barres & al., 2011), one giving rise to *E. tuckeyana* in Cape Verde, and the other one giving rise to the rest of the species in the other archipelagos. Further discussion on the diversification of the group, the colonisation of the different archipelagos and islands, and the origin of the continental populations could not be confirmed because phylogenetic reconstructions showed little resolution and because only one individual per species was included. However, it was hypothesized that two main speciation processes had been involved in the diversification of the group: allopatric speciation (speciation among islands) and ecological speciation (adaptive radiation).

Though phylogeny-based studies of Macaronesian endemic plant groups discussing processes of colonisation, speciation and dispersal are abundant in the literature (Kim & al., 1996; Helfgott & al., 2000; Francisco-Ortega & al., 2002; Carine & al., 2004; Trusty & al., 2005; García-Maroto & al., 2009), phylogeographical studies of specific endemic plant groups that have largely radiated in the entire Macaronesia are scarcely found (but see Francisco-Ortega & al., 1996; Díaz-Pérez & al., 2008).

In the current study, we use the amplified fragment length polymorphism (AFLP) DNA fingerprinting method (Vos & al., 1995), which often provides more detailed information on patterns of genetic variation and its geographical distribution than DNA sequence data (Meudt & Clarke, 2007), at the populational level, together with analyses

of morphological character evolution, with the following aims: (1) to discern taxonomic entities within subsect. *Macaronesicae* based on morphological and genetic data and (2) to improve our understanding of colonisation and genetic and morphological diversification mechanisms of this group of species in the Macaronesia.

MATERIAL AND METHODS

Sampling.— The study includes 206 individual samples from 35 populations of the 11 species of subsect. *Macaronesicae* (Fig. 1, Table 2). The sampling was designed to represent the global distribution of all the species (Table 2). Field localities of previously reported hybrid specimens (Molero & Rovira, 2005a) and specimens with intermediate morphological characters newly detected in the field were not sampled. Fresh leaves from up to 6 individuals from each field locality were collected and dried in silica gel. A voucher specimen from each locality is deposited in BC or BCN herbariums. See Table 2 for details on the localities and number of samples used in different datasets for each species.

DNA extraction and AFLP fingerprinting.— Total genomic DNA was extracted from 10 mg of silica gel dried leaves using the commercial kit NucleoSpin Plant (Macherey-Nagel GmbH & Co. KG, Düren, Germany) following the manufacturer's protocol. Total DNA was digested using the restriction enzymes pair *EcoRI* / *MseI*. Nineteen selective primer pairs were surveyed on three individuals from three different species of which four were selected based on polymorphism and reproducibility of the alleles scored: (1) *EcoRI*-AAG / *MseI*-CTA, (2) *EcoRI*-AGC / *MseI*-CCA, (3) *EcoRI*-AGC / *MseI*-CTT, and (4) *EcoRI*-ACA / *MseI*-CCA. We followed AFLP protocol from Vos & al. (1995) as modified by Berres (2001). Selective amplifications were performed using the primer *EcoRI* marked with the fluorescent dye 6-FAM. Fragment analyses were done with an ABI PRISM 3730 capillary sequencer genetic analyser (Applied Biosystems, Foster City, CA, USA) in the Pritzker Laboratory of the Field Museum of Chicago using 6-carboxyl-x-rhodamine (ROX) labeled internal lane standard (GeneFlo 625; CHIMERx, Madison, WI, USA). Alignment, binning, and scoring of fragments between 60 and 500 bp were performed with GeneMarker v1.85 (Softgenetics, State College, PA, USA).

Reproducibility was checked for each primer pair with 13 randomly chosen individuals from different species and an error rate was calculated (Bonin & al., 2004). AFLP loci that were ambiguous, non-reproducible or scored as present for fewer individuals than the error rate were excluded from the dataset. The final scoring was exported as an absence/presence binary matrix.

AFLP analyses.— The binary data matrix was used to calculate a pairwise genetic distance matrix by using Nei & Li (1979) restriction site distances. Neighbour Joining (NJ) analysis of the genetic distance matrix was computed with TREECON v1.3b (Van de Peer & De Wachter, 1994). Support for the branches was estimated with 2000 bootstrap (BS) replicates using the same program. The tree was rooted with *E. tuckeyana*, based on previous analyses (Barres & al., 2011). Two UPGMA clustering analysis were performed with 2000 BS replicates using outgroup and midpoint rooting with the same software. Principal Coordinate Analysis (PCO) was conducted with NTSYS_{PC} v2.0 (Rohlf, 1997) in a sample set excluding the outgroup, *E. tuckeyana*. We used SplitsTree4 v4.11.3 (Huson & Bryant, 2006) to construct split networks of the total dataset with a neighbour-net (NN) algorithm using the absence/presence matrix.

Several genetic structure analyses were performed using the Bayesian clustering method of Pritchard & al. (2000) in Structure v2.3.3. We first analyzed the total sampling excluding *E. tuckeyana*. Analyses were conducted under an admixture model and allele frequencies correlated among populations. The total sampling excluding *E. tuckeyana* was analysed setting the number of groups (K) from 1 to 15. We performed additional partial clustering analyses of some clades observed in the NJ tree. For the analyses of *E. aphylla*, *E. bourgeana*, and *E. piscatoria* we used a dataset that excludes primer pair *EcoRI-ACA / MseI-CCA* in order to increase the number of specimens (see Table 2). The parameter for distribution of allele frequencies (λ) and the degree of admixture (α) were inferred from the data. An initial burn-in of 100000 generations followed by 1000000 further MCMC generations was set. The optimal number of K was considered following the Evanno & al. (2005) approach or alternatively by considering the maximal Ln P(D) value in the cases where the results of Evanno & al. (2005) approach had no biological sense.

To assess the distribution of genetic variation, analyses of molecular variance (AMOVA) were carried out based on Euclidean distances between samples using Arlequin v3.1 (Excoffier & al., 2005) with 1000 random permutations. Different nested analyses were performed depending on the species.

Analyses of character evolution.— Ancestral character state reconstructions were performed with Mesquite v2.74 (Maddison & Maddison, 2010) to provide information on the evolution of the morphological characters over the molecular phylogeny obtained. Species were represented by one terminal taxon except for *E. regis-jubae*, with two individuals, due to the presence of an exclusive character state in the Moroccan populations. *Euphorbia tuckeyana* was excluded from the analyses because the lack of members of subsect. *Africanae* could slant the results (see Barres & al., 2011). Maximum Likelihood (ML) was used to trace the evolution of six selected characters on a NJ tree inferred from Nei and Li distances calculated with PAUP v.4.0b10 (Swofford, 2002) from the AFLP data. The discrete characters used for the ancestral state reconstruction were selected trying to represent different attributes related to ecological preferences, pollination or seed dispersal. Information on the characters states studied was obtained from our own observations and from the literature (Boissier, 1862; Press & Short, 1994; Figueiredo, 1996; Molero & Rovira, 1996; 1998; Benedí & al., 1997; Brochmann & al., 1997; Bramwell & Bramwell, 2001; Molero & al., 2002; Acevedo & al., 2003; Mesa & al., 2007; Mesa, 2009). The characters states used to perform the ancestral state reconstruction were defined as following: pleochasial organization (as the branching pattern of the typical sympodium synflorescence in *Euphorbia*: simple, 0; double, 1); nectaries morphology (truncate, 0; subtruncate, 1; dentate, 2; horned, 3); sub-cyathial bracts persistency (deciduous before fructification, 0; deciduous just after fructification, 1; persistent, 2); sub-cyathial bracts union (free, 0; connate, 1); seeds surface (smooth-rugulose, 0; rugose, 1; excavate, 2; scrobiculariate, 3); caruncle morphology (obnavicular-truncate, 0; obnavicular-elongate, 1; mitriforme, 2).

RESULTS

AFLP analyses.— A total of 346 bands were scored for 189 individuals, from which 332 (95.95%) were polymorphic. Reproducibility of the AFLP was assessed by an error rate of 1.16% (following the approach of Bonin & al., 2004). Three fixed private alleles were found, one in *E. anachoreta* and two in *E. bravoana*. For the NJ analyses, *E. tuckeyana*, which was defined as outgroup based on previous studies (Barres & al., 2011), was also recovered as basal to the rest when performing mid-point rooting analyses (not shown). The NJ tree showed species as monophyletic with BS support between 71% and 100% (Fig. 2), except for *E. regis-jubae*. The tree showed three main clusters (Fig. 2): the first one included all the populations of *E. aphylla* supported by 100% of BS, the second one included all the species from the *E. atropurpurea* complex (*E. atropurpurea*, *E. bravoana* and *E. bourgeana*) with 94% of BS, and the third one included all the species from the *E. lamarckii* complex (*E. anachoreta*, *E. berthelotii*, *E. lamarckii* var. *lamarckii*, *E. lamarckii* var. *broussonetti*, *E. pedroi*, *E. piscatoria* and *E. regis-jubae*), except for *E. tuckeyana*, with 95% of BS support. All samples of *E. pedroi* merged within the *E. regis-jubae* clade with 100% of BS. The same results were recovered with the UPGMA tree (not shown).

The PCO analyses (Fig. 3) produced congruent results with the NJ tree and revealed that 21.50% of the variability is explained by the first axis, 17.67% by the second axis and 11.65% by the third axis; representing the 50.84% of the total variability. Specimens were grouped by species except for *E. pedroi* which fell within the *E. regis-jubae* cluster. The three species from the *E. atropurpurea* complex (*E. atropurpurea*, *E. bourgeana* and *E. bravoana*) were tightly clustered together. *Euphorbia anachoreta*, *E. berthelotii* and *E. lamarckii* specimens also fell near one another.

Congruent results with those from the NJ tree and the PCO analysis were also obtained from the NN diagram produced with SplitsTree4 (Fig. 4).

In the genetic structure analyses of the whole dataset excluding *E. tuckeyana*, the optimal number of populations assumed as assigned for the optimal value of K was 10 (Table 3). With this K, each group comprise all samples of a species, except for *E. regis-jubae* and *E. pedroi* (Fig. 5A), as in the NJ tree (Fig. 2). Some level of admixture was observed. *Euphorbia berthelotii* showed some degree of common ancestry with *E.*

lamarckii and one individual assigned to *E. lamarckii* showed some shared ancestry with *E. bravoana* (Fig. 5A). The partial structure analyses of some of the clusters detected in the NJ tree showed the following results: the optimal number of groups was three for *E. bourgeana* (Fig. 5B), which presented geographical structure, one group included all the specimens from La Gomera, the second one included the specimens from East Tenerife, with some level of admixture with the third group, which included the specimens from West Tenerife. Four groups were assigned as optimal for the cluster constituted by *E. anachoreta* and *E. lamarckii* (Fig. 5C), showing three different geographical groups within *E. lamarckii*, one group is found in South Tenerife, corresponding to *E. lamarckii* var. *lamarckii*, one corresponded to the populations of *E. lamarckii* var. *broussonetii* from La Palma and El Hierro, and the last one included the populations of *E. lamarckii* var. *broussonetii* from North Tenerife and La Gomera. Structure analyses detected two genetic groups within *E. piscatoria* (Fig. 5D), which corresponded to two different islands in Madeiran archipelago, except for one individual from Porto Santo that was assigned to the Madeiran island population. The analyses of the cluster *E. regis-jubae* + *E. pedroi* (Fig. 5E) separated the Gran Canarian populations of *E. regis-jubae* from the rest of populations of *E. regis-jubae* and *E. pedroi*. Finally, one group (no population structure) was detected for both *E. aphylla* and *E. tuckeyana* (not shown). Average values of Ln P(D) and standard deviation for each K tried are given in Table 3.

The results of all the AMOVA analyses performed are shown in Table 4. ϕ_{ST} values obtained ranged from 0.32 to 0.84.

Analyses of character evolution.— A summary of ancestral character evolution optimized from ML analyses is shown in Fig. 6. The ancestral state for pleochasial organization was inferred to be simple, with acquisition of a double organization in the *E. atropurpurea* complex (Fig. 7A). For the nectaries morphology, the ancestral state was reconstructed to be truncate. Dentate nectaries were inferred to have appeared twice independently, in *E. piscatoria* and with some ambiguity in the ancestor of the *E. pedroi* + *E. regis-jubae* cluster, which was inferred to have dentate, horned or truncate nectaries with the same probability (Fig. 6B). Subtruncate nectaries are an autapomorphy of *E. bourgeana* and horned nectaries are an autapomorphy of the Canarian populations of *E. regis-jubae*. The sub-cyathial bracts persistency ancestral state was reconstructed with

the highest probability to be deciduous before fructification (Fig. 6C). The ancestor of the *E. atropurpurea* complex would have acquired persistent sub-cyathial bracts and some members of the *E. lamarckii* complex would have shift to deciduous bracts just after fructification. Free sub-cyathial bracts were inferred as the ancestral state for the sub-cyathial bracts union with a shift to connate bracts for the *E. atropurpurea* complex (Fig. 6D). The seed surface was reconstructed to be smooth-rugulose in the ancestor of the Macaronesian sect. *Aphyllis*. Rugose seeds is an autopomorphy of *E. piscatoria* and excavate seeds were inferred to appear in the ancestor of the *E. atropurpurea* complex (Fig. 6E). *Euphorbia bravoana* was reconstructed to have later acquired scrobiculate seeds as an autopomorphy. The obnavicular-truncate caruncle was inferred to be the ancestral condition for the caruncle morphology (Fig. 6F). Two latter shifts were reconstructed: one to obnavicular-elongate state in *E. pedroi* and the other to mitriforme state in *E. atropurpurea*.

DISCUSSION

Origin, diversification and dispersion of sect. *Aphyllis* subsect. *Macaronesicae*.- Excluding *E. tuckeyana*, the rest of species of subsect. *Macaronesicae* have a common ancestor as indicated by the NJ tree (Fig. 2). Hence, they form a monophyletic group, and have diversified after a single colonisation event of the Macaronesian region, as already suggested in previous studies of this group (Barres & al., 2011). Analyses of AFLP fragments showed a general correspondence of species with clearly distinguishable and isolated genetic groups (with one exception that will be explained later) (Fig. 2). Even in the case of species that are distributed in several islands, all the populations of the same species clustered together in all the AFLP analyses (Figs. 2 – 4). These results indicate that, although the radiation of the group is hypothesised to have been relatively recent, there has been time and isolation enough to generate genetic differentiation between species and maintain them as genetically isolated and morphologically distinguishable entities. The existence of one-island endemisms points out a role for allopatric speciation in the group, although the coexistence of several species with different ecological preferences in some of the islands suggests that speciation due to ecological differentiation may have also played a role in the diversification of the group. However,

the current wide distribution of some of them in different islands may be due to more recent dispersal events.

No evidence for a stepping-stone colonisation westwards from the African mainland or southwards from the Mediterranean area is detected in our analyses. Populations from different islands do not show a geographical correlation indicating a direction in the dispersal from the mainland, as shown in other Macaronesian endemic plant groups such as *Argyranthemum*, for which a dispersal route North to South in Madeira-Desertas-Selvagens was proposed (Francisco-Ortega & al., 1996). On the contrary, in our case of study, the direction of dispersal seems to have been northwards from the Canary Islands, as the basal position of *E. aphylla* is suggesting.

Seed dispersal in *Euphorbia* is promoted by autochory at a close distance when the fruit explodes triggered by desiccation and secondarily by myrmecochory, sometimes favored by the presence of an elaiosome (caruncle) that attracts ants. However, also rock pigeons (*Columba livia canariensis* Bannerman) and the migratory turtle doves (*Streptopelia turtur turtur* L.) have been recorded as *Euphorbia* seeds feeders (Nogales, 1985; Berg, 1990). Specifically, a study of seed dispersal in *E. balsamifera* Ait. suggested that pigeons can act as long-distance *Euphorbia* seeds' dispersal agents' by accidental endozoochory (Berg, 1990) but viability and germination of *Euphorbia* seeds after granivorous birds ingestion have not been studied. Secondary seed dispersal by predatory birds may also be another cause for island colonisation from the continent and inter-island dispersal, as has been shown for other plant groups in the Macaronesia (Nogales & al., 2007). This would explain the lack of directional genetic structure of populations given that birds do not follow a unique geographical direction but randomly disperse the seeds, and would also explain the presence of several species in several islands.

The basal position and genetic structure of *E. tuckeyana*.- The results of all the analyses performed with the AFLP markers showed a big genetic distance between *E. tuckeyana* and the remainder species within subsect. *Maraconesicae*, which is compatible with the previous finding of *E. tuckeyana* being sister to the rest of the group, including subsect. *Africanae* of sect. *Aphyllis* (Barres & al., 2011). Therefore, *E. tuckeyana* would have colonized the Macaronesian region independently from the other

species, as previously suggested in Barres & al. (2011). Allan & al. (2004) also found a basal position regarding the rest of Macaronesian species for two Cape Verdean endemics in *Lotus*. Three main floristic elements have been defined in Cape Verde by its phytogeography (Brochmann & al., 1997): northern, southern and eastern elements (see Fig. 1). Our *E. tuckeyana* sampling was limited to the northern and southern elements, the most geographically distant, but our results do not show any accordance with these floristic elements (Figs. 2, 4, 5), as no phylogeographic structure was revealed. Cape Verde archipelago ages ranges from < 2 to 16 million years (Ma; García-Maroto & al., 2009) but shows low habitat diversification in comparison with other Macaronesian islands. For example, forests are absent in the present Cape Verde (Brochmann & al., 1997) in part due to its aridity and low mountains. The low ecological diversity of Cape Verde would have hindered processes of ecological adaptive radiation and could explain the lack of further speciation in the group and the lack of genetic structure within *E. tuckeyana*. Although *Euphorbia tuckeyana* is genetically differentiated from the rest of species from the *E. lamarckii* complex (Fig. 2), morphological characters approach this species to this complex (Table 1). However, considering previous results (Barres & al., 2011), the biogeographic history of Cape Verde and the genetic differentiation of *E. tuckeyana*, we decide to exclude this taxon from the *E. lamarckii* complex.

***Euphorbia aphylla* and two main complexes within subsect. *Macaronesicae*.**

Euphorbia aphylla, a fleshy aphyllous shrub found in halophytous habitats in the central Canary islands (Gran Canaria, La Gomera and Tenerife), was resolved as sister to the rest of the Macaronesian species with 100% BS support in the NJ analyses (Fig. 2). Genetic results were in agreement with morphological observations, given that this species had not been included in any of the two main taxonomical complexes recognised for the group by Molero & al. (2002).

Excluding *E. aphylla* and *E. tuckeyana*, all the analyses performed supported the two mentioned taxonomic complexes (Figs. 2 – 4), which were shown as sister to one another with strong BS support (BS = 95%; Fig. 2). Both complexes, apart from being characterised morphologically and genetically, are also ecologically defined. The mesophilous and meso-hygrophilous habitats affected by trade winds where laurel forests grow in Tenerife and La Gomera are occupied by the species of the *E.*

atropurpurea complex. By contrast, the xerophilous and mesophilous habitats not affected by trade winds occupied by pine forest and arid lowland scrub in Madeira, the Canary Island and the two continental enclaves, are colonized by species from the *E. lamarckii* complex (Table 1).

The ancestor of subsect. *Maraconesicae* was reconstructed to be morphologically closer to *E. aphylla* and the *E. lamarckii* complex (Fig. 6) and is probably related to arid habitats now predominant in the islands closest to the mainland. The ancestor of the *E. atropurpurea* complex was reconstructed to have excavate seed surface and an obnavicular-truncate caruncle. Acquisition of a double pleochasial organization and connate and persistent sub-cyathial bracts (Table 1, Fig. 6) are probably due to a secondary adaptation to meso-hygrophilous habitats in the *E. atropurpurea* complex.

The Euphorbia atropurpurea complex.- In the *E. atropurpurea* complex, *E. atropurpurea* and *E. bravoana* were closely related with high support (BS = 100%, Fig. 1) and they share a high level of recent common ancestry (Fig. 4). The Teno populations of *E. atropurpurea* f. *lutea* (ATR8), a particular form described because it has yellow synflorescences, showed no genetic differentiation from other populations of *E. atropurpurea* (Fig. 2). This result reveals the high plasticity of this character, which should not be used as a diagnostic character.

Three clusters were shown in *E. bourgeana* (Fig. 2). The first group encompassed three populations from Tenerife (BS = 74%), the second included one population from west Tenerife (BS = 95%) and the third included all the populations from La Gomera (BS = 89%). *Euphorbia bourgeana* populations of La Gomera were first described by Sventenius (1960) as *E. lambii*, but the status of this taxon has been discussed by some authors. Bramwell & Bramwell (2001) accepted *E. lambii* because of some distinctive morphological characters, like dentate cyathial glands and sub-cyathial bracts joined only at the base, whereas in *E. bourgeana* they found horned cyathial nectaries and sub-cyathial bracts joined at least 2/3 of its total length. More recently, some authors (Molero & al., 2002; Molero & Rovira, 2005b) considered *E. lambii* as a synonym of *E. bourgeana* because of the inconsistency of the diagnostic characters within populations. In our genetic structure analyses, we found a strong genetic differentiation between the populations of the two islands (Figs. 2, 5), and the ϕ_{ST} values (0.83) also showed the

highest level of genetic differentiation when AMOVA analyses were made by island groups (Table 4), in accordance with their geographic isolation. However, in spite of the genetic differences, we consider that there are not enough morphological differences to recognize *E. lambii* as a species.

The *E. bourgeana* populations from Tenerife showed a striking genetic structure (Fig. 5B) with two different clusters. The first group is composed by the eastern populations from the Anaga massif (BOU14) and the Ladera of Güímar (BOU12), and the second one is formed by the western populations from Teno (BOU13 and BOU54), with high level of admixture, especially in BOU13. The Teno populations of *E. bourgeana* have been recently discovered (Acevedo & al., 2003), as this species was thought to grow only in eastern Tenerife, from where it was originally described.

The vicariance detected between populations of *E. bourgeana* may be explained by the geographical history of Tenerife, as its current shape has only existed within the last 3.5 Ma (Fernández-Palacios & al., 2011) and is the result of the union of three independent former islands: Teno (7.4 Ma), Anaga (5.8 Ma) and Roque del Conde (11.6 Ma) (Juan & al., 2000). Disjoint distribution patterns between Anaga and Teno are found in some plants (*Navaea phoenicea* in Escobar García & al., 2009; *Teline pallida* in Aguilar, 2000) and animals groups (see Juan & al., 2000) as result of vicariance events. Different hypotheses can explain this case of vicariance: (1) multiple catastrophic landslides occurred in the N part of the island (Carracedo & al., 1998) would have isolated Teno populations in the West and Anaga populations in the East; (2) the present distribution of disjoint species would be a result of ecological requirements, as Anaga and Teno are the only areas in Tenerife where mesophilous and laurel forests are found; (3) anthropogenic activities would have reduced a former more widely distribution to the present patchy distribution in the eastern and western parts of the island.

From our results we suggest that the Teno populations of *E. bourgeana*, species included in the Red List of threatened species as “vulnerable” (Bañares & al., 2010), should be considered as an independent gene pool when designing conservation strategies in order to conserve the total genetic diversity of this species. However, additional molecular studies including all the known populations in Teno need to be performed in order to understand the genetic structure of this species.

The Euphorbia lamarckii complex.- Regarding the *E. lamarckii* complex, four clusters were found (Fig. 2): *E. regis-jubae* constituting a cluster with *E. pedroi* (BS = 100%), *E. piscatoria* (BS = 100%), *E. berthelotii* (BS = 100%) and the cluster composed by *E. anachoreta* and *E. lamarckii* (BS = 100%).

Two main groups within the clade *E. regis-jubae-E. pedroi* were obtained by the SplitsTree4 (Fig. 4) and the Structure analyses (Fig. 5E). The Gran Canaria populations of *E. regis-jubae* formed a different cluster from the group including the eastern *E. regis-jubae* populations (Fuerteventura, Lanzarote and the two continental enclaves: Morocco and *E. pedroi* in Portugal). Some mixed ancestry was detected between the Gran Canaria and the rest of *E. regis-jubae* populations, specially between those populations geographically closest (Fig. 5E). The Fuerteventura populations of *E. regis-jubae* are the populations showing more genetic admixture with the singular Gran Canaria populations.

The inclusion of the *E. pedroi* cluster within *E. regis-jubae* appeared in all the AFLP analyses performed (Figs. 2 – 5). These results reveal that *E. pedroi* makes part of the genetic pool of *E. regis-jubae*. However, *E. pedroi* is morphologically differentiated from the *E. regis-jubae* populations, showing a characteristic extremely elongate caruncle on the seed (Fig. 6E). *Euphorbia pedroi* shows no genetic admixture with the rest of populations of this group (Fig. 5E) and we detect an incipient genetic differentiation in the NJ tree (Fig. 2), that could be further promoted by its geographical isolation. Furthermore, morphological divergence between isolated populations can occur earlier than genetic differentiation (Francisco-Ortega & al., 1996). For these reasons, we support to maintain *E. pedroi* as a separate species.

Individual samples of *E. pedroi* showed very short branches in the NJ tree (Fig. 2) showing a low genetic diversity within this species. Additionally, the AMOVA analysis showed that 69.21% of the genetic variability of *E. pedroi* is among populations. When compared to the average G_{ST} values for endemic outcrossing species ($\phi_{ST} = 0.18$; Hamrick & Godt, 1997), we obtain a high genetic differentiation ($\phi_{ST} = 0.69$) among the two populations of *E. pedroi*. These results could be explained by a bottleneck effect produced by a decrease of the population size in the new area colonised after a back colonisation to the continent from one of the islands where *E. regis-jubae* is found, as also suggested in Barres & al. (2011).

Back-dispersal of Macaronesian organisms to the mainland has been reported for several plant groups (Mes & Hart, 1996; Park & al., 2001; Carine & al., 2004) and animals (Illera & al., 2011). During the Quaternary glaciations, the Macaronesian islands could have acted as a biodiversity refuge, providing a source of genetic differentiation that would have later contributed to the mainland biodiversity and submarine seamounts between Iberia and the Macaronesia were emerged and could have acted as stepping-stones (Caujapé-Castells, 2011) contributing to this dispersion. Then, the Macaronesia could have been acting as a source of biodiversity rather than an end of dispersal routes from the continent.

A back colonisation to the continent can also explain the presence of *E. regis-jubae* in the Atlantic coast of Morocco. Ecological conditions in Fuerteventura and Lanzarote have been similar to those in the west coast of Morocco since the Pliocene (Caujapé-Castells, 2011), favouring the establishment of *E. regis-jubae* in the mainland. However the resolution of our results in the NJ tree (Fig. 2) does not provide enough resolution to confirm or reject this hypothesis.

Euphorbia piscatoria constitutes a clearly distinct gene pool from other species in the *E. lamarckii* complex (Figs. 2 – 5). Its isolated distribution in the Madeiran archipelago, 400 km from the Canary Islands where other species from this complex are found, has probably promoted a strong genetic differentiation. The populations from *E. piscatoria* included in this study are geographically structured between Madeira and Porto Santo, except for one individual of Roche de Nosa Senhora in Porto Santo, which is grouped with the specimens from Madeira (PIS34; Fig. 5D). This can be due to: (1) a human error during the DNA extraction, (2) a hazardous reintroduction of this individual from Madeira to Porto Santo or (3) a recent natural reintroduction by birds. Porto Santo is geologically differentiated from the Madeira Island because of its age (Porto Santo, 40 km from Madeira, has been dated in 14.3 Ma while Madeira is dated in 4.6 Ma; Geldmacher & Hoernle, 2000) and consequently its geological development stage (Porto Santo is in a basal plain stage while Madeira is in a erosion and dismantling stage; Fernández-Palacios & al., 2011). In the past, the retention of trade winds associated with the presence of higher mountains in earlier development stages of Porto Santo may have favoured the development of more mesophytic habitats (Fernández-Palacios & al., 2011) and the establishment of an *E. piscatoria* ancestor. The genetic differentiation found

between the two islands is confirmed by the morphology, as the *E. piscatoria* populations of Porto Santo can be distinguished morphologically from the Madeiran populations in the pleochasial rays only one time bifurcated and strongly marked stem scars forming a knot on the base of the ramification (Carvalho, comm. pers.). Porto Santo populations must be a conservation priority in order to keep all the genetic diversity within *E. piscatoria*. Porto Santo populations are specially threatened due to the strongest menaces of the flora in this island (Arechavaleta & Martín, 2008): fragmentation of natural habitats and introduced grass-feeding animals, mainly the goat and the rabbit that feed or stamp on *Euphorbia* seedlings. Further studies regarding this species should include populations from the Desertas Islands, at 25 km of distance, to know their genetic affinities and possible origin.

The populations of *E. berthelotii*, endemic to La Gomera, are clustered in one clade with high support (BS = 100%, Fig. 2). Although collection of putative hybrids was avoided, genetic admixture was obtained between *E. lamarckii* and *E. berthelotii* (BER 11) in La Gomera in the Structure analysis (Fig. 5A).

Euphorbia anachoreta and *E. lamarckii* appeared joined in the same clade with high BS support (BS = 100%, Fig. 2), indicating their common ancestry. *Euphorbia anachoreta* is endemic to a sole islet in the Selvagens Islands, and the results of the NJ tree suggest that this species could have been originated from geographic isolation after a dispersion from the Canarian archipelago. It is included in the Red List of threatened species as “critically endangered” (Martín & al., 2008). Though we only included three individuals in the analyses, this represents about the 12% of the unique population of this species. *Euphorbia lamarckii* has undergone a wide dispersion into four different islands of the western Canarian Archipelago. Geographical structure of *E. lamarckii* is detected at the molecular level. *Euphorbia lamarckii* var. *lamarckii* is characterised by its very narrow leaves and sub-cyathial bracts, and grows in southern Tenerife, from southern Anaga to southern Teno, being frequent in arid coasts with intense winds and insolation (“malpaís”). *Euphorbia lamarckii* var. *broussonetti* presents wider leaves and rounded or subtruncate sub-cyathial bracts (Molero & Rovira, 2004), and is distributed in more humid habitats from northern Tenerife, La Gomera, La Palma and El Hierro. The taxonomical categories are grouped, as shown in the genetic structure analysis (Fig. 5C). Furthermore, a genetic differentiation between the *E. lamarckii* var. *broussonetti*

populations from the island of La Palma and the ones from the island of El Hierro, not observed in the morphology, was also detected in the genetic structure analyses (Fig. 5C).

General patterns of diversification and genetic variation in the Canary Islands.-

If we focus in the Canarian endemics from sect. *Aphyllis* subsect. *Macaronesicae*, we can observe that 7 of the 9 species (77.78%) are found in the central group of islands (Gran Canaria, Tenerife and La Gomera), three of them being endemics from one single island (Tenerife). This diversity distribution pattern agrees with Sanmartín's & al. (2008) model, who proposed a subdivision of the archipelago in three island groups, and showed that the central islands are the main source of inter-island dispersal and diversification in the archipelago.

Though its closeness to the mainland and the older age of the eastern group of islands (Fuerteventura, Lanzarote and Gran Canaria), the total number of Macaronesian endemic species in these islands is lower than in the western islands (Reyes-Betancort & al., 2008). In accordance with this pattern, in our study there is only one species in the eastern islands (*E. regis-jubae*), and also the level of inter-population genetic structure (Figs. 4-5) is low in eastern species. The group *E. regis-jubae*-*E. pedroi* does not have a marked genetic structure despite the wide distribution, and genetic variation is noticeably higher within populations than among populations, which means that there is gene flow among populations, or that their origin is relatively recent (Figs. 1, 2, 6, Table 4). An explanation for the low genetic structure is that the flat topology and the ecological homogeneity of the eastern islands would have favored high levels of gene flow hiding any genetic differentiation related to possibly different colonizing genotypes before isolated in mainland (Caujapé-Castells, 2011). On the contrary, species from the western islands are reported to usually show a bigger genetic structure among their populations due to the topological, climatic and habitat heterogeneity of these islands (Caujapé-Castells, 2011). However, in our case of study this pattern is only observed in *E. bourgeana*, which showed levels of genetic variation among populations much higher than within populations (Table 4).

Hybridization.- The presence of hybridization events between several species of sect. *Aphyllis* subsect. *Macaronesicae* has been hypothesised in the literature on the basis of the existence of morphologically intermediate individuals between several pairs of species (Molero & Rovira, 2005a), and has been later pointed out as a phenomenon affecting the resolution of molecular phylogenies of the group (Barres & al., 2011). Although the aims of the study did not include the detection of hybrids and these were deliberately avoided in our sampling, some specimens with mixed ancestry have been detected in the genetic clustering analyses (Fig 5). *Euphorbia lamarckii* seems to present high admixture with *E. berthelotti* (explained above) and *E. bravoana* (Fig. 5A). This could be suggesting the existence of introgression, given that these specimens of mixed ancestry were not detected morphologically as hybrids when they were collected, and introgressed specimens have been reported to be sometimes undetectable from the morphology (Galbany-Casals & al., 2012). However, we did not obtain evidence of genetic intermediacy in the NN analyses performed with Splitstree. Given that the reliability of clustering analyses in assessing levels of hybridisation or introgression has been questioned (Bohling & al., 2013) when there is no evidence from other analyses specifically designed to detect reticulation such as Splitstree (Huson & Bryant, 2006), further analyses need to be performed to confirm these cases. Additionally, further studies of the *E. bravoana* and *E. lamarckii* populations in Altos de Uteza, including morphologically intermediate specimens, would be particularly desirable to detect their level of hybridization and to help establish criteria for conserving *E. bravoana*, included in the Red List of threatened species as “vulnerable” (Moreno, 2008).

CONCLUSIONS

In the current study, total-genomic AFLP fingerprinting technique is demonstrated to be useful in providing taxonomical conclusions and well supported phylogeographic hypotheses of Macaronesian groups that have experienced a rapid radiation.

The evolutionary history of *Euphorbia* sect. *Aphyllis* subsect. *Macaronesicae* has been complex and involves at least two colonisation processes to the Macaronesia, repeated inter-island dispersals and back-colonisation events to the mainland. Inter-island dispersal has been more common than movements between mainland and the

island, though boomerang phenomena have been detected twice in the *E. regis-jubae*-*E. pedroi* complex. Probably, harder climatic conditions in the Quaternary provoked plant extinctions in the mainland and favored establishment and speciation of these species in the Macaronesia, that could have later returned to the continent when climate improved. Species are genetically well delimited and have originated from a combination of allopatric and ecological speciation. The present wide distribution of some species in several islands may suggest that dispersion events between islands have not been rare, probably carried out by accidental endozoochory by granivorous birds.

The two morphological complexes traditionally recognised in subsect. *Macaronesicae* are strongly supported by molecular markers, except for *E. tuckeyana*, which is clearly excluded from the *E. lamarckii* complex because it had an independent origin from the rest of Macaronesian species. *Euphorbia pedroi* is part of the genetic pool of *E. regis-jubae*, and constitutes an example of how morphological differentiation can occur more rapidly than genetic differentiation in a case of allopatric speciation.

Our results partially reflect the general patterns previously reported for the Canary Islands with regards to speciation and genetic structure of the species, given that subsect. *Macaronesicae* shows the highest levels of speciation in the central Canarian islands, whereas the eastern islands have only one species, which furthermore presents low genetic structure. However, only one of the endemic species from the western islands presents high levels of genetic structure.

Morphological characters divergence between isolated populations is not always correlated with genetic differentiation in species of rapid radiation.

ACKNOWLEDGMENTS

The authors gratefully acknowledge Ricardo Mesa, Juan Matos, Jordi López-Pujol, Francisco Zamora, Ángel Fernández López, Aurelio Acevedo, Rafael Rodríguez de Paz and José Augusto Carvalho for their assistance in the fieldwork. Special thanks go to Gobierno de Canarias – Consejería de Medio Ambiente y Ordenación Territorial for their permits to collect species on Spanish Red List. Also thanks to Parque Nacional de Garajonay, Cabildo Insular de Tenerife, Cabildo Insular de La Gomera, Cabildo Insular de La Palma and Cabildo Insular de El Hierro for their authorization to collect plants and to

Jardín Botánico da Madeira for providing material from Ilhas Selvagens. Alka Srivastava, Jaime Weber, Kyong-Sook Chung and Marcial Escudero provided useful and pleasant laboratory assistance. This study was supported by the Ministry of Education and Science, Spanish Government (projects CGL2010-18631/BOS, CGL2009-13322-C03-03, MEC-CSIC (200730i1035) and BES-2007-14260 Ph.D. grant to L. Barres) and the Catalan Government ('Ajuts a grups consolidats' 2009/SGR/00439).

LITERATURE CITED

Acevedo, A., Rodríguez, A., Rodríguez, B. & Hernández, A. 2003. Chorology of *Euphorbia bourgeauana* Gay ex Boiss. in DC. in Teno massif (Tenerife, Canary Islands) (Euphorbiaceae). *Vieraea* 31: 45–50.

Aguilar, M.D. 2000. Notes on the taxonomy and nomenclature of *Teline pallida* (Poir.) G-Kunkel. *Taxon* 49: 17–25.

Allan, G.J., Francisco-Ortega, J., Santos-Guerra, A., Boerner, E. & Zimmer, E.A. 2004. Molecular phylogenetic evidence for the geographic origin and classification of Canary Island *Lotus* (Fabaceae: Loteae). *Molec. Phylogen. Evol.* 32: 123–138.

Arechavaleta, M. & Martín, J.L. 2008. La perspectiva archipelágica: Canarias. Pp: 109–128 in: Martín, J.L., Arechavaleta, M., Borges, P.A.V. & Faria, B. (eds.), *Top 100—Las cien especies amenazadas prioritarias de gestión en la región europea biogeográfica de la Macaronesia*. Santa Cruz de Tenerife: Consejería de Medio Ambiente y Ordenación Territorial, Gobierno de Canarias.

Bañares, Á., Blanca, G., Güemes, J., Moreno, J.C. & Ortiz, S. (eds.). 2010. *Atlas y Libro Rojo de la Flora Vasculare Amenazada de España. Adenda 2010*. Madrid: Dirección General de Medio Natural y Política Forestal (Ministerio de Medio Ambiente, y Medio Rural y Marino) - Sociedad Española de Biología de la Conservación de Plantas.

Barres, L., Vilatersana, R., Molero, J., Susanna, A. & Galbany-Casals, M. 2011. Molecular phylogeny of *Euphorbia* subg. *Esula* sect. *Aphyllis* (Euphorbiaceae) inferred from nrDNA and cpDNA markers with biogeographic insights. *Taxon* 60: 705–720.

Benedí, C., Molero, J., Simon, J. & Vicens, J. 1997. *Euphorbia* L. Pp. 210–285 in: Castroviejo, S., Laínz, M., López-González, G., Montserrat, P., Muñoz-Garmendia, F.,

Paiva, J. & Villar, L. (eds.), *Flora Iberica*, vol. 8. Madrid: Real Jardín Botánico de Madrid, CSIC.

Berg, R.Y. 1990. Seed dispersal relative to population structure, reproductive capacity, seed predation, and distribution in *Euphorbia balsamifera* (Euphorbiaceae), with a note on sclerendochory. *Sommerfeltia* 11: 35–63.

Berres, M. 2001. General fluorescent AFLP (fAFLP) protocols. University of Wisconsin Department of Zoology http://ravel.zoology.wisc.edu/sgaap/AFLP_html/fAFLP_protocols.htm (accessed 30 Sep 2002).

Bohling, J.H., Adams, J.R. & Waits, L.P. 2013. Evaluating the ability of Bayesian clustering methods to detect hybridization and introgression using an empirical red wolf data set. *Molec. Ecol.* 22: 74–86.

Boissier, P.E. 1862. Euphorbiaceae subordo Euphorbieae. Pp. 3–188 in: Candolle, A.P. de (ed.), *Prodromus systematis naturalis regni vegetabilis*, vol. 15. Paris: Treuttel & Würtz.

Bonin, A., Bellemain, E., Eidesen, P.B., Pompanon, F., Brochmann, C. & Taberlet, P. 2004. How to track and assess genotyping errors in population genetics studies. *Molec. Ecol.* 13: 3261–3273.

Bramwell, D. & Bramwell, Z.I. 2001. *Flores silvestres de las islas Canarias*. Madrid: Ed. Rueda.

Brochmann, C., Rustan, Ø.H., Lobin, W. & Kilian, N. 1997. The endemic vascular plants of the Cape Verde Islands, W. Africa. *Sommerfeltia* 24: 1–356.

Carine, M.A., Russell, S.J., Santos-Guerra, A. & Francisco-Ortega, J. 2004. Relationships of the Macaronesian and Mediterranean floras: Molecular evidence for multiple colonizations into Macaronesia and back-colonization of the continent in *Convolvulus* (Convolvulaceae). *Amer. J. Bot.* 91: 1070–1085.

Carracedo, J.C., Day, S., Guillou, H., Badiola, E.R., Canas, J.A. & Torrado, F.J.P. 1998. Hotspot volcanism close to a passive continental margin: The Canary Islands. *Geol. Mag.* 135: 591–604.

Caujapé-Castells, J. 2011. Jesters, red queens, boomerangs and surfers: a molecular outlook on the diversity of the Canarian endemic flora. Pp: 284–324 in: Bramwell, D. & Caujapé-Castells, J. (eds.), *The biology of Island of Floras*. London: Cambridge University Press.

Caujapé-Castells, J., Tye, A., Crawford, D.J., Santos-Guerra, A., Sakai, A., Beaver, K., Lobin, W., Florens, F.B.V., Moura, M., Jardim, R., Gomes, I. & Kueffer, C. 2010. Conservation of oceanic island floras: Present and future global challenges. *Perspect. Plant Ecol.* 12: 107–129.

Díaz-Pérez, A., Sequeira, M., Santos-Guerra, A. & Catalan, P. 2008. Multiple colonizations, in situ speciation, and volcanism-associated stepping-stone dispersals shaped the phylogeography of the macaronesian red fescues (*Festuca* L., Gramineae). *Syst. Biol.* 57: 732–749.

Escobar García, P., Schoenswetter, P., Fuertes Aguilar, J., Nieto Feliner, G. & Schneeweiss, G.M. 2009. Five molecular markers reveal extensive morphological homoplasy and reticulate evolution in the *Malva* alliance (Malvaceae). *Molec. Phylogen. Evol.* 50: 226–239.

Evanno, G., Regnaut, S. & Goudet, J. 2005. Detecting the number of clusters of individuals using the software STRUCTURE: a simulation study. *Molec. Ecol.* 14: 2611–2620.

Excoffier, L., Laval, G. & Schneider, S. 2005. Arlequin ver. 3.0: An integrated software package for population genetics data analysis. *Evol. Bioinform.* 1: 47–50.

Fernández-Palacios, J.M., de Nascimento, L., Otto, R., Delgado, J.D., García-del-Rey, E., Ramon Arévalo, J. & Whittaker, R.J. 2011. A reconstruction of Palaeo-Macaronesia, with particular reference to the long-term biogeography of the Atlantic island laurel forests. *J. Biogeogr.* 38: 226–246.

Figueiredo, E. 1996. Euphorbiaceae in: Paiva, J., Martins, E.S., Diniz, M.A., Moreira, I., Gomes, I. & Gomes, S. (eds.), *Flora de Cabo Verde: Plantas vasculares. No 54*. Praia - Lisbon: Instituto de Investigação Científica Tropical -Instituto Nacional de Investigação e Desenvolvimento Agrário.

Francisco-Ortega, J., Crawford, D.J., Santos-Guerra, A. & Carvalho, J.A. 1996. Isozyme differentiation in the endemic genus *Argyranthemum* (Asteraceae: *Anthemideae*) in the Macaronesian islands. *Plant Syst. Evol.* 202: 137–152.

Francisco-Ortega J., Fuertes-Aguilar J., Kim S.C., Santos-Guerra A., Crawford D.J. & Jansen R.K. 2002. Phylogeny of the Macaronesian endemic *Crambe* section *Dendrocrambe* (Brassicaceae) based on internal transcribed spacer sequences of nuclear ribosomal DNA. *Am. J. Bot.* 89: 1984–1990.

- Galbany-Casals, M., Carnicero-Campmany, P., Blanco-Moreno, J.M. & Smissen, R.D.** 2012. Morphological and genetic evidence of contemporary intersectional hybridisation in Mediterranean *Helichrysum* (Asteraceae, *Gnaphalieae*). *Pl. Biol.* (Stuttgart) 14: 789–800.
- García-Maroto, F., Manas-Fernández, A., Garrido-Cardenas, J.A., López Alonso, D., Guill-Guerrero, J.L., Guzmán, B. & Vargas, P.** 2009. Delta(6)-Desaturase sequence evidence for explosive Pliocene radiations within the adaptive radiation of Macaronesian *Echium* (Boraginaceae). *Molec. Phylogen. Evol.* 52: 563–574.
- Geldmacher, J. & Hoernle, K.** 2000. The 72 Ma geochemical evolution of the Madeira hotspot (eastern North Atlantic): recycling of Paleozoic (≤ 500 Ma) oceanic lithosphere. *Earth Planet. Sc. Lett.* 183: 73–92.
- Hamrick, J.L. & Godt, M.J.W.** 1997. Effects of life history traits on genetic diversity in plant species. Pp: 102–118 in: Silvertown, J., Franco, M. & Harper, J.L. (eds.), *Plant life histories: ecology, phylogeny and evolution*. Cambridge: Cambridge University Press.
- Helfgott, D.M., Francisco-Ortega, J., Santos-Guerra, A., Jansen, R.K. & Simpson, B.B.** 2000. Biogeography and breeding system evolution of the woody *Bencomia* alliance (Rosaceae) in Macaronesia based on ITS sequence data. *Syst. Bot* 25: 82–97.
- Huson, D.H. & Bryant, D.** 2006. Application of phylogenetic networks in evolutionary studies. *Molec. Biol. Evol.* 23: 254–267.
- Illera J.C., Koivula K., Broggi J., Packert M., Martens J. & Kvist L.** 2011. A multi-gene approach reveals a complex evolutionary history in the *Cyanistes* species group. *Molec. Ecol.* 20: 4123–4139.
- Juan, C., Emerson, B.C., Oromi, P. & Hewitt, G.M.** 2000. Colonization and diversification: towards a phylogeographic synthesis for the Canary Islands. *Trends Ecol. Evol.* 15: 104–109.
- Kim, S.C., Crawford, D.J., Francisco-Ortega, J. & Santos-Guerra, A.** 1996. A common origin for woody *Sonchus* and five related genera in the Macaronesian islands: Molecular evidence for extensive radiation. *P. Natl. Acad. Sci. U.S.A.* 93: 7743–7748.
- Maddison, W.P. & Maddison, D.R.** 2010. Mesquite: a modular system for evolutionary analysis. Version 2.73 <http://mesquiteproject.org>
- Martín, J.L., Arechavaleta, M., Borges, P.A.V. & Faria, B.** (eds.). 2008. *TOP 100 - As cem espécies ameaçadas prioritárias em termos de gestão na região europeia biogeográfica*

da Macaronésia. Consejería de Medio Ambiente y Ordenación Territorial, Gobierno de Canarias.

Mes, T.H.M. & Hart, H.T. 1996. The evolution of growth-forms in the Macaronesian genus *Aeonium* (Crassulaceae) inferred from chloroplast DNA RFLPs and morphology. *Molec. Ecol.* 5: 351–363.

Mesa, R. 2009. *Seguimiento de poblaciones de especies amenazadas*, *Euphorbia lambii* Svent. La Laguna: Viceconsejería de Medio ambiente, Gobierno de Canarias.

Mesa, R., Acevedo, A., Marrero, M. & Carqué, E. 2007. *Seguimiento de poblaciones de especies amenazadas*, *Euphorbia bourgeauana* Gay ex Boiss. in DC. La Laguna: Viceconsejería de Medio ambiente, Gobierno de Canarias.

Meudt, H.M. & Clarke, A.C. 2007. Almost forgotten or latest practice? AFLP applications, analyses and advances. *Trends Plant Sci.* 12: 106–117.

Molero, J., Garnatje, T., Rovira, A., García-Jacas, N. & Susanna, A. 2002. Karyological evolution and molecular phylogeny in Macaronesian dendroid spurges (*Euphorbia* subsect. *Pachycladae*). *Plant Syst. Evol.* 231: 109–132.

Molero, J. & Rovira, A.M. 1996. Fruit and seed morphology of *Euphorbia* Sect. *Balsamis*. Barcelona: IV Conference on Plant Taxonomy.

Molero, J. & Rovira, A.M. 1998. A note on the taxonomy of the Macaronesian *Euphorbia obtusifolia* complex (Euphorbiaceae). *Taxon* 47: 321–332.

Molero, J. & Rovira, A.M. 2004: *Euphorbia lamarckii* Sweet, correct name for *E. obtusifolia* Poir. non Lam. *Vieraea* 32: 117–122.

Molero, J. & Rovira, A.M. 2005a. Natural hybrids in endemic Canarian dendroid spurges (*Euphorbia* subsect. *Pachycladae*). *Willdenowia* 35: 271–280.

Molero, J. & Rovira, A.M. 2005b. Typification of some Macaronesian and Mediterranean dendroid spurges. *Taxon* 54: 472–474.

Moreno, J.C. 2008. *Lista Roja 2008 de la flora vascular española*. Madrid: Dirección General del Medio Natural y Política Forestal (Ministerio de Medio Ambiente y Medio Rural y Marino y Sociedad Española de Biología de la Conservación de Plantas).

Nei, M. & Li, W.H. 1979. Mathematical-model for studying genetic-variation in terms of restriction endonucleases. *Proc. Natl. Acad. Sci. U.S.A.* 76: 5269–5273.

Nogales, M. 1985. *Contribución al estudio de la flora y fauna en los montes de Pajonales, Ojeda e Inagua (Gran Canaria)*. PhD Thesis. La Laguna: Universidad de la Laguna.

- Nogales, M., Padilla, D.P., Nieves, C., Illera, J.C. & Traveset, A.** 2007. Secondary seed dispersal systems, frugivorous lizards and predatory birds in insular volcanic badlands. *J. Ecol.* 95: 1394–1403.
- Park, S.J., Korompai, E.J., Francisco-Ortega, J., Santos-Guerra, A. & Jansen, R.K.** 2001. Phylogenetic relationships of *Tolpis* (Asteraceae : Lactuceae) based on *ndhF* sequence data. *Pl. Syst. Evol.* 226: 23–33.
- Press, J.R. & Short, M.J.** 1994. *Flora of Madeira*. London: HMSO.
- Pritchard, J.K., Stephens, M. & Donnelly, P.** 2000. Inference of population structure using multilocus genotype data. *Genetics* 155: 945–959.
- Reyes-Betancort, J.A., Santos Guerra, A., Rosana Guma, I., Humphries, C.J. & Carine, M.A.** 2008. Diversity, rarity and the evolution and conservation of the Canary Islands endemic flora. *Anales Jard. Bot. Madrid* 65: 25–45.
- Riina, R., Peirson, J.A., Geltman, D.V., Molero, J., Frajman, B., Pahlevani, A., Barres, L., Morawetz, J.J., Salmaki, Y., Zarre, S., Kryukov, A., Bruyns, P.V. & Berry, P.E.** In press. A worldwide molecular phylogeny and classification of the leafy spurges, *Euphorbia* subgenus *Esula* (Euphorbiaceae). *Taxon*.
- Rohlf, F.J.** 1997. NTSYS-Pc. Numerical taxonomy and multivariate analysis system, v. 1.80. New York: Exeter Software.
- Sanmartín, I., Van der Mark, P. and Ronquist, F.** 2008. Inferring dispersal: a Bayesian approach to phylogeny-based island biogeography, with special reference to the Canary Islands. *J. Biogeogr.* 35: 428–449.
- Sunding, P.** 1979. Origins of the Macaronesian flora. Pp. 13–40 in: Bramwell, D. (ed.), *Plants and islands*. London: Academic Press.
- Sventenius, E.S.** 1960. *Additamentum ad floram canariensem*. Madrid: Agronomiarum Investigationem Nationale Hispanicum Institutum.
- Swofford, D.L.** 2002. PAUP*: Phylogenetic analysis using parsimony (*and other methods), version 4.0b 10. Sunderland, Massachusetts: Sinauer.
- Trusty, J.L., Olmstead, R.G., Santos-Guerra, A., Sa-Fontinha, S. & Francisco-Ortega, J.** 2005. Molecular phylogenetics of the Macaronesian-endemic genus *Bystropogon* (Lamiaceae): palaeo-islands, ecological shifts and interisland colonizations. *Molec. Ecol.* 14: 1177–1189.

Van de Peer, Y. & De Wachter, Y. 1994. TREECON for Windows: a software package for the construction and drawing of evolutionary trees for the Microsoft Windows environment. *Comput. Applic. Biosci.* 10: 569–570.

Vos, P., Hogers, R., Bleeker, M., Reijans, M., Vandele, T., Hornes, M., Frijters, A., Pot, J., Peleman, J., Kuiper, M. & Zabeau, M. 1995. AFLP - a new technique for DNA-fingerprinting. *Nucleic Acids Res.* 23: 4407–4414.

Whittaker, R.J. & Fernández-Palacios, J.M. 2007. *Island biogeography: ecology, evolution, and conservation*. Oxford: Oxford University Press.

Table 1. Morphological and ecological diagnostic characters of the taxonomic complexes of *Euphorbia* sect. *Aphyllis* in the Macaronesia (Molero & al., 2002).

	Leaves	Symflorescence	Sub-cyathial bracts	Seeds	Ecology
<i>E. atropurpurea</i> complex including <i>E. atropurpurea</i> , <i>E. bourgeana</i> and <i>E. bravoana</i>	Semi-persistent	Double	Large (10 – 20 mm) Connate Persistent	Excavate to scrobiculariate	Mesophilous and mesohygrophilous habitats
<i>E. lamarckii</i> complex including <i>E. anachoreta</i> , <i>E. berthelotii</i> , <i>E. lamarckii</i> var. <i>lamarckii</i> , <i>E. lamarckii</i> var. <i>broussonetti</i> , <i>E. pedroi</i> , <i>E. piscatoria</i> , <i>E. regis-jubae</i> and <i>E. tuckeyana</i>	Deciduous	Simple loosed	Small (< 10 mm) Free to the base Deciduous	Smooth to rugose	Xerophilous and mesophilous habitats
<i>E. aphylla</i>	Absent	Simple congested	Small (< 2 mm) Free Deciduous	Smooth to rugulose	Xerophilous-halofitous habitats

Table 2. Taxa sampled, general distribution, population codes, localities and number of individuals used for the AFLP study. Number of individuals in parenthesis are those present in the subset used for some structure analyses including only three primer pairs.

Species	Distribution	Pop.	Locality and Collection Number	No ind.
<i>Euphorbia anachoreta</i> Svent.	Selvagens Islands	ANA1	Portugal, Madeira, Ilhas Selvagens, <i>National Park s.n.</i> (BC)	3
<i>Euphorbia aphylla</i> Brouss. ex Willd	Gran Canaria, La Gomera and Tenerife (Canary Islands)	APH2	Spain, Canary Islands, Tenerife, Teno, Punta del Fraile, <i>Barres 74 & Vilatersana.</i> (BC)	2 (4)
		APH3	Spain, Canary Islands, Gran Canaria, La Isleta, close to the military installations, road Las Coloradas, <i>López-Pujol 9 & Caujapé-Castells.</i> (BC)	1 (2)
		APH4	Spain, Canary Islands, La Gomera, Vallehermoso, playa de Vallehermoso, <i>Barres 97 & Vilatersana.</i> (BC)	- (2)
		APH5	Spain, Canary Islands, La Gomera, San Sebastián de la Gomera, Puntallana Natural Reserve, Nuestra Señora de Guadalupe Chapel, <i>Barres 109 & Vilatersana.</i> (BC)	1 (3)
		ATR6	Spain, Canary Islands, Tenerife, Güímar, old Güímar road (Güímar Viewpoint), <i>Barres 63 et al.</i> (BC)	4
<i>Euphorbia atropurpurea</i> Brouss.	Tenerife (Canary Islands)	ATR7	Spain, Canary Islands, Tenerife, Guía de Isora, <i>Barres 66 & Vilatersana.</i> (BC)	5
<i>Euphorbia atropurpurea</i> f. <i>lutea</i> A. Santos	Tenerife (Canary Islands)	ATR8	Spain, Canary Islands, Tenerife, Teno, Punta del Fraile, <i>Barres 75 et al.</i> (BC)	2
		BER9	Spain, Canary Islands, La Gomera, road from El Pajarito to Alajeró, <i>Barres 99 & Vilatersana.</i> (BC)	4
<i>Euphorbia berthelotii</i> Bolle ex Boiss.	La Gomera (Canary Islands)	BER10	Spain, Canary Islands, La Gomera, Gran Rey Valley, near Cesar Manrique House, <i>Barres 112 & Vilatersana.</i> (BC)	4
		BER11	Spain, Canary Islands, La Gomera, Santiago, between Sabinarés turning and Santiago beach, <i>Barres 116 & Vilatersana.</i> (BC)	5

<i>Euphorbia bourgeana</i> J.Gay ex Boiss.	La Gomera and Tenerife (Canary Islands)	BOU12	Spain, Canary Islands, Tenerife, Güímar, Chamoco ravine, <i>Barres 61 et al.</i> (BC)	4 (4)
		BOU13	Spain, Canary Islands, Tenerife, Punta de Teno, El Charco ravine, <i>Barres 73 et al.</i> (BC)	2 (2)
		BOU14	Spain, Canary Islands, Tenerife, Anaga, Roque Negro, <i>Barres 78 et al.</i> (BC)	3 (3)
		BOU15	Spain, Canary Islands, La Gomera, Garajonay National Park, Los Noruegos, <i>Barres 94 et al.</i> (BC)	5 (5)
		BOU16	Spain, Canary Islands, La Gomera, road from El Cercado to Las Hayas, <i>Barres 101 et al.</i> (BC)	3 (4)
		BOU17	Spain, Canary Islands, La Gomera, Garajonay National Park, Chorros de Epina, <i>Barres 103 et al.</i> (BC)	1 (5)
<i>Euphorbia bravoana</i> Svent.	Tenerife (Canary Islands)	BOU54	Spain, Canary Islands, Tenerife, Teno, Chajabe-Los Martínez, <i>Mesa et al. s.n.</i> (Personal Herbarium)	3 (5)
		BRA18	Spain, Canary Islands, La Gomera, road from Agulo to Las Rosas, <i>Barres 96 & Vilatersana.</i> (BC)	2
<i>Euphorbia lamarckii</i> Sweet var. <i>lamarckii</i>	South Tenerife (Canary Islands)	LAM21	Spain, Canary Islands, Tenerife, Güímar, <i>Barres 54 & Vilatersana.</i> (BC)	5
		LAM22	Spain, Canary Islands, Tenerife, Güímar, <i>Barres 54 & Vilatersana.</i> (BC)	5
<i>Euphorbia lamarckii</i> var. <i>broussonetii</i> (Willd. ex Link) Molero & Rovira	North Tenerife, La Gomera, La Palma and El Hierro (Canary Islands)	LAM19	Spain, Canary Islands, Tenerife, Guía de Isora, <i>Barres 67 & Vilatersana.</i> (BC)	5
		LAM20	Spain, Canary Islands, La Gomera, San Sebastián de la Gomera, Puntallana Natural Reserve, Riscos de Aluce, <i>Barres 115 & Vilatersana.</i> (BC)	2
		LAM23	Spain, Canary Islands, Tenerife, Anaga, Punta de Hidalgo, <i>Barres 85 & Vilatersana.</i> (BC)	5
		LAM24	Spain, Canary Islands, El Hierro, Frontera, Punta de la Dehesa, El Verodal beach, <i>Barres 86 & Vilatersana.</i> (BC)	5
		LAM25	Spain, Canary Islands, La Gomera, between Epina and Vallehermoso, near Macayo, <i>Barres 113 & Vilatersana.</i> (BC)	4
		LAM26	Spain, Canary Islands, La Gomera, Vallehermoso, <i>Barres 98 & Vilatersana.</i> (BC)	4
		LAM27	Spain, Canary Islands, La Palma, Las Angustias ravine, Los Llanos, <i>Barres 119 et al.</i> (BC)	5
		LAM28	Spain, Canary Islands, La Palma, Fuencaliente, <i>Barres 124 et al.</i> (BC)	5

<i>Euphorbia pedroi</i> Molero & Rovira	Sesimbra Peninsula (Portugal)	PED29	Portugal, Sesimbra, Cabo Espichel, Chao dos Navegantes, Molero 30/03/2010_1. (BC)	3
		PED30	Portugal, Sesimbra, Serra de Arrabida Natural Park, between California and Cape Ares, Molero 30/03/2010_2. (BC)	5
<i>Euphorbia piscatoria</i> Ait.	Madeira, Porto Santo & Desertas Islands	PIS31	Portugal, Madeira, Machico, Machico viewpoint, Barres 126 et al. (BC)	3 (3)
		PIS32	Portugal, Madeira, Serra de Água, Pousada dos Vinhaticos, Barres 130 et al. (BC)	5 (5)
		PIS33	Portugal, Madeira, Ribeira da Janela, Barres 131 et al. (BC)	5 (5)
		PIS34	Portugal, Madeira, Porto Santo, Roche de Nosa Senhora, Barres 159 et al. (BC)	2 (4)
		PIS35	Portugal, Madeira, Porto Santo, Pico Ana Ferreira south slope, Barres 161 et al. (BC)	4 (4)
		REG36	Morocco, road from Tiznit to Souk el Arba du Sahel, near Mirleft, Barres 50 & López-Viñallonga. (BC)	3
		REG37	Morocco, between Agadir and Essouira, Cape Ghir, Barres 51 & López-Viñallonga. (BC)	4
<i>Euphorbia regis-jubae</i> J. Gay	Fuerteventura, Lanzarote, Gran Canaria and west coast of Morocco	REG38	Spain, Canary Islands, Gran Canaria, between Vega de San Mateo and Teror, López-Pujol 1 & Caujapé-Castells. (BC)	4
		REG39	Spain, Canary Islands, Gran Canaria, El Sao, Agaete Valley, López-Pujol 2 & Caujapé-Castells. (BC)	5
		REG40	Spain, Canary Islands, Lanzarote, Lomo de En medio, Los Valles, López-Pujol 4 & Olangua. (BC)	5
		REG41	Spain, Canary Islands, Lanzarote, Graciosa Island, between Agujas and Morro de las Pedreras, López-Pujol 6 & Olangua. (BC)	2
		REG42	Spain, Canary Islands, Fuerteventura, Jandía, Los Canarios ravine, López-Pujol 7 & Olangua. (BC)	5
		REG43	Spain, Canary Islands, Fuerteventura, La Asomada, López-Pujol 8 & Olangua. (BC)	1

<i>Euphorbia tuckeyana</i> Steud.	Boa Vista, Brava, Fogo, Sal, Santiago, Santo Antao, Sao Nicolau, Sao Vicente (Cape Verde)	TUC44	Cape Verde, Santiago, Sierra Malagueta, <i>Galbany-Casals 2100 & Molero</i> . (BCN)	2
		TUC45	Cape Verde, São Nicolau, between Barril and Praia Branca, Covadinha ravine, <i>Galbany-Casals 2104 & Molero</i> . (BCN)	5
		TUC46	Cape Verde, São Nicolau, Alto das Cabaças, <i>Galbany-Casals 2107 & Molero</i> . (BCN)	5
		TUC47	Cape Verde, Santiago, Pico de Antonia mountains, <i>Galbany-Casals 2121 & Molero</i> . (BCN)	5
		TUC48	Cape Verde, Fogo, between Achada Grande and Corvo, <i>Galbany-Casals 2125 & Molero</i> . (BCN)	4
		TUC49	Cape Verde, Fogo, Cha das Caldeiras, <i>Galbany-Casals 2128 & Molero</i> . (BCN)	5
		TUC50	Cape Verde, Fogo, Ribeira Felipe after Lomba, <i>Galbany-Casals 2133 & Molero</i> . (BCN)	4
		TUC52	Cape Verde, Santo Antão, Cova, Agua das Caldeiras, <i>Molero s n. & Rovira</i> . (BCN)	3
		TUC55	Cape Verde, São Vicente, Monte Verde, <i>Molero s n. & Rovira</i> . (BCN)	2

Table 3. Genetic structure results values provided by Structure v2.3.3. Average values for $\ln P(D) \pm$ standard deviation are given for each K considered. Numbers in bold indicate the values for $\ln P(D)$ mean chosen as the best K for each case. Species names are labelled as following: ANA, *E. anachoreta*; APH, *E. aphylla*; BER, *E. berthelotii*; BOU, *E. bourgeana*; LAM, *E. lamarckii*; PED, *E. pedroi*; PIS, *E. piscatoria*; REG, *E. regis-jubae*; TUC, *E. tuckeyana*.

	AFLP dataset excluding <i>E. tuckeyana</i> (4 primer pairs)	APH (3 primer pairs)	BOU (3 primer pairs)	ANA + LAM (4 primer pairs)	PIS (3 primer pairs)	REG + PED (4 primer pairs)	TUC (4 primer pairs)
K = 1	-25805.30 ± 12.20	-590.1 ± 22.77	-1333.29 ± 95.14	-3277.67 ± 16.50	-1067.03 ± 35.20	-2528.20 ± 95.80	-1520.10 ± 36.70
K = 2	-14059.59 ± 15873.81	-594.49 ± 57.37	-1016.40 ± 137.83	-3140.41 ± 21.20	-870.95 ± 7.62	-2215.97 ± 327.79	-1697.69 ± 275.33
K = 3	-17257.19 ± 1762.39	-627.58 ± 66.40	-711.27 ± 40.86	-2872.07 ± 93.48	-1137.59 ± 36.15	-2560.78 ± 219.25	-1788.42 ± 370.10
K = 4	-14418.67 ± 1413.78	-766.89 ± 147.42	-796.17 ± 50.05	-2591.25 ± 4.71	-995.26 ± 60.66	-2386.15 ± 501.47	-1540.57 ± 104.60
K = 5	-12149.26 ± 896.60	-612.34 ± 85.19	-866.75 ± 147.55	-3098.25 ± 1898.69	-931.12 ± 68.86	-2235.65 ± 114.34	-1670.39 ± 328.89
K = 6	-10422.75 ± 748.47	-798.73 ± 213.47	-1131.92 ± 60.39	-2769.97 ± 193.43	-918.79 ± 38.77	-2478.30 ± 100.99	-2056.33 ± 615.89
K = 7	-9104.41 ± 403.43	-	-1141.67 ± 19.07	-2969.75 ± 197.98	-	-2521.58 ± 98.92	-2264.5 ± 809.68
K = 8	-10154.57 ± 2572.68	-	-1105.59 ± 142.67	-2872.90 ± 263.59	-	-2571.38 ± 93.98	-2009.98 ± 800.03
K = 9	-11064.03 ± 5953.48	-	-	-3580.40 ± 769.96	-	-2539.66 ± 122.57	-2804.98 ± 2199.32
K = 10	-8924.07 ± 822.041	-	-	-3352.35 ± 639.57	-	-2805.28 ± 336.61	-4564.72 ± 6143.50
K = 11	-24667.49 ± 59678.32	-	-	-	-	-	-1697.69 ± 275.30
K = 12	-12128.18 ± 5418.16	-	-	-	-	-	-
K = 13	-9390.94 ± 1288.09	-	-	-	-	-	-
K = 14	-10800.04 ± 2490.29	-	-	-	-	-	-
K = 15	-11361.04 ± 3150.42	-	-	-	-	-	-

Table 4. Analyses of molecular variance (AMOVA) with Euclidean pairwise distances of AFLP markers, using 346 (4 primer pairs) or 249* (3 primer pairs). In all cases P -values of ϕ_{ST} are < 0.0001 . d.f. = degrees of freedom.

		d.f.	Sum of squares	Variance components	% of variation	ϕ_{ST}
<i>E. aphylla</i> *	Among populations	2	30.54	2.86	32.76	0.33
	Within populations	7	39.67	5.67	67.24	
<i>E. berthelotii</i>	Among populations	2	46.06	3.57	31.80	0.32
	Within populations	10	76.55	7.65	68.20	
<i>E. bourgeana</i> *	Among populations	6	141.83	5.37	69.28	0.69
	Within populations	21	50.07	2.38	30.72	
<i>E. bourgeana</i> * by structure groups	Among groups	2	105.65	4.97	54.49	0.74
	Among populations	4	36.17	1.77	19.38	
	Within populations	21	50.07	2.38	26.13	
<i>E. bourgeana</i> * by islands	Among groups	1	51.94	3.91	54.45	0.84
	Among populations	4	36.17	2.09	29.10	
	Within populations	17	20.07	1.18	16.45	
<i>E. anachoreta</i> + <i>E. lamarckii</i> by structure groups	Among groups	4	201.37	3.68	28.46	0.47
	Among populations	6	103.33	2.39	18.51	
	Within populations	37	253.97	6.86	53.03	
<i>E. lamarckii</i>	Among populations	9	242.12	4.43	38.53	0.38
	Within populations	35	247.30	7.06	61.47	

<i>E. lamarckii</i> by islands	Among groups	3	139.39	2.63	21.88	0.41
	Among populations	6	102.73	2.33	19.35	
	Within populations	35	247.30	7.06	58.77	
<i>E. pedroi</i>	Among populations	1	15.51	3.69	69.21	0.69
	Within populations	6	9.87	1.64	30.79	
<i>E. piscatoria</i>	Among populations	4	82.75	3.85	37.66	0.38
	Within populations	14	89.35	6.38	62.34	
<i>E. piscatoria</i> * by structure groups	Among groups	1	42.09	3.18	33.51	0.48
	Among populations	3	31.52	1.33	14.01	
	Within populations	16	79.72	4.98	52.48	
<i>E. regis-jubae</i>	Among populations	7	169.01	4.33	33.08	0.33
	Within populations	21	184.17	8.77	66.92	
<i>E. regis-jubae</i> + <i>E. pedroi</i>	Among populations	9	244.72	5.49	43.30	0.43
	Within populations	27	194.03	7.19	56.70	
<i>E. regis-jubae</i> + <i>E. pedroi</i> by structure groups	Among groups	1	83.31	4.39	28.83	0.53
	Among populations	8	161.41	3.66	24.03	
	Within populations	27	194.03	7.19	47.14	
<i>E. regis-jubae</i> + <i>E. pedroi</i> by islands or mainland enclaves	Among groups	4	169.104	3.37	25.92	0.45
	Among populations	5	75.62	2.46	18.88	
	Within populations	27	194.03	7.18	55.20	

<i>E. regis-jubae</i> + <i>E. pedroi</i> by species	Among groups	1	60.21	2.73	19.00	0.50
	Among populations	8	184.51	4.44	30.95	
	Within populations	27	194.03	7.18	50.05	
<i>E. tuckeyana</i>	Among populations	8	113.79	2.69	41.07	0.41
	Within populations	26	100.55	3.87	58.93	
<i>E. tuckeyana</i> by islands	Among groups	4	82.57	2.09	30.26	0.44
	Among populations	4	31.22	0.96	13.83	
	Within populations	26	3100.55	3.87	55.91	
<i>E. tuckeyana</i> by islands groups	Among groups	1	30.94	1.06	15.05	0.45
	Among populations	7	82.85	2.10	29.94	
	Within populations	26	100.55	3.87	55.01	

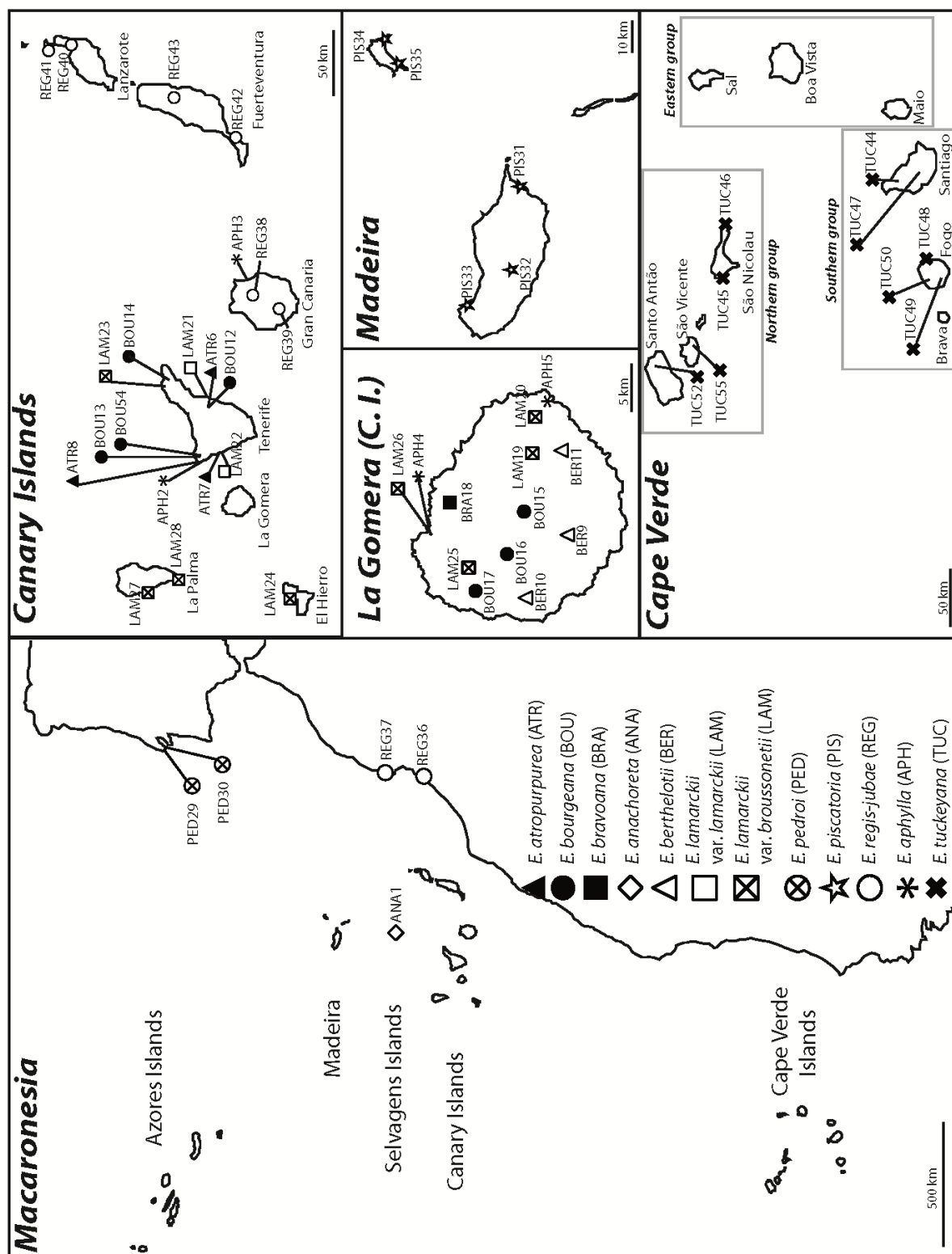

Fig. 1. Sampling localities of 53 populations of the 11 *Euphorbia* species included in the AFLP analyses. Details on the localities and number of specimens sampled are given in Table 2.

0.1 substitutions/site

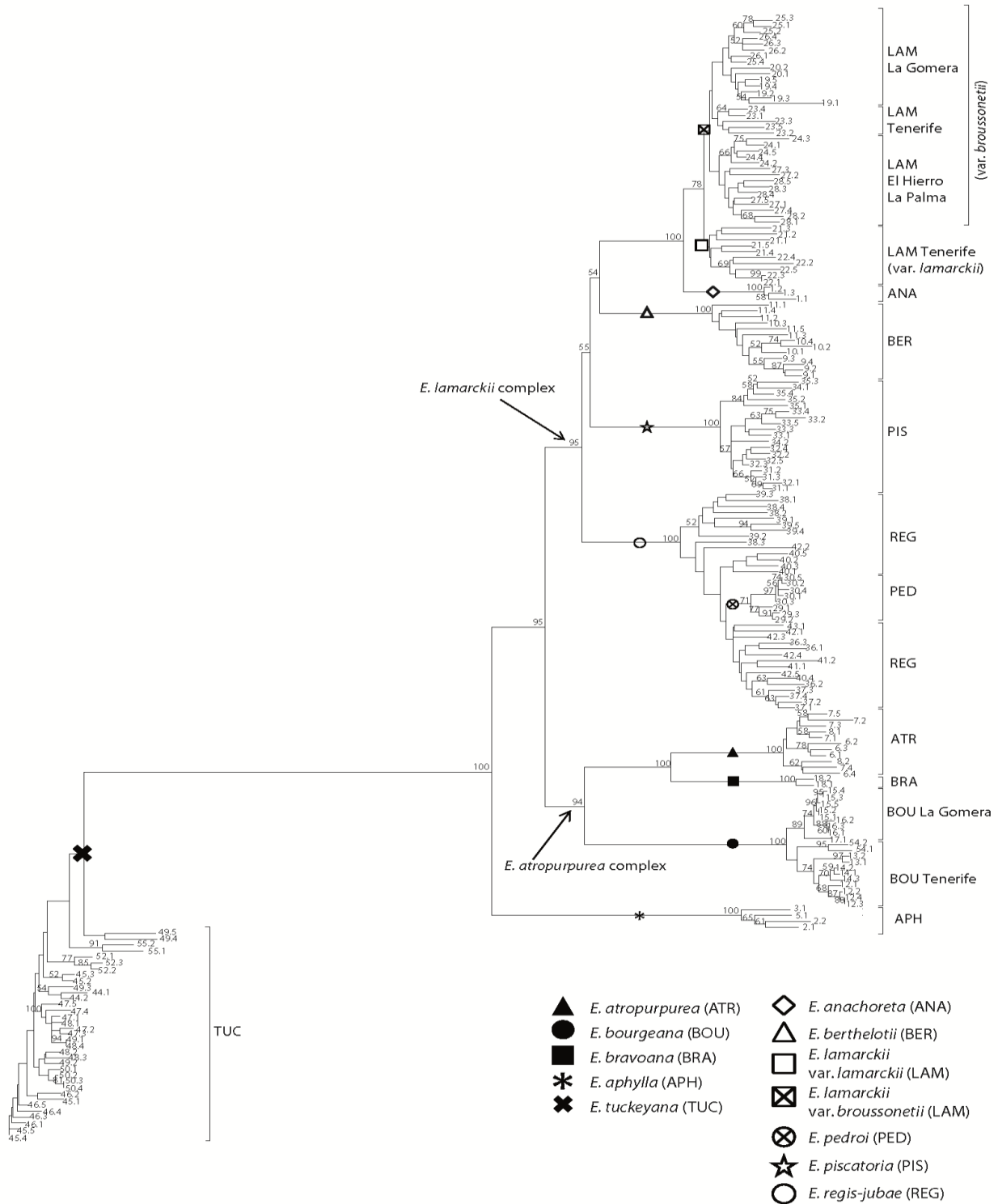
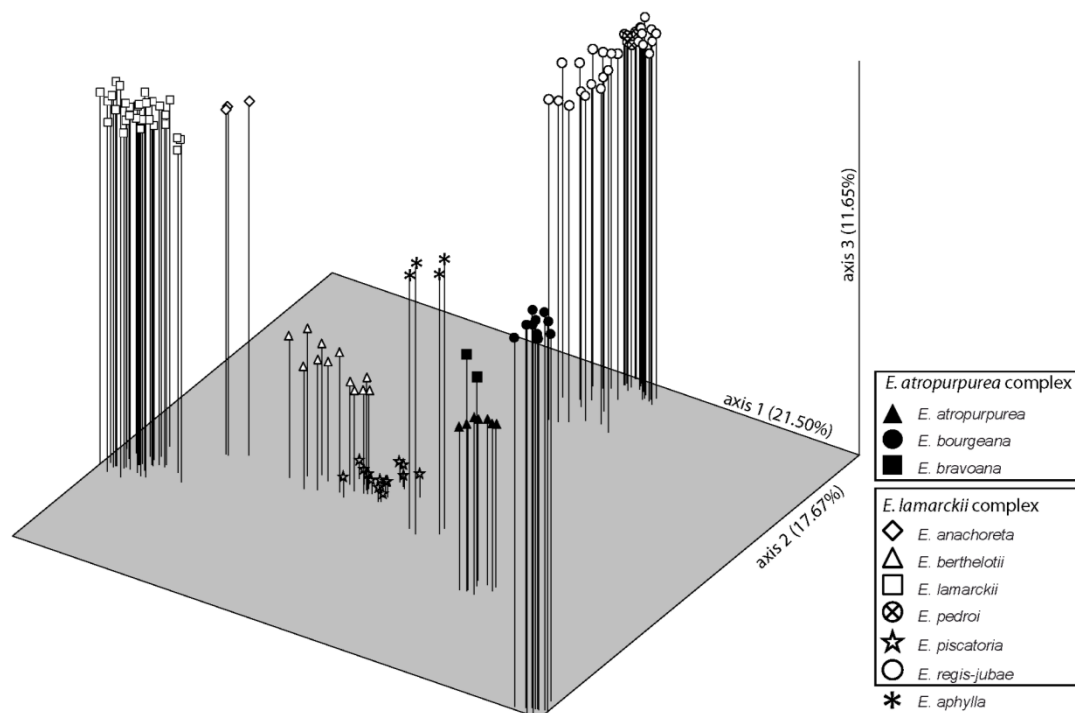

Fig. 2. Neighbour Joining tree of 189 individuals from 53 populations inferred from Nei-Li distances matrix. Numbers above branches indicate BS support estimated using 2000 replicates. BS values < 50% are not shown. Species names are labelled as following: ANA, *E. anachoreta*; APH, *E. aphylla*; BER, *E. berthelotii*;



BOU, *E. bourgeana*; LAM, *E. lamarckii*; PED, *E. pedroi*; PIS, *E. piscatoria*; REG, *E. regis-jubae*; TUC, *E. tuckeyana*.

0.01

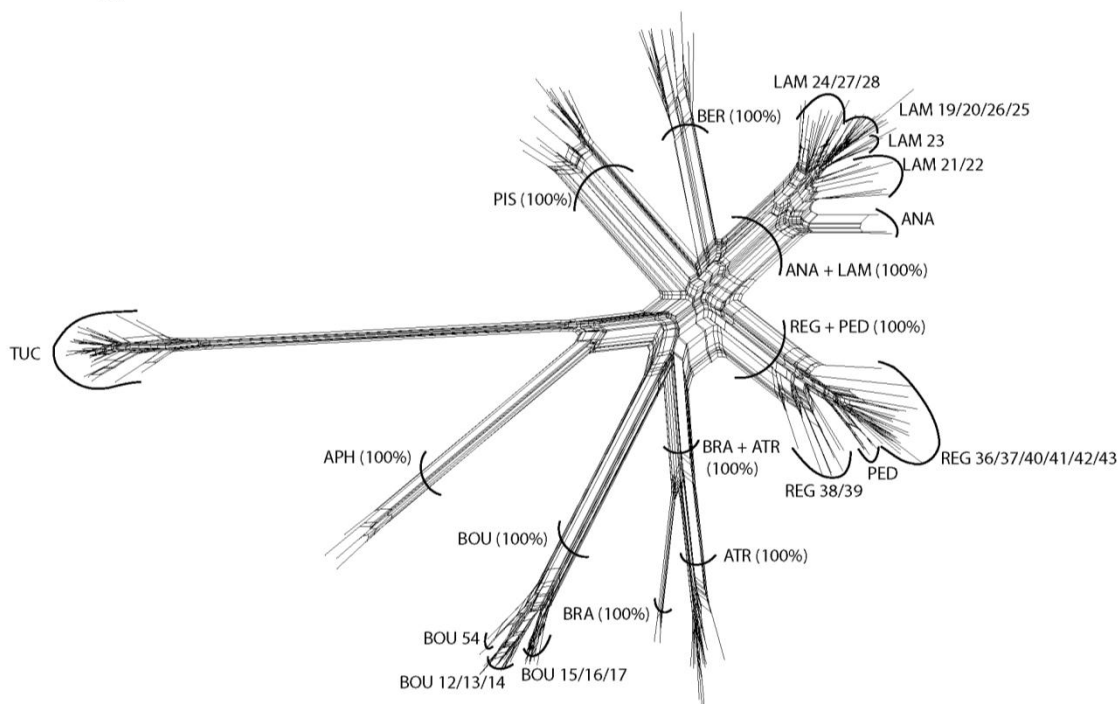
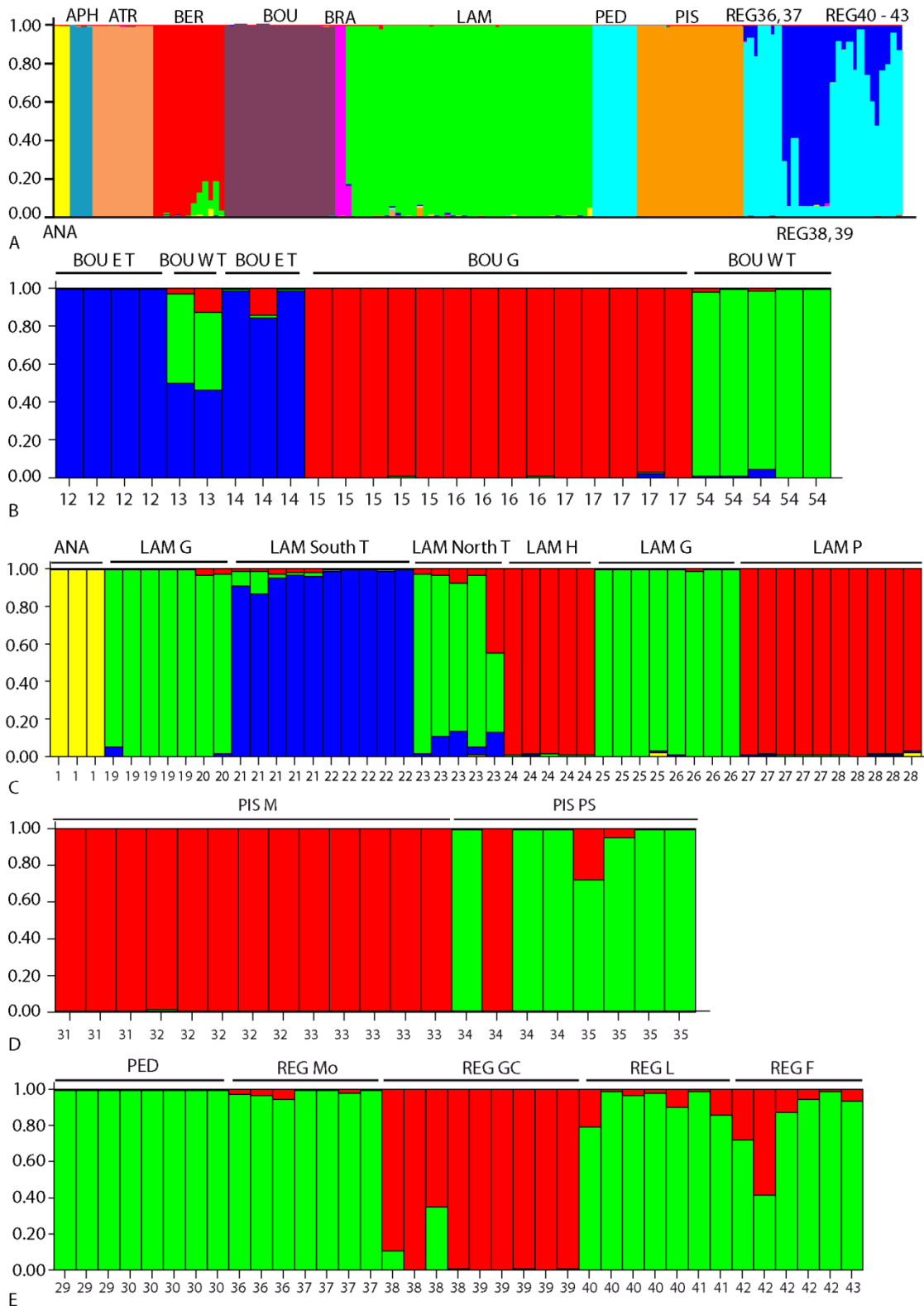

Fig. 3. Plot of the Principal Coordinate Analysis of 346 AFLP markers based on Dice's similarity coefficient.

Fig. 4. Neighbour-net diagram of the whole AFLP dataset constructed with Splitstree v4.11.3 from Nei-Li distances. BS values above 80% from a Neighbour Joining analysis of the same dataset are shown on main clades. Species names are labelled as following: ANA, *E. anachoreta*; APH, *E. aphylla*; BER, *E. berthelotii*;



BOU, *E. bourgeana*; LAM, *E. lamarckii*; PED, *E. pedroi*; PIS, *E. piscatoria*; REG, *E. regis-jubae*; TUC, *E. tuckeyana*.

Fig. 5. Bar plots from the genetic structure analyses obtained with Structure v2.3.3. (A) K = 10 for the whole dataset excluding *E. tuckeyana*. (B) K = 3 for 28 *E. bourgeana* individuals. (C) K = 5 for 61 individuals of the NJ tree supported clade of *E. anachoreta* and *E. lamarckii*. (D) K = 2 for 30 *E. piscatoria* individuals.

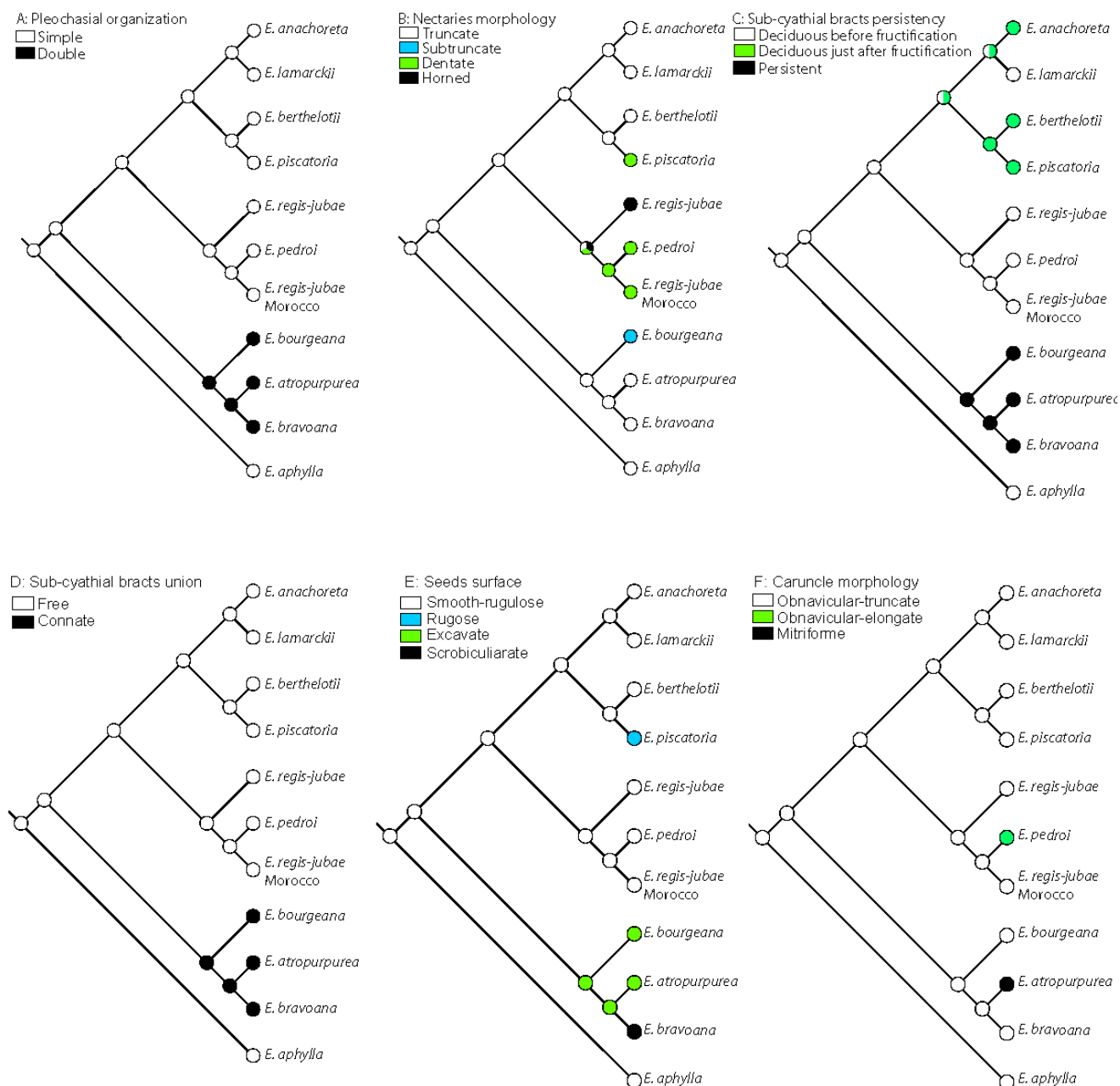

(E). $K = 2$ for 37 individuals of the NJ tree supported clade including *E. regis-jubae* and *E. pedroi*. Numbers indicate populations as indicated in Fig. 1. Geographic origin is labelled as in Fig. 1.

Fig. 6. Ancestral character state reconstruction based on maximum likelihood reconstructed with Mesquite 2.74. A: pleochasial organization, B: nectaries morphology, C: sub-cyathial bracts persistency, D: sub-cyathial bracts union, E: seed surface and F: caruncle morphology.

8.3. Publicació 3: Reconstructing the evolution and biogeographic history of tribe *Cardueae* (*Compositae*)

Acceptat a *American Journal of Botany*.

Reconstruint l'evolució i la història biogeogràfica de la tribu *Cardueae* (*Compositae*).

Laia Barres, Isabel Sanmartín, Cajsja-Lisa Anderson, Alfonso Susanna, Sven Buerki, Mercè Galbany-Casals and Roser Vilatersana

Resum

La tribu de les *Cardueae*, coneguda informalment com a cards, conté aproximadament 2400 espècies i és una de la tribus més grans en nombre d'espècies de la família *Compositae*. L'àrea biogeogràfica que concentra la major diversitat de la tribu és la regió Mediterrània, d'on les *Cardueae* representen un dels components principals de la seva flora. La descoberta recent de nous fòssils de les *Compositae* i l'obtenció en aquest estudi d'una filogènia quasi totalment resolta de la tribu *Cardueae* han permès reconstruir el marc espaiatemporal de l'evolució d'aquest grup mitjançant mètodes de datació molecular i de reconstrucció biogeogràfica. Els mètodes emprats per a la inferència filogenètica s'han basat en les anàlisis de Màxima Parsimònia i Inferència Bayesiana de les seqüències nucleotídiques de regions nuclears i cloroplàstiques del genoma. Les estimacions dels temps de divergència entre espècies s'han realitzat amb el mètode de la versemblança penalitzada i les reconstruccions d'àrees ancestrals mitjançant anàlisis bayesianes de dispersió-vicariança. La filogènia obtinguda mostra que la subtribu *Cardopatiinae* és la clada germana a la resta d'espècies de les *Cardueae* i les subtribus *Carlininae* i *Echinopsinae* apareixen com a successives clades germanes del grup *Carduinae/Centaureinae*. La reconstrucció biogeogràfica i la datació molecular ens mostren que la tribu *Cardueae* es va originar a l'Eocè mitjà a l'oest d'Àsia, regió que representa l'origen de la majoria de les subtribus de les *Cardueae*. La diversificació dins de cada subtribu va començar durant la transició entre l'Oligocè i el Miocè. La majoria de processos de diversificació dins les *Cardueae* es relacionen principalment amb dos processos geològics: els cicles de fragmentació i unió entre la micropalca d'Anatòlia i la conca Mediterrània oriental durant l'Oligocè-Miocè i amb l'aixecament de la serralada

dels Himàlaies, que es va iniciar al Miocè. A partir d'aquestes dues regions de diversificació, a l'Àsia central i la Mediterrània, les *Cardueae* van colonitzar la resta de continents (Àfrica, Austràlia, Amèrica del Nord i del Sud) probablement en períodes més freds durant la transició entre el Pliocè i el Pleistocè.

Barres, L. et al., Biogeographic history of thistles (Cardueae)

RECONSTRUCTING THE EVOLUTION AND BIOGEOGRAPHIC HISTORY OF TRIBE

CARDUEAE (COMPOSITAE)¹

LAIA BARRES^{2,7}, ISABEL SANMARTÍN³, CAJSA-LISA ANDERSON^{3,4}, ALFONSO SUSANNA²,
SVEN BUERKI^{3,5}, MERCÈ GALBANY-CASALS⁶, AND ROSER VILATERSANA²

² Institut Botànic de Barcelona (IBB - CSIC - ICUB), Pg. del Migdia s.n., E-08038 Barcelona, Spain; ³ Real Jardín Botánico (RJB - CSIC), Plaza de Murillo 2, E-28014 Madrid, Spain;

⁴Present address: Department of Plant and Environmental Sciences, University of Gothenburg, Box 461, 450 30 Göteborg, Sweden, ⁵Jodrell Laboratory, Royal Botanic Gardens, Kew, Richmond, Surrey TW9 3DS, United Kingdom; and ⁶Unitat de Botànica, Dept. Biologia Animal, Biologia Vegetal i Ecologia, Facultat de Biociències, Universitat Autònoma de Barcelona, E-08193 Bellaterra, Spain.

Manuscript received _____; revision accepted _____.

The authors thank the Ministry of Education and Science of the Spanish Government (projects CGL2006-01765/BOS, CGL2009-13322-C03-03/BOS and CGL2009-13322-C03-01/BOS, and Ph.D. grant BES-2007-14260 to L. Barres) and the Catalan Government ('Ajuts a grups consolidats' 2009/SGR/00439) for financial support. S.B and C.L.A. were supported by postdoctoral grants at RJB from the Swiss National Science Foundation grant (PBNEP3-129903) and the Swedish Research Council, respectively. The authors would also like to thank R. Bayer, M. Dematteis, V. Funk, D. Gutiérrez, D. Arredondo, M. Tobar and T. Wendt, who kindly provided plant material.

⁷Author for correspondence (email: laia.barres@gmail.com)

Abstract

- *Premise of the study:* Tribe Cardueae (“thistles”) forms one of the largest tribes in the family Compositae (2400 species), with representatives in almost every continent. The greatest species richness of Cardueae occurs in the Mediterranean Region where it forms an important element of its flora. New fossil evidence and a nearly resolved phylogeny of Cardueae are used here to reconstruct the spatio-temporal evolution of this group.
- *Methods:* We performed Maximum Parsimony and Bayesian phylogenetic inference based on nrDNA and cpDNA markers. Divergence times and ancestral area reconstructions for main lineages were estimated using penalized likelihood and dispersal-vicariance analyses, respectively, and integrated over the posterior distribution of the phylogeny from Bayesian MCMC analysis to accommodate uncertainty in phylogenetic relationships.
- *Key results:* The phylogeny shows that subtribe Cardopatiinae is sister to the remaining subtribes and subtribes Carlininae and Echinopsinae appear as consecutive sister-clades to the Carduinae/Centaureinae. Tribe Cardueae is inferred to have originated around the Mid Eocene in West Asia, which is also the ancestral area of most subtribes within Cardueae. Diversification within each subtribe began during the Oligocene-Miocene period.
- *Conclusions:* Most diversification events within Cardueae are related to the continuous cycles of area connection and division between the Anatolian microplate and the Western Mediterranean Basin during the Oligocene-Miocene, and with the uplift of the Himalayan range from the Miocene onwards. From these two regions, thistles dispersed and colonized the rest of the continents (e.g., the New World, Africa, and Australia), most likely during the colder Pliocene-Pleistocene period.

Key words: Bayes-DIVA; Bering Land Bridge; biogeography; Cardueae; Carduoideae; Himalayan uplift; Mediterranean Basin; molecular dating.

INTRODUCTION

Thistles (tribe Cardueae) represent one of the largest tribes of the family Compositae, with over 2400 species distributed amongst 73 genera (Susanna and Garcia-Jacas, 2009). Cardueae are a common and essential element of the Mediterranean landscape (Quézel, 1978; Takhtajan, 1986), but they can also be found in other continents and ecosystems, such as steppes and semi-arid environments. Of the four tribes comprising the subfamily Cardioideae, tribe Cardueae is the largest and the only one that has a worldwide distribution, with representatives in every continent except Antarctica (Susanna and Garcia-Jacas, 2009). The remaining tribes, Dicomeae Panero & V. A. Funk, Oldenburgieae, and Tarchonantheae, have a much lower diversity and are distributed exclusively in Africa (Ortiz et al., 2009). Until recently, Dicomeae, Oldenburgieae, and Tarchonantheae were included in tribe Mutisieae Cass. *sensu* Cabrera (1977) before being transferred to Cardioideae, based on new molecular and morphological evidence (Panero and Funk, 2008; Ortiz et al., 2009).

Cardueae include perennial, biennial, or monocarpic herbs and shrubs and, less often, annual herbs or small trees. The style is characterized in having the stigmatic areas confined to the inner surfaces of the style arms and an articulation below the branches of the upper region, which is usually provided with a collar of hairs. Historically, subtribal classification has been controversial, with subtribes Echinopsinae and Carlininae considered as either subtribes or as independent tribes (Cassini, 1819; Bentham, 1873; Hoffmann, 1894; Wagenitz, 1976). Several molecular studies have recognized Cardueae as monophyletic (Susanna et al., 1995; Garcia-Jacas et al., 2002; Susanna et al., 2006). In the most complete study to date, Susanna et al. (2006) identified five monophyletic lineages or subtribes within Cardueae: Cardopatiinae, Carduinae, Carlininae, Centaureinae and Echinopsinae, with Carduinae being paraphyletic. However, this study failed to solve basal relationships between these lineages.

The main area of distribution of Cardueae is the Mediterranean Region, with centers of endemism in the eastern and western Mediterranean, the western Irano-Turanian region, and North Africa (Susanna and Garcia-Jacas, 2007). The eastern limits of many genera are located in central Asia, in the mountains of Tian Shan, Pamir, and the Himalayas. A few genera occur in regions that are distant from these two areas (Mediterranean and Himalayas), for example, in Japan (*Atractylodes* DC., *Cirsium* Mill.,

Synurus Iljin), North America (*Cirsium*, *Plectocephalus* D. Don, and *Saussurea* DC.), South America (*Centaurodendron* Johow), and Australia (*Rhaponticum* Vaill.). Some genera are subcosmopolitan (*Arctium* L., *Cirsium*), whereas others include noxious weeds (*Carthamus* L., *Centaurea* L., *Crupina* (Pers.) DC., *Notobasis* Cass., *Rhaponticum*; Susanna and Garcia-Jacas, 2007). There are also some striking intercontinental disjunctions. One example is *Plectocephalus* (Centaureinae), a genus distributed in East Africa, North America, and South America. A recent study (Susanna et al., 2011) suggests an origin of this lineage in West Asia with subsequent migrations to North America through the Bering Land Bridge. However, the scope of this study was restricted to subtribe Centaureinae and its biogeographic conclusions were based exclusively on geological evidence. Here, we provide improved sampling and test these hypotheses within a formal biogeographic analysis based on fossil-calibrated molecular dating and ancestral area reconstructions. Other interesting disjunctions in Cardueae are shown by *Rhaponticum* Vaill., distributed in North Africa, Eurasia, Asia, and eastern Australia; and *Cirsium*, distributed in Eurasia, northern and eastern Africa, and North America.

Despite the importance of thistles for understanding the evolution of the Mediterranean vegetation and landscape (Quézel, 1978), there has been no attempt to infer the biogeographical history of this tribe. One reason for this is the absence of fossil record to estimate absolute divergence times. Another reason lies in the difficulty to solve basal relationships among the different subtribes of Cardueae, since a sound phylogenetic hypothesis is a basic pre-requisite for inferring biogeographic history. The recent discovery of new fossil evidence assigned to basal subfamilies (such as Barnadesioideae) within Compositae (Barreda et al., 2010a, b), together with advances in integrating phylogenetic uncertainty into biogeographic reconstructions (Nylander et al., 2008), has provided us with new and powerful tools to infer the spatio-temporal evolution of thistles.

The particular aims of our study are: (1) to provide a resolved generic phylogeny of tribe Cardueae, with special focus on phylogenetic relationships among subtribes and major lineages; (2) to estimate divergence times for the main diversification events within Cardueae; (3) to infer the ancestral areas and main migration events within the tribe allowing us to explain how it attained such a widespread and disjunct distribution;

and (4) to provide new insights into the evolution of the Mediterranean flora, of which tribe Cardueae is an important element (Quézel, 1978).

MATERIAL AND METHODS

Plant Material—To facilitate the resolution of relationships at the subtribal level, taxon sampling included members of all subtribes and informal groups described by Susanna et al. (2006) for tribe Cardueae (Table 1). Species were also selected to maximize geographic representation, i.e., to include all the areas of distribution of the tribe. The final dataset was based on Susanna et al. (2006), to which we have added ten additional species from seven different genera: *Ancathia* DC., *Centaurodendron*, *Dipterocome* Fisch. & C. A. Mey., *Goniocaulon* Cass., *Ochrocephala* Dittrich, *Plectocephalus*, and *Xanthopappus* C.Winkl. (Table 1). In all, 132 species were included, with 62 of the 73 recognized genera in tribe Cardueae (Susanna and Garcia-Jacas, 2009) represented. Eight species representing additional tribes and subfamilies within Compositae, as well as related families were used as different alternative outgroups for the phylogenetic, dating, and biogeographical analyses (see below) based on Funk et al. (2009).

A total of 300 new sequences were generated for this study and 359 sequences were downloaded from GenBank. Species names, voucher information and GenBank accession numbers for all sequences are provided in Appendix S1 (see Supplemental Data in the online version of this article).

DNA extraction, amplification and sequencing—DNA was extracted using the CTAB procedure (Doyle and Dickson, 1987) as modified by Soltis et al. (1991) and Cullings (1992) using fresh plant tissue from collections growing in the Botanical Institute of Barcelona, as well as silica gel-dried leaves or herbarium specimens.

The ITS, *trnL-trnF* region including the *trnL* intron, the 3' *trnL* (UAA) exon, and the intergenic spacer between *trnL* (UAA) and *trnF* (GAA), and the first 1000 base pairs at the 5' end of *matK* gene were amplified and sequenced following Susanna et al. (2006). The cpDNA *ndhF* gene was amplified only in its 3' region because of the low variation level of the 5' end of the gene (Kim and Jansen, 1995). We used a set of two primer pairs to obtain overlapping sequence fragments of the 3' region of the *ndhF* gene. For the 5' fragment, we used 3'F as forward primer (Eldenäs et al., 1999) and 1783R (1) as reverse primer, and for the 3' fragment, we used 1626F (2) as forward primer and +607 (Kim and Jansen, 1995) as reverse primer. Both internal primers were specially designed for this study: (1) 1783R: 5'-ATT CAT ACC AAT CTA TTG AAT TGT- 3' and (2) 1626F: 5'-TGA ATC GGA TAA TAC TAT GTT ATT- 3'. The profile used for amplification consisted of: 3 min at 94 °C, 1 min at 46 °C, 1 min 20 s at 71 °C, followed by 34 cycles of 1 min at 94 °C, 1 min at 50 °C and 1 min 20 s at 71 °C, together with an extension phase of 7 min at 71 °C. The cpDNA *rbcl* gene was amplified in two overlapping fragments using the primer pairs 1F/724R (Olmstead et al., 1992) and 636F/1460R (Fay et al., 1998). The profile used for PCR amplification was as described by Roquet et al. (2009). All reactions were performed in 25 µL volumes with 10% 10× AmpliTaq buffer, 10% 25 mM MgCl₂, 10% of 2 mM dNTPs mix, 4% of each primer at 5 µM, 0.5 µL DMSO (dimethyl sulfoxide; Sigma-Aldrich, St.

Louis, MO, USA), 1 U AmpliTaq DNA polymerase (Applied Biosystems, Foster City, CA, USA) and 2 µL of template DNA of an unknown concentration. In the amplifications of chloroplast regions, 2.5 µL of 400 ng/µL BSA (bovine serum albumin; New England Biolabs, Ipswich, MA, USA) were added to the reaction. This was made up to 25 µL with distilled, sterile water. PCR products were purified with ExoSAP-IT (USB Corp., Cleveland, Ohio, USA) and sequencing of the amplified DNA segments was performed using BigDye Terminator Cycle Sequencing v.3.1 (Applied Biosystems), following the manufacturer's protocol at the University of Florida ICBR Core Facility on an ABI 3730xl capillary sequencer (Applied Biosystems).

Phylogenetic analyses—Sequences were edited using BioEdit 7.0.9.0 (Hall, 1999), aligned using the software T-Coffee (Notredame et al., 2000) and adjusted manually. T-Coffee is especially appropriate for difficult alignments because it uses a position-specific scoring scheme instead of a substitution matrix, and has the ability to consider information from all sequences during each alignment step, not just those being aligned at a particular stage.

We used two different datasets to perform the analyses. Dataset 1 included sequences of nrDNA (ITS) and cpDNA (*trnL-trnF*, *matK*, *ndhF*, *rbcL*) regions for 127 taxa and was used to solve phylogenetic relationships within tribe Cardueae. Representatives of two other tribes from Carduoideae, *Brachylaena discolor* and *Oldenburgia intermedia* (tribe Oldenburgieae), and *Tarchoanthus camphoratus* (tribe Tarchonanthae), were used as outgroups for this dataset. A second, larger dataset of 132 taxa (dataset 2) based only on the cpDNA regions (*trnL-trnF*, *matK*, *ndhF*, *rbcL*) was used to perform the dating and biogeographical analyses. The ITS marker was excluded from this dataset because of difficulties to align the most external outgroups (see below) and to avoid artifacts from simultaneously analyzing chloroplast and nuclear genomes, which have very different divergence rates (Wolfe et al., 1987). The cpDNA dataset allowed us to include representatives of two subfamilies of Compositae that occur in the fossil record and might facilitate the provision of external calibration points for the dating analysis: Barnadesioideae, which is the sister subfamily of the remaining Compositae (Funk et al., 2009), represented here by *Dasyphyllum leptacanthum* and *Chuiraga spinosa*; and Gochnatioideae, which is closely related to Carduoideae (Funk et al., 2009), represented by *Gochnatia hiriartiana*. Finally, a member of family Goodeniaceae (*Scaevola aemula*), and *Boopis anthemoides*, belonging to family Calyceraceae, were included as external outgroups because these two families have been shown to be closely related to Compositae (Lundberg, 2009), following the relationship: ((Calyceraceae, Compositae), Goodeniaceae).

We first performed a partition homogeneity test (incongruence length difference, ILD; Farris et al., 1995a, b) to test the heterogeneity of phylogenetic signals between the chloroplast and the nuclear markers on dataset 1. ILD significance values were calculated in TNT v.1.1 (Goloboff et al., 2008) with the INCTST script (kindly provided by the authors of the program) using 1000 replicates. The ILD test indicated significant incongruence between the ITS and cpDNA datasets ($p = 0.001$). However, numerous studies have discussed the limitations in interpreting this test (e.g., Hipp et al., 2004; Quicke et al., 2007). We, therefore, performed additional separate phylogenetic analyses (same settings as below) for the ITS and the cpDNA markers and made direct comparisons between their consensus trees. In the resulting trees

(Appendices S2 and S4), all clades receiving significant node support in the bootstrap (70%) and Bayesian (95%) analyses were congruent between nuclear and chloroplast markers, except for two groupings. Firstly, the *Arctium-Cousinia* complex, which is resolved as sister to the Centaureinae together with the *Jurinea-Saussurea* clade in the ITS (Appendix S4). This result is caused by a 7 bp-long deletion in the ITS shared by the Centaureinae and the *Arctium-Cousinia* and *Jurinea-Saussurea* clades (Häffner and Hellwig, 1999). The second one is the position of some annual Centaureinae genera (*Goniocaulon*, *Stizolophus* Cass. and *Zoega* L.). As argued by Susanna et al. (2011), these annual genera are probably misplaced in the ITS phylogenetic tree due to a long-branch attraction artifact caused by the higher divergence rate. We, therefore, decided to combine all markers into a single concatenated dataset for further phylogenetic analysis of dataset 1: the position of the annual taxa in the combined tree agreed with that in the cpDNA dataset.

We coded indels (gaps) as additional characters for the analyses of dataset 1 using the Modified Complex Indel Coding (MCIC) algorithm (Müller, 2006) implemented in IndelCoder 1.0 (Müller, 2006). Indels were excluded from dataset 2 because of difficulties in estimating the rate of variation of the molecular clock in the gap partition.

Phylogenetic analyses of datasets 1 and 2 were performed using Maximum Parsimony (MP) and Bayesian inference (BI) methods, implemented in PAUP* v.4.0b10 (Swofford, 2002) and MrBayes 3.2cvs (Ronquist and Huelsenbeck, 2003; sourceforge.mrbayes.com), respectively. MP analyses used heuristic search with 1000 replicates of random taxon addition with MULPARS in effect and tree bisection reconnection (TBR) branch swapping and saving all the most parsimonious trees. Parsimony uninformative positions were excluded. After computing the strict consensus tree, bootstrap analyses (BS; Felsenstein, 1985) were performed following Lidén et al. (1997) using 1000 replicates of heuristic search, 10 random taxon additions with 10 replicates per replicate, MULTREES option not in effect and no branch swapping. Nodes with BS \geq 75% were considered as significantly supported.

The Akaike Information Criterion (Akaike, 1973), as implemented in the software MrModeltest 2.3 (Nylander, 2004), was used to select the best-fit model of substitution for each region for the BI analyses. The General Time Reversible model with variable sites was assumed to follow a gamma distribution, and an invariant portion (GTR + I + G) was selected for all regions except for *matK* (GTR + G). However, several studies have shown that the invariable gamma parameter can overestimate the rate of molecular evolution and consequently, affect the estimation of divergence times (Wahlberg, 2006). We, thus, decided to use GTR + G as model of evolution for all DNA regions. For the gap partition, we used the restriction model (F81) in accordance with the MrBayes manual (Table 2). Two independent analyses of three Metropolis-coupled Markov chains were run for 5 million generations in MrBayes, starting from different random trees and with the heating temperature parameter set to 0.1, saving one in every 1000 trees. A 50% majority rule consensus tree was computed from the posterior distribution after discarding the first 25% of trees as burn-in. Nodes with a Bayesian posterior probability (BPP) of between 0.5 and 0.74 were considered as weakly supported, $0.75 \geq \text{BPP} \geq 0.89$ as moderately supported, and $0.9 \geq \text{BPP} \geq 1$ as well supported.

Dating analyses— We used the non-parametric dating method implemented in the software PATHd8 (Britton et al., 2007) to estimate the percentage of nodes in the 50% majority rule consensus tree from the Bayesian analysis of dataset 2 that conformed to the expectations of a molecular clock. Because 87.80% of nodes did not follow a molecular clock, we used a relaxed-clock, semiparametric approach, penalized likelihood (PL; Sanderson, 2002), implemented in the program r8s v1.70 (Sanderson, 2003), to estimate divergence times within *Cardueae*. PL allows divergence rates to vary along the tree but penalizes rate variation between ancestor and descendant by a smoothing parameter. To select an optimal level of smoothing, we performed the fossil cross-validation process (Near and Sanderson, 2004). Phylogenetic uncertainty in divergence times was incorporated using a similar approach to Buerki et al. (2011): we performed PL analysis on 1000 trees randomly selected from the Bayesian Markov Chain Monte Carlo (MCMC) stationary distribution, after discarding those trees that did not conform with the topological constraints imposed by the fossil calibrations, i.e., trees that did not support the monophyly of clades to which a fossil calibration point was attached (see below). Results from the 1000 dating analyses were summarized using TreeAnnotator v.1.4.7 (Drummond and Rambaut, 2007) and subsequently used to estimate mean values and 95% confidence intervals for each node in the halfcompat consensus tree (Buerki et al., 2011).

Age constraints and the fossil record—Until recently, Asterales had a scant fossil record, and macrofossils were known mainly from the Neogene (Barreda et al., 2010b). New fossil discoveries in the last two years, however, have provided better estimates of the age of divergence of some basal lineages within *Compositae*, such as *Barnadesioideae*, as well as of closely related families such as *Calyceraceae*, *Goodeniaceae*, and *Menyanthaceae*. In particular, the pollen fossil record has been greatly enriched (see Barreda et al., 2010a, for a review).

Six fossil calibration points were used for estimating ages of divergence between lineages:

- a) The earliest accepted pollen fossil record of *Compositae* is *Tubulifloridites* sp. from the Paleocene-Eocene boundary of South Africa (Zavada and De Villiers, 2000; Zavada and Lowrey, 2010; Barreda et al., 2010a). We have used this age as a fixed age of 55.8 Ma for the stem *Compositae* in the dating analyses.
- b) The second calibration point used was the *Raiguenrayun cura* Barreda, Katinas, Passalia & Palazzesi capitulescence from the Patagonian described as belonging to the crown *Compositae* (Barreda et al., 2012) and dated by radiometric methods at 47.5 Ma. We have used this fossil as a minimum age constraint for the split between *Barnadesioideae* and the rest of *Compositae*.
- c) As a minimum age constraint for the crown group of the subfamily *Barnadesioideae*, we used the fossil pollen *Quilembaypollis* sp., from the Patagonian Oligocene-Miocene, dated at 23 Ma (Palazzesi et al., 2009).
- d) Split of lineages *Arctium minus* and *A. lappa* was set to a minimum age of 8 Ma, based on mid-late Miocene achenes described by Mai (2001) and assigned to *Arctium* (López-

Vinyallonga et al., 2009).

- e) Stem lineage of *Carduus-Cirsium* was set to a minimum age of 14 Ma based on mid Miocene achenes identified as *Cirsium* (Mai, 1995).
- f) The minimum stem age for *Centaurea* was set to 5 Ma, based on several records of pollen and achenes for this genus dating from the early Pliocene onwards (e.g. Mai, 1995; Popescu, 2002).

Ancestral area reconstruction—Biogeographic areas were defined on the basis of patterns of endemism among current taxa (Table 2; Susanna and Garcia-Jacas, 2007; Greuter, 2006-2009) and to maximize congruence with large-scale biogeographic patterns and paleogeographic history (Takhtajan, 1986). Generic distributions were scored according to the distribution of the species representing each genus in the dataset. These in turn were selected so as to cover the entire distribution range of the genus and to minimize bias in taxon sampling. Additionally, we checked phylogenetic studies on several genera of Cardueae (Hidalgo et al., 2006; Garnatje et al., 2007; Garcia-Jacas et al., 2008; López-Vinyallonga et al., 2009; Sánchez-Jiménez et al., 2010; Vilatersana et al., 2000; 2010) to ensure that the scored distribution ranges represent the most likely ancestral distribution of the genus (*sensu* Ronquist, 1996); for example, we discarded rare distributions that were presumably the result of human introductions (Nylander et al., 2008). Fourteen areas were defined (Fig. 1): A, Western Mediterranean Basin; B, Eastern Mediterranean Basin (the Balkans Peninsula); C, Western Asia, including the Anatolian Peninsula, the Caucasus, the Levant region, Iran and Iraq; D, Central and North Europe; E, Middle Asia, including the Mountains of Tian Shan and Pamir; F, Japan; G, Macaronesia; H, North America; I, Southern South America; J, Central and South Africa; K, Himalayan range; L, North Africa; M, coastal areas along the Indian Ocean from the Horn of Africa to India; and N, Australia.

A parsimony method that minimizes dispersal and extinction events, dispersal-vicariance analysis (DIVA, Ronquist, 1997), was used to reconstruct ancestral areas and biogeographic events for the main lineages within Cardueae based on dataset 2. We assumed that the dispersal ability of the ancestors was probably not higher than that of extant species (Sanmartín, 2003) and limited the maximum number of areas in ancestral distributions in DIVA to four, which is the maximum distributional range of most species within Cardueae. To account for uncertainty in phylogenetic relationships, i.e., the existence of soft polytomies and/or weak nodal support in the Bayesian majority-rule consensus tree, we followed the Bayes-DIVA approach of Nylander et al. (2008). We used Perl scripts (Nylander et al., 2008) to average DIVA parsimony-based reconstructions over a post burn-in sample of trees from the MCMC Bayesian analysis of dataset 2 (in all 7502 trees). We then summarized these frequencies as marginal probabilities for alternative ancestral areas for each node in a reference tree, in this case, the halfcompat consensus tree of dataset 2.

RESULTS

Table 2 shows sequence variation and several numeric parameters from the phylogenetic analysis of the combined (ITS + cpDNA) dataset 1 and the chloroplast (cpDNA) dataset 2. Both datasets recovered similar topologies under the two methods of phylogenetic inference (MP and BI). Figure 2 and Appendix S2 (see Supplemental Data in the online version of this article) show the BI consensus tree with bootstrap support (BS) and posterior probability (BPP) values for each node for datasets 1 and 2, respectively. Since the combined dataset provided further resolution in the basal nodes and generally yielded better support values, we discuss here phylogenetic relationships based on dataset 1 (Fig. 2).

Our phylogenetic analysis supported the monophyly of tribe Cardueae (BS = 100%, BPP = 1; Fig. 2), and of subtribes Cardopatiinae (BS = 99%, BPP = 1; Fig. 2), Carlininae (BPP = 1; Fig. 2), Echinopsinae (BS = 100%, BPP = 1; Fig. 2) and Centaureinae (BS = 100%, BPP = 1; Fig. 2), the latter embedded within Carduinae. Subtribe Cardopatiinae was shown as sister-group to the rest of subtribes, while subtribes Carlininae and Echinopsinae appeared as consecutive sister-clades to the Carduinae/Centaureinae clade (Fig. 2). The phylogenetic position of subtribe Echinopsinae was only moderately supported (BPP = 0.84; Fig. 2). Subtribe Carduinae was recovered as paraphyletic in the analysis, with Centaureinae nested within it (Fig. 2). Phylogenetic relationships within the main informal groups defined by Susanna et al. (2006) and Susanna and Garcia-Jacas (2009) were only partially resolved. Within subtribe Carduinae, the formerly unassigned genus *Dipterocome* was placed with the *Xeranthemum* group as sister to the rest of the taxa (BS = 79%, BPP = 1; Fig. 2). The two African *Carduus* L. species in our analyses (*C. keniensis* and *C. nyassanus*) were here shown to be closely related to *Cirsium*, rendering *Cirsium* as paraphyletic (Fig. 2). The *Arctium-Cousinia* group was recovered as polyphyletic, with *Cousinia* Cass. nested within the *Jurinea-Saussurea* group (BPP = 1; Fig. 2). Within subtribe Centaureinae, a basal clade including *Goniocaulon*, *Schischkinia* Iljin and *Volutaria* Cass. (e.g. the *Volutaria* group; excluding *Mantiscalca salmantica*) was shown as sister to the rest of the taxa (Fig. 2). Our analysis also confirmed the monophyly of “core” Centaureinae, with *Rhaponticoides hajastana* as sister to the rest of the clade, including *Centaurea* s.str. and the *Carthamus-Carduncellus* group (Fig. 2).

Phylogenetic analysis of dataset 2 (Appendix S2) produced a tree topology with the same supported clades as dataset 1. The only exception was the clade grouping the *Arctium-Cousinia* group, the *Carduus-Cirsium* group and the *Cynara* group, which was recovered as sister group to Centaureinae, with a high BPP support value (BPP = 1; Appendix S2).

Figure 3 provides mean divergence times for all nodes within Cardueae and Appendix S3 (see Supplemental Data in the online version of this article) shows mean age values and credibility intervals. Figure 4 displays ancestral ranges of tribe Cardueae. According to our spatial-temporal reconstruction, tribe Cardueae originated around the Middle Eocene (Fig. 3) in West Asia (node 1, Fig. 4). The origin of Cardopatiinae was dated in the Early Oligocene (Fig. 3), with considerable uncertainty in its biogeographic origin, although West Asia (area C) and Middle Asia (E) were included within the ancestral ranges with the highest marginal probability (node 2, Fig. 4). An ambiguous origin for subtribe Carlininae in the Late Eocene was inferred (Fig. 3), but again West Asia-Middle Asia (areas C and E), formed part of the most likely ancestral range (node 3, Fig. 4). Subtribes Echinopsinae, Carduinae and Centaureinae were reconstructed to have originated in West Asia (nodes 4–6; Fig. 4) during the Early Miocene, the Late Eocene, or the Late Oligocene, respectively (Fig. 3).

DISCUSSION

Phylogenetic Relationships—In comparison with previous studies of the tribe (Susanna et al., 2006; Garcia-Jacas et al., 2002), our phylogeny, including two new cpDNA markers, provided better resolution of basal relationships within Cardueae. Cardopatiinae was reconstructed as sister-group to the other subtribes, with subtribe Carlininae diverging next, followed by Echinopsinae, although the phylogenetic position of the latter was not well supported (Fig. 2, Appendix S2). Petit (1997) interprets similarities between the inflorescences of subtribes Cardopatiinae and Echinopsinae as indicating a close phylogenetic relationship, but our phylogeny indicated that these are probably the result of convergence, with Echinopsinae closer to the Carduinae-Centaureinae clade.

Our study showed Carlininae as the next diverging subtribe within Cardueae (Fig. 2, Appendix S2). This subtribe is characterized by some morphological traits, such as the

presence of true ligules in *Atractylis*, that are considered to be plesiomorphic within *Cardueae* (Susanna and Garcia-Jacas, 2009). Within subtribe *Carduinae*, *Dipterocome* was shown as sister-group to the remaining genera of the *Xeranthemum* group (Fig. 2, Appendix S2), with which it shares (together with *Siebera* J. Gay) a bilabiate corolla (Anderberg et al., 2007). Our phylogenetic analysis did not agree with previous studies (López-Vinyallonga et al., 2009) on the phylogenetic relationships within the *Arctium-Cousinia* group, which could be due to different general sampling and outgroup selection of these two works, with different aims. Although previous studies (Vilatersana et al., 2010) found statistical support for the monophyly of the *Cynara* complex (including *Cynara* L., *Lamyropsis* (Kharadze) Dittrich, and *Ptilostemon* Cass.), this was not supported by our analyses (Fig. 2, Appendix S2). The position of the annual Mediterranean species *Galactites tomentosa* could not be resolved (Fig. 2, Appendix S2), and this can be explained by a long-branch attraction artifact produced by the rapid accumulation of evolutionary changes resulting from the annual life cycle of this species (Felsenstein, 1978). Taxonomic delimitation of the two largest genera *Carduus* (90 species) and *Cirsium* (250 species) has long been controversial (Häffner and Hellwig, 1999). Our analyses confirmed the close relationship among *Carduus* species from tropical East Africa and *Cirsium* (Fig. 2, Appendix S2). Häffner and Hellwig (1999) suggest the same affinities on the basis of morphological similarities.

Within subtribe *Centaureinae*, the *Volutaria* group (Fig. 2, Appendix S2) was placed as sister group to the rest of *Centaureinae*, in agreement with Susanna et al. (2011). The annual genus *Schischkinia* was nested within this clade. Previous phylogenetic studies (Garcia-Jacas et al., 2001; Susanna et al., 2006) group *Schischkinia* within a clade of annual genera, including *Stizolophus* and *Zoegea* but this position is likely to be an artifact derived from the inclusion of annuals within a group of mainly perennial genera. Lopez-Viñallonga et al. (2009) already discussed other examples of artificial placement of annual species nested within mainly perennial lineages within *Cardueae*. As in Susanna et al. (2011) the American *Plectocephalus* was monophyletic only if it included *Centaurodendron*, the pachycaul tree endemic to Juan Fernández Islands. Further discussion on this clustering is reported in Susanna et al. (2011). *Rhaponticoides* Vaill. has been related to several basally-diverging groups in *Centaureinae* based on the presence of morphological traits, such as a caudate hilum,

the *Centaurea centaurium*-pollen type, and a chromosome number of $x = 15$ (Garcia-Jacas et al., 1996). However, our analyses showed that this species is more closely related to other “core” Centaureinae genera (Fig. 2).

Historical biogeography of Cardueae — Divergence among the three subtribes of Carduoideae included in this study (Cardueae, Oldenburgieae and Tarchonantheae) was dated to approximately the Early Eocene. Despite this early divergence, only Cardueae presents a high species diversity and a range of distribution out of Africa. The aridification process that began in Africa from the Oligocene onwards (Ortiz et al., 2009) could explain the low radiation in the other tribes, which remained restricted to this area.

Within Cardueae, our dating biogeographic analysis suggested a complex biogeographical history, with an origin in West Asia and early diversification in the Mediterranean and Middle Asian regions, followed by repeated intercontinental dispersal events (Figs. 4, 5). Despite considerable morphological variation, and the presumed role of this organ in seed dispersal in Compositae, the pappus of Cardueae does not seem to function as an effective long dispersal mechanism, because the pappus is often too small, or if large, it is deciduous (Susanna and Garcia-Jacas, 2007). Hence, the present widespread distribution of Cardueae is more likely due to short or medium-distance migration events and rarely to long distance dispersal (except in the cases of colonization of oceanic islands like *Rhaponticum australe* in Japan and *Cheirolophus* Cass. in Macaronesia. Given the large confidence intervals for some divergence time estimates (Fig. 3, Appendix S3), the following discussion will only focus on major biogeographic patterns and/or events. Nevertheless, the spatio-temporal framework given here (Figure 4) will provide a valuable basis for further studies focusing on specific clades of Cardueae.

Origin in West Asia and Mediterranean diversification (Figure 4)— The origin of the tribe Cardueae was inferred to be in West Asia around the Middle Eocene (node 1, Fig. 4). This date is much older than those suggested in other molecular studies, in which the stem-age of the tribe is estimated as ca. 29–24 Ma (Kim et al., 2005). Indeed, our dating corresponds to the oldest age among tribes of Compositae: 23 Ma in

Anthemideae (Oberprieler, 2005), 28 Ma in Cichorieae (Zhang et al., 2011), 34.5 Ma in Gnaphalieae (Bergh and Linder, 2009), while Kim et al. (2005) date the radiation of Compositae tribes as Oligocene in age. This difference in age might be attributed to the existence of a better calibration point provided by the recent discovery of an Eocene fossil of Compositae in South America (Barreda et al., 2010b; 2012). Though a Palaeogene fossil record exists (Barreda et al., 2010b), it is sparse and thus not suitable for calibrating a phylogenetic tree, so the Eocene fossil of Barreda et al. (2010b) is the oldest fossil of Compositae available at the moment.

Our reconstruction indicates that ancestors of *Cardueae* dispersed from Africa to West Asia, probably via stepping-stones along the Tethyan coast. The most probable dispersal route is across northeastern Africa (Fig. 4A), since all western Mediterranean *Cardueae* lineages were inferred to have a west Asian origin. Nevertheless, a dispersal event through the Iberian plate cannot be ruled out, since the position of the African plate with regard to Iberia has remained stable for the last 65 million years (Meulenkamp and Sissingh, 2003; Fig. 4A). Phylogenetic studies in other angiosperm groups have also indicated a West Asian origin for clades that, like *Cardueae*, are species-rich in the Mediterranean Basin, e.g., *Campanula* L. (Roquet et al., 2009), *Arum* L. (Espíndola et al., 2010); *Loliinae* (Inda et al., 2008). Quézel (1985) also stresses the importance of West Asian (Irano-Turanian) elements in the Mediterranean flora, which presumably invaded the Mediterranean Basin in several waves from the Eocene onwards.

The first divergence event, splitting *Cardopatiinae* from the rest of subtribes, was dated as Early Oligocene (node 7, Fig. 3). The facts that the two genera included in this subtribe, *Cardopatium* Juss. and *Cousiniopsis* Nevski, are monotypic, and that they have disjunct distributions, suggests that *Cardopatiinae* could be a palaeoendemic group (*sensu* Stebbins and Major, 1965), a relict of a former widespread distribution. *Cardopatium corymbosum* is a perennial, ruderal species that does not extend westwards beyond Tunisia (North Africa), and is limited in Europe to Sicily and Greece. *Cousiniopsis atractylodes* is an annual herb adapted to the deserts of Middle Asia. A perennial habit is probably the ancestral state of *Cardopatiinae*, as has been suggested for the entire tribe *Cardueae* (Ortiz et al., 2009). The aridification of Middle Asia during

the Oligocene-Miocene transition (Tang et al., 2011) triggered the formation of dry steppe and semi-desert landscapes with abundant herbaceous xerophytes, and this could have favored the adaptation of *Cousiniopsis* to this new habit.

The geographic origin of subtribe Carlininae (node 3, Fig. 4) was uncertain, whereas initial diversification in the remaining subtribes (Echinopsinae, Carduinae, and Centaureinae) was inferred to have occurred in West Asia (nodes 4–6, respectively, Fig. 4), followed by repeated dispersal events across the Mediterranean region. Many of these events were dated to the Oligocene-Miocene period, when additions of microplates located between the Paratethys and Tethys formed a continuous landmass across the Mediterranean, which connected the West Mediterranean Basin with the West Asia-Eastern Mediterranean region (Meulenkaamp and Sissingh, 2003). This landmass might have enabled the dispersal/migration of Cardueae along the Mediterranean basin (Fig. 4B). Thompson (1999) point out the importance of Late Miocene tectonic movements in explaining Mediterranean plant disjunctions. Oosterbroek and Arntzen (1992) suggest a similar connection pattern to explain the East-West Mediterranean disjunctions of several animal groups. In our analysis, repeated expansions to the East Mediterranean Basin and Central Europe in the Oligocene-Miocene were inferred for subtribes Carduinae (nodes 8–10, Fig. 4) and Carlininae (nodes 11–12, Fig. 4).

The Messinian Salinity Crisis (MSC, 5.96–5.33 Ma; Duggen et al., 2003) is another period for which trans-Mediterranean dispersal of several plant groups has been suggested (Thompson, 1999). During this time, climate aridification and the closing of the Gibraltar Strait caused a general drop of sea level in the Mediterranean Basin, allowing species to reach areas previously isolated by sea barriers (Fig. 4C). Land connections between Iberia and North Africa during the Late Miocene (Fig. 4C) would have allowed migration across North Africa and the Eastern Mediterranean for lineages belonging to the “core” Centaureinae (nodes 13–15, Fig. 4). Diversification of *Onopordum* L. (Carduinae) in the Mediterranean Region (node 16, Fig. 4) was dated as Pliocene (Fig. 3), when rapid climate oscillations would have favored migration of these species, some of them weeds, through disrupted habitats.

Dispersal to Africa and Macaronesia — Our analysis suggested that several *Cardueae* species have migrated secondarily to the mountains of tropical Africa. The *Cardueae* species that reached Africa are only found in mountain areas of this continent; this may indicate that these species colonized Africa during cooler periods and found refuge in the mountain regions of tropical Africa when the climate started to become arid again. Within *Carduinae*, *Carduus nyassanus* and *C. keniensis* (node 17, Fig. 5A) reached Africa in the Pleistocene (Fig. 3). Similarly, in *Echinopsinae* (*Echinops angustilobus* and *E. hoehnelii*) a dispersal event from West Asia to Central/South Africa or the Horn of Africa (node 18, Fig. 5A) was inferred to have occurred during the Quaternary glaciations.

Paleogeographic reconstruction of the Macaronesia region shows that this archipelago has been available for colonization and for stepping-stone dispersals between continents during a broad time scale (Fernandez-Palacios et al., 2011). *Cardueae* have reached Macaronesia at least twice independently at very different time intervals, as inferred by our analyses. The first relates to *Cheirolophus* (node 19, Fig. 4) and occurred sometime during the Late Miocene (node 87, Fig. 3). Poor representation of this genus in our analysis and weakly resolved relationships with other groups (Fig. 2) made it difficult to reconstruct the origin and direction of this dispersal event, but previous studies have suggested a North African origin for this genus (Susanna et al., 1999). Apart from Macaronesia, the highest species richness for the genus is found in the Western Mediterranean region and North Africa, with one species, *C. crassifolius* occurring in the Central Mediterranean (Malta).

A second dispersal event to Macaronesia was inferred for subtribe *Carlinae* (node 20, Fig. 4) during the Pleistocene (Fig. 3), in the split between *Carlina falcata* (endemic to the island of La Palma) and *C. lanata* (widely distributed in the Mediterranean basin). Lower sea levels associated with the Quaternary glaciations may have facilitated stepping-stone dispersal events to the Canary Islands (García-Talavera, 1997), probably from North Africa, where other *Carlina* species are currently distributed.

Expansion to the east: the Himalayan uplift (Figure 5)— Along with the Mediterranean region, Middle Asia seems to have been a major area of diversification for the *Cardueae* (Susanna & Garcia-Jacas, 2009), especially for subtribe *Carduinae*, for

which the uplift of the Qinghai-Tibetan plateau (QTP) played a major role. The uplift of the QTP occurred at several periods, commencing with the Early Eocene collision of India with Eurasia (52 to 45 Ma; Rowley, 1996). Four major periods of uplift have been proposed: 22–20, 15–13, 8–7 and 3.6–1.8 Ma (Wang et al., 2009 and references therein). Intense orogenic activity would have led to the isolation of populations in valleys and the formation of new habitats on the slopes and peaks of the mountains, which, in turn, contributed to the diversification of plant groups in this region via allopatric speciation. The aridification process triggered by the retreat of the Paratethys Sea (Tang et al., 2011), and the shadow effect created by the uplift of the high Asian plateaus and mountains (Tibet, Pamir, Tian Shan), would have favored diversification in cold- and dry-adapted taxa, such as *Cardueae*.

Dispersal events from West Asia to Middle Asia were inferred in all five subtribes. In *Carlininae*, a range expansion to Middle Asia and Japan was reconstructed for the Late Eocene-Early Oligocene (node 3, Fig. 5B). This migration event is more likely to have followed a northern route (through the North Caspian Sea) before the uplift of the Pamir Mountains, with later extinction of these xeric adapted taxa in cold latitude areas. Another option is a southern route using the Iranian connection because no basally diverging *Carlininae* species occur in south-west Asia (e.g., the Kopet-Dag mountains), where more xeric habitats occur.

The *Arctium* and the *Cousinia-Jurinea-Saussurea* clades recovered in our phylogenetic analysis were reconstructed to have originated in Middle Asia in the Late Oligocene (nodes 21–23, Fig. 4), with divergence of *Arctium* around the Early Miocene (Fig. 3). This is considerably older than previous estimates, which placed the origin of this genus around the Late Miocene (9.68 Ma; López-Vinyallonga et al., 2009), and can be explained by differences in dating methods: the study by López-Vinyallonga et al. (2009) applied a strict molecular clock approach calibrated with ITS substitution rates, whereas here we used a fossil-calibration molecular dating approach. *Arctium* (previously known as Arctioid *Cousinia* species; Lopez-Vinyallonga et al., 2011) includes narrow endemics in the Tian Shan Mountains of Middle Asia, which present character states in pollen morphology and chromosome number that are considered plesiomorphic within the *Cousinia* group (López-Vinyallonga et al., 2009). The several periods of uplift of QTP during the Middle-Late Miocene might have triggered the diversification of the *Arctium*

group (Fig. 5B), which contains species adapted to cold and dry habitats. The Late Miocene age of *Cousinia* estimated here (Fig. 3) agrees well with the estimations of López-Vinyallonga et al. (2009), who dates the origin of *Cousinia* to 8.72 Ma. The date inferred for initial diversification of this genus – one of the largest in Compositae with ca. 500 species – within the Irano-Turanian phytogeographical region is in agreement with the geological events, as the uplifting of mountain belts in the borders of the Iranian plateau during the rapid QTP uplift took place in the Late Miocene (ca. 8 ma; Zhang and Fritsch, 2010), following the collision of the Indian and Eurasian plates (Dercourt et al., 1986).

Within Carduinae, the split of the Himalayan endemic *Xanthopappus* (node 24, Fig. 5B) was dated to the Middle Miocene (Fig. 3) and is probably associated with the Miocene QTP uplift some 15–13 Ma (Harrison et al., 1992; Spicer et al., 2003; Fig. 5B). Wang et al. (2007) postulate a similar hypothesis, but their molecular dating analysis estimates a younger age for *Xanthopappus* (5.7–4.7 Ma), probably because they used ITS substitution rate to date their tree instead of fossil calibration. Migration from West Asia to the Himalayas in the Echinopsinae clade (node 25, Fig. 5B) was date to the Quaternary (Fig. 3). The most recent period of uplift of the Qinghai-Tibetan Plateau that occurred sometime between 3.6–1.8 Ma (Zhang and Fritsch, 2010) may have favored diversification in this clade (Fig. 5B).

Only two genera of Centaureinae, *Goniocaulon* and *Tricholepis* DC., are present in south and Southeast Asia (India and Burma). Both belong to the *Volutaria* group, sister-group to the remaining Centaureinae. *Goniocaulon* was reconstructed to have migrated in the Early Miocene (Fig. 3) from West Asia (node 26, Fig. 5A), before the closing of this route by the uplifting of the Himalayas. A remarkable migration event from the East Mediterranean/West Asia to Australia dated to the Mid Miocene (Fig. 3) may explain the distribution of the only Centaureinae species native to Australia, *Rhaponticum australe* (node 27, Fig. 5A). The presence in China, Mongolia, Korea, and Japan of *R. uniflorum*, sister species to *R. australe* (Hidalgo et al., 2006), suggests that this long-distance dispersal was mediated via Middle and East Asia (Fig. 5A). Migration from South East Asia to Australia was possible after the collision of the Asian and Australian plates in the Miocene, which led to the uplift of high mountain chains along Malaysia, northeastern Australia and the Highlands of New Guinea, and the onset of a drying trend that enabled

the colonization of temperate taxa along the newly created montane habitats (Sanmartín, 2002).

Colonization of the New World: long distance dispersal or land-based migration? (Figure 5)—Floristic exchanges between North America and Asia were possible until about 3.5 Ma, when the Bering Land Bridge (BLB) ceased to be available as a land connection, but were re-established during the Pleistocene during glacial periods (Wen, 1999; Sanmartín et al., 2001). Two dispersal events to the New World were inferred in our analyses. The first one is inferred for the *Plectocephalus* group (node 28, Fig. 5A), whose main distribution is North and South America, but it is also found in Ethiopia. The closest relatives of *Plectocephalus* were not resolved in our phylogenetic reconstruction, but Susanna et al. (2011) suggest that the ancestors of this group could have occurred in West and Middle Asia, since its representatives share morphological characters with *Psephellus* Cass. (distributed in Turkey, the Caucasus and the Irano-Turanian region) and *Phalacrachena* Iljin (distributed in Ukraine and Russia). This distribution pattern would indicate migration of *Plectocephalus* ancestors from West Asia to the New World via the BLB, with posterior extinction occurring in East Asia. Migration of xeromorphic *Plectocephalus* may have been favored by the formation of xeric habitats in Middle and East Asia following the Late Oligocene-Miocene aridification event (Susanna et al., 2011). The temporal framework of this hypothesis agrees well with our dating analyses, which estimates that *Plectocephalus* originated in the Middle Miocene (Fig. 3), before the opening of the Bering Strait and coincident with the existence of a land connection between Siberia and northwestern North America (the “second Beringian Land Bridge”, Sanmartín et al., 2001). Our reconstruction also suggests the occurrence of a dispersal event from South America to the Horn of Africa-India during the internode leading to the split of *P. varians* (node 29, Fig. 5A), which seems unlikely knowing the origin of this group. A more probable explanation is that the ancestor of *P. varians* migrated from West Asia to East Africa. Differences in life cycle and evolution rates between species could be responsible for the difficulties encountered in elucidating actual phylogenetic and biogeographic relationships within the *Plectocephalus* group (Susanna et al., 2011).

A second migration event to North America during the Pliocene (Fig. 3) is shown in the clade formed by two eastern North American *Cirsium* species (*C. scariosum* and *C. tracyi*) included in the *Carduus-Cirsium* group (node 30, Fig. 5A). New World *Cirsium* lineage has been shown as a monophyletic group by Kelch & Baldwin (2003) indicating a single colonization event of the North American continent by this lineage. Unfortunately, the sister clade to the New World *Cirsium* clade is not resolved in our analyses, and thus, we are not able to infer the direction of this dispersal, although the origin of the New World clade is probably explained by a migration via the second BLB before its closure (Sanmartín et al., 2001), probably from Middle Asia, where other *Cirsium* species are found.

LITERATURE CITED

- AKAIKE, H. 1973. Information theory and an extension of the maximum likelihood principle. In B. N. Petrov, and F. Csáki [eds.], Second International Symposium on Information Theory, 267–281. Akadémiai Kiadó, Budapest, Hungary.
- ANDERBERG, A. A., F. GHAREMANINEJAD, AND M. KÄLLERSJÖ. 2007. The enigmatic genus *Dipterocome*. *Compositae Newsletter* 45: 23–36.
- BARREDA, V. D., L. PALAZZESI, L. KATINAS, J. V. CRISCI, M. C. TELLERÍA, K. BREMER, M. G. PASSALA, et al. 2012. An extinct Eocene taxon of the daisy family (Asteraceae): evolutionary, ecological and biogeographical implications. *Annals of Botany* 109: 127–134.
- BARREDA, V., L. PALAZZESI, M. C. TELLERÍA, L. KATINAS, AND J. V. CRISCI. 2010a. Fossil pollen indicates an explosive radiation of basal Asteracean lineages and allied families during Oligocene and Miocene times in the Southern Hemisphere. *Review of Palaeobotany and Palynology* 160: 102–110.
- BARREDA, V. D., L. PALAZZESI, M. C. TELLERÍA, L. KATINAS, J. V. CRISCI, K. BREMER, M. G. PASSALIA, et al. 2010b. Eocene Patagonia fossils of the daisy family. *Science* 329: 1621–1621.
- BENTHAM, G. 1873. Compositae. In G. Bentham, and J. D. Hooker [eds.], *Genera Plantarum*, 162–533. Lovell Reeve, London, UK.

- BERGH, N. G., AND H. P. LINDER. 2009. Cape diversification and repeated out-of-southern-Africa dispersal in paper daisies (Asteraceae-Gnaphalieae). *Molecular Phylogenetics and Evolution* 51: 5–18.
- BRITTON, T., C. L. ANDERSON, D. JACQUET, S. LUNDQVIST, AND K. BREMER. 2007. Estimating divergence times in large phylogenetic trees. *Systematic Biology* 56: 741–752.
- BUERKI, S., F. FOREST, N. ALVAREZ, J. A. A. NYLANDER, N. ARRIGO, AND I. SANMARTÍN. 2011. An evaluation of new parsimony-based versus parametric inference methods in biogeography: a case study using the globally distributed plant family Sapindaceae. *Journal of Biogeography* 38: 531–550.
- CABRERA, A. L. 1977. Mutisieae – systematic review. In V. H. Heywood, J. B. Harborne, and B. L. Turner [eds.], *The biology and chemistry of the Compositae*, 1039–1066. Academic Press, London, UK.
- CASSINI, H. 1819. Sur la famille des Synanthérées, contenant les caractères des tribus. *Journal de Physique, de Chimie, d'Histoire Naturelle et des Arts* 88: 189–204.
- CULLINGS, K. W. 1992. Design and testing of a plant-specific PCR primer for ecological and evolutionary studies. *Molecular Ecology* 1: 233–240.
- DE GRAVE, J., M. M. BUSLOV, AND P. VAN DEN HAUTE. 2007. Distant effects of India-Eurasia convergence and Mesozoic intracontinental deformation in Central Asia: Constraints from apatite fission-track thermochronology. *Journal of Asian Earth Sciences* 29: 188–204.
- DERCOURT, J., L. P. ZONENSHAIN, L. E. RICOU, V. G. KAZMIN, X. LE PICHON, A. L. KNIPPER, C. GRANDJACQUET, et al. 1986. Geological evolution of the Tethys belt from the Atlantic to the Pamirs since the Lias. *Tectonophysics* 123: 241–315.
- DOYLE, J. J., AND E. E. DICKSON. 1987. Preservation of plant-samples for DNA restriction endonuclease analysis. *Taxon* 36: 715–722.
- DRUMMOND, A. J., AND A. RAMBAUT. 2007. BEAST: Bayesian evolutionary analysis by sampling trees. *BMC Evolutionary Biology* 7: 214.
- DUGGEN, S., K. HOERNLE, P. VAN DEN BOGAARD, L. RUPKE, AND J. P. MORGAN. 2003. Deep roots of the Messinian salinity crisis. *Nature* 422: 602–606.
- ELDENÄS, P., M. KÄLLERSJÖ, AND A. A. ANDERBERG. 1999. Phylogenetic placement and circumscription of tribes Inuleae s. str. and Plucheeae (Asteraceae): Evidence from sequences of chloroplast gene *ndhF*. *Molecular Phylogenetics and Evolution* 13: 50–58.

- ESPÍNDOLA, A., S. BUERKI, M. BEDALOV, P. KÜPFER, AND N. ALVAREZ. 2010. New insights into the phylogenetics and biogeography of *Arum* (Araceae): Unravelling its evolutionary history. *Botanical Journal of the Linnean Society* 163: 14–32.
- FARRIS, J. S., M. KÄLLERSJÖ, A. G. KLUGE, AND C. BULT. 1995a. Testing significance of incongruence. *Cladistics* 10: 315–319.
- FARRIS, J. S., M. KÄLLERSJÖ, A. G. KLUGE, AND C. BULT. 1995b. Constructing a significance test for incongruence. *Systematic Biology*. 44: 570–572.
- FAY, M. F., C. BAYER, W. S. ALVERSON, A. Y. DE BRUIJN, AND M. W. CHASE. 1998. Plastid *rbcL* sequence data indicate a close affinity between *Diegodendron* and *Bixa*. *Taxon* 47: 43–50.
- FELSENSTEIN, J. 1978. Cases in which parsimony or compatibility methods will be positively misleading. *Systematic Zoology* 27: 401–410.
- FELSENSTEIN, J. 1985. Confidence limits on phylogenies: An approach using the bootstrap. *Evolution* 39: 783–791.
- FERNANDEZ-PALACIOS, J. M., L. DE NASCIMENTO, R. OTTO, J. D. DELGADO, E. GARCIA-DEL-REY, J. R. AREVALO, AND R. J. WHITTAKER. 2011. A reconstruction of Palaeo-Macaronesia, with particular reference to the long-term biogeography of the Atlantic island laurel forests. *Journal of Biogeography* 38: 226–246.
- FUNK, V. A., A. SUSANNA, T. F. STUESSY, AND H. ROBINSON. 2009. Classification of Compositae. In V. A. Funk, A. Susanna, T. F. Stuessy, and R. J. Bayer [eds.], *Systematics, evolution, and biogeography of Compositae*, 171–189. IAPT, Vienna, Austria.
- GARCIA-JACAS, N., M. GALBANY-CASALS, K. ROMASCHENKO, AND A. SUSANNA. 2008. On the conflicting generic delineation in the *Onopordum* group (Compositae, Cardueae-Carduinae): a combined nuclear and plastid molecular approach. *Australian Systematic Botany* 21: 301–311.
- GARCIA-JACAS, N., T. GARNATJE, A. SUSANNA, AND R. VILATERSANA. 2002. Tribal and subtribal delimitation and phylogeny of the Cardueae (Asteraceae): A combined nuclear and chloroplast DNA analysis. *Molecular Phylogenetics and Evolution* 22: 51–64.
- GARCIA-JACAS, N., A. SUSANNA, T. GARNATJE, AND R. VILATERSANA. 2001. Generic delimitation and phylogeny of the subtribe Centaureinae (Asteraceae): A combined nuclear and chloroplast DNA analysis. *Annals of Botany* 87: 503–515.

- GARCIA-JACAS, N., A. SUSANNA, AND R. ILARSLAN. 1996. Aneuploidy in the Centaureinae (Compositae): is $n=7$ the end of the series? *Taxon* 45: 39–42.
- GARCÍA-TALavera, F. 1997. Las Canarias orientales y la vecina costa africana en el Holoceno. *Eres* 7: 55–63.
- GARNATJE, T., S. GARCIA, AND M. A. CANELA. 2007. Genome size variation from a phylogenetic perspective in the genus *Cheirolophus* Cass. (Asteraceae): biogeographic implications. *Plant Systematics and Evolution* 264: 117–134.
- GOLOBOFF, P. A., J. S. FARRIS, AND K. NIXON. 2008. TNT, a free program for phylogenetic analysis. *Cladistics* 24: 774–786.
- GREUTER, W. 2006-2009. Compositae (*pro parte majore*). In W. Greuter, and E. von Raab-Straube [eds.], Compositae. Euro+Med Plantbase - the information resource for Euro-Mediterranean plant diversity. Website <http://www.emplantbase.org/home.html> [accessed 30 October 2009].
- HÄFFNER, E., AND F. H. HELLWIG. 1999. Phylogeny of the tribe Cardueae (Compositae) with emphasis on the subtribe Carduinae: An analysis based on ITS sequence data. *Willdenowia* 29: 27–39.
- HALL, T. A. 1999. BioEdit: a user-friendly biological sequence alignment editor and analysis program for Windows 95/98/NT. *Nucleic Acids Symposium Series* 41: 95–98.
- HARRISON, T. M., P. COPELAND, W. S. F. KIDD, AND A. YIN. 1992. Raising Tibet. *Science* 255: 1663–1670.
- HIDALGO, O., N. GARCIA-JACAS, T. GARNATJE, AND A. SUSANNA. 2006. Phylogeny of *Rhaponticum* (Asteraceae, Cardueae-Centaureinae) and related genera inferred from nuclear and chloroplast DNA sequence data: Taxonomic and biogeographic implications. *Annals of Botany* 97: 705–714.
- HIPP, A. L., J. C. HALL, AND K. J. SYTSMA. 2004. Congruence versus phylogenetic accuracy: Revisiting the incongruence length difference test. *Systematic Biology* 53: 81–89.
- HOFFMANN, O. 1894. Compositae. In A. Engler, and K. Prantl [eds.], Die natürlichen Pflanzenfamilien, 324–333. Engelmann, Leipzig, Germany.
- INDA, L. A., J. G. SEGARRA-MORAGUES, J. MULLER, P. M. PETERSON, AND P. CATALÁN. 2008. Dated historical biogeography of the temperate Loliinae (Poaceae, Pooideae) grasses in the northern and southern hemispheres. *Molecular Phylogenetics and Evolution* 46: 932–957.

KIM, K. J., K. S. CHOI, AND R. K. JANSEN. 2005. Two chloroplast DNA inversions originated simultaneously during the early evolution of the sunflower family (Asteraceae). *Molecular Biology and Evolution* 22: 1783–1792.

KIM, K. J., AND R. K. JANSEN. 1995. NdhF sequence evolution and the major clades in the sunflower family. *Proceedings of the National Academy of Sciences, USA* 92: 10379–10383.

LIDÉN, M., T. FUKUHARA, J. RYLANDER, AND B. OXELMAN. 1997. Phylogeny and classification of Fumariaceae, with emphasis on *Dicentra* s. l., based on the plastid gene rps16 intron. *Plant Systematics and Evolution* 206: 411–420.

LÓPEZ-VINYALLONGA, S., I. MEHREGAN, N. GARCIA-JACAS, O. TSCHERNEVA, A. SUSANNA, AND J. W. KADEREIT. 2009. Phylogeny and evolution of the *Arctium-Cousinia* complex (Compositae, Cardueae-Carduinae). *Taxon* 58: 153–171.

LÓPEZ-VINYALLONGA, S., K. ROMASCHENKO, A. SUSANNA, AND N. GARCIA-JACAS. Systematics of the Arctioid group: Disentangling *Arctium* and *Cousinia* (Cardueae, Carduinae). *Taxon* 60: 539–554.

LUNDBERG, J. 2009. Asteraceae and relationships within Asterales. In V. A. Funk, A. Susanna, T. F. Stuessy, and R. J. Bayer [eds.], Systematics, evolution, and biogeography of Compositae, 157–169. IAPT, Vienna, Austria.

MAI, D. H. 1995. Tertiäre Vegetationsgeschichte Europas: Methoden und Ergebnisse. Gustav Fischer Verlag, Jena, Germany.

MAI, D. H. 2001. Die mittelmiozänen und obermiozänen Floren aus der Meuroer und Raunoer Folge in der Lausitz, Teil II: Dicotyledonen. *Palaeontographica Abteilung B-Palaophytologie* 257: 35–174.

MEULENKAMP, J. E., AND W. SISSINGH. 2003. Tertiary palaeogeography and tectonostratigraphic evolution of the Northern and Southern Peri-Tethys platforms and the intermediate domains of the African-Eurasian convergent plate boundary zone. *Palaeogeography, Palaeoclimatology, Palaeoecology* 196: 209–228.

MÜLLER, K. 2006. Incorporating information from length-mutational events into phylogenetic analysis. *Molecular Phylogenetics and Evolution* 38: 667–676.

NEAR, T. J., AND M. J. SANDERSON. 2004. Assessing the quality of molecular divergence time estimates by fossil calibrations and fossil-based model selection. *Philosophical Transactions of the Royal Society B-Biological Sciences* 359: 1477–1483.

- NOTREDAME, C., D. G. HIGGINS, AND J. HERINGA. 2000. T-Coffee: A novel method for fast and accurate multiple sequence alignment. *Journal of Molecular Biology* 302: 205–217.
- NYLANDER, J. A. A. 2004. MrModeltest, version 2. Program distributed by the author. Evolutionary Biology Centre, Uppsala University, Uppsala, Sweden.
- NYLANDER, J. A. A., U. OLSSON, P. ALSTRÖM, AND I. SANMARTÍN. 2008. Accounting for phylogenetic uncertainty in biogeography: A Bayesian approach to dispersal-vicariance analysis of the thrushes (*Aves: Turdus*). *Systematic Biology* 57: 257–268.
- OBERPRIELER, C. 2005. Temporal and spatial diversification of Circum-Mediterranean Compositae-Anthemideae. *Taxon* 54: 951–966.
- OLMSTEAD, R. G., H. J. MICHAELS, K. M. SCOTT, AND J. D. PALMER. 1992. Monophyly of the Asteridae and identification of their major lineages inferred from DNA-sequences of *rbcl*. *Annals of the Missouri Botanical Garden* 79: 249–265.
- OOSTERBROEK, P., AND J. W. ARNTZEN. 1992. Area-cladograms of circum-Mediterranean taxa in relation to Mediterranean paleogeography. *Journal of Biogeography* 19: 3–20.
- ORTIZ, S., J. M. BONIFACINO, J. V. CRISCI, V. A. FUNK, H. V. HANSEN, D. J. N. HIND, L. KATINAS, et al. 2009. The basal grade of the Compositae: Mutisieae (sensu Cabrera) and Carduoideae. In V. A. Funk, A. Susanna, T. F. Stuessy, and R. J. Bayer [eds.], *Systematics, evolution, and biogeography of Compositae*, 193–213. IAPT, Vienna, Austria.
- PALAZZESI, L., V. BARREDA, AND M. C. TELLERÍA. 2009. Fossil pollen grains of Asteraceae from the Miocene of Patagonia: Barnadesioideae affinity. *Review of Palaeobotany and Palynology* 155: 83–88.
- PANERO, J. L., AND V. A. FUNK. 2008. The value of sampling anomalous taxa in phylogenetic studies: Major clades of the Asteraceae revealed. *Molecular Phylogenetics and Evolution* 47: 757–782.
- PETIT, D. P. 1997. Generic interrelationships of the Cardueae (Compositae): A cladistic analysis of morphological data. *Plant Systematics and Evolution* 207: 173–203.
- POPESCU, S. M. 2002. Repetitive changes in Early Pliocene vegetation revealed by high-resolution pollen analysis: Revised cyclostratigraphy of southwestern Romania. *Review of Palaeobotany and Palynology* 120: 181–202.
- QUÉZEL, P. 1978. Analysis of the flora of Mediterranean and Saharan Africa. *Annals of the Missouri Botanical Garden* 65: 479–534.

- QUÉZEL, P. 1985. Definition of the Mediterranean region and the origin of its flora. In C. Gómez-Campo [ed.], *Plant conservation in the Mediterranean area*, 9–24. Junk, Dordrecht, Netherlands.
- QUICKE, D. L. J., O. R. JONES, AND D. R. EPSTEIN. 2007. Correcting the problem of false incongruence due to noise imbalance in the incongruence length difference (ILD) test. *Systematic Biology* 56: 496–503.
- REE, R., AND SANMARTÍN, I. 2009. Prospects and challenges for parametric models in historical inference. *Journal of Biogeography* 36: 1211–1220.
- RONQUIST, F. 1996. DIVA, version 1.1 Computer program available by anonymous ftp. Uppsala University, Uppsala, Sweden.
- RONQUIST, F. 1997. Dispersal-vicariance analysis: A new approach to the quantification of historical biogeography. *Systematic Biology* 46: 195–203.
- RONQUIST, F., AND J. P. HUELSENBECK. 2003. MrBayes 3: Bayesian phylogenetic inference under mixed models. *Bioinformatics* 19: 1572–1574.
- ROQUET, C., I. SANMARTÍN, N. GARCIA-JACAS, L. SÁEZ, A. SUSANNA, N. WIKSTROM, AND J. J. ALDASORO. 2009. Reconstructing the history of Campanulaceae with a Bayesian approach to molecular dating and dispersal-vicariance analyses. *Molecular Phylogenetics and Evolution* 52: 575–587.
- ROWLEY, D. B. 1996. Age of initiation of collision between India and Asia: A review of stratigraphic data. *Earth and Planetary Science Letters* 145: 1–13.
- SÁNCHEZ-JIMÉNEZ, I., G. A. LAZKOV, O. HIDALGO, AND T. GARNATJE. 2010. Molecular systematics of *Echinops* L. (Asteraceae, Cynareae): A phylogeny based on ITS and *trnL-trnF* sequences with emphasis on sectional delimitation. *Taxon* 59: 698–708.
- SANDERSON, M. J. 2002. Estimating absolute rates of molecular evolution and divergence times: A penalized likelihood approach. *Molecular Biology and Evolution* 19: 101–109.
- SANDERSON, M. J. 2003. R8s: inferring absolute rates of molecular evolution and divergence times in the absence of a molecular clock. *Bioinformatics* 19: 301–302.
- SANMARTÍN, I. 2002. A paleogeographic history of the Southern Hemisphere. Available at Digital.CSIC: <http://hdl.handle.net/10261/34831>.
- SANMARTÍN, I. 2003. Dispersal vs. vicariance in the Mediterranean: historical biogeography of the Palearctic Pachydeminae (Coleoptera, Scarabaeoidea). *Journal of Biogeography* 30: 1883–1897.

- SANMARTÍN, I., H. ENGHOFF, AND F. RONQUIST. 2001. Patterns of animal dispersal, vicariance and diversification in the Holarctic. *Biological Journal of the Linnean Society* 73: 345–390.
- SANTOS-GALLY, R., P. VARGAS, AND J. ARROYO. 2011. Insights into Neogene Mediterranean biogeography based on phylogenetic relationships of mountain and lowland lineages of *Narcissus* (Amaryllidaceae). *Journal of Biogeography*. doi: 10.1111/j.1365-2699.2011.02526.x
- SOLTIS, D. E., P. S. SOLTIS, T. G. COLLIER, AND M. L. EDGERTON. 1991. The *Heuchera* group (Saxifragaceae): Evidence for chloroplast transfer and paraphyly. *American Journal of Botany* 78: 1091–1112.
- SPICER, R. A., N. B. W. HARRIS, M. WIDDOWSON, A. B. HERMAN, S. X. GUO, P. J. VALDES, J. A. WOLFE, AND S. P. KELLEY. 2003. Constant elevation of southern Tibet over the past 15 million years. *Nature* 421: 622–624.
- STEBBINS, G. L., AND J. MAJOR. 1965. Endemism and speciation in California flora. *Ecological Monographs* 35: 1–35.
- SUSANNA, A., M. GALBANY-CASALS, K. ROMASCHENKO, L. BARRES, J. MARTÍN, AND N. GARCIA-JACAS. 2011. Lessons from *Plectocephalus* (Compositae, Cardueae-Centaureinae): ITS disorientation in annuals and Beringian dispersal as revealed by molecular analyses. *Annals of Botany* 108: 263–277.
- SUSANNA, A., AND N. GARCIA-JACAS. 2007. Tribe Cardueae. In J. W. Kadereit, and C. Jeffrey [eds.], Flowering Plants. Eudicots. Asterales, vol. VIII. In K. Kubitzki [ed.], The families and genera of vascular plants, 123–146. Springer Verlag, Berlin, Germany.
- SUSANNA, A., AND N. GARCIA-JACAS. 2009. Cardueae (Carduoideae). In V. A. Funk, A. Susanna, T. F. Stuessy, and R. J. Bayer [eds.], Systematics, evolution, and biogeography of Compositae, 293–313. IAPT, Vienna, Austria.
- SUSANNA, A., N. GARCIA-JACAS, O. HIDALGO, R. VILATERSANA, AND T. GARNATJE. 2006. The Cardueae (Compositae) revisited: Insights from ITS, *trnL-trnF*, and *matK* nuclear and chloroplast DNA analysis. *Annals of the Missouri Botanical Garden* 93: 150–171.
- SUSANNA, A., N. GARCIA-JACAS, D. E. SOLTIS, AND P. S. SOLTIS. 1995. Phylogenetic relationships in tribe Cardueae (Asteraceae) based on its sequences. *American Journal of Botany* 82: 1056–1068.

- SUSANNA, A., T. GARNATJE, AND N. GARCIA-JACAS. 1999. Molecular phylogeny of *Cheirolophus* (Asteraceae: Cardueae-Centaureinae) based on ITS sequences of nuclear ribosomal DNA. *Plant Systematics and Evolution* 214: 147–160.
- SWOFFORD, D. L. 2002. PAUP*. Phylogenetic Analysis Using Parsimony (*and Other Methods), ver. 4.0b10. Sinauer, Sunderland, MA, USA.
- TAKHTAJAN, A. 1986. Floristic Regions of the World. University of California Press, Berkeley, CA, USA.
- TANG, Z. H., Z. L. DING, P. D. WHITE, X. X. DONG, J. L. JI, H. C. JIANG, P. LUO, AND X. WANG. 2011. Late Cenozoic central Asian drying inferred from a palynological record from the northern Tian Shan. *Earth and Planetary Science Letters* 302: 439–447.
- THOMPSON, J. D. 1999. Population differentiation in Mediterranean plants: insights into colonization history and the evolution and conservation of endemic species. *Heredity* 82: 229–236.
- VILATERSANA, R., N. GARCIA-JACAS, T. GARNATJE, J. MOLERO, G. SONNANTE, AND A. SUSANNA. 2010. Molecular phylogeny of the genus *Ptilostemon* (Compositae: Cardueae) and its relationships with *Cynara* and *Lamyropsis*. *Systematic Botany* 35: 907–917.
- VILATERSANA, R., A. SUSANNA, N. GARCIA-JACAS, AND T. GARNATJE. 2000. Generic delimitation and phylogeny of the *Carduncellus-Carthamus* complex (Asteraceae) based on ITS sequences. *Plant Systematics and Evolution* 221: 89–105.
- WAGENITZ, G. 1976. Systematics and phylogeny of Compositae (Asteraceae). *Plant Systematics and Evolution* 125: 29–46.
- WAHLBERG, N. 2006. That awkward age for butterflies: Insights from the age of the butterfly subfamily Nymphalinae (Lepidoptera: Nymphalidae). *Systematic Biology* 55: 703–714.
- WANG, Y. J., J. Q. LIU, AND G. MIEHE. 2007. Phylogenetic origins of the Himalayan endemic *Dolomiaea*, *Diplazoptilon* and *Xanthopappus* (Asteraceae: Cardueae) based on three DNA regions. *Annals of Botany* 99: 311–322.
- WANG, Y. J., A. SUSANNA, E. VON RAAB-STRAUBE, R. MILNE, AND J. Q. LIU. 2009. Island-like radiation of *Saussurea* (Asteraceae: Cardueae) triggered by uplifts of the Qinghai-Tibetan Plateau. *Biological Journal of the Linnean Society* 97: 893–903.
- WEN, J. 1999. Evolution of eastern Asian and eastern North American disjunct distributions in flowering plants. *Annual Review of Ecology and Systematics* 30: 421–455.

WOLFE, K. H., W. H. LI, AND P. M. SHARP. 1987. Rates of nucleotide substitution vary greatly among plant mitochondrial, chloroplast, and nuclear DNAs. *Proceedings of the National Academy of Sciences, USA* 84: 9054–9058.

YIN, A., AND T. M. HARRISON. 2000. Geologic evolution of the Himalayan-Tibetan orogen. *Annual Review of Earth and Planetary Sciences* 28: 211–280.

ZAVADA, M. S., AND T. K. LOWREY. 2010. Comparative pollen morphology of *Brachylaena*, *Tarchonanthus* and two species of *Tubulifloridites* (Asteraceae) from the Eocene, Knysna Lignite of South Africa. *Review of Palaeobotany and Palynology* 162: 183–192.

ZAVADA, M. S., AND S. E. DE VILLIERS. 2000. Pollen of the Asteraceae from the Paleocene-Eocene of South Africa. *Grana* 39: 39–45.

ZHANG, J.-W., Z.-L. NIE, J. WEN, AND H. SUN. 2011. Molecular phylogeny and biogeography of three closely related genera, *Sorosseris*, *Stebbinsia*, and *Syncalathium* (Asteraceae, Cichorieae), endemic to the Tibetan Plateau, SW China. *Taxon* 60: 15–26.

ZHANG, M.-L., AND P. W. FRITSCH. 2010. Evolutionary response of *Caragana* (Fabaceae) to Qinghai-Tibetan Plateau uplift and Asian interior aridification. *Plant Systematics and Evolution* 288: 191–199.

TABLES

TABLE 1. Area coding for distribution areas as used in the Bayes-DIVA reconstruction of the biogeographic history of tribe Cardueae and allies is represented by letters (A, Western Mediterranean Basin; B, Eastern Mediterranean Basin (the Balkans Peninsula); C, Western Asia, including the Anatolian Peninsula, the Caucasus, the Levant region, Iran and Iraq; D, Central and North Europe; E, Middle Asia, including the Mountains of Tian Shan and Pamir; F, Japan; G, Macaronesia; H, North America; I, Southern South America; J, Central and South Africa; K, Himalayan range; L, North Africa; M, coastal areas along the Indian Ocean from the Horn of Africa to India; and N, Australia). Informal groups used as in Susanna and Garcia-Jacas (2009).

Taxon name	Subgenus or informal group	Tribe or Subtribe	Distribution
Outgroups			
<i>Boopis anthemoides</i> Juss.		Calyceraceae R.Br. ex Rich.,	I
<i>Scaevola aemula</i> R. Br.		Goodeniaceae R. Brown	N

Compositae		
<i>Brachylaena discolor</i> DC.		Oldenburgieae S. Ortiz J, M
<i>Oldenburgia intermedia</i> Bond.		Oldenburgieae J
<i>Chuquiraga spinosa</i> D. Don		Barnadesioideae I
<i>Dasyphyllum leptacanthum</i> (Gardner) Cabrera		Barnadesioideae I
<i>Gochnatia hiriartiana</i> Medrano, Villaseñor & Medina		Gochnatioideae I
<i>Tarchonanthus camphoratus</i> L.		Tarchonantheae Kostel. J, M
Cardueae Cass. (Cauduoideae Cass. ex Sweet, Compositae)		
<i>Cardopatium corymbosum</i> (L.) Pers.		Cardopatiinae Less. B, C, L
<i>Cousiniopsis atractyloides</i> (C. Winkl.) Nevski		Cardopatiinae E
<i>Atractylis cancellata</i> L.		Carlininae Dumort. A, B, C, L
<i>Atractylis carduus</i> (Forssk.) Christ.		Carlininae C, L
<i>Atractylodes japonica</i> Koidz. ex Kitam.		Carlininae E
<i>Carlina acanthifolia</i> All.		Carlininae A, B, D
<i>Carlina falcata</i> Svent.		Carlininae G
<i>Carlina gummifera</i> (L.) Less.		Carlininae A, B, L
<i>Carlina lanata</i> L.		Carlininae A, B, C, L
<i>Carlina vulgaris</i> L.		Carlininae A, B, C, D
<i>Tugarinovia mongolica</i> Iljin		Carlininae E
<i>Echinops acantholepis</i> Jaub. & Spach		Echinopsinae (Cass.) Dumort. C
<i>Echinops angustilobus</i> S. Moore		Echinopsinae J, M
<i>Echinops hoehnelii</i> Schweinf.		Echinopsinae J, M
<i>Echinops niveus</i> Wall.		Echinopsinae K
<i>Echinops persicus</i> Stev. & Fisch.		Echinopsinae C
<i>Echinops tschimganicus</i> B. Fedtsch.		Echinopsinae E
<i>Echinops viscosus</i> DC.		Echinopsinae B, C, L
<i>Arctium eriophorum</i> (Regel & Schmalh.) Kuntze	<i>Arctium-Cousinia</i> group	Carduinae (Cass.) Dumort E
<i>Arctium grandifolium</i> (Kult.) S. López, Romaschenko, Susanna & N. Garcia	<i>Arctium-Cousinia</i> group	Carduinae E
<i>Arctium lappa</i> L.	<i>Arctium-Cousinia</i> group	Carduinae A, B, C, D, E
<i>Arctium lappaceum</i> (Schrenk) Kuntze	<i>Arctium-Cousinia</i> group	Carduinae E
<i>Arctium minus</i> Bernh.	<i>Arctium-Cousinia</i> group	Carduinae A, B, C, D
<i>Arctium triflorum</i> (Schrenk) Kuntze	<i>Arctium-Cousinia</i> group	Carduinae E
<i>Arctium umbrosum</i> (Bunge) Kuntze	<i>Arctium-Cousinia</i> group	Carduinae E
<i>Cousinia coronata</i> Franch.	<i>Arctium-Cousinia</i> group	Carduinae E
<i>Cousinia microcarpa</i> Boiss.	<i>Arctium-Cousinia</i> group	Carduinae E
<i>Cousinia polycephala</i> Rupr.	<i>Arctium-Cousinia</i> group	Carduinae E
<i>Berardia subacaulis</i> Vill.	<i>Berardia</i> and <i>Staehelina</i>	Carduinae D
<i>Staehelina dubia</i> L.	<i>Berardia</i> and <i>Staehelina</i>	Carduinae A, L
<i>Staehelina fruticosa</i> L.	<i>Berardia</i> and <i>Staehelina</i>	Carduinae B
<i>Staehelina lobelii</i> DC.	<i>Berardia</i> and	Carduinae B, C

<i>Carduus carlinoides</i> Gouan	<i>Staehelina</i>		
<i>Carduus defloratus</i> L.	<i>Carduus-Cirsium</i> group	Carduinae	A
<i>Carduus keniensis</i> R. E. Fr.	<i>Carduus-Cirsium</i> group	Carduinae	A, D
<i>Carduus nyassanus</i> R. E. Fr.	<i>Carduus-Cirsium</i> group	Carduinae	J
<i>Cirsium echinus</i> (M. Bieb.) Hand.-Mazz.	<i>Carduus-Cirsium</i> group	Carduinae	J, M
<i>Cirsium nipponicum</i> Makino	<i>Carduus-Cirsium</i> group	Carduinae	C
<i>Cirsium ochrolepidium</i> Juz.	<i>Carduus-Cirsium</i> group	Carduinae	F
<i>Cirsium palustre</i> (L.) Scop.	<i>Carduus-Cirsium</i> group	Carduinae	E
<i>Cirsium scariosum</i> Nutt.	<i>Carduus-Cirsium</i> group	Carduinae	A, B, C, D
<i>Cirsium tanakae</i> Matsum.	<i>Carduus-Cirsium</i> group	Carduinae	H
<i>Cirsium tracyi</i> Rydb.	<i>Carduus-Cirsium</i> group	Carduinae	F
<i>Galactites tomentosa</i> Moench	<i>Carduus-Cirsium</i> group	Carduinae	H
<i>Notobasis syriaca</i> (L.) Cass.	<i>Carduus-Cirsium</i> group	Carduinae	A, B, L
<i>Picnomon acarna</i> (L.) Cass.	<i>Carduus-Cirsium</i> group	Carduinae	A, B, C, L
<i>Silybum marianum</i> (L.) Gaertner	<i>Carduus-Cirsium</i> group	Carduinae	A, B, C, D, L
<i>Tyrimnus leucographus</i> (L.) Cass.	<i>Carduus-Cirsium</i> group	Carduinae	A, B, C, L
<i>Cynara cornigera</i> Lind.	<i>Cynara</i> group	Carduinae	B
<i>Cynara humilis</i> L.	<i>Cynara</i> group	Carduinae	A, L
<i>Lamyropsis carpini</i> Greuter	<i>Cynara</i> group	Carduinae	B
<i>Lamyropsis cynaroides</i> (Lam.) Dittrich	<i>Cynara</i> group	Carduinae	B
<i>Ptilostemon abylenis</i> (Maire) Greuter	<i>Cynara</i> group	Carduinae	L
<i>Ptilostemon afer</i> (Jacq.) Greuter	<i>Cynara</i> group	Carduinae	B, C
<i>Ptilostemon diacanthus</i> (Labill.) Greuter	<i>Cynara</i> group	Carduinae	C
<i>Ptilostemon hispanicus</i> (Lam.) Greuter	<i>Cynara</i> group	Carduinae	A
<i>Jurinea albicaulis</i> Bunge	<i>Jurinea-Saussurea</i> group	Carduinae	E
<i>Jurinea carduiformis</i> Boiss.	<i>Jurinea-Saussurea</i> group	Carduinae	C
<i>Jurinea humilis</i> DC.	<i>Jurinea-Saussurea</i> group	Carduinae	A, L
<i>Saussurea alpina</i> (L.) DC.	<i>Jurinea-Saussurea</i> group	Carduinae	D, E
<i>Saussurea discolor</i> (Willd.) DC.	<i>Jurinea-Saussurea</i> group	Carduinae	D
<i>Alfredia cernua</i> (L.) Cass.	<i>Onopordum</i> group	Carduinae	E
<i>Alfredia nivea</i> Kar. & Kir.	<i>Onopordum</i> group	Carduinae	E
<i>Ancathia igniaria</i> (Spreng) DC.	<i>Onopordum</i> group	Carduinae	E
<i>Lamyropappus schacaptaricus</i> (B. Fedtsch.) Knorr. & Tamamsch.	<i>Onopordum</i> group	Carduinae	E
<i>Olgaea baldshuanica</i> (C. Winkl.) Iljin	<i>Onopordum</i> group	Carduinae	E
<i>Olgaea pectinata</i> Iljin	<i>Onopordum</i> group	Carduinae	E
<i>Onopordum nervosum</i> Boiss.	<i>Onopordum</i> group	Carduinae	A
<i>Onopordum tauricum</i> Willd.	<i>Onopordum</i> group	Carduinae	B, C
<i>Synurus palmatopinnatifidus</i> (Makino) Kitam.	<i>Onopordum</i> group	Carduinae	F
<i>Syreitschikovia spinulosa</i> (Franch.) Pavlov	<i>Onopordum</i> group	Carduinae	E
<i>Xanthopappus subacaulis</i> C. Winkl.	<i>Onopordum</i> group	Carduinae	K
<i>Amphoricarpos autariatus</i> Blečić & Mayer	<i>Xeranthemum</i> group	Carduinae	B
<i>Amphoricarpos exsul</i> O. Schwarz	<i>Xeranthemum</i> group	Carduinae	C
<i>Dipterocome pusilla</i> Fisch. & C. A. Mey.	<i>Xeranthemum</i> group	Carduinae	C
<i>Chardinia orientalis</i> (L.) O. Kuntze	<i>Xeranthemum</i> group	Carduinae	C
<i>Siebera pungens</i> (Lam.) DC.	<i>Xeranthemum</i> group	Carduinae	C
<i>Xeranthemum annuum</i> L.	<i>Xeranthemum</i> group	Carduinae	B, C, D, E
<i>Xeranthemum inapertum</i> (L.) Miller	<i>Xeranthemum</i> group	Carduinae	A, B, C, L
<i>Xeranthemum longepapposum</i> Fisch. & C. A. Mey.	<i>Xeranthemum</i> group	Carduinae	C, E

<i>Carduncellus duvauxii</i> Batt. & Trab.	<i>Carthamus-Carduncellus</i> group	Centaureinae (Cass.) Dumort	L
<i>Carthamus oxyacantha</i> M. Bieb.	<i>Carthamus-Carduncellus</i> group	Centaureinae	C
<i>Carthamus turkestanicus</i> Popov.	<i>Carthamus-Carduncellus</i> group	Centaureinae	C
<i>Femeniasia balearica</i> (J. J. Rodr.) Susanna	<i>Carthamus-Carduncellus</i> group	Centaureinae	A
<i>Phonus rhiphaeus</i> (Font Quer & Pau) G. López	<i>Carthamus-Carduncellus</i> group	Centaureinae	L
<i>Klasea algida</i> (Iljin) Hidalgo	<i>Klasea</i> group	Centaureinae	E
<i>Klasea coriacea</i> (Fisch. & C. A. Mey. ex DC.) Holub	<i>Klasea</i> group	Centaureinae	C
<i>Klasea serratuloides</i> (DC.) Greuter & Wagenitz	<i>Klasea</i> group	Centaureinae	C
<i>Serratula coronata</i> L.	<i>Klasea</i> group	Centaureinae	D, E
<i>Centaurodendron palmiforme</i> Skottsb.	<i>Plectocephalus</i> group	Centaureinae	I
<i>Plectocephalus americanus</i> D. Don	<i>Plectocephalus</i> group	Centaureinae	H
<i>Plectocephalus chilensis</i> G. Don ex Loudon	<i>Plectocephalus</i> group	Centaureinae	I
<i>Plectocephalus tweediei</i> (Hook. & Arn.) N. Garcia & Susanna	<i>Plectocephalus</i> group	Centaureinae	I
<i>Plectocephalus varians</i> (A. Rich.) C. Jeffrey	<i>Plectocephalus</i> group	Centaureinae	M
<i>Psephellus gilanicus</i> (Bornm.) Wagenitz	<i>Psephellus</i> group	Centaureinae	C
<i>Psephellus persicus</i> (DC.) Wagenitz	<i>Psephellus</i> group	Centaureinae	C
<i>Psephellus pulcherrimus</i> (Willd.) Wagenitz	<i>Psephellus</i> group	Centaureinae	C
<i>Callicephalus nitens</i> (M. Bieb. ex Willd.) C. A. Mey.	<i>Rhaponticum</i> group	Centaureinae	C, E
<i>Centaurothamnus maximus</i> Wagenitz & Dittrich	<i>Rhaponticum</i> group	Centaureinae	M
<i>Myopordon aucheri</i> Boiss.	<i>Rhaponticum</i> group	Centaureinae	C
<i>Myopordon hyrcanum</i> (Bornm.) Wagenitz	<i>Rhaponticum</i> group	Centaureinae	C
<i>Ochrocephala imatongensis</i> (Philipson) Dittrich	<i>Rhaponticum</i> group	Centaureinae	M
<i>Rhaponticum acaule</i> DC.	<i>Rhaponticum</i> group	Centaureinae	L
<i>Rhaponticum australe</i> (Gaud.) Soskov	<i>Rhaponticum</i> group	Centaureinae	N
<i>Rhaponticum repens</i> (L.) Hidalgo	<i>Rhaponticum</i> group	Centaureinae	B, C
<i>Mantiscalca salmantica</i> (L.) Briq. & Cavill.	<i>Volutaria</i> group	Centaureinae	A, B, C, L
<i>Goniocaulon indicum</i> C. B. Clarke	<i>Volutaria</i> group	Centaureinae	M
<i>Volutaria crupinoides</i> (Desf.) Maire	<i>Volutaria</i> group	Centaureinae	C, L
<i>Schischkinia albispina</i> (Bunge) Iljin	<i>Volutaria</i> group	Centaureinae	E
<i>Centaurea depressa</i> M. Bieb.	Subg. <i>Cyanus</i>	Centaureinae	C
<i>Centaurea lingulata</i> Lag.	Subg. <i>Cyanus</i>	Centaureinae	A
<i>Centaurea behen</i> L.	Subg. <i>Centaurea</i>	Centaureinae	C
<i>Centaurea bruguierana</i> (DC.) Hand.-Mazz.	Subg. <i>Centaurea</i>	Centaureinae	C
<i>Centaurea involucrata</i> Desf.	Subg. <i>Centaurea</i>	Centaureinae	A, L
<i>Centaurea carolipauana</i> Fern. Casas & Susanna	Subg. <i>Acrocentron</i>	Centaureinae	L
<i>Centaurea lagascana</i> Graells	Subg. <i>Acrocentron</i>	Centaureinae	A
<i>Crocodilium creticum</i> (Boiss. & Heldr.) N. Garcia & Susanna		Centaureinae	C
<i>Crocodilium syriacum</i> Cass.		Centaureinae	C
<i>Cheirolophus mauritanicus</i> (Font Quer) Susanna		Centaureinae	L
<i>Cheirolophus teydis</i> (C. Smith) G. López		Centaureinae	G
<i>Rhaponticoides hajastana</i> (Tzvel.) M. V. Agab. & Greuter		Centaureinae	C
<i>Stizolophus balsamita</i> (Lam.) Cass. ex Takht.		Centaureinae	C
<i>Stizolophus coronopifolius</i> Cass.		Centaureinae	C
<i>Zoegea leptaurea</i> L.		Centaureinae	C

TABLE 2. Numerical results from the phylogenetic analyses (MP) of the combined (nrDNA + cpDNA) dataset and the chloroplast-only (cpDNA) dataset. Models of nucleotide evolution for each independent marker used in the BI analysis.

	ITS	<i>trnL-trnF</i>	<i>matK</i>	<i>ndhF</i>	<i>rbcL</i>	Dataset 1 (ITS ¹ + <i>trnL-trnF</i> ² + <i>matK</i> ³ + <i>ndhF</i> ⁴ + <i>rbcL</i> ⁵ + gap codification ⁶)	Dataset 2 (<i>trnL-trnF</i> ² + <i>matK</i> ³ + <i>ndhF</i> ⁴ + <i>rbcL</i> ⁵)
Number of taxa	-	-	-	-	-	127	132
Length range (bp)	594-647	765-848	282-991	1301-1316	1416-1422	3847-4591	3847-4581
Total characters	685	947	1003	1328	1431	5617	4709
Variable characters (%)	439 (64.09)	236 (24.92)	352 (35.09)	322 (24.25)	200 (13.98)	1549	1110
Parsimony informative characters	350	133	179	194	116	1080	622
Number of indels	172	320	723	34	19	1268	1096
Number of steps	2886	256	392	516		4817	1925
Consistency Index (CI)	0.24	0.65	0.59	0.51		0.33	0.5
Retention Index (RI)	0.65	0.86	0.83	0.83		0.71	0.79
Homoplasy Index (HI)	0.76	0.34	0.41	0.49		0.66	0.5
Model of Evolution						GTR+G ^{1, 2, 3, 4, 5} , F81 ⁶	GTR+G ^{2, 3, 4, 5}

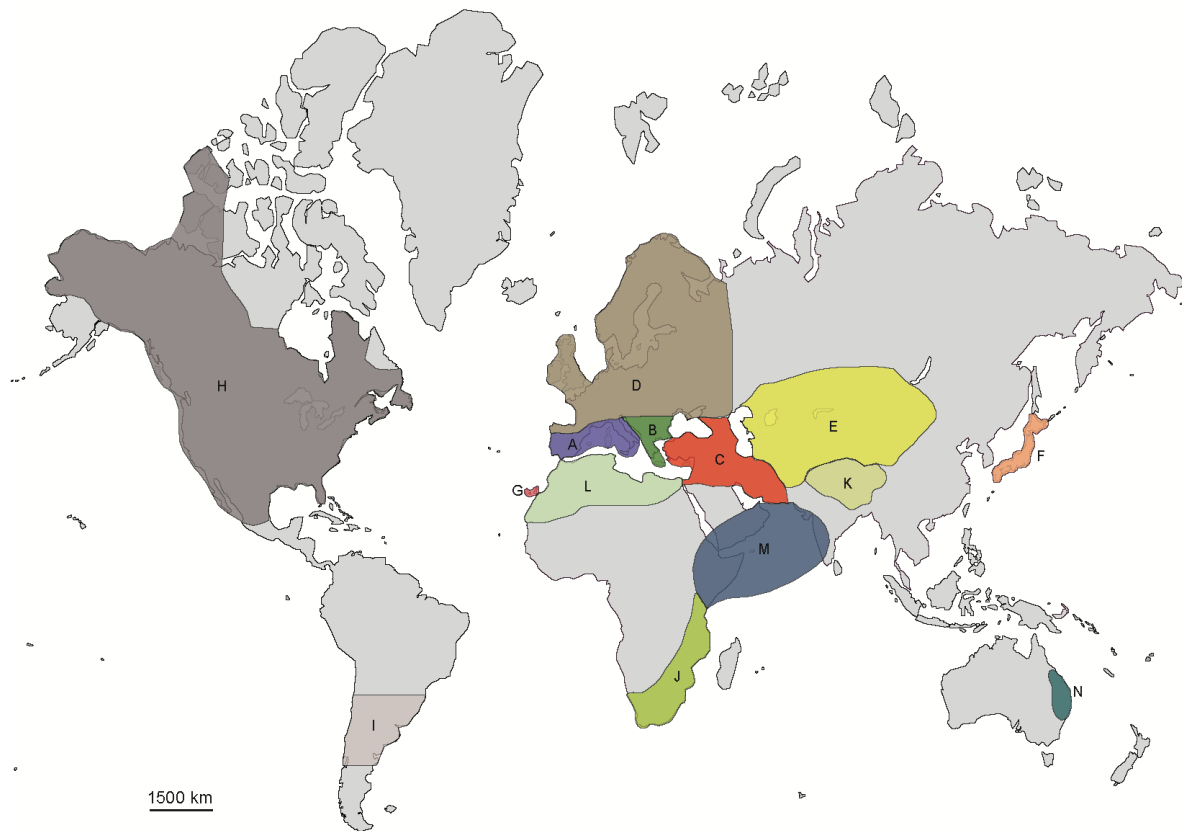

Fig. 1. The 14 distribution areas of tribe Cardueae and close relatives used in the Bayes-DIVA biogeographic reconstruction: A, Western Mediterranean Basin; B, Eastern Mediterranean Basin (the Balkans Peninsula); C, Western Asia; D, Central and North Europe; E, Middle Asia; F, Japan; G, Macaronesia; H, North America; I, Southern South America; J, Central and South Africa; K, Himalayan range; L, North Africa; M, coastal areas along the Indian Ocean from Horn of Africa to India and N, Australia.

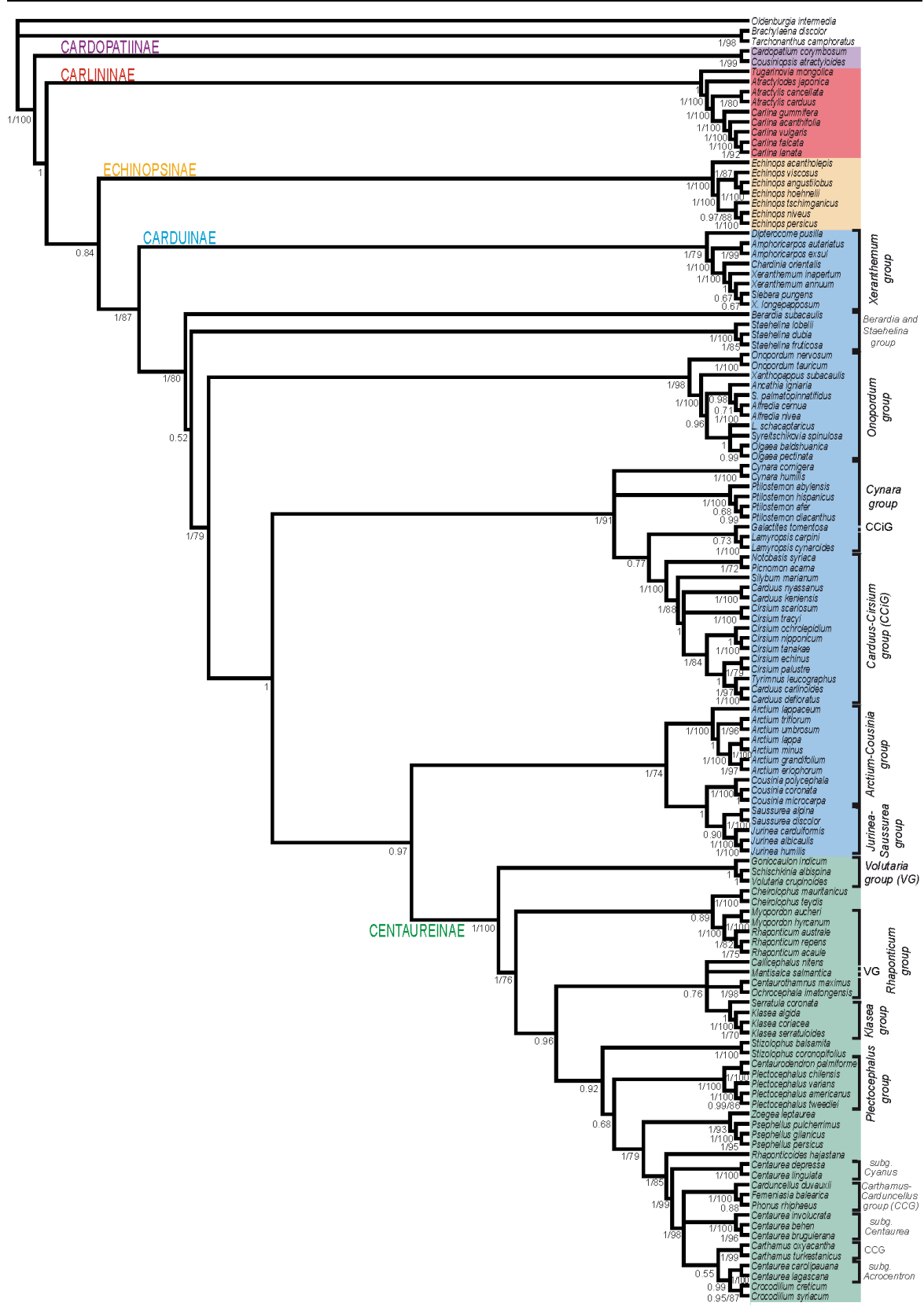

Fig. 2. Majority-rule (“halfcompat”) consensus tree from a Bayesian analysis of the combined (nuclear and chloroplast) dataset of tribe Cardueae (Compositae), with bootstrap values ($\geq 75\%$) and Bayesian posterior probabilities (≥ 0.50) indicated below branches.

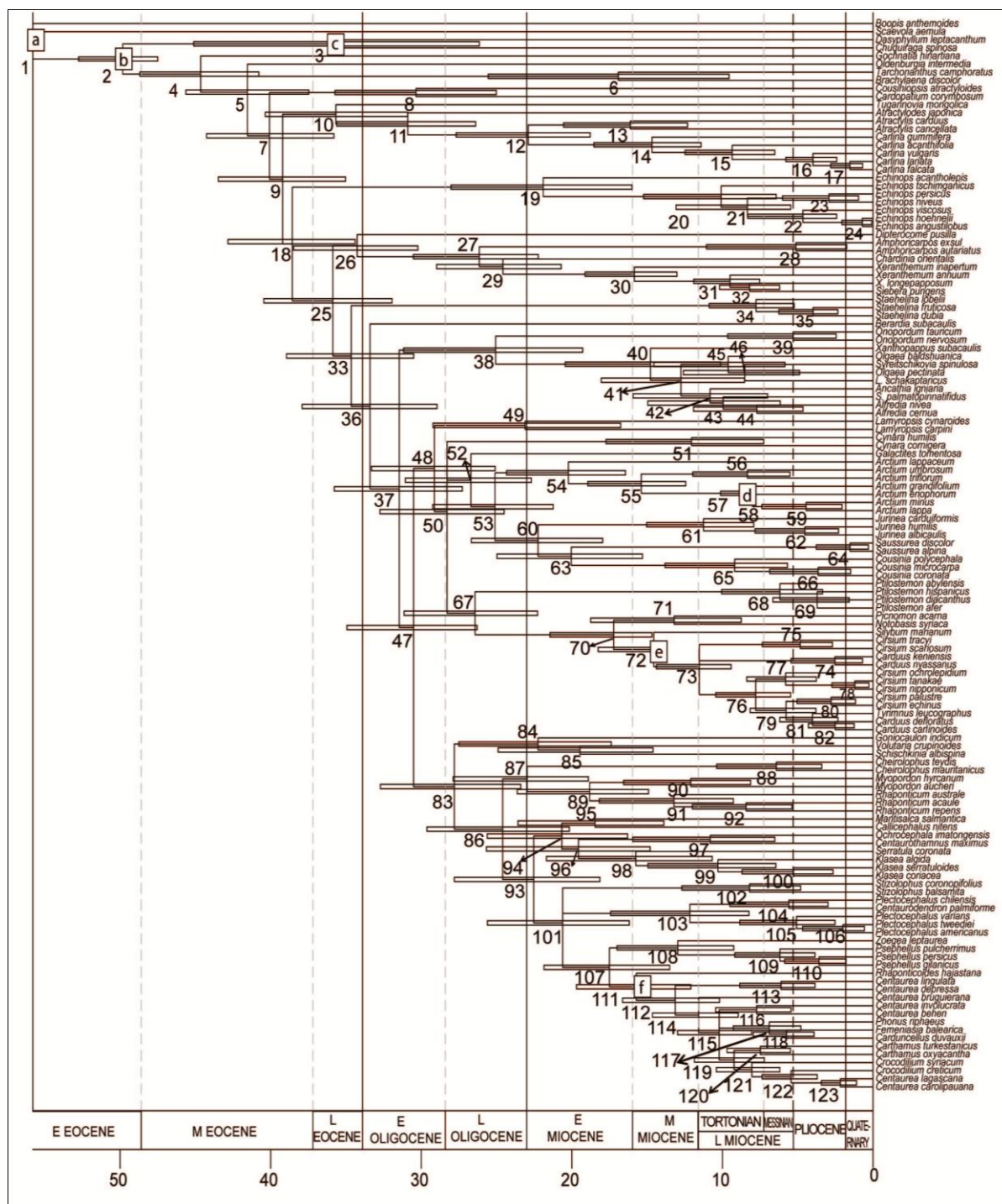

Fig. 3. Chronogram showing the majority-rule “halfcompat” consensus tree from the Bayesian analysis of the chloroplast dataset of tribe *Cardueae* (*Compositae*) and close allies, with mean divergence times and confidence intervals (95%) for nodal ages estimated by penalized Likelihood (PL) over a sample of 1000 trees from the MCMC stationary distribution of this analysis. Lower case letters in box indicate the nodes calibrated with fossil constraints. Node numbers refer to Appendix S3 (see Supplemental Data with the online version of this article).

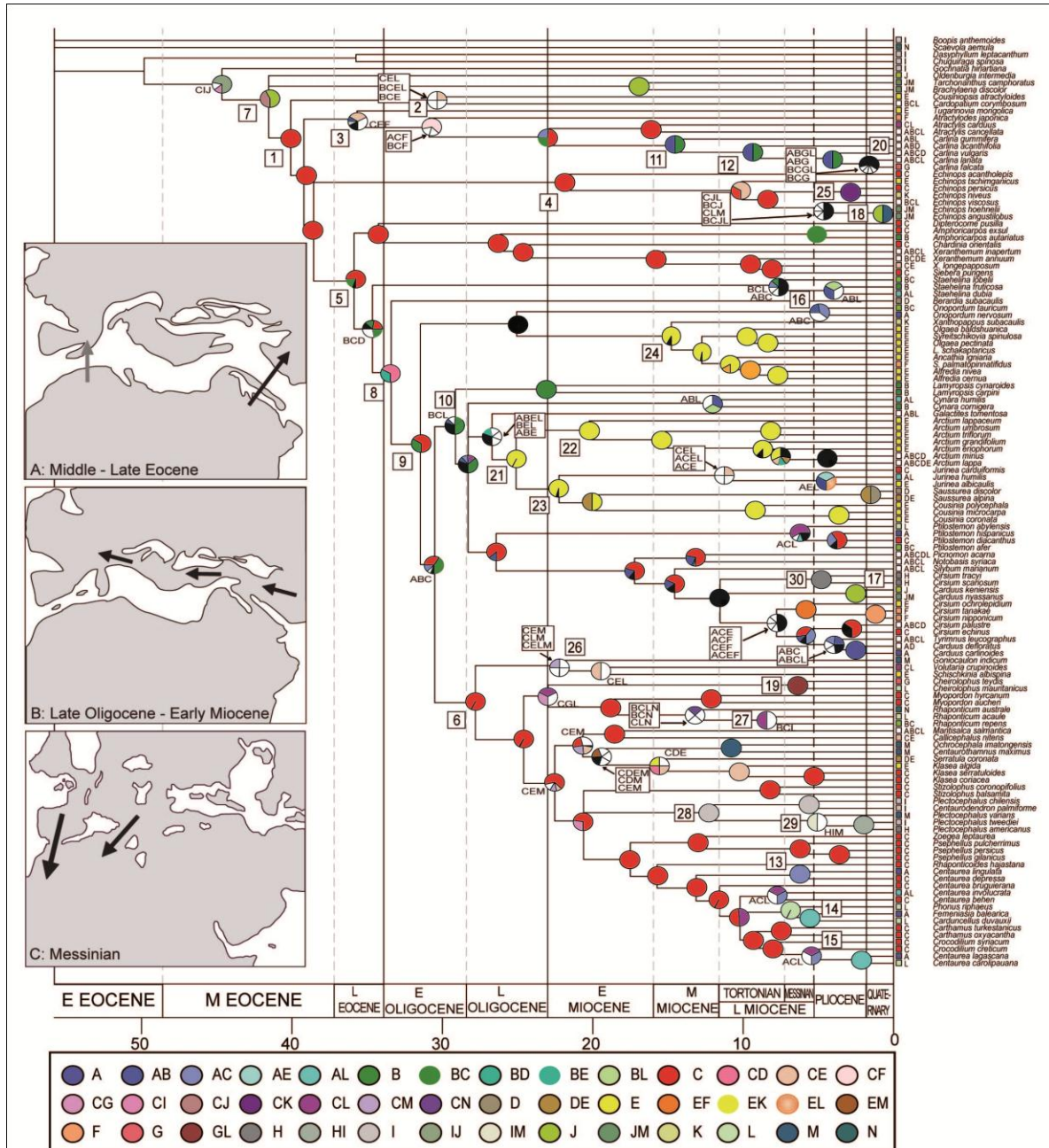

Fig. 4. Bayesian dispersal-vicariance (Bays-DIVA) reconstruction of the biogeographic history of tribe Cardueae (Compositae) and close allies plotted on the PL chronogram of Fig. 3. Distribution areas given before each taxon name and next to the pie chart legend are defined in Fig. 1. The pie charts represent the marginal probabilities of ancestral areas reconstructed for each node in Fig. 3, as estimated by averaging DIVA reconstructions over an MCMC stationary distribution from the Bayesian analysis of the chloroplast dataset. Color codes for ancestral areas are shown in the inset, with ancestral area probabilities < 0.1 pooled together (summed) into the “black” section of the pie chart. Ancestral area reconstructions assigned to more than four areas together are shown in white color and labeled. Numbers close to the nodes indicate nodes discussed in the text. Maps showing paleogeographical reconstructions of the Mediterranean area since the Eocene are redrawn after Ree and Sanmartín (2009) and Santos-Gally et al. (2011).

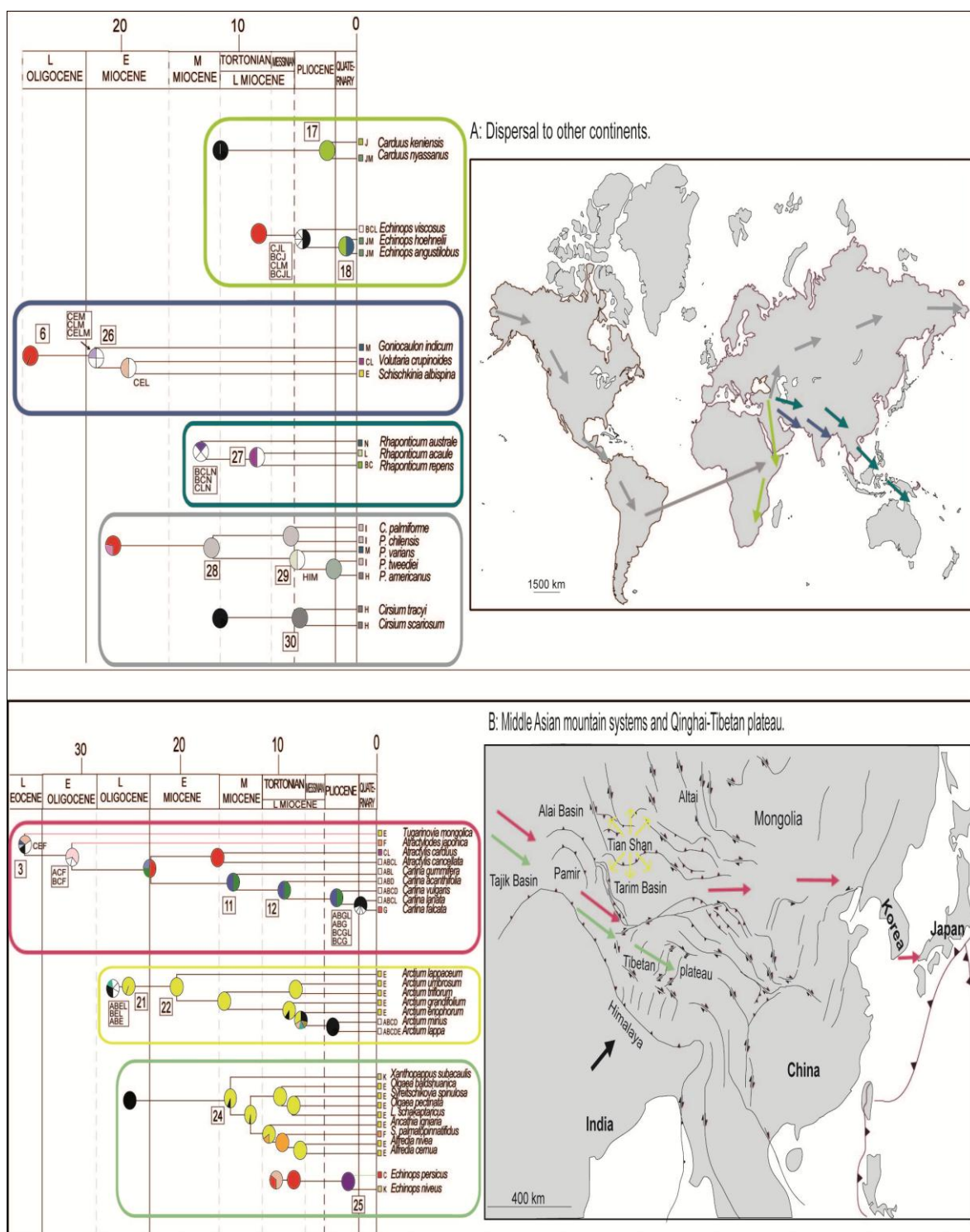

Fig. 5. Biogeographic scenarios showing inferred intercontinental dispersal events (A) and radiation events in Middle Asia and the Qinghai-Tibetan plateau (B) to explain the spatio-temporal evolution of *Cardueae* during the Cenozoic. The color of arrows corresponds to the colors of the clade frames. Maps redrawn after Yin and Harrison (2000) and De Grave et al. (2007). Key and abbreviations for pie charts and ancestral area probabilities are as in Fig. 4.

Appendix S1. List of taxa, geographic origin, voucher and Genbank accession number (ITS, *trnL-trnF*, *matK*, *ndhF*, *rbcl*). Detailed location is only given for new extracted material. Genbank accession numbers marked with superindex were already published (¹Susanna et al., 2006; ²Garcia-Jacas et al., 2008; ³Gruenstaeudl et al., 2009; ⁴Kim and Jansen, 1995; ⁵Susanna et al., 2011; ⁶Panero and Funk, 2008; ⁷Anderberg et al., 2007; ⁸Sánchez-Jiménez et al., 2010; ⁹Hidalgo et al., 2006; ¹⁰Vilatersana et al., 2010; ¹¹Jansen et al., 2007). New sequences are boldfaced.

***Alfredia cernua* (L.) Cass.**; Denmark, Copenhagen Botanical Garden (BC); AY826225¹; AY772269¹; AY013519¹; **KC589912** ; **KC589785**. ***Alfredia nivea* Kar. & Kir.**; Kazakhstan; AY826226¹; AY772270¹; AY785087¹; **KC589913**; **KC589786**. ***Amphoricarpos autariatus* Blečić & Mayer**; Serbia and Montenegro; AY826227¹; AY772271¹; AY785088¹; **KC589914**; **KC589787**. ***Amphoricarpos exsul* O. Schwarz**; Turkey; AY826228¹; AY772272¹; AY785089¹; **KC589915**; **KC589788**. ***Ancathia igniaria* (Spreng) DC.**; Dagestan; FJ0078721²; FJ007861²; **KC590012**; **KC589916**; **KC589789**. ***Arctium eriophorum* (Regel & Schmalh.) Kuntze**; Kazakhstan; AY826326¹; AY772361¹; AY373681¹; **KC589917**; **KC589790**. ***Arctium grandifolium* (Kult.) S. López, Romaschenko, Susanna & N. Garcia**; Kazakhstan; AY826268¹; AY772310¹; AY373679¹; **KC589918**; **KC589791**. ***Arctium lappa* L.**; Belgium, Lovaina Botanical Garden (BC); AY826229¹; AY772273¹; AY013520¹; **KC589919**; **KC589792**. ***Arctium lappaceum* (Schrenk) Kuntze**; Kazakhstan; AY826269¹; AY772311¹; AY373677¹; **KC589920**; **KC589793**. ***Arctium minus* Bernh.**; Belgium, Lovaina Botanical Garden (BC); AY826230¹; AY772274¹; AY013521¹; **KC589921**; **KC589794**. ***Arctium triflorum* (Schrenk) Kuntze**; Kazakhstan; AY826275¹; AY772315¹; AY373675¹; **KC589922**; **KC589795**. ***Arctium umbrosum* (Bunge) Kuntze**; Kazakhstan; AY826276¹; AY772316¹; AY373676¹; **KC589923**; **KC589796**. ***Atractylis cancellata* L.**; Spain; AY826231¹; AY772275¹; AY013522¹; **KC589924**; **KC589797**. ***Atractylis carduus* (Forssk.) Christ.**; Egypt; AY826232¹; AY772276¹; AY013523¹; **KC589925**; **KC589798**. ***Atractylodes japonica* Koidz. ex Kitam.**; Japan, Tokyo Botanical Garden (BC); AY826233¹; AY772277¹; AY013524¹; **KC589926**; **KC589799**. ***Berardia subacaulis* Vill.**; France; AY826234¹; AY772278¹; AY013525¹; **KC589927**; **KC589800**. ***Boopis anthemoides* Juss.**; Argentina; Voucher 1 : --; EU841095³/EU547627³; EU841363³; -- ; EU841136³. Voucher 2 : -- ; -- ; -- ; L39384⁴; --.

Brachylaena discolor DC.; South Africa; AY826236¹; AY772280¹; AY785090¹; **KC589928**; **KC589801**. *Callicephalus nitens* (M. Bieb. ex Willd.) C. A. Mey.; Armenia; AY826237⁹; AY772281¹; AY013492²; JF754833³; **KC589802**. *Cardopatum corymbosum* (L.) Pers.; Greece; AY826238¹; AY772282¹; AY013526¹; **KC589929**; **KC589803**. *Carduncellus duvauxii* Batt. & Trab.; Morocco; AY826239¹; AY772283¹; AY013493¹; **KC589930**; **KC589804**. *Carduus carlinoides* Gouan; Spain; AY826240¹; AY772284¹; AY013527¹; **KC589931**; **KC589805**. *Carduus defloratus* L.; Spain; AY826241¹; AY772285¹; AY785091¹; **KC589932**; **KC589806**. *Carduus keniensis* R. E. Fr.; Kenya, Mount Kenya, *Galbany s.n.* & Arrabal (BC); **KC590040**; **KC590047**; **KC590013**; **KC589933**; **KC589807**. *Carduus nyassanus* R. E. Fr.; Tanzania, Olmoti crater, *Galbany s.n.* & Arrabal (BC); **KC590041**; **KC590048**; **KC590014**; **KC589934**; **KC589808**. *Carlina acanthifolia* All.; Spain; AY826242¹; AY772286¹; AY013529¹; **KC589935**; **KC589809**. *Carlina falcata* Svent.; Spain; AY826243¹; AY772287¹; AY013530¹; **KC589936**; **KC589810**. *Carlina gummifera* (L.) Less.; Switzerland, Genève Botanical Garden (BC); AY826244¹; AY772288¹; AY013531¹; **KC589937**; **KC589811**. *Carlina lanata* L.; Crete; AY826245¹; AY772289¹; AY013532¹; **KC589938**; **KC589812**. *Carlina vulgaris* L.; Switzerland, Zürich, Botanical Garden (BC); AY826246¹; AY772290¹; AY013533¹; **KC589939**; **KC589813**. *Carthamus oxyacantha* M. Bieb.; Iran; AY826248¹; AY772292¹; AY013494¹; **KC589940**; **KC589814**. *Carthamus turkestanicus* Popov.; Armenia, AY826249¹; AY772293¹; AY785093¹; **KC589941**; **KC589815**. *Centaurea behen* L.; Armenia; AY826250¹; AY772294¹; AY013496¹; **KC589942**; **KC589816**. *Centaurea bruguierana* (DC.) Hand.-Mazz.; Armenia; AY826251¹; AY772295¹; AY013497¹; **KC589943**; **KC589817**. *Centaurea carolipauana* Fern. Casas & Susanna; Morocco; AY826253¹; AY772296¹; AY013498¹; **KC589944**; **KC589818**. *Centaurea depressa* M. Bieb.; Turkey; AY826255¹; AY772297¹; AY013499¹; **KC589945**; **KC589819**. *Centaurea involucrata* Desf.; Algeria; AY826256¹; AY772298¹; AY013503¹; **KC589946**; **KC589820**. *Centaurea lagascana* Graells; Spain; AY826257¹; AY772299¹; AY013504¹; **KC589947**; **KC589821**. *Centaurea lingulata* Lag.; Spain; AY826258¹; AY772300¹; AY013505¹; **KC589948**; **KC589822**. *Centaurodendron palmiforme* Skottsb.; Chile; JF754806⁵; JF754757⁵; **KC590015**; JF754836⁵; **KC589823**. *Centaurothamnus maximus* Wagenitz & Dittrich; Yemen; AY826259¹; AY772301¹; AY013506¹; JF754837; **KC589824**. *Chardinia orientalis* (L.) O. Kuntze; Iran; AY826260¹; AY772302¹; AY013534¹; **KC589949**; **KC589825**. *Cheirolophus mauritanicus* (Font Quer) Susanna; Morocco; AY826261¹; AY772303¹; AY013507¹; JF754838; **KC589826**.

Cheirolophus teydis (C. Smith) G. López; Spain; AY826262¹; AY772304¹; AY785094¹; JF754839; **KC589827**. *Chuquiraga spinosa* D. Don; Chile; --; EU547636³; EU841331³; EU385146⁶; EU384960⁶. *Cirsium echinus* (M. Bieb.) Hand.-Mazz.; Iran; AY826263¹; AY772305¹; AY013535¹; **KC589950**; **KC589828**. *Cirsium nipponicum* Makino; Japan, Tokyo Metropolitan Medicinal Plant Garden (BC); **KC590042**; **KC590049**; **KC590016**; **KC589951**; **KC589829**. *Cirsium ochrolepidium* Juz.; Uzbekistan; AY826264¹; AY772306¹; AY785095¹; **KC589952**; **KC589830**. *Cirsium palustre* (L.) Scop.; Spain; AY826265¹; AY772307¹; AY013536¹; **KC589953**; **KC589831**. *Cirsium scariosum* Nutt.; USA, Wyoming, Shoshone National Park Forest, Gros Ventre Mountains, Bayer, Purdy & Minish WY-90040 (BC); **KC590043**; **KC590050**; **KC590017**; **KC589954**; **KC589832**. *Cirsium tanakae* Matsum.; Japan, Tokyo Metropolitan Medicinal Plant Garden (BC); **KC590044**; **KC590051**; **KC590018**; **KC589955**; **KC589833**. *Cirsium tracyi* Rydb.; USA, Utah, Manti-La Sal National Forest, La Sal Mountains, Marvin 3188 (BC); **KC590045**; **KC590052**; **KC590019**; **KC589956**; **KC589834**. *Cousinia coronata* Franch.; Uzbekistan; AY826267¹; AY772309¹; AY373662¹; **KC589957**; **KC589835**. *Cousinia microcarpa* Boiss.; Kazakhstan; AY826270¹; AY772312¹; AY373667¹; JF754840; **KC589836**. *Cousinia polycephala* Rupr.; Kazakhstan; AY826273¹; AY772313¹; AY373668¹; **KC589958**; **KC589837**. *Cousiniopsis atractyloides* (C. Winkl.) Nevski; Uzbekistan; AF319071¹/AF319125¹; AY772317¹; AY785097¹; **KC589959**; **KC589838**. *Crocodylium creticum* (Boiss. & Heldr.) N. Garcia & Susanna; Greece; AY826278¹; AY772318¹; AY013490¹; **KC589960**; **KC589839**. *Crocodylium syriacum* Cass.; Egypt; AY826279¹; AY772319¹; AY785098¹; **KC589961**; **KC589840**. *Cynara cornigera* Lind.; Egypt; AY826281¹; AY772321¹; AY013538¹; **KC589962**; **KC589841**. *Cynara humilis* L.; Portugal; AY826282¹; AY772322¹; AY785099¹; **KC589963**; **KC589842**. *Dasyphyllum leptacanthum* (Gardner) Cabrera; Brasil; --; EU841080³/EU547649³; EU841344³; --; EU841121³. *Dipterocome pusilla* Fisch. & C. A. Mey.; Voucher 1: Iran, FJ813487⁷; -; -; FJ813488⁷; -. Voucher 2: Iran, Joharcchi & Zangoori 19925 (S); -; **KC590053**; **KC590020**; -; **KC589843**. *Echinops acantholepis* Jaub. & Spach; Uzbekistan; AY826222¹; AY772267¹; AY785086¹; **KC589964**; **KC589844**. *Echinops angustilobus* S. Moore; Tanzania; GU116505⁸; GU134531⁸; **KC590021**; **KC589965**; **KC589845**. *Echinops hoehnelii* Schweinf.; Kenya; GU116506⁸; GU134565⁸; **KC590022**; **KC589966**; **KC589846**. *Echinops niveus* Wall.; Croatia; AY538634¹; AY772323¹; AY785100¹; **KC589967**; **KC589847**. *Echinops persicus* Stev. & Fisch.; USA, The Medicinal Herb Garden at the University of

Whashington, Seattle, (BC); AY538639¹; AY772324¹; AY785101¹; **KC589968**; **KC589848**. *Echinops tschimganicus* B. Fedtsch.; Uzbekistan; AY538633¹; AY772325¹; AY785102¹; **KC589969**; **KC589849**. *Echinops viscosus* DC.; Germany: Berlin Botanical Garden (BC); AY826283¹; AY772326¹; AY013540¹; **KC589970**; **KC589850**. *Femeniasia balearica* (J. J. Rodr.) Susanna; Spain; AY826284¹; AY772327¹; AY013509¹; **KC589971**; **KC589851**. *Galactites tomentosa* Moench; Spain; AY826285¹; AY772328¹; AY013541¹; **KC589972**; **KC589852**. *Gochnatia hiriartiana* Medrano, Villaseñor & Medina; Mexico; --; EU385072⁶; EU385358⁶; EU385166⁶; EU384979⁶. *Goniocaulon indicum* C. B. Clarke; Ethiopia, Friis s.n. et al. (K); JF775393; JF775385; **KC590023**; JF775397; **KC589853**. *Jurinea albicaulis* Bunge; Greece; AY826287¹; AY772330¹; AY373684¹; **KC589973**; **KC589854**. *Jurinea carduiformis* Boiss.; Iran; AY826289¹; AY772332¹; AY785103¹; **KC589974**; **KC589855**. *Jurinea humilis* DC.; Spain; L35868¹; **KC590054**; **KC590024**; **KC589975**; **KC589856**. *Klasea algida* (Iljin) Hidalgo; Tajikistan; DQ310929⁹; DQ310895⁹; **KC590025**; **KC589976**; **KC589857**. *Klasea coriacea* (Fisch. & C. A. Mey. ex DC.) Holub; Armenia; DQ310926⁹; DQ310892⁹; **KC590026**; JF754843; **KC589858**. *Klasea serratuloides* (DC.) Greuter & Wagenitz; Armenia; AY826295¹; AY772334¹; AY013514¹; JF754844; **KC589859**. *Lamyropappus schacaptaricus* (B. Fedtsch.) Knorr. & Tamamsch.; Kyrgyzstan; AY826296¹; AY772335¹; AY785104¹; **KC589977**; **KC589860**. *Lamyropsis carpini* Greuter; Greece; GU907724¹⁰; **KC590055**; **KC590027**; **KC589978**; **KC589861**. *Lamyropsis cynaroides* (Lam.) Dittrich; Turkey; AY826297¹; AY772336¹; AY785105¹; **KC589979**; **KC589862**. *Mantiscalca salmantica* (L.) Briq. & Cavill.; Spain; AY012292¹/AY012328¹; JF754765⁵; **KC590028**; JF754846⁵; **KC589863**. *Myopordon aucheri* Boiss.; Iran; AY826299¹; AY772338¹; **KC590029**; JF754847⁵; **KC589864**. *Myopordon hyrcanum* (Bornm.) Wagenitz; Iran; AY826300¹; AY772339¹; --; **KC589980**; **KC589865**. *Notobasis syriaca* (L.) Cass.; Egypt; AY826302¹; AY772340¹; AY013545¹; **KC589981**; **KC589866**. *Ochrocephala imatongensis* (Philipson) Dittrich; Ethiopia; DQ310931⁹; DQ310897⁹; **KC590030**; **KC589982**; **KC589867**. *Oldenburgia intermedia* Bond.; South Africa; AY826303¹; AY772341¹; AY785106¹; **KC589983**; **KC589868**. *Olgaea baldshuanica* (C. Winkl.) Iljin; Tadjikistan; AY826304¹; AY772342¹; AY785107¹; **KC589984**; **KC589869**. *Olgaea pectinata* Iljin; Kazakhstan; AY826305¹; AY772343¹; AY785108¹; **KC589985**; **KC589870**. *Onopordum nervosum* Boiss.; France, Dijon Botanical Garden (BC); AY826308¹; AY772346¹; AY785109¹; **KC589986**; **KC589871**. *Onopordum tauricum*

Willd.; Germany, Berlin Botanical Garden (BC); AY826309¹; AY772347¹; AY785110¹; **KC589987**; **KC589872**. *Phonus rhiphaeus* (Font Quer & Pau) G. López; Morocco; AY826310¹; AY772348¹; AY013512¹; **KC589988**; **KC589873**. *Picnomon acarna* (L.) Cass.; Iran; AY826311¹; AY772349¹; AY013549¹; **KC589989**; **KC589874**. *Plectocephalus americanus* D. Don; USA ; JF754817⁵; JF754769⁵; **KC590031**; JF754853⁵; **KC589875**. *Plectocephalus chilensis* G. Don ex Loudon; Chile (BC); JF775394⁵; JF775386⁵; **KC590032**; JF775398⁵; **KC589876**. *Plectocephalus tweediei* (Hook. & Arn.) N. Garcia & Susanna; Argentina; JF775392⁵; JF775384⁵; **KC590033**; JF775396⁵; **KC589877**. *Plectocephalus varians* (A. Rich.) C. Jeffrey; Ethiopia; JF775395⁵; JF775387⁵; **KC590034**; JF775399⁵; **KC589878**. *Psephellus gilanicus* (Bornm.) Wagenitz; Iran; AY826315¹; AY772351¹; AY013501¹; **KC589990**; **KC589879**. *Psephellus persicus* (DC.) Wagenitz; Iran; AY826316¹; AY772352¹; AY013500¹; JF75485⁵; **KC589880**. *Psephellus pulcherrimus* (Willd.) Wagenitz; Armenia; AY826317¹; AY772353¹; AY013491¹; JF754856⁵; **KC589881**. *Ptilostemon abylenis* (Maire) Greuter; Morocco; GU907726¹⁰; **KC590056**; **KC590035**; **KC589991**; **KC589882**. *Ptilostemon afer* (Jacq.) Greuter; Germany, Freiburg Botanical Garden (BC); AY826318¹; AY772354¹; AY785111¹; **KC589992**; **KC589883**. *Ptilostemon diacanthus* (Labill.) Greuter; Turkey; AY826319¹; AY772355¹; AY785112¹; **KC589993**; **KC589884**. *Ptilostemon hispanicus* (Lam.) Greuter; Spain; AY829444¹; **KC590057**; **KC590036**; **KC589994**; **KC589885**. *Rhaponticoides hajastana* (Tzvel.) M. V. Agab. & Greuter; Armenia; AY826235¹; AY772279¹; AY013502¹; JF754857⁵; **KC589886**. *Rhaponticum acaule* DC.; Algeria; AY826334¹; AY772369¹; AY013515¹; JF754859⁵; **KC589887**. *Rhaponticum australe* (Gaud.) Soskov; Australia; AY826335¹; AY772370¹; AY785120¹; **KC589995**; **KC589888**. *Rhaponticum repens* (L.) Hidalgo; Uzbekistan; AY826223¹; AY772268¹; AY013489¹; JF754831⁵; **KC589889**. *Saussurea alpina* (L.) DC.; Italy, Cogne Botanical Garden (BC); AF319091¹/AF319145¹; **KC590058**; **KC590037**; **KC589996**; **KC589890**. *Saussurea discolor* (Willd.) DC.; Switzerland, Meyrin Botanical Garden (BC); AF319092¹/AF319146¹; **KC590059**; **KC590038**; **KC589997**; **KC589891**. *Scaevola aemula* R. Br.; Australia; --; EU385109⁶; EU385394⁶; EU385203⁶; EU017199¹¹. *Schischkinia albispina* (Bunge) Iljin; Turkmenistan; AY826325¹; AY772360¹; AY785113¹; JF754862⁵; **KC589892**. *Serratula coronata* L.; Austria, Vienna Botanical Garden (BC); AY826327¹; AY772362¹; AY785114¹; JF754863⁵; **KC589893**. *Siebera pungens* (Lam.) DC.; Turkey; AY826328¹; AY772363¹; AY785115¹; **KC589998**; **KC589894**. *Silybum marianum* (L.) Gaertner; Spain;

AY826329¹; AY772364¹; AY013551¹; **KC589999**; **KC589895**. *Staehelina dubia* L.; France; AY826330¹; AY772365¹; AY785116¹; **KC590000**; **KC589896**. *Staehelina fruticosa* L.; Greece; AY826331¹; AY772366¹; AY785117¹; **KC590001**; **KC589897**. *Staehelina lobelii* DC.; Turkey; AY826332¹; AY772367¹; AY785118¹; **KC590002**; **KC589898**. *Stizolophus balsamita* (Lam.) Cass. ex Takht.; Armenia; AY826336¹; AY772371¹; AY785121¹; JF754864; **KC589899**. *Stizolophus coronopifolius* Cass.; Turkey; AY826337¹; AY772372¹; AY013516¹; JF754865; **KC589900**. *Synurus palmatopinnatifidus* (Makino) Kitam.; Japan, the Nippon Shinyaku Institute for Botanical Research (BC); AY826338¹; AY772373¹; AY013552¹; **KC590003**; **KC589901**. *Syreitschikovia spinulosa* (Franch.) Pavlov; Kazakhstan; AY826339¹; AY772374¹; AY785122¹; **KC590004**; **KC589902**. *Tarchonanthus camphoratus* L.; South Africa; AY826340¹; AY772375¹; AY785123¹; **KC590005**; **KC589903**. *Tugarinovia mongolica* Iljin; Mongolia; AY826342¹; AY772377¹; AY785124¹; **KC590006**; **KC589904**. *Tyrimnus leucographus* (L.) Cass.; Spain; AY826343¹; AY772378¹; AY013554¹; **KC590007**; **KC589905**. *Volutaria crupinoides* (Desf.) Maire; Morocco; AY826344¹; AY772379¹; AY785125¹; JF754867⁵; **KC589906**. *Xanthopappus subacaulis* C. Winkl.; China, Qinghai (Tibet), Liu 50 (PE); **KC590046**; **KC590060**; **KC590039**; **KC590008**; **KC589907**. *Xeranthemum annuum* L.; Turkey; AY826345¹; AY772380¹; AY785126¹; **KC590009**; **KC589908**. *Xeranthemum inapertum* (L.) Miller; Spain; AY826347¹; AY772381¹; AY013555¹; **KC590010**; **KC589909**. *Xeranthemum longepapposum* Fisch. & C. A. Mey; Kazakhstan; AY826348¹; AY772382¹; AY785127¹; **KC590011**; **KC589910**. *Zoegea leptaura* L.; Iran; AY826349¹; AY772383¹; AY013517¹; JF754868; **KC589911**.

LITERATURE CITED

- ANDERBERG, A. A., F. GHAREMANINEJAD, AND M. KÄLLERSJÖ. 2007. The enigmatic genus *Dipterocome*. *Compositae Newsletter* 45: 23–36.
- GARCIA-JACAS, N., M. GALBANY-CASALS, K. ROMASCHENKO, AND A. SUSANNA. 2008. On the conflicting generic delineation in the *Onopordum* group (Compositae, Cardueae-Carduinae): a combined nuclear and plastid molecular approach. *Australian Systematic Botany* 21: 301–311.
- GRUENSTAEUDL, M., E. URTUBEY, R. K. JANSEN, R. SAMUEL, M. H. J. BARFUSS, AND T. F. STUESSY. 2009. Phylogeny of Barnadesioideae (Asteraceae) inferred from DNA sequence data and morphology. *Molecular Phylogenetics and Evolution* 51: 572–587.

- HIDALGO, O., N. GARCIA-JACAS, T. GARNATJE, AND A. SUSANNA. 2006. Phylogeny of *Rhaponticum* (Asteraceae, Cardueae-Centaureinae) and related genera inferred from nuclear and chloroplast DNA sequence data: Taxonomic and biogeographic implications. *Annals of Botany* 97: 705–714.
- JANSEN, R. K., Z. CAI, L. A. RAUBESON, H. DANIELL, C. W. DEPAMPHILIS, J. LEEBENS-MACK, K. F. MUELLER, et al. 2007. Analysis of 81 genes from 64 plastid genomes resolves relationships in angiosperms and identifies genome-scale evolutionary patterns. *Proceedings of the National Academy of Sciences of the United States of America* 104: 19369–19374.
- KIM, K. J., AND R. K. JANSEN. 1995. NdhF sequence evolution and the major clades in the sunflower family. *Proceedings of the National Academy of Sciences, USA* 92: 10379–10383.
- PANERO, J. L., AND V. A. FUNK. 2008. The value of sampling anomalous taxa in phylogenetic studies: Major clades of the Asteraceae revealed. *Molecular Phylogenetics and Evolution* 47: 757–782.
- SÁNCHEZ-JIMÉNEZ, I., G. A. LAZKOV, O. HIDALGO, AND T. GARNATJE. 2010. Molecular systematics of *Echinops* L. (Asteraceae, Cynareae): A phylogeny based on ITS and *trnL-trnF* sequences with emphasis on sectional delimitation. *Taxon* 59: 698–708.
- SUSANNA, A., M. GALBANY-CASALS, K. ROMASCHENKO, L. BARRES, J. MARTÍN, AND N. GARCIA-JACAS. 2011. Lessons from *Plectocephalus* (Compositae, Cardueae-Centaureinae): ITS disorientation in annuals and Beringian dispersal as revealed by molecular analyses. *Annals of Botany* 108: 263–277.
- SUSANNA, A., N. GARCIA-JACAS, O. HIDALGO, R. VILATERSANA, AND T. GARNATJE. 2006. The Cardueae (Compositae) revisited: Insights from ITS, *trnL-trnF*, and *matK* nuclear and chloroplast DNA analysis. *Annals of the Missouri Botanical Garden* 93: 150–171.
- VILATERSANA, R., N. GARCIA-JACAS, T. GARNATJE, J. MOLERO, G. SONNANTE, AND A. SUSANNA. 2010. Molecular phylogeny of the genus *Ptilostemon* (Compositae: Cardueae) and its relationships with *Cynara* and *Lamyropsis*. *Systematic Botany* 35: 907–917.

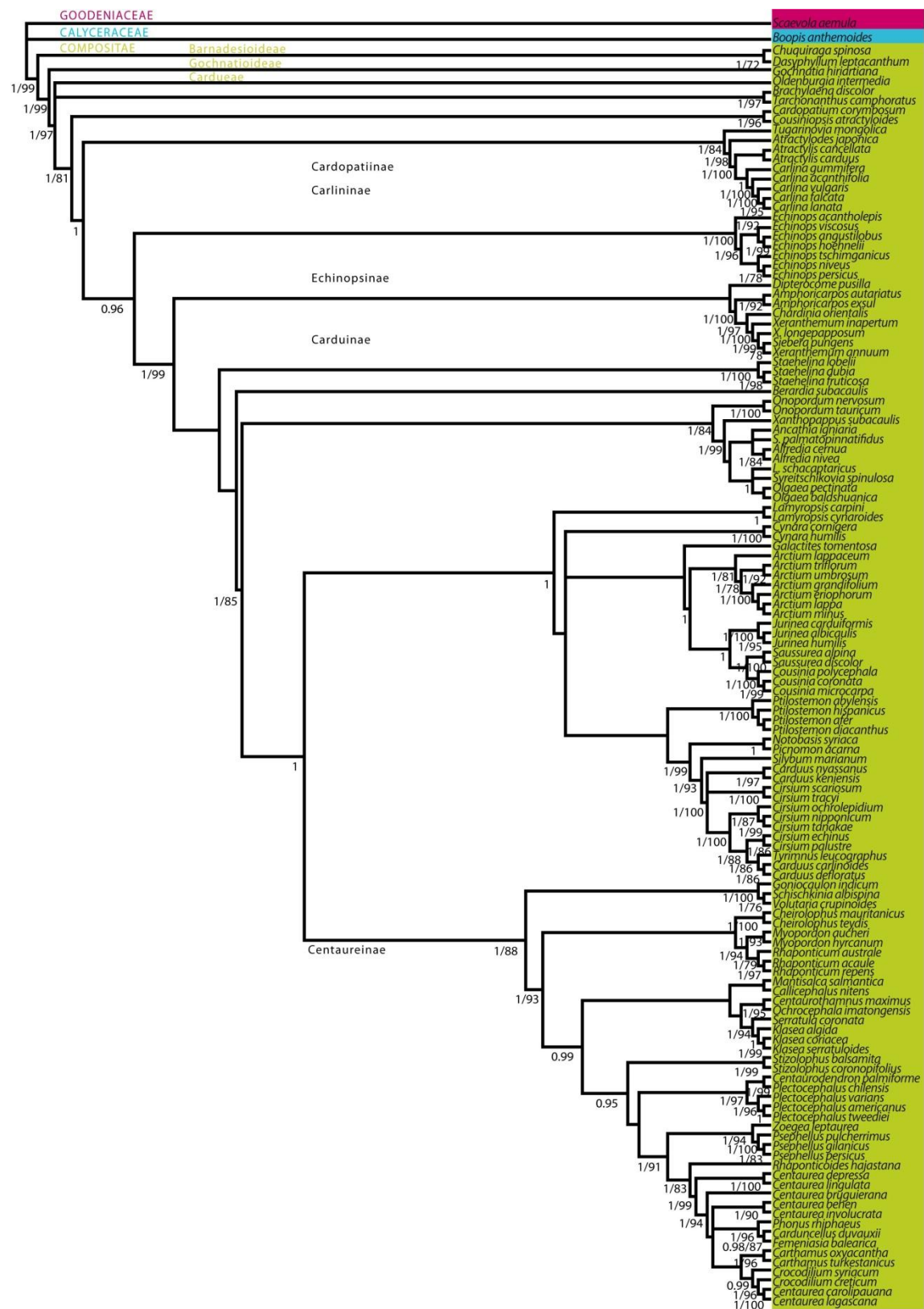

Appendix S2. 50% majority-rule consensus tree derived from Bayesian analyses of combined cpDNA markers. Bootstrap values ($\geq 70\%$) and Bayesian posterior probabilities (≥ 0.50) are indicated under branches.

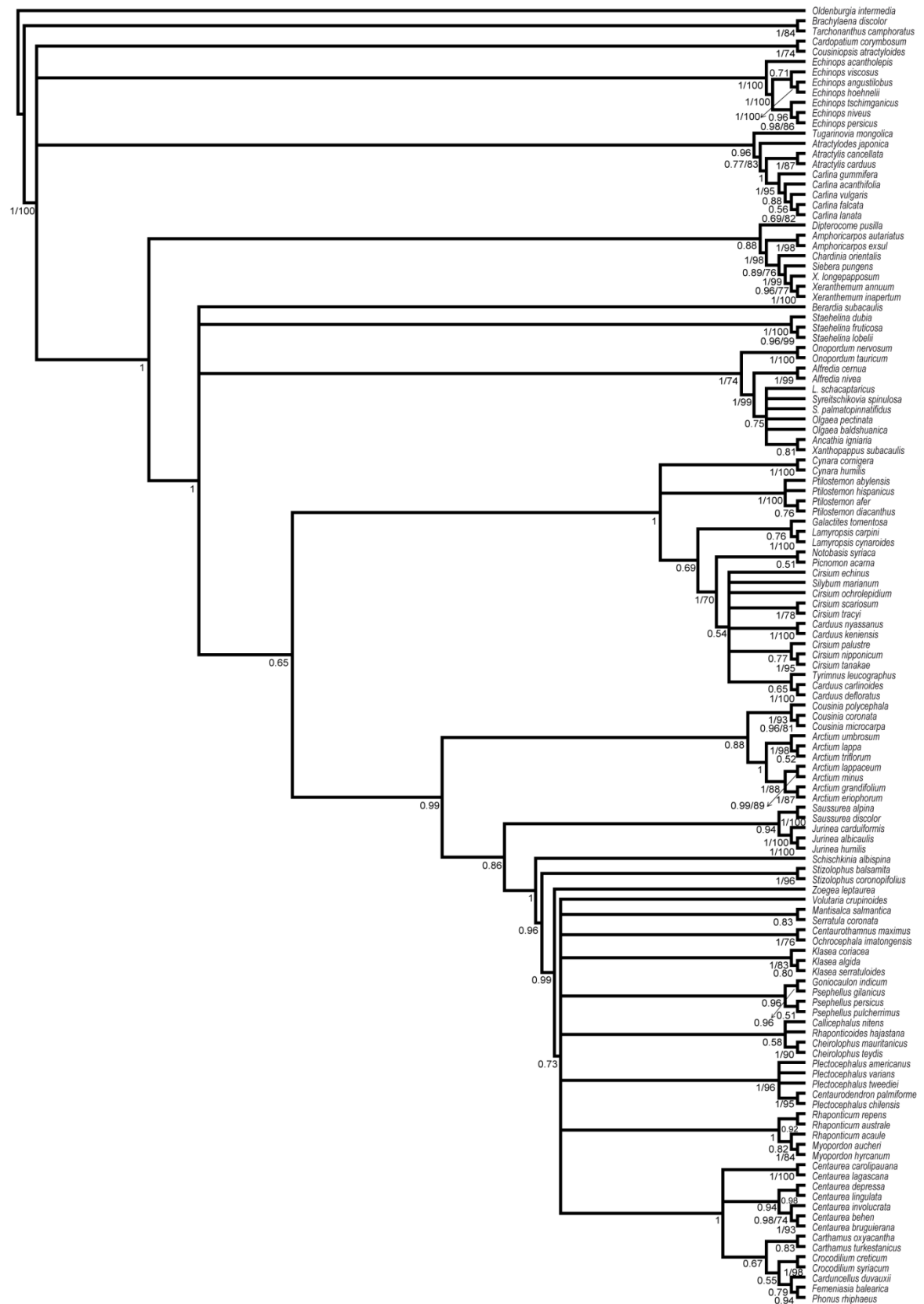

Appendix S4. Majority-rule (“halfcompat”) consensus tree derived from Bayesian analysis of ITS. Bootstrap values ($\geq 70\%$) and Bayesian posterior probabilities (≥ 0.50) are indicated under branches.

8.4. Publicació 4: Lessons from *Plectocephalus* (Compositae, Cardueae-Centaureinae): ITS disorientation in annuals and Beringian dispersal as revealed by molecular analyses

Annals of Botany 108: 263–277 (2011).

Lliçons de *Plectocephalus* (Compositae, Cardueae-Centaureinae): La desorientació de l'ITS en espècies anuals i la dispersió per Beringia revelats per anàlisis moleculars.

Alfonso Susanna, Mercè Galbany-Casals, Konstantyn Romaschenko, Laia Barres, Joan Martín & Núria Garcia-Jacas

Resum

La distribució geogràfica del gènere *Plectocephalus* comprèn una espècie a Etiòpia, dues a Amèrica del Nord i probablement quatre més a Amèrica del Sud, formant una disjunció excepcional dins la tribu *Cardueae*. El gran abast d'aquesta disjunció origina dubtes sobre la delimitació taxonòmica d'aquest gènere. Així els objectius d'aquest estudi van ser definir els límits genèrics de *Plectocephalus* i formular una hipòtesi que expliqui la seva distribució actual. Per tal de resoldre aquests objectius, es van combinar marcadors moleculars d'origen nuclear (ITS i ETS) amb marcadors moleculars d'origen cloroplàstic (*trnL-trnL-F*, *rpl32-trnL^{UAG}* i *ndhF*) i un cop obtingudes les seqüències nucleotídiques es van realitzar anàlisis filogenètics pels mètodes de la Màxima Parsimònia i la Inferència Bayesiana. Els resultats obtinguts mostren que *Plectocephalus* forma un grup natural que inclou l'espècie africana *P. varians*, les espècies sud-americanes classificades prèviament dins el gènere *Centaurea* (*C. cachinalensis*, *C. floccosa* i *C. tweediei*), per les quals es proposen noves combinacions nomenclaturals, i el gènere *Centaurodendron*, endèmic de les illes Juan Fernàndez. Tot i així, es considera més apropiat considerar *Centaurodendron* com un gènere independent, deixant així *Plectocephalus* com un gènere parafilètic. El grup germà al grup *Plectocephalus* segurament es troba entre els gèneres orientals de les *Centaureinae* però les relacions filogenètiques obtingudes a la base de les *Centaureinae* no concorden amb anteriors treballs. Aquest fenomen s'explica per artefactes produïts per les diferents taxes de

mutació entre espècies anuals i perennes. D'entre totes les regions estudiades en aquest treball, la regió nuclear ITS és la més sensible a aquestes diferències. La distribució disjunta del grup *Plectocephalus* s'explica per una dispersió des d'Anatòlia seguint la ruta siberiana i creuant cap al continent americà pel pont terrestre de Bering durant el Miocè-Pliocè, ruta anteriorment proposada per altres grups taxonòmics.



DIGITAL.CSIC

CIENCIA EN ABIERTO

El texto completo de este trabajo no se encuentra disponible por cuestiones de copyright

Referencia bibliográfica completa:

SUSANNA, Alfonso ; GALBANY-CASALS, Mercè ; ROMASCHENKO, Konstantyn ; BARRES, Laia ; MARTÍN, Joan ; GARCIA-JACAS, Núria.
Lessons from *Plectocephalus* (Compositae, Cardueae-Centaureinae): ITS disorientation in annuals and Beringian dispersal as revealed by molecular analyses. *Annals of Botany* 108(2) : 263-277
DOI: <http://dx.doi.org/10.1093/aob/mcr138>

