



FEMA



U.S. DEPARTMENT OF  
**ENERGY**

# Puerto Rico Grid Resilience and Transitions to 100% Renewable Energy Study (PR100):

## Six-Month Progress Update

July 2022



# Authors

## Dozens of talented researchers from the six participating National Laboratories are contributing to the PR100 Study. This presentation was authored by:

- **National Renewable Energy Laboratory (NREL):** Robin Burton, Murali Baggu, Jill Rhodes, Nate Blair, Tom Harris, Manajit Sengupta, Clayton Barrows, Haiku Sky, Jaemo Yang, James Elsworth, Paritosh Das, Patrick Duffy, Gabriel Zuckerman, Jeremy Stefek, Prateek Joshi
- **Argonne National Laboratory (ANL):** Lawrence Paul Lewis, John Murphy
- **Lawrence Berkeley National Laboratory (LBNL):** Peter Cappers, Jeff Deason, Margaret Pigman
- **Oak Ridge National Laboratory (ORNL):** Yilu Liu, Bandana Kar, Shih-Chieh Kao
- **Pacific Northwest National Laboratory (PNNL):** Marcelo Elizondo, Xiaoyuan Fan, Patrick Maloney, Vishvas Chalishazar, Patrick Royer, Fernando Bereta Dos Reis
- **Sandia National Laboratories:** Amanda Wachtel, Matthew Lave, Olga Epshtein Hart, Christian Birk Jones, James Ellison, Cody Newlun
- **Additional Team Members:** Michele Chait (Michele Chait LLC); Harvey Cutler and Martin Shields (Colorado State University)

# Acknowledgements

- This work is supported by Federal Emergency Management Agency (FEMA) through an interagency agreement with the U.S. Department of Energy (DOE).
- This presentation was prepared by the PR100 multilab team, led by the National Renewable Energy Laboratory (NREL) with support from Argonne (ANL), Lawrence Berkeley (LBNL), Oak Ridge (ORNL), Pacific Northwest (PNNL), and Sandia National Laboratories.
- We appreciate the voluntary participation of the more than 80 members of our Advisory Group, whose input ensures the process and results will reflect their priorities and perspectives.
- Thank you to the DOE's Puerto Rico Energy Recovery Team, Marisol Bonnet, Eric Britton, Ernesto Rivera-Umpierre, and Elizabeth Arnold for their leadership.
- Thank you also to Adam Warren and Juan Torres with NREL for providing technical review of this presentation, and Moriah Petty, Sarah Hauck, Fred Zietz, and additional members of the NREL communications team for their contributions to the project and this presentation.

# Contents

- 1 Introduction
- 2 Overview and Timeline
- 3 Six-Month Deliverable: Four Initial Scenario Definitions
- 4 Updates by Study Activity
  - Responsive Stakeholder Engagement and Energy Justice
  - Data Gathering and Generation
  - Scenario Generation and Capacity Evaluation
  - Impact Modeling and Analysis
- 5 Appendices: Terminology, Background Reading, Additional Resources



# Introduction

- Puerto Rico has committed to meeting its electricity needs with 100% renewable energy by 2050, along with realizing interim goals of 40% by 2025, 60% by 2040, the phase-out of coal-fired generation by 2028, and a 30% improvement in energy efficiency by 2040, as established in [Puerto Rico Energy Public Policy Act \(Act 17\)](#).
- To meet these goals and support a more reliable and resilient electric grid, Puerto Rico is exploring renewable energy as well as energy storage, distributed generation, distribution control, electric vehicles, and energy-efficient and responsive loads that can be deployed in each of Puerto Rico's cities and communities.
- Since hurricanes Irma and Maria in September 2017, DOE and its national laboratories have provided Puerto Rico energy system stakeholders with tools, training, and modeling support to enable planning and operation of the electric power grid with more resilience against further disruptions.
- On February 2, 2022, DOE, FEMA, and six national laboratories launched the two-year [Puerto Rico Grid Resilience and Transitions to 100% Renewable Energy Study \(PR100\)](#) to conduct comprehensive analysis of stakeholder-driven pathways to Puerto Rico's energy future. The robust and objective energy analysis entails five activities, with an emphasis on power system reliability, resilience, and generation planning.
- This presentation provides a six-month progress update on the study, including presentation of four initial scenario defined with extensive stakeholder input.

# PR100 Study Overview and Timeline

---

# What is the PR100 Study?

- A comprehensive analysis of possible pathways for Puerto Rico to achieve its goal of 100% renewable energy by 2050, based on extensive stakeholder input.
- A coordinated effort led by FEMA, DOE and NREL, leveraging the unique tools and capabilities of five additional national laboratories.

# PR100 Scope

## In Scope

### In this study, the project team will:

- Model pathways and analyze impacts
- Conduct analysis to inform potential investment decisions
- Produce a roadmap with recommended near- and long-term actions to transition to renewable resources
- Facilitate stakeholder interaction and information exchange to create foundation for future implementation
- Publish and disseminate results, including high-resolution datasets and open-source models.

## Out of Scope

### The study will not:

- Make policy recommendations
- Develop a detailed implementation plan
- Make specific investment recommendations
- Address economy-wide decarbonization
- Replace mandated capital investment planning processes such as the Integrated Resource Plan (IRP).



# How Stakeholders Can Use PR100 Study Results

- The PR100 study will produce a set of results—including data and models—that outline alternatives for how Puerto Rico can achieve its resilience and renewable energy goals.
- The results are intended to answer stakeholder questions and inform decision-making using world-class data, modeling, and analysis.
- It will be up to Puerto Rico energy system stakeholders to choose a path forward and implement it.

# Activities in the Puerto Rico 100% Renewable Energy Study

## 1 Responsive Stakeholder Engagement and Energy Justice

- Stakeholder engagement inclusive of procedural justice
- Energy justice and climate risk assessment

## 2 Data Gathering and Generation

- Resource potential and demand projections (solar, wind, hydro)
- Demand projections and adoption of DER (considering load, EVs, energy efficiency, distributed PV and storage)

## 3 Scenario Generation and Capacity Evaluation

- Detailed scenario generation
- Distributed PV and storage grid capacity expansion
- Production cost and resource adequacy

## 4 Impacts Modeling and Analysis

- Bulk system analysis for enhanced resilience
- Distribution system analysis
- Economic impacts

## 5 Reports, Visualizations, and Outreach

- Scenarios for grid resilience and 100% renewable electricity for Puerto Rico
- Reports and outreach
- Implementation roadmap

Activity 5:  
Reports, Visualization,  
and Outreach

Activity 1:  
Responsive Stakeholder  
Engagement and  
Energy Justice

Activity 4:  
Impact Modeling  
and Analysis

Activity 2:  
Data Gathering  
and Generation

Activity 3:  
Scenario Generation and  
Capacity Evaluation

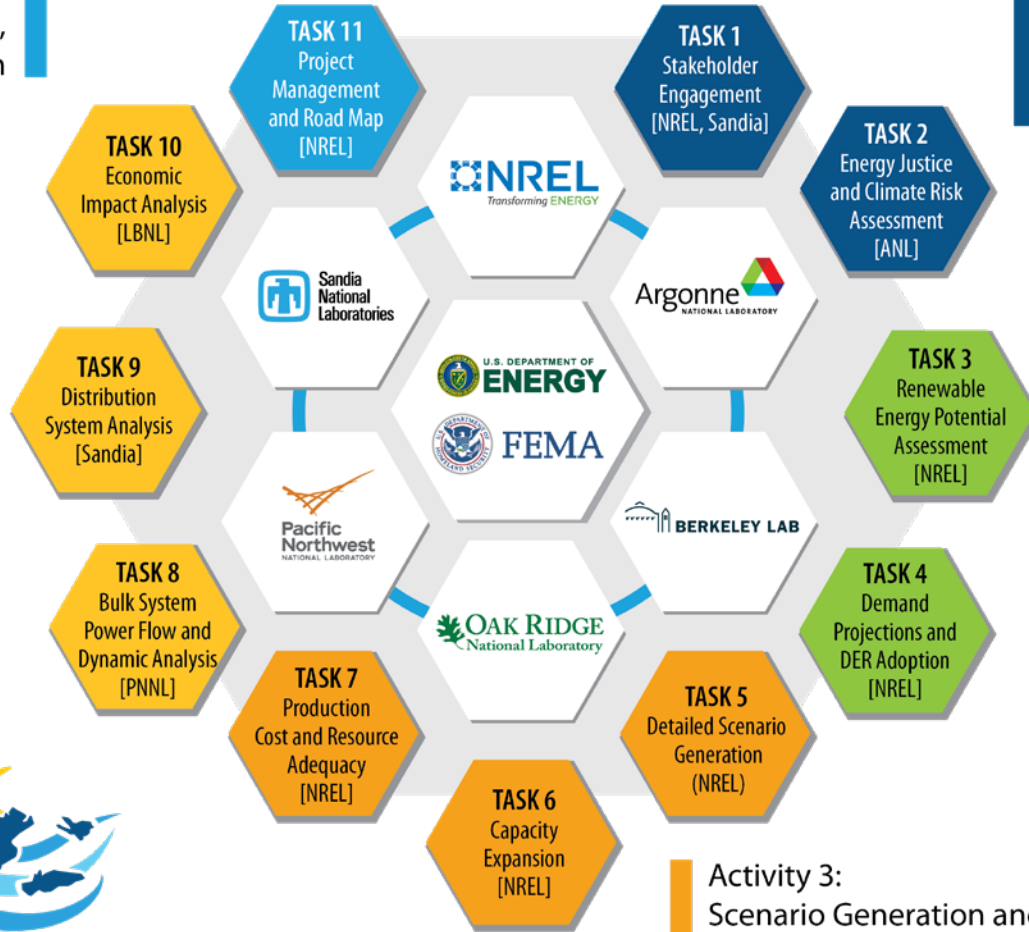

# PR100 Timeline

## Six Months (by June 2022):

- Established stakeholder group meets monthly to inform scenarios
- Defined four initial scenarios to achieve Puerto Rico's goals.

## Year One (by December 2022):

- High-resolution data sets for wind and solar resource for 10 years
- Three feasible scenarios with high-level pathways.

## Year Two (by December 2023):

- Comprehensive report and web-based visualizations
- Outreach and public engagement.

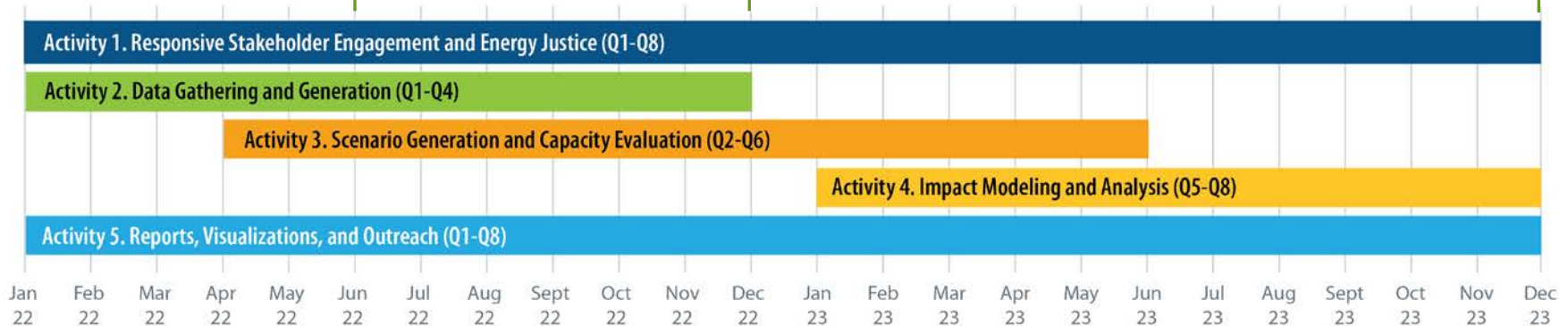



Six-Month Deliverable:  
Four Initial Scenario  
Definitions

---

# Initial Scenario Definition

- The project team worked closely with the Advisory Group during the first six months of the study to define four initial scenarios to model based on these priorities:
  - Energy access and affordability
  - Reliability and resilience (under both normal and extreme weather conditions)
  - Siting, land use, environmental and health effects
  - Economic and workforce development
- The primary distinction between the four scenarios is varying levels of distributed energy resources, such as rooftop solar and energy storage.
- Variations of electric load and land use, as well as transmission and distribution expansion, will be incorporated in each scenario.

# Scenario 1. Economic Adoption of Distributed Energy Resources

Electricity system is modeled to achieve 100% renewable energy by 2050



# Scenario 2. Deployment of Distributed Energy Resources for Critical Services

Installation of distributed energy resources is prioritized beyond Scenario 1 for critical services like hospitals, fire stations, and grocery stores





# Scenario 3. Equitable Deployment of Distributed Energy Resources

Installation of distributed energy resources is prioritized beyond Scenario 2 for remote and low- and moderate-income households

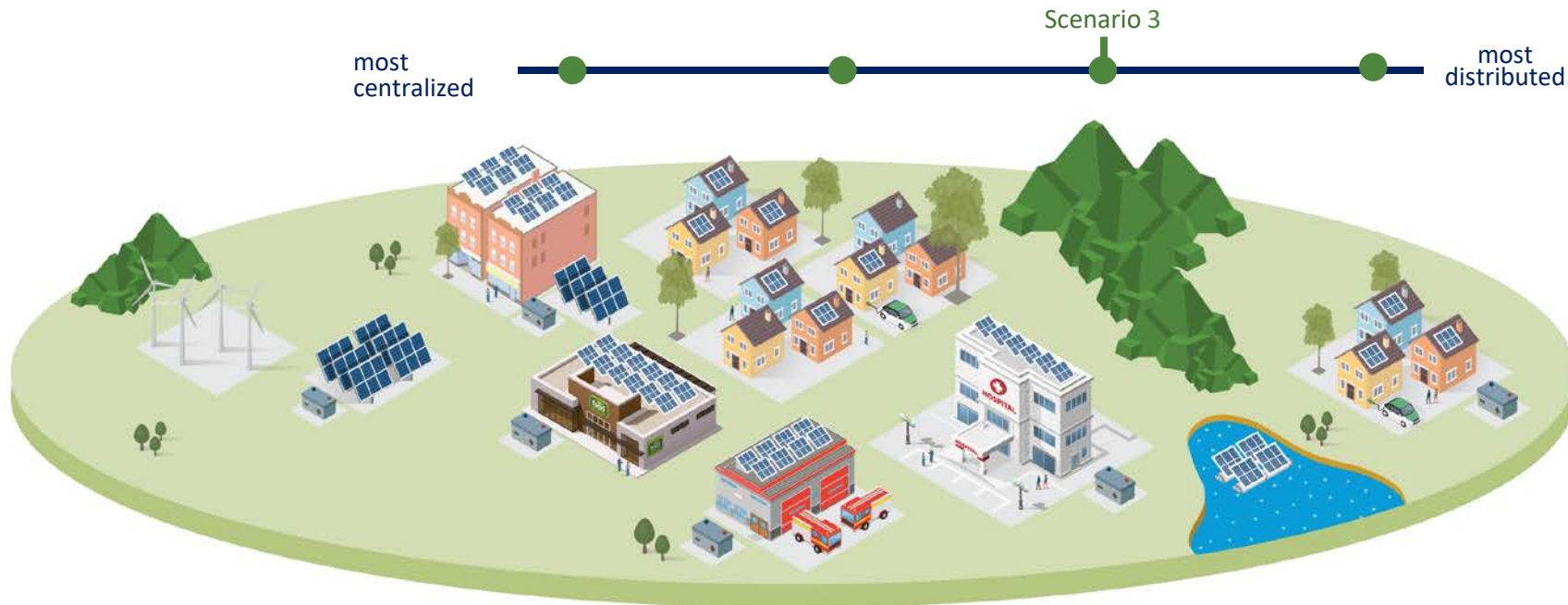

# Scenario 4. Maximum Deployment of Distributed Energy Resources

Distributed solar and storage is added to all suitable rooftops



# Activity 1. Responsive Stakeholder Engagement and Energy Justice

---

Task 1. Stakeholder Engagement

Task 2. Energy Justice and Climate Risk Assessment

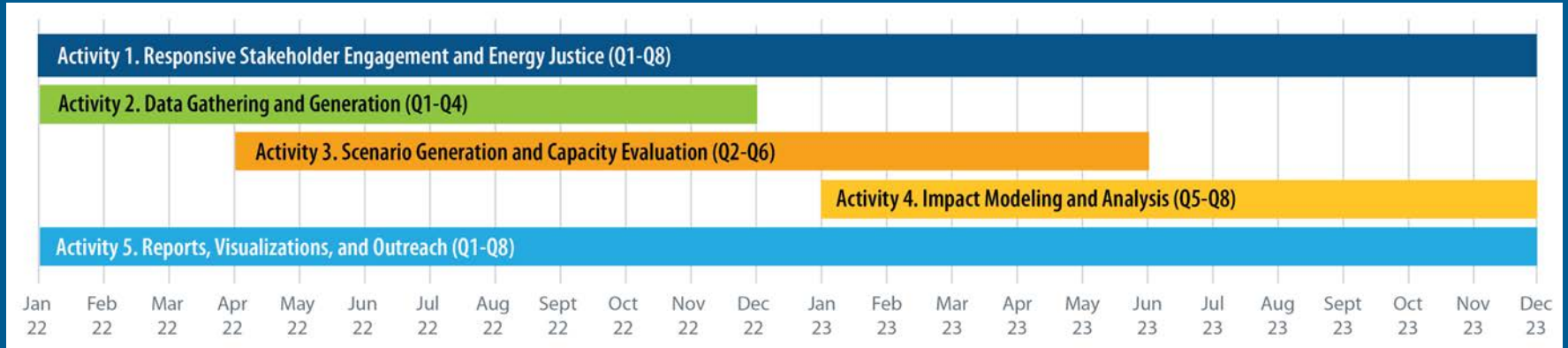





# TASK 1: Stakeholder Engagement

Lead Labs: NREL and Sandia

Supporting: ANL, ORNL

# Advisory Group Formation and Engagement

- Convened Advisory Group of 80+ members from academia, public and private sectors, community-based and environmental organizations, and other sectors.
- Facilitated monthly Advisory Group meetings from February–July 2022 (four remote and two hybrid); bi-monthly or quarterly meetings to be held through December 2023.
- Received member input on the following topics and iterated on initial scenario framework generation for PR100:
  - Priorities for Puerto Rico’s energy future
  - Scenario frameworks and electricity demand levels
  - Energy justice priorities
  - Data inputs including land use and technology cost.
- Partnered with [Hispanic Federation in Puerto Rico](#) for facilitation and stakeholder engagement support.



*Presentation during hybrid Advisory Group meeting held in San Juan, Puerto Rico in May 2022. Photo by Robin Burton, NREL*

# Information Exchange

- Launched online community on Mobilize for networking and information exchange with Advisory Group members and the public
- What is Mobilize?
  - Web-based platform where Puerto Rico energy system stakeholders can come together and share ideas
  - Space for DOE and national labs to provide project updates and gather feedback, and for all users to share resources and network
  - Foundation for implementation of pathways to 100% renewable energy.
- Users can access the platform in Spanish using the Translate extension in Google Chrome
- [Register to join the online community!](#)

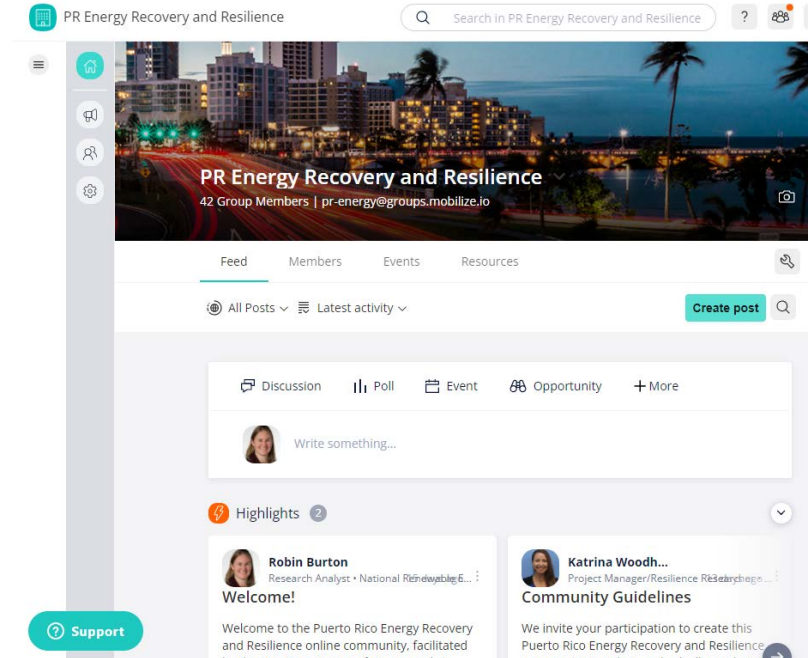

# Capacity Building

- **The objectives of this task are to:**
  - Facilitate university participation in scenario development, technical support, and analysis
  - Support the use of lab data, tools, and analysis by university and other partners to build local capacity.
- **Progress: University of Puerto Rico Mayagüez (UPRM) subcontract**
  - During the first six months, DOE and the labs met regularly with UPRM faculty resulting in a subcontract for UPRM faculty and students to participate as members of the PR100 team.
  - Between June 2022 and July 2023, UPRM will:
    - Advise the PR100 team on the development of methods, inputs, and assumptions to accurately represent rooftop solar resources across models
    - Produce new data through a comprehensive survey to improve the PR100 team's understanding of residential solar systems
    - Assist in the development of energy justice metrics based on outage restoration data from Hurricane Maria
    - Coordinate with parallel research efforts.



# Metrics and Evaluation

## Purpose of Engagement

- Inform development of scenarios to meet Puerto Rico's goal of 100% renewable energy by 2050
- Understand and answer stakeholder questions about possible pathways to 100% renewable energy.

## Purpose of the Metric

- Evaluate the effectiveness of stakeholder engagement by answering the following questions:
  - Are stakeholders actively participating in the study and exchanging information with the project team and each other?
  - How well is engagement sustained overtime?
  - Did we ensure equitable representation across stakeholder groups?
  - To what extent has stakeholder input been integrated into the study?
  - To what extent has stakeholder input influenced project direction and results?

## Metric Dimensions

- Participation. Extent to which stakeholders are engaged in the study process and product review, and stay engaged over time:
  - Measure meeting attendance, input provided.
- Inclusion / Representation. Extent to which stakeholders are equitably represented and have access to influence project direction:
  - Measure how well each sector is represented in the AG and ability to access information.
- Engagement. Extent of stakeholder engagement with project team and each other:
  - Measure responsiveness (involved in every aspect of project discussion), rate of engagement.

# Metrics and Evaluation

## Data Sources

- Advisory Group member database and meeting attendance records
- Meeting notes and chat log
- Mobilize platform
- Feedback instrument results on Advisory Group member sentiment about project team's efforts to incorporate their input, ensure representation across sectors, and extent of their influence.

## Analysis

- Visualization of member participation, representation by sector and change over time
- Social network analysis to understand extent of stakeholder interaction with each other and change overtime.

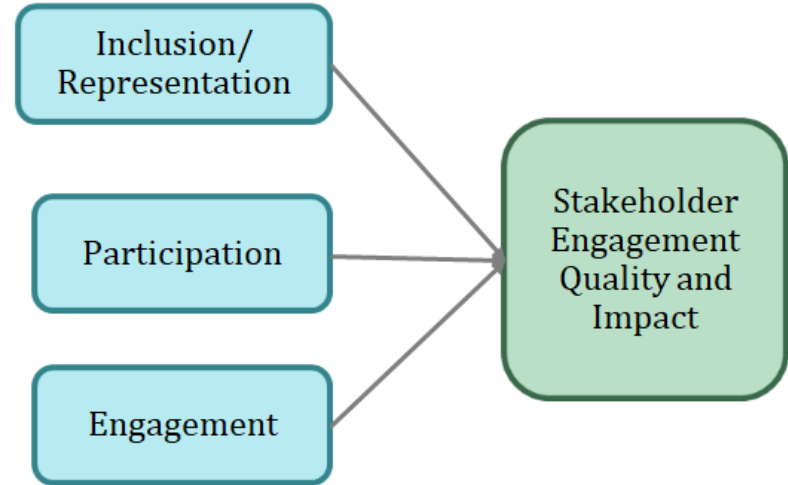

*Graphic from ORNL*



# TASK 2: Energy Justice and Climate Risk Assessment

Lead Lab: ANL

Supporting: NREL, Sandia, ORNL

# Energy Justice Definition and Pillars

## Energy Justice Definition

- “Refers to the goal of achieving equity in both the social and economic participation in the energy system, while also remediating social, economic, and health burdens on those historically harmed by the energy system...”
- “Connects to, and builds upon, the deep scholarly and grassroots traditions of the environmental justice and climate change movements.”

## Energy Justice Pillars

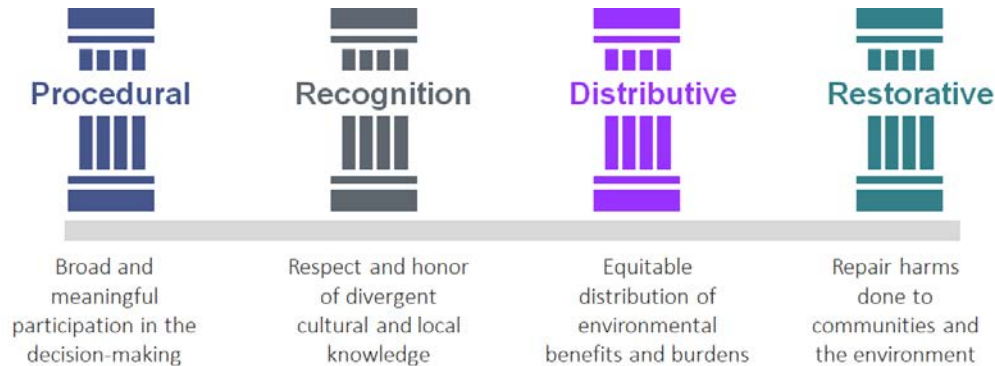

Many actions that promote energy justice, such as expanding economic benefits through renewable energy job creation in areas with high unemployment, encompass multiple pillars.

# Energy Justice Themes From the Literature

Energy Access

Infrastructure  
Interdependencies

Land Use and  
Siting

Economic and  
Workforce  
Development

Environmental and  
Health Impacts

Academic  
Frameworks

Utility Actions

Energy  
Democracy

Access a database of energy justice literature by theme compiled during this phase of the study in the [Resources](#) section of Mobilize.



# Energy Justice in PR100

## Procedural Justice

- Ensure stakeholder access to planning process by convening Advisory Group of members with diverse perspectives representing a breadth of sectors
- Recognize and incorporate local knowledge into the study
- Share results in a way that everyone can understand them.

## Metrics-based Energy Justice Analysis

- Evaluate societal “cost” of long-duration outages and disparities in social burden
- Evaluate energy justice impacts of modeled scenarios.

## Infrastructure Interdependency Assessment

- Identify and characterize electric power interdependencies of other critical infrastructure (i.e., communications, IT, transportation, water), community lifeline assets, etc.
- Evaluate the extent to which energy injustices have resulted in other resource justice concerns.

## Climate Risk Assessment and Adaptation Strategies

- Project where changing climate conditions will present future risks to infrastructure and the communities it supports
- Inform siting and operational needs of infrastructure to avoid premature obsolescence.

# Energy Justice Workflow

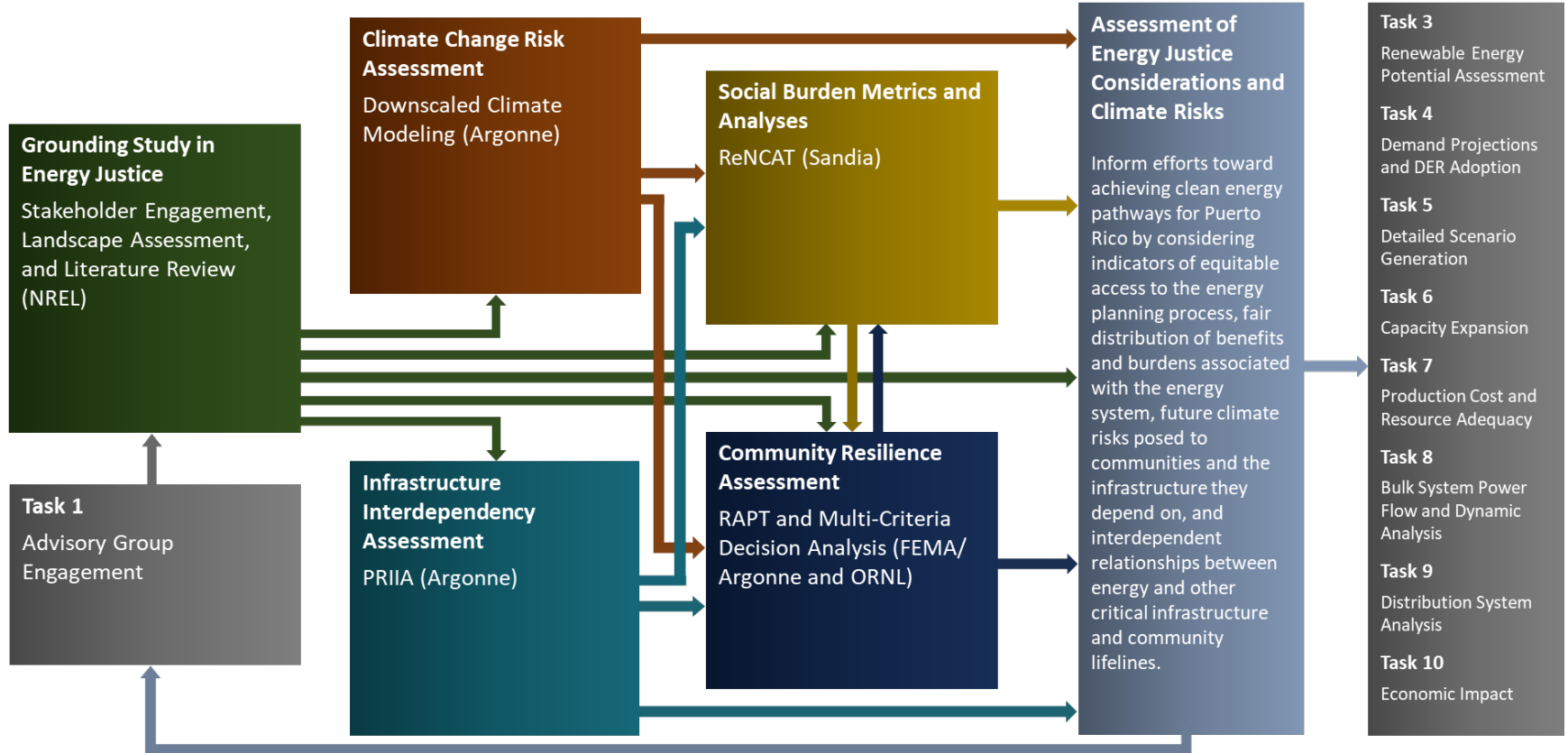

# Progress on Climate Risk Assessment

- Downscaled climate modeling:
  - Leveraged climate modeling capabilities to develop 4-km grid and dataset for a range of climate variables projected for mid-century and end-of-century, including:
    - Surface parameters (e.g., accumulated total precipitation, daily minimum and maximum temperatures, etc.)
    - Atmospheric parameters (e.g., wind speeds, cloud fraction, relative humidity, etc.)
    - Soil parameters (e.g., soil temperature, moisture, liquid water, etc.)
    - Hydrologic parameters (e.g., sea level rise, inland waterway level rise, etc.).
- Progress on downscaled climate modeling:
  - Completed first modeling decadal tranche of historic (2000-2010) and mid-century (2040-2045) variables
  - Currently processing second tranche of historic (2010-2020) and mid-century (2045-2050) variables, with end-of-century (2090-2100) up next.

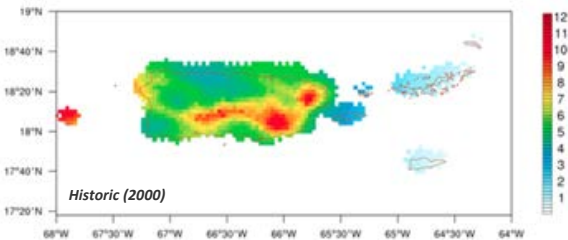

Preliminary downscaled modeling of historic annual daily average precipitation amount (mm/day) (graphic from Argonne)

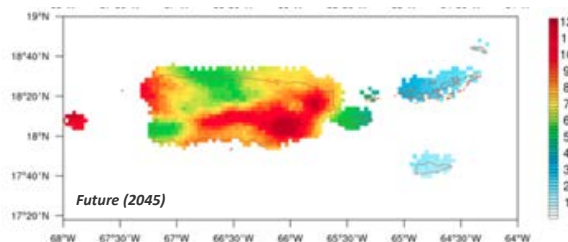

Preliminary downscaled modeling of future annual daily average precipitation amount (mm/day) (graphic from Argonne)

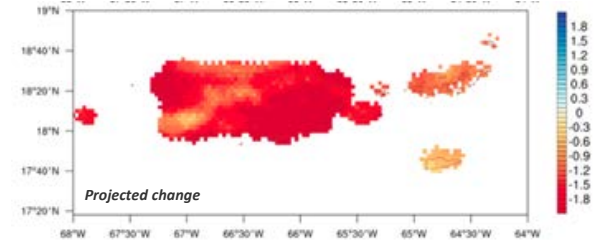

Preliminary downscaled modeling of projected climate-driven change to annual daily average precipitation amount (mm/day) (graphic from Argonne)



# Progress on Energy Justice Metrics

- Puerto Rico Infrastructure Interdependency Assessment (PRIIA):
  - Identify and characterize electric power dependencies of other critical infrastructure through a network analysis of their overlapping and dependent service area connections
  - Assess the criticality of substations and loads (i.e., other critical infrastructure) throughout communities based on simulations of potential cascading failures across dependent assets that might scale up the consequences of disruption.
- Progress running the PRIIA model:
  - Completed modeling of service areas for electricity-dependent critical infrastructure across Puerto Rico (i.e., all 38-kv substations, cellular transmission towers, water treatment plants, and wastewater treatment plants)
  - Developed GIS dataset and visualization of critical infrastructure dependencies for each distribution substation
  - Finalizing dataset and GIS visualization widget for sharing across PR100 and with local stakeholders.

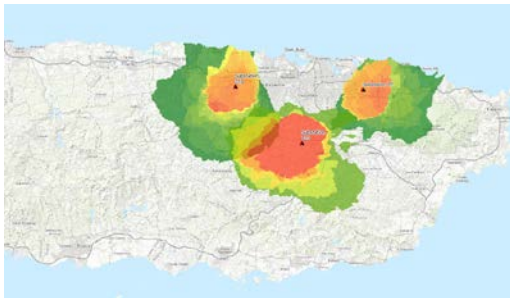

Service areas modeling results in PRIIA (graphic from Argonne)

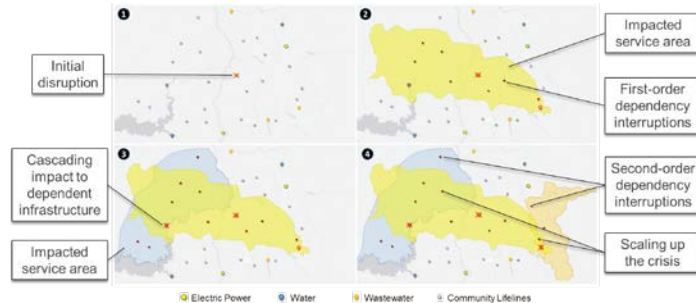

Notional illustration of a cascading electricity failure impacting water and wastewater service in PRIIA (graphic from Argonne)



Result for modeled cascading failure in PRIIA (graphic from Argonne)

# Next Steps on Energy Justice Metrics

- Community resilience assessment (RAPT and Multi-Criteria Decision Analysis):
  - Capture municipal- and census tract-level demographic data related to overall community resilience as well as the proximity and availability of community lifelines to communities
  - Apply indicators derived through social statistics and best-in-class community resilience indicators to determine how underlying characteristics may influence energy justice concerns.
- Social burden analysis (ReNCAT):
  - Quantifying census block groups' ability to access critical services (fuel, food, other services) both historical and across future scenarios
  - Evaluating populations' relative ability to access such services during disasters, given natural hazard risk profiles that affect power systems.

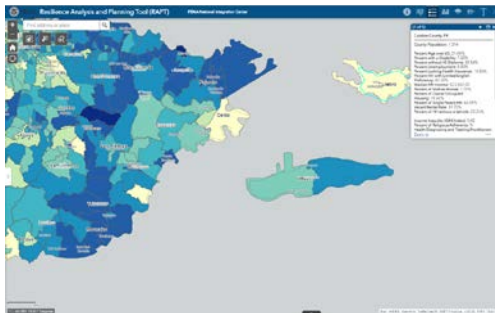

Community resilience indicators in RAPT  
(graphic from Argonne)



Identification of community lifelines in RAPT  
(graphic from Argonne)



Social burden analysis in ReNCAT (graphic from Sandia)

# Activity 2. Data Gathering and Generation

---

Task 3. Renewable Energy Potential Assessment

Task 4. Electricity Demand Projections and Distributed Energy Resources Adoption

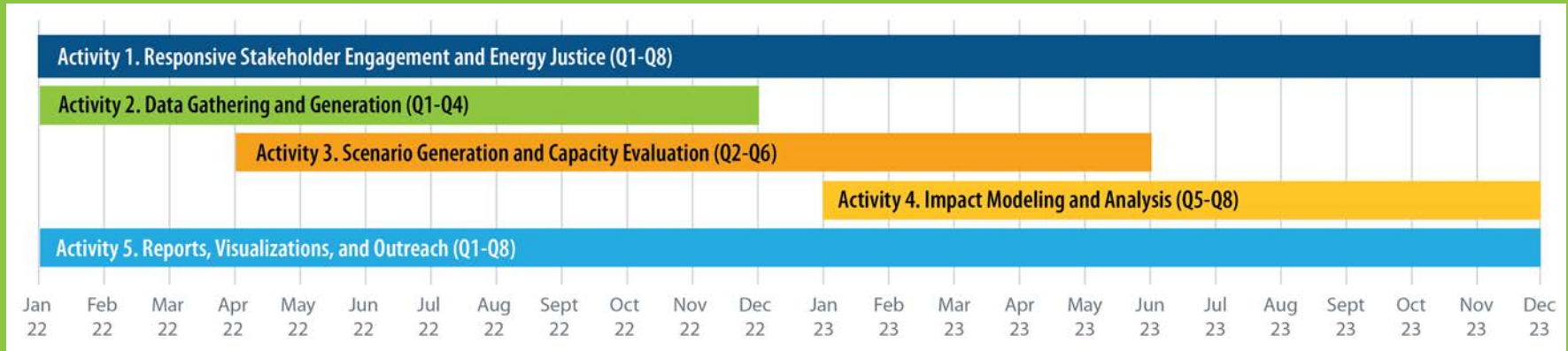





# TASK 3: Renewable Energy Potential Assessment

Lead Lab: NREL

Supporting: ORNL, PNNL, Sandia

# Wind Resource Assessment

---

Development of high-resolution wind  
resource datasets

# Overview of Wind Resource Data Development

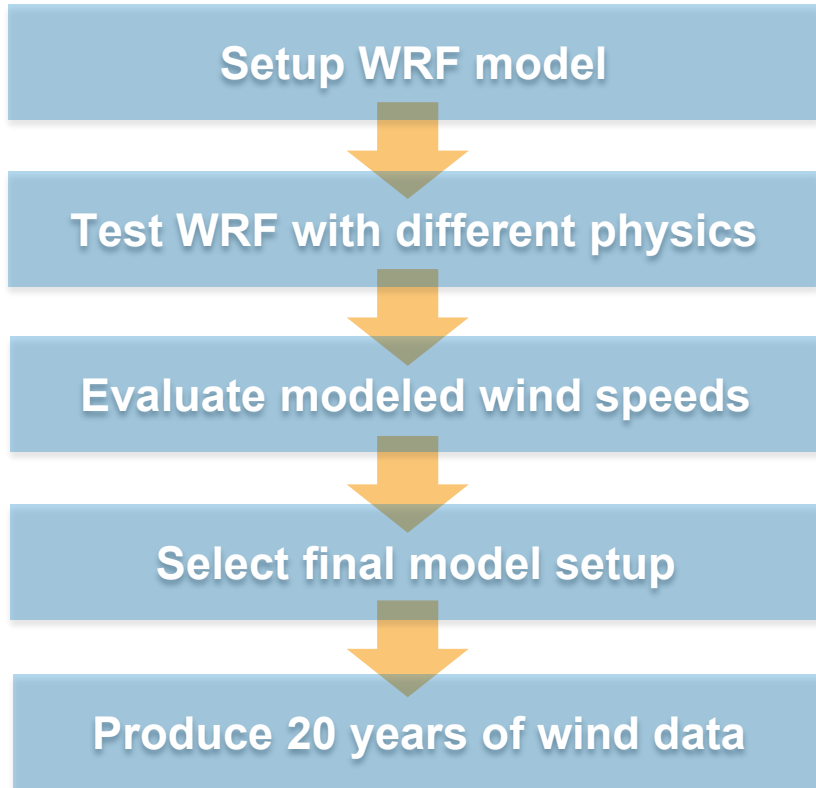

- Publicly available Weather Research and Forecasting (WRF) model used to develop wind resource.
- Test various choices within WRF to identify the most accurate module combination for generating wind resource data
- Assess modeled wind data using observations.
- Determine the best-performing WRF setup from the model evaluation.
- Generate 20 years of data (2001-2020) from WRF and make the data publicly available through the [Wind Integration National Dataset \(WIND\) Toolkit](#).

# WRF Model Domain

## WPS Domain Configuration

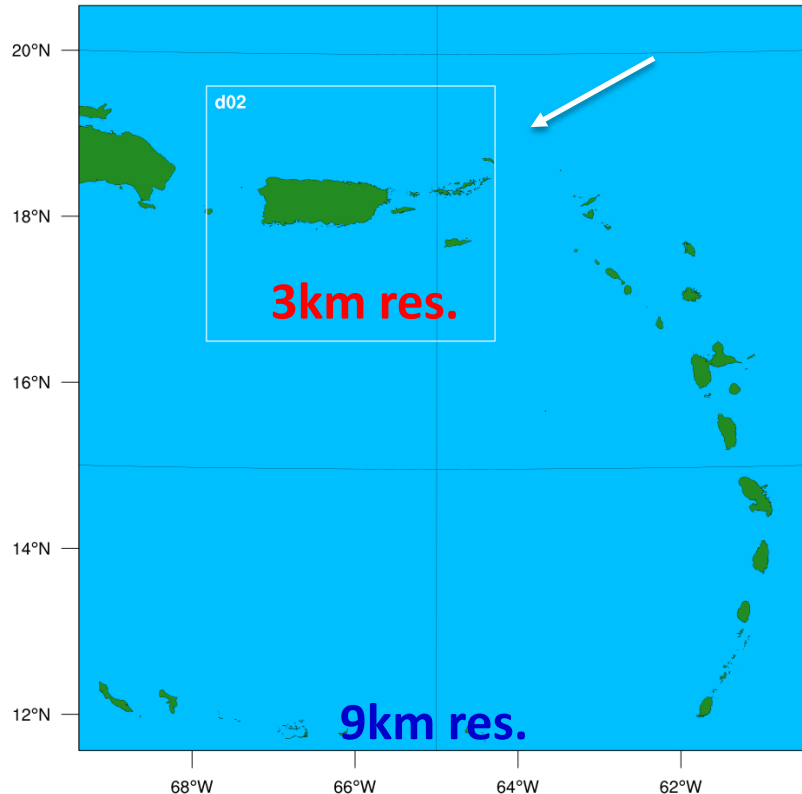

- Grid dx: 9 km (outer), 3 km (inner)
- Model inputs: ERA5
- Time interval between incoming data: Hourly
- Temporal resolution of output: 5 minutes
- SST update: Hourly
- Time steps: 20 sec
- Two-way nesting: Yes
- Number of vertical layers: 61.

- 3 km domain covers entirety of Puerto Rico.
- 9 km domain covers Puerto Rico more widely so we can capture tropical storms.

Computations using NREL [High-Performance Computing](#) (HPC)



# Wind Resource in Puerto Rico

2019: 1-yr averaged wind speed at 80m

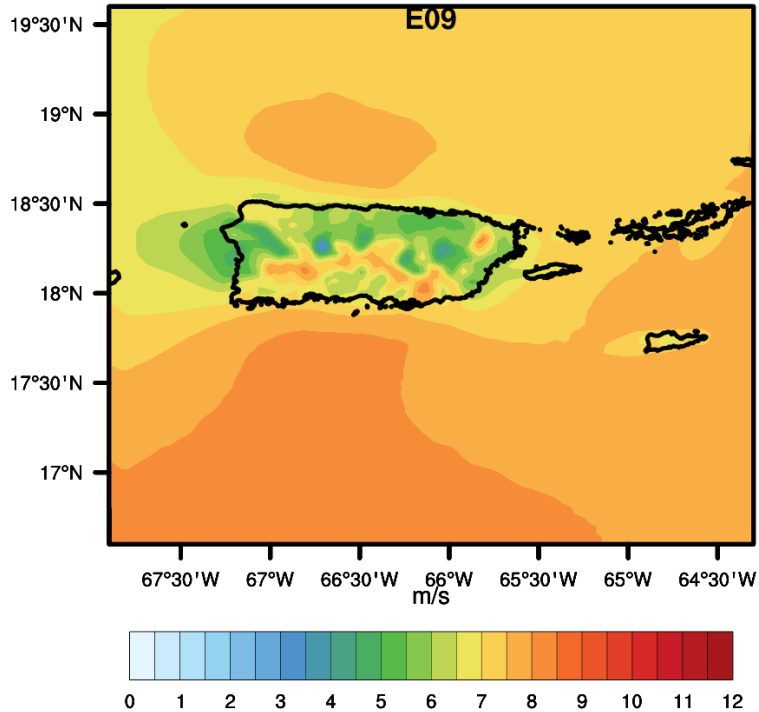

Wind speed at 80m (m/s, 2019-01-01T00:00:00)

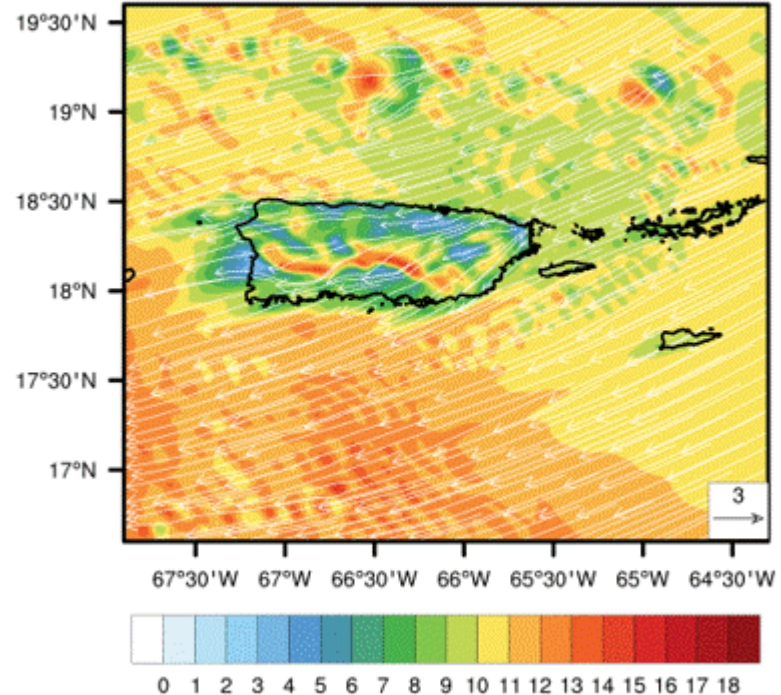

20 years of high-resolution offshore and onshore wind data was developed.



# Representation of Severe Weather

Wind speed at 80m (m/s, 2017-09-20T10:00:00)

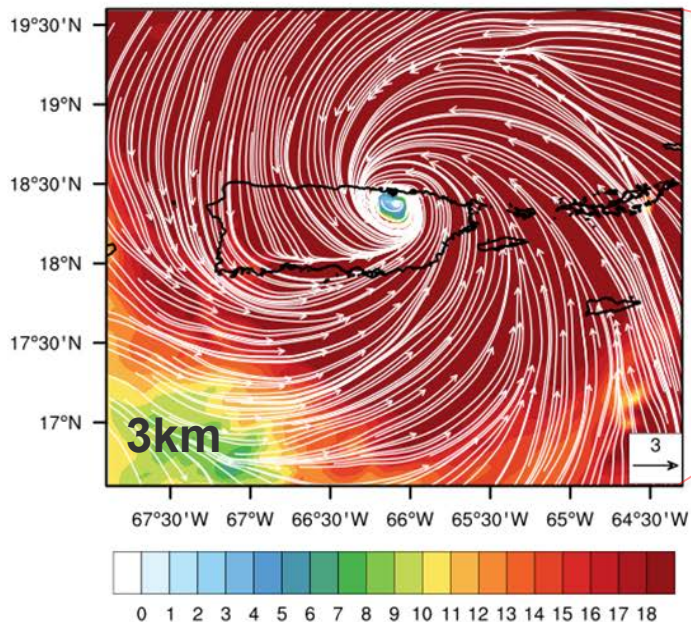

Hurricane Maria track (from 9km domain)

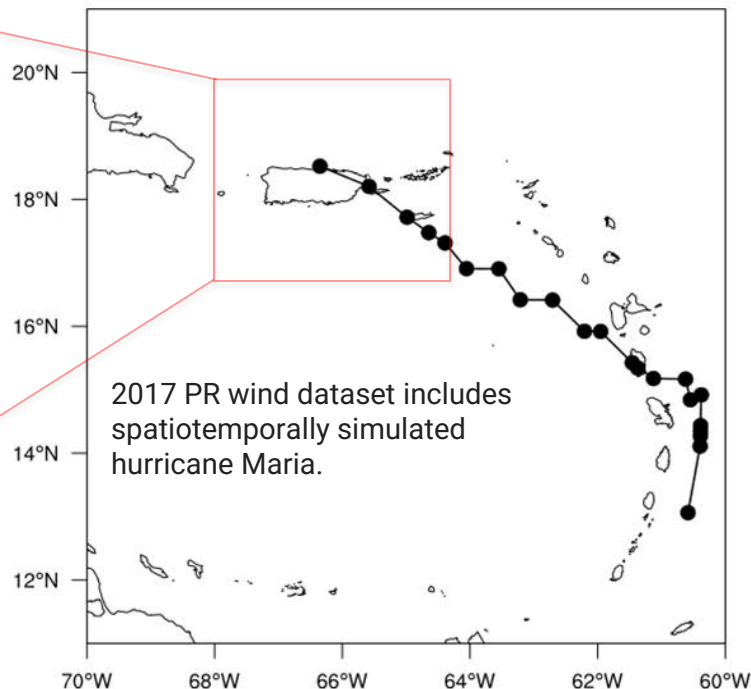

Graphics from NREL

- Extreme weather events bring utmost challenges to power system reliability and resilience due to their multifaceted impacts on renewable generation resources, demand, and power system outages.
- Through investigating of extreme weather events captured within the 20 years of wind data, it is expected that it will be possible to understand the recent trend in climate of Puerto Rico and its impact on severe weather.

# Topography



Terrain and water depth around Puerto Rico

# Offshore Assumption Development: Fixed vs. Floating Offshore Wind

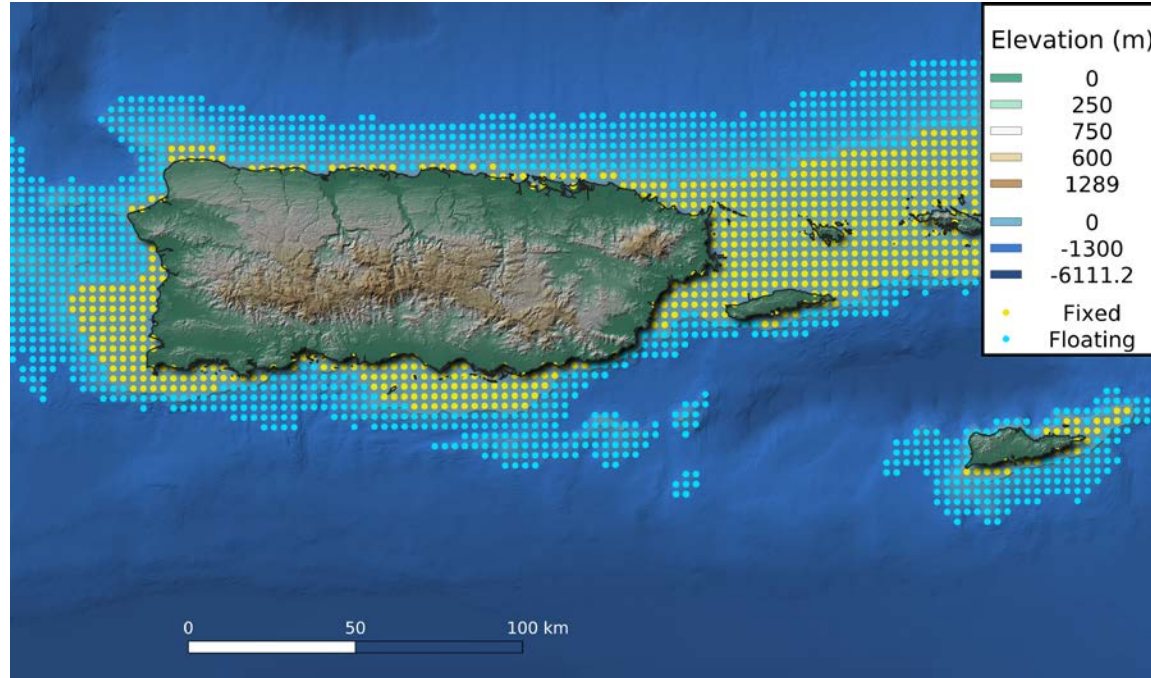

- When modeling offshore wind, we assume fixed-bottom foundations are cost effective until 60m water depths based on recent market trends (yellow dots).
- Floating substructures are assumed to be cost effective up to 1,300m with current floating technologies (blue dots).

# Diurnal Analysis of Wind Data: Onshore

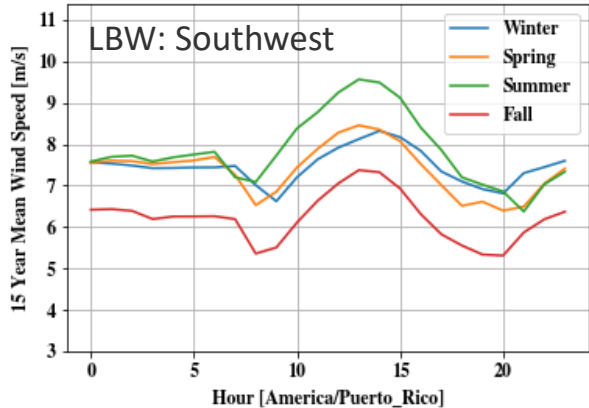
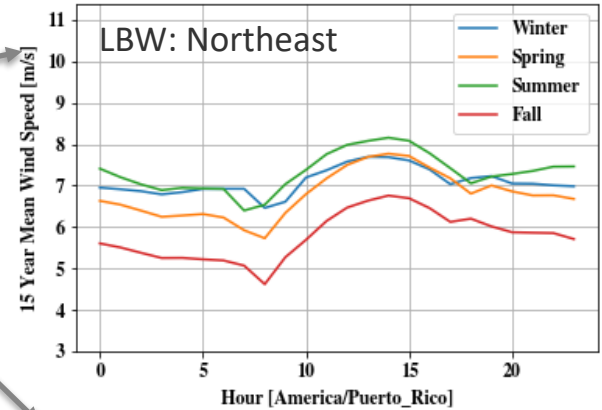
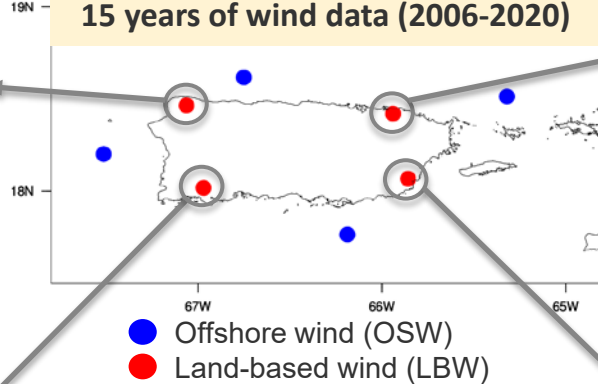
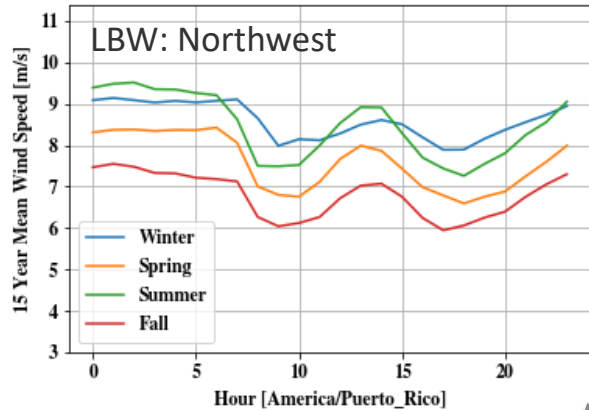

- Seasonal wind speeds feature similar patterns among four sites with increase around noon (e.g., because of strong sea breeze during daytime).
- Wind speed is higher in summer/winter than in spring/fall.

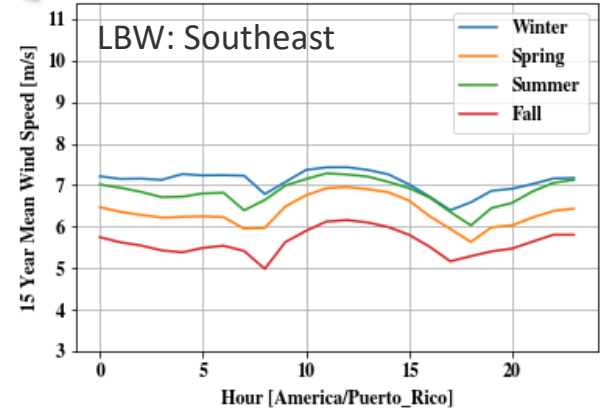

# Diurnal Analysis of Wind Data: Offshore

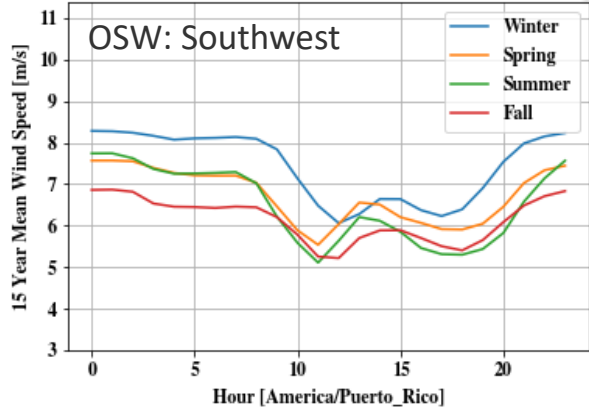
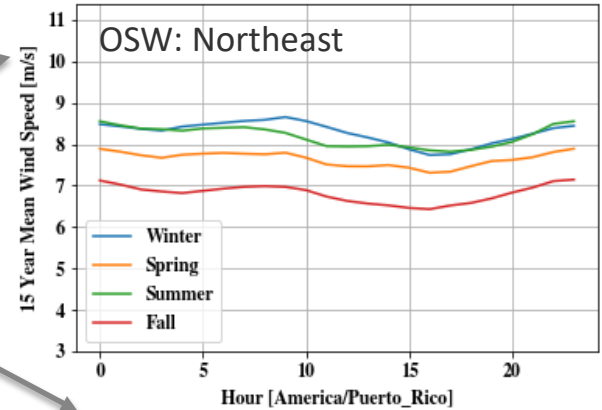
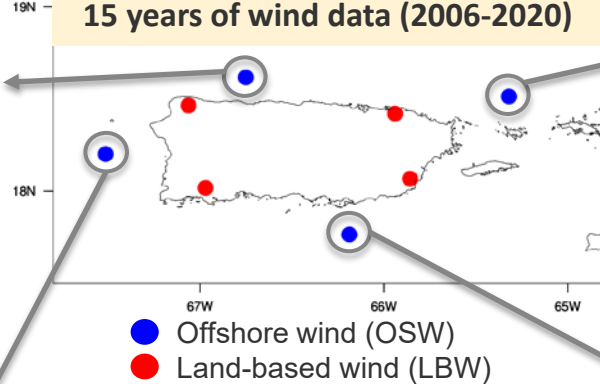
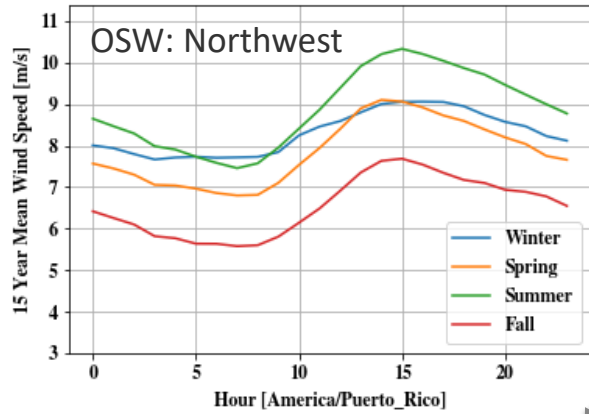

- Northwest site shows high wind magnitude during daytime. Potentially good signal for supporting high demand of energy in summer.
- The other sites show higher wind speeds during nighttime. Potential complementarity between solar and wind generation.

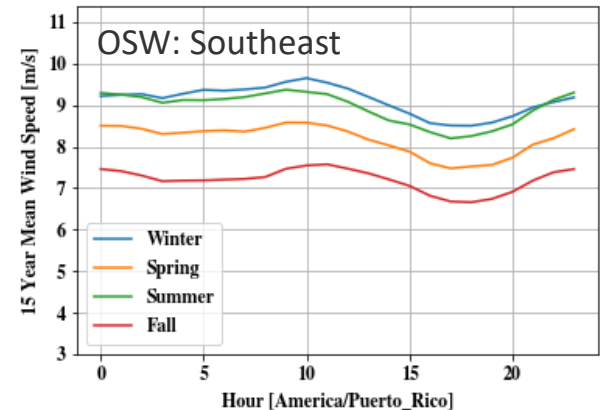

# Solar Resource Assessment

---

Development of high-resolution solar  
resource datasets



# Overview of Solar Resource Data Development

- The [National Solar Radiation Database \(NSRDB\)](#) provides a serially complete database of solar irradiance and meteorological information across the United States.
- Developed under funding from EERE Solar Program, the NSRDB provides 20 years (+ Typical Meteorological Year) of half-hourly data at a 4x4-km spatial resolution.
- The NSRDB data is the source of solar resource and ancillary data for solar modeling for PR100.
- Comprehensive evaluation on an annual basis ensures that high-quality solar resource data is available for distributed and centralized solar photovoltaic (PV) modeling.

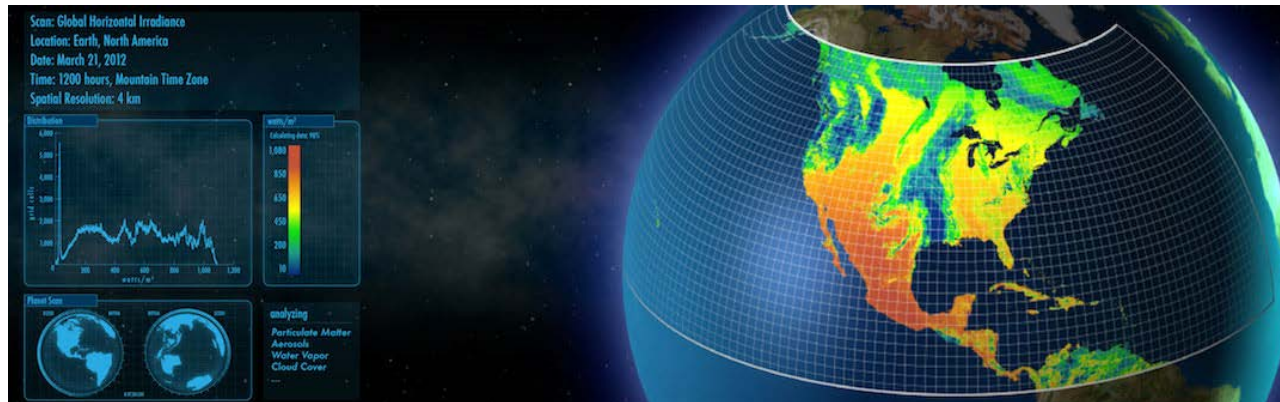

Map from NREL, [National Solar Radiation Database](#)

# NSRDB: From Satellite to Solar Resource

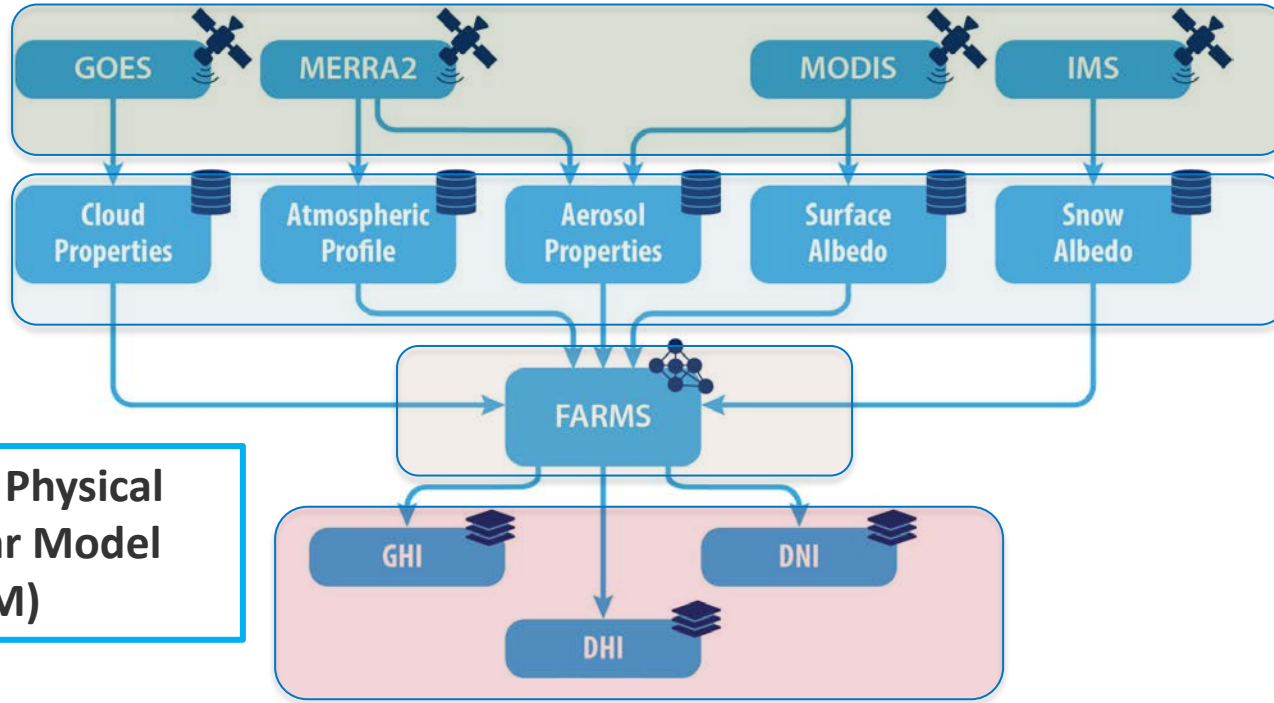

**The Physical  
Solar Model  
(PSM)**

Satellite and operational  
model data

Intermediate products for  
input to solar model

Intermediate products for  
input to solar model

Solar radiation products:

- Global Horizontal Irradiance
- Direct Normal Irradiance
- Diffuse Horizontal Irradiance.

The NSRDB uses satellite data from the National Oceanic and Atmospheric Administration's (NOAA's) GOES satellites and calculates solar radiation at the surface for use in solar modeling.



# Solar Resource Characteristics

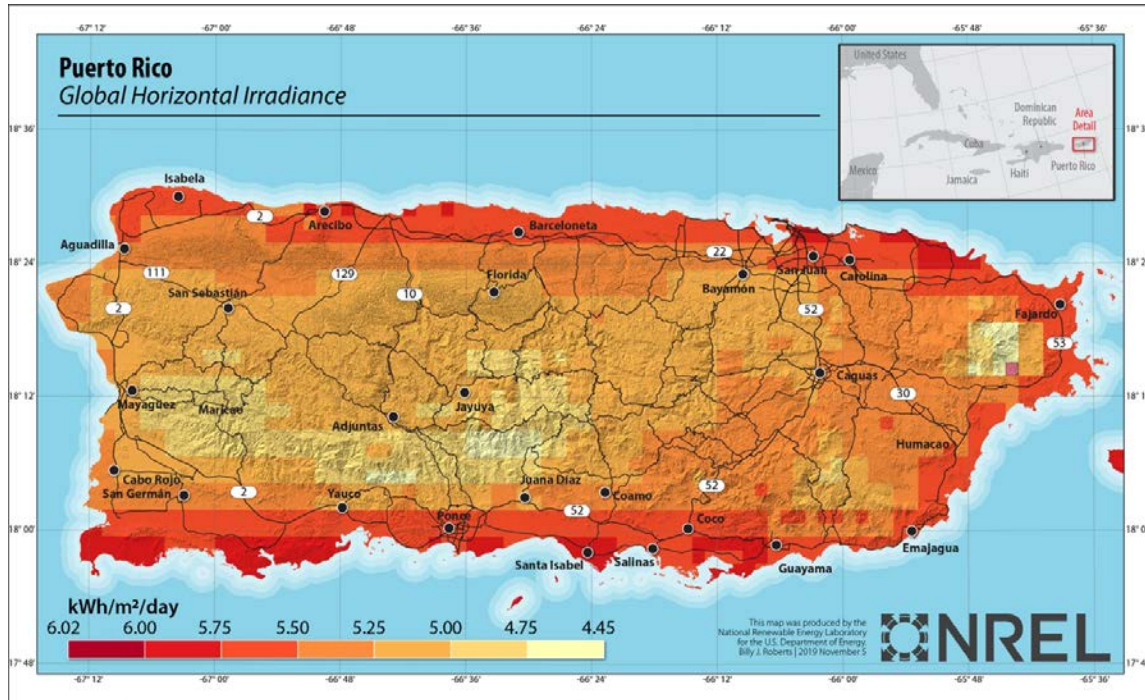

Average daily Global Horizontal Resolution (GHI) for 1998-2017

Additional data from 2018-2020 is being added and new analysis is being conducted.

Average daily solar radiation over 20 years show that coastal areas around PR have the highest radiation and are favorable for solar development.

# Modeled Capacity Factor

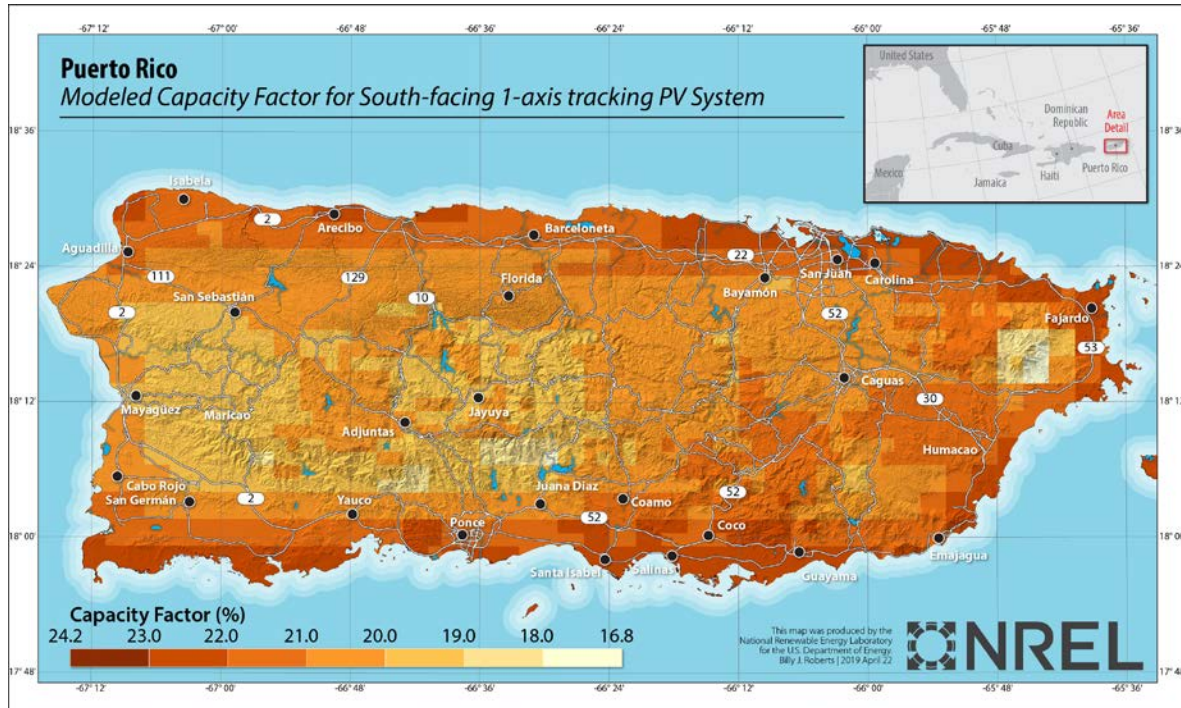

Utility Scale  
Capacity Factor for  
South-Facing 1-axis  
tracking PV systems

High capacity factors of 20% and above throughout PR demonstrate the favorability of solar development throughout the island.

# Solar Resource in Puerto Rico

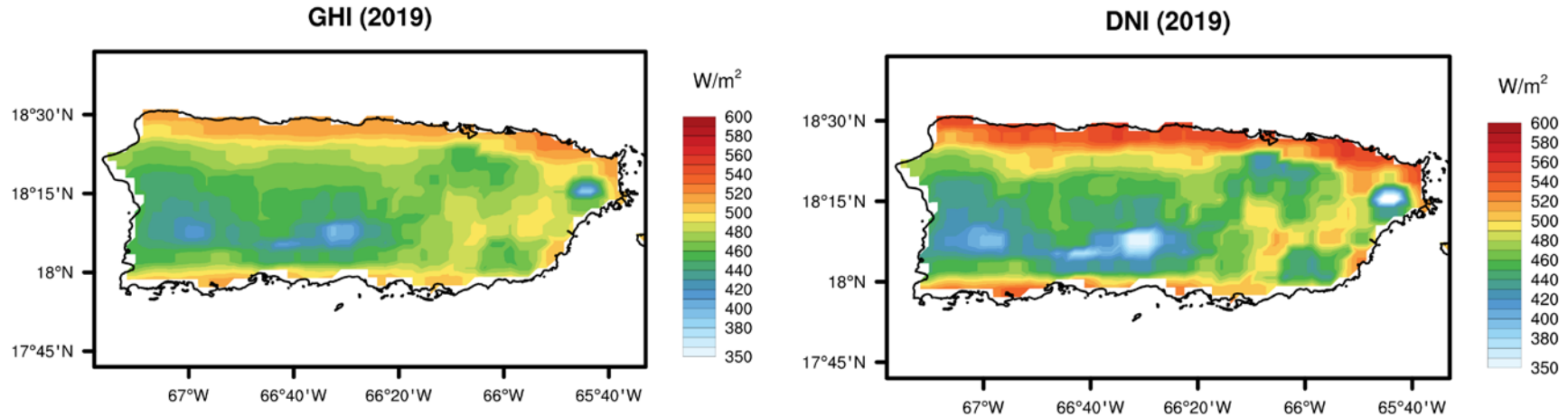

Solar datasets are being added for 2018-2020. Average solar global horizontal irradiance (GHI) and direct normal irradiance (DNI) for 2019 shows that most of the island including the coastal regions have high solar resource.

# Rooftop Solar Assessment

## NREL's [Puerto Rico Low-to-Moderate Income Rooftop PV and Solar Savings Potential](#) (2020):

- Processed light detection and ranging (LiDAR) scans of 96% Puerto Rico's building stock
- Intersected LiDAR data with Census demographics tables of household counts by income, tenure, and building type
- Used a statistical model trained on LiDAR tracts to impute building stock characteristics (area, orientation, shading, etc.) for 4% of building stock without sufficient LiDAR data
- Simulated solar generation for each roof plane using NREL PVWATTS and aggregate at the tract and county level.



# Rooftop Solar Assessment

## Rooftop Suitability Assumptions

Roof Physical Characteristics	Description
Shading	Measured shading for four seasons and required an average of 80% unshaded surface
Azimuth	All possible azimuths
Tilt	Average surface tilt $\leq 60$ degrees
Minimum Area	$\geq 1.62 \text{ m}^2$ (area required for a single solar panel)

## PV Performance Assumptions

PV System Characteristics	Value for Flat Roofs	Value for Tilted Roofs
Tilt	15 degrees	Tilt of plane
Ratio of Module Area to Suitable Roof Area	0.70	0.98
Azimuth	180 degrees (south facing)	Midpoint of azimuth class
Module Power Density	183 W/m <sup>2</sup>	
Total system losses	Varies (social accounting matrix defaults + individual surface % shading)	
Inverter efficiency	96%	
DC-to-AC ratio	1.2	



# Residential Rooftop Solar Potential by County

Distributed Solar resource exceeds 20 GW of capacity technical potential.





# LMI Households Statistics

## Households by Income

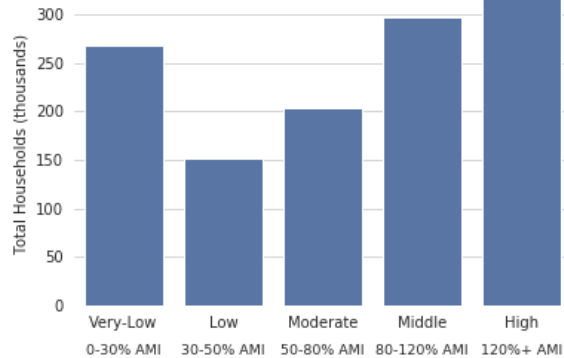

## Households by Income-Building Type

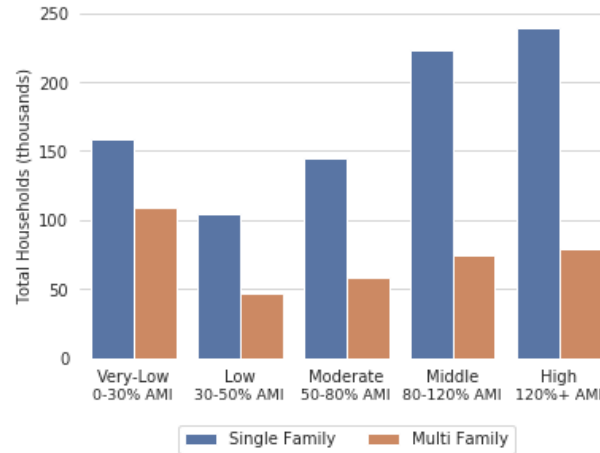

## Households by Income-Tenure

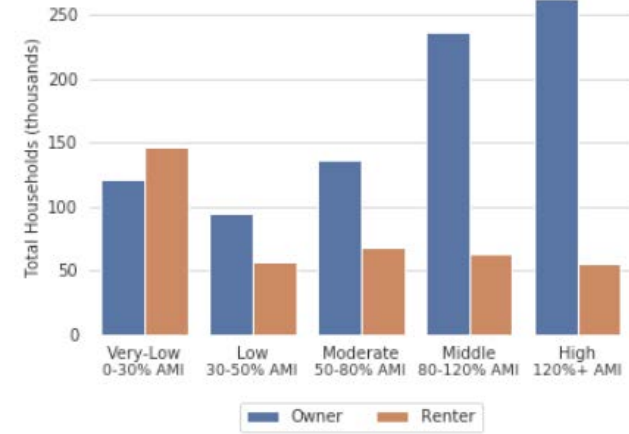

- **50%** of Puerto Rico's population is considered LMI (compared to 42.6% in the 50 states of the United States and the District of Columbia, hereafter referred to as the 50 states).
- Rooftop PV on PR's LMI buildings consists of **9.8 GW** of capacity and **11.9 TWh** of generation potential, which is roughly **48%** of PR's total residential potential.

# Puerto Rico Residential Solar PV Rooftop Potential

Residential PV Rooftop Technical Potential by Income Group

Income Group	Households (thousands)	Suitable Buildings (thousands)	Suitable Module Area (millions of m <sup>2</sup> )	Capacity Potential (GW <sub>DC</sub> )	Annual Generation Potential (TWh/year)
Very Low (0-30% AMI)	267.8	203.6	21.9	4.0	4.8
Low (30-50% AMI)	151.2	129.1	13.5	2.5	3.0
Moderate (50-80% AMI)	203.3	177.4	18.6	3.4	4.1
Middle (80-120% AMI)	297.8	267.7	28.2	5.1	6.2
High (>120% AMI)	317.1	279.5	29.6	5.4	6.5
All LMI Buildings	622.3	510.1	54.0	9.8	11.9
All Residential Buildings	1,237.2	1,057.3	111.8	20.4	24.6

Annual residential solar potential is **24.6 TWh**, and nearly **48% (11.9 TWh)** of total annual residential solar potential is from LMI buildings.

# Wind and Solar Resource

---

Initial findings and correlation

# Annual Wind and Solar Resource Comparison

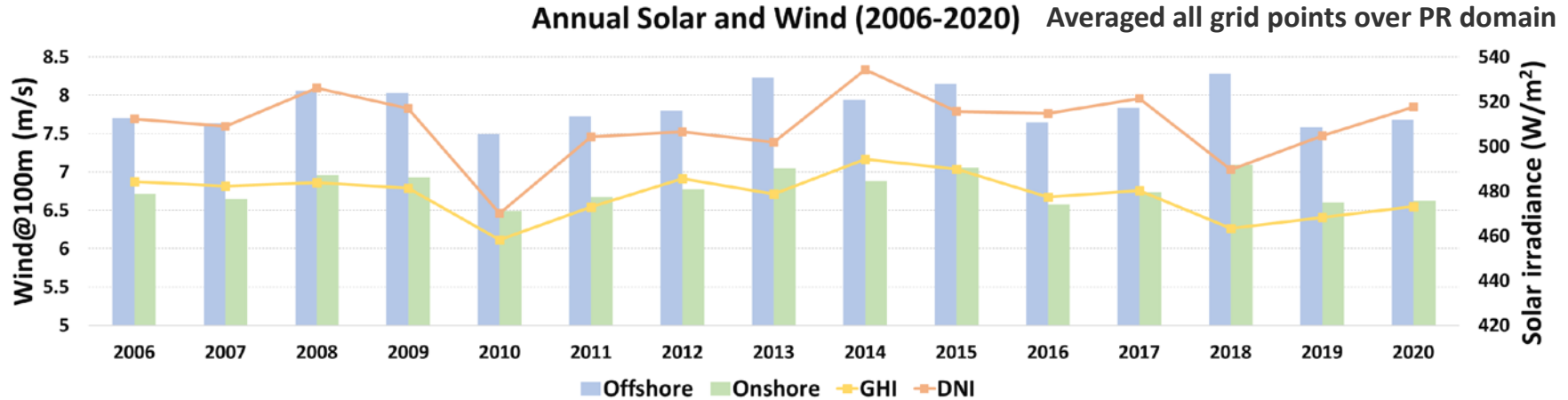

- Annual solar and wind resources and their variability were analyzed using NSRDB and NWP-based datasets for Puerto Rico (standard deviation for 15 of the 20 years- Offshore: 0.24m/s, Onshore: 0.19m/s, GHI: 9.41W/m<sup>2</sup>, DNI: 14.92W/m<sup>2</sup>).
- The year of 2018 shows the most abundant wind resource, and the sunniest year was 2014.
- The year of 2010 exhibits the lowest wind/solar resources compared to the other years.
- As expected, offshore includes more wind resources compared to onshore.

# Summary of Wind and Solar Resource Potential

- A WRF model configuration that performs best for Puerto Rico was identified from among 15 configurations using wind observations.
- 20 years of offshore and onshore wind resource data at 15-minute, 3-km resolution was developed to cover 2001-2020.
- Solar resource and ancillary data for 2001-2020 was acquired from the NSRDB.

## **Key takeaways**

- Some complementarity between solar and wind
- Severe weather events such as Hurricane Maria are well represented in the wind resource data.
- Onshore seasonal wind speeds feature similar patterns among four sites with increase around noon.
- Onshore wind speed is higher in summer/winter than in spring/fall.
- Offshore wind in the northwest has high magnitude during daytime and can support high summer demand.
- Other locations show higher wind speeds during nighttime with complementary solar and wind resource.
- Coastal areas around PR have the highest solar radiation and are favorable for solar development.
- High capacity factors of 20% and above throughout PR demonstrates the favorability of solar development.
- 2018 shows the most abundant wind resource, and 2014 was the sunniest year.
- 2010 exhibits the lowest wind/solar resources compared to the other years.
- Offshore sites have higher wind resource compared to onshore.
- 2019 is an average year for both wind and solar and is being used for PR100 modeling.

# Additional Resource Potential Assessments in Progress or Under Consideration

---



# Resource Potential Assessments in Progress or Under Consideration

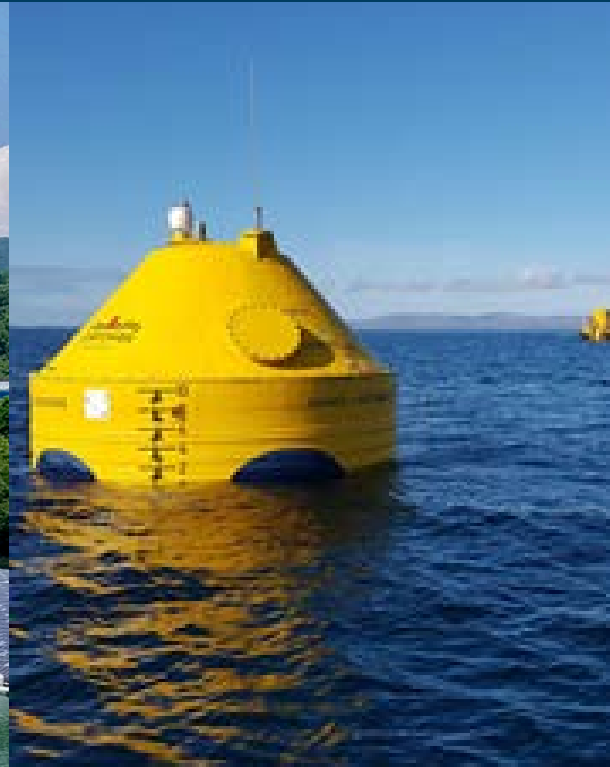

Through year one and into year two of the study, the team will evaluate hydropower and pumped hydro storage, marine energy, and may address additional technologies such as floating solar PV, bioenergy, and ocean thermal technology conversions.

# Hydroelectric Power Resource Assessment

- Provide estimates of new hydropower capacity, energy, and cost for:
  - Upgrade/expansion of existing hydropower fleet
  - Non-powered dam development
  - New-stream reach and conduit (TBD).
- Provide daily streamflow analysis from 1950–2014 to support the evaluation of water availability, flow duration curves, and other water resources applications
- Provide supply curves for capacity and energy expansion models to project hydropower growth in Puerto Rico.

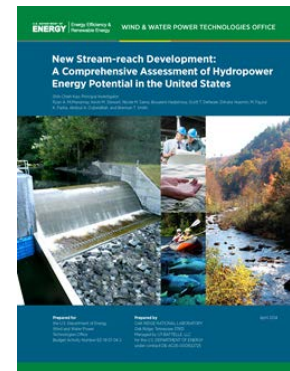
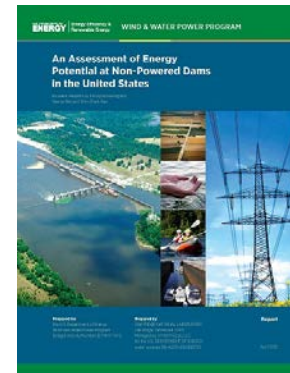
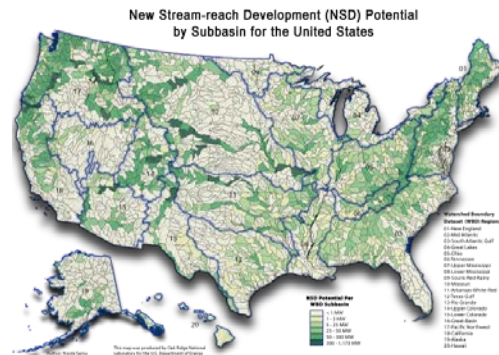
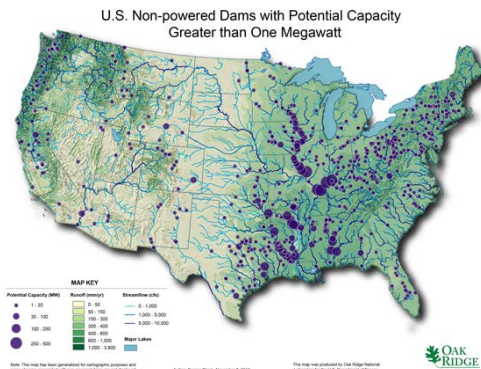

Expanding nationwide hydropower resource assessments to include Puerto Rico

# Assessment of Capacity Increases at Existing Hydroelectric Power Facilities

- USGS completed a sedimentation study of Lago Dos Bocas in 2009.
- Black and Veatch completed a feasibility study of the hydroelectric system on behalf of PREPA in February 2021.
- From the study:
  - Maximum capacity of the 10 facilities is 94 MW.
  - Current total active capacity is approximately 39 MW.
  - Four of ten facilities active.
  - Results of Black and Veatch study indicate that it is feasible to increase generation and improve the capacity factors.
  - Repairs/upgrades required to reach a capacity factor of 0.28 from current 0.06.
- PR100 study will evaluate hydroelectric and reservoir capacity expansion and optimization of reservoir operational curves, accounting for other water uses.

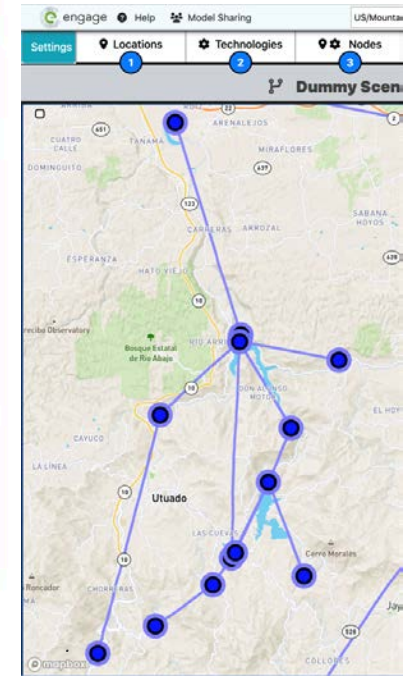

Graphics illustrate how the Engage model will represent and evaluate hydroelectric resources. Sources: U.S. Geological Survey. Sedimentation Survey of Lago Dos Bocas, 2009 (left); Engage in-progress model of hydrology, reservoirs, and hydroelectric system in Rio Grande de Aricebo Basin from NREL (right).

# Land Exclusions

---



# Summary of Wind and Solar Exclusions

- The following slides present a series of possible exclusions identified to date for wind, and data sources for solar which reflect input provided by Advisory Group members.
- Geographic exclusions are areas determined to be excluded from potential utility-scale renewable energy development.
- Land use and potential exclusions has been a topic of interest for the Advisory Group, which we will continue to explore.
- Onshore exclusion layers, including terrain, protected areas, water bodies, roads and building, etc., are being considered.
- Offshore exclusion layers include Unexploded Ordinance Zones, Protected Areas, Danger Zones, Ocean Disposal Sites.
- Offshore wind may be limited due to rapid increase of ocean depth near the shore.

# Land Exclusions: Building Locations

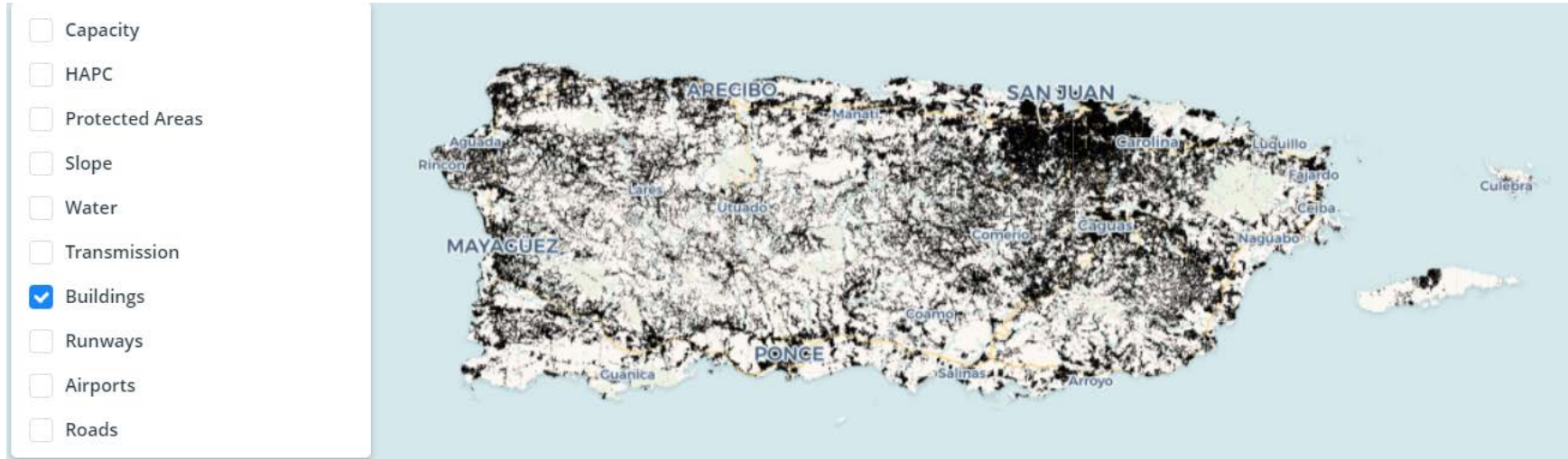



# Land Exclusions: Roads

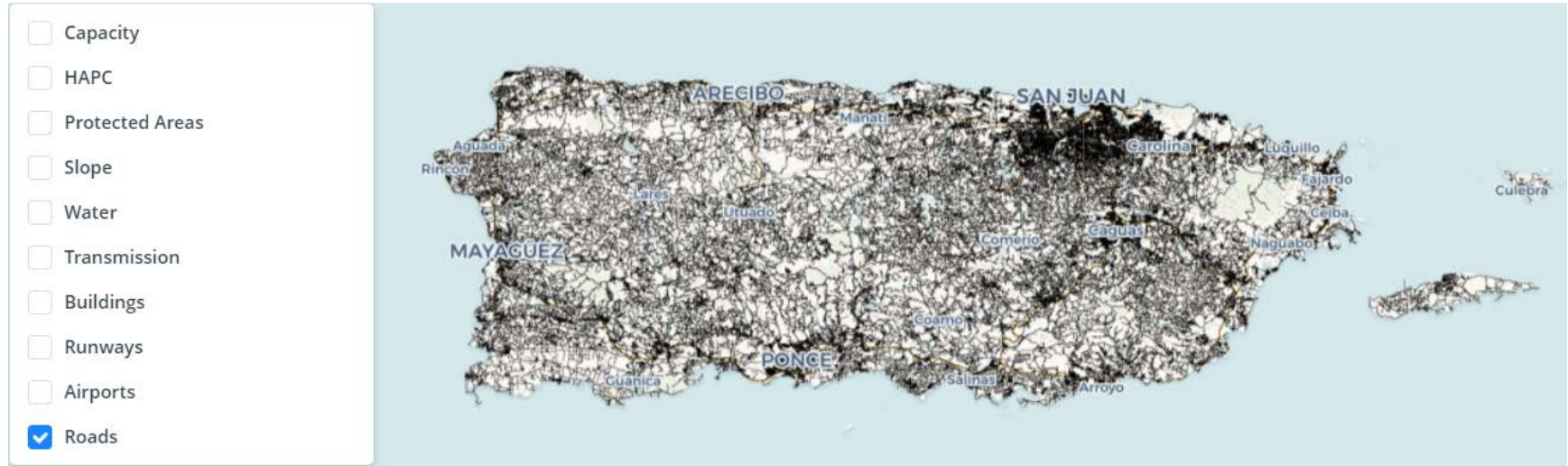

# Land Exclusions: Water Bodies



# Land Exclusions: Protected Areas

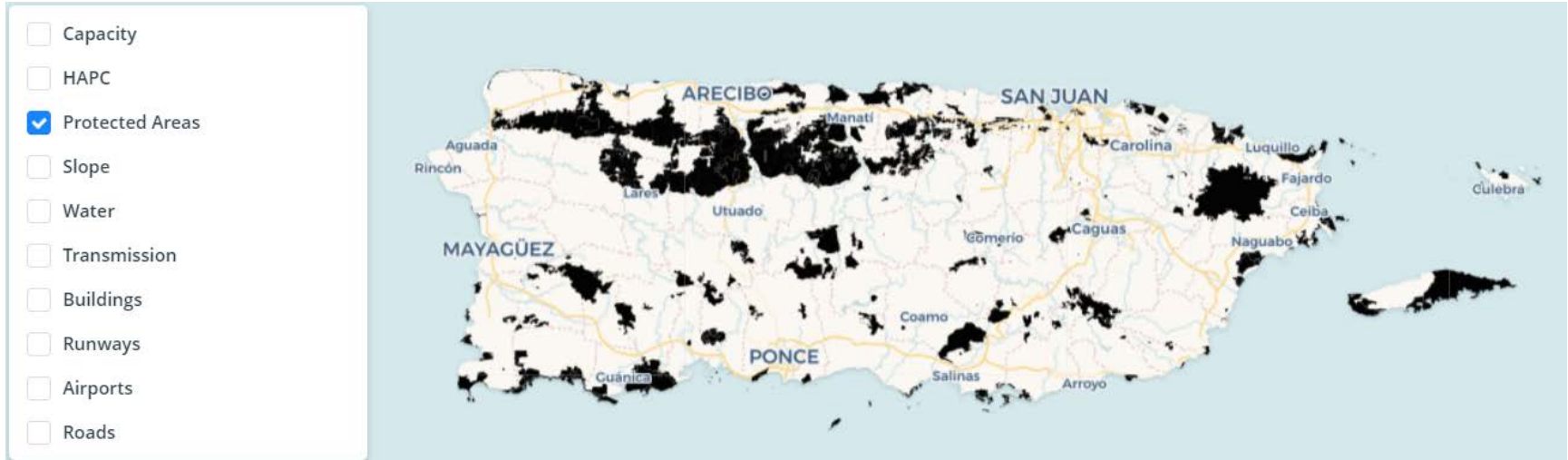

Caribbean Landscape Conservation Cooperative's Protected Areas Conservation Action Team (PA-CAT)

# Land Exclusions: Habitat Areas of Particular Concern



Habitat Areas of Particular Concern are discrete subsets of essential fish habitat that provide extremely important ecological functions or are especially vulnerable to degradation.

# Offshore Exclusions: Unexploded Ordinance Zones

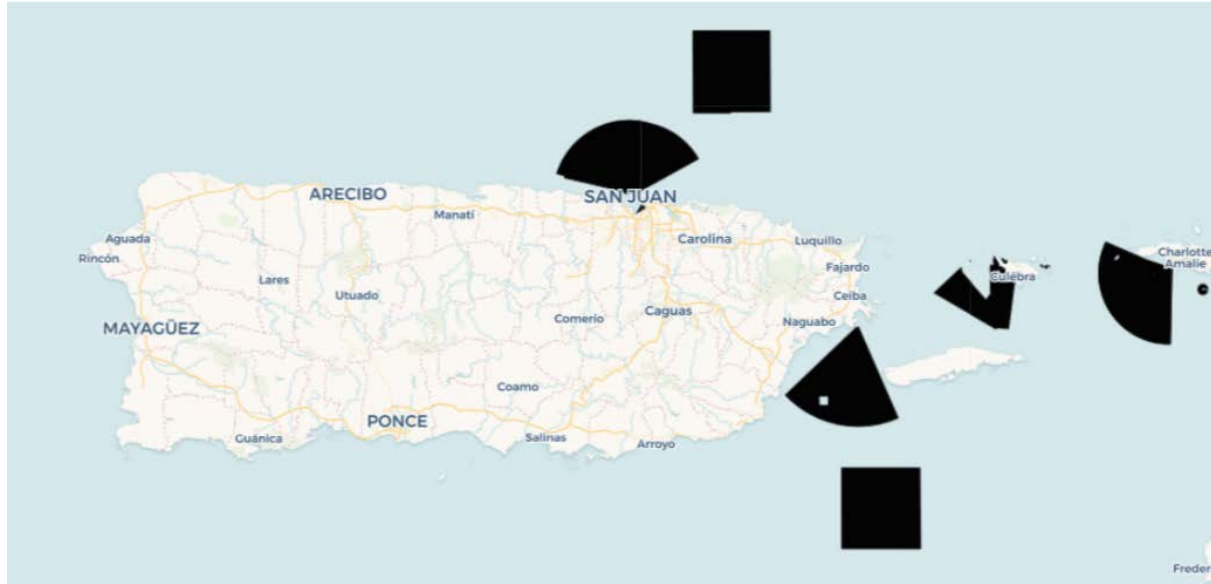

Unexploded ordinance zones are areas containing explosive weapons that still pose risk of detonation.

# Offshore Exclusions: Protected Areas, Danger Zones, Ocean Disposal Sites



Ocean disposal sites are areas containing past or active disposal of sediment and waste. Danger zones are areas used for target practice and other hazardous operations by armed forces. Protected areas include MPAs and additional offshore protected areas.



# All Potential Offshore Wind Exclusions

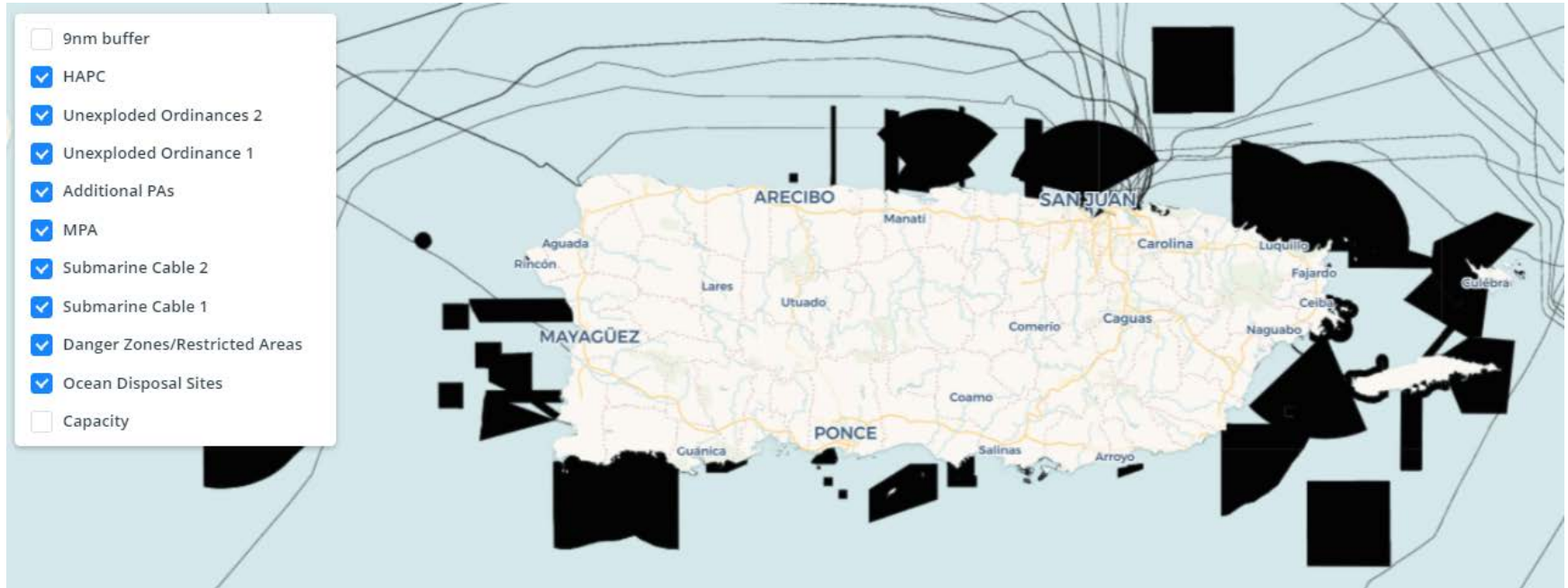

The team is only looking at theoretical and feasible potential. Other exclusions, such as benthic habitats (data provided by the Nature Conservancy) and near-shore areas within the viewshed of coastal communities may limit the potential further. This is an area of ongoing discussion with stakeholders.

# Suggested Data Sources for PR Land Use Consideration and Possible Exclusions

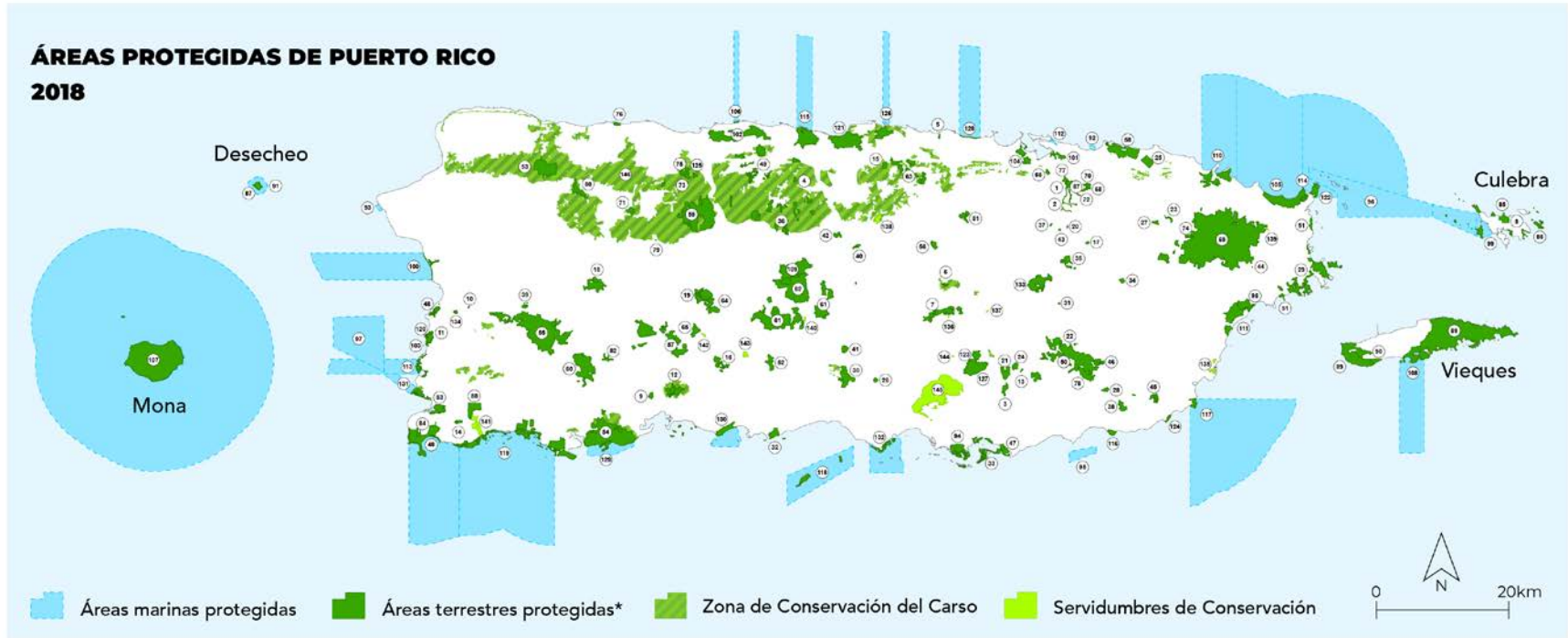

Protected areas that are excluded for land-based and offshore wind.

# Suggested Data Sources for PR Land Use Consideration and Possible Exclusions

Puerto Rico Land Use Plan adopted by the Planning Board in 2015

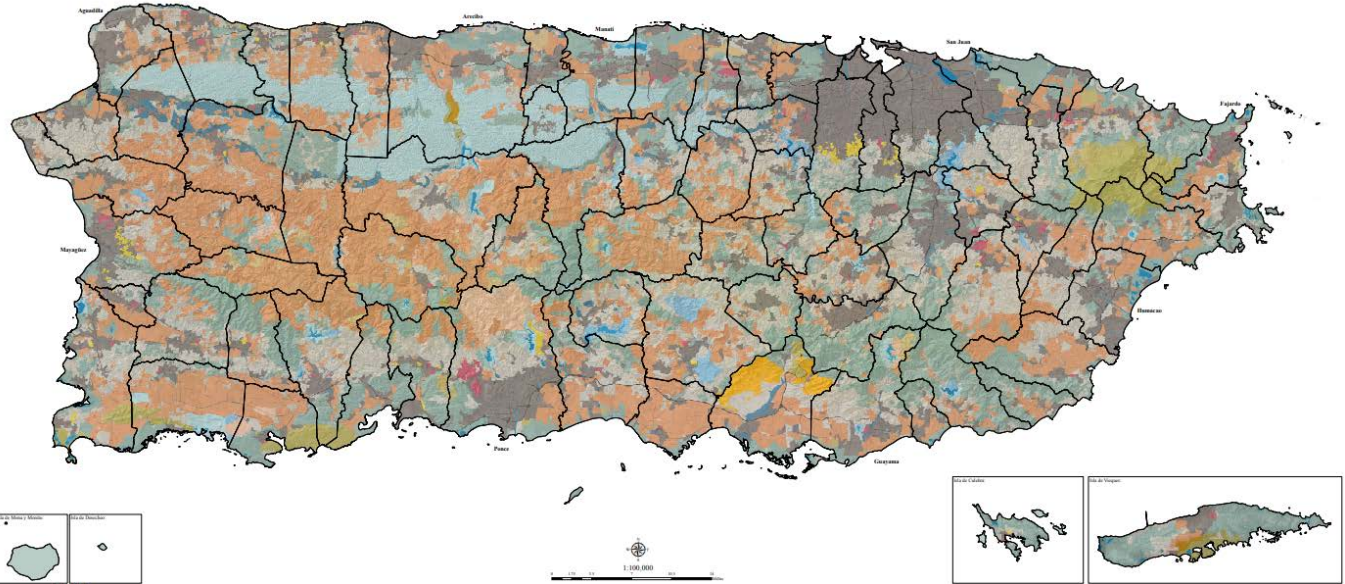

## Legenda:

- Limite Municipal
- Red Vial
- Hidrografia

## Clasificaciones:

### Suelo Urbano

- SU - Suelo Urbano

### Suelo Urbanizable

- SURP - Suelo Urbanizable Programado
- SURNP - Suelo Urbanizable No Programado

### Suelo Rústico

- SRC - Suelo Rústico Común
- SREP - Suelo Rústico Especialmente Protegido
- SREP-H - Suelo Rústico Especialmente Protegido-Hídrico
- SREP-P - Suelo Rústico Especialmente Protegido-Paisaje
- SREP-A - Suelo Rústico Especialmente Protegido-Agrícola
- SREP-AE - Suelo Rústico Especialmente Protegido-Agrícola/Ecológico
- SREP-AP - Suelo Rústico Especialmente Protegido-Agrícola/Paisaje
- SREP-AH - Suelo Rústico Especialmente Protegido-Agrícola/Hídrico
- SREP-E - Suelo Rústico Especialmente Protegido-Ecológico
- SREP-EA - Suelo Rústico Especialmente Protegido-Ecológico/Agrícola
- SREP-EH - Suelo Rústico Especialmente Protegido-Ecológico/Hídrico
- SREP-EP - Suelo Rústico Especialmente Protegido-Ecológico/Paisaje

English translation of legend categories: VIAL: Road network; AGUA: Water; SU: Urban Land; SURP: Urbanizable Land – Programmed; SURNP: Urbanizable Land - Not Programmed; SRC: Rustic Common Land; SREP: Specially Protected Rustic Land; SREP-H: Specially Protected Rustic Land – Hydric; SREP-P: Specially Protected Rustic Land – Landscape; SREP-A: Specially Protected Rustic Land – Agricultural; SREP-AE: Specially Protected Rustic Land - Agricultural/Ecological; SREP-AP: Protected Rustic Land - Agricultural/Landscape; SREP-AH: Specially Protected Rustic Land - Agricultural/Hydric; SREP-E: Specially Protected Rustic Land – Ecological; SREP-EA: Specially Protected Rustic Land - Ecological/Agricultural; SREP-EH: Specially Protected Rustic Land - Ecological/Hydric; SREP-EP: Specially Protected Rustic Land - Ecological/Landscape

Sources: Puerto Rico Planning Board, November, 2015. Puerto Rico Land Use Plan. Data uploaded to Data Basin by Caribbean Landscape Conservation Cooperative. <https://databasin.org/datasets/7f1cc5f0febc40829e5845df556981fe/>; Puerto Rico Planning Board. 2015. Land Classification Map, Puerto Rico Land Use Plan. <https://jp.pr.gov/wp-content/uploads/2021/09/Mapa-PUT-Vigente.pdf>.





# TASK 4: Demand Projections and DER Adoption

Lead Lab: NREL

Supporting: ANL, LBNL, Sandia

# Electricity Demand Impacts

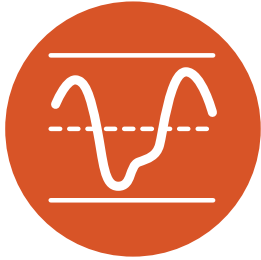

- ↔ The end-use electric usage is based on prior methods with updated data. (Note: Both the prior baseline and updated forecasts are on subsequent slides.)
- ↓ The electric usage will be reduced by energy efficiency improvements.
- ↑ The electric usage will be increased by modeled electric vehicle adoption.
- ↓ The electric usage will be reduced by adoption of distributed solar and storage.
- ↔ The remaining (net) electric usage will be met by utility-scale solar, wind, and other RE sources.

Note: This study analyzes pathways to 100% renewable energy, not full decarbonization of the energy sector.

# Baseline Demand Projections

---

Baseline demand components covered in this section are:

1. Baseline Projections: Input Data
2. Baseline Projections: Electricity Sales
3. Baseline Projections: Electricity Demand



# Baseline Demand Projections: Input Data

The input data represented in this subsection inform the linear regression model developed by Siemens for the last Integrated Resource Plan (IRP):

- Population
- Real Gross National Product (GNP)
- Cooling Degree Days (CDDs)
- Manufacturing Employment

# Population Projections

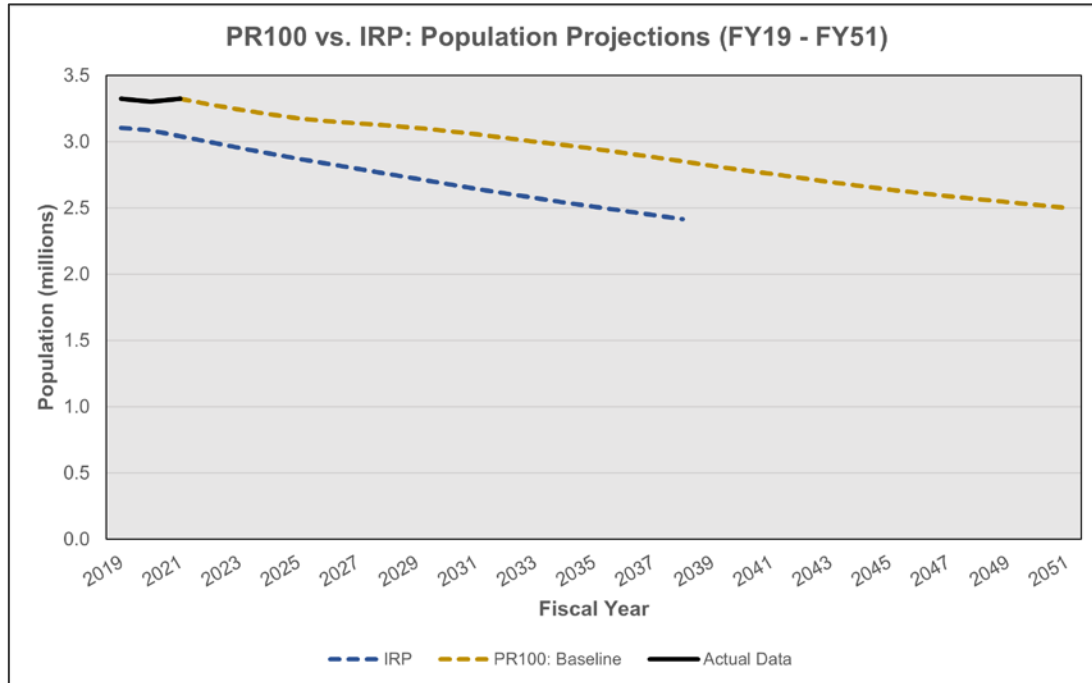

Graphic from NREL

The IRP (Integrated Resource Plan) population projection is lower than the actual data from FY 2019–FY 2021 and is lower than the PR100 projection from FY 2022–FY 2038.

## IRP (FY 2019–FY 2038):

FOMB “Fiscal Plan for Puerto Rico”  
Report (June 2018)

## PR100: Baseline (FY 2022–FY 2051):

FOMB “Fiscal Plan for Puerto Rico”  
Report (January 2022)

## Actual Data (FY 2019–FY 2021):

FOMB “Fiscal Plan for Puerto Rico”  
Report (January 2022)

# Real GNP Projections

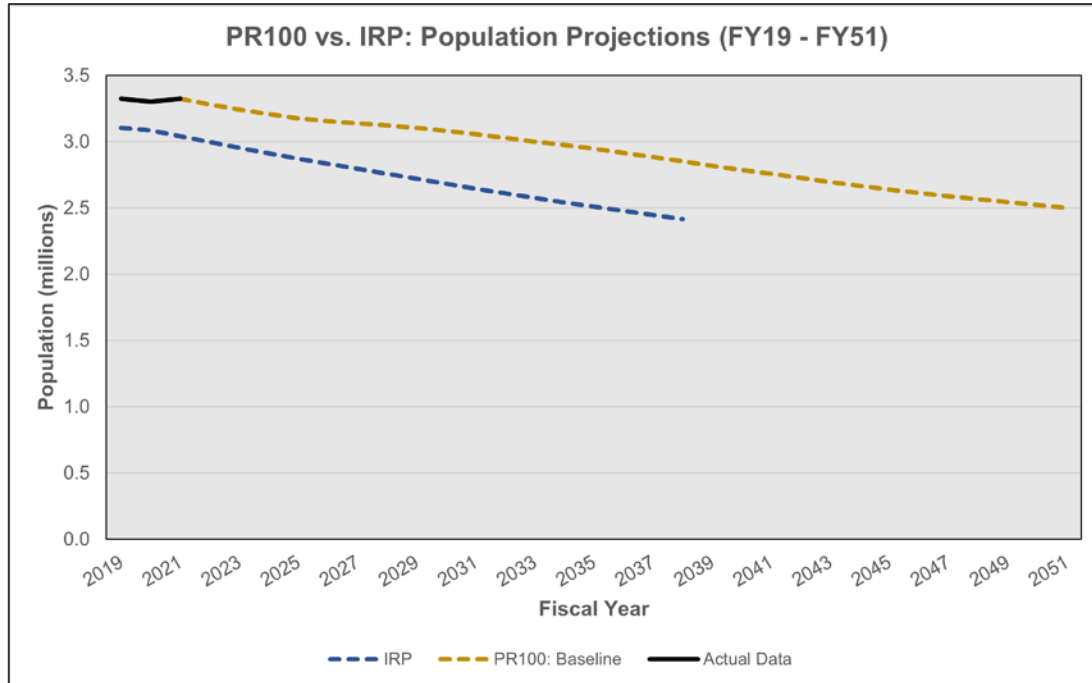

Graphic from NREL

The IRP real GNP projection is lower than both the actual data from FY 2019–FY 2021 and than the PR100 projection from FY 2022–FY 2023 and FY 2029–FY 2034. However, it is higher than the PR100 projection from FY 2024–FY 2028 and FY 2035–FY 2038.

## IRP (FY 2019–FY 2038):

FOMB “Fiscal Plan for Puerto Rico”  
Report (June 2018)

## PR100: Baseline (FY 2022–FY 2051):

FOMB “Fiscal Plan for Puerto Rico”  
Report (January 2022)

## Actual Data (FY 2019–FY 2021):

FOMB “Fiscal Plan for Puerto Rico”  
Report (January 2022)

# CDD Projections

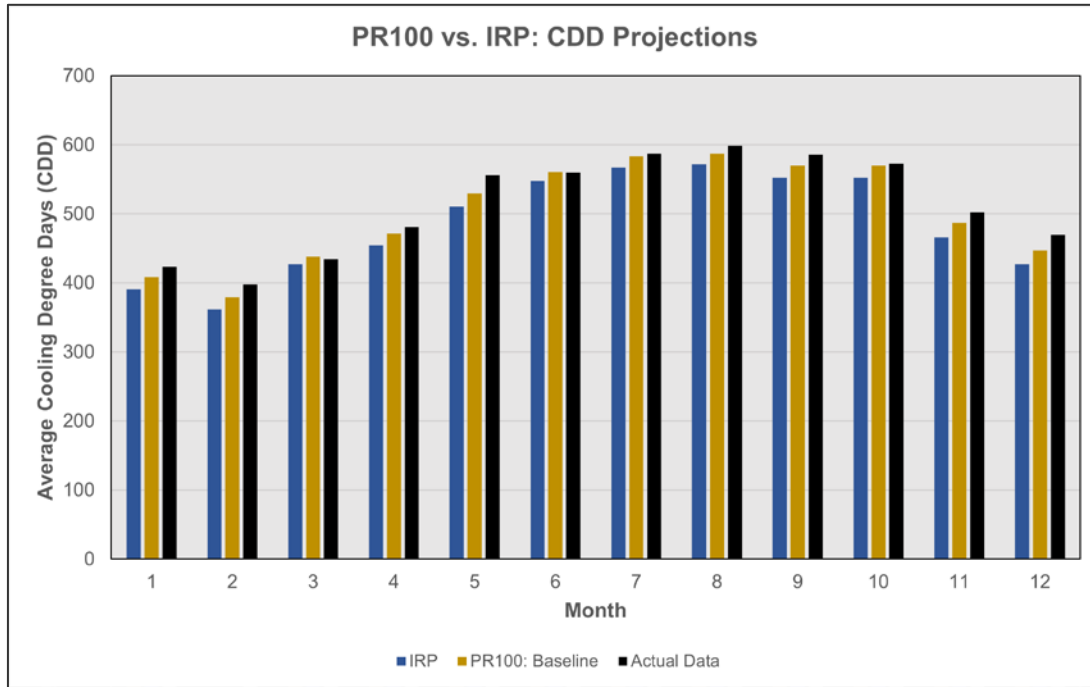

Graphic from NREL

The IRP monthly CDD projections are lower than the PR100 projections, and both projections are lower than the actual data from FY 2019–FY 2021.

## IRP (FY 2019–FY 2038):

NOAA San Juan Average Monthly Values (2000–2016)

## PR100: Baseline (FY 2022–FY 2051):

NOAA San Juan Average Monthly Values (2005–2021)

- NOTE: This data will ultimately be informed by climate projections from Argonne.

## Actual Data (FY 2019 –FY 2021):

NOAA San Juan Monthly Values (July 2018–December 2021)

# Baseline Demand Projections: Electricity Sales

The following baseline projections do not include energy efficiency or electric vehicle impacts:

- Residential
- Commercial
- Industrial
- Public Lighting, Agriculture, and Other

# Residential Solar

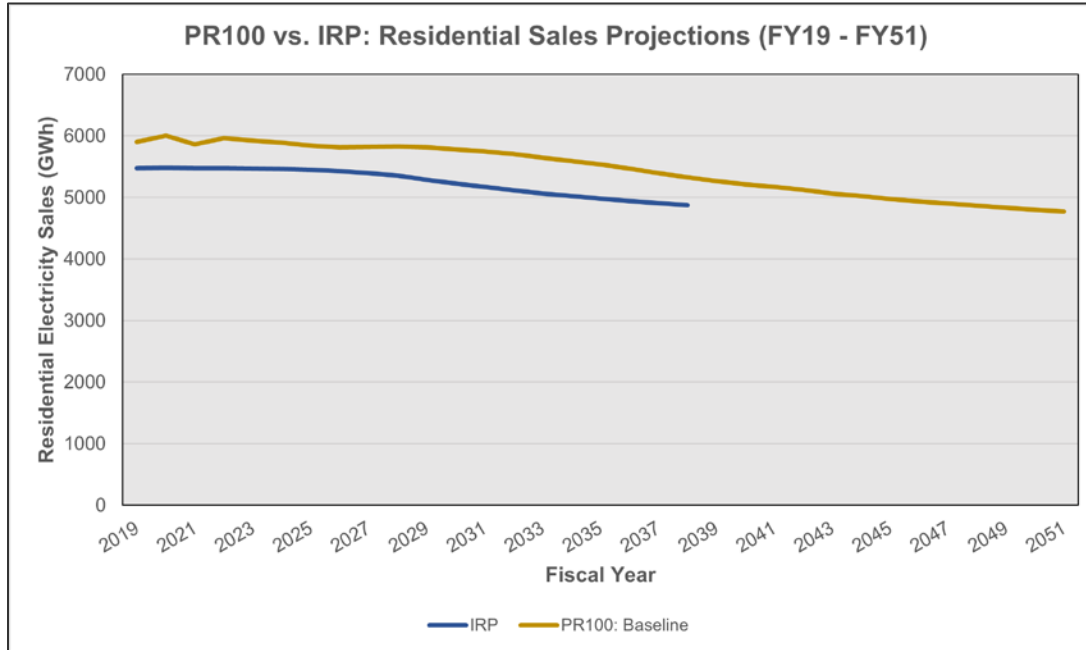

Graphic from NREL

PR100: New Input Data  
Population  
Real GNP  
CDD

IRP: Old Input Data  
Population  
Real GNP  
CDD



IRP: Linear Regression Equation  
Historical Data from 2000–2017



PR100: New Projection  
Residential Sector  
Electricity Sales  
(FY 2019–FY51)

IRP: Old Projection  
Residential Sector  
Electricity Sales  
(FY 2019–FY 2038)



# Commercial Sector

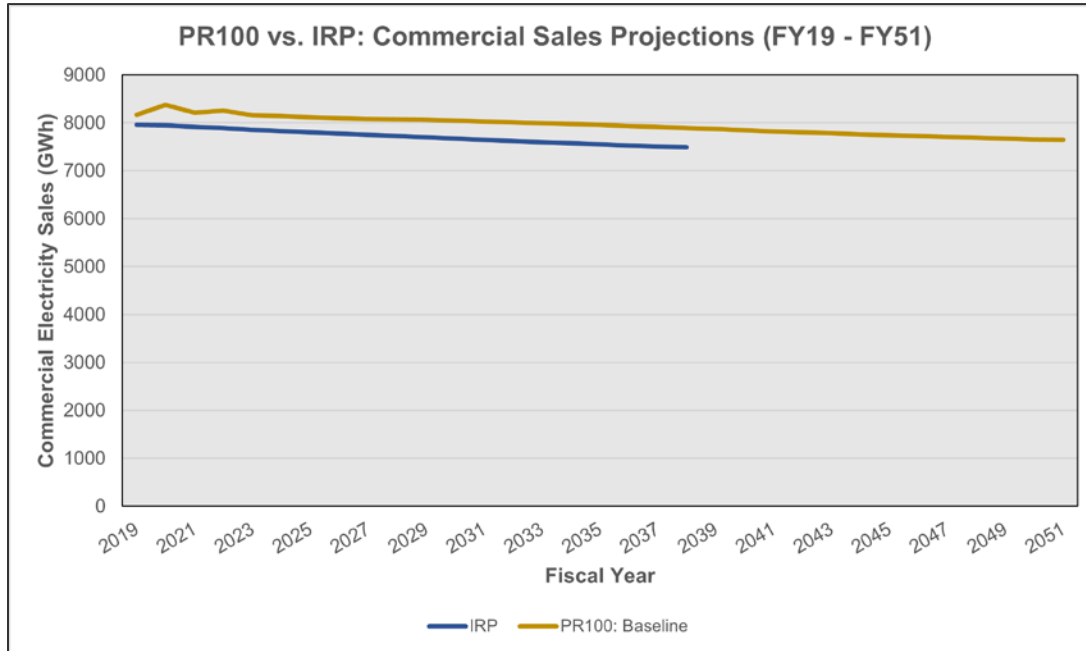

Graphic from NREL

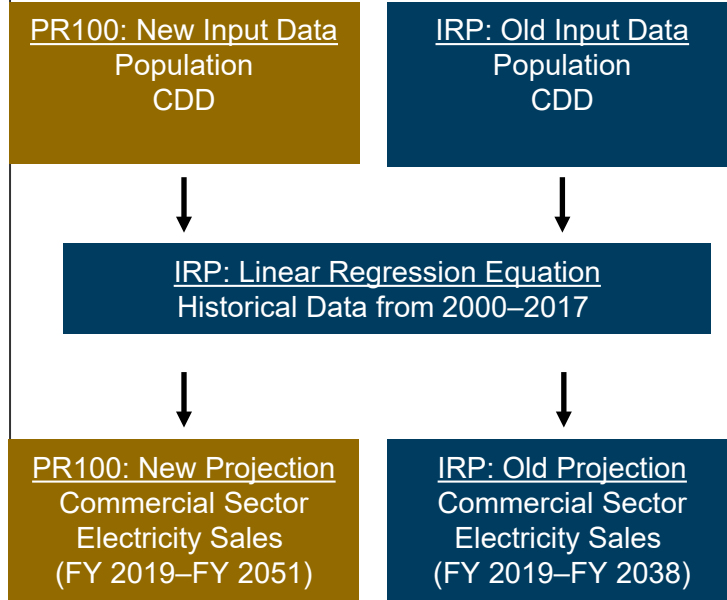

# Industrial Sector

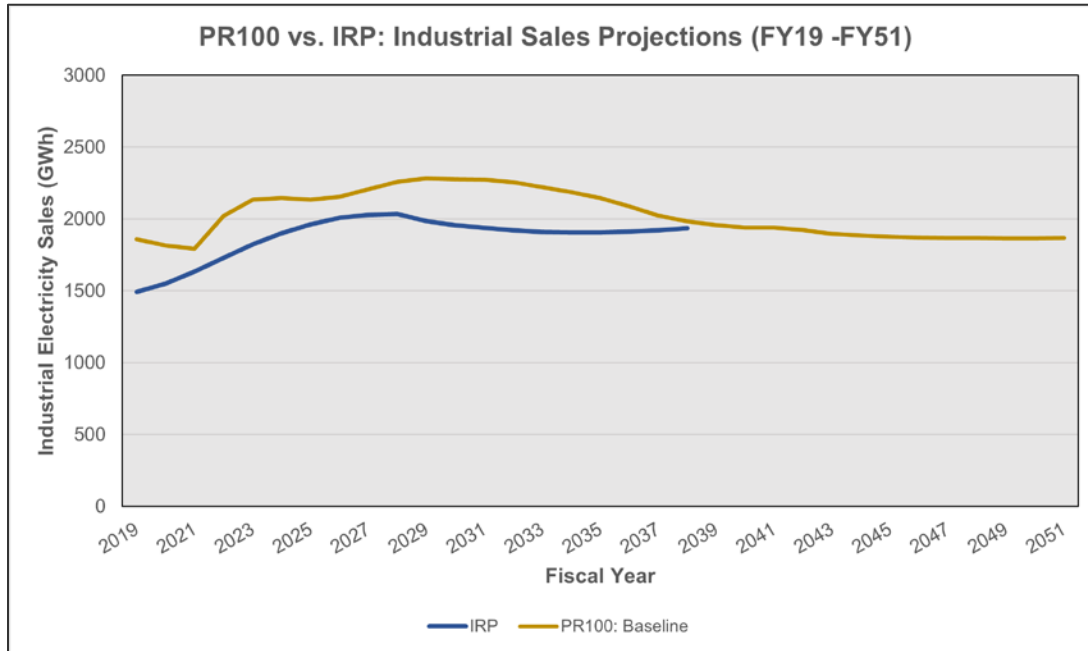

Graphic from NREL

**PR100: New Input Data**  
Real GNP  
CDD  
Manufacturing Equipment

**IRP: Old Input Data**  
Real GNP  
CDD  
Manufacturing Equipment

**IRP: Linear Regression Equation**  
Historical Data from 2000–2017

**PR100: New Projection**  
Industrial Sector  
Electricity Sales  
(FY 2019–FY 2051)

**IRP: Old Projection**  
Industrial Sector  
Electricity Sales  
(FY 2019–FY 2038)

# Public Lighting, Agriculture, and Other Sectors

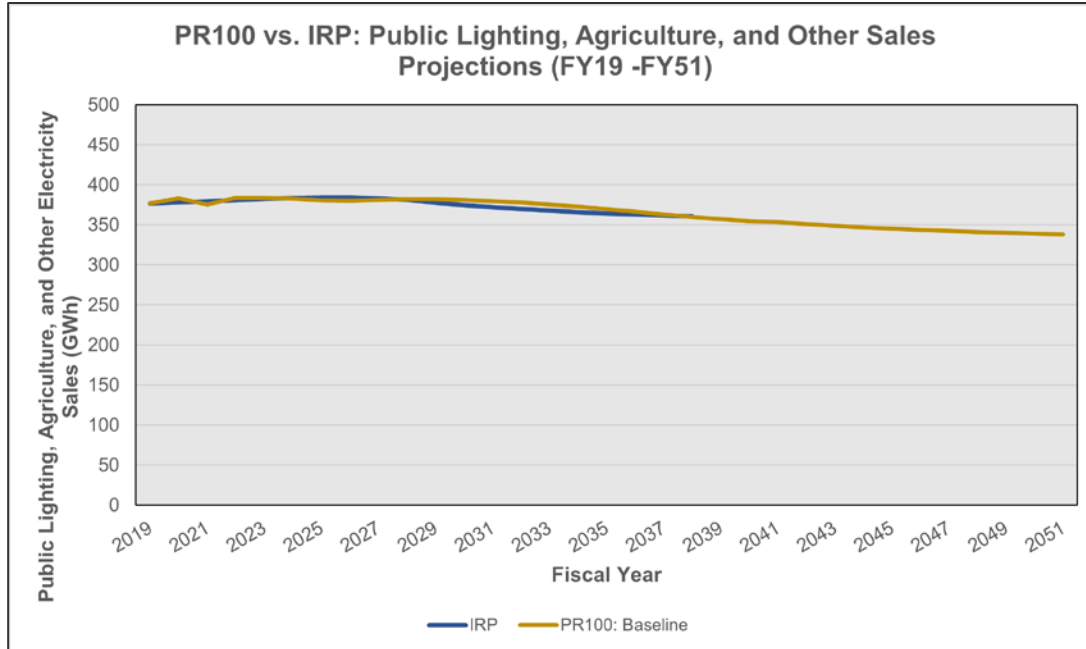

Graphic from NREL

**PR100: New Input Data**  
Residential, Commercial,  
and Industrial Sales  
(FY 2019–FY 2051)

**IRP: Old Input Data**  
Residential, Commercial,  
and Industrial Sales  
(FY 2019–FY 2051)

**IRP Assumption**  
The sales for the public lighting, agriculture,  
and other sectors follow the same annual  
growth rates as the combined residential,  
commercial, and industrial sales.

**PR100: New Projection**  
Public Lighting,  
Agriculture, and Other  
Electricity Sales  
(FY 2019–FY 2051)

**IRP: Old Projection**  
Public Lighting,  
Agriculture, and Other  
Electricity Sales  
(FY 2019–FY 2038)

# Baseline Demand Projections: Electricity Demand

This subsection addresses:

- Losses, Auxiliary Loads, and PREPA's Own Use
- Stochastic Projections
- Comparison of Projections to LUMA FY 2019–FY 2021 Data
- Baseline “High,” “Medium,” and “Low” Projections
- Hourly Demand Projections by Sector
- Hourly Demand Projections by Sector and Region

# Losses, Auxiliary Load, and PREPA's Own Use

## Total Electricity Demand (IRP and PR100)

Total electricity sales + technical losses + non-technical losses + auxiliary load + PREPA's own use

### Technical Losses

IRP Assumption  
9.40% of total electricity sales for each year from FY19 – FY38

PR100 Assumption  
Linear decline from 9.40% of total electricity sales in FY22 to 5.57% in FY51 (2020 U.S. Average)

### Non-Technical Losses

IRP Assumption  
5.40% of total electricity sales for each year from FY19 – FY38

PR100 Assumption  
Same as IRP and extended to FY51

### Auxiliary Load

IRP Assumption  
751 GWh for each year from FY19 – FY38

PR100 Assumption  
4.48% of total electricity sales for each year from FY22 – FY51 (FY21 IRP Value)

### PREPA's Own Use

IRP Assumption  
34 GWh for each year from FY19 – FY38

PR100 Assumption  
Same as IRP and extended to FY51

# Stochastic Projections

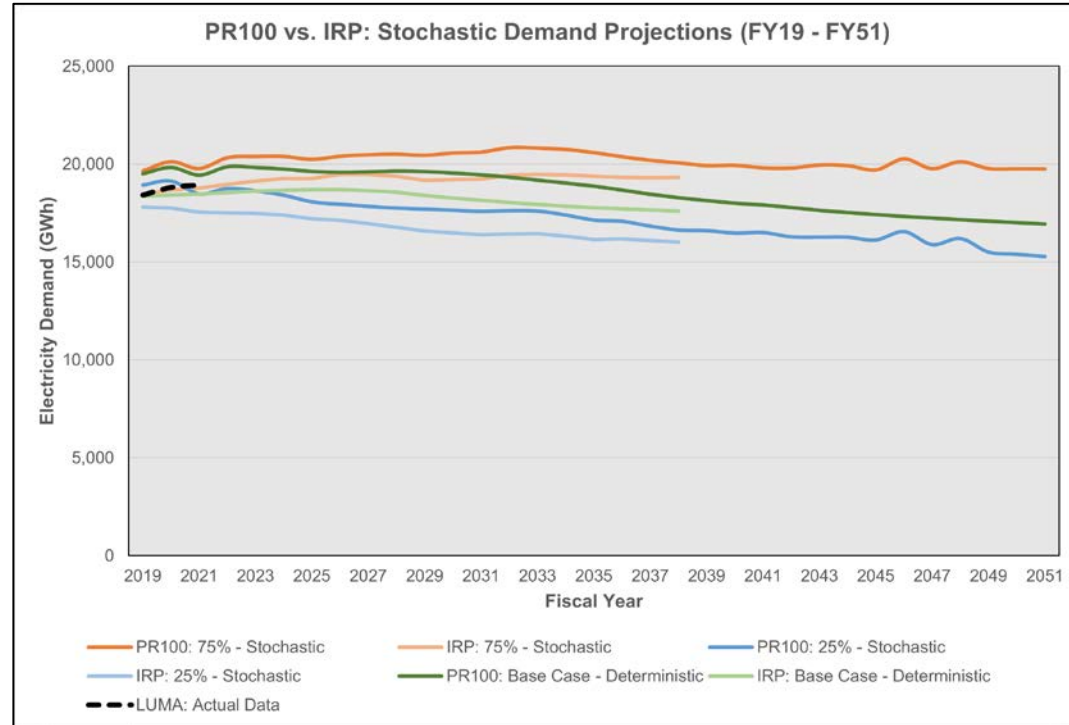
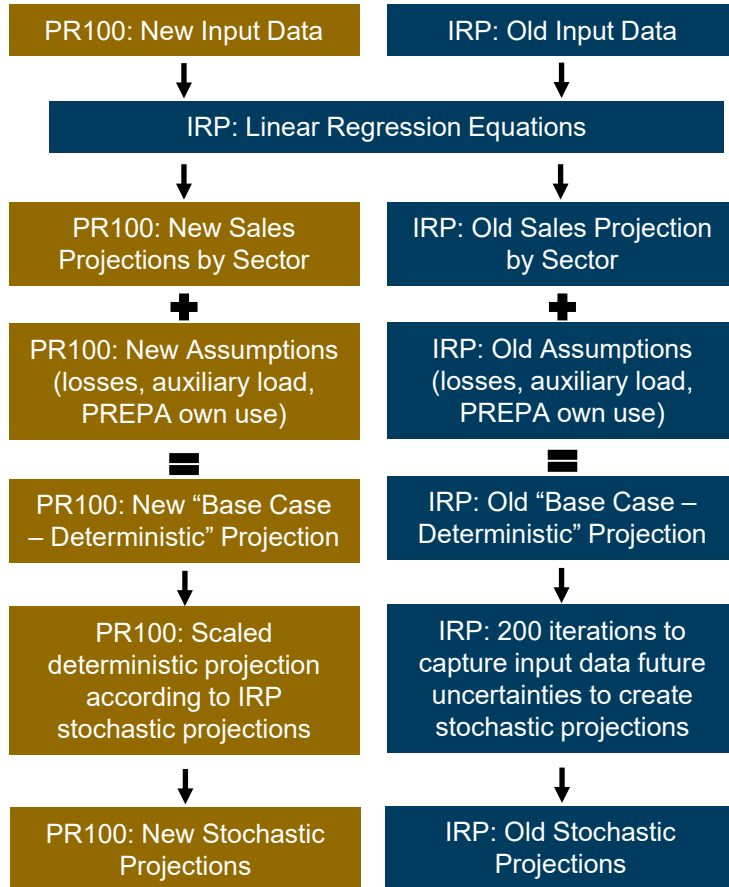

Graphic from NREL



# Comparison of Projections to LUMA FY 2019–FY 2021 Data

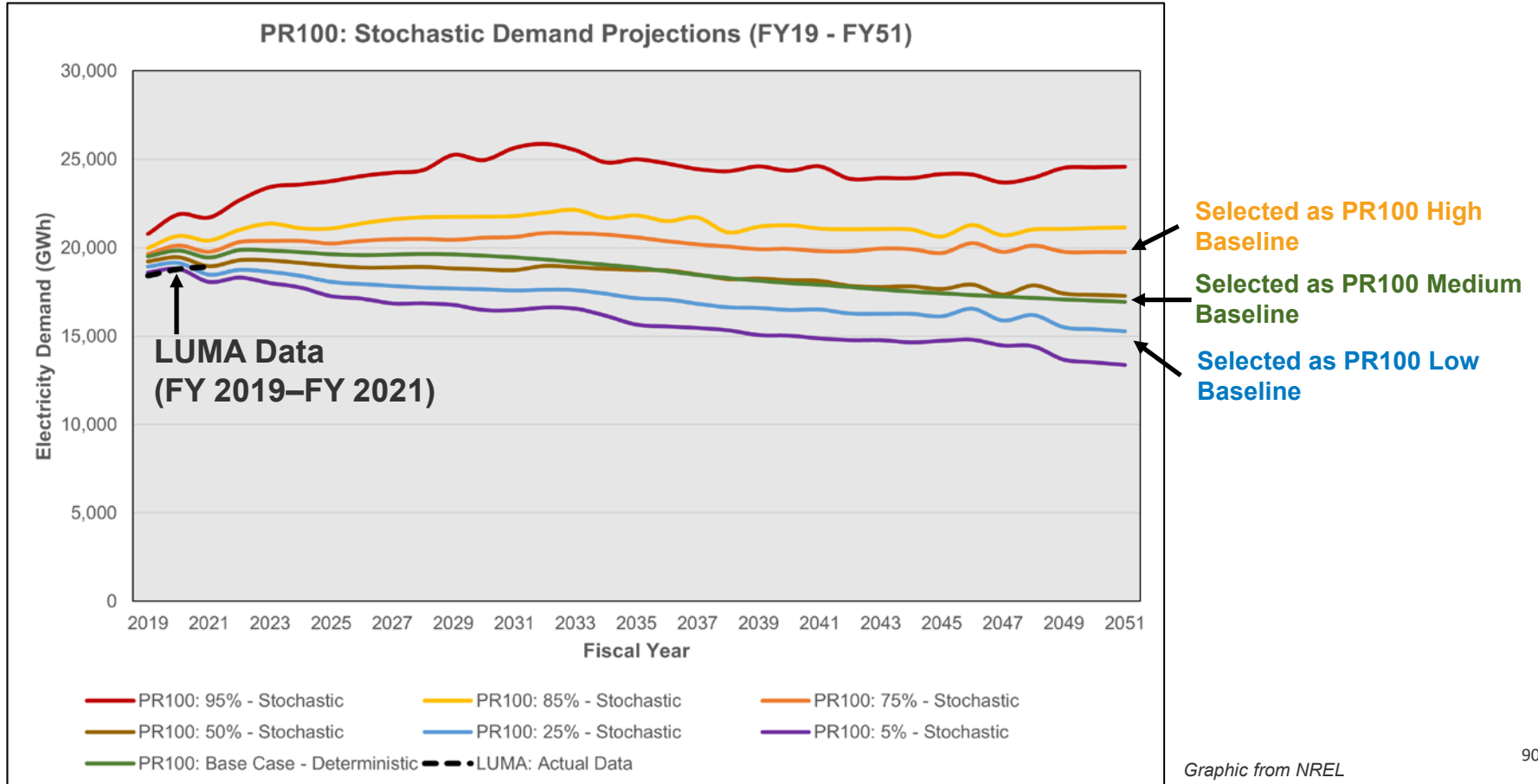

# Baseline “High,” “Medium,” and “Low” Projections

PR100 vs. IRP: Baseline Demand Projections (FY19 - FY51)

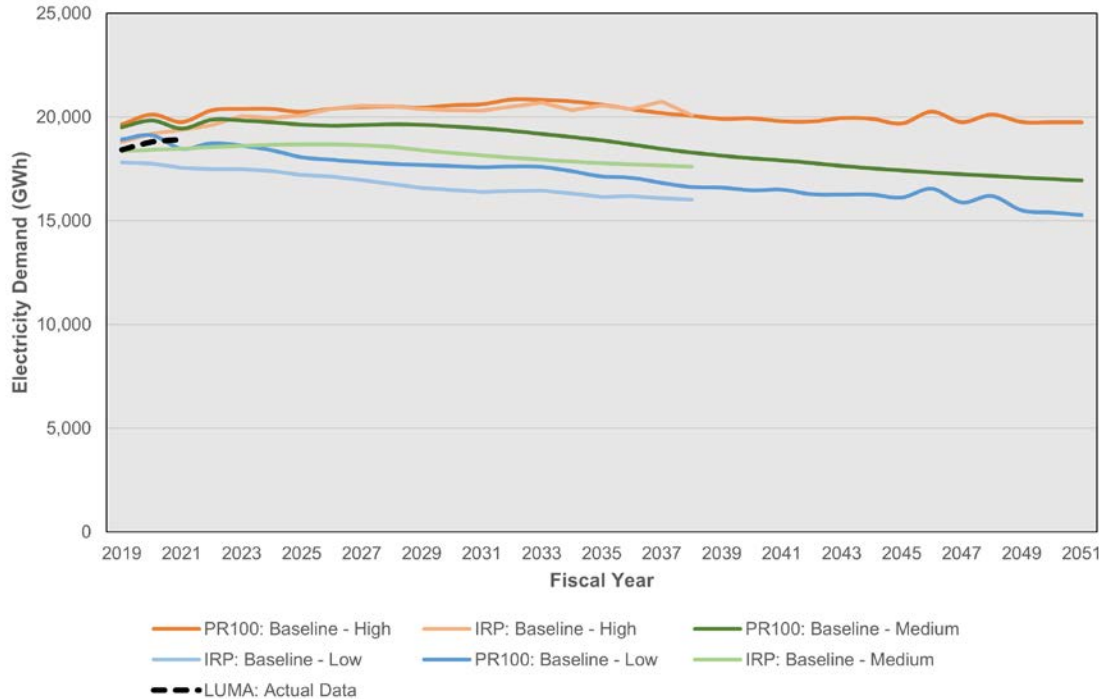

## IRP Projections (FY 2019–FY 2038):

“85% – Stochastic” = “**Baseline – High**”

“Base Case – Deterministic” = “**Baseline – Medium**”

“25% – Stochastic” = “**Baseline – Low**”



## PR100 Projections (FY 2022–FY 2051):

“75% – Stochastic” = “**Baseline – High**”

“Base Case - Deterministic” = “**Baseline – Medium**”

“25% – Stochastic” = “**Baseline – Low**”

*NOTE: the “IRP: 25% - Stochastic” projection is not equivalent to the “PR100: 25% - Stochastic” projection because the “Base Case – Deterministic” projections differ as described in previous slides.*

# Hourly Demand Projections

## Annual Projections for FY 2022–FY 2051

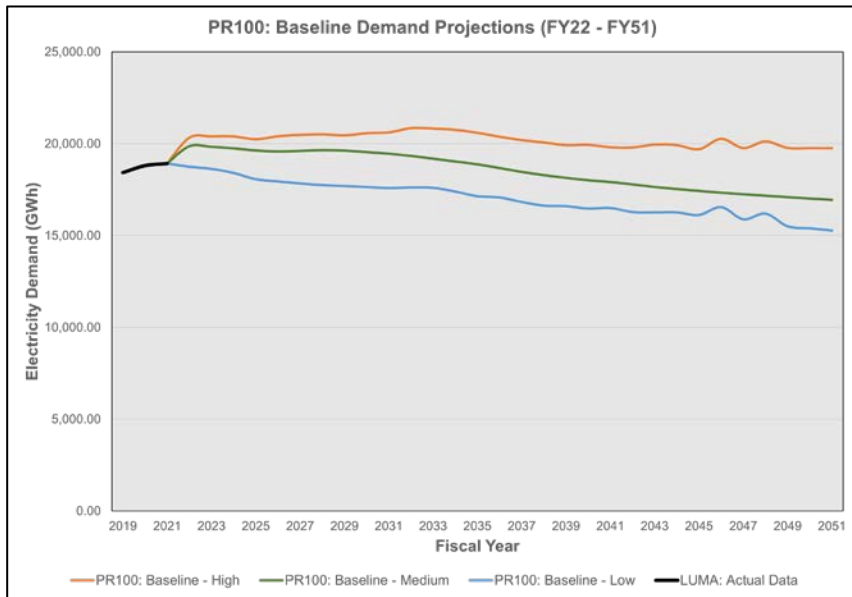

## Hourly Projections for FY 2022–FY 2051

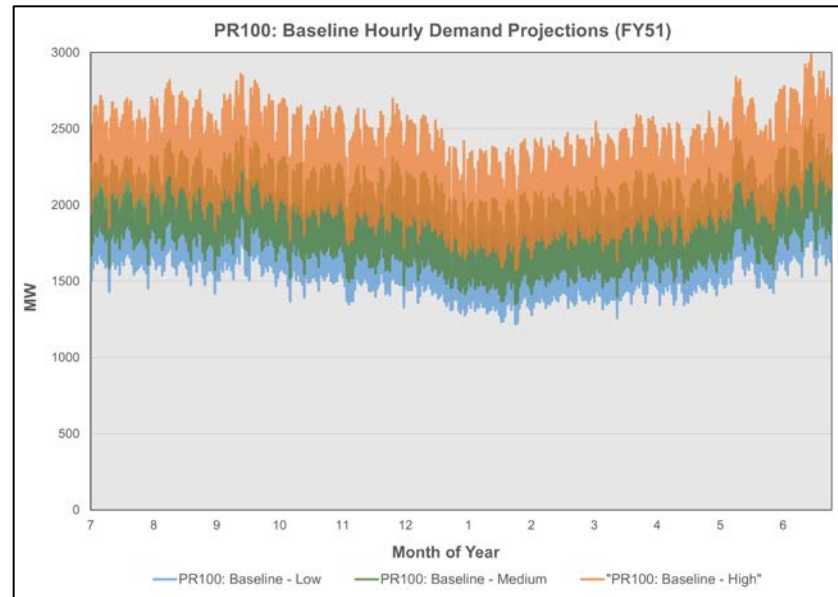

Graphics from NREL

# Demand Projections Updates

**LUMA Data**  
(inclusive of losses, auxiliary load, and PREPA's own use)

Based on PREPA FY17 Hourly Data

### Hourly Demand Data by Sector (FY19)

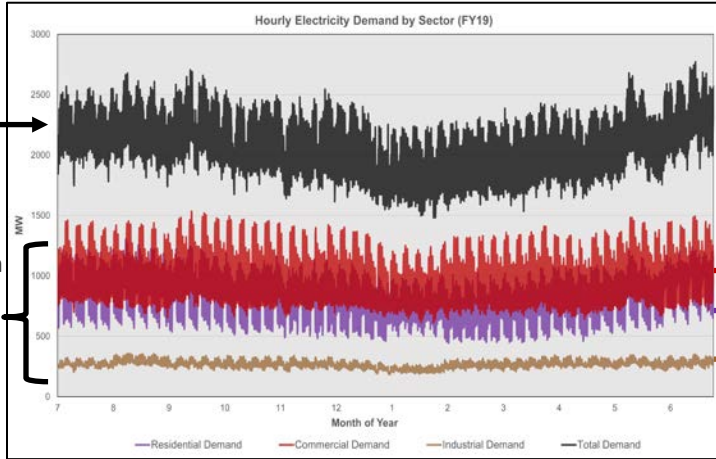

### Hourly Demand Projections by Sector (FY22–FY51)

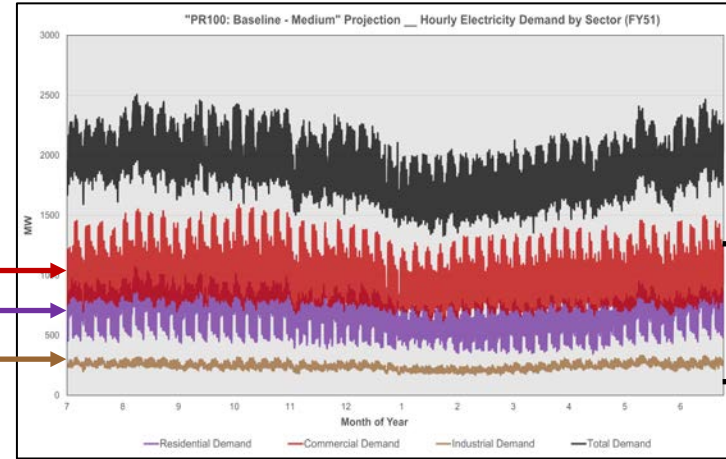

Inclusive of losses, auxiliary load, and PREPA's own use

Graphics from NREL

FY 2019 hourly demand data by sector from LUMA are scaled according to monthly demand projections by sector for FY 2022–FY 2051 to determine hourly demand projections by sector for FY 2022–FY 2051.

# Hourly Demand Projections by Region

## FY20: Distribution of Electricity Sales by Municipality

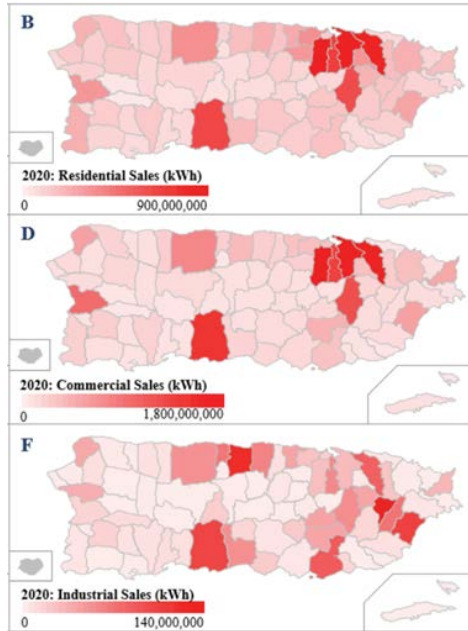

Percentage  
breakdowns  
assumed to  
remain  
constant from  
FY22 to FY51

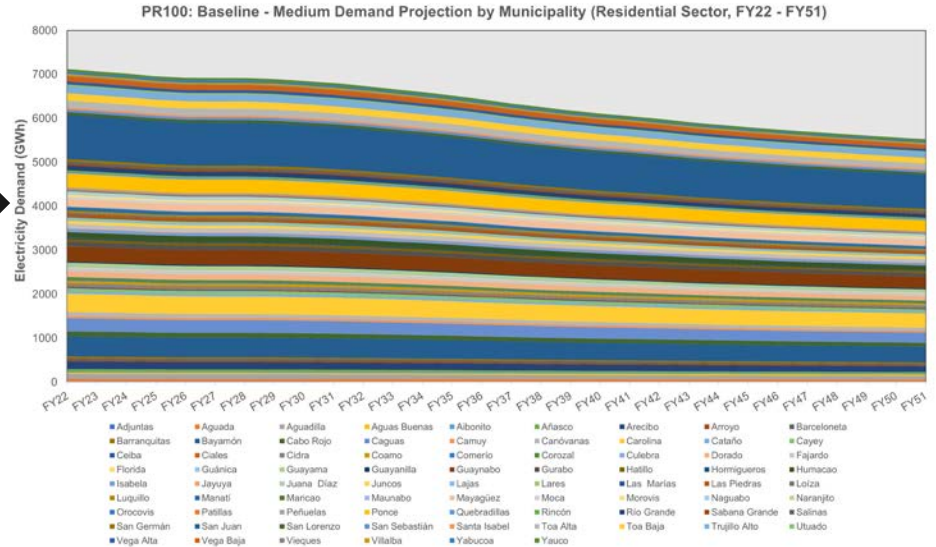

## FY22–FY51

Hourly electricity demand projections disaggregated by:

- Sector (residential, commercial, industrial, other)
- Region (78 municipalities)

# Demand Projections Updates

PR100: Default Electric Load

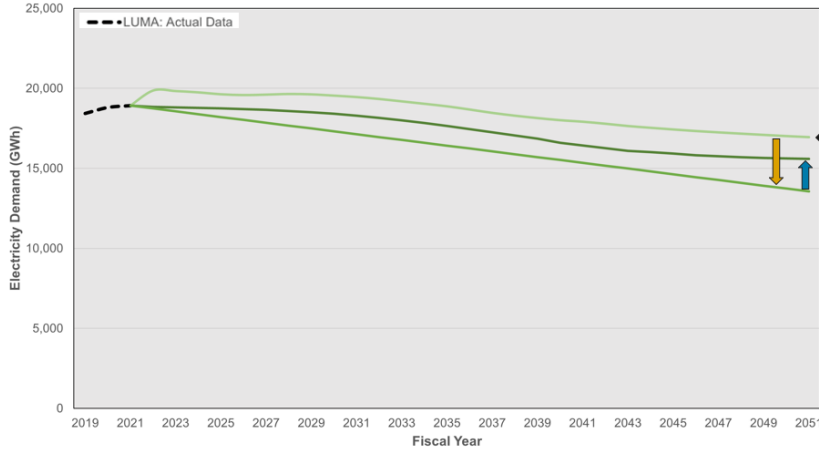

**NOTE:** Placeholder data used for energy efficiency and EV adoption to illustrate potential impacts to the baseline electric load projections.

## Next Steps

- Incorporate **Energy Efficiency** (LBNL) and **Electric Vehicle** (Sandia) impacts into final demand projections to create the *Default* and *Stress* Scenarios illustrated here.

PR100: Stress Electric Load

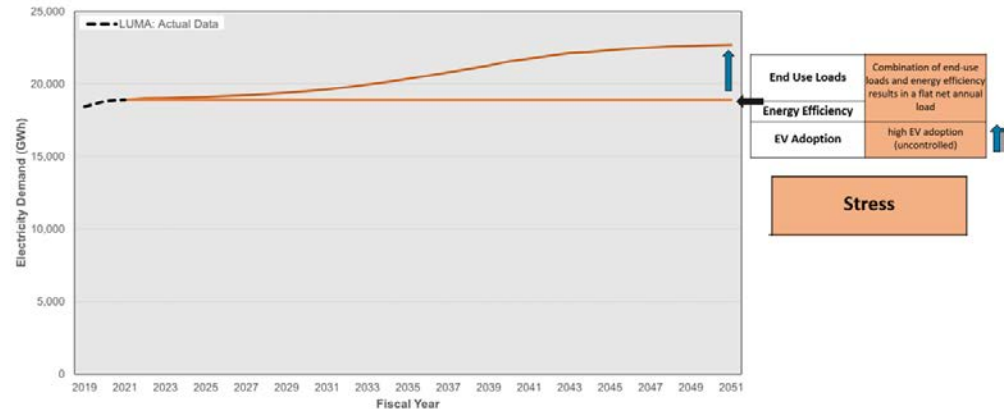



# Demand Impacts

---

This subsection addresses how the following technologies impact baseline demand projections:

- Electric Vehicle (EV)
- Energy Efficiency (EE)
- Distributed Solar and Storage

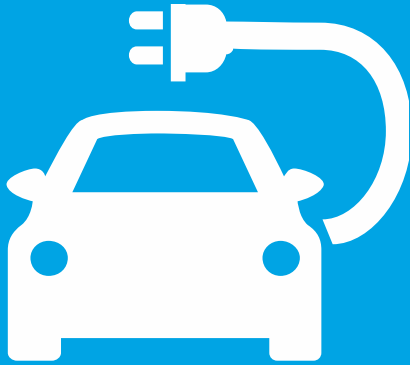

# Electric Vehicle Demand Impacts

# Electric Vehicle Spatial-Temporal Projections

## Spatial EV Adoption Model:

- Input historical EV data and census data
- Output spatial diversity of EV adoptions.

## Temporal EV Adoptions:

- Use forecast developed by Energy Policy Solutions for U.S. and other states.

## Model Deployment

- Input Puerto Rico Census data
- Output Number of EVs in each Municipio from 2020 to 2050.

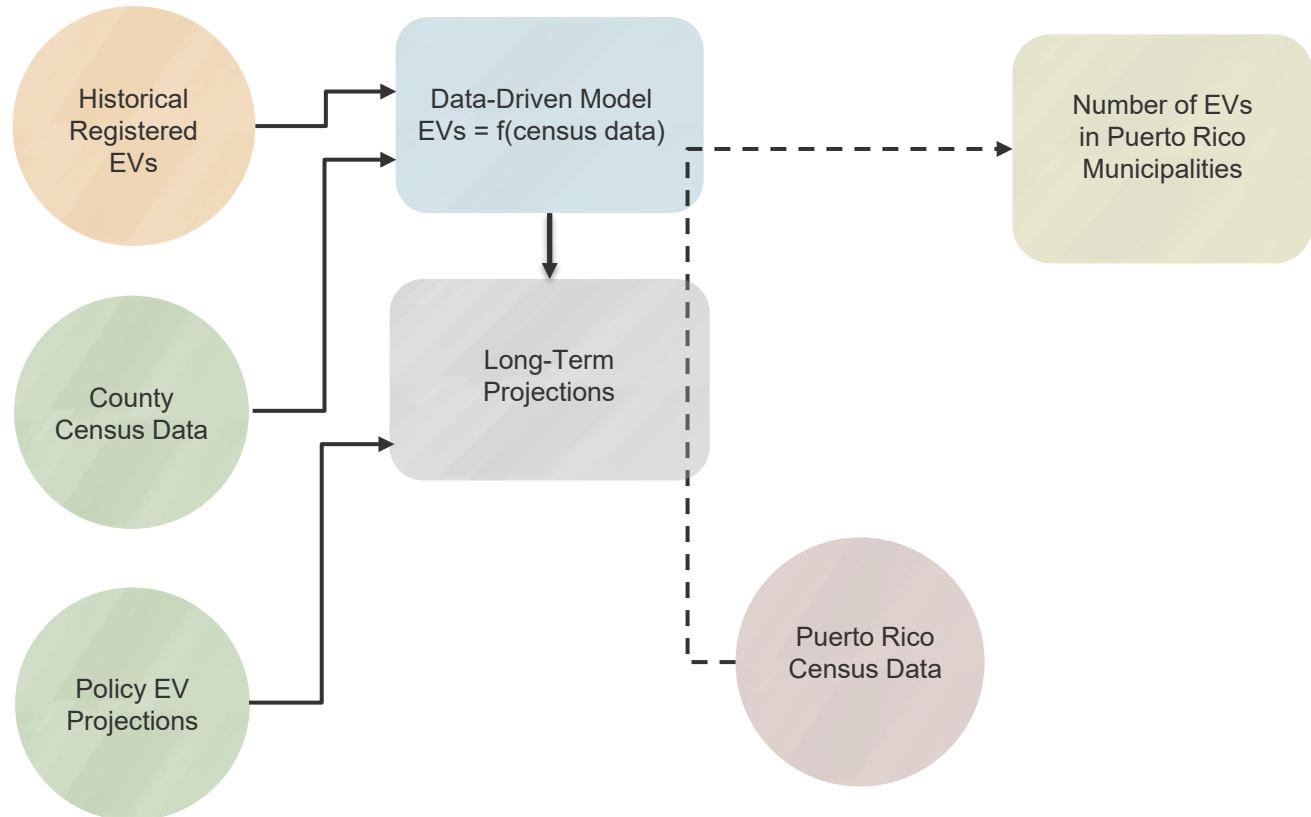

# Spatial EV Model Development

## Historical Registered EVs

EV registration data from counties in other U.S. states was used to create spatial model.

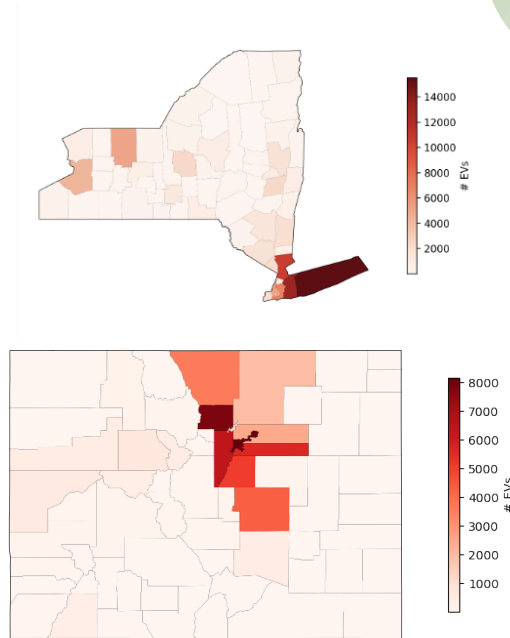

## County Census Data

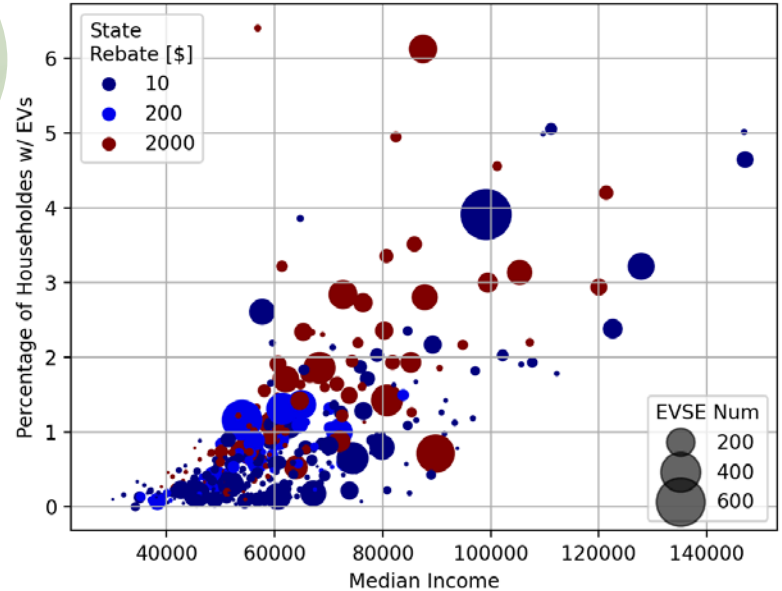

An evaluation of census data Identify the dependencies of EV adoptions, such as median income, and number of households. These data features were used by the model to estimate spatial diversity in PR.

# Time-Series Model Development

## Long-Term Projections

The percentage of EVs overtime in Puerto Rico was estimated using Energy Policy Solution's Forecasts.

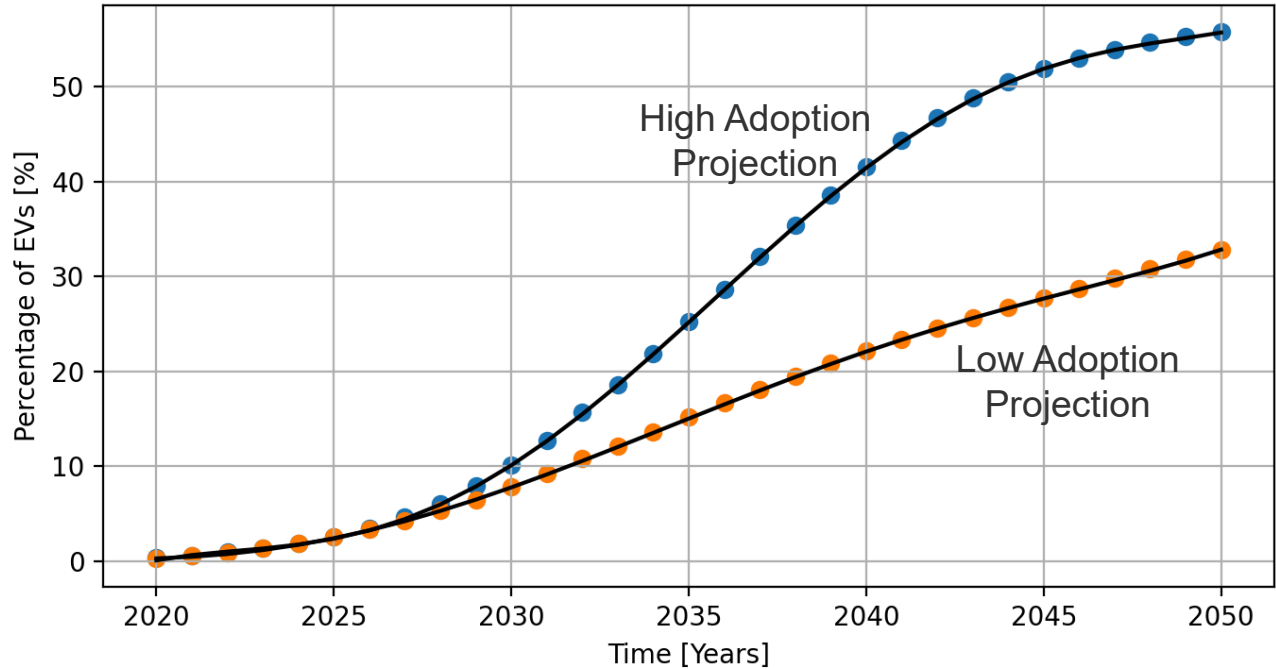

# Preliminary Adoption Results

Number of EVs  
in Puerto Rico  
Municipalities

The spatial adoption of EVs depended on the number of households and the median income of each municipality.

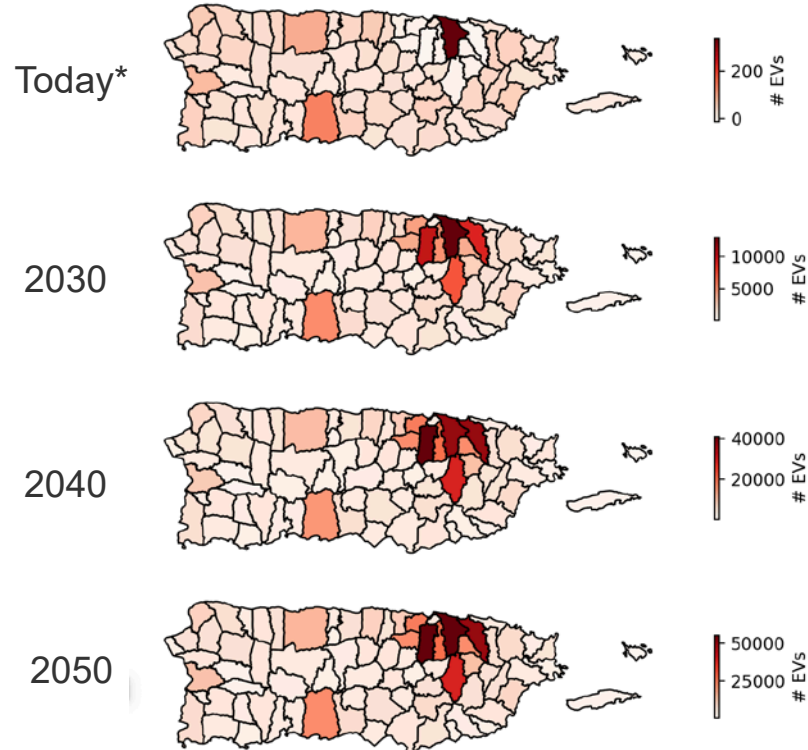
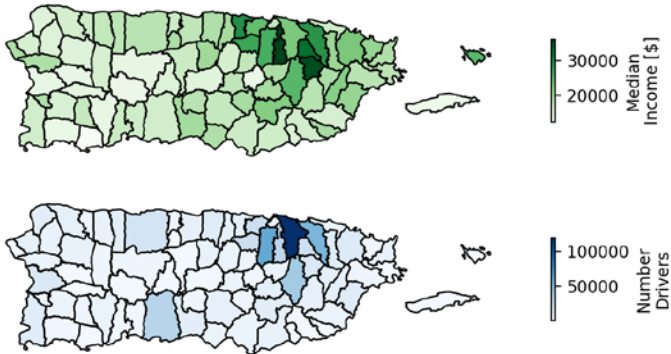

\* Records show that about 2,500 EVs are registered in PR today. Our model estimated 2,700 EVs.





# Energy Efficiency Demand Impacts

# Energy Efficiency Annual Savings

Typically, an energy efficiency model would perform these key steps. For Puerto Rico, the level of building data and electricity usage breakdowns are not available.

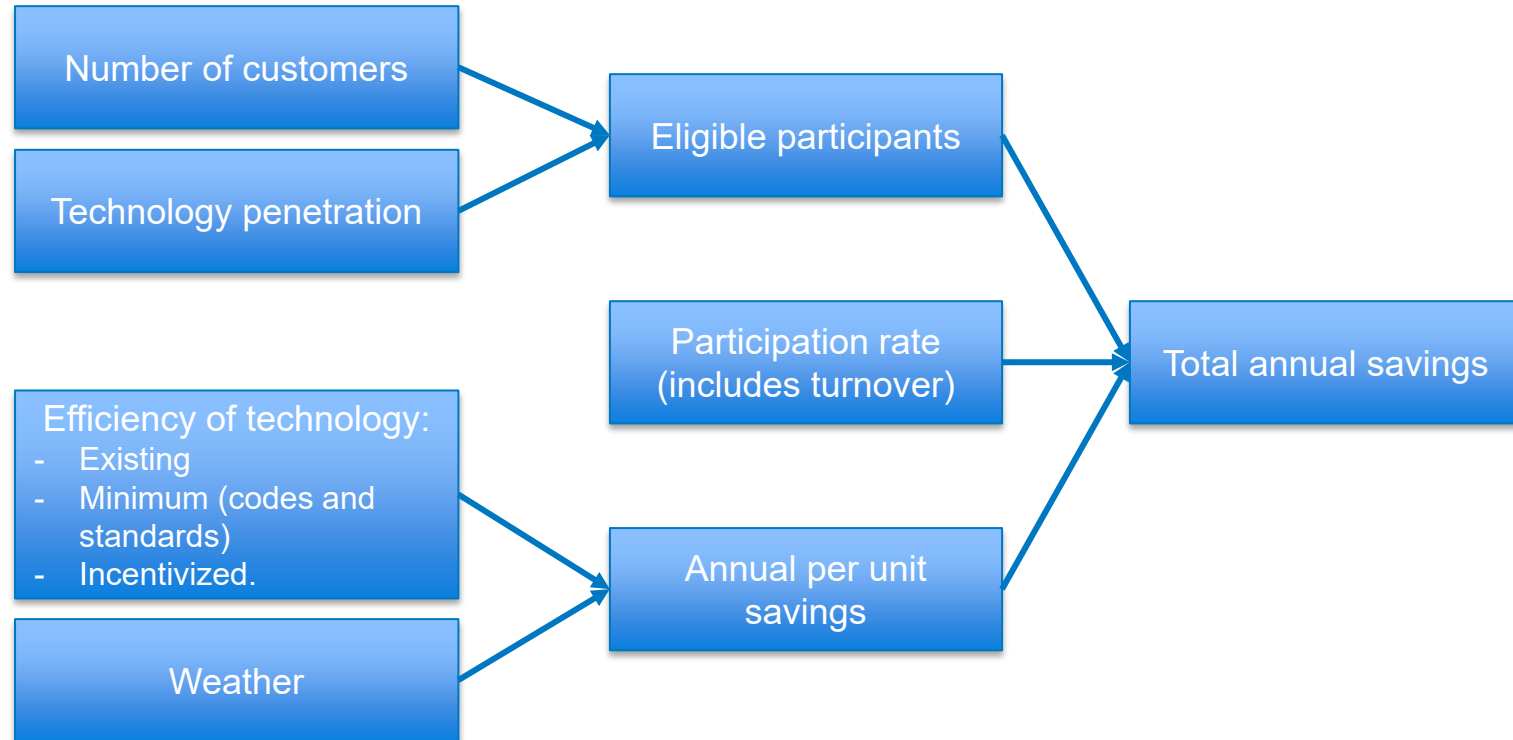

# Energy Efficiency Data Sources

The energy efficiency team has been gathering available data to inform analysis around likely future energy efficiency impacts, including:

- Existing technologies: interviews with AG members
- Puerto Rico's [Regulation for Energy Efficiency](#)
- Program offerings: discussion with LUMA
- Changes in efficiency over time: U.S. Energy Information Agency (EIA) [Annual Energy Outlook](#) (AEO) typical and high efficiency projections
- Per-unit savings from several sources:
  - [Puerto Rico Energy Efficiency Scenario Analysis Tool \(PREESAT\)](#)
  - Prior Integrated Resource Plans
  - State technical resource manuals
  - Puerto Rico Weatherization Assistance Program
  - Percent reduction of estimated end-use consumption.

# Sources of Energy Efficiency Savings

Source of energy efficiency savings	Default	Stress
<b>Programs</b>	Programs (both transition period and permanent) are implemented as contemplated in current energy efficiency proceedings	No new programs are implemented, likely due to a lack of available funding for the planned programs
<b>Building energy codes</b>	Puerto Rico adopts increasingly stringent building energy codes and enforces them sufficiently to produce savings	Little to no savings from codes, either because Puerto Rico does not adopt more stringent codes or is unable to enforce them sufficiently
<b>Appliance and equipment standards</b>	Puerto Rico receives savings from the implementation of increasingly stringent federal standards	Same as default except that federal standards adoption is somewhat slower, reducing savings
<b>Net impact</b>	Energy efficiency decreases load	Energy efficiency is only sufficient to offset demand, resulting in flat net load

# Plan for Assessing Hourly Impacts of Energy Efficiency

- NREL's [ResStock](#) and [ComStock](#) have calibrated and validated end-use load profiles at high levels of geographic granularity for the mainland building stock—not available for Puerto Rico.
- We anticipate assuming that consumption and savings shapes are the same—reduce the load by the constant percentage needed to account for the annual savings.
- We anticipate constructing savings shapes for 24 days—weekday and weekend for each month—and repeat as necessary to reach 8,760.

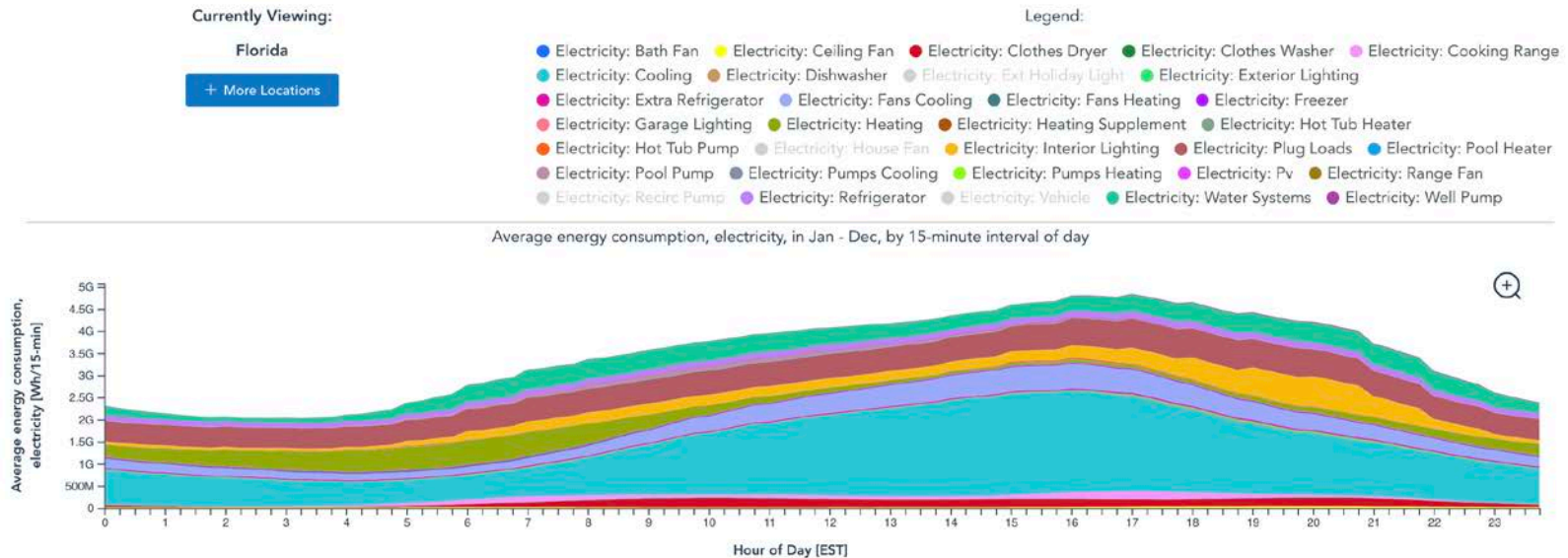

# Issues in Creating Hourly EE Savings: Residential

Puerto Rico residential shape is completely different from Miami and Hawaii, even though the climate is very similar.

**Is it reasonable to assume that the difference is only based on cooling and that other load component shapes are the same?**

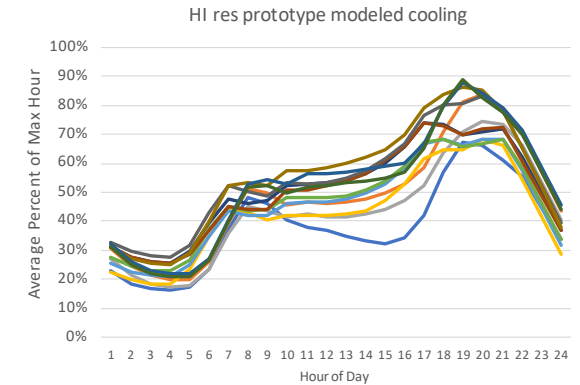
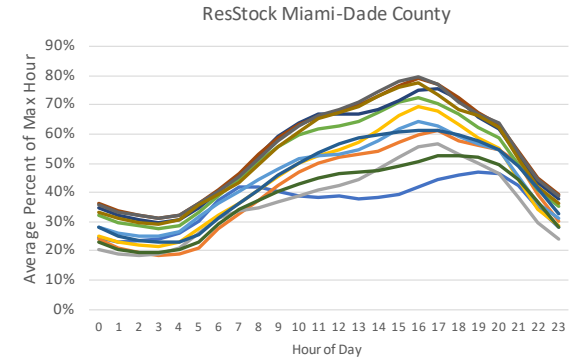
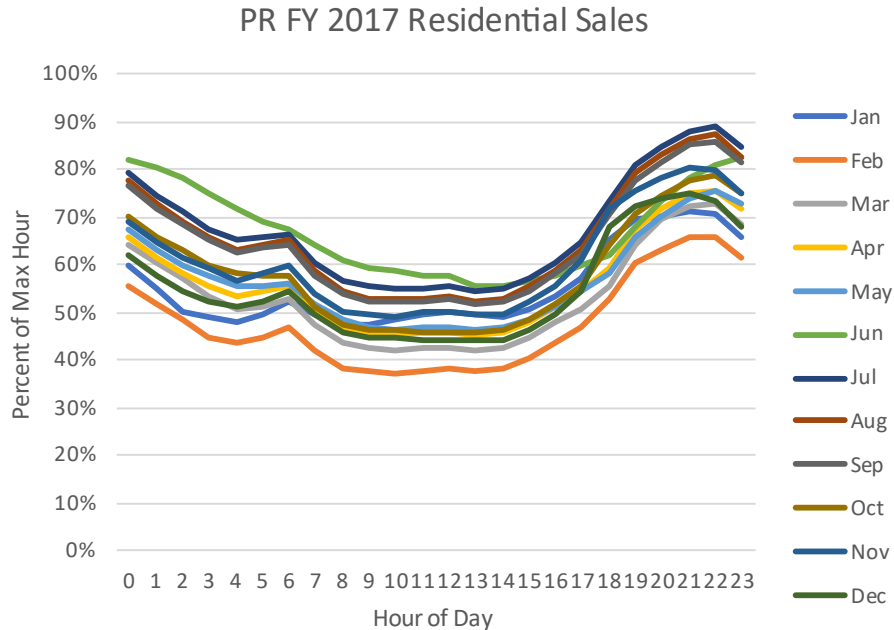

# Issues in Creating Hourly EE Savings: Commercial

Commercial shapes peak at a more similar time, but how does the distribution of commercial building types in PR compare to Miami or Hawaii?

PR FY17 Commercial Sales

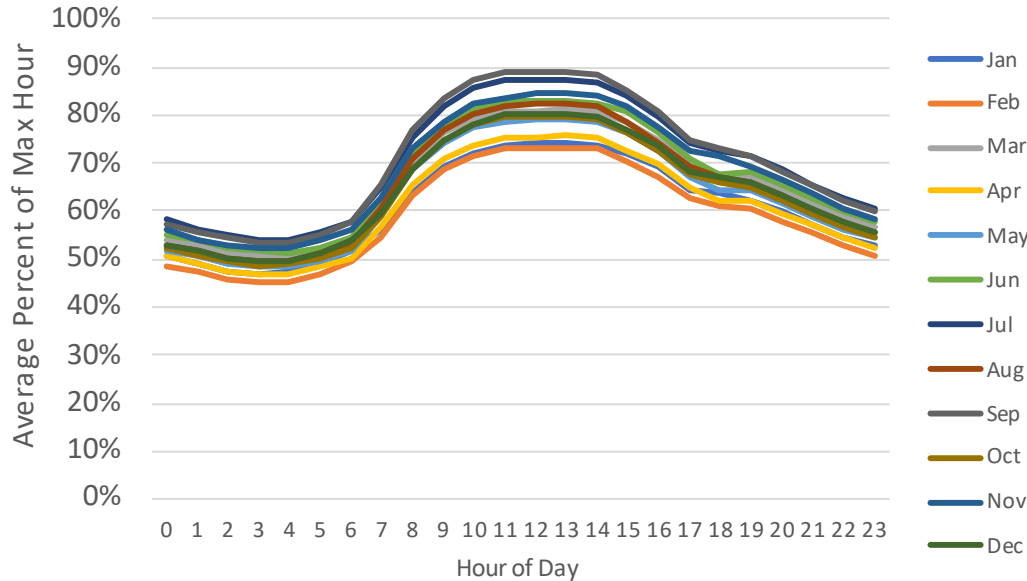

ComStock Miami -Dade County

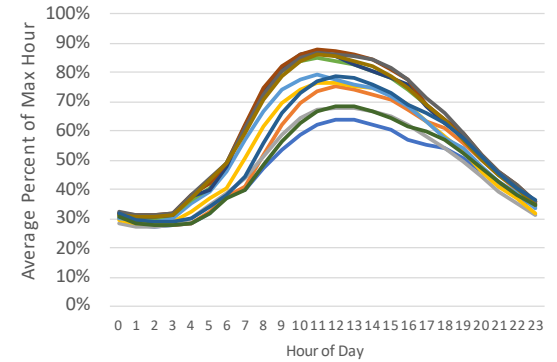

ComStock HI

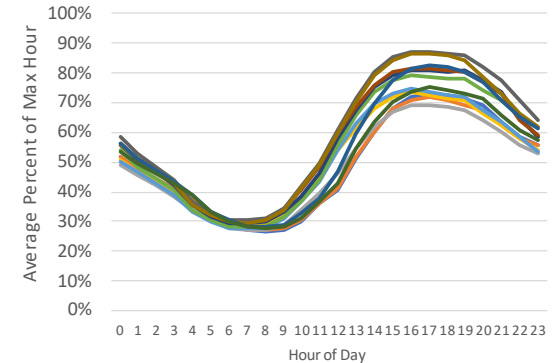





# Distributed Solar and Storage Demand Impacts

# Distributed PV+Storage Adoption Using the dGen™ Model

About the Distributed Generation Market Demand (dGen™) model:

- Agent-based model simulates consumer decision-making.
- Forecasts adoption of distributed solar by sector and state through 2050
- Incorporates detailed spatial data to understand geographic variation (see Task 3)
- Agent characteristics derived from population-weighted sampling to create a comprehensive and representative database of the analysis population.

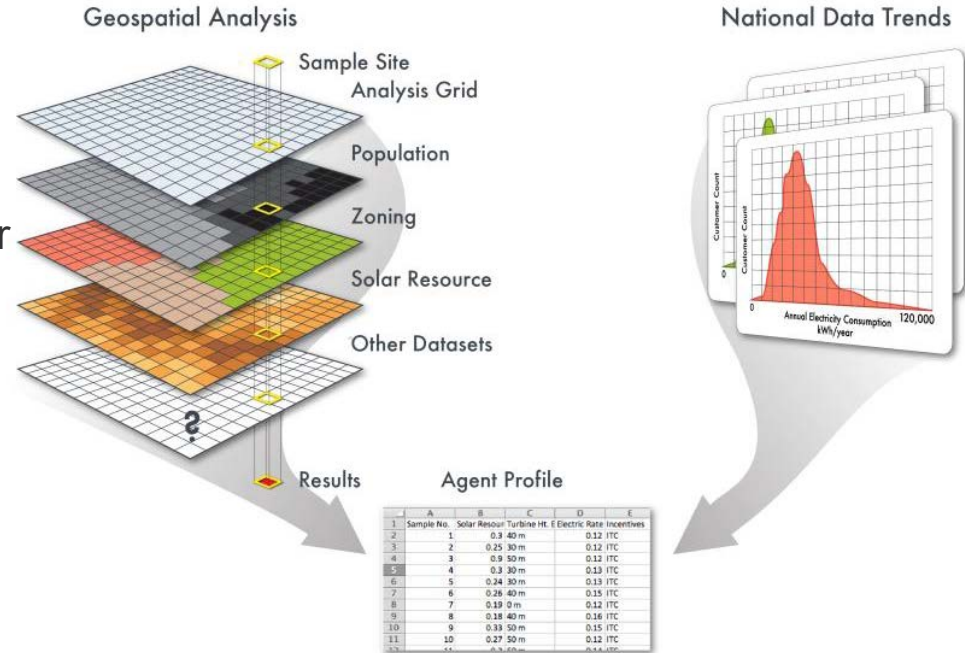

Website: [www.nrel.gov/analysis/dgen/](http://www.nrel.gov/analysis/dgen/)

Documentation: [www.nrel.gov/docs/fy16osti/65231.pdf](http://www.nrel.gov/docs/fy16osti/65231.pdf)

# Distributed PV Modeling Methodology

Adoption of rooftop solar is modeled through an agent-based approach that includes four steps:

1. **Generating agents** (i.e., potential customers) and assigning them attributes based on a probabilistic representation of individual customer types
2. Applying **technical and siting restrictions**, such as resource quality, rooftop solar availability (see Task 3), and quality for each agent
3. Performing **economic calculations** using cash flow analysis incorporating project costs, prevailing retail rates, incentives, and net metering considerations.
4. Estimating total rooftop solar deployment by applying **market diffusion estimates**.

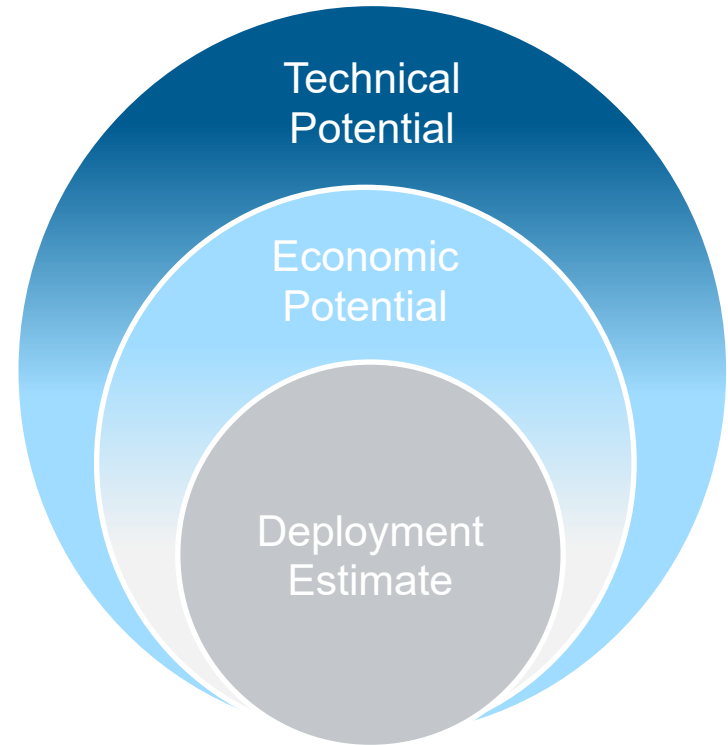

# Financial Assumptions

## Financial Modeling

- Each agent completes a discounted cash flow analysis in each model year (uses hourly solar generation and electricity consumption profiles).
- Cash flows include capital and operations and maintenance (O&M) costs, revenue from bill savings.

## Baseline Retail Rates

- Agents are assigned appropriate tariffs (w/ net metering) based on geographic and energy/demand consumption constraints.
- Actual utility retail rate structures are incorporated.
- EIA AEO2022 annual real retail price escalations is used.

## Financing (NREL 2022 Annual Technology Baseline [ATB])

- 4.4% weighted average cost of capital (WACC) is used to discount cash flows.
- Assumes all consumers have access to financing.

# Modeling Solar Adoption

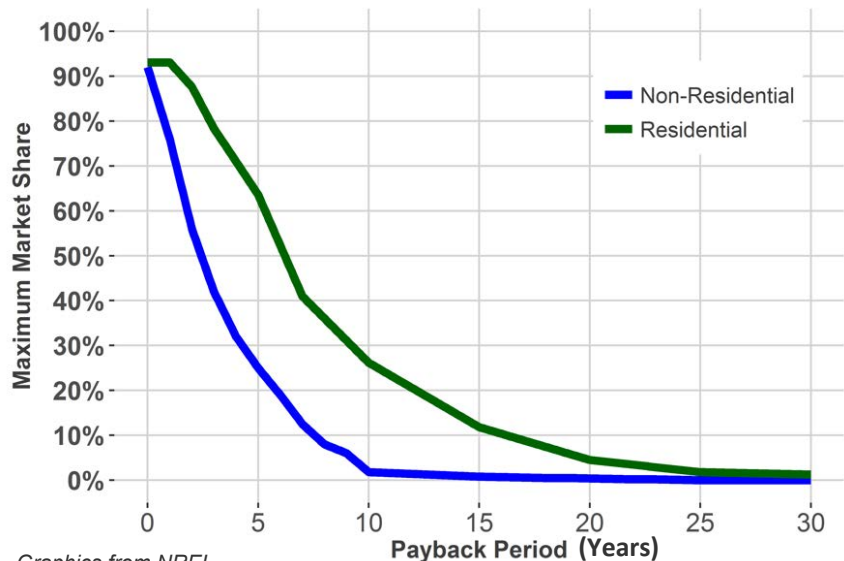

Graphics from NREL

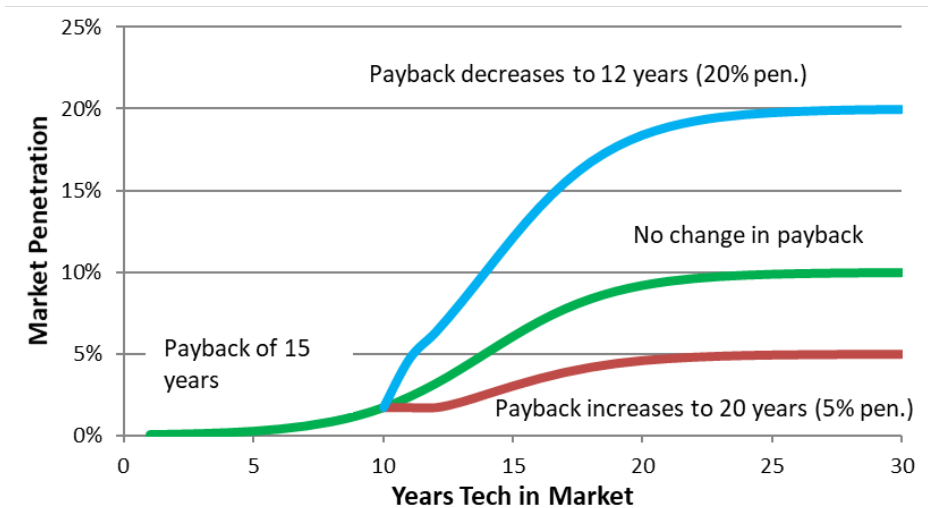

- Using consumer surveys, we relate the system payback to the fraction of consumers that would adopt solar.
- We evaluate the optimal system size using 4.4% WACC.
- We use the Bass Diffusion model to simulate adoption over time, using the “Maximum Market Share” as the terminal adoption level.
- Note: Graphics on this slide are illustrative and are not representative of Puerto Rico specifically.

# Distributed PV Cost Trajectory

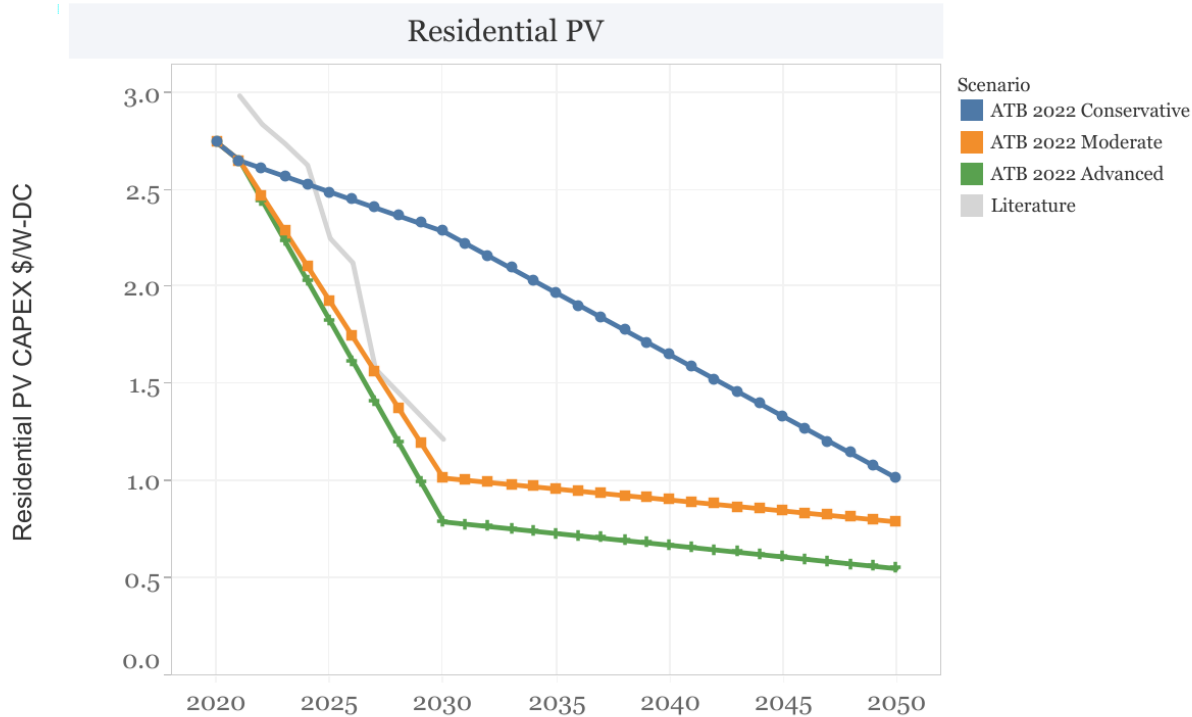

## Initial PR Data:

- \$27,000-\$30,000 for a 6-kW system and one Powerwall
- Results in a \$3.7/W PV cost (assuming \$8,000 for battery system)
- Reduce using percentage reductions from the ATB.

ATB cost projections compared with literature.  
The year represents the commercial online date.



ATB data for technologies  
on the website:  
<https://atb.nrel.gov/>

# Activity 3. Scenario Generation and Capacity Evaluation

---

Task 5. Detailed Scenario Generation

Task 6. Capacity Expansion Planning

Task 7. Production Cost Modeling

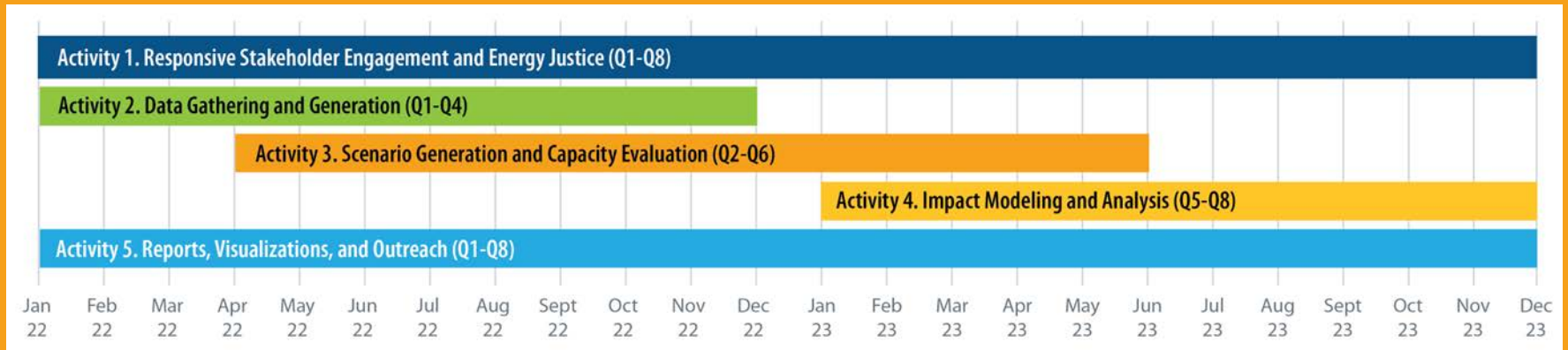





## TASK 5: Detailed Scenario Generation

Lead Lab: NREL

Supporting: All

# Scenario Modeling: What Is a Scenario?

A scenario is a possible pathway toward a clean energy future driven by a set of inputs.

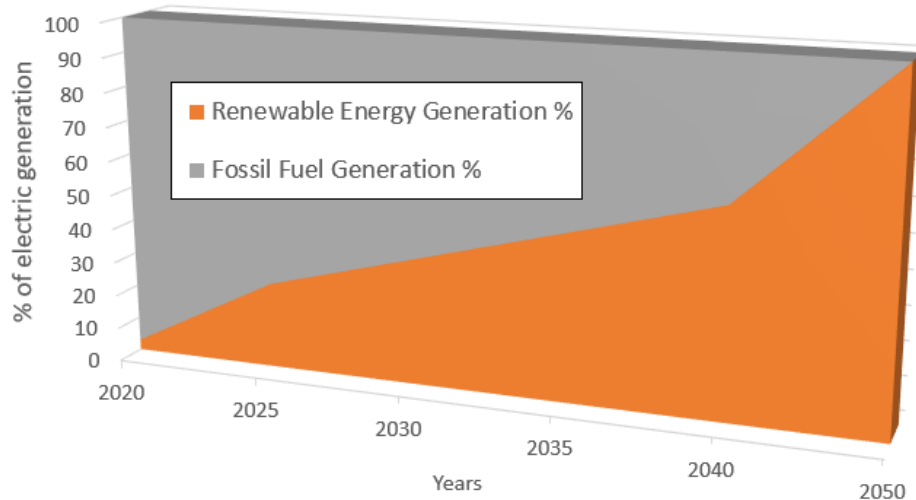

## Variable Scenario Inputs (Examples):

### Energy Demand

How will demand for electricity change over time?

- Economic inputs
- Expected energy efficiency and EV adoption
- Value of backup power

### Energy Supply

How will demand be met with 100% renewable energy?

- Distributed solar and storage
- Large scale solar, wind, etc.
- Public policy (like Act 17)
- Resiliency requirements
- Transmission cost

# Prior Scenarios Work: LA 100

## Four key scenarios examining trade-offs between:

- Compliance with CA Senate Bill 100
- Transmission
- Electrification
- Biofuels

Each scenario was evaluated under different projections of customer electricity demand (moderate, high, or stress).



### SB100

Evaluated under **Moderate, High, and Stress Load Electrification**

- 100% clean energy by **2045**
- Only scenario with a target based on retail sales, not generation
- Only scenario that allows up to 10% of the target to be natural gas offset by renewable electricity credits
- Allows existing nuclear and upgrades to transmission



### Early & No Biofuels

Evaluated under **Moderate and High Load Electrification**

- 100% clean energy by **2035**, 10 years sooner than other scenarios
- No natural gas generation or biofuels
- Allows existing nuclear and upgrades to transmission



### Transmission Focus

Evaluated under **Moderate and High Load Electrification**

- 100% clean energy by **2045**
- Only scenario that builds new transmission corridors
- No natural gas or nuclear generation



### Limited New Transmission

Evaluated under **Moderate and High Load Electrification**

- 100% clean energy by **2045**
- Only scenario that does not allow upgrades to transmission beyond currently planned projects
- No natural gas or nuclear generation



## Three possible futures for customer electricity demand

### Moderate energy efficiency, electrification, and demand flexibility, e.g.:

- 30% of passenger cars on the road in 2045 are plug-in electric
- Residential building equipment and appliance sales are distributed across all efficiency levels
- 80% of new & retrofit equipment is 5 years ahead of California's Title 24 commercial building energy-efficiency code-minimum
- 75% of residents have access to residential charging; 25% access to workplace charging

### High energy efficiency, electrification, and demand flexibility, e.g.:

- Appliances, heating within buildings switch from natural gas to electric
- Residential building equipment and appliance sales are at highest efficiency available
- 80% of passenger cars on the road in 2045 are plug-in electric
- 60% of residents have access to residential charging; 50% access to workplace charging to encourage more daytime charging
- Demand is more flexible in its timing

### Stress grid conditions—high electrification but low energy efficiency and demand flexibility:

- All the electrification of High
- But timing of demand is not aligned with renewable generation
- Energy efficiency adoption is lower than Moderate (matches LADWP's 2017 Strategic Long-Term Resource Plan 10-year efficiency goals)
- 90% of residents have access to residential charging; 15% access to workplace charging to restrict daytime charging

# Prior Scenarios Work: Solar Futures Study

- The Solar Futures Study considers three future scenarios, two of which assume deep decarbonization of the electric grid and examines the role solar energy could play.
- Note this references the Electrification Futures Study, which also has a scenario structure that is perhaps of interest.

Table 1 - 1. Solar Futures Scenarios Definitions

Scenario Name	Renewable Energy and Storage Technologies	Demand Flexibility	Electricity Demand	Policies
Reference	Moderate cost reductions	None	U.S. Energy Information Administration Reference	Existing policies* as of June 2020
Decarbonization (Decarb)	Advanced cost reductions	None	U.S. Energy Information Administration Reference	Existing policies* + 95% reduction in CO <sub>2</sub> emissions from 2005 levels by 2035, 100% by 2050
Decarbonization with Electrification (Decarb+E)	Advanced cost reductions	Enhanced	High electrification based on NREL Electrification Futures Study	Existing policies* + 95% reduction in CO <sub>2</sub> emissions from 2005 levels by 2035, 100% by 2050

\* The existing policies assumed include state renewable and clean energy mandates, state and regional emissions limits, and federal tax incentives.



# Prior Scenarios Work: NREL Standard Scenarios

- The Standard Scenarios, which are simulated using ReEDS and the dGen capacity expansion models, are updated each year.
- Fifty scenarios are examined overall. The reference scenario (called the Mid-case) uses default or median assumptions.
- To examine decarbonized futures, the Mid-case is run with three levels of power sector decarbonization.
  - No new carbon policies.
  - CO<sub>2</sub> emissions decrease linearly to 95% below 2005 by 2050.
  - CO<sub>2</sub> emissions decline to 95% below 2005 levels by 2035 and are eliminated on a net basis by 2050.
- Sixteen sensitivity scenarios incorporate factors such as fuel prices, demand growth, technology costs, and transmission and resource conditions.

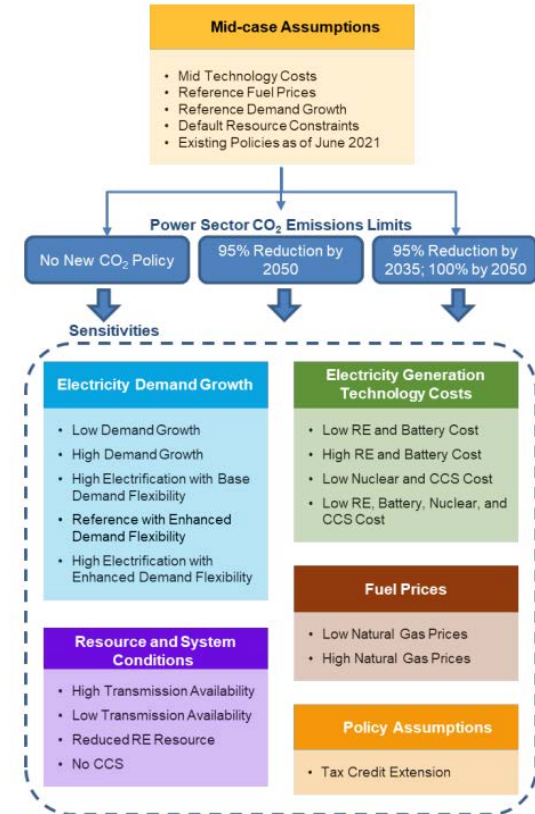

# Prior Scenario Work: Hawai'i Clean Energy Initiative Offshore Wind Energy Versus PV Land Use

Oahu has:

- High energy consumption
- Limited land available and competing uses (e.g., agriculture, grazing, woodlands, farmsteads, real estate, and residential uses)
- Competing maritime uses and opposition to offshore wind energy.

Visualization shows:

- Trade-off in land and maritime surface uses with 2045 100% electric sector sales from RE
- Left: no offshore wind energy, 2500 MW PV
- Right: 1200 MW offshore wind energy, 500MW PV.

Land use by solar projected buildout is shown from lowest to highest leveled cost of electricity (LCOE) in non-excluded areas.

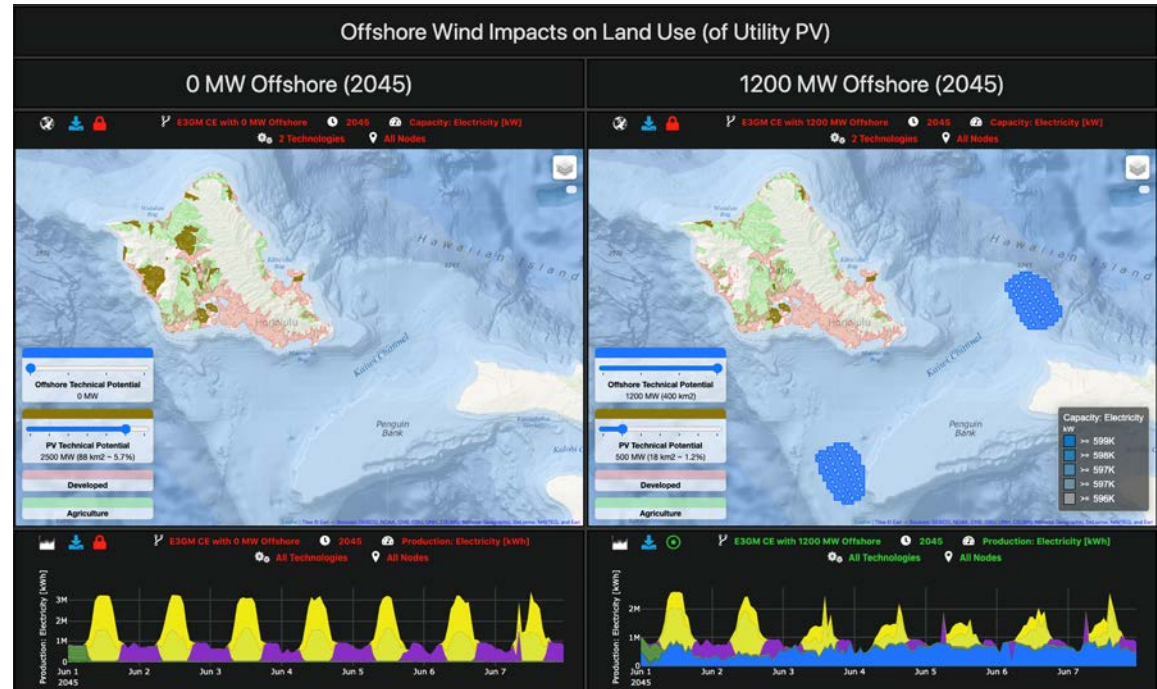

# Modeling Near-Term Investments

## FEMA-Funded Grid Upgrades

Funded projects to upgrade Puerto Rico's electric generation, transmission and distribution system will be included in modeling as they are relevant. Projects approved by FEMA to begin design and construction activities can be found at [FEMA's Accelerated Awards Strategy \(FAASt\) website](#).

## Procurement Plan for Renewable Energy Generation and Storage Resources

Puerto Rico Energy Power Authority (PREPA) is procuring 3,750 MW of renewable energy resources and 1,500 MW of energy storage resources—in six tranches over three years—toward implementation of the 2019 IRP (Puerto Rico Energy Bureau [\[PREB\] docket](#)). PREPA is finalizing negotiations for proposals submitted in [Tranche 1](#).

- Projects selected in Tranche 1 will be assumed in future modeling.
- Tranches 2–6 projects will not be assumed unless they are selected in time to be included within the study timeline.

## Thermal Generation Plant Retirements

Retirement schedule for existing fossil fuel generation units will be assumed as written in the August 24, 2020, IRP ([PREB final resolution on 2019 IRP](#)). Revisions to existing retirement schedules will not be included in the models unless they are approved within the study timeline. Sensitivities to this can be performed.



# Reliability and Resilience Modeled in All Scenarios

## Legend

- **Blue Box** = Modeling Activity
- **Red Text** = Associated Tasks
- **Yellow Text** = Key Output for Next Modeling Activity

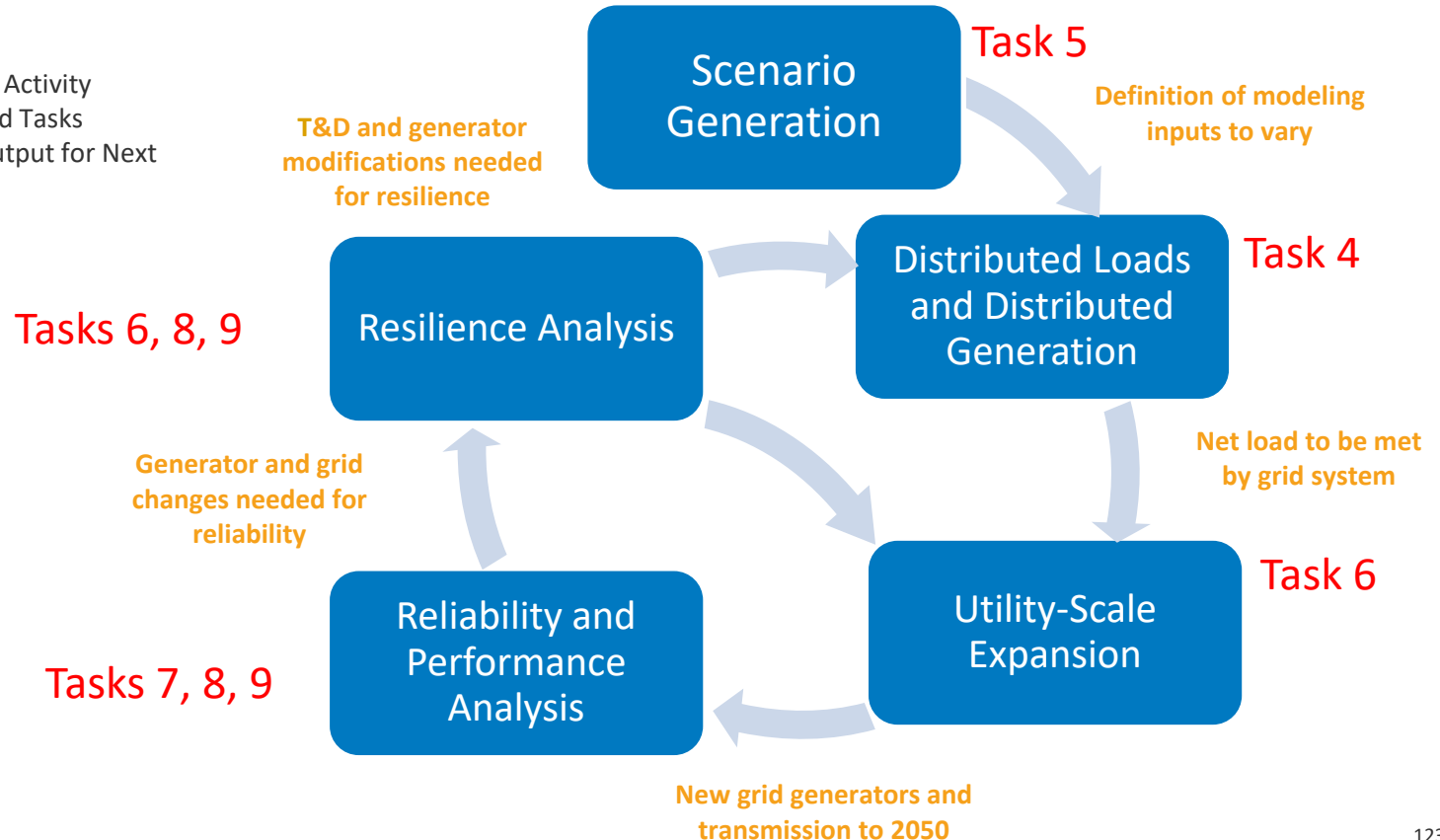

# Initial Scenario Framework Definition

- The project team worked closely with the Advisory Group during the first six months of the study to define four initial scenarios to model based on these priorities:
  - Energy access and affordability
  - Reliability and resilience (under both normal and extreme weather conditions)
  - Siting, land use, environmental and health effects
  - Economic and workforce development
- The primary distinction between the four scenarios is varying levels of distributed energy resources, such as rooftop solar and energy storage.
- Variations of electric load and land use, as well as transmission and distribution expansion, will be incorporated in each scenario.

# Scenario 1. Economic Adoption of Distributed Energy Resources

Electricity system is modeled to achieve 100% renewable energy by 2050

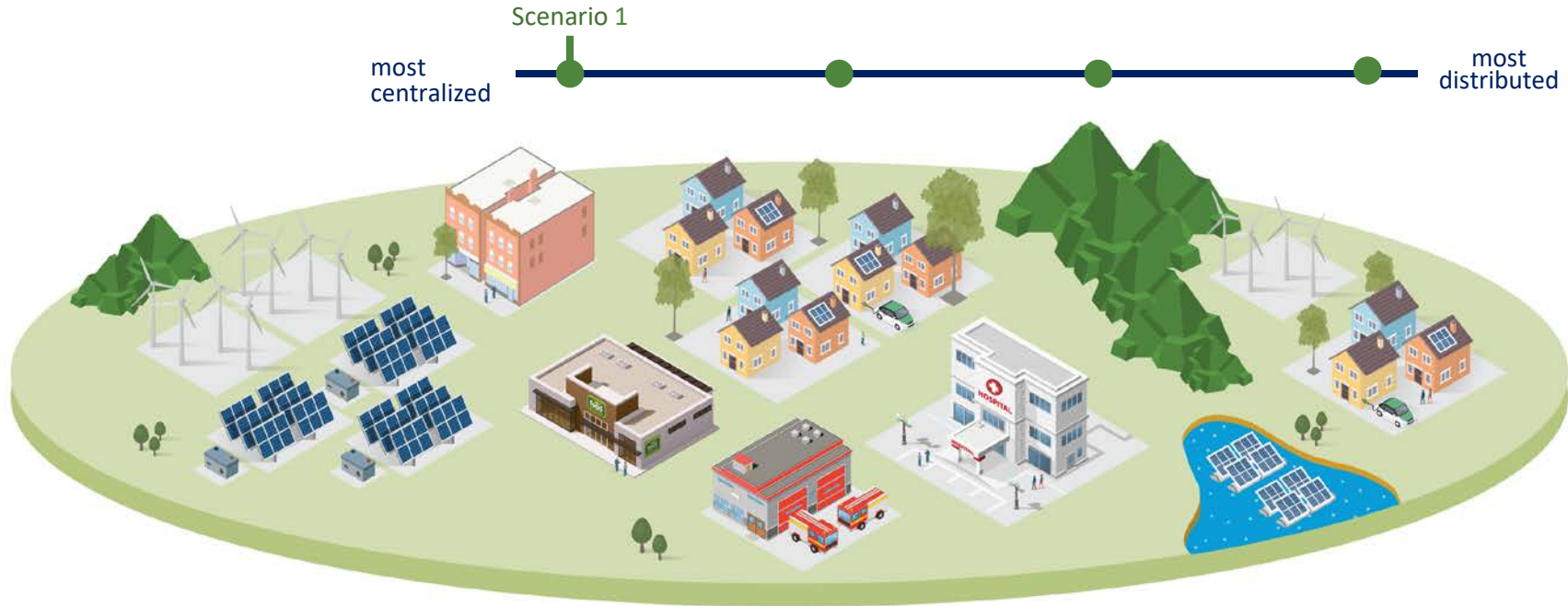

# Scenario 2. Deployment of Distributed Energy Resources for Critical Services

Installation of distributed energy resources is prioritized beyond Scenario 1 for critical services like hospitals, fire stations, and grocery stores



# Scenario 3. Equitable Deployment of Distributed Energy Resources

Installation of distributed energy resources is prioritized beyond Scenario 2 for remote and low- and moderate-income households

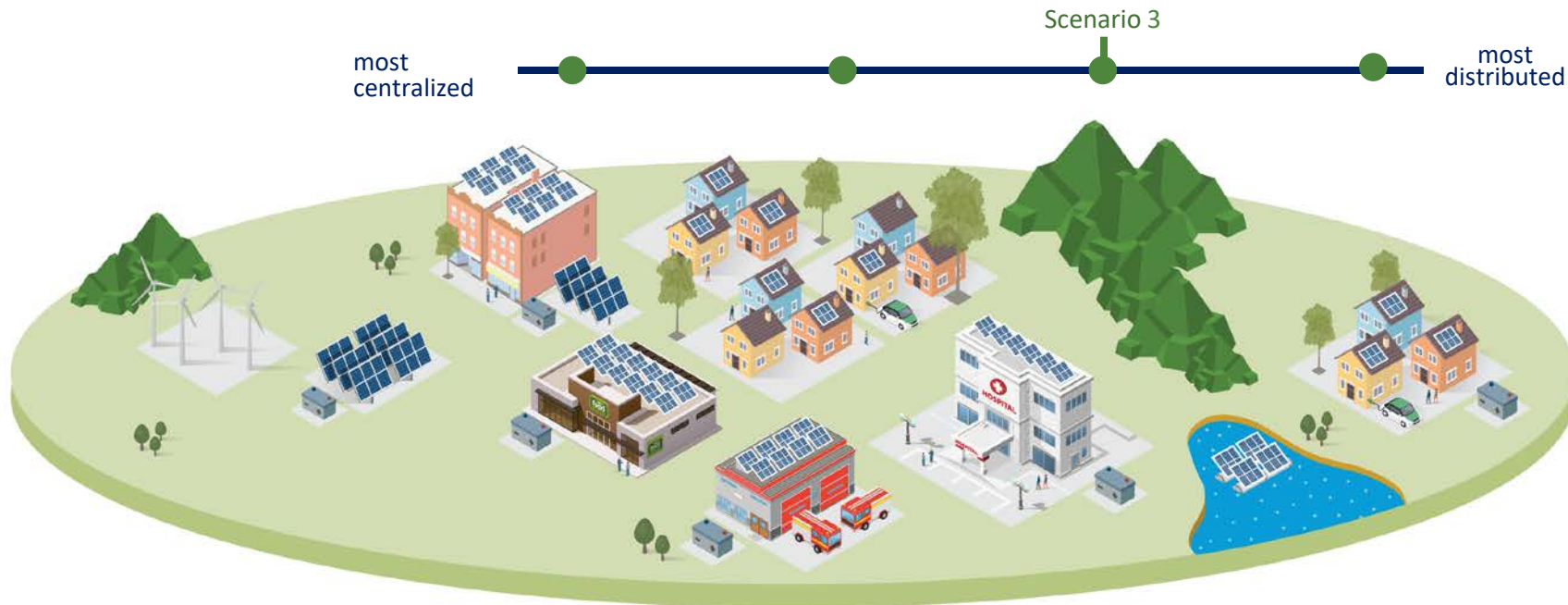

# Scenario 4. Maximum Deployment of Distributed Energy Resources

Distributed solar power and energy storage is added to all suitable rooftops



# Potential Electric Load Options

PR100: Default Electric Load

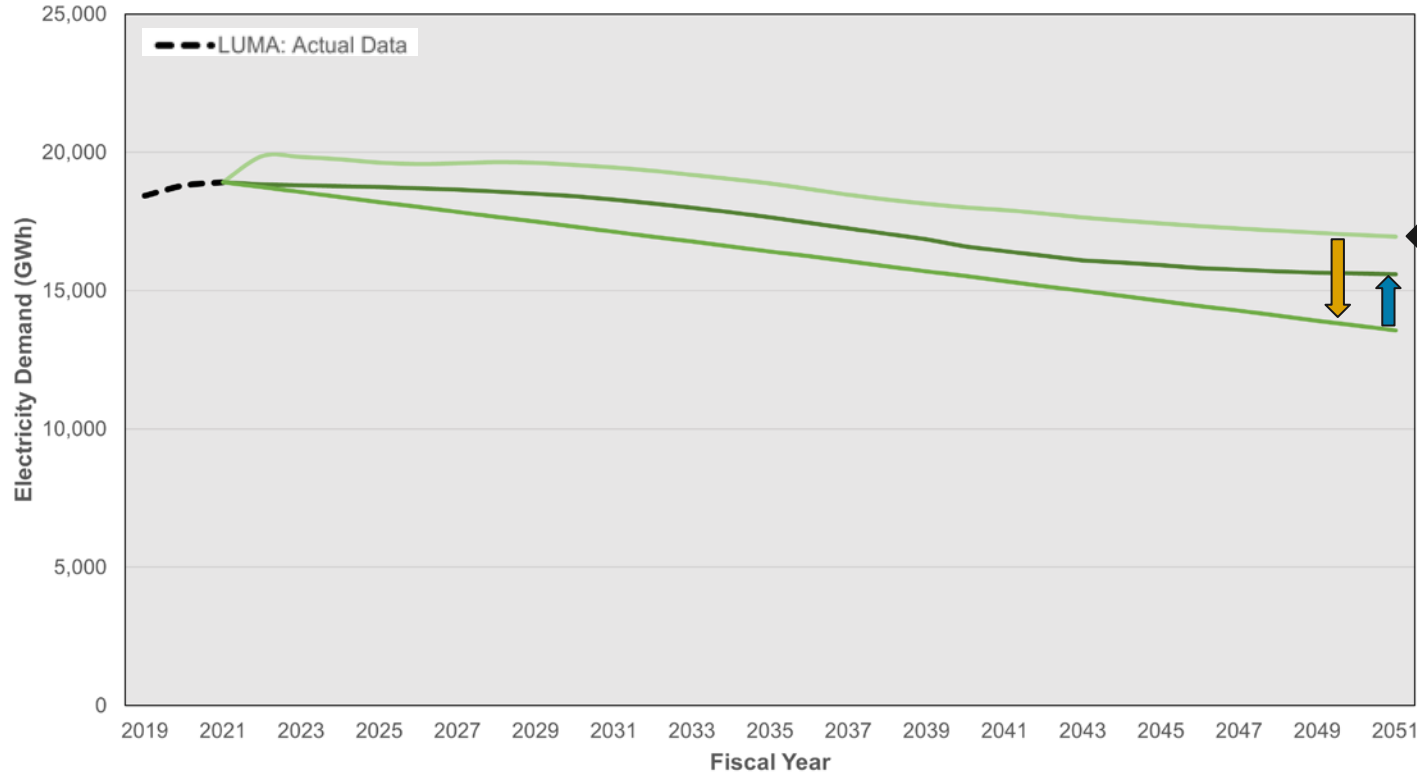

Default

End Use Loads	Updated 2019 IRP process
Energy Efficiency	mid-case
EV Adoption	mid-case

**NOTE:** Place-holder data used for energy efficiency and EV adoption to illustrate potential impacts to default electric load.

Graphic by NREL (graph developed for illustration purposes only)



# Potential Electric Load Options

PR100: Stress Electric Load

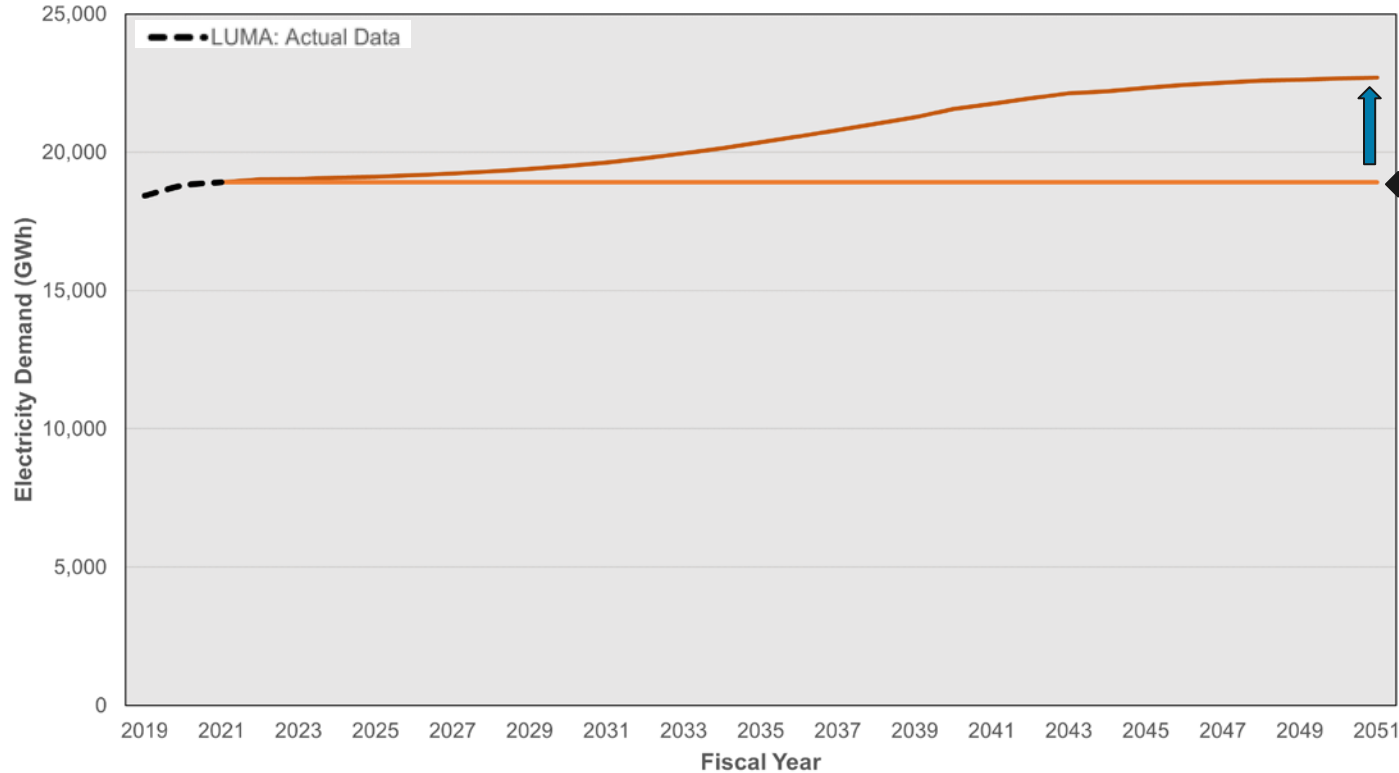

**Stress**

<b>End Use Loads</b>	Combination of end-use loads and energy efficiency results in a flat net annual load
<b>Energy Efficiency</b>	
<b>EV Adoption</b>	high EV adoption (uncontrolled)

**NOTE:** Placeholder data used for energy efficiency and EV adoption to illustrate potential impacts to default electric load.

# Potential Electric Load Options

PR100: Default vs. Stress Electric Load

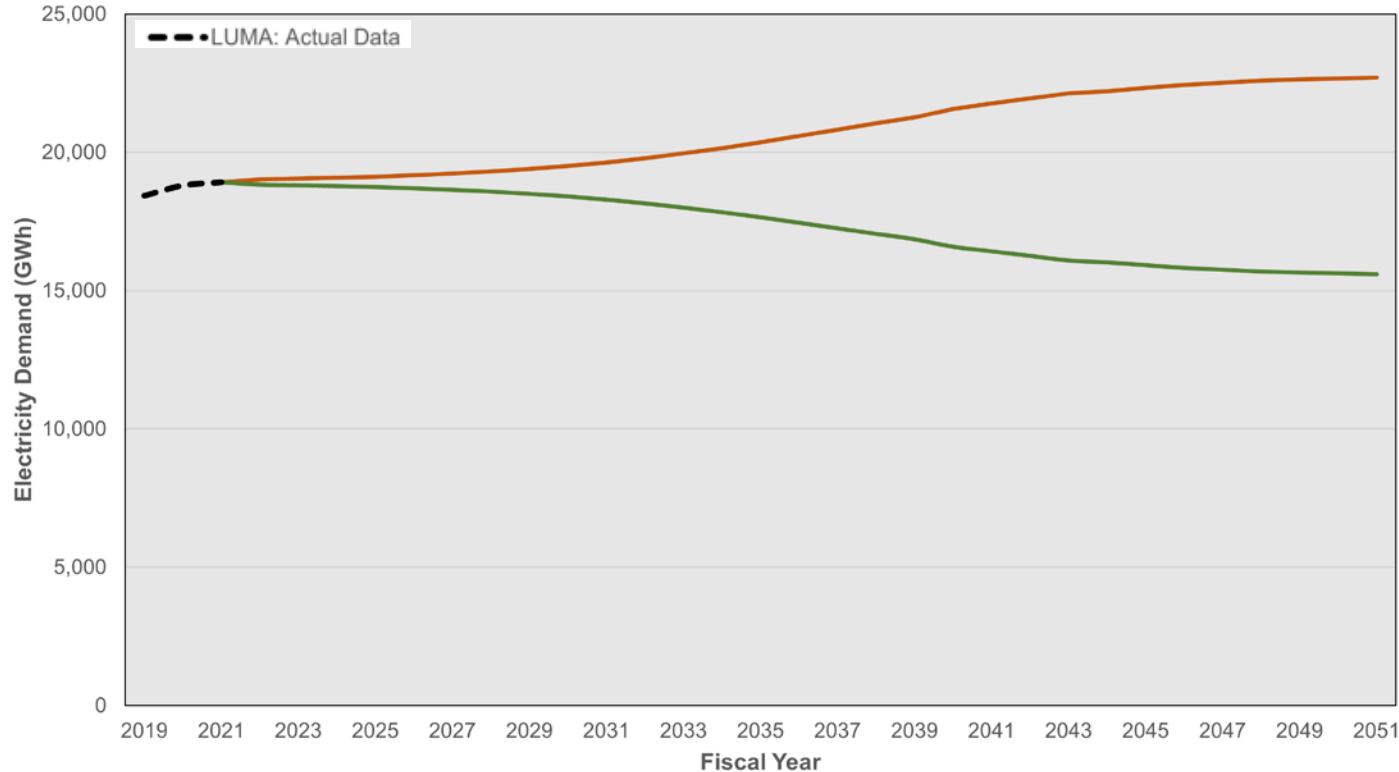

Stress

Default

**NOTE:** Placeholder data used for energy efficiency and EV adoption to illustrate potential impacts to default electric load.

# Key Driver: Electric Load Variations

	Default	Stress
End Use Loads	Updated 2019 IRP process	Combination of end-use loads and energy efficiency result in a flat net annual load
Energy Efficiency	Mid-case	
EV Adoption	Mid-case	High EV adoption (uncontrolled)

- End-Use Loads:
  - IRP process has four inputs: GNP, population, cooling degree days, and manufacturing jobs. NREL updated 2019 IRP with updated data from LUMA.
  - Anticipated to decline by 2050 so growing loads would be an increase.
- These varying levels of electric load components can be combined with the other scenarios to examine impact of variations in load.
- The “Stress” scenario would result in the highest loads and the largest electric system build-out.
- The “Stress” scenario is designed to model the largest likely land-use impacts.

# Key Driver: Marine and Land Exclusion Variations



Available Offshore Wind Areas after Known Possible Exclusions

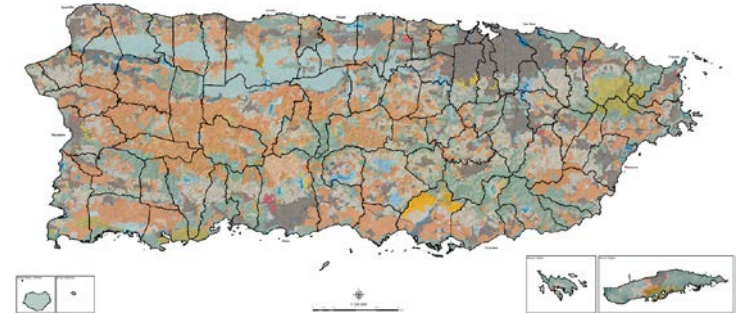

Puerto Rico Land Use Plan will inform land use constraints for onshore wind and solar

Many layers of marine and land use data have been gathered. Two possible exclusion variations will be applied to the scenarios:

- Less Constrained: Allow land and marine use for utility-scale renewables consistent with current use
- More Constrained: Allow less land and marine use for utility-scale renewables based on stakeholder input



# TASK 6: Capacity Expansion Modeling

Lead Lab: NREL

Supporting: ANL, PNNL



# Capacity Expansion Modeling

## What is it?

- Cost-minimized optimum investments for the transmission grid
- Planning generation and transmission capacity investments (size and placement) to meet expected load
- Forward-looking, from a few years to many decades, depending on the analysis questions
- Includes investment and operating and maintenance costs (including fuel)
- Investment decisions are subject to operational, legal, regulatory, and grid services (e.g., reserves) requirements.

## How do we use it?

- To assess what generation and other grid investments are likely over time across varying inputs (scenarios)
- Results inform questions about likely future implications of current actions or market forces
- With the complexity of grid investment decisions, a simple analysis (such as LCOE) is inadequate to assess what could happen in the future.



# engage

*accessibility  
collaboration  
communication*

Engage™ empowers diverse stakeholder groups to understand and participate in transformational energy ecosystem planning by enabling multi-energy-sectoral optimization via web application.

## Question It Answers

- What future scenarios achieve my energy, resilience, and other goals (commodities, transportation, end-use)?
- What technologies will be used to get there?
- What will be the cost to buy and operate the system?

## Why Engage?

- Engage is used in Puerto Rico and is a “leave behind” model.
- Engage readily models arbitrary technologies with their additional value streams (OTEC with food and fresh water production), resources such as water flows (e.g., hydroelectric and potable water demand), and end uses (e.g., heating, cooling, transportation).
- Engage models at varying scales making it appropriate for Puerto Rico.

## Relevance

Usable for all locations. Data needed to make use of tool.

## Link

<https://engage.nrel.gov>

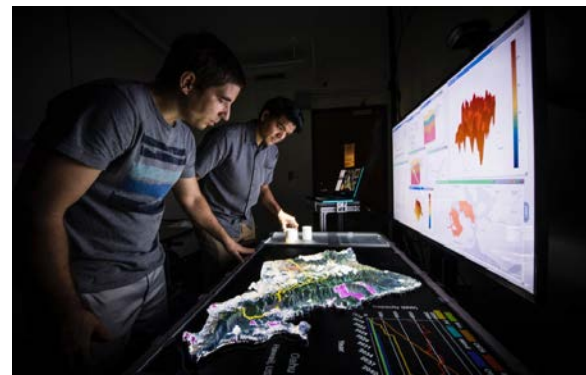
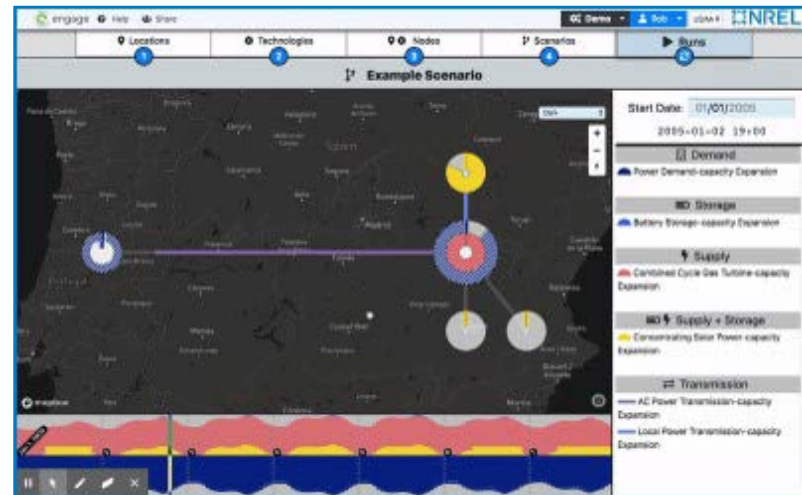
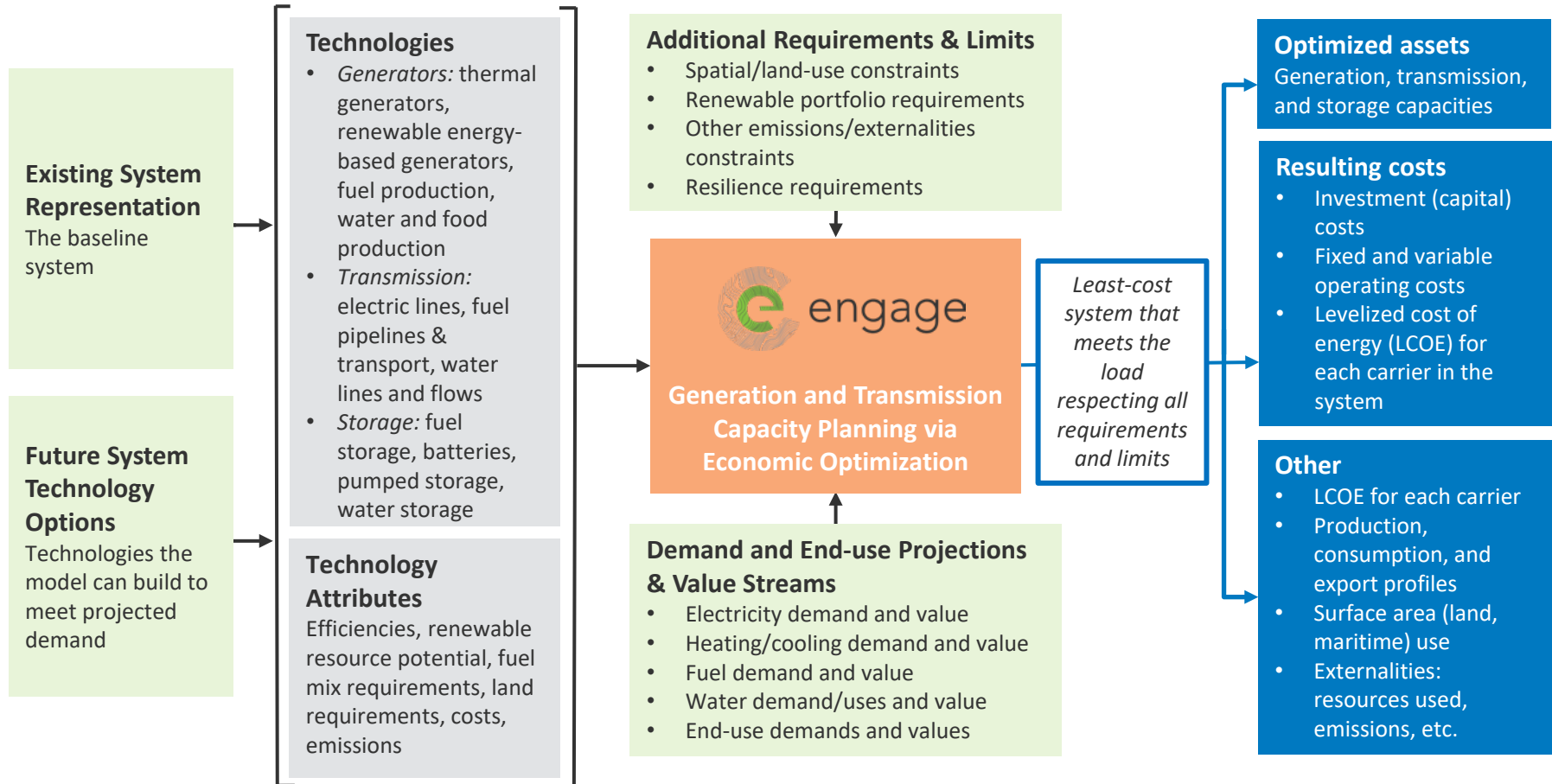

Photo by Dennis Schroeder, NREL 57777



# Engage Capacity Expansion Modeling



# Engage Technology Characterizations

Characterization: Cost and benefit characterizations of technologies, contracts, resilience vs. fragility

- PV, wind turbines (including offshore wind turbines and possibly floating PV)
- Transmission and interconnect points, transmission expansion, transmission hardening
- Coal thermal, combined cycle gas turbines, gas turbines, diesel (possibly to include biodiesel)
- Hydroelectric and pumped storage hydropower
- Ocean thermal energy conversion
- Batteries
- Longer-term storage/excess energy storage (e.g., hydrogen generation and storage and hydrogen-fueled generation)
- Power purchase and operating agreements (PPOAs)
- Possible incorporation of resilience constraints/cost/benefits associated with certain measures, technologies, and events

 Current focus

 Short-term focus

 Medium-term focus

 Long-term focus

# Engage in PR100 Context: Current Phase

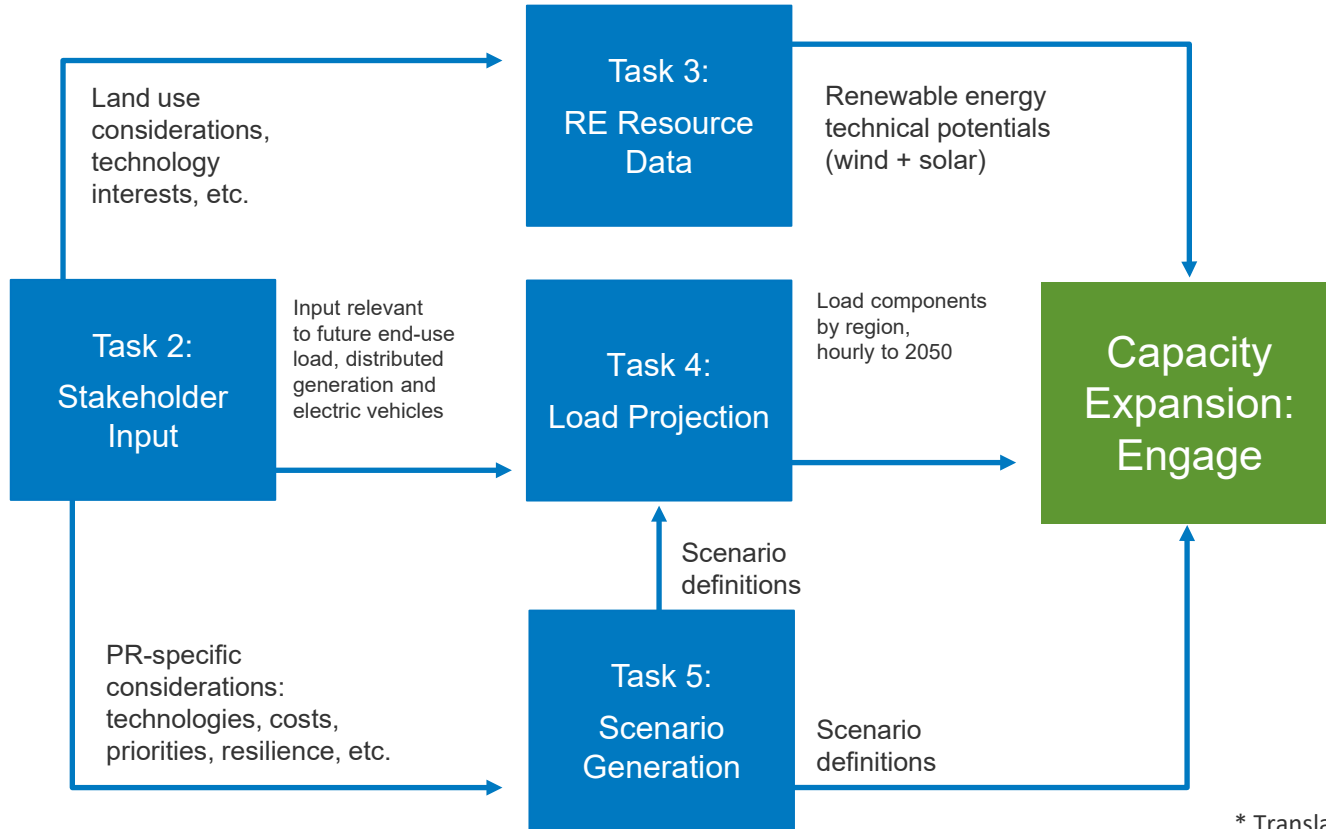

- Collected existing generation and transmission assets data from PREPA/LUMA. Technical data (PSSE files) complete, need to validate heat rates; for-cost data using old placeholder PREPA data, need updated cost data/validation.
- Created data ingestion pipeline with placeholder data from Task 3 (RE resource data: 80% complete), Task 4 (load, EV, EE: Engage piece complete, collaborating on data translation pipeline\*), and system data.
- Characterize additional existing system technologies (hydro) and future system technologies in the Engage model. Hydro, OTEC, and storage technology and cost representations (with Task 10) in progress.

\* Translation is from load, EV, EE municipality-level data to substation-level data for the electrical models. 139

# Engage in PR100 Context: Next Phase

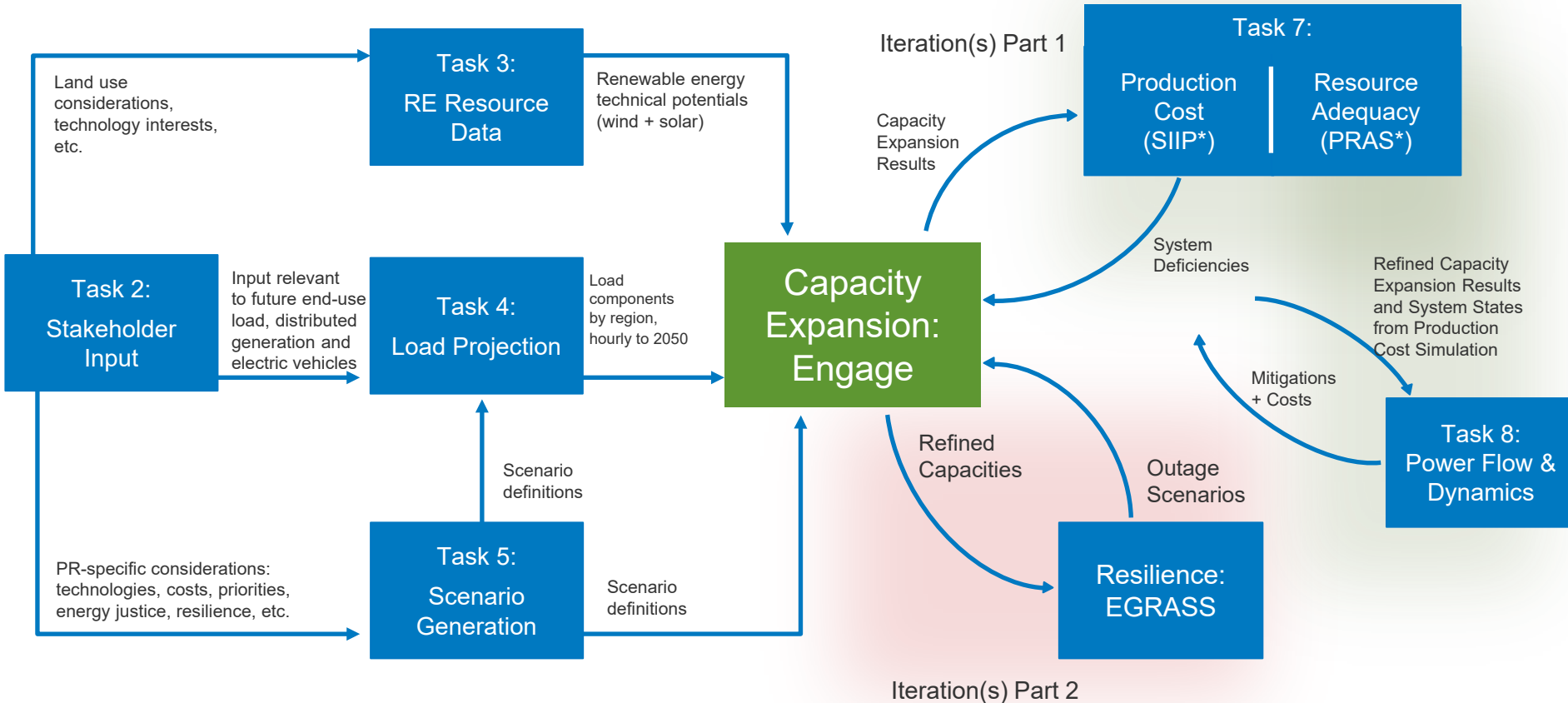



# TASK 7: Production Cost and Resource Adequacy

Lead Lab: NREL

Supporting: ANL



# What Is Production Cost and Resource Adequacy Modeling?

## Resource Adequacy

- Calculates the likelihood that a given system will be sufficient to meet demand
- Considers component outage rates and coincidence of renewable generator availability and demand time series
- Represents approximation of transmission (by region) and generator commitment/dispatch.

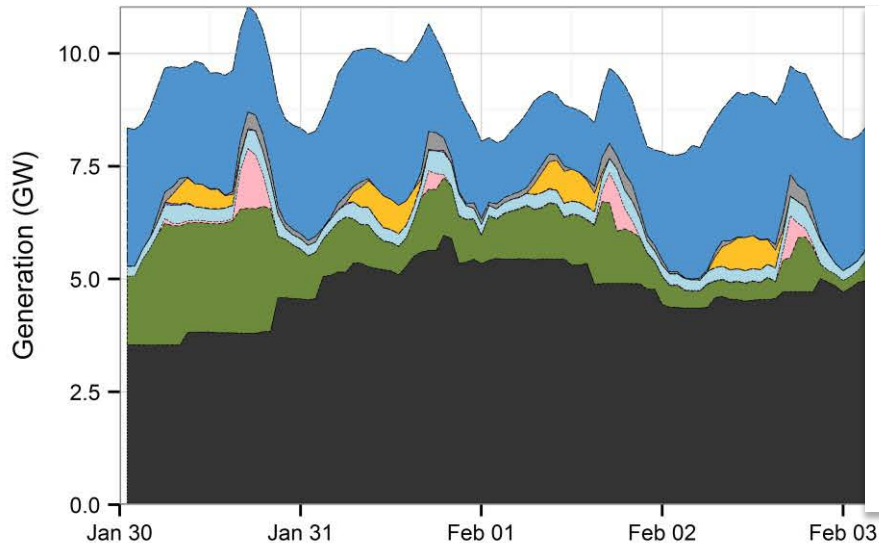

## Production Cost Modeling

- Simulates economic scheduling of resources that “exist” in each scenario (as compared with adding new resources in capacity expansion modeling)
- What is the impact of forecast errors?
- How does the system perform (prices, ramping, emissions, production costs, etc.)?

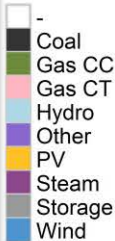

Feb 04 Feb 05 Feb 06 Feb 07 Feb 08

# Production Cost and Resource Adequacy: Tools and Workflow Coordination Progress to Date

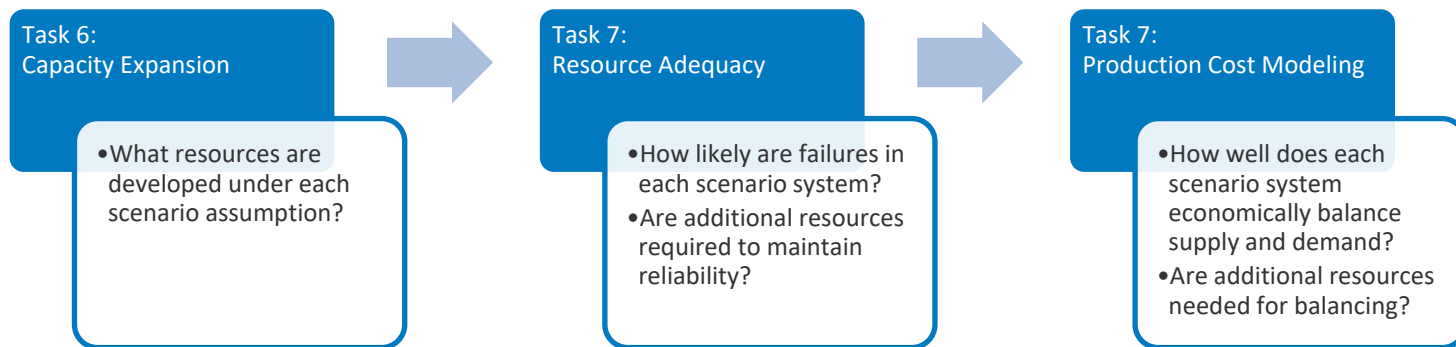

## Progress to Date:

- Coordinated common reference data based on load flow case shared by LUMA
- Identified required metrics for downstream analysis in Tasks 8 and 10
- Enabled key inter-model data handoffs and translations required for accepting capacity expansion model results as inputs and providing inputs to downstream tasks
- Developed initial base-case resource adequacy and production cost modeling datasets.

## What is coming in Task 7:

- Validated base case model results
- Expanded system scenario results and analysis:
  - Feedback on expanded system performance to identify additional resource requirements
  - System performance analysis of probability of lost load, total production costs, plant operations, transmission utilization, and reserve allocation
  - Impact analysis of emissions and wholesale electricity prices.



# Production Cost and Resource Adequacy: Tools and Workflow Coordination Progress to Date

## SIIP – Scalable Integrated Infrastructure Planning

[www.nrel.gov/analysis/siip.html](http://www.nrel.gov/analysis/siip.html)

### Open-Source Packages:

#### **PowerSystems.jl**

Coherent power system data spec for PowerSimulations.jl and PRAS

#### **PowerSimulations.jl**

Quasi-static optimization problems simulating power system scheduling (energy and ancillary services)

#### **Probabilistic Resource Adequacy Suite (PRAS)**

Monte Carlo analysis of system adequacy given pseudo-random component failures and renewable resource variability

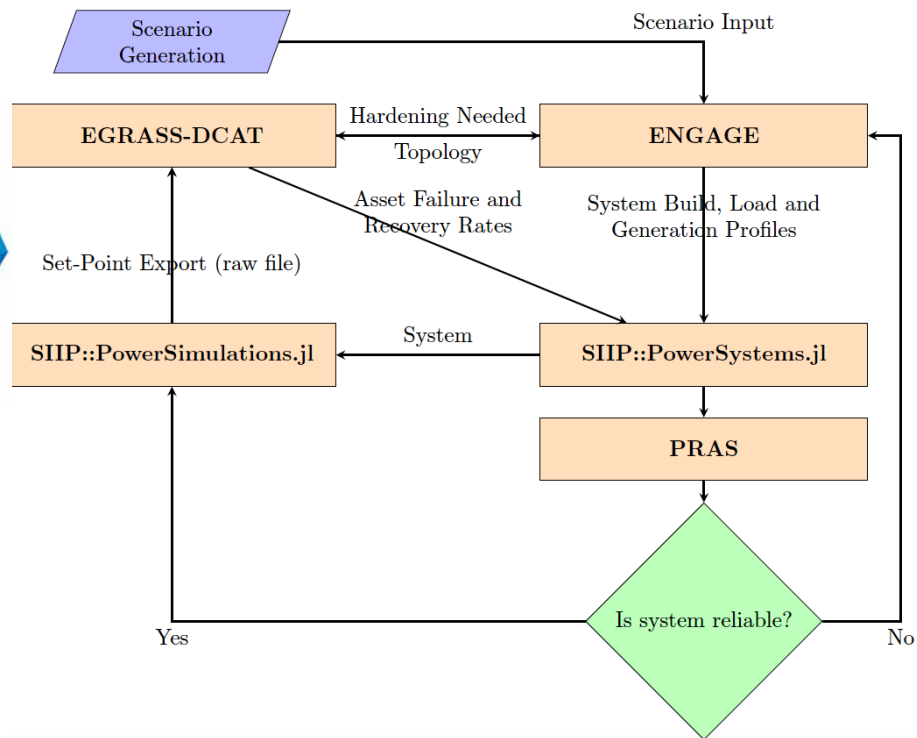

# Production Cost and Resource Adequacy: Base-Case Model Preparation

## Production Cost Data Completeness

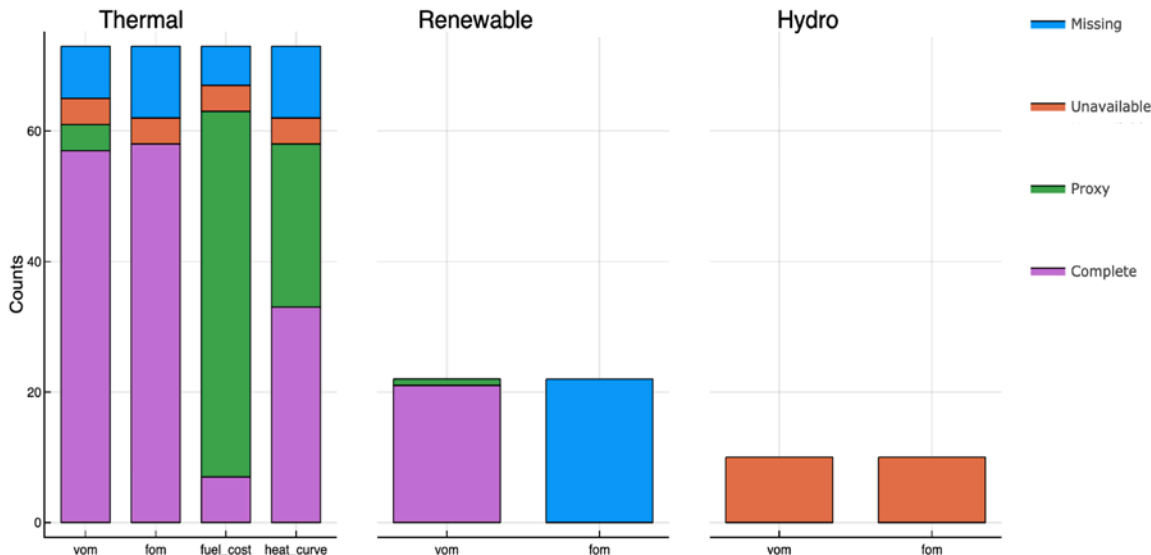

### Base-case data collection and model preparation:

- Effort to date:
  - Majority of base-case data collected.
  - Data requests have been made to fill missing and replace proxy data.
- Next steps:
  - Refine proxy data usage, add solar profile data, collect and implement hydropower representations
  - Validate model results and tuning of base-case input data
  - Produce base-case model results and analysis.

# Production Cost and Resource Adequacy: Preliminary Results

## Preliminary Base-Case Dispatch Result Sample

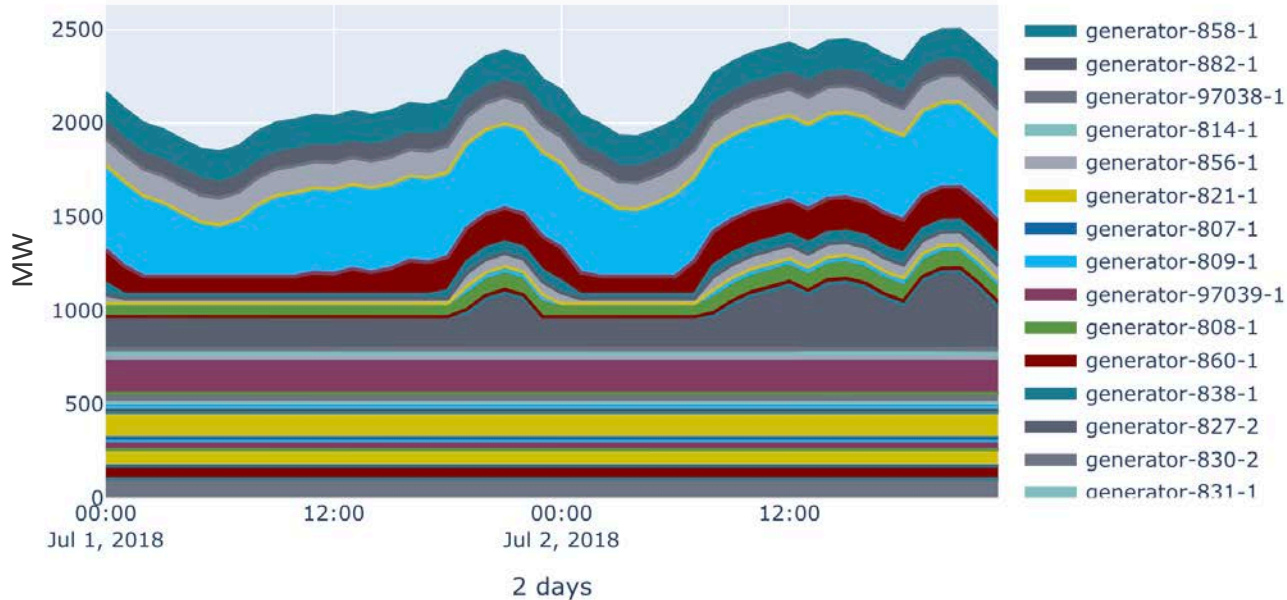

### Validation needed:

- Heat rates/costs
- Outage rates
- Combined cycle configurations.

### Data gaps:

- Hydropower (pending coordination with ORNL)
- Solar profiles (forthcoming).

# Activity 4. Impact Modeling and Analysis

---

Task 8. Bulk System Power Flow and Dynamic Analysis

Task 9. Distribution System Analysis

Task 10. Economic Impact Analysis

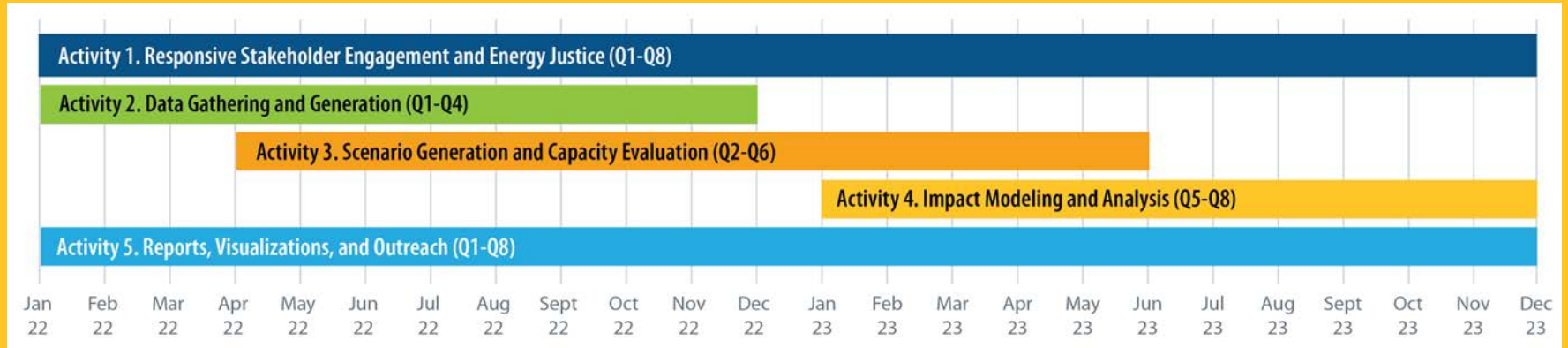





# TASK 8: Bulk System Power Flow and Dynamic Analysis

Lead Lab: PNNL

Supporting: ORNL, NREL

# Bulk System Power Flow and Dynamics Analysis

## Progress to Date

- AC Power Flow
  - LUMA provided 2021 Base Case
  - PNNL prepared 48.5% (approx. trench 1), and additional RE penetration for initial testing (60%, 70%, 80%, 100%)
- Dynamics (PSS/E, PSCAD)
  - PNNL adapted 2019 PSS/E dynamic model to 2021 case, and built initial tests for higher RE 48.5% and 60%
  - NREL built PSCAD model based on 2019 dynamics; and PSCAD model for tranche 1
  - PNNL working on PSSE DER and motor load models
- Sensor Data and Model Validation
  - LUMA shared event data with Task 8 team
  - ORNL identified events of interest and obtained initial validation results – coordination with LUMA's efforts
- Resilience Evaluation
  - Configured EGRASS-DCAT to run vulnerability assessment – hurricane N-k dynamic cascading analysis
  - EGRASS being adapted to inform capacity expansion (within task 6) – also adding distribution and solar PV
- Data and Model Coordination with LUMA, and Tasks 6, 7, 8, and 9

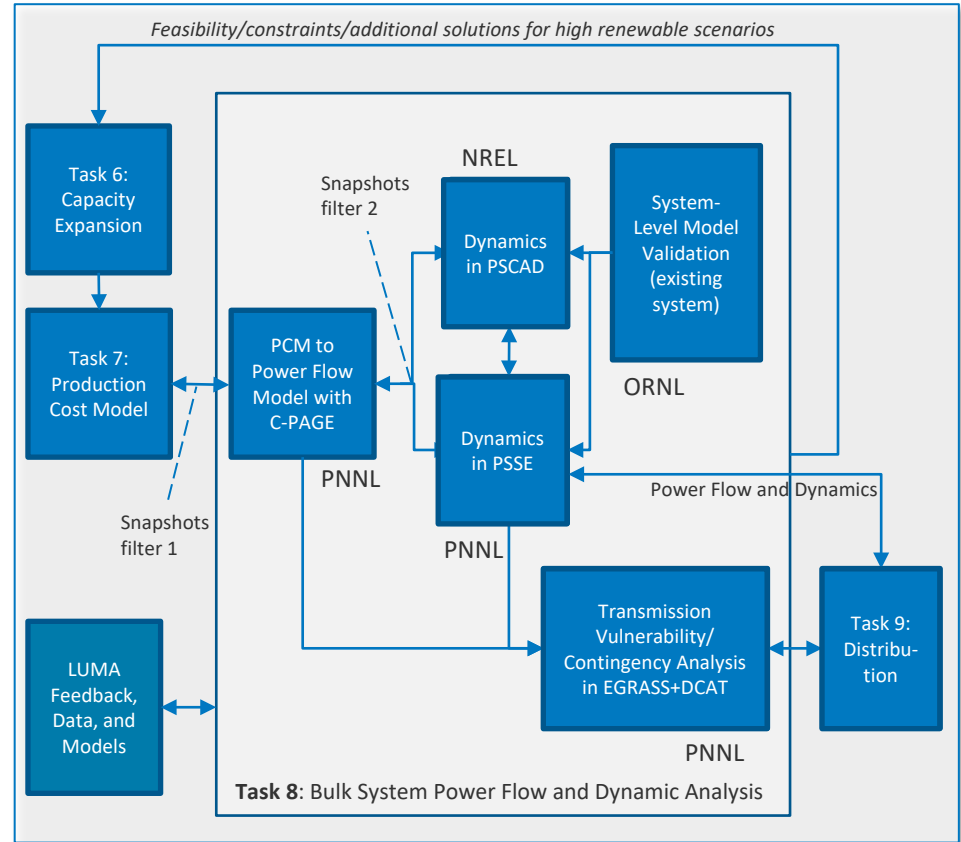

# Bulk System Power Flow and Dynamics Analysis

## What Is Coming in Task 8

- Validation of system-level dynamics
- Control and stability for high penetration of renewables: concerns → possible solutions
  - Low inertia → inverter control (e.g., fast frequency response), synchronous condensers
  - Weak grids → inverter control (e.g., grid forming), synchronous condensers
  - Balancing reserves → variability and uncertainty analysis
  - Monitoring, control, and coordination of distributed energy resources → distribution-level control, transmission-level control/coordination
- Scenario analysis
  - Analysis of various operating points
  - Control and stability impacts and solutions at transmission with aggregated behavior from distribution and solar PV
  - Vulnerability: hurricane N-k dynamic cascading analysis

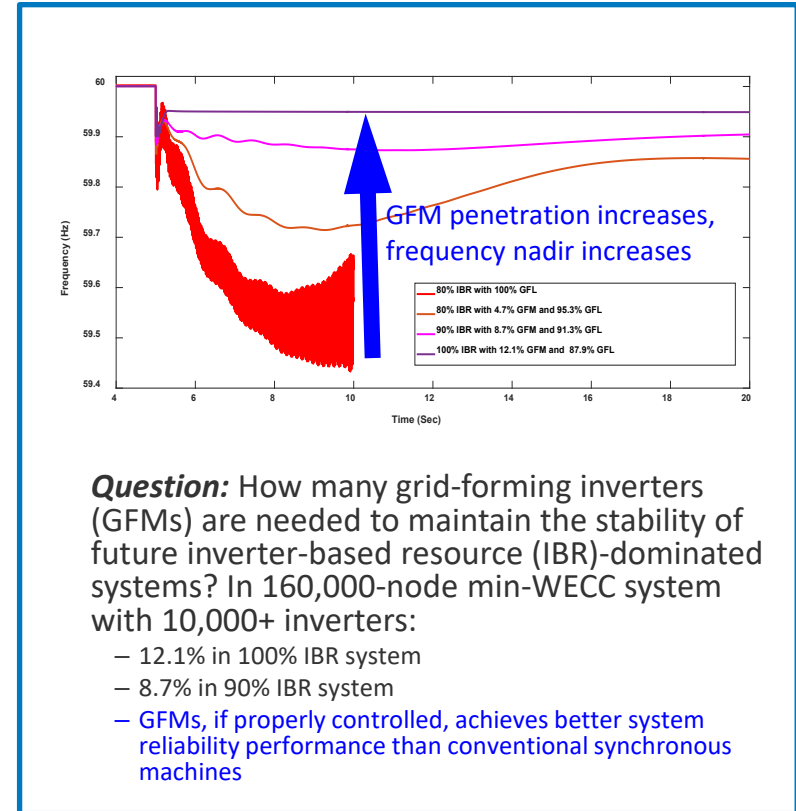

Source: Du, W. "[Transient and Dynamic Modeling and Droop-Controlled, Grid-Forming Inverters at Scale](#)." Presented at UNIFI-Spring 2022 Seminar Series on Grid-Forming Technologies, Virtual, Washington. PNNL-SA-169855.





# TASK 9: Distribution System Analysis

Lead Lab: Sandia

Supporting: NREL, PNNL

# Distribution System Analysis

## Progress to Date

- Working on conversion of ~30 distribution feeders supplied by LUMA in Synergy to research platform OpenDSS
- Setting up hosting capacity analysis to understand DER capacities
- Engaging in crosscutting discussions with other tasks to set up control strategies, resilience metrics, etc.
- Refining hosting capacity analysis to account for controls, grid upgrades, or other mitigation measures
- Identifying and quantifying resilience benefits from large amounts of DERs and storage on distribution grids.

Synergy feeder example

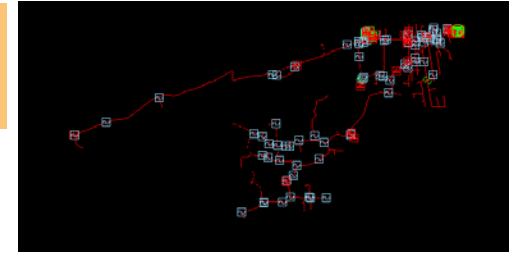

Voltage impact from DERs

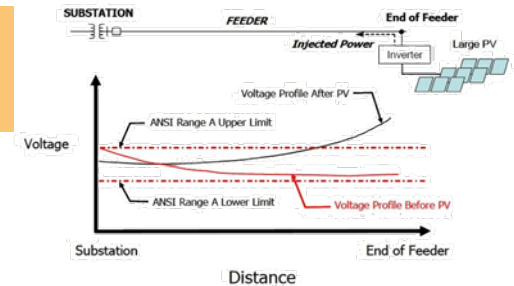

Mitigation strategy: volt/var controls



# Distribution System Analysis

- In the next 6 months:
  - Detailed analysis to understand capacity for distributed renewables and limiting factors
  - Implement planned system upgrades into modeling
  - Quantify possible increases to capacity due to controls (e.g., volt-VAR)
- In the next 12 months:
  - Identify interdependencies between distribution and bulk system operations
  - Simulate vulnerabilities under high penetrations
  - Explore microgrid opportunities from high levels of DERs and resulting resilience benefits

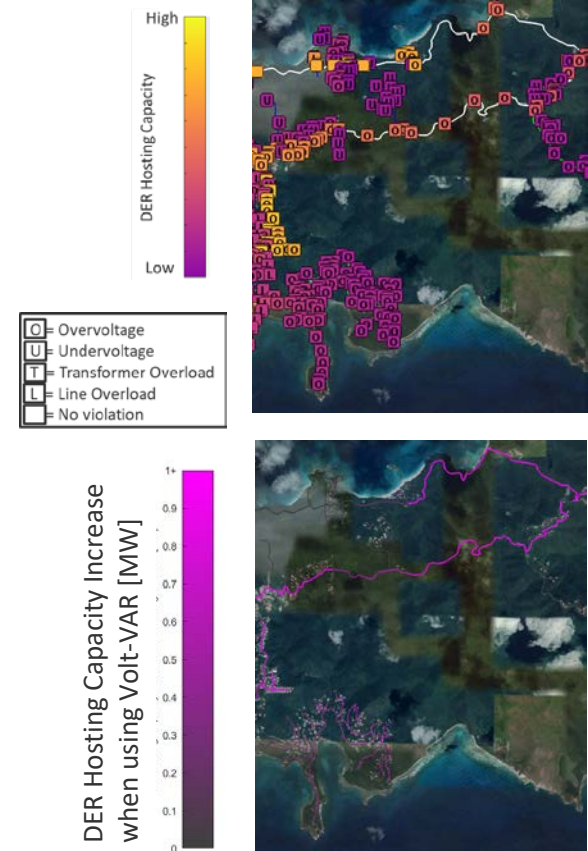





# TASK 10: Economic Impact

Lead Lab: LBNL

Supporting: NREL

# Economic Impact Analysis: Key Research Questions

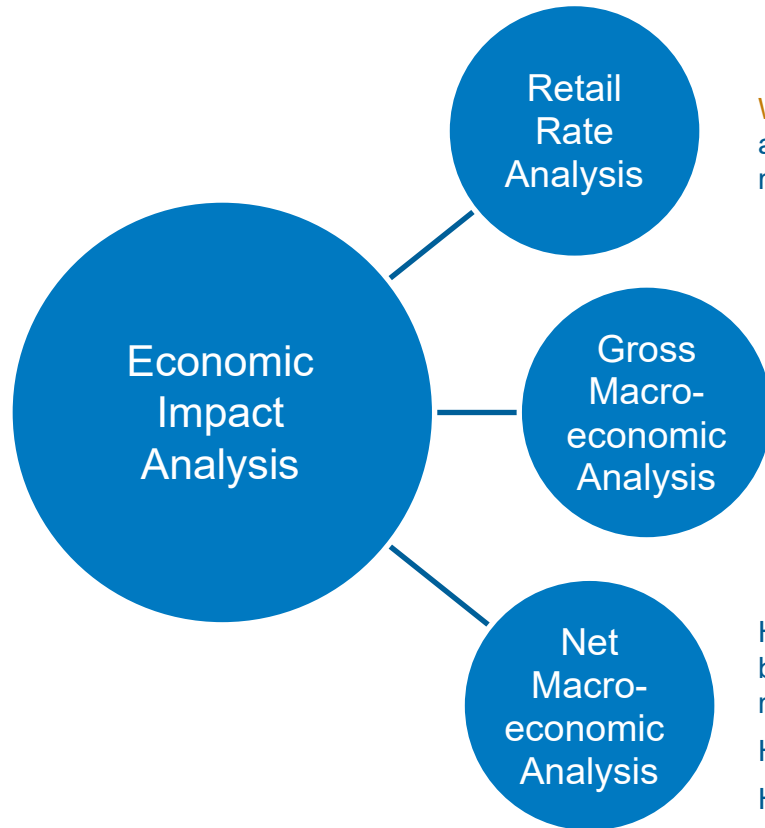

What are the impacts on electricity rates from achieving Puerto Rico's transition to 100% renewable energy?

How will the Puerto Rico economy be impacted by the renewable energy generation investments needed to meet the 100% goal?

How many jobs in Puerto Rico will be created by the renewable energy generation investments needed to meet the 100% goal?

How will the Puerto Rico economy be directly and indirectly impacted by the transition to 100% renewable energy generation, including reliability investments?

How will changes in electricity rates affect consumers?

How will these economic impacts vary across different regions?

# Retail Rates Analysis Key Research Questions

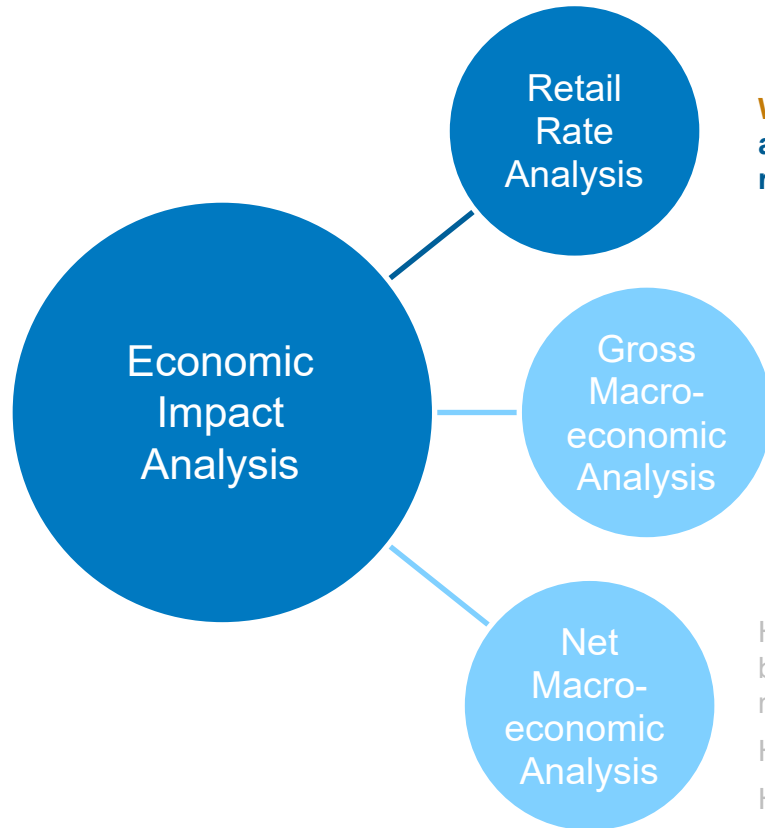

**What are the impacts on electricity rates from achieving Puerto Rico's transition to 100% renewable energy?**

How will the Puerto Rico economy be impacted by the renewable energy generation investments needed to meet the 100% goal?

How many jobs in Puerto Rico will be created by the renewable energy generation investments needed to meet the 100% goal?

How will the Puerto Rico economy be directly and indirectly impacted by the transition to 100% renewable energy generation, including reliability investments?

How will changes in electricity rates affect consumers?

How will these economic impacts vary across different regions?



# Retail Rates Analysis Overview

1. Determine the annual cost of serving all PREPA/LUMA customers

2. Determine the annual cost responsibility of each customer class

3. Projected retail rates are annual class revenue requirements divided by annual class retail sales.

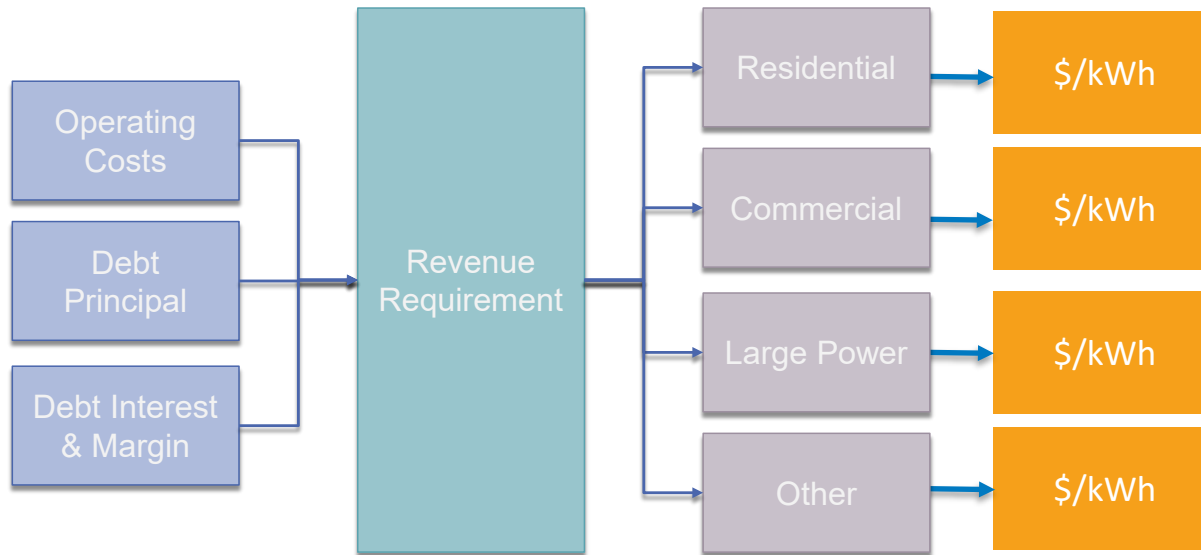

# Many Inputs to Retail Rate Analysis Come From Outputs of Other PR100 Tasks

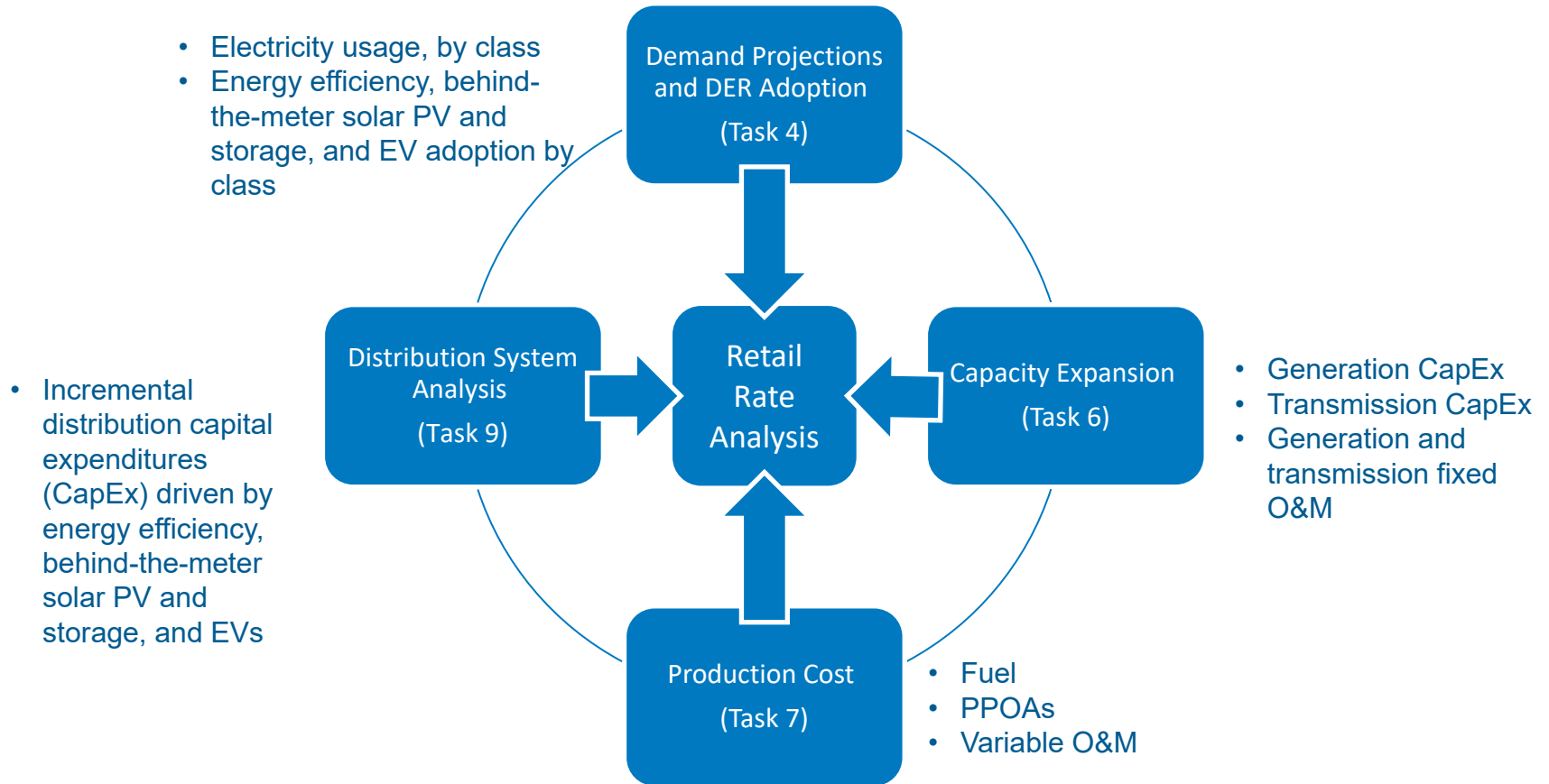

# Retail Rate Analysis Efforts to Date

- Collected and organized publicly available current and forecasted PREPA/LUMA cost and financial data
- Sought to better understand current state of PREPA bankruptcy proceeding in order to assess how to represent existing debt obligations post-bankruptcy
- Collaborated with other tasks to better understand analytical methods and likely outputs in order to identify opportunities to utilize PR100 internally-consistent data as SUPRA model inputs

# Retail Rate Analysis Efforts To Come

- **Twelve-Month Deliverable:** Initial PREPA/LUMA pro forma financial model (SUPRA) preparation
  - Fully characterize PREPA/LUMA current financial situation
  - Work with PREPA, LUMA, FOMB, Ankura, and P3A to determine most appropriate way to characterize PREPA/LUMA post-bankruptcy and post-reorganization
  - Identify the most appropriate source of funding for near-term capital expenditures: FEMA, HUD, PREPA/LUMA rate payers
  - Produce estimates of retail electric rates for an initial set of scenarios
- **Year 2 Deliverable:** SUPRA model completion
  - Assess what model inputs need to be altered based on a final set of scenarios
  - Produce estimates of retail electric rates for a final set of scenarios

# Gross Macro-economic Analysis: Key Research Questions

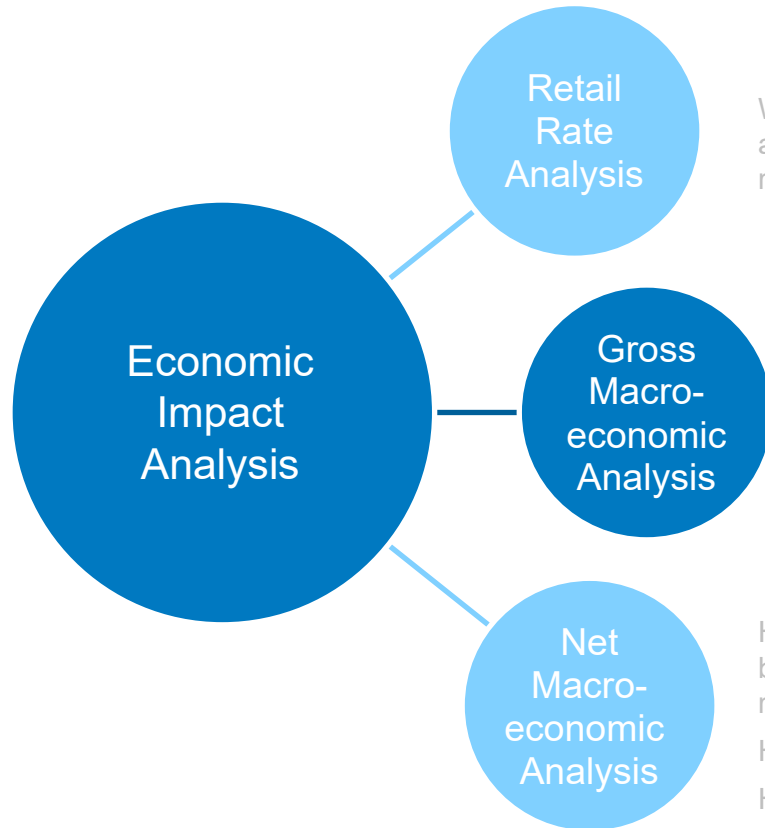

What are the impacts on electricity rates from achieving Puerto Rico's transition to 100% renewable energy?

**How will the Puerto Rico economy be impacted by the renewable energy generation investments needed to meet the 100% goal?**

**How many jobs in Puerto Rico will be created by the renewable energy generation investments needed to meet the 100% goal?**

How will the Puerto Rico economy be directly and indirectly impacted by the transition to 100% renewable energy generation, including reliability investments?

How will changes in electricity rates affect consumers?

How will these economic impacts vary across different regions?

# Jobs and Economic Development Impact (JEDI) Model Overview

Estimates the economic outputs and jobs supported by the construction and operation of renewable energy generation facilities to meet Puerto Rico goals



**Direct:** Immediate impacts associated with Capital or Operating Expenses (OpEx)

- Considers labor and equipment for design, construction, installation, transport

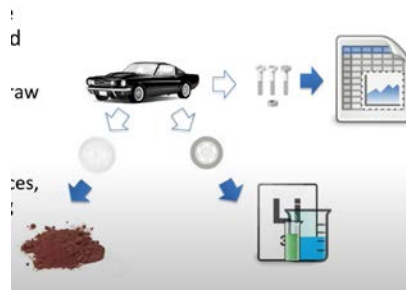

**Indirect:** Supply chain raw material extraction, business-to-business services, manufacturing

- Goods or services need to provide direct goods and services



**Induced:** Impacts resulting from the expenses made by direct and indirect workers

- Retail, agriculture, housing, health services, education



# Many Inputs to Gross Macroeconomic Analysis Come From Outputs of Other PR100 Tasks

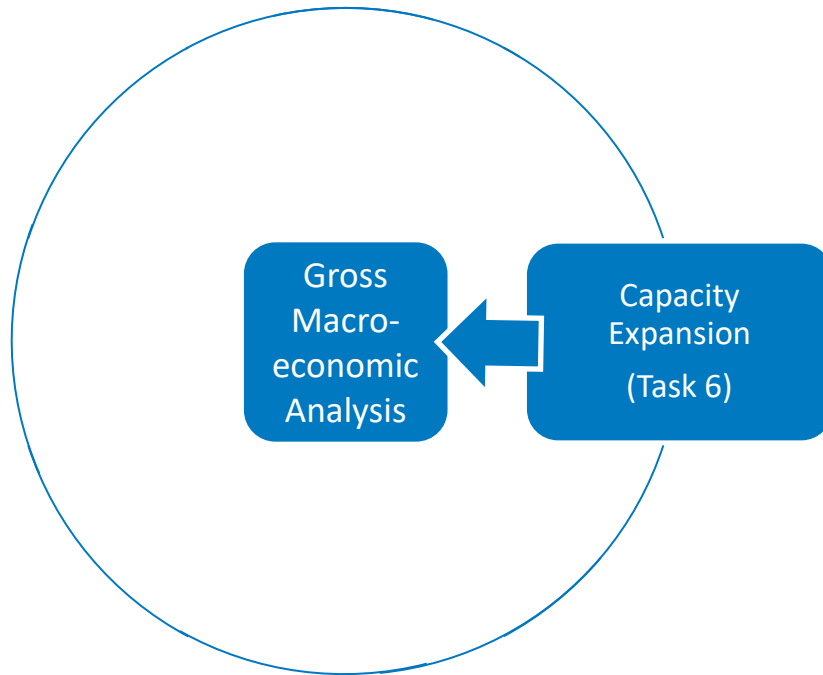

- Renewable generation CapEx
- Transmission CapEx associated with renewable energy generation
- Fixed and variable O&M associated with above investments (as applicable)

# Gross Macroeconomic Analysis Efforts to Date

- Acquired territory-level data for Puerto Rico from [IMPLAN](#)
- Collaborated with other tasks to better understand analytical methods and likely outputs in order to identify opportunities to utilize PR100 internally consistent data as SUPRA model inputs

# Gross Macroeconomic Analysis Efforts To Come

- **Twelve-Month Deliverable:** Initial JEDI model preparation
  - Set up JEDI model for all technology types to integrate capacity and cost scenarios
  - Determine local spending patterns for capital and operating costs
  - Produce estimates for initial set of scenarios
- **Year 2 Deliverable:** JEDI model completion
  - Finalize gross economic impact estimates
  - Engage with other tasks that need jobs data

# Net Macro-economic Analysis: Key Research Questions

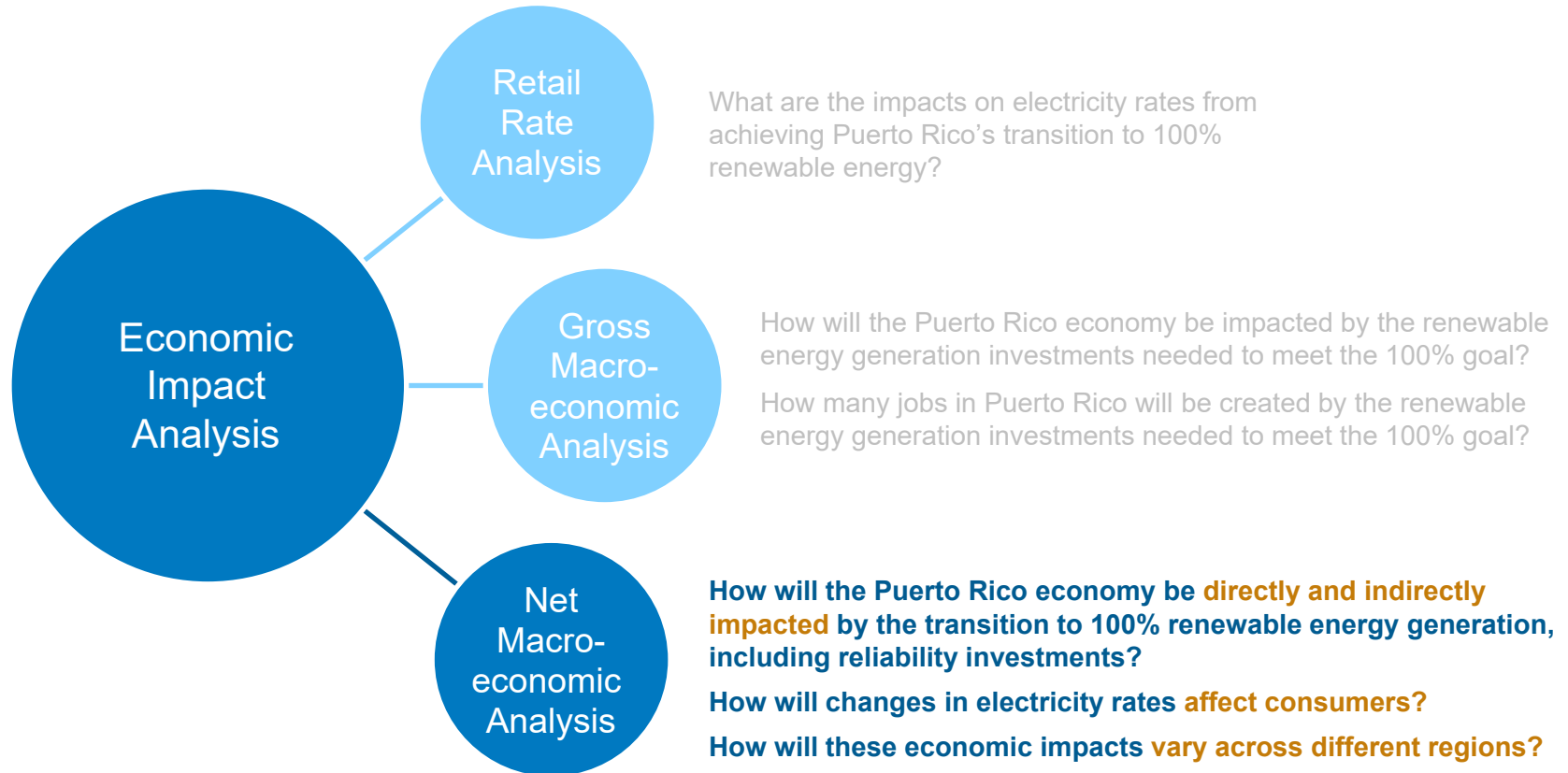

# Computable General Equilibrium Model Represents Economics Flows

- Four key economic actors:
  - Firms
  - Government
  - Households
  - The rest of the world.
- The model allows us to examine how different “shocks” affect the economy.
- Here, our interest is new investment and electricity price changes.

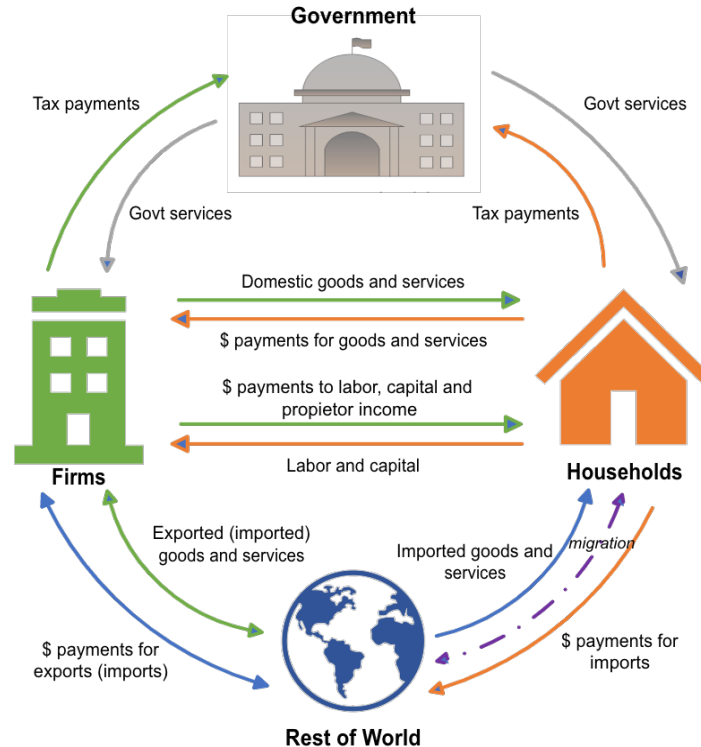

Graphic from Colorado State University team members

# Many Inputs to Net Macroeconomic Analysis Come From Outputs of Other PR100 Tasks

- Electricity rates
- Base Case distribution CapEx and OpEx
- Contributions in lieu of taxes, pensions
- Bankruptcy obligations
- FEMA/ HUD grant funding adjustments
- LUMA and GenCO fees
- Debt service and Debt Service Coverage Ratio
- Incremental distribution CapEx driven by EE, DG, and EVs

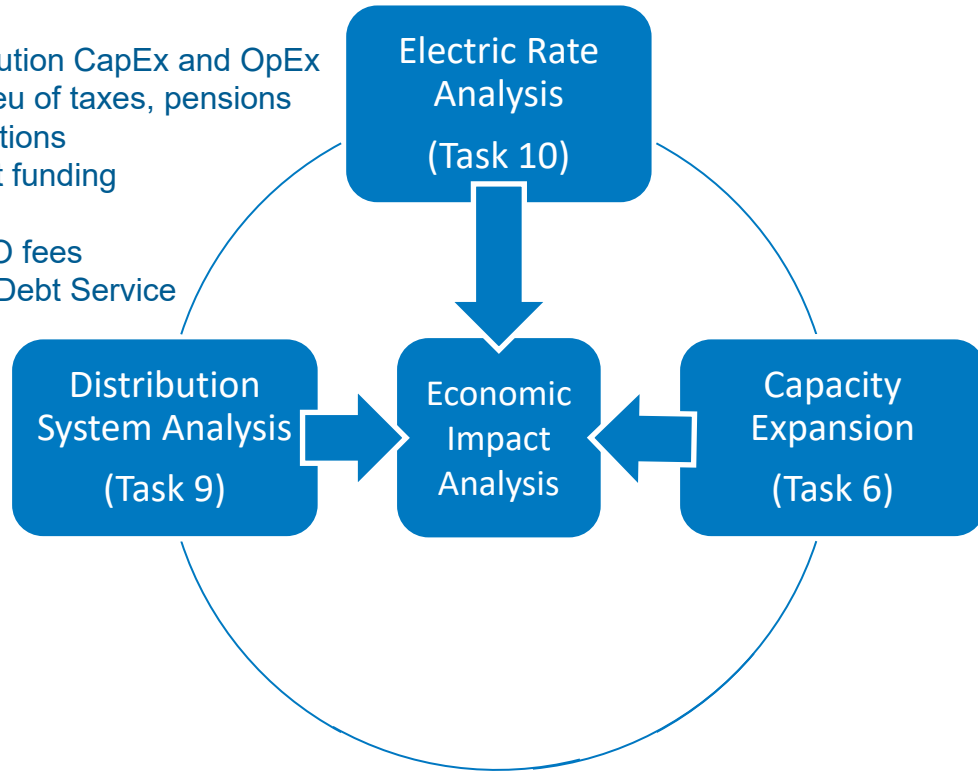

- Renewables and reliability generation CapEx
- Renewables and reliability transmission CapEx
- Fixed and variable O&M associated with above investments (as applicable)



# Net Macroeconomic Analysis Efforts to Date

- Collected and organized household-level data for sector-level income and employment and demographic characteristics
- Investigated the availability capital stock data for Puerto Rico
- Collaborated with other tasks to better understand analytical methods and likely outputs in order to identify opportunities to utilize PR100 internally consistent data as SUPRA model inputs

# Net Macroeconomic Analysis Efforts To Come

- **Twelve-Month Deliverable:** Initial computable general equilibrium (CGE) model preparation
  - Start constructing the CGE model for Puerto Rico
  - Commence construction of the social accounting matrix
  - Produce estimates for an initial set of scenarios
- **Year 2 Deliverable:** CGE model completion
  - Finalize the construction of the CGE model and the social accounting matrix
  - Calibrate CGE model for all scenarios
  - Produce estimates of earnings, jobs, and GDP from construction, manufacturing and supply chain, O&M, and population migration for a final set of scenarios

# Activity 5. Reports, Visualizations & Outreach

---

## Task 11. Project Management, Data Management, Outreach, and Reporting

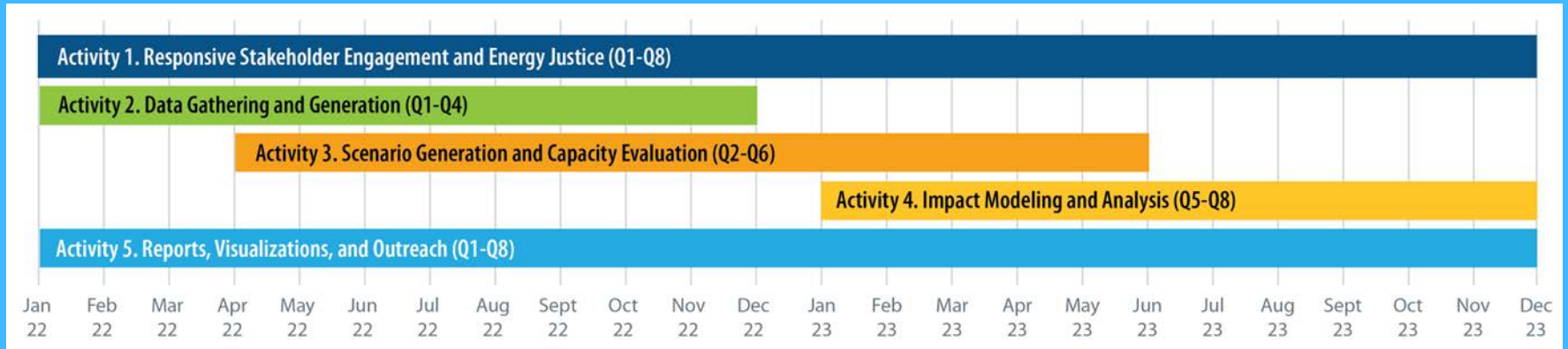



# TASK 11: Project Management, Data Management, Outreach, and Reporting

Lead Lab: NREL

Supporting: Sandia

# Data Management

---

# Data Management: Stakeholder Engagement

General process of how stakeholders are involved in determining applicable data for project modeling and analysis:

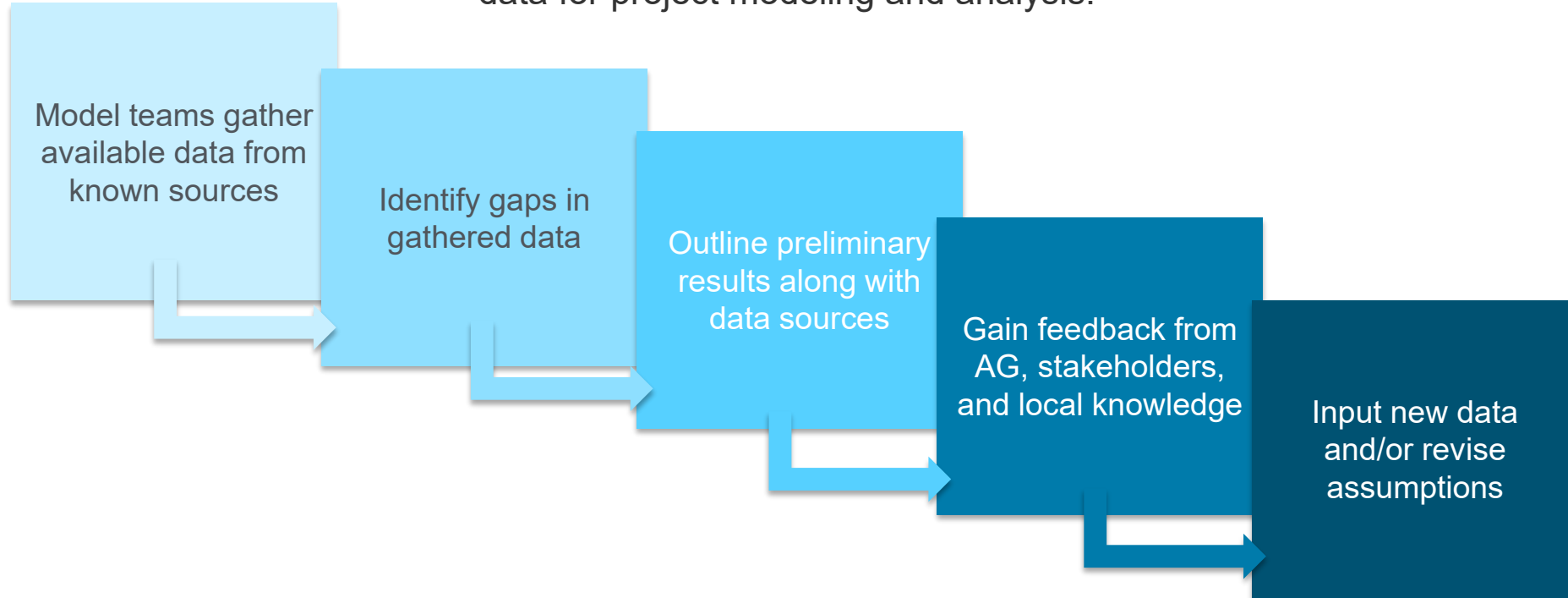

# Data Management: Data Providers and Sources

## Puerto Rico Entities

- Puerto Rico Energy Bureau (PREB)
- Puerto Rico Electric Power Authority (PREPA)
- Financial Oversight and Management Board (FOMB)
- State Data Center de Puerto Rico (SDC-PR)
- Puerto Rico Institute of Statistics
- LUMA Energy

## U.S. Government Entities

- U.S. Geological Survey (USGS)
- Federal Emergency Management Agency (FEMA)
- Environmental Protection Agency (EPA)
- U.S. Energy Information Agency (EIA)
- National Oceanic and Atmospheric Administration (NOAA)
- U.S. Census Bureau

## Public Data Sources

- Marine Cadastre National Viewer
- National Hurricane Center

## Resource Data Sources

- National Solar Radiation Database (NSRDB)



The listed entities represent the primary sources from which data has been acquired and assumptions have been derived from to date.



# Data Management: Data Acquired and Produced

## Data Acquired

- Consumption and clients by municipality
- Cost data (current known/estimated, future projections)
- Customer class by feeder
- Critical loads
- Damage reports (distribution lines/feeders, regional)
- Event detection
- Financial and incentives assumptions (e.g., inflation, discount rate, ITC/PTC fade out)
- Generation by plant (FY 2017–FY 2018)
- GIS data (substation, transmission, distribution, land use)
- Integrated Resource Plan (IRP)
- Interconnection Report
- Load data (projections, flow cases, critical list, hourly)
- Microgrids (connected transformers, hourly loading, Vieques and Culebra)
- Outage data
- PSS/E model data (region, system, Base Case, peak)
- Solar resource (from NSRDB PSM v3)
- Substations (hourly, FY 2019–FY 2020, demand for Vieques and Culebra)

## Data Produced to Date

- Wind, offshore (20 years, 2001–2020)
- Wind, land-based (20 years, 2001–2020)

This list will expand as we conduct the modeling and analysis.

# Data Management: Model Integration

Task Title	Model/Analysis
Energy Justice and Climate Risk Assessment	Energy Justice Dashboard RAPT (FEMA) PRIIA ReNCAT
Renewable Energy Potential Assessment	WRF PSM reV
Demand Projections and DER Adoption	dGen EE Electricity Demand Projection EV Adoption
Capacity Expansion	Engage Calliope
Production Cost and Resource Adequacy	SIIP Aurora PRAS
Bulk System Power Flow and Dynamic Analysis	EGRASS DCAT ReNCAT PRIIA PSCAD PSS/E Dynamics C-PAGE T&D CoSIM
Distribution System Analysis	EGRASS DCAT ReNCAT HELICS OpenDSS
Economic Impact	JEDI CGE SUPRA

Numerous models and analysis tools exist across tasks within the project, many of which utilize the same sources of data.

Outputs from each model/analysis will be used as inputs to at least one, if not several, downstream model/analysis.



# Data Management: Anticipated Model Outputs

Task Title	Model/Analysis	Anticipated Outputs
Energy Justice and Climate Risk Assessment	LEAD (DOE) EJSCREEN (EPA) RAPT (FEMA) PRIIA ReNCAT	<ul style="list-style-type: none"> <li>• Baseline energy justice assessment</li> <li>• Downscaled climate model data set</li> <li>• Climate hazards for risk assessment of critical infrastructure, community institutions, and vulnerable populations</li> </ul>
Renewable Energy Potential Assessment	WRF PSM reV	<ul style="list-style-type: none"> <li>• High-resolution solar radiation, offshore wind, and land-based wind resource data sets spanning at least 10 years</li> <li>• Updated utility-scale solar, offshore wind, and land-based wind generation profiles, technical potential, cost information, and supply curves using at least 10 years of data up to 2020</li> <li>• Day-ahead hourly solar and wind forecasts for 3 years for use in the PCM is available for use by the project</li> <li>• Energy potential assessment for additional sources of generation (e.g., FPV, Hydropower) including resource potential, capacity factor, technical potential, and supply curves</li> </ul>
Demand Projections and DER Adoption	dGen EE Electricity Demand Projection EV Adoption	<ul style="list-style-type: none"> <li>• Hourly demand projection for each year 2022–2050</li> <li>• Implications of demand changes due to uncontrolled EV additions</li> <li>• Considerations for DER adoption in island locations</li> <li>• Results based on net load for distributed PV + storage</li> <li>• Scenario results incorporating stakeholder input and data from Tasks 1–3</li> </ul>

# Data Management: Anticipated Model Outputs (Continued)

Task Title	Model/Analysis	Anticipated Outputs
Capacity Expansion	Engage Calliope	<ul style="list-style-type: none"> <li>• Estimates of capital and operational costs</li> <li>• Locational land, rooftop, and maritime surface area used by renewable generation assets</li> <li>• Locational and capacity information on new bulk generation, storage, and transmission assets</li> <li>• Generation asset retirement suggestions</li> </ul>
Production Cost and Resource Adequacy	SIIP Aurora PRAS	<ul style="list-style-type: none"> <li>• Key interdependences among power, gas, water, and transportation infrastructures</li> <li>• Benchmark for reduced-order reference PCM case based on the model files for the Base Case</li> <li>• Five-minute resolution, unit commitment and dispatch set points, curtailment, reserve provision, and power flow schedules, loss of load probability, and other standard temporally resolved RA and PCM metrics</li> <li>• Executable, open-source data sets and software for initial simulations, along with training and supporting materials to facilitate ongoing PREPA/LUMA feedback and explorations</li> </ul>
Bulk System Power Flow and Dynamic Analysis	EGRASS DCAT ReNCAT PRIIA PSCAD PSS/E Dynamics C-PAGE T&D CoSIM	<ul style="list-style-type: none"> <li>• Simulation results of selected scenarios to identify stability margins under contingencies with complementary simulations in both PSS/E (industry-standard and faster simulations) and PSCAD (high-fidelity models)</li> <li>• Full AC power flow models of generation and transmission scenarios</li> <li>• High-fidelity analysis for controls designs for IBRs (such as solar and wind power plants and hybrid plants) in grid-forming and grid-following control</li> <li>• Vulnerability and resilience of the system for hurricane-related N-k contingencies for scenarios with high penetrations of renewables</li> <li>• Transfer of methodologies and modeling procedures to planners and operators to use all models developed for future studies</li> </ul>

# Data Management: Anticipated Model Outputs (Continued)

Task Title	Model/Analysis	Anticipated Outputs
Distribution System Analysis	EGRASS DCAT ReNCAT HELICS OpenDSS	<ul style="list-style-type: none"> <li>• Database of representative feeders implemented in OpenDSS</li> <li>• Identification of vulnerabilities through EGRASS-DCAT and ReNCAT</li> <li>• Distribution-level control strategies implemented into co-simulation with bulk system models using HELICS</li> <li>• Demonstration of the bulk system impact of distribution-level controls</li> <li>• Resilience benefits under 100% renewables scenarios (including microgrid formation opportunities) using EGRASS-DCAT and ReNCAT</li> </ul>
Economic Impact	JEDI CGE SUPRA	<ul style="list-style-type: none"> <li>• Inventory of data elements accepted from other tasks</li> <li>• Schedule of retail rates entire analysis period by scenario and customer class</li> <li>• Simulation results (CGE)</li> <li>• Economic impacts, including gross jobs, earnings, output, and GDP for all technologies (JEDI)</li> </ul>

# Data Management: Data Sharing and Collaboration

Upon completion of the project, final data outputs and associated nonproprietary raw data used during the project will be made available to stakeholders.

Example output pathway: Open Energy Data Initiative (OEDI)

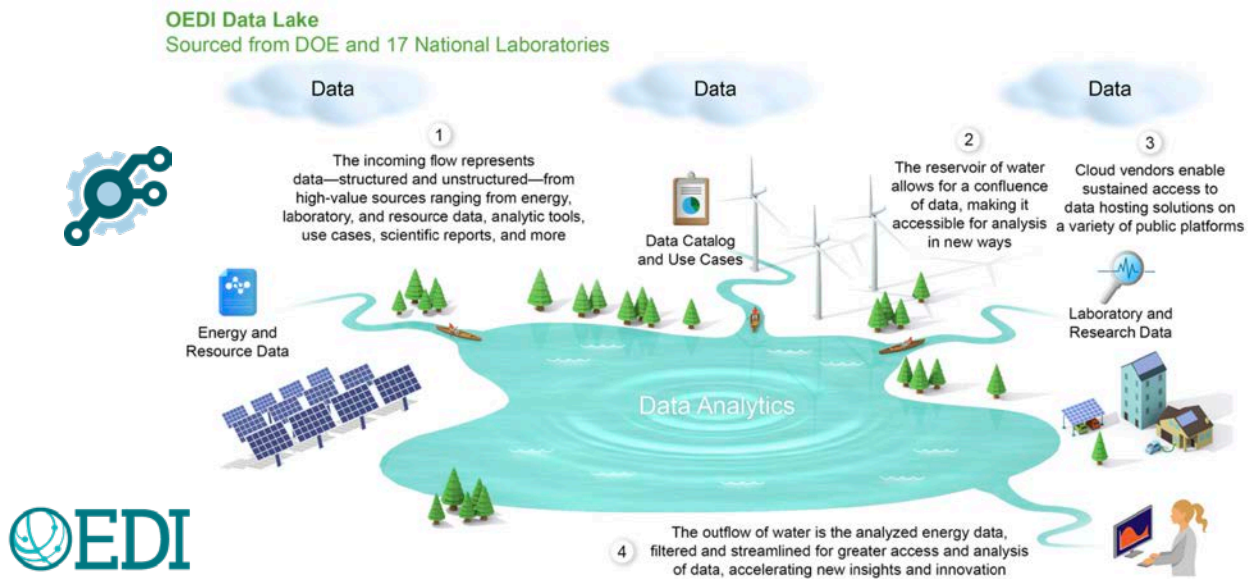

# Implementation Roadmap

---



# Implementation Roadmap

## The PR100 team will:

- Advise stakeholders on the electric grid operation actions needed in both the near term and long term to follow a path to achieving the renewable energy goals in Act 17.
- Engage with the government of Puerto Rico and its stakeholders to understand current organization, technical capabilities, and operations.
- Support validation of expansion planning results based on national lab expertise and tools.
- Develop a transition plan and suggest paths for quick-impact actions (i.e., "near-term wins").

# Appendices

---

Key Terminology

Modeling Tools

Data Providers and Sources

Additional Resources

# Terminology

- Key terms:
  - **Energy justice dimensions** from [The Energy Justice Workbook](#):
    - Energy burden: expense of energy expenditures relative to overall household income
    - Energy insecurity: inability to meet basic household energy needs due to the high cost of energy
    - Energy poverty: lack of access to energy itself
    - Energy democracy: notion that communities should have a say and agency in shaping their energy future.
  - **Resilience:** The ability to anticipate, prepare for, and adapt to changing conditions and withstand, respond to, and recover rapidly from disruptions through adaptable and holistic planning and technical solutions. *Definition from NREL* [Resilience Roadmap: A Collaborative Approach to Multi-Jurisdictional Planning](#)
  - **Reliability:** A measure of the ability of the system to continue operation while some lines or generators are out of service. Reliability deals with the performance of the system under stress. *Definition from* [EIA Glossary](#)
  - **Technical Potential:** An estimate of the capacity of an RE technology (solar PV, wind, etc.) available for development after accounting for topographic limitations, land-use constraints, and system performance. *Definition from NREL's* [Technical Potential Assessment for the Renewable Energy Zone \(REZ\) Process: A GIS-based Approach](#)
- Glossaries referenced by the project team include:
  - U.S. Energy Information Administration (EIA) Glossary, <https://www.eia.gov/tools/glossary/>
  - Greening the Grid Glossary, <https://greeningthegrid.org/about/glossary/glossary#R>

# Modeling Tools

Acronym	Name and/or Link	Lab or Organization	Purpose
	<a href="#">Aurora</a>	Energy Exemplar	Capacity expansion and energy system interdependency modeling
CGE	Computable General Equilibrium		Economy-wide model to derive policy impacts in the economy
C-PAGE		PNNL	Realistic, long-term planning for grid operators
DCAT	<a href="#">Dynamic Contingency Analysis Tool</a>	Sandia	Assess impact and likelihood of extreme contingencies
dGen	<a href="#">Distributed Generation Market Demand</a>	NREL	Distributed generation modeling and PV + storage adoption modeling
WRF	Downscaled Climate Modeling	ANL	Climate risk assessment
EGRASS	<a href="#">Electrical Grid Resilience and Assessment System</a>	PNNL	Extreme events and power systems modeling
	<a href="#">Energy Justice Dashboard (BETA)</a>	DOE	Visualization of energy justice indicators
	<a href="#">Engage</a>	NREL	Capacity expansion and energy system interdependency modeling
HELICS	<a href="#">Hierarchical Engine for Large-scale Infrastructure Co-Simulation</a>	Sandia	Interdependency impact co-simulation platform
JEDI	<a href="#">Jobs and Economic Development Impact Models</a>	NREL	Modeling of local economic impacts of renewable projects
PRAS	<a href="#">Probabilistic Resource Adequacy Suite</a>	NREL	Resource adequacy modeling
PREESAT	<a href="#">Puerto Rico Energy Efficiency Scenario Analysis Tool</a>	NREL	Estimate electricity consumption impact of energy efficiency measures in Puerto Rico
PRIIA	Puerto Rico Infrastructure Interdependency Assessment	ANL	Infrastructure interdependency assessment
PSCAD	<a href="https://github.com/NREL/PyPSCAD">https://github.com/NREL/PyPSCAD</a>	NREL	Power flow & dynamic analysis
PSS/E	<a href="#">Power System Simulator for Engineering</a>	Siemens	Transmission planning analysis
RAPT	<a href="#">Resilience Assessment and Planning Tool</a>	FEMA	Resilience planning
ReNCAT	Resilient Node Cluster Analysis Tool	Sandia	Social burden analysis
SIIP	<a href="#">Scalable Integrated Infrastructure Planning Model</a>	NREL	Grid operations modeling
SUPRA	<a href="#">Standardized Utility Pro-Forma Financial Analysis</a>	LBNL	Electric rates

# Data Providers and Sources

## Puerto Rico Entities

- Puerto Rico Energy Bureau (PREB)
- Puerto Rico Electric Power Authority (PREPA)
- Financial Oversight and Management Board (FOMB)
- State Data Center de Puerto Rico (SDC-PR)
- Puerto Rico Institute of Statistics
- LUMA Energy

## U.S. Government Entities

- U.S. Geological Survey (USGS)
- Federal Emergency Management Agency (FEMA)
- Environmental Protection Agency (EPA)
- U.S. Energy Information Agency (EIA)
- National Oceanic and Atmospheric Administration (NOAA)
- U.S. Census Bureau

## Public Data Sources

- Marine Cadastre National Viewer
- National Hurricane Center

## Resource Data Sources

- National Solar Radiation Database (NSRDB)

# Additional Resources

- Project overview with links to National Lab publications and tools
  - DOE webpage: [Puerto Rico Energy Recovery and Resilience](#)
  - NREL webpage: [Multilab Energy Planning Support for Puerto Rico](#)
- [PR100 Study](#) webpage and [PR100 Overview](#) slide deck
- PR100 Public Launch [webinar recording](#) and [published slide deck](#)
- [Memorandum of Understanding](#) among DOE, Departments of Homeland Security and Housing and Urban Development, and the Puerto Rico government to accelerate work to strengthen the island's grid resilience and advance new initiatives to enhance Puerto Rico's energy future.
- [PR Energy Recovery and Resilience](#) online community on Mobilize, including links to videos about modeling tools used in the PR100 study
- [DOE Office of Electricity Email Updates](#) (under Subscription Topics choose "Puerto Rico Resilience Efforts")



---

# Thank you

NREL/PR-6A20-83432

This work was authored in part by the National Renewable Energy Laboratory, operated by Alliance for Sustainable Energy, LLC, for the U.S. Department of Energy (DOE) under Contract No. DE-AC36-08GO28308. Support for the work was also provided by the Federal Emergency Management Agency under Interagency Agreement HSFE02-20-IRWA-0011. The views expressed in the article do not necessarily represent the views of the DOE or the U.S. Government. The U.S. Government retains and the publisher, by accepting the article for publication, acknowledges that the U.S. Government retains a nonexclusive, paid-up, irrevocable, worldwide license to publish or reproduce the published form of this work, or allow others to do so, for U.S. Government purposes.