

# Forgotten Books

— [www.forgottenbooks.com](http://www.forgottenbooks.com) —

Copyright © 2016 FB &c Ltd.

All rights reserved. No part of this publication may be reproduced, distributed, or transmitted in any form or by any means, including photocopying, recording, or other electronic or mechanical methods, without the prior written permission of the publisher, except in the case of brief quotations embodied in critical reviews and certain other noncommercial uses permitted by copyright law.

PROCEEDINGS  
OF THE  
ACADEMY OF NATURAL SCIENCES  
OF  
PHILADELPHIA.

---

1893.

---

COMMITTEE ON PUBLICATION.

JOHN H. REDFIELD,

EDWARD J. NOLAN, M. D.,

THOMAS MEEHAN,

CHARLES E. SMITH,

GEORGE H. HORN, M. D.

EDITOR: EDWARD J. NOLAN, M. D.

PHILADELPHIA:  
ACADEMY OF NATURAL SCIENCES,  
LOGAN SQUARE.  
1894.

ACADEMY OF NATURAL SCIENCES OF PHILADELPHIA,  
March 29, 1894

I hereby certify that copies of the Proceedings for 1893 have been presented at the meetings of the Academy as follows:—

Pages	9 to 56	.	.	.	.	March	14, 1893.
"	57 to 72	.	.	.	.	March	21, 1893.
"	73 to 120	.	.	.	.	March	28, 1893.
"	121 to 168	.	.	.	.	April	11, 1893.
"	169 to 200	.	.	.	.	April	18, 1893.
"	201 to 216	.	.	.	.	May	23, 1893.
"	217 to 232	.	.	.	.	July	18, 1893.
"	233 to 312	.	.	.	.	September	12, 1893.
"	313 to 344	.	.	.	.	October	17, 1893.
"	345 to 360	.	.	.	.	October	24, 1893.
"	361 to 376	.	.	.	.	December	12, 1893.
"	377 to 424	.	.	.	.	January	30, 1894.
"	425 to 456	.	.	.	.	February	27, 1894.
"	457 to 520	.	.	.	.	March	13, 1894.
"	521 to 552	.	.	.	.	March	27, 1894.

EDWARD J. NOLAN,  
*Recording Secretary.*

# LIST OF CONTRIBUTORS.

*With reference to the several articles contributed by each.*

---

For Verbal Communications see General Index.

---

Brown, Arthur Erwin. Notes on some Snakes from Tropical America lately living in the Collection of the Zoological Society of Philadelphia . . . . .	429
Calvert, Philip P. The Odonate genus <i>Ortholestes</i> . . . . .	377
Chapman, Henry C., M. D. The interpretation of certain verses of the First Chapter of Genesis in the light of paleontology	68
Notes on <i>Choeropsis liberiensis</i> (Morton) (Plate IV) . . ; . .	185
Observations on the Japanese Salamander, <i>Cryptobranchus maximus</i> (Schlegel) (Plates V, VI and VII) . . . . .	227
Chapman, Henry C., M. D. and Albert P. Brubaker, M. D. The radius of curvatures of the Cornea . . . . .	349
Cope, Edward D. A new extinct species of Cyprinidae . . . . .	19
A contribution to the herpetology of British Columbia . . .	181
Description of a lower jaw of <i>Tetrabelodon Shepardii</i> Leidy.	202
On a collection of Batrachia and Reptilia from southwest Missouri . . . . .	383
On the Batrachia and Reptilia of the Plains at Latitude 36° 30' . . . . .	386
Geographic variations in <i>Bassariscus astutus</i> , with description of a new subspecies . . . . .	413
Dall, W. H. The phylogeny of the Docoglossa . . . . .	285
Dixon, Samuel G., M. D. Involution form of the Tubercle Bacillus and the effect of subcutaneous injection of organic substances on inflammations . . . . .	100
Ellis, J. B. and B. M. Everhart. New species of North American Fungi from various localities . . . . .	128
New species of Fungi from various localities . . . . .	440
Fox, William J. The North American Larridæ . . . . .	467
Goldsmith, E. Notes on some minerals and rocks (Plates I and II) . . . . .	174
A tempered steel meteorite (Plate IX) . . . . .	373
Keller, Ida A. The glandular hairs of <i>Brasenia peltata</i> Pursh (Plate III) . . . . .	188
Meehan, Thomas. Contributions to the life histories of plants, No. 9 . . . . .	289
Meehan, William E. A contribution to the flora of Greenland .	205

Meyer, Abraham. Notes on the occurrence of quartz and other minerals in the Chemung Measures, near the line of Lycoming and Tioga Counties, Pennsylvania . . . . .	194
Pyrophyllite slate in Northern Pennsylvania . . . . .	197
Moore, J. Percy. On some Leech-like parasites of American Crayfishes (Plate XII). . . . .	419
Rex, George A., M. D. New North American Myxomycetes . .	364
Rhoads, Samuel R. The birds observed in British Columbia and Washington during the spring and summer, 1892 . . . . .	2I
Description of new species of North American Mammals with remarks on species of the genus <i>Perognathus</i> . . . . .	404
Ryder, John A. The inheritance of modifications due to disturbances of the early stage of development, especially in the Japanese domesticated races of Gold-Carp . . . . .	75
The vascular respiratory mechanism of the vertical fins of the viviparous <i>Embiotocidæ</i> . . . . .	95
Sharp, Benjamin, M. D. Catalogue of the Crustaceans in the Museum of the Academy of Natural Sciences of Philadelphia . . . . .	104
Sterki, V. Observations on <i>Vallonia</i> (Plate VIII) . . . . .	234
Growth changes in the radula in Land Mollusks (Plates X, XI) . . . . .	388
Stone, Witmer. Description of a new species of <i>Neotoma</i> from Pennsylvania . . . . .	16
Strecker, Herman. Descriptions of two new species of North American <i>Bombycidæ</i> . . . . .	282
Tarr, Ralph S. Notes on the physical geography of Texas . . .	313

PROCEEDINGS  
OF THE  
ACADEMY OF NATURAL SCIENCES  
OF  
PHILADELPHIA.

---

1893.

---

JANUARY 3.

The President, GENERAL ISAAC J. WISTAR, in the chair.

Sixty-three persons present.

A paper entitled "The Interpretation of Certain Verses of the First Chapter of Genesis in the Light of Paleontology," by Henry C. Chapman, M. D., was presented for publication.

The Council reported that the following Standing Committees had been appointed to serve during the ensuing year:—

ON LIBRARY.—W. S. W. Ruschenberger, M. D., Henry C. Chapman, M. D., Gavin W. Hart, Charles P. Perot and J. Bernard Brinton, M. D.

ON PUBLICATIONS.—John H. Redfield, Charles E. Smith, Thomas Meehan, George H. Horn, M. D., and Edward J. Nolan, M. D.

ON INSTRUCTION AND LECTURES.—Charles Morris, Isaac C. Martindale, Harold Wingate, George A. Rex, M. D., and J. Bernard Brinton, M. D.

STANDING COMMITTEE OF COUNCIL ON BY-LAWS.—W. S. W. Ruschenberger, M. D., Theo. D. Rand, William Sellers and Isaac J. Wistar.

The deaths of Wm. S. Pine, a member and P. R. Hoy, a correspondent, were announced.

The death on the 3rd inst. of ISAAC C. MARTINDALE, the Treasurer of the Academy, having been announced the following minute was adopted:—

The Academy of Natural Sciences of Philadelphia, in view of the sudden death of Mr. ISAAC C. MARTINDALE, its late Treasurer, expresses its profound regret thereat, and records its sense of the great service rendered by him in the faithful, laborious and efficient discharge of his duties as custodian of the Academy's funds.

As a naturalist Mr. Martindale won the confidence and respect of his fellow Academicians. He was regarded as one of the best analytical botanists in the United States. His knowledge of special American, European and Australian floras was very exact and wide. His herbarium was one of the standard collections of the country, frequently consulted by students of plants and always generously placed at the service of his fellow botanists.

As an entomologist he had acquired a good knowledge and a valuable collection of Lepidoptera. At his death he was the Vice-President of the American Entomological Society and Entomological Section of the Academy.

Mr. Martindale's relations to his associates were always most pleasant and helpful. His invariable courtesy, willingness to aid his fellow naturalists and his unselfish interest in the advancement of science and especially the prosperity of the Academy are here most cordially recognized and recorded.

*Metamorphism of Sedimentary Rocks.*—MR. JOS. WILLCOX stated that he had observed an example of the metamorphism of sedimentary deposits into crystalline rocks on an island in Rideau Lake, Canada, about 40 miles north of Alexandria Bay. At this locality the Laurentian granite is covered by gneiss rocks which in some cases appear like a coarse granite containing cleavable feldspar as large as an egg. The sedimentary origin of these gneiss rocks is indicated by many enclosed, smooth, round quartz pebbles some of which are more than two inches in diameter.

---

JANUARY 10.

The President, GENERAL ISAAC J. WISTAR, in the chair.

Forty persons present.

Papers under the following titles were presented for publication:—

“On a now extinct species of Cyprinidæ,” by Edw. D. Cope.

“On the Inheritance of Modifications due to the Disturbance of the Early Stage of Development in the Japanese Domesticated Races of Gold Carp,” by John A. Ryder.

“The Vascular Respiratory Mechanism of the Vertical Fins in the Viviparous Embiotocidæ,” by John A. Ryder.

---

JANUARY 17.

The President, GENERAL ISAAC J. WISTAR, in the chair.

Fifty-three persons present.

Papers under the following titles were presented for publication:—

“Catalogue of the Crustaceans in the Museum of the Academy of Natural Sciences of Philadelphia,” by Benjamin Sharp, M. D.

“Description of a New Species of Neotoma,” by Witmer Stone.

Mr. CHAS. P. PEROT was elected Treasurer to fill the vacancy caused by the death of Mr. Isaac C. Martindale.

---

JANUARY 24.

The President, GENERAL ISAAC J. WISTAR, in the chair.

Fifty-nine persons present.

A paper entitled “New Species of North American Fungi from various localities,” by J. B. Ellis and B. M. Everhart, was presented for publication.

The deaths of Dr. J. S. Newberry and Sir Richard Owen, correspondents, were announced.

*The Forms of Edentulous Jaws in the Human Subject.*—Dr. HARRISON ALLEN demonstrated the peculiarities of the edentulous upper and lower jaws of the human subject. He held that the statement made that the jaws exhibit the result of uniform absorption of the alveolar processes was not true. The bone tissue which held the teeth in place being a complementary structure is indeed rapidly absorbed after the teeth are lost. But when the alveolar processes have disappeared, a secondary process of adaptive hyperostosis takes place. These statements relate in the main to the upper jaw, but the conclusions can be applied also to the lower jaw.

This adaptive process occurs in three regions, namely, that for the incisor teeth, that for the canine tooth and the first bicuspid tooth, and that for the second bicuspid tooth and the molar teeth. These



regions answer roughly to those occupied by various kinds of teeth, and differ in much the same way as the incisiform, caniniform and molariform teeth differ from one another. The region of the incisor teeth is compressed and beaked, that of the canine tooth and the first bicuspid tooth is coarsely conical or tubercular, while that of the second bicuspid and molar teeth is either broad and massive, or compressed. It is rare to find an edentulous dental arch uniformly hyperostosed or uniformly atrophied, but one or more of the regions above named assume the form described, or at least exhibit indications of changes different in character from the mere loss of the alveolar processes.

The lower jaw passes up in front of the upper jaw in aged individuals who have lost teeth. As a result, the attrition of the incisorial region of the lower jaw is secured against the *front* of the upper jaw. The result attained by such attrition Dr. Allen called "shearing." Shearing takes place in proportion as the upper jaw at its anterior arc is beaked. It is interesting to find that when "shearing" is present the articular surface of the condyloid process is invariably at the anterior part.

The loss of the alveolar process in the incisorial region of the upper jaw causes the incisive foramen to assume an absolutely new position in relation to the line of mastication. It exhibits a disposition to lie *in* the dental arch instead of back of it. The attrition by "shearing" however, protects the contents of the foramen from pressure.

The region in the upper alveolar arch directly back of the last molar is apt to become symmetrically hyperostosed. These masses appear to be dominated by the pyramidal process of the palatal bones and the pterygoid process of the sphenoid bone. At least they are not used for mastication.

The subdivision of the teeth into kinds, which answer to the incisors, canines, bicuspid and molars, correlates to the strongest suture lines in the face, that is to say, the incisors correspond to the premaxillo-vomerine junction, the canine and first bicuspid to the fronto-maxillary junction, and the remaining teeth to the fronto-malar junction.

The edentulous skulls examined were 14 in number, distributed as follows; Ancient Egyptian, 3; Arabian, 2; Hindu, 2; Peruvian, 2; Negro, 1; N. A. Indian, 2; Anglo-American, 2. Of this number the Anglo-Americans alone could by any possibility represent the teeth of persons who could have worn artificial teeth, and in this way modify the act of mastication in the aged. Since one of the Anglo-American crania was that of an idiot, the probability is reduced to a minimum that an artificial denture had been used during life in any of the specimens examined.

{	Entire arch hyperostosed,	3.	
{	Entire arch absorbed,	4.	
{	Left side arch hyperostosed,	1.	
{	Right side arch hyperostosed,	0.	
{	Left side arch absorbed,	2.	
{	Right side arch absorbed,	4.	
	Region of incisors hyperostosed ("beaked"),	6.	
	Region of incisors "sheared,"	5.	
{	Region of canine and first bi-cuspid hyperostosed	{ Right and Left,	2.
		{ Left,	1.
{	Region of canine and first bi-cuspid absorbed	{ Right,	1.
		{ Right and Left,	2.
{	Region of second bicuspid and molars hyperostosed	{ Left,	1.
		{ Right,	1.
{	Region of second bicuspid and molars absorbed	{ Right and Left,	0.
		{ Left,	1.
{	Region of second bicuspid and molars "beaked"	{ Right,	2.
		{ Right and Left,	2.
{	Region of second bicuspid and molars "beaked"	{ Left,	0.
		{ Right,	0.

Symmetrical hyperostoses in alveolar arch in front of pterygoid process 8.  
Incisive foramen in line of dental arch 8.

It is noteworthy that from the entire series only four showed complete absence of any secondary bone adaptation consequent upon the loss of alveolar processes, and that all of these were from civilized races, two ancient Egyptian and two Anglo-American. The want of harmony between the secondary adaptations probably correlates with the irregular rate at which the teeth are lost. Individual peculiarities in this regard are doubtless numerous.

Dr. Allen assumed that the coarse food of savage and semi-savage people caused the jaws even in an edentulous condition to be used actively in the act of mastication, while the more carefully prepared food suitable to the aged of civilized people enabled the jaws to have comparative rest, and hence the mechanical conditions which predetermined the localization of new structures were not active. The speaker concluded that the series of observations strengthens the position taken that the same forces which differentiate the kind of teeth operate in fashioning the shape of the jaws, even after the loss of the teeth.

Dr. C. N. PIERCE remarked that the four superior arches, which Doctor Allen has presented as being representatives of civilized races, could not be accepted as indicating a uniform condition of edentulous jaws at the present time. The crania collected from civilized communities in the future will, in their edentulous jaws, certainly show less irregularity in the individual alveolar ridges than was present in the several specimens exhibited by Dr. Allen, and in the absence or presence of a ridge would not

display the uniformity seen in the four exhibited. In the future, the greatest variations will certainly be exhibited. In some a prominence will be present, which in life amounted to almost a monstrosity, while in others there will be found a complete atrophy or absorption of the entire ridge in both the superior and inferior maxilla. The symmetry of the ridge will in a measure be due to the uniformity of pressure from an artificial denture, and an absence of the forces alluded to by Dr. Allen, which doubtless had had in some cases an influence in the secondary development of bony structure, while those parts were forced to perform the function of the teeth which had been prematurely lost, though some of the prominences to which attention had been drawn, were, in the estimation of Dr. Pierce, due to the difference in the time of the loss of the teeth. Why some maxillaries should show such complete atrophy, while others had secondary development, Dr. Pierce could not explain, but he believed it was associated with temperamental and nutritional conditions. The development certainly indicated a healthy recuperative power on the part of the individual.

With reference to the protrusion of the lower jaw and chin, and the change in adaptation of condyle to glenoid cavity, which Dr. Allen had so aptly illustrated, Dr. Pierce thought they could be explained upon the principle of use and disuse, with adaptation of structures. In infancy, the angle resulting from the relation of the ramus to the body of the bone was much greater than a right angle, indeed the ramus was but little above the same horizontal plane occupied by the body of the bone, and the jaw was capable only of vertical and anteroposterior motion, such as is essential to sucking or nursing. As the three true or permanent molars are developed, the ramus assumes its vertical position, forming almost a right angle with the body of the bone, and at the same time making lateral or horizontal movement possible while establishing the concomitant relation between the condyles and glenoid cavities. As these permanent molars later in life are lost, the force upon the jaw in occlusion is confined to the anterior part or incisive locality, which would necessarily tend to increase the angle and protrude the chin. This occurs sometimes quite early in life and while all the anterior teeth are in position. At the same time that the vertical motion is exerting this influence the necessity for lateral motion has ceased, by the loss of the grinders; hence the change in the relative position of the condyle, which was so well shown by the previous speaker, and which has been necessitated by a return to the vertical and anteroposterior motion common to infancy, with the loss of the horizontal or lateral motion of maturity.

In consequence of his election to the office of Treasurer, Mr. Chas. P. Perot resigned from the Finance Committee. DR. GEO. H. HORN was elected to fill the vacancy.

JANUARY 31.

The President, GENERAL ISAAC J. WISTAR, in the chair.

One hundred and one persons present.

The deaths of Nicholas Koksharow and Axel Gadolin, correspondents, were announced.

MR. THOMAS A. ROBINSON was elected to fill a vacancy in the Council caused by the ex-officio membership therein of Mr. Chas. P. Perot.

The following were elected members:—

Geo. M. Warren, Nelson H. Strong, Norris J. Scott, Thomas Say Speakman, Clarence B. Moore, Mary K. Gibson, Jr., J. Howard Gibson, Thomas Bradley, Edwin Greble Dreer, Richard C. Schiedt, Charles N. B. Camac, Wm. Evans Wood, John C. Sims, William D. Winsor, Clarence B. Newbold, Wm. H. Joyce, Alexander J. Cassatt, Samuel F. Houston, Alexander E. Harvey, Charles Hacker, Edw. A. Buckley, Jr., Mark T. Patterson, Geo. B. Heckel, Benjamin W. Richards, Eugene Delano, Malcolm Lloyd, Charles H. Banes, Theodore C. Search, William H. Ingham and Algernon Sydney Logan.

The following were elected correspondents:—William Libbey, Jr. of Princeton, N. J., Alfred Russell Wallace of London, G. B., and G. H. Theodor Eimer of Tubingen, Germany.

The following were ordered to be printed:—

**DESCRIPTION OF A NEW SPECIES OF NEOTOMA FROM PENNSYLVANIA.**

BY WITMER STONE.

I have recently obtained through the kindness of Mr. J. G. Dillin two specimens of a wood rat which were secured near the top of South Mountain (2,000 ft.), Cumberland County, Penna., some six miles from Pine Grove, at a point known as Lewis's Cave, which constitute the first record of the occurrence of the genus *Neotoma* in this State.

The first specimen of this rat secured by Mr. Dillin was a male, and was taken in a trap set for raccoons. It was at once recognized as different from the common brown rat, and was preserved with a view to having its identity settled, but was afterward unfortunately lost.

The next day, Dec. 2, 1892, a female specimen was secured and was brought to me in the flesh. At my request Mr. Dillin wrote to friends who were hunting on South Mountain and secured one more specimen.

After comparing these two specimens with a series of Neotomas from the collection of the American Museum of Natural History kindly loaned me by Mr. F. M. Chapman and some specimens loaned by Dr. C. Hart Merriam, of the U. S. Department of Agriculture, I am convinced that they represent an undescribed species, for which I propose the name of *Neotoma pennsylvanica*.

This species may be distinguished from *N. floridana* of the South Atlantic and Gulf States by its larger size, its densely hairy and distinctly bicolored tail and by certain well marked cranial characters.

The specimens here described are both females, and are perhaps not quite full sized, though evidently adult. The male specimen, according to Mr. Dillin's account, must have been at least twenty inches (508 mm.) long, and had the tail more hairy than the two in my possession. The detailed description follows:

*Neotoma pennsylvanica* sp. nov. Pennsylvania Wood Rat.

Type No. 156 Collection of Witmer Stone, ♀ South Mountain, Cumberland County, Penna., Dec. 2, 1892. J. G. Dillin.

General color similar to that of *N. floridana*, plumbeous above with a number of black hairs interspersed and a yellowish brown

undertone which is pure and bright on the sides of the head and body, becoming almost a pinkish tint on the flanks. Feet and lower surface pure white.

Tail densely hairy, surpassing in this respect any specimens of either *N. floridana* or *N. mexicana* that I have seen. The color of the tail is black above and pure white beneath, the line of demarcation being very sharp; viewed from directly above, the scales are completely hidden by the hairs. The two females in my possession measure as follows:

	Length.	Tail (Vert.).	Hind Foot.
	mm.	mm.	mm.
No. 156, Collection W. S.....	403	185	41
No. 157, " " .....	416	190	43

Comparing the skull of *N. pennsylvanica* with that of *N. floridana* we find it larger and proportionately longer and narrower. The upper surface is more nearly horizontal (*i. e.* not so much curved), the frontal bones are much depressed along the frontal suture, the outer edges next to the orbits forming decided ridges. The pterygoid processes are larger and converge more than in *N. floridana*, so that the meso-ptyergoid fossa is longer and narrower. The upper margin of the infra-orbital foramen as viewed from above is also much narrower in *N. pennsylvanica*. The teeth are rather heavier than in *N. floridana*, and the distance between the anterior molar and the incisor (from the alveolæ) is relatively greater.

A table of cranial measurements follows, the measurements of a male (No. 1,129) and female (No. 1,127) *N. floridana* from Gainesville, Florida, Amer. Mus. Nat. Hist. collection, being given for comparison:—

	N. pennsylvanica.		N. floridana.	
	Coll. W. Stone No. 157.	No. 156	Am. Mus. Nat. Hist. No. 1127	No. 1129
Occipito-nasal length.....	53	—	49·8	50
Basilar length (from foramen magnum to incisor).	44·9	54	40·5	40
Zygomatic breadth.....	27	27	25·2	25
Mastoid breadth.....	20·6	20	19	19·2
Interorbital constriction.....	7	6·6	6·1	7·3
Length of nasals.....	20	21	18·5	18·9
Foramen magnum to incisive foramen.....	31	—	27·2	27
Foramen magnum to palate.....	20·6	—	20	19·5
Length of upper molar series (on alveolæ).....	9·8	10	9·2	9
Length of incisive foramen.....	10	10·6	10·2	10·5
Length of mandible (symphysis to angle).....	30·5	30	28·5	27·5
“ “ “ (symphysis to condyle).....	32·2	31	31	29·6
Coronoid process from angle.....	15·3	14·5	13·8	12·2
RATIOS TO BASILAR LENGTH.				
Zygomatic breadth.....	60·1		62·2	
Mastoid breadth.....	45·9		46·9	
Nasals.....	44·5		45·6	
Upper molar series (on alveolæ).....	21·8		22·7	
Incisive foramen.....	22·2		25·1	
Foramen magnum to incisive foramen.....	69		67·1	
Foramen magnum to palate.....	45·8		49·4	

## A NEW EXTINCT SPECIES OF CYPRINIDÆ.

BY E. D. COPE.

Dr. J. Lindahl, Geologist of Illinois, recently sent me some specimens of fossil fishes which were found in Pulaski County, in the southern part of that State. They are indifferently preserved on laminæ of a papier kohl of lacustrine origin, which is frequently impregnated with pyrite. Five specimens present characters of value, but no one of them is sufficiently well preserved to furnish all the necessary definitions. However, the specimens agree in all points where comparisons can be made, so that I believe them to pertain to a single species.

The characters displayed by this fish refer it to the Cyprinidæ, and to the neighborhood of the genus *Leuciscus*. In specimen No. 8,402 a cast of one of the inferior pharyngeal bones is preserved, and this displays three obtusely conical teeth of an external row, and a trace of a single smaller tooth of the internal row. There was apparently another tooth of the external row inferior to and larger than the others; the four forming a series on a curved line corresponding with the axis of the bone. The apices of these teeth are not perfect. The fins do not present any conspicuous spines; and the front of the dorsal fin is above the ventral; mouth terminal. These characters would refer this fish to *Minnilus* or *Cliola*, but another character appears to distinguish it from these. This is the absence of scales. In none of the dozen specimens sent is any trace of scales to be found. As compared with the scaleless genera, the American *Meda*, and the Old World *Aulopyge*, the present fish differs in the absence of conspicuous spines at the front of the dorsal and anal fins. Supposing the absence of scales to be normal, I refer the Illinois species to a new genus under the name of *Aphelichthys*. The species I describe as

*Aphelichthys lindahlii* sp. nov.

The specific characters are derived from four specimens. These I tabulate as follows:

	Dorsal Vert.	Caudal Vert.	Fin rays.			
			D.	A.	V.	C.
No. 8,402.....	15		12	11		
No. 8,404.....	16	19-20	13	11	7	15
No. 8,397.....	15	20				



The caudal fin is emarginate. The general form is moderately slender, much as in our chubs of the genus *Semotilus*. The length of the head measured above, enters the length to the caudal notch about five times; and when measured on the side about four times; and the depth at the front of the dorsal fin enters the same about four times. The mouth is directed obliquely upward, and its rictus appears to be nearly in the line of the anterior border of the orbit. The paired fins are rather short, the pectorals not reaching the ventrals, nor the ventrals the anal (No. 8,404). The borders of the dorsal and anal are straight (8,402, 8,404). The ribs and vertebral spines are slender. The vertebral bodies have on each side a longitudinal median keel, which is bounded above and below by a fossa.

#### DIMENSIONS.

	MM.
Length of superior surface of head of No. 8,402.....	15.5
Length of No. 8,404a to notch of caudal fin.....	39.5
Length of head of No. 8,404a on side.....	9
Total length of No. 8,397.....	160
Length of head of No. 8,397 on side.....	41
Length from end of muzzle to origin of dorsal fin (No. 8,397)	77

The earliest Cyprinidæ in North America whose horizon is positively known are from the Idaho beds of Idaho and eastern Oregon, which are of Pliocene age. It is likely that the lake deposit in which the *Aphelichthys lindahlii* is found is not of an earlier age than the Idaho beds. Species of existing genera of the family occur, however, in the middle Miocene of Europe. I dedicate the species to my friend Dr. Josua Lindahl, State Geologist of Illinois.

**THIS PAGE IS LOCKED TO FREE MEMBERS**

Purchase full membership to immediately unlock this page

# DELVE INTO FANTASY, MAGIC, MYTHOLOGY & FOLKLORE

Forgotten Books'  
Full Membership gives  
access to 797,885 ancient  
and modern, fiction and  
non-fiction books.

**Continue**

\*Fair usage policy applies

*clarkii*(?) and *Dendrioca æstiva morcomi*) and excluding *Dryobates pubescens* from Fannin's list, numbers 326.

The additional species are:

*Simorhynchus pusillus.*  
*Charadrius dominicus fulvus.*  
*Callipepla californica vallicola.*  
*Bubo virginianus.*  
*Bubo virginianus subarcticus.*  
*Glaucidium gnoma.*  
*Perisoreus canadensis capitalis.*  
*Chondestes grammacus strigatus.*  
*Zonotrichia querula.*  
*Spizella socialis.*  
*Passerella iliaca schistacea.*

*Clivicola riparia.*  
*Vireo huttoni obscurus.*  
*Helminthophila ruficapilla gutturalis.*  
*Dendroica maculosa.*  
*Sylvania pusilla.*  
*Icteria virens longicauda.*  
*Certhia familiaris montana.*  
*Parus hudsonicus columbianus.*  
*Turdus ustulatus swainsonii.*  
*Turdus aonalaschkæ pallasii.*

One of these, *Parus hudsonicus columbianus*, is described as new, a detailed notice of which, together with that of ten other species given in this paper, appears in the Auk for January, 1893.

To the combined lists of Cooper, Suckley and Lawrence, twenty-five species of Washington birds are added. These, with those not included in Mr. Lawrence's Gray's Harbor lists, are:

*Colymbus holbaëllii.*  
*Urinator arcticus.*  
*Simorhynchus pusillus.*  
*Synthliboramphus antiquus.*  
*Brachyramphus marmoratus.\**  
*Cepphus columba.\**  
*Uria troile californica.*  
*Larus argentatus smithsonianus.*  
*Larus californicus.\**  
*Larus delawarensis.\**  
*Larus brachyrhynchus.*  
*Phalacrocorax dilophus cincinatus.*  
*Merganser serrator.\**  
*Lophodytes cucullatus.\**  
*Anas discors.*  
*Spatula clypeata.\**  
*Aix sponsa.\**

*Tringa canutus.*  
*Totanus flavipes.*  
*Arenaria interpres.\**  
*Hæmatopus bachmani.*  
*Oreortyx pictus.\**  
*Callipepla californica vallicola.*  
*Dendragapus franklinii.\**  
*Lagopus leucurus.*  
*Cathartes aura.\**  
*Circus hudsonius.*  
*Falco peregrinus pealei.*  
*Falco columbarius suckleyi.*  
*Asio wilsonianus.*  
*Syrnium occidentale.*  
*Megascops asio kennicottii.\**  
*Dryobates pubescens gairdneri.\**  
*Sphyrapicus ruber.\**  
*Cypseloides niger.*

*Aythya americana.*  
*Histrionicus histrionicus.\**  
*Anser albifrons gambeli.\**  
*Branta canadensis hutchinsii.\**  
*Branta canadensis occidentalis.\**  
*Branta canadensis minima.*  
*Olor buccinator.\**  
*Grus mexicana.*  
*Porzana carolina.*  
*Fulica americana.\**

*Chaetura vauuxii.*  
*Pica pica hudsonica.*  
*Agelaius phœniceus.\**  
*Progne subis.\**  
*Vireo solitarius cassinii.\**  
*Dendroica coronata.\**  
*Sitta carolinensis aculeata.\**  
*Sitta canadensis.\**  
*Parus atricapillus occidentalis.*

Owing to the former incompleteness of bird material from the northwest, the relationships of some western forms to their eastern allies has remained a vexed question. The series in my possession have, in some instances, supplied this deficiency and seem to justify certain changes in nomenclature. Of these may be mentioned, 1. *Corvus caurinus* merged with the northwest form of *C. americanus*, and conjointly separated from eastern *C. americanus* under the name *Corvus americanus caurinus*. 2. The relegation of *Melospiza lincolni striata* to synonymy. 3. The elevation of the northwest Warbling Vireo to its former rank of *Vireo gilvus swainsonii*. 4. *Sylvania pusilla pileolata* made synonymous with *Sylvania pusilla*. 5. The possibility that *Turdus aonalaschke* and *Turdus aonalaschke pallasii* are specifically distinct.

The localities where collections were made number fourteen. In order of sequence they may thus be separately described :

1. Tacoma, Washington, March 4–28.
2. Nisqually Flats, Washington, March 29–April 22.

The situation of Tacoma on Puget Sound is well known, that of Nisqually Flats, fourteen miles southwest of it, at the mouth of the river of the same name, though less known, is far more historic ground, being part of the territory surveyed by the well known naturalists of the Pacific Railroad Expedition of 1853–55. The country in this region is moderately hilly and densely forest-clad, save where intervening level, park-like areas indicate by their stunted vegetation the presence of vast beds of glacial gravel. The shore lines of Puget Sound present an almost unbroken frontage of abrupt, fir-clad slopes from 100 to 500 feet high ; many rocky islands, some of goodly size, intervene and the uplands are well interspersed with

---

\* Asterisk after species given by Suckley and Cooper.

lakes. Alluvial tide meadows, of which the Nisqually rank as the most extensive, occasionally break the monotony of the shore. These are grass grown, and, along the river banks, bear cottonwood, aspen, vine-maple, willow and giant cedar, in some places joined by bush and vine in an inextricable tangle. The tides fall from nine to twelve feet below high water, exposing at Nisqually thousands of acres of mud-flats which afford subsistence to myriads of water fowl.

During the winter of 1891-2 it did not snow, nor did the ground freeze, at Tacoma. Twenty-three of the thirty April days spent in this region were rainy; only two were cloudless; but the total precipitation for the month was less than four and a half inches. There are no mountains in the near vicinity, the central Cascades being forty miles distant.

3. Victoria, B. C.,  
4. Goldstream, B. C., } May 3-25.

Goldstream is a ranch about twenty miles north of Victoria, Vancouver Island. The features of the southern part of the island are those of a rocky, open, hill-country, sometimes densely wooded but often relieved by open stretches of a park-like character dotted with lakes. An exceptional feature is the presence of oaks, *Quercus garryana*, which appear here and nowhere else in British Columbia, nor in Washington. The mountains rarely attain an elevation of 2,000 feet; precipitation less and summer temperature greater than on Puget Sound.

5. Lulu Island, B. C., May 26-June 1.

A delta of the Frazer River, two and a half feet below neap tides, dyked throughout and covered with grass, bushes and isolated higher tracts of woodland. Much of the land is fertile and well cultivated.

6. Ashcroft, B. C., June 2-12.

Ashcroft is on the northernmost frontier of the Great Basin or arid upper Sonoran region, or, as Dr. Merriam rightly terms it, in the area of "Transition" from that life-region to the Boreal Zone. British Columbia rainfall is here at its minimum, and summer temperature at its maximum. Fauna and flora coincide remarkably with those of Arizona found above an elevation of 4,000 feet, the mountains about Ashcroft rarely reaching that altitude. Ashcroft is on the west bank of the Thompson River, in a narrow valley, 1,500 feet above the sea, hemmed in by mountains thinly clad with

bunch grass, cacti, sage brush and rose bushes, and bearing on their summits open forests of fir and pine.

7. Bonaparte, B. C., June 13-17.

The first stopping place on the famous Cariboo Road which connects Ashcroft with the northern mining regions, and twenty miles away from the latter place. Bonaparte is at the southern limit of the true Boreal region and the northern limit of abundant cacti and sage brush. Its mean elevation is 1,000 feet higher than Ashcroft. *Salpinctes obsoletus*, *Tyrannus verticalis*, *Sayornis saya* and *Icterus bullockii* draw the line at this point.

8. Clinton, B. C.,

9. Lac La Hache, B. C., } June 18-July 7.

Clinton, thirty miles north of Ashcroft, rests in a green valley at the foot of outlying spurs of the Cascades. Its elevation is about 2,500 feet. It is the first step into the typical Boreal environment of pine, fir, spruce, juniper and aspen, preparing one for the upland lake plateaus in which lakes La Hache and Quesnel form a conspicuous feature.

To reach La Hache from Clinton the stage line passes for twenty miles over a broad, wooded ridge, 4,000 to 5,000 feet high, and descends again to 2,400 feet in the La Hache Valley. Both localities are semi-arid, well wooded, devoid of much under-growth, covered with nutritious grasses and thickly dotted with alkaline and fresh-water lakes which have no visible outlet. The climate is not rigorous and singularly equable for the latitude.

Lac La Hache was the northern terminus of my journey, 200 miles north of the United States, in latitude 52°.

10. Kamloops, B. C., July 12-15.

Fifty miles east of Ashcroft at head of Kamloops Lake. Similar in situation and environment to Ashcroft with slightly greater rainfall. The border of the arid region continues eastwardly along the Canadian Pacific Railway, from Kamloops, fifty miles, nearly to Salmon River, where it descends directly south to the head of Okanagan Lake, thence east to the foot of the Gold Range which bounds it on that side to within twenty miles of the United States. At this point it widens suddenly, extending eastwardly to and beyond the valley of the Columbia River.

11. Sicamous, B. C., July 16-19.

A railroad Junction of the Canadian Pacific Railway with the Shuswap and Okanagan branch which runs fifty miles south into

the best agricultural valley of the Province. Sicamous overlooks Shuswap Lake, into which it is nearly crowded by the surrounding mountains that here flank the western slopes of the Gold Range. The mountains are rugged, densely wooded, and those above 5,000 feet are topped with snow. We begin here to have a reproduction of the climatic conditions which, in the more easterly Selkirk Range, correspond so nearly to those of the west slopes of the Cascades.

12. Vernon, B. C., July 21–August 11.

Terminus of Okanagan and Shuswap railway, in the midst of the famous Spulamacheen Valley. Rainfall is sufficient to mature staple crops without irrigation. Vernon is surrounded by a rolling, open, mountainous country with wooded elevations. The variety and abundance of its fauna and flora are astonishing. Mean elevation of the valley is 1,100 feet, that of the surrounding mountains 2,500 to 3,000 feet. Climate, that of northern Pennsylvania, with less rainfall.

13. Nelson, B. C., August 16–23.

A mining town in the southern Selkirks on the west shore of Kootenay Lake. Situated among rugged, cliff-like mountains at 1,200 feet. While its climate is less moist than that of the west slope, the abundant vegetation is characteristic of the Selkirks.

14. Field, B. C., August 27–September 3.

In the central Rocky Mountains, 5,000 feet above the sea and on the line of the Canadian Pacific Railway, through Kicking Horse Pass, eight miles west of the eastern boundary of British Columbia and thirty miles east of the Columbia River. The scenery around Field is a fitting climax to that which greets the eye from every point of vantage in the mountain-burdened Province of British Columbia. From boreal to alpine is a comparatively short step in the natural history of Field.

In general, the faunal position of those parts of Puget Sound, South Vancouver Island and Lulu Island visited by me is simple, but in British Columbia, as a whole, it is quite complex. The former localities are included in the typical northwest coast region of excessive rainfall which varies from sixty to one hundred inches yearly in the localities where collections were made. The coast region, while essentially boreal in character, possesses many elements peculiar to itself, due to moisture, cloudy skies, temperate and equable climate and the density of the resulting vegetation. It also affords shelter for some species which have been considered repre-

sentative of Californian and Sonoran sub-regions, such as *Glaucidium gnoma californicum*, *Syrnium occidentale*, *Coccyzus americanus occidentalis*, *Vireo huttoni* (*obscurus*), *Salpinctes obsoletus*, and *Psaltriparus minimus*. There is also a slight intermingling element of typical eastern forms in the central and northerly part of the Pacific coast fauna due to similarity of its climate to that of the North Atlantic coast and the accessibility of the region to migrants from the northwest interior and Alaska. Thus we have *Spizella socialis*, *Empidonax pusillus traillii*, *Dendroica coronata*, *Spinus tristis*, *Colaptes auratus* (?) and *Sylvania pusilla* breeding on Vancouver Island, while in the interior of British Columbia, east of the Cascades, these are wholly, or for the most part, replaced by *Spizella socialis arizonæ*, *Empidonax pusillus*, *Dendroica auduboni* and *Colaptes cafer*, *Spinus tristis* appearing (?) to be absent.

As a whole, the province of British Columbia includes a diversity of faunal characters which no single geographic area in America can match. As a result it may further boast of a longer list of summer residents than any equal area included in the A. O. U. check list limits. Approximately these number 330 in British Columbia. In the rest of British America, an area ten times larger, it is about 365; in the Middle States, 177, and in the United States east of the Mississippi, 300. This exceptional showing is brought about by a conjunction, intrusion and overlapping of the Arctic, Boreal and Transition life zones. It is further complicated by the westerly extension of Atlantic-boreal forms to the Pacific, the intrusion of upper Sonoran species into the central, arid region, the straggling of Pacific coast forms across the Cascades, the sojourn of Arctic species on the higher mountains and "barren grounds" of the north and the southward migration of all, including land and marine species of the polar regions, across common territory. This cosmopolitan feature of British Columbian biology makes the study of its zoogeography both difficult and fascinating. Mr. Chapman has pointed out some of these peculiarities in his paper on the Streater collection, and considering that he had no personal acquaintance with the country, his deductions are remarkably just. After what has been said on the subject, however, we cannot admit that in British Columbia "faunal lines are not so complicated" as in "northern California," for they are infinitely more so. Mr. Chapman has drawn close lines for the eastern boundary of the habitat of so-called "coast forms," but of the thirty-one species enumerated



by him as limited thereto, ten:—*Dendragapus obscurus fuliginosus*, *Bonasa umbellus sabinii*, *Megascops asio kennicottii*, *Bubo virginianus saturatus*, *Colaptes cafer saturator*, *Junco hyemalis oregonus*, *Melospiza fasciata guttata*, *Troglodytes hiemalis pacificus*, *Regulus satrapa olivaceus* and *Turdus aonalaschkæ*, are represented in various localities between and including the Cascades and the Rockies. Of those restricted by him to territory east of the Cascades, *Dendragapus franklinii*, *Bonasa umbellus togata*, *Bubo virginianus* (?), *Falco peregrinus anatum*, *Falco columbarius*, *Ammodramus sandwichensis alaudinus* and *Sylvania pusilla*, are also found west of them.

It is thus seen that coast and interior species overlap across wide areas. This is probably due less to migration than to isolated reproduction of eastern and western environments in alternate sections of country induced by altitude, the Japan current, prevailing winds, parallel and intervening mountain ranges and the projection of an arid Transito-Sonoran area, 200 miles wide and 100 long, into the midst of the southern section of the Province. I am nowise convinced that we are to look east or west for an annual supply of those birds assigned to so-called "eastern or western races" which are found in out-of-the-way or unlooked-for localities in British Columbia. On the contrary, it is probable they are the native born product of similar isolated environments and, while of the same ancestral stock, have become so isolated by changes in the climate and topography of intervening territory. In other cases they will be found, by a more thorough exploration of the country, to be connected with the type habitat by narrow lines of distribution, projecting south and west from Alaska and Great Slave Lake and east and west through the low passes of the Cascades and Northern Rockies. Such aspects of distribution have little to do with the mere annual north and south movement which we call migration; evolution of environment and evolution in accord with environment are the responsible factors. These have made possible the occurrence of *Spizella socialis* on Vancouver Island and of *Bubo virginianus saturatus* in Labrador, each represented over a vast intervening territory by a distinct race. The migration of eastern forms resident in southern British Columbia is undoubtedly over an independent Great Basin route and not, as Mr. Chapman surmises, along the western edge of the Great Plains.

To Edwards Bros. of Tacoma, Messrs Fannin, Maynard and Lindley of Victoria, the Messrs McKinley of Lac La Hache, and Mr.

**THIS PAGE IS LOCKED TO FREE MEMBERS**

Purchase full membership to immediately unlock this page

# Know Your Bible

Forgotten Books' Full Membership provides unlimited access to more than 28,000 volumes of Christian literature for \$8.99/month

**HOLY BIBLE**

**Continue**

\*Fair use policy applies

- \*8. *Urinator lumme*. Red-throated Loon.

Specimens examined were from the coast as far south as Tacoma. None met with inland.

- \*9. *Lunda cirrhata*. Tufted Puffin.

Abundant on coast and Islands of Straits of Fuca and Gulf of Georgia. Not noted on Puget Sound.

- \*10. *Ptychoramphus aleuticus*. Cassin's Auklet.

Specimens from Puget Sound in Edwards Bros. collection.

- \*11. *Simorhynchus pusillus* (?). Least Auklet.

A straggler on Puget Sound—Edwards Bros.<sup>1</sup>

12. *Synthliboramphus antiquus*. Ancient Murrelet.

A specimen from the northwest coast of Vancouver Island, taken by W. S. Lindley, is in the collection.

13. *Brachyramphus marmoratus*. Marbled Murrelet.

Abundant resident on Puget Sound and Gulf of Georgia.

- \*14. *Cephus columba*. Pigeon Guillemot.

Abundant. Same distribution as last.

- \*15. *Uria troile californica*. California Murre.

A pair seen on Puget Sound near Nisqually.

16. *Larus glaucescens*. Glaucous-winged Gull.

Abound in the Sound and sea-coast harbors.

17. *Larus occidentalis*. Western Gull.

Associates abundantly with preceding.

- \*18. *Larus argentatus smithsonianus*. American Herring Gull.

Less abundant than preceding species.

19. *Larus californicus*. California Gull.

More abundant than *L. a. smithsonianus*.

20. *Larus delawarensis*. Ring-billed Gull.

Abundantly associating with next species in all sea-coast harbors and inlets.

21. *Larus brachyrhynchus*. Short-billed Gull.

The most abundant of the Pacific *Laridæ*.

22. *Larus philadelphia*. Bonaparte's Gull.

Migrating and feeding in dense flocks over sea-coast harbors and river mouths the latter part of April. Breed about interior lakes and rivers of British Columbia.

---

<sup>1</sup>Auk, January, 1893.

\*23. *Sterna*—?

Two Terns were seen on the Columbia River, at the head of upper Arrow Lake, in August. At first they resembled *Larus philadelphia*, but a nearer approach showed them to be Terns, probably *Sterna paradisæa*.

\*24. *Phalacrocorax dilophus cincinatus*. White-crested Cormorant.\*25. *Phalacrocorax pelagicus robustus*. Violet-green Cormorant.

Edwards Bros. have secured both species on Puget Sound. I have seen one, if not both, on the coast of Vancouver Island.

\*26. *Pelecanus erythrorhynchos*. American White Pelican.

Occasional as far north as Stewart's Lake and Peace River, British Columbia, according to Mr. G. Hamilton, an ex-Factor of Fort James. I was told by the McKinley Bros. that "white pelicans" were formerly numerous "in the migrations" at La Hache, Williams and Quesnel Lakes. I saw a fine male in the shop of Mr. Pound, at Vernon, which was shot this spring on Okanagan Lake. From accounts, its distribution in British Columbia, once general, is yearly becoming restricted to the southern districts. Puget Sound, Edwards Bros.

\*27. *Pelecanus californicus*. California Brown Pelican.

This species has been seen by Mr. Hamilton on La Hache and Williams Lakes in company with the preceding. Mr. J. F. Brown, of Empire Valley, has noted them in the Chilcotin district, British Columbia. I did not meet with either species. Tacoma, Edwards Bros.

28. *Merganser americanus*. American Merganser.29. *Merganser serrator*. Red-breasted Merganser.

On the coast there was little difference in the abundance of these resident species. *Americanus* was rare in the interior, where both were breeding.

\*30. *Lophodytes cucullatus*. Hooded Merganser.

Evenly distributed everywhere, but nowhere abundant.

\*31. *Anas boschas*. Mallard.

Mallards were abundant and resident in every locality below 4,000 feet elevation.

\*32. *Anas strepera*. Gadwall.

Rare. Specimens from Puget Sound in Edwards Bros. collection.

**33. *Anas americana.* Baldpate.**

Very abundant on Pacific Coast and Puget Sound in spring. Breeding in the interior lake districts. Ashcroft, Clinton, Lac La Hache.

**34. *Anas carolinensis.* Green-wing Teal.**

Assembling in incredible numbers on the flats of Nisqually River. Resorting with others to the interior in summer.

**35. *Anas discors.* Blue-wing Teal.**

Mr. Fannin calls this a "very rare bird" in British Columbia. I found it breeding about several of the small lakes in the vicinity of Lac La Hache. A male, female and three young were secured.

**36. *Anas cyanoptera.* Cinnamon Teal.**

To Mr. Fannin's two records of this species I can add several. In the smaller, more retired, woodland lakes along the Cariboo Road above Clinton, I frequently flushed the Cinnamon Teal. Only one specimen was secured. Mr. D. McKinley, Lac La Hache, says the "red teal" breeds sparingly in that neighborhood every year.

**37. *Spatula clypeata.* Shoveller.**

Numerous on Puget Sound in spring. A few found breeding along the Cariboo Road.

**38. *Dafile acuta.* Pintail.**

Abundant in all coast waters during migrations; breeding throughout the interior.

**\*39. *Aix sponsa.* Wood Duck.**

Rarely met with. Puget Sound specimens in Edwards Bros. museum.

**\*40. *Aythya americana.* Red-head.**

Reported as a rare duck in the vicinity of Tacoma, by Edwards Bros. A few were found breeding with *A. vallisneria* about an alkali lake near Lac La Hache.

**41. *Aythya vallisneria.* Canvas-back.**

Sparingly distributed over the entire country and summering on the more inaccessible lakes of the northern interior.

**\*42. *Aythya marila nearctica.* American Scaup Duck.**

Plentifully distributed. A summer resident east of Cascades in all parts visited.

\*43. *Aythya affinis*. Lesser Scaup Duck.

Rare. A specimen in Edwards Bros. collection and one in the British Columbia Museum, at Victoria, belong to this species.

44. *Glaucionetta clangula americana*. American Golden Eye.

Several seen at Nisqually. In the interior an abundant summer resident. They occasionally nest on the ground.

45. *Glaucionetta islandica*. Barrow's Golden Eye.

Two specimens collected on Puget Sound by Jos. Edwards, who pronounces them to be rare. In the eastern Cascade region they associate and breed with *G. clangula americana* in the proportion of one to three.

46. *Charitonetta albeola*. Buffle Head.

Same distribution as *Glaucionetta clangula americana*.

\*47. *Clangula hyemalis*. Old Squaw.

A few seen on the Vancouver Island coast. Puget Sound ; Edwards Bros.

\*48. *Histrionicus histrionicus*. Harlequin Duck.

Rare in Puget Sound, Edwards Bros. Rare at Lac La Hache, Duncan McKinley.

49. *Oidemia americana*. American Scoter.

A few noted at Nisqually among flocks of *O. deglandi*.

\*50. *Oidemia deglandi*. White-winged Scoter.

Most abundant of the genus, both on the coast and mainland interior. I am convinced it breeds as far south as 150-Mile House, Cariboo Road, individuals being seen at Lac La Hache July 4.

\*51. *Oidemia perspicillata*. Surf Scoter.

Fairly abundant on coast sounds and harbors during my stay.

\*52. *Erismatura rubida*. Ruddy Duck.

Sparingly represented on the interior lakes during summer. Not met with on coast. Puget Sound, Edwards Bros.

\*53. *Anser albifrons gambeli*. American White-fronted Goose.

A few seen at Nisqually are referable to this species. Tacoma, Edwards Bros. It is not probable that they breed on Puget Sound.

54. *Branta canadensis*. Canada Goose.

In flocks on the mud flats of Puget Sound during April. According to the McKinleys it breeds about the mainland lakes and is distinguished from smaller races by the name of "Honker." One

specimen shot at Nisqually is referable to this species, but resembles *occidentalis* in color of lower parts.

55. *Branta canadensis hutchinsii*. Hutchin's Goose.

56. *Branta canadensis occidentalis*. White-cheeked Goose.

\*57. *Branta canadensis minima*. Cackling Goose.

Intergrades connect any series of Washington birds of this group so completely that it is impossible to class every individual by its size or coloration. Three specimens obtained from the same flock may be severally referred to *hutchinsii* and *occidentalis*, one of them being intermediate between *hutchinsii* and *occidentalis* and another between *hutchinsii* and *minima*. All the Canada geese obtained on my trip were secured at Nisqually in April and were migrants. If Mr. Fannin's statements are based on authentic records and on specimens taken in the proper season, *canadensis* and *hutchinsii* breed in the same localities on the mainland, a state of affairs unknown east of the Rockies and inconsistent with their classification as it now stands in the books. The bulk of Pacific coast skins examined present a most puzzling constancy in their intermediate size coupled with an inconstancy of coloration which makes their classification by the most adjustable formula of little value.

The faunal position of Puget Sound and the Gulf of Georgia makes them the winter resort not only of *canadensis* but of all its three offshoots, thus presenting an array of combinations in winter which the magic wand of migration alone can classify. Until we follow and secure them on their breeding grounds the true relationships of the *Branta canadensis* group in British Columbia will remain a mystery. But it is probable it will resolve itself at that season into a case of parallel intergradation, *occidentalis* east of the Cascades insensibly diminishing into *minima*, and west of the Cascades, *canadensis* merging into *hutchinsii*, as they severally approach the Arctic Circle.

\*58. *Branta nigricans*. Black Brant.

Numerous on the larger bodies of salt water during March and April.

\*59. *Olor columbianus*. Whistling Swan.

Puget Sound, Edwards Bros.; Vancouver Island, W. Lindley; Vernon, W. C. Pound; La Hache and Williams Lakes (breeds), G. Hamilton.

\*60. *Olor buccinator*. Trumpeter Swan.

Six Trumpeters were seen at Nisqually. They migrate along the Columbia and visit Lac La Hache in fall.

\*61. *Botaurus lentiginosus*. American Bittern.

Noted only in the interior of British Columbia where it breeds.

62. *Ardea herodias*. Great Blue Heron.

Abounds on the coast. Contrary to Mr. Fannin's experience, I was struck by the total absence of this heron from the interior, none being seen or heard of. An old male from Nisqually is darker on sides of neck than any other examples examined. Mr. Chapman informs me that it is possible, from imperfect specimens sent to the American Museum of Natural History from the Queen Charlotte Islands, that a darker race inhabits the region of maximum rainfall on the Pacific coast. Specimens in the Victoria Museum, from Vancouver Island, neither strengthen nor disprove this theory.

\*63. *Grus canadensis*. Little Brown Crane.

Passing in flocks along the shores of Puget Sound with the next species. Heard of, but not seen, in the interior of British Columbia.

\*64. *Grus mexicana*. Sandhill Crane.

Breeding in isolated pairs through the lake region of British Columbia. Young found in early July.

\*65. *Rallus virginianus*. Virginia Rail.

Tacoma, Edwards Bros.; Victoria, A. J. Maynard.

66. *Porzana carolina*. Sora.

Breeding commonly throughout British Columbia. Not seen in Washington.

\*67. *Fulica americana*. American Coot.

Oftener heard than seen about the lakes of coast and interior, where they breed.

68. *Crymophilus fulicarius*. Red Phalarope.

None seen. A female in the collection was taken by Mr. Lindley near Victoria.

\*69. *Gallinago delicata*. Wilson's Snipe.

Abundant in spring along the coast. Breeds sparingly in the east Cascade region.

\*70. *Macrorhamphus scolopaceus*. Long-billed Dowitcher.

A few seen among flocks of *Tringas* at Nisqually.



\*71. *Tringa canutus*. Knot.

Sparingly associated with preceding during spring migration along the coast.

72. *Tringa minutilla*. Least Sandpiper.

Six seen and two shot at Nelson. Breed sparingly by the lakes of Okanagan Valley and Rocky Mountain districts. Migrant on coast of Washington and Vancouver Island.

73. *Tringa alpina pacifica*. Red-backed Sandpiper.

Abundant about coast waters in spring. None seen during breeding season.

74. *Ereunetes occidentalis*. Western Sandpiper.

Common on coast in spring and breeding in suitable parts of the interior. Two male specimens from Tacoma and Victoria are smaller than the minimum measurements assigned by Mr. Ridgway to *occidentalis* but their bills exceed the average for *pusillus*. Coloration in all is that of *occidentalis*. Perhaps, if Mr. Chapman's specimen of "*pusillus*," taken at Ducks, British Columbia, shows rusty tinge of upper parts, it may be considered a dwarf example of the western species.

75. *Totanus melanoleucus*. Greater Yellow Legs.

Found along coast during migrations. Breeding about inland lakes as far south as Clinton. At this season both sexes stand sentinel on the tops of trees in the vicinity of the nest, rarely alighting on the ground during the presence of an intruder. The newly fledged young often follow the example of their parents in this respect. From this elevated position the male keeps up an incessant clamor throughout the day. One series of notes, uttered only during periods of fancied security, is peculiar and unquestionably a love song.

\*76. *Totanus flavipes*. Yellow Legs.

One seen (?) at Nisqually. Specimen seen in central British Columbia.

77. *Actitis macularia*. Spotted Sandpiper.

Two seen on the shores of Puget Sound. Rare at Tacoma. Fairly abundant about all interior lakes.

78. *Numenius longirostris*. Long-billed Curlew.

Seen at Victoria and Lulu Island in May. Breeding at Lac La Hache and Vernon.

**THIS PAGE IS LOCKED TO FREE MEMBERS**

Purchase full membership to immediately unlock this page

# DELVE INTO FANTASY, MAGIC, MYTHOLOGY & FOLKLORE

Forgotten Books'  
Full Membership gives  
access to 797,885 ancient  
and modern, fiction and  
non-fiction books.

**Continue**

\*Fair usage policy applies

become naturalized and abundant throughout the settled parts of Vancouver Island.

**87. *Dendragapus obscurus fuliginosus*. Sooty Grouse.**

Abundant everywhere and at all elevations west of the Cascades. This form reappears on the higher areas of increased rainfall between the Rocky Mountains and Cascades in British Columbia.

**88. *Dendragapus obscurus richardsonii*. Richardson's Grouse.**

Everywhere throughout the interior of British Columbia. A complete series of this race from all parts of British Columbia compared with a like series of *fuliginosus* will be likely to present certain facts of distribution and differentiation quite at variance with our present view of the subject.

**89. *Dendragapus franklinii*. Franklin's Grouse.**

Numerous on the slopes and summits of the higher mountains of the mainland to and including the Cascades and Rockies. On the Cascades as far south as Naches Pass, Washington.

**90. *Bonasa umbellus togata*. Canadian Ruffed Grouse.**

**91. *Bonasa umbellus sabini*. Oregon Ruffed Grouse.**

Specimens from districts between Cascade and Rocky Mountains in British Columbia are pretty uniformly colored, one male alone showing red phase of *sabini*. Intermediates nearly connect the grayest coast specimens of *sabini* with darkest examples of *togata* from the interior. A male *sabini* from Lulu Island has a nearly typical *togata* tail. I find no eastern specimens in the Academy's collection comparable in grayness with any from British Columbia or Washington.

**\*92. *Bonasa umbellus umbelloides*. Gray Ruffed Grouse.**

Of the Ruffed Grouse found in the Rocky Mountains at Field I failed to secure specimens. Mr. Fannin classes them as *umbelloides*.

**93. *Lagopus rupestris*. Rock Ptarmigan.**

Summits of Cascades, Clinton, Lac La Hache; also on summits of Rocky Mountains, Field, Hector, Ottertail. Abundant, descending to 4,000 feet in winter.

**\*94. *Lagopus leucurus*. White-tailed Ptarmigan.**

Residents inform me this species is also found sparingly in winter in Kicking Horse Pass, British Columbia. One obtained at Hector examined. Reported from Soues Mountain, Clinton, by Mr. Jos. Smith, also from Mount Tacoma, Washington; Edwards Bros.

95. *Pediocaetes phasianellus columbianus*. Columbian Sharp-tailed Grouse.

Abounding in central British Columbia. This Grouse is not essentially a plain-haunting bird. I found them frequent on the densely wooded plateau extending from Clinton to 108-Mile House, Cariboo Road in country 5,000 feet above the sea level.

96. *Columba fasciata*. Band-tail Pigeon.

Found at Tacoma, Vancouver Island and Lulu Island. Not met with elsewhere nor reported from east of Cascades.

97. *Zenaidura macroura*. Mourning Dove.

Sparingly represented in interior of British Columbia as far north as Clinton.

\*98. *Pseudogryphus californianus*. California Vulture.

Seen on Lulu Island as late as "three or four years ago" by Mr. W. London. "None seen since, used to be common."

\*99. *Cathartes aura*. Turkey Vulture.

Numerous on Puget Sound. In greatly diminished numbers over the whole Province of British Columbia as far north as Lac La Hache.

100. *Circus hudsonius*. Marsh Hawk.

Noted at every stopping place. Nowhere abundant.

101. *Accipiter velox*. Sharp-shinned Hawk.

Cosmopolitan but not abundant.

102. *Acciptier cooperi*. Cooper's Hawk.

Distribution general. Breeding at Lac La Hache. Rocky Mountains, 7,000 feet. Rare.

\*103. *Accipiter atricapillus*. American Goshawk.

Seen only at Vernon.

\*104. *Buteo borealis calurus*. Western Red Tail.

Distribution and abundance like that of the eastern form. Breeding near the summits of Rockies at Field.

\*105. *Buteo lineatus elegans*. Red-bellied Hawk.

Hawks, presumably of this species, were thrice seen in the British Columbia interior.

106. *Buteo swainsoni*. Swainson's Hawk.

Breeds in the arid, mountainous interior. In July I found them abundant on the higher unwooded elevations at the head of Okanagan Lake near Vernon. One evening they congregated about the

summit of a rocky eminence, 3,000 feet above the lake, to the number of three or four hundred, every large boulder seating one or more birds, and many others sitting contentedly on the flat ground. Ninety per cent of those which flew near me were in the dark phases of plumage, some of them appearing uniformly black as they swept past. Three females secured had the crop stuffed exclusively with grasshoppers.

\*107. *Archibuteo lagopus sancti-johannis*. American Rough-legged Hawk.

One seen at Vernon, and a specimen seen at the same place in the collection of Mr. Pound. Another, shot on Vancouver Island, is in the possession of Mr. Lindley, of Victoria. Considered a very rare bird on the Pacific Coast.

\*108. *Aquila chrysaetos*. Golden Eagle.

Seen two or three times in the interior mountains. As rare in British Columbia as on the Atlantic seaboard.

\*109. *Haliaeetus leucocephalus*. Bald Eagle.

As omnipresent in British Columbia and Washington as the lakes and streams.

\*110. *Falco peregrinus anatum*. Duck Hawk.

Rare. I refer two specimens seen east of the Cascades to this species. They reach the Pacific.

\*111. *Falco peregrinus pealei*. Peale's Falcon.

Mounted specimens seen in the shop of Mr. Inglis, of Vancouver, British Columbia. Duck Hawks of both (?) races were seen at Nisqually.

112. *Falco columbarius*. Pigeon Hawk.

A mated pair shot at Lac La Hache.

113. *Falco columbarius suckleyi*. Black Merlin.

Examples seen on the coast should be classed under this name, though Mr. Fannin has found both west of the Cascades. A specimen from Victoria is in the collection.

114. *Falco richardsonii*. Richardson's Merlin.

One shot at the head of Okanagan Lake.

115. *Falco sparverius*. American Sparrow Hawk.

Everywhere the most abundant Raptore.

\*116. *Pandion haliaetus carolinensis*. American Osprey.

Wherever fish abound in the northwest these fishermen have "preempted the claim."

\*117. *Asio wilsonianus*. Long-eared Owl.

Rare everywhere, but likely to turn up anywhere in Washington or British Columbia. Tacoma, Edwards Bros.

118. *Asio accipitrinus*. Short-eared Owl.

Vancouver and Lulu Islands; at Nisqually and about the lakes of the interior.

\*119. *Syrnium occidentale*. Spotted Owl.

A specimen taken near Tacoma by Edwards Bros. is in the collection. Others have been seen and taken in that vicinity.

\*120. *Scotiaptex cinerea*. Great Gray Owl.

One shot near Vernon was mounted by Mr. Pound last year.

121. *Nyctala acadica*. Saw-whet Owl.

An immature male taken at Vernon in July. Specimens mounted in the collections of gentlemen at Victoria, Vancouver and Tacoma.

122. *Megascops asio kennicottii*. Kennicott's Owl.

I obtained a male from Mr. Lindley, of Victoria. This Owl entirely escaped notice during my trip.

123. *Bubo virginianus*. Great Horned Owl.

124. *Bubo virginianus subarcticus*. Western Horned Owl.

\*125. *Bubo virginianus arcticus*. Arctic Horned Owl.

126. *Bubo virginianus saturatus*. Dusky Horned Owl.

A discussion of the Horned Owls of Washington and British Columbia will be found in the article in the Auk already referred to. It is probable that all the races of *Bubo virginianus* are to be found in British Columbia.

\*127. *Surnia ulula caparoch*. Hawk Owl.

Vancouver Island, W. F. Lindley. Vernon, W. C. Pound.

\*128. *Speotyto cunicularia hypogaea*. Burrowing Owl.

A special trip was made in the vicinity of Kamloops and Ashcroft for this species, but no trace remained of the colonies once existing there. The last pair known to remain in that locality lived in a badger's burrow on the bank of Thompson River, near the ferryman's house. None have been seen at Kamloops or Ashcroft since 1890.

129. *Glaucidium gnoma*. Pygmy Owl.

Interior British Columbia birds secured at Vernon are true *gnoma*. Mr. Pound says they winter there.

130. *Glaucidium gnoma californicum*. California Pygmy Owl.

Numerous west of Cascades.

131. *Ceryle alcyon*. Kingfisher.

Cosmopolitan and resident on the coast all winter.

132. *Dryobates villosus leucomelas*. Northern Hairy Woodpecker.

In a series of eight skins, one, a young female, lacks the white spotting on wing coverts characteristic of *leucomelas*. It is also much smaller than the rest, whose measurements correspond to those given by Mr. Ridgway for *leucomelas*.

133. *Dryobates villosus harrisii*. Harris's Woodpecker.

Three, of nine specimens, have unspotted wing coverts, the rest are spotted in varying degrees but less so than darkest examples of *villosus*. An adult male from Nisqually, with unspotted wing coverts, lacks the sooty suffusion of under parts in a remarkable degree.

134. *Dryobates pubescens oreæcus*. Batchelder's Woodpecker.

Mr. Fannin includes *D. pubescens* as a "common resident east of and including Cascades," a statement which my series of twenty-one specimens fails to prove. Four interior specimens contained in the Streater collection are classed as intermediates between *pubescens* and *oreæcus*. On examination I find that these agree with mine in the lack of distinct markings of lower tail coverts, one of these and six of the others showing traces of streaks on that part. In lack of white markings of wing coverts and secondaries the majority of the series agree with *oreæcus*, six being intermediate between that race and *pubescens*.

\*135. *Xenopicus albolarvatus*. White-headed Woodpecker.

This bird has a claim to notice in this paper, solely on evidence of woodsmen at Vernon, who assert they sometimes see a "little white-headed sapsucker" in the forests at the head of Lake Okanagan. The striking difference between this and any other species of Woodpecker makes this testimony worth notice.

136. *Sphyrapicus varius nuchalis*. Red-naped Sapsucker.

Generally distributed and breeding throughout the interior. Did not see it in Washington nor on the British Columbia coast.

137. *Sphyrapicus ruber*. Red-breasted Sapsucker.

A male, shot near Tacoma was the only one seen.

138. *Ceophloeus pileatus*. Pileated Woodpecker.

Found in comparative abundance everywhere.

139. *Melanerpes torquatus*. Lewis' Woodpecker.

East of Cascades only. Rare in some localities, in others abundant.

\*140. *Colaptes auratus*. Flicker.

Two specimens in the Victoria Museum appear to be unmixed *auratus*. I neither saw nor heard of pure *auratus* in the interior of British Columbia nor in Washington.

141. *Colaptes cafer*. Red-shafted Flicker.

142. *Colaptes cafer saturator*. Northwest Flicker.

While *cafer* seems to be exclusively an eastern Cascade species, *saturator* cannot be said to confine itself to the coast, examples from local areas of great rainfall in the interior being indistinguishable from ordinary Vancouver Island specimens. Hybrids between these forms and *auratus* are exceptionally abundant in the northwest and have been made the subject of a special paper in *Science*, Vol. XX, No. 514, to which the reader is referred.

143. *Chordeiles virginianus*. Nighthawk.

Abundant in all interior localities.

144. *Chordeiles virginianus henryi*. Western Nighthawk.

Had not arrived on coast during my stay. Tacoma, Edwards Bros.

145. *Cypseloides niger*. Black Swift.

First seen at Lulu Island, May 25th, and more seen on the 26th, migrating leisurely. Frequently seen in great flocks on the Thompson and over the lakes near Ashcroft. On the 7th of June my notes report "2,000 hovering low about a small lake," the only chance I had to secure specimens. They remained there all that day but were gone the next day. Occasional flocks appeared at Clinton, Lac La Hache, Ashcroft and Kamloops until June 12th. They were again seen at Vernon, June 22nd. At no time did they appear singly or in detached pairs.

The mystery of their nidification I was unable to solve, as they appeared on all occasions to be gregarious and nomadic, rarely remaining two days in the same place. None were seen on the mountains during ascent, but they frequently disappeared among them after a foray in the valley. At no time did they



display the arts indicative of the breeding period seen in other birds, not a call note or other sign of recognition being detected during my extended acquaintance with them.

146. *Chaetura vauxii*. Vaux's Swift.

Arrived April 11th, at Nisqually and May 13th at Goldstream, where they were an abundant migrant, associating at times with *C. niger*. Seen at Lac La Hache, July 1st.

147. *Selasphorus rufus*. Rufous Humming-bird.

Incredibly numerous on the coast during April migration; nesting at Nisqually while night frosts still lingered and mercury averaged 45° to 50° during the day. Scarcely less common in many parts of the interior districts and found on the summits of highest mountains, including the Rockies. Nests with eggs nearly hatched found April 18th.

\*148. *Stellula calliope*. Calliope Humming-bird.

A few very small "hummers" frequenting the interior and southern Rocky Mountain districts were probably *S. calliope*.

149. *Tyrannus tyrannus*. Kingbird.

Abundant in the interior.

150. *Tyrannus verticalis*. Arkansas Kingbird.

Finds its northern limit a few miles south of Clinton. Ranges west in the breeding season to the Selkirk Mountains. I did not find it on the coast.

151. *Sayornis saya*. Say's Flycatcher.

Not common. Same distribution as preceding species.

152. *Contopus borealis*. Olive-sided Flycatcher.

Breeding at high altitudes in the east Cascade and Rocky Mountain districts.

153. *Contopus richardsonii*. Western Wood Pewee.

Not abundant, but represented in all localities visited.

154. *Empidonax difficilis*. Western Flycatcher.

Mr. Streator says that this species, while "common in the coast region," is "more so in the interior." Not only is this disproved by the specimens taken by him but by my own skins, all of which came from west of the Cascades.

**THIS PAGE IS LOCKED TO FREE MEMBERS**

Purchase full membership to immediately unlock this page

# Know Your Bible

Forgotten Books' Full Membership provides unlimited access to more than 28,000 volumes of Christian literature for \$8.99/month

**HOLY BIBLE**

**Continue**

\*Fair use policy applies

rial to show how far *obscurus* reaches eastward, nor just where the western range of *capitalis* terminates.

164. (?) *Corvus corax sinuatus*. American Raven.

Ravens were abundant in the Cascades, rare in the Bonaparte Valley, at Lac La Hache and at Vernon, but at Nelson became abundant again. One specimen secured at the latter place approaches more nearly to *sinuatus* than *principalis*, the latter being given by Mr. Fannin for British Columbia.

165. *Corvus americanus*.  
*Corvus caurinus*. } Northwest Crow.

On the west coast crows are abundant. In the interior of British Columbia they are found in diminished numbers. Their habits and voices are essentially the same. In size they are extremely variable, the smallest individuals being found on the shores of the Pacific, the larger ones coming from the interior of British Columbia. These are connected by an unbroken series of intergrades. In coloration they are also variable, many specimens of both large and small birds differing but slightly from *americanus* of the east, but the average of all British Columbia specimens is less glossy than that of eastern birds, the reflections being confined chiefly to head, neck and wing coverts, and often lacking on lower parts. Large and small birds pair together, both east and west of the Cascades. Average measurements of northwest crows, as compared with those of birds from the Atlantic slope are decidedly less. These facts not only confirm Baird's theory that *caurinus* is a "dwarfed race" of *americanus*, but show that they, together with the larger crows of the northwest, should be separated from *Corvus americanus* of the east under the name *Corvus americanus caurinus*. A detailed discussion of the relationships of the birds in question, with tables of comparative measurements, is contained in the Auk for January, 1893.

166. *Picicorvus columbianus*. Clarke's Nutcracker.

Extending from the summits of Cascades to the summits of Rocky Mountains in summer. Rare at Clinton and Lac La Hache but wintering wherever found. The Indians declare they breed in February and again in July.

167. *Molothrus ater*. Cowbird.

A young male was shot at Vernon. Mr. D. McKinley reports them as occasionally visiting the cattle corrals at Lac La Hache.

\*168. *Xanthocephalus xanthocephalus*. Yellow-headed Blackbird.

I saw a skin of this bird, shot at Vernon. Clinton; J. Smith. Lac La Hache, McKinley Bros.; White Valley, Okanagan. Casually breeding in British Columbia.

169. *Agelaius phoeniceus*. Red-wing Blackbird.

Of very local occurrence. Found breeding at Victoria, Lulu Island and Vernon. In a series of twenty-three Washington and British Columbia skins no differences are apparent between these and Atlantic coast specimens.

170. *Sturnella magna neglecta*. Western Meadowlark.

Very rare at Lac La Hache. In all other open situations abundant, from Vancouver Island to the Rocky Mountain foothills.

171. *Icterus bullockii*. Bullock's Oriole.

Rare at Ashcroft and disappearing midway between Ashcroft and Clinton, on the Bonaparte River. More numerous at Kamloops and abundant around Swan Lake, at Vernon.

172. *Scolecophagus cyanocephalus*. Brewer's Blackbird.

Breeding in suitable localities, both east and west of Cascades to Vernon, in the south, and Lac La Hache in the north.

173. *Pinicola enucleator*. Pine Grosbeak.

East and west Cascade and Rocky Mountain regions of British Columbia. Not common.

174. *Carpodacus purpureus californicus*. California Purple Finch.

Found breeding on the coast.

\*175. *Carpodacus cassinii*. Cassin's Purple Finch.

A few examples, probably of this species, were found breeding in the interior.

176. *Loxia curvirostra minor*. American Crossbill.

Coextensive with coniferous forests at all elevations. East and west of Cascades.

177. *Leucosticte tephrocotis*. Gray-crowned Finch.

A flock of these was seen on the Rocky Mountain summits near Field.

178. *Acanthis*? Redpoll.

A Redpoll secured by Mr. Lindley at Victoria resembles *linaria* but is larger and otherwise different. From my lack of specimens of the other forms its identity remains questionable.

179. *Spinus pinus*. Pine Siskin.

A very abundant resident in all localities.

180. *Poöcaetes gramineus*. Vesper Sparrow.

Numerous in all open situations between the Cascades and Rockies as far north as Lac La Hache. The presence of birds in the Ashcroft region, so nearly identical with Atlantic coast specimens, is at variance with the prevailing tendency of western forms to supplant the Boreal in that locality.

\*181. (?) *Poöcaetes gramineus confinis*. Western Vesper Sparrow.

I wounded a singing male Vesper Sparrow near Victoria, but it was lost. Fannin calls the coast *Poöcaetes*, *P. gramineus confinis*. If it differs at all from *P. gramineus* I am disposed to think it will prove to be *P. gramineus affinis*.

182. *Ammodramus sandwichensis*. Sandwich Sparrow.

183. *Ammodramus sandwichensis alaudinus*. Western Savanna Sparrow.

Mr. Chapman having kindly loaned me the entire series of *Ammodramus* in the Streater collection, I am enabled, in connection with my own series, to trace the relations and distribution of the two forms with some exactness. Sixty-five skins from twenty localities in Washington and British Columbia, taken during regular intervals from April to October inclusive, form the basis of this examination. *Alaudinus* breeds in all localities in Washington and British Columbia, from the Rocky Mountains to the coast (including the islands), from sea level to an elevation of 5,000 feet. It probably winters sparingly on the south shores of Puget Sound, and begins to breed there the second week in April. In the interior it was not found nesting before June 1st, laying probably the latter part of May.

Intermediates referable to *alaudinus* were passing northward in flocks on Vancouver Island after typical *alaudinus* had begun to breed there. These connect so perfectly the two forms breeding respectively in Alaska and southern British Columbia that it is impossible to classify satisfactorily any but the extremes. It is on this account, probably, that Mr. Fannin has included Vancouver Island in the breeding range of *sandwichensis*. On the contrary, typical *sandwichensis* have all passed Victoria by the middle of May, leaving behind them typical *alaudinus* and a few intermediates as summer residents. In the interior this intergrading is scarcely noticeable, due, probably, to the absence of *sand-*

*wichensis* as a migrant east of the Cascades. The proportion of typical *sandwichensis* to *alaudinus* during migrations on the coast is as one in twenty, but if we include among the former the largest intermediates the proportion would be one in ten. The bulk of typical *sandwichensis* probably winter on the coast north of Victoria, while the majority of the larger intermediates found migrating at Victoria breed south of the 55th parallel. Many intermediates closely resemble *A. sandwichensis savanna*. It is probable one of these, taken in San Diego, California, by W. O. Emerson, that Mr. Ridgway has wrongly identified as belonging to the eastern race.<sup>1</sup>

\*184. *Chondestes grammacus strigatus*. Western Lark Sparrow.

Seen only at Vernon, where two pairs of adult birds were feeding their newly fledged young. This is the first authentic record of *Chondestes* north of the United States boundary.

\*185. *Zonotrichia querula*. Harris Sparrow.

A specimen of this unlooked-for species, shot by Mr. Maynard near Victoria, was shown me by Mr. Fannin. As it has not, to my knowledge, been put on record, I take the liberty of mentioning it here. It is not only the first record for British Columbia, but the first capture of the species on the Pacific side of the Rocky Mountains. It was shot early in April, 1891.

186. *Zonotrichia leucophrys intermedia*. Intermediate Sparrow.

During migrations this race is sparingly scattered as far west as Vancouver Island, where I took two specimens. It becomes more frequent on the western slope of the Cascades and in the interior I found it breeding at higher latitudes and altitudes.

187. *Zonotrichia leucophrys gambeli*. Gambel's Sparrow.

A very abundant summer resident on the coasts of British Columbia and Washington.

188. *Zonotrichia coronata*. Golden-crowned Sparrow.

In abundant flocks during our stay at Goldstream. I am inclined to doubt Mr. Fannin's statement that they are resident on Vancouver Island and would restrict their southern range in summer to the Queen Charlotte Islands.

---

<sup>1</sup> Zoe, April, 1890, p. 45.

189. *Spizella socialis*. Chipping Sparrow.

190. *Spizella socialis arizonæ*. Western Chipping Sparrow.

The Chipping Sparrows of British Columbia present color characters analogous to those already given for *Empidonax pusillus* and *E. pusillus traillii*. Measurements of six specimens from Victoria coincide with those of average *socialis*. In color they are like *socialis*, being darker on under parts than *arizonæ*. In color of upper parts many may be referred to either or both forms with equal propriety. In fact, differences between breeding specimens, now before me, of *socialis* and *arizonæ*, from such widely remote points as Fort Simpson, Philadelphia, California and central Mexico, are so slight and inconstant as to make their separation of questionable import, I would refer all British Columbia specimens collected by Mr. Streater and myself, including those from the coast, to *socialis*, with the exception, possibly, of six skins collected at Ashcroft, which I agree with Mr. Chapman in calling "intermediates." Average measurements of the eastern and western forms as given by Mr. Ridgway, with those of specimens from Ashcroft and Victoria, are appended:

	Wing.	Tail.	Exposed Culmen.
Socialis	2.75	2.47	.35
Arizonæ	2.88	2.51	.35
Ashcroft	2.75	2.32	.35
Vancouver Island	2.77	2.37	.35

191. *Spizella breweri*. Brewer's Sparrow.

I was induced by the unusually sweet song of a "chipping sparrow" in the pine-wood mountains above Ashcroft, to shoot it. It proved the only specimen of Brewer's Sparrow noted during the trip.

192. *Junco hyemalis oregonus*. Oregon Junco.

193. (?) *Junco hyemalis shufeldti*. Rocky Mountain Junco.

After comparing my series of thirty Juncos from British Columbia and Washington with Mr. Chapman's lengthy discussion of the Streater series, I cannot say that he has characterized any constant differences between eastern and western Cascade forms. The extent of black markings and intensity of color shows itself to be dependent mainly on the make-up of the skin and the season in which it was taken, and the white areas on the rectrices of my series show

decidedly that this character has no diagnostic value whatever. How Mr. Coale's type of *shufeldti* can be, as Mr. Chapman says, "intermediate" between coast and interior birds from British Columbia I cannot conceive. It is highly probable that the Juncos of western North America are as susceptible to local differences of environment occurring throughout their extensive breeding range as any other genus in the country and that a recurrence of any form is liable to happen at any isolated point where physical conditions are duplicated. A thorough overhauling of the group on this principle may yet rescue it from the sacrilegious hands of the species hunter and synonymist. I think it is safe to say that birds indistinguishable from *oregonus* breed on the better-watered mountains of interior British Columbia. The only approach to "*shufeldti*" (sic) is found in birds from the most arid lowlands and most eastern Rockies, but their differences are too slight and fortuitous to warrant a distinction.

**194. *Melospiza fasciata guttata.* Rusty Song Sparrow.**

Specimens collected during the breeding season show that *Melospiza fasciata rufina* is not present on the southern coasts of British Columbia at that time. The distribution of *guttata* in Washington and British Columbia is singularly uniform in all kinds of localities, no difference between coast and interior individuals being apparent.

**195. *Melospiza lincolni striata.* } Lincoln's Finch.  
*Melospiza lincolni.* }**

As given in my notice of this species in the Auk, further material from the type district of *striata* shows that the characters assigned to that race are too slight and variable to distinguish it from *lincolni*. Since the paper referred to went to press I have received Mr. Brewster's series of *striata* but see no reason to alter my previous statements regarding that race.

**196. *Passerella iliaca unalaschensis.* Townsend's Sparrow.**

**197. *Passerella iliaca schistacea.* Slate-colored Sparrow.**

Fifty-two skins of *unalaschensis*, including the Smithsonian Institution series and those collected by Mr. Streater, present the subjoined facts. Starting in the Rocky Mountains, we have first a light gray specimen of typical *schistacea* from Nelson; going west we find another slightly darker and another of the same shade with slightly larger bill which Mr. Chapman labels "sub-sp. nov.," both of which are *schistacea* intermediates. From the west Cascades, British Col-



umbia, Western Oregon and Washington we find average *unalaschensis*. Two winter specimens from Vancouver Island show the extreme of the melanistic coast tendency, being nearly black and very dark specimens from Kalama, Washington and Humboldt Bay, California, show the direction and extent of the migration of this phase along the coast. Alaska specimens are lighter, three from Koniusk Island being nearly as light above as *schistacea*, so that extremes of dark and light from south and north, respectively, appear like distinct species, but they are connected by a perfect intergradation. Winter specimens of *schistacea* all come from California, while all Oregon specimens are winter *unalaschensis*. British Columbia thus forms common ground for *unalaschensis* and *schistacea*, the Cascades being the habitat of intermediates in the breeding season. *Unalaschensis* breeds on Vancouver Island and northward. While *unalaschensis* from north Alaska is nearly as light as *schistacea*, there is a marked difference between the two, the former retaining the brown shade above as contrasted with the ashy cast of upper parts in the latter.

**198. *Pipilo maculatus megalonyx*. Spurred Towhee.**

Abundantly haunting the woodlands of the interior in all localities visited, up to 4,000 feet.

**199. *Pipilo maculatus oregonus*. Oregon Towhee.**

Replacing *megalonyx* west of the Cascades. Its exact counterpart in habits and habitat.

**200. *Habia melanocephala*. Black-headed Grosbeak.**

Not met with alive. Many skins from parts of Washington and British Columbia examined.

**201. *Passerina amoena*. Lazuli Bunting.**

This beautiful finch is very abundant between the coast range and the Rockies, but does not extend farther north than Bonaparte. Its habitat, in this respect, coincides with that of other species of southern extraction in British Columbia.

**202. *Piranga ludoviciana*. Louisiana Tanager.**

Fairly abundant and uniformly distributed over the coasts, islands and mainland of Washington and British Columbia.

**203. *Progne subis*. Purple Martin.**

Only one specimen, a male from Victoria, being secured, it is difficult to state whether the Martins of Vancouver Island belong to

**THIS PAGE IS LOCKED TO FREE MEMBERS**

Purchase full membership to immediately unlock this page

# DELVE INTO FANTASY, MAGIC, MYTHOLOGY & FOLKLORE

Forgotten Books'  
Full Membership gives  
access to 797,885 ancient  
and modern, fiction and  
non-fiction books.

**Continue**

\*Fair usage policy applies

tions, mostly inhabiting the tops of loftiest Coniferæ. Coast and interior specimens are alike.

**215. *Vireo huttonii* (obscurus.) Anthony's Vireo.**

May be considered a rare visitor to Vancouver Island. I secured one near Victoria. This specimen, also two secured by Mr. Maynard in the spring of 1891, near the same place, are of the strongly marked race of *huttonii*, proposed by A. W. Anthony in 1890.<sup>1</sup>

**216. *Helminthophila ruficapilla gutturalis*. Calaveras Warbler.**

Two examples of the Calaveras Warbler were taken at Vernon and others were seen at Nelson. They may be considered as neither rare nor abundant in British Columbia.

**217. *Helminthophila celata*. Orange-crowned Warbler.**

Five specimens from the interior of British Columbia are distinguishable from the coast form, which does not appear to cross the Cascades. This species is sparsely scattered over the whole interior region.

**218. *Helminthophila celata lutescens*. Lutescent Warbler.**

A very abundant summer resident on the Pacific slope, coast and islands. All but one of the series can be separated from *celata* by the darker yellow lower tail coverts.

**219. *Dendroica aestiva*. Yellow Warbler.**

The most omnipresent and abundant species of the genus.

**220. *Dendroica coronata*. Myrtle Warbler.**

I did not meet with the "Yellow-rump" east of the Cascades, but found it associating with *D. auduboni* in Vancouver Island and Washington during the migrations. It is much less abundant than *auduboni*. The distribution of this bird in British Columbia is, in some respects, unique.

**221. *Dendroica auduboni*. Audubon's Warbler.**

Abundant summer resident everywhere.

**222. *Dendroica maculosa*. Magnolia Warbler.**

A specimen taken at Field and two or three observed at Vernon entitle this species to a place in the fauna of British Columbia.

**\*223. *Dendroica nigrescens*. Black-throated Gray Warbler.**

On Vancouver Island the peculiar song of *nigrescens* was occasionally detected but no birds secured. I feel quite sure that I saw a pair on the mountains near Clinton.

---

<sup>1</sup> Zoe, Dec., 1890, p. 307.

224. *Dendroica townsendi*. Townsend's Warbler.

Rare east of Cascades, but abundant in Washington and on Vancouver Island.

225. *Seiurus noveboracensis notabilis*. Grinnel's Water Thrush.

Found breeding along interior streams. Lac La Hache and Bonaparte.

226. *Geothlypis macgillivrayi*. Macgillivray's Warbler.

Found breeding at all localities and elevations.

227. *Geothlypis trichas occidentalis*. Western Yellow-throat.

Rare on Vancouver Island. Abundant at Lulu Island and about the shores of reedy lakes in the interior of British Columbia.

228. *Icteria virens longicauda*. Long-tailed Chat.

In the bushes which line the banks of the Thompson River below Ashcroft I secured two males of this species. Another was heard singing on a ranch above the town. Fort Lapwai, Idaho, was heretofore the most northern record for this Chat.

229. *Sylvania pusilla*. Wilson's Warbler.

*Sylvania pusilla pileolata*. Pileolated Warbler.

The series of Wilson's Warblers taken in eastern and western British Columbia, compared among themselves and with specimens from the Atlantic States, are devoid of any differences which would justify their separation. There is a singular uniformity in the average measurements of specimens from all localities and, saving two specimens from Vancouver Island which show deeper yellow on the forehead, their coloration is remarkably uniform. Judged by the specimens examined, there is not, when we consider its transcontinental range, a more "hard and fast" species than *Sylvania pusilla*.

North of the United States *S. pusilla pileolata* has no better claim to recognition than *Dendroica aestiva morcomi*.

230. *Setophaga ruticilla*. Redstart.

Well represented all over interior British Columbia.

231. *Anthus pensilvanicus*. American Pipit.

Washington and the Province of British Columbia at large. Breeding sparsely on the plateaus and mesas of the interior, up to 4,000 feet.

232. *Cinclus mexicanus*. American Dipper.

Associated with all dashing streams, from the mountains to the sea.

**233. Galeoscoptes carolinensis.** Cat Bird.

Not abundant anywhere and very local in its distribution. It does not appear to get farther north than Clinton. The brownish cast of upper parts, especially on the crown, rarely seen in eastern skins, is very marked in some British Columbia examples and is present in nearly all of them. Western birds average darker beneath than specimens from the Atlantic coast. Measurements of thirteen specimens (including the Streater series) from British Columbia, give the following averages as compared with those of a series of ten from the eastern United States.

	Wing.	Tail.	Exposed Culmen.	Tarsus.
British Columbia	2.58	3.78	.62	1.10
Atlantic States	3.54	3.75	.63	1.12

Both of these differences and those of coloration are too slight and variable to warrant any subdivision of the species.

**\*234. Salpinctes obsoletus.** Rock Wren.

Found about Ashcroft and northward to Cache Creek; also at Kamloops where one was nesting in a "section house," ten feet from the railroad tracks. Five specimens from Ashcroft do not materially differ from Arizona and Utah skins.

**235. Thryothorus bewickii spilurus.** Vigor's Wren.

Abundant in the west Cascade region of Washington and British Columbia. It is doubtful whether this species ever crosses the coast mountains to the interior, it being essentially a lover of lower levels.

**236. Troglodytes aedon parkmanii.** Parkman's Wren.

I never found Parkman's Wren above the 2,000-foot limit. It is not as abundant or evenly distributed in the interior as coastwise.

**237. Troglodytes hiemalis pacificus.** Western Winter Wren.

Abounding on the coast. Two moulting birds from the Selkirk Mountains near Nelson are even darker than skins from Puget Sound. I did not find any Winter Wrens in the arid interior of British Columbia west of the Gold Range, nor at Lac La Hache. The reappearance in the Selkirks of typical *pacificus* and its absence again from the Rockies at Field tallies perfectly with the alternating climatic conditions already pointed out as occurring across this vast area. Dr. Merriam calls the Winter Wren found by him in the Saw Tooth Mountains, Idaho, *hiemalis*.

238. *Cistothorus palustris paludicola*. Tule Wren.

Breeding over the lake country east of Cascades. I found it abundant at Lac La Hache. It must range much farther north than this, probably (G. Hamilton) to Stewart's Lake, British Columbia, latitude 54°.

239. *Certhia familiaris montana*. Rocky Mountain Creeper.

Rare in British Columbia. A male Creeper from Nelson appears to be *montana*.

240. *Certhia familiaris occidentalis*. California Creeper.

Neither rare nor common on the Pacific slope. Rare at Nisqually. Probably reappears on interior mountain peaks.

241. *Sitta carolinensis aculeata*. Slender-billed Nuthatch.

One specimen was taken at Tacoma. It is rare on the coast but abounds in the wooded hills of the interior of British Columbia.

242. *Sitta canadensis*. Red-bellied Nuthatch.

East and West of Cascades; also in the Rocky Mountains.

243. *Sitta pygmæa*. Pygmy Nuthatch.

Only found, and that sparingly, at Vernon.

244. *Parus atricapillus septentrionalis*. Long-tailed Chickadee.

Abound in the inter-mountainous region of British Columbia, up to 3,000 feet.

245. *Parus atricapillus occidentalis*. Oregon Chickadee.

Abound in the coast region.

246. *Parus gambeli*. Mountain Chickadee.

Found in the interior mountains of British Columbia but not in the Rockies.

247. *Parus hudsonicus columbianus*, subsp. nov. Columbian Chickadee.

Four specimens of this strongly differentiated ally of *hudsonicus* were secured in the high mountains surrounding Field, British Columbia. They were abundant in the deepest and darkest recesses of the coniferous forest, associating in flocks of ten to twenty individuals after the familiar manner of the genus. A description of this new form having already appeared in the Auk, it is useless to refer to it further here except to say that it is larger and darker than *hudsonicus*, with a much larger bill and with the throat patch jet black instead of brownish-black.

**248. *Parus rufescens*.** Chestnut-backed Chickadee.

Very common on the coast and Islands but never found east of the Cascades.

**249. *Regulus satrapa olivaceus*.** Western Golden-crowned Kinglet.

I can find no color difference between the east and west Cascade Kinglets. In this respect they agree with the British Columbia Winter Wrens.

**250. *Regulus calendula*.** Ruby-crowned Kinglet.

Numerous on the coast in spring. Breeding in the interior. The nuptial song of this tiny bird is a truly marvellous production. Perched in the top of a giant fir it will remain motionless for thirty minutes at a stretch, singing an incessant hurly-burly loud enough to be heard half a mile away.

**251. *Myadestes townsendii*.** Townsend's Solitaire.

I secured a Solitaire on Vancouver Island in May. They were met with at high altitudes on both slopes of the Cascades, Selkirks and Rockies, as far north as the 52nd parallel, increasing in abundance eastwardly.

**252. *Turdus fuscesens salicicolus*.** Willow Thrush.

In all visited localities of the interior. Breeding at Lac La Hache. This extends Mr. Streater's nesting record of the species 150 miles farther north.

**253. *Turdus ustulatus*.** Russet-back Thrush.

Abundant coastwise.

**254. *Turdus ustulatus swainsonii*.** Swainson's Thrush.

A female and young male in nesting plumage shot at Nelson where they were fairly abundant.

**255. *Turdus aonalaschkae*.** Dwarf Hermit Thrush.

On the coast in migrations. Probably breed in the Cascades and mountains of Vancouver Island. I was surprised to again meet this species at Field, where I saw many and secured three birds. One of these in spotted nesting plumage proves that the summer habitat of the Dwarf Thrush is far more extended than formerly supposed and accounts for the appearance of this form in Utah and Nevada in fall migrations.

**256. *Turdus aonalaschkæ pallasii*.** Hermit Thrush.

That *pallasii* and not *auduboni* breed in the region around Lac La Hache is attested by certain skins in the collection. Neither

form was found in any other part of British Columbia. If it be found that *aonolaschkæ* and *pallasii* breed indifferently across common ground in the interior and Rocky Mountain regions of British Columbia, without the intervention of intermediates, a more complete separation of the two than is now recognized must be made. At least two points are established by skins in the collection—1st, the breeding of *aonolaschkae* in the Rocky Mountains of British Columbia; 2nd, the breeding of *pallasii* west of the Rockies and south of the 52nd parallel.

**257. *Merula migratoria propinqua*.** Western Robin.

Uniformly abundant everywhere.

**258. *Hesperocichla naevia*.** Varied Thrush.

Abundant on the coast, but by no means confined thereto, being found at high altitudes on all the mountains of the interior to the Rocky Mountain summits.

**259. *Sialia mexicana*.** Western Bluebird.

Not common anywhere but less so in the east Cascade districts where it does not range beyond the Transition Zone.

**260. *Sialia arctica*.** Arctic Bluebird.

Abundant in northern and western interior portions of British Columbia.

A tabulated list of all the specimens forming the author's collection of British Columbia and Washington birds, including those collected by Messrs Morris and Evans in the same region, is appended. The collection has been recently purchased by the Academy of Natural Sciences.



	Puget Sound, Wash.	Vancouver Isl., B. C.	Lulu Isl., B. C.	Ashcroft, B. C.	Bonaparte, B. C.	Clinton, B. C.	Lac La Hache, B. C.	Kamloops, B. C.	Sicamous, B. C.	Vernon, B. C.	Nelson, B. C.	Field, B. C.
<i>Colymbus auritus</i>				1								
<i>Podilymbus podiceps</i>		4										
<i>Urinator imber</i>							2					
<i>Urinator arcticus</i>	1											
<i>Synthliboramphus antiquus</i>		1										
<i>Brachyramphus marmoratus</i>		2										
<i>Larus glaucescens</i>	1											
<i>Larus occidentalis</i>	2											
<i>Larus californicus</i>	1											
<i>Larus delawarensis</i>	4											
<i>Larus brachyrhynchus</i>	7											
<i>Larus philadelphia</i>	10											
<i>Merganser americanus</i>	2											
<i>Merganser serrator</i>	1											
<i>Anas boschas</i>	5			1								
<i>Anas americana</i>	5											
<i>Anas carolinensis</i>	2											
<i>Anas discors</i>							5					
<i>Anas cyanoptera</i>							1					
<i>Spatula clypeata</i>	1											
<i>Dafila acuta</i>	3											
<i>Aythya vallisneria</i>	1											
<i>Glaucionetta clangula americana</i>	2						3					
<i>Glaucionetta islandica</i>							1					
<i>Charitonetta albeola</i>	5											
<i>Oidemia deglandi</i>	1											
<i>Branta canadensis</i>	1											
<i>Branta canadensis hutchinsii</i>	3											
<i>Branta canadensis occidentalis</i>	2											
<i>Ardea herodias</i>	1											
<i>Porzana carolina</i>										2		

**THIS PAGE IS LOCKED TO FREE MEMBERS**

Purchase full membership to immediately unlock this page

# Know Your Bible

Forgotten Books' Full Membership provides unlimited access to more than 28,000 volumes of Christian literature for \$8.99/month

**HOLY BIBLE**

**Continue**

\*Fair use policy applies







	Puget Sound, Wash.	Vancouver Isl., B. C.	Lulu Isl., B. C.	Ashcroft, B. C.	Bonaparte, B. C.	Clinton, B. C.	Lac I. a Hache, B. C.	Kamloops, B. C.	Sicamous, B. C.	Vernon, B. C.	Nelson, B. C.	Field, B. C.
<i>Sylvania pusilla</i>		8	1								1	1
<i>Setophaga ruticilla</i>												
<i>Anthus pensilvanicus</i>	8	1										
<i>Cinclus mexicana</i>		6										
<i>Galoescoptes carolinensis</i>					2					5	1	
<i>Thryothorus bewicki spilurus</i>	4	1	1									
<i>Troglodytes aedon parkmani</i>		3								4	1	
<i>Troglodytes hiemalis pacificus</i>	3	3									2	
<i>Cistothorus palustris paludicola</i>							2			7		
<i>Certhia familiaris montana</i>											1	
<i>Certhia familiaris occidentalis</i>	3											
<i>Sitta carolinensis aculeata</i>	1			2						2		
<i>Sitta canadensis</i>										4		
<i>Sitta pygmaea</i>										3		
<i>Parus atricapillus septentrionalis</i>					1	1	1	1		1		
<i>Parus atricapillus occidentalis</i>	8		5									
<i>Parus gambeli</i>				2	2	1	3					
<i>Parus hudsonicus columbianus</i>												4
<i>Parus rufescens</i>	10	6										
<i>Regulus satrapa olivaceus</i>	4	6	1							1	2	2
<i>Regulus calendulus</i>	2						1					
<i>Myadestes townsendi</i>		1				1						
<i>Turdus fuscescens salicicolus</i>					1	1		2		2		
<i>Turdus ustulatus</i>		9	2									
<i>Turdus ustulatus swainsonii</i>											2	
<i>Turdus aonalaschkæ</i>												3
<i>Turdus aonalaschkæ pallasii</i>							2					
<i>Merula migratoria propinqua</i>	4	5	2	1	1		3			1		
<i>Hesperocichla naevia</i>	9	4									1	
<i>Sialia mexicana</i>	2	2										
<i>Sialia arctica</i>						1		1		1		5

## FEBRUARY 7.

The President, GENERAL ISAAC J. WISTAR, in the chair.

Fifty-nine persons present.

The deaths of the following members were announced:—John Markoe, February 1, 1893; F. A. Genth, M. D., February 2, 1893.

Papers under the following titles were presented for publication:—

“Notes on some Minerals and Rocks,” by Edw. Goldsmith.

“A Contribution to the Herpetology of British Columbia,” by Edw. D. Cope.

“Pyrophyllite Slate in Northern Pennsylvania,” by Abraham Meyer.

“Notes on the Occurrence of Quartz and other Minerals in the Chemung Measures near the Line of Wyoming and Tioga Counties,” by Abraham Meyer.

## FEBRUARY 14.

The President, GENERAL ISAAC J. WISTAR, in the chair.

Forty-two persons present.

The death of Joseph C. Turnpenny, a member, July, 1892, was announced.

## FEBRUARY 21.

The President, GENERAL ISAAC J. WISTAR, in the chair.

Forty-seven persons present.

A paper entitled “Involution Form of the Tubercle Bacillus and the Effect of Subcutaneous Injection of Organic Substances on Inflammations,” by S. G. Dixon, M. D., was presented for publication.

## FEBRUARY 28.

The President, GENERAL ISAAC J. WISTAR, in the chair.

Twenty-eight persons present.

The death on the 26th inst of Mr. Jacob Binder, Curator of the William S. Vaux Collections, was announced, whereupon the following minute was adopted:—

The Academy having heard with sincere regret of the death, the 26th inst., of MR. JACOB BINDER, the Curator of the William S. Vaux Collections, it is fitting that a record be made of the society's appreciation of the loss which it has thereby sustained.

During the latter years of Mr. Binder's life, from his election to membership in January 1879 until incapacitated by the lingering illness which has just terminated fatally, his best energies have been devoted to farthering the interests of the Academy.

He performed his duties as Curator from January 1883 to January 1892, as member of the Board of Trustees of the Building Fund from January 1884 to February 1890 and as Curator of the William S. Vaux Collections since 1883, with energy, discretion and liberality. His knowledge of business details was of the utmost value in the financial administration of the society, while his personal qualities were such as to endear him to his associates.

The Academy desires to convey to Mr. Binder's wife and children the assurance of its profound sympathy in their bereavement.

On the recommendation of the Council the following were elected to constitute the Committee on the HAYDEN MEMORIAL GEOLOGICAL AWARD:—Angelo Heilprin, J. P. Lesley, Persifor Frazer, Benjamin Smith Lyman and William B. Scott.

The Council reported the election of BENJAMIN SHARP, M. D., to fill the vacancy in the Committee on Instruction and Lectures caused by the death of Mr. Isaac C. Martindale.

The following were elected members:—

Joseph Sailor, M. D., Henry Erben, Warner J. Banes, Walter Erben, Charles M. Thomas, M. D., Harold H. Kynett, M. D., Ernest La Place, M. D., Edw. C. Kirk, M. D., Henry L. Taggart, William B. Scott and H. Frank Moore.

The following were elected correspondents:—

The Rt. Hon. Lord Kelvin, Leonard Stejneger of Washington, D. C., Charles B. Cory of Boston, Mass., Arnold Lang of Jena, Germany, Robert Ridgway of New York, William Brewster of Boston, Mass. and J. A. Allen of Cambridge, Mass.

The following were ordered to be printed:—



**THE INTERPRETATION OF CERTAIN VERSES OF THE FIRST CHAPTER  
OF GENESIS IN THE LIGHT OF PALEONTOLOGY.**

BY HENRY C. CHAPMAN, M. D.

To those unfamiliar with the fact that the text of Genesis has before now constituted a subject of discussion before the Academy,<sup>1</sup> some apology on the part of the author might be thought appropriate for the introduction of such a subject for its consideration. It might naturally be supposed also that there could be but little left to say as to the interpretation of the first chapter of Genesis in the light of paleontological research, especially in view of the consideration recently given to that subject by such distinguished controversialists as Mr. Gladstone<sup>2</sup> and Prof. Huxley.<sup>3</sup> As the latter discussion, as well as many other similar ones, appears to have been based almost entirely upon the text of the English version of the Old Testament, revised or otherwise, it may not be regarded as superfluous if the order of the creation of life as given in the original Hebrew and literally translated, be compared with the order in which life appeared according to the testimony of the rocks. To those having no knowledge of Hebrew it should be mentioned that the language is an exceedingly elastic one, especially in the hands of those skilled in Hebrew exegesis—the same word having undoubtedly very many different meanings, according to the context, etc. By far the greater number of the stem words in Hebrew consist of three consonants and the system of “pointing,” or the vocalization of such stem words by the addition of points, was introduced by the Jews with the view of fixing definitely the meaning of the stem words. Thus, for example, the word אדם Adm, read in Hebrew from right to left, will mean either “he was red,” “red,” or “man,” according as אדם is written with the points, as אָדָם, אֲדָם, אֱדָם. The system of pointing or the vocalization of the stem words was, however, only introduced in comparatively recent times (in the interval between the composition of the Targum from the third to the sixth centuries and the making of grammars by the Jews in the Arabic language in the beginning of the tenth century) and therefore long after the original Manuscript

<sup>1</sup> Proc. Acad. Nat. Sciences, 1854.

<sup>2</sup> Nineteenth Century, 1885, 1886.

<sup>3</sup> Nineteenth Century, 1885, 1886—Essays upon some Controverted Questions, 1892.

**THIS PAGE IS LOCKED TO FREE MEMBERS**

Purchase full membership to immediately unlock this page

# DELVE INTO FANTASY, MAGIC, MYTHOLOGY & FOLKLORE

Forgotten Books'  
Full Membership gives  
access to 797,885 ancient  
and modern, fiction and  
non-fiction books.

**Continue**

\*Fair usage policy applies

by Symmachus ἔρπετόν, and by St. Jerome in the Vulgate, reptile. Now while it may be urged by those who favor the text of the English versions that as a reptile is a moving or creeping creature the word *shrtz* may be so translated it does not necessarily follow that all moving creatures are reptiles. It is obvious, therefore, that if the order of creation according to Genesis is to be compared at all with the order of evolution according to the testimony of the rocks, precise rather than general interpretations, as far as possible, must be offered of the Hebrew words in question. The Hebrew word *ouph*, derived from the stem word meaning to vibrate, to flutter, to fly, we have translated "birds" rather than "fowl," as there is nothing in the context to indicate that fowl especially were the first birds created. According then to the 20th verse of the first chapter of Genesis reptiles were created first and birds of some kind afterward.

It is admitted by paleontologists that the earliest formations in which the remains of reptiles have been found are of Permian age, the remains found in the earlier carboniferous strata being rather Amphibian than Reptilian in character. It is also admitted that the earliest formations in which the remains of birds have been found are of Jurassic age, a much later formation than the Permian. According to the testimony of the rocks, then, reptiles appeared first and birds of some kind afterward, and this is true even if the supposed footprints found in Triassic rocks should have been made by bird-like animals, since the Triassic as well as the Jurassic formations are of later date than the Permian. Such being the case, the sequence of life as given in the 20th verse of Genesis is the same sequence as that of the rocks. Continuing now the exposition in the 21st verse, according to the original Hebrew,

ויברא אלהים את התנינם הגדלים ואת כל נפש החיה הרמשת אשר  
שרצו המים למינהם ואת כל עוף כנף

living creature every the and great reptiles the Aleim created and  
wing of bird every the and kind their for waters the abundantly produced which moving

or according to the old and new versions "And God created great whales (O. V.), the great sea-monsters (N. V.), and every living creature that moveth which the waters brought forth abundantly after their kind and every winged fowl."

The only two words in the above verse the interpretation of which demands especial consideration are *tninm* and *rmsh*. The word *tninm* is translated in the Vulgate *cete*, and in the old English version "whales," in the Septuagint *χῆτη*, and in the new version "sea-

monster," the word used in the old English version being apparently based upon the Latin, that in the new upon the Greek translations of the Hebrew Bible. The word *tnim* is derived, according to some Hebrew grammarians from *tne*, to shriek or wail, and denotes in the form of a noun some kind of serpent, on account of the hissing noise made by such animals. By others, however, the root is supposed to be *tnn*, to extend, the noun derived from the latter indicating an elongated kind of reptile, such as a great serpent or sea monster of some kind. That the word *tnim*, however derived, refers to some kind of reptile is shown by it being rendered in the 148th Psalm, 7 verse, in the Septuagint, *δρακοντες*, in the Vulgate *dracones*, and in the English versions "dragons." While the word *tnim* might be translated "sea monsters," since reptiles like the *Dinosauria*, etc., are regarded as sea dragons in a popular sense, it is difficult to justify the rendering of the word by "whales." Further, if the latter interpretation of the word be accepted the difficulty will then present itself of reconciling the statement of Genesis that whales were created before mammals with the evidence of the rocks that goes far to prove that the whales have descended from carnivorous mammals like the seals, the *Zeuglodon*, an extinct cetacean form combining in many respects the characters of both these orders. On the supposition, however, that by *tnim* is meant reptiles of some kind there is no difficulty in reconciling the statements in Genesis with the facts of paleontology, the reptiles (*Schurtz*) appearing in Permian and Triassic times, such as *Proterosaurus*, *Nothosaurus*, *Rhynchosaurus*, etc., being followed by very different kinds of reptiles (*tnim*) in Jurassic and Cretaceous eras. Marine monsters like the *Plesiosaurus*, *Ichthyosaurus*, *Elasmosaurus*, *Edestosaurus* and land monsters of which *Hadrosaurus*, *Laelaps*, *Iguanodon* and *Megalosaurus* are examples. The Hebrew word *rmsht* being derived from the stem word *rmsb*, to move, is rendered both in the old and in the revised versions by "moveth," and in the Vulgate by "motabilem." As *rmsb* secondarily, however, means to creep or to crawl it was translated by the Seventy *ἐρπετων*. All aquatic animals that moveth, creepeth or crawleth are not, however, necessarily reptiles since there are mammals that "moveth" in the water and "creepeth" or "crawleth" out of it. Indeed, in the reference made in Gen., c. 7: v. 21, to the death of all flesh "that moveth upon the earth, both of fowl and of cattle and of beast," and in Psalm 104, v. 21, "wherein all of the beasts

of the forest do creep," the word used in the original Hebrew to express the idea of beasts moving or creeping is *rmsb*. The word *rmsb* being so associated with beasts it is as justifiable to suppose that the moving or crawling animals that the waters so abundantly produced at this period of the earth's history, "day the fifth" so-called, were aquatic mammals as that they were aquatic reptiles. Such an interpretation is consistent with the facts of paleontology, the earliest mammal yet discovered, *Dromatherium*, obtained from rocks of Triassic age and probably of monotrematous nature, being preceded by reptile-like animals, such as the theromorphric *Pelycosauria* of the Permian, described by Cope. Returning to the exposition of the 21st verse it will be observed that while in the 20th verse, in referring to the creation of birds, the Hebrew word *ouph* alone is used, in the 21st verse the same word is coupled with another word, *knp*. The word *knp*, being derived from the stem word *knp*, to cover, when used as a

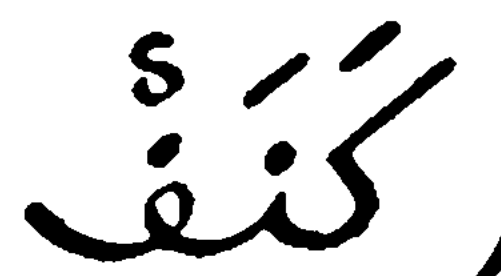
noun should be translated "wing," the Arabic word  <sup>a a un</sup> Knf having that meaning. The birds with wings, *ouph*, *knp*, were created then, according to Genesis, after the birds *ouph*, presumably without wings. The order of creation, however, is that of evolution, since the reptiles appeared first, being followed by reptile-like birds, *Compsognathus*, and bird-like reptiles, *Archeopteryx*, *Hesperornis* (Marsh.)

Passing now to the consideration of the 24th verse, containing the account of the creation of beasts, and translating the original Hebrew literally we would read as follows:

וַיֹּאמֶר אֱלֹהִים תּוֹצֵא הָאָרֶץ נֶפֶשׁ חַיָּה לְמִינָהּ

kind its for living creature the earth the forth bring shall Aleim said and

בְּהֵמָה וְרֶמֶשׂ וְחַיְתוֹ אֶרֶץ

earth the of beasts wild and thing moving and cattle

or as rendered in the old and new Versions "And God said let the earth bring forth the living creature after his kind, cattle and creeping thing and beast of the earth."

The Hebrew word *bhm* is probably derived from a stem word, *bhm*, though as a matter of fact there is no such verb in use at the present day. As the kindred words in the Arabic and the Ethiopian languages signify, however, "dumbness," the word used in Hebrew as a noun has come to be accepted as meaning "dumb beasts." According to this interpretation it was rendered by the Seventy,

*τετράποδα*, four footed and in the Vulgate, Jumenta, draught cattle. The word *rmsh* we have translated "moving thing," consistently with the interpretation already given of that word in verse 21. The word was translated *έρπετα* in the Septuagint and reptilia in the Vulgate; inconsistently in the latter case, however, as essentially the same word was previously rendered motabilem. It is difficult to understand why the word "reptile" should be associated with cattle and wild beasts as the context would lead one to suppose that at this late period in the creation of animal life beasts were more particularly created. It is immaterial, however, to the argument whether *rmsh* be translated in this verse "reptiles" or "moving, creeping or crawling creatures," since it is not to be supposed that reptiles at once ceased to appear upon the earth. The translation of the Hebrew word *hitu* admits of no discussion, being translated in the Septuagint *θηρία*, in the Vulgate *bestias* and in the English versions "beasts." It will be remembered that the first mammalia appearing upon the earth, the descendants of reptiles, were probably Monotremata, resembling the Ornithorynchus and Echidna of the present day. From such lowly organized mammalian forms descended the mammalia of the early Tertiary which in turn gave place to the mammalia of the later Tertiary and present geologic epochs. As the "beasts," "mammalia," the *bhm* of the Hebrews were created on "day the sixth," that is after the *rmsh* or promammalia, the account of the creation of the mammalia as given in Genesis is therefore consistent with the order of the evolution of the mammalia as based upon the testimony of the rocks. Resuming what Genesis states as to the creation of life, it appears, if the translation just submitted be accepted as correct, that during "day the fifth" the ancestors of the reptiles, the proreptilia, appeared upon the earth, being succeeded during that period successively by the ancestors of the birds, the pro-aves, reptiles, the pro-mammalia and birds, and that during the following period, "day the sixth," the mammalia appeared. The accompanying diagram will illustrate succinctly and genealogically the order of creation as just given.

The order of creation then, as given in the verses of the first chapter of Genesis just translated, is essentially the same order as that based upon the remains of animal life preserved in the rocks. It may be argued, however, that the account of the creation of animal life as given in Genesis is very meagre, nothing being said as to the creation or appearance of the lower forms of life, fishes even being

only incidentally alluded to in verses 26 and 28 as among the animals given to man to rule over. The prescribed limits of this essay

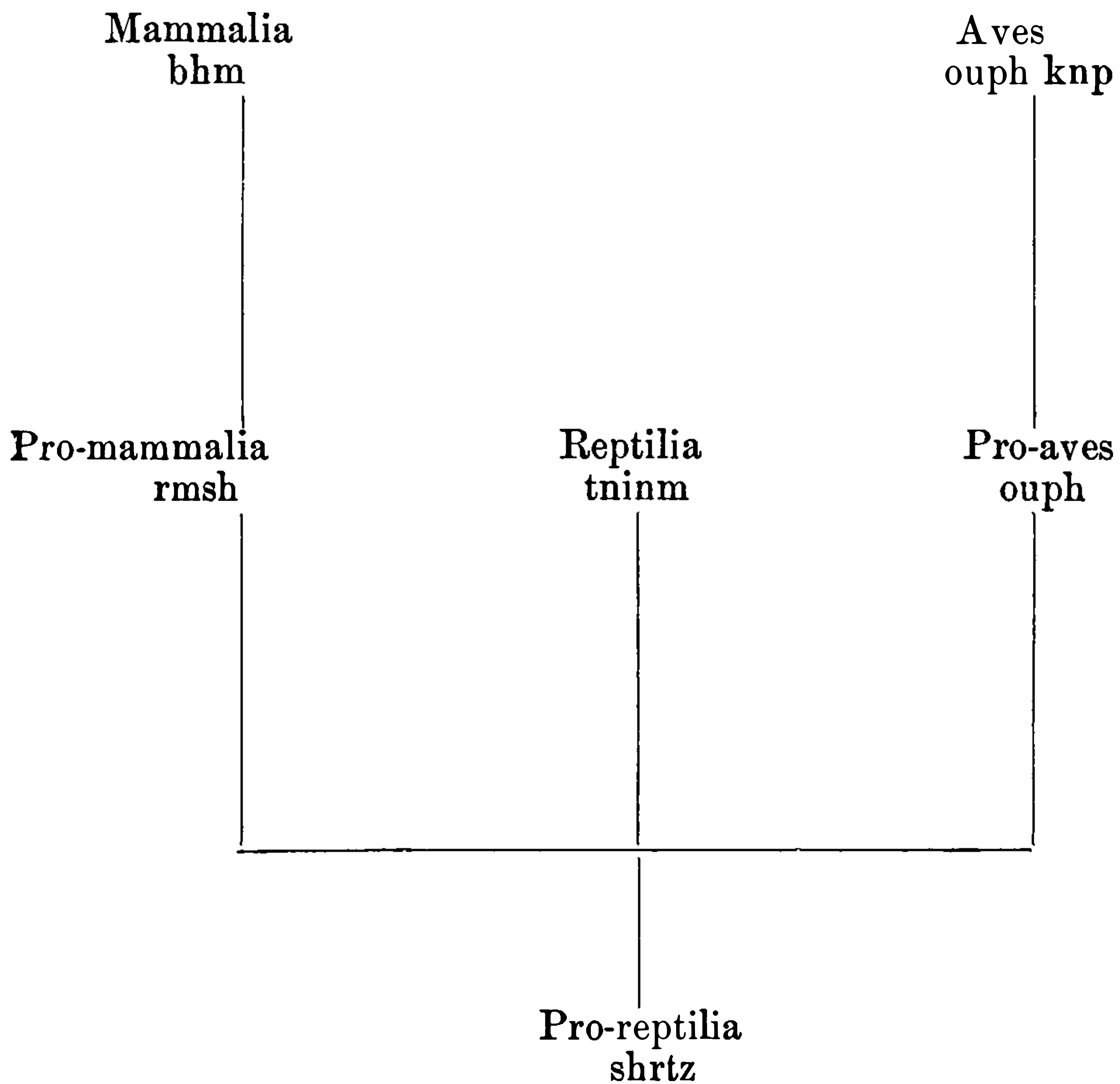

do not permit of the consideration of such meagreness, its object being simply to show that the order of creation according to the first chapter of Genesis so far as it is given, is consistent with the well established facts of paleontology.

THE INHERITANCE OF MODIFICATIONS DUE TO DISTURBANCES OF  
THE EARLY STAGES OF DEVELOPMENT, ESPECIALLY IN THE  
JAPANESE DOMESTICATED RACES OF GOLD-CARP.

BY JOHN A. RYDER.

The recent experiments in shaking apart the cells produced by the first cleavage in the eggs of Echinoderms by Driesch, and of *Amphioxus* by Wilson, as well as the experiments of Roux, in the same direction, with frogs' eggs, show that it is possible for a single one of the two blastomeres resulting from the first segmentation to produce at once a complete embryo, or at any rate to finally reconstitute the missing half by means of what Roux has called *post-generation* as in the case of the frogs' eggs.

These experiments, leading to the development of two separate embryos from the same single egg, have been regarded as so remarkable that they have caused a good deal of discussion. They are, however, it seems to me, to be regarded as having much in common with phenomena that at first thought seem to be widely distinct from them, namely, the production of monstrosities in invertebrates and vertebrates. The occasional duplication of peripheral parts also, such as the tail in lizards when broken off, and an excess of toes or fin-rays, perhaps, may be regarded as belonging ultimately to the same category of phenomena, with a similar set of causes operating to produce them, namely, profound disturbances of the normal processes of karyokinesis during development or at the moment of the beginning of the regeneration of lost parts.

Weber's experiment, reported many years ago, proving that the eggs of the common pike, *Esox lucius*, could be caused to produce double monstrosities if the recently fertilized ova were violently shaken, is well known. The experience of fish-culturists in handling the eggs of Salmonoids is also well known. A man of very great experience in the fish-cultural establishments of Austro-Hungary informed me some years since that so great was the danger in roughly handling or shaking the ova of the Salmonoids, during the very early stages of their development, that carelessness in this respect would result in producing monstrosities almost exclusively. I have myself, while employed as an assistant by the U. S. Fish Commission, seen batches of salmon brood, which were almost entirely composed of fry that had developed as double or triple monsters, each with but a single yolk.



The well-known experiments of Dareste in artificially producing monstrosities during the incubation of bird's eggs, are also well known, as well as his methods of experiment, which consisted in shaking the eggs, varnishing a portion of the shell or placing them in an abnormal position, upon one end, for example, during the early days of incubation. Similar experiments have also been made by others, that abundantly confirm the conclusion that abnormal conditions or absolute mechanical disturbances during segmentation are the causes of such duplication of the embryo. Rauber attacked the problem from a morphological standpoint and indicated in some measure the method according to which the doubling occurred in the germinal disk of the eggs of fishes, working upon the blastoderm of the eggs of the Pike, *Esox*. He showed that the embryonic axis was duplicated or triplicated, as the case might be, at the border of the blastoderm. That the distance apart of the two contemporaneously developed embryos along the rim of the blastoderm, determined the degree to which their axes would be ultimately fused or distinct when the larval development had been completed.

In the study of a series of double monsters of the common lobster, *Homarus Americanus*, I found that some similar law applied in some way, but unfortunately the very early stages were not seen, so that it could not be formulated with precision. The evidence for the existence of such a law was, however, sufficiently complete to warrant certain general deductions, since various degrees of fusion were seen which were perfectly parallel to those of fishes, except that instead of the ventral aspects being fused where the rudiments of the embryo had been first formed at  $180^\circ$  apart on the blastoderm, it was here the dorsal aspects that were fused, a fact which is as strictly in conformity with the morphology of the Arthropod series, to which the lobster belongs, as the fusion of the ventral aspect of the embryo of vertebrates is in conformity with the morphology of the adult vertebrate body.

The discovery of Kleinenberg that the embryos of certain earth-worms studied by him, were sometimes double and coherent, shows that such a method of double development is widely distributed within the series of Bilateralia or bilaterally symmetrical animals.

Such a budding or division in the embryo may indeed be looked upon as somewhat akin to the development of buds or gemmæ in the Porifera or the statoblasts of certain fresh-water Bryozoa which normally develop double embryos directly from a germinal body.

**THIS PAGE IS LOCKED TO FREE MEMBERS**

Purchase full membership to immediately unlock this page

# Know Your Bible

Forgotten Books' Full Membership provides unlimited access to more than 28,000 volumes of Christian literature for \$8.99/month

**HOLY BIBLE**

**Continue**

\*Fair use policy applies

from the stump of the old ray in a divergent fashion. This fact I have repeatedly observed, as well as the regeneration, *in situ*, of the scales, where they have been forcibly removed from the fish by accident. A case of this kind I traced and described some years ago, the subject being a fine specimen of the mirror-carp that had lost one of the large scales of the lateral line. In this case, however, there is no duplication of the scale during its regeneration.

It is also a notorious fact that when extra toes or fingers are developed in the human subject, or in a mammal, they tend to become hereditary. And the same seems to be the case with birds, in the instance of the Dorking fowl amongst domestic breeds. It is my belief from the evidence presented above that such supernumerary digits have been in the first place produced by disturbances during segmentation or karyokinesis. While the embryo was developing its digits in such higher forms and that such disturbances have been registered, so to speak, as part of the hereditary tendencies of the organism, and have thus been handed on to offspring as developmental tendencies. The tendency to reproduce supernumerary toes in the cat is well-known. The same tendency is shown in the disposition to reproduce extra thumbs or toes in certain human families. The most extraordinary of these duplications is however presented by the double or fan-tailed races of Japanese Gold-fishes, where the duplication sometimes extends even to the anal fin, so that I have elsewhere been tempted, upon the evidence presented by Dr. Watase as to the development of these fishes, to put in a plea for the actual realization of an *eight-limbed vertebrate*, a thing against which the learned Professor Haughton, of Dublin, has argued with his wonted acumen, in a still earlier paper touching the utility of the four-limbed condition of the higher vertebrates.

I believe, however, now that the key to the mystery of the production of the double-tailed gold-fishes is within our reach in the light of the evidence presented above, that we can guess how the Japanese went to work to produce their singular breeds of *Carassius auratus*. I believe, in short, that their practice was very simple, and that they have probably antedated the practical application of the facts of experimental embryology, as known in Europe and our still more western civilization, by several centuries. Since the Japanese records of some of these breeds are very old, as well as the fact that the work of the Marquis de la Savigny, figuring the breeds of these fishes, was published in 1790, we can infer for them an antiquity of, at the very least, a couple of centuries.

Now as to how the Orientals accomplished the production of double-tailed forms of fishes. I believe they did this by taking the eggs of the normal species of gold-fishes and shaking them, or disturbing them in some way, as did Professor Weber with the eggs of the pike. They would thus get some complete double monsters, some with two heads and a single tail, and some with double tails. Manifestly the complete double monsters would be unlikely to survive. Those most likely to survive would be those with only a duplication of the tail. These being selected and bred would in all probability hand onward the tendency to reproduce the double tail, a tendency which could become very fixed and characteristic if judicious selection were maintained by interested fanciers and breeders, such as are said to exist in Japan, where these fishes of the finest double-tailed races command high prices amongst the wealthy and cultivated classes.

If the remarkable peculiarities of the Japanese Gold-fishes were produced as suggested above, and there seems to be no more likely method of their origination, the whole question of the inheritance of mutilations is reopened from a totally new point of view, and one that cannot be assailed by Weismann and his following with much show of success from their present attitude toward these questions. It is clear, however, that we have here a most promising field for experimental inquiry and one that should be at once cultivated in a practical way.

That the direction of the regeneration of lost parts may be affected by the plane of mutilation is sufficiently well attested by the experiments of Barfurth on the tails of tad-poles, some of which I have successfully repeated. If the tip of the tail were snipped off exactly at right angles to the axis of the body, the tail was regenerated of the normal form and straight backward. If at an acute angle, regeneration took place so that the new tip was directed either upward or downward, according as the inclined, regenerating cut surface looked upward or downward. Such facts cannot be dismissed as useless in connection with the problem of inheritance in general, if they have any bearing upon the questions raised in connection with the inheritance of mutilations as viewed in the preceding discussion. It is not unlikely that Barfurth's results do have some bearing upon these questions as here viewed. If the plane of mutilation or line of removal of digits affects their direction of growth, as seems likely from Barfurth's and my own experiments,

we know to a certainty that there is only one avenue for the access of new material during the process of regeneration of a digit for example, and that is its proximal or basal portion. Through this basal portion alone can new material reach the digit to build up its distal parts. If growth and its accompanying karyokineses were interfered with in any way across a narrow line over the stump, the regenerative energies would be caused to manifest themselves on either side of that line, and the result would be a tendency to reproduce the digits in duplicate beyond the point of mutilation, and in a divergent fashion from the basal area through which alone new material could find access by intussusception during the process of regeneration. We consequently get a mechano-physiological explanation of why it is that doubly reproduced distal parts tend to diverge from each other radially.

The same principle, together with concrescence, may be invoked, as it has been in another form, by Rauber, to explain the degree of fusion of double or triple monsters produced by shaking mesoblastic ova during their early blastodermic stages of development. But Rauber's explanation must in this case be supplemented by a consideration of the physical laws of the interfacial and free surface-tensions which condition growth during the development of a thin blastoderm in a meroblastic egg, making, for self-evident physical reasons, the production of completely separate embryos well nigh an impossibility, even by shaking or otherwise interfering with development. Even if separate germinal disks were developed on a telolecithal egg, there is every reason to believe that, as segmentation proceeded, the two resulting blastoderms would become fused by their edges as the latter advanced over the yolk and approached each other as they necessarily must in order to increase, as they do, in a geometrical ratio, their power of appropriating the stored nutritive mass of yolk. *On a priori* grounds, and for mechanical reasons, therefore, the complete separation of the germinal matter of a large-yolked meroblastic egg is impossible. The total separation of the two first blastomeres of the equally segmenting, holoblastic eggs of echinoderms and *Amphioxus*, on the other hand, is easily accomplished by mere violent mechanical interference, so that completely distinct and separate, but smaller, embryos are easily obtainable if such separated blastomeres are allowed to develop under favorable conditions.

As stated in the earlier part of this paper, the regenerative power seems, in low and primitive forms, and also in the very early stages of the highest, as shown by von Jhering in the development of Armadilloes, by what he calls *temnogeny*, or normal division and complete separation of the cells of the fertilized egg, to be most completely represented in the early blastomeres or the products of the early segmentations. In the next grade of organic types, Porifera and Coelenterata, there appears to be a wider extension upon the whole organism and its parts of this regenerative power. In bryozoa and echinoderms there is still in many forms more or less of this regenerative power distributed throughout the organism, but as specialization proceeds it seems to become less marked, and if there is disturbance of the mode of development of the Bilateralia, besides the apparently normal consecutive or linear gemmation as in *Monotus*, *Myrianida* and *Autolytus*, there is developed a tendency to double the axis so that branched or coherent double individuals arise. This reaches a most remarkable expression amongst Syllid worms, as worked out by Professor McIntosh, and may even extend to an early stage, as in the case of the production of double embryos in *Lumbricus*, according to Kleinenberg. In both the arthropod and vertebrate series disturbances of early embryonic development, affecting the order and relations of the karyokinetic processes in the blastoderm, are productive of double monstrosities variously fused, according to a law which has been to some extent defined by Rauber.

As we proceed in our review of the successively higher groups we find that this purely regenerative power becomes less and less marked. In some worms, for example, the head may be regenerated if cut off. It is doubtful whether this would be possible with even the lowest vertebrate. In the vertebrates and arthropods or highest Bilateralia, the regenerative power is reduced to the power of reproducing lost digits or entire appendages, as in crustacea. In vertebrates it is finally restricted in fishes, batrachians and reptiles to the regeneration of the tail or the distal parts of the extremities in the adult, and in the highest of these series, namely, birds and mammals, the power of the adult to regenerate lost distal parts of the extremities is also lost. Nevertheless, there remains in the tolerably advanced embryos of these forms the power to respond in a remarkable way to disturbances of the normal hereditary or regenerative processes involving the distal parts of the extremities, such as the

digits. The regenerative powers therefore seem to become diminished with the specialization of a type, and to be manifested last of all in the distal ends of the extremities. The most marked changes may occur in the way of duplication, triplication, etc., of the axis, even in the highest types, provided the development or processes of segmentation are disturbed early enough, and in some definite way. The conclusion which is warranted from the whole of the foregoing is that *the regenerative power of organisms disappears as we rise in the scale of organization, last of all in the peripheral extremital parts.* A further observation is justified, which is, that *the power to produce monstrosities or congenital aberrations of development due to external disturbances of segmentation, during growth, diminishes in the higher forms pari passu with the advance in development.* Finally, it may be affirmed with much show of probability that aberrations of development produced by disturbances of the processes of segmentation during growth, may become hereditary, as illustrated by the probable inheritance of partially duplicated axes in the tails of Japanese gold-fishes, or of supernumerary digits in many mammals and in Man.

How such new parts, originated as here supposed, can transmit to the ova of the parent body, of which they form a part, a tendency to cause them (the new characters) to reappear in the offspring developed from such ova or germs, cannot be explained without supposing that the new part of the body of the parent influences at a distance the characters and potentialities of the germinal matter produced by it in its gonads. The difficulties in the case of the partly double body of the Japanese Gold-fishes are peculiar, in that we have to assume that hereditary tendencies are transmitted from a parent body and part of another of each sex, making in all, tendencies transmitted from two bodies and parts of two others, in the course of the ordinary sexual reproduction of the double-tailed species, since there cannot be the slightest doubt that, in this case, we have to deal with partially double monsters (as is proved by their morphology), with normally developed reproductive powers. I confess to an utter inability to see how this can be done by means of gemmules, the oldest hypothesis of heredity, first formulated by Democritus, then restated in a more modern form by Buffon, then by Erasmus Darwin in the *Zoonomia*, and lastly by Charles Darwin. This doctrine therefore has a very respectable pedigree, but it is strange that none of the later writers credit their predecessors with

having entertained similar opinions. But to recur to my point, it is clearly certain that the partially double body of the parent in this case must have influenced the germs it inclosed at some time in the history of the race, or at the time the latter was originated by the Orientals. The first partially double, monstrous pair of gold-fishes to have offspring must have been reared somewhere in the East; whether in Corea, China or Japan does not matter. The fact that they reproduced themselves is indisputable. That they were first produced by artificial interference with, or mutilation of the normal processes of their early development becomes, in the light of what has been said above, a conclusion of the utmost probability. Weismann and his followers can take either horn of this dilemma. The inevitable conclusions are: first, that new parts of the parent body at a distance do at once, in the first generation, influence the germ-cells inclosed by such a parent body; secondly, the probability of the inheritance of the effects of certain mutilations, injuries, interferences or displacement of parts, during the early stages of development, amounts almost to a certainty.

Moreover, whereas the separation of the early cells or blastomeres in certain eggs, such as those of Armadilloes, Sea-Urchins and the Lancelet and Frog is possible, the egg in these cases being essentially holoblastic at the time of the first two cleavages, two or more completely separate embryos can be developed. The conditions of development, it must be borne in mind, in the higher series, where a blastoderm is developed, closely and firmly adherent to, the very large, nutritive yolk, are very different from the foregoing. So different indeed, are the conditions of development in these latter meroblastic forms that it would be extremely improbable that entirely separate and multiple embryos could be developed from their ova. At most only such mechanical disturbances would be possible as would lead to a more or less complete duplication, triplication, etc. of embryos. That the effects of such embryonic mutilations or interferences may be hereditarily transmitted will hardly be admitted by the anti-mutilationists, but to evade the force of these facts is impossible.

The coherence of the embryos together in meroblastic eggs, conditioned as it is by the interfacial and free surface-tensions between the blastoderm and yolk, is, it seems to me, plainly indicative of the indisputable conclusion that mutilational influences operating upon meroblastic ova are themselves influenced by mere physical condi-



tions and forces, and that even these leave a reminiscence of their effects upon the germs, the development of which they thus indirectly affect. What again shall be said in such cases of the effect of such external or physical agencies or conditions in modifying the development of future generations, as seems to be proved by the history of the domesticated races of Japanese Gold-fishes? Weismann must now own, if the preceding views can be sustained, that he is beaten upon his own ground, and also admit that he has been in error from the beginning as to the non-transmission to the germs of characters that have been acquired by the body of the parent.

The domesticated races of Japanese Gold-fishes outstrip every known form of domesticated animal in the extent to which they have been modified, and it is therefore strange that Mr. Darwin should have devoted so little consideration to them in his works, In one of his botanical works Mr. Darwin makes the suggestion that the bilateral halves of the Bilateralia may have arisen by longitudinal concrescence of two similar individuals of opposite sex. This suggestion of his, as to the origin of the bilaterally symmetrical condition, may be dismissed as exceedingly improbable and unfortunate, and as in direct conflict, moreover, with the known mode of the development of monsters with double axes. Such monstrous races, as is proved by the morphology of the adult Japanese Gold-fishes, their known analogies to the development of double vertebrate monsters, have been produced almost beyond a shadow of doubt by mutilational interference with the early processes of normal development, and this monstrous mode of development has become hereditary.

The procedure by means of which the Orientals originated their peculiar races of Gold-fishes I believe was more exactly as follows: After the blastoderm had spread over about one-third or more of the surface of the yolk, the eggs were shaken or violently disturbed. This proceeding would cause the production of one or more new embryonic axes at the rim of the blastoderm near the original axis, but the new axes would not develop a head, but would, as a result of the operation of the principle of concrescence, soon fuse with the caudal end of the original or first-formed embryonic axis. This would cause a doubling, more or less complete, of the caudal end or urosome of the embryo. In this way it may be supposed that the partially double urosome of these singular fishes

**THIS PAGE IS LOCKED TO FREE MEMBERS**

Purchase full membership to immediately unlock this page

# DELVE INTO FANTASY, MAGIC, MYTHOLOGY & FOLKLORE

Forgotten Books'  
Full Membership gives  
access to 797,885 ancient  
and modern, fiction and  
non-fiction books.

**Continue**

\*Fair usage policy applies

## I.

	Total length of head, body and urosome.	Length of body.	Length of head.	Length of intestine.	Width of end of urosome.
1 Common race.	90 mm.	62 mm.	28 mm.	364 mm.	15 mm.
2 Long-bodied Japanese double-tailed race.	74 mm.	51 mm.	23 mm.	213 mm.	10 mm.
3 Short-bodied Japanese double-tailed race.	47 mm.	28 mm.	19 mm.	226 mm.	7 mm.

with other facts, that there has been a process of degeneration at work in reducing the proportional volume of the musculature of the body and urosome in the double-tailed races. Table II gives the height of this frustum of a cone to which I have compared the musculature of the body, as well as the major diameters of the base and apex of the frustum in millimetres, for each race in absolute measurement.

## II.

	Length of caudal fin.	Distance from vent to caudal.	Width of base of muscular frustum of a cone.	Height of muscular frustum.	Width of apex of muscular frustum of a cone.
Common race.	36 mm.	25 mm.	37 mm.	62 mm.	15 mm.
Long-bodied Japanese double-tailed race.	80 mm.	19 mm.	28 mm.	51 mm.	10 mm.
Short-bodied Japanese double-tailed race.	36 mm.	10 mm.	23 mm.	28 mm.	7 mm.

In a third table I have attempted to represent the proportions of the several parts to each other, but from tables I and II, I obtain data for a more general and final fourth table in which the individuals are supposed to be of the same age, and more nearly of the same size and weight than was the material at my disposal.

## III.

	Ratio of head to length of intestine.	Ratio of total length to length of intestine.	Ratio of length of the body to the length of the intestine.	Ratio of width of urosome to total length of head, body and urosome.	Ratio of total length of the head, body and urosome to the length of the tail.
Common race.	1 : 13	1 : 4.45	1 : 5.85.	1 : 6	2.5 : 1
Long-bodied Japanese race.	1 : 9.25	1 : 2.85	1 : 4.2	1 : 7.4	1 : 8.3
Short-bodied Japanese race.	1 : 11.75	1 : 4.6	1 : 8	1 : 6.71	1.33 : 1

Taking the head as the least variable portion of the three races, and assigning to it an arbitrary value of 50 mm. in a hypothetical individual by dividing the actual lengths of the other parts in millimetres by their own length of head in millimetres, then multiplying this product by 50, I get a new set of values in which the parts are in the proportion of the preceding table, but in which the individuals are, in the case of each race, of about the same size, age and condition of volume, and consonant with the modifications that have been suffered by each one. This table is given below, and from it it is possible to plot the outlines of the three hypothetical frustums of cones that will represent approximately the condition of development of the musculature of the body and tail of the three races as seen from the side.

## IV.

	Length of intestine.	Length of head.	Height of frustum.	Diameter of major axis of base of frustum.	Diameter of major axis of apex of frustum.	Distance of anus from base of caudal.
Common race.	650 mm.	50	110.7 mm.	66.2 mm.	24.3 mm.	42 mm.
Long-bodied Japanese race.	462.5 mm.	50	110.8 mm.	65 mm.	21.7 mm.	41 mm.
Short-bodied Japanese race.	587.5 mm.	50	73.65 mm.	61.3 mm.	18.4 mm.	26.3 mm.

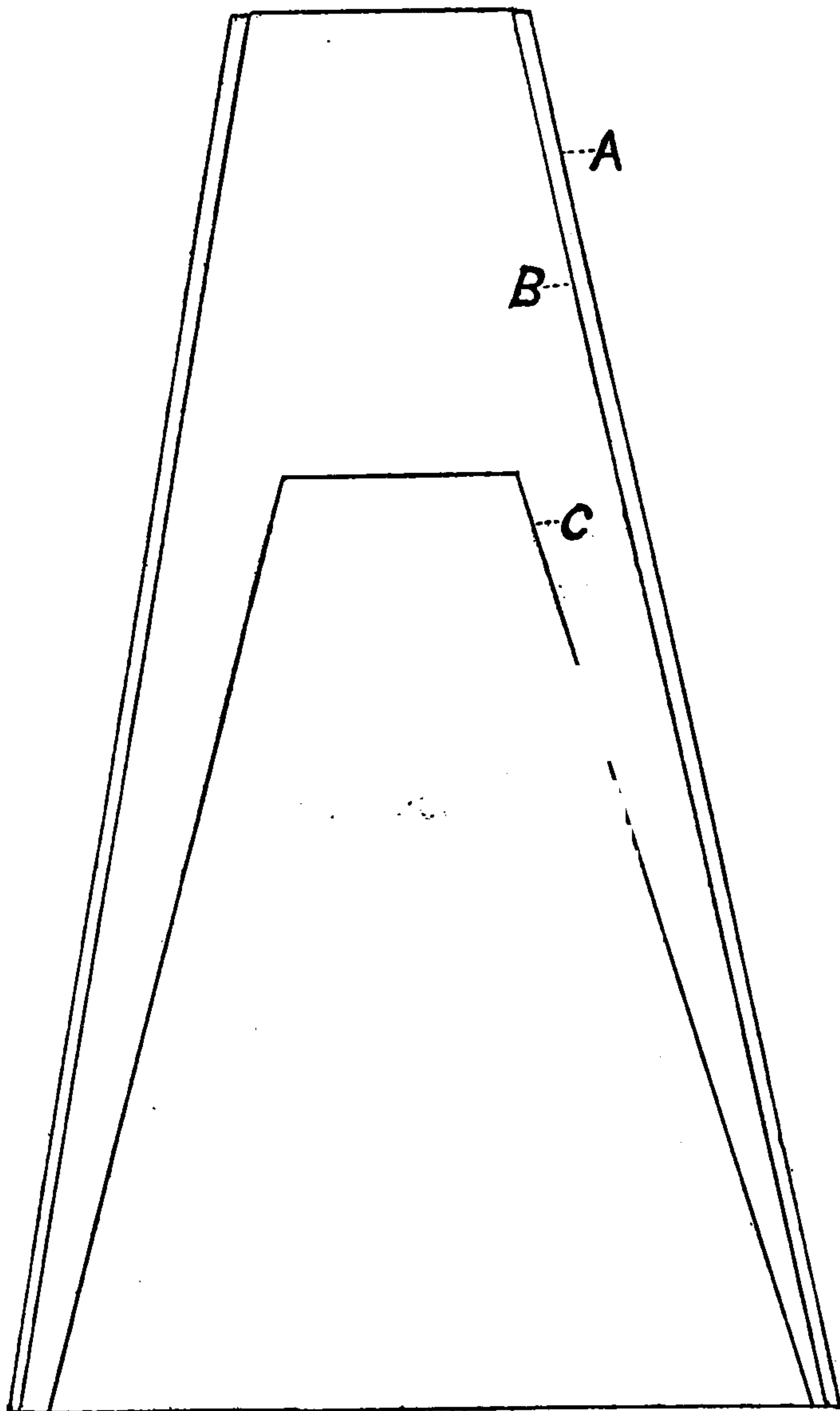

A. Outline of frustum of cone representing the musculature of body and urosome of common race of Gold-carp. B. Same of long-bodied Japanese race, reared by Dr. Wahl. C. Same of short-bodied Japanese race.

These tables and the appended diagram based upon them, it seems to me, make it tolerably certain that there has actually been a marked degeneration in the relative proportional development of the volumes of the musculature of the body and urosome or tail in two of the three races examined. Other facts, however, fortify this conclusion very strongly. The most important being the fact that the vertical rows of scales just behind the abdomen, on the sides of the urosome of the short-bodied race, overlap each other far more extensively than do those in the other two. When we

come to examine the muscular somites underlying these rows of greatly overlapping scales in the short-bodied race, we actually find them markedly shorter than those some distance behind, or those some distance in front of them. This seems to me to prove conclusively that there has been actual degeneration of the muscular system of the body or trunk, and that this degeneration is especially well marked in the short-bodied race. The intestine in the latter is also found to be proportionally longer than in the normal, common,

or in the long-bodied, double-tailed races. This increase in the length of the intestine is also indicated by the very protuberant abdomen of the short-bodied race. This short-bodied race, with a protuberant abdomen, I am informed by breeders, is a very voracious feeder, thus not belying the indications of its large abdomen and proportionally long intestine.

It is also probable that the bodies of the vertebræ are shorter in the short-bodied than in the long-bodied races. This point I have, however, neglected to determine.

I believe, in short, that the degenerative changes in the muscular system of the Japanese Gold-fishes is connected with their continued restraint to small aquaria for many generations, and that their muscular system has degenerated through disuse. That, on the other hand, the failure to be able to expend energy in the production of motion of the body in the water has reacted in other ways upon their organization, and especially upon the growth of the fins. This has gone on until, in some of the races, it would actually be possible to envelop almost the entire head and body in the enormous double caudal. In fact, these members grow so long that they become an actual hindrance to rapid swimming, and are of less use in propelling the fish in the water, so that their swimming becomes very slow, and seemingly performed with some difficulty as compared with the normal form. All the fins partake of this tendency to become extended; the pectorals enlarge and lengthen, and the dorsal, in some races, becomes so long that it falls over and overhangs one side of the body. Fish-culturists also tell me that it is useless to try to keep these races with other species of fishes in ponds, because the more active carnivorous forms will soon bite off and destroy the long, graceful, and lace-like caudals of these helplessly modified Japanese races. These races have been so modified by man's agency, that they have become absolutely unfitted to successfully battle for existence, if left to themselves.

Their sluggish habits have been purposely cultivated by Oriental fish-fanciers. To such an extreme of sluggishness have they been brought, that, owing to their monstrous development, they are sometimes no longer able to maintain their equilibrium in the water; but stand on the head or tail in the very small aquaria, in which they are kept, and in which they would become asphyxiated were it not for the precaution taken by the Japanese to introduce into the same

aquarium small, harmless, but very active fishes of other species, in order that the water be kept circulating, and thus aerated for the benefit of the helplessly modified, but most valued tenant.

These circumstances give, it seems to me, a clew to the explanation, not only of the degeneration of the musculature under domestication, owing to its enforced disuse, but also some indication of what are the causes of the extension of the fins. The material saved from expenditure in muscular effort may be expended in growth in another direction, and the most advantageous would be that which would increase the surface of the fins, and thus render them useful in dermal respiration. The large vessels and numerous capillaries in the huge tails of very fine specimens of the Kinyiko race, that I have seen, indicate that the caudal fin may possibly serve in a very important way as an adjunct to branchial respiration. The question therefore arises, have not the immense fins of the Japanese double-tailed gold-fishes been developed partially in physiological response to artificial conditions of respiration, that were not as favorable as those enjoyed by their wild congeners? That the dorsal, anal and caudal fins may be so modified as to minister in an important way to the needs of respiration, is proved by the development of the richly vascular and exaggerated vertical fins of the embryos of foetal Embiotocoid fishes, as long ago shown by Blake, and fully confirmed and elaborated in greater detail by the writer.

It is also a remarkable fact that the fins and tail of the larvæ of the double long-tailed races do not show such characters at once, but it is not until long after the larval stages are passed, that the breeder can be certain of rearing a specimen with a fine long tail, from any given young fish. The fishes are usually upward of two inches in length before the breeder can be pretty sure that the young or half-grown individuals will develop a great length of tail. This fact shows that the long tail was originally acquired very late in ontogenetic development, and is not a larvally apparent differentiation. This circumstance is also unique amongst fishes, and for that matter, almost the exact reverse of what usually takes place, since the young of many marine fishes have certain parts of the fins very greatly produced, only to be absorbed before adolescence is reached. This is the case with the larvæ of *Lophius* and *Fierasfer*. Only amongst higher animals do we find secondary sexual characters produced at a late period of growth, such as the deciduous horns of the Deer

family, or defensive organs, such as the horns of the ox and antelope families, which are produced at a relatively late period.

The fact that the very long fins of the full grown individuals of the double-tailed races of Gold-carp are only fully developed at a very late period of the growth of the animal, is in harmony with the view that the hypertrophy of those organs is associated with a correlative degeneration of the muscular system of the trunk, and a possible use of these structures with their great amount of surface as respiratory organs, in the restricted and badly aerated tanks and aquaria in which they have been bred for centuries.

Since the above was written, Mr. W. P. Seal has sent me a series of the "telescope-eyed" double-tailed race of Gold-carp. This, together with the materials previously supplied by the same gentleman and Dr. Wahl, enables me to greatly extend my comparisons and also, as will be seen below, to add some very remarkable facts to our knowledge of these singular domesticated races of fishes as compared with their wild congeners, long since introduced into the Schuylkill, and now native to that river.

The most astonishing peculiarity of the "telescope-eyed" race is the development of the eyes. The latter are very much larger proportionally than in the common or in any other races, so that the eyes actually protrude from the orbits in a most grotesque manner. The size of the eyes on opposite sides of the head even seem to vary somewhat, and in the extent to which they protrude from the orbit. In some specimens the eye-balls are a third more in diameter across the equator than in either the common or the other double-tailed races. A broad band or ring of integument passes all round the equator of the eye-ball joining the cornea distally and the margin of the orbit proximally.

The most surprising fact of all, however, is the shape of the eye-ball in the telescope-eyed race, in that the eye-ball tends to become greatly elongated in the direction of its optic axis. Sometimes the difference between the axial and equatorial diameter is as much as three millimetres, constituting an extremely myopic form of eye-ball. The form of the eyeball in the common race is flat or hypermetropic in character. A gradual passage from the hypermetropic form of eye-ball to the myopic is shown in the following table, as based upon actual approximate measurements of the eye-balls of individuals of the three races.



## V.

Races.	Total length of specimen.	Equatorial diameter of eye-ball.	Axial diameter of eye-ball.
Common.	130 mm.	7 mm.	5 mm.
Short-bodied.	55 mm.	5 mm.	4 mm.
"Telescope-eyed."	No. 1.	63 mm.	6 mm.
	No. 2.	70 mm.	9 mm.

The size and shape of the globular lens in the "telescope-eyed" race is not appreciably different from that of the other races with smaller eye-balls. It would therefore, seem impossible for the image formed by the lens of a distant object in the "telescope eyed" race, to be thrown upon the retina at all, consequently the condition is one of near-sightedness, or of an optical adjustment for very near objects. The conditions of life of these races, in small tanks or aquaria, where they are bred under conditions of the greatest protection from man, would in their restricted quarters actually foster the development of near-sightedness, and any variations in that direction would actually tend to be preserved. There is a condition of disuse also to be taken into account in this process, since these fishes no longer need their eyes with which to watch the approach of their enemies, but only to look out for their food, which is supplied to them by their human friends and protectors. To what extent this factor has been of service in altering the shape of the eye-balls, it is of course, as yet, impossible to state. The preceding table V, however, makes the gradual passage from the hypermetropic or flat eye of the normal race to that of the myopic or long eye of the "telescope-eyed" race sufficiently obvious as the series of measurements given of the eye-balls of the different races proves.

The fact that a race of fishes may become myopic, as would seem to be indicated by the foregoing data, is most surprising, and affords a case parallel in some respects with that of the human race itself; but in the case of these fishes the myopic tendency has probably been further developed by the intentional selection of myopic indi-

**THIS PAGE IS LOCKED TO FREE MEMBERS**

Purchase full membership to immediately unlock this page

# Know Your Bible

Forgotten Books' Full Membership provides unlimited access to more than 28,000 volumes of Christian literature for \$8.99/month

**HOLY BIBLE**

**Continue**

\*Fair use policy applies

up to the vertebral axis, so that, morphologically speaking, there are parts of two distinct axes, or individuals, present in each specimen. This evidence, together with that respecting the defective development of the dorsal, and the tendency toward a hunch-backed and deformed condition, perfectly parallel to the conditions seen in traumatically deformed trout, seems to me to almost conclusively prove that the double-tailed races of Gold-carp have arisen in the first place as a consequence of injuries inflicted during the early development of the eggs and embryos, and that the effects of these embryonic traumatisms have become hereditarily transmissible, as the facts seem to indicate.

THE VASCULAR RESPIRATORY MECHANISM OF THE VERTICAL FINS  
OF THE VIVIPAROUS EMBIOTOCIDÆ.

BY JOHN A. RYDER.

The young surf-perch, *Ditrema laterale*, from which this figure is drawn, measured about twenty-three millimetres in length. It was one of several which were removed from the saccular ovary of the parent, each young fish lying lengthwise and disposed so as to bring the enormously expanded vertical fins into contact with the wide ovarian folds and the sides of the ovarian walls. As can be seen from the figure, the lateral area of the vertical fins quite equals,

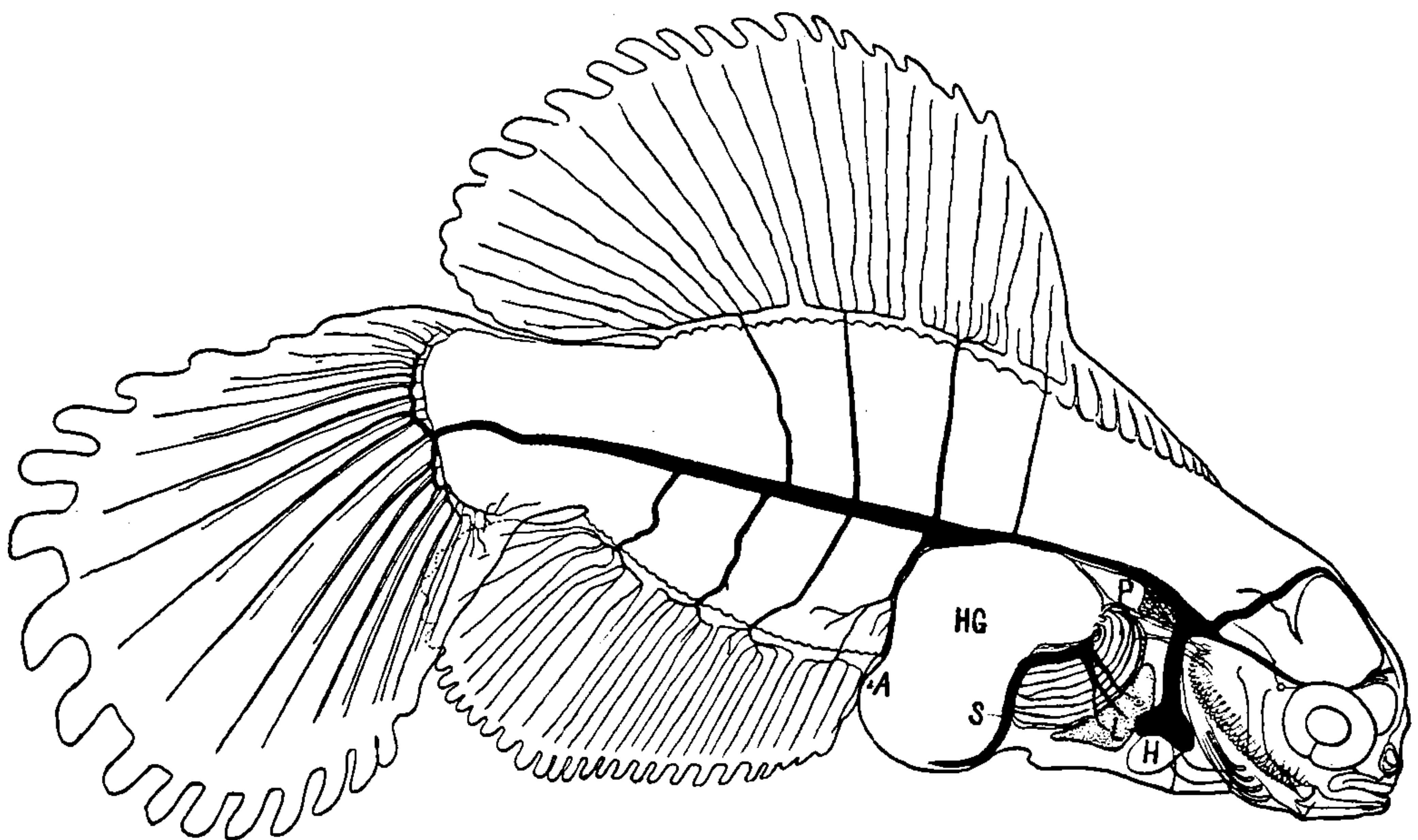

if it does not exceed, the lateral areas of the body. In fact, the dorsal is as high as the body is deep. In the same way the caudal fin is as wide at its widest part as the body's greatest width. The total length of the caudal is not far from a third of the total length of this larval stage. Another feature which distinguishes this young fish from the young of all other species is the highly vascular condition of the inter-radial membranes of the vertical fins. This vascularity is not only obvious when the object is viewed with a transmitted light, but also in sections. The most marked development of capillary vessels is found in the flattened lobes with which the fins are bordered. Fourteen very distinct lobes with deep notches between them are found along the margin of the tail; about

twenty-eight smaller lobes can be counted on the margin of the anal fin. About eighteen well-marked lobes presenting the highly vascular character of the others, already mentioned, are found to border the dorsal fin, the spaces between the anterior nine rays of which, unlike the others of the same fins, are non-vascular. In correspondence with this highly vascular condition of the marginal lobes and the inter-radial spaces in these three sets of fins, there is found to be developed a system of three sets of large arterial and venous trunks which send the blood to and carry it away from the vertical fins.

The caudal termination of the caudal vein and aorta supply the caudal fin. In the figure it is mainly the venous trunks which are represented. It is seen that at the point where the caudal vein enters the caudal fin it divides into two very large trunks, such as are not met with in any other known type of fish of the same age. One of these trunks passes in a dorsal and another in a ventral direction, carrying away the blood from the dorsal and ventral halves respectively of the caudal fin. The number of branches which pass from the two trunks mentioned correspond very closely to the number of inter-radial spaces. A second system of vessels, much slighter in caliber after death than they probably were during life, is seen just a little way anterior to the two large venous trunks already described. These are probably the dorsal and ventral branches of the arterial system into which the posterior termination of the caudal portion of the aorta divides in order to supply the caudal fin-membranes with arterial blood. The radiating venous and arterial inter-radial vessels pass quite to the margin of the caudal, where they form vascular arcs around the edges of the flat vascular lobes already described. From within this vascular arc to the point of insertion of the caudal rays the inter-radial membrane is found to be traversed by a close plexus of capillary vessels. This plexus is excavated in a connective tissue which lies between the epidermis of the opposite sides of the fin.

Four sets of vascular trunks pass from the dorsal; of these the three posterior are the most strongly developed. They take their rise directly from the caudal vein and caudal portion of the aorta on the dorsal aspect of these vessels. Each of these vessels upon reaching the base of the dorsal divides into an anterior and posterior trunk. Each of these trunks gives off in a vertical direction nearly at right angles to themselves a series of inter-radial vessels.

The posterior trunk gives off the greatest number of these inter-radial vessels. The anterior main trunk gives off four inter-radial vessels. The marginal lobes are highly vascular, although not so wide nor so long as those of the caudal fin.

The anal fin receives its vascular supply through four sets of large trunks coming off from the inferior aspect of the caudal vein and aorta. These trunks pass nearly straight downward toward the margin of the anal, their distal portions only being slightly tortuous. The posterior or fourth trunk, as are all the others, is bifurcated at the base of the anal into an anterior and posterior branch much in the same way as the similar vessels divide in the dorsal. The fourth trunk gives off the greatest number of inter-radial vessels. The second and third give off a smaller number of such inter-radial branches. The first anal trunk appears to supply a portion of the inter-radial spaces at the anterior edge of the anal fin while branches more or less intimately associated with it, or derived from it, pass to the greatly hypertrophied hind-gut. At any rate the vascular supply of this curiously hypertrophied part of the alimentary tract is given off close to this vessel.

In whatever way the blood passes through the walls of the hind gut H. G.; it finds its way at last to a large vascular trunk marked S, lying on the ventro-anterior face of H. G. This large vessel S is evidently the homologue of the sub-intestinal vein in other fishes. At the anterior end of S large trunks diverge from it, pass around the mid gut and find their way into the liver. These trunks represent the portal system. Little that is noteworthy can be made out from a transparent view in regard to the way in which the blood reaches the heart from the jugulars. Sections indicate that the Cuvierian ducts are very spacious, more so than is represented in the diagram.

The ventricle of the heart H is well developed with thick muscular walls. The bulbus arteriosus is a simple thickened muscular tube extending forward from H. The homologies and relations of a large trunk ascending obliquely forward and upward, then bending downward and forward, probably meeting its fellow of the opposite side before it traverses the median face of the mid brain is difficult to determine. A smaller trunk descends from the region over the body toward the eye and probably joins the ophthalmic vessels in that region to finally empty into the basilars and jugulars which pass backward toward the origin of the Cuvierian ducts.

The membrane bones of the skull are already fairly well developed, as are, in fact, the membrane bones throughout the body generally. The vertebral rings of the vertebral column are already defined, and are separated from each other by considerable inter-vertebral spaces. Their dorsal and vertical outer margins are gently concave. The ribs, the neural and hæmal arches are developed and the complicated musculature of the caudal fin is already well marked. The hypural pieces of the caudal are well-developed in cartilage and a partly membranous matrix. The pectoral fins are already well-developed but present as far as I have been able to make out no such vascularization as the others. The ventrals are still small and undeveloped. The lateral line system does not seem to be strongly marked at this stage; the small round pore behind the eye represents its connection with the exterior. The air bladder is developed and occupies considerable space at the point P in the body cavity. Just in front of the air bladder is a large highly vascular mass representing the Wolffian body or kidney. The glandular portion of the Wolffian body is thus seen to be quite anterior in position. Cross-sections show that Wolffian ducts are present behind the region of the Wolffian body as a pair of simple longitudinal canals. These ducts pass backward parallel with each other as far as the downward flexure of the hind gut H G. At this point they suddenly bend downward and gradually converge so as to meet just before opening to the exterior between the hernia-like protrusion of the lower portion of the hind gut and the anterior margin of the anal fin.

As already stated the hind gut is very much enlarged in transverse diameter, as may be seen from the accompanying figure. Upon being cut open it is found to be filled up with villous or filamentous productions of its lining mucous membrane. These villi tend to be flattened, and with the widest portion of their bases extending parallel with respect to each other and in conformity with the length of the intestine. The anal opening A is found on the posterior face of the hernia-like protrusion of the abdominal wall caused by the hypertrophied hind-gut. The mid-gut is separated sharply from the hind-gut by a pyloric constriction just a little below and behind P as shown in the diagram. The mid-gut or gastric portion of the intestinal canal presents no very unusual features except that its internal face is thrown into parallel longitudi-

nal folds, which curve in the direction of the flexure of this part of the intestine which appears to form a loop upon itself.

The function of the inter-radial and marginal plexuses of capillaries of the young of these fishes, as the accompanying figure shows must be in large measure respiratory. The figure shows the maximum proportional development of the vertical fins, but at a stage about twice the length of the one here figured, the vertical fins begin to become reduced in size so as to approximate their relatively reduced proportions in the adult. The integuments of the sides of the body now also become highly vascular, which dermal vascularity also seems to disappear before the birth of the young. The great vascular trunks that especially supply the vertical fins with blood, as shown in the figure, also now atrophy in a measure and become subservient only to the nourishment and metabolism of the tissues of the fins. The histological changes in the fins of these young viviparously developed fishes are therefore very great in the course of their sojourn in the ovary of the parent. That the highly vascular fins and the great vascular trunks which supply them, must in a measure subserve a function in such foetal fishes very similar to that of a placenta in a non-deciduate foetal mammal, there can scarcely be any doubt.



INVOLUTION FORM OF THE TUBERCLE BACILLUS AND THE EFFECT  
OF SUBCUTANEOUS INJECTIONS OF ORGANIC SUB-  
STANCES ON INFLAMMATIONS.

BY SAMUEL G. DIXON, M. D.

Prof. Robert Koch announced in 1882 the discovery of the cause of Tuberculosis. He claimed that consumption was produced by a *peculiar bacillus of a special shape*. This he described as a rod-shaped micro-organism with rounded ends, either straight or curved, and frequently beaded. This simple form was accepted as a constant character until the summer of 1889, when I first observed, in an artificial culture on an Agar Agar glycerin nidus, a slight inclination to bud in one or more places along the rod, without the production of any particular angle, some relations forming an acute while others formed a right or possibly an obtuse angle. A single bud could only be recognized with a high power objective focused and illuminated with particular nicety. The indications, however, were so often repeated in each field as the slide was moved upon the stage of the microscope that I was sufficiently convinced of the presence of branches to review the life-history of the tube in which they were found and to speculate upon the factors likely to have brought about the evident volution. The result was the production of germs with decided *branches*, some of which were quite as long as the parent rods or stems. This result was published in the *Medical News* of October 19th, 1889. In 1891, Prof. Allen J. Smith observed branched forms of tubercle bacilli in human sputum. Since then Prof. Klein, Herren Fischel, Mafucci et al., have described the branching of this germ. In the summer of 1892 I observed the bacillus in this cycle of life in the liver of the Green Jay of Mexico, *Xanthoura luxosa*. This discovery, coupled with my observations of 1889, and corroborated by the statements of other scientists, must now compel the bacteriological world to recognize a more complex form of the tubercle bacillus than that observed by the great German bacteriologist in 1882. Since the discovery of the branched form of the tubercle germs in 1889, I have been able to continuously reproduce them on artificial mediums. While the young germs seem to be quite simple in form, appearing in straight rods and rods bent upon themselves, those which have arrived at the age of four weeks, particularly in the

**THIS PAGE IS LOCKED TO FREE MEMBERS**

Purchase full membership to immediately unlock this page

# DELVE INTO FANTASY, MAGIC, MYTHOLOGY & FOLKLORE

Forgotten Books'  
Full Membership gives  
access to 797,885 ancient  
and modern, fiction and  
non-fiction books.

**Continue**

\*Fair usage policy applies

heretofore failed to produce any marked changes. When, however, in the course of my investigations I overloaded the animal system with some of its waste products, Dr. William L. Zuill, M. D., D. V. S., who has kindly carried on the clinical work on animals for our Bacteriological Laboratory, reported in the *Times and Register* of Sept. 26th, 1891, a reaction by the Amide group on inflammatory tissues, the animals experimented on being tuberculous. As this group included that which we believe to produce the inflammation of gout, I was led to review my experience with tuberculosis in relation to lithemia. Studying this field with the lithemic and tuberculous habits in view I was soon impressed with the fact that when these diseased conditions were present at the same time in any individual we could claim it to be an exception to the rule.

To determine the special action of the Amide group upon inflamed tissues when introduced into the circulation, a case of Lupus vulgaris was selected and first treated by the subcutaneous introduction of .03240 Gm. of Kreatinin, alternated twice weekly with .130 Gm. of Taurin, Urea and Uric acid. The average temperature during treatment was slightly raised, though not to any very marked degree, under the influence of such small doses. The more recent patches of Lupus, however, became markedly inflamed, being accompanied with a burning sensation. On the third day after the first injection, a marked granulation could be detected around the outer edge by the aid of a strong amplifying pocket glass. This apparently healthy granulation has continued for ten days, in which time the patch has one half of its original area healed. The result shown at this early stage of the experiment is sufficiently encouraging to warrant not only a continuation of the treatment in this case but in other forms of Tuberculosis. The only other subjects upon which these injections have been tried have been cases of pulmonary tuberculosis in a very advanced stage, where there was too much lung-tissue already destroyed to warrant the expectation of a favorable result. The fact that we apparently have an action on the Lupus and no marked result with *small* doses on advanced cases of pulmonary tuberculosis causes me to realize that the line of experimentation must not be confined to tuberculous inflammation but extended to the action of these organic substances on the entire group of inflammatory growths, the effect being produced, possibly, by supplying that in which the pathological tissues are deficient. This line of inquiry, which had

its origin in the Bacteriological Laboratory of the Academy, has opened up a new and wide field of important scientific medical investigation. The main object of this communication, at this time, is to confirm the original discovery of the *branched form* of the tubercle bacillus by recording the observations of the same life-cycle of that micro-organism found in animal tissues. I have, however, ventured to advance theories and results regarding the action of substances far removed from the bacillus, because they were suggested during my studies of the branched form of that organism.

**CATALOGUE OF THE CRUSTACEANS IN THE MUSEUM OF THE ACADEMY OF NATURAL SCIENCES OF PHILADELPHIA.**

BY DR. BENJ. SHARP.

According to the catalogue of Professor Lewis R. Gibbes, of Charleston, S. C., published in the Proceedings of the Academy for 1850 (p. 22 to 30), the collection of crustacea contained one hundred and seventy-five (175) species.

In 1851, additions were made by Mr. McAndrews and Messrs E. & C. Wilson. In this year Dr. T. B. Wilson presented the collection of Guérin-Méneville, consisting of 413 species (1,482 specimens). They were classified and catalogued by Dr. R. Bridges, and the collection now contained 980 species (2,054 specimens).

In 1852, Edward Wilson, Esq., presented 54 species from Great Britain, and Dr. T. B. Wilson presented 282 species of the Guérin Collection. About 64 species were presented during the year from M. J. Verreaux, of Paris, and Messrs E. Wilson, S. Ashmead, J. Le Conte and others.

In 1855, Mr. S. Ashmead presented 34 species.

In 1856, 65 species (358 specimens) were received from Messrs W. S. Wilson, S. Ashmead, Davidson and others.

In 1857, 15 species were received from Dr. W. Stimpson from the West Coast of America, and 30 species from Drs. W. S. W. Ruschenberger and Hammond and Mr. Pease.

In 1858, Mr. W. J. Taylor, Dr. J. L. Le Conte and others, presented 15 species, and Mr. Slack 22 species.

In the beginning of the year 1860 the collection contained about 1,000 species.

In 1861, the Smithsonian Institution presented 55 species, and G. Davidson 12.

In 1864, the Smithsonian Institution presented 62 species, mostly collected by Dr. Wm. Stimpson of the North Pacific Exploring Expedition.

In 1872, a collection was presented by Wm. M. Gabb, from San Domingo.

In 1873, a fine collection in alcohol from the Fiji Islands was presented by Mr. A. J. Garrett.

In 1875, many species were presented by Dr. Wm. H. Jones, of the United States Navy, and during this year the collection was

**THIS PAGE IS LOCKED TO FREE MEMBERS**

Purchase full membership to immediately unlock this page

# Know Your Bible

Forgotten Books' Full Membership provides unlimited access to more than 28,000 volumes of Christian literature for \$8.99/month

**HOLY BIBLE**

**Continue**

\*Fair use policy applies

**LYSIOSQUILLA Dana, 1852.**

*Coronis* Latreille, 1825 (name pre-occupied).

**L. GLABRIUSCULA** (Lamarck, 1818).

*Squilla glabriuscula* Lamarck, 1818.

*Squilla vittata* H. Milne-Edwards, 1837.

Habitat. Eastern coast of North America.

18. (1d) Key West, Florida. S. Ashmead.

37. (1a) Hilton Head, South Carolina. J. J. Craven.

49. (1a) No locality. Smithsonian Institution.

**L. MACULATA** (Fabricius, 1793).

*Squilla maculata* Fabricius, 1793.

*Cancer arenarius* Herbst, 1796.

Habitat. Indo-Pacific region.

19. (2d) Sandwich Islands. J. K. Townsend.

46. (1a) Oahu, Sandwich Islands. Dr. W. H. Jones.

**L. SCABRICAUDA** (Lamarck, 1818).

*Squilla scabricauda* Lamarck, 1818.

*Squilla hoeveni* Herklots, 1851.

*L. inornata* Dana, 1852.

Habitat. Eastern coast of America.

20 & 21. (1d & 2d) Key West, Florida. S. Ashmead.

22. (1d) Brazil. Dr. T. B. Wilson.

44. (2a) No locality. No donor's name.

45. (1a) West Indies. Dr. T. B. Wilson.

47. (1a) No locality. Dr. T. B. Wilson.

**PSEUDOSQUILLA Dana, 1852.**

**P. CERISII** (Roux, 1828).

*Squilla cerisii* Roux, 1828.

*Squilla broadbenti* Coco, 1833.

Habitat. Mediterranean.

30. (1a) Algiers. Guérin Collection.

**P. CILIATA** (Fabricius, 1793).

*Squilla ciliata* Fabricius, 1793.

*Squilla stylifera* Lamarck, 1818.

*P. stylifera* Dana, 1852.

*Squilla quadrispinosa*, Miers, 1880.

Habitat. Indo-Pacific region.

15. (5d) Sandwich Islands. Nuttall & Townsend.

16. (1d) Peru. Dr. W. S. W. Ruschenberger.

28. (1a) Mauritius. Guérin Collection.

29. (6a) Oahu, Sandwich Islands. Dr. W. H. Jones.

36. (2a) No locality. Smithsonian Institution.

55. (2a) Tahiti. A. J. Garrett.

**P. LESSONII** (Guérin, 1830), (type No. 4).

*Squilla cerisii* Guérin, 1830.

*Squilla lessonii*, Guérin, 1830.

*Squilla spinifrons* Owen, 1832.

*Squilla monoceros* H. Milne-Edwards, 1837.

*P. marmorata* Lockington, 1877.

Habitat. Indo-Pacific region.

4. (1d) Mauritius. Guérin Collection (Guérin's type).

10, 11 & 12 (1d, 1a, 1d) Chili. Guérin Collection.

17. (1d) Peru. Dr. W. S. W. Ruschenberger.

**P. MONODACTYLA** (A. Milne-Edwards, 1878.)

*Squilla monodactyla* A. Milne-Edwards, 1878.

Habitat. Pacific region.

56. (1a) Lat. 6° North; Long. 166° West. Dr. W. H. Jones.

**P. STYLIFERA** (H. Milne-Edwards, 1837).

*Gonodactylus styliferus* H. Milne-Edwards, 1837.

Habitat. Pacific region.

13. (1d) Chili. Guérin Collection.

14. (1d) Sandwich Islands. J. K. Townsend.

58. (1a) Valpariso, Chili. Dr. W. S. W. Ruschenberger.

**SQUILLA** Fabricius, 1798.

including

*Chlorida* Edyoux & Souleyet, 1841 (name pre-occupied).

*Chloridella* Miers, 1880.

**S. DESMARESTII** Risso, 1816.

Habitat. Seas of Europe.

1. (4d) Mediterranean. Guérin Collection.

**S. DUBIA**. H. Milne-Edwards, 1837.

*S. mantis* Desmarest, 1825.

*S. rubrolineata* Dana, 1852.

Habitat. Eastern coast of America.

9. (1d) Trinidad, B. W. I. Dr. Samuel Lewis.

**S. EMPUSA** Say, 1818 (? No. 2 type).

Habitat. Atlantic region.

2. (3d) Rhode Island. W. E. Halloway (probably Say's type).

8. (1d) Gulf of Mexico. C. Bryan.

31. (1a) New Bedford, Mass. J. H. Thompson.



32. (1a) No locality. Smithsonian Institution.  
 33. (1a) Hilton Head, South Carolina. J. J. Craven.  
 34. (1a) Beaufort, North Carolina. E. D. Cope.  
 35. (1a) No locality. J. Walton.  
 39. (2a) South America. No donor's name.

**S. MANTIS** Latreille, 1802.

Habitat. European Seas.

6. (3d) Mediterranean. Guérin Collection.

**S. NEPA** Latreille, 1825.

- S. affinis* Berthold, 1847.  
*S. oratoria* DeHaan, 1849.  
*S. laevis* Hess, 1865.

Habitat. Indo-Pacific region.

3. (2d) No locality. No donor's name.  
 7. (3d) China. Dr. T. B. Wilson.  
 40 & 43. (3a & 2a) No locality. Smithsonian Institution.  
 41. (2a) Oahu, Sandwich Islands. Dr. W. H. Jones.  
 42. (1a) Malacca. Guérin Collection.

**S. PRASINOLINEATA** Dana, 1852.

- S. dufresnii* Miers, 1880.

Habitat. East coast of tropical America.

48. (1a) Silam, Yucatan. Mexican Expedition (*fide* Ives, 1891).

**S. RAPHIDEA** Fabricius, 1798.

- S. mantis* var. *B major* Lamarck, 1818.  
*S. harpax* DeHaan, 1849.

Habitat. Indo-Pacific region.

5. (1d) India. Guérin Collection.  
 38. (1a) Malacca. Guérin Collection.

Numbers 101 to 110 inclusive, are alcoholic specimens of Stomatopod larvae collected by Dr. W. H. Jones in Central and Eastern Pacific, as far North as Latitude 50°.

## PENAEIDEA.

**PENAEIDAE** Sp. Bate, 1886.

**PENAEUS** Fabricius, 1798.

**P. BRASILIENSIS** Latreille, 1817.

- P. brevirostris* Kingsley, 1878.

Habitat. Atlantic region.

59. (xa) West coast of Florida. Heilprin Collection, 1886 (*fide* Ives, 1891).

**THIS PAGE IS LOCKED TO FREE MEMBERS**

Purchase full membership to immediately unlock this page

# DELVE INTO FANTASY, MAGIC, MYTHOLOGY & FOLKLORE

Forgotten Books'  
Full Membership gives  
access to 797,885 ancient  
and modern, fiction and  
non-fiction books.

**Continue**

\*Fair usage policy applies

**P. MEMBRANACEUS** Risso, 1816.*P. longirostris* Lucas, 1849 (No. 145, probably type).*P. bocagei* Johnson, 1863.

Habitat. Mediterranean.

145. (1a) Algiers. Guérin Collection (? Lucas' type of *P. longirostris*).**P. MONOCEPHALUS** Fabricius, 1798.

Habitat. Indian region.

360. (1d) Bombay, India. Guérin Collection.

**P. MONODON** Fabricius, 1798.

Habitat. Indo-Pacific region.

74. (1a) Mauritius. Guérin Collection.

**P. SETIFERUS** (Linnaeus, 1766).*Cancer setiferus* Linnaeus, 1766.*Palaemon setiferus* Olivier, 1811.*P. orbignyanus* Latreille, 1817.*P. fluviatilis* Say, 1817.

Habitat. East coast of America.

67. (2a) Hilton Head, South Carolina. J. J. Craven.

68. (2a) New Orleans, Louisiana. Dr. Walker.

75 &amp; 76. (1a &amp; 2a) No locality. Smithsonian Institution.

361. (1d) Cuba, West Indies. Guérin Collection.

362. (2d) Charleston, South Carolina. Dr. W. Blanding.

**P. STYLIROSTRIS** Stimpson, 1871.*P. occidentalis* Streets, 1871 (No. 73 type).

Habitat. East Coast of Central America.

73. (xa) Panama. McNeil Expedition (Streets' type).

**P. VILLOSUS** Guérin, 1830 (No. 79 type).

Habitat. Pacific region.

79. (1a) New Ireland. Guérin Collection (Guérin's type).

**SICYONIA** H. Milne-Edwards, 1830.**S. SCULPTA** H. Milne-Edwards, 1830.

Habitat. Atlantic region and Mediterranean.

100. (1a) Hilton Head, South Carolina. J. J. Craven.

**SERGESTIDAE** Sp. Bate, 1886.**SERGESTES** H. Milne-Edwards 1830.**S. ARCTICUS** Kroeyer, 1855.

Habitat. North Atlantic.

112. (1a) Lat. 40° 16' 30" North ; Long. 67° 26' 15" West—828 fathoms. Smithsonian Institution.

**EUCYPHIDEA.****PASIPHAEIDAE** Sp. Bate, 1886.**PASIPHÆA** Savigny, 1818.

**P. SIVADO** (Risso, 1816).

*Alpheus sivado* Risso, 1816.

*P. savignyi* H. Milne-Edwards, 1837.

*P. brevirostris* H. Milne-Edwards, 1837.

Habitat. West coast of Europe and Mediterranean.

364. (1d) Nice, France. Guérin Collection.

**ATYIDAE** Kingsley, 1878.**ATYA** Leach, 1817.

*Atys* Leach, 1815 (name pre-occupied).

including

*Atyoida* Randall, 1839.

**A. BISULCATA** (Randall, 1839) (No. 231 type).

*Atyoida bisulcata* Randall, 1839.

Habitat. Sandwich Islands.

162. (xa) Oahu, Sandwich Islands. Dr. W. H. Jones.

231. (1d) Sandwich Islands. T. Nuttall (Randall's type, damaged).

**A. SCABRA** Leach, 1815.

Habitat. East coast of tropical America.

229. (1d) Mexico. W. Stimpson.

230. (1d) Martinique, Fr. W. I. Guérin Collection.

**CARIDINA** H. Milne-Edwards, 1837.*Caradina* Kingsley, 1879.

**C. AFRICANA** Kingsley, 1882 (No. 163 type).

Habitat. Zulu-land, South Africa.

163. (xa) Zulu-land, South Africa. S. A. Grout (Kingsley's types).

**C. LONGIROSTRIS** H. Milne-Edwards, 1837.

Habitat. Mediterranean.

233. (1d) Algiers. Guérin Collection.

**C. TYPUS** H. Milne-Edwards, 1837.

*Caradina typus* Kingsley, 1879.

Habitat. Indo-Pacific Region.

232. (1d) Mauritius. Guérin Collection.

**ALPHEIDAE** Sp. Bate, 1886.

ALOPE White, 1847.

**A. PALPIPES** White, 1847.

Habitat. New Zealand and Australia.

234 (1d) New Zealand. Dr. T. B. Wilson.

**ALPHEUS** Fabricius, 1878.

including,

*Cryptophthalmus* Rafinesque, 1814.*Asphalius* Roux, 1831.*Dienecia* Westwood, 1835.*Haplopsyche* Saussure, 1857.*Alpheoides* Paulson, 1880.**A. BELLIMANUS** Lockington, 1876.

Habitat. Coast of California.

118. (3a) San Diego, California. Joseph Jeans.

**A. BREVIROSTRIS** (Olivier, 1811).*Palaemon brevirostris* Olivier, 1811.*Asphalius brevirostris* Roux, 1831.*A. malabaricus* Hilgendorf, 1878.

Habitat. Indo-Pacific region.

245. (3d) Yanaon, French India. Guérin Collection.

246. (1d) Manilla. Dr. Burrough.

**A. DENTIPES** Guérin, 1832 (No. 239 type).

Habitat. Mediterranean.

239. (1d) Nice, France. Guérin Collection (Guérin's type).

**A. DOTO** Miers, 1878.

Habitat. Australia.

237. (1d) Australia. Dr. T. B. Wilson.

**A. EDWARDSII** Audouin, 1810 (?).? *A. monodon* Bosc. 1801.*A. pacificus* Dana, 1852.*A. edwardsii* var *leviusculus* Dana, 1852.*A. avarus* Sp. Bate, 1887.*A. leviusculus* (Dana, 1852) Sp. Bate, 1887.

Habitat. Tropical seas.

129. (xa) Bermuda. Heilprin Collection, 1888.

135. (1a) No locality. W. N. Lockington.

250. (1d) Australia. Dr. T. B. Wilson.

**A. HETEROCHELES** Say, 1818 (? No. 240 type).*A. armillatus* H. Milne-Edwards, 1837.*Haplopsyche lutaria* Saussure, 1857.

**THIS PAGE IS LOCKED TO FREE MEMBERS**

Purchase full membership to immediately unlock this page

# Know Your Bible

Forgotten Books' Full Membership provides unlimited access to more than 28,000 volumes of Christian literature for \$8.99/month

**HOLY  
BIBLE**

**Continue**

\*Fair use policy applies

Habitat. Seas of Europe.

130. (3a) Villa Franca, France. Dr. B. Sharp, 1882.

A. MINUS Say, 1818.

*A. formosus* Gibbes, 1851.

*A. tridentulatus* Dana, 1852.

*A. saulcyi* Guérin, 1857 (No. 236 type).

*A. minor* Lockington, 1878.

Habitat. East coast of America.

117. (xa) Bermuda. Heilprin Collection, 1888.

236. (1d) Martinique. Guérin Collection (Guérin's type, *A. saulcyi*).

248. (5d) No locality. Smithsonian Institution.

1006<sub>+</sub> (1a) Port Antonio, Jamaica. W. J. Fox.

? A. NOVAE-ZELANDIAE Miers, 1876.

Habitat. New Zealand.

252. (2d) New Zealand. No donor's name.

A. POEYI Guérin, 1857 (No. 235 type).

*A. floridianus* Kingsley, 1878.

Habitat. West Indian region.

235. (1d) Cuba. Guérin Collection (Guérin's type).

A. SINUOSUS Guérin, 1857 (No. 388 type).

Habitat. West coast of South America.

388. (1d) Callao, Peru. Guérin Collection (Guérin's type).

A. THETIS Miers, 1875.

Habitat. Pacific region.

238. (2d) New Zealand. Dr. T. B. Wilson (*vide* Kingsley, 1882).

**ATHANAS** Leach, 1815.

A. NITESCENS Leach, 1815.

*Palaemon nitescens* Leach, 1815.

*Arete diocletiana* Heller, 1862.

*Arete nitescens* Heller, 1863.

Habitat. Seas of Europe.

253. (1d) Coast of France. Guérin Collection.

**PANDALIDAE** Sp. Bate, 1886.

**PANDALUS** Leach, 1815.

P. ANNULICORNIS Leach, 1815.

*P. leavigatus* Stimpson, 1854.

*P. montagui* Smith, 1879.

Habitat. Circumpolar and North Atlantic.

139. (3a) Lat. 46°, 23' N.; Long. 52°, 45' W. U. S. Fish Commission, 1885.

140. (xa) Massachusetts Bay. U. S. Fish Commission.  
 141. (xa) Salem, Massachusetts. Dr. T. H. Streets.  
 142. (4a) Halifax, Nova Scotia. Dr. T. H. Streets.  
 255. (2d) Belfast Bay, Ireland. W. Thompson (in exchange).

**P. BOREALIS** Kroeyer, 1838.

Habitat. Circumpolar and North Atlantic.

137. (3a) Salem, Massachusetts, 50 fathoms. Dr. T. H. Streets.  
 138. (4a) Massachusetts Bay, 40–55 fathoms. U. S. Fish Commission.

**P. DANAE** Stimpson, 1854.

Habitat. Northwest coast of America.

144. (3a) Marmot Isle, Alaska (45 fathoms). Dr. W. H. Jones.  
 254. (1d) Coast of Oregon. W. Stimpson.

**P. LEPTOCERUS** Smith, 1881.

Habitat. North Atlantic.

143. (4a) Lat.  $41^{\circ}$ ,  $48'$ ,  $45''$  N., Long.  $65^{\circ}$ ,  $47'$ ,  $00''$  W. 85 fathoms; U. S. Fish Commission, 1885.

**P. PROPINQUUS** G. O. Sars, 1869.

Habitat. North Atlantic.

136. (2a) Off Martha's Vineyard, 390 fathoms. U. S. Fish Commission.

**HIPPOLYTIDAE** Sp. Bate, 1886.

**HIPPOLYSMATA** Stimpson, 1860.

**H. WURDEMANNI** (Gibbes, 1850).

*Hippolyte wurdemanni* Gibbes, 1850.

Habitat. Coasts of Florida.

164. (3a) Pt. Pinellas, Tampa Bay, Florida. Heilprin Collection, 1886 (*fide* Ives, 1891).

**HIPPOLYTE** Leach, 1815.

**H. CRANCHII** Leach, 1815.

*Palaemon microramphos* Risso, 1816.

*H. crassicornis* H. Milne-Edwards, 1837.

*H. yarelli* Thompson, 1853.

Habitat. European seas.

258. (2d) Rochelle, France. Guérin Collection.  
 259. (xd) Pembrokeshire, Wales. E. Wilson.

**H. FABRICII** Kroeyer, 1842.

Habitat. North Atlantic.

166. (4a) Salem, Massachusetts. Dr. T. H. Streets.



167 & 264. (4a & 3d) No locality. Smithsonian Institution.

265. (1d) Coast of Massachusetts. Dr. T. H. Streets.

H. GAIMARDII H. Milne-Edwards, 1837.

*H. gibba* Kroeyer, 1842.

Habitat. Circumpolar.

150. (1a) Lat.  $46^{\circ}, 09', 30''$  N., Long.  $49^{\circ}, 48', 30''$  W. 39 fathoms;  
U. S. Fish Commission, 1885.

155. (4a) Spitzbergen. Guérin Collection (Guérin mss. type,  
*H. Robertii*).

257. (1d) Maine coast. Dr. J. H. Slack.

H. GIBBEROSUS H. Milne-Edwards, 1837.

*H. gibbosus* Dana, 1852.

Habitat. Pacific region.

165. (1a) Oahu, Sandwich Islands. Dr. W. H. Jones, 1874.

175. (2a) ? South Pacific. No donor's name.

H. GROENLANDICA (J. C. Fabricius, 1775).

*Astacus groenlandica* J. C. Fabricius, 1775.

*Cancer aculeatus* O. Fabricius, 1780.

*Alpheus aculeatus* Sabine, 1821.

*H. aculeata* Owen, 1835.

*H. armata* Owen, 1839.

*H. cornuta* Owen, 1839.

Habitat. Circumpolar.

151. (3a) Marmot Isles, Alaska, 45 fathoms. Dr. W. H. Jones.

152. (1a) No locality. No donor's name.

153. (1a) Godhaab, Greenland. Dr. Hayes' Expedition.

H. LILLJEBORGII Danielssen, 1861.

*H. securifrons* Norman, 1863.

Habitat. North Atlantic.

146. (1a) Lat.  $42^{\circ}, 41', 00''$  N., Long.  $64^{\circ}, 55', 30''$  W. 62 fathoms;  
U. S. Fish Commission, 1885.

H. LINEATA Lockington, 1876.

Habitat. Coast of California.

174. (3a) San Diego, California. Joseph Jeans.

H. MARMORATA (Olivier, 1811).

*Palaemon marmoratus* Olivier, 1811.

*Alpheus marmoratus* Lamarck, 1818.

Habitat. Pacific region.

148. (1a) Samoan Islands. J. S. Kingsley (in exchange).

161. (2a) ? South Pacific. No donor's name.

**THIS PAGE IS LOCKED TO FREE MEMBERS**

Purchase full membership to immediately unlock this page

# DELVE INTO FANTASY, MAGIC, MYTHOLOGY & FOLKLORE

Forgotten Books'  
Full Membership gives  
access to 797,885 ancient  
and modern, fiction and  
non-fiction books.

**Continue**

\*Fair usage policy applies

- Alpheus spinus* Leach, 1815.  
*Hippolyte sowerbaei* Leach, 1815.  
*Hippolyte spinus* Owen, 1835.

Habitat. North Atlantic.

- 156 & 267. (6a & 1d) No locality. Smithsonian Institution.  
 157. (8a) Salem, Mass. Dr. T. H. Streets.  
 158. (7a) Coast of Maine, Dr. J. H. Slack.  
 159. (1a) Bay of Fundy, 10–20 fathoms. U. S. Fish Commission.  
 160. (8a) Marmot Isle, Alaska, 45 fathoms. Dr. W. H. Jones.

**VIRBIUS Stimpson, 1860.**

- V. VARIANS (Leach, 1815).  
*Hippolyte varians* Leach, 1815.  
*Hippolyte smaragdina* Kroeyer, 1842.

Habitat. European seas.

268. (7d) France. Guérin Collection.

- V. VIRIDIS (Otto, 1828).  
*Alpheus viridis* Otto, 1828.  
*Hippolyte brullei* Guérin (No. 269 type).  
*Hippolyte viridis* H. Milne-Edwards, 1837.  
*Hippolyte mauritanicus* Lucas, 1849.  
*V. brullei* Czerniawsky, 1884.

Habitat. Mediterranean and Black Sea.

269. (1d) Coast of Morea. Guérin Collection (Guérin's type of *H. brullei*).

**RHINOCOCYNETIDAE Ortman, 1890.**

**RHINOCOCYNETES H. Milne-Edwards, 1837.**

R. TYPUS H. Milne-Edwards, 1837.

Habitat. Indo-Pacific and Red Sea.

168. (2a) Red Sea. Guérin Collection.  
 169. (4a) No locality. Smithsonian Institution.  
 170. (2a) Chili. Wilkes' Expedition.  
 270. (2d) Chili. Dr. T. B. Wilson.  
 272. (1d) New Zealand. Dr. T. B. Wilson.

**PONTONIIDAE Sp. Bate, 1887.**

**ANCHISTIA Dana, 1852.**

A GRANDIS Stimpson, 1860.

Habitat. Coast of China.

176. (xa) No locality. No donor's name.

**PONTONIA** Latreille, 1829.*Conchodytes* Peters, 1852.**P. ARMATA** H. Milne-Edwards, 1837.

Habitat. New Ireland and Cuba.

344. (1d) Cuba. Guérin Collection.

**P. CUSTOS** (Forskael, 1775).*Cancer custos* Forskael, 1775.*Astacus tyrrhenus* Petagna, 1792.*Alpheus tyrrhenus* Risso, 1816.*Gnathophyllum tyrrhenus* Desmarest, 1825.*P. tyrrhena* Latreille, 1825.*Callianassa tyrrhenus* Risso, 1826.*Alpheus pinnoplax* Otto, 1828.

Habitat. Mediterranean.

177. (xa) Greece. Guérin Collection.

**TYPTON** Costa, 1844.*Pontonella* Heller, 1856.**T. SPONGICOLA** Costa, 1844.*Pontonella glabra* Heller, 1856.*T. spongiosus* Sp. Bate, 1868.

Habitat. Mediterranean.

178. (1a) Villa Franca, France. Dr. B. Sharp, 1882.

**HYMENOCERIDAE** Ortmann, 1890.**HYMENOCERA** Latreille, 1829.**H. LATREILLII** Guérin (No. 367 type).

Habitat. Indian region.

367. (1d) Agalega, Seychelles. Guérin Collection (type).

**PALAEMONIDAE** Sp. Bate, 1887.**BITHYNIS** Philippi, 1860.**P. GAUDICHAUDII** (Olivier, 1791).*Palaemon gaudichaudii* Olivier, 1791.*Palaemon coementarius* Poeppig, 1836.*Bithynis longimana* Philippi, 1860.*Macrobrachium africanum* Sp. Bate, 1868.

Habitat. Rivers of Chili and Peru.

98. (1a) Chili. Guérin Collection.

359. (1d) Peru. Dr. W. S. W. Ruschenberger.

**LEANDER** Desmarest, 1849.**L. ADSPERSUS** (Rathke, 1837).*Palaemon adspersus* Rathke, 1837.

*Palaemon squilla* (part) H. Milne-Edwards, 1837.

*Palaemon fabricii* Rathke, 1843.

*Palaemon rectirostris* Zaddach, 1844.

*Palaemon leachii* Bell, 1853.

*L. rectirostris* Heller, 1863.

Habitat. European seas.

128. (1a) Liberia. No donor's name.

L. DEBILIS Dana, 1852.

Habitat. Indo-Pacific.

395. (xa) Oahu, Sandwich Islands. Smithsonian Institution.

L. NATATOR (H. Milne-Edwards, 1837).

*Palaemon natator* H. Milne-Edwards, 1837.

*Palaemon latirostris* DeHaan, 1849.

*L. erraticus* Desmarest, 1849.

*Palaemon tenuirostris* (Say) Carus, 1884.

Habitat. On weed in all seas.

126. (xa) Lat. 23°, 53' N.; Long. 53°, 06' W. Dr. W. H. Jones.

132. (xa) Lat. 24°, 26' N.; Long. 34°, 32', W. Dr. W. H. Jones.

345. (2d) Atlantic Ocean. Guérin Collection.

346. (2d) Antilles. Guérin Collection.

L. SERRATUS (Pennant, 1777.)

*Astacus serratus* Pennant, 1777.

*Cancer squilla* Herbst, 1796.

*Palaemon serratus* Fabricius, 1798.

*Palaemon squilla* Latreille, 1806.

Habitat. European seas.

119. (xa) British. No donor's name.

120. (3a) No locality. Guérin Collection.

348. (3d) Wales. E. Wilson.

349. (1d) Coast of France. Guérin Collection.

L. SQUILLA (Linnaeus, 1758).

*Cancer squilla* Linnaeus, 1758.

*Astacus squilla* Petagna, 1792.

*Palaemon squilla* Fabricius, 1793.

*Palaemon antennarius* H. Milne-Edwards, 1837 (part).

Habitat. Mediterranean.

127 & 398. (2a & 1a) Algiers. Guérin Collection.

L. XIPHIAS (Risso, 1816).

*Palaemon xiphias* Risso, 1816.

*Palaemon crenulatus* Risso, 1826.

**THIS PAGE IS LOCKED TO FREE MEMBERS**

Purchase full membership to immediately unlock this page

# Know Your Bible

Forgotten Books' Full Membership provides unlimited access to more than 28,000 volumes of Christian literature for \$8.99/month

**HOLY  
BIBLE**

**Continue**

\*Fair use policy applies

*Astacus carcinus* Fabricius, 1793.

*Bithynis carcinus* Sp. Bate, 1887.

Habitat. Indo-Pacific region.

347. (1d) Bombay. Guérin Collection (mss. type of *P. whitei* Guérin.)

358. (1d) Hoogley River, India. Dr. Harlan.

**P. FAUSTINUS** Saussure, 1858.

Habitat. Rivers of the West Indian region.

122. (6a) Vera Cruz, Mexico. No donor's name.

**P. FLUVIATILIS** Streets, 1871 (No. 114 type).

Habitat. Rivers of Mexico.

114. (2a) Tehautepec. No donor's name (Streets' type).

**P. GRACILIMANUS** Randall, 1839 (No. 125 type).

Habitat. Sandwich Islands.

125. (1a) Sandwich Islands. Nuttall and Townsend (Randall's type).

**P. GRANDIMANUS** Randall, 1839 (No. 123 type).

*Bithynis grandimanus* Sp. Bate, 1887.

Habitat. Sandwich Islands.

123. (2a) Sandwich Islands. J. K. Townsend (Randall's type).

**P. HIRTIMANUS** Olivier, 1811.

*P. latimanus* De Man, 1887.

*Bithynis hirtimanus* Sp. Bate, 1887.

Habitat. Indo-Pacific region.

99. (2a) Mauritius. Guérin Collection.

**P. JAMAICENSIS** Olivier, 1811.

*Astacus fluviatilis* Sloane, 1725, (not binominal).

*P. carcinus* Leach, 1815.

*P. brachydactylus* Wiegmann, 1836.

*P. punctatus* Randall, 1839 (No. 90 type).

*P. aztecus* Saussure, 1858.

*Macrobrachium americanum* Sp. Bate, 1868.

*Bithynis jamaicensis* Sp. Bate, 1887.

Habitat. West Indies.

90. (1a) No locality. No donor's name (Randall's type of *P. punctatus*).

91. (7a) St. Martin, West Indies. Dr. J. Van Rijgersma.

92. (1a) Cuba, West Indies. Dr. T. B. Wilson.

93. (1a) Guatemala. W. S. Vaux.

94. (8a) San Domingo. W. M. Gabb.  
 95. (4a) No locality. Smithsonian Institution.  
 287. (1d) Brazil. Dr. T. B. Wilson.  
 356. (1d) Cuba, West Indies. Dr. Spackman.  
 357. (1d) No locality. No donor's name.  
 1001. (2a) Kingston, Jamaica. W. J. Fox, 1891.

**P. LAR** Fabricius, 1798.

- P. longimanus* Fabricius, 1798.  
*P. ornatus* Olivier, 1811.  
*P. vagus* Heller, 1862.  
*P. equidens* Heller, 1862.  
*P. reunionensis* Hoffman, 1874.  
*P. mayottensis* Hoffman, 1874.  
*P. madagascarensis* Hoffman, 1874.  
*Bithynis ornatus* Sp. Bate, 1887.  
*Bithynis lar* Sp. Bate, 1887.  
*P. ornatus* var *vagus* De Man, 1891.

**Habitat.** Indo-Pacific region.

97. (4a) Navigator Islands. Dr. W. S. W. Ruschenberger:  
 353 & 355. (1d & 1d) Mauritius. Guérin Collection.  
 96 & 181. (8a & 1a). No locality. No donor's name.

**P. MEXICANUS** Saussure, 1858.

- P. dasydactylus* Streets, 1871 (No. 89 type).  
*P. sexdentatus* Streets, 1871 (No. 113 type).

**Habitat.** Rivers of Mexico and West Indies.

89. (2a) Coatzacoalcos River, Mexico. No donor's name (Streets' type of *P. dasydactylus*).  
 113. (3a) Coatzacoalcos River, Mexico. No donor's name (Streets' type of *P. sexdentatus*).

**P. OHIOENSIS** S. I. Smith, 1874.

- P. sallei* Guérin, mss. (No. 86 type).

**Habitat.** Ohio and Mississippi Rivers.

80. (xa) Vicksburg, Mississippi. L. C. Rice.  
 86. (2a) Mississippi River. Guérin Collection (Guérin's mss. type).

**P. OLFERSII** Wiegmann, 1836.

- P. spinimanus* H. Milne-Edwards, 1837.  
*Bithynis spinimanus* Sp. Bate, 1887.  
*P. cubanus* Guérin, mss. (No. 182 type).

**Habitat.** Rivers of tropical America and of West Africa.

121. (1a) No locality. No donor's name.



182. (1a) Cuba, Guérin Collection (Guérin's mss. type of *P. cubanus*).

354. (1d) Brazil. No donor's name.

**PALAEEMONELLA Dana, 1852.**

*P. YUCATANICA* Ives, 1891 (No. 389 type).

Habitat. East coast of Mexico.

389. (1a) Progreso, Yucatan. Mexican Expedition, 1890 (Ives' type.)

**PALAEEMONETES Heller, 1869.**

*P. PALUDOSA* (Gibbes, 1851).

*Hippolyte paludosa* Gibbes, 1851.

*P. exilipes* Stimpson, 1871.

Habitat. East coast of United States.

352. (4d) Wyandotte Cave, Indiana. E. D. Cope.

390. (1a) Caloosahatche River, Florida. Heilprin Collection 1886 (fide Ives, *P. exilipes*, 1891.).

391. (4a) Lake Hikpoche (canal), Florida. Heilprin Collection 1886 (fide Ives, *P. exilipes*, 1891.).

392. (8a) Lake Okeechobe, Florida. Heilprin Collection 1886 (fide Ives, *P. exilipes*, 1891.).

*P. VARIANS* (Leach, 1815).

*Palaemon varians* Leach, 1815.

*Palaemon antennarius* H. Milne-Edwards, 1837 (part).

*Palaemon lacustris* Martens, 1857.

*Pelias migratorius* Heller, 1862.

*Anchistia migratorius* Heller, 1863.

*Leander antennarius* Czernaiwsky, 1884.

Habitat. Seas of Europe.

351. (3d) France. Guérin Collection.

*P. VULGARIS* (Say, 1818).

*Palaemon vulgaris* Say, 1818.

Habitat. East coast of United States.

179. (5a) Greenport, Long Island. Smithsonian Institution.

180. (xa) No locality. No donor's name.

1028. (xa) Beasley's Point, New Jersey. Dr. B. Sharp, 1893.

1029. (xa) Nantucket, Massachusetts. Dr. B. Sharp, 1893.

**NIKIDAE, Sp. Bate, 1887.**

**PROCESSA** Leach, 1815.

*Nika* Risso, 1816.

*Nica* Stimpson, 1860.

**THIS PAGE IS LOCKED TO FREE MEMBERS**

Purchase full membership to immediately unlock this page

# DELVE INTO FANTASY, MAGIC, MYTHOLOGY & FOLKLORE

Forgotten Books'  
Full Membership gives  
access to 797,885 ancient  
and modern, fiction and  
non-fiction books.

**Continue**

\*Fair usage policy applies

*E. loricatus* Risso, 1816.

*Crangon cataptractus* H. Milne-Edwards, 1837.

*Crangon cataphractus* Heller, 1863.

Habitat. European seas.

282. (1d) Algiers. Guérin Collection.

**E. FASCIATUS** (Risso, 1816.)

*Crangon fasciatus* Risso, 1816.

*Aegeon fasciatus* Kinahan, 1862.

Habitat. European seas.

281. (4d) Mediterranean. Guérin Collection.

**NECTOCRANGON** Brandt, 1852.

*Argis* Kroeyer, 1841 (name preoccupied).

**N. ALASKENSIS** Kingsley, 1878 (No. 384 type).

Habitat. Alaska.

384. (1a) Marmot Isle, Alaska, 45 fathoms, Dr. W. H. Jones  
(Kingsley's type).

**N. LAR** (Owen, 1839.)

*Crangon lar* Owen, 1839.

*Argis lar* Kroeyer, 1843.

Habitat. Arctic seas and North Atlantic.

382. (1a) Newfoundland. Guérin Collection.

383. (3a) Halifax, Nova Scotia. Dr. T. H. Streets.

**PARACRANGON** Dana, 1852.

**P. ECHINATUS** Dana, 1852.

Habitat. Northwest coast of America.

387. (2a) Marmot Isle, Alaska, 45 fathoms. Dr. W. H. Jones.

**PONTOPHILUS** Leach, 1815.

**P. NORVEGICUS** (M. Sars, 1861.)

*Crangon norvegicus* M. Sars 1861.

Habitat. North Atlantic.

385. (2a) Lat. 43°, 32' N., Long. 59°, 22' W. 110 fathoms  
U. S. Fish Commission.

**P. SPINOSUS** Leach, 1815.

*Crangon cataphractus* Olivi, 1792 (part).

*Crangon spinosus* Lamarck, 1818.

*Cheraphilus spinosus* Kinahan, 1862.

Habitat. European seas.

283. (2d) Mediterranean. Guérin Collection.

**SABINEA** Owen, 1835.**S. SEPTEMCARINATA** (Sabine, 1824).*Crangon septemcarinata*. Sabine, 1824.

Habitat. Arctic seas and North Atlantic.

284. (1d) No locality. Smithsonian Institution.

386. (4a) Off Salem, Massachusetts, 35 fathoms. Dr. T. H. Streets.

**SCLEROCRANGON** G. O. Sars, 1885.**S. BOREAS** (Phipps, 1774).*Cancer boreas* Phipps, 1774.*Cancer homaroides* O. Fabricius, 1780.*Astacus boreas* Olivier, 1791.*Crangon boreas* Fabricius, 1798.*Cheraphilus boreas* Miers, 1877.

Habitat. Arctic seas and North Atlantic.

285. (1d) Lat. 66° North, 40 fathoms. No donor's name.

378. (2a) Halifax, Nova Scotia. Dr. T. H. Streets.

379. (5a) Spitzbergen. Guérin Collection.

380. (2a) Smithsonian Institution. No locality.

381. (1a) McCormick Bay. West Greenland Expedition, 1891.

**S. SALEBROSUS** (Owen, 1839).*Crangon salebrosus* Owen, 1839.

Habitat. Arctic seas.

376. (1a) No locality. Smithsonian Institution.

**GNATHOPHYLLIDAE** Ortmann, 1890.**DRIMO** Risso, 1826.*Gnathophyllum* Latreille, 1829.**D. ELEGANS** (Risso, 1816).*Alpheus elegans* Risso, 1816.*Gnathophyllum elegans* Latreille, 1829, and authors.

Habitat. Mediterranean.

286. (5d) Oran, Algiers. Guérin Collection.

## SUMMARY.

Stomatopoda, genera, 4 species	17 (var 0)	types	1 doubtful types	1.
Peneidea,	“ 3	“ 15 ( “ 1)	“ 3	“ “ 1.
Eucyphidea,	“ 33	“ 96 ( “ 0)	“ 12	“ “ 1.
Total	“ 40	“ 128 ( “ 1)	“ 16	“ “ 3.

**NEW SPECIES OF NORTH AMERICAN FUNGI FROM VARIOUS LOCALITIES.**

BY J. B. ELLIS AND B. M. EVERHART.

**\*PYRENOMYCETES.**

***Asterina graminicola* E. & E.**

On living and partly dead leaves of *Oryzopsis asperifolia*, Lansing, Mich. May, 1892. (G. H. Hicks. No. 574). Perithecia scattered or subgregarious, superficial, convex-discoid, perforated at the apex,  $150\mu$ , diam., mycelium reduced to a scanty fringe of spreading hyphæ around the base. Asci obovate,  $22-30 \times 12-20\mu$ , sessile, 8-spored. Sporidia inordinate, clavate-oblong, hyaline, uniseptate and strongly constricted at the septum so as easily to separate into two parts, quite variable in size—in some perithecia  $7-10 \times 2\frac{1}{2}\mu$ , in others  $10-15 \times 3-3\frac{1}{2}\mu$ .

***Asterina leemingii* E. & E.**

On living leaves of *Galax aphylla*, Marion, Va. June, 1892. Coll. Miss Helena Dewey Leeming, com. Smith Ely Jelliffe, M. D. Mycelium hypophyllous, forming black, orbicular spots 2-4 mm. diam., composed of superficial appressed, radiating, dendroid-branched hyphæ furnished with globose hyphopodia  $8-10\mu$ , diam. Perithecia numerous, seated on the hyphæ, depressed-globose,  $150\mu$ , diam., with a papilliform ostiolum which is soon deciduous leaving the perithecium perforated and convex. Asci oblong,  $35-40 \times 20-24\mu$ , paraphysate, 8-spored. Sporidia crowded, oblong-fusoid, yellowish-hyaline, uniseptate, scarcely constricted, slightly curved,  $18-22 \times 5-6\mu$ . Has the habit of *Dimerosporium orbiculare* B. & C. but differs in several respects.

***Rosellinia megalæcia* E. & E.**

On dead willow. Sheridan, Montana. Jan., 1892. (Mrs. Lydia A. Fitch.)

Perithecia gregarious, globulose, subapplanate above, brown, sunk in the bark,  $1\frac{1}{2}$  mm. diam., the apex erumpent and surrounded by the laciniae of the ruptured epidermis, ostiolum tubercular-conical, black. Asci cylindrical, paraphysate, 8-spored, p. sp. about  $100 \times 6-7\mu$ . Sporidia uniseriate, oblong, brown,  $15-20 \times 7-8\mu$ , not appendiculate. The walls of the perithecia are thick and solid, coriaceo-

**THIS PAGE IS LOCKED TO FREE MEMBERS**

Purchase full membership to immediately unlock this page

# Know Your Bible

Forgotten Books' Full Membership provides unlimited access to more than 28,000 volumes of Christian literature for \$8.99/month

**HOLY BIBLE**

**Continue**

\*Fair use policy applies

*Perithecia* gregarious, ovate,  $\frac{1}{3}$  mm. diam., sparingly pilose around the base, with rather pale, weak hairs, smoother and bare above, black. Ostiolum papillose-conic, perforated. Asci clavate-cylindrical,  $100 \times 10\mu$ , with abundant paraphyses, 8-spored. Sporidia obliquely uniseriate or sub-biseriate, oblong-elliptical, hyaline, granular,  $13-16 \times 5-6\mu$ . The sporidia agree with those of *Tr. punctillum* Rehm, but that has the perithecia smaller and seated on a distinct brown subiculum.

***Herpotrichia incisa* E. & E.**

On dead roots of *Acer spicatum*, London, Canada. April, 1892. (Dearness, No. 1,810.)

*Perithecia* densely gregarious, superficial on the blackened surface of the wood, ovate-conical or subpyramidal,  $300-400\mu$ , diam., often stellately incised at the apex, black, roughish, with a few weak, pale, rudimentary hairs at first. Asci cylindrical,  $150-200 \times 12-15\mu$ , with abundant, paraphyses, 8-spored. Sporidia overlapping-biseriate, fusoid, subhyaline, slightly curved, uniseptate and slightly constricted at the septum,  $35-45 \times 7-8\mu$ .

***Chaetomium glabrescens* E. & E.**

On a rotten limb (*Salix*)? Rockport, Kansas. Dec., 1892. (Bartholomew, No. 810.)

Gregarious, surrounded by and nearly sunk in a felt-like, black subiculum composed of rough, branching black, interwoven hairs sending up numerous straight, rough, simple bristles,  $\frac{1}{4}-\frac{1}{2}$  mm. long. *Perithecia* ovate-globose about  $\frac{3}{4}$  mm. diam., clothed, especially below, with long, straight, rough, simple bristles which also clothe at first, but more sparingly, the upper part of the perithecium, but these are soon deciduous, leaving the apex bare. Ostiolum conic-papilliform, soon deciduous. The perithecia are very brittle and the upper part soon falls away leaving the cup-shaped base. Sporidia elliptical, or almond-shaped,  $8-10 \times 6-7\mu$  (front view),  $7-9 \times 5\mu$ , when seen edge-wise. Asci not seen.

***Teichospora gregaria* E. & E.**

On decorticated *Fraxinus*, London, Canada. Feb., 1892. (J. Dearness, No. 1,027.)

*Perithecia* densely gregarious, ovate,  $\frac{1}{3}-\frac{1}{2}$  mm. diam., black, superficial, with a conic-papilliform ostiolum. Asci cylindrical, short-stipitate, 8-spored, with abundant paraphyses, p. sp. about  $75 \times 14\mu$ . Sporidia subuniseriate, oblong-elliptical, about 5-septate with a lon-

gitudinal septum often extending through all the cells, constricted in the middle, hyaline and uniseptate at first, becoming yellow-brown, 18–22 x 10–12 $\mu$ , ends obtusely pointed or regularly rounded.

The perithecia are attenuated above into the ostiolum so as to be subconical.

**Teichospora variabilis** E. & E.

On dead sage brush (*Artemisia*), Sheridan, Montana. Jan., 1892, (Mrs. L. A. Fitch.)

Perithecia scattered, erumpent-superficial, black, rough, depressed-hemispherical,  $\frac{1}{3}$ – $\frac{1}{2}$  mm. diam., at first partly covered by the loose fibers of the weather beaten bark, finally collapsing above. Ostiolum papilliform, finally perforated. Asci oblong, abruptly contracted below into a very short stipe, paraphysate, 8-spored, 75–80 x 20–22 $\mu$ , Sporidia biseriate or crowded, elliptical, at first of a uniform yellow, soon becoming a bright golden yellow and 5–7-septate and muriform, finally becoming almost black and opaque, 20–25 x about 12 $\mu$ .

**Teichospora nautica** E. & E.

On decorticated, weather-beaten, poplar limbs, in Mill Creek, Sheridan, Montana. June, 1892. (Mrs. L. A. Fitch.)

Perithecia scattered or gregarious, hemispherical or hemispheric-elliptical, with the flattened base slightly sunk in the surface of the wood; carbonacco-membranaceous, about  $\frac{1}{2}$  mm. diam., black, subshining at the apex. Ostiolum papilliform, at length perforated. Asci cylindrical, short-stipitate, 100–110 x 12 $\mu$ , paraphysate, 8-spored. Sporidia uniseriate or sub-biseriate, elliptical or slightly ovate-elliptical, with three main transverse septa, often becoming 5-septate, with 1–2 of the cells divided by a transverse septum, 18–22 x 8–11 $\mu$ .

**Teichospora aspera** E. & E.

On old weather-beaten, cottonwood boards, Rockport, Kansas. Jan., 1892. (Bartholomew, No. 853.)

Perithecia gregarious, semi-erumpent, membranaceous, hemispherical or depressed-globose, about  $\frac{1}{2}$  mm. diam., tubercular roughened, collapsing when dry, with a broad papilliform ostiolum, finally broadly perforated or sublacinately ruptured at the apex. Asci clavate-cylindrical, paraphysate, sessile, 75–90 x 10–12 $\mu$ , 8-spored. Sporidia mostly overlapping uniseriate, ovate-oblong, 3-septate, and constricted at the middle septum (sometimes at all the septa), brown,



one or both the inner cells divided by a longitudinal septum, 15–20 x 6–8 $\mu$ .

Differs from *T. muricata* E. & E. in its shorter and narrower asci and narrower sporidia.

Closely allied to *T. emilii* Fabre.

**Teichosporella montanæ** E. & E.

On drift wood, in Mill Creek, Sheridan, Montana. June, 1892. (Mrs. L. A. Fitch.)

Perithecia scattered, ovate-conical,  $\frac{1}{4}$ – $\frac{1}{3}$  mm., diam., at length partially collapsing above, emergent-superficial among the loosened fibres of the wood, membranaceous, black, perforated above. Asci clavate, short-stipitate, 8-spored, with abundant paraphyses, 80–85 x 12–15 $\mu$ , (p. sp. 65–70 $\mu$ ). Sporidia biseriate, oblong-clavate or oblong-elliptical, 3–5-septate, with 1–2 of the cells divided by a longitudinal septum, hyaline, 22–30 x 8–12 $\mu$ , mostly a little curved and finally more or less constricted at the septa.

**Lophiosphæra hysteroioides** E. & E.

On a rotten log of *Carya*, St. Martinville, La. Jan., 1890. (Langlois, 2,215.)

Perithecia densely gregarious, hemispherical, subelliptical on a transverse section, about  $\frac{3}{4}$  mm. diam., with their bases slightly sunk in the wood, black, subcarbonaceous. Ostiolum linear, compressed; extending nearly or quite across, open, and often with a parallel groove on each side of the base; sometimes the ostiolum is only slightly prominent, then resembling *Hysterium*. Asci slender-clavate-cylindrical, 55–60 x 8 $\mu$ , (p. sp.) or, including the slender base, 80–90 $\mu$  long, with abundant paraphyses. Sporidia subbiseriate above, fusoid, uniseptate and constricted at the septum, slightly curved, pale yellowish-brown, 16–18 x 4–4 $\frac{1}{2}$  $\mu$ .

**Lophiosphæra gloniospora** E. & E.

On decorticated willow limbs, among driftwood, in Mill Creek, Sheridan, Montana. June, 1892. (Mrs. L. A. Fitch.)

Perithecia scattered or gregarious, erumpent, convex-hemispherical, about  $\frac{3}{4}$  mm. diam., of carbonaceo-coriaceous texture, becoming prominent but not superficial, remaining more or less covered by the fibers of the wood. Ostiolum narrow, compressed, not apparent in the young specimens. Asci cylindrical, short-stipitate, 100–110 x 10–12 $\mu$ , 8-spored, with abundant paraphyses. Sporidia uniseriate, obovate, hyaline, uniseptate, constricted at the septum, 12–16 x 6–7 $\mu$ ,

**THIS PAGE IS LOCKED TO FREE MEMBERS**

Purchase full membership to immediately unlock this page

# DELVE INTO FANTASY, MAGIC, MYTHOLOGY & FOLKLORE

Forgotten Books'  
Full Membership gives  
access to 797,885 ancient  
and modern, fiction and  
non-fiction books.

**Continue**

\*Fair usage policy applies

Perithecia scattered or subgregarious, superficial, ovate-conical, black and subshining, minute, 150–200 $\mu$  diam., with a conic-papilliform ostiolum. Asci fusoid, i. e. thickest in the middle and tapering to each end, obscurely paraphysate, 8-spored, about 50 x 5–6 $\mu$ . Sporidia biseriate in the middle of the ascus, uniseriate at each end, oblong-elliptical, hyaline, binucleate, 5–6 x 1½–2½ $\mu$ .

**Sphærella dircæ** E. & E.

On living leaves of *Dirca palustris*, London, Canada. July, 1892. (Dearness, No. 1,941.)

Spots amphigenous, dark brown below, dirty white above with a dark brown border, irregular in shape, 2–4 mm. diam., subconfluent, often several of the dirty white spots included in a large dark brown area. Perithecia epiphyllous, scattered on the spots, subprominent, perforated above, 80–110 $\mu$  diam. Asci oblong-cylindrical, about 35 x 6 $\mu$ . Sporidia biseriate, oblong, uniseptate, hyaline, scarcely constricted, 15–20 x 5–6 $\mu$ .

A *Macrosporium* was found on the same spots.

**Sphærella oryzopsis** E. & E.

On leaves of *Oryzopsis asperifolia*, Lansing, Mich. May, 1892. (G. H. Hicks, No. 573.)

Perithecia scattered or oftener in definite patches about 1 cm. diam., sunk, except the subobtuse, slightly projecting apex, in the parenchyma of the leaf, small (75–80 $\mu$ ), black. Asci fasciculate, sessile, paraphysate, 35–40 x 10–12  $\mu$ , 8-spored. Sporidia biseriate, clavate-oblong, hyaline, uniseptate and slightly constricted at the septum, 12–15 x 3–3½ $\mu$ .

Apparently closely allied to *S. oryzæ* (Catt.), but differs in its oblong-fusoid asci, and sporidia.

**Sphærella solani** E. & E.

On leaves of *Solanum dulcamara*. Ohio, Kellerman, No. 412, and London, Canada. (Dearness, No. 866.)

Spots numerous, small (1–2 mm.), round, white, deciduous, thin and pellucid. Perithecia mostly epiphyllous, few on a spot, lenticular, perforated, 80–110 $\mu$  diam. Asci oblong, 35–40 x 10 $\mu$  paraphysate, 8-spored. Sporidia biseriate, fusoid-oblong, uniseptate, scarcely constricted, 10–12 x 3 $\mu$ , ends subacute.

Not distinguishable outwardly from *Leptosphaeria solani* E. & E. which is found on the same leaves.

**Sphærella lycii** E. & E.

On living leaves of *Lycium vulgare*, London, Canada. Aug., 1892. (Dearness, No. 1,984.)

Maculicolous, epiphyllous, on small (1–1½ mm.), definite, thin round, white spots. Perithecia subdiscoid, black, about ¼ mm. diam. few on a spot. Asci 35–45 x 10 $\mu$ , oblong-clavate, 8-spored. Sporidia biseriate, oblong-fusoid, inequilateral, hyaline, subobtuse at the ends, (becoming uniseptate)? 12–15 x 5–6 $\mu$ .

**Pleospora carpinicola** E. & E.

On dead limbs of *Carpinus americana*, London, Canada. April, 1892. (Dearness, No. 1,738.)

Perithecia buried in the bark, gregarious, depressed-globose, covered by the epidermis which is raised into distinct pustules and barely pierced by the papilliform ostiolum. Asci cylindrical, short-stipitate, 100–110 x 8–9 $\mu$ , paraphysate. Sporidia uniseriate, elliptical, obtusely pointed at the ends, 3-septate, constricted at the middle septum, one or two of the inner cells divided by a longitudinal septum, pale yellow, 14–16 x 7–8 $\mu$ , ends obtusely pointed.

**Pleospora decipiens** E. & E.

On decorticated, bleached wood of *Azalea*, Newfield, N. J. June, 1877, with *Cheiromyces comatus* E. & E.

Perithecia gregarious, membranaceous, subelliptical, about ¾ mm. diam., convex, collapsing above when dry. Ostiolum indistinct. Asci oblong, 55–65 x 15–20 $\mu$ , sessile, sparingly paraphysate, 4–8-spored. Sporidia subbiserial, oblong or clavate-oblong, 5–7-septate and muriform, hyaline or slightly tinged with yellow, 35–40 x 10–12 $\mu$ .

Outwardly this cannot be distinguished from *Zignoella diaphana* (C. & E.) but that has the sporidia smaller and in all the species seen, including those from Montana and Oregon, only 3-septate.

**Leptosphæria lasioderma** E. & E.

On dead stems of *Artemisia tridentata*, Sprucemont, Nevada. Oct., 1892, 8,500 ft. alt. (M. E. Jones, No. 2.)

Perithecia scattered, erumpent-superficial, hemispherical, ½–¾ mm. diam., perforated above, shagged with a loose coat of brown, continuous, flaccid hairs 100–150 x 5–6 $\mu$ . Asci clavate-cylindrical, 65–75 x 15–20 $\mu$ . with abundant paraphyses, short-stipitate. Sporidia biserial, broad oblong-fusoid, slightly curved, 25–30 x 10–12 $\mu$ , golden yellow, somewhat constricted at the septa, and occasionally with a short apiculus at each end.

**Leptosphaeria lilii** Ell. & Dearness.

On leaves of *Lilium superbum*, London, Canada. Aug., 1890. (J. Dearness.)

Spots amphigenous, elliptical, becoming pale,  $\frac{1}{2}$ –1 cm. long x 3–5 mm. wide, definite, with a narrow, reddish-purple border. Perithecia amphigenous, scattered, black, sublenticular, pierced above, 150–200 $\mu$  diam., erumpent. Asci oblong-cylindrical, paraphysate, with a short, nodular base, 50–60 x 7 $\mu$ . Sporidia biseriate, fusoid, 3-septate, constricted at the middle septum with the cell next above swollen, hyaline at first, becoming yellowish, nearly straight 15–18 x 3 $\mu$ .

The spermogonial stage (*Phyllosticta lilii* Ell. & Dearness) occurs on the same leaves and does not differ outwardly, sporules hyaline 4–5 x 2 $\frac{1}{2}$ –3 $\mu$ .

**Leptosphaeria solani** E. & E.

On living leaves of *Solanum dulcamara*, London, Canada. Aug., 1892. (Dearness, No. 886 B.)

Perithecia epiphyllous, on small round, white spots 1–3 mm. diam. with a narrow, slightly raised reddish-brown margin, depressed-globose, 150 $\mu$  diam., black, erumpent-superficial. Asci clavate-cylindrical, 55–60 x 8 $\mu$ , sessile; paraphyses, if any, very obscure. Sporidia biseriate, fusoid, nearly straight, yellowish, 3-septate, constricted at the middle septum, and the two adjacent cells, especially the one next above, slightly swollen, 16–20 x 2 $\frac{1}{2}$ –3 $\mu$ .

There is a *Phyllosticta* on the same spots with smaller, perithecia and sporules, 5–7 x 3 $\mu$ . (*P. dulcamaræ* Sacc.)?

**Metasphaeria maximiliani** E. & E.

On dead stems of *Helianthus maximiliani*, Rockport, Kansas. Dec., 1892. (Bartholomew, No. 821.)

Perithecia scattered, erumpent and semi-emergent or nearly superficial by the peeling off of the epidermis, ovate, about  $\frac{1}{3}$  mm. high, black, with a papilliform ostiolum. Asci cylindric-clavate, 75 x 8 $\mu$ , paraphysate, 8-spored. Sporidia biseriate, oblong-fusoid, hyaline, 2-septate, and constricted at the septa, obtuse, not appendiculate, 15–20 x 4–5 $\mu$ .

Differs from *M. helianthi* Awd. in its rather longer, 2-septate sporidia.

**Metasphaeria sphenispora** E. & E.

On dead culms of *Erianthus alopecuroides*, near Newark, Del. April, 1892. (Commons, No. 1,941.)

**THIS PAGE IS LOCKED TO FREE MEMBERS**

Purchase full membership to immediately unlock this page

# Know Your Bible

Forgotten Books' Full Membership provides unlimited access to more than 28,000 volumes of Christian literature for \$8.99/month

**HOLY BIBLE**

**Continue**

\*Fair use policy applies

Asci oblong, short-stipitate, overtopped by the abundant, filiform paraphyses,  $35-60 \times 10-12\mu$ , 8-spored. Sporidia biseriate, clavate-pyriform, yellowish-hyaline, 1-2-septate, not constricted, subinequilateral,  $13-15 \times 4-5\mu$ , at first filled with minute nuclei and without septa. The specimens were not well matured and it may be that the sporidia become 3-septate, but only 2 septa were seen.

**Massariovalsa caudata** E. & E.

On bark of dead *Ulmus*, London, Canada. June, 1892. (Dearness, No. 1,901.)

Perithecia subcircinate, 3-8 together, buried in the scarcely altered substance of the inner bark, coriaceo-membranaceous,  $\frac{1}{3}-\frac{1}{2}$  mm. diam., their obtusely conic-papilliform ostiola erumpent in a small, compressed fascicle through the pustuliform-elevated epidermis. Asci broad oblong-clavate, pseudoparaphysate, substipitate, 8-spored, p. sp.  $80-110 \times 20\mu$ . Sporidia biseriate, oblong, obtusely rounded at the ends, hyaline, becoming brown, 3-septate,  $25-45 \times 12-15\mu$ , with a cornute, mostly curved, hyaline, evanescent appendage  $12-20\mu$  long, at the lower end and sometimes at both ends.

The sporidia have a thin, hyaline envelope and remain for a long time hyaline.

**Clypeosphæria minor** E. & E.

On bark of dead birch roots, London, Canada. April, 1892. (J. Dearness.)

Perithecia gregarious, about  $\frac{1}{2}$  mm. diam., slightly sunk in the inner bark and raising the epidermis into distinct pustules pierced at the apex by the slightly compressed, subconical ostiolum. Asci clavate,  $50-55 \times 5\mu$ , with filiform paraphyses 8-spored. Sporidia sub-biseriate, fusoid-oblong, olivaceous-brown, 3-septate, slightly curved,  $10-12 \times 2\frac{1}{2}-3\mu$ , attenuated toward each end but subobtuse.

**Clypeosphæria ulmicola** E. & E.

On dead limbs of *Ulmus*, London, Canada. April, 1892. (Dearness, No. 1,776.)

Perithecia thickly but evenly scattered, buried in the bark which is raised into minute pustules, about  $\frac{1}{2}$  mm. diam., of a slaty black color and of uniform soft consistence throughout. Ostiola papilliform, erumpent through the minute, black stromatic shield but not prominent. Asci (p. sp.)  $75-85 \times 8-9\mu$ , cylindrical, paraphysate. Sporidia uniseriate, oblong-elliptical, brown, 3-septate and often constricted at the middle septum,  $14-16 \times 7-8\mu$ , ends rounded and obtuse.

**Thyridium syringæ** E. & E.

On dead stems of *Syringa* (lilac), London, Canada. March, 1892. (Dearness, No. 1,654.)

Perithecia thickly scattered, buried in the bark, about  $\frac{1}{2}$  mm. diam., with thick, coriaceous walls. Ostiolum papilliform, black, barely perforating the bark which is raised into slight pustules but not ruptured. Asci clavate-cylindrical, 75–80 (p. sp. 65) x  $12\mu$ , (paraphysate)? 8-spored. Sporidia biseriate above, oblong or clavate-oblong 3-(exceptionally 4-) septate, with one or two of the cells divided by a longitudinal septum, yellowish-brown, 12–15 x 5–7 $\mu$ .

**Thyridium americanum** E. & E.

On dead and considerably decayed limbs of *Xanthoxylum americanum*, London, Canada, April, 1892. (Dearness, No. 1,780.)

Perithecia evenly scattered or 2–3 lying close together, buried in the inner bark, which is blackened on the surface, 200–400 $\mu$  diam., globose, homogeneous and white inside, contracted above into short necks, their globose or conic-papilliform ostiola piercing the epidermis and raising it into numerous small pustules. Asci cylindrical, 100–115 x 12–15 $\mu$ , p. sp. 80–90 $\mu$  long, paraphysate, 8-spored. Sporidia uniseriate, elliptical or ovate, 3-septate and submuriform, constricted at the middle septum, 14–17 x 8–9 $\mu$ . Very different from *Thyronectria xanthoxyli* (Pk.). Accompanying the ascigerous perithecia are other similar ones, some of which contain minute spermatia 2 $\frac{1}{2}$ –3 x  $\frac{3}{4}\mu$ , others with sporules oblong-fusoid, hyaline, 2-nucleate, 10–12 x 3 $\mu$ , on clavate-basidia 12–15 $\mu$ . long (*Dendrophoma*) ? and others (*Hendersonia xanthoxyli* E. & E.), with oblong-cylindrical, brownish, 3-septate sporules, 10–12 x 3 $\mu$ .

**Anthostomella mammoides** E. & E.

On dead limbs of *Ostrya virginica*, London, Canada. June, 1892. (Dearness, No. 1,801.)

Perithecia gregarious, about  $\frac{1}{2}$  mm. diam., with thick, coriaceous walls, about half sunk in the inner bark, the upper half raising the closely adherent epidermis into strong, dome-like, hemispherical pustules about 1 mm. across, the prominent, large, papilliform ostiola erumpent. Asci cylindrical, paraphysate, 110–120 x 12–15 $\mu$ , 8-spored, p. sp. 90–110 $\mu$ , long. Sporidia uniseriate, elliptical, brown, 15–22 x 10–13 $\mu$ .



**Eutypella amorphæ** E. & E.

On dead stems of *Amorpha fruticosa*, Rockport, Kansas. Dec., 1892. (Bartholomew, No. 822.)

Stromata scattered, numerous and lying close together, but mostly not confluent, conic-convex, about 2 mm. diam., formed above from the scarcely altered but slightly paler substance of the bark, and closely circumscribed by a narrow, black line which does not penetrate the wood. Perithecia 6–8 in a stroma, rather less than  $\frac{1}{2}$  mm. in diameter, globose, with rather thick walls, partly sunk in the surface of the wood, lying closely crowded together, their slender necks rising close together and the rather large subtubercular, sulcate-cleft fasciculate ostiola piercing, but not rupturing the closely adherent epidermis, which is not perceptibly raised. Asci clavate,  $36\text{--}40 \times 3\text{--}3\frac{1}{2}\mu$ . (p. sp.  $15\text{--}20\mu$  long), 8-spored. Sporidia subbiseriate, allantoid, slightly curved, hyaline, with a nucleus in each end,  $5\text{--}6 \times 1\frac{1}{2}\mu$ .

**Diaporthe albocarnis** E. & E.

On the smaller dead limbs of *Cornus* sp. and on *Staphylea trifolia* and *Ostrya virginica*, London, Canada. May, 1891. (J. Dearness.)

Perithecia 2–4 together in a minute, cortical stroma, small ( $\frac{1}{4}$  mm.), solid and white inside, ovate-globose, attenuated above into very short necks with their obscure, scarcely prominent, perforated ostiola united in a flat, black disk, erumpent through the ruptured epidermis which is raised into little pustules thickly scattered over the limbs. Asci clavate, p. sp. about  $75 \times 7\text{--}8\mu$ . Paraphyses simple filiform, rather stout, longer than the asci. Sporidia subbiseriate, fusoid 4-nucleate at first, becoming uniseptate (seldom 3-septate) and constricted and slightly swollen on each side of the septum, sometimes brownish,  $12\text{--}20 \times 3\frac{1}{2}\text{--}5\mu$ .

There is no circumscribing line around the stroma but the wood to the depth of about 2 mm. is slightly discolored, presenting a clouded or marbled appearance. The margin of the ruptured epidermis is at first stained yellowish. Sometimes there is only a single perithecium in a stroma. This can hardly be *Diaporthe sphingiphora* Ouds. On the same limbs occurs *Myxosporium nitidum* B. & C., which may be the spermogonial stage.

**Diaporthe apiospora** E. & E.

On bark of dead *Ulmus*, London, Canada. (Dearness), Iowa (Holway.)

**THIS PAGE IS LOCKED TO FREE MEMBERS**

Purchase full membership to immediately unlock this page

# DELVE INTO FANTASY, MAGIC, MYTHOLOGY & FOLKLORE

Forgotten Books'  
Full Membership gives  
access to 797,885 ancient  
and modern, fiction and  
non-fiction books.

**Continue**

\*Fair usage policy applies

The spermogonia (*Cytispora pruni* Ell. and Dearness), contain an abundance of oblong-fusoid sporules, 2-4-nucleate, hyaline, 10-12 x 3 $\mu$ . The perithecia appear in the bark, directly beneath the spermogonia.

**Diaporthe calosphærioides E. & E.**

On dead stems of *Sambucus*, London, Canada. April, 1892. (Dearness, No. 1,744.)

Stroma cortical, convex, 2-4 mm. diam., raising the bark into broad pustules, sunk to the wood but not penetrating it or surrounded by any black circumscribing line, thin, brownish-black, mostly coming off with the bark. Perithecia 6-12, circinate, thin membranaceous and collapsing when dry, about  $\frac{1}{2}$  mm. diam., necks slender, decumbent, converging with their broad-papilliform, finally subumbilicate ostiola joined in a flat, brown disk erumpent through the epidermis and closely surrounded by it. Asci fusoid-clavate, p. sp. 50-60 x 8-10 $\mu$ , with a fugacious stipe 15-20 $\mu$ . long, and long, lanceolate but very evanescent paraphyses. Sporidia biseriate, allantoid, hyaline, 3-4-nucleate, rounded at the ends, finally uniseptate, about 15 x 3-3 $\frac{1}{2}$  $\mu$ .

This has an outward resemblance to *Pseudovalsa sambucina* Pk., but differs in its sporidia. The long paraphyses and circinate perithecia barely covered by the thin stroma indicate a relationship with *Calosphæria*.

**Diaporthe aliena E. & E.**

On *Cratægus* (hawthorn), London, Canada. March, 1892. (Dearness, No. 1,793.)

Perithecia 4-6 in a pustule, buried in the scarcely altered bark, not sunk in the wood, black, subcompressed,  $\frac{1}{2}$ - $\frac{3}{4}$  mm. diam., with short necks and black, obtuse, coarse ostiola erumpent in a brown, convex disk which is soon obliterated. Asci cylindrical, 75-80 x 7-8 $\mu$ . Sporidia uniseriate, 8 in an ascus, short and obtusely-elliptical, hyaline, uniseptate and constricted, with a large nucleus in each cell, 10-13 x 7-8 $\mu$ .

According to the spece. of *D. crataegi* (Curr.) in Cke. F. Brit. ser. 1st, No. 380, this cannot be that species, which in the specc. cited, has smaller perithecia and smaller asci with biseriate, oblong-fusoid sporidia about 15 x 3 $\frac{1}{2}$  $\mu$ , 4-nucleate, becoming uniseptate. There is some confusion in Currey's figures. The ascus he figures on Pl. 48, fig. 135, has uniseriate, elliptical, uniseptate sporidia, while the sporidia figured at 135 (a), are oblong-cylindrical.

**Diaporthe spicata** E. & E.

On dead limbs of *Acer spicatum*, London, Canada. April, 1892. (Dearness, No. 1,784.)

Perithecia few in a pustule (4-8), small (250-300 $\mu$ ), black, buried in the bark and not penetrating the wood. Ostiola short-cylindrical or conic-cylindrical, raising the epidermis into little pustules and rupturing or piercing it, but mostly remaining partly covered by it. Asci oblong-fusoid, p. sp. 40 x 7 $\mu$ . Sporidia biseri-ate, oblong or fusoid-oblong, slightly curved, subacute, about 4-nucleate, becoming 1-septate, hyaline, 12-13 x 3-3 $\frac{1}{2}$  $\mu$ .

Differs from *D. acerina* (Pk.) in its smaller perithecia not sunk in the wood, and its curved sporidia.

**Eutypella coryli** E. & E.

On dead *Corylus*, London, Canada. June, 1892. (Dearness, No. 1,872.)

Perithecia 8-15 in a pustule, globose, coriaceous, about  $\frac{1}{4}$  mm. diam., circinately buried in the unchanged substance of the inner bark, their 4-cleft ostiola erumpent in a convex, black disk 1-2 mm. diam., which is soon obliterated. Asci clavate, 20-30 x 4 $\mu$ , 8-spored. Sporidia biseri-ate, allantoid, yellowish, moderately curved, 5-6 x 1 $\frac{1}{4}$   $\mu$ .

The tufts of erumpent ostiola are distinctly prominent. This seems quite distinct from any of the other described species on *Corylus*.

**Fenestella ulmicola** E. & E.

On dead limbs of *Ulmus americana*, London, Canada. August, 1892. (J. Dearness.)

Stroma orbicular, convex, about  $\frac{1}{2}$  cm. diam., closely covered by the epidermis, which is raised into a broad pustule pierced by the minute, black disk but not laciniately torn. Perithecia 6-12, circinate in the dull yellowish, light colored substance of the stroma,  $\frac{1}{2}$ - $\frac{3}{4}$  mm. diam., ovate-globose, their necks converging and their conic-papilliform or convex, black ostiola erumpent and united in the small disk, which rises slightly above the epidermis. Asci cylindrical, short-stipitate, paraphysate; 110-120 x 12 $\mu$ . Sporidia uniseriate, oblong-elliptical, 5-septate, with a longitudinal septum running through, brown, 12-16 x 7-8 $\mu$ .

The substance of the stroma is similar to that of *F. vestita*, but the asci and sporidia are smaller.

**Valsaria staphylina** E. & E.

On dead limbs of *Staphylea trifolia*, London, Canada. May, 1892. (Dearness, No. 1,848.)

Stromata orbicular or elliptical, 2–3 mm. diam., convex-hemispherical, buried in the inner bark which is uniformly blackened on the surface but remains unaltered within, often seriatly arranged. Perithecia subcircinate 6–12 in a stroma, 300–350 $\mu$  diam., with short, slender necks, the papilliform ostiola erumpent in a small, black, mostly acutely-elliptical disk visible in longitudinal clefts of the slightly raised epidermis. Asci cylindrical, p. sp. 80–90 x 7 $\mu$ , paraphysate, 8-spored. Sporidia uniseriate, oblong-elliptical, obtuse, dark brown, constricted, 12–15 x 7–8 $\mu$ , each cell with a single nucleus.

Of less robust growth than *V. insitiva* not blackening the wood, and only blackening the surface of the inner bark.

**Diatrypella pulcherrima** E. & E.

On dead twigs of *Salix*, London, Canada. May, 1892. (Dearness, No. 1,875.)

Stromata minute, gregarious, cortical, raising the smooth epidermis into convex-hemispherical pustules about 1 mm. diam., and crowned with a minute, white, orbicular disk which is soon obliterated in the center by the tips of the crowded, black, smooth, minute ostiola, which do not however rise quite up to the surface of the disk. Perithecia 8–12, minute ( $\frac{1}{4}$  mm. or less), lying in a subcircinate manner in the stroma. Asci (p. sp.) oblong 30–35 x 8–10 $\mu$ , polysporous. Sporidia inordinate, allantoid, hyaline, moderately curved, 8–12 x 1 $\frac{1}{2}$  $\mu$ .

**Nummularia lateritia** E. & E.

On bark of dead *Fraxinus sambucifolia*, London, Canada. March, 1892. (Dearness, No. 1,283.)

Stroma carnose-carbonaceous, orbicular, discoid,  $\frac{1}{2}$ –1 cm. across, and about 1 mm. thick, dark reddish-brown, bordered by the margin of the ruptured epidermis, seated on the surface of the inner bark and circumscribed by a black line which penetrates to the wood. Ostiola papilliform, becoming umbilicate, scarcely prominent. Perithecia peripheral, ovate  $\frac{1}{2}$  mm., or a little more high, and about  $\frac{1}{3}$  mm. broad, forming a closely compacted stratum. Asci clavate, paraphysate, long-stipitate, 100–120 x 8 $\mu$ , p. sp. 55–60 x 8 $\mu$ . Sporidia obliquely uniseriate, navicular, 10–12 x 4–5 $\mu$ ,

**THIS PAGE IS LOCKED TO FREE MEMBERS**

Purchase full membership to immediately unlock this page

# Know Your Bible

Forgotten Books' Full Membership provides unlimited access to more than 28,000 volumes of Christian literature for \$8.99/month

**HOLY BIBLE**

**Continue**

\*Fair use policy applies

clavate-cylindrical, 75–80 x 5 $\mu$ , with a slender stipe-like base<sup>r</sup> mostly curved, with filiform paraphyses. Sporidia overlapping uniseriate or biseriate, fusoid-oblong, curved, becoming 1–3-septate, 10–15 (exceptionally 20) x 2½–3 $\mu$ .

This agrees well with the description of *H. pallescens*, but its smaller size, acutely margined, more distinctly stipitate pruinose cups, and its sporidia often 3-septate seem to separate it from that species.

**Phialea dearnessii** E. & E.

On dead stems of *Monarda*, London, Canada. May, 1890. (Dearness, No. 1,713.)

Erumpent, scattered, substipitate, nearly sulphur yellow. Ascomata about ¾ mm. diam., subolivaceous at first, becoming yellow, substriate, margin subfimbriate, at first incurved then erect, stipe short, less than diameter of the disk, stout. Asci clavate-cylindrical, sessile, 75–80 x 10 $\mu$ , with stout paraphyses scarcely thickened above. Sporidia biseriate, fusoid, slightly curved, with two large nuclei, 30–35 x 3 $\mu$ , gradually attenuated to the slender subulate-pointed ends.

**Chlorosplenium salviicolor** E. & E.

On dead stems of *Vitis vulpina*, St. Martinville, La. March, 1889. (Langlois, No. 1,679.)

Scattered, subhemispherical at first with the margin incurved, soon expanding to nearly plane, 1½–2 mm. across, dark sage-green, pruinose outside contracted below into a short stipitate base. Margin subincurved and subundulate when dry. Asci clavate-cylindrical, slender, sessile, 30 x 2½–3 $\mu$ . Paraphyses branched above and conidiiferous. Sporidia biseriate, oblong, minute, hyaline 3–4 x 1–1½ $\mu$ . Smaller throughout and of a duller shade of green than *C. æruginescens* Rehm, and does not stain the subjacent wood.

**Chlorosplenium canadense** E. & E.

In depressions in the rough bark of *Tilia*, and on the bare wood, London, Canada. Oct., 1892. (Dearness, No. 2,032.)

Ascomata cespitose or solitary, stipitate, 1–2 mm. diam., closed at first, then open and umbilicate or concave, hymenium olive-black, margin grayish and often subrepand or lobed. Stem 2–4 mm. long, olivaceous, roughish under the lens, becoming black, clothed at base with a light-olive tomentum composed of sparingly branched hairs, and finally becoming black. Asci slender clavate, 130–150 x 8–10 $\mu$ ,

8-spored, with filiform paraphyses. Sporidia subbiseriate, cylindrical, nearly straight, multi-nucleate, hyaline, 30–60 x 3 $\mu$ .

*Coryne ellisii* Berk, *Stilbum magnum* Pk., is probably the conidial stage.

**Niptera lithospermi** E. & E.

On dead stems of *Lithospermum canescens*, Mount Helena, Montana. Oct., 1889. (Anderson & Kelsey, No. 4.)

Erumpent-superficial, scattered, sessile, about  $\frac{3}{4}$  mm. diam., closed at first and opening tardily, black-brown outside and granular from the projecting cells of the external layer, margin whitish. Disk livid white becoming darker, cup-shaped. Asci oblong-cylindrical, sessile, 45–55 x 8–10 $\mu$ , with obscure paraphyses. Sporidia biseriate, oblong-cylindrical, 1-septate and mostly broadly constricted in the middle, hyaline, 12–20 (mostly 12–15) x 3–3 $\frac{1}{2}$  $\mu$ . ends, rounded or sometimes obtusely pointed. Hardly distinguishable from *Pyrenopeziza nigrella* Fckl. outwardly, but the sporidia are very different.

**Mollisia trametis** E. & E.

Parasitic on *Polyporus stevensii* Berk. On a decaying oak chip, Newfield, N. J. Dec., 1888.

Growing on the margin and inner surface of the pores. Cups obconic, 114–150 $\mu$  diam. honey colored, of fibrous structure, the ends of the fibers projecting so that the outer surface and the margin appear granulose-pubescent or as if covered with sharp pointed granules, convex-hemispherical at first and immarginate, so as to resemble *Nectria*, but soon becoming concave with a distinct sub-fimbriate margin. Asci clavate-oblong, 20–23 x 4–5 $\mu$ , sessile and without paraphyses. Sporidia biseriate or obliquely uniseriate, narrow-elliptical or clavate oblong, hyaline, continuous, 3 $\frac{1}{2}$ –4 $\frac{1}{2}$  x 1 $\frac{1}{2}$ –2 $\mu$ . The cups are so near the color of the pores of the fungus on which they grow as to be easily overlooked.

**Mollisia nipteroides** E. & E.

On dead stems of *Smilax*, St. Martinville, La. March, 1889. (Langlois, No. 1,674.)

Shallow cup-shaped, 1–1 $\frac{1}{2}$  mm., across contracted below into a very short stem (almost sessile). Umber color but whitened outside by a pruinose coat and a short erect glandular pubescence which is more abundant toward the margin. Asci oblong-cylindrical, 35–40 x 5–6 $\mu$ , sessile. Paraphyses branched above and bearing minute globose conidia. Sporidia biseriate, hyaline, 2–3-nucleate, oblong,



straight or slightly curved,  $4-5 \times 1\frac{1}{4}-1\frac{1}{2}\mu$ . More or less contracted with the margin incurved when dry.

**Dermatea fusispora** E. & E.

On dead birch limbs, Orono, Maine. (F. L. Harvey.)

Ascomata gregarious, obconical, erumpent-superficial, about 1 mm. diam., subolivaceous outside, the subundulate margin and dull reddish disk white-pruinose; texture loose and soft. Asci narrow-clavate, paraphysate,  $70-75 \times 6\mu$ . Sporidia biseriate, fusoid, hyaline, continuous,  $15-20 \times 2\mu$ , slightly curved, continuous. Recognized by its reddish disk and fusoid sporidia.

**Dermatea chionanthi** E. & E.

On dead limbs of *Chionanthus virginica*, Wilmington, Del. May, 1890. (Commons, 1,449.)

Sessile, solitary or oftener cespitose in compact fascicles of 2-4, dark chestnut-color, obconic, with a narrow margin,  $\frac{1}{2}-1$  mm. diam., disk when dry often subrugose, substance firm and dry. Asci  $100-110 \times 18-20\mu$ . Sporidia biseriate, oblong, continuous, obtuse, slightly curved, granular, hyaline or nearly so,  $18-22 \times 7-8\mu$ .

**Dermatella montanensis** E. & E.

On small, dead limbs, among driftwood, Sheridan, Montana. May, 1892. (Mr. and Mrs. H. M. Fitch.)

Erumpent-superficial, orbicular, discoid immarginate,  $\frac{3}{4}-1$  mm. diam., livid and subgelatinous when fresh, concave and black with a thin erect margin when dry. Asci oblong-obovate, short-stipitate, p. sp.  $72-80 \times 18-22\mu$ , 8-spored. Paraphyses stout, ( $2-2\frac{1}{2}\mu$  thick), branched and septate, united above in a dark brown epithecium. Sporidia crowded-biseriate, oblong or clavate-oblong, obtuse, 3-septate slightly constricted at the septa, hyaline, becoming yellow-brown,  $20-24 \times 7-8\mu$ .

**Dermatella caryigena** E. & E.

On dead limbs of *Carya*, West Chester, Pa. July, 1889.

Cespitose in clusters of 4-8, nearly black, disk slightly convex when fresh,  $\frac{1}{2}-\frac{3}{4}$  mm. across with a narrow margin. Asci clavate-cylindrical,  $75-80 \times 10\mu$ , with abundant subolivaceous paraphyses slightly thickened above. Sporidia obovate-oblong, subinequilateral, 3-septate, greenish-yellow,  $12-14 \times 4\frac{1}{2}-6\mu$ . The clusters of perithecia which are 1-2 mm. across are erumpent through the epidermis but are attached to it and readily peel off with it.

**THIS PAGE IS LOCKED TO FREE MEMBERS**

Purchase full membership to immediately unlock this page

# DELVE INTO FANTASY, MAGIC, MYTHOLOGY & FOLKLORE

Forgotten Books'  
Full Membership gives  
access to 797,885 ancient  
and modern, fiction and  
non-fiction books.

**Continue**

\*Fair usage policy applies

narrow, obtuse margin. Asci clavate-cylindrical, 80–100 x 12 $\mu$ , with filiform paraphyses curved at the tips. Sporidia cylindrical, hyaline, multiseptate nearly straight, 40–60 x 2½ $\mu$ . The perithecia are at first nearly globose but as the hymenium develops they become excavated above and finally concave.

**Blitrydium sabalidis** E. & E.

On partly living leaves of *Sabal palmetto*, Bayou Chene, La. Oct., 1888. (Langlois, No. 1,772.)

Perithecia scattered or gregarious, black, conical and closed at first, then open exposing the smoky-gray disk which becomes dirty white, margin sublacerate toothed and subincurved, about ¼ mm. diam. All the upper part finally falls away leaving only a black circle with a white center. Asci clavate, 40–50 x 15–20 $\mu$ . Paraphyses none? Sporidia crowded brownish-yellow, oblong, 4-septate with the next to the upper cell divided by a longitudinal septum, 15–20 x 6–7 $\mu$ .

This is very distinct from *Dermatea sabalidis* E. & M. (*Cenangium sabalidis* in Sacc. Syll. vol. VIII, p. 562.)

**Diplonævia melaleuca** E. & E.

On decorticated Poplar, Sand Coulee, Montana. Oct., 1889. (F. W. Anderson, No. 645.)

Perithecia at first closed and buried in the wood, about 1 mm. diam. carnose-membranaceous, thin and black, soon partly erumpent with a round opening at the apex, the margin narrowly white lacerate-fimbriate. Disk livid, concave. Asci subcylindrical, sessile, 75–85 x 6–8 $\mu$ , surrounded by abundant filiform paraphyses slightly longer than the asci, their tips bent or curved but not distinctly thickened. Sporidia 6–8 in an ascus, biseriate, cylindrical, hyaline, curved, obtuse, 1-septate, 12–15 x 3 $\mu$ .

**Stictis schizoxylodes** E. & E.

On dead limbs among driftwood, Mill Creek, Montana. Jan., 1892. (Mrs. L. A. Fitch.)

Ascomata scattered or gregarious, about half sunk in the wood, the upper part convex-hemispherical and prominent, 1–1½ mm. diam., pierced in the center with a small round opening, outside cinereo-furfuraceous and rough. The apical opening gradually enlarges till the glauco-cinereous, concave disk is entirely exposed, bordered by the slightly incurved, prominent margin, appearing then like little cups sunk in the wood. Asci oblong-clavate, sessile, 8-spored,

55–65 x 6–7 $\mu$ . Paraphyses branched and conidiiferous at the tips. Sporidia fasciculate, cylindrical, multinucleate, 45–55 x 3 $\mu$ , straight while lying in the asci, spirally curved when free, hyaline, faintly 4–6 (or more) septate.

**Stictis helicotricha** E. & E.

On leaves and sheaths of *Arundinaria tecta*, Starkville, Miss. April, 1890. (Tracy, 1,335.)

Purplish-black throughout about  $\frac{1}{2}$  mm. diam., closed at first, at length opening with a small round mouth with the entire border scarcely prominent. The base of the ascoma projects in a pustuliform manner on the other side of the leaf. Asci subcylindrical, attenuated above, 150–170 x 6 $\mu$ , with abundant filiform paraphyses broadly recurved at their tips. Sporidia filiform, about as long as the asci, interwoven, multinucleate, becoming multiseptate 1–1 $\frac{1}{2}$  $\mu$  thick. Differs from *S. arundinacea* Pers. in lacking the prominent, white border around the mouth, and in the strongly recurved tips of the paraphyses and rather narrower sporidia.

The specific name alludes to the strongly recurved and subinvolute tips of the paraphyses.

**Næmacyclus culmigenus** Ell. & Langlois.

On dead culms of *Panicum proliferum*, Louisiana. June, 1888. (Langlois, No. 1,443.)

Narrow-elliptical, 1–1 $\frac{1}{2}$  x  $\frac{1}{2}$ – $\frac{3}{4}$  mm., acute at each end bordered by the ruptured epidermis. Disk livid-white. Asci oblong, obtusely pointed, 50 x 6 $\mu$ . Sporidia linear-fusoid, continuous, about 40 $\mu$ , long, faintly nucleolate.

**Propolidium fuscocinereum** E. & E.

On bark of dead willow limbs, London, Canada. (Dearness.)

Apothecia subcuticular, orbicular, 1–1 $\frac{1}{2}$  mm. diam., flat, thin, light slate-color, with a slightly elevated, narrow, white margin which is not lobed or cleft, soon piercing the epidermis with a round opening exposing the disk. Asci sessile, clavate-oblong, 50–60 x 12–15 $\mu$ . Paraphyses branched at their tips and conidiiferous, forming a slightly olivaceous epithecium. Sporidia inordinate, cylindrical, curved, 3-septate, hyaline, ends obtuse, 15–23 x 3–3 $\frac{1}{2}$  $\mu$ . Differs from *P. atrovirens* (Fr.) in its thinner substance, different color and narrower sporidia.

**Coccophacidium salicinum** E. & E.

On dead limbs of *Salix*, Helena, Montana. Jan., 1889. (Rev. F. D. Kelsey, No. 5.)

Ascomata gregarious, erumpent, orbicular, 1 mm. or a little less in diam., depressed-hemispheric at first, then open, discoid and appanate, brown-black outside, margin incurved and finely fimbriate-toothed. Disk slightly concave, (when dry) cinereous. Asci sessile, oblong-cylindrical,  $75-80 \times 8\mu$ . Paraphyses about equaling the asci, tips brown and bearing small brown, globose  $3\mu$  diam., conidia. Sporidia vermiform-fusoid, curved when free so as to form a semicircle or even an imperfect spiral,  $35-50\mu$  long, about 3 or  $3\frac{1}{2}\mu$  thick in the middle tapering gradually to each end, nucleate, becoming 7-10-pseudo-septate, hyaline.

\* \* \* **UREDINEÆ AND USTILAGINEÆ.**

***Puccinia distichlydis* E. & E.**

On *Distichlys maritima*, Helena, Montana. Sept., 1891. (Rev. F. D. Kelsey, No. 23.)

III. Sori elongated 2-10 mm. long and 1-2 mm. wide, erumpent, naked, nearly black. Teleutospores oblong or oblong-elliptical,  $45-70 \times 15-20\mu$ , constricted in the middle, pale-brown, becoming deep chestnut brown; epispore smooth, thickened at summit which is either regularly rounded or subacuminately or mucronately pointed. Pedicels,  $80-100\mu$  long, stout ( $6-7\mu$  thick) and persistent, yellowish-hyaline.

Seems distinct from *P. graminis*, in its longer, more distinctly constricted spores on longer, stouter pedicels.

***Puccinia douglasii* E. & E.**

On leaves of *Phlox douglasii*, Detroit, Utah. May, 1891. (M. E. Jones, No. 25.)

III. Sori amphigenous, minute,  $\frac{1}{3}-\frac{1}{2}$  mm., naked but closely embraced by the epidermis, rather pale chestnut color or sometimes darker, mostly seriate, a single series of sori being arranged along each side of the midrib, the leaf being slightly thickened. Teleutospores oblong-elliptical,  $25-55 \times 12-15\mu$ , chestnut brown, constricted, rounded at the apex or obtusely pointed, epispore smooth, distinctly thickened at the apex, with or without a papilla.

Differs from *P. plumbaria* Pk., in its smaller, naked sori, which are also much smaller than in *P. giliae* Hark.

***Puccinia gutierreziae* E. & E.** (*P. Bigeloviae*, E. & E., N. A. F. 2,248.)

On leaves of *Gutierrezia euthamia*, Digway, Utah. June, 1892. (M. E. Jones, No. 23.)

**THIS PAGE IS LOCKED TO FREE MEMBERS**

Purchase full membership to immediately unlock this page

# Know Your Bible

Forgotten Books' Full Membership provides unlimited access to more than 28,000 volumes of Christian literature for \$8.99/month

**HOLY BIBLE**

**Continue**

\*Fair use policy applies

Teleutospores clavate,  $40-50 \times 18-20\mu$ , constricted at the septum, upper cell broader and darker, lower cell, attenuated below and paler (subhyaline), epispore smooth, strongly thickened at the rounded or subacute apex. Pedicels as long as or a little longer than the spores.

Very distinct from *P. œnotheræ* Vize.

***Puccinia virgata* E. & E.**

On dead leaves of *Panicum virgatum*, Rockport, Kansas. March, 1892. (E. Bartholomew, No. 496.)

III. Sori amphigenous but more fully developed on the lower side of the leaf, linear, often 1 cm. or more long, erumpent and margined laterally by the ruptured epidermis, dark chestnut-brown, almost black. Teleutospores mostly wedge-shaped or clavate but also, some of them oblong,  $40-70 \times 18-22\mu$ , the upper cell shorter and elliptical or subglobose and dark, the lower cell longer, narrower and lighter colored, apex rounded and obtuse or subtruncate, and sometimes a little roughened. Epispore thickened at the apex but without any distinct papilla.

Has a general resemblance to *P. graminis* but the spores are different.

***Puccinia lygodesmiæ* E. & E.**

(*P. variolans* Hark? var. *caulicola* in Ell. and Ev., N. A. F. 2,237.)

(I.)? and III. On stems of *Lygodesmia juncea*, Cheyenne Wells, Colorado. July, 1887. (C. H. Demetrio.)

III. Sori about  $\frac{1}{2}$  or  $\frac{3}{4}$  mm. diam., densely cespitose in elongated patches partly or entirely surrounding the stems, and sometimes covered by the whitened cuticle, but finally bare and dark chestnut color. Teleutospores oblong-elliptical, constricted at the septum, mostly rounded at each end, epispore smooth, thickened at the apex and often with a broad, sometimes oblique papilla,  $35-45 \times 20-23\mu$ , on stout, persistent pedicels,  $100-120\mu$  long. The mode of growth is similar to that of *P. enormis* Fckl., the stems being more or less swollen where occupied by the clusters of sori.

This is very distinct from *P. harknessii* Vize (on *Lygodesmia spinosa*) but closely allied to *P. variolans* Harkness, from which, however, it differs in habit and in the epispore being much thinner in the middle of the spore.

An *Æcidium* which may belong here, was found on the same host in Montana, by Mr. Anderson. The æcidia arising from yellow

swellings on the stems and leaves, are about  $\frac{1}{2}$  or  $\frac{3}{4}$  mm. high, erect and deeply fimbriate-lacerate above, the membrane thin and white. Aecidiospores, globose, oblong or irregular in shape, smooth or nearly so,  $18-22\mu$  in the longer diameter.

**Uromyces macounianus** E. & E.

On *Euphorbia* sp. (*E. maculata affinis*), Vancouver Island, British Columbia. Aug., 1887. (Macoun, No. 322.)

II. III. Sori amphigenous, convex or subhemispherical, surrounded by the ruptured epidermis, mostly crowded, light chestnut color, becoming darker, about 1 mm. diam. Uredospores globose or ovate, echinulate, about  $15\mu$  diam. Teleutospores globose or ovate-elliptical, pale brown, slightly tuberculo-echinulate especially at the apex which is not thickened and is mostly without any distinct papilla,  $14-16\mu$  diam. Pedicels shorter than the spores, hyaline and deciduous.

Differs from *U. euphorbiæ* C. & P., in its smaller, less distinctly roughened spores and crowded, lighter colored sori which often nearly cover one or both sides of the leaf but are not confluent.

**Uromyces sporoboli** E. & E.

On *Sporobolus asper* Rockport, Kansas. Sept., 1892. (Bartholomew, No. 733.)

III. Sori mostly hypophyllous, black or nearly so, elongated or linear, 1-4 mm. long, soon naked. Teleutospores of variable shape, subglobose, about  $20\mu$ . diam., or obovate,  $25-30 \times 20-22\mu$ , or elongated-piriform or oblong,  $30-40 \times 20-22\mu$ , evenly rounded at the apex or oftener with a distinct papilla, epispore smooth, distinctly thickened at the apex, chestnut-brown; pedicels  $70-100\mu$  long, mostly colored.

Differs from *U. dactylidis* Otth. *U. peckianus* Farlow and *U. graminicola* Burrill in its more robust growth and larger spores, and from the two first mentioned in the absence of paraphyses.

**Æcidium ludwigiae** E. & E.

On leaves of *Ludwigia sphaerocarpa*, Ellendale, Sussex Co., Del. Sept., 1892. (Commons, No. 1,983.)

Spots amphigenous, purplish-red above, more obscure below, scattered or subconfluent, suborbicular, 1-3 mm. diam. Aecidia amphigenous, but more abundant below, either standing singly or oftener collected in a compact cluster forming a little tubercle 1-2 mm. diam., as in *Æc. myricatum* Schw.; single cups minute ( $\frac{1}{4}$  mm.),



margin sublacerate-toothed, erect or nearly so, component cells subquadrate or pentagonal, about  $15\mu$  diam., the marginal ones more elongated ( $20\mu$ ). Spores orange-yellow, subglobose or subangular,  $12-15\mu$  diam.

Berkeley in Grevillea, reports *Æcid. epilobii* on *Ludwigia*, but the Delaware spec. on account of their smaller clustered cups and smaller spores, can not be referred to that species.

**Cerebella spartinæ** E. & E.

On spikes of *Spartina gracilis*, Biloxi, Miss. . Sept., 1892. (Tracy, No. 1,838.)

Stromata small (2-4 mm.), thin, subconfluent, extending along one side of the spike, often for its entire length, gyrose- or porose-plicate, dark olive. Primary spores ovate or globose,  $6-10\mu$  diam., pale, with the epispore minutely granular, compound spores subquadrate, composed of 3-4 of the primary spores, brown,  $12-16\mu$  diam., mostly with a short, thick pedicel.

Differs from *C. andropogonis* in habit and from *C. paspali*, in its smaller differently shaped spores.

**Sorosporium solidaginis** E. & E.

In the dwarfed and condensed inflorescence of *Solidago missouriensis*, Rockport, Kansas. March, 1892. (E. Bartholomew.)

Spore masses subglobose,  $30-50\mu$  diam., consisting of 12-40 or more, closely conglutinated spores about  $8\mu$  diam., with the epispore delicately warted. The color of the spores is nearly that of burnt umber, rather darker than in *S. californicum* Hark., which this much resembles, but from which it differs in its larger spore masses and spores not so distinctly roughened.

\* \* \* \* **SPHÆROPSIDÆÆ.**

**Phyllosticta tenerrima** E. & E.

On living leaves of *Saponaria officinalis*, London, Canada. Aug., Sept., 1892. (Dearness, No. 1,999.)

Spots small (1-2 mm.), thin, round, white and transparent and finally deciduous, numerous but mostly not confluent. Perithecia epiphyllous, depressed-hemispherical, thin-membranaceous,  $60-100\mu$  diam., few on a spot. Sporules elliptical or oblong-elliptical, hyaline,  $4-6 \times 2-2\frac{1}{2}\mu$ , abundant.

Easily recognized by its thin, white, transparent spots.

**THIS PAGE IS LOCKED TO FREE MEMBERS**

Purchase full membership to immediately unlock this page

# DELVE INTO FANTASY, MAGIC, MYTHOLOGY & FOLKLORE

Forgotten Books'  
Full Membership gives  
access to 797,885 ancient  
and modern, fiction and  
non-fiction books.

**Continue**

\*Fair usage policy applies

groups. Sporules oblong-cylindrical, hyaline, continuous, straight or very slightly curved,  $10-14 \times 3-3\frac{1}{2}\mu$ . There are no distinct spots, but the numerous groups of perithecia give the leaf a mottled appearance.

**Phoma subcircinata** E. & E.

On pods of Lima bean, Newfield, N. J. Oct., 1892.

Perithecia subcuticular,  $70-90\mu$  diam., sublenticular, subconfluent pierced above, membranaceous, black, subcircinately arranged in large (1 cm.), round, faintly zonate spots, finally spreading and occupying the entire surface of the pods. Sporules oblong-elliptical, hyaline, 2-nucleate,  $5-6 \times 2-2\frac{1}{2}\mu$ , on simple basidia rather longer than the sporules.

This differs from *Phoma leguminum* West., in the subcircinate arrangement of the perithecia and the rather longer, binucleate sporules.

**Phoma caulophylli** E. & E.

On dead stems of *Caulophyllum thalictroides*, London, Canada. June, 1892. (Dearness, No. 1,864.)

Perithecia gregarious, elliptical,  $\frac{1}{2}-\frac{3}{4}$  mm. in the longer diameter, covered by the thin epidermis which is raised and blackened over them and pierced by the minute, papilliform ostiolum. Sporules oblong-fusoid, hyaline, 2-nucleate,  $5-12 \times 2\frac{1}{2}-3\mu$ .

**Sphæronema negundinis** (E. & E., Ell. & Evrht. North Am. Fungi, 2775.)

On bark of dead *Negundo aceroides*, Fairmount Park, Philadelphia, Pa. June, 1890. Coll. Hugo Bilgram, com., W. C. Stevenson, Jr.

Perithecia thickly gregarious, conic-cylindrical, black,  $1-1\frac{1}{2}$  mm. high and about  $\frac{3}{4}$  mm. thick, truncate at the apex and crowned with a flesh-colored globule of ejected sporules, which are hyaline, fusoid, 3-4-nucleate,  $12 \times 3\mu$ .

*S. pruinatum* B. & C. has the perithecia acute at the apex and has larger sporules. In one species the perithecia are nearly cylindrical.

**Asteroma saxifragæ** E. & E.

On leaves of *Saxifraga bracteosa*, St. George Island, Bering Sea. Sept., 1891. J. M. Macoun.

Epiphyllous. Perithecia globose,  $50-80\mu$  diam., of coarse cellular structure densely crowded and connected by stromatic matter, forming a continuous black crust mixed with brown, creeping hyphæ and

covering the entire upper surface of the leaf. Sporules poorly developed, apparently oblong-elliptical,  $5 \times 2\mu$ , borne on stout sporophores arising from the inner surface of the perithecia, with oil globules intermixed.

**Actinonema psoraleæ** E. & E.

On living leaves of *Psoralea digitata*, Rockport, Kansas. June, 1892. (E. Bartholomew, No. 627.)

Spots amphigenous, definite, suborbicular, rusty brown 2–4 mm. diam. Perithecia discoid, black, rough,  $75\text{--}90\mu$  diam., mostly confluent, forming a black crust about 1 mm. diam., in the middle of the spot, mostly amphigenous. Sporules oblong, hyaline, 2-nucleate,  $12\text{--}15 \times 3\frac{1}{2}\text{--}4\mu$ .

**Asterinula dearnessii** E. & E.

On leaves of *Gerardia quercifolia*, London, Canada. August, 1892. (Dearness, No. 1,966.)

Perithecia subdiscoid, brownish-black,  $\frac{1}{2}\text{--}\frac{3}{4}$  mm. diam., amphigenous, scattered, entirely superficial. Sporules oblong, uniseptate, olivaceous, abundant,  $9\text{--}12 \times 3\mu$ .

**Vermicularia ochrochæta** E. & E.

On the lower surface a decaying maple leaf, near Ottawa, Canada. Sept., 1891. (J. Macoun.)

Perithecia scattered, superficial, black, membranaceous, subglobose, astomous, of radiate-cellular structure, about half a mm. diam., sparingly clothed with long ( $200\text{--}300\mu$ ), pale, straight sparingly septate hairs about  $8\mu$  thick at the base and tapering above. Sporules subcylindrical, very slightly curved, obtuse, hyaline, nucleate,  $6\text{--}7 \times 1\frac{1}{2}\mu$ .

**Dothiorella fraxini** E. & E.

On dead *Fraxinus*, London, Canada. April, 1892. (J. Dearness.)

Perithecia globose, black, buried in the bark, thickly scattered, either singly or 2–4 together in subvalsiform groups, their short subpapilliform, black ostiola erumpent through the epidermis, with the general appearance of a minute *Valsa*. Sporules elliptical, hyaline,  $18\text{--}20 \times 10\text{--}12\mu$ , on stout basidia.

The ostiola merely rupture the bark but do not rise above it. Found associated with *Endoxyla fraxini* E. & E.

Differs from *D. fraxinea* Sacc. and Roum., in its buried perithecia and larger sporules.

**Cytispora annulata** E. & E.

On dead limbs of *Negundo aceroides* with *Sphæroopsis albescens* E. & E., Brookings, South Dakota. Oct., 1891. (Thos. A. Williams.)

Stromata minute, convex, multilocular, hardly exceeding 1 mm. in diam., subcuticular, slate-color inside, furnished with a single central pore which opens through the apex of a minute pustule and is surrounded by a minute light colored ring. Sporules oblong, straight or only slightly curved, hyaline, continuous,  $5-6 \times 1-1\frac{1}{4}\mu$ . The epidermis is finally blackened directly over the pustules, except the ruptured margin which forms a pale ring around the ostiolum.

This differs from *C. macilenta* Rob. and Desm. as shown by the specc. in *Desm. exsicc.* in its much smaller sporules and more numerous cells.

**Cytispora carnea** E. & E.

On basswood bark, Orono, Maine. (F. L. Harvey.)

Stromata convex, 3-4 mm. diam., granulose-tomentose and grayish-black outside, multilocular and grayish-black, streaked with white within, uneven above and furnished with 3-4 or more stout ostiola which rupture and raise the epidermis and are crowned with a flesh colored globule of discharged sporules which are oblong, hyaline (under the microscope), obtuse, straight,  $8-12 \times 3\mu$ . The stromata do not penetrate deeply into the inner bark and are not circumscribed by any black line but the bark is more or less blackened.

**Ascochyta rhei** E. & E.

(*Phyllosticta rhei* E. & E., Journ. Mycol. I, p. 145.)

More perfect specc. on leaves of *Rheum rhaponticum* from Rockport, Kansas (Bartholomew, No. 713), show that this is an *Ascochyta*, the sporules becoming uniseptate; they are also mostly narrowed in the middle and are larger than in the Newfield specc. ( $7-12 \times 3\frac{1}{2}-4\mu$ .) The spots are about the same only not so distinctly zonate, but the perithecia are smaller.

**Sphæroopsis vitigena** E. & E.

On dead shoots of *Vitis* (cult.), Rockport, Kansas. Feb., 1892. (E. Bartholomew, No. 507.)

Perithecia globose, minute, about  $\frac{1}{4}$  mm. diam., numerous, buried in the bark and raising the epidermis into numerous small pustules which are pierced by the papilliform ostiolum. Sporules oblong-elliptical, brown,  $18-20 \times 8-10\mu$ , not nucleate or septate.

Quite different from *S. viticola* Cke. in Rav., F. Am., 542 (on leaves of *Vitis*), and also from *S. uvarum* B. & C. (on the fruit.)

**THIS PAGE IS LOCKED TO FREE MEMBERS**

Purchase full membership to immediately unlock this page

# Know Your Bible

Forgotten Books' Full Membership provides unlimited access to more than 28,000 volumes of Christian literature for \$8.99/month

**HOLY BIBLE**

**Continue**

\*Fair use policy applies

Differs from *H. fiedleri* West and *H. decipiens* Thüm. in its much larger sporules.

**Hendersonia staphyleæ** E. & E. Journ. Mycol. I, p. 151.

On dead twigs of *Staphylea trifolia*, Wilmington, Del. April, 1892. (A. Commons, No. 1939.)

The following diagnosis of this species is given as supplementary to the brief notice in Journ. Mycol.

Perithecia evenly scattered, numerous, pustuliform with a flat base, seated on the surface of the inner bark and covered by the blackened epidermis, which is not laciniately ruptured, but merely pierced by the apex of the perithecium. Sporules, oblong-fusoid, pale brown, 3-septate, and slightly constricted at the septa, narrower below with the lower cell hyaline, 12–20 (mostly 15–18) x 4–5 $\mu$ , on basidia about as long as the sporules.

Differs from *H. sarmentorum* West in not penetrating the inner bark and in its longer, paler sporules on shorter basidia. The same thing has been sent from Kansas (Kell. and Swingle, 1,237) on *Euonymus atropurpureus*.

**Stagonospora strictae** E. & E.

On leaves of *Carex stricta*, Rockport, Kansas. Jan., 1892. (Elam Bartholomew.)

Spots elliptical, dirty white, 3–5 x 1½–2 mm., with a darker border. Perithecia scattered on the spots, sunk in the parenchyma of the leaf, brown, or when dry nearly black, 100–150 $\mu$  diam., perforated above, visible on the upper surface through the thin epidermis. Sporules elliptic-oblong, hyaline, 2-septate and constricted at the septa, 20–30 x 8–10½ $\mu$ .

The spots are like those of "*Phleospora*" (*Stagonospora*) *caricis* E. & E., but the sporules are different.

**Stagonospora sclerotioides** E. & E.

On decorticated wood of *Ostrya virginica*, London, Canada. March, 1892. (J. Dearness.)

Perithecia subseriate, erumpent-superficial, brownish-black, elongated at first, then globose, sometimes subconfluent, about 1 mm. diam., of horn-like consistence, white inside, seated on indefinite, subelongated spots limited by a narrow, black, circumscribing line which penetrates deeply into the wood. Sporules oblong, hyaline, 2-nucleate, 6–7 x 1½ $\mu$ .

**Septoria mitellæ** E. & E.

On leaves of *Mitella diphylla*, near the Mich. Ag. College. May, 16th, 1892. (G. H. Hicks.)

Spots suborbicular or irregular rusty brown, becoming white or whitish in the center, with a rather broad, reddish-brown margin, 2–4 mm. diam., often numerous. Perithecia epiphyllous, black, subprominent, scattered or sometimes only 1–3 in the center of the spot, depressed hemispherical, 75–80 $\mu$  diam., pierced at the apex and blackened around the orifice. Sporules acicular, hyaline, continuous, straight or only slightly curved, acute, 15–22 x 1 $\mu$ .

**Septoria agropyri** E. & E.

On leaves of *Agropyrum repens*, Racine, Wis. July, 1892. (Davis, No. 925.)

Perithecia about 75 $\mu$  diam., buried in the substance of the leaf and only visible as minute, black specks on the upper surface. They appear at first on narrow, pale yellowish strips soon confluent laterally and finally changing to a uniform brown color and occupying a great part of the leaf. Sporules rod-shaped, slightly curved, ends subacute, faintly nucleate, continuous, 18–25 x 1½ $\mu$ , hyaline.

. Differs from *S. gracilis* Pass. on the same host, in its sporules twice as large, and in its different habit.

**Septoria purpureocincta** E. & E.

On leaves of *Prunus americana*, Rockport, Kansas. Sept., 1892. (Bartholomew, No. 709.)

Spots amphigenous, irregular in shape, whitish in the center, with a broad, shaded dark purple border above, rusty brown and without any distinct border below. Perithecia epiphyllous, globose, open above, 75–85 $\mu$  diam., brownish black, numerous, subprominent. Sporules filiform, hyaline, 20–30 x 2 $\mu$ , with a row of very distinct nuclei but not septate (in any of the spec. examined.)

The character of the spots will easily separate this from any of the other species on *Prunus*.

**Septoria aurea** E. & E.

On leaves of *Ribes aureum*, Rockport, Kansas (Bartholomew, No. 49), and Racine, Wis. (Davis, No. 9,037.)

Spots amphigenous, greenish, definite, darker and mostly zonate toward the margin, 2–4 mm. diam., often concave below. Perithecia crowded in the middle of the spots, mostly hypophyllous, 80–100 $\mu$  diam., subprominent, but innate in the substance of the leaf.



Sporules filiform, rather broader above, multinucleate, becoming 3-5-septate, hyaline,  $30-55 \times 1\frac{1}{2}-2\mu$ .

*Var. destruens* (Bartholomew, No. 703, Sept., 1892), has the tips of the leaves and often the entire leaf mottled with black and yellow, becoming brown and dead, and the sporules  $40-75 \times 2-2\frac{1}{2}\mu$ .

This differs from *S. ribis* Desm. in its septate sporules and the different character of the spots.

***Septoria gaillardiae* E. & E.**

On leaves of *Gaillardia pulchella*, Rockport, Kansas. Aug., 1892. (E. Bartholomew.)

Spot amphigenous, orbicular, light brown, with a dull white center; both the dull white center and the larger, brown spot in which it is included, are surrounded by a narrow, raised border. Perithecia amphigenous,  $75-90\mu$ , semierumpent, black, either confined to the white central spot or often scattered over the white and brown. Sporules filiform, nucleate,  $45-65 \times 1\frac{1}{4}-1\frac{1}{2}\mu$ .

***Septoria glabra* E. & E.**

On leaves of *Æsculus glabra*, Indianapolis, Indiana. Aug., 1880. (Coll., W. J. Beale, com., G. H. Hicks.)

Perithecia hypophyllous, globose, black,  $75-85\mu$  diam., scattered on dark brown spots which are more or less whitened, especially above, by the thin bleached epidermis. The spots are situated either in the green parts of the leaf or on dead red-brown areas, and are rather irregular in outline, 2-3 mm. diam., with a rather broad, not raised, dark border, the central portion more or less whitened. Sporules filiform, continuous, nearly straight, faintly nucleate,  $30-45 \times 1\frac{1}{2}-2\mu$ .

This is certainly different from *S. æsculi* (Lib.) which (sec. spec. in Sacc. M. Ven., Thüm. M. U. and Briosi and Cavarra's F. Parass.) has only 1-3 perithecia on small ( $1-1\frac{1}{2}$  mm.), white spots, with shorter, thicker sporules arcuate curved and about 3-septate.

Briosi and Cavarra remark that *Septoria æsculina* Thüm. and *S. hippocastani* B. & Br., are hardly more than forms of *S. æsculi* and the species in our Exsiccati seem to warrant that conclusion.

***Septoria lepachidis* E. & E.**

On leaves of *Lepachys columnaris*, Rockport, Kansas. June, 1893. (Mr. E. Bartholomew, No. 584.)

**THIS PAGE IS LOCKED TO FREE MEMBERS**

Purchase full membership to immediately unlock this page

# DELVE INTO FANTASY, MAGIC, MYTHOLOGY & FOLKLORE

Forgotten Books'  
Full Membership gives  
access to 797,885 ancient  
and modern, fiction and  
non-fiction books.

**Continue**

\*Fair usage policy applies

*Perithecia* gregarious, erumpent-superficial, thin, black,  $\frac{1}{3}$ -- $\frac{1}{2}$  mm. diam., closed, globose and smooth at first, soon broadly open above and cup-shaped, with the margin substrate and more or less distinctly fringed with short, brown hairs. Sporules navicular, continuous, olivaceous,  $5-6 \times 2\frac{1}{2}\mu$ , ends acute, borne on simple, stout, olivaceous basidia about  $12 \times 2\frac{1}{2}\mu$ .

***Excipulina hicksiana* E. & E.**

On bleached, decorticated wood, Michigan. (G. H. Hicks.)

*Perithecia*, scattered, globose or oblong and hysteriiform,  $\frac{1}{3}$ -- $\frac{3}{4}$  mm. in the longer diameter, thin, membranaceous, obsolete below, darker and more coarsely granular toward the margin, at first closed, soon opening with a longitudinal dehiscence like a *Hysterium*, base adnate to the wood, hymenium, pale. Sporules oblong-cylindrical, hyaline, obtuse, 2-3-septate,  $8-15 \times 3-4\mu$ , straight or slightly curved; texture loosely cellular, thin, not fibrous.

***Catinula saligna* E. & E.**

On dead limbs of *Salix*, London, Canada. Feb., 1890. (Dearness, No. 1,420.)

*Perithecia* scattered, erumpent, short cylindrical or obconical, substipitate, about 1 mm. high, broadly perforated or open at the apex, black and subshining. Sporules oblong-cylindrical, hyaline, continuous,  $15-20 \times 6-7\mu$ , on basidia  $15-20 \times 3\mu$ .

This differs from *C. turgida* Desm. only in its more elongated perithecia and rather narrower sporules. A form occurs on *Carpinus* (Dearness, No. 1,565) that cannot be distinguished from *C. turgida*, and it may be as well to consider our *C. saligna* as only a robust form of that species.

***Hainesia borealis* E. & E.**

Ell. & Evrht. N. A. F., 2,785.

On leaves of *Galium boreale*, British Columbia. July, 1889. (J. Macoun.)

Acervuli hypophyllous, scattered, convex-discoid,  $175-200\mu$  diam., flesh-colored becoming darker when dry, subcuticular at first but soon erumpent-prominent. Conidia allantoid, hyaline, slightly curved,  $5-6 \times 1\mu$  on simple, slender basidia  $12-15 \times 1-1\frac{1}{2}\mu$ .

The parts of the leaf occupied by the fungus soon become pale brown and dead. *Hainesia rubi* (West.) has been sent from Ontario, Canada, by Mr. Dearness.

**Glæosporium davisii** E. & E.

On pods of *Vicia americana*, Berryville, Wis. July, 1890.  
(Davis, No. 927.)

Occupying small (1-2 mm.), dead spots on the pods. Acervuli innate, erumpent in small, pale rose colored pustules. Conidia oblong-elliptical, hyaline, continuous,  $5-8 \times 3-4\mu$ .

Distinguished from *G. viciæ* E. & E., as well as from *G. leguminis* C. & H., by its much smaller conidia.

**Glæosporium americanum** E. & E.

On leaves of *Vicia americana*, Berryville, Wis. July, 1892.  
(Davis, No. 928.)

Spots amphigenous, dull green, 2-3 mm. diam., suborbicular and rather indefinitely limited, only two or three on a leaf. Acervuli innate, about  $80\mu$  diam., pale rose color, erumpent above. Conidia oblong, obtuse,  $12-16 \times 3-3\frac{1}{2}\mu$ , on basidia of about the same length.

Comes nearest *G. kurzianum* Niessl, but a comparison with species of that species in Rab. F. Eur. shows the habit to be quite different. *Gl. viciæ* Fauntrey and Roum. has conidia,  $16 \times 12\mu$ .

**Glæosporium ribicolum** E. & E.

On fruit of *Ribes* (English gooseberry, cult.), Wilmington, Del. June, 1892. (A. Commons, No. 1,961.)

Acervuli minute, numerous, crowded, pale, soon erumpent and subconfluent in orbicular patches  $\frac{1}{2}$  cm. across and of a pale orange color. Spores oblong,  $7-12 \times 3-3\frac{1}{2}\mu$ , on stout, densely fasciculate basidia about  $20\mu$  long. Seems most nearly allied to *G. phomoides* Sacc.

**Glæosporium caryæ** E. & E. (N. A. F., 2783.)

On leaves of *Carya alba*, London, Canada. (Dearness.)

Spots amphigenous, suborbicular, indefinite, brown, 1-2 cm. diam. Acervuli hypophyllous, numerous,  $80-150\mu$  diam. Sporules oblong, continuous, hyaline,  $7-10 \times 1-1\frac{1}{2}\mu$ .

**Cylindrosporium phaceliæ** E. & E.

On leaves of *Phacelia sericea*, Basin, Montana. July, 1892.  
(Kelsey, No. 1.)

Amphigenous. Acervuli minute, buried, numerous, the exuding conidia making the surface of the leaf white-farinose. Conidia oblong or cylindrical, variable in length ( $15-40 \times 3-3\frac{1}{2}\mu$ .)

**Cylindrosporium caryigenum** E. & E. N. A. F., 2451.

On living leaves of *Carya amara*, London, Canada. (Dearness.)

Hypophyllous, spots indefinite, pale at first, finally brownish and visible on both sides of the leaf. Acervuli, minute, numerous, pale. Sporules erumpent below, cylindrical, curved, with a row of nuclei, 25–40 x 3 $\mu$ .

In the early stage of growth, this has the aspect of a *Ramularia*.

**Marsonia rhabdospora** E. & E.

On leaves of *Populus grandidentata*, Newfield, N. J. Sept.-Oct., 1892.

Spots amphigenous, numerous, subangular, 1–4 mm. diam., with a cinereous-white center and definite, narrow, dark margin, surrounded with a yellow aureola. Acervuli hypophyllous, flesh colored, erumpent, often seated around the margin of the spot with one or more in the center. Conidia cylindrical, nearly straight, uniseptate, 20–30 x 2 $\frac{1}{2}$  $\mu$ , ends obtuse, much resembling the sporules of *Septoria populi* Desm. which is quite different from this, having true perithecia which are also epiphyllous and nearly black.

The spots in our fungus are at first minute and brownish-black, but even then surrounded by the yellow aureola.

**Coryneum cornicolum** E. & E.

On the inner surface of dead bark of *Cornus alternifolia*, London, Canada. June, 1892. (Dearness, No. 1,892.)

Acervuli erumpent, various, tubercular, pulvinate or convex, black, punctiform or 1 mm. or more in diam., and subconfluent, appearing much like the masses of erumpent spores of some *Melanconium*. Conidia vermiform-fusoid, 6–8-septate, the end cells hyaline, the others brown, mostly curved, 35–45 x 7–8 $\mu$ , on basidia about half as long or even less.

\* \* \* \* \* **HYPHOMYCETÆ.**

**Botrytis pannosa** E. & E.

On rotten maple, Seattle, Washington. March, 1892. (Miss Parker, No. 60.)

Hyphæ effused and interwoven, brown, subcontinuous, and suboppositely branched, the ends of the branches mostly a little swollen and spiculiferous, bearing the abundant, ovate, hyaline conidia, 5–6 x 3–3 $\frac{1}{2}$  $\mu$ .

The tufts of hyphæ form, an olive-brown, rather thick, loosely felted layer several centimeters in extent.

This is *B. fairmani* E. & E. in Herb.

**THIS PAGE IS LOCKED TO FREE MEMBERS**

Purchase full membership to immediately unlock this page

# Know Your Bible

Forgotten Books' Full Membership provides unlimited access to more than 28,000 volumes of Christian literature for \$8.99/month

**HOLY BIBLE**

**Continue**

\*Fair use policy applies

Forming black tuberculiform tufts on the dead stems, about 1 mm. across and composed of closely packed chains of conidia about  $120\mu$  long and  $10-12\mu$  broad, the single conidia being elliptical, brown, uniseptate and constricted, about  $20 \times 10-12\mu$ , placed end to end without any connecting cell.

***Cercospora nicotianæ* E. & E.**

On leaves of tobacco, Raleigh, N. C. Oct., 1891. (com., Gerald McCarthy.)

Spots amphigenous, pale, becoming white, 2–5 mm. diam., with a narrow, inconspicuous, reddish, slightly raised border, often concave below. Hyphæ tufted, amphigenous,  $75-100 \times 4-5\mu$ , 2–3-times geniculate above and sometimes with a short, lateral branch brown, septate. Conidia slender,  $40-75 \times 3-3\frac{1}{2}\mu$ , hyaline, slightly curved, multiseptate (mostly about 6-septate.)

***Cercospora nesææ* E. & E.**

On leaves of *Nesaea verticillata*, Milford, Del. Sept., 1892. (Commons, No. 1,984.)

Spots amphigenous, scattered, suborbicular or irregular, 2–4 mm. diam., with a shaded, purple border. Hyphæ epiphyllous, tufted,  $35-45 \times 2\frac{1}{2}-3\mu$ , continuous, olivaceous or smoky-hyaline, geniculate above. Conidia clavate-cylindrical, hyaline, 3–5-(mostly 3-) septate,  $25-75 \times 2\frac{1}{2}-3\mu$ .

The minute black tufts of hyphæ under the hand lens resemble the perithecia of some *Septoria* or *Phyllosticta*.

***Cercospora weigelæ* E. & E.**

On leaves of *Weigelæ* (cult.), Newfield, N. J. Sept., 1889. Sent also from Washington, D. C. by Miss E. A. Southworth.

Spots small (1–2 mm.), white, with a broad, shaded, dark purple border. Hyphæ in small tufts scattered thickly over the central part of the spot, geniculate and toothed above  $70-90 \times 3\frac{1}{2}-4\frac{1}{2}\mu$ , brown, continuous. Conidia terminal slender clavate, hyaline, nucleate,  $50-75 \times 2\frac{1}{2}-3\mu$ .

***Cercospora crotonis* E. & E.**

On leaves of *Croton texensis*, Rockport, Kansas. Aug., 1892. (Bartholomew, No. 359.)

Spots indistinct, pallid, not definitely limited, finally subconfluent and brownish, giving the leaf a dirty withered look. Tufts mostly epiphyllous, in small but dense fascicles, appearing under the lens like minute, black grains thickly scattered over the spots. Hyphæ

olive-brown, continuous, nucleate, torulose above  $35-50 \times 4\mu$ . Conidia obclavate, brownish, obtuse, nearly straight, faintly 1-4-septate,  $40-90 \times 4-5\mu$ .

Quite distinct from *C. crotonifolia* Cke. which is on definite spots and has much shorter hyphæ and smaller conidia.

**Cercospora ditissima** E. & E.

On leaves of *Cnicus undulatus*, Rockport, Kansas. June, 1892. (E. Bartholomew, No. 605.)

Spots dirty brown, subindefinite, suborbicular, 3-5 mm. diam. Hyphæ amphigenous, densely tufted on a dark colored, tubercular base  $75-85\mu$  diam., short ( $15-20 \times 2\frac{1}{2}-3\mu$ ), subhyaline, toothed above and subobtuse, simple, continuous,  $30-75 \times 4-6\mu$ , subhyaline, straight, oblong or obclavate, 3-5-septate.

**Cheiromyces comatus** E. & E.

On decorticated *Azalea*, Newfield, N. J. June, 1877.

Gregarious on the bleached surface of the wood. Acervuli minute ( $\frac{1}{2}-\frac{3}{4}$  mm. long), subhysteriiform-erumpent, black. Conidia multipartite, the divisions (nearly 100 in number) subcylindrical, somewhat attenuated above,  $35-40 \times 2-2\frac{1}{2}\mu$ , 5-7-septate, hyaline, united at base so as to form a brush-like tuft  $15-20\mu$  thick. The tufts arise directly from the cells of the proligerous layer, without any distinct basidia. The habit is the same as that of *C. beaumontii* B. & C. as distributed in N. A. F., 762, and like that species and *C. tinctus* Pk., differs considerably from the species figured by Berk. in Int. Crypt. Bot. in the absence of any pulvinate stromatic base.

**Volutella bartholomæi** E. & E.

On leaves of *Sporobolus asper*, Rockport, Kansas. Sept., 1892. (E. Bartholomew.)

Sporodochia evenly scattered, hemispherical or oblong-hemispherical, olive-black,  $\frac{1}{3}-\frac{1}{2}$  mm. diam., made up of closely packed, oblong-cylindrical, olivaceous, 2-nucleate,  $9-11 \times 2\frac{1}{2}\mu$  conidia arising directly from the proligerous layer, without any visible sporophores, the whole surrounded by an imperfectly developed, membranaceous ring or border subtended by a few (3-6) erect-spreading olivaceous, continuous bristles  $4-5\mu$  thick at base and tapering to the obtuse, subhyaline apex.

**Stigmina liriodendri** E. & E.

On fading leaves of *Liriodendron tulipifera*, Saltillo, Mississippi. Oct., 1892. (Tracy, No. 1,829.)



Spots amphigenous, subindefinite, dark brown, with a yellow-shaded border, 3–5 mm. diam. Acervuli numerous, hypophyllous, standing circumferentially on the spots so as to leave the center bare. Conidia oblong-cylindrical, brown, 1–3 (mostly 3-) septate, 10–15 x  $3\frac{1}{2}$ –4 $\mu$ , not constricted at the septa, 3–4-or more-catenulate, catenulæ sometimes branching above.

**THIS PAGE IS LOCKED TO FREE MEMBERS**

Purchase full membership to immediately unlock this page

# DELVE INTO FANTASY, MAGIC, MYTHOLOGY & FOLKLORE

Forgotten Books'  
Full Membership gives  
access to 797,885 ancient  
and modern, fiction and  
non-fiction books.

**Continue**

\*Fair usage policy applies

## NOTES ON SOME MINERALS AND ROCKS.

BY E. GOLDSMITH.

**PIMELITE.** The material was found by Mr. Theo. D. Rand on his property at Radnor, Delaware Co., Penna., at a moderate depth. It is soft and very finely micaceous, having an apple green color and is greasy to the feel. Specific gravity was found with the Thoulet solution to be 2.596.

Beneath the microscope it shows irregular outlines. Dichroism none. Interference colors brilliant. A cleavage is noticed in a direction apparently at right angles to the plates which give an inclined extinction on rotating the object. The mineral is therefore defined as crystallized and may belong to the monoclinic system.

It is not fusible. With carbonate of soda on charcoal it affords a black mass containing nickel. With the fluxes it shows silica, nickel and iron. Hydrochloric acid decomposes it on boiling, leaving some mixed sand; after repeated boiling with the acid the insoluble portion was found to be 31.1 per cent. of the whole mass.

The soluble part, which is supposed to be the pimelite, being so intimately mixed with the insoluble impure sand, I analyzed quantitatively with the following result:

Silica.....	45.93 per cent.....	O=24.49	
Magnesia.....	34.44 per cent. ....	O=13.77	} =25.81
Nickeloxid.....	7.69 per cent.....	O= 1.66	
Water.....	11.68 per cent.....	O=10.38	

Which gives the ratios of  $\text{SiO}_2 : \text{RO} :: 1 : 1.05$ . A unisilicate, which may be represented in this form:  $(\text{Mg}_x + \text{Ni}_y + \text{H}_z) \text{O} \cdot \text{SiO}_2$ .

If ever the mineral pimelite is found and analyzed in a purer state it may possibly have the above composition; but the Radnor mineral is a mixture.

**ASBEFERRITE.** This variety of amphibole occurs mixed with cobalt and nickeliferous pyrites on calcite. It occurs abundantly as a secondary product in the iron mine near the Falls of French Creek, Chester Co., Penna. It is mostly on the calcite, but some of it has crystallized within it, giving the calcite a greenish tint. The asbeferrite, when dry, has a faint green color; if wet, as it comes out of the mine, it appears dark green. The best designation may be

grayish-green. Apparently it is amorphous macroscopically, in reality crystallized in fine fibres which lie in all directions as if felted together. The crystals as seen under the microscope are mostly very thin and appear colorless, but those which are thicker show a green color and with one nicol prism; when the object is rotated, a second color, yellow, is observed. The thicker crystals are therefore dichroic. These latter, when viewed parallel with the orthodiagonal plane, show this dichroic property particularly, but it is extinguished parallel to their longer axis, between the crossed nicols. The extinction parallel to the clinodiagonal I determined to be equal to  $-28^\circ$ . The color of interference of this latter plane was a bright yellow, but parallel to the orthodiagonal it was blue. These optical characters indicate that this variety of amphibole is monoclinic.

The hardness is not determinable. Specific gravity = 2.6.

Heated in the oxidizing flame it assumes a rusty color, fusing with difficulty to a black mass; in the reducing flame it becomes gray. With the fluxes iron and silica are indicated.

The analytical result was as follows:

SiO <sub>2</sub> .....	48.45 per cent.
Fe <sub>2</sub> O <sub>3</sub> .....	33.90 per cent.
CaO.....	11.80 per cent.
MgO.....	6.23 per cent.

A trace of manganese was observed but not determined quantitatively.

The composition of byssolite of Saussure is nearly the above, but this variety occurs as stiff, shining, bristle-like crystals, not felt-like as is the case with the dull, soft material under discussion. At any rate it is but a variety of amphibole and compares better with the Scandinavian mineral asbeferrite.

**CACOXENITE.** This species occurs on limonite at Beartown, Lancaster Co., Penna. The reddish-yellow radiating tufts are made up of very fine, fragile crystals whose hardness cannot be determined. It is entirely soluble in nitric acid, and the solution gives reactions for phosphoric acid and iron. It also contains water.

Beneath the microscope the orthorhombic forms are clearly observable, as (110) (001). They are dichroic; gray when parallel with the lower nicol and yellow when at a right angle to it. Between the crossed nicols superb interference colors of orange, yellow, blue and violet appear. This seems singular because the crystals do not

show much difference in thickness. Extinction invariably parallel to the longer axis.

Sericite-schist, also called hydromica schist, has been observed on several outcrops about one mile north of Berwyn, Pa. It is a glistening soft schistose rock much interspersed with quartz. Parallel to the layers it is smooth and fatty to the touch; at right angle to it, rather sharp and rough. It is so brittle that transparent sections are difficult to make.

With the microscope the section gave indications of the fragmental nature of its constituents. These are the peculiar leaflets of sericite, very irregular in outline and in distribution, and fragments of a feldspar, which is probably orthoclase, and quartz. As accessories I found some chlorite having faint dichroic properties playing between green and brown. A multitude of acicular crystals is strewn through the mass which seem to be apatite. Phosphoric acid and lime were found by chemical tests.

**AMPHIBOLITE.** This is a perfectly black rock found at Swarthmore, Delaware Co., Penna. There are lines which indicate stratification and it may be therefore of metamorphic origin. The fracture is curved. The hand specimen is of an even, crystalline structure throughout the mass, but the crystals are not lying all in the same direction. It is very compact and sound without any sign of weathering or decomposition. It is apparently nothing but amphibole, so far as the ordinary vision goes. In thin section, however, there are, beside the amphibole, small irregular shaped fragments of feldspar, mica and quartz, and magnetite in fair quantity.

**GABBRO-PHONOLITE.** Mr. Theo. D. Rand showed me in a not very deep ravine near Radnor Station, Delaware Co., Penna., a rock of very dark color, fine-grained and tough which had not been determined. He is of the opinion that the rock is in its original position, which may be correct, although I have not been able to see the proofs of it. It seems to me to be an isolated boulder.

If struck with the hammer it does not give a metallic sound, but its mineralogical composition seems to indicate a phonolite. The thin section magnified 100 diameters gave the following result: Figure 1, sanidine, plagioclastic feldspar, diallage and magnetite.

**PHONOLITE.** About a mile east of French Creek Falls Station, Chester Co., Penna., occurs a dyke whose rock splits in slabs after heating it and marking with the chisel and hammer the direction in which the division shall take place. I have seen plates of  $\frac{1}{4}$  inch in

**THIS PAGE IS LOCKED TO FREE MEMBERS**

Purchase full membership to immediately unlock this page

# Know Your Bible

Forgotten Books' Full Membership provides unlimited access to more than 28,000 volumes of Christian literature for \$8.99/month

**HOLY BIBLE**

**Continue**

\*Fair use policy applies

igneous rock in the form of slabs and huge boulders. These were generally called trap by our geological friends, but the people call them ringing rocks; or, what means the same, klinkstones. The exposure is a large one, but, on inspection it was found that the trees encroach upon it and have already conquered a considerable area of the outcrop. They will probably in time cover the entire locality which is called the Stony Garden by the people who go there on picnics.

The klinkstones, as they are called (or, more properly speaking phonolites), produce a metallic sound when struck by a hammer, and the sound differs with almost every block or slab.

It is known that these rocks are basic in their chemical relations and this fact was fully established by my having, after a careful examination of some specimens, obtained 52.15% of silica ( $\text{SiO}_2$ .)

These phonolites, if not affected by atmospheric influence, are of a dark color; but they become ash-gray externally whenever exposed to the air. They are tough and mostly fine-grained; so much so that, macroscopically, it is utterly impossible to determine their mineralogical composition, although, with the aid of the pocket lens, a few crystals may be seen. The thin section (fig. 2) had to be magnified 100 diameters to make the components visible. It was compared with standard rock slides: diallage, plagioclastic feldspar, sanidine, amphibole and magnetite.

Inasmuch as the composition embodied in these rocks constitutes a gabbro, I have proposed the name gabbro-phonolite for this, the first American phonolite.

Another dyke of phonolite, of essentially the same character and of nearly the same composition, is exposed in Bucks County near the Delaware River, opposite Holland Station, New Jersey.

Three miles north of Pottstown, Montgomery County, Pa., is a fine exposure of the same kind of phonolite as described above. The people of the town call it the Ringing Hill. As it is easily reached it is used as a pleasure grove. The encroaching trees will, in all probability cover the entire outcrop, the greater part having already been covered up.

In Pl. II, figure 3, I have tried to illustrate a thin section of gabbro-phonolite collected from the dyke through which the North Pennsylvania Railroad passes. The point is about two miles north of Quakertown, Bucks County, Pa. A description may appear superfluous because the composition is so nearly like the one from

Haycock Mountain except that the sound emitted is not so highly metallic as in the case of the latter. There are, however, twins of diallage in the section which will easily be recognized by those interested in the subject. The sanidine is present in less quantity than the plagioclastic feldspar which seems to be labradorite. Huge blocks, rounded by weathering, occur in the neighboring fields in great abundance. Specimens collected and studied in the same way, gave the same general results, and have therefore not travelled any great distance.

Mr. Theo. D. Rand collected two specimens of rock which he submitted to me for determination. The one was found at Buck Run, 2 miles southwest of Mortonville, Chester County, Pa.; and the other from 2 miles south-southeast of Thorndale, Chester County, Pa. Both specimens proved to be the same kind of gabbro-phonolite. Slight differences are noticed in the Mortonville rock; beside the sanidine, plagioclastic feldspar, the diallage and augite, there is some hematite beside the magnetite.

The Thorndale rock is the same in composition except that some chlorite was recognized in the mixture.

**GRANULITE.** The specimen was collected in the quarry at Pigeon Cove, Mass., by Mr. Theo. D. Rand who told me that the quarrymen complained of the extreme hardness of the rock, which they could not account for. I was requested to investigate it and to ascertain what the cause of the extreme hardness might be.

The hand specimen is a coarse grained, mostly light colored rock intermixed irregularly with large black patches having a metallic lustre. The rock contains no mica.

The thin section (Pl. II, fig. 4) as observed beneath the microscope showed the constituent minerals to be orthoclastic feldspar, quartz and magnetite. It is essentially the same rock which is so extensively used in Philadelphia for Belgian block pavements.

The feldspar and the quartz are interpenetrated and can be best recognized by reflected light; when so examined the quartz appears dark and the feldspar light. With the aid of the polarized ray the interference phenomena of the two mineral species are clearly shown; the reflected ray however, shows it to the best advantage especially for the shading in the illustration. The contour was drawn with the pen and the aid of a rectangular prism (Dr. Piffards) which projects the picture of the slide upon the paper. Under these conditions the contour can be drawn with accuracy and ease, provided



one has enough light. The section as drawn shows how intimately the quartz and feldspar are mixed. The two species are so commingled as to indicate that they must have crystallized simultaneously, the greater hardness seeming to be due to a somewhat greater proportion of quartz.

#### EXPLANATION OF PLATES I AND II.

Figure 1. Gabbro Phonolite, Radnor. Magnified 100 diameters shows, (1) Sanidine, (2) Plagioclastic Feldspar, (3) Diabase, (4) Magnetite.

Figure 2. Gabbro Phonolite, 10 miles east of Quakertown.  $\times 100$ ; (1) Diabase, (2) Plagioclastic Feldspar, (3) Sanidine, (4) Amphibole, (5) Magnetite.

Figure 3. Gabbro Phonolite, north of Quakertown,  $\times 15$ ; (1) Diabase, (2) Plagioclastic Feldspar, (3) Magnetite, (4) Amphibole, (5) Sanidine.

Figure 4. Granulite, Pigeon Cove, Mass.  $\times 15$ ; (1) Orthoclastic Feldspar, the dark portion quartz, (3) Magnetite.

**THIS PAGE IS LOCKED TO FREE MEMBERS**

Purchase full membership to immediately unlock this page

# DELVE INTO FANTASY, MAGIC, MYTHOLOGY & FOLKLORE

Forgotten Books'  
Full Membership gives  
access to 797,885 ancient  
and modern, fiction and  
non-fiction books.

**Continue**

\*Fair usage policy applies

*Rana temporaria pretiosa* B. & G.

Sicamoos, B. C., and Field, B. C., in the Rocky Mountains—numerous specimens.

*Rana virescens* Kahn.

A small specimen, having the general appearance of the subspecies *brachycephala* Cope, but with the length of the head entering the total less than three times. From the plains east of the Rocky Mountains.

*Spea hammondii intermontana* Cope.

A single specimen from Vernon, B. C. The frontoparietal fontanelle is closed, and the supraorbital borders are thickened, so as to give the profile a distinct convexity. The discovery of this species, so far north, greatly extends its range.

## REPTILIA.

*Pityophis sayi bellona* B. & G.

Vernon.

*Eutaenia leptcephala* B. & G.

An interesting series of eight specimens was obtained by Mr. Rhoads, five from Tacoma and three from Victoria, B. C. He did not obtain it from any locality east of the latter point. In my paper on the Characters and Variations of the Snakes of North America,<sup>1</sup> p. 660, I state that of the specimens in the National Museum, rather less than half have two preocular plates, and one half have seventeen and the other half nineteen rows of scales. Of the eight specimens brought by Mr. Rhoads, six have two, and two have three preoculars; one of the latter coming from Tacoma and one from Victoria. Six have seventeen rows of scales, and two have nineteen, both the latter from Tacoma. The distinctive characters of the species are thus confirmed. The ground color in two of the Tacoma specimens is black, and the others brown. All of the Victoria specimens are brown, and two of them have a red dorsal stripe.

*Eutaenia sirtalis trilineata* Cope, 1. sup. cit. 662-5.

Four specimens, two from Tacoma, and one each from Hatzic and Sicamoos, B. C. The last two specimens are typical *E. s. trilineata*, but in the two from Tacoma the dorsal stripe marks only a single row of scales, and the lateral is principally on one row, and partly on another. It is not unlikely that the two subspecies

<sup>1</sup> Proceeds. U. S. Natl. Museum, 1892, p. 589 (pub. Sept. 1, 1892).

—*E. s. pickeringii* and *E. s. trilineata*—may have to be united. In my key of subspecies of *E. sirtalis*, the *E. s. pickeringii* was placed inadvertently in section III, while it should have been placed in section IV.

***Eutaenia sirtalis parietalis* Say.**

Three from Hatzic, two from Sicamoos, B. C., and one from Nelson and Vernon, B. C., respectively. Constant to its characters in the interior, but the three specimens from Hatzic show an approach to the *trilineata* form. This is produced by a diminution in the size of the red spots anteriorly, and their obliteration on the posterior part of the body and on the tail.

***Eutaenia elegans linealata* Cope.**

Two from Tacoma, and one from Sicamoos, B. C.

***Eutaenia elegans vagrans* B. & G.**

Three from Nelson, B. C.

***Crotalus confluentus lucifer* B. & G.**

Vernon.

Total number of species obtained, thirteen, of which eight are batrachians and five snakes, two of the latter represented by two subspecies each.

An interesting feature in this collection is the remarkable extension of the northern range of the *Spea hammondi intermontana*, and the *Pityophis sayi bellona*. The former had not been known previously north of Pyramid Lake, Nevada, and the latter, north of the Humboldt River in the same State.

Both are restricted to the Great Basin, and their northern range indicates the extension of the fauna to a higher latitude than has been hitherto known. This is consistent with the physical characters of the country, and with the indications furnished by the bird-life, as I am informed by Mr. Rhoads. Another peculiarity is the occurrence of *Crotalus confluentus lucifer* in the same region, instead of the Great Basin form *C. c. lecontei*. The former is the coast species, and has never been detected in the Great Basin.

The species are distributed according to districts, as follows :

PACIFIC COAST.

*Diemyctylus torosus*.

*Hyla regilla*.

*Rana agilis aurora*.

*Eutaenia leptcephala.*  
*Eutaenia sirtalis pickeringii.*  
*Eutaenia elegans lineolata.*

## ARID REGION.

*Spea hammondii intermontana.*  
*Pityophis sayi bellona.*  
*Eutaenia sirtalis parietalis.*  
*Crotalus confluentus lucifer.*

## ROCKY MOUNTAINS.

*Rana temporaria pretiosa.*  
*Eutaenia sirtalis parietalis.*  
*Eutaenia sirtalis trilineata.*  
*Eutaenia elegans lineolata.*  
*Eutaenia elegans vagrans.*

## THE PLAINS.

*Rana virescens.*

*Bufo columbiensis* was sent from the coast and from the Rocky Mountain region. It occurs also in the arid region in Oregon. *Eutaenia sirtalis parietalis* has the same distribution.

*Amblystoma macrodactylum* has not been previously recorded from British Columbia, although its occurrence at Puget Sound would lead us to expect it.

**THIS PAGE IS LOCKED TO FREE MEMBERS**

Purchase full membership to immediately unlock this page

# Know Your Bible

Forgotten Books' Full Membership provides unlimited access to more than 28,000 volumes of Christian literature for \$8.99/month

**HOLY BIBLE**

**Continue**

\*Fair use policy applies

*amphibius*.<sup>8</sup> Thus, for example, Flower,<sup>9</sup> a very high authority, does not consider the difference in the shape of the cranium and in the number of the incisor teeth in the lower jaw as warranting the establishment of the genus *Choeropsis*. The difference presented by the crania in the two kinds of hippopotamus, Flower regards as similar to those "between the Tiger and the smaller species of *Felis*, the Gorilla and Baboons and the smaller allied apes." In the judgment of the author, however, it may be at least questioned whether the differences existing between the smaller species of *Felis* do not justify separating them into distinct genera. On the other hand, although the Gorilla has descended in all probability from some Baboon-like form, zoologists do not as yet recognize these two apes as species of the same genus. The fact that *Hippopotamus amphibius* syn. *Tetraprotodon* has, according to Gaudry,<sup>10</sup> exhibited in one instance unilateral hexaprotodontism and *Choeropsis*, according to Flower,<sup>11</sup> in one instance unilateral tetraprotodontism would influence but few palæontologists in regarding, like Lydekker,<sup>12</sup> *Hexaprotodon*, *Tetraprotodon* and *Choeropsis* as merely species of one genus *Hippopotamus*. *Hexaprotodon* and *Tetraprotodon*, with the incisor formula  $\frac{3}{3}-\frac{3}{3}$  and  $\frac{2}{2}-\frac{2}{2}$  respectively, are still considered either as sub-genera, as they were originally by Falconer and Cautley,<sup>13</sup> or as genera, as by the greatest of British palæontologists, the late Sir Richard Owen.<sup>14</sup> The latter view being accepted by the author, *Choeropsis*, with the incisor formula  $\frac{2}{1}-\frac{2}{1}$ , and differing in other respects far more from the living hippopotamus (*Tetraprotodon*) than the latter does from the extinct one (*Hexaprotodon*), should certainly be regarded as a genus distinct from *Hippopotamus*.

It appears to us that too much importance has been attached by Lydekker and Flower to the presence of an extra incisor tooth in the lower jaw of *Hippopotamus amphibius* and *Choeropsis* respectively, especially as it has only been noticed once in either case. We would rather regard the presence of such an incisor tooth as an individual peculiarity and as an instance of redundancy than of reversion. In view of what has already been urged by Leidy,

<sup>8</sup> Carus, Zoologie, 1868, p. 145.

<sup>9</sup> Pro. Zool. Soc. London, 1887, p. 612.

<sup>10</sup> Bull. Soc. Geologique, Ser. 3, Vol. 4, p. 504.

<sup>11</sup> Op. cit.

<sup>12</sup> Memoirs of the Geological Survey of India, 1884-1886, Vol. 3, p. 47.

<sup>13</sup> Falconer, Palæontological Memoirs, Vol. 1, 1868, p. 140.

<sup>14</sup> Odontography, 1840, p. 566.

Gratiolet, Milne-Edwards in favor of distinguishing *Choeropsis* as a genus distinct from *Hippopotamus*, there is but little further to be added. It may be mentioned, however, in this connection, that the brain of *Choeropsis* as described by Macalister<sup>15</sup> differs very considerably from that of the adult hippopotamus dissected by Garrod<sup>16</sup> and of the young animal dissected by the author,<sup>17</sup> the differences between the two brains being essentially the same as those presented by the casts of the cranial cavities described and figured by Milne-Edwards. The above remarks are made on the occasion of the presentation to the Academy by Mr. W. E. Rothery, Consul of the Liberian Government, through Mr. Arthur E. Brown, of a fine skin and skeleton of the *Choeropsis liberiensis*. The value of this generous gift will be better appreciated when it is known that the only specimen of *Choeropsis liberiensis* ever exhibited abroad was the one that lived only five minutes after its arrival at the Zoological Garden of Dublin, and which constituted the subject of the dissection made of that animal by Macalister. So far as known to the author, with the exception of the skin presented to the Academy this evening, there are but two others in collections—those referred to by Milne-Edwards and Flower. Our *Choeropsis*, of which we give an illustration taken from a photograph, (Plate IV) is 5 feet 3 inches in length, and 2 feet 5 inches in height, the latter measurement being taken from the shoulder. The color of the skin appears to have been originally of a bluish black, fainter in some parts than others, and presenting, therefore, a somewhat mottled appearance. The difference in color from that of the *Choeropsis* described by Milne-Edwards, which is represented as of a reddish hue, may possibly have been due to the liquor in which the skin was preserved. It is more probable, however, that *Choeropsis* varies in color. In other respects, our specimen resembles that described and illustrated by Milne-Edwards.

---

<sup>15</sup> Proc. Royal Irish Acad., 2d Ser, Vol. 1, 1873, p. 494.

<sup>16</sup> Trans. of Z. S. London, 1880.

<sup>17</sup> P. A. N. S., 1881, p. 126.



## THE GLANDULAR HAIRS OF BRASENIA PELTATA PURSH.

BY IDA A. KELLER.

The thick coating of jelly with which certain parts of *Brasenia peltata* are covered can not have escaped the attention of any one who is familiar with that member of the family of Nymphæaceæ. In my search for descriptions of the method of formation of this secretion, for such we must term the jelly-like mass, I have found but one brief statement in explanation of the development of it. This is by Asa Gray, who says "The jelly by which the stalks, etc., are thickly coated, I find to arise from the rapid formation and rupturing of successive epithelial cells, in the same way that muci-lage is formed on the surface of animal mucous membranes."<sup>1</sup> This explanation is wholly inadequate, and I might also say entirely incorrect, as will become apparent further on.

Turning our attention first of all to the distribution of the jelly, it may be noticed in the plant represented on Plate III, fig. 1, that there is none of this coating substance to be found on the older parts of the creeping rhizome, and particularly not at such portions which were not of this year's growth, nor is any of the secretion observable on the petioles and blades of the older leaves still alive and vegetating. Three such leaves are represented by B, C, & A, in fig. I. On these, none of the jelly except perhaps slight traces of it, was perceptible to the touch. The next two leaves, D, & E, in fig. I, evidently younger and less well developed, show a thick film of jelly-like substance on the petioles, and this film extended also over the under surface of the leaf blades. The leaves of *Brasenia peltata* are alternate and elliptical in shape, and centrally peltate. The long diameter of each of the three older leaves above referred to—as destitute of the coating of jelly was about 8 cm. The long diameter of each of the two leaves with the jelly-like coating on the petioles and under leaf-surfaces was 7 cm. and 6½ cm. respectively.

The leaves are involute in vernation, and the next younger leaf having not yet expanded, fig. I F shows the sides rolled inward, parallel to the longest diameter. This latter measured 5 cm. The entire leaf in this case seemed to be enveloped in a gelatinous sheath. On unrolling the sides I found, however, that the secretion originated

---

<sup>1</sup> A. Gray, *Genera Floræ Americæ Boreali-Orientalis*, Vol. I, p. 96, Note.

**THIS PAGE IS LOCKED TO FREE MEMBERS**

Purchase full membership to immediately unlock this page

# DELVE INTO FANTASY, MAGIC, MYTHOLOGY & FOLKLORE

Forgotten Books'  
Full Membership gives  
access to 797,885 ancient  
and modern, fiction and  
non-fiction books.

**Continue**

\*Fair usage policy applies

At the apex of the gland proper, a cap is noticeable, fig. II, A, Z, which was more highly refractive than the remainder of the cell wall. Directly below it the protoplasm seemed more dense, the protoplasm itself was yellow or brownish, granular and in part showed reticulations. Since I did not examine fresh material, I cannot, at present, say how far the protoplasm had been affected or altered in appearance by the alcohol.

The outer envelope or portion which I have for want of a better term called "sheath," is delicately walled, sometimes closed at the top, fig. II, A, and sometimes open, fig. II, B, C, D. The wall is transparent—almost colorless. This sheath, in all probability, represents the "epithelial cells" of Gray, but instead of being epithelial cells rapidly formed and ruptured, the observation of the method of development of these sheaths indicates a totally different explanation regarding their true nature. The method of secretion witnessed in glandular hairs is generally as follows: "The secretion regularly occurs first at the apex and spreads from there, lifting off the thin cuticle in shape of a bladder whose contents are then filled with the secretion."<sup>1</sup> Regarding fig. VI, where a sheath is just beginning to be formed, S'', and where another has already attained a considerable size, S', there can be little doubt of the fact that the method of secretion in case of the glandular hairs of *Brasenia peltata* is entirely in accordance with that observed in glandular hairs generally. The sheath then is nothing more nor less than the cuticle lifted off by the secretion. The cuticle, as will be seen on comparison of the figures, is capable of growing or becoming stretched to a remarkable extent; this may be especially well seen in fig. VI and fig. VIII, both glands being taken from near the vegetative point where secretion seemed most active. The cuticle finally becomes broken, indistinct, and eventually seems to dissolve, as indicated in fig. II, C & D. A peculiar rupture of the cuticle witnessed in a few cases is shown in Fig. II, B. This was perhaps caused by some external agency, since, usually, the sheath seems to become indistinct rather gradually instead of a portion breaking off with a smooth edge.

According to Hanstein, the cuticle of glandular hairs in case of unopened leaf-buds after rupture is often regenerated, and the formation of new secretion begins.<sup>2</sup> This process is particularly evident

---

<sup>1</sup> Julius Sachs, *Vorlesungen über Pflanzen Physiologie*, Leipzig, 1887, p. 195.

<sup>2</sup> DeBary, *Vergleichende Anatomie*, Leipzig, 1877, p. 104.

in case of the glandular hairs of *Brasenia peltata*, especially so in hairs from near the vegetative point. On these successive sheaths may be frequently seen, as in fig. VI, S' & S'', the next one appearing before the preceding one is dissolved. Fig. VII represents the apices of three such sheaths, the innermost always being the one last formed.

In accordance also with observations on similar organs of other plants, the secretion and secreting organs are most thick on the youngest and most tender parts as already described and represented in fig. I. The activity of the hairs evidently decreases from the punctum vegetationis backward, and ceases entirely on the older fully-developed parts. The hairs, although they cannot dry up in the manner usually to be observed on land plants, seem to die off and finally disappear, as indicated in fig. IV, a cross section of an older portion of the rhizome which no longer possessed any or, perhaps, slight traces of the gelatinous coating. Fig. V represents a surface view of the epidermis taken from about the same point as the cross section represented in fig. IV. In fig. V the places where the glandular hairs had once been active, are represented by H.

Fig. III, on the other hand, shows the great quantity of glands which beset a petiole which is thickly coated with jelly, and the more closely the vegetative point is approached, the more closely the glands are packed together, in fact, as has been stated before, at the points of greatest activity they are crowded to such an extent as to leave no spaces between them.

The glandular hairs of *Brasenia peltata* are then, as plant hairs are very apt to be, transitory organs, disappearing in the course of the development of the part which produces them. In function they are no doubt comparable to the "Colleters" of Hanstein.<sup>1</sup> This name Hanstein applies to the more massive trichomes which are found on the epidermis of leaves while still in the bud, and secreting during that stage different substances, such as gum or gum and resin, and by this means causing the parts to adhere to each other and protecting them from unfavorable external agencies. This active secretion must have been noticed by every one who has ever observed the opening of the buds of the horse-chestnut, poplar, etc. It may also be seen in the case of *Salvia*, *Polygonum*, *Helianthus* and other herbaceous plants.

---

<sup>1</sup> DeBary, *Vergleichende Anatomie*, Leipzig, 1877, p. 104.

It is interesting to find in *Brasenia peltata*, a member of the water-lily family and living therefore as an aquatic under entirely different conditions, similar means of protection for the younger parts as observed in the case of the terrestrial plants just referred to.

Although the chemical composition of the substances secreted by means of the "Colleters" varies considerably in different land plants, Hanstein applies the name "Blastocolla" indiscriminately to the product. There is no reason why this name should not also apply to the gelatinous coating found on the younger organs of *Brasenia peltata*. It may be expected that a plant surrounded by air requires totally different means of protection from one whose surrounding medium is water, and it may be taken for granted that the gelatinous coating of *Brasenia peltata* is one peculiarly adapted to the conditions in which that plant lives. At present, it is impossible for me to state the chemical composition of this substance. The only point which I can state with certainty is that the principal constituent of the secretion is water, which fact indicates that the secretion is one of those plant products which are capable of imbibing great quantities of water. It must be remembered that in water plants the principal water-conducting tissue, the xylem of the fibro-vascular bundles, is usually reduced to a more or less extent. In case of *Brasenia peltata*, I notice that this reduction is carried to an extreme degree, the xylem being entirely obliterated in the leaf petioles. There is, therefore, in this plant, no tissue particularly adapted to the rapid transportation of great quantities of water. The question naturally arises, how, under the circumstances here prevailing, in a plant entirely surrounded by water, containing within no xylem or water-conducting tissue, par excellence, is this imbibition process accomplished? The determination of this matter is, as I believe, of considerable importance, and requires a most critical observation. Two methods naturally suggest themselves: the secretion may draw the water from within, the water would then have to be taken in at other points of the surface of the different parts of the plant, and transferred from there to the glandular hairs; or the secretion may draw the water, or a part of it, directly from the outside. This latter, under the circumstances, seems to me the most probable explanation of the phenomena here witnessed. The question must, however, for the present, remain an open one. So far as I know, the imbibition of water from the outside by means of glandular hairs, has nowhere, as yet, been observed. Should the method

**THIS PAGE IS LOCKED TO FREE MEMBERS**

Purchase full membership to immediately unlock this page

# Know Your Bible

Forgotten Books' Full Membership provides unlimited access to more than 28,000 volumes of Christian literature for \$8.99/month

**HOLY BIBLE**

**Continue**

\*Fair use policy applies

NOTES ON THE OCCURRENCE OF QUARTZ AND OTHER MINERALS IN  
THE CHEMUNG MEASURES, NEAR THE LINE OF LYCOMING  
AND TIOGA COUNTIES, PENNSYLVANIA.

BY ABRAHAM MEYER.

Ascending the "Roaring branch" of Lycoming Creek, the upper Catskill measures may be seen. After passing two or three thousand feet of red and gray rocks we reach the upper measures of the Chemung VIII<sup>f</sup> and VIII<sup>e</sup>. Below, these dip from 10° to 80° beyond which they are nearly horizontal.

In these horizontal strata which rise to heights of from one hundred to three hundred feet above the stream, may be seen peculiar undulations or rolls, some being slight short curves, others semi-circular, while some form an entire circle with the layers concentric. These are most apparent near the base of No. VIII<sup>e</sup>, in shales and fossiliferous limestone and iron ore. The rolls differ from the rock, which surrounds them, though the latter follows to a certain extent the convexity of the rolls.

Near one of these rolls a drift was made in search of ore. On the east side appeared a seemingly vertical wall of dark metamorphosed fossiliferous rock of considerable hardness, containing much carbonaceous material and iron pyrites, with cavities holding drusy quartz, calcite, chalcopryrite, etc. On the west side was a soft (pyrophyllite) slate, with calcite and quartz crystals near the line of contact.

In the four or five feet between these was a heterogeneous mixture of hard and soft rocks of varying character, from a soft bluish clay to a very compact quartz resembling novaculite, a breccia together with geodes containing quartz crystals, calcite in the form of dog-tooth spar, pearl spar, chalcocite, chalcopryrite, galena and blende with possibly siderite, fluorite and millerite.

The quartz crystals are generally attached to the rock in the usual manner; some, however, are loose and nearly perfect, often smoky and usually containing remarkable inclusions both solid and liquid. There is much carbonaceous material, quite loose and soiling anything with which it comes in contact. The shale impregnated with this is sometimes metamorphosed into an excessively hard material approaching carbonado in its character.

This material was penetrated for between 40 and 50 feet when the body of the roll was met, dipping about  $15^{\circ}$ . Here, at the bottom of the drift, on the east side, was a white granular quartz with intermingled quartz crystals some of them rolled. In three feet this increased from a half inch to three inches in thickness accompanied by a harsh silicious carbonaceous rock containing pyrites and chalcopyrite and some steel gray crystals not determined. This seemed to continue, but water coming in, the exploration was abandoned. The quartz crystals exhibited show among other things as follows :

1. A transparent, doubly terminated smoky crystal with a fluid inclusion and also small pearly crystals; also a rectangular and a hexagonal prism beside moss-like aggregates. Near the apex of the pyramidal termination there is a pearly crystal in form resembling a twin of selenite.

In another position, the same crystal shows a vast number of inclusions, some mere points, others fine lines, circles and rosettes, colorless, yellow, orange and black. A group of twelve quartz crystals associated with chalcopyrite and perhaps ilmenite. These under the microscope show octahedral crystals included, with fluid and bubble-containing cavities.

2. Crystals, colorless and transparent, also smoky and some opaque, containing inclusions in fine lines and other figures. These were obtained in a loose blue clay, arising from the decomposition of the soft blue shales of the Chemung formation, and also from a cylindrical chimney, six inches in diameter and two feet long which was found near the top of the drift. The crystals were loose, in a mass of decomposed ferruginous calcite and clay.

3. Similar crystals in ferruginous calcite, found between conglomerate and dolomitic spar in the roll.

4. A white and grayish-white laminated or tabular quartz in quite thin plates, the surface studded with minute quartz crystals with occasional larger transparent or milky crystals.

The slates accompanying these gave evidence by slickensided surfaces of movement under pressure.

5. Quartz crystals upon crystallized calcite and dolomite; the surfaces coated with minute crystals.

6. These occurred with the tabular quartz described above and are in nodular masses of metamorphosed slate and shale. Some crystals are transparent, others dark smoky to black. Some of the



black crystals are much harder than common quartz, and have centers of prismatic colors, which by reflected light assume an asteriated form.

7. Associated also with the tabular quartz is a brownish-red ferruginous quartz one piece of which showed crystals of intense black color, except two zones at the base, which showed prismatic colors, and under the microscope the asterism. The point of this crystal was extremely hard.

8. On a line with the rolls, but 125 feet above them topographically, was ferruginous calcite and massive quartz with rough quartz crystals, the surfaces pitted and filled with clay. The massive quartz breaks very readily into angular fragments, the surfaces coated with dendrites. Some of the crystals are coated with druses of black color and metallic lustre, some crystalline, some quite rough. Under the microscope some of these show crystalline forms of light straw color resembling millerite.

My theory of the formation of these rolls is that a subterranean force acting over an oval area ten or twelve miles by four culminated in making them; the zone of most active force being about two and a half miles in diameter. That steam and water carrying carbon, lime, iron, etc., penetrated the crevices, formed and deposited the minerals and crystals; unfortunately for mining interests this action was scattered over a considerable extent of country whereas had it been confined to a narrow vein, a valuable mine might have been the result.

**THIS PAGE IS LOCKED TO FREE MEMBERS**

Purchase full membership to immediately unlock this page

# DELVE INTO FANTASY, MAGIC, MYTHOLOGY & FOLKLORE

Forgotten Books'  
Full Membership gives  
access to 797,885 ancient  
and modern, fiction and  
non-fiction books.

**Continue**

\*Fair usage policy applies

ing six inches, except the soft shaly measures occurring in Pine Township, which were from fifteen to eighteen inches thick. The measures, however, were very much crushed and broken up—no regular layers, but accompanied with a light sprinkle of copper green. This form of exposure was observed at three localities.

The third exposure occurs near the mouth of Otter Run, Pine Township, under a heavy mass of concretionary limestone, quite thick (and was very similar to the Vermont and Deep River, N. C., coarse pencil slates), but, being in the bed of the stream, it was difficult to ascertain the thickness and extent of deposit. Good sized plates were obtained, large enough for a medium-sized school slate, three-fourths of an inch thick.

The fourth exposure was observed near the head of a small run entering Larry's Creek, northeast of Cogan House P. O. The measures occur about fifty feet above the bed of the stream, the overlying rock being a soft, calcareous red sand rock, in places having cavities containing nodules of green sand, which, upon short exposure, disintegrate into a bluish and green sand. This bed has been observed five to eight feet thick, the washing of the overlying surface soil and rock obscuring the true thickness. The upper layers being in the bed of a run, are quite soft and shelly, but layers are quite regular at the top, being from one-fourth to one-half inch thick, while lower in the measures they are from one-half an inch to one inch in thickness. A marked peculiarity near the surface is that a number of layers have a rounded, irregular surface on the upper side and assume a great variety of concretionary forms. The observer can find regular squares faced outside of layers, but on disturbing them they fall apart into all kinds of odd and regular oval, ovoid and irregular forms, from a rough-cast for skinning stones fitted for instant use to the aborigines' hand, to others that a little labor by rubbing would soon have converted into the same form. Some of the shales have the impressions of algæ (?) upon them. Toward the bottom the measures change and merge into a pale, reddish and gray, micaceous, sandy shale, some of the laminae curved with rough, shallow cavities over the surface. These are followed by a shale which is somewhat cellular in appearance, but, where exposed, there is nothing in the cavities. This, in turn, is succeeded by a more highly ferruginous shale and silicious layers, gray and red in color. Among the gray measures, some are observed quite micaceous, having a bluish film over the surface, while others

are black on the line of the fossil markings; and, as this exposure is all above any heavy body of water, it forms a good point of observation for a full order of superposition, though narrowness between the banks of the run, with green timber growing thereon, is a bar to any extensive investigations as to quantity or extent of the same. The measures are all somewhat irregular on their bedding planes, but give a nearly flat surface on one plane. The entire deposit is ten to twelve feet in thickness, of which the pyrophyllite slates proper occupy about five feet of the upper portion of the measures, and is the only full section that has been seen.

The fifth exposure occurs on Bear Run, a tributary of Little Pine Creek, about two and a half miles from the mouth of the Run, on the south bank above the forks. It adjoins the edge of the Run, and is partly below water-level, a great hindrance to the full and proper study of the section, which presents itself under more inviting surroundings than any of the preceding exposures in the extent and quality of the outcrop, as well as its very interesting occurrence. It occurs at the foot of the side hill, about 1,400 feet above tide, in a cliff ten to twelve feet high, and fifteen to twenty yards in length. The overlying rocks are red and gray shales and sandstones, of Formation No. IX, Catskill group, and the roof rock is a calcareous ferruginous sandrock (with small nodules of red oxide of iron disseminated through it) in part coming in as a wedge, while another portion of the measures further west—a brownish, rotten sandrock—is the cover, immediately under which occurs a thin, shelly, fissile, red slate, six to eight inches thick. This is followed by two feet of very soft, gray, fissile slates,  $\frac{1}{8}$  to  $\frac{1}{4}$ -inch in thickness, increasing to  $\frac{1}{2}$ -inch with much exfoliation. These may be only the result of weathering at the surface, as it was observed in going in on the measures a short distance, they became somewhat thicker and more solid. The slates on the outcrop were quite soft and aluminous (hardening on exposure). In a few of the layers were impressions of algae (?); on others, numerous rough accretions on the surface, simulating small fossil shells. Proceeding downward, the slates assumed a more distinct layerlike appearance, and became thicker, being  $\frac{1}{4}$ -inch to  $1\frac{1}{2}$  inches—one surface was generally quite smooth and flat, while the other would be somewhat irregular. Upon getting into these thicker layers, the removal of them opened up many odd and interesting forms resembling aboriginal stone implements. Below these the slates became thicker to water level, with

more layers containing fossil impressions of plant life. The layers now becoming more uniform in their bedding planes, with one, and sometimes both planes, smooth and parallel to each other, of a thickness of 1 to  $2\frac{1}{2}$  inches, the surfaces having a slight film of a rusty, ferruginous color, sometimes bearing arborescent forms. These layers were observed 6 to 10 inches wide, and would evidently get more massive working into the side hill. The total thickness of the pyrophyllite slates is about six feet to water level. This exposure is on lands of R. J. C. Walker and Wm. Weightman of Philadelphia.

**THIS PAGE IS LOCKED TO FREE MEMBERS**

Purchase full membership to immediately unlock this page

# Know Your Bible

Forgotten Books' Full Membership provides unlimited access to more than 28,000 volumes of Christian literature for \$8.99/month

**HOLY BIBLE**

**Continue**

\*Fair use policy applies



3

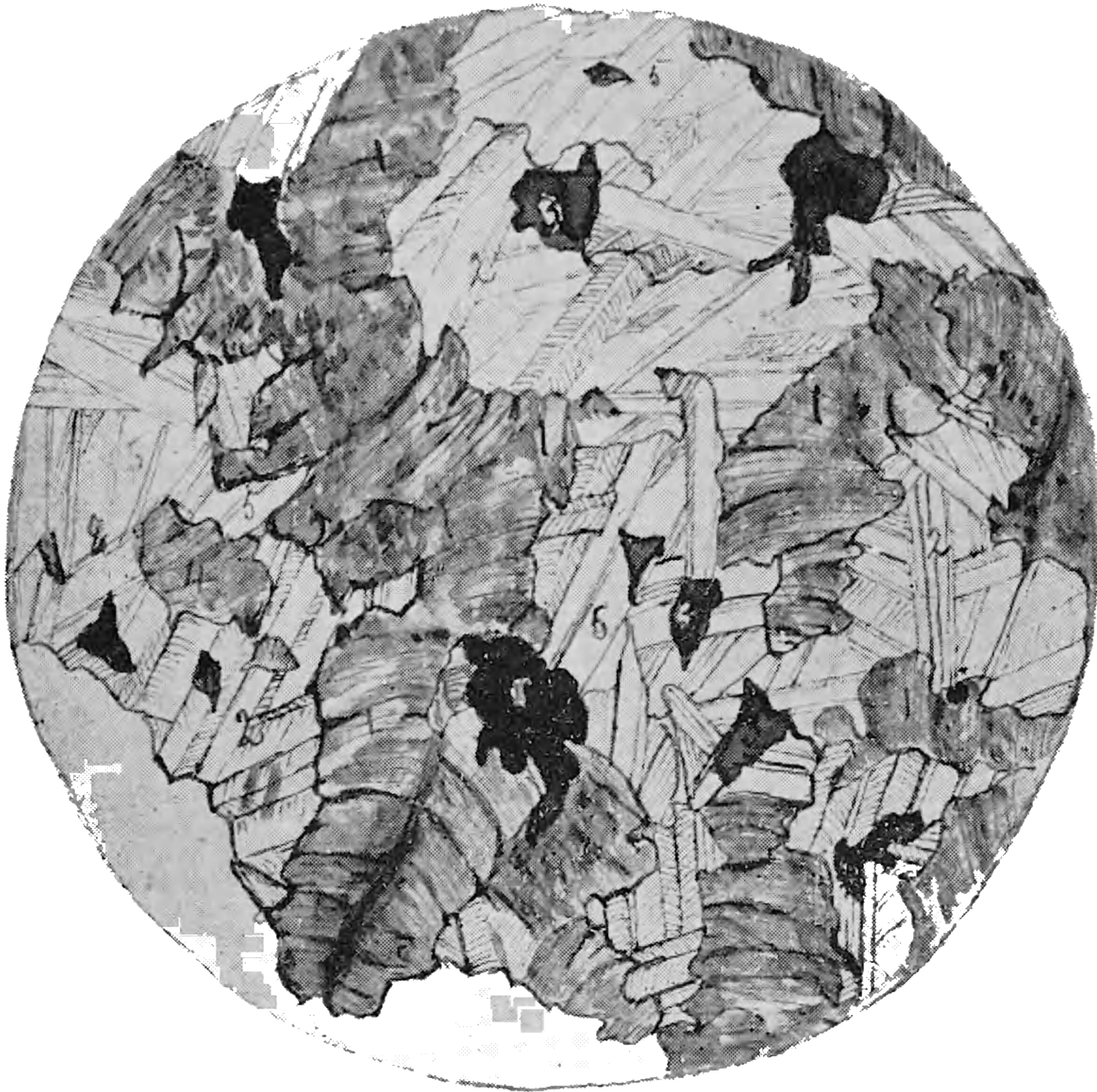

4

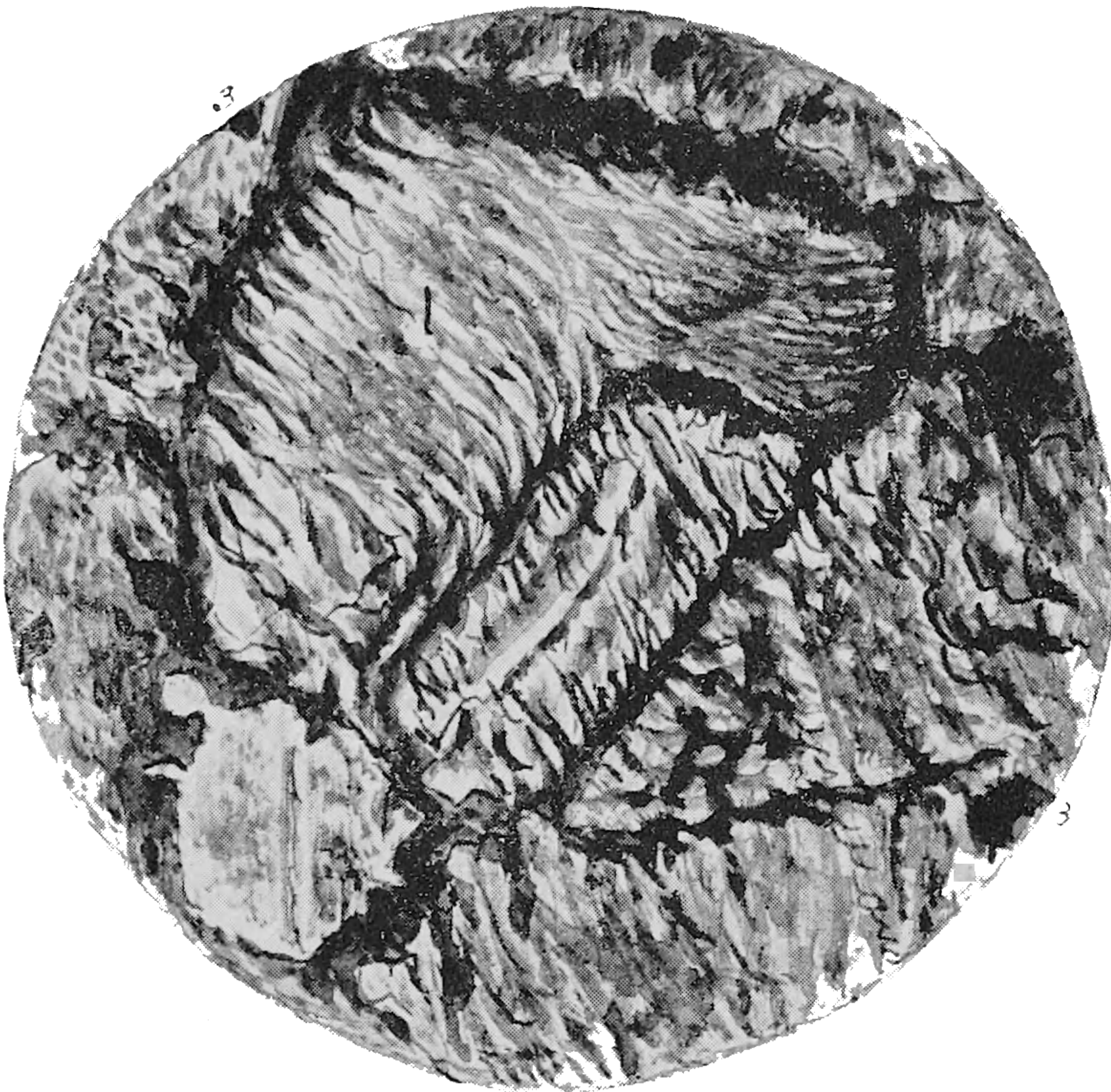





**THIS PAGE IS LOCKED TO FREE MEMBERS**

Purchase full membership to immediately unlock this page

# DELVE INTO FANTASY, MAGIC, MYTHOLOGY & FOLKLORE

Forgotten Books'  
Full Membership gives  
access to 797,885 ancient  
and modern, fiction and  
non-fiction books.

**Continue**

\*Fair usage policy applies



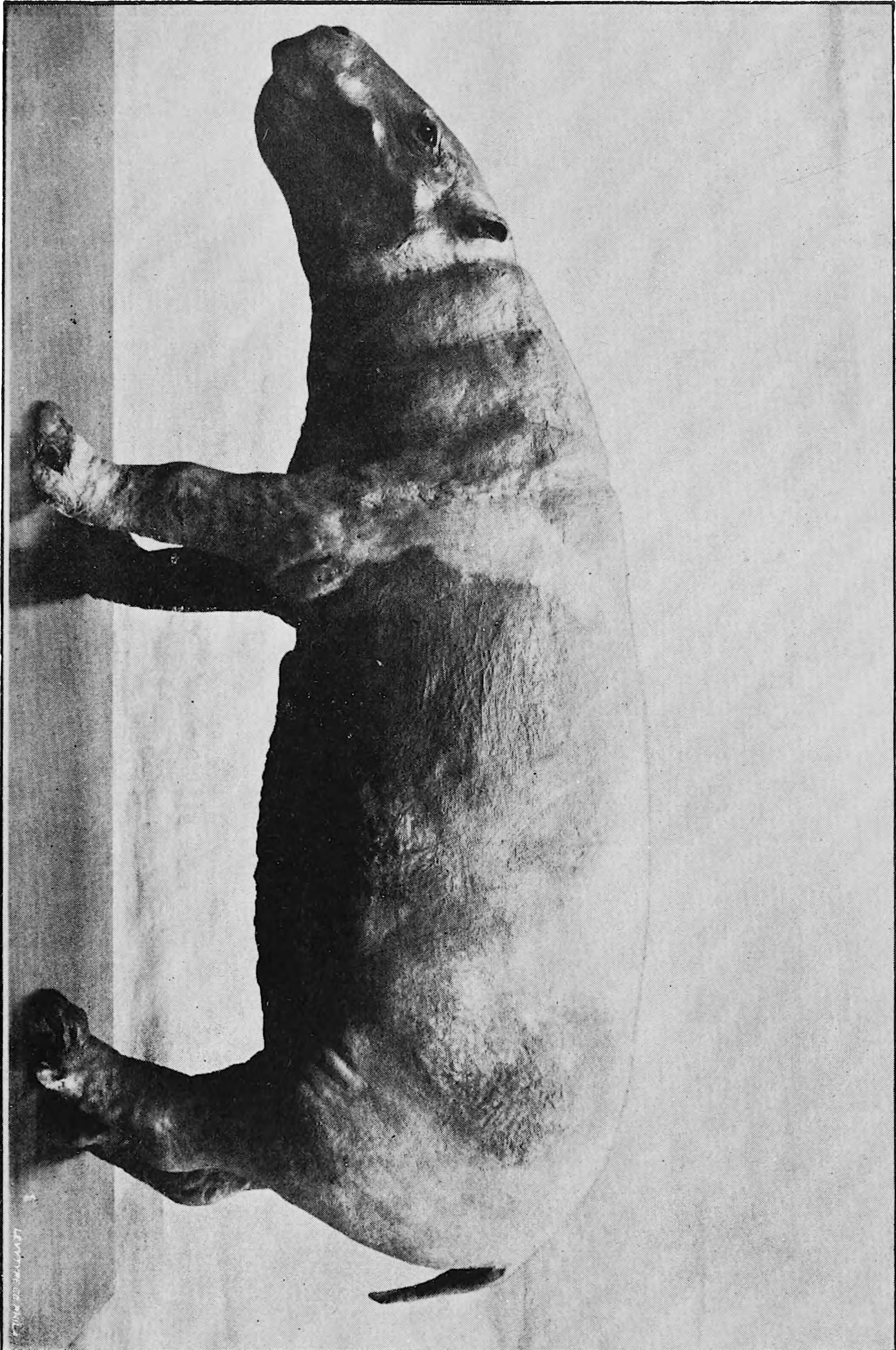

CHOEROPSIS LIBERIENSIS (MORTON.)



**THIS PAGE IS LOCKED TO FREE MEMBERS**

Purchase full membership to immediately unlock this page

# Know Your Bible

Forgotten Books' Full Membership provides unlimited access to more than 28,000 volumes of Christian literature for \$8.99/month

**HOLY BIBLE**

**Continue**

\*Fair use policy applies

DESCRIPTION OF A LOWER JAW OF TETRABELODON SHEPARDII  
Leidy.

BY E. D. COPE.

This species has been known hitherto by a third inferior molar only. This has been described or figured at the following places of reference:

*Mastodon shepardii* Leidy, Proc. Acad. Philadelphia, 1870, p. 98; 1872, p. 472. Cope, American Naturalist, 1884, p. 524.

*Dibelodon shepardii* Cope, Proc. Amer. Philosoph. Soc., 1884, p. 5, partim.

*Mastodon observus* Leidy, partim, Report U. S. Geological Survey Terrs. I, p. 330, Pl. XXI, 1873.

A lower jaw of this species, lacking the condyles and supporting the second and third true molars, was taken from the bluff in Crosby County, Texas, from the same excavation that yielded the *Plianchenia spatula* Cope, and within fifty feet of that at which the tooth of the *Dibelodon praecursor* was obtained. It came into possession of Mr. M. M. Cox, of Estacado, from whom I obtained it by purchase after my return from Texas. The acquisition of this specimen is important as enabling me to determine the true characters of the species. Besides the last inferior molar, Leidy has referred to it provisionally a fragment of a tusk, which, like the molar, came from California.

The second true molars are much worn, but they show, as was to have been expected from the character of the third molar, only three cross-crests without a rudimental fourth. The third true molar exhibits exactly the simple characters of the typical specimen described by Leidy; that is, it has four well separated cross-crests, and a very rudimental heel. The external half of each cross-crest wears into a trefoil, while the internal half is simple and undivided, and is a little anterior in position to the external half. The tooth continues its width posteriorly, so that the transverse diameters at the first and fourth cross-crests are equal. A marked character of the species is the elevation of the anterior part of the ramus and the decurvature of the symphysis, from which it results that the superior face of the symphysis, or the spout, descends very steeply to its extremity from the second true molar quite as in the proximal part of the spout of *Dinotherium*. It has a very short horizontal por-

tion anterior to the second true molar to represent the long horizontal production in *Dibelodon tropicus*, *Mastodon americanus*, etc. The symphysis is also much compressed above, so that the spout is narrow. The extremity of the spout is produced and contracted, and slightly recurved at the extremity, and there issues from the right side a well developed, vertically compressed mandibular tusk. On the left side is the empty alveolus of its counterpart, which was of much larger diameters than that of the right side. The portions of superior tusks found in California are stated by Leidy to possess an enamel band. As there are mandibular tusks, I refer the species to *Tetrabelodon* rather than to *Dibelodon* as heretofore.

The contracted symphysis steeply descending forward and expanding downward at the base from a posterior elevation, distinguishes this species from any of those of the genera *Tetrabelodon*, *Dibelodon* or *Mastodon* known to me. Hence there is no question of its difference from *T. productus* Cope, with which it was identified by Leidy,<sup>1</sup> where the symphysis is flat and much longer. In *Dibelodon cordillerarum*, according to D'Orbigny and Burmeister, the symphysis is not elevated behind, is produced and decurved at the extremity, and has a wide spout—all characters quite different from what is seen in *T. shepardii*. The symphysis is totally distinct in *D. tropicus*, where it is toothless and not decurved, and the last true molar is much more complex in the latter. I formerly identified the species so abundant in the Equus Beds of the valley of Mexico with this species. This determination must now be reconsidered, since the form of the mandibular symphysis is entirely different; there is no mandibular tusk, and the last lower molar is not identical in form,<sup>2</sup> though I formerly thought it not so different as to preclude the possibility of the species being identical did no other differences exist. The differences observed in this tooth may, however, be of specific value. The relative width of the crown is greater, especially anteriorly, and the lateral borders of the latter are not parallel, as in *T. shepardii*, but converge posteriorly, as in *M. praeursor*. The lobes of the cross-crests are opposite, as in the latter species. From *M. praeursor* this tooth differs in the more tubercular and less crest-like character of the cross-crests, and in their more profound division on the median line, especially in the third and fourth crests. *M. praeursor* is zygo-

---

<sup>1</sup> By reference to it of specimens of *T. productus* from Santa Fe, New Mexico, in Report U. S. Geol. Surv. Terrs. I, 1873, p. 5.

<sup>2</sup> Proceeds. Am. Philos. Soc., 1884, p. 5.



phodont, while the Mexican species is bunolophodont. The various characters just mentioned also distinguish *M. praecursor* from *T. shepardii*. There is no evidence that the Mexican species possesses an enamel band on the superior incisors. My assertion to this effect was based on a specimen which presents this character which is preserved in the Esquela das Minas of Mexico. This specimen came from Tehuichila, in the State of Vera Cruz, from a formation which I subsequently determined to be of Loup Fork age, so that the identity of the species with that found in the Equus beds of the valley of Mexico is highly improbable. I therefore refer the latter to the genus *Mastodon* under the specific name of *M. oligobunis* Cope. It differs from *Dibelodon tropicus* in the smaller number of cross-crests of the last molar, and their greater simplicity, since they are not divided at all, and the external halves of the first and second only have anterior and posterior buttresses, in some of the individuals at least.<sup>3</sup>

*Measurements of T. shepardii.*

	M M.
Length of right ramus and symphysis.....	730
Length of right ramus to symphysis.....	515
Depth of ramus at posterior end of M. iii.....	135
Depth of ramus at anterior end of M. ii.....	175
Width across both rami at posterior end of M. iii.....	420
Width of right ramus at posterior end of M. iii.....	140
Width of both rami at base of symphysis .....	214
Width of spout at proximal end.....	65
Width of distal extremity of symphysis.....	120
Length of spout.. .....	215
Diameters of M. ii { anteroposterior.....	125
{ transverse at middle.....	75
Diameters of M. iii { anteroposterior.....	164
{ transverse at middle.....	75
Diameters of right symphyseal tusk { vertical.....	68
{ transverse.....	27
Diameters left symphyseal alveolus { vertical.....	78
{ transverse .....	45

<sup>3</sup> A figure of this tooth is given by Felix in *Paleontographica*, Vol. xxxvii, pl. 30, 1891.

**THIS PAGE IS LOCKED TO FREE MEMBERS**

Purchase full membership to immediately unlock this page

# DELVE INTO FANTASY, MAGIC, MYTHOLOGY & FOLKLORE

Forgotten Books'  
Full Membership gives  
access to 797,885 ancient  
and modern, fiction and  
non-fiction books.

**Continue**

\*Fair usage policy applies

Bay, and Godthaab, the capital of the Southern Inspectorate of South Greenland.

Dr. Burk's collections were made at Godhavn, Upernavik, Duck Islands, Cape York and McCormick Bay.

The range of territory covered by the writer and Dr. Burk, therefore, was between about latitude  $63^{\circ}$  and above  $78^{\circ}$  or between Godthaab and Littleton Island.

In the catalogue prepared, a copy of which with remarks is appended, those which were collected only by Dr. Burk are so stated, as also are those collected only by the writer. As nearly the whole collection was repeated by each collector, it may be taken as a fairly complete flora of that portion of the territory of Greenland.

Before starting in their respective journeys, both Dr. Burk and the writer were instructed to examine as far as possible the influence of ice sheets on the geographical distribution of plants. Professor Thomas Meehan, the father of the latter, in a "Catalogue of Plants collected in July, 1883, during an Excursion along the Pacific Coast in Southeastern Alaska"<sup>1</sup> had given reasons for believing that plants did not merely advance in the wake of retreating glaciers, or push into growth from material brought down in their advance, but that when caught under the mass of flowing ice, would remain for an indefinite period, retaining vitality, and push again into growth when the ice retreated. Professor Meehan was led to this conclusion from finding no annual plants among those collected in the immediate wake of retreating glaciers in Alaska, while the actual number of species of perennials collected in such locations would be as great as if much time had been given for a floral advance. He had but little opportunity for actual observation as to the plants brought down with the earth carried on the ice, but so far as this went only *Epilobium latifolium* and *Dryas octopetala* were found in this condition, and scarcely any plants were observed on recently deposited moraines. These and some other facts led to the hypothesis that the plants were not migratory, but had held their position through the whole icy period.

The writer believes he has added to these facts by the determination of the existence of much the same flora in isolated spots of land recently bared by the névé of the inland ice, as grow away from the margins of the ice sheet, while the finding of living willow trunks, grass and perennial plants of many years growth close to the edges.

---

<sup>1</sup> Proceedings of the Academy of Natural Sciences of Philada., 1884.

of retreating glaciers, seem to place the point beyond any reasonable doubt, especially when after careful survey, through the construction and positions of the glaciers, there was the absolute certainty that the plants could not have been deposited by lateral, medial or terminal moraines, though they might have been by ground moraines,—a circumstance which would settle Professor Meehan's position affirmatively beyond dispute, since the ground moraines are borne under the flowing ice rivers. Abundant vegetation was also found in nunataks,—peaks of land projecting above the glaciers or ice cap,—but little significance was placed on this circumstance since all such nunataks visited were within a reasonably close proximity to the main land masses, and the vegetation might readily have sprung from seeds blown there by the winds or brought by mud on the feet of birds. But the demonstration of aged living plants in the other situations named must have a strong bearing on the discussions involved as to the influence of the ice age on the distribution of plants over the surface of the earth.

The abundance of lichens is characteristic of the flora of Greenland. Rocks supposed from a distance to be naturally colored are found on closer inspection to derive their hue from a complete investiture of some lichen. In this particular the crimson cliffs, beginning at Cape York and extending many miles northward, are a conspicuous example. These cliffs, rising sheer from the water's edge to heights of from seventeen hundred to two thousand feet or more, though of gray granite, show no spot of the intrinsic color even on being nearly approached, but present a uniform red appearance over their whole surface from a large orange red lichen which covers them.

In view of Schwendener's theory that lichens are but symbiotic forms of algæ and fungi, it is to be regretted that the probably rich fields afforded by the latter named great families in this region have yet to be investigated.

Mosses are even more abundant than lichens. They grow in such vast quantities in spots, that their light or dark greens are visible often for some miles away, brightening the otherwise bleak shores wonderfully. Their persistence in growth under apparently adverse circumstances is also remarkable. No obstacle save the sea seems sufficient to stop their progress. Even dead glaciers have been and are being buried under the steady march of these cryptogamous plants. Mosses fulfil the same duty in Greenland that other forms

of plant life perform in more favored climes, and the amount of rich vegetable matter being deposited by them may be of great value in the future to that great arctic island.

The Academy is indebted to Mr. Stewardson Brown, Corresponding Secretary of its Botanical Section, for the determination of the flowering plants; to Dr. John W. Eckfeldt for the determination of the lichens, while for the naming of the mosses the Academy is indebted to the kindness of Mrs. N. L. Britton of New York, whose knowledge of this department of botany is conceded to be pre-eminent.

**Ranunculus Lapponicus L.**

Dr. Burk.

**Ranunculus nivalis L.**

Etah, in great abundance, and with great vigor, a point characteristic of the vegetation about this ancient Esquimo settlement.

**Ranunculus pygmæus Wahl.**

Apparently confined to swampy places.

**Papaver nudicaule L.**

Common everywhere in Greenland. A remarkably variable plant. On the table land, back of McCormick Bay (Prudhoe Land) a white flowered form is somewhat common; it has a more compact habit and smaller flowers than the yellow or more prevalent form. On Wostenholm Island, the compactness of growth is particularly marked. The number of petals varies, and the margins are not unfrequently fimbriate. In the vicinity of Disco the peduncles are hairy. At Upernavik forms with hairy and smooth peduncles grow together.

**Cheiranthus pygmæus Adams.**

Dr. Burk.

**Arabis alpina L.**

Found only on Disco Island—only two specimens on soggy ground, one in flower the other in fruit.

**Cardamine pratensis var. alpina L.**

Not in Dr. Burk's collections, and a single specimen only gathered in wet ground on Disco Island.

**Vesicaria arctica Rich.**

Inglefield Gulf in dry places between rocks, in fruit middle of August.

**THIS PAGE IS LOCKED TO FREE MEMBERS**

Purchase full membership to immediately unlock this page

# Know Your Bible

Forgotten Books' Full Membership provides unlimited access to more than 28,000 volumes of Christian literature for \$8.99/month

**HOLY BIBLE**

**Continue**

\*Fair use policy applies

*Potentilla emarginata* Pursh.

Wostenholm Island, Upernavik, and on the Nunatak in the Verhoeff glacier.

*Potentilla nivea* L.

Dr. Burk.

*Potentilla pulchella* R. Br.

Disco.

*Potentilla maculata* Pourr.

Disco, not in Dr. Burk's collection.

*Potentilla tridentata* Ait.

Godthaab, and as far North as Disco.

*Dryas octopetala* L.

Next to *Papaver* perhaps the commonest flower of Greenland. Sometimes in clumps of a foot across, with sometimes a hundred flowers open at once. Also on the Verhoeff Nunatak.

*Alchemilla vulgaris* L.

Varying in size. At Disco preferring wet places.

*Saxifraga cæspitosa* L.

*Saxifraga cernua* L.

Disco. On the Verhoeff Nunatak.

*Saxifraga flagellaris* Willd.

McCormick Bay. Appears to be rare. I only found a few plants here, and only one specimen was seen by Dr. Burk, and that in the same locality.

*Saxifraga oppositifolia* Willd.

Growing in great masses, and giving great beauty to the rocks about the "Redcliff House," Lieutenant Peary's winter quarters.

*Saxifraga nivalis* L.

Disco.

*Saxifraga rivularis* L.

Above Meville Bay, not half the size of those at Disco.

*Saxifraga tricuspidata* Retz.

Common everywhere. On the Verhoeff Nunatak.

*Saxifraga azoides* L.

Wostenholm Island and McCormick Bay, not in Dr. Burk's collection.

**Saxifraga stellaris** L.

Not in Dr. Burk's collection, but not rare at Disco. Much larger than specimens from Point Barrow, on the Northwest Pacific coast.

**Sedum Rhodiola** D. C.

Rocks at Godthaab.

**Cornus canadensis** L.

Godthaab specimen not collected though observed by me.

**Epilobium angustifolium** L.

Not collected by Dr. Burk.

**Epilobium latifolium** L.

Found on cliffs close up to the ice cap.

**Erigeron alpinus** L.

Found only by Dr. Burk.

**Erigeron compositus** Pursh.

Inglefield Gulf. It is interesting to note that while the plants of Greenland vary much according to location, these are exactly like Rocky Mountain specimens, and specimens of Nuttall from Walla Walla on the Columbia River.

**Matricaria inodora** L.

This indomitable traveler has gained a foot-hold in Disco. Soil was brought from Denmark for the Inspector's garden, and the seed probably came in that way.

**Antennaria alpina** Gærtn.

Varying in no degree from those in American alpine heights.

**Artemisia borealis** Pall.

Disco. Not in the collection of Dr. Burk.

**Arnica alpina** Olin.

In great abundance on the Verhøeff Nunatak.

**Taraxacum officinale** Web.

The *lividum* form common at Disco.

**Campanula uniflora** L.

Disco.

**Campanula rotundifolia** L.

Disco. Nearly always with a single large flower on the scape.



**Vaccinium uliginosum L.**

Some of the plants have the leaves colored with rose. These are always sterile; only the fully green-leaved plants produce berries. These are gathered and prepared for food by the Esquimos. To us the berries seemed tasteless.

**Rhododendron Lapponicum Wahl.**

Collected by Dr. Burk. I did not meet with it in flower, but a specimen was among some given me by the Inspector at Disco.

**Bryanthus taxifolius Gr.****Cassiope hypnoides Don.**

Almost everywhere where the ground was dry.

**Cassiope tetragona Don.**

Only in dry places. Emitting a delightful odor, like that of a Lily of the Valley; overhanging rocks in long spreading masses; collected and preserved for fuel by the North and South Greenland Esquimos.

**Ledum palustre L.**

“Labrador tea” and used as tea by the South Greenland Esquimos.

**Pyrola rotundifolia var. pumila L.****Diapensia Lapponica L.**

Disco.

**Armeria vulgaris L.**

Disco.

**Mertensia maritima Don.**

Sea Beach at Disco.

**Veronica alpina L.**

Disco.

**Bartsia alpina L.**

Disco.

**Pedicularis capitata Adams.**

Disco.

**Pedicularis flammea L.**

Disco. Found only by myself.

**Pedicularis hirsuta L.**

McCormick Bay. Variable. Now growing to a foot high and branching, and now but an inch or two high, with a simple stem.

**THIS PAGE IS LOCKED TO FREE MEMBERS**

Purchase full membership to immediately unlock this page

# DELVE INTO FANTASY, MAGIC, MYTHOLOGY & FOLKLORE

Forgotten Books'  
Full Membership gives  
access to 797,885 ancient  
and modern, fiction and  
non-fiction books.

**Continue**

\*Fair usage policy applies

*Empetrum nigrum* L.

The Eskimos are very fond of the fruit. Women and children go out to gather it, as they would blackberries or strawberries with us. I was told that at Disco and Godthaab the natives make preserves of it. It is kept for fuel.

*Tofieldia palustris* Hudson.

Disco.

*Luzula arcuata* Mey.

*Luzula spadicea* D. C.

Disco. Not in Dr. Burk's collection.

*Eriophorum polystachyon* L. var. *latifolium*.

Called by the natives Ewickswa—"Rabbits-foot grass." Used by the Eskimos as punk or tinder. It is first ignited by a spark, and then blown into a flame on dry moss. It grows in vast quantities in low wet places. From Melville Bay south it reaches a foot high,—but only about six inches above that point.

*Scirpus cæspitosus* L.

Dr. Burk.

*Carex vulgaris* Fr. var. *hyperborea*.

*Carex atrata* Boott.

Not in Dr. Burk's collection. Specimens in the Herbarium of the Academy collected in latitude 81°, 82° by Dr. Emil Bessels of the ill-fated Polaris expedition are barely 2 inches high. These from McCormick Bay are about one foot.

*Kobesia scirpina* Willd.

Dry places, McCormick Bay. Plants remarkably stout and stocky, but culms scarcely reaching three inches high.

*Hierochloë alpina* R. & S.

McCormick Bay. Making a close herbage nearly one foot high.

*Alopecurus alpinus* L.

This seems to be the prevailing grass around Eskimo settlements. It grows in such wild luxuriance, with herbage a foot in height, and of such a vivid green that it can be seen for two or three miles from the shore. Some of my specimens were 18 inches in length. At Godthaab hay is made from it.

*Poa alpina* L.

Near Disco it grows from 18 inches to 2 feet high, but the leaves are comparatively short.

*Poa arctica* R. Br.

*Poa nemoralis* L.

Upernavik.

*Poa pratensis* L. .

Not in Dr. Burk's collection. Abundant in McCormick Bay. At Disco it makes culms 18 inches to 2 feet.

*Trisetum sesquiflorum* Trin.

Collected only by myself. McCormick Bay.

*Glyceria fluitans*.

Only by Dr. Burk.

*Festuca ovina* L. var. *brevifolia*.

*Festuca ovina* var. *vivipara*.

At Godthaab, but growing only about six inches high.

*Arctagrostis latifolia* Griesb.

*Elymus mollis* Trin.

Disco. Not in Dr. Burk's collection. At Atanekerdlut, reaching three or four feet high along the Sea Beach.

*Equisetum arvense* Lin.

*Equisetum variegatum*.

Dr. Burk.

*Woodsia ilvensis* Br.

Disco. In crevices of rocks.

*Cystopteris fragilis* Bernh.

Disco. About 12 inch fronds, in crevices of rocks. Not in Dr. Burk's collection.

*Nephrodium spinulosum* Mul.

Crevices of Rocks at Godthaab. Among the few things cultivated by the Danes at Godthaab. Not in Dr. Burk's collection.

*Lycopodium annotinum* L.

Disco, reaching close to the edge of the ice cap.

*Lycopodium Selago*.

Disco, reaching about two inches high.

#### LICHENS.

The collection has been kindly determined by Dr. John M. Eckfeldt. Those marked \* were also collected in the first expedition by Dr. Burk. † Collected only by Dr. Burk.

The profusion of Lichens strikes the visitor to Greenland at once on reaching its shores. Many species seem to have preferences for peculiar situations, and give the rocks when at some distance the appearance of being variously colored.

- |   |  |
|---|--|
| * <i>Cetraria nivalis</i> (L.) Ach.       | <i>Solomia crocea</i> (L.) Ach.                      |
| † <i>Cetraria Islandica</i> .             | † <i>Pannaria hypnorum</i> (Hoff.) Kolb.             |
| <i>Cetraria cucullata</i> (Bill.) Ach.    | <i>Collema melænum</i> Ach.                          |
| * <i>Alectoria ochroleuca</i> Nyl.        | McCormick Bay.                                       |
| var. <i>rigida</i> Fr.                    | <i>Placodium vitellinum</i> Ehrh.                    |
| <i>Theloschistes lychnus</i> Nyl.         | McCormick Bay.                                       |
| <i>Parmelia saxatilis</i> (L.) Fr.        | <i>Placodium elegans</i> Link.                       |
| McCormick Bay.                            | McCormick Bay.                                       |
| <i>Parmelia conspersa</i> (L.) Wallr.     | <i>Lecanora lentigera</i> (Webb.) Ach.               |
| McCormick Bay.                            | McCormick Bay.                                       |
| <i>Parmelia lanata</i> (L.) Wallr.        | <i>Lecanora ventosa</i> (L.) Ach.                    |
| McCormick Bay.                            | <i>Rinodina sophodes</i> (Ach.) Nyl.                 |
| <i>Parmelia incana</i> (Pers.) Fr.        | <i>Pertusaria coriacea</i> (Th.) Fr.                 |
| McCormick Bay.                            | † <i>Pertusaria paradoxa</i> Lindb.                  |
| <i>Physcia pulverulenta</i> Schreb.       | <i>Gyalecta peziza</i> Mont.                         |
| McCormick Bay.                            | † <i>Stereocaulon alpinum</i> Lam.                   |
| <i>Umbilicaria proboscidea</i> (L.) Stin. | <i>Cladonia pyxidata</i> (L.) Fr.                    |
| McCormick Bay.                            | <i>Cladonia gracilis</i> (L.) Nyl.                   |
| <i>Umbilicaria rugifera</i> Nyl.          | var. <i>elongata</i> , forma <i>macroceris</i> Tuck. |
| McCormick Bay.                            | <i>Cladonia deformis</i> (L.) Hoff.                  |
| * <i>Umbilicaria hyperborea</i> Hoff.     | <i>Lecidia platycarpa</i> Ach.                       |
| McCormick Bay.                            | McCormick Bay.                                       |
| <i>Umbilicaria anthracoria</i> Wulf.      | <i>Buellia geographica</i> (L.) Tuck.                |
| McCormick Bay.                            | McCormick Bay.                                       |
| <i>Nephroma arctica</i> (L.) Fr.          | <i>Sphærophorus globiferus</i> (L.) D. C.            |
| McCormick Bay.                            | McCormick Bay.                                       |
| † <i>Peltigera canina</i> (L.) Hoffm.     | <i>Coniocybe furfuracea</i> L.                       |
| † <i>Peltigera aphthosa</i> L.            | <i>Verrucaria pygmæa</i> Koelt.                      |
| <i>Solomia saccata</i> (L.) Ach.          | Parasitic on <i>Cladonia gracilis</i> .              |
|   | <i>Thamnolia vermicularis</i> (Sw.) Ach.             |

**THIS PAGE IS LOCKED TO FREE MEMBERS**

Purchase full membership to immediately unlock this page

# Know Your Bible

Forgotten Books' Full Membership provides unlimited access to more than 28,000 volumes of Christian literature for \$8.99/month

**HOLY BIBLE**

**Continue**

\*Fair use policy applies

## MAY 2.

The President, GENERAL ISAAC J. WISTAR, in the chair.

Fifty persons present.

A paper entitled "Observations on the Japanese Salamander, *Cryptobranchus maximus* (Schlegel)" by Henry C. Chapman, M. D., was presented for publication.

---

MAY 9.

The President, GENERAL ISAAC J. WISTAR, in the chair.

Forty-seven persons present.

Papers under the following titles were presented for publication:—

"Observations on Vallonia," by Dr. V. Sterki.

"Some new and little-known Palæozoic and Jurassic Fishes," by Edw. D. Cope.

The death of J. GIBBONS HUNT, M. D. on the 29th ult., having been announced at the last meeting the following minute submitted by a committee appointed for the purpose was unanimously adopted:—

*Resolved*, That the members of this Academy have learned with profound sorrow of the death of their late associate, PROFESSOR J. GIBBONS HUNT, M. D., who, as one of the founders of the Biological and Microscopical Section of the Academy and the first Professor appointed by the Academy under its by-laws, as amended a few years since, to the Chair of Histology and Microscopical Technology, has rendered lasting services to the Society that are held in grateful remembrance by his associates.

That we also give expression to our sense of appreciation of the late Professor Hunt as a pioneer teacher and master in the most refined methods of modern microscopical research, for which, however, owing to his native modesty and reserve, he never received a large share of popular recognition, though known throughout the country to all specialists for the important improvements and discoveries in technique, by means of which he had enlarged the possibilities of a science but little cultivated amongst us when he began his work upward of thirty years ago. That we vividly recall the

power and grace with which he could paint in spoken or written words, the aspects and moods of that world of nature, great and small, in field and forest, that he so dearly loved and enjoyed with all the sincerity and philosophical sobriety of an Emerson. That these traits and his readiness also to offer advice and help to beginners in the fields of animal and vegetable histology (in both of which he was a deservedly recognized authority), his uniform kindness of manner, uprightness and purity of character, have endeared his memory to his fellow-members of the Academy.

*Cretaceous Ammonites and other Fossils near Moorestown, N. J. Their stratigraphic position shown by an Artesian Well Section at Maple Shade, N. J. Incidental reference to Water Horizons.*—LEWIS WOOLMAN stated that during the fall of 1892 there had been placed in his hands for identification by Joseph Walton of Moorestown, N. J., an interesting set of cretaceous fossils collected by him at the clay pits belonging to A. A. Reeve upon the left bank of the north branch of the Pensauken Creek, two miles very slightly south of west from Moorestown station and between Maple Shade and Lenola stations on the Burlington County R. R.

The fossils are mainly in the form of casts, and are remarkably well-preserved in comparison with similar fossils from other localities in the State.

The most noticeable among them are two species of *Ammonites* each about twelve inches in diameter, being considerably larger than any of the same species now in the Academy's collection from the State of New Jersey, though there are in the Museum two individuals of one of the forms from the Delaware and Chesapeake Canal that measure respectively 16 and 18 inches across.

The number of species collected by Joseph Walton numbered twenty-three, all mollusks except one—an *Echinus*.

More recently visits to the locality have been made by C. W. Johnson with a class from the Wagner Institute, by Prof. A. Heilprin with the Academy's Geological Class and by the speaker accompanied by Professors Smock and Salisbury.

These parties collectively obtained not only all the molluskan forms found by Joseph Walton but also forty-two additional ones mostly of the smaller forms. This makes the total number of species of mollusks sixty-four.

There were also found fish remains consisting of teeth belonging to the genus *Pycnodus*, and also undeterminable fragments of bones and portions of crab's claws together with considerable lignite. The latter was in some cases much bored by the *Teredo* and the cavities frequently lined with minute crystals of iron pyrites. A number of specimens of *Martesia cretacea* showing the shell were also found in burrows they had themselves made in the wood.



Through the courtesy of several members of the two classes a considerable number of the specimens they procured were submitted for examination. These together with those previously collected were carefully compared by H. A. Pilsbry and the speaker with the figures and text of Whitfield's Paleontology of New Jersey and with the works of other authorities, and also with the types and other specimens in the Museum of the Academy.

One form, *Voluta delawarensis*, was identified by Professor R. P. Whitfield. Professor A. Heilprin kindly assisted in the final determination of a few forms. In nomenclature we have followed Whitfield, to whose work the specialist is referred for synonyms and references to other literature. For convenience the volume, page, plate and figure where each is described and illustrated are noted. The list is as follows:

### CEPHALOPODA.

*Ammonites (Placentaceras) placenta* DeKay.<sup>1</sup> Vol. II, page 255 pl. XL, fig. 1, XLI, figs. 1 and 2.

*Ammonites delawarensis* Morton. Vol. II, page 252, pl. XLII, figs. 6 to 9.

*Scaphites hippocrepis* DeKay. Vol. II, page 262, pl. XLIV, figs. 8 to 12.

*Scaphites nodosus* Owen. Vol. II, page 261, pl. XLIV, figs. 13 and 14.

*Baculites ovatus* Say. Vol. II, page 275, pl. XLVI, figs. 3 to 9.

### GASTEROPODA.

*Cerithium (Potamides?)* Sp.?

*Dentalium subarcuatum* Conrad, internal casts. Vol. II, page 166, pl. XX, figs. 19 and 20.

*Dentalium subarcuatum* Conrad, external impression. Vol. II, page 166, pl. XX, figs. 21 to 24.

*Alaria rostrata* Gabb, (numerous). Vol. II, page 119, pl. XIV, figs. 5 and 6.

*Gyrodes infracarinata* Gabb. Vol. II, page 125, pl. XV, figs. 13 to 16.

*Lunatia halli* Gabb. Vol. II, page 130, pl. XVI, figs. 13 to 16.

*Natica abyssina* Morton. Vol. II, page 123, pl. XV, fig. 9 to 12.

*Turbinella parva* Gabb. Vol. II, page 80, pl. IX, figs. 4 to 6.

*Turritella vertebroides* Morton (?). Vol. II, page 146, pl. XVIII, figs. 13 to 18.

*Voluta (?) delawarensis* Gabb. Vol. II, page 84, pl. X, figs. 5 to 7.

*Volutoderma abbotii* Gabb. Vol. II, page 173, pl. XXI, figs. 4 to 9.

*Volutomorpha*—Sp.?

*Avellana bullata* Morton. Vol. II, page 163, pl. XX, figs. 1 to 4.

<sup>1</sup> The references are to Whitfield's Palæontology of New Jersey.

**THIS PAGE IS LOCKED TO FREE MEMBERS**

Purchase full membership to immediately unlock this page

# DELVE INTO FANTASY, MAGIC, MYTHOLOGY & FOLKLORE

Forgotten Books'  
Full Membership gives  
access to 797,885 ancient  
and modern, fiction and  
non-fiction books.

**Continue**

\*Fair usage policy applies

- Pinna laqueata* Conrad. Vol. I, page 81, pl. XVI, figs. 1 and 2.  
*Pholadomya occidentalis* Morton. Vol. I, page 175, pl. XXIV, figs. 1 to 3.  
*Plicatula urtica* Morton. Vol. I, page 61, pl. IX, figs. 1 and 2.  
*Tenea pinguis* Conrad. Vol. I, page 163, pl. XXII, figs. 1 to 3.  
*Anomia tellinoides* Morton. Vol. I, page 43, pl. IV, figs. 12 and 13.  
*Axinea mortoni* Conrad. Vol. I, page 99, pl. XI, figs. 23 to 25.  
*Aphrodina tippana* Conrad. Vol. I, page 154, pl. XXII, figs. 6 and 7.  
*Cyprimeria densata* Conrad. Vol. I, page 157, pl. XXII, figs. 19 to 21.  
*Clavagella armata* Morton. Vol. I, page 192, pl. XXV, fig. 24.  
*Exogyra costata* Say. Vol. I, page 39, pl. VI, figs. 1 and 2.  
*Idonearca vulgaris* Morton. Vol. I, page 98, pl. XIII, figs. 1 to 5.  
*Mytilus oblivius* Whitfield. Vol. I, page 64, pl. XVII, fig. 1.  
*Martesia cretacea* Gabb. Vol. I, page 190, pl. XXV, figs. 20 to 23.  
*Panopea decisa* Conrad. Vol. I, page 181, pl. XXIV, figs. 5 to 8.  
*Trigonia mortoni* Whitfield. Vol. I, p. 112, pl. XIV, figs. 5 and 6.  
*Teredo irregularis* Gabb. Vol. I, page 191, pl. XXV, figs. 18 and 19.  
*Teredo tibialis* Morton. Vol. I, page 201, pl. XXVI, figs. 19 to 22.  
*Veniella conradi* Morton. Vol. I, page 144, pl. XIX, figs. 8 to 10.

Included in the total number of molluscan species as above stated, and therefore to be added to this list, are two forms of Gasteropoda pronounced by Prof. R. P. Whitfield to be new to the New Jersey fauna; one of these, in a preliminary note received, he inclines to regard as a *Volutoderma* and the other he states is probably a *Cerithium* and much resembles *C. conradi* Whitfield,<sup>2</sup> the type of which came from the cretaceous of Syria. These forms have been again referred to him for further detailed description.

## ECHINODERMATA.

- Hemiaster parastatus* Morton. Morton's Cretaceous Fossils, page 77, pl. III, fig. 21.

It may here be noted that one specimen of *Ammonites delawarensis* has the outer whorls on one side broken off so as to show the inner whorl. This initial whorl is identical in sculpturing with Morton's figure of *A. vanuxemi* which was doubtless named by him

<sup>2</sup> See Bulletin New York Museum of Natural History, Vol. III, No. 2, page 428, pl. IX, figs. 11 and 12.

either from imperfect or from young specimens. This double naming of what is really one species has been noted by other writers.

Respecting *Dentalium subarcuatum* above listed numerous casts occur that have generally been referred to that species. Most such casts were obtained in nearly straight short fragments. Examples, however, were noted in the specimens under study that were from four to five inches long, more or less bent and irregular in some parts of their length, while quite straight in other parts. This irregularity suggests that instead of belonging to the genus *Dentalium* they may very probably represent casts made by the filling in of the borings of some worm. This idea was suggested by Professor A. Heilprin. These remarks do not, however, refer to the external impressions listed as *Dentalium* which undoubtedly belong to that genus.

Most of the fossils occur in a bed of black sand about three feet thick, interbedded between two clay beds, the lower one a thick bed of black clay somewhat micaceous, and the upper one composed of two divisions, as follows: that next the black sand, a ferruginous clay with ironstone crusts, and the one above this, a soft, yellow clay. Over these are the superficial or yellow gravels. A few fossils however are found both above and below the black sand but not in the gravels.

The yellow and the black clays are used for making bricks. The black clay has been dug into or otherwise tested at the pits to the depth of about 25 feet without getting through it. Its entire thickness has, however, been ascertained to be 44 feet from a well-boring recently made at Maple Shade, one mile west.

The relative position of the fossiliferous horizon is shown in the following section, which gives the thickness of strata as ascertained at Reeve's clay-bank, and at the well as learned from a record furnished by those interested in its boring.

Surface gravel .....	5 ft.	
Yellow clay.....	8 ft.	13 ft.
Ferriferous clay and ironstone crust.....	4 ft.	17 ft.
Fossiliferous black sand, containing Ammonites, Scaphites, Baculites and other Mollusks.....	3 ft.	20 ft.
Black clay.....	44 ft.	64 ft.
(A) Fine and coarse gray sands at the top, changing to medium and then to coarse and pebbly gravels at the bottom.....	33 ft.	97 ft.
Green sand marl.....	6 ft.	103 ft.
(B) Fine, gray sand and coarse gravel, similar to A.....	27 ft.	130 ft.
White clay.....	100 ft.	230 ft.
Red clay.....	10 ft.	240 ft.
Alternations of sand and clay, sometimes reddish.....	20 ft.	260 ft.

(C) White sand.....	40 ft.	300 ft.
White sand, fine, with streaks of clay.....	15 ft.	315 ft.
White sand, coarse.....	15 ft.	330 ft.
White sand, medium coarse.....	20 ft.	350 ft.
White gravel, coarse.....	10 ft.	360 ft.
White gravel, coarser.....	10 ft.	370 ft.
(D) White gravel very coarse, with large pebbles and boulders.....	5 ft.	375 ft.

The sands and gravels marked A, B, C and D, all furnish water, and may be regarded as water horizons; that marked A being the one reached by wells dug in this neighborhood and which penetrate through the black clay.

Excepting the few feet of surface gravels which are of more recent date, it may be premised that all the beds in the section are below the lower green sand marl bed, since they are west of the outcrops of the same, as mapped by the New Jersey Geological Survey. In the report of the survey for 1868, Professor G. H. Cook describes next below the lower green sand a series of beds of "clay marls," with an estimated thickness of 277 feet, of which the upper 170 feet, he states, is composed of laminated sands and thin clay seams, and the lower 170 feet of heavy, dark clays and green sands.

These "clay marls," in turn, rest upon another group of strata, composed largely of white, yellow and red clays, termed plastic clays, and which form the base of the cretaceous as it exists in New Jersey.

These plastic clays have a thickness, as shown in the report on clays (N. J. Survey, 1868), of 347 feet. The plastic clays can be distinguished from the "clay marls" by the entire absence of green sand grains in them.

Referring to the section, it may be noticed that beneath the black clays there are 66 feet of fine and coarse sand and medium, coarse and heavy gravels, including a parting near the middle six feet thick, largely composed of green sand. The presence of the green sand would seem to class these gravels with the laminated sands and clay marls, rather than with the plastic clays. The division between these two groups therefore occurs at the depth of 130 feet. Allowing five feet for the surface gravels, we have 125 feet as the thickness at this locality of the lower or dark clay and green sand division of the group of laminated sands and "clay marls." The thickness of the overlying gravel is, however, probably greater than five feet upon the more elevated portions of this region, so that a greater depth would have to be gone through in some places to reach the yellow and black clays of the clay marl series.

*Remarks on Hawaiian Crania.*—DR. C. N. PEIRCE remarked that Dr. I. M. Whitney of Honolulu, S. I., to whom the Academy is indebted for the collection of crania presented this evening, had informed him that the ancient Hawaiians had two quite distinct

**THIS PAGE IS LOCKED TO FREE MEMBERS**

Purchase full membership to immediately unlock this page

# Know Your Bible

Forgotten Books' Full Membership provides unlimited access to more than 28,000 volumes of Christian literature for \$8.99/month

**HOLY BIBLE**

**Continue**

\*Fair use policy applies

MAY 16.

The President, GENERAL ISAAC J. WISTAR, in the chair.

Fifty-four persons present.

REV. F. C. MORSELL, in connection with the meeting of the Biological and Microscopical Section, made an illustrated communication on polarized light under the title "Taking a Sunbeam apart," (No abstract.)

---

MAY 23.

The President, GENERAL ISAAC J. WISTAR, in the chair.

Forty persons present.

---

MAY 30.

The President, GENERAL ISAAC J. WISTAR, in the chair.

Twenty-three persons present.

The deaths were announced of Edward Bancroft, a member, May 22, 1893, and of Dr. Robert Hartmann a Correspondent, April 21, 1893.

Papers under the following titles were presented for publication:—

"Descriptions of two new species of North American Bombycidæ" by Herman Strecker.

"The Measurement of the Radius of Curvature of the Cornea by means of the Helmholtz Ophthalmometer," by Henry C. Chapman, M. D.

Morris L. Orum and Ernest B. Sangree, M. D., were elected members.

Otto Staudinger of Dresden, Germany and F. Ducane Godman of London, England, were elected Correspondents.

The following were ordered to be published:—

OBSERVATIONS ON THE JAPANESE SALAMANDER, *CRYPTOBRANCHUS MAXIMUS* (Schlegel).

BY HENRY C. CHAPMAN, M. D.

Questions as to what constitute a good or a bad species, whether a species should be elevated to the rank of a genus, or degraded to that of a variety, concerning which naturalists at one time disputed so vehemently, have lost much of their interest in the light of evolution. Indeed, if all the extinct forms of animal life could be reproduced, the gaps now separating living ones would be so bridged over that the species, orders, families, etc., of the systematic zoologist would cease to have any significance whatever.

As an illustration of such conflict of opinion may be cited the difficulty experienced by naturalists in assigning to the great Japanese salamander its proper position in relation to other batrachia, it having been named successively *Salamandra maxima*,<sup>1</sup> *Megalobatrachus sieboldii*,<sup>2</sup> *Sieboldia maxima*,<sup>3</sup> *Cryptobranchus japonicus*,<sup>4</sup> *Megalobatrachus maximus*,<sup>5</sup> and, finally, if the author's interpretation of its organization be accepted, *Cryptobranchus maximus*. Inasmuch as the Japanese salamander is not a salamander, as was supposed by Schlegel, the name *Salamandra* was soon set aside, as it gave an erroneous idea as to the affinities of the animal. Tschudi, regarding the form as sufficiently peculiar in its organization to warrant placing it in a distinct genus, designated it as *Megalobatrachus sieboldii*. Bonaparte, afterwards, wishing to do honor to the distinguished naturalist Siebold, who first introduced the Japanese animal to the notice of Europe, and regarding it also as a distinct genus of batrachia, named it *Sieboldia*. The name *Cryptobranchus* was given as long ago as 1821 by Leuckart<sup>6</sup> to our common Allegheny hell-bender. That animal having been described, however, a few years later by Harlan,<sup>7</sup> first as *Abranchus*, a name soon given up, it having been previously given by Hasselt to a mollusk from Java,

<sup>1</sup> Schlegel, Fauna Japonica, Lugd. Bat. 1838, p. 127, pls. 6-8.

<sup>2</sup> Tschudi, Batrachia, Neuchatel, 1838, p. 96, Taf. viii.

<sup>3</sup> Bonaparte, Fauna Italica, Tomo II, Roma 1832-1841. Sheet 131 \* \* \* see Euproctus.

<sup>4</sup> Van der Hoeven, Proc. Zoo. Soc., London, 1838, p. 25.

<sup>5</sup> Boulenger, Catalogue of the Batrachia Gradientia, London, 1882, p. 80. Cope, The Batrachia of North America, Washington, 1889, p. 37.

<sup>6</sup> Isis von Oken, Jena, 1821, p. 259.

<sup>7</sup> Annals of the Lyceum of Nat. History, New York, 1824, pp. 222, 270.



then as *Menopoma alleghaniensis*, naturalists, at least in this country, in speaking of the hell-bender usually refer to it even now as the *Menopoma*, of course improperly, as the name *Cryptobranchus*, having priority, should be used in preference. Van der Hoeven<sup>8</sup> regarding the so-called Japanese salamander as essentially in its organization nothing but a big hell-bender or *Menopoma*, named it *Cryptobranchus japonicus*, the *Menopoma* of Harlan being then consistently designated as *Cryptobranchus alleghaniensis*, and the name *Menopoma* was set aside.

Boulenger and Cope, high authorities on the subject of the batrachia, regarding, however, as Tschudi and Bonaparte did, the Japanese animal as differing sufficiently from the American hell-bender (*Cryptobranchus* syn. *Menopoma*) to warrant placing it in a distinct genus, have revived in recent times the old name and designate it now *Megalobatrachus maximus*.

In dissecting recently a fine specimen of the Japanese animal, measuring 46 inches in length (115 cent.) which lived for a number of years in the Philadelphia Zoological Garden, the author was much impressed with the similarity of its organization to that of our common hell-bender, of which he has dissected numerous specimens. It may not be superfluous therefore to call attention to such parts of the anatomy of the Japanese batrachian as have not been already described, to those points in which the organization of the Japanese and American forms agree and disagree, finally, as to why, in the judgment of the author, the Japanese batrachian should be regarded as a big hell-bender, a kind of *Cryptobranchus* or *Menopoma*, rather than as a distinct genus *Megalobatrachus*.

The myology, splanchnology and nervous system of the Japanese animal have been described by Goddard, Schmidt and Van der Hoeven.<sup>9</sup> Peculiarities of the hyoid apparatus and of the muscular and nervous systems are incidentally alluded to by Fischer,<sup>10</sup> more particularly in their relation to the corresponding parts in the Perennibranchiata and Derotremata. The osteology and splanchnology are well considered by Hyrtl<sup>11</sup> in his beautifully illustrated mono-

---

<sup>8</sup> Tijdschrift voor Natuurlijke Geschiedenis, 1837-1838, p. 375.

<sup>9</sup> Aanteekenigen over de anatomie van den *Cryptobranchus Japonicus*, Haarlem, 1862.

<sup>10</sup> Anatomische Abhandl. über die Perennibranchiaten und Derotremen, Hamburg, 1864.

<sup>11</sup> *Cryptobranchus Japonicus*, Vindobonae, 1865.

**THIS PAGE IS LOCKED TO FREE MEMBERS**

Purchase full membership to immediately unlock this page

# DELVE INTO FANTASY, MAGIC, MYTHOLOGY & FOLKLORE

Forgotten Books'  
Full Membership gives  
access to 797,885 ancient  
and modern, fiction and  
non-fiction books.

**Continue**

\*Fair usage policy applies

characters. In this connection it should be stated, however, as the previous measurements made differ very considerably, that those of the author, viz.  $\frac{1}{8}$  mm. in the longest and  $\frac{1}{32}$  mm. in the shortest diameter, agree most closely with those of Gulliver. The disposition of the genito-urinary apparatus is essentially the same as that which generally obtains in the male derotrematous batrachia. The form, position and relation of the testicles, their ducts passing into the upper part of the Wolffian bodies, the ducts from the latter passing in turn into the common genito-urinary duct, the openings of the latter and that of the bladder into the cloaca, are so well shown by the representations from nature, Plates VI, VII, and the accompanying diagrammatic figure, Plate VII, fig. 2, that any particular detailed description of the same is unnecessary.

Whatever may be the views of zoologists as to the natural affinities of the Japanese batrachian, there has never been any difference of opinion among anatomists on this point; at least all those who have had the opportunity of dissecting the animal have regarded it as a large *Cryptobranchus* or *Menopoma*, the two animals resembling each other so closely in their organization. Thus, for example, the skull of the American *Menopoma* is a miniature of that of the Japanese form. The hyoid apparatus in both animals consists of the basi-hyal, glosso-hyal and cerato-hyal constituents. The glosso-hyal is, however, sometimes subdivided into two pieces in *Cryptobranchus*, while the cerato-hyals in the Japanese animal differ from the homologous parts in the American one in being usually<sup>17</sup> unsegmented, gristly and joined to the glosso-hyal. While it is true that in the branchial arches of the Japanese form only the first and second pair persist, the remaining two pairs, corresponding to the third and fourth pairs of the American form, disappearing, it will be observed that those pairs which persist in the former agree with the corresponding ones in the latter in that the first pair is unsegmented and that the second pair is segmented and ossified. It should be mentioned in this connection that the first pair of arches in the Japanese animal unite at their inner ends, whereas the corresponding pair in the American animal remain ununited. The uro-hyal bone is, however, absent in both animals.

---

<sup>17</sup> Stannius, Handbuck der Zoötomie, zweiter Theil, Berlin, 1856, S. 64—"Auch Salamandra maxima besitzt drei Bogen: einen vordersten knorpeligen, dessen Seitenschenkel je aus zwei Stücken bestehen."

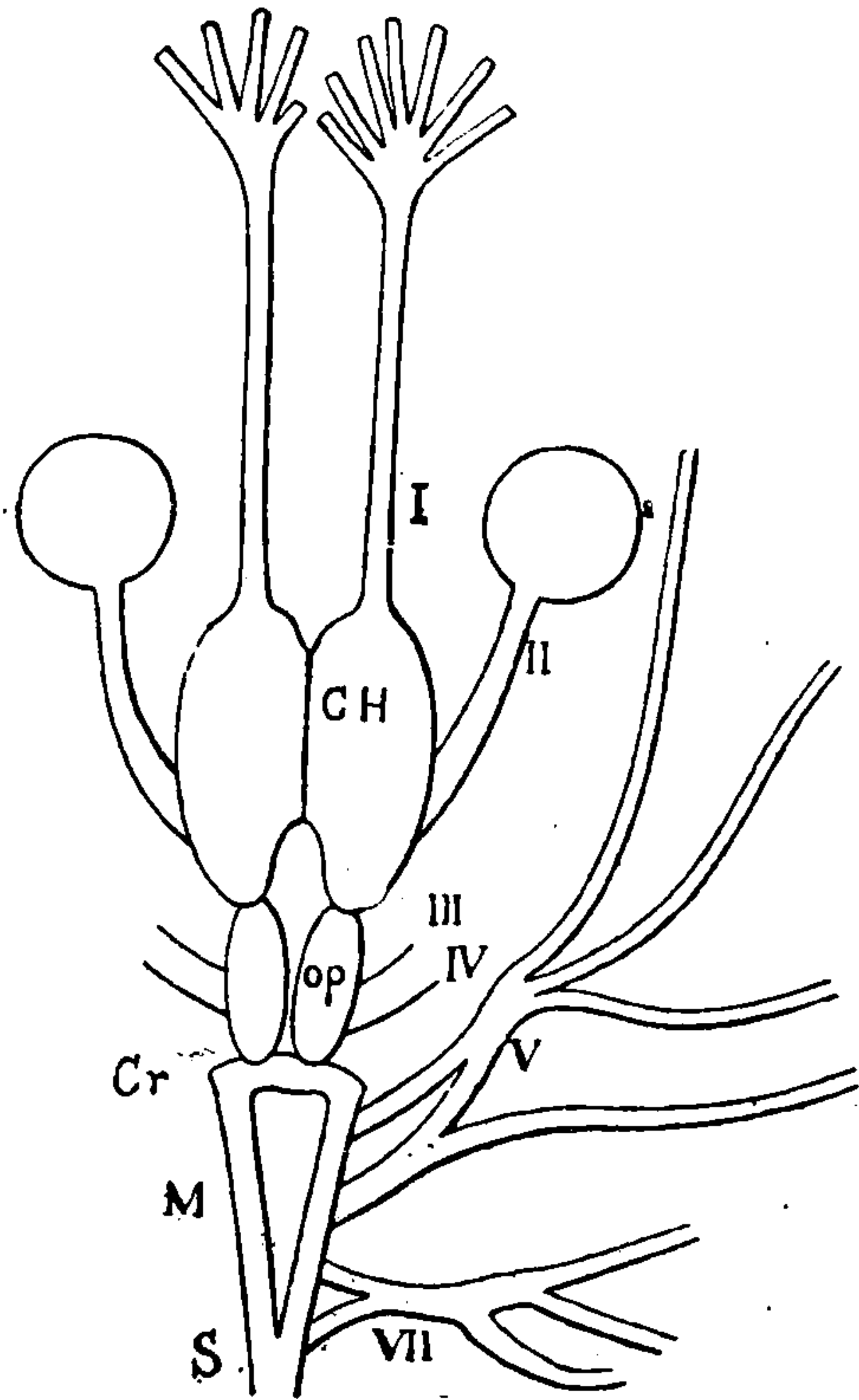

Brain of *Cryptobranchus maximus*.

C H, cerebral hemispheres; op, optic lobes; Cr, cerebellum; M, medulla; S, spinal cord; I, II, III, IV, V, VI, VII, cranial nerves.

Except in the points of disagreement just mentioned, conditioned through the absence of the gill opening, it will be observed that the hyoid apparatus of the Japanese batrachian agrees essentially with that of the American one. The general character of the brain and the manner in which the cranial nerves arise and are distributed, are essentially the same in both batrachians.

As might be expected on account of the similarity in the skeleton of the two animals the disposition of the muscles is essentially the same. Indeed, as regards the cranial muscles, the only noticeable difference is the absence in the Japanese batrachian of the constrictores and adductores arcuum and the modifica-

tion of the levatores arcuum conditioned by the absence of the gill opening. The remaining important muscles of the skull and hyoid apparatus, such as the temporal, masseter, digastric, sub-mentalis, sterno-hyoid, genio-hyoid and cerato-hyoid, are distributed in much the same manner in both animals.

The alimentary canal with its appendages, does not differ in the Japanese batrachian in any respect from that of the American form except that in the former animal, just within the lower jaw, two larger racemose glands, about two inches long, were found, the ducts of which opened on the floor of the mouth. From their position and structure it is to be inferred that these glands are salivary in function. Up to the present time, however, neither submaxillary nor any other kind of distinct salivary glands have been observed in the amphibia. The only notable difference in the disposition of the vascular system in the Japanese animal as compared with the American is that in the former there are three branchial vessels, 1, 2, 3, Plate V, fig. 1, while in the latter there are four.

The manner, however, in which the blood passes to and from the lungs is the same in both animals. The genito-urinary apparatus of the Japanese *Menopoma* does not differ from that of the American animal. As in the case of the skull, the latter is but a miniature of the former.

From the above resumé of the organization of the two batrachians, it will be observed that the Japanese differs from the American animal in one essential respect, and only one, viz.: in the absence of the spiraculum or gill opening, and the modification of the hyoid apparatus conditioned thereby. That little or no importance can be attached to the presence or absence of the spiraculum as serving as a generic character or as warranting the establishing of the distinct genus *Megalobatrachus*, is shown by the fact of the spiraculum not being always present in *Menopoma*. At least, in one instance, its absence was observed by Boulenger.<sup>18</sup>

If the views here advanced as to the nature of the Japanese batrachian be accepted, if it be admitted that it is a large *Menopoma*—a *Cryptobranchus*—it will illustrate once more the truth of the Linnæan maxim: “una nota non facit genus,” the true affinities of an animal being determined, not by the presence or absence of a particular structure, but by the character of its entire organization. The position occupied by the Japanese *Cryptobranchus* or *Menopoma* among the Urodela, if the animal be admitted to be such, would then be between the Derotremata and Myctodera, according to the old classification of Stannius,<sup>19</sup> bridging over the gap between these groups to such an extent that their taxonomic value loses most of its significance.

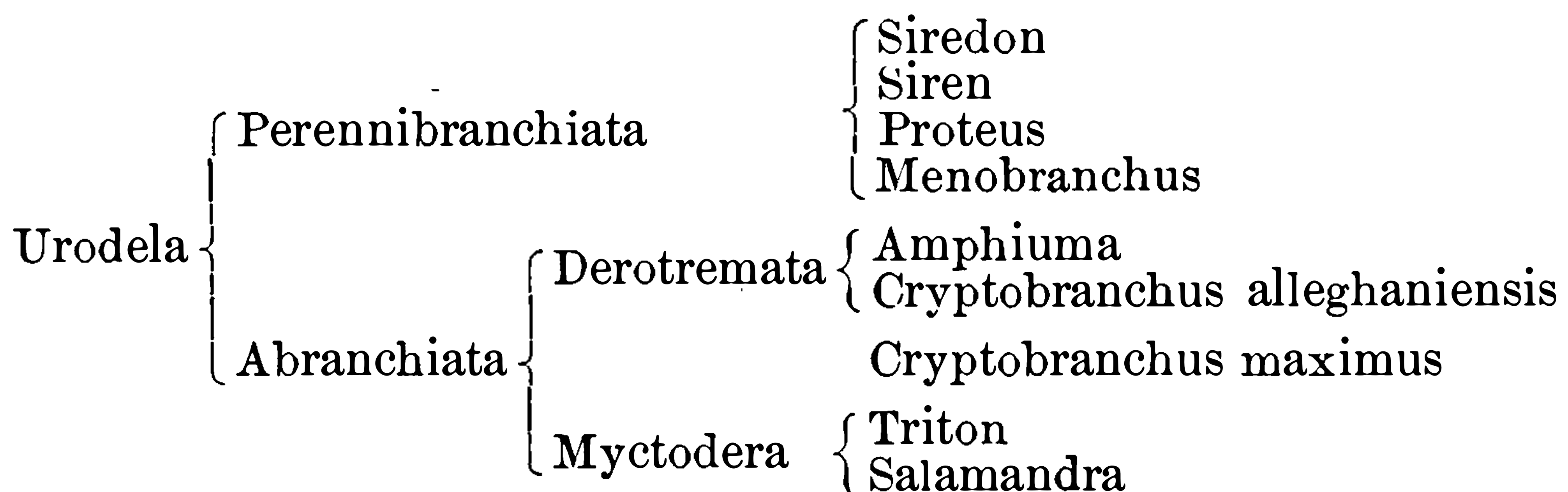

In conclusion it may not be uninteresting to call attention to the fact that the Japanese *Cryptobranchus* was not always restricted to Japan and China as it appears to be at present, it having, at one

<sup>18</sup> Op. cit. p. 82.

<sup>19</sup> Stannius, Op. cit. S. 4.

**THIS PAGE IS LOCKED TO FREE MEMBERS**

Purchase full membership to immediately unlock this page

# Know Your Bible

Forgotten Books' Full Membership provides unlimited access to more than 28,000 volumes of Christian literature for \$8.99/month

**HOLY  
BIBLE**

**Continue**

\*Fair use policy applies

## OBSERVATIONS ON VALLONIA.

BY DR. V. STERKI.

The genus *Vallonia*, established by Risso<sup>1</sup> as early as 1826, has been generally accepted only of late years. It has been ranged under different groups of *Helix* by various writers, and later regarded as a subgenus. In America; Morse<sup>2</sup> was the first to treat it as a genus, and he was followed by W. G. Binney (Manual Am. Land Shells, p. 76).

*Acanthinula* Beck and *Vallonia* have been united by Kobelt, and after him by Dr. v. Ihering<sup>3</sup> to form *Theba*, a subgenus or genus of *Helix*. Pilsbry, in his Check-List,<sup>4</sup> has placed *Acanthinula* as a section under *Patula*, and *Vallonia* as a section under his subgenus (or genus) *Polygyra* (Say), but subsequently<sup>5</sup> he regarded *Vallonia* as a genus.

There are a few points known of the anatomy. The absence of a secondary ureter, according to Braun and Boehme, as cited by v. Ihering,<sup>6</sup> is characteristic. As to the genitalia, a dart sac is said to be present, and there is a flagellum to the penis; glandulæ mucosæ were not found by Lehmann or by Moquin-Tandon, as cited by v. Ihering (*l. c.*), yet appear to be present, as Pilsbry (*l. c.*) ranges our genus under the group *Belogona* ("with dart sac and mucous glands"). Further anatomic examinations of all the soft parts of the body are necessary. My own observations are not ready for communication.

The comparatively large number of species and forms known at present, all somewhat similar as to the shell and the rather characteristic and uniform configuration of the radula and jaw, tend to prove the individuality of the group as a genus, and that it is a well-defined one.

---

<sup>1</sup> Hist. Nat., de l'Eur. Mérid., iv, 1826.

<sup>2</sup> Observations on the Terrestrial Pulmonifera of Maine. Journ. Portl. Soc. of Nat. Hist., 1864, pp. 4 and 21.

<sup>3</sup> Morphologie und Systematik des Genitalapparates von Helix. Zeitschr. f. wiss. Zool., 1892 (pp. 386-520, pl. xviii and xix) p. 480.

<sup>4</sup> Nomenclature and Check-List of North American Land Shells. Proc. Acad. Nat. Sc. Philadelphia, 1889, pp. 191-210.

<sup>5</sup> Preliminary Outline of a new classification of the Helices, *Ibid.*, 1892, p. 396.

<sup>6</sup> *L. c.* and Les relations naturelles des Cochliques et des Ichnopodes. Bull. Scientifique, Paris, 1891, p. 214.—Unfortunately, Lehmann, lebende Schnecken, is not accessible to me.

As with the genus so it was with the species ranged under it. Müller<sup>7</sup> described "*Helix*" *pulchella* and *costata*, and for nearly a century, even up to our own time, almost all writers united them in one species, under one or the other of the two names, generally *pulchella*, regarding the other form as varietal. The fact alone that the two forms, evidently of very ancient origin like the whole genus, have persisted as such, side by side almost everywhere, over a very wide area, is sufficient to prove their distinctness, not to speak of the really marked differences of the shells. Only in the last decades, however, has this conviction become prevalent; and in America, Morse (*l. c.*) was the first to express this opinion. On closer study, conchologists admitted that there are quite a number of other species besides the two "standard" ones.

But of many of them it is difficult to judge. 1. Their anatomic characters have not, especially the genitalia, been studied sufficiently, and it is not known whether they present any specific peculiarities<sup>8</sup> apart from those of the jaw and radula. 2. The material at hand, considering the shells alone, is insufficient to allow the formation of a judgment whether certain forms are species, varieties, or mere local variations and mutations. 3. The shells in this genus are so uniform in size, shape and color, that it takes careful comparison to become familiar with the forms and their peculiar features, as well as the ranges of variation.

When Mr. Pilsbry requested me to study the genus, I knew very little about it, and was disposed to decline. After a conscientious study of the material at hand, and the literature accessible, I believe I have effected something to promote our knowledge of these minute and interesting mollusca. This paper, in the absence of anatomical study and of specimens of many published species, is not a monograph of the genus. It may, however, serve as a guide to further investigations.

To Mr. H. A. Pilsbry I am especially indebted for much information, references to literature, etc., and I take this opportunity of tendering him my hearty thanks.

#### GENERAL DESCRIPTION.

*Soft parts.*—They are, in general aspect, like those of *Helix*, but, as already pointed out, there is no secondary ureter. A few other

---

<sup>7</sup> O. F. Muller, *Vermium Historia*, 1774, pp. 30, 31.

<sup>8</sup> Such differences, however, may be looked for as probable, as such have been found among nearly related species of other groups; *conf. e. g. v.* Ihering's book on the genital apparatus of *Helix*, cited above.



features have been indicated above and will not be repeated here. Owing to the kindness of several conchologists, I have had living examples of a number of species—*V. pulchella*, *excentrica*, *costata*, *parvula*, *albula*, *perspectiva*—and I have, besides observing the animals, examined the jaw and radula, necessarily deferring further anatomical studies.

The *foot* is small in proportion to the shell, being scarcely as long as the diameter of the latter in the species seen. It is colorless, translucent, as is also the head, so that the internal parts are seen rather indistinctly from above—the jaw, buccal body, oesophagus, with morsels of food and numerous minute air bubbles at times passing it, and even the cerebral ganglia being observable with a good lens. A fine, raised median line extends from the head over the neck. A very fine but distinct line makes a narrow margin or seam above the longitudinal edge of the disc or sole, which shows about 8 to 10 distinct crenulations on either side from head to posterior end. The raised parts are separated by very fine lines, grooves or hyaline septa, which, on the posterior part, have somewhat the appearance of an inverted honey-comb, as the septa are impressed. At the tail a slight groove, like a rudimentary mucous pore, seems to be present. I could not determine distinctly separated or defined longitudinal areas in the sole, so that there is no true locomotive disc as described by W. G. Binney, the whole sole being probably comprised in such a disc, since the lateral parts are wanting, as in many *Hyalinia*, etc. The locomotive waves or undulations extend over the whole width of the disc, and even on the margin above, succeeding each other rapidly and often somewhat irregularly, advancing from the posterior end, about five at the same time. They were seen when the animal was retiring in the shell and only the posterior part of the foot still projecting and not attached to anything. In the sole are seen numerous very small white dots, such as are found in almost all our land and fresh water Gasteropoda.

The *eye-peduncles* are slender, very little if at all thickened at the ends, glassy, with very finely granulated surface; inferior tentacles short but distinct. There are two rather large horizontal flaps or lappets at either side of the mouth, but their margins are not crenulated as in *Acanthinula harpa*. In several species, such as *pulchella*, *excentrica*, *albula*, I found the edge of the mantle slightly colored with a rusty pigment at the periphery, but varying in the different forms; probably it will be found in all species.

**THIS PAGE IS LOCKED TO FREE MEMBERS**

Purchase full membership to immediately unlock this page

# DELVE INTO FANTASY, MAGIC, MYTHOLOGY & FOLKLORE

Forgotten Books'  
Full Membership gives  
access to 797,885 ancient  
and modern, fiction and  
non-fiction books.

**Continue**

\*Fair usage policy applies

stronger and somewhat irregularly distributed, irregularly denticulating the superior and inferior or cutting edges. In fig. I, Plate VIII, they are exactly drawn from a jaw of *V. pulchella*, enlarged about 300 diam., and it is distinctly seen that one rib stands regularly on either side of the not otherwise marked median line, being more distant in the superior part, then approximating to near the cutting edge. The other ribs, about 12 on either side, stand somewhat irregularly, sometimes in pairs. Near the ends of the jaw they become, rather abruptly, quite fine, visible only under strong enlargement, so that otherwise these parts appear to be smooth. Whether this formation of the jaw is derived from a goniognathous one in the embryonal stage remains to be determined, but it is probable, the more so if we compare it with the jaw of *V. parvula* (Plate VIII, fig. R). There the ribs, especially those on the middle of the lateral parts, were not simply and symmetrically raised, but their sides are steep, abrupt outward, more gently sloping inward. Thus they give the impression of plates originally separated and grown together by subsequent growth.

In the middle and upper part of the jaw, very fine, dense, somewhat irregular, horizontal "striæ," apparently undulating, evidently lines of growth, corresponding with the ribs, are visible.

From the main plate or jaw proper, a rather strong posterior plate springs from the whole inferior or cutting edge, extends backward without interruption and tapers into the long and strong hyaline tenaculum membrane of the jaw. It evidently serves to reinforce the jaw, and especially the cutting edge. Plate VIII, fig. I, shows it as seen from the front through the main plate, from *a* to *b*, on one side, both its contours being plainly visible. When the jaw is resting on its front side the posterior plate may conceal the cutting edge from sight, and then the latter appears to be quite even, not denticulated, especially so in the median part. How far this formation of the jaw is present in other land-pulmonates, I do not know—very probably there are many intermediate stages. In *Patula striatella* I have found it almost exactly the same as in *Vallonia* and in the *Zonitidæ*; in *Zonitoides ligera* Say, there is a distinct indication of it, though with some modifications.

The jaw, especially in the species where it is comparatively stout, presents quite different aspects, according to the side and direction from which it is viewed. Thus we may understand partly the fig-

ures of Morse (*l. c.*, *V. minuta*), of W. G. Binney,<sup>9</sup> in which, in harmony with the descriptions, the superior and cutting edges have evidently been mistaken for each other. The jaw was somewhat softened by strong caustic alkali, and the object drawn was evidently extended by pressure.

The *radula*, or lingual membrane, bears markedly different central, lateral and marginal teeth. I found from 23–33 in a transverse row, the former number in *cyclophorella* and *perspectiva*, the latter in *parvula*. Morse counted 23 in *minuta*, W. G. Binney 21 in *pulchella*. The difference may be partly explained by the rather strong enlargement used by me, and partly by local variations. The number of transverse rows varies from 63 in *cyclophorella* to 84 in *excentrica*, and there is, as everywhere, some individual variation. The size of the radula is not always in proportion to the shell. In *pulchella* it is about 0.68 mm. long, and 0.24 wide; in *excentrica* with the shell rather smaller, the dimensions were found 0.79 and 0.24 respectively. One transverse row measures 0.01–0.011 in length, while only 0.009 in *perspectiva*.

The central tooth is small, its plate of attachment narrow, as long as the row space, the posterior end somewhat wider in various degrees. If not carefully examined, this may appear so in a higher degree than it really is, since the plate is not exactly in the same level. The side edges of the posterior end are curved up and the angles are projecting like cusps. Plate VIII, fig. P, shows a central tooth of *V. parvula* viewed in half profile with these angles projecting almost beyond the level of the cusps. The reflection at the front end is small, short, and bears 3 cusps, the median about  $\frac{1}{4}$ – $\frac{1}{3}$  as long as the plate. The side cusps are very small, sometimes hardly perceptible. There are, as a rule, 3–4 perfect laterals, bicuspid, a larger mesodont and a small ectodont, the former with a distinct free cutting point, the latter with just a trace of it. The plate of attachment is almost as wide as long, and the posterior part of the edge is curved up, as in the centrals, with the angle projecting, also like a cusp. It doubtless acts as such, since in the oldest teeth, where the cusps are nearly worn off, the same is true of these posterior distal angles, including those of the central tooth as represented in Pl. VIII, fig. G. On the fourth or fifth tooth sometimes the remains of the two cusps are no longer coherent,

<sup>9</sup> It is evidently the same cut, but in different position; and it must be noted that Morse, *l. c.*, in all his figures, has the cutting edges above, while W. G. Binney in his Manual, has them directed downward.

but isolated in this state. In the first lateral the mesodont is large, as long as the plate or more so; then it becomes gradually shorter till in the last perfect lateral it scarcely reaches beyond the middle of the plate. The ectodont is always small, but in some instances I have seen it longer in the last lateral than in the one preceding. W. G. Binney says (*l. c.*) that the posterior mesial (inner) angle of the plate is suppressed. As a rule, I could see that angle well formed in isolated teeth, although not projecting.

Outside of the laterals follow 2 or 3 *transition teeth*, of which at least the first mesial might range with the laterals, as there is a well formed though somewhat shorter plate with the distal angle not projecting and two cusps; the mesodont becomes longer again and the ectodont simple or subsimple, but finely double-pointed, which splitting becomes more marked in the next following tooth, thus resembling more the true marginals (Pl. VIII, A, 5 and 6, B 5, C 5 and 6, D 7, E 6, F 6.)

The mesodont is of a peculiar formation in these transition teeth. As illustrated in Pl. VIII, A 4, B 5, C 5, D 5 and 6, F 4 and 5, it becomes obvious that the true mesodont is rather disappearing, while, in fact, a different cusp, another element, grows out from it, or rather, on the mesial side of it, in close connection with the plate of attachment, which then becomes the mesial cusp of the true marginals, in which the plate of attachment does not reach beyond the reflection. In these, the distal cusps, corresponding to the multiplied ectodont, increase in number up to 3-5 and even 6, gradually becoming smaller and obsolete toward the distal end of the single tooth as well as of the row; so that, as a rule, the last tooth is simply a small, wide, transverse bar, without any perceptible cusps. At the same time these cusps become longer, like the teeth of a comb, so that the marginals may be said to be rather *pectinate* than serrate. In some species, there is a peculiar formation of the middle marginals, especially in *V. excentrica* (Pl. VIII, fig. B, 7-10), in which the cusps do not stand singly on the base, but on a common socle, thus giving the tooth a fan-like appearance. The same is seen, but in a lesser degree, in *V. cyclophorella*, Pl. VIII, fig. E, 7-11. In these teeth the mesial cusps are particularly directed inward.

*Shell.*—It has already been said that the shells of all the *Vallonia* species are remarkably uniform—there is moderate diversity in size, the smallest averaging 2.0 (some specimens 1.7) the largest about

**THIS PAGE IS LOCKED TO FREE MEMBERS**

Purchase full membership to immediately unlock this page

# Know Your Bible

Forgotten Books' Full Membership provides unlimited access to more than 28,000 volumes of Christian literature for \$8.99/month

**HOLY BIBLE**

**Continue**

\*Fair use policy applies

abruptly to the aperture, while the back of the whorl keeps straight, horizontal (Man. Conch., Pl. 32, fig. 25) or even a little ascending, to the very margin, as we see it in *V. parvula*, and in some forms of *V. costata*, while in most of them, (3) as a rule, the whole whorl descends slightly (Man. Conch., Pl. 32, fig. 21). 4. Still others have the last whorl near the aperture markedly and decidedly entirely descending, so as to form a distinct curvature of the back as in *V. perspectiva* (Man. Conch. Pl. 33, fig. 42), *cyclophorella* (Man. Conch., Pl. 33, fig. 37) and others. The suture either descends comparatively more than the other part, or not so decidedly, as in the Kroellwitz *V. tenuilabris* (?) These formations have a marked influence on the shape and direction of the aperture, for the latter will necessarily be more inclined where the last whorl is strongly decurved. Where only or principally the suture descends, the aperture will be more circular, and less crescentoid, as becomes apparent at once if we compare *V. pulchella* and *excentrica* with *parvula* and *costata*.

In different forms the last whorl not only descends to the aperture, but previously to that rises more or less gradually to or above the niveau of the penultimate whorl (Man. Conch., Pl. 33, fig. 33, 37), thus causing the spire to appear somewhat papilliform, if the shell is viewed from the front. This we find most marked in *V. cyclophorella*, *tenuilabris* (Man. Conch., Pl. 33, fig. 32), and others in which the penultimate whorl appears narrowed above (Man. Conch., Pl. 33, fig. 30). This ascending is directly associated with rapid recession outward as seen in those species at the base. The same thing, though less strongly marked, is found also in many specimens of *V. costata*, and, not infrequently, in *pulchella*. We have in *Helix (Pedinogyra) cunninghami* Gray,<sup>10</sup> a very illustrative model of the described configuration of the last whorl, especially on the upper side.

The *aperture* is described as being more or less oblique. We must here distinguish its direction as compared with the vertical axis of the shell, which may be called its *inclination*, from its direction compared with the horizontal axis, or its *obliquity*. The latter is very marked in *V. parvula* and *perspectiva* (Man. Conch., Pl. 33, fig. 42) and others, where a prolonged horizontal line through the aperture would just touch the circumference of the shell, that is, would be tangential, or cut off a very small part of it. We find the con-

<sup>10</sup> In Tryon-Pilsbry, Man. of Conch., (2) VI, pl. 2, fig. 30, it is well shown, although not especially mentioned in the text (p. 12).

trary in *V. altilis* (Man. Conch., Pl. 32, fig. 17), where the aperture is also very little inclined.

As to the shape of the aperture, there are two principal groups of species—in one it is nearly circular, no wider than high or rarely so; in the other the transverse diameter is greatest, and the aperture is ovoid or pear-shaped. Most forms of the latter group have no thickened lip, as a rule, while those of the former may be of the same character, or provided with a more or less strong white lip. In a few forms the peristome is simple and straight, as in *V. pollinensis* and *V. altilis*, while in most it is everted (or “reflexed”) in various degrees and rather abruptly, as in *pulchella*, *costata*, etc., or more gradually as in *cyclophorella*. It must be specially noted that in all instances the peristome is straight above, not everted, at the suture and for a greater or less distance from it. This will not be repeated as a general character in the special descriptions.

It remains to say a few words in general about the structure of the *surface* of the shell. Ribbed and plain species have been distinguished, but there are all possible intermediate forms between these extremes, and it may be added at once that even in the same species considerable variation may be found, e. g., in *V. pulchella* and *costata*. What we generally call ribs are membranous elevations or duplicatures of the epiconch, and, properly speaking, they do not deserve that name. They vary from very coarse and rather distant, and equidistant, as in some forms of *V. costata*, to quite fine and crowded, and more or less irregularly set. I counted from 22 (*V. costata* var. *amurensis*) up to nearly 70 (in *V. cyclophorella*) on the last whorl. These membranous ribs generally stand on stronger striæ or fine ribs of the shell itself. But in some species there are rather strong true ribs devoid of membranes, as in *V. gracilicosta* Reinh. To what degree the variability may go is seen in *V. costata* var. *helvetica*, which has not a trace of membranous ribs and the “shell ribs” are very fine striæ, visible only with a good lens. It is not sufficient, then, to say in descriptions, that a shell is “ribbed” or “not ribbed,” but the character of the ribs must clearly be stated, as this is a prominent character. On the dead shells, and sometimes partly on the living, the epiconch loosens and becomes lost by the action of the water or atmospheric influences, and with it disappear the membranous ribs. Such specimens, mixed with more or less perfect ones, are especially found in drift materials along rivers and streams. It is unnecessary to say that fossil shells



are almost always in this condition, and it may be impossible to know whether they originally had such ribs or not, if they be of a form not represented in the recent fauna.

It seems that there are also differences in the surface sculpture of the nucleus or the (about  $1\frac{1}{2}$ ) embryonal whorls. While in the ribless species—*V. pulchella*, *excentrica*, *declivis*—it is, as a rule, smooth, the ribbed *V. costata* and related forms have it marked with fine, rather dense revolving, raised lines (Man. Conch., Pl. 33, fig. 54), about 10 or less, on the visible part. Whether they are also present below the periphery of the embryonal shell I am unable to say.

*Habits of the animals.*—I have seen living specimens only of *V. pulchella*, *excentrica*, *costata*, *albula* and *perspectiva* (of the latter only one). They were kept in confinement for weeks. As we find mature and young specimens at all times, it seems that their propagation, as well as the duration of life, are not bound to a certain season. Their movements are slow and somewhat unsteady—evidently it is not easy to carry the comparatively large and heavy shell. It occupies 15–30 seconds in transversing a space corresponding to the diameter of the shell. They shun light decidedly, as do most of our North American land snails. I repeatedly observed individuals, when brought into day- or lamp-light, moving slowly with head and disc only a little projecting, the eye peduncles quite short; when they were shaded, the latter stretched out and the motion grew more lively; when in full light again, the animal became evidently uneasy, made a few quicker motions, and changed its direction. It was generally several seconds before perception was followed by motion. To judge also from other experiments, sight seems to be very imperfect. It is not only in this group of molluscs, but in others, quite unlike the sense of feeling, which is more acute.

The *heart* is, as in other mollusca, strongly influenced by temperature and the degree of general activity or rest. In a temperature of about 50–60° F., it contracts at a very slow rate, about 20–25 per minute, but variously in different individuals, as will be seen from the following observation: Of two mature *V. pulchella* lying on the table at a temperature of about 65° F., one had the heart contracting 72, the other 32 times per minute; after they had been on my warm hand for about two minutes, the heart of the former made 110, of the latter 68 contractions per minute. They are able to live under water for a considerable time, even for several hours;

**THIS PAGE IS LOCKED TO FREE MEMBERS**

Purchase full membership to immediately unlock this page

# DELVE INTO FANTASY, MAGIC, MYTHOLOGY & FOLKLORE

Forgotten Books'  
Full Membership gives  
access to 797,885 ancient  
and modern, fiction and  
non-fiction books.

**Continue**

\*Fair usage policy applies

## SPECIAL DESCRIPTIONS.

Since the number of species has increased considerably in the last decades, they should be described as exactly as possible, especially in view of the above facts. Thus I think allowable the alteration of previous descriptions of several species, especially *V. pulchella* and *costata*, in some points which proved to be essential in exactly characterizing them; and there is no use in citing the older descriptions,<sup>11</sup> or in especially mentioning the changes made—the former are found elsewhere, and a comparison will show the latter at once.

In spite of some striking differences in the formation of the shell, it appears to be impossible to divide the species under well-defined subgenera or sections, as there are intermediate forms everywhere, and the anatomy, especially of the jaw and radula, furnishes no reason for doing so. An attempt, however, has been made to arrange them in natural groups, in the table after the special descriptions.

It might be thought useless to name many varieties; but this could hardly be avoided after careful study of the forms, and more of this has been done among larger mollusca.

Judging from Morse's and W. G. Binney's description of *Patula* (*Planogyra*) *asteriscus* Mse., I supposed this species might be a *Vallonia*. One specimen was not softened sufficiently to be examined thoroughly. The radula, however, showed the essential characters of *Vallonia*. Fresh specimens must be studied. Yet the finer surface structure of the shell is different from that of all true *Vallonia* I have seen: the nucleus is thickly set with minute pits somewhat elongated radially, and the post-embryonal whorls show microscopic revolving lines, as figured by Morse (*l. c.*). To judge from Morse's (*l. c.*) figure 51. p. 24, of the front part of the animal, this would also not agree with that of *Vallonia*.

**V. pulchella** Muller. Pl. VIII, fig. A, G, H, I, K, L. Man. Conch., Pl. 32, fig. 15.<sup>12</sup>

*Hel. pulchella* Müller, Verm. Hist., II, 1774, p. 30.

*Hel. pulchella* Auct.

*Hel. paludosa* Da Costa, 1780.

*Hel. crystallina* Dillwyn, 1817.

<sup>11</sup> It may be mentioned that they do not always agree among themselves, and that different forms have been comprised under one name and different characters regarded as essential or otherwise by various authors.

<sup>12</sup> Plates 32 and 33, referred to throughout this paper, will be found in Tryon and Pilsbry's Manual of Conchology (2), VIII.

*Hel. pulchella* var. *laevigata* Moq.-Tand., 1855, a. o.

*Hel. minuta* Say, Journ. Acad. Phila., 1817, p. 123.

*Hel. minuta* Say, Nichols. Enc., ed. 3, 1819.

*Vallonia minuta* Morse, Pulmonifera of Maine, 1864, p. 21 (part).

*Vallonia minuta* Tryon, Am. Journ. Conch., III, 1867, p. 36 (?).

*Vallonia pulchella* W. G. Binney, Terr. Moll. V., p. 344.

*Vallonia pulchella* W. G. Binney, Man. Am. Land Shells, 1885, p. 77.

Shell of medium size, first moderately, then for the last  $\frac{1}{3}$  whorl widely umbilicated, convex or depressed conic above, pale horn or straw colored, transparent or milky opaque, finely and densely striate, somewhat stronger and rather regularly at the suture and the umbilicus, shining, smooth at the nucleus;<sup>13</sup> whorls  $3\frac{1}{3}$ –4, rather rapidly increasing, with a rather deep suture, the last comparatively large, well rounded, little expanded toward the aperture, not descending in front or slightly so at the suture; aperture moderately oblique and inclined,  $\frac{5}{8}$  circular with umbilical margin a little more straight and slightly protracted; peristome decidedly and rather abruptly everted, with a strong, white lip, thinner at either end.

Diam. maj. 2.4, min. 2.0, alt: 1.2 mm.<sup>14</sup>

Soft parts as described above for the genus. The liver was found quite various in color: light yellow to lighter or darker brown, as has been noted above. The action of the heart also is described in the general description.

The jaw (Pl. VIII, figs. H, I, K, L) is rather strongly curved with obtuse ends, and no median projection on the cutting edge. The latter is more or less denticulated, irregularly, corresponding with the 18–25 variously coarse, rather sharp, longitudinal ribs irregularly distributed over the front plane of the jaw. For details see general description, p. 235. The width of the jaw was found to be 0.13–0.23, the height 0.065–0.07 mm.

The radula (Pl. VIII, figs. A, G) has 65–70 transverse rows of 27 teeth; it has already been said that Morse and W. G. Binney counted 23 and 21. There are three perfect laterals, with rather strong mesodonts, rapidly diminishing in size from the first to the third. The fourth and fifth make the transition, and at least the former is different from the true laterals only by the longer mesodont of the peculiar formation described above. In the fifth, which still has a well-formed though smaller plate, the mesodont is of the same char-

<sup>13</sup> Yet, in a single specimen, I have seen few indistinct short lines.

<sup>14</sup> The altitude given here, and for all the following species, is of the whole shell, since it is almost impossible to reliably measure in any other way.

acter as in the true marginals. Sometimes in the fourth, and even in the third tooth, the ectodont, though essentially simple, is finely double-pointed, and in the same longitudinal rows single- and double-pointed ectodonts may be seen irregularly alternating. The sixth, though a marginal in its configuration, still makes the transition, sometimes having an indication of a plate reaching beyond the reflection, and bearing only two outer cusps, rather short and a prolongation distal-ward with room for additional cusps, of which there is sometimes just a trace in the form of a very short blunt fourth one. The true marginals show 5–6 cusps, moderately long, in the 7th–9th, the mesial one being somewhat longer than the second, and slightly directed inward. The 12th tooth, like the following, is a fine transverse bar, only finely serrate, while the 13th or last, generally shows hardly a trace of cusps.

One example showed a peculiar feature of the radula: At the front end, for about 15 transverse rows, the cusps were worn off almost entirely by rasping, as usual (compare fig. G, Pl. VIII), but here the cusps of the last few rows were less so than the others. For this there can be no explanation but that after a period of comparative rest one of greater activity followed.

The following dimensions of the radula were found in several fresh individuals, as well as in those treated with alkali: length 0.68–0.71, width 0.24 mm.; length of transverse row about 0.01 mm.

A younger specimen, of about 1.5 mm. diam., had the radula with 60 transverse rows of 23 teeth, the first 3 on either side being perfect laterals, the fifth a marginal, with only 2 or 3 small distal cusps. The last 4 marginals are wide and thin transverse bars, with quite small cusps, the last with none at all.

The striation of the shell is somewhat unequal while quite fine and irregular over the most part of the whorls, it is stronger and rather regular at the umbilicus, and also at the suture; here the striæ appear, under the microscope, like ribs, about 0.03–0.035 mm. apart.

Westerlund says in his diagnosis (*l. c.*) of the present species: “distinctly angular at the groove-like deepened suture.” It made the same impression on me; but after examining numerous examples in different stages of growth, it was found that the whorls are equally rounded to the very suture, and that the apparent angle was an illusion caused by the reflection of the light.

**THIS PAGE IS LOCKED TO FREE MEMBERS**

Purchase full membership to immediately unlock this page

# Know Your Bible

Forgotten Books' Full Membership provides unlimited access to more than 28,000 volumes of Christian literature for \$8.99/month

**HOLY  
BIBLE**

**Continue**

\*Fair use policy applies

Now and then one is found with a small shell, rapidly increasing last whorl and comparatively large aperture, strongly recalling similar examples of *Helix thyroides* Say. The whorls are, as a rule,  $3\frac{1}{3}$ – $3\frac{1}{2}$  in number, and only the largest shells have 4 or nearly so. There is some variability in the size and shape of the umbilicus, being in some nearly as in *excentrica*, while in others it is almost regular or funnel-shaped; yet a marked widening near the aperture is almost always found.

It has been accepted as a character of *pulchella* that the last whorl does not descend at the aperture. This is only approximately true because while not in such a degree as in some other species, the last whorl descends distinctly, especially at the suture, in about one-third or one-fourth of the specimens from different places in Europe and North America. The last whorl, moreover, slightly ascends more at the back than at the suture, and specimens are even found with the last whorl first ascending and then descending slightly but distinctly at the suture, a character which is found more constant and more marked in *V. cyclophorella*, *tenuilabris* and others.

There is some variation also in the size and shape of the lip; it is almost typically stronger in the upper outer part, so as to modify the shape of the actual aperture, as shown in Man. Conch., Pl. 32, figs. 3 and 5, the same as in *V. costata*, fig. 22, and *pulchellula* Hde., fig. 53. In the upper part also the lip often protrudes beyond the margin, and specimens are not uncommon where the strong lip projects on the whole circumference, except at the ends (fig. 4). While fresh shells are usually of pale horn color and transparent, some may be found whitish or milky opaque. I found a colony of about a hundred exclusively so colored some years ago, in

---

	Average.	Largest.	Smallest.
Aargau, Switzerl. (drift).....	2.3	2.5	2.1
Lyons, France (the largest).....	2.5	2.7	2.3
Madeira.....	2.4	2.5	2.3
Washington, D. C.....	2.3	2.4	2.2
Saco, Maine (2 examples. only).....	2.2	2.2	2.2
Quebec, Canada.....	2.3	2.4	2.1
Brantford, Ontario.....	2.4	2.5	2.2
Tremont, Pa.....	2.4	2.6	2.2
New Philadelphia, Ohio.....	2.3	2.6	2.1
Joliet, Ill.....	2.4	2.5	2.0
Iowa City, Iowa.....	2.4	2.6	2.2
Greenville, Tenn.....	2.3	2.4	2.1
San José, Cal. (greenhouse).....	2.3	2.4	2.1
Mauritius.....	2.3	2.4	2.3

a garden of New Philadelphia, all living, while at other places in and around the city they were of the ordinary appearance. I have seen the same form from other localities, yet it seems not to represent a true variety.

*V. pulchella* may be mistaken, when young or immature, for *Hyal. minuscula* Binn., in North America only, having the same lipless, glassy shell and the same color of the soft parts. Yet the somewhat experienced collector will know the latter by the comparatively smaller, more gradually increasing (and so more numerous) whorls, the generally stronger striation and the umbilicus being wider from beginning. On the Old Continent, there is no land snail, as far as I know, which our species closely resembles, even when immature, except other species of *Vallonia*.

*V. pulchella* var. *enniensis* Gredl. Tirol's Conchylien, 1856.

A form with strong, rib-like striæ, but without membranous ribs. It has been found in Tirol, at Neumarkt, Hall and Botzen. I found two specimens, evidently of this form mixed in a lot of *V. costata* from Grasse, France (Acad. Coll.). The striæ are very strong, but the other characters of the shell are those of *V. pulchella*.

*V. pulchella* var. *hispanica*, n.

Shell small, diam. maj. 2·0–2·3, averaging 2·1, pale horn colored or whitish; whorls 3–3½, the last little predominating, somewhat expanding toward the aperture; the latter  $\frac{5}{8}$  circular; peristome moderately everted, with a moderately strong lip, little or not thinner at the ends; spire little elevated, in some examples almost flat; umbilicus as in typical *pulchella*; surface strongly, rather regularly striate, rather ribbed (ribs without membranes); nucleus with rather strong revolving lines. Spain (no special habitat), ten specimens in the Nat. Mus. Coll. Anatomical examination would be very desirable and possibly might show the form to be a distinct species. Resembles the preceding variety.

*V. pulchella* var. *persica* Rosen. Nachrichtsbl. D. Mal. Ges. 1892, p. 123.<sup>17</sup>

Differs from the type by the last whorl descending to the aperture, with a flat [*plano*], widely expanded peristome. Hab. Schamhala, Prov. Chorassan, Persia.

I have seen no specimens, but think this might be a form distinct from *pulchella*.

<sup>17</sup> Beiträge zur Kenntniss der Molluskenfauna Transkaspiens und Chorassans, von Baron Otto Rosen, Ashabad.



2. *V. excentrica* n. sp., Pl. VIII, fig. B, M. Man. Conch., Pl. 32, figs. 6-9.

*Vallonia minuta* Say, Morse, Pulmonif. Me., p. 21 (part.).

Shell of medium size, with maj. diam. markedly longer, and with irregular, somewhat elongated umbilicus at first rather narrow, then for the last  $\frac{1}{3}$  whorl rapidly widening; slightly rounded convex above, smooth or very finely and irregularly striate, strongly and regularly at the umbilicus; nucleus smooth; pale horn colored, transparent or slightly opaque, with a somewhat fatty gloss; whorls 3-3 $\frac{1}{2}$ , rather rapidly increasing with a moderately deep suture, the last comparatively large, well rounded, expanding near the aperture, not descending, or very little at the suture; aperture moderately oblique and inclined,  $\frac{5}{8}$  circular, subangular at the base; the umbilical margin somewhat protracted; peristome not everted above, very little at the periphery and moderately below, with a rather strong white lip, thinner at the ends, visible through the shell.

Diam. maj. 2.3, min. 1.8, alt. 1.1 mm.

I was enabled to see the soft parts in a few specimens from Quebec, kindly forwarded by Mr. H. W. Hanham. The foot is, compared with that of *costata*, a little less transparent and of a slight yellowish tinge, as is also that of *pulchella*. But this difference of tint is perceptible only when the animals are side by side. The *jaw* (Pl. VIII, fig. M) is moderately curved above; the cutting edge with a slight, wide median projection and almost straight side parts; the ends are rounded. The front bears rather fine, dense, sharp, slightly irregular ribs, all over. Size of jaw 0.08 mm. high, 0.28 wide, when depressed.

The radula (Pl. VIII, fig. B) has 81-84 transverse rows of 29 teeth. There are four perfect laterals; the fifth marks the transition; it distinctly shows the peculiar formation of the mesodont, has smaller though well-formed plate of attachment, and two small distal cusps, the ectodont being already split. The sixth is a marginal but still marks the transition: it is triangular, with 3-4 cusps. With the exception of the last 1 or 2 which are hardly serrate, the marginals are pectinate with 5-7 cusps, and the 7th-10th are placed in a peculiar way, as at least the 3-4 mesial cusps are standing on a common socle. The radula is 0.79 mm. long., 0.29 wide; one transverse row measures, as usual, nearly 0.01 mm.

The animal seems to be somewhat less lively and more timid than *V. costata*.

**THIS PAGE IS LOCKED TO FREE MEMBERS**

Purchase full membership to immediately unlock this page

# DELVE INTO FANTASY, MAGIC, MYTHOLOGY & FOLKLORE

Forgotten Books'  
Full Membership gives  
access to 797,885 ancient  
and modern, fiction and  
non-fiction books.

**Continue**

\*Fair usage policy applies

variability in the transparency of the shell—the New York and New England specimens are, as a rule, more glassy and shining than those from Washington, D. C. and from Europe.

In a lot of *Vallonia* from the Pyrenees (no special habitat or region is noted), belonging to the Academy Collection, there was one poor weathered specimen of *V. pulchella* and a number of *V. costata*, together with a peculiar variety, and the present form, which then struck me for the first time as probably being a distinct species.

At Washington, D. C., I collected in February and again in March, 1889, under granite stones, numerous *Vallonia* which then were simply placed as *pulchella*. Many of those collected there in March, under bricks in an old brick-yard were in company with *Hyalinia minuscula* Binn., and *Pupa procera* Gould, of which, it may be mentioned, I secured about 800 specimens in a few hours by brushing the bricks. When I began to study *Vallonia* specially, these shells were looked over carefully,<sup>18</sup> and then I was surprised to find both species, *pulchella* and the one under consideration, in both of the two former lots, while those from the brick-yard were *pulchella* exclusively. They were so exactly like the Pyrenean shells that there could not be the least doubt as to their identity; they were so distinct from *pulchella* as to be separated one by one at first glance, there being no doubtful or intermediate examples. Subsequently I looked over every specimen of more than 90 parcels of *Vallonia* containing either *pulchella* or the new form, or both, coming from Europe and North America, and the result was to establish the certainty that the present is a good species, for which I propose the name *V. excentrica*. It is of a wide geographical distribution, its shell being readily discerned when once attention has been directed to its peculiarities. But it must be added that specimens are found occasionally in which the distinction is somewhat obscure; these are generally small *pulchella* which had been damaged and restored more or less imperfectly, with little everted peristome. I have several such examples: one from Illinois which, at first sight, would be taken for *excentrica*, but by close examination proves to be *pulchella*. On the other hand, one example of *V. excentrica*, from Washington, D. C., has a rather strongly everted lip, caused by a breakage near the aperture.

It is somewhat surprising that this form has been overlooked in

---

<sup>18</sup> As I have sent specimens to several conchologists, they should now be revised.

Europe, being taken for *pulchella*. In North America we meet the old question of the validity of *V. (Hel.) minuta* Say. When Say described this species, "he was probably unacquainted with *Vallonia pulchella* of Europe, as he makes no remarks on the resemblance of this species to the European form," as Morse (*l. c.*) justly remarks, continuing: "Stimpson, Kirtland, and De Kay retain the specific name of *minuta* for this shell, while Binney, Gould, W. G. Binney, Adams, Mighels and all the European writers unite it with *pulchella*."

Among writers since Morse's publication, opinion is still divided. Say's description (*l. c.*) is as follows: "Shell rather thick; spire convex, little elevated, with three volutions; suture well-defined, impressed; whorls obtusely wrinkled across; aperture nearly orbicular; lip much thickened, reflected, white, distant from the umbilicus; umbilicus large, exhibiting the volutions. Breadth less than one-tenth of an inch." The description decidedly points to *pulchella* in nearly every particular and can not be applied to *excentrica*. Say, himself, however, later acknowledged the identity of his *minuta* with *pulchella*,<sup>19</sup> and these are reasons enough for not applying this name to a species distinct from *pulchella*.

Morse (*l. c.*) expresses the opinion that the American shell, *minuta*, is distinct from the European, *pulchella*, and proves it, mainly from the shape of the aperture and the angle formed by the latter with the axis of the shell, the American form being more translucent, and the epiconch somewhat different.

J. W. Thomson<sup>20</sup> refers only to *V. minuta*, and adds: "I cannot consider this species to equal *H. pulchella* Müll." It certainly is probable that Morse had our *V. excentrica* before him, as it, as well as *pulchella*, is frequent in Maine, but it is surprising that he did not speak of other differences, especially the peculiar shape of the umbilicus, the outline of the whole shell, and the fact that the peristome is very little everted in comparison with *pulchella*. The transparency of the shell differs in each species, and I have seen *excentrica* rather more opaque than usual in *pulchella*. The form of the upper part of the aperture is also variable in *pulchella* as well as in *excentrica*, especially in the suture slightly descending to the aperture in many specimens, while in others it does not. The difference in the inclination of the aperture I have not found so constant and

---

<sup>19</sup> See W. G. Binney, Terr. Moll. IV, p. 69.

<sup>20</sup> The Land Mollusca of Bristol Co., Mass., Journ. Conch., 1885, p. 372.

marked after comparing numerous specimens from many localities on both continents.

Morse also speaks of differences in the lingual dentition and buccal plate (jaw) between *minuta* and *pulchella*, but it seems not from his own observations; and it must be said that his description and figure<sup>21</sup> of the radula seem rather to be drawn from *pulchella* than from what we consider *excentrica*. The latter has the formula 14-1-14, or 29 in a transverse row against 23-1-23 in *pulchella*. I would have drawn the marginals (or uncini, as he calls them) differently, had he then really had *excentrica* before him. Since the two species live together along the Atlantic coast, it is probable that they were mixed, as is the case in nearly every lot coming from the coast from Maryland to Nova Scotia. The mistake was very likely to occur, even in the case of such a careful observer as Morse.

W. G. Binney,<sup>22</sup> as well as other writers, is of the opinion that there is only one species, *pulchella*, and his own description as well as figures represent the same. Evidently he examined only examples of the species referred to.

Has *V. excentrica* been introduced from Europe? It is found only in the East, in the oldest settled parts of the country, where also several European Limaces are common. But the latter live almost exclusively in and about dwellings, while *Vallonia* seems to be spread all over the region. Thus it may be considered native here as well as *V. pulchella* and *costata*.

### 3. *V. adela* Westerlund.

*Hel. adela* Westerlund, Ofversigt af K. Vet. Ak. Forh., 1881, 4, p. 37.

*Hel. adela* Westerlund, Fauna der in der Palaearktischen Region lebenden Binnenconchylien, I, Berlin, 1889, p. 14.

“Shell openly umbilicated, depressed trochiform or convex, very indistinctly, finely striate or smooth, whitish; whorls 4-4½, rather convex, not at all angular at the rather deep suture, rather rapidly increasing, the last comparatively large, rounded, not expanded, not descending in front; aperture crescentic-circular, with margins separated, peristome very narrowly everted or almost straight and without a lip. Size 2½ to 3 : 1½ to 1¾ mm. (Suabian Alps; fossil in a sub-marine peat-bog, near Ystad, in southern Sweden.)”

The above description is translated from West. Fauna, *l. c.* I have seen no specimens. Two examples, in a vial, with the label :

<sup>21</sup> L. c., p. 21, fig. 57, Pl. 8.

<sup>22</sup> L. c. and Invertebrata of Mass. ed. II, p. 428. The outlines of the upper figure in the latter rather strongly resemble those of *V. costata*; generally the umbilicus is not as regular as shown in the lower figures of either work.

**THIS PAGE IS LOCKED TO FREE MEMBERS**

Purchase full membership to immediately unlock this page

# Know Your Bible

Forgotten Books' Full Membership provides unlimited access to more than 28,000 volumes of Christian literature for \$8.99/month

**HOLY BIBLE**

**Continue**

\*Fair use policy applies

It differs from *V. pulchella* in its somewhat larger size, the wider and more regular umbilicus, the whorls being  $\frac{1}{2}$  more in number and more slowly increasing, the last comparatively narrower, gradually descending entirely to the aperture, and the peristome being straight or just perceptibly everted with a much thinner lip.

*V. declivis* var. *atilis*, nov. Man. Conch., Pl. 32, fig. 14-17.

This form differs from the above in its somewhat larger size, narrower and deeper umbilicus, more elevated spire, the last whorl descending below the circumference of the penultimate; the peristome being quite straight and thin, without a lip; the aperture is very little oblique, in fact, the least so of all the *Vallonia* I know, and moderately inclined, rather higher than wide, subangular inward at the base; whorls  $4\frac{1}{3}$ ; the color is whitish, the surface densely, rather regularly striate.

Diam. maj. 2.9 min. 2.5, alt. 1.7 mm.

This form might represent a species, but, from its similarity to *declivis*, and the few examples known, I prefer, for the present, to regard it as a variety.

I found one specimen in 1882, also in drift on the Aar River, Switzerland. Another has been kindly forwarded by Mr. Pilsbry, it is from drift on the Main River, in Middle Germany, and bears also the name *H. tenuilabris* Braun. They are exactly alike.

I found, in 1882, while in Switzerland, among drift shells from the Doubs River, on the western slope of the Jura Mountains, a few specimens of either *declivis* or *atilis*, having then labeled them also *H. tenuilabris* A. Br.

All the examples of this species extant, though dead shells and found in drift, are fresh and in good condition, and it is to be expected that living specimens will be found in those countries. If a new species has been established on the few specimens, it is because they could not reasonably be brought under one of those already known without modifying their diagnoses so that they would have been valueless.

I believed for a time that this might be the *V. adela* of Westerlund, judging from the description. But the author says expressly that the last whorl does not descend at all,<sup>23</sup> while in the forms under consideration this is just the prominent feature. Since I failed to

---

<sup>23</sup> Conf. Westerlund Fauna, I Suppl. 1890, p. 120, *H. tenuilabris* var. under *V. mionecton* Bttg., also cited below, No. 14.

obtain authentic specimens of *adela*, some doubt in regard to this question will yet remain.

4. *V. pollinensis* Paulucci.

*Hel. pollinensis* in Westerlund, Fauna, I Suppl., p. 120.

Shell with a rather narrow, funnel-shaped umbilicus (the same at the aperture, little and gradually widening), convex, with obtuse, prominent apex, light horn colored, exceedingly finely striate, adorned with more distant, acute, lamelliform, regular fine ribs; whorls  $4\frac{1}{2}$ , regularly increasing, convex, with impressed suture, the last gradually increasing and not at all expanded at the aperture, rather constricted, scarcely wider than the penultimate, slightly, and gradually descending above; aperture little oblique, crescentic-circular, descending [?], margin straight, simple; only the columellar margin somewhat everted high up. Size  $2\frac{1}{2}$  by  $1\frac{1}{2}$  m. (Italy, Monte Pollina in Prov. Potenza: Paul. ex.) Not figured.

Translated from Westerlund, *l. c.*

I have seen no specimens. To judge from the description, it seems to be a somewhat intermediate form between the above species and the costate groups.

5. *V. costata* Muller, Pl. VIII, figs. C, N. Man. Conch., Pl. 32, figs. 18-22, 27, Pl. 33, fig. 54.

*Helix costata* Müller, Verm. Hist., II, 1774, p. 31.

*Helix costata* Rossm. Icon., 439.

*Helix costata* Dupuy, Hist. 1848, p. 162, T. 7, fig. 4.

*Helix costata* Westerlund Fauna, I, p. 14—a. o.

*Helix pulchella* var. *costata* of most authors.

*Vallonia rosalia* Risso, 1826 (ex. West. *l. c.*).

Shell with a moderate umbilicus more widening for the last  $\frac{1}{3}$ — $\frac{1}{2}$  whorl, depressed convex above (or nearly flat), grayish to light or reddish horn colored, with rather regularly set membranous ribs and irregular microscopic striæ between them; nucleus with fine revolving lines; whorls  $3\frac{1}{2}$ , slightly flattened above and below the periphery, at the latter somewhat angular, with a deep suture, rather rapidly increasing; the last expanding near the aperture and shortly descending, more so at the suture than on the back; aperture rather inclined and oblique, almost circular, a little flattened above and angular at the base, with ends of margin much approximate, slightly protracted and auricled, connected by a thin callus; peristome strongly and abruptly everted, except near the suture, with a strong, white lip evanescent at either end.

Diam. maj. 2.5, min. 2.1, alt. 1.1 mm.



*Soft parts*: the foot is about as long as the diameter of the shell, quite transparent, a little more so than in *V. pulchella* and *excentrica*. The jaw, Pl. VIII, fig. N, is rather strongly curved moderately high, stout, chestnut colored in the inferior part, with 16–18 rather strong ribs on the front side, leaving about  $\frac{1}{3}$  of either side at the end ribless and smooth. The cutting edge is denticulated, and sometimes appears a little more straight in the median part, but there is no projection. The lines of growth are distinctly visible. Width of jaw 0.25, height 0.088 mm.

The radula has 69–72 transverse rows of 27 (or 29) teeth. In the central the side cusps are very small, barely perceptible, and the side margins of the plate are curved up in nearly their entire length. There are 4 perfect laterals with the mesodont comparatively thin, the ectodont very small, scarcely half the size of the same in *V. excentrica*. The fifth makes the transition, but resembles rather the laterals, having a well-formed plate of attachment with a projecting posterior distal angle. Its mesodont shows an indication of its transformation and the ectodont is essentially simple, but, at least in some parts, with two points. The sixth or first marginal is somewhat triangular, and with a distinctly backward extended plate of attachment, and the reflection with 2 or 3 short distal cusps, as it is still in the following or seventh tooth. On the other marginals the cusps are comparatively small and stand immediately up on the bases. Length of the radula 0.71, width 0.22–0.23 mm.

*V. costata* is distributed over a wide geographical area, being found all over Europe, Northern Africa, and the most part of Asia. In North America it seems to occupy a wide area also, though it is not as common as *V. pulchella*. It has been cited from Philadelphia and Cincinnati. I have seen it from Washington, D. C., from Quebec, Canada, and Isle d'Orleans, near that city, collected by Mr. A. W. Hanham, also from Iowa, Nebraska, Kansas and Colorado. All reports of distribution must be received with reserve, and especially those from high altitudes in western North America, as under the name of *costata* doubtless different forms are comprised, such as *gracilicosta*, *parvula*, *cyclophorella* and others. It has also been found in Australia, by Cox, as reported by Brazier (Journ. Conch., 1879).\*

Until recently, and even now, *V. costata* has been considered a variety of *pulchella*. The characters of the shell, decidedly and

---

\* See Appendix.

**THIS PAGE IS LOCKED TO FREE MEMBERS**

Purchase full membership to immediately unlock this page

# DELVE INTO FANTASY, MAGIC, MYTHOLOGY & FOLKLORE

Forgotten Books'  
Full Membership gives  
access to 797,885 ancient  
and modern, fiction and  
non-fiction books.

**Continue**

\*Fair usage policy applies

specimens with a thin or wanting lip are likely to be either immature or erroneously identified. Occasionally the lip protrudes strongly with a sharp edge, beyond the level of the aperture, as it occurs also in *V. pulchella*.

The following forms are more distinct, and must be regarded as varieties:

*V. costata* var. *helvetica*, n.

Shell small, colorless, glassy-transparent, shining, with rather regularly set, stronger (yet fine) striæ, but without membranous ribs; umbilicus regularly spiral; diameter averaging 2.2 mm.

This is a very peculiar and beautiful *Vallonia*. It might be taken for a different species or for *pulchella*, but the deeper and, at the aperture, descending suture, the more approximate margins, and the regular though very fine rib-striæ, range it near *costata*. Those striæ are perceptible rather more by their being whitish in the glassy shell than by their size.

The originals were collected in 1882 on the Geissberg, Jura Mountains, near Brugg, Switzerland, by Dr. R. Hæusler. After the description, it is hardly necessary to add that they were quite fresh, not weathered; the epiconch, though very thin, was not wanting. In drift on the Aar River, then being in the Jura range, I found some more specimens the same year, together with *V. pulchella*, *declivis*, typical *costata*, and intermediate specimens between the latter and the present variety.

*V. costata* var. *amurensis*, n. Man. Conch., Pl. 33, figs. 50-52.

Shell small; umbilicus rather regular, wide perspective from the first volutions; spire nearly flat; ribs strong and distant, about 22 on the last volution; last whorl very little or not at all descending on the back; color deep horn; diameter 2.2 mm.

The specimens are from Kassakewitsch on the Amur (Northeastern Asia) and were kindly forwarded by MM. O. Staudinger and A. Bang-Haas.

*V. costata* var. *pyrenaica*, n.

Shell large; umbilicus wide, perspective rather regular; whorls 4, more gradually and regularly increasing than in the type, the last less expanding at the aperture, moderately or not at all descending in toto; ribs small, hardly membranous. The outline is somewhat peculiar: there is a slight angle in the circumference of the last whorl about  $\frac{1}{5}$  volution above the aperture, much as in *V.*

*cyclophorella* (Man. Conch., Pl. 33, fig. 30). Diam. 2·6–2·8 mm. It is a form decidedly different from the type, but, as it seems, connected by intermediate specimens..

Pyrenees (Acad. Coll.; see under *V. perspectiva*, p. 271).

*V. costata* var. *montana*, n.

Shell rather small and thick, colorless translucent, a little opaque, spire a little elevated; surface with rather crowded rib-striæ, but without membranous ribs; last whorl slightly and gradually ascending, not at all or very little descending to the aperture in toto, shortly and decidedly at the suture; lip very strong.

There are two specimens, not quite fresh, in the Acad. Coll., marked "*H. minuta* Say, Rocky Mts., E. Hall," with the above characteristics. They cannot be ranged under typical *costata*, yet they have the general appearance of that species, so that they may be placed as a variety under it until more and better specimens are obtained.

6. *V. albula* n. sp., Pl. VIII, figs. D and O. Man. Conch. Pl. 33, figs. 48, 49.

About the middle of Nov., 1892, Mr. A. W. Hanham sent me a third lot of fresh *Vallonia* from St. Joseph, Quebec,<sup>24</sup> Canada. Among them were four beautiful examples, three of them living, which I first somewhat doubtfully referred to *V. gracilicosta*. After repeated comparison I find that they differ essentially from this species. I cannot, with certainty, range them under any other.

The shell is rather large, 2·7–2·8 mm. gr. diam., whitish translucent, with a somewhat elevated spire; whorls 3½–4; the last whorl and aperture are rather well rounded, the latter resembling that of *costata*. The lip is moderately strong. The ribs of the shell are distinct but small, crowded, about 55 on the last whorl, and bearing fine membranes which give the surface a beautiful silky gloss as in some *cyclophorella*. There are differences in the elevation of the spire and the ascending of the last whorl among the four specimens, as is the case in most other forms.

In outer aspect the soft parts are much like those of other species. The liver is pale yellowish or horn colored. The jaw and especially the radula show some peculiarities, both being comparatively large. The jaw is 0·31 mm. wide, of pale horn color, and appears some-

<sup>24</sup> Mr. Hanham's assiduous collecting brought to our knowledge four different *Vallonia* from the vicinity of Quebec: *pulchella*, *excentrica*, *costata*, and the one under consideration.

what thin and flexible, with rather crowded, strong, irregular rib-striæ, evanescent toward the upper and strongly denticulating the cutting edge; the posterior duplicature appears also rather thin and soft; Pl. VIII, fig. O, shows it extended by pressure.

I could not measure exactly the length of the radula nor count the transverse rows in the specimen examined; it is 0.27 mm. wide. Formula R: 4+2:10 (11); there are, consequently, 33 (35) teeth, the highest number seen in a *Vallonia*. The central tooth is of common shape, rather wide but not much wider posteriorly, its lateral edges curved up for the most part of their length. On the 4 perfect laterals the cusps are stout; the fifth and sixth are transition teeth having a smaller though distinct plate, but with hardly projecting posterior distal angle. Their mesodonts are marked of the formation pointed out in the general description, while the ectodonts are simple in most, finely two-pointed in some interspersed teeth. Of all laterals the ectodonts are larger than the same in *V. costata*. The marginals are as usual, but with comparatively few cusps. The seventh tooth from the center is a true marginal in its whole configuration, though with only 2-3 short distal cusps; here the transition from laterals to marginals is more abrupt than in any other species seen. The last marginals (1-2) are quite small and with hardly any perceptible cusps.

The shell is related on one side to *costata*, on the other to *cyclophorella*, and seems to be intermediate. It resembles the latter in its size and general appearance, the umbilicus being rather wide and considerably expanding for the last  $\frac{1}{2}$  whorl, the latter distinctly ascending before descending; in the fine dense ribs, which are stronger and sharper on the shell itself and bear smaller membranes than in *costata* and in the coloration. It has, however, some features allying it to *costata*—the aperture although less transversely elongated, is not circular. The presence of a lip is characteristic, and the peristome is rather abruptly and strongly everted, as in *costata*. These characters, together with the formation of the jaw and radula place this *Vallonia* in a peculiar position. I regard it as a distinct species, for which I propose the name *albula*, because of its whitish shell.

Mr. Geo. W. Taylor, of Victoria, B. C., sent me recently a few *Vallonia* for examination, among which there was one specimen from the Rocky Mountains, B. C., resembling in size and shape the Quebec specimens, although it was weathered and had lost its epi-

**THIS PAGE IS LOCKED TO FREE MEMBERS**

Purchase full membership to immediately unlock this page

# Know Your Bible

Forgotten Books' Full Membership provides unlimited access to more than 28,000 volumes of Christian literature for \$8.99/month

**HOLY BIBLE**

**Continue**

\*Fair use policy applies

the plate of attachment. A radula was 0.58 mm. long, 0.2 wide, thus one transverse row measures about 0.009 mm. in length.

The ganglia are described above.

This is a North American species, occurring apparently almost exclusively in the prairie States. I have seen specimens from Joliet and Ottawa, Illinois; Davenport and Bonair, Iowa; numerous examples in drift on the Missouri River, collected at Eastport, Iowa, together with *V. costata* and a few *perspectiva*; Nebraska; Wichita, Kansas; Indian Territory. Doubtless many of them are in collections under the name *costata*, etc.

*V. parvula* much resembles *costata*, but it is decidedly and constantly smaller, having scarcely half the bulk of the latter, and distinguished by the comparatively wider umbilicus and by the last whorl not descending, the peristome, as a rule, being quite straight on the back to margin, as shown in Man. Conch., Pl. 32, fig. 25. Sometimes it is gradually and slightly ascending, as in *V. costata*, *pulchella*, *excentrica*. Never have I seen a doubtful specimen between *parvula* and *costata*, and they inhabit the same region. Our species also resemble *perspectiva* in color, size and presence of the ribs; the differences will be pointed out in connection with the latter species.

*V. parvula* shows a little variation. The average size is scarcely 2.0 mm.; one is found with 2.1, but some are as small as 1.7. The lip is almost always comparatively strong, and the aperture always rather circular, sometimes as shown in fig. 26. One specimen from Bird's Bridge, Will County, Illinois, among about eight which I owe to the kindness of Mr. Ferriss, has the last whorl descending, the peristome continuous and free from the penultimate, thus resembling *V. perspectiva*; but the strong lip and the rather circular, not transversely elongate aperture characterize it as *parvula*. The abnormality may be caused by a breakage, as in other species.

For a time I regarded this *Vallonia* as *americana* of Ancy (ms.) Mr. Theo. D. A. Cockerell kindly furnished me a copy of Ancy's ms. description which I communicate here: *V. americana* differs from *cyclophorella* by its "taille plus faible, son ombilic très-grand aussi [?] et fortement dilaté au dernier tour, ses tours à croissance plus rapide, et en nombre moindre (3¼ seulement) son dernier tour nullement descendant, plus ample à sa terminaison, son péristome fortement épaissi, son ouverture à bords distants et beaucoup plus grand," etc. From *costata* it differs "par l'ampleur de son dernier

tour vers l'ouverture, le caractère de son ombilic qui est aussi un peu plus grand; la croissance plus rapide des tours qui sont un peu moins nombreux, enfin par sa taille plus faible." The size is not given.

This description would fairly well correspond with *V. parvula*, but for one point. Ancey says: "son ouverture à bords distant," while in our species they are much approximate, even more so than in *costata* and in *cyclophorella*. We can hardly understand how Ancey would characterize *V. americana* by comparing it with *cyclophorella* if it were the present species, since the two are very different. There is no description of the color or the structure of the surface. I did not succeed in procuring specimens for comparison.

There is a note in Mr. Cockerell's letter worth communicating: "*costata* var. *minor*—very small, diam.  $1\frac{1}{2}$ – $1\frac{3}{4}$  mm., compact, aperture round, ribs very prominent." This small form, which may, perhaps, fall as a subvariety under *americana*, was found by Mr. D. B. Cockerell at Niagara Falls, on the Canadian side. When sending it to me he remarked: "The only place I found this variety was on the Canadian side, although the type was common everywhere else but where I found var. *costata*." I confess that the meaning of the last sentence is somewhat obscure to me. But the fact is stated of the existence of a small costate form in that locality. Any conchologists visiting Niagara Falls should be on the lookout for this *Vallonia*, as well as for others. Mr. Cockerell wrote me that the specimens in question had been accidentally destroyed.

#### 8. *V. tenera* Reinhard.

*Hel. tenera* Reinhard, Jahrb. D. Mal. Ges., 1877, p. 322, T. XI, f. 4.

(?) *Hel. pulchellula* Heude, Moll. Terr. Fl. Bleu, 1882, p. 20, T. 8, f. 17.<sup>27</sup>

(?) *Hel. pulchellula* Hilber, Sitzungsber. K. Acad. Wiss. Wien, LXXXVI, p. 3.<sup>27</sup>

(?) *Hel. pulchellula* O. v. Moellendorff, Jahrb. D. Mal. Ges., 1884, p. 315.

Unfortunately, the original descriptions are not accessible to me. From two authentic specimens in the collection of the Academy, fresh and evidently mature, or nearly so, we can characterize *V. tenera* as follows:

Shell rather small and of the general appearance of *V. costata*, with spire little elevated, very depressed, conic, light grayish horn colored, thin and transparent, somewhat shining; surface with rather fine and dense membranous ribs, about 33–43 on the last whorl; umbilicus rather wide and regular, a little more widened for

<sup>27</sup> Cited from Moellendorff, *l. c.*



the last  $\frac{1}{2}$  whorl; whorls rather more than  $3\frac{1}{2}$ , regularly increasing, a little angular at the periphery, with a rather deep suture, the last moderately wide, distinctly flattened above and sloping outward, somewhat expanding toward the aperture, ascending before, moderately descending in front, a little more so at the suture; aperture very oblique and inclined, transversely elongate, markedly flattened above, moderately curved below (not subangular) somewhat angular at the periphery, margins approximate, the superior more advancing in front than the inferior; peristome, except above, moderately and abruptly everted with a rather thin, almost glassy transparent, hardly white, lip.

Diam. maj. 2.3 (2.2) min. 1.9, alt. 1.0 mm.

Soft parts not examined.

Shanghai, China; Kobi, Nippon, Japan (Acad. Coll.) Dunca Yosky, (?) Japan, (Nat. Mus. Coll.).

As far as I can judge from the few specimens seen, I believe *V. tenera* Reinh. is a well-characterized species.

To the kindness of Dr. O. v. Møllendorff, I owe three specimens of *V. pulchellula* Heude, from Shanghai, China. One of them has a diam. maj. of 2.3, the others of scarcely 2.2 mm.; the former corresponds exactly with those of *tenera* Reinh., described above, while the two smaller ones are somewhat different in coloration, which is rather yellowish horn, and in their umbilicus being a little narrower in the upper part and then more rapidly widening. In the collection of the Academy there are two specimens of *V. pulchellula* Hde. from China said to be authentic; one although not quite mature, agrees in every particular, as far as it goes, with *V. tenera*; the other is not quite fresh, diam. scarcely 2.2, and here also the umbilicus is first a little narrower and more rapidly widens in the latter part; the lip is quite thin, though distinct, the coloration somewhat indistinctly yellowish horn, the spire somewhat more elevated, and the last whorl descending very slowly, yet the suture being below the periphery at the aperture. This form is represented in Man. Conch., Pl. 33, fig. 53.

From all this we may conclude that *V. pulchellula* Hde. is not specifically distinct from *tenera* Reinh., the latter name having priority. The somewhat different form noted above, and rather closely corresponding in the two lots, which possibly or even probably, are from the same place, may represent a var. *pulchellula* Hde., if they agree with the original description, which I have not

**THIS PAGE IS LOCKED TO FREE MEMBERS**

Purchase full membership to immediately unlock this page

# DELVE INTO FANTASY, MAGIC, MYTHOLOGY & FOLKLORE

Forgotten Books'  
Full Membership gives  
access to 797,885 ancient  
and modern, fiction and  
non-fiction books.

**Continue**

\*Fair usage policy applies

Collected on the Little Missouri, by MM. Krause. (Orig. descr., translated).

I have seen no authentic examples of this species. But there are four fresh specimens of a form from Logan Canyon, Utah, collected by Mr. Henry Hemphill, in the collection of the Academy labelled "*H. pulchella* var. *costata* Müll.," certainly not *costata*, but which I take to be *V. gracilicosta*, as they rather conform to the description.

The spire is quite low, but distinctly conic. The ribs of the shell itself are rather regular, about 40 on the last whorl, without membranous appendages. Such are not worn off, since there is no trace of them to be seen at the suture or umbilical part. Nucleus with indistinct microscopic revolving lines. The last whorl is slightly flattened above and below the periphery, thus being somewhat angular at the periphery and base, in its last  $\frac{1}{4}$  slightly but distinctly ascending before it descends in front, somewhat more at the suture. Aperture of the form given in the above description, appearing slightly triangular. Diam. 2.6 mm.

A corresponding lot of four specimens from the same place and the same collector is in the National Museum Collection.

Near the preceding we have to range some fossil forms. In the southern part of New Mexico, near Eddy, in a dry "Salt Lake," some fine quartz sand with numerous minute fossil, or semi-fossil shells, was collected by a party of the Texas Geological Survey. The shells were picked out and kindly forwarded to me for examination by Mr. J. A. Singley. There were about fourteen land and fresh water species, extremely fragile and bleached. Among them was a number of *Vallonia* which I then named *costata* var., but they differ from that species in the more elevated spire, the last whorl markedly ascending, and the surface rather densely and somewhat irregularly striate, quite unlike *costata*. Whether they had membranous ribs when fresh, it is, of course, impossible to tell, but, from analogy with recent forms, it is probable that they had.

Two specimens, much like those from Eddy, were found among a number of minute land and fresh water shells in the same condition and with the same white quartz sand seen by Mr. W. F. Cummins, of the Texas Geological Survey, in Osborn's Julia Canyon, N. W. Texas, near the top of the bluff.

Both these finds are said to be quaternary, and it is believed that the species are not represented in the recent fauna of that part of the country. As a whole they suggest parts of a more northern fauna. A list of them will be published in another article.

Further studies of more material of all these forms will be necessary.†

11. *V. perspectiva*, n. sp.,<sup>29</sup> Pl. VIII, fig. F. Man. Conch., Pl. 33, fig. 39-46.

Shell small, with very wide perspective umbilicus, more widening for the last  $\frac{1}{2}$  whorl, flat, or a little elevated above, with rather dense, somewhat regularly set, moderately strong membranous ribs (about 35 on the last whorl) and with finer striæ between them; nucleus without revolving lines; pale horn to colorless, thin, translucent; whorls  $3\frac{1}{2}$ , gradually increasing, a little flattened above and below the periphery, with a deep suture, the last rounded, comparatively narrow, little expanding toward the aperture, rather rapidly descending in toto; aperture very inclined and oblique, almost tangential, transversely (short) ovoid or oblong; peristome continuous, shortly but not abruptly everted except near the suture, without (or with a very thin) lip.

Diam. maj. 2.0, min. 1.7, alt. 0.7 mm.

*Soft parts* as usual in the genus; the liver, as seen through the shell, appears grayish brown. Jaw slightly arcuate, with rather fine irregular ribs. Radula with 77 transverse rows of 25 teeth: R: 3+2:7. There are 3 perfect laterals and the fourth resembles them closely, yet forms the transition from laterals to marginals, and even the fifth might rather range with the former, as its plate is distinct though small; its ectodont is two-pointed, and the peculiarly-formed mesodont rather long. The sixth is a marginal, with 2 distal cusps; the other marginals are wide and short, with 4 to 6 slender cusps, the mesodont being moderately longer than the others. The last 1 or 2 are very small, and their cusps indistinct even when highly magnified.

This is a North American species, which I saw first from Knoxville, Tennessee, where it had been collected by Mrs. Judge Andrews in damp moss on the cliffs above the Holston River. Later it was found in Jackson County, Alabama, by Mr. H. E. Sargent, and, among the specimens sent, there were a few living, so that I could observe the animal and examine at least the jaw and radula. Doubtless our species will be found at more localities in the Appalachian Mountains. In the Missouri River drift, from Eastport, Iowa, mentioned under *V. parvula*, there were four examples of this species, somewhat small, 1.8 and 1.9 mm. diam.

---

\*See Appendix.

<sup>29</sup> S. notice in "Nautilus," V, No. 4, p. 101.

Those from Tennessee and Alabama show some slight variation. The size is from 1.7–2.1 mm. gr. diam., 2.0 being the average. On some specimens the aperture is not pear shaped as in most, but rather broadly rounded at the left side, as shown in Man. Conch., Pl. 33, fig. 44. There is also some difference in the more or less strongly everted peristome. A few specimens from Alabama show a thin lip, but from its appearance it seems to be caused by some disease.

*V. perspectiva* can not be mistaken for any other species except *parvula*, which it resembles in size, coloration and the membranous ribs. But it is sufficiently distinguished by the wider umbilicus, the comparatively narrow last whorl, less expanding and descending in toto to the aperture, which is smaller and not circular; the continuous peristome and the absence of a lip. It holds a singular position also among the species with strongly descending last whorl and transversely elongated aperture by the comparatively more distant and regularly standing membranous ribs, and its small size.

12. *V. cyclophorella* Ancy, Pl. VIII, f. E. Man. Conch., Pl. 33, f. 34–38, Pl. 32, f. 29.

“Resembles *tenuilabris* A. Braun, in its rather slight peristome, and *costata* in its sculpture. Umbilicus large (about 1 mm. diam). Whorls about 4, the last depressed above. Costulations fine; aperture oblique, nearly round. Diam.  $2\frac{2}{3}$ , alt. 1 mm.” This description has been communicated by Mr. Theo. D. A. Cockerell, with the note: “*V. cyclophorella*, collected at West Cliff, Colorado, has the animal entirely translucent, white (except the dark eyes). The liver, seen through the shell, is red-brown.”

As noted, this species has been collected over a wide range of the Rocky Mountains, and is in collections under different names. Colorado: North Park, Ingersoll collection, received from Mr. J. H. Thomson; E. A. Barber, Aug., 1874, in collection of the Academy (as *V. minuta* Say), West Cliff, Mr. Cockerell; South Park; Utah: American Fork Canyon, J. D. Putnam; Montana: Helena, Mr. Henry Hemphill (in Acad. Coll.); Idaho; Wyoming: Fort Bridger, Dr. Jos. Leidy; Washington: Walla Walla, Mr. Hemphill; Nevada: Hamilton (in Nat. Mus. Coll.); New Mexico (or Arizona), in Nat. Mus. Coll.

The above description would be insufficient to characterize the species. By the kindness of Mr. Theo. D. A. Cockerell, who sent me some authentic specimens from Colorado, and Mr. J. A. Thomson, who presented me his examples, collected by Ingersoll, I was

**THIS PAGE IS LOCKED TO FREE MEMBERS**

Purchase full membership to immediately unlock this page

# Know Your Bible

Forgotten Books' Full Membership provides unlimited access to more than 28,000 volumes of Christian literature for \$8.99/month

**HOLY BIBLE**

**Continue**

\*Fair use policy applies

ually deep descending; suture rather impressed; aperture very oblique, little crescentic, transversely oval, rounded with the margins much approximate; peristome widened [everted], thinly lipped, yellowish horn-colored, inferior margin reflexed. Size 3 :  $2\frac{3}{4}$ –2 mm.

(Siberia : Jarzowa, Selo at  $60^{\circ} 10'$ , and Werschininski  $68^{\circ} 55'$ ; fossil in southern Germany.)” Translated from Westerlund, Fauna.

I have seen no recent Asiatic specimens. From Europe there is a fossil from Kroellwitz, near Halle on the Saale, Saxony. Ten specimens before me, obtained from two different parties under the name of *Hel. tenuilabris* A. Br., are nearly alike except for slight differences in size, represented in Man. Conch., Pl. 33, fig. 30–33. This is a shell probably well-known among European conchologists, but there are some characters which do not agree with the above description. They are in good condition, appearing remarkably fresh for fossils, more or less translucent, and in most the epiconch is preserved. The surface is rather finely striate, but not acutely ribbed. There is also no trace of a difference in coloration of the apertural part and the rest of the shell; this would, of course, be of little importance if the shells are weathered and opaque, but in the state of preservation they present, it is significant. The whole shell is equally colorless, and must have been glassy transparent when fresh. There is also no trace of a lip. The size is somewhat larger : greater diam. 3.1–3.3, lesser 2.4–2.6, alt. 1.7 mm.

From all this it is evident that the Kroellwitz shell can not be identical with *tenuilabris* as described. It would be hasty to take it for a different species before authentic specimens can be compared. We may eventually propose for the fossil the varietal name *saxoniana*. The last whorl is very distinctly ascending before it descends to the aperture, as shown in Man. Conch., Pl. 33, fig. 33; this is also seen from above (fig. 30). Very probably *V. tenuilabris* presents the same character; apex almost papilliform, which becomes apparent at once if we compare fig. 32. But this, as has been pointed out, appears to be a characteristic, not of a single species, but of a whole group. From its size, color and the ribbed surface we may conclude that *V. tenuilabris* is related to *V. cyclophorella*.

It has been noted above that I received another form under the name of *V. tenuilabris*, from Germany. This is of quite a different type (see under *V. declivis* p. 257).

14. *V. mionecton* Boettger.

*Hel. adela* West. var. *mionecton* Bttg, Zool. Jahrb. IV, 1889, T. 27, f. 11.

*Hel. tenuilabris* var. *mionecton* (Bttg.), West. Fauna, I. Supl. p. 120.

*Vallonia mionecton* Bttg, cit. in Nachr. Bl. D. Mal. Ges. 1892, p. 125 (O. Rosen.)

“Smaller, more depressed, almost regularly, very finely rib-striate; whorls only 3, the last, as also the upper margin of the peristome, somewhat angular above; size  $2\frac{3}{8}$ – $2\frac{1}{2}$  :  $1\frac{1}{8}$  mm. (Trans-Caucasia, on the summit of the Agh-dagh in the Kopet-dagh, at 9–10,000 feet). Dr. Boettger ranges this form under my *adela*, but the excellent figures show the last whorl much widened in front, deep descending above, margins much approximate, almost connected, etc.” From Westerlund, Fauna, *l. c.* translated.

In Baron O. Rosen’s article, evidently influenced by Dr. O. Boettger, *V. mionecton* is treated as a species, and published.

*V. mionecton* var. *schamhalensis* Rosen.

Differs from the type in the shell being smooth [*polita*] not rib-striate. Schambala, Prov. Chorassan, Persia.

I have seen no specimens of either the type or variety.

15. *V. ladacensis* Nevill.

Scient. Res. of the Sec. Yarkand Miss., Moll., p. 4—Mts. Centralasiat. Moll., 1882, p. 3, T. 3, f. 3.—Westerlund, Fauna, I, p. 15.

“Shell widely umbilicated, depressed, with little elevated spire, densely and finely ribbed (ribs sometimes almost obsolete), grayish white; whorls  $3\frac{1}{2}$ , somewhat convex, the last rounded, descending in front; aperture very oblique, transversely pear-shaped, peristome everted (“reflexed”), rather thin, with margins much approximate, inferior margin more curved. Size  $3\frac{1}{2}$  :  $1\frac{1}{2}$  m. (Central Asia, near Iskardo in Tibet).” Descr. from Westerlund, *l. c.* translated.

*V. ladacensis* var. (?) *asiatica* Nevill.

*Hel. costata* var. *asiatica* Nevill, *l. c.*

*Vall. ladacensis* var. *asiatica* Nevill, Reinhard, über die von den Herren Gebr. Krause auf ihrer Reise gesammelten Pupa-, Hyalina- und Vallonia-Arten; Sitzungsber. der Ges. Naturf. Freunde, Berlin, 1883, p. 42.

Reinhard says (*l. c.*) that on Pyramid Island, Alaska, a *Vallonia* has been collected by MM. Krause which is identical with *asiatica*, except for its somewhat smaller size. He states that the latter comes nearer *ladacensis* than *costata*, under which it has been ranged by the author. Mr. Pilsbry believes that the Alaska form is not the same as the Asiatic.



I have seen no specimens of either the type or the variety, which also has been regarded as a species, and am unable to judge about them.

KEY TO SPECIES OF VALLONIA.

It is necessarily difficult to give a synopsis of the species of *Val-lonia* based on the shell alone. The characters are quite interwoven among the groups and species, and several attempts to found natural groups upon one, or even a few prominent features proved to be failures. Yet there are such natural groups, though not well-defined, and the following table may serve to characterize them and the subordinate groups, at the same time affording a means of identifying specimens, definitely or approximately, without going over all the descriptions.

GROUP I (of *pulchella*). Aperture crescentic, forming  $\frac{4}{5}$  to  $\frac{5}{6}$  of a circle (not transversely elongated), with ends of margin distant, little or moderately inclined and oblique; suture not markedly descending to the aperture or not more so than the last whorl; shell of medium size; surface rarely or never ribbed; nucleus, as a rule, smooth (?).<sup>30</sup>

A. Last whorl not, or scarcely descending

1. Peristome with a strong white lip,

a. Peristome decidedly everted; shell and umbilicus rather symmetrical; surface finely striate *pulchella*.

aa. Peristome scarcely everted; shell and umbilicus elongate, surface smooth or very finely striate; spire small and low *excentrica*.

2. Peristome without a lip, little everted; whorls 4-4½ diam. 2.5-3 mm. *adela*.

B. Last whorl gradually and steadily descending in toto, peristome not everted; lip thin or wanting

1. Surface microscopically striate, appearing almost smooth; lip thin or wanting *declivis*.

2. Surface with fine membranous ribs, peristome straight and thin, without a lip *pollinensis*.

GROUP II (of *costata*). Aperture almost circular or transversely elongate, with margins approximate; peristome distinctly everted, with a white lip; last whorl moderately or not descending in front, suture more descending, surface (as a rule) with distinct ribs or rib-striæ.

<sup>30</sup> In *adela* and *pollinensis* the nucleus is unknown.

**THIS PAGE IS LOCKED TO FREE MEMBERS**

Purchase full membership to immediately unlock this page

# DELVE INTO FANTASY, MAGIC, MYTHOLOGY & FOLKLORE

Forgotten Books'  
Full Membership gives  
access to 797,885 ancient  
and modern, fiction and  
non-fiction books.

**Continue**

\*Fair usage policy applies

3. *V. adela* West.: Central Europe; fossil in Sweden.
- 3a. *V. declivis* Sterki: Central Europe.
4. *V. pollinensis* Paul.: Italy.
5. *V. costata* Müll.: circumboreal; Australia.
6. *V. albula* Sterki: Northern North America.
7. *V. parvula* Sterki: North America.
8. *V. tenera* Reinh.: China, Japan.
9. *V. patens* Reinh.: China.
10. *V. gracilicosta* Reinh.: Rocky Mountains.
11. *V. perspectiva* Sterki: North America.
12. *V. cyclophorella* Anc.: Western North America.
13. *V. tenuilabris* A. Br: Asia; fossil in Germany.
14. *V. mionecton* Bttg.: Western Asia.
15. *V. ladacensis* Nev.: Central Asia; Alaska.

## APPENDIX.

After this paper had been written, Mr. Wm. H. Dall kindly forwarded me many additional specimens of *Vallonia* from the National Museum. I would add the following notes upon them:—

*V. pulchella* Müll was largely represented from Madeira and Bermuda. The specimens from the latter locality are of a somewhat peculiar form, being composed of only three comparatively large whorls, the umbilicus is first quite narrow, rapidly widening for the last  $\frac{1}{2}$  whorl.

*V. excentrica* seems to be widely distributed in Great Britain, being represented from different places.

*V. costata*: The specimens assigned to this species reported from Iowa, Nebraska, etc., must be referred to the following, the distribution of which in the United States should be further studied.

*V. gracilicosta*. There was among the National Museum material over a hundred specimens from drift on the Missouri River, collected near Fort Berthold, Dak. They are all dead shells, yet some of them are in good condition, of 2.5–2.8 mm. diam. They, especially the smaller, somewhat resemble *V. costata*, while the fresh examples of the two lots from Utah mentioned above are decidedly different. As far as I am able to judge from the material seen, the two species are distinct, constantly differing in a number of points. In *V. gracilicosta*, also averaging larger, the whorls, especially the last, are more depressed above, the aperture is more inclined and oblique, much more curved below than above, and

somewhat angular at the periphery; the shells show distinct ribs and the membranous "ribs" upon them are quite small and fine, while in *costata* the ribs are quite small; the membranes are as a rule, coarse. In the former, the ribs are also more numerous, and more oblique, especially as seen from above. The lip, in fresh specimens, is pure white, never so in *costata*, and of a somewhat different form.

As said above, the specimens seen from the states west of the Mississippi, must be referred to *V. gracilicosta* instead of to *costata*.

#### EXPLANATION OF PLATE VIII.

(Plates 32 and 33 referred to throughout the text will be found in Pilsbry's continuation of Tryon's Manual of Conchology (2), VIII.)

Fig. A-F Radula, enlarged about 900 diam. The first laterals and last marginals are always represented, so that the last gives the number in the half transverse row.

Fig. A. Radula of *V. pulchella*; 3 is nearly like 4 in B.

Fig. B. Radula of *V. excentrica*.

Fig. C. Radula of *V. costata*.

Fig. D. Radula of *V. albula*.

Fig. E. Radula of *V. cyclophorella*.

Fig. F. Radula of *V. perspectiva*.

Fig. G. Radula of *V. pulchella*, the central and first lateral in the first (anterior) transverse rows, with cusps worn off.

Fig. H. Jaw of *V. pulchella* as seen under moderate enlargement, cutting-edge below, as in all figs: scale about 150 : 1.

Fig. I. The same, another specimen, enlarged nearly 300 diam.; a b the posterior plate, extending backward into the tenaculum membrane t t.

Fig. K. The same, another specimen, as seen in profile.

Fig. L. The same, median section (partially diagrammatic).

Fig. M. Jaw of *V. excentrica*.

Fig. N. Jaw of *V. costata*.

Fig. O. Jaw of *V. albula*, extended.

Fig. P. Central tooth of the radula (of *V. parvula*), half profile view.

Fig. R. One-half jaw of *V. parvula*, seen obliquely from above.

## JUNE 6.

Rev. HENRY C. McCOOK, D. D., Vice-President, in the chair.

Twenty-four persons present.

A paper entitled "Notes on the Physical Geography of Texas," by Ralph S. Tarr, was presented for publication.

The paper entitled "New and little known Paleozoic and Jurassic Fishes," by Edw. D. Cope, was ordered to be printed in the Journal.

## JUNE 13.

Rev. HENRY C. McCOOK, D. D., Vice-President, in the chair.

Thirty-eight persons present.

Papers under the following titles were presented for publication:—

"New North American Myxomycetes," by Geo. A. Rex, M. D.

"The Phylogeny of the Docoglossa," by W. H. Dall.

## JUNE 20.

Rev. HENRY C. McCOOK, D. D., Vice-President, in the chair.

Twenty-six persons present.

The death, May 29, 1893, of Prof. Carl Semper, a correspondent, was announced.

## JUNE 27.

Rev. HENRY C. McCOOK, D. D., Vice-President, in the chair.

Thirty-six persons present.

The death on the 25th inst., of James J. Levick, M. D., a member, was announced.

A paper entitled "Contributions to the Life-Histories of Plants, No. 9," by Thomas Meehan, was presented for publication.

*Note on the mechanism of the act of the expulsion of secretion from the anal sac in Mephitis.*—DR. HARRISON ALLEN invited attention to the anatomy of the anal region in *Mephitis*. Jeffries Wyman (Proc. Bost. Soc. Nat. History, 1844) briefly recorded the muscular nature of the act of propulsion of the secretion which was assigned

**THIS PAGE IS LOCKED TO FREE MEMBERS**

Purchase full membership to immediately unlock this page

# Know Your Bible

Forgotten Books' Full Membership provides unlimited access to more than 28,000 volumes of Christian literature for \$8.99/month

**HOLY BIBLE**

**Continue**

\*Fair use policy applies

DESCRIPTIONS OF TWO NEW SPECIES OF NORTH AMERICAN  
BOMBYCIDAE.

BY HERMAN STRECKER.

**Cossus Orc.**

♂ Light grayish. Antennæ pectinated. Head and thorax heavily clothed with coarse, dark brown and whitish scales; abdomen with grayish hair, beneath somewhat paler.

Primaries. Ground color light gray but more or less suffused with brownish especially on the basal two-thirds. The whole wing is striated, mottled might almost be the better term, with fine intersecting lines of various thickness which connect and interlace producing a curious and notable effect; there is a sort of submarginal jagged band (but scarcely deserving to be so-called) formed by the lines there being heavier; there is also conspicuous mottling interior to the middle of the wing produced by the same cause. The mottling, for it is more mottled than striated, is unlike that of any other species I know of whether native or foreign and will readily and strikingly distinguish this from all others. Secondaries gray, reticulated with fine lines, but with little of the tendency to semitransparency that is shown in some other species.

Expands  $2\frac{1}{4}$  inches.

The ♀ is like the ♂ but broader winged and expanding 3 inches. The antennæ but very slightly pectinated. This is a true *Cossus* nearer to the European *ligniperda* which it more resembles, except in the style of mottling of the wings, than any species occurring in this country.

Hab. State of Washington; captured by Prof. O. B. Johnson from whom I received it.

**Hepialus Los.**

Head and body unicolorous pale smoky gray, tarsi pinkish.

Primaries same color as head and body with four dark grayish-brown somewhat oval almost connected spots extending from costa at base obliquely to the inner margin about two-thirds the distance from the base, a small silver spot or dot is the second of these from the costa. On the inner margin another not so conspicuous spot, on the costa two spots or marks, one at the middle and the other interior to it, beyond the first of these, commencing at the costa, an irregular

band which extends inward half way between the costa and interior margin. A large subapical patch only partially separated from the broad exterior marginal band by a broken irregular patch of the paler ground color, this marginal band encloses a paler semi-band on the inner half, and a row of pale lunate spots on the margin which are largest at the anal angle and become smaller and more indistinct the nearer they approach the apex. All the dark spots, etc., are margined with a lighter color. In the centre of the subapical patch is a small round silver dot, on the marginal band interior to the latter two very small silver marks.

Secondaries almost uniform smoky gray, darker toward apex near which, touching outwardly on the costa, is a pale elongate mark. A row of indistinct lunules at exterior margin.

Expands nearly 4 inches. Taken near Bangor, Maine.

This differs from other known North American species which I here diagnose.

*Hepialus argenteomaculatus* Harris, Cat. Ins. Mass., p. 72, 1864.

A pale olivaceous species with darker bands, etc., inclining in part to a golden tinge, occurring from Maine to Wisconsin, and in Canada.

*H. argentata* Pack., Proc. Ent. Soc. Phil. III, p. 392, 1864.

I know only by the description which leaves little doubt but that it was founded on a dark example of the preceding.

*H. quadriguttatus* Grote, l. c., p. 73, t. 1, f. 6, 1864.

The large yellowish salmon colored species found in Maine and New Hampshire. In Can. Ent., Vol. XXV, p. 124, 1893, it has been claimed that this insect was never really described and that *Quadriguttatus* is synonymical with *argenteomaculatus*. On this assumption it was there described as *argent. var. semiauratus* n. v. but on looking carefully at Grote's description it will be seen that it fits the salmon colored species at least as well as the other and his figure undoubtedly represents that one. His description says plainly "Posterior wings entirely pale salmon color" etc. "Abdomen pale salmon color"; etc. "Under surface of both wings tinged with salmon color." Now none of this applies to *argenteomaculatus* which has grayish or pale ochraceous brown posterior wings and abdomen, and whose under surface is also ochraceous or brown, varying in depth of color in different examples but entirely destitute of any indication of the fleshy red tint known as salmon-color—from this it seems



easily to be seen that there are very insufficient if any grounds for the sinking of Grote's name, or for making this, his species, a var. of Harris', as any one will see by comparing a suite of the two that they are very different in size and color and in markings, as much as is the case with species of the same group in this interesting family. I have received *argenteomaculatus* from Maine, Canada, New York, Michigan, Illinois and Wisconsin. *Quadriguttatus* only from White Mts. of New Hampshire and Maine. In the last named State the two occur at same time and in same localities.

*H. purpurascens* Pack., Bost. Jour. Nat. Hist., p. 598, 1863.

Unknown probably save from the type and description. I have never seen the former, but from the description it must be a large species ("expands 4.20 inches") unique in appearance it being described as "dark sable brown with irregular bands of silvery purple. Head and body deep sable brown", etc. It was "captured by Mr. S. H. Scudder at the base of Mt. Washington" and is a ♀.

*H. thule* Streck., Lep. Rhop. Het, p. 105, t. XII, f. 6, 1875.

A large white species with but little of the usual ornamentation on primaries and that little confined mostly to inner half of costal part. The type was taken in a park in Montreal by the late Mr. F. B. Caulfield of that city from whom I received it. Another was taken later, I think near the same city, and a third one was captured in Wisconsin. The remaining species of North American Hepialidæ of small size and, excepting *auratus* Grote, are inconspicuous insects presenting little affinity in appearance to those here enumerated.

**THIS PAGE IS LOCKED TO FREE MEMBERS**

Purchase full membership to immediately unlock this page

# DELVE INTO FANTASY, MAGIC, MYTHOLOGY & FOLKLORE

Forgotten Books'  
Full Membership gives  
access to 797,885 ancient  
and modern, fiction and  
non-fiction books.

**Continue**

\*Fair usage policy applies

remain in any of the three groups, and whether most ancient or not, so far as these characters go the *Lepetidæ* are nearest to the Protolimpet.

In my work on the Blake Mollusks (II, p. 436) I said that *Acmæidæ*, of all the groups of *Docoglossa*, is the most typical; that is, within the limits of that family are found assembled, sometimes in one and the same animal, the greatest number of organs which taken singly are characteristic of *Docoglossa*. This is strictly true, but Dr. Thiele (Gebiss, p. 340, vol. II) has mistranslated me to the extent of saying that I have regarded the *Acmæidæ* as the most "primitive" group, in opposition to my earlier views; which is quite inaccurate. I have in the Blake Gastropods (p. 436-7) shown why the *Patellidæ* may reasonably be regarded as derived from *Acmæidæ*, the original ctenidia having been wholly lost. The row of lamellæ within the mantle edge have taken up the branchial function and in some species, as in *Ancistomesus*, become arborescent proliferations. The branchial cordon is occasional in *Acmæidæ*, I have seen it complete in *Scurria mesoleuca*; it is present but incomplete in the common *Lottia gigantea* of California; and even if Dr. Thiele was correct in supposing that it was absent in *Scurria scurra* there would still be no ground for his conclusion that its absence in the latter species indicates a failure of the grounds upon which I united in one group, as *Proteobranchiata*, the *Acmæidæ* and *Patellidæ*.

But there is excellent reason for believing Dr. Thiele to have been misled by an exceptionally contracted specimen of *Scurria scurra* and to be entirely wrong in his conclusion that the species is without a branchial cordon. The latter is figured and described by Orbigny from living specimens (Am. Mér., p. 478, pl. 64, figs. 11-14). I have seen sketches by Couthouy made from life fully confirming Orbigny, and lastly I have seen, but do not now remember where, an alcoholic specimen which showed them clearly. Dr. Thiele's specimen only appeared "etwas wulstig," somewhat puffed up, in the place where the cordon should be, but there can be no doubt that this puffing up simply represented the alcoholically contracted lamellæ of the cordon, rendered indistinct by improper preparation.

Many of the minor details in which Dr. Thiele's observations differ from mine may be reasonably explained by the variation which is exhibited by individuals; and my chief criticism upon what is, in the main, a praiseworthy and useful work is that Dr. Thiele has failed to take account of this factor, which more extensive experience

with the radula of a single species would have undoubtedly revealed to him. The result has been, not only has he estimated too highly the constancy of minor details of the radula in single species, but he has made an excessive number of so-called "generic" distinctions, the names of which in many cases will simply enlarge our catalogues of synonyms.

In conclusion I may point out that the relations of the radula in *Lepetella* to that of *Lepeta*, etc., offer additional reasons for thinking that the *Lepetidæ* are of the limpets those most nearly allied to normal or more usual types of gastropods, and also that the similarity of the shell of the silurian *Tryblidium* to that of some recent limpets (*Olana*, etc.) by no means authorizes us to conclude that the soft parts of *Tryblidium* were also similar to those of recent *Patellidæ*. Indeed, when the almost incalculable length of time intervening between our days and the Silurian is considered, together with the similarity of recent limpet shells which are secreted by widely different animals, it is almost inconceivable that the Silurian form should have any closely allied recent representative. The rhythmical manner in which the adductor scars of *Tryblidium* are arranged in pairs, clearly indicates a peculiar disposition of the organs which might, indeed, have paralleled in some particulars the organization of some of the *Chitons* of that ancient time.

• For the rest, many of the ancient limpets are represented by shells which might well have belonged to *Lepeta* or *Acmæa*, yet of the relations of which, as in the case of many recent limpets, we are not permitted to arrive at any dogmatic opinion for want of the requisite data, a deficiency which, in the case of the fossils, must remain forever unsupplied.

JULY 4.

Rev. HENRY C. McCOOK, D. D., Vice-President, in the chair.

Five persons present.

---

JULY 11.

Rev. HENRY C. McCOOK, D. D., Vice-President, in the chair.

Nineteen persons present.

---

JULY 18.

GEORGE H. HORN, M. D., in the chair.

Ten persons present.

---

JULY 25.

GEORGE H. HORN, M. D., in the chair.

Thirteen persons present.

Miss Maria Blanchard, Miss Harriet Blanchard and Miss Anna Blanchard were elected members.

Dr. O. Boettger of Frankfurt a. M., Germany, Dr. H. von Ihering of Rio Grande do Sul, Brazil, and Charles Hedley of Sydney, N. S. W., were elected Correspondents.

The following was ordered to be printed:—

**THIS PAGE IS LOCKED TO FREE MEMBERS**

Purchase full membership to immediately unlock this page

# Know Your Bible

Forgotten Books' Full Membership provides unlimited access to more than 28,000 volumes of Christian literature for \$8.99/month

**HOLY BIBLE**

**Continue**

\*Fair use policy applies

study of the plant at Seal Harbor, Maine, on July 9th seemed to make its peculiarity clear.

It may first be noted that when a leaf starts from its parent stem we may look for a bud in the axis. If a leaf be present without an axillary bud, we conclude that there has been or ought to have been one, and look for some reason for the seemingly abnormal condition.

As already noted by the author, the common peduncle opposite to a leaf in Boraginaceous and other plants, means simply that the arrested axis has been pushed aside by the strongly developed growth of the axillary bud, which then assumes the leadership until "history repeats itself," and it also is pushed aside to make way for a new leader. But *Mertensia maritima* does not seem to follow this rule, and seems wholly exceptional. Everything proceeds for awhile in the usual way. The leaves are all alternate as a well-behaved Boraginaceous plant should be. But when in the flowering stage there are a pair of opposite leaves, and at the same node, three branches—one bearing flowers, and the other two continuing each an axial growth. How is it possible that three axial growths should have been developed from only a pair of leaves?

When these leaves are carefully examined, however, the axillary buds are found to be still there. They have not followed the Boraginaceous habit of pushing at once into growth, and, assuming leadership, pushing the parent shoot aside. The pair of leaves are not exactly opposite, and the branch bearing the flowers seems to occupy a space of its own on the stem, between the pair of leaves.

#### DICOTOMOUS BRANCHING IN SPERGULARIA MEDIA.

Noting that every flower was abundantly fertile, and suspecting from this fact self-fertilization, investigation followed and it was found that the pollen is shed just at the time of opening, thoroughly covering the stigmas, and absolutely insuring self-fertilization.

Comparing the inflorescence with some Boraginaceæ nearby, along the coast at Seal Harbor, an interesting lesson is taught as to how the dichotomous arrangement is produced from the opposite leaved, and the extra-axillary from the alternate leaved character, respectively. In *Spergularia media*, when the arrestation of axial growth occurs previous to the advent of the floral condition, the next pair of axillary buds start at once into growth and we thus have two actual centers of axillary growth, the arrested

flower branch remaining in the dichotomous fork. In *Boraginaceæ* with its alternate leaved system, there is but a single bud to push into growth and become the main axis, which it does, pushing the arrested flowering branch wholly to one side, and which, in technical language becomes extra-axillary.

#### MISSING VIRTICEL IN *GLAUX MARITIMA*.

Examining on July 14th at Seal Harbor some specimens of *Glaux maritima*, commenting on the well known and remarkable alternation of the stamens with the lobes of the calyx, a friend remarked that this arrangement would necessitate the lobes of the corolla being opposite the lobes of the calyx if the flowers had not been apetalous, which would be an anomaly in floral structure. But as the stamens in *Primulaceæ* are opposite the lobes of the corolla, we might naturally look for the same phenomenon in *Glaux* had the corolla been developed. Yet there is one point in this connection worth noting. In *Samolus* and some allied genera there are imperfect anthers in between the lobes of the corolla, and the opposite stamens are therefore easily accounted for when we understand that a series between them and the corolla has been suppressed. The position of the stamens alternate with the sepals in *Glaux*, again proves the existence of two series, as the suppression of both would bring the stamens just where they are between the lobes of the calyx. Another point is that the ease with which the outer series of stamens, united with the corolla in *Primulaceæ* generally, has been suppressed, causes no surprise when we see the corolla itself wholly suppressed in *Glaux*.

The tendency to suppression of parts and general irregularity is particularly striking in this genus. Though I examined many flowers of this plant on the north Pacific coast, I did not note any that were not 5-lobed and 5-stamened. Fully one-fourth of the flowers at Seal Harbor were tetramerous.

The irregularity of the leaves is well known—opposite until the flowering stage is reached, when they become alternate and frequently three-whorled.

Every flower is fertile; but all the flowers I could examine were expanded, and afforded no opportunity to observe the condition of affairs before opening.

Morphology is much aided by a study of the acceleration and arrestation of parts in erratic plants like these, and I regretted



that my opportunities for further observations on this plant were so limited. It affords a promising field for others more fortunate.

### THE RELATION BETWEEN RHYTHMIC GROWTH AND VARIETY IN CITRUS FRUITS.

The recognition that growth is rhythmic, and not one continuous act, affords a ready explanation of many phenomena otherwise inexplicable; and this is well illustrated by a comparison of various forms of fruit in the orange and other varieties of the citrus tribe.

Occasionally an orange may be found wholly formed inside of another orange, and more frequently an orange will be found projecting from the apex of another—that is, but partially enclosed—while in another which has been propagated as a distinct variety and called the Navel orange, a very small attempt to form another fruit at the apex is generally seen giving the navel or umbilical appearance from which the variety derives its name.

The morphological unity of the foliaceous and floral parts of a plant being conceded, we conceive of the axis as being arrested in its longitudinal development when a flower is being formed. In most oranges we find the axis still extending a considerable distance into the fruit, but varying very much in consistency in different varieties. Sometimes it is quite woody, in others it is found cellular and so soft that it can be compressed between finger and thumb; while in some—notably in a variety known as the Tangerine—there is rarely but a few lines of axis, usually no axis at all.

The rhythmic waves of growth are not all of equal measure. As in jumping a ditch, a boy may now rest exactly where he lands, and now have to continue several paces before final rest, so does the wave force in growth vary in intensity. In the process of the metamorphosis of a branch with its various nodes into a flower and finally a fruit, the expenditure of force in the arrestation of axial growth and the development of the appendages to petals, stamens and carpels is exactly meted to the results—now it is short of the mark, and the axis starts under another rhythmic movement the next time to be arrested for good and all.

It is this succession of growth rhythms that produces the double fruit oranges, but the phenomenon is not confined to the citrus tribe. In the formation of cones in the coniferous family the branch in its axial growth is usually wholly suppressed; but occa-

**THIS PAGE IS LOCKED TO FREE MEMBERS**

Purchase full membership to immediately unlock this page

# DELVE INTO FANTASY, MAGIC, MYTHOLOGY & FOLKLORE

Forgotten Books'  
Full Membership gives  
access to 797,885 ancient  
and modern, fiction and  
non-fiction books.

**Continue**

\*Fair usage policy applies

strate this as an actual fact as in the case of the orange, but I feel sure some one may meet with an abnormal specimen which will prove the point.

The varying intensity of rhythmic waves of growth may come to be regarded as a leading factor in the development of form. These waves certainly have to do with the varying sexual characters of trees, as I have shown in other papers. The fact brings us near to a certain knowledge of the origin of form, though we have still to learn what causes the variations in the intensity of these waves. Even in these different forms of citrus fruits the varying forces affect fertility. In the case of the Tangerine orange, in which the secondary rhythm has been accelerated to such an extent as to cause abortion in the whole of the lower carpellary system, the seeds necessarily are not formed. In the case of the Navel, where the secondary wave has only drawn part of the force from the lower, it usually results in so much weakening of the latter's power that few or no seeds result. The Navel is usually a seedless fruit.

#### MORPHOLOGY OF THE STIPULE IN *COMARUM PALUSTRE*.

I have claimed that when axial growth is arrested to form the inflorescence, a suppression of leaf-blade, and a corresponding development of stipule or dilated petiole usually occurs in the morphological conception of a flower. In other words, instead of petals and sepals being metamorphosed leaves, they are more critically metamorphosed stipules.

This is well illustrated in *Comarum palustre*. Examining a branch we find only a stipule at the lowermost node. Ultimately a leaf with two pairs of leaflets and one odd one. Then growth becomes suppressed as the flowering stage approaches. The next node has the leaf trifoliate, the next with only a single terminal leaflet, the next with the stipule only. It is seen that all the next nodes have stipules only and the sepals are but stipules. I have before noted that *Rosaceæ* afford the best illustration of the fact that petals are but enlarged and modified stipules, and not transformed "leaves" as generally understood.

#### FERTILIZATION OF *MALVA ROTUNDIFOLIA*.

Prof. Herman Mueller, in his work on cross-fertilization of flowers, indicates that *Malva rotundifolia* invariably fertilizes itself in case insects should not visit the flower in its earliest stages. Unless, as I think may be the case, flowers behave differently in

one stage of growth, or at one season, from another, I must conclude that it is fertilized before expansion, and that insects in no way assist the operation.

Early in October I noticed a plant, five feet in diameter, that had evidently been blooming for months previously. It had many hundreds of capsules, and there were no indications that a single flower had failed to be fertile. With my own proposition before me that perfect fertility indicates close fertilization, I was led to place the plant under close observation many times a day for a week.

During all this time I did not notice a single insect visitor. Watching the plant a few times by night, no nocturnal visitors were seen. At seasons more pregnant with insect life the plant would no doubt be visited, for no flower is slighted in case of necessity by honey or pollen gatherers. There were none at this time, but the seeding was still going on, and continued till the first severe frost in December. It can be surely stated as a matter of fact, that there were no insect visitors during the last half of the season, and yet the plant was abundantly and unfailingly fertile.

An interesting result of my close observation was the discovery of three great periods of rest and of growth-resumption during anthesis. In the early morning of one day is seen the folded pink corolla in the position of a small cone peeping through the green calyx. Commencing watch at this stage, growth progresses till about noon, when there is a rest till the next morning; again there would be the same period of advance to rest, and the third day again an advance, followed by the withering of the floral organs.

Returning to the first period, the unopened bud, dissected at 8 A. M., showed no indications of pollen having been discharged. By 10 A. M., the flowers were still tightly closed, but the anther sacs had become ruptured, and the pretty purple styles, nestling in the center of the mass of stamens, were completely covered by pollen. By 11 A. M., the corolla had so far untwisted that a slight glance of the stamens and styles could be had in some flowers. By 12, noon, the corolla had taken on a narrow campanulate form, as wide at the bottom as at the top. By 1 P. M., it had again closed, so that the flower was expanded but about an hour only during the whole period of its existence. If it were desirable, therefore, for any insect to aid it in fertilization it would have but an hour at noon in which to work; but as we have already seen, the pollen had reached the stigmas a short time before.

From this time until near noon the next day, everything seems absolutely at rest; but at 11 A. M., the corolla again expands so as to be widely campanulate, and the pistils are found advancing beyond the line of the anther cells, carrying along with them the comparatively large pollen grains that had been deposited the day before. By 1 P. M., the corolla has again closed, drawing up and closely pressing the pistils and the anther cells together. It is at this period of the observations that the most beautiful phenomenon of the whole may be observed. Along the inner face of the style from apex to base is a single line of minute hairs. The pollen grains attach themselves to these hairs and are thus arranged in a single line like bright pearls along a curved silken thread. Dr. Ida A. Keller, who has kindly repeated some of the observations I here record, finds indications of pollen tubes entering the pistils through the papillæ or hairs.

On the third day, toward noon, though the petals remain closed, the pistils will be found withering, and the carpels enlarging, thus indicating that fertilization has been accomplished.

In the Proceedings of the Academy, 1889, page 55, in a paper entitled "On Secund Inflorescence," I have shown that in a number of flowers with a convolute æstivation, the spiral line in closing is directly the reverse of that followed in the opening. A surprising fact was noted in connection with this *Malva* that in closing, the twist might be either from left to right or right to left—both lines existing on the same plant. All attempts to form an hypothesis accounting for this remarkable behavior failed.

One fact strongly developed by these observations is that fertilization may be accomplished before the pistils have completed their growth, thus confirming the observation of Dr. Ida A. Keller in her paper on *Monarda fistulosa* in the Proceedings of the Academy, 1892, p. 452.

#### THE PEDUNCLE IN STREPTOPUS AMPLEXIFOLIUS.

The point I have strongly presented in connection with "extra-axillary" branches, that these are but arrested leaders which have been supplanted in leadership by the strong growth of the axillary bud, is remarkably well illustrated in *Streptopus amplexifolius*. Dr. Asa Gray says of it "it has small (extra) axillary flowers, either solitary or in pairs, on slender thread-like peduncles, which are abruptly bent or contorted near the middle." And further, "the peduncles, as in the next, are opposite the leaves, rather than truly

**THIS PAGE IS LOCKED TO FREE MEMBERS**

Purchase full membership to immediately unlock this page

# Know Your Bible

Forgotten Books' Full Membership provides unlimited access to more than 28,000 volumes of Christian literature for \$8.99/month

**HOLY BIBLE**

**Continue**

\*Fair use policy applies

the lower lobe of the forked style—pressed into it, and covered with pollen. A number of flowers were opened, all exhibiting the same phenomenon. The branched filament, as is well known, bears an anther cell on one fork only. At the time above noted the arms diverge in nearly opposite directions; but eventually the barren one becomes nearly erect, which has led some authors to describe the stamen bearing the anther on a lateral horn-like process.

The opening of the flowers is the work of the lower lip alone. In the unexpanded bud it extends inward and under the upper lip, and falls over, seeming to clasp the anthers. When the opening time arrives this lower lip is withdrawn till it presents a right angle with the upper lip, and finally falling back till it reaches the tube of the corolla. Soon after mid-day the style branches close—an indication that fertilization has been accomplished. The style, however, continues to lengthen. The corolla only continues about 24 hours, as early the day following they drop out of the calyx tube.

A small species of bumble-bee, rather numerous, paid constant visits to the flowers. Hypothetically one might reasonably regard the flower as arranged for cross-fertilization by insect agency. The branches of the style seem favorably situated to receive pollen from the back of an insect visitor. As a matter of fact, however, none of these visiting bees were seen touching the style branches in any way, though I watched them closely for a long time. As the lobes close at noon, there could be no benefit if they did touch them after that. Insect aid could be given between 8 A. M., and noon. If in any other part of the world they are of service they must be larger than these bees were; but as the flower certainly fertilizes before opening at this season, in this place, it is not conceivable that the hypothetical arrangements are theoretically correct.

The head of flowers is a contracted spike, and is composed of numerous verticils in which there are three flowers to each axil. The central flower of these three is always the first to open, and hence the anthesis is centripital. Though this would thus seem to be the general plan, strange to say, the first flower to bloom on a head may be from any part—either near the apex or near the base. They appear from any part without any regard to order or system. No explanation of this disorderly blooming seemed satisfactory.

It has been a point with the author of these "Contributions" that a leaf does not originate at the node from which it seems to spring, but at some indefinite point on the axis below. In *Brunella* the

edges of the leaves are ciliate. The stems are bifariously hirsute. No explanation of this seems to the author reasonable but that this results from the meeting of the cilia on the edges of the narrow bases of the foliar organs, and which, at the node above, expanded into a laminal condition—a leaf blade.

#### BRANCHING OF *EUPHORBIA HYPERICIFOLIA* AND *E. MACULATA*.

There are some peculiarities in the branching of these two species of *Euphorbia* difficult of explanation in each case, but very clear when studied in comparison with each other. As a general principle in plants we look for an axillary bud at the base of every leaf, or we can usually conceive some reason why the axillary bud has not been developed. Taking a branch of *Euphorbia hypericifolia* we find the leaves opposite, but one somewhat stronger than the other. The main stems are somewhat flexuose. On the one side of the main shoot an axillary bud has developed from the base of the leaf into a weak lateral branch, but there seems to be no trace of an axillary bud at the base of the leaf opposite. We ask, what has become of the bud which should have been at the base of that leaf?

In *E. maculata* the branches are not flexuose. A straight stem proceeds from the main branch, having many pairs of leaves at the nodes. At the base of one of the leaves there is an axillary bud, no bud at the base of the leaf opposite, which seems very closely attached to the straight central axis or main stem.

Returning to *E. hypericifolia* we find, toward the end of the season's branch, a very weak peduncle between the forks of the branches, having at the apex a head of flowers. We now see that this pedicel was the original main stem, and that what we have before taken for main stems were the products of axillary buds in cases where the main axes were wholly suppressed. With this total suppression came the effort on the part of one of the axillary branches to supply the loss, and this is the one which has given the impression that the subtending leaf had no axillary bud. There was a bud, and that bud pushed so strongly as to become a substitute for the suppressed central stem. The weaker bud, axillary to the weaker leaf, either continues as a bud or pushes into a weaker axillary growth. It is, however, of sufficient strength to compete somewhat with the opposite stem growth, which cannot, therefore, become perfectly straight, and the result is, as we see, a necessarily flexuose habit.



Now reverting to *E. maculata* we find a much greater disparity in the size of the opposite leaves, and necessarily in the size of the strength of the axillary bud. The large leaf, which seems to have no axillary bud has really had one so strong in proportion to the leaf opposite that it has pushed it wholly aside, has succeeded in forming a perfectly straight stem. The straight stem in *Euphorbia maculata*, is really made up, therefore, of an axillary branch which at each node has wholly taken the place of the main axis which has become totally suppressed at each point.

As, however, the vegetative growth becomes more under the control of the reproductive force, the vigor of the side branches which proceed from the axillary buds along the main stem is checked; and with this the axial growth develops sufficiently to form a peduncle and flower-head as already noted, and these central axes bearing the flowers get stronger and stronger, just in proportion to the development of reproductive agencies.

We are taught by these illustrations the great lesson that the power of an axillary bud to draw to itself nutrition at the expense of the main axis and opposite axillary bud is the chief cause of the varying characteristics of the branches. In the same plant it causes a variation from a merely flexuose stem in the lower portion to an almost perfectly forked condition finally—while it equally accounts for a wholly different character of straight main stems in an allied species.

The exact manner in which an axillary bud can achieve such a power of nutrition as to entirely obliterate and supplant the main axis, and how again that main axis can still again overthrow its lateral competitor and advance sufficiently to become a flower-bearing peduncle is yet a grave question which cannot be answered. But a consideration of all the facts brings out the safe conclusion that the achievement of greater power in some buds to advance over others by drawing to themselves nutrition at their expense is a powerful factor in the origin of form.

As every flower head produces seed, it is safe to assume on my theory that the flowers self-pollinate. An examination shows that this is the case. Long before the involucre unfolds the staminate flowers have scattered their pollen over the pistils of the female flower, thoroughly dusting them. The glands are generously nectariferous, larger and more productive of fluid in *E. maculata* than in *E. hypericifolia*. All effort to form a conception of

**THIS PAGE IS LOCKED TO FREE MEMBERS**

Purchase full membership to immediately unlock this page

# DELVE INTO FANTASY, MAGIC, MYTHOLOGY & FOLKLORE

Forgotten Books'  
Full Membership gives  
access to 797,885 ancient  
and modern, fiction and  
non-fiction books.

**Continue**

\*Fair usage policy applies

two coils of a spiral, and the whole pistil resembles in miniature a ramrod when in use cleaning a gun. As soon as the stigma emerges from the closed corolla, the coil straightens out in a very short time.

The flower seems to have taken a rest at this stage in all its departments. At 9 A. M., the next day, an unopened bud of the same age as the former, had still not ruptured the pollen sacs. It was the same at 10, 11, and again at 12, noon. The unbroken anthers on the short stamens, were double the size of these on the longer stamens, in this respect differing from the observations of Mr. Darwin. At 2 P. M., the anther cells of the lower stamens were polliniferous: up to 6.30 P. M. the upper anther cells were entire. At 8 A. M., of Aug. 1, the upper series of anthers had still closed cells. At 12 noon, of this day, five unexpanded flowers with long exserted styles were examined. In three axes the anthers of the short stamens had shriveled without ejecting pollen—in one, two were pollen-bearing, while four had shriveled—in the remaining one, the whole six were abundantly polliniferous.

The mass of wild plants is not extensive, but it furnished a good bunch of specimens with long-styled flowers, and another bunch with styles exserted only half the length of the calyx tube. None with the very short styles figured by Mr. Darwin were growing in this mass. It occurred to me to note the relative fertility of the long and medium styled plants. Of the shorter styled, one branchlet had seed vessels from 55 axils, with from 4–6 seed vessels in each axil, and four others, 45, 48, 45 and 66, respectively. Of the longer styled 57, 35, 45 and 44.

So far as comparative fertility is concerned there is no material difference between the two classes.

It is clear to my mind that the flowers in these two classes do not furnish each one its own pollen, nor do they receive much aid from diurnal insects. Possibly nocturnal ones may assist, but if so, no moth hair is visible on the stigmas, as there should be. As the styles remain without withering for some days, showing that they have not received pollen, the great probability is that the pollen is in some way scattered from the upper flowers on the stigmas which continue in a vital condition long enough to profit by it. Strong vegetative vigor prevents seeding in the lower parts of the stronger branches, even though the flowers were fertilized.

STRUCTURE OF FLORETS IN *BIDENS BIPINNATA*.

Watching closely, on August 28, the anthesis of *Bidens bipinnata*, precisely the same phenomena were observed as is recorded of *Heliopsis lævis*. The style pushes up the staminal tube, starting at night-fall. During the next day the pollen is pressed through the divisions of the incurved staminal appendages, the style branches protrude the following nightfall, the staminal tube retires the next day, followed the following day by the retreating style.

In the arrangement of the floral parts there seems more definiteness than in many *Compositæ*. Normally there are five outer "involucral bracts" with foliaceous scales,—and these spread, some time before the rest of the flowers open. But sometimes only three of this verticil spread, in which case the other two remain erect and are not distinguishable from the inner series of involucral scales. Cutting away these five carefully we find no sign of an axillary bud at the base of these bracts. Then we have another series of five (seven in appearance, where the two lower bracts have become "scales"), at the base of these five we find axillary buds. By examining a number of heads, it is soon seen that these axillary buds develop to florets. The buds develop equally in the axis of each scale, when they rest, apparently for about a day, and growth is resumed, when, strange to say, one leads off in rapidity of growth, outstripping the rest. Occasionally another will nearly equal it, but two at least exhibit a very puny growth. These form the ligulate rays, and in consequence of the irregularity noticed, there are often only two fully formed ray florets, the others remaining beneath the outer series of scales in an independent state. Inside of this series, another series of five scales appear, the axillary buds of which develop to fully formed disc florets. The next series of five, however, seldom all perfect,—usually only two.

Taking the theoretical structure of the flower to be on the plan of five, we look for indications of this numeral in the ovarium. I have, however, never found traces of five awns. Four are usually present; but one or two so weak that unless searched for, two only might be supposed present. The weakest is at the base of the scale and the next weakest opposite. The two stronger are in the lateral positions fronting the scales, and give eventually the bidentate character to the akene. At times there are only three teeth. We may probably assume, in the theoretical conception of the floret, that five "involucral scales" primarily formed the calyx which becom-

ing adnate with the ovarium formed the akene, but that one of these became wholly absorbed before the final growth of the structure. The scales are the dilated bases of leaves, and the awns abortive petioles or laminæ. When but two awns remain, it is simply the result of the total or partial suppression of three of the original members of the five-leaved verticil.

#### RHYTHMIC GROWTH IN FLOWERS OF *HELIOPSIS LÆVIS*.

It must be well known to observers that the column of stamens in many Compositæ is drawn up far beyond the mouth of the floret by the advancing pistil, and that subsequently it descends, and is included in the floret. I believe I am the only one who has called particular attention to this behavior in Compositæ, though others before me have noted a shrinking tendency in the filaments of some Chicoraceæ, which has been attributed to an irritable habit. Noting in a large mass of *Heliopsis lævis* growing near my house in Germantown that the elevation and depression of the staminal column occurred at stated hours during the day, I started on the 16th of August to devote observations several times a day for a week to an examination of the behavior of the flowers.

The first observation was that of the hundreds of flower-heads that had flowered during the summer season, not a floret could be found infertile. This with me is indicative of self-fertilization. But I believe it is conceded by all biologists who have given attention to this large order of plants, Compositæ, comprising a tenth part of the vegetable kingdom, that the florets are mostly self-fertilizers. Where there is a tendency to diœcism, and where there are ray florets pistilliferous only, these—the very small minority—must, of course, have florets requiring aid in pollination from other flowers. The most that has been claimed for Compositæ is that they are “adapted to cross-fertilization;” but even this statement is derived from a theoretical conception of the plant’s behavior, for every practical test made by excluding insects has found the florets just as fertile as if insects had been allowed free access to them. It was, however, well worth while to keep this topic in view while making my notes. The date of the observations is given, as I have a suspicion that the phases of growth are not identical in different seasons or localities, though the uniformity goes on with tolerable regularity.

**THIS PAGE IS LOCKED TO FREE MEMBERS**

Purchase full membership to immediately unlock this page

# Know Your Bible

Forgotten Books' Full Membership provides unlimited access to more than 28,000 volumes of Christian literature for \$8.99/month

**HOLY BIBLE**

**Continue**

\*Fair use policy applies

shriveling of the style shows that fertilization had been accomplished during the night, and that the furnishing of the honeyed sweets to the insect visitors was a purely gratuitous act, for which the plant seemingly receives no compensation.

The style is bulbous at the base. The style on withering disarticulates at the apex of the bulb which remains as part of the seed vessel. Morphologically the bulb may represent an arrested node of growth, and it would not be surprising in some monstrous forms to find appendages develop from it or closely related genera, with some form of structure in which some organs developed from a position such as the bulb occupies.

The strongly adhesive power of the gelatinous pollen is indicated by the difficulty the style branches have in separating. The lower portion spreads while inside the staminal tube; but the apex still remains in contact, so that after the style branches have become quite clear of the tube, the branches, still together at the apex, form a diamond-shaped termination to the style. If a lance separates the mass of pollen, and thus liberates the apices, the style branches fly back with considerable force.

The style branches, after being drawn down into the corolla tube, were still of the same proportionate length with the undivided portion of the style, as when fully expanded: again showing that the withdrawal was not due to any irritating or contracting power at the base, but to a uniform shriveling in all its parts. These advances of the different parts of flowers and rests while others advance, are extremely interesting. It is now twenty-three years since I recorded similar behavior in the flowers of the compass plant, *Silphium laciniatum*,<sup>1</sup> and I regret that neither I nor others have followed far in the path of observation there marked out.

#### FLOCCOSE LEAVES OF ANTENNARIA PLANTAGINIFOLIA.

In the midst of a large quantity of *Antennaria plantaginifolia* in Mount Desert Island, Me., while numbers had the leaves green on the upper surface, many plants were so densely floccose that no green could be seen. The deprivation of the light was complete, and I could form no conception as to how the green could be equally dense beneath this thick growth of wool, as in the leaves exposed. The text-books say "leaves silky-woolly when young, at length green above." But the woolly plants seem woolly to the last, while the

---

<sup>1</sup> Proceedings of the Academy of Natural Sciences, 1870, p. 117.

green-surfaced leaves seem on wholly different plants. The latter has undulate, and occasionally crenate serrate, leaves; and the leaves are minutely dotted in places where hair should have grown.

#### ENDURANCE OF *PORTULACA OLERACEA*.

In early autumn light white frosts occur, the tenderer plants being injured in patches. Blackened leaves occur at intervals, and considerable areas will have escaped, though of the same species as those injured. This erratic character of an early light frost is usually referred to atmospheric currents, the atmosphere being a trifle higher or lower according as injury or escape from injury may result. This is probably the case, though no absolute tests by self registering thermometers have been made to my knowledge.

After one of these early frosts, the past October, I noted that a large area covered with *Portulaca oleracea*, the common Purslane, had a large number blackened by frost, while possibly an equal number were unharmed. I was about passing over the fact under the explanation already noted, when I observed that in many instances healthy plants and plants blackened by frost would be found together, their branches interlacing. In every case of the kind examined, not a single leaf would be injured in the one case, while in the other case the whole plant would be destroyed. The destruction in these cases could not have been by any variation in the intensity of the cold wave, but must have been from a less power of resistance in the plant itself.

The facts detailed furnish valuable lessons and suggestions. May not the varying effects of a first "white frost" be as often from varying powers of resistance as from varying intensities of the cold wave?

Again it is frequent to have increased hardiness, as well as many other characteristics, referred to the effects of environment. As the plants here, and their ancestors for many generations, must have been under like conditions, the unequal results can scarcely be attributed to environment, but to the elasticity of character possessed by the whole organized world. In *Portulaca oleracea* we may safely say some plants are hardier than others; yet over the whole northern world where it is found, the plants are yet totally destroyed by a comparatively light frost. Ages of existence under severe climatic conditions have not rendered it, on the whole, hardier than



when it first ventured on its hyperborean march,—for the great home of the family is undoubtedly sub-tropical. The seeds of this and other plants with a similar home, are frost-proof. They will live in the ground, under any degree of frost. Hence sub-tropical plants that can perfect their seeds before frost arrives, can travel very far northward. It is to this power and not to any change of original character by environment that the northward march of these plants has been due.

#### EARLY FERTILIZATION OF *SCUTELLARIA GALERICULATA*.

Wishing to study the teleology of the crest or pouch on the calyx lobe of *Scutellaria*, a large number of specimens of *S. galericulata* in various stages of growth were collected at Seal Harbor, Me., on July 13. No additional light could be thrown on the purpose of this curious process, but some facts not generally known in relation to the behavior of the flower during anthesis were noted as being worth recording.

Of all authors at the command of the writer, Bromfield<sup>1</sup> is the only one that notes in this species that “the stamens as well as the style included, and lodged with it in the oblong inflated convexity or crown of the upper lip.” I had noticed that every flower was fertile, and from this inferred self-fertilization. The style is never longer than the stamens, and the anthers and upper portion of the style are bound together in their “lodging.” The anthers burst their sacs simultaneously with the expansion of the flower, and cover the whole upper portion of the style with pollen. Portions of the corolla fold so tightly over the upper portions of stamens and style that no insect can reach them. Even when an attempt is made to press open this portion of the corolla with a light twig, the expansion is unwillingly performed.

A remarkable circumstance is that the flower falls soon after full expansion, carrying the style with it, thus showing that full fertilization of the ovarium had already taken place. It is probable that the pollen grains are active much earlier in the unopened flower, than seemed to be the case from my few hours of observation.

#### FERTILIZATION OF *TRIFOLIUM PRATENSE*.

At my own residence, Philadelphia, I have never been able to notice humble-bees entering Red Clover by the mouth of the corolla,

---

<sup>1</sup> *Flora Vectensis*, p. 383.

**THIS PAGE IS LOCKED TO FREE MEMBERS**

Purchase full membership to immediately unlock this page

# DELVE INTO FANTASY, MAGIC, MYTHOLOGY & FOLKLORE

Forgotten Books'  
Full Membership gives  
access to 797,885 ancient  
and modern, fiction and  
non-fiction books.

**Continue**

\*Fair usage policy applies

## AUGUST 1.

REV. HENRY C. MCCOOK, Vice-President, in the chair.

Eight persons present.

A paper under the following title was presented for publication :—  
“Certain Sand Mounds of the St. John’s River, Florida. Part I,”  
by Clarence B. Moore.

## AUGUST 8.

Mr. CHARLES MORRIS in the chair.

Eleven persons present.

## AUGUST 15.

Mr. USELMA C. SMITH in the chair.

Twenty-two persons present.

The Publication Committee reported in favor of publishing the paper by Clarence B. Moore entitled “Certain Sand Mounds of the St. John’s River, Florida, Part I,” as the first paper of Volume X of the Journal of the Academy.

*Remarks on a New Species of Cypræa.*—MR. JOHN FORD, in presenting the types of a new species of *Cypræa* remarked that his conclusions regarding their distinctive specific character were based upon the careful study of a large number of specimens of various sizes and stages of growth, all of which could be readily separated from any other species belonging to the genus.

In the first description, published by him in *The Nautilus*, Feb., 1893, the shells were defined as a variety of *C. cruenta* Gmel., the suggestion being made, however, that most students would have given them specific standing. For this reason this change has since been made, and any further reference to their previous varietal standing is deemed unnecessary. It may be said, however, that the shell appears to have been figured by Kiener<sup>1</sup> as a variety of *C. variolaria* Lam. (*C. cruenta* Gmel.) and possibly by Sowerby,<sup>2</sup> and Melvill,<sup>3</sup> the two latter authors apparently differing in opinion as to its relative varietal standing, the former referring it to

<sup>1</sup> *Iconographie Coquilles Vivantes*, page 57, pl. 27, fig. 2.

<sup>2</sup> *Thesaurus Conchyliorum*. Plate 23, fig. 190.

<sup>3</sup> 1st Vol. 4th series of *Memoirs and Proc. of the Manchester, (Engd.) Lit. and Phil. Society*, 1887–8.

*C. caurica* Linn. Melvill, if one may judge by his published statement, appearing somewhat doubtful as to whether it was the offspring of *C. cruenta*, of *C. caurica*, or of both species.

No description of the shell other than that published by the speaker, was given until July, 1893, when a summary of the speaker's observations over Mr. Melvill's signature appeared in the Quarterly (English) Journal of Conchology.

The full description of the species (published in *The Nautilus*, August, 1892,) is as follows:—

CYPRÆA GREGORI Ford, n. sp.

Shell depressed, orbicular oval in form, callus on the sides and ends remarkably thickened. That on the sides light salmon in color, with irregular purple-brown spots, having a blotchy appearance. Dorsal surface similar to that of *cruenta*, but lacking the whitish spots typically present in that species. Base semi-translucent, spotless, dark buff or salmon colored, darkest in the interstices. Teeth on outer lip very strong, long and whitish; on inner lip finer, with exception of the anterior fold and one or two adjacent teeth, the first of these latter being very prominent and notably transverse. Space between the anterior fold and the following tooth wide and bright red; posterior teeth of inner lip prolonged outward upon the base. Dimensions of average specimen.: length  $1\frac{1}{4}$ , breadth  $\frac{7}{8}$  inch.

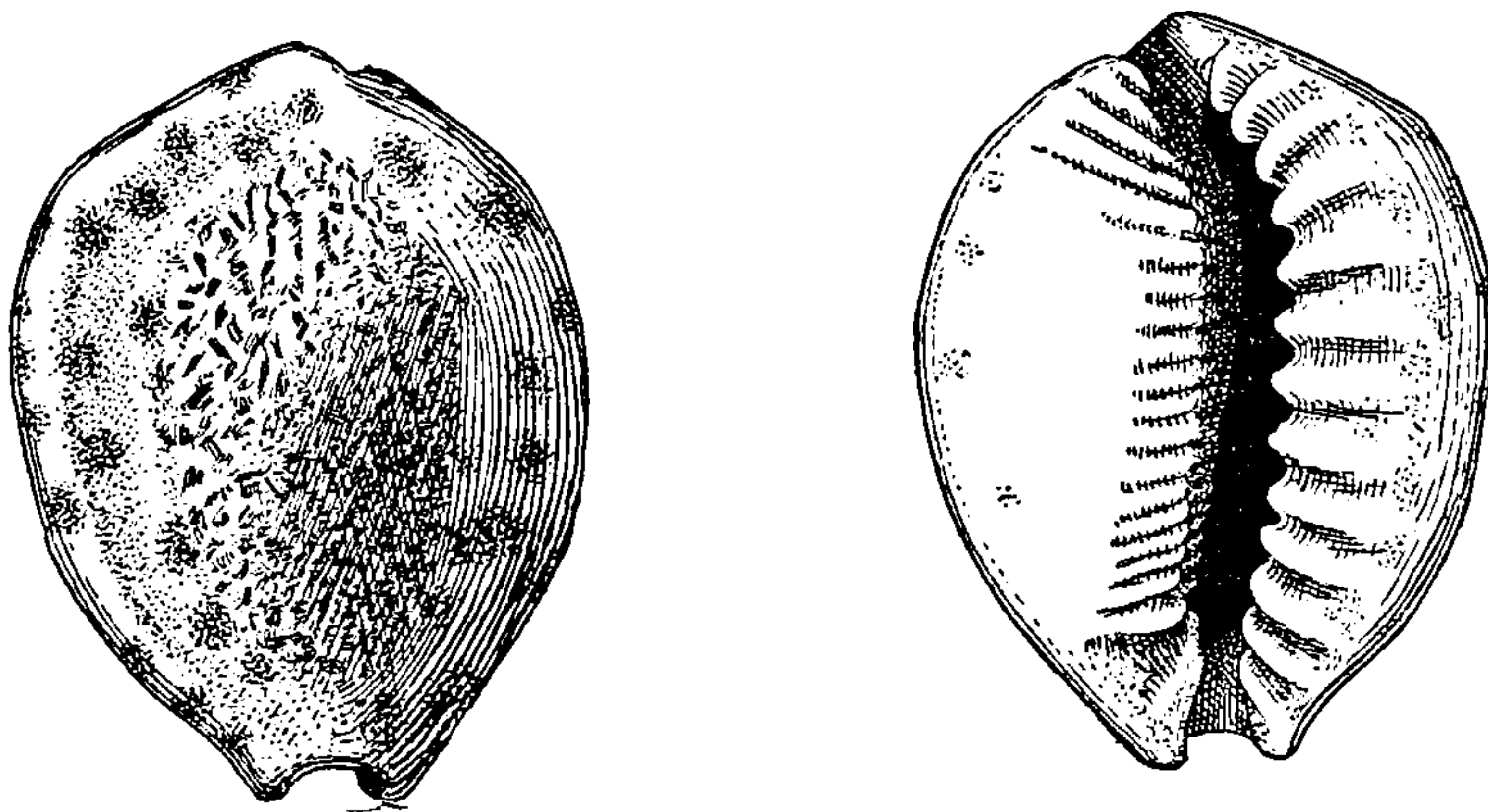

That *C. Gregori* is more nearly related to *C. cruenta* than to any other species, Mr. Ford had no doubt. Nevertheless, the fact remains that the former possesses several characters altogether distinct from those belonging to the latter.

*C. Gregori* is for instance, more translucent, less variable, more rugged, much smaller and rounder in form, different in general color, and in the peculiar variations of the teeth; also in the remarkable thickness and brilliancy of the callus with which it is rimmed.

With exception of one poor specimen, the shell was unknown to the late Mr. Tryon, and for the same reason perhaps, it was not noticed by Mr. Roberts in his catalogue of the species.

The speaker had good reasons for believing that Mr. Tryon had at one time almost decided to name and describe this one poor specimen as a new species, but finally concluded that the material at hand was insufficient for the purpose.

Had he seen the brilliant suite of specimens now in the Academy, it is not likely that he would have hesitated a moment to follow his first intention. The shells are doubtless quite rare in collections, both in the United States and Europe, those known here, in fact, having chiefly come in one lot of mixed species of *Cypræa*, from Southern India and Ceylon. The latter region, judging from all available evidence, may be considered the habitat of the species.

It may be safely said that among all the smaller species of *Cypræa* none are more brilliant or more distinctly specific than *C. Gregori* Ford. It is not strange therefore that this new species has already been endorsed by a number of our most eminent conchologists.

---

AUGUST 22.

Mr. LEWIS WOOLMAN in the chair.

Eleven persons present.

---

AUGUST 29.

Mr. LEWIS WOOLMAN in the chair.

Thirteen persons present.

A paper entitled "Change with Age in the Radula of Land-Mollusca," by V. Sterki, was presented for publication.

The following was ordered to be printed:—

**THIS PAGE IS LOCKED TO FREE MEMBERS**

Purchase full membership to immediately unlock this page

# Know Your Bible

Forgotten Books' Full Membership provides unlimited access to more than 28,000 volumes of Christian literature for \$8.99/month

**HOLY BIBLE**

**Continue**

\*Fair use policy applies

that river of a great plateau broken by mountain ranges, southern spurs of the Rocky mountains. The plain east of the Pecos is broken in only one place, where the Palæozoic rocks are exposed by the removal of the Cretaceous covering, and this has been called by Professor Hill, the Central Denuded Area.

On the Gulf coast are the Quaternary beds, forming the Coastal Prairies, a great, level tract of land chiefly swampy and but slightly elevated above the Gulf. A forested region of Tertiary sands and clays, carved into gently undulating topography is interposed between the Coastal Prairies and the great Cretaceous plain. The Cretaceous plain, commencing at an elevation, in the vicinity of Austin, of not far from four hundred feet, though varying in different parts, forms one of the greatest geographical units of Texas. It is a treeless prairie, with a few exceptions, and occupies nearly one fourth of the state, rising gradually away from the coast and reaching an elevation of two thousand feet and more.

Partly enclosed in this Prairie is the Central Denuded Area, a region of hilly, sparsely forested Carboniferous and older rocks, which to the west merge into the Red Beds of Permian age. These beds on the east have something of the topographic diversity of the older rocks, but to the west change gradually in topographic form and merge, geographically, almost imperceptibly into the lake or inland sea beds of the Staked Plains, the Llano Estacado. These plains, treeless and arid, form a true plateau with an elevation of from 3,000 to 4,500 feet. The Pecos river flows along the base of the Llano Estacado plateau which ends abruptly in a steep west facing escarpment. To the west there is another plateau, broken by mountain ranges, the Trans-Pecos Mountain and Basin region of Hill.

There are, therefore, six great topographic divisions in Texas:—1st, the Coastal Prairies; 2nd, the Rolling Forested Tertiary Area; 3rd, the Grand Prairie; 4th, the Central Denuded Area; 5th, the Llano Estacado; 6th, the Trans-Pecos Mountain and Basin Region. To this might be added many minor divisions dependent upon minor topographical or geographical features. East of the Pecos the country is one of plateaus, plains, and prairies, forested only in one of its parts (with one or two exceptions to be hereafter noted). The Central Denuded Area alone is hilly and in no place are there mountains. Buttes, chiefly of Cretaceous strata, form the only striking elevations and these are dignified by the name of mountains by the

settlers, in the absence of more striking elevations. West of the Pecos the country is truly mountainous.

(*b*) *Drainage*.—The drainage naturally falls into two classes, the western, including the Rio Grande and Rio Pecos which receive their water supply from the mountains of New Mexico, and whose Texas tributaries are withered channels favored with water only at rare intervals; and secondly, those of the east, including the Colorado and Brazos, whose headwaters are withered channels in the Llano Estacado and the Permian plain, and whose lower tributaries, flowing in a humid or sub-humid climate, are the source of constant supply.

## 2.—GENERAL CLIMATIC CONDITIONS.

Texas is humid in the east, excessively so near the Gulf Coast. The climate in this region, for instance near Galveston, is semi-tropical. Proceeding inland, with increasing elevation comes more temperate conditions. Snow falls, and frost occurs in the greater part of the State, this being due to the cold north winds, “the northers” which are not uncommon during the winter. Even as near the coast as Austin the decrease in rainfall is noticeable, and it is necessary to travel inland from here but a hundred miles or so to reach a subhumid belt. The town of Abilene lies in this sub-humid region, and to the west of this the climate becomes rapidly more arid until truly arid conditions are met with, and with this change there is a change in the character of vegetation. The Trans-Pecos region is arid, so is the Llano Estacado and the western Permian. More than a third of the State is arid or subhumid.

## 3.—GENERAL GEOLOGIC AND GEOGRAPHIC DEVELOPMENT.

(*a*) *Pre-Carboniferous Land*.—This statement is necessarily generalized and, with the present imperfect state of our knowledge of the geology of large parts of Texas, it may in some details be incomplete. I shall attempt nothing more than seems warranted by the facts at present at hand; but these are sufficient for our present purpose which is to trace the general development of the Texas region.

The oldest part of Texas is the Central Denuded Area, and this has had a very complicated history. There is a Pre-Cambrian area, referred by Mr. Walcott to lower Cambrian<sup>3</sup> and later to Algonkian<sup>4</sup>

---

<sup>3</sup> Am. J. Sci., XXVIII, 1884, pp. 431–33.

<sup>4</sup> Bull. U. S. Geol. Survey, No. 30, 1886, pp. 57–64.



age and which Dr. Comstock<sup>5</sup> considers true Archean. The extent of this area is at present limited and there is no means of determining its former boundaries. The strata are highly metamorphosed, in part by intrusions of Plutonic rocks. About this core are Cambrian and Silurian strata, according to Dr. Comstock folded and faulted in an extremely complicated manner. These older rocks obtained most of their complication and metamorphism before the beginning of the Carboniferous period, for the strata of the latter age rest with marked unconformity on the northern slopes of the Silurian hills.

What was the limit of this Pre-Carboniferous land we have no exact means of determining, but that the present exposure by no means expresses the original extent of outcrop seems certain from the vast quantities of material in the Carboniferous and later strata. Moreover the conglomeratic and sandy nature of the lower Carboniferous deposits, along their eastern margin, indicates very strongly that beneath the Cretaceous not far distant from this, the older land exists. I believe it more than possible that this buried land extended to the areas of Indian Territory and Arkansas, thus connecting them with the central core of Texas.

Be this as it may, there was, in one part at least, a land area in immediate Pre-Carboniferous time. This land was mountainous in type, so far as structure is concerned, and had practically its present degree of metamorphism.<sup>6</sup> Whether the land was topographically mountainous or not I cannot say. It certainly was not so in the immediate neighborhood of the Carboniferous, for the valleys and hills which were buried beneath the Carboniferous strata were low and well rounded, being mature in type, much more mature than the present topography of the same district, and quite closely like that of the less hilly parts of New England. For this reason I assume that all the land in the neighborhood had undergone long continued denudation and was mature in geographic form. It was a mountainous area worn to its roots in Pre-Carboniferous time.

(b) *Carboniferous Modification of the older Palaeozoic Land.*—The next event in the history is the oncoming of the Carboniferous depression and period of sedimentation, a period introduced apparently in Sub-Carboniferous times and continuing with slight interruption to the close of the Permian. The evidence of a Sub-Carboniferous

---

<sup>5</sup> 1st Ann. Rept., Texas Geol. Survey, 1889, pp. 255-82.

<sup>6</sup> This fact is proved by the existence of marble and flint pebbles in the Carboniferous, with the same structure that the materials at present have in the neighboring Silurian.

**THIS PAGE IS LOCKED TO FREE MEMBERS**

Purchase full membership to immediately unlock this page

# DELVE INTO FANTASY, MAGIC, MYTHOLOGY & FOLKLORE

Forgotten Books'  
Full Membership gives  
access to 797,885 ancient  
and modern, fiction and  
non-fiction books.

**Continue**

\*Fair usage policy applies

Cretaceous overlap, which is everywhere, on the Carboniferous, a gently undulating line, with no sharply defined buried topographic features. It was a plain and probably a base-leveled plain. The older Palæozoic core formed the highlands of the region, and here, in consequence of the harder nature of the rocks and their more variable character with reference to hardness and altitude, the topography was distinctly more diversified.

(*d*) *Cretaceous Subsidence*.—With the beginning of the Cretaceous period there came an extensive and rapid<sup>9</sup> subsidence, during which both the upper and the lower Cretaceous beds were deposited. The history of this period has been so fully worked out by Prof. Hill and so clearly described by him in various places that I shall do no more than state the fact. This part of the history of Texas is already known to geologists. The several thousand feet of Cretaceous completely buried the older Palæozoic land as first pointed out by Prof. Hill.<sup>10</sup> This fact has been disputed by Dr. Comstock<sup>11</sup> who has spent several years in a study of the older Palæozoic rocks of the Central Denuded Area. Prof. Hill reiterates his statement later and is supported in the conclusion by Mr. Walcott<sup>12</sup> and Dr. Curtice.<sup>13</sup> I have studied the problem from a standpoint different from that of the geologists above referred to and am convinced of the accuracy of Prof. Hill's deductions, and, in the paper on this subject above referred to, have given my reasons for this conclusion, these being both geographic and geologic. Since they do not fall within the scope planned for this paper I make no further reference to them here.

This complete transformation of a large area of nearly base-leveled land to a condition of deep sea sedimentation lasted until mid Cretaceous time when there was an elevation followed by another depression in which the upper Cretaceous beds were formed. There was at this time, that is during the upper Cretaceous epoch, a period of volcanic eruption in the vicinity of and southwest of Austin, the relics of which remain now as low necks of nepheline basalt. These, the Shumard Knobs, are, according to Hill,<sup>14</sup> marine volcanoes in the Cretaceous Sea.

---

<sup>9</sup> For proofs of the rapid subsidence I refer to an article by the author in the *American Geologist*, Vol. IX, 1892, pp. 169-178.

<sup>10</sup> *Am. J. Sci.*, XXXVII, 1889, p. 283.

<sup>11</sup> *First Ann. Rept.*, Texas Geol. Survey, 1889, pp. 315-318.

*Second Ann. Rept.*, Texas Geol. Survey, 1890, pp. 663-664.

<sup>12</sup> *Bull. Geol. Soc. Am.*, 1890, Vol. II., pp. 522-3.

<sup>13</sup> *Bull. Geol. Soc. Am.*, 1890, Vol., II., pp. 526-8.

<sup>14</sup> *Am. Geol.* Nov. 1890, pp. 286-292.

(e) *Post Cretaceous Changes*.—With the close of the Cretaceous period of deposition there began the mountain building work which culminated in the formation of the Rocky Mountains and to which the present form of Texas is in large measure due. In the East it caused the bodily uplift of the great Cretaceous plain, the remnant of which forms the Grand Prairie. An extensive fault, the Balcones fault of Hill, occurred possibly at this time, and is at present an important feature in the topography of eastern Texas. It is, however, such a striking feature and so well marked that it more probably occurred during the Tertiary or possibly even during the Quaternary uplift, to be mentioned presently.

The Rocky Mountain uplift which formed the plateaus and plains of central Texas, by a bodily uplift more pronounced in the west, took, in the Trans-Pecos region, the form of mountain building. Little is known of these mountains, but the Guadalupe Mountains which the author has studied, are monoclinical in structure, faulted on the western side. Others are more complicated, and some are associated with igneous eruptions or intrusions. Little is known about this region other than that it is a mountain range and basin region in which Tertiary lakes lingered until the period of Quaternary desiccation caused them to disappear.

A period of sedimentation following the Cretaceous uplift admitted of the deposition of the Tertiary clays and sands, which, by their elevation, added another strip to the Texas region, that which Prof. Hill has designated the Eocene Lignite or Forest region. Again, in Quaternary time, another strip was added, and the Coastal Prairie is so recent that shells now living in the Gulf are enclosed in the strata as fossils. A slight submergence of very recent date is indicated by the fjorded character of the streams on the Texas coast.

The Llano Estacado plateau is said by Prof. Hill<sup>15</sup> to be capped by lacustrine sediments of late Tertiary or Quaternary age and this forms another chapter in the history of Texas, but we have few details in regard to this most interesting episode.

(f) *Post Cretaceous Drainage*.—It has been my effort in the preceding pages to trace as briefly as possible the geological history of the development of the Texas region—the steps by which it has come to assume the present form. The minor details of the land sculpturing as revealed by the river histories registered in the topography remain to be considered. A few general points on the sub-

---

<sup>15</sup> Am. Geol., V, 1890, pp. 27-29.

ject may well be stated here before taking up the detailed study. With a few exceptions this study is of necessity confined to east and central Texas for the reason that west Texas, or Trans-Pecos Texas, is practically an unknown land. That part which concerns us most at the present time, is the portion elevated during the beginning of the formation of the Rocky Mountains as a great plain, chiefly if not entirely Cretaceous covered, and dipping eastward. Upon this the streams have developed, being revived by the Tertiary and Quaternary uplift. They have in places cut through the Cretaceous covering and, in the Central Denuded Area, have revealed great areas of buried Palæozoic rocks upon which they are superimposed. The reason why the streams have cut through to the Palæozoic at this their most elevated portion is not now definitely certain. It may have been the result of mere chance, or it may be that this region, having a thinner cover than the other region, was first reached, and, being more resisting because relatively elevated and diversified, and consequently a region of excessive denudation, became a center of drainage. Another possibility is that the Palæozoic Highland was expressed in the Cretaceous sea by a dome-like bulging in the Cretaceous sediments, and consequently was the first land to be made and the first and most rapidly denuded. For a discussion of the subject I refer to my paper on the Cretaceous Covering of the Central Palæozoic of Texas.<sup>16</sup>

## PART II.—PHYSIOGRAPHIC DESCRIPTION.

### 1.—GENERAL.

The different geographic units above mentioned exhibit different phenomena and it seems, therefore, best to divide the discussion so as to give each geographic unit a separate consideration. This division of the subject cannot be adhered to rigidly because the various regions merge one into the other and the physiography of one very often resembles closely that of another. Yet each geographic unit presents unique features and, for this reason, it seems necessary to consider them as units. Moreover it is the only method of treatment which seems possible without the introduction of much confusion.

### 2 —THE QUATERNARY COASTAL PRAIRIES.

(a) *Geographic Description.*—Of this plain Hill writes,<sup>17</sup> “ It is

---

<sup>16</sup>Am. Geol., Vol. IX, 1892, pp. 169-178.

<sup>17</sup>Am. Geol., V, p. 11.

**THIS PAGE IS LOCKED TO FREE MEMBERS**

Purchase full membership to immediately unlock this page

# Know Your Bible

Forgotten Books' Full Membership provides unlimited access to more than 28,000 volumes of Christian literature for \$8.99/month

**HOLY BIBLE**

**Continue**

\*Fair use policy applies

are growing at their headwaters. The time of occupancy by these two types of streams has been so short that the interspaces are flat-topped and undrained, and the channels' steep-sided and cañon-like.

(c) *Estuarine Condition*.—Even in this brief period the streams of the coastal prairie have been subjected to an accident. All the larger streams are at their mouths estuarine. They are also flowing, even on the plain many miles from the shore, in channels with little slope. These facts record a slight submergence since the greatest elevation, though the phenomenon is also due in part to the overburdened condition of the streams.

(d) *Young, Growing Coast Line*.—The extended rivers helped to form the coastal plain when the shore line was farther inland, and they are now at work with the aid of tides, waves and currents in the construction of a similar plain along its margin. Each large river is overburdened with sediment derived from the Tertiary clays, the Cretaceous, and Palæozoic rocks, and this sediment is being used by the waves and tides in the construction of land. The coast line is growing outward. Shoals, bars, and islands are registers of this growth, and the beaches, even the much boasted beach at Galveston, upon which the surf-rolls laden and muddy with river furnished sediment, show the progress of outward growth. The harbors of Texas exist because the river mouths are fjorded, and because protective bars and islands have been thrown across the mouths of the estuaries, by the currents laden with sediment brought down by the rivers. They are poor harbors because the excess of sediment thus furnished is being deposited in the estuaries. The engineering improvements proposed for the harbors of the Texas coast must take into account this outward growth of the coast line.

The bars thrown up along the Gulf coast line have enclosed lagoons, sometimes quite completely, and here is formed one of the few kinds of lacustrine basins in Texas.

### 3.—THE ROLLING FORESTED TERTIARY AREA.

(a) *Topographic Description*.—This country <sup>19</sup> consists largely of the inshore part of the bottom of the old Tertiary Sea, which once covered the whole Gulf coast. This area has been elevated into a

---

<sup>19</sup>The description in this paragraph is abstracted from Penrose's report on the Gulf Tertiary of east Texas. (First Ann. Rept., Texas Geol. Survey, 1889, pp. 7-13), the abstracts in most cases being verbatim quotations.

table-land one hundred to seven hundred feet above the sea level, sloping gradually to the southeast and emptying its waters in the same direction into the Gulf of Mexico. Since its elevation it has undergone great erosion and is still being denuded at a tremendous rate. The strata are all composed of sands and clays, and succumb very readily to the eroding action of atmospheric agencies. The result is that all that is left of the once level surface of this table-land are a few flat-topped hills and ridges. The highest points, locally called mountains, are buttes or mesas having their summits capped by an almost horizontal bed of iron ore or sandstone, and to this covering they owe their existence. A large part of this area is a heavily timbered region, and marks the southwestern terminus of the great Atlantic timber belt, extending from the Arctic regions continuously along the coast of the Atlantic Ocean and the Gulf of Mexico until it finally disappears in the mesquite and cactus prairies between the Colorado River and the Rio Grande.

(*b*) *Mature, Consequent and Extended Drainage.*—The conditions described above, under the Quaternary, in all probability are repetitions of similar conditions in the Tertiary area in earlier times. This area is composed of horizontal and cross-bedded strata, now partly consolidated clays and sands, which undoubtedly formed a coastal strip at the close of the late Tertiary uplift. Streams which had developed on the Cretaceous plains and had uncovered portions of the buried Palæozoic, extended across the coastal strip of Tertiary strata, and between them young consequent streams began their development. The Brazos, Trinity and Colorado were here, as in the present coastal strip, extended rivers. The then young consequent streams of the older plain, such as the Neches and Angelina, are now extended across the Quaternary plain.

The elevation of the old coastal strip was greater than that of the more recent one for it now rises on its inner margin, in some places, to an elevation of seven hundred feet above sea level and there is evidence that it extended farther inland at one time. The topographic development of this region of Tertiary strata has proceeded to the point of producing a rolling country of low and gently sloping hills with broad valleys. In other words it has proceeded as far as early maturity. It may seem at first thought that this is at variance with the description of the Cretaceous area which follows. Here the streams are topographically young, yet this land is vastly older. This apparent anomaly is due to three causes: first, the fact



that the streams on the Cretaceous have been rejuvenated by the late Tertiary and Quaternary elevation in the first of which the area under consideration was elevated above sea level as a young unscoured plain; secondly, that the streams on the Tertiary are chiefly extended, hence well developed lower portions of streams and their development is more rapid than the headwater streams which are also higher above sea level and hence have a greater depth to cut through before reaching base level; and thirdly, the fact that the Tertiary strata are unconsolidated while those of the Cretaceous are in large part indurated. Topographic age is a relative term varying according to circumstances, not the least important of which is the character of the strata. In soft strata topographic maturity will be reached much sooner than in hard strata, other conditions being equal.

(c) *Origin of the Flood Plains.*—The broad flood plains of the forested area are worthy of some attention. In the spring and early summer such streams as the Brazos in this region overflow their banks and transform the swampy malarial plains upon either side into impassable lakes, very much as does the Red River of Arkansas. The immediate cause of this is the excessive floods which come from the rains at the headwaters. The reason why such excessive flooding is possible is that the rivers of Texas are overburdened streams. The sands and clays of the Permian and Carboniferous areas cause the streams which flow through them to be overburdened far up toward the headwaters, and this condition continues and increases through the Cretaceous and Tertiary areas. In the forested region, the slope being diminished as the sea is approached, much of the sediment burden can be carried no farther. This tendency to deposit the sediment in the stream beds has been exaggerated by the recent slight submergence indicated by the fjords and estuaries at the river mouths in the Quaternary plain. In this way the deposits near the mouths of the streams have been brought about in the effort to restore the profile of equilibrium, and secure a channel-way to the sea through which the sediment load can be transported. This establishment of the profile of equilibrium is now in progress and the flood plains are growing up stream.

For some reason there has been a change in conditions of recent date. Formerly the rivers flowing through this Tertiary area were able to keep their channels clear and carve them deeper. Now they are building them up, and this in spite of an elevation of some fifty

**THIS PAGE IS LOCKED TO FREE MEMBERS**

Purchase full membership to immediately unlock this page

# DELVE INTO FANTASY, MAGIC, MYTHOLOGY & FOLKLORE

Forgotten Books'  
Full Membership gives  
access to 797,885 ancient  
and modern, fiction and  
non-fiction books.

**Continue**

\*Fair usage policy applies

sediment supply. The slight submergence of the coast line has merely increased the tendency to build flood plains.

(d) *Origin of Forests.*—The rolling Tertiary area is a forested area unlike the coastal prairies on the one side and the Cretaceous plain on the other. I am unable to say definitely why this is so. The soil is more sandy and consequently more porous than that of the Cretaceous and this in all probability is the reason why forests exist here.<sup>20</sup> The coastal strip is entirely too wet for forest growth.

(e) *Rio Grande Embayment.*—I have entirely omitted the consideration of the Rio Grande embayment for the reason that I have no personal knowledge respecting it, and indeed little is known about it. It is evident that the lower Rio Grande was estuarine in Tertiary times, but of the extent and nature of this I am unable to speak.

#### 4—THE CRETACEOUS GRAND PRAIRIE.

(a) *Topographic Description.*—Professor R. T. Hill has so frequently described this region<sup>21</sup> from various standpoints that I feel called upon to make in large measure merely a brief summary of his results. This great Cretaceous plateau is in reality made up of two plateaus separated by a quite continuous scarp, the Balcones scarp of Hill, in part. That portion of the plateau which lies to the east of this escarpment is called by him the Black Prairie region, while the name Grand Prairie is assigned to that part which lies to the west. The Black Prairie is a gently undulating plateau with varying width, merging to the east into the forested area, to the west ending abruptly at the base of the scarp. The soil is black and sticky when wet, whence its name, the Black Waxy Prairie.

The scarp is in part a scarp of erosion, but a fault scarp in the vicinity of Austin, and to the southwest as far as the Rio Grande. It forms a marked topographic feature, a rather abrupt wall rising to a height of two or three hundred feet. The fact that the fault is so plainly indicated in the topography seems to point to a recent origin, though this is advanced only tentatively. A number of large springs occur along the fault line.

---

<sup>20</sup>Penrose states (First Ann. Rept., Texas Geol. Survey, 1889, p. 9) that the early settlers found this region much less densely timbered than at present. This was particularly the case on the uplands. He suggests as an explanation of this the habit which the Indians had of burning the tall grass in their search for game.

<sup>21</sup>See particularly, Am. Geol., Vol. V, 1890, pp. 9-29.

Nearly coincident with this line are a series of volcanic knobs, the Shumard knobs of Hill, and referred by him<sup>22</sup> to marine volcanoes in the Cretaceous sea. It is not impossible that there exists here an old Cretaceous fault line, a line of weakness which in the Tertiary elevations furnished a slipping plain from which the present fault of the Balcones resulted. The Shumard knobs at present exist as a series of low, well-rounded hills rising out of the prairie, and made up of nepheline basalt.

The Grand Prairie proper consists of a series of nearly horizontal, gently east-dipping, alternating hard and soft beds of lower Cretaceous. Its eastern margin is regular, and coincides with the western margin of the Black Prairie. On the western edge, on the other hand, the escarpment is one of extreme irregularity and weird beauty. The Colorado River and its tributaries have here cut through the Cretaceous and reached the underlying Palæozoic rocks; and the young drainage, intensified by the sub-humid conditions of rainfall, has caused a marvellous complication of buttes, mesas, irregular parks, and projecting promontories. The young drainage has cut down to the base of the Cretaceous, but subærial denudation has not been able to keep pace with the down-cutting; and flat-topped divides remain between the streams. A hard stratum of limestone caps these buttes and mesas and is largely responsible for the type of topography. This irregular escarpment almost completely surrounds the region, so aptly called the Butte or Denuded region by Professor Hill, and far away from the scarp, out on the Carboniferous strata, isolated buttes, remnants of the former Cretaceous covering, still remain.

(*b*) *The Cross Timbers*.—This Grand Prairie region is treeless except for two narrow strips, the Cross Timbers, which extend approximately north and south across the prairie. Along the streams and in the rougher parts of the area live-oaks and other Texas trees grow in small groves or in isolated patches. The Cross Timbers early attracted the attention of the settlers and many speculations have been indulged in to account for their existence. Loughridge, for instance, in the Tenth Census report states that these occupy two old abandoned river beds. Hill has, however, shown<sup>23</sup> that this is not so, for the timber areas occupy two sandy strips which are not river beds but merely the outcrop of sandy layers in the Cretaceous.

---

<sup>22</sup>Am. Geol., Nov. 1891, pp. 286-294.

<sup>23</sup>Am. J. Sci., April, 1887.

Hill ascribes their presence here to the influence of the sand which, by its porous nature and the fact that it is a storehouse for moisture, renders tree growth possible, whereas the clays of the prairie are too close grained for forest growth. I find myself unable to agree with Prof. Hill on this point, for I believe the cause of the absence of forested areas on these plains is to be found in the habit which the Indians had of setting fire to the prairies in order to facilitate the search for game.<sup>24</sup> My reason for the belief is that wherever in this region, for any reason, the growth of grass is sparse, forests or groves or scattered trees grow. In the Carboniferous area, enclosed in part in this Grand Prairie, the hill sides are almost invariably covered with a sparse tree growth, whereas the low undulating divides are treeless, although there is very little if any difference in character of soil, except that the hill sides are more rocky. This is true on both limestone and sandstone soils. It seems to me much more reasonable to suppose that, being sandy, these areas supported a growth of vegetation too sparse to readily spread the prairie fires and were consequently protected from them and therefore are forested. From my view of the Cross Timbers in a drive across them I feel confident that a fire could not long burn in them, for they are low scrub oaks and very much scattered.

(c) *Rejuvenated Peneplain*.—The drainage of the Cretaceous plateau is young, or, more properly, rejuvenated. There are great areas of Cretaceous removed, so much indeed that I think it extremely unlikely that it has all been removed in the present cycle. The stripping of the covering from the central Palæozoic prairie, the removal of the upper Cretaceous beds from the Grand Prairie, and the uncovering of the Shumard Knobs and their subsequent denudation are hardly in keeping with the supposition that this work has been done by young streams. My acquaintance with the drainage of the Cretaceous Grand Prairie is so slight (being confined to the vicinity of Austin with the exception of one or two trips across it on the railroad) that I cannot state as a definite fact the history of the region which I suspect; but there is a line of reasoning which renders it highly probable that before the Tertiary elevation the Cretaceous was reduced nearly to sea level. It is as follows:—In the first place the vast denudation mentioned above suggests long continued erosion. At the beginning the Cretaceous was at least seven hundred feet lower than at present, and this condition

---

<sup>24</sup>Shaler,—Aspects of the Earth,—New York, 1889, p. 287.

**THIS PAGE IS LOCKED TO FREE MEMBERS**

Purchase full membership to immediately unlock this page

# Know Your Bible

Forgotten Books' Full Membership provides unlimited access to more than 28,000 volumes of Christian literature for \$8.99/month

**HOLY BIBLE**

**Continue**

\*Fair use policy applies

Whatever the former condition of this area, the drainage is at present in a state of youth or early adolescence. Larger rivers, such as the Colorado, flow in deep cañons, sometimes with almost vertical walls and with small flood plains, sometimes with none. The river flow is rapid, and the channel is at times obstructed with rapids. Into these larger valleys side streams empty through narrow cañons with rapid slope, and the divides have not been reduced to a state of tolerable permanency but often remain gently rounded broad topped areas. This is particularly true of that part of the prairie immediately to the west of the Balcones scarp,—another suggestion of the recency of this fault. In the denuded Palæozoic area other conditions exist, as I shall attempt to show shortly; in the lower lying Tertiary area to the east, the beds being softer, the elevation less, and the streams overburdened, the topography, as has been already stated, is less abrupt, less distinctly young, and the streams, though rapid, are not carving their channels deeper but are building them higher in order to establish a profile of equilibrium, a slope down which the sediment load can all be carried.

#### 5.—CENTRAL PALÆOZOIC DENUDED AREA.

(a) *Topographic Description.*—In this region there are three distinct classes of topographic relief, the result of erosion upon three different classes of rock, the Silurian, Carboniferous and Cretaceous. The Silurian, with its inherited rugged topography of pre-Cretaceous age, has, since the removal of the Cretaceous, been exposed to quite rapid denudation, because of its greater elevation. Consequently the Silurian area is a region of marked topographic diversity, and this feature tends to be preserved because of the great durability of the rock. Not only is this varied outline brought about by elevation, inherited relief and the hardness of the rock, but also because of the complicated stratigraphy which in a measure guides the erosion.

One can, in a measure, tell the difference between the Silurian and Carboniferous by the topographic outline, for the hills of the latter are more broadly flat-topped, though by no means as strikingly so as the Cretaceous. The butte and mesa type of erosion so characteristic of the Cretaceous in this region is so entirely absent from the Carboniferous that generally no difficulty is experienced in discriminating between Cretaceous and Carboniferous by the topographic features alone.

The Carboniferous has inherited from Pre-Cretaceous time a base-levelled surface, and where the Cretaceous has only recently been removed the Carboniferous hills are broad and flat-topped. All of the Carboniferous, excepting that close to the larger streams, might be said to have been recently uncovered; but generally the surface is more or less carved by recent erosion which has destroyed much of the inherited topographic individuality. In San Saba county, however, about midway between the Colorado and San Saba Rivers, there is a long flat-topped divide extending for a distance of twelve miles in an east and west direction, but in places somewhat destroyed by the headwater erosion of some small creeks. This divide is approximately the Pre-Carboniferous land surface, and that it has very recently been uncovered is proved by the fact that these hill-tops are all somewhat littered with pebbles of the Trinity (lowermost Cretaceous) conglomerate—the last remnant of the Cretaceous covering. The flat-topped divide is less than a mile in width. For the conquest of this the small tributaries of Richland Creek are combating with some small creek tributary directly to the Colorado. The latter have previously had the best in the contest and have pushed the divide back to within three miles of Richland Creek.

Away from the divide, and nearer to the center of strong erosion, that is near the large streams, the Carboniferous is very much cut up into sharp hills and deep valleys and this feature is now extending into the higher and more remote regions. Where denudation of this strong type has been for some time in progress in the Carboniferous area, two distinct types of topography have arisen, one in sections where the bed rock is of quite uniform character, the other in regions of greater lithologic diversity. The great sandstone area of San Saba county is a typical example of the former; and here sharply rising hills with deep valleys on the several sides have resulted. In portions less exposed to denudation the surface is gently undulating.

Where the lithologic character is diverse, long hills running northeast and southwest with steep bluffs on the southeast side result. This is the direct result of the effect of strike and dip, and furnishes an excellent example of monoclinal shifting of divides. In Coleman County the topography is distinctly of this type because here there are alternating beds of soft clays and hard limestones with a gentle dip to the northwest. The hills are step-like, and in travelling across the county one rises by a steep slope from one



plain to another, the face of the slope being clay, littered with boulders dropped down from the overlying limestone stratum which forms the floor of the plain above. If these beds were horizontal there would be here a butte and mesa topography instead of a step-topography.

Almost completely surrounding this area is the irregular Cretaceous escarpment with its buttes and mesas, and, upon the Carboniferous itself, often many miles from this scarp, are degraded remnants of Cretaceous in isolated buttes, or small mesas, or in degraded patches the last remnants of former buttes. These buttes are capped by a hard limestone and once this is cut through and destroyed the complete destruction of the Cretaceous is easy, since the major part of the beds beneath are soft and quite incoherent. These buttes and mesas are here because they are divides between streams, and, as at the divide the development of the stream is least rapid, so here at the divides the removal of the Cretaceous covering has been least complete.

(*b*) *Peculiarities of Creek Erosion.*—The stream valleys of the central Texas region furnish interesting peculiarities, the result, in large measure, of the peculiar rainfall conditions. During the winter which I spent there, from November to February inclusive, there was not a single rain that raised the volume of the stream perceptibly; but in the spring and summer the country is liable to excessive rains and the streams to excessive floods. For the greater part of the year little erosive work is done but occasional floods do much more in a few days than is done during the entire year in a rainy country. The violence of this erosion is everywhere shown in the creeks both by the character of the bars and other deposits and, in the larger streams, by the presence of rafted logs well up in the tops of the pecan trees. On the Colorado I have seen large logs lodged in the trees fully fifty feet above the low water surface of the river.

Creek erosion under these circumstances differs in some minor respects in different parts of the region, particularly in the sandstone and limestone regions. In the Silurian, for instance, where the rocks are chiefly marble, the creek valleys are deep, precipitous and picturesque, with bluffs and isolated columns of limestone, and, over all, a beautiful mat of moss and ferns. Some of these valleys are fully seventy-five feet deep, yet, during the greater part of the year no water flows in these creeks, or, at the best, only a small, clear stream slowly trickles down. The water stands in pools and slowly

**THIS PAGE IS LOCKED TO FREE MEMBERS**

Purchase full membership to immediately unlock this page

# DELVE INTO FANTASY, MAGIC, MYTHOLOGY & FOLKLORE

Forgotten Books'  
Full Membership gives  
access to 797,885 ancient  
and modern, fiction and  
non-fiction books.

**Continue**

\*Fair usage policy applies

times several hundred feet in length. Where the creek flows through a flood plain of gravel the channel is between gravel banks, generally less than thirty-five feet wide and twenty-five feet deep. At flood time not only is the channel filled, but the surrounding plain is covered with water for some distance, and during these times the erosive work of the year is done.

(c) *Effect of the Superimposition of the Colorado on the Silurian.*

(i) *Temporary Base Level.*—The Colorado River and its tributaries which drain this region, are superimposed through the Cretaceous upon the buried Palæozoic. It so happens that the Colorado itself has found, in its down cutting, a hard spur of Silurian marble and it is now wrestling with this obstacle. Over this spur the current flows with numerous rapids, and the stream is here very busy deepening its channel; the precipitous walls of its cañon, which begin here, show that the work has for some time been in progress. The softer Carboniferous rocks upstream from this, yield much more readily and the stream above the Silurian is waiting for the progress of the work below. The river is eroding on the Silurian but is building up on the Carboniferous for a score of miles above the natural dam, since the river is always heavily burdened.

This accident to the river has given rise to several interesting peculiarities, not only the river itself but all its large tributaries being influenced by the retardation. They have reached a temporary base level, their mouths are widening and extensive flood plains are being built. This is seen in the Pecan Bayou and in the San Saba River. The latter in its upper course flows in a deep cañon in the Silurian where it is still at work eroding, but for eight or ten miles from its mouth it has reached the temporary base-level and is not at work eroding its channel.

The flood plain of the Colorado is frequently fifty feet deep and is being rapidly built up. This is proved by buried trees, both dead stumps and partly buried living pecans. In flood-time great quantities of sediment are brought down from the headwaters and deposited here and during the winter very little is done toward removing this material, for even then the river is heavily burdened.

In a river of such habits as the Colorado the valley is, as would be expected, peculiar. The ordinary channel, though quite wide and deep, is incapable of holding even the ordinary floods. Such floods, which may occur several times in a year and last for several days, do not rise to the level of the flood plain proper, but

have carved out a channel in this flood plain nearly twice as wide as the natural channel. The greater spring floods extend even above this channel and cover the neighboring flood plain. Thus the valley of the Colorado is terraced, the first terrace being about thirty-five feet above the bed of the low-water channel, and the second, or flood plain proper, fifteen feet or thereabouts above the first. The first or high water terrace is sometimes on both sides of the river, though generally on one side better developed than on the other. The second or flood plain terrace is usually well developed on both sides. This form of terrace is not without its significance in connection with some of the river terraces of the glacial belt.<sup>25</sup>

The Colorado which, as suggested above, is a young stream probably because of the rejuvenating influence of the Tertiary uplift, shows all the signs of youth. In the hard Silurian not only is the valley a cañon, but the channel is marked by numerous rapids. On the softer Carboniferous the cañon is disappearing, particularly where the retarding influence of the hard Silurian barriers is felt. The tributaries, and the river itself above the temporarily base-levelled parts, are rapidly at work, and deep and narrow cañon valleys with rapid slope are the result.

(ii) *Loss of Drainage Territory.*—The influence of the Silurian barrier has made itself felt in another respect. As has been stated, the eastern border of the denuded area is an escarpment of Cretaceous of irregular form—a region of buttes and mesas. This escarpment is a part of the valley of the Colorado and the minor details of sculpturing are the result of the erosive work of the tributaries to the Colorado. Only a few miles from the main river (six to ten miles) there is a flat-topped divide separating the waters of the Brazos from those of the Colorado. The former has tributaries here that have to flow seventy-five miles before emptying into the main river. In other words, the Brazos has pushed its conquest, by headwater erosion, into the territory of the Colorado and has placed the divide only a few miles from the latter.

The reason for this seems quite certainly to be the influence of the Silurian barrier. This explanation will be found in more detail elsewhere.<sup>26</sup> It is, briefly, that the two rivers, the Brazos and the Colorado, are superimposed through the Cretaceous on the Palæozoic, but the latter, encountering the hard Silurian, has had its down cutting retarded, whereas the Brazos has had only the much softer

---

<sup>25</sup>Tarr, *Am. J. Sci.*, XLIV, 1892, pp. 59-61.

Carboniferous beds to cut through, and these higher up in its course. This has consequently given to the Brazos tributaries much more power than is possessed by those of the Colorado. The Colorado flows in a channel between eleven and twelve hundred feet above sea-level, just above the Silurian, whereas the Brazos east of here is only half that elevation.

(d) *Adjusted Stream Courses.*—The valley of the Colorado in this vicinity is remarkable for its serpentine course. In one place the river flows in a bend six miles long where a cut-off would reduce the distance to two miles. Along the boundary of San Saba county the river flows fifty miles, and, at the end of this distance, is only thirty miles from the first point. The valley here is a cañon, somewhat degraded it is true, but nevertheless the serpentine course is one in rock walls, not upon a flood plain. I have suggested in an earlier part of this paper that this course may be in a large measure an inherited course from a Tertiary peneplain, formed before the elevation recorded both by the Tertiary forested area and by the rejuvenated condition of the streams in the Cretaceous. The fact that the Brazos has much the same peculiarity supports this hypothesis.

While I believe this to be a true cause I am equally convinced that it is not the sole cause. The entire drainage system of the Colorado in the denuded area is superimposed.<sup>27</sup> It is in consequence not in accord with the revealed structure, for its course was originally consequent on a Cretaceous surface, and this course is now enforced upon it in spite of the altered condition. It is, however, a habit of rivers to attempt adjustment under such conditions and to be influenced by the revealed structure; and, as time goes on, this adjustment becomes more complete. As I have shown in the article cited many of the tributaries to the Colorado are quite in accord with the Carboniferous structure, particularly in the regions that have been longest exposed, and in the smaller streams. This has given rise to strike valleys which, in the vicinity of the Cretaceous, change to unadjusted courses.

Dr. Comstock<sup>28</sup> has called attention to the quite perfect accord of the streams on the Silurian to the more complicated structure, this being the result, in a large measure, of the longer exposure of this region, by the early removal of the Cretaceous.

---

<sup>26</sup>Tarr, *Am. J. Sci.*, XL, 1890, pp. 359–362.

<sup>27</sup>For a discussion of this subject see an article by the author in *Am. J. Sci.*, XL, 1890, pp. 359–362.

<sup>28</sup>Second Ann. Report, Geol. Survey Texas, 1890, p. 664.

**THIS PAGE IS LOCKED TO FREE MEMBERS**

Purchase full membership to immediately unlock this page

# Know Your Bible

Forgotten Books' Full Membership provides unlimited access to more than 28,000 volumes of Christian literature for \$8.99/month

**HOLY BIBLE**

**Continue**

\*Fair use policy applies

escarpment; and about fifty miles west of here is another escarpment, facing west, which makes the western edge of the Llano Estacado. These plains are narrow here, this being the southern angle of the triangle formed by these bounding escarpments. The plains themselves are gently undulating and unscoured by erosion. Farther north they are traversed by deep cañons, but here almost no drainage lines are apparent.

(b) *River Valleys Abandoned through Dessication.*—A careful study of these plains along the eastern part of the Llano Estacado will reveal some interesting facts, and I believe it is to the drainage lines that we will have to look for a solution of the history of this region. I can do no more than throw out a hint. The streams have carried more water than at present. This may show nothing more than a decrease in rainfall, or it may be the key to a complicated history.

From the Red Fork of the Colorado River, near Colorado City, to the Pecos, a distance of not less than one hundred and seventy-five miles, there was not, in April, 1890, a single flowing stream, yet the maps show several large branches of the Colorado crossing the line travelled. Three of these in particular, Girard Creek and two branches of the Concho River, are on the map made to rise far up in the Staked Plains. The Concho I crossed without being aware of the fact, for the valley of each branch is a broad valley with gently sloping sides and no channel. This is not a case of "arroyo" type of drainage, that is, a channel which occasionally carries floods. It is an old abandoned valley.

Girard Creek, which I was able to study more carefully, is of the same type, but less distinctly dessicated, being intermediate in degree of abandonment between the Colorado proper and the Concho. From Big Springs westward for six miles the valley averages a mile in width and is bounded by degraded bluffs from fifty to one hundred feet in height. There is no channel, but the valley bottom is a series of alkaline flats of the playa type, between cone deltas formed by the wash from the valley sides. These alluvial cones frequently extend completely across the valley and are overgrown by mesquite, showing quite plainly that no flow of water occurs in the valley. The flats between these cones resemble in appearance the estuarine marshes of the northeastern coast. Below Big Springs the channel is clear, and the drainage is young, being of the strong

arroyo type of the arid regions. I am puzzled to know the reasons for these peculiarities.

(c) *Æolian Deposits in the Pecos Valley*.—At the western base of the Staked Plains, along the escarpment of the Pecos Valley there is an extensive æolian deposit about fifteen miles in width. Professor Hill<sup>29</sup> states that this strip of sand is fully one hundred miles in length, extending up into Eddy County, New Mexico. It is plainly due to the prevailing west winds (as suggested by Hill) which have heaped the sands here at the base of the escarpment. It is the most absolute desert waste I ever chanced to see. Crater-like pits and cones of the sand dune type are here most perfectly developed, and the sparse sand-plant growth serves only partially to keep the sand in place.

It was my ill-fortune to be obliged to study this deposit quite carefully, for my team was unable to carry the loaded wagon over the sandy trail into which the wheels sunk, often to the hub. The difficulties of the trip were increased manifold by the sharp grades caused by the pits and cones, and by the shifting sands. Abandoned wagons proved that I was not the first to find the difficulties of the sandy strip. Being informed of the existence of a ranch a dozen or fifteen miles to the north I started on horseback in search of aid. Mile after mile I travelled in the hot sun with the drifting sand blowing in my face. Everywhere the same scene was before my eyes, the escarpment to the east being my only topographic guide. At last I turned back unsuccessful in my search. My tent was banked up with sand, sand was on everything and in everything. At night the eddies of wind would start whirls of sand within the tent, and cooking was quite out of the question. With four horses I was barely able to get my wagon, not a very heavy one, across this strip of sand.

So far as I know this deposit is unique in this country in point of size. Blown as it is quite constantly at the face of the escarpment it must be a powerful agent of erosion, and it is not impossible that this escarpment owes its present position in large measure to æolian action. The Pecos River is twenty-five or thirty miles away and though this was undoubtedly the originator of the escarpment, its present position is due to recession, and, I believe, recession brought about in part by the continual blowing of sand at its base.

---

<sup>29</sup>Hill, Am. Geol., Vol. VII, 1891, p. 369.



## 7.—THE TRANS-PECOS REGION.

(a) *Topographic Description.*—This is almost a terra incognita. It is in brief a region of mountains and basins, the highest mountains being the Guadalupe Mountains which extend from New Mexico into Texas. This is a faulted monocline, rising to the south, where, at Guadalupe Peak, it has an elevation of fully 8,000 feet above sea level and 3,000 feet above the plateau, being terminated by a sheer precipice 2,000 feet in height. It is a mountain of Carboniferous limestone faulted in the western side. Other mountains are associated with igneous action, but our knowledge of them is extremely limited.

(b) *Erosion in the Guadalupe Mountains.*<sup>30</sup>—I introduce here a few notes on the topography of the Guadalupe Mountains taken during a brief sojourn there. The dip of the strata is to the east, gently at the base of the mountains, increasing to an angle of fifteen degrees or thereabout, then becoming nearly horizontal to the west bounding fault beyond which the dip is steeply west. The west dipping rocks, the downthrow of the fault, form the western foot hills. The drainage is chiefly to the east, being consequent on the structure, and therefore long cañons enter from the east well up to the western edge of the mountains, and the west flowing streams are small and short.

Of the east flowing streams McKitterick cañon is a typical example. For two miles from its exit from the mountain, this mountain gorge is accessible to wagons, but beyond this travel on foot is possible only with difficulty. It is extraordinarily rough, being bounded by precipices and steeply sloping sides rising to a height of fully two thousand feet, and the valley is littered with huge boulders and fragments of the cliff which have dropped down from the valley side. The slope of the valley walls is rarely less than thirty degrees and there are sheer precipices of magnesian limestone rising to a height of from one thousand to eighteen hundred feet. There are several hundred of these precipices and it is only rarely that the mountain top is accessible from the interior gorges. There is no soil on these slopes which are either bare bed rock or boulder strewn. The vegetation is of the arid type, except in the shaded valleys or well up on the mountain top, where fair sized pines and cedars grow. Snow accumulates in the cañons but disappears in

---

<sup>30</sup> See Bull. 3 Texas Geol. Survey, 1892, Reconnaissance of the Guadalupe Mountains, by R. S. Tarr.

**THIS PAGE IS LOCKED TO FREE MEMBERS**

Purchase full membership to immediately unlock this page

# DELVE INTO FANTASY, MAGIC, MYTHOLOGY & FOLKLORE

Forgotten Books'  
Full Membership gives  
access to 797,885 ancient  
and modern, fiction and  
non-fiction books.

**Continue**

\*Fair usage policy applies

represents a marine formation of Quaternary age, but without being able to disprove this I would suggest another cause which seems equally possible. It seems to me that this is no more than a gravel slope formed in part from the wash from the mountains, but having chiefly been brought down by the mountain streams and deposited in their channels, which have since been abandoned. Just such deposits are at present found in the broad stream valleys and if they should abandon their course the present stream bed deposits would remain to cap the hill tops when the general level of the region was lowered.

(d) *Dessicated Quaternary Lakes.*—There are in this region many lake basins of Quaternary age. One of these, Crow Flat Valley, I have studied in part. The fault scarp of the Guadalupe Mountains and the foot of the hills at its base form the eastern boundary of this lake. The other enclosing walls I have not seen. It is in part a synclinal valley formed by the dragging up of its strata on the east by the Guadalupe fault. The Crow Flat is a level plain, deeply filled with silt, at least forty feet deep, of a very fine quality, and having shore lines and deltas on either side. Its extent I am unable to state even approximately.

The lake is not quite extinct. It is a catchment basin for a large area and water is found throughout the valley at a depth of from five to forty feet in the lake silts. It is invariably alkaline, frequently saline. In the lowest portion of the valley the water comes to the surface in a great salt, marshy area, upon which a crust of salt exists. Alkaline flats and marshy areas are common, and gypsum deposits occur in several places. There is a gypsum stratum quite uniform in extent and in one place a dune-like accumulation of gypsum sand. This is but one of a series of dessicated lake basins in this region, none of which have been studied except in a hurried reconnoissance.

(e) *The Rio Grande and Rio Pecos.*—I am unable to say anything about the Rio Grande and Pecos Rivers in Texas. Both of these rise in the northern regions, in the mountains, and enter Texas as well defined and overburdened streams. Their Texas tributaries are nearly all of the arid arroyo type, carrying water only in times of heavy rains. Of these two large rivers I have seen only enough to convince me that they have an interesting history, but my knowledge of them is too indefinite to admit of the statement of my suspicions concerning this history.

## 8.—ABSENCE OF LARGE LAKES IN TEXAS.

It is a striking fact, that in a State covering an area as great as that of Texas, there is not a single large lake. Almost every other geographic form is represented, often in great variety, and the climatic conditions vary from moist to arid.

The lagoons of the sea shore near river mouths and in other favorable situations are perhaps the nearest approach to lakes in the state. The young land, as yet hardly land, encloses temporary lakes of saline water, which on the one hand are liable to destruction by the sea, or on the other to be quickly filled by the sediment of the streams.

The Tertiary and Cretaceous plains have been raised above the sea without sufficient structural features for lake formation. They consist of gently dipping strata and the lakes, which may have originally existed in early shallow inequalities, have been long since removed by the establishment of drainage. In the flood plains of the Tertiary district there are lakes of small size, according to Penrose who writes<sup>31</sup> "lakes are of a very rare occurrence, and are never seen except in river bottoms, where they form muddy lagoons abounding in fish and generally fed by springs. They are often of considerable depth, and are connected with the main river by narrow channels." It seems probable that these lagoons are unfilled portions of abandoned river channels. Penrose states that in the Tertiary district he saw but one lake in the uplands, this amounting to little more than a large spring, having a diameter of about two hundred yards.

In central Texas the river erosion has uncovered the Carboniferous from beneath the Cretaceous, and the drainage, although superimposed, is establishing itself without the presence of lakes. In this section, in places where side streams have been held back by the effort of the main stream to overcome some barrier below, extensive flood plains have been built up in the lower part of the valley of the small stream and here lagoons and oxbow lakes are sometimes found. This is the case in the lower Pecan Bayou and San Saba River, both tributaries to the Colorado. These streams are laked in their lower course by the upbuilding of the flood plain of the Colorado due to the retardation in its down-cutting caused by the Silurian barrier. During the dry season all the medium sized streams of the semi-arid belt become a chain of lakes of extremely

---

<sup>31</sup>First Ann. Report, Texas Geol. Survey, 1889, p. 11.

small size, for the water stands in pools of varying size and trickles from one to another in a tiny stream. These pools are enclosed sometimes by bars and deltas, sometimes by walls of solid rock, the pools themselves being the result of corrosion.

The elevated plateau region west of this and east of the Pecos River contains a number of lake basins of sink-hole type, but no water, or at best very little, stands in them. Very probably there are sink-hole basins on the Cretaceous limestone in east central Texas. Still farther west, in the Trans-Pecos region, there are several large lake basins, abandoned either in part or entirely, by dessication. Here lakes of consequent origin, the result of mountain deformation, have existed and will exist again if the conditions of rainfall become favorable.

Hence it is that Texas contains no large lakes: first, because there are no regions of striking structural features, except one (the older Palæozoic area) in which erosion has long been in progress, and its lakes long since destroyed, and one in a region too dry for the existence of lakes; and secondly, because erosion has tapped the shallow lakes that formerly, no doubt, existed on the new Cretaceous and Tertiary land. Sink holes in limestone regions frequently containing small and shallow bodies of water, lagoons on the sea shore, and oxbow lakes in the flood plains, constitute the major part of the Texas lakes. To these might be added the expanded springs, the laked streams caused by the overburdened condition of the main stream (Pecan Bayou and San Saba River tributary to the Colorado), and the chain of pools of the sub-humid region, formed by the dessication of the river. The salt lakes, playas and alkaline marshes and flats of the Trans-Pecos region are the dessicated remnants of lakes, formerly of greater size, just as the pools are the result of the annual dessication of normally continuous streams.

#### 9.—SUMMARY.

The State of Texas is a series of prairies, plains and plateaus, low coastal plains in the east, elevated plateaus in the center, and in the extreme west a plateau broken by mountain ranges. A buried land, now uncovered, forms a central hilly district. In climate the State varies from the moist Gulf coast to the truly arid Trans-Pecos region.

The evolution of the Texas region began, so far as our present records can show, with an old Palæozoic or Pre-Palæozoic mountains land which was denuded at the beginning of Carboniferous

**THIS PAGE IS LOCKED TO FREE MEMBERS**

Purchase full membership to immediately unlock this page

# Know Your Bible

Forgotten Books' Full Membership provides unlimited access to more than 28,000 volumes of Christian literature for \$8.99/month

**HOLY BIBLE**

**Continue**

\*Fair use policy applies

## BIBLIOGRAPHY.

Comstock, T. B.—Preliminary report on the Geology of the Central Mineral Region of Texas. First Ann. Rept., Geol. Survey Texas, 1889, pp. 239–391.

Comstock, T. B.—Report on the Geology and Mineral Resources of the Central Mineral Region of Texas. Second Ann. Rept., Geol. Survey Texas, 1890, pp. 553–664.

Curtice, Cooper.—Discussion.—Bull. Geol. Soc. Am., Vol. 2, 1890, pp. 527–8.

Hill, R. T.—Present Condition of Knowledge of the Geology of Texas. Bull. U. S. Geol. Survey, No. 45, 1887, 95 pp.

Hill, R. T.—The Topography and Geology of the Cross Timbers, etc. Am. J. Sci., 1887, Vol. 33, pp. 291–303.

Hill, R. T.—A portion of the Geologic Story of the Colorado River of Texas. Am. Geol., Vol. III, 1889, pp. 287–299.

Hill, R. T.—Events in North American Cretaceous History, illustrated in the Arkansas-Texas Division of the Southwestern Region of the United States. Am. Journ. Sci., XXXVII, 1889, pp. 282–90.

Hill, R. T.—A Preliminary Annotated Check List of the Cretaceous Invertebrate Fossils of Texas, etc. Bull. 4, Geol. Survey Texas, 1889, pp. I–XXXI.

Hill, R. T.—A Brief Description of the Cretaceous Rocks of Texas, etc. First Ann. Rept., Geol. Survey Texas, 1889, pp. 105–141.

Hill, R. T.—Classification and Origin of the Chief Geographic Features of the Texas Region. Am. Geol., V, 1890, pp. 9–29; 68–80.

Hill, R. T.—Pilot Knob: A Marine Cretaceous Volcano, (with notes on its Petrography by J. F. Kemp). Am. Geol., Vol. VI, 1890, pp. 286–94.

Hill, R. T.—The Comanche Series of the Texas Arkansas Region. Bull. Geol. Soc. Am., Vol. II, 1891, pp. 503–524.

Hill, R. T.—Æolian Deposits of Eddy County, New Mexico. Am. Geol., Vol. VII, 1891, p. 369.

Hill, R. T.—Preliminary notes on the Topography and Geology of Northern Mexico and Southwest Texas and New Mexico. Am. Geol., Vol. VIII, 1891, pp. 133–141.

Hill, R. T. and Penrose, R. A. F., Jr.—Relation of the Uppermost Cretaceous Beds of the Eastern and Southern United States. Am. Journ. Sci., XXXVIII, Dec., 1891, pp. 468–73.

Hill, R. T.—On the Occurrence of Artesian, etc., Waters in Texas, etc. Washington, May, 1892.

Loughridge, R. H.—Report on the Cotton Production of the State of Texas, etc. Tenth Census, United States, Vol. V, 1884, pp. 653–831.

Penrose, R. A. F., Jr.—A Preliminary Report on the Geology of the Gulf Tertiary of Texas, etc. First Ann. Rept., Geol. Survey Texas, 1889, pp. 5-101.

Penrose, R. A. F., Jr. and Hill, R. T.—Relation of the Uppermost Cretaceous Beds of the Eastern and Southern United States. *Am. Journ. Sci.*, XXXVIII, Dec., 1891, pp. 468-73.

Shumard, Geo. G.—A Partial Report on the Geology of Western Texas, Austin, Texas, 1886, 145 pp.

Taff, J. A.—Cretaceous Deposits of Trans-Pecos Texas. Second Ann. Rept., Geol. Survey Texas, 1890, pp. 714-738.

Tarr, R. S.—Origin of Some of the Topographic Features of Central Texas. *Am. Journ. Sci.*, XXXIX, pp. 306-311.

Tarr, R. S.—A Preliminary Report on the Coal Fields of the Colorado River. First Ann. Rept., Texas Geol. Survey, 1889, pp. 201-216.

Tarr, R. S.—The Carboniferous Area of Central Texas. *Am. Geol.*, Vol. VI, 1890, pp. 145-153.

Tarr, R. S.—Superimposition of the Drainage in Central Texas. *Am. Journ. Sci.*, XL, 1890, pp. 359-62.

Tarr, R. S.—The Permian of Texas. *Am. Journ. Sci.*, XLIII, 1892, pp. 9-12.

Tarr, R. S.—The Cretaceous Covering of the Texas Palæozoic. *Am. Geol.*, Vol. IX, 1892, pp. 169-178.

Tarr, R. S.—A Hint with respect to the origin of Terraces in Glaciated Regions. *Am. Journ. Sci.* XLIV, 1892, pp. 59-61.

Tarr, R. S.—Reconnaissance of the Guadalupe Mountains. Bull. 3, Texas Geol. Survey, 1892.

Walcott, C. D.—Discussion.—*Bull. Geol. Soc. Am.*, Vol. II, 1891, pp. 526-7.



SEPTEMBER 5.

GEO. H. HORN, M. D., in the chair.

Twenty-six persons present.

---

SEPTEMBER 12.

MR. CHARLES P. PEROT in the chair.

Thirty-six persons present.

A paper entitled "A Tempered Steel Meteorite," by Edw. Goldsmith was presented for publication.

The death of Prof. John M. Maisch, a member, the 10th inst. was announced.

---

SEPTEMBER 19.

MR. CHARLES P. PEROT in the chair.

Thirty-two persons present.

---

SEPTEMBER 26.

MR. CHARLES P. PEROT in the chair.

Thirty-one persons present.

A paper entitled "The Odonate Genus Ortholestes," by Philip P. Calvert, was presented for publication.

The death of Henry L. Taggart, a member, the 22nd inst. was announced.

Julia B. Platt of Chicago was elected a Correspondent.

The following was ordered to be printed:—

**THIS PAGE IS LOCKED TO FREE MEMBERS**

Purchase full membership to immediately unlock this page

# DELVE INTO FANTASY, MAGIC, MYTHOLOGY & FOLKLORE

Forgotten Books'  
Full Membership gives  
access to 797,885 ancient  
and modern, fiction and  
non-fiction books.

**Continue**

\*Fair usage policy applies

The construction of the heliometer is based upon the fact that while an object appears single (Fig. 1) when viewed through two object glasses of equal focal length placed side by side at the end of a tube provided with a single eye piece, it will appear double (Fig. 2) when the object glasses are displaced. As the two images (Fig. 2) at the focus are separated from each other by a distance equal to the distance of the centres of the object glasses, the displacement of the latter as measured by a micrometer screw will give

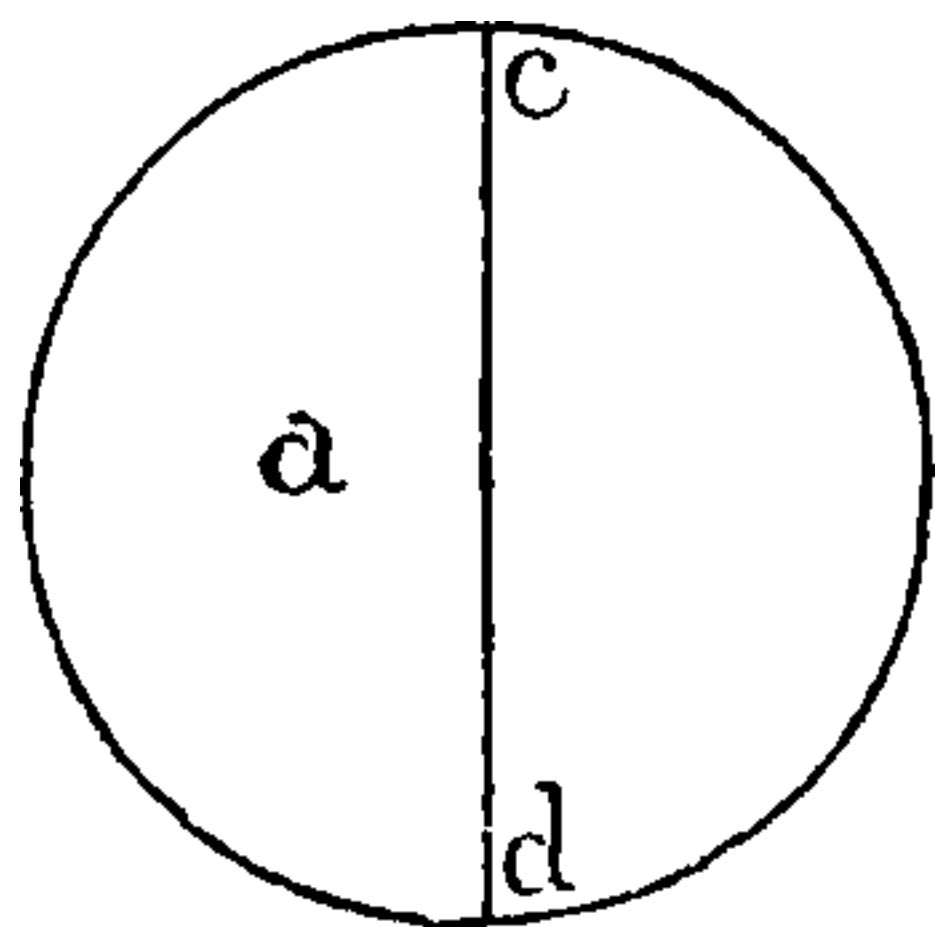

Fig. 1.

the displacement of the angular diameter, (Fig. 2, c d) of a celestial body. The angle subtended by the apparent diameter of the sun, for example Fig. 2, c d, can then be determined by simply bringing the two images of the sun in contact (Fig. 2) and measuring the displacement necessary to accomplish this by a filar micrometer, the angular value of the revolution of the screw being known.

A few years after Bouguer invented his heliometer which Lalande used to determine the diameter of the sun, Dollond substituted for the two object glasses the two halves of one object glass (Fig. 3, A B). By means of this arrangement two images (Fig. 2, a b) are seen as in

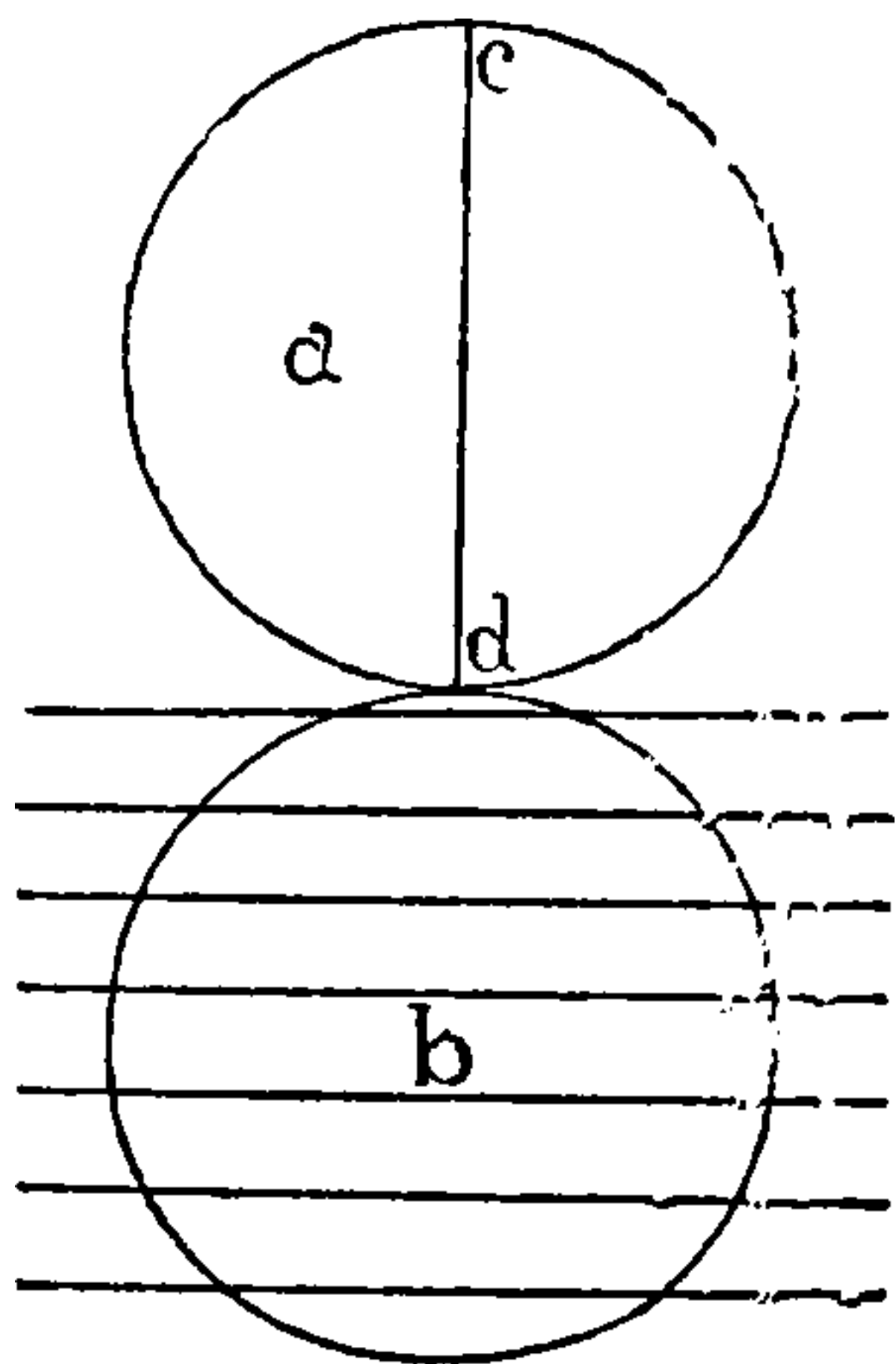

Fig. 2.

Bouguer's heliometer, each semi-lens giving an image except when the two semi-lenses are juxtaposed, the two images being then superimposed. By fixing the semi-lens A and making the semi-lens B (Fig. 3) slide over it, the image a (Fig. 2) due to the semi-lens A becomes also immovable. The distance through which the semi-lens B (Fig. 3) is moved in order to bring the image b (Fig. 2) due to it, in contact tangentially with the image a and equal to the apparent diameter sought, is measured by means of

a micrometer screw as in Bouguer's instrument. The value of the angle under which the apparent diameter of the object (Fig 2, c d) is seen can be thus determined.

In connection with the invention of the heliometer, it is interesting as illustrating the influence of the progress of astronomy upon physiology that the Observatory of Königsberg, to which Helmholtz was attached as assistant when a young man, possesses one of the finest heliometers ever constructed: that by Fraunhofer. Doubtless this instrument suggested to Helmholtz the invention of the ophthal-

ometer. It should be mentioned, however, that in the ophthalmometer as devised by Helmholtz<sup>6</sup> the two images of the object are produced by means of two glass plates such as were suggested by Clausen to obtain two images of a star. The ophthalmometer

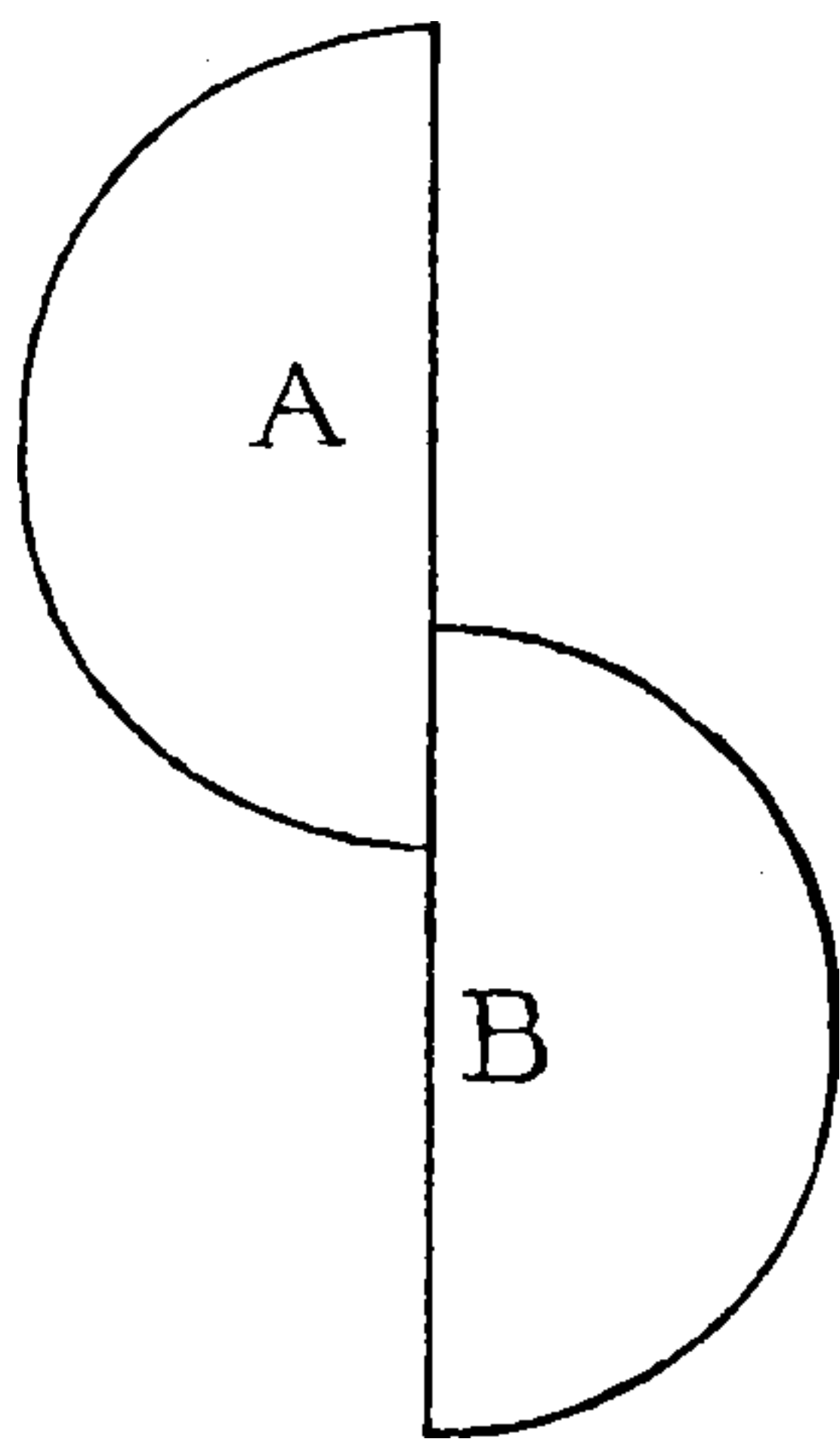

Fig. 3.

as constructed by Meyerstein of Göttingen consists of a small telescope (Fig. 4, T) the objective of which, b, is enclosed within a brass box C, the latter supported upon a tripod and capable of being leveled in all azimuths. The brass box contains two plane parallel glass plates  $P^1 P^2$ , which are situated in front of the objective of the telescope. By means of a screw mechanism the glass plates can be so turned around a common axis that they can be brought either into the same plane (Fig 5) or into two different planes (Fig. 6).

The angular deviation produced by the movement of the glass plates just referred to can be determined by two graduated wheels which rotate as the glass plates diverge from each other to the one-tenth of a degree, the instrument being provided with a vernier.

By means of the ophthalmometer we are enabled to determine the size of the virtual image produced when rays of light emanating

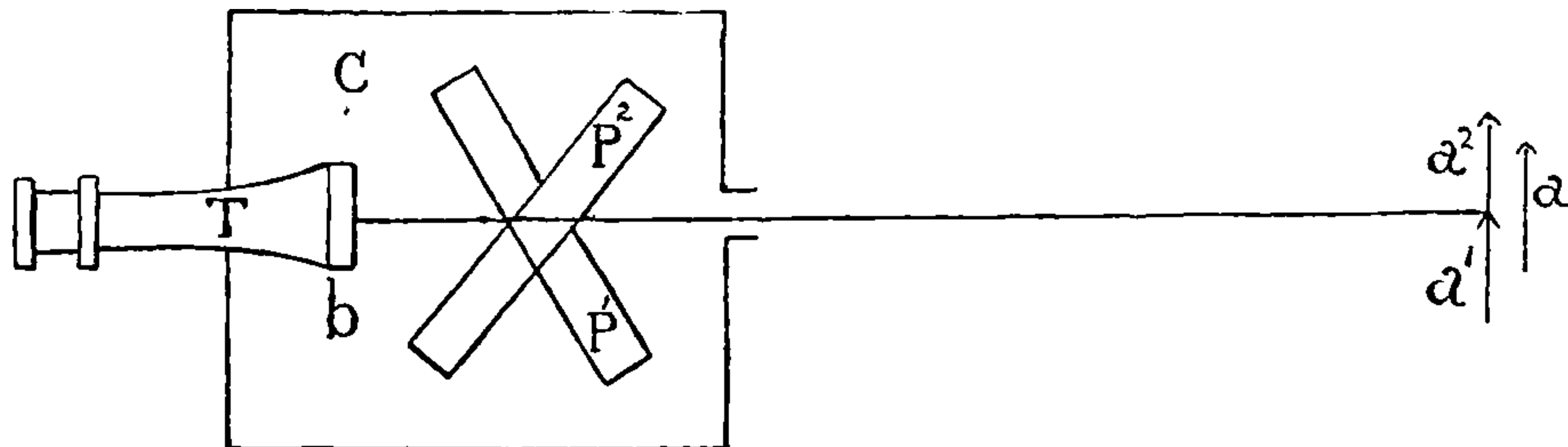

Fig. 4.

from an external object are allowed to fall upon the cornea and, further, as we will show presently, by determining from the size of such corneal image the radius of the curvature of the cornea. The principle by which the size of the corneal image is determined by the ophthalmometer is the same as already mentioned as that of obtaining the apparent diameter of a heavenly body by means of a heliometer.

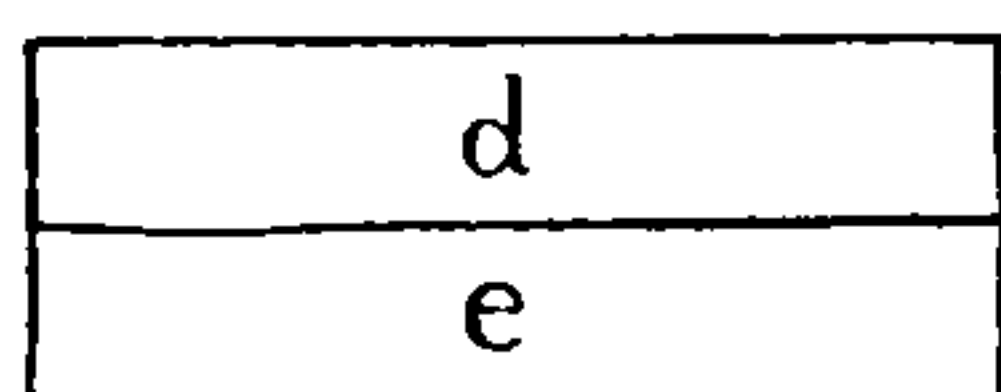

Fig. 5.

The only essential difference in the theory of the two instruments is that while in the heliometer one semi-lens alone moves, and moves in the same plane with the other fixed semi-lens, (the displace-

<sup>6</sup> Archiv fur Ophthalmologie. Band 1, Abth. II, S 1.

ment being measured by a micrometer screw), in the ophthalmometer both glass plates move, and move in different planes, the displacement being deduced from the formula  $I = 2 T \frac{\sin (a-b)}{\cos b}$  in which  $a$  = the

angular deviation of the glass plates obtained experimentally. Before developing the formula just mentioned and which is indispensable for the working of the ophthalmometer let us first consider the paths of such rays of light as, emanating from a luminous object or its reflected image, pass through its two glass plates, the latter making an angle with each other.<sup>7</sup>

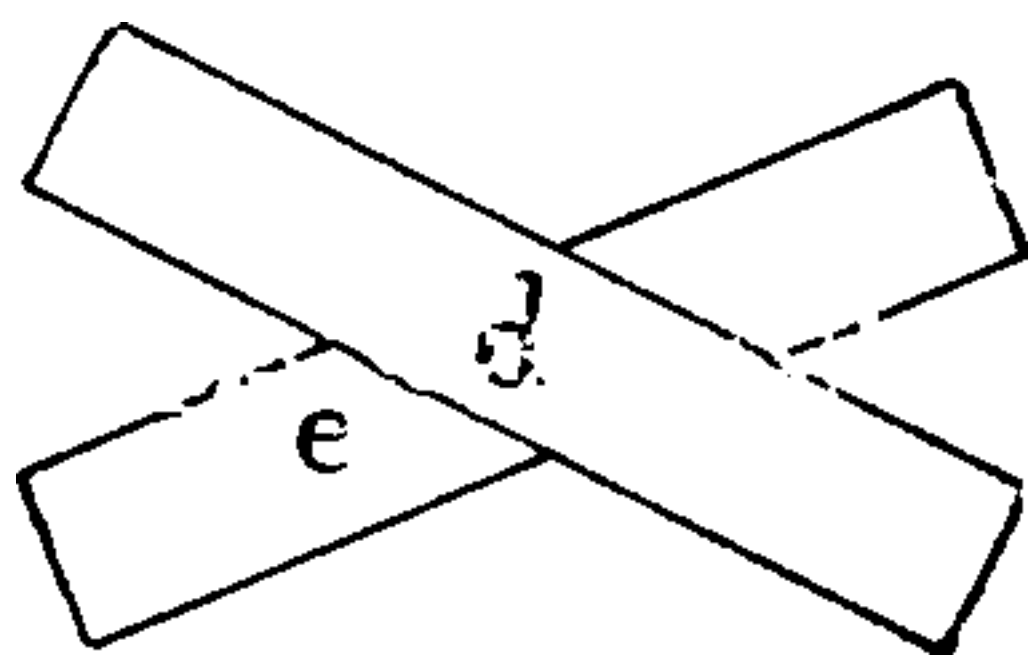

Fig. 6.

From a consideration of Fig. 7 it will be seen that as the rays of light from the object  $a$ , falling upon the glass plate  $P^1$  are projected subjectively back to  $a^1$  those falling upon  $P^2$  to  $a^2$  the object will be consequently seen double as  $a^1 a^2$ . Now if the two images  $a^1 a^2$  are brought into contact with each other tangentially, their total displacement, that is the sum of the displacement of the

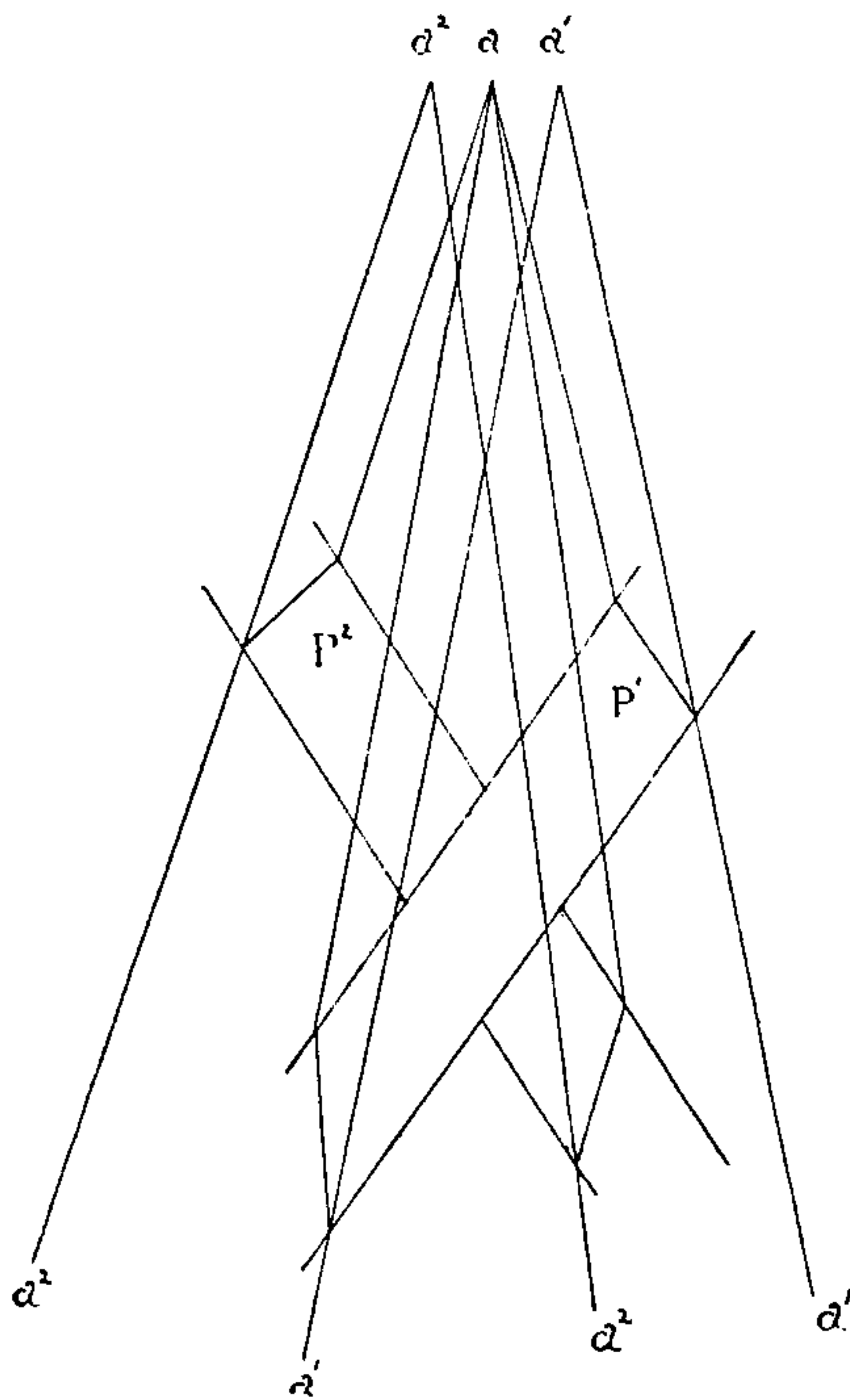

Fig. 7.

two images to the right and to the left, will be equal to the size of the object. That such must be the case becomes at once apparent, if the object and the two images are round bodies as represented in Fig. 8, in which  $a b$  is the displacement to the right,  $c d$  the displacement to the left and  $a d$  the diameter of the object.

It will be observed that while the total displacement— $a b + c d = a d$  the diameter of the object, the distance  $c b$  between the outer edges of the two images is twice  $a d$ , or twice the diameter of the object.

Such being the case it is evident that if we can measure the total displacement of the two images of the

<sup>7</sup> It is unnecessary to say that as long as the two glass plates are in the same plane the luminous object being seen as a single image it is unnecessary to consider the paths of the rays of light under these conditions.

**THIS PAGE IS LOCKED TO FREE MEMBERS**

Purchase full membership to immediately unlock this page

# Know Your Bible

Forgotten Books' Full Membership provides unlimited access to more than 28,000 volumes of Christian literature for \$8.99/month

**HOLY BIBLE**

**Continue**

\*Fair use policy applies

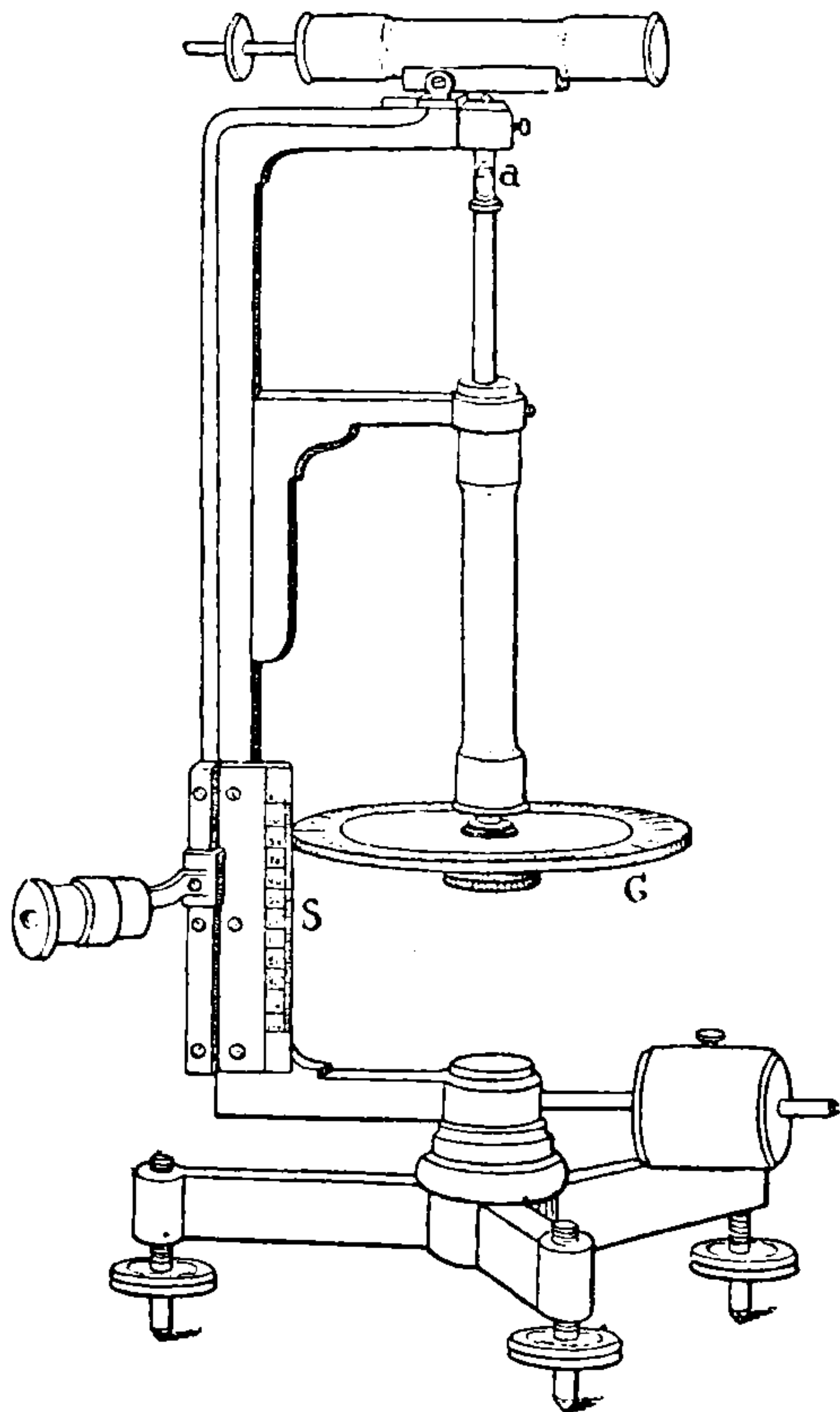

Fig. 10.

or  $I$  will be equal to  $2 a b = 2 T \frac{\sin (A-B)}{\cos B}$

As it is essential in the working of the ophthalmometer by means of the formula just developed, that the thickness of its two glass plates as well as their index of refraction should be determined as accurately as possible, the methods by which these contrasts were obtained will be briefly described.

In determining the thickness of the glass plates a Pfister spherometer was made use of, the general construction of which is well shown in Fig. 10. The object to be measured in this instance, the glass plate, was placed upon a little table at the top of the screw (not represented in fig.) and the latter elevated until the glass plate came in contact with the knife edge  $a$ . The level being then in adjustment, the extent of the separation of the little table and the upper knife edge or the thickness of the glass plates was then obtained by observing the distance through which the screw had descended, as given by the divisions on the scales and on the graduated circle, each division of the scale corresponding to  $\frac{1}{2}$  millimeter each division of the circle to  $\frac{1}{100}$  millimeter. The following resumé of 25 determinations of the thickness of each glass plate proves the accuracy of the method made use of:—

ness of the glass plates which is known, we may call it  $T$  and say therefore that  $CI = \frac{T}{\cos B}$ .

Further the angle  $cIf = hIf - hic$ , but as  $hIf = uca$  or  $A$ , their sides being parallel, and  $hic = IcK$  or  $B$  they being alternate angles it follows that  $\sin cIf = \sin (A-B)$ . Substituting now these values of  $cI$  and  $\sin cIf$  in the equation  $cf = cI \sin cIf$  we obtain  $cf$  or  $a b = T \frac{\sin (A-B)}{\cos B}$ . Inasmuch, however,

as there are two plates in the ophthalmometer and the size of the image is equal to the displacement to the left, plus that to the right, the size of the image

As the average thickness of the two glass plates is the same, viz.: 4.4015 mm., the result is what might have been anticipated since the two glass plates were the halves of one plate.

*Resumé of 25 determinations of the thickness of the right and left glass plates of the Ophthalmometer by the Sphärometer.*

Readings from the Instrument.		Corrected and reduced.	
R.	L.	R.	L.
		mm.	mm.
8—81.1 error 1.0	8—81.2	4.4005	4.4010
.5	.5	25	25
.4	.6	20	30
.2	.0	10	00
.0	.1	00	05
.1 error 1.0	.0	05	00
.0	.8	00	40
.8	.3	40	15
.8	.2	40	10
.0	.0	00	00
80.8 error 0.7	.0	05	15
81.1	.6	20	45
.2	.0	25	15
.3	.1	30	20
.6	.0	45	15
.1 error 0.9	.0	10	05
.1	.6	10	35
.4	.3	25	20
.2	.2	15	15
.3	.2	25	15
80.8 error 0.8	.0	00	10
.9	.1	05	15
.8	80.8	00	00
.8	.9	00	05
81.0 error 0.8	.9	10	05
		4.4015 mm.	4.4015 mm.

In determining the index of refraction of the two plates of the ophthalmometer the sphärometer was also made use of, its application for this purpose being based upon the principle of the index of refraction being equal to the ratio of the actual thickness to the apparent thickness when viewed normally to the surface. Let us suppose that a number of equidistant, parallel lines ruled upon a



glass, e. g. a stage micrometer, be viewed under the microscope and when seen in focus, that a spirit level be placed upon the upper ends of the microscope and of the screw of the sphärometer, the spirit level of the latter having been temporarily removed. The upper ends of the two instruments being now at the same level, let a reading be taken off the sphärometer and, for example, suppose it to be 46.16. Now place upon the stage micrometer one of the glass plates of the ophthalmometer, the latter being interposed between the lines and the objective of the microscope. The tube of the microscope must now be elevated in order that the lines may be brought again into focus. The upper end of the microscope being now at a higher level than that of the sphärometer, the screw of the latter must now be raised until the upper ends of the two instruments are again at the same level and a second reading be taken which we will suppose, for example, to be 43.14. The difference between the two readings,  $3.02 = 1.510$  mm.,<sup>8</sup> will be the distance through which the microscope was elevated in order to see the ruled lines when the plates of the ophthalmometer were interposed between the lines and the microscope. Now if this difference, 1.510 mm., be

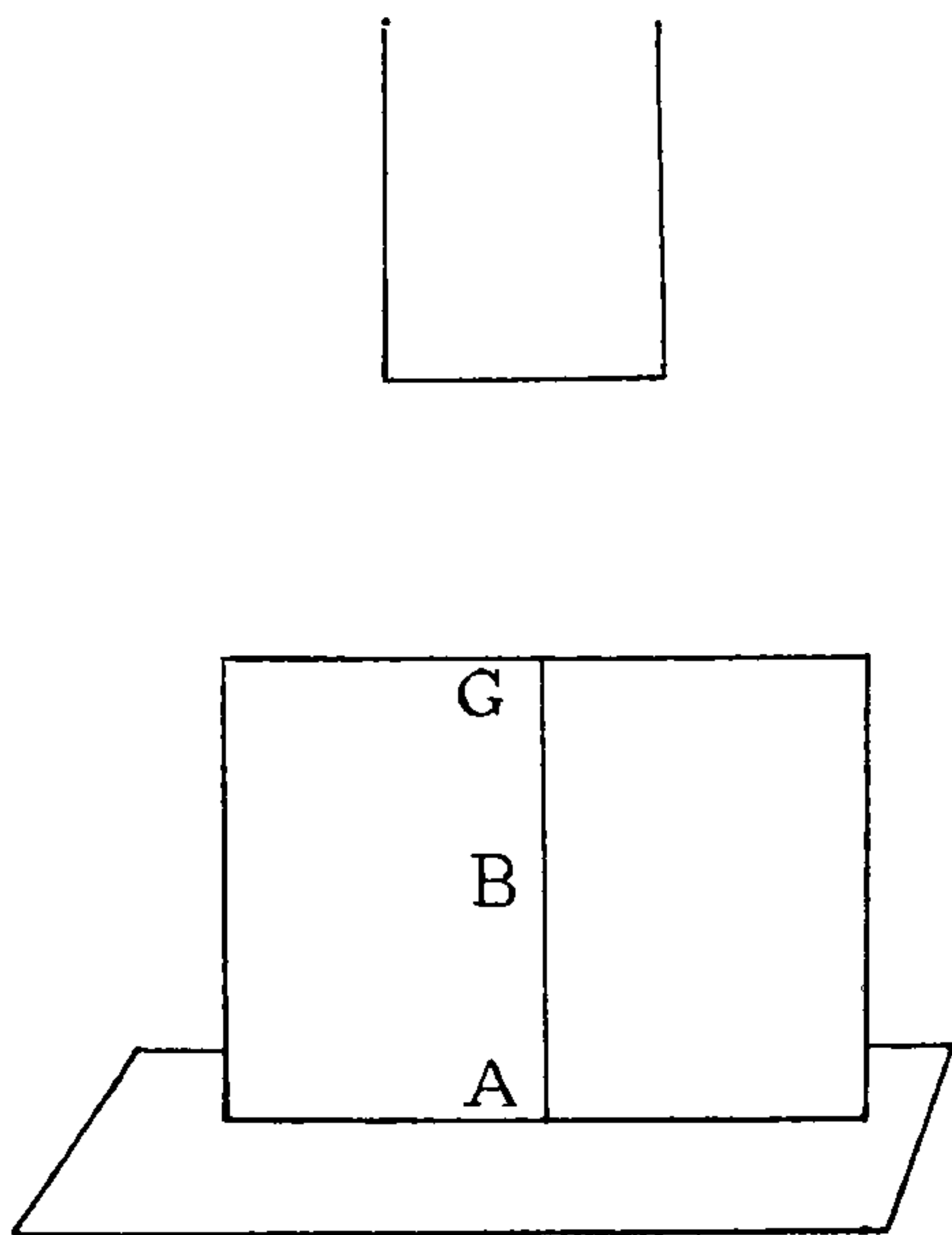

Fig. 11.

deducted from the thickness of the glass, 4.4015, and the remainder, 2.8915 mm., be divided into the thickness of the glass, the quotient, 1.5222, according to the principle above enumerated, will be the index of refraction sought. Thus, for example, let Fig. 11, represent the micrometer resting upon the stage of the microscope, A G, the actual thickness of the plate of the ophthalmometer interposed between the lines and the microscope, then according to theory and experiment  $A G - A B = B G$  or  $4.4015 \text{ mm.} - 1.510$

<sup>8</sup> Each division of the scale equals  $\frac{1}{2}$  of a millimeter.

NOTE.—The methods just described of determining the thickness of the glass plates of the ophthalmometer and their index of refraction were suggested to the authors by Professor A. W. Goodspeed of the University of Pennsylvania, whose well known experimental skill is a sufficient guarantee of the accuracy of the data submitted and the results obtained.

**THIS PAGE IS LOCKED TO FREE MEMBERS**

Purchase full membership to immediately unlock this page

# DELVE INTO FANTASY, MAGIC, MYTHOLOGY & FOLKLORE

Forgotten Books'  
Full Membership gives  
access to 797,885 ancient  
and modern, fiction and  
non-fiction books.

**Continue**

\*Fair usage policy applies

and left respectively. The subject of the experiment upon whose eye the light from the three gas jets falls, sits with the head resting in a frame at a distance of about 90 centimeters from the ophthalmometer,

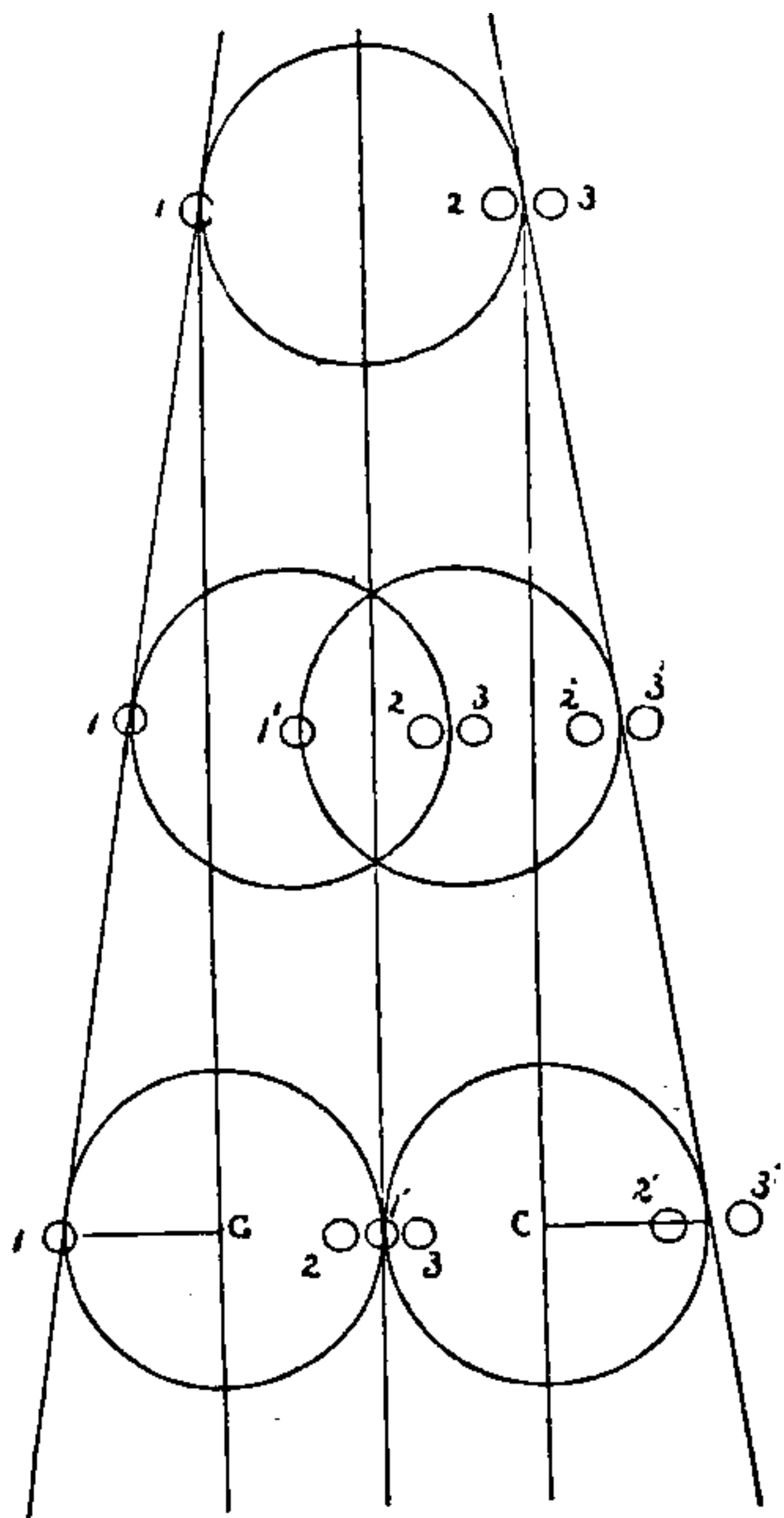

Fig. 12.

and looks directly at the center of the frame supporting the three gas jets. Three corneal images being then perceived by the observer looking through the ophthalmometer erect virtual, but reversed as in a looking glass, the plates of the ophthalmometer are made to diverge until the image 1' reaches a point just midway between the images 2 and 3. The original images, or the distance between 1 and a point midway between 2 and 3, being then doubled, the angle of deviation of the plates, or A, is then read off. The angle A, so obtained experimentally, being substituted in the formula  $I = 2 T \frac{\sin (A-B)}{\cos B}$  the size of the

image or I is then obtained by calculation as shown by the following example:

$$I = 2 T \frac{\sin (A-B)}{\cos B}$$

A = 32° 48', T = 4.4015 mm. Index of refraction = 1.5249

sin A

———— = index of refraction = 1.5249

sin B

sin 32° 48'

———— = sin B

1.5249

log sin 32° 48' = 9.733765

log 1.5249 = 0.183241

—————

log sin B = 9.550524

B = 20° 48' 30"

A — B = 11° 59' 30"

log sin (A — B) = 9.317582

log cos B = 9.970707

—————

9.346875

log 2 T = 0.944631

—————

log I = 0.291586

I = 1.957 mm.

It has already been incidentally mentioned that the size of the corneal image having been determined, we are enabled

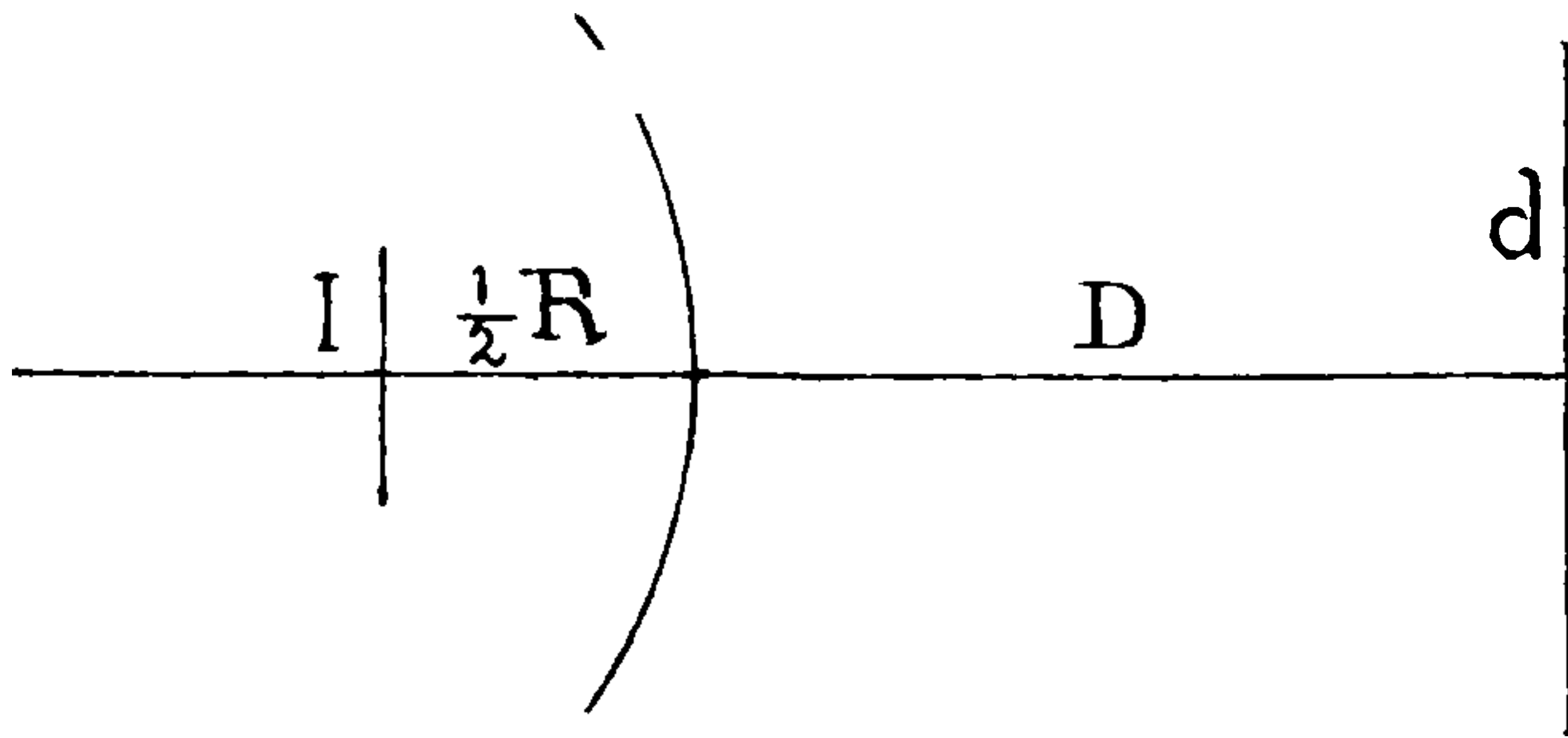

Fig. 13.

thereby to deduce the radius of the curvature of the cornea. This is accomplished by means of the formula  $d-I : I :: D : \frac{R}{2}$  or  $R = \frac{2 D I}{d-I}$  in

which Fig. 13 R is

the radius sought, D the variable distance of the luminous object, the three gas jets, from the cornea C, I the size of the corneal images as determined by the ophthalmometer, and d the constant length of the luminous object 480 mm., that is the distance between the first gas jet and a point midway between the second and third gas jets, the latter being separated by a distance of 80 millimeters. The following example will illustrate the manner in which the formula is used:—

$$R = \frac{2 D I}{d-I}$$

D=900 mm.	d=480 mm.	I=1.957 mm.
	d=480.000	
	I= 1.957	
	-----	
	d-I=478.043	
	2 D=1800.	
Log 2 D=	3.255273	
Log I =	0.291506	
	-----	
Log (d-I)=	2.679467	
	-----	
Log R =	0.867312	
R =	7.367 mm.	=radius of curvature of the cornea.

In connection with the formulæ just made use of in determining the radius of the curvature of the cornea, it may not be superfluous to call attention to the extent to which the result so obtained will be affected by small errors made in determining the values of T, n, I, D, d, incidental to experimentation. Thus, for example, if an error of 0.02 mm. be made in T, the error in n will amount to 0.0002 mm. It is not necessary, therefore, to use the value of the thickness of the

glass plate T beyond the second decimal place, since the value of  $n$ , or the index of refraction, cannot be measured beyond the third decimal place. While an error of 2 mm. in the measurement of D will affect R to an extent only of 0.016 mm., the same amount of error in d will affect R as much as the 0.032 mm. An error of 0.02 mm. in T will involve only an error of 0.01 mm. in I, but an error of 0.01 mm. in  $n$  will change I by as much as 0.02 mm. Finally as an error of 0.02 mm. in I will change the value of R by as much as 0.07 mm. it follows that of these different values that of  $n$ , or the index of refraction, is the most important, the value of  $n$  affecting that of R through I.

*Resumé of 50 experiments with the ophthalmometer.*

Name.	Age.	Horizontal Meridian	Vertical Meridian
		Radius of Curvature.	Radius of Curvature.
		mm.	mm.
1. A. E. H.	25	7.367	7.312
2. J. B. L.	20	7.833	7.747
3. E. E. S.	23	7.744	7.345
4. W. W. K.	36	8.240	8.001
5. C. E. P.	26	7.938	7.851
6. W. H. S.	27	7.935	7.819
7. C. R. C.	32	7.654	7.172
8. W. H. L.	24	7.921	7.606
9. A. A. E.	22	7.882	7.790
10. G. J. M.	23	7.845	7.816
11. E. J. C.	36	7.753	6.637
12. S. R. H.	24	7.670	7.527
13. S. J.	26	7.815	7.527
14. M. W. M.	22	7.321	7.209
15. H. O. S.	20	8.259	7.305
16. G. S.	20	7.438	7.212
17. G. M. K.	25	7.890	7.629
18. M. L.	26	8.993	7.789
19. H. L.	27	7.572	7.430
20. O. A.	19	7.861	7.572
21. J. N.	27	7.648	7.676
22. C. R.	24	7.803	7.515
23. L. L.	24	7.249	7.277
24. M. C. S.	22	7.745	7.377
25. F. K. P.	21	7.816	7.498
26. G. W. H.	26	8.170	7.935

**THIS PAGE IS LOCKED TO FREE MEMBERS**

Purchase full membership to immediately unlock this page

# Know Your Bible

Forgotten Books' Full Membership provides unlimited access to more than 28,000 volumes of Christian literature for \$8.99/month

**HOLY BIBLE**

**Continue**

\*Fair use policy applies



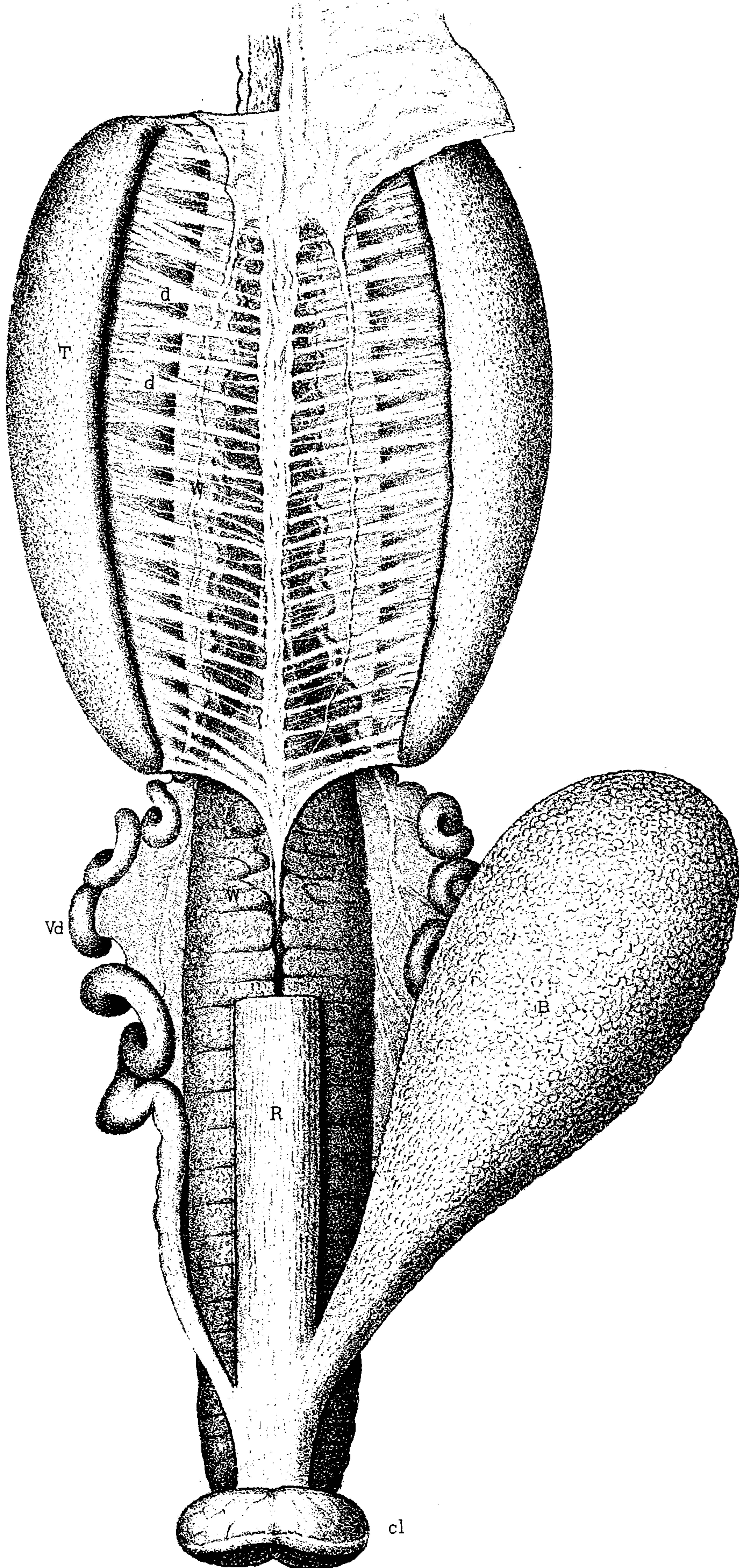

T

d

d

W

Vd

W

R

B

cl





**THIS PAGE IS LOCKED TO FREE MEMBERS**

Purchase full membership to immediately unlock this page

# DELVE INTO FANTASY, MAGIC, MYTHOLOGY & FOLKLORE

Forgotten Books'  
Full Membership gives  
access to 797,885 ancient  
and modern, fiction and  
non-fiction books.

**Continue**

\*Fair usage policy applies



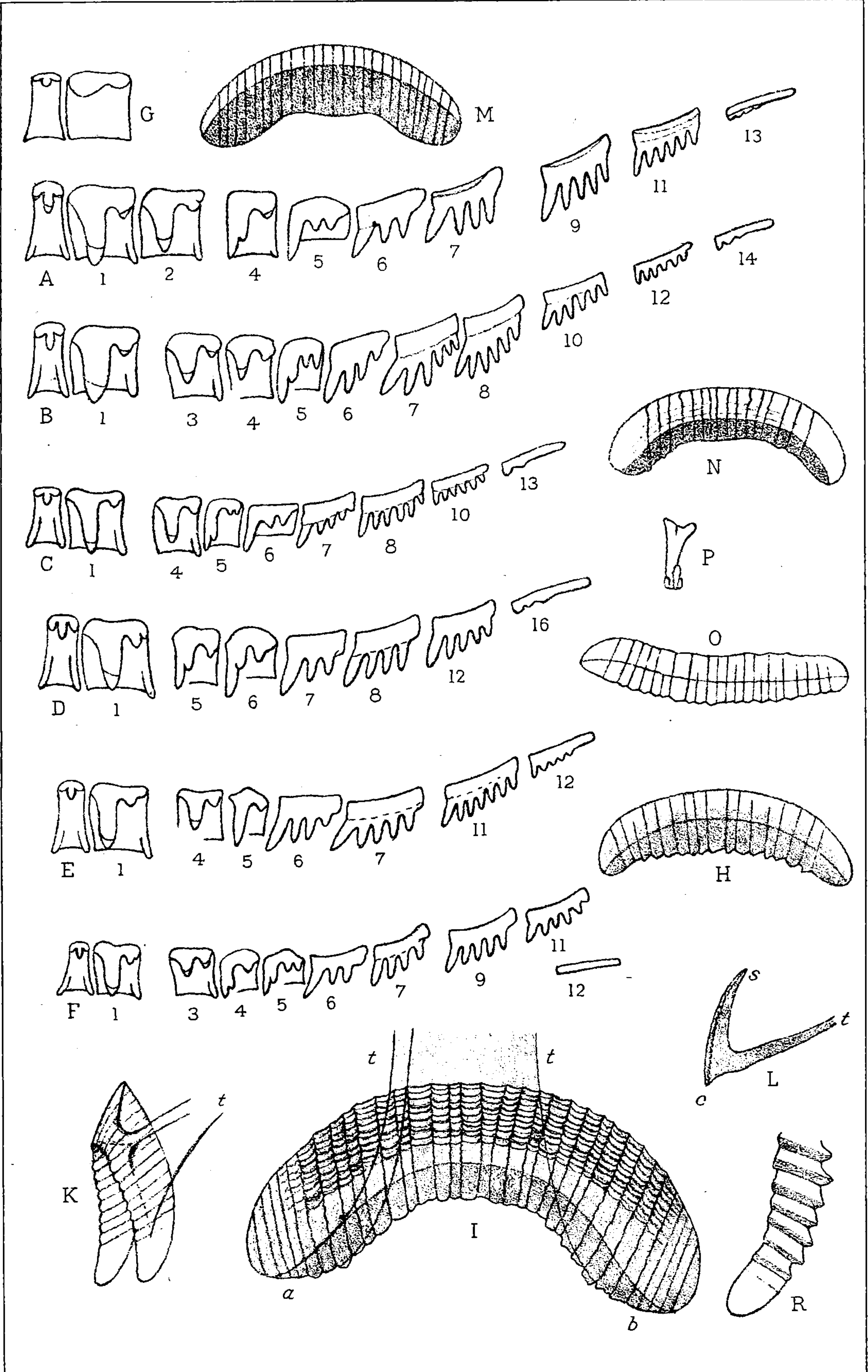

Edwin Sheppard, del.

Geo.S.Harris & Sons Lith Phila

STERKI ON VALLONIA.



**THIS PAGE IS LOCKED TO FREE MEMBERS**

Purchase full membership to immediately unlock this page

# Know Your Bible

Forgotten Books' Full Membership provides unlimited access to more than 28,000 volumes of Christian literature for \$8.99/month

**HOLY BIBLE**

**Continue**

\*Fair use policy applies

## OCTOBER 3.

Mr. JOHN H. REDFIELD in the chair.

Thirty-two persons present.

Papers entitled as follows were presented for publication:—

“On a Collection of Batrachia and Reptilia from South West Missouri,” by E. D. Cope.

“On the Batrachia and Reptilia of the Plains at Latitude 36° 30’,” by E. D. Cope.

---

## OCTOBER 10.

Rev. H. C. McCook, D. D., Vice-President, in the chair.

Thirty members present.

Additions to a paper entitled, “New and little known Paleozoic and Jurassic Fishes,” by E. D. Cope, was presented for publication in the Journal.

---

## OCTOBER 17.

Mr. CHARLES MORRIS in the chair.

Thirty-eight persons present.

A paper entitled, “On Cyphornis, an extinct Genus of Birds,” by E. D. Cope was presented for publication.

The Publication Committee reported in favor of publishing an addition to a paper entitled “New and little known Paleozoic and Jurassic Fishes,” by E. D. Cope in the Journal.

---

## OCTOBER 24.

Mr. CHARLES P. PEROT in the chair.

Thirty-seven persons present.

The death of Charles Hacker, a member, was announced.

---

## OCTOBER 31.

The President, GENERAL ISAAC J. WISTAR, in the chair.

Thirty-seven persons present.

A paper entitled "Notes on some Snakes from Tropical America lately living in the Collection of the Zoological Society of Philadelphia," by Arthur E. Brown.

The Publication Committee reported in favor of publishing a paper entitled "On *Cyphornis*, an extinct genus of Birds," by E. D. Cope, in the Journal.

The following were ordered to be printed:—



## NEW NORTH AMERICAN MYXOMYCETES.

BY GEO. A. REX, M. D.

The Myxomycetes described in this paper are in part new and hitherto undescribed species, and in part well marked and stable varieties of existing species.

*Ophiotheca wrightii* B. & C. var. *stipitata* n. var.

Sporangia stipitate, reniform, globose or ellipsoidal; stipes variable in height, sometimes mere plasmodic thickenings of the bases of the sporangia, sometimes attaining through intermediate grades a height of .5 mm., slightly tapering from below upward, of medium thickness, black, and granulose or occasionally rugose on the surface; capillitium deep yellow, freely branched and combined to form a long loosely meshed net; threads provided with scattered short, sharp and either straight or slightly curved spines; spores yellow, 10–12 $\mu$  in diameter delicately spinulose.

Fairmount Park, Philadelphia, Pa. (Harold Wingate.)

This very unusual and interesting variety is probably the first recorded instance of a stipitate species occurring in the Perichœnaceæ.

It differs from the typical form of the species in the presence of stipes, in the closer meshes of the net of the capillitium, and in the shorter spines on the threads of the capillitium.

The sporangia, however, excepting the stipes, are similar in every respect to the globose and reniform sporangia of the ordinary sessile form.

*Arcyria magna* n. sp.

Sporangia shortly stipitate, densely aggregated, growing either in small clusters or in large effused masses many square inches in area; individual sporangium elongated, cylindrical, tapering toward the end, evanescent above with a small, pale yellowish-gray, funnel-shaped permanent base or calyculus; inner surface of calyculus smooth, except very rarely a few scattered spinules are found under high amplification; stipes one mm. in height, tubular, the cavity being filled with rounded plasmodic masses; capillitium much elongated, about 12 mm. in length relaxed, drooping, tawny gray or drab in color, attached slightly by a few threads to the bottom of the calyculus, and forming a loose large-meshed network; threads of capillitium cylindrical, of uniform thickness, coarsely sculptured

**THIS PAGE IS LOCKED TO FREE MEMBERS**

Purchase full membership to immediately unlock this page

# DELVE INTO FANTASY, MAGIC, MYTHOLOGY & FOLKLORE

Forgotten Books'  
Full Membership gives  
access to 797,885 ancient  
and modern, fiction and  
non-fiction books.

**Continue**

\*Fair usage policy applies

The peculiar spore warting of *A. magna* can be found with a high degree of amplification in *A. punicea*, *A. nutans* and several other species of the eu-arcyriæ. It may practically be considered the type of the spore-sculpturing of that section of the genus.

*Trichia pulchella* n. sp.

Sporangia substipitate or sessile with a narrow base, globose, averaging .6 mm. in diameter, bright vitelline yellow, growing either singly or in small scattered clumps containing but few sporangia, but not upon a common hypothallus; sporangium-wall clear, translucent, rupturing irregularly at the top; capillitium and spores vitelline yellow in mass; capillitium composed of cylindrical threads  $3.5-4.5\mu$  in diameter, terminating in pointed ends from one to one and one half times the diameter of the thread in length; spirals three to four in number, winding more or less irregularly; interspiral filaments absent or very rudimentary; threads occasionally branched and having occasionally bulbous expansions in their course; spores 11 to  $12.5\mu$  in diameter; episporia provided with a sculptured reticulation composed of very narrow rounded thread-like raised bands combined into more or less broken polygons numbering from five to seven to the entire episporium.

Adirondack Mts., N. Y.—Chestnut Hill, Philadelphia, Pa.

This species is allied to the group of Trichias of which *T. chryso-sperma* may be said to be the central form. It differs from them all however, in the solitary or individual habit of growth of the sporangia, which are not developed on a common hypothallus, and in the absence of interspiral ridges even under high amplification.

The very delicate thread-like character of the reticulations of the episporia is remarkable. The threads forming the sides of the polygons are sometimes simple, sometimes zigzag or broken in outline enclosing minute rhombic interspaces, or sometimes marked by a row of rudimentary pits like those often found in the episporia of *T. chryso-sperma*. The spores of the two gatherings from which the species is described are identical, but the capillitium varies, being more bulbous and irregular in one gathering than in the other, due to the fact that it was developed in colder weather. In neither of the specimens could the sporangia be said to be stipitate, but the character of the dark plasmodic bases of the few sessile sporangia, warrants the belief that under specially favorable conditions, stipitate sporangia may be developed analogous to those of the neighboring species *T. varia*, var. *nigripes*.

*Comatricha typhina* Roth. var. *heterospora* n. var.

Sporangia stipitate, cylindrical with rounded apex, or expanded above and terminating in a point curved to one side, about 2 mm. in height including stipes; sporangium-wall evanescent; capillitium composed of slender, sinuous threads arising from the columella, branched many times at irregular intervals and joined together forming a dense tangled network extending to the surface; spores purple-brown in mass when recent, fading in time, 5–6 $\mu$  in diameter; episporium sculpturing complex and only evident with high amplification, consisting of about 10 to 12 dark violet colored hemispherical papillæ irregularly scattered over the surface between which may be found a delicate reticulation of narrow raised bands forming rhombic or irregular quadrilateral meshes.

New York, Pennsylvania, Virginia, North Carolina.

As this variety is seen in the herbarium, it resembles closely the usual form of *C. typhina*. There are however, well marked and positive differences. The capillitium is more slender and forms a denser network which is branched and combined to the very surface, giving the impression, without a close examination, of a parallel peripheral network. It is generally found also in small isolated clumps containing but a few closely aggregated individuals. In the spores of the typical form the larger scattered papillæ are also found but the intervening spore surface is not reticulated but very minutely verruculose.

This variety is not a mere sport or temporary variation, but occurs frequently and is constant in character, so that an observer familiar with it can always identify it in the field without difficulty. The spore sculpturing, however, is so evidently an evolution from that of the regular form of the species, that it seems to be entitled only to varietal distinction.

*Diachæa thomasii*. Proceedings of Acad. Nat. Sci. Phila., 1892, p. 329.

Plasmodium ochre yellow, immature sporangia pure white, mature sporangia metallic, either silvery or gold-bronze in lustre, sometimes iridescent,  $\frac{1}{2}$  to  $\frac{2}{3}$  of a mm. in diameter, scattered or grouped in clusters, stipitate or sessile, globose when stipitate but flattened at the base when sessile; stipes variable, usually short but sometimes  $\frac{2}{3}$  of mm. in height, thick, rugose, dull ochre yellow containing lime; columella ochre-yellow, rough, penetrating from  $\frac{1}{4}$  to  $\frac{1}{2}$  the height of the sporangium, varying in shape from bluntly conical to cylindrical or cylindric-clavate, containing minute round or oblong ochre

colored granules of lime; spores pale brown 11–12 $\mu$  in diameter; episporae sparsely covered with minute papillæ interspersed with a variable number of from four to eight large irregular dark violet papillæ apparently, which are resolved by sufficiently high amplification into dense clusters of from five to eight closely aggregated small papillæ; capillitium sparse, brown-violet in color, composed of rigid, straight, tapering threads arising from the columella and base of the sporangium, joined by a few lateral branches in the middle and near the ends into a loose open network; threads 3–7 $\mu$  in thickness at the basal point of attachment, tapering to a point at their attachment to the sporangium-wall; hypothallus variable, usually membranous with scattered deposits of ochre-colored lime granules, but thick and crustaceous with lime when the sporangia are sessile.

Mitchell Co., North Carolina (Lancaster Thomas.)

This species and the two other distinctively North American species *D. splendens* Pk. and *D. subsessilis* Pk. are characterized by peculiarly specialized spore sculpturings, which would sufficiently serve to distinguish them from the cosmopolitan species *D. leucopoda*, even if their general characters were not equally well marked.

The spore markings of *D. thomasi* as given above, differ greatly from the others.

In *D. splendens* the episporae are studded with irregularly scattered, long, projecting columnar processes which are truncate or flat at the end, not spinose or rounded. These are sometimes joined at various angles forming elongated or angular bars.

In *D. subsessilis* the episporae are marked with diffusely branched rows of minute dark bead-like papillæ ranged side by side in a moniliform manner, sometimes terminating in free ends, sometimes running in a zig-zag irregular manner, but usually combined into a loose reticulation with large irregular meshes.

The episporae of *D. leucopoda* are delicately warted in a uniform manner, like those of many species of the Calcareæ and Stemonitaceæ.

**Chondrioderma roanense** n. sp.

Sporangia stipitate, discoidal, either circular or irregularly elliptical in outline, thin, flattened or slightly convex above, plane or plano-concave below, about one mm. in diameter when circular, or one by one-half mm. when elongated; upper surface of sporangia mottled, presenting the appearance of large irregular spots of dark umber joined by narrow bands of a paler brown color; under sur-

**THIS PAGE IS LOCKED TO FREE MEMBERS**

Purchase full membership to immediately unlock this page

# Know Your Bible

Forgotten Books' Full Membership provides unlimited access to more than 28,000 volumes of Christian literature for \$8.99/month

**HOLY BIBLE**

**Continue**

\*Fair use policy applies

Cranberry, North Carolina (Lancaster Thomas.)

This species is also allied to *C. radiatum*. The ridges which cause the peculiar shrivelled appearance of the surface of the sporangia are not the result of the drying of immature sporangia, but are present in all cases. They are morphological in character, their location being indicated by grayish lines on the chalky white surface of the immature sporangia from a very early period of their development while they are still in a soft and plump condition.

**Craterium rubescens** n. sp.

Sporangia stipitate, about one mm. high including stipe, cylindroid or elongated cyatbiform, apex convex; sporangium-wall single, dark violet-red, smooth except at the upper portion which is slightly roughened by an external deposit of scattered lime granules of a pale lilac color; lower third of wall ridged longitudinally; on spore dehiscence the apex falls away separating by an irregular line in a circumscissile manner; stipe violet-black, one-half the height of the sporangium, wrinkled longitudinally, the ridges being continuous with those upon the sporangium; capillitium composed of an irregular, branched central mass of violet-red lime granules, the branches connected with the sporangium-wall either directly or by a scanty network of delicate colorless tubules with long angular knots of red lime granules at the nodes; spores  $7.5-8.5\mu$  in diameter, brown-violet, episporous thick, minutely warted with dark violet warts.

Louisiana (A. B. Langlois, com. J. B. Ellis.)

This species is allied to both *C. aureum* and *C. leucocephalum*, more especially in their elongated and cylindroid forms. It is distinguished from them by the *Badhamia*-like character of the capillitium and by the color which exhibits some shade or tone of red or violet-red in every part of its structure. The color of the sporangium-wall is due largely to the violet-red innate lime granules which it contains.

**Craterium concinnum** n. sp.

Sporangia usually minute, stipitate, broadly funnel shaped, one-half to two-thirds of a mm. in height including stipe, and one-fifth to one-half of a mm. wide at the top, dehiscing by a regular cap or operculum; color variable, sometimes light or dark umber uniformly diffused over the entire sporangium, sometimes dark brown on the lower half of the sporangium, abruptly shading into brownish-white

in the upper half, operculum brownish-white, darkest in the center; operculum always more or less convex, rarely approaching a hemispherical shape; sporangium-wall smooth, simple, variously colored by the innate lime granules; stipe equalling the sporangium in length, dark brown, longitudinally ridged; capillitium composed of a close meshed, all-sided network with small rounded or slightly angular nodal masses of ochre brown lime granules, averaging about  $25-30\mu$  in diameter; no true columella, but the central nodes larger than the others; spores  $9-10\mu$ , brown, delicately warted.

Fairmount Park, Philadelphia, Pa.

This species differs from the various forms of *Craterium vulgare* to which it is most nearly allied, by its habit of growth, its generally different shape, its convex operculum and especially by the very different capillitium with its minute nodes which are invariably of a dull brownish-ochre color. Like *Lachnobolus globosus* with which this species is frequently associated, it is usually found upon chestnut burs lying upon the ground in moist places.

*Physarum variabile* n. sp.

Sporangia scattered, stipitate, substipitate or sessile, about one mm. high; regularly or irregularly globose, ellipsoidal, obovate or cylindric-clavate in shape; sporangium-wall sometimes apparently thick, of a dingy yellow or brownish-ochre color, slightly rugulose on surface, crustaceous, brittle, rupturing irregularly, sometimes thin, translucent covered externally with flat circular lime masses falling away in patches; stipes nearly equal, occasionally much expanded at the base, rough, longitudinally rugose, variable in size, sometimes one-third of a mm. high, sometimes a mere plasmodic thickening of the base of the sporangium; color of stipes varying from a yellowish-white to a dull brownish-gray; capillitium a small meshed network of delicate colorless tubules with large many-angled rounded masses of white or rarely yellowish-white lime granules at the nodes; no true columella but often a central irregular mass of white lime granules; spores dark violet-brown, verruculose  $9-10\mu$  in diameter.

Adirondack Mts., New York.

A comparison of several gatherings of this species shows a great diversity of forms, the most curious of which is the erect, sessile cylindroid form. Nevertheless the essential characters are the same in all, making them referable to one species. The crustaceous semi-glazed sporangium-wall and similar capillitium ally this species



to *P. citrinellum* Pk. most nearly. It differs from the various forms of *P. schumacheri* Rost. in the absence of a columella.

***Badhamia orbiculata* n. sp.**

Sporangia stipitate or sessile, orbicular, discoidal, irregularly elongated or plasmodiocarpous; averaging about one mm. when simple but of larger size when plasmodiocarpous; when stipitate flattened or depressed above and plane or slightly umbilicate below; sporangium-wall single, more or less translucent from the varying number of innate lime granules; external surface sometimes covered with scattered flat circular masses of lime granules, gray in color except a small area about the attachment of the stipe which is dark brown; inner surface also gray except an area of brown becoming brown-black in the center of the base; stipes short, .3mm. high, deep black, rough, ridged longitudinally; capillitium composed of an irregular central network of tubules containing white lime granules, attached above and below by slender straight sometimes forked tubules, to the sporangium-wall; spores 14-16 $\mu$  in diameter, dark brown, warted under high amplification.

Fairmount Park, Philadelphia, Pa.—Nebraska (H. Webber) Ohio (A. P. Morgan.)

The discoidal character of the simple sporangia of this species is constant and there is but rarely, in any form, any noticeable degree of convexity of the upper surface; on the contrary some sporangia exhibit a somewhat double concave surface, the upper and lower walls nearly coalescing in the center.

**THIS PAGE IS LOCKED TO FREE MEMBERS**

Purchase full membership to immediately unlock this page

# DELVE INTO FANTASY, MAGIC, MYTHOLOGY & FOLKLORE

Forgotten Books'  
Full Membership gives  
access to 797,885 ancient  
and modern, fiction and  
non-fiction books.

**Continue**

\*Fair usage policy applies

plate of soft iron it made an impression alike visible to the eye and sensible to the touch. These three physical proofs would seem to warrant calling the object a tempered steel meteorite.

How the metal became tempered can only be explained hypothetically. Meteorites, in their passage through the atmosphere, become red-hot and if they fall into a pool of water or a deposit of snow or ice they are quickly cooled. Should the chemical composition be such as to form steel, the mass, under such conditions, becomes hardened. On heating one of the granules to redness and allowing it to cool slowly, its softness under the file-test conclusively demonstrated that natural steel is similar to the artificial product. The sharp-edged steel tool of a planing machine would doubtless have been broken by contact with the hard mass while in motion.

The extreme hardness might be supposed to indicate the presence of diamonds, but that mineral is never found in any of these suspected meteorites. The Widmanstaitian figures are small, as might be expected when we consider the quick cooling; only small crystals forming under such circumstances.

Upon magnifying the figures about twenty diameters, by reflected light, the rectangular figures of the cube forming at times rod-shaped elongations and also triangular outlines of the octahedron, sometimes with sharply defined cleavage lines, were observed together with very acute triangles, which may belong to the tetrahedron.

A second surface on the same specimen, nearly at right angles to the first, was ground with greater ease on a corundum wheel running at great speed in order to determine whether the crystallization could be recognized to better advantage, but without result, as the second surface was no better than the first. That the structure might be presented to better advantage, the polished, etched surface was magnified about three diameters and photographed. (Plate IX, fig. 1). The lines, although faint, are apparent and, generally, the angular outlines of crystal forms can be easily traced. The half tones in the picture are the portions of the surface eaten out by the nitric acid. The shining surfaces are the reflections of the nickel steel and the dark pits are the crude untouched material. Cleavage lines predominate throughout the whole surface. A few of the regular outlines were drawn and appear in figure 2. The most common outline appears in figure 4. The dark crystalline figure was etched out by the acid treatment, as was also the larger dark

spot with peculiar markings within. The straight lines which cross each other are cleavages and have, in all probability, a structural meaning. If we focus into the deep pits of the specimen, crystalline bodies appear, of which a few have been drawn, (figure 3). These solid crystals, sometimes show a pale yellow color and may be troilite; some, however, have a deep blue tint, similar to the thin coat of oxide produced on heating iron or steel much below redness.

The microscopic investigation, which could be made only by reflected light, revealed some additional points. The mass is so very cellular and the cells, if the term be allowed, so close together as to require magnifying power in studying them. The quasi cells are filled out with the other material, thus constituting the whole mass. It is not difficult to recognize the faint brass (or yellow) colored troilite and the jet-black magnetite, the latter sometimes filling cells having a distinct crystalline contour as shown in figure 4.

The nickel is probably not evenly divided through the whole of the metallic mass, as part of the metal is readily affected by the nitric acid, while the rest is not. The tempered steel meteorite is, therefore, not homogeneous but highly compound.

Results were obtained by the qualitative chemical analysis showing conclusively the distinct difference between the granules and the separated dark powder. The former contains a sulphuret, probably troilite; the latter contains no sulphuret but, instead, a sulphate.

Iron, nickel, sulphur, traces of carbon, chlorine, phosphorus and chromium were found; also a silicate in which were recognized lime and magnesia. Copper and cobalt were searched for, but in vain. This leads me to direct attention to the Disco Island terrestrial iron, in which, according to Professor A. E. Nordenskiöld and J. L. Smith, are found copper, cobalt, phosphorus and comparatively large quantities of carbon, differences too great to be overlooked in comparing analytical work.

Composition of the granules:

Iron	.	.	.	.	86.66 per cent.
Nickel	.	.	.	.	2.32 per cent.
Sulphur	.	.	.	.	0.19 per cent.
x Silicate	.	.	.	.	4.41 per cent.
Oxygen	.	.	.	.	6.42 per cent.

If the sulphur is combined with iron to form troilite and the oxygen to form magnetite we have:

Iron . . . . .	66.79 per cent.
Nickel . . . . .	2.32 per cent.
Troilite (Fe S) . . . . .	0.52 per cent.
Magnetite (Fe <sub>3</sub> O <sub>4</sub> ) . . . . .	25.96 per cent.
x Silicate . . . . .	4.41 per cent.

Composition of the separated magnetic powder :

Iron . . . . .	68.18 per cent.
Nickel . . . . .	0.31 per cent.
Sulphuric anhydrite . . . . .	1.75 per cent.
Water . . . . .	3.43 per cent.
x Silicate . . . . .	10.10 per cent.
Oxygen . . . . .	16.23 per cent.

According to well known theoretical affinities we may expect the mixture to be :

Iron . . . . .	25.58 per cent.
Nickel . . . . .	0.31 per cent.
Magnetite (Fe <sub>3</sub> O <sub>4</sub> ) . . . . .	56.30 per cent.
Magnetic sulphate (Fe <sub>3</sub> O <sub>4</sub> , 2 SO <sub>3</sub> ) . . . . .	4.28 per cent.
x Silicate . . . . .	10.10 per cent.
Water . . . . .	3.43 per cent.

As long as there is any troilite in the mass a further oxidation and disintegration may be expected. The cellular structure of this steel meteorite seems to permit of such a process continuously.

My statement regarding the magnetic sulphate of iron, is made because, first: the whole of the powder is magnetic, whilst the basic sulphate of iron is not; and, secondly: when I tried to compute it as basic ferric sulphate I invariably obtained a numerical result whose aggregate was 1.05% too high. When regarding it as magnetic ferric sulphate no such discrepancy occurred.

My thanks are due to Professor Angelo Heilprin for the opportunity of investigating the first tempered steel meteorite.

#### EXPLANATION OF PLATE IX.

Fig. 1. Photographic projection of the polished and etched surface of the hard steel meteorite magnified about three diameters.

Fig. 2. Cubic and octahedral forms.

Fig. 3. Solid crystal forms as seen in the pits of the specimen.

Fig. 4. One of the many irregular outlined forms; the crossed lines represent the cleavages.

Figs. 2, 3 and 4 are magnified about twenty diameters.

**THIS PAGE IS LOCKED TO FREE MEMBERS**

Purchase full membership to immediately unlock this page

# Know Your Bible

Forgotten Books' Full Membership provides unlimited access to more than 28,000 volumes of Christian literature for \$8.99/month

**HOLY  
BIBLE**

**Continue**

\*Fair use policy applies

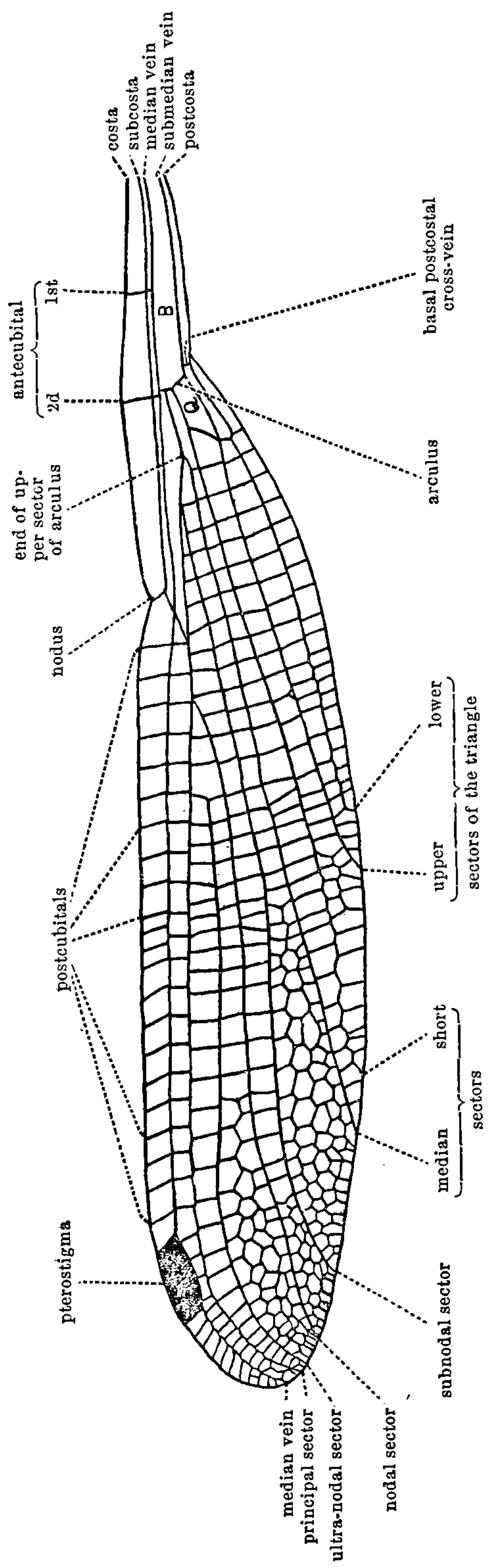

FIG. 1.

Front wing of *Ortholestes clara* ♂.

B, basilar space. Q, quadrilateral.

numbered as 3, 5, 6 and 8, and from the genera, *in addition to the legionary differences*, as follows:

From *Megalestes* by 9.

From *Archilestes* by 1, 2, 4, 7 and 10.

From *Lestes* by 1.

From *Sympycna* by 1, 4, 7, 11 and 12.

From *Platylestes* by 1.

Additional differences from *Megalestes* and *Platylestes* may exist, as I have not seen examples of these two genera.

Other details of generic structure in *Ortholestes* are: the absence of supplementary sectors between the ultra-nodal and the principal, although the last one or two intervening cells may be divided. *Archilestes*, *Lestes* and *Sympycna* also agree here.

Between the ultra-nodal and nodal sectors are two or more supplementary sectors which are quite broken and form an irregular net work with 4–8 marginal cells. In *Archilestes*, *Lestes*<sup>1</sup> and *Sympycna* there are usually but two supplementary sectors between ultra-nodal and nodal; they are quite distinct and regular; the upper one commences 1–2 cells before the lower one and is usually unbroken (*Lestes* and *Sympycna*) or somewhat broken (*Archilestes*); the lower one is usually much broken; the number of marginal cells between nodal and ultra-nodal is 3–6.

The ultra-nodal sector arises at about the level of the fifth or sixth post-cubital, and therefore at about one-third the length of the post-cubital series. In *Archilestes*, *Lestes* and *Sympycna*, the same sector more usually arises near the middle of that series.

Two to eight marginal cells may be present between the nodal and subnodal sectors, depending on the degree of development of supplementary sectors.

The supplementary sectors between the subnodal and median sectors are much broken.

The basal postcostal cross-vein is placed distinctly nearer the level of the second than of the first ante-cubital; the reverse is usually the case in *Archilestes*, *Lestes* and *Sympycna*. These relations may be stated in another way by saying that in *Ortholestes* the first ante-cubital lies but little beyond half way from the base of the

---

<sup>1</sup>The statements here made for *Lestes* are based on the following 17 species; *unguiculata*, *uncata*, *disjuncta*, *forcipata*, *inequalis*, *vigilax*, *rectangularis*, *forcifcula*, *curina*, *congener*, and *tenuata* of North America; *viridis*, *nympha*, *sponsa*, *virens* and *barbara* of Europe; *Colenisonis* of New Zealand.



wing to the second ante-cubital, while in the other three genera it is usually at two-thirds that distance.

The ninth abdominal segment is at least twice as long as the tenth; the appendages are longer than the tenth. In *Lestes* the appendages of the females are shorter than 10.

Recently, I have expressed the opinion<sup>2</sup> that the Calopteryginæ are to be looked upon as representing the most primitive of the living subfamilies of the Odonata, that from them the Agrioninæ are descended, and that of the latter group the legion *Lestes* is phylogenetically the oldest. De Selys long ago suggested<sup>3</sup> that the Calopterygine genus *Amphipteryx*, of tropical America, stands in near relationship to the *Lestes*. Whether we look upon *Amphipteryx* as most nearly approaching the ancestral form of the *Lestes* or not, if we accept the general phylogenetic series above sketched, *Ortholestes* possesses more primitive characters than any other genus of its legion in those above numbered 3, 5 and 6. If we go a step farther and attach a direct ancestral importance to *Amphipteryx*, then may we look upon characters 1, 9 and 11 as relatively long inherited, while 8 appears to be much more lately acquired and quite distinctive of *Ortholestes*.

*Ortholestes clara* Calvert, Ent. News II, p. 199, 1891.

♂. *Head. Teneral*: labrum, clypeus, middle only of top of head brown with a slight metallic, bluish reflection; labium, mandibles, yellow; genæ, sides of frons and vertex bright yellow, but with a brown patch adjoining the margin of the eyes opposite the vertex; antennæ yellow. *Adult*: labrum, clypeus, frons and vertex dark metallic blue or black, a small orange spot on the outer side of each posterior ocellus, a pruinose spot around anterior ocellus, a small pruinose postocular spot each side; labium, mandibles except at tips, genæ, pale luteous (perhaps yellow or even blue in life); antennæ black, first and second articulations yellowish.

*Thorax. Teneral*: brown; prothorax with a small yellow spot each side on middle lobe, hind margin yellowish; remainder of thorax with the following yellow: an antehumeral stripe not attaining the antealar sinus, a complete humeral stripe, a lateral stripe in front of the metastigma with a small spot above, the two forming a reversed! all behind the second lateral suture, pectus. *Adult*:

<sup>2</sup>Trans. Am. Ent. Soc. XX, p. 212, 1893.

<sup>3</sup>Monog. Calopt. p. 241, 1854.

**THIS PAGE IS LOCKED TO FREE MEMBERS**

Purchase full membership to immediately unlock this page

# DELVE INTO FANTASY, MAGIC, MYTHOLOGY & FOLKLORE

Forgotten Books'  
Full Membership gives  
access to 797,885 ancient  
and modern, fiction and  
non-fiction books.

**Continue**

\*Fair usage policy applies

4; a small lateral spot on 8, apical dorsal half of 9 and the lateral stripe on 2-3, yellow; yellow spots on dorsum of 10 extremely small or absent. Appendages dark brown, longer than 10, not denticulated. Genital valves brown, margins not denticulated. Pterostigma luteous (teneral), light brown (adult). 18-23 post-cubitals on front wings, 17-20 on hind wings.

Measurements. Total length ♂ 41.5-47 mm., ♀ 37-40. Abdomen (including appendages) ♂ 34-38, ♀ 29-31.5. Front wing ♂ 25.5-30, ♀ 26-29. Hind wing ♂ 24.5-29, ♀ 25-28. Pterostigma 2-2.25. Superior appendages ♂ 1-1.33. Appendages ♀ .8.

Described from the original four types, viz., one male, one female, Kingston, Jamaica, May, 1890, by E. M. Aaron (Collection of P. P. Calvert); one male, Kingston, by W. J. Fox (Coll. American Entomological Society); one female, Jamaica, by C. W. Johnson (Coll. Wagner Institute of Science); ——— and from two additional males, both from the Bath district of Jamaica by Mrs. Swainson (one in Coll. Institute of Jamaica at Kingston, the other in Coll. P. P. C.).

*Ortholestes abbotti* n. sp.

♂ closely resembling *O. clara*. Differs by the shape of the superior appendages in that the more basal of the two inferior teeth is not so clearly distinct from the dilatation of the lower margin,



FIG. 3. Profile view, appendages of *O. abbotti* ♂

while the more apical tooth is transformed into a slender, acute, somewhat curved spine, situated on the apical side of the basal tooth, and directed backward; the cylindrical terminal portion of the appendage forms about one-fourth the entire length.

Measurements. Total length 39 mm. Abdomen (incl. app.) 31.5. Front wing 24. Hind wing 23. Pterostigma nearly 2. Superior appendages 1.3. Female unknown.

Described from one male from Hayti, by Dr. W. L. Abbott (Collection of the American Entomological Society).

ON A COLLECTION OF BATRACHIA AND REPTILIA FROM SOUTHWEST MISSOURI.

BY E. D. COPE.

The zoology of the Ozark Mountain country is less known than that of some more remote regions of our country. The fishes have, however, been pretty fully investigated by the ichthyologists of the United States Fish Commission, and the mammals are now claiming the attention of the zoologists of the Bureau of Animal Industry of the United States Agricultural Departments. In the present paper I contribute something to the knowledge of the herpetology of the region.

BATRACHIA.

*Amblystoma punctatum* L.

*Spelerpes maculicaudus* Cope,

*Spelerpes melanopleurus* sp. nov.

This species is near to the *S. bilineatus* Green, but differs in both proportions and coloration, and is also smaller, being the least species of the genus. I took five specimens among the stones on the banks of Raley's Creek, one of the head tributaries of the White River.

The width of the head enters the length to the groin 4.5 times (nearly 6 times in *S. bilineatus*), and the length to the axilla enters the same 2.3 to 2.5 times (2.7 times in *S. bilineatus*). The limbs and all the toes are well-developed, and the anterior and posterior meet when applied to the side of the body; they are separated by three full intercostal spaces in *S. bilineatus*. There are always only 13 costal grooves (14 in *S. bilineatus*). Tail strongly compressed. The sides of the head, body and tail are black, with generally sparse white spots; the upper border of this band is darkest, representing the dorsolateral line of *S. bilineatus*. A few black spots along median dorsal line. End of muzzle and chin black. Limbs closely reticulated with black. Belly white in life (yellow in *S. bilineatus*). Measurements of largest specimen: length to angle of lower jaw, 4.5 mm.; do. to axilla, 10 mm.; do. to groin, 23 mm.; do. to end of tail, 57.5 mm.; do. of fore-limb, 6.5 mm.; do. of hind limb, 8 mm.

Although this species is smaller than *S. bilineatus*, it is more robust and less sepsiform in its proportions. In life, the white belly constitutes a conspicuous color-character.

*Typhlotriton spelæus* Stejneger, Proceeds U. S. Natl. Museum, Vol. XV, 1893.

I obtained several specimens of this interesting species from the proprietor of the Marble Cave, Mr. T. Powell. In spirits it has a pale yellow color, as described by Dr. Stejneger, but in life it is white. It occurs in a stream that flows at least 300 feet below the surface. I examined this and other parts of the cave, which is a very extensive one, and observed very little life in it. It seems difficult to understand how the salamander, which is by no means small, could find subsistence, but Mr. Powell states that a species of "fly" inhabits the cave, and is sometimes very abundant.

The vertebræ, as observed by Stejneger, are opisthocoelous, although the ball of the centrum remains cartilaginous. The tarsus is cartilaginous, although the elements are distinct. These consist, as in *Desmognathus*, of ulnare, intermedium, radiale, centrale, and five tarsalia, of which the first is on the inner border of the sole. The location of the genus *Typhlotriton* in the Desmognathidæ by Stejneger is thus justified, and the addition of the genus *Thorius* to the same family, as proposed by Boulenger, is sustained.

The temporal muscle divides a short distance above its insertion in the coronoid process of the mandible after passing under a malar ligament. The inferior and most robust belly is attached to the inferior part of the parietal bone. The superior and more slender belly passes over the parietal bone, lying in a groove between the inferior belly and the low sagittal angle of the skull, and is inserted into the spine of the atlas vertebra, as is the case in the genus *Desmognathus*. It differs from the corresponding muscle in *Desmognathus* in not developing a tendon where it passes over the parietal bone, the point of insertion into the atlas only showing this character.

## REPTILIA.

*Sceloporus undulatus* Daud.

*Crotaphytus collaris* Say. *C. baileyi* Stejneger, North American Fauna, 1890, p. 103.

This species is quite abundant near Galena, Missouri. It has not been hitherto noted as existing in Missouri, the nearest localities recorded being the Neosho River, I. T., and the Arkansas River in Western Arkansas.

**THIS PAGE IS LOCKED TO FREE MEMBERS**

Purchase full membership to immediately unlock this page

# Know Your Bible

Forgotten Books' Full Membership provides unlimited access to more than 28,000 volumes of Christian literature for \$8.99/month

**HOLY BIBLE**

**Continue**

\*Fair use policy applies

ON THE BATRACHIA AND REPTILIA OF THE PLAINS AT LATITUDE  
36° 30'.

BY E. D. COPE.

The following species were obtained by the writer and Professor A. P. Brown, of the University of Pennsylvania, at the following localities: Fort Supply, in northwest Oklahoma; Miami and Mobeetie in the northeastern part of the Panhandle of Texas, and Hennessy, in central Oklahoma. For the greater number of species obtained at Fort Supply, I am indebted to Dr. Corbusier, U. S. A., whose material aid I hereby gratefully acknowledge.

**BATRACHIA.**

*Amblystoma tigrinum* Green.

Fort Supply; Hennessy.

*Bufo lentiginosus americanus* Loec.

Fort Supply.

*Chorophilus triseriatus clarkii* Bd.

Abundant and noisy in pools near the Cimmaron River, at Tucker, Oklahoma. Similar to the individuals reported by me from Clarendon, Texas.<sup>1</sup>

**REPTILIA.**

*Cistudo ornata* Agass.

Fort Supply.

*Cinosternum flavescens* Agass.

Professor Brown found a living specimen of this species about six miles west of Mobeetie, Texas. This is much the most northern locality recorded for the species.

*Chelydra serpentina* L.

Hennessy, Oklahoma Territory.

*Crotaphytus collaris* Say.

Fort Supply and Miami.

*Holbrookia maculata* B. & G.

Fort Supply and Mobeetie.

---

<sup>1</sup> Proceedings Academy Natural Sciences of Philada., 1892, p. 333.

*Phrynosoma cornutum* Hasl.

Fort Supply, Mobeetie, and Hennessy.

*Cnemidophorus sexlineilus* L.

Fort Supply and Miami.

*Ophisaurus ventralis* Daud.

Hennessy.

*Ophibolus doliatus sysputus* Cope.

Hennessy, Oklahoma Territory.

*Ophibolus getulus sayi* Holbr.

Mobeetie.

*Pityophis sayi sayi* Schleg.

Fort Supply.

*Coluber spiloides* D. & B.

Fort Supply.

*Bascanicum flagelliforme testaceum* Say.

Fort Supply.

*Diadophis amabilis docilis* B. & G.

Hennessy, Oklahoma Territory.

*Heterodon nasicus nasicus* B. & G.

Fort Supply.

*Tropidoclonium lineatum* Hallow.

Hennessy.

*Eutaenia elegans marciana* B. & G.

Fort Supply.

*Crotalaphorus catenatus edwardsii* B. & G.

Mobeetie and Hennessy. These localities extend the range of this species. It is characteristic of the sandy country that extends from Mobeetie eastward, and which is also seen about Hennessy in central Oklahoma.

*Crotalus confluentus* Say.

The Staked Plain west of Mobeetie.



## GROWTH CHANGES OF THE RADULA IN LAND-MOLLUSKS.

BY DR. V. STERKI.

The radula, or lingual membrane of the glossophorous mollusca has been most assiduously studied, being a very attractive and interesting object in itself, and a valuable character for systematic distinctions. Its features in the land mollusca of America have been investigated by W. G. Binney;<sup>1</sup> but thus far the adult animals only have been considered, and conclusions regarding the morphology of the teeth have been based chiefly upon these. Of the development of the radula and its changes with advancing age, very little is known. The writer published some years ago, a short article on the subject,<sup>2</sup> but the considerations then advanced prove to be quite insufficient.

During the last few months a number of species have been examined with special reference to these changes, and the results prove to be of unexpected value. The subject has been studied from a morphological standpoint only. For histological details the publications of Kœlliker, Semper, A. Ruecker and others must be consulted.

The special cases to be described in detail below may be more readily understood by attention to the following general considerations. If we carefully examine a well prepared and extended radula of a young specimen, it will be seen that in the anterior, or older part (which was formed, however, by the animal when younger), a transverse row contains fewer teeth than a row in the posterior or more lately formed part. In other words, new teeth, one or more new longitudinal rows, are added. The new teeth are at first mere traces, resembling the outermost marginals in general form, being small, roundish nodules, transverse or longitudinally elongated plates, which, by gradual changes in each succeeding transverse row, develop into true marginal teeth. At the same time it may be found that there are, in a transverse row at the anterior, one or more laterals fewer than in a row at the posterior part; and a closer

---

<sup>1</sup>Terr. Moll. U. S., Vol. V.; and Jaw and Dentition of Pulmonate Mollusks, Annals N. Y. Acad. of Sci., Vol. III.

<sup>2</sup>Altersverschiedenheiten der Radula bei *Hyalinia*, Nachrichtsbl. d. Deutschen Malak. Gesellschaft, 1882, p. 172-177.

**THIS PAGE IS LOCKED TO FREE MEMBERS**

Purchase full membership to immediately unlock this page

# DELVE INTO FANTASY, MAGIC, MYTHOLOGY & FOLKLORE

Forgotten Books'  
Full Membership gives  
access to 797,885 ancient  
and modern, fiction and  
non-fiction books.

**Continue**

\*Fair usage policy applies

land mollusca, but singly or few aggregated. They are at first not globular, but distinctly ellipsoidal, the shell being perfectly glassy and transparent, so that yolk division and the formation and development of the embryo may be observed through it.

The buccal body and radula develop rather rapidly. In an embryo taken from the ovum, about 2.5 mm. long when extended, not quite mature, with the caudal bladder still rather large, but the heart formed and regularly contracting, the shell measured about 0.35 mm. long. The radula was 0.35 mm. long and had as many as 34 transverse rows of teeth. In the first of them there were 3 teeth, the central and a lateral on either side, appearing as thin, barely visible plates, or mere traces ( $O^3$ , in fig. 1). Other specimens showed the same more distinct, as represented in fig. VI. In the following transverse rows they are larger, and rapidly develop in shape, while at the margin new teeth of the same character are added, at first with each row, then at greater and greater intervals, so that, in the radula mentioned above, the formula was 12.c.12 in the twenty-fifth transverse row. The development of the radula proceeds comparatively very fast, in this and other species, faster than the growth of the animal, so that even very young specimens have the radula far advanced and show nothing more of the earliest formed teeth. The addition of new teeth is not always regular and symmetrical on both sides; thus, the fifth longitudinal row may begin at the sixth transverse row on one side, and with the seventh on the other, so that the formula for the sixth would then be 5.c.4.

Not all of the teeth are formed and transformed in the same way, in this and other species, as may be seen by the figures. But *Limax campestris*, and other *Limaco-Zonitidæ* and *Helicidæ*, show such new and unexpected features that they must be considered more in detail.

For a better understanding and easier reference the following table gives the particulars of a series of the specimens examined, all of them, except two, being represented in figs. I-V on Pl. 10.

	Embryo 2.0 mm. long; radula 0.3 mm. long, with 27 transverse rows.
Fig. 1.	Embryo 2.5 mm. long; radula 0.35 mm. long, with 34 transverse rows.
	Animal 3.0 mm. long; radula 0.55 mm. long, with 56 transverse rows.
Fig. 2.	Animal 3.5 mm. long; radula 0.72 mm. long, with 65 transverse rows.
Fig. 3.	Animal 7 mm. long; radula 1.15 mm. long, with 86 transverse rows.
Fig. 4.	Animal 15 mm. long; radula 2.24 mm. long, with 104 transverse rows.
Fig. 5.	Animal 27 mm. long; radula 2.72 mm. long, with 105 transverse rows.

---

<sup>3</sup> They were first overlooked, and afterward designated as O in the original drawing, of which the present is a copy.

## THE CENTRAL TEETH.

The central tooth is first formed as a simple, roundish or oval nodule, with a blunt point directed backward (fig. I and VI), rapidly increasing in length in the following rows. At the same time one or two somewhat irregular side cusps appear on either side, which on about the eighth tooth become more constant, more marked, and single on each side. There are, however, occasional exceptions as shown in the tenth of fig. VI, where on the right<sup>4</sup> side there are again two side cusps. Thus it attains its final shape, but is somewhat unsymmetrical, and so it remains, not only in one specimen, but as a rule in all (see figs. II-VI). This is also the case in other species. In some individuals the right side cusp is more posterior, in others the left. It early becomes noticeable that the central tooth stands more posteriorly than the laterals on either side of it, as represented in fig. VI. Comparatively early the plate of attachment extends backward, at first quite small, barely noticeable, and only on the side bearing the anterior side-cusp; but later it extends on both sides.

These facts make it evident that the central tooth is simple primarily, not formed by the coalescence of two original laterals as has been supposed.

## THE LATERAL TEETH.

An adult specimen of *Limax campestris* has about 11 to 18<sup>5</sup> lateral teeth. And to my surprise I found that, although they are exactly alike in their final shape, they are formed in two widely different ways:

(1). The 6 or 7 *mesial laterals* on each side first appear as thin, simple, transverse, nearly rectangular plates, each as a rule preceded by a short, nodule-like "trace," (see figs. I and VI). They soon become longer at their inner ends, more triangular, and the mesodont forms, being at first short and blunt, but immediately growing longer,

---

<sup>4</sup> Right and left are here given as they appear under the microscope.

<sup>5</sup> These limits are exceptionally wide and may be considerably narrowed by subsequent careful observations. The specimens with fewer laterals may very likely be immature. In the slugs there is no definite criterion of maturity, except probably in the genital organs, which should be consulted in every case. W. G. Binney found the tooth formula to be c. 18.22 in one specimen, c. 11.25 in another; I counted c. 14x1.31 in an individual 27 mm. long but still probably not fully mature.

more slender, sharp-pointed and spine-like. At the same time 2 or 3, or even 4 smaller cusps are formed on the outer side, and one (an endodont) or sometimes two cusps on the inner, so that there are typically 4 or 5, sometimes 6 or even 7 cusps on a tooth (see fig. VI first lateral in the second and fifth transverse rows.) This peculiar formation of the *inner group of laterals* is found in the embryonal or larval stage of the animal only; and in order to have an appropriate name for this form of tooth, we may properly term it *echinate*.

The teeth, passing through the echinate stage, gradually again change in form; the body of the tooth becomes longer, the mesodont loses its spine-like form, becoming wider, and its free cutting point shorter; the endodont becomes more coalescent with the mesodont, with a short and less acute point; but it remains constant, being visible in all specimens in different stages of growth which were examined, from this locality.<sup>6</sup>

Further modifications are that one or two of the distal cusps disappear, and the one or two remaining are transformed into the single ectodont of the adult (conf. fig. VI, the first lateral in the eighth to eleventh transverse rows); moreover the plate of attachment begins to be prolonged backward, at first being very thin and small, barely visible. The outcome of this series of changes is the perfect lateral tooth of the adult *Limax*.

All of the forms above described may be seen in one transverse row, (as represented in the fifteenth row of fig. I), and the different stages of transformation are shown in every longitudinal row of the same figure and fig. VI; but it must be added that the transverse rows, especially in the anterior part of the radula, are closer together than represented in the drawing, in which they are separated for the sake of distinctness; and the cusps reach further backward over the body of each following tooth. The individual teeth are fully as wide in the front part of the radula as more posteriorly.

(2). The *distal laterals* are evolved through other intermediate stages much resembling those undergone by the later aculeate marginals, as illustrated in figs. II-V. Fig. II represents at A the thirtieth, at B the forty-fifth transverse row of teeth from a spec-

---

<sup>6</sup> It may be noted here that in the persistence of the endodont, *Limax campestris* offers no distinctive character from *Limax agrestis* Linn.; and it may be added that in drawings made in 1882, of the radula of *Limax tenellus* Nils. and *L. cinereus* Lister, from the Swiss Alps, the endodont is distinctly shown.

**THIS PAGE IS LOCKED TO FREE MEMBERS**

Purchase full membership to immediately unlock this page

# Know Your Bible

Forgotten Books' Full Membership provides unlimited access to more than 28,000 volumes of Christian literature for \$8.99/month

**HOLY  
BIBLE**

**Continue**

\*Fair use policy applies

comparison, that in *Limax tenellus* Nils., all (32) marginals were found to have a distinct "outer cusp"; but on the marginals of *L. cinereus* Lister (about 130 on each side) no ectodonts were seen.

A similar formation of the earliest teeth will probably be found in other *Limaces*, and in such *Zonitidæ* as *Hyalinia radiatula* Gray, *petrophila* Bld., *capsella* Gld., etc., species in which the laterals bear distinct endodonts.

*Zonitoides arboreus* Say. Pl. 11, figs. I, II.

No embryo of this species was obtained, but a very young specimen with shell and soft parts nearly colorless, the former measuring 1.1 mm. diameter, with  $1\frac{1}{2}$  whorls. The radula (fig. I), was 0.39 mm. long, and had 48 transverse rows, of which, however, some of the youngest, at the posterior end, could not be clearly seen. Here there are 7.c.7 teeth, three of which are rather well formed laterals. Very few rows and teeth could have been lost from the front end of the radula, and the first present in the specimen examined were evidently of primitive shape, and a type entirely different from that of *Limax*, rather resembling those of *Patula striatella*, conf. fig. VIII.

The central teeth have a wide, short base or "body," with a distinct mesodont and at least quite early a side cusp on each side. Comparatively soon the plate of attachment is seen posteriorly, though very small. The laterals (about 5 in the adult) are wide transverse plates, somewhat irregular, longer in the mesial half, with a short, wide, blunt mesodont gradually becoming longer and more slender, and 2 or 3 small cusps in place of the later ectodont. No trace of an endodont is seen. As the teeth without much change gain their definite shape, the plates of attachment also develop.

Fig. II represents the radula of a nearly adult specimen, the shell having a diameter of 4.3 mm. The radula is 1.05 mm. long, 0.35 wide, and has 77 transverse rows of 17.5 c. 5.17 teeth. Only the first marginal bears an ectodont. Another example, of 4.5 mm. diameter, had a radula 1.33 mm. long, 0.45 wide, with 19.1x5.c. 5x1.19 teeth. Another of a peculiar form from Alabama gave the formula 20.1x4.c. .4x1.20.

Embryonic specimens remain to be examined, and the earliest form of the central and inner lateral teeth ascertained.

*Zonitoides ligerus* Say. Pl. 11, figs. III. IV.

We have in Pennsylvania and Ohio, a very small form measuring 9-10 mm. diameter, which has been considered *Z. ligerus*, although with some doubt. Besides other differential characters, there are two accessory glands near the head of the dart sac, while W. G. Binney found only one in typical *ligerus*.

No embryo has been secured thus far. The smallest examples found measured about 3 mm. in diameter; and the radula of one of these is represented in fig. III, having 20·c·20 teeth, of which 6 are perfectly formed laterals and the 7th and 8th nearly so, the latter corresponding with the 13th of an adult, and the "transition tooth" 9 to 14. At least 9-13 then, of the younger specimen, will be transformed into laterals. In either example all the teeth showing the transition from the aculeate marginals to the laterals have been represented in my figures, 14-7 in III, 17-11 in IV,<sup>7</sup> so that the transformation can immediately be seen by comparing the teeth bearing the same numbers. We specially notice: first, the total absence of endodonts in all teeth, just as in *Z. arboreus*; second, the absence of ectodonts in the distal, newly formed, aculeate teeth—*i. e.* in most marginals except a few mesial; and third, the longitudinally elongated plates of the youngest marginals.

Besides *Z. ligerus*, young and adult examples of a few other nearly related species were examined, one from Tennessee probably new, and *Z. suppressus* Say. They gave essentially the same results as *ligerus*.

*Patula striatella* Auth. Pl. 11, figs. VII, VIII, IX.

Several embryos from the eggs were examined. Fig. IX shows the buccal body of a quite young specimen with the commencement of the radual, in optical section. Diameter of the buccal body 0·12 mm. The spindle-shaped cells above are the developing retractor muscle.

Of an embryo more advanced, about 1 mm. long, and nearly mature, having a shell of 1½ whorls, and the caudal bladder small but still slowly contracting, the radula is represented in fig. VIII. It is 0·14 mm. long, with 21 transverse rows, in the last 9·c·9 teeth. But the formation of new teeth is somewhat irregular on the two sides

---

<sup>7</sup> For distinctness they are separated in the drawing; in nature they lie close together; this is indicated by the sign.



in this as well as some other species. The first transverse row is represented only by the first lateral on the right; the second by 1·c·1 and so on, as shown in the figure. The transformation is rather simple and decidedly slow. The *centrals* are wide and short, at first with a short, wide, blunt median projection which develops into the mesodont, and very slowly, like the side cusps. All other teeth are first formed as simple transverse bars or plates, the *laterals* gradually assuming their definite shapes without intermediate stages; even the ectodonts seem to be always single. Otherwise there is much similarity to *Z. arboreus*, but the forms are somewhat more plump.

The first formation and development of the *marginals* has not yet been observed with sufficient exactness. The mesodont and partly the ectodont are "double-pointed," and it appears probable that the mesial small cusp of the former is really the entodont, as it first stands near the base (fig. VII, 15) and then gradually ascends on the mesodont and becomes evanescent, as seen in fig. VII, 12-8. This figure represents the radula, 1·4 mm. long, from a specimen having a shell of 5·3 mm. diameter, apparently not quite mature. Yet in all the 94 transverse rows, no new teeth are added; the formula is c. 6x1:10. There is very little change in the shapes of the single teeth, except that the plates of the sixth and seventh laterals are noticeably longer in the posterior than in the front part of the radula.

Of *Patula alternata* Say, a number of examples were examined. One having a shell of 20 mm. diameter had a radula 4·5 mm. long, 1·5 wide, with 143 transverse rows of 34·c·34 teeth, with about 15 laterals. In a young specimen of 3 mm. diameter the radula was 0·88 mm. long, and had 72 transverse rows of 11·c·11 in the anterior, 12·c·12 in the posterior part.

The radula of *Patula solitaria* Say, extracted from a shell of 23 mm. diameter, is 5 mm. long, 1·8 wide, with 142 transverse rows of 31·c·31 teeth, 16 laterals. In a young one, the shell of 5·3 mm. diameter, I counted 68 transverse rows of 13·c·13 teeth in the anterior 15·c·15 in the posterior part.

*Polygyra*<sup>8</sup> (*Triodopsis*) *tridentata* Say. Pl. 11, figs. V, VI.

No embryo or quite young specimens were at my disposition. The smallest found had a shell measuring about 6 mm. in diameter,

<sup>8</sup>See Pilsbry, Preliminary outline of a new classification of the Helices. Proc. Acad. Nat. Sc., Phila., 1892, p. 400.

**THIS PAGE IS LOCKED TO FREE MEMBERS**

Purchase full membership to immediately unlock this page

# DELVE INTO FANTASY, MAGIC, MYTHOLOGY & FOLKLORE

Forgotten Books'  
Full Membership gives  
access to 797,885 ancient  
and modern, fiction and  
non-fiction books.

**Continue**

\*Fair usage policy applies

5. In certain species and groups there are forms of teeth in the embryonal, or larval stage, entirely different from those found in post-embryonal life, so that we may properly speak of the change as a metamorphosis.

6. The new formation and transformation of teeth is, as a rule, not exactly symmetrical on the two sides of the radula, so that a formula of one side is often only approximately true.

7. The width of the individual teeth, (and of the longitudinal rows), is the same from the earliest formation to the later stages and the increase in width of the whole radula is effected exclusively by the addition of new longitudinal rows.

8. The central teeth seem to be<sup>9</sup> (and in some species are doubtless) simple from their first formation; not a product of the coalescence of two original laterals.

9. They are, as a rule, more or less markedly asymmetrical.

10. The terms "lateral" and "marginal" teeth are not of absolute significance: The "marginals" of a younger specimen, or a part of them, will have transformed into laterals when the animal is adult.

11. It is also quite inadmissible to speak of the marginals as modified laterals, for a transformation never takes place in this direction. We should not say, as has been usual, that the simple mesodont of the laterals becomes split, or bicuspid, in the marginals; but the contrary is true: the "double pointed mesodont" of the marginal loses its endodont and becomes simple as the tooth is gradually replaced by a lateral. It is incorrect to say: "The teeth become smaller towards the margins," as they virtually increase in size from the margin toward the middle.

12. The expression "transition teeth" between marginals and laterals (not the reverse) has become of a real, actual meaning, just as the word "relationship" among organisms has gained its proper meaning by the theory of descent,

13. The different ways in which the teeth are formed and transformed will probably furnish valuable hints for systematic malacology.

---

<sup>9</sup>At least in the land Pulmonata (Nephropneusta v. Ih.); in some Limnaeidae, e. g. *Limnaea palustris* Müll., there is a strong probability that the centrals are double in first formation.

14. The rate of increase in number of the teeth will furnish the means for calculating the rate of the new formation of the radula as a whole. This is more rapid than is generally supposed.<sup>10</sup>

15. It is evident that the morphology of a radula can be thoroughly understood only by examining and comparing the different stages of its formation.

In the text nothing has been said about the methods of preparation and manipulation of the radulæ,—not much is necessary. As far as possible, the radula has been removed from the fresh animal unchanged. Caustic alkali has been used where necessary. By careful desiccation, and also by the action of chromic acid solution, for staining, valuable results may be obtained, as the teeth and especially the plates of attachment shrink somewhat and thus are separated from each other, and seen more exactly. But it is almost unnecessary to add that this means can only be used in connection with observations on the intact radula, for without this check artificial might be mistaken for natural features.

#### EXPLANATION OF PLATES 10 AND 11.

PLATE 10, Fig. I—Radula of an embryo of *Limax campestris* Say, not quite mature, showing first part of radula formed.

II—Radula of a specimen a few days old (after hatching), and measuring 3·5 mm. long.

A. 30th transverse row (about 42nd of total number).

B. 45th transverse row (about 57th of total number).

III—Radula of a specimen 7 mm. long, one-half of a transverse row, formula c. 10·18.

IV—Radula of a specimen 15 mm. long, one-half of a transverse row, formula, c. 14·27.

V—Radula of a specimen 15 mm. long, one-half of a transverse row, formula, c. 14·32.

<sup>10</sup> Without repeating the calculations here, it may be said that I found the radula of *Limax campestris* to form about 800 transverse rows in all—probably considerably more; this would mean that the radula is about eight times entirely changed during life. For *Polygyra (Mesodon) thyroides* about 2000 transverse rows were found, corresponding to about 16 to 18 total renewals.

VI—Left side of first part of radula of another embryo.

PLATE 11, Fig. I—*Zonitoides arboreus* Say, quite young, anterior part;  
x 600.

II—The same, nearly mature; x ca. 750.

III—*Zonitoides ligerus* Say, young, 3 mm. diam.; x 400.

IV—The same, adult, 9·5 mm. diam.; x 400.

V—*Polygyra tridentata* Say, young, 6 mm. diam.; x 400.

VI—The same, adult, 15 mm. diam.; x 400.

VII—*Patula striatella* Auth., adult, 5·3 mm. diam.;  
x 470.

VIII—The same, embryo, 1·0 mm. diam.; x 400.

IX—The same, very young embryo, buccal body, 0·12  
mm. diam.

**THIS PAGE IS LOCKED TO FREE MEMBERS**

Purchase full membership to immediately unlock this page

# Know Your Bible

Forgotten Books' Full Membership provides unlimited access to more than 28,000 volumes of Christian literature for \$8.99/month

**HOLY BIBLE**

**Continue**

\*Fair use policy applies

differs from those already known in the shortness of the dorsal fin, etc. The characters of the species so far as determinable are as follows :

*AMYZON BREVIPINNE* sp. nov.—Form, medium ; depth of body equal length of head. Fin radii ; D. 22-3 ; A. 8 ; V. probably 11, an interruption in the order of the rays making the location of these rays uncertain. Seventeen vertebræ may be counted anterior to the caudal region, of which 10 are anterior to the anterior base of the dorsal fin. Space for two additional vertebræ exists at an interruption of the dorsal series, so that the total number of precaudal vertebræ is probably nineteen, as the dorsal fin is uninterrupted. Distal caudal vertebræ and fin absent. Pectoral, ventral and anal fins well separated from each other. Length anterior to caudal vertebræ 57 mm. ; length of base of dorsal fin, 23·5 mm. ; depth at anterior base of dorsal fin, 25 mm. The species differs from those already described in the smaller number of dorsal fin-rays, and of dorsal vertebræ. The specimen on which it is based is of smaller size than those of most of the other species, but some of the fragments of the collection indicate larger individuals.

The discovery of this species, extends the distribution of the Amyzon beds beyond its previous limits. The localities at present known are the South Park, Colorado, and Osino, Elko Co., Nevada. Dr. Dawson informs me that both insect and plant remains occur in these fish-shales and that Prof. Scudder finds the former to belong to species different from those of other localities.

---

NOVEMBER 28.

The President, GENERAL ISAAC J. WISTAR, in the chair.

Forty-seven persons present.

Papers under the following titles were presented for publication:—

“North American Larridæ,” by Wm. J. Fox.

“New Species of Fungi from various localities,” by J. B. Ellis and B. M. Everhart.

“Critical List of Mollusks collected in the Potomac Valley,” by H. A. Pilsbry.

The Committee on the Hayden Memorial Geological Award reported that the medal and the interest arising from the fund had been this year voted to THOMAS HENRY HUXLEY, L. L. D., F. R. S., Professor of Biology in the Royal College of Science of London.

REPORT OF THE COMMITTEE ON THE HAYDEN MEMORIAL  
GEOLOGICAL AWARD.

The Committee on the Hayden Geological Memorial Award in fulfilling the trust confided to it by the Academy recommends that the Hayden Memorial Medal and the balance of the interest arising from the fund be awarded this year to THOMAS HENRY HUXLEY, Ph. D., LL. D., D. C, L., F. R. S., F. L. S., F. G. S., Professor of Biology in the Royal College of Science of London, in recognition of the great services which he has rendered to science and especially to geology, during the long period of his valuable original researches.

In doing this the Committee is but acting as the agent of the Academy, but it desires in addition and on behalf of its members whom his labors have assisted and enlightened, to add a tribute of its own to the high scientific value of Dr. Huxley's achievements.

PERSIFOR FRAZER,  
ANGELO HEILPRIN,  
J. PETER LESLEY,  
BENJ. SMITH. LYMAN,

Committee.

*Thysanophora coloba* n. sp.—MR. H. A. PILSBRY exhibited specimens of a minute land snail from Polvon, Nicaragua, which had been for many years in the collection of the Academy under the name *Helix wilhelmi* Pfr. He stated that it was not that species, but a new form of the genus *Thysanophora*, for which the name *coloba* was proposed. He defined the species as follows:

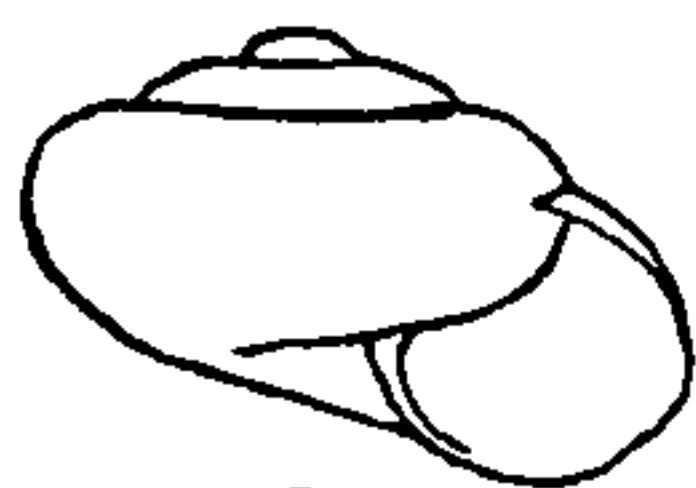
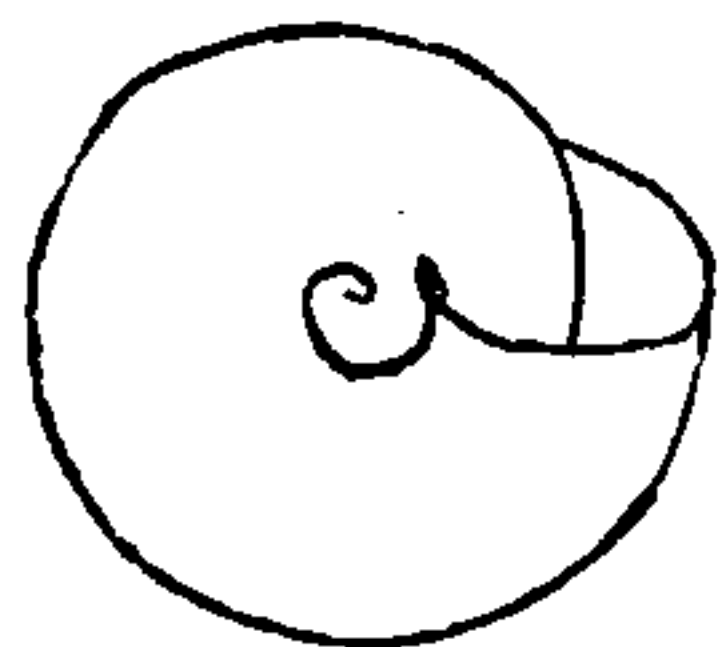
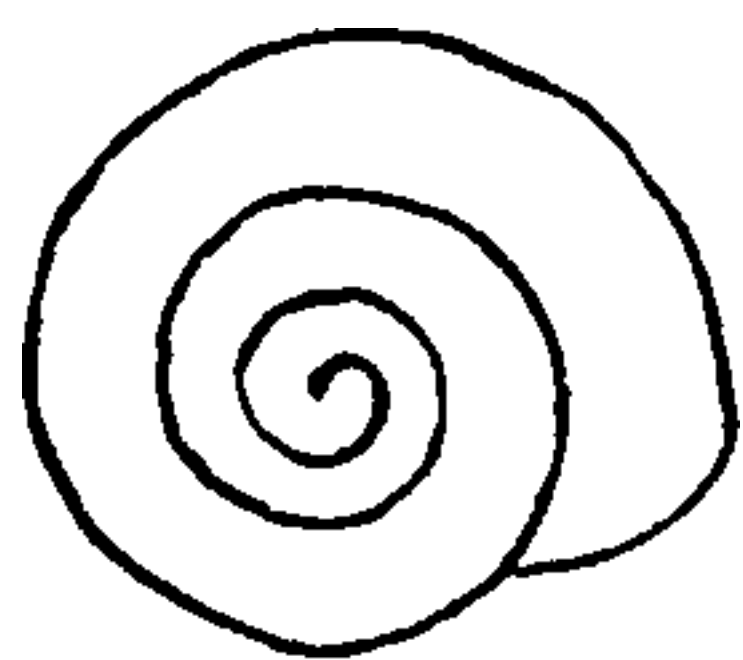

x9

*Sp. char.*:—Shell minute, depressed, with slightly conoidal spire; thin and fragile, light reddish horn colored. Umbilicus open but narrow, one-sixth the diameter of the base; whorls  $3\frac{1}{2}$ , convex, the first one smooth, the others very finely and closely striated, the striæ oblique, arcuate, on the last whorl becoming small, wrinkle-like riblets; Under a high magnification (50 diameters) an excessively close, fine sculpture of revolving lines becomes visible. Aperture rounded-lunate, oblique; lip thin, sharp, the columellar margin dilated. Alt. 1.16 mm., diam. 1.84 mm. The specimens are from Polvon, Nicaragua, collected by the McNeil expedition. This species seems nearly allied to *T. guatemalensis* C. and F., but it is much more depressed, more widely umbilicated and smaller.

Henry C. Mercer and Susanna M. Gaskell were elected members. The following were ordered to be printed:—



DESCRIPTIONS OF NEW SPECIES OF NORTH AMERICAN MAMMALS  
WITH REMARKS ON SPECIES OF THE GENUS PEROGNATHUS.

BY SAMUEL N. RHOADS.

The pocket mouse from Texas here described as new was obtained during the past year by Prof. E. D. Cope and placed in the collection of the Academy of Natural Sciences of Philadelphia.

The specimens of *Perognathus lordi* on which I have based the duplicate description of that species, so imperfectly characterized by Gray, were taken during a collecting trip in Washington and British Columbia last year, and are included in the author's private collection at the Academy.

By the rediscovery of *P. lordi* of Gray I am enabled to throw some light on certain questions of synonymy propounded by Dr. Merriam in his monographic revision of the genus.<sup>1</sup>

The figure of skull of *P. femoralis* here given completes the illustrations of known species of the genus.

1. *Perognathus copei*, sp. nov. (type No. 1612, ad. ♂, Col. Acad. Nat. Sci., Phila., Staked Plains near Mobeetie, Texas, August 26th, 1893; col. by Prof. E. D. Cope).

Description.—Size small, somewhat greater than Baird's measurements of *P. flavus*. Colors similar to Baird's description of *P. monticola* but smaller. Ears destroyed. Tail thickly covered with coarse hairs, concealing the annuli; grayish white above, pure white below, with terminal pencil, slightly crested-penicillate.

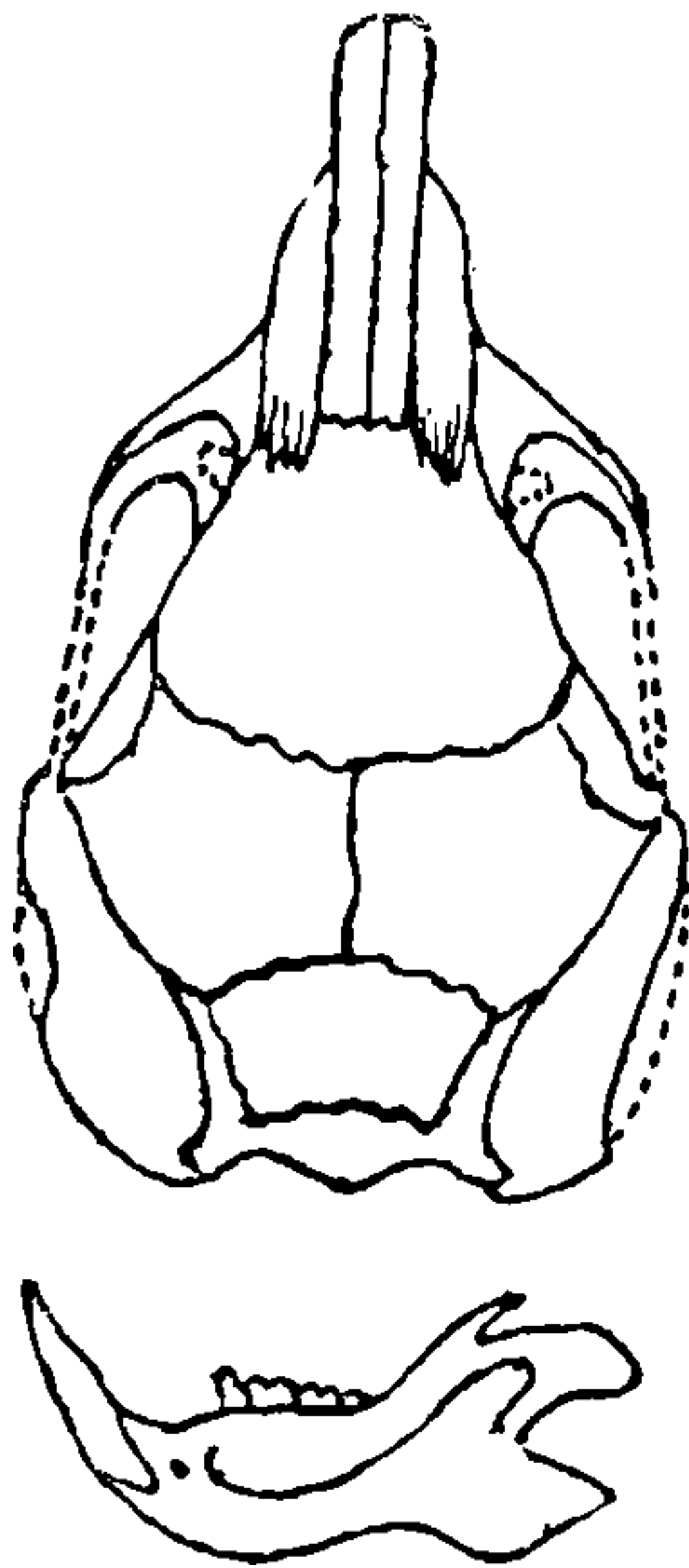

Fig. 1.<sup>2</sup>

Beneath, including whisker patch and feet, white. Upper back and head grizzled blackish fawn, the black tips coarsely predominating. Rump and thighs strongly washed with cinnamon, this color forming a broad posterior band diminishing laterally to a faint line at fore-legs; soles nearly naked, heel clothed with bristly hairs half way to toes, as in *flavus*; skull similar to *flavus* but longer and narrower, the mastoids less pronounced both laterally and posteriorly, the interparietal a squarish pen-

<sup>1</sup> N. Amer. Fauna, No. 1, 1889.

<sup>2</sup> All figures twice natural size.

**THIS PAGE IS LOCKED TO FREE MEMBERS**

Purchase full membership to immediately unlock this page

# DELVE INTO FANTASY, MAGIC, MYTHOLOGY & FOLKLORE

Forgotten Books'  
Full Membership gives  
access to 797,885 ancient  
and modern, fiction and  
non-fiction books.

**Continue**

\*Fair usage policy applies

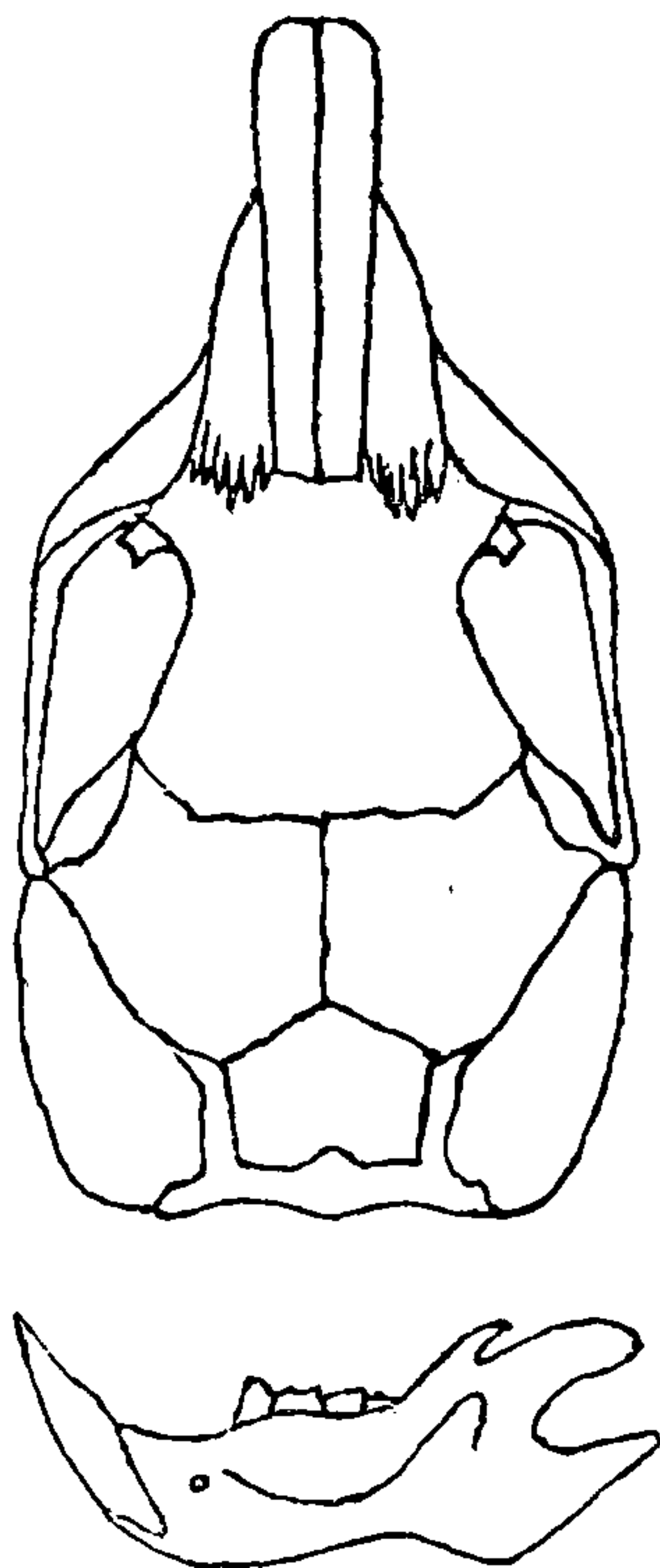

Fig. 2.

a symphysis but separated by  $\frac{1}{2}$  mm. anteriorly; bullae not projecting beyond plane of occiput.

Remarks.—Eight specimens of this species were trapped on the semi-arid foothills at the head of Lake Okanagan. They abundantly frequented the open hillsides of bunch grass and sage-bush up to timber line and down to near the lake levels, driving their myriad tunnels without difficulty through the dry, indurated and stony soil. Their habits seem to more closely resemble those of *Thomomys* than any other genus of burrowing rodent. Owing to their habit of pushing a load of dirt ahead of them it was difficult to catch them in their retreats but a trap set by the mouth of certain foraging exits was more successful. In the daytime they keep underground, coming forth nightly to replenish their larder with the seeds of weeds and grasses. This species was not found in similar localities farther north. It is probably limited to the southern parts of the Great Basin fauna of British Columbia as defined by me in the Proceedings of the Academy of Natural Sciences of Philadelphia, 1893, page 25, and extends south into Northeastern Washington. It is very doubtful if its habitat reaches farther west than the more arid foothills of the Cascade Mountains; the Selkirk Range would form a natural barrier to its dispersion eastward.

base of ear, white. Sides of cheek, neck, belly, thighs and tail washed with pale buff, this color often broadly encroaching upon the pure white of throat and belly. Upper third of tail colored same as back, darkening to black at the tip.

Measurements.—Total length, 179; tail, 92; hind foot, 24; ear, from crown, 4.5. Skull.—Total length, 26; basilar length 17.5 greatest mastoid breadth, 14; length of nasals, 10.7; interorbital constriction, 6.2; length of mandible, 12; height of coronoid process from angle, 5.2. Ratio of mastoid breadth to basilar length, 82; of mastoid breadth to total length, 53.9; of length to breadth of interparietal, 71. Lower premolar larger than the last molar; audital bullae not united by

3. *Perognathus femoralis* J. A. Allen.

Dr. Allen described this species in 1891.<sup>4</sup> Its cranial characters never having been figured, I take this opportunity of illustrating them from three specimens taken at the type locality during the past year (1893). *Femoralis* differs from its allies *fallax*, *californicus* and *armatus* in essential cranial peculiarities, as may be seen by a com-

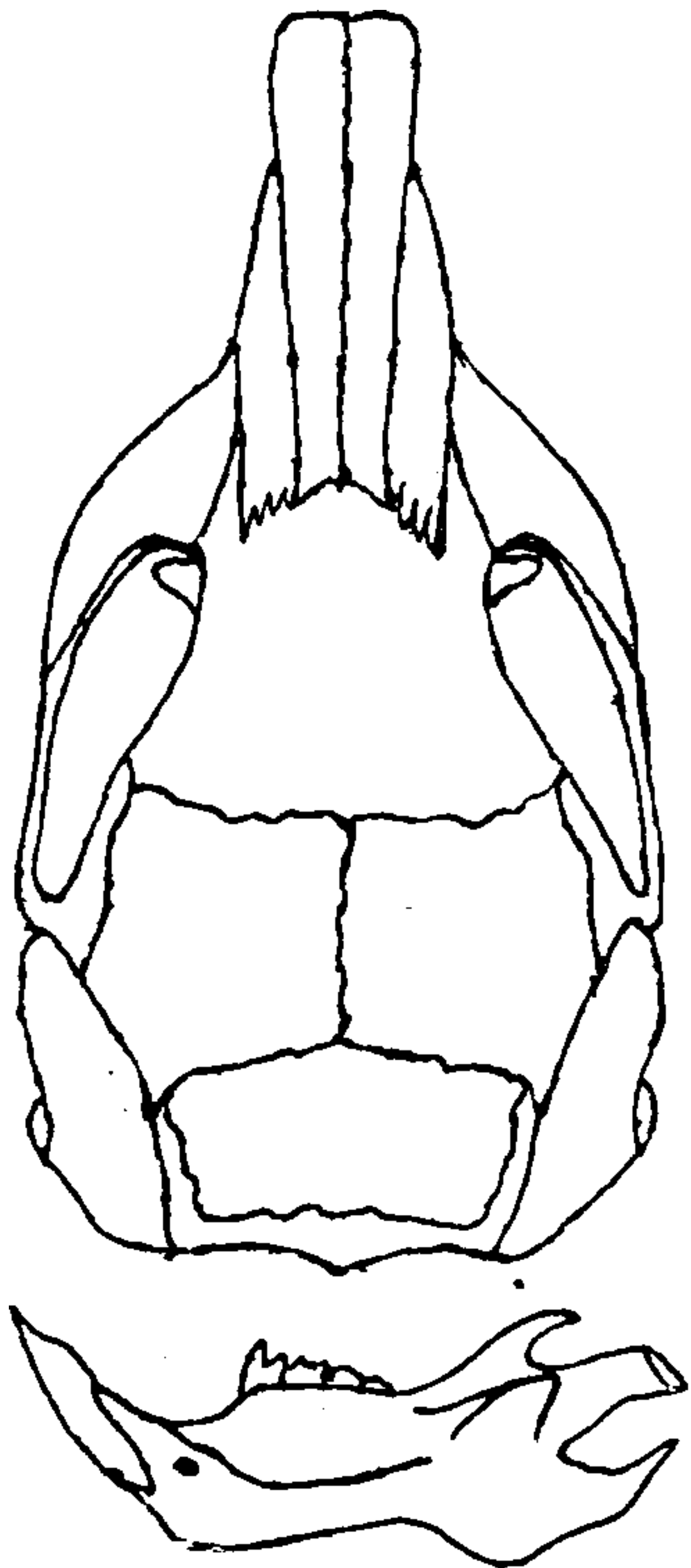

Fig. 3.

Mr. Merriam.

*Notes on the Affinities of Perognathus lordi, P. mollipilosus and Cricetodipus parvus.*—In his admirable Revision of the North American Pocket Mice Dr. Merriam enumerates three species whose identity it was then impossible to determine, viz., the *Abromys lordi* of Gray, the *Perognathus mollipilosus* of Cones and the *Cricetodipus parvus* of Peale. Dr. Merriam, in summing up his conclusions, refers to these as follows: “My opinion is that this animal, (*P. mollipilosus*), will prove to be identical with *P. lordi* and both may be the same as *P. parvus* of Peale.” In another place (page 27) he states: “all three come from the Pacific province, from Northern California northward.”

Taking the above description of *lordi* as a basis, it remains to be

<sup>4</sup> Bul. Am. Mus. N. H., Vol. 3, No. 2, 281.

decided, (1) whether the British Columbia Pocket Mice taken by me are identical with the type of *lordi*. (2) If so, can they be identical with *mollipilosus*? (3) What is their relationship to *P. monticola* of Baird? (4) Are any of these the same as *Cricetodipus parvus*? (5) To what faunal areas do these species belong?

(1). To the first query I can answer without hesitation in the affirmative. I cannot find the slightest discrepancy between Gray's original description and the specimens from Vernon. This is further confirmed by Mr. Oldfield Thomas's letter quoted by Dr. Merriam in his remarks on *lordi* in American Fauna No, 1.

(2). *Perognathus mollipilosus* differs from *lordi* in the following particulars: *a*, smaller size; *b*, tail one-third longer than head and body; *c*, cinnamon tints; *d*, color of upper parts descending to wrist; *e*, it inhabits a different faunal region. Its only affinities to *lordi*, so far as can be determined from Coues's description, consist in the non-penicillate tail, soft and smooth pelage, white lower parts, pale fulvous lateral stripe and bicolor tail. In *lordi*, however, the tail is slightly crested-penicillate and plainly tricolor, the latter a peculiarity I have not noticed in any other murine rodent.

(3). The characters of *lordi* coincide more closely with those of *P. monticola* of Baird and Merriam than with any other. Mr. Thomas wrote Dr Merriam, after examining the type of *lordi* in the British Museum, that, "so far as (he could) make out from Coues's description (it) is the same as *P. monticola*."

The description of Coues referred to was made on the supposition that a specimen from Fort Crook, California, was the same as Baird's type which is supposed to have come from St. Mary's Mission, Montana. Dr. Merriam refers to this Fort Crook specimen without hesitation as *mollipilosus*, (Coues's provisional name for it), and says the *P. monticola* of Baird "is a very different animal." We have seen that *lordi* and *mollipilosus* are not synonymous, and Dr. Merriam thinks *mollipilosus* and *monticola* are quite distinct, while Mr. Thomas thinks the type of *lordi* answers Coues's hybrid description of *monticola et mollipilosus*.

As the description of *monticola* has several year's priority over *lordi* the stability of the latter in our nomenclature depends on its specific dissociation from *monticola*. That they are different species I have very little doubt, notwithstanding their apparent resemblance.

As compared with *lordi*, *monticola* may be distinguished by *a*,

**THIS PAGE IS LOCKED TO FREE MEMBERS**

Purchase full membership to immediately unlock this page

# Know Your Bible

Forgotten Books' Full Membership provides unlimited access to more than 28,000 volumes of Christian literature for \$8.99/month

**HOLY BIBLE**

**Continue**

\*Fair use policy applies

the other hand it is peculiarly diagnostic of *Perodipus* from California and Oregon; *y*, *C. parvus* came from Oregon; *Perodipus* has also been taken there and in southeastern Washington but I am not aware of any records of *Perognathus* from these States.

If the type of Peale's mysterious rodent, like other priceless and ill-used novelties of the Audubonian period, "cannot be found," to disprove the above interpretation, it cannot be denied that there is much evidence in favor of its being the type of a five-toed Kangaroo Rat instead of a five-toed Pocket Mouse. As such, *Cricetodipus* Peale, 1848, antedates *Perodipus* Fitzinger, 1867.

(5). Dr. Merriam's statement that *lordi*, *mollipilosus* and *C. parvus* all came from the Pacific Province now needs qualification. While this is probably true of the last two, *lordi* should certainly be assigned to a region quite devoid of the faunal peculiarities of the Pacific slope.

Previous to my rediscovery of *lordi* its precise habitat in British Columbia could only be conjectured, and so far as it went Dr. Merriam's supposition that this type came from the West Cascade region was reasonable enough.

From the nature of its chosen habitat at Vernon, and the absence of a similar environment west of the Cascades it is more than probable that the type came from the same region farther south and that the species is essentially a Great Basin form.

---

The following species of North American mammals have recently been added to the collections of the Academy of Natural Sciences of Philadelphia. They were taken by Mr. R. B. Herron, who is at the present time continuing a collecting trip in California in the interests of the Academy. Other novelties which may be taken by Mr. Herron, as well as a circumstantial account of the entire collections of birds and mammals made by him, will appear in a future number of the Proceedings.

4. *Dipodomys simiolus*,<sup>5</sup> sp. nov. (Type No. 1616, ♀ Col. Acad. Nat. Sciences. Phila.; Agua Caliente, California, Oct. 19, 1893, col. by R. B. Herron).

Description.—Minature of *D. deserti* with very similar colors, color-pattern and proportions. No white terminal pencil, the dark

---

<sup>5</sup> *Simi* an ape or mimic; *olus* diminutive.

ashy upper fourth of tail extending to tip; a faint streak of brownish-black on under side of middle third of tail disappearing toward either extremity. Soles scarcely darker than white feet. Tail strongly crested-penicillate, the vertebræ one and one-half times as long as head and body. General shade of upper parts slightly darker than in *deserti*, inclining to cinnamon on rump in adults.

Measurements.—Total length, 241; tail vertebræ, 149; pencil, 35; hind foot, 38; ear from crown (dry) 9. Skull—Basilar length, 21.8; mastoid breadth, 24; interorbital constriction, 14.5; length of nasals, 13; length of mandible to base of incisor, 13.8; height of coronoid process from angle, 5.6.

Six specimens were taken, all in the Mohave Desert at Agua Caliente. The average measurements are less than those given above. This species is easily distinguishable from *deserti* by small size, slightly darker coloration and lack of white tip to tail; from *similis* by its lack of black on rump, tail, soles and hind legs.

5. *Dipodomys similis*, sp. nov. (Type No. 1617. ♀ Col. Acad. Nat. Sciences, Phila.: White Water, San Diego Co., California, Oct. 24, 1893. col. by R. B. Herron).

Description.—In size and color pattern almost an exact counterpart of *Perodipus agilis*. Colors similar to *D. simiolus* and *D. deserti* but darker than either and with tail and limbs relatively shorter than the latter. Above light tawny tipped and lined sparingly with blackish, the latter color more pronounced on rump. Posterior surface of thigh to heel, soles, ring around eyes, base of whiskers, top of nose and upper and lower fourths of tail to tip, blackish. The remainder of body white, including small spot above eye, a larger one at posterior base of ears and stripe across thighs. Ears grayish. Tail crested-penicillate.

Measurements.—Total length, 241; tail vertebræ, 143; pencil, 25; hind foot, 38, ear (dry) above crown, 10.5. Skull—basilar length, 22; mastoid breadth, 24.5; interorbital constriction 14; length of nasals, 14; height of coronoid process from angle, 5. Skull similar to that of *simiolus* but with smaller mastoids and wider across ante-orbital processes of maxillary. In *similis* the lower premolar is narrower anteriorly than posteriorly and as long as wide, in *simiolus* it is of equal width on both faces and much wider than long. In *similis* the extremity of angle of mandible is prolonged and acuminate, in *simiolus* it is shorter and rounded at the extremity.



A male and female from White Water on the western side of Mohave Desert represent the species. They are alike in all important respects.

6. *Perognathus alticolus*, sp. nov. (Type No. 1615, ♂, Col. Acad. Nat. Sciences, Phila.; San Bernardino Mts., California, Sept. 22, 1893, col. by R. B. Herron).

Description.—Most similar to *P. apache* and *P. inornatus*, differing cranially, and in larger size from either, less yellow than *apache* and more decidedly lined with black than *inornatus*. Size small, tail equals length of head and body, or longer, slightly crested penicillate. Above yellowish brown heavily but finely lined with blackish. Pelage very soft and full. Bases of hairs above plumbeous for three-fourths their length. A tawny lateral stripe from nose to and including upper half of tail. Distal third of tail above becoming blackish. One-fourth of heel end of soles, haired. Lower parts, feet, fore legs and lower edge of ear white to roots of pelage.

Measurements (from dry skin).—Total length, 157; tail vertebræ, 77; pencil, 9; hind foot, 20; ear from crown, 5. Skull—Basilar length, 16; mastoid breadth, 12·5; interorbital constriction, 6; length of nasals, 8·6; length of mandible, 10·5; height of coronoid process, 4·6.

Cranially *alticolus* may be distinguished from both its allies by the well defined separation of audital bullae below. Its lower premolar is similar to that of *inornatus*, but the mastoids of the latter are very much larger than those of *alticolus*. The same may be said of *apache*. *P. alticolus* belongs to the *fasciatus* group of the subgenus *Perognathus*.

Skull figures of this species and the two *Dipodomys* above described will probably appear in the final report of Mr. Herron's collections.

**THIS PAGE IS LOCKED TO FREE MEMBERS**

Purchase full membership to immediately unlock this page

# DELVE INTO FANTASY, MAGIC, MYTHOLOGY & FOLKLORE

Forgotten Books'  
Full Membership gives  
access to 797,885 ancient  
and modern, fiction and  
non-fiction books.

**Continue**

\*Fair usage policy applies

The tail is mostly black above, the white being mostly half-rings confined to the lower surface. These two specimens accord with the peculiar phases of geographical color-variation commonly characterizing the mammals and birds of the two regions in question. Should the Oregon specimen here described prove to indicate the average condition of the species along the Pacific coast to the northward, as seems probable, the form there prevailing may require to be varieties distinguished under the name *raptor* Baird, this name doubtless referring to the Pacific coast form as already explained. Five specimens from near the southern border of Texas agree in being rather darker than the Arizona specimen and present only a moderate range of color variation."

The three additional specimens from Grant's Pass sufficiently confirm the color characters alluded to by Dr. Allen to make the question of subspecific separation worth careful consideration. With this in view I have, through the courtesy of Mr. F. W. True, secured the loan of the Smithsonian Institution series of *Bassariscus astutus*. The series consists of eighteen specimens; of these the majority are hunters, or flat skins, lacking skulls. Skulls accompany eight, measurements and data, five, and the whole series is labeled with the locality of capture.

Beside these and the Oregon specimens, I have examined four in the museum of the Academy of Natural Sciences, making a total of twenty-five. Among them is the type, skin and skull, of Baird's '*B. raptor*.' A most valuable and important addition to the series consists in a set of five (2 ♂ s, 2 ♀ s and 1 juv. ♂ ) finely prepared skins and skulls from Cuernavaca, Morelos, Mexico, taken in 1892, by Mr. P. L. Jouy.

Apart from their excellent preservation and full data these specimens are unique in being the only ones in the series taken in the southernmost range of *B. astutus*, where it overlaps the habitat of *B. sumichrasti*.

We must first determine from what locality came the type specimens of *astutus*. Lichtenstein states in his description that these were sent to the Berlin Museum by one Dr. Deppe during the residence of the latter in Mexico. We are left to our imagination as to the precise locality of Dr. Deppe's residence, and, while it is reasonable to believe that the type specimens were taken in the "vicinity" and that it is very probable the doctor "practised"

south of the twentieth parallel in those early days, direct evidence is wanting.

But we have in Lichtenstein's conscientious description and plate of *astutus* in *Darstellungen der Säugethiere der zoologische Museum*, (1827-34, pl. 43) so exact a reproduction of the peculiarities of the Cuernavaca specimens taken by Mr. Jouy as to leave us in no reasonable doubt that the type of *astutus* came from southern Mexico. Lichtenstein's description makes no allusion to variations from the type in the numerous examples at his disposal. If, however, we compare therewith specimens from northern Mexico northward we find an increasing departure from the characters assigned to typical *astutus* until, in the Oregon examples, we have a form to all appearances quite distinct.

It is quite proper that the two should be separated, perhaps specifically, though there is some probability that a complete series will insensibly connect the two extremes. Such cranial differences as I have detected may all come within the range of individual and geographic variation. At any rate the skull series is too incomplete as yet for a decided answer.

In either case the question arises as to the tenability of the name '*raptor*' for the northern form. It was originally proposed for a Pacific Coast species.

The value of the name is, in the first place, lessened by the fact that it was applied to an animal escaped from confinement in the east and "supposed" to come from California.

The distinctive characters assigned to '*raptor*' by Baird are: *a*, small number of black rings on tail and of greater extent compared with white rings; *b*, black rings nearly complete below; *c*, no difference in colors of remaining parts of body; *d*, ears decidedly smaller; *e*, cranium broader, more constricted behind post-orbital processes; *f*, temporal crests closer together; *g*, pterygoids farther apart; *h*, ratio of greatest breadth to length 63 to 100 instead of 59, as in a female from Texas. Dr. Allen has shown, and the series in my possession verifies his view, that these cranial differences are accountable to age, sex and individual variation. The skull of *raptor* is nearly duplicated by No. 35,254 from Texas. I find that in only one respect, the relative width of white and black tail-rings does Baird's diagnosis as given above apply to the Pacific coast form as contrasted with those from Texas. But even in this particular

typical *B. astutus* is very variable. I therefore propose, for the Bassarisk of Northern Mexico and the United States the name *Bassariscus astutus flavus*. Should the so-called *astutus* of the United States and northern Mexico prove a distinct species, the small, dark coast form from northern California northward (not of central and southern California) should be made a sub-species of *flavus*. In that case it should be called *Bassariscus flavus oregonus*.<sup>3</sup> It is possible that Dr. Merriam has enough material in his custody to decide the question at an early date.

So far as they may now be distinguished, the Civet Cats belonging to the *astutus* group are characterized :

1. *Bassariscus astutus* (Licht.)

Description.—Size large, fur scant and harsh. Tail vertebræ longer than head and body, 14 to 16-ringed exclusive of tip, black rings below interrupted by a broad, continuous mesial band.

Upper parts of body uniform blackish gray, often tinged with pale fulvous on sides of rump and belly, the black hairs of the dorsal region disappearing laterally. Under parts clear gray with dirty, pale yellowish suffusion. Underfur and roots of hairs ashy. A roundish spot above the eye, a larger one beneath it and a semilunar spot at the entrance of ear, white. Top of head, forehead, band around nose and soles of hind feet, blackish. Skull large, strong and angular; zygomatic fossæ wide and deep; post-orbital processes small and deflected downwards; rostrum broad, canines widely separated; sagittal crest well developed in adult males, frontal bones narrowed and long-waisted behind the supraorbital processes; canines sulcate on the inner-posterior and anterior edges above, on the anterior edge below.

Measurements.—Total length, (Jouy.) 802 to 855, (Licht.) 850; tail (Jouy) 360 to 420, (Licht.) 368; hind foot, (Jouy) 76 to 79 (Licht.) 72; length of ear (Jouy) 45 to 49, (Licht.) 34(?); breadth of ear, (Jouy) 52 to 59, (Licht.) 25(?).

Skull.—Total length, 82 to 87; greatest breadth 53.5 to 59. Interorbital constriction 17. from tip to tip of postorbital processes 27. Taken from adult male skull.

The above is about equivalent to a translation of Lichtenstein's two original descriptions of *astutus*. The cranial diagnosis is chiefly

<sup>3</sup> The type will be No. 1,614, Col. Academy of Natural Sciences of Phila.

**THIS PAGE IS LOCKED TO FREE MEMBERS**

Purchase full membership to immediately unlock this page

# Know Your Bible

Forgotten Books' Full Membership provides unlimited access to more than 28,000 volumes of Christian literature for \$8.99/month

**HOLY BIBLE**

**Continue**

\*Fair use policy applies

The range in the variation of external characters among the Bassarisks from northern Mexico and the United States, excluding the Oregon specimens, is not great, but variation in the size and proportions of the skull in animals of the same age and sex from a stated locality (Texas) is perplexing, seeming to connect *flavus* with typical *astutus*.

Color characters and body measurements on the other hand are constant enough to establish their title to separate specific rank.

Some cranial points seem to confirm this view, the molar dentition of the two forms, however, is identical. A bona-fide Californian specimen is as light-colored or lighter than Baird's pseudonymous one, the latter (whose sole claim on our notice consists in its bare name) sharing the same characteristic tawny seen in darkest Texan examples. The light hued Camp Grant specimen, mentioned (*supra cit.*) by Dr. Allen is in all respects only a small, pale *flavus*.

The Oregon series on the other hand are almost as different, externally, from average Texas skins as the latter are from true *astutus*. The diminutive size, brownish black color, nearly black upper tail, completeness of the terminal black rings mesially, etc. are subspecific characters apparently separating *oregonus* from its nearest congeners in the United States.

## ON SOME LEECH-LIKE PARASITES OF AMERICAN CRAYFISHES.

BY J. PERCY MOORE.

In 1851 Dr. Leidy described in the Proceedings of this Academy the external characters of *Astacobdella philadelphica*, which he found occupying generally the exterior of *Cambarus bartonii*. This account was quoted in full in the Synopsis of American Freshwater Leeches published in 1874 by Verrill, who adds no observations of his own. Other than these the writer is acquainted with no published accounts of American Discodrilidæ (Vejdovsky). Attracted by the peculiar structure, the uncertain affinities, and most of all, by the remarkable variability of these parasites, a score of zoologists have been led to contribute to our knowledge of the European forms. The question of the specific distinctness or unity of the several forms which take up their abode on *Astacus fluviatilis* has led to considerable discussion, which has not yet reached a definite settlement. Vejdovsky believes the three or four forms which have been described as distinct species to be but varieties of one extremely variable species—a view to which a strong support is lent by the elaborate tables of variations prepared by Voigt. Whitman has found living on the crayfishes of Japan a similar multiplicity of forms, which have been regarded as constituting three distinct species, but which have not, the writer believes, been described.

It now appears that our American crayfishes likewise carry about with them a heterogeneous burden of leech-like parasites (or mess-mates?). Our common *Cambarus bartonii*, for example, is affected by at least four forms, which are easily distinguished, and which will be here described as specifically distinct. Other and different forms have been found by the writer on *C. affinis* and on *C. ———* which inhabits the larger mountain streams of western North Carolina. These being the facts, the writer thought it well to present for publication the present short account, which is entirely preliminary to a more complete discussion of the structure and affinities of these Annulata, the first instalment of which will soon appear. It is hoped that this paper will serve to direct the attention of zoologists to this neglected



group, and lead to the collection of the numerous forms which it seems reasonable to suppose must attach themselves to the bodies of our many species of crayfish. The monographic study of such a group as this would doubtless furnish us with data of great value in the consideration of our theories of variation. The writer would be especially indebted to anyone who will kindly furnish him with material collected in other localities or from other species of crayfish.

Regarding the specific distinctness of the forms here described it may be said that the writer has examined several hundred specimens ranging in size and age from individuals just emerged from the cocoon to those of the largest dimensions, and while each species exhibits a considerable range of variation (which will form the subject matter of a subsequent paper), no important transitional forms have been discovered, the diagnostic characters here given being maintained with as much constancy as is usual amongst closely allied animal species.

Even should the views of Vejdovsky and Voigt prove to be correct for the European species, which seems probable, this would in no way affect the status of the American forms; for other cases are not wanting where a group of animals which in one region is represented by a single variable species, in another has numerous specific representatives. This would then be only another fact in support of the view, now almost universally conceded, that species are but more widely separated varieties, which under the stress of changing conditions have continued to diverge from a common origin. Indeed, it is not certain that these species should be placed in the same genus even, for they are distinguished from one another by anatomical characters of such importance as would, in some groups of animals, rank of generic value. The several species are here referred to the single genus *Branchiobdella* chiefly because the writer is uncertain as to the legitimate limits of a genus in zoology, and because in this preliminary paper it is sufficient to recognize the existence of distinct forms without attempting to fix the exact conventional value of the gap which separates them—a labor which belongs more rightly to the systematist, whose work of sorting and arranging would be quite premature in a group of which only a very small portion of the probable number of existing species have been examined. Moreover it should be borne in mind that much confusion has resulted from the unnecessary multiplication of genera.

**THIS PAGE IS LOCKED TO FREE MEMBERS**

Purchase full membership to immediately unlock this page

# DELVE INTO FANTASY, MAGIC, MYTHOLOGY & FOLKLORE

Forgotten Books'  
Full Membership gives  
access to 797,885 ancient  
and modern, fiction and  
non-fiction books.

**Continue**

\*Fair usage policy applies

single small bunch in the median region of each lip is all that is present.

The jaws are remarkable, and although large, are inconspicuous on account of their transparency and lack of color. On the dorsal one, which is much the larger, a high median ridge is developed, which bears three strong teeth, the points of which are directed posteriorly (down the throat). The ventral jaw is shaped like a U each limb of which is bent out of the common plane into a boomerang shape. The angle of the boomerang on each side is uppermost and bears a very strong curved tooth, the two bounding a deep groove which accommodates the dorsal dentigerous ridge.

The stomach is comparatively small, and behind it the evenly tubular intestine is thrown into loops, which become more obvious with the greater degree of contraction of the animal.

In connection with the vascular system is developed a remarkable shallow sinus which covers almost the entire surface of the alimentary canal. This presents dorsal and ventral longitudinal enlargements into which the principal vascular trunks are received. The extensive vascular surface with the contained bright red blood thus presented gives the animals a delicate pinkish hue which distinguishes living individuals at a glance from the other species herein described.

In each of the nine post-cephalic segments is a pair of peculiar translucent glandular bodies composed of large nucleated cells, and communicating with the exterior by slender ducts having ventro-lateral openings.

The anterior two nephridia open into a gourd-shaped vesicle having an opening to the exterior in the mid-dorsal region of the major annulus of the third segment. The spermatheca is short, cylindrical and bifid; the penis-sac short-pediced and spherical, and the atrium clavate and curved. The spermatheca, penis, ovaries, posterior paired nephridia and anus open respectively on the fifth, sixth, seventh, eighth and ninth post-cephalic segments. Length of full grown individuals, 4 mm., maximum diameter (7th segment) .9 mm., diameter of acetabulum .35 mm. The figure represents an individual of maximum size.

The cocoon is regularly ellipsoidal in shape and bears an anchoring pedicle at each pole of the major axis. Length of cocoon, .55 mm., diameter, .40 mm., length of pedicles, .33 mm.

This species is very common and has been found in the branchial

chamber of nearly one-half of the larger individuals of *C. bartonii* that I have examined. It appears never to leave the branchial chamber during the life of the crayfish, except at the time of moult. The cocoons are found throughout the year attached to the branchial filaments, especially the inner ones. Philadelphia, Pa. and Watauga Co., North Carolina,

*B. pulcherrima*, sp. nov.

Fig. 2*a*, Plate XII, outline of the entire animal as seen from the side, showing the adhesive organs on the eighth and ninth segments, x23. Fig. 2*b*, the same specimen from the dorsal aspect, with an outline of the alimentary canal, x23. These drawings are from a medium sized preserved specimen. Fig. 2*c*, one of the jaws of the usual form, x200. Fig. 2*e*, a cocoon, x45.

The beautiful transparency of the anterior segments, which enables one to see with great distinctness the internal organs of that region suggested the name given to this species.

Form rather stout, the body depressed, especially in the posterior region. The segments increase regularly in width to the seventh, which is the broadest; and behind which they rapidly narrow to the acetabulum. Each post-cephalic segment consists of an anterior larger and a posterior smaller annulus. The ventral surfaces of the eighth and ninth segments are strongly flattened, and each bears on its extreme lateral margins a cup-shaped adhesive organ, into the central depression of which a conspicuous gland opens. These are directed ventralward and doubtless serve as accessory organs of attachment to aid the rather weak sucker. Those on the eighth segment are usually the larger, but a considerable range of variation is exhibited in this respect. The structures become proportionally larger and more conspicuous in older individuals.

The head is urn-shaped, slightly longer than broad in preserved specimens, and its greatest width less than or just equal to that of the first body segment. The breadth of the head varies greatly with the degree of contraction of the specimen, but in the living individual always appears narrow, and to form part of the generally even tapering outlines of the body, never abruptly expanded as in *B. instabilis*. The oral region is separated from the cephalic region by a deep constriction, which completely encircles the head. The mouth is enveloped by a pair (dorsal and ventral) of distinct thick

muscular lips, of which the dorsal one is the larger and droops downward, partially enclosing the ventral lip. Each presents a slight median emargination, but is otherwise entire. The lips and head, as well as the sides of the principal annuli of the body, are provided with a fringe of delicate hairs. Mouth opening nearly circular, between the parted lips.

The jaws are small and inconspicuous, in adult specimens less than one-twelfth of the width of the head, and of a pale brown or amber color. The rounded base bears three teeth, of which the larger lateral ones are stout, curved, and divergent, while the smaller median one is straight and sharp-pointed. The variations in the jaws involve frequent unsymmetrical development of the teeth. The dorsal and ventral jaws are similar, and both are fixed opposite to the constriction behind the lips, the teeth being directed inward.

The straight alimentary canal is strongly sacculated in the second, third and fourth segments, behind which it is narrow, and direct in its course to the anus, which opens on a slight papilla on the dorsal side of the ninth segment.

The greater part of the body cavity of the fifth and sixth segments is filled with testicular cells in various stages of development; and the glandular thickening of the skin of these segments renders the walls conspicuously opaque. The two pairs of vasa deferentia open into the nearly spherical atrium in the sixth segment. A conspicuous and broadly pyriform spermatheca opens on the fifth segment. The ovaries and accessory structures occupy the seventh. The anterior nephridia alternate in position, but open to the exterior by paired orifices in segment three. The posterior paired nephridia occupy the space on each side of the intestine in segment eight.

This species is colorless and more or less translucent; the first four segments behind the head are remarkably clear and translucent, but behind this the body walls are rather opaque and the position of the internal organs obscured. The alimentary canal is throughout darkly colored, except within the head.

Blood very pale red.

Length of mature individuals . . . . .	6 mm.
Maximum breadth . . . . .	1.3 "
Width of jaws . . . . .	.06 "
Diameter of acetabulum . . . . .	.6 "

**THIS PAGE IS LOCKED TO FREE MEMBERS**

Purchase full membership to immediately unlock this page

# Know Your Bible

Forgotten Books' Full Membership provides unlimited access to more than 28,000 volumes of Christian literature for \$8.99/month

**HOLY BIBLE**

**Continue**

\*Fair use policy applies

being the case in both jaws in nearly all of the many specimens examined.

The acetabulum resembles that of *B. pulcherrima* in being directed ventralward. Its diameter is greater than that of the first or second body segments. Bi-annulation is conspicuous on the anterior four post-cephalic segments only.

The alimentary canal is strongly sacculated in the fourth and fifth segments, in the sixth is pushed to the left side by the development of the atrium (this occurs in adults only), in the seventh is thrown into a complete double transverse loop which passes first to the right and then to the left, and finally passes directly to the anus in the ninth body segment. The spermatheca is very small and inconspicuous, while the penis-sac is well developed, and possesses a long vermiform appendage (atrium) which forms a loop dorsally over and around the intestine. Sexual and nephridial openings as in *B. pulcherrima*.

In contraction the body of this species is shaped like a short-handled raquet; in extension it has the outline of an Indian club from dorsal and ventral views.

Length of mature animal . . . . .	5.5 mm.
Maximum breadth, . . . . .	1.3 “
Diameter of acetabulum . . . . .	.5 “
Transverse diameter of jaw . . . . .	.048 “
Length of cocoon without pedicle . . . . .	.35 “

The cocoons resemble those of the last described species, but are frequently provided with an apical fibrous tuft. They are invariably attached (to the extent of my experience) to the palmar surface of the propodite of the great chelæ. The animals themselves are largely restricted in their distribution to the same segments of the limb, and are usually to be found in numbers clustered at the base of the pincers to which position the form of the body peculiarly adapts them; for while the constricted anterior region, by reason of its tenuity, easily escapes crushing between the closing limbs of the chela, in which position it is frequently liable to be caught, the important organs of reproduction and digestion are massed together near the base of attachment, entirely out of reach of danger from this source. Frequently they wander to other parts of the same pair of limbs, or even to the two pairs of ambulatory limbs following.

Watauga Co., North Carolina, and by Mr. P. P. Calvert in Delaware Co., Penna.

**B. philadelphia** Leidy. *Astacobdella philadelphia* Leidy, Pro. Acad. Nat. Sci. Phila., 1851, p. 209, Verrill, Rep. U. S. Com. Fisheries for 1872-73, p. 688.

Fig. 4*a*, Plate XII, shows the external outlines of the body, and the alimentary canal of a moderately sized living adult, x23. Figs. 4*b* and *c* represents the dorsal, and 4*d* the ventral jaw, x100. Fig. 4*e*, cocoon, x45.

Dr. Leidy's description is here reproduced "Body whitish, translucent; sides nearly parallel, a little broader posteriorly, sixteen alternately broad and narrow segments exclusive of head and posterior end. Head campanulate, terminated by a circular or elliptical crenated lip, fringed with very minute stiff hairs, one two-thousandth of an inch long. Acetabulum circular, one-sixth or one-fourth of a line in diameter; mouth elliptical. Dental plates brown, nearly equal, forming an isosceles triangle, with the base longest and attached apex of superior plate ending in a sharp conical point; with several very minute denticulations on each side, apex of inferior plate bifurcated into two points, with two minute denticulations on each side. Stomach capacious, nearly filling the anterior eight alternately broad and narrow segments posterior to the head. Anus dorsal, one-fifth of a line from the acetabulum. Generative opening ventral, anterior to the anal aperture. Length, one to four lines; breadth, one-sixth to one-half of a line. Head, one-sixth to one-half of a line long. Ovum attached by a pedicle, with an operculum pointed at summit. From base of attachment to point of opercle, one-fifth of a line. Length of body of ovum, one-sixth of a line; breadth, one-eighth of a line.

"Habitat.—Found frequently in numbers from one to several dozen upon any part of the exterior of the body of *Astacus bartonii* Fab., but more especially upon the inferior surface and the branchiæ."

The spermatheca is large, short-cylindrical, and curved; and the penis-sac is cylindrical and possesses prominent atrial appendage. The external openings of these and the ovaries are as usual. The anterior nephridia terminate in very large transverse tubes which open into a pulsatile vesicles situated in the third segment. The other anatomical characters are in no way remarkable.

I have never found this species inhabiting the branchial chamber,



but principally the sternal surface of the entire body, among the bases of the appendages. The cocoons are attached to the abdominal sternites, but more frequently to the setæ of the pleopods. They are to be found principally in summer, but are not entirely absent at any season.

Phila. Pa., and Watauga Co., North Carolina.

The author has, since writing the above, examined a preparation of *B. parasita* Braun, in which he was able to distinguish only a single unpaired vas deferens. Compare Vejdovsky, Systemu Monographie der Oligochæten.

**THIS PAGE IS LOCKED TO FREE MEMBERS**

Purchase full membership to immediately unlock this page

# DELVE INTO FANTASY, MAGIC, MYTHOLOGY & FOLKLORE

Forgotten Books'  
Full Membership gives  
access to 797,885 ancient  
and modern, fiction and  
non-fiction books.

**Continue**

\*Fair usage policy applies

There is also a yellowish tinge on the eleventh and twelfth rows, giving the appearance of a broken line of that color. A dark patch on the frontal and parietals and a line from the nostril to side of the neck.

(c) From Banes, Cuba, 27 rows of scales, four exterior smooth, ventrals, 194; subcaudals, 24. Total length, 736 mm. (tail 51).

This specimen is peculiar in coloring, being a bright orange yellow on the whole upper surface, slightly paler on the sides and beneath. There is an occasional indication of the dark dorsal and lateral dots. In all these specimens the frontal plate is nearly twice as long as broad and the parietals are separated by one large and one small scale.

***Epicrates cupreus* Fisch.**

One specimen from Venezuela (O'Reilly, coll.), 51 rows of scales, ventrals, 236; subcaudals, 54; 13 superior and 15 inferior labials, the sixth and seventh labials entering the orbit. Total length, 1,247 mm. (tail 133).

Color, uniform copper above, with a rich, plum colored bloom. Faintly indicated darker mottling on the back and sides. Beneath, white with a spot of the body color on the base of each scutum near the end.

For purposes of comparison, the scutellation of a small *E. anguifer*, from Cuba, is given:—Total length, 635 mm. (tail 63), 63 rows of scales; ventrals, 274; subcaudals, 50; 13 superior labials, not touching orbit; 16 lower labials.

***Xiphosoma hortulana* (Linn).**

(a) From Trinidad (O'Reilly, coll.), 43 rows of scales; 2 loreals; 13 superior labials, of which eight are pitted; 16 lower labials, eight pitted; 8 to 12 scales across top of head between orbits; ventrals, 264; subcaudals, 112. Total length, 1,096 mm. (tail 241).

Color, black with a series of white rings, somewhat alternating on opposite sides of the body, many of them open below and prolonged downward to the ventrals, in the form of two white bars.

(b) From Trinidad or Guiana (O'Reilly, coll.) 41 rows of scales; 2 loreals; 12 superior labials, 8 pitted; 14 lower labials, 6 pitted; 10 to 12 scales between orbits; ventrals, 253; subcaudals, 95. Total length, 1,012 mm. (tail 203).

Color reddish brown; lateral blotches yellowish brown, not form-

ing rings as distinctly as in the black type. An occasional scale is black or white. Abdomen yellowish cream color with small dusky blotches, especially towards the tail. The whole pattern is less distinct than in the ordinary form and is difficult to describe.

*Xiphosoma ruschenbergeri* Cope.

Two specimens from Trinidad (*a*, O'Reilly, coll.)

(*a*) 4. rows of scales; 2 loreals; 13 superior and 13 inferior labials; 9 to 12 scales between orbits; 4 large plates on muzzle; ventrals, 261; subcaudals, 101. Total length, 1,680 mm. (tail 305).

Color, greenish brown above, with an occasional yellow scale. All the scales narrowly margined with dark brown. Underneath, bright yellow, clouded with dusky. A few small black spots towards the tail.

(*b*) 43 rows of scales; 2 loreals; 14 superior labials, 8 pitted; 13 inferior, 7 pitted; 9 to 11 scales between orbits. Six large plates on muzzle. Ventrals, 258; subcaudals, 101. Total length, 1,655 mm. (tail 305).

Color similar to specimen *a*, but without any yellow scales on the body.

*Xiphosoma annulata* Cope.

(*a*) Said to have come from Jamaica, but probably exotic; 54 rows of scales; 3 loreals; 12-14 superior labials, 6 pitted; 18 inferior, 9 pitted; 12 to 16 scales between orbits; ventrals, 260; subcaudals, 82. Total length, 863 mm. (tail 152).

Color, gray with a series of darker gray rings with lighter centers, on each side. These rings often coalesce across the back, and become bands on the tail. Light gray underneath. Head with a few dark markings and a black band through the eye.

(*b*) From Bocas del Toro, Columbia; 54 rows of scales; 3 loreals; 14 superior labials, 8 pitted; 18 inferior, 10 pitted; 14 to 16 scales between orbits; ventrals, 252; subcaudals, 80. Total length 990 mm. (tail 152).

Color much as in specimen *a*, but with a slightly brownish tinge.

The muzzle in this species is broader than in *hortulana*, the internasals are shorter and the superciliaries less distinguishable.

*Dipsas cenchoa* (Linn.).

One specimen from Columbia; 17 rows of scales; median much enlarged; 1 ante and 2 post-orbitals; 7 superior, 9 inferior labials; ventrals, 246; subcaudals, 180 pairs: anal divided. Total length, 1,028 mm. (tail 330).

Color, reddish brown above with blotches of darker brown; yellowish beneath, punctuated with black.

*Leptophis liocercus* (Neuwied).

One specimen from Venezuela (O'Reilly, coll.); 15 rows of scales, those on the body keeled; no loreal; temporals, 1-2; 8 superior, 10 inferior labials. Ventrals, 161; subcaudals, 157 pairs; anal divided. Total length, 1,235 mm. (tail 381).

Color, bright metallic green above; belly white, extending to the second or third rows of scales. Each subcaudal has a minute point of green about the centre. The dark line through the eye, is very narrow in this specimen.

*Herpetodryas carinatus* (Linn).

Two specimens from Trinidad, (*b*, O'Reilly, coll.)

(*a*) 9 superior labials; 9-10 inferior labials; temporals, 1-2; 12 rows of scales; 2 median rows keeled; ventrals, 160; subcaudals, 117. Total length, 1,373 mm. (tail 457).

Color, greenish black above with indications of a light dorsal stripe. Greenish white underneath.

(*b*) 9 superior, 11 lower labials; temporals, 1-2; 12 rows of scales, all smooth; ventrals, 164; subcaudals, 129 pairs. Total length, 1,502 mm. (tail 509).

Color, bluish black above; bluish white beneath.

*Spilotes pullatus* (Linn).

Two specimens from Trinidad, (O'Reilly, coll.)

(*a*) 17 rows of scales; 8 superior and 8 inferior labials; temporals, 1-1; ventrals, 214; subcaudals, 103 pairs. Total length, 1,930 mm. (tail 458).

The light markings in this specimen are pure white.

(*b*) 15 rows of scales: 6 superior, 8 inferior labials; temporals, 1-1; ventrals, 214; subcaudals, 110 pairs. Total length, 2,240 mm. (tail 533).

The light markings are pale yellow.

*Spilotes corais melanurus* (D. & B.)

One specimen from Mexico; 17 rows of scales; 8 labials above, 8 below; temporals, 2-2; ventrals, 192; subcaudals, 59 pairs. Total length, 2,105 mm. (tail 381).

**THIS PAGE IS LOCKED TO FREE MEMBERS**

Purchase full membership to immediately unlock this page

# Know Your Bible

Forgotten Books' Full Membership provides unlimited access to more than 28,000 volumes of Christian literature for \$8.99/month

**HOLY BIBLE**

**Continue**

\*Fair use policy applies

occasional red patch on the lower abdomen and tail. A dark blotch on the parietals, frontal and superciliaries. In all details of scutellation these specimens agree with *A. angulifer* of Cuba and are precisely similar in color to five other specimens which were in possession of the dealer from whom they were procured.

The form is that described by Garman as *A. caymanus* (Proc. Am. Phil. Soc., 1887, p. 276) in which the color variation seems to be well fixed. One specimen of *A. angulifer* in the Academy's collection rather tends towards it, however, and it seems best to regard the form as a subspecies from some of the outlying keys and islands.

**Helicops angulatus** (Linn).

One specimen from Trinidad (O'Reilly, coll.); 19 rows of scales; keeled; loreal present; temporals, 1-3; ventrals, 119; subcaudals, 65 pairs; anal divided. Total length, 368 mm. (tail 89).

Color greenish olive. The light cross bands widen and end in a red spot on the flanks. Underneath, orange, with a row on each side, of alternating dark blotches.

**Scytale neuwiedi** D. & B.

One specimen from Guiana (O'Reilly, coll.); 19 rows of smooth scales; 8 superior labials, fourth and fifth in orbit; 8 lower labials; 2 nasals, posterior large; a loreal which is long and narrow, hard to distinguish from the prefrontals; 1 ante, 2 post-orbitals; temporals, 1-2; ventrals, 188; subcaudals, 83, undivided; anal undivided. Total length, 914 mm. (tail 229).

Color, uniform reddish brown above, pearl white beneath; lustrous and opalescent.

**Bothrops atrox** (Linn).

Two specimens from British Guiana, (O'Reilly, coll.)

(a) 27 rows of scales; 7 upper and 8 lower labials; ventrals, 196; subcaudals, 42 pairs. Total length, 635 mm. (tail 89).

(b) 27 rows of scales; 7 upper and 9 lower labials; ventrals, 195; subcaudals, 59 pairs. Total length, 722 mm. (tail 121).

Scales broad and with a high, short keel, which does not extend to the tip of the scale.

Color, grayish olive with brown, black edged blotches on the back, widening on the sides. Interspaces along the back, about equal in length to the blotches. Abdomen yellow, heavily blotched with dark brown.

**Bothrops lanceolatus** (Merrem).

Two specimens from Martinique, (O'Reilly, coll.)

(a) 25 rows of scales; 7 upper and 9 lower labials; ventrals, 199; subcaudals, 69 pairs. Total length, 559 mm. (tail 101).

(b) 25 rows of scales; 7 upper and 9 lower labials; ventrals, 200; subcaudals, 69 pairs. Total length, 610 mm. (tail 114).

Scales narrower than in *atrox*, keel less marked and running to the tip of the scale.

Color, gray above with pale brown rhomboidal blotches on the back and small spots on the sides, both very irregular. Abdomen yellow, unspotted.

**Bothrops jararaca** (Neuwied.)

One specimen from Brazil, (O'Reilly, coll.)—27 rows of scales; 7 upper and 9 lower labials; ventrals, 206; subcaudals, 57 pairs. Total length, 635 mm. (tail 101).

Body scale much as in *lanceolatus*. Those on the muzzle proportionately rather larger. Angle of canthus less sharp.

Color, sage green, with dark transverse bands, widening on the sides. Interspaces along the back are considerably longer than the bands. An occasional dark spot in the interspaces on the dorsal line. Abdomen yellow, unspotted.

The specimens of *Bothrops* given above are identified with some hesitation. In fact the difficulty of finding any marked, substantial characters, distinguishing these three species, suggests a doubt of their right to full specific rank. In case they should be regarded as subspecies of one widely ranging form, *B. atrox*, (Linn) would have priority.



## DECEMBER 5.

The President, GENERAL ISAAC J. WISTAR, in the chair.

One hundred and thirty-eight persons present.

A paper entitled "Earthenware of Florida, Collections of Clarence B. Moore," by W. H. Holmes, was presented for publication.

DR. BENJAMIN SHARP made a communication on his recent visit to the Hawaiian Islands. (No abstract).

*Heredity in the Social Colonies of the Hymenoptera.*—At the meeting of the Academy held May 23 PROF. EDW. D. COPE, referring to the question of heredity in the social colonies of the Hymenoptera, remarked that perhaps the strongest case that can be made out against the theory of use-inheritance has been presented by Mr. W. P. Ball, \* viz.: that of the variety of structure displayed by the neuter members of the colonies of ants and termites. Mr. Ball describes these briefly as follows:

"But there happens to be a tolerably clear proof that such changes as the evolution of complicated structures and habits and social instincts *can* take place independently of use-inheritance. The wonderful instincts of the working bees have apparently been evolved (at least in all their later social complications and developments) without the aid of use-inheritance nay, in spite of its utmost opposition. Working bees, being infertile "neuters," cannot, as a rule, transmit their own modifications and habits. They are descended from countless generations of queen bees and drones, whose habits have been widely different from those of the workers, and whose structures are dissimilar in various respects. In many species of ants there are two, and in the leaf-cutting ants of Brazil there are *three* kinds of neuters which differ from each other and from their male and female ancestors "to an almost incredible degree."<sup>1</sup> The soldier caste is distinguished from the workers by enormously large

---

\* The Effects of Use and Disuse. Nature Series, 1890, P. 24.

<sup>1</sup>Origin of Species, pp. 230, 232; Bates' Naturalist on the Amazons. Darwin "is surprised that no one has hitherto advanced the demonstrative case of neuter insects, against the well-known doctrine of inherited habit, as advanced by Lamarck." As he justly observes, "it proves that with animals, as with plants, any amount of modification may be effected by the accumulation of numerous, slight, spontaneous variations, which are in any way profitable, without exercise or habit having been brought into play. For peculiar habits confined to the workers or sterile females, however long they might be followed, could not possibly affect the males and fertile females, which alone leave any descendants." Some slight modification of these remarks, however, may possibly be needed to meet the case of "factitious queens," who (probably through eating particles of the royal food) become capable of producing a few male eggs.

**THIS PAGE IS LOCKED TO FREE MEMBERS**

Purchase full membership to immediately unlock this page

# DELVE INTO FANTASY, MAGIC, MYTHOLOGY & FOLKLORE

Forgotten Books'  
Full Membership gives  
access to 797,885 ancient  
and modern, fiction and  
non-fiction books.

**Continue**

\*Fair usage policy applies

less exacting character. In a second stage of evolution the community would present the character of a family of varied forms all of whose members would produce any or all of the types of form to be found in it, under slight diversities of condition, just as now, all species produce young of two sexes. The differences between the members of an ant community are considerable in appearance, but not so great essentially as that between sexes. Finally, in a third stage of the history, the function of reproduction came to be the special office of a few members of the community. This may have been due to a deficiency of food accessible to certain individuals aborting the reproductive powers; but whatever may have been the cause, a majority of individuals became sterile. The reproducing members of the community, however, have continued to produce all of the forms of the community. They produce sterile workers and soldiers, sometimes of several forms, through hereditary influences. But this, says Mr. Ball, is evidence that inheritance can have no share in the process. He believes that each one of the structural types of the community is produced by the treatment accorded to the young by the workers, *each generation for itself*. How excessive additions to structure can be produced by starvation, he does not attempt to show.

As we have seen that the embryonic and paleontologic histories distinctly negative the idea that each generation has been produced by itself without inheritance, let us endeavor to read the riddle in the light of the knowledge we have gained from paleontology. We assume that the most specialized types, the soldiers, represent the fertile type of the species in Liassic time, when the family first appears, or soon after. The process of change into workers and breeders has been degenerative. In ants, as in the case of the many other animals, slight differences in the supply of nutritive energy may prevent or produce these degenerative processes, as it appears to do in the case of the production of the sexes. (Experiments on lepidopterous larvæ have shown that excessive food supply produces females and deficient supply produces males). In bees, the larvæ of the female (queen) receive the largest food supply; those of the males less; and those of the neuters the least of all. How the food supply came to be varied so as to produce the several types, in accordance with the exigencies of the community, is a question to be solved by future research. Perhaps it was due to variations in the supplies available at particular times of the year; and perhaps the ants thus acquired a habit of feeding and came to practise it intelligently. It is enough for the present purpose to have shown that it is more probable that the basis of the entire community, the original fertile soldier, acquired his characters in the usual way: by use, and that all other forms have been derived from him by inheritance, modified by disuse or degeneracy, under the influence of variations in the food supply.

## DECEMBER 12.

The President, GENERAL ISAAC J. WISTAR, in the chair.

Thirty-seven persons present.

The death of James Wood Mason, a correspondent, May 6, 1893, was announced.

## DECEMBER 19.

The President, GENERAL ISAAC J. WISTAR, in the chair.

One hundred and fifty-five persons present.

The death of General William Lilly, a member, Dec. 1, 1893, was announced.

PROF. WILLIAM LIBBY, JR. made a communication on the physical geography of the Hawaiian Islands. (No abstract.)

## DECEMBER 26.

REV HENRY C. MCCOOK, D. D., in the chair.

Thirty-five persons present.

A paper entitled "Homologies of the Alisphenoid and Petromastoid Bones in Vertebrates," by Henry C. Chapman, M. D. was presented for publication.

The Publication Committee reported in favor of the publication of the following papers in the Journal:

Extinct Bovidæ, Canidæ and Felidæ from the Plistocene of the Plains. By E. D. Cope.

Earthenware of Florida, Collections of Clarence B. Moore. By W. H. Holmes.

The following were ordered to be printed:

## NEW SPECIES OF FUNGI FROM VARIOUS LOCALITIES

BY J. B. ELLIS AND B. M. EVERHART.

## \* HYMENOMYCETES.

*Agaricus* (*Tricholoma*) *subrufescens* E. & E.

Pileus carnose, convex-plane, 4-5 cm. across, light colored with a reddish tinge, center darker, innate-fibrillose-squamose, not at all viscose, flesh white and quite thin towards the margin. Lamellæ unequal, rounded behind, very light flesh color, with a reddish tinge, especially where bruised or broken, moderately crowded, 2-3 mm. wide, substance rather thick. Tasteless, but with a strong farinose smell like that of a freshly cut cucumber. Stem of fibrous texture, softer within and becoming hollow, about 8 cm. high and 1 cm. thick below, subattenuated above, surface somewhat squamulose, about the same color as the pileus, the whole plant assuming a distinctly reddish tinge, more decided with age. Spores white, sub-globose, about  $3\frac{1}{2}\mu$ . diameter.

In low, mixed woods, among decaying leaves, Newfield, N. J., Sept. to Oct.

*Hygrophorus squamulosus* E. & E., in Ellis & Everhart's North Am. Fungi, 2d series, No. 1912.

Carnose throughout and brittle. Pileus hemispherical, expanding to convex, 3-4 cm. across, bright orange-red, becoming paler especially around the margin, tomentose-squamulose, more distinctly so in the disk, never viscose. Lamellæ emarginate-adnate, with a slight decurrent tooth, light yellow, unequal, rather broad, moderately crowded, margins obtuse, at length pulverulent, interspaces only slightly rugose. Stem about 5 cm. long,  $\frac{1}{2}$ - $\frac{3}{4}$  cm. thick, subattenuated above and slightly farinose at the summit, hollow, light orange with a deeper tint midway, often compressed and curved. Spores white, oblong-elliptical,  $5-6 \times 3-3\frac{1}{2}\mu$ . Basidia clavate-cylindrical,  $22-25 \times 3\frac{1}{2}-4\mu$ , stipitate.

Near *H. coccineus* Schaeff. but the pileus is orange red, not scarlet and only convex, not conical or ever viscose.

In low, swampy woods, amongst moss and decaying wood and leaves. Newfield, N. J., July to October.

**THIS PAGE IS LOCKED TO FREE MEMBERS**

Purchase full membership to immediately unlock this page

# Know Your Bible

Forgotten Books' Full Membership provides unlimited access to more than 28,000 volumes of Christian literature for \$8.99/month

**HOLY BIBLE**

**Continue**

\*Fair use policy applies

Mycelium hypophyllous, superficial, sparingly branched, radiate, with sessile, globose hyphopodia as in *Asterina Leemingii*, forming orbicular spots 2-3 mm. diameter or more or less confluent. Perithecia seated on the mycelium, ovate, 65-80 $\mu$  diam., pierced above, black. Asci oblong, obtuse, paraphysate, abruptly short-stipitate, 30-40 x 7-8 $\mu$ , 8-spored. Sporidia biseriate, oblong, 1-septate and slightly constricted at the septum, each cell nucleate, yellowish-hyaline, 10-12 x 3-3 $\frac{1}{2}$  $\mu$ . Some of the perithecia contain oblong, hyaline, 2 nucleate stylospores 6-7 x 3 $\mu$ .

This occurs on the same leaves as *Asterina Leemingii* E. & E., but is distinct in its ovate, smaller perithecia and smaller sporidia. This last named species was described as having the perithecia depressed-globose, but they are really only convex or scutellate, and of radiate-cellular structure.

**Hypocrea tenerrima** E. & E.

Spreading over mosses, decaying sticks, &c., Nuttallburg, West Va., July, 1893. (L. W. Nuttall, No. 123).

Perithecia gregarious, minute ( $\frac{1}{8}$  mm.), clothed (except the black apex) with a thin white tomentum, seated on a thin snow-white, tomentose-arachnoid subiculum. Asci cylindrical, 40 x 3 $\mu$ , without paraphyses, 8-spored. Sporidia uniseriate, oblong, obtuse, hyaline, 5-6 x 2 $\mu$ , with a single nucleus in the center, (becoming uniseptate)?

This is closely allied to *H. subcarnea* E. and E., but differs in the color of the subiculum, the black apex of the perithecia, the narrower asci and rather longer sporidia.

**Hypocrea Virginiensis** E. and E.

On partly dead leaves of *Rhododendron maximum*, Nuttallburg, West Va., August, 1893. (L. W. Nuttall).

Epiphyllous, stromata carnose, scattered, sub-hemispherical or depressed-turbinate, 1-2 mm. diam., of a yellowish gray color, subtruncate above and obscurely margined (when mature). Perithecia buried in the stroma, ovate, membranaceous, 110-150 $\mu$  diam. Ostiola hemispherical, prominent, black, broadly perforated and sometimes collapsed. Asci clavate-cylindrical, p. sp. 40-45 x 7-8 $\mu$ , short-stipitate, filiform-paraphysate, 8-spored. Sporidia biseriate, oblong-fusoid, yellowish-hyaline, uniseptate, slightly constricted at the septum, obtusely pointed at the ends, 10-12 x 3-3 $\frac{1}{2}$  $\mu$ .

*H. viridens* B. and C. seems to differ in its hidden ostiola (ostiolis latitantibus).

*Nectria bicolor* E. and E.

On dead twigs of *Carya*, Wilmington, Del., Sept. 1893. (Commons, No. 2245).

Gregarious, perithecia ovate, slightly contracted at base, reddish-flesh-color, 250-300 $\mu$  diam., clothed, except a small space around the conic-papilliform, darker colored ostiolum, with clavate, 1-2 septate hairs hyaline and 3-4 $\mu$  thick at base, yellow and granular-roughened, and 5-7 $\mu$  thick at the rounded, obtuse, oblique apex. Asci clavate-cylindrical, p. sp. 35-40 x 6-7 $\mu$ , pseudo paraphysate, 8-spored, short stipitate. Sporidia biseriate, oblong, straight, hyaline, subobtuse, 7-11 x 2 $\frac{1}{2}$ -3 $\frac{1}{2}$  $\mu$ , 2-3 nucleate, continuous at first, finally faintly uniseptate and slightly constricted.

The yellow color of the hairy coat is the same as in *N. sulphurea* Ell. and Calk, but there is no subiculum, and in that species the perithecia are not hairy, but simply pruinose. *Fusarium episphaerium* C. and E. (Grev. V. p. 50) appears to be the conidial stage.

*Lasiosphaeria striata* E. and E.

On dead willow limbs near Park Hill, Ont., Canada, May, 1893. (Dearness, No. 2177).

Perithecia gregarious, subglobose,  $\frac{3}{4}$ -1 mm. diam., fibrose-membranaceous, pale reddish-brown, thin and collapsed above, fibrose-striate, seated on a thin, dark colored, crustaceo-tomentose subiculum extending along and blackening the limb for several centimeters. Asci clavate-cylindrical, short-stipitate, 100-110 x 7-8 $\mu$ , 8-spored with filiform paraphyses. Sporidia crowded-biseriate, fusoid, hyaline, acute, 3-5 septate, 40-60 x 2 $\frac{1}{2}$ -3 $\mu$ .

The young perithecia are filled with stylospores 20-27 x 3 $\mu$ , 3 septate, hyaline.

*Acanthostigma parasiticum* E. & E.

Parasitic on *Diatrype stigma*, Newfield, N. J., November, 1892.

Perithecia scattered, ovate, superficial, small (100-112 $\mu$  high), clothed with stout, straight, rigid, spreading bristles 50-75 x 5 $\mu$ ; ostiolum papilliform. Asci oblong, 55-70 x 12-15 $\mu$ , slightly overtopped by the abundant paraphyses. Sporidia fasciculate, fusoid, multi-(6-12) septate, slightly curved, thickened above, yellowish-



hyaline, 40–70 x 4–5 $\mu$ , (mostly 40–50 $\mu$  long), 6–8-septate.

*A. pygmaeum* Sacc. and *A. Clintonii* Pk., have sporidia of equal thickness throughout and in the latter, straight, but the three are closely allied.

**Rosellinia Hystrix** E. & E.

On old hickory nuts, lying on the ground, Newfield, N. J. May, 1893.

Perithecia gregarious, ovate, obtuse, 110–120 $\mu$  wide, 130–150 $\mu$  high, rather thickly clothed all over with short (8–12 $\mu$ ), black bristles. Asci (p. sp.) cylindrical, 35–40 x 6–7 $\mu$ , short-stipitate, overtopped by the abundant, filiform paraphyses. Sporidia uniseriate, short-elliptical, pale olivaceous, slightly compressed, 5–6 $\mu$  long, about 2½ $\mu$  thick and 3½ $\mu$  broad.

Differs from the other bristly species in its smaller compressed sporidia.

**Ceratostoma corticolum** E. & E.

On the inside of cast-off bark of *Ailanthus* decaying on the ground, Newfield, N. J., March 21, 1893.

Perithecia gregarious, globose about ¼ mm. diam. or less, membranaceous, black and rough, at first buried in the bark, with only the point of the cylindrical ostiolum erumpent, at length more or less distinctly superficial by the weathering away of the bark. Ostiolum about as long as the diam. of the perithecium, smooth and black at the apex, straight. Asci cylindrical, p. sp. about 75 x 7–8 $\mu$ , paraphysate?. Sporidia uniseriate, elliptical, continuous, brown, 12–14 x 6–7 $\mu$ .

Differs from *C. brevirostre* (Fr.), in its rough perithecia and rather smaller sporidia, and from *C. Therryanum*, in its much smaller perithecia.

**Ceratostomella microspora** E. & E.

On a rotten beech log, Alcove, N. Y. Sept., 1893. (C. L. Shear, No. 174.)

Perithecia buried in the wood, finally suberumpent, scattered, minute (150 $\mu$  diam.,) ovate-globose, membranaceous, contracted above into a cylindrical ostiolum 200–300 $\mu$  long, the apex erumpent and slightly projecting. Asci clavate, a paraphysate, 16 x 3 $\mu$ . Sporidia collected in the swollen apex of the ascus, allantoid, hyaline,

**THIS PAGE IS LOCKED TO FREE MEMBERS**

Purchase full membership to immediately unlock this page

# DELVE INTO FANTASY, MAGIC, MYTHOLOGY & FOLKLORE

Forgotten Books'  
Full Membership gives  
access to 797,885 ancient  
and modern, fiction and  
non-fiction books.

**Continue**

\*Fair usage policy applies

more scattered mode of growth and its longer, narrower, fusoid, (not ovate-oblong) sporidia.

**Teichospora nucis** E. & E.

On old hickory nuts lying on the ground, Newfield, New Jersey. May, 1893.

Perithecia scattered or loosely gregarious, superficial or erumpent superficial, black, small, conic-hemispherical, 125–150 $\mu$  broad, 100–110 $\mu$  high, with a papilliform ostiolum, finally collapsing above. Asci oblong-cylindrical, 70–75 x 12–15 $\mu$ , abruptly contracted at base with a very short, nodular stipe. Paraphyses filiform. Sporidia obliquely uniseriate, or subbiseriate, elliptical, yellow (becoming brown or even opaque), about 5-septate, with a longitudinal septum more or less perfect, sometimes constricted in the middle, 14–18 x 8–9 $\mu$ .

Comes near *T. Emilii* Fabre, but perithecia much smaller and not sprinkled with any white powder.

**Didymosphæria vagans** E. & E.

On dead limbs of *Ostrya*, *Carya*, and *Ulmus*, London, Canada. May, 1893. (Dearness Nos. 2110, 2113, 2113 B.)

Perithecia densely gregarious, small,  $\frac{1}{4}$ – $\frac{1}{3}$  mm. diam., white inside, covered by the epidermis which is raised into pustules and blackened directly over them and finally pierced by the papilliform ostiolum. Asci clavate, paraphysate, 8-spored, gradually narrowed toward the base, 100–110 x 12 $\mu$ . Sporidia uniseriate, elliptical, brown, uniseptate, scarcely constricted, 15–20 x 9–11 $\mu$ .

Differs from *D. epidermidis* (Fr.), in its larger sporidia and perithecia white inside and from *D. nitidula* Sacc., in its smaller perithecia and sporidia.

**Sphærella phragmitis** E. & E.

On dead leaves of *Phragmites communis*, Pine, Indiana. Sept., 1893. (Prof. R. A. Harper).

Perithecia scattered, globose, 100–110 $\mu$  diam., pierced above, buried in the parenchyma of the leaf, but visible by translucence. Asci oblong-cylindrical, short-stipitate, 30–45 x 7–9 $\mu$ , aparaphysate, 8-spored. Sporidia biseriate, clavate-piriform, 1-septate and scarcely constricted, sometimes slightly curved, hyaline, 9–12 x 3–4 $\mu$ . Differs from *S. lineolata* (Rob. and Desm.), which also occurs on *Phragmites*,

in its scattered perithecia and smaller sporidia. On the culm and lower part of the leaves is a *Stagonospora* (*S. Phragmitis* E. and E.), which appears to be the stylosporous stage of the *Sphærella*. The sporules are oblong-elliptical, 2–3-nucleate, yellowish-hyaline, very abundant, 10–12 x 3–4 $\mu$ , in perithecia about the same as the ascigerous perithecia.

**Sphærella Chimaphilæ** E. & E.

On living leaves of *Chimaphila umbellata*, Faulkland, Del. May, 1887. (Commons, No. 479).

Spots amphigenous, 2–3 mm. diam., concave above, orbicular, with a slightly raised border, dark with a lighter center and mostly surrounded by a dark colored area of greater or less extent. Perithecia amphigenous, seated on the spots and on the blackened area around them, innate with the apex erumpent, 75–100 $\mu$  diam. Asci cylindrical-oblong, sessile, 40–45 x 6–7 $\mu$ . Sporidia subbiseriate, oblong-fusoid, uniseptate, hyaline, not constricted, 7–8 x 2–2½ $\mu$ . The larger spots are indistinctly zonate.

Allied to *S. Vaccinii* Cke. but in that there are no definite spots and the sporidia, as shown by an examination of authentic specc., are longer (12–15 x 1½–2 $\mu$ ) or (Sec. Cke.) 12–18 x 1½–2 $\mu$ .

**Physalospora Ambrosiæ** E. & E.

On living leaves of *Ambrosia trifida*, Racine, Wis. Sept. 1893. (Davis, No. 9317).

Spots irregularly elliptical or sub-orbicular, ½–1¼ cm. diam., rusty brown, surrounded by a light yellow aureole. Perithecia ovate, about 200 $\mu$  diam., the perforated apex strongly projecting above and the rounded base equally prominent below. Asci clavate-cylindrical, 60–70 x 10–12 $\mu$ , sessile, paraphysate, 8-spored. Sporidia uniseriate below, subbiseriate above, oblong-elliptical, hyaline, continuous, 2-nucleate, 10–12 x 6–7 $\mu$ .

**Leptosphæria muricata** E. & E.

On leaves of *Andropogon muricatus*, St. Martinville, La. (Langlois).

Perithecia scattered, lying in the channels between the nerves of the leaf and covered by the epidermis, with the apex and papilliform ostiolum slightly projecting, subelliptical, 150–250 $\mu$  in the longer diam. Asci slender, sub-cylindrical, 65–70 x 5–6 $\mu$ , paraphysate,

8-spored, short-stipitate. Sporidia overlapping-uniseriate, short-fusoid, yellowish, 2-septate, scarcely constricted,  $10-11 \times 2\frac{1}{2}-3\mu$ , mostly not over  $2\frac{1}{2}\mu$ , ends acute.

Differs from *L. Michotii* West, in its elliptical perithecia, slender asci and shorter, fusoid paler sporidia.

**Ophiobolus Andropogonis** E. & E.

On dead leaves of *Andropogon muricatus*, Louisiana. (Langlois).

Perithecia scattered, subcuticular, elliptical,  $220-250\mu$  in the longer diameter, the apex and papilliform ostiolum slightly prominent. Asci clavate-cylindrical,  $60-80 \times 8-10\mu$ , short-stipitate, with abundant paraphyses. Sporidia linear, yellowish, multiseptate, mostly straight,  $40-80 \times 2-2\frac{1}{2}\mu$ .

In the North Am. Pyrenomycetes this was included in *O. Medusae* E. and E., but it is distinct on account of its much shorter asci and sporidia, as well as its smaller, elliptical, glabrous, more distinctly prominent perithecia. The habit, however, is the same.

**Diaporthe (Chorostate) Dircae** E. & E.

On dead and nearly decayed limbs of *Dirca palustris*, London, Canada. July, 1892. (Dearness, No. 2992).

Perithecia in subcircinate groups of 12-20, buried in the surface of the wood, depressed-globose,  $\frac{1}{3}-\frac{1}{2}$  mm. diam., whitish inside, with ostiola convergent and erumpent in a little fascicle, joined together below, their short-cylindrical,  $\frac{1}{2}$  mm. long apices free and slightly projecting through the ruptured epidermis. Asci clavate-cylindrical,  $50-60 \times 6-7\mu$ , paraphysate. Sporidia biseriate, oblong-fusoid, straight, 4-nucleate, hyaline,  $11-13 \times 2\frac{1}{2}-3\mu$ .

There is no black circumscribing line around each separate group of perithecia, but a continuous black line or stratum running along for some inches in extent, in the wood beneath the perithecia.

**Diaporthe (Chorostate) Juglandis** E. & E.

On dead limbs of *Juglans cinerea*, Alcove, N. Y. Aug. 1893. (C. L. Shear, No. 145).

Perithecia buried in the unchanged substance of the inner bark without any circumscribing line, circinate, 6-12 together, globose,  $400-600\mu$  diam., with slender necks converging and rising through the bark, terminating in a dense fascicle of short-cylindrical or hemispherical, broadly perforated ostiola, erumpent in a small, convex,

**THIS PAGE IS LOCKED TO FREE MEMBERS**

Purchase full membership to immediately unlock this page

# Know Your Bible

Forgotten Books' Full Membership provides unlimited access to more than 28,000 volumes of Christian literature for \$8.99/month

**HOLY  
BIBLE**

**Continue**

\*Fair use policy applies

has longer, coarser ostiola and longer, narrower asci, with constricted sporidia.

**Pseudovalsa ulmicola** E. & E.

On dead elm limbs, London, Canada. May, 1893. (J. Dearness, 1430c).

Stroma orbicular or elliptical,  $\frac{1}{2}$ -1 cm. diam., or by confluence becoming irregular and much larger, formed of the whitened substance of the bark and surrounded (in a horizontal section) by a black line. Perithecia ovate-globose,  $\frac{1}{2}$ - $\frac{3}{4}$  mm. diam., entirely buried in the bark and penetrating nearly or quite to the wood, 8-20, subcircinately arranged, their necks converging and the hemispherical, perforated ostiola erumpent in a minute fascicle perforating the epidermis, but scarcely rising above it. Sporidia allantoid, yellow-brown, 20-28x5-7 $\mu$ , 1-3-septate, ends obtuse and often swollen.

The specc. were rather old and the asci dissolved.

**Hypoxyton discoideum** E. & E.

On bark of dead stems of the climbing var. of *Rhus Toxicodendron*, Newfield, N. J. Dec. 1892.

Stromata gregarious, subseriate, erumpent-superficial, black (when mature), 2-3 mm. diam., at first hemispherical, then with the thin margin slightly raised from the bark so as to become subdiscoid, with quite a resemblance (outwardly) to *Hypocrea Schweintzii* Fr. Ostiola papilliform, at length often umbilicately collapsing. Sporidia oblong, straight or slightly curved, pale brown, 2-nucleate, 8-11 (mostly 8-10) x 3-3 $\frac{1}{2}$  $\mu$ . The specc. were old and the asci had disappeared.

**Tryblidium Ohense** E. & E.

On rotten wood, Ohio. (Morgan.)

Perithecia gregarious, oblong or oblong-elliptical, 1-1 $\frac{1}{2}$  x  $\frac{1}{2}$ - $\frac{3}{4}$  mm. straight or slightly curved, black, roughish, with 1-2 deep longitudinal striæ on each side of the loosely closed lips, ends sub-acute or obtuse. Asci cylindrical, sessile, densely paraphysate, 75-80 x 8-10 $\mu$ , 8-spored. Sporidia uniseriate, oblong-elliptical, uniseptate, hyaline at first, becoming brown, 12-15 x 4-5 $\mu$ .

This would come under *Mytilidion*, but the perithecia are flattened above and the lips separated by a deep cleft.

*Tryblidiella pygmæa* E. & E.

On weather-beaten wood, Ohio. (Morgan).

Perithecia gregarious, semi-immersed, acutely elliptical, black, not striate,  $\frac{1}{2}$ - $\frac{3}{4}$  mm. long, lips incurved, not closed, exposing the dark colored disk. Asci clavate, 60-75 x 12-15 $\mu$ , sessile, with filiform, branched paraphyses. Sporidia biseriate, clavate, 3-4-septate, 20 x 6-7 $\mu$ , hyaline becoming brown.

Has the same habit as *Glonium lineare*.

\* \* \* DISCOMYCETES.

*Lachnellula microspora* E. & E.

On bark of spruce trees, New Harbor, Newfoundland. May, 1893. (Rev. A. C. Waghorne).

Sessile or very short-stipitate, 2-3 mm. across, cup shaped, (nearly closed at first), margin fringed and outside clothed with a dense coat of rufo-cinereous 70-80 x 3 $\frac{1}{2}$  $\mu$ , stout, rough, simple or regularly branched, subfasciculate hairs. Disk pale orange when fresh, subrufous when dry. Asci clavate-cylindrical, sessile, 55-60 x 6-7 $\mu$ , paraphysate, 8-spored. Sporidia uniseriate, globose, hyaline, smooth, about 3 $\frac{1}{2}$  $\mu$  diam.

Has the general appearance of *Lachnella corticalis* (Pers.)

*Cyathicula quisquiliaris* E. & E.

On decaying leaves, petioles, &c., lying on the ground in woods, Nuttallburg, West Va. May, 1893. (L. W. Nuttall).

Gregarious, sessile, 1-1 $\frac{1}{2}$  mm. diam., cup-shaped, disk pale, with a tinge of brick color when dry, dull, dirty white and furfuraceous outside, margin distinctly cleft-toothed and incurved when dry. Asci cylindrical, sessile, 55-65 x 6-7 $\mu$ , with filiform paraphyses scarcely thickened above. Sporidia uniseriate, or sub-biseriate above, elliptical, hyaline, continuous, 6-8 x 3-4 $\mu$ .

*Dermatea simillima* E. & E.

On bark of *Acer rubrum*, cut for firewood, last winter. Newfield, N. J. Oct. 1893.

Cespitose or subseriate, but sometimes standing singly. Ascomata short stipitate, yellowish-olive, disk concave, becoming nearly plane, with a thick, obtuse margin, outside reddish, stipe stout, about  $\frac{1}{2}$  mm. long arising from a reddish carnose stroma. Asci clavate, 80-100 x 12-15 $\mu$ . Paraphyses stout, thickened, colored and subundulate



above. Sporidia biseriate, oblong, hyaline, granular and nucleate,  $14-16 \times 6-7\mu$ .

Differs from *D. olivacea* Ell., in its carnose stroma and smaller asci and sporidia.

**Belonidium minimum** E. & E.

On dead stems of *Aralia racemosa*, Granogue, Del. Aug. 1893. (Commons No. 2226).

Scattered, erumpent, sessile, pale rose color, minute ( $90-110\mu$ ), sub-discoid, indistinctly margined, subgelatinous, furfuraceo-pilose, or nearly glabrous. Asci clavate-cylindrical, aparaphysate, sessile,  $45-55 \times 6-7\mu$ , 8-spored. Sporidia biseriate, fusoid, slightly curved, hyaline, 3-septate, not constricted, subacute,  $14-20 \times 3-3\frac{1}{2}\mu$ .

Outwardly hardly distinguishable from *Peziza exigua* Ck., but asci twice as large and aparaphysate and sporidia nearly three times as large and 3-septate.

**Cenangium tuberculiforme** E. & E.

On dead twigs of *Ilex glabra*, Newfield, N. J. Nov. 1893.

Ascomata coriaceous, thin, densely cespitose on an erumpent, yellowish stroma, forming tubercular masses  $\frac{1}{4}$ -1 cm. diam., light yellow and furfuraceo-squamulose outside, with the margin entire, white and slightly incurved, urceolate, 2-3 mm. diam., hymenium pale brick-red contracted below into a short, thick, stipe-like base. Asci clavate-cylindrical,  $40-50 \times 4-5\mu$ , 8-spored. Paraphyses filiform, simple or dichotomously branched above not distinctly thickened at the apex. Sporidia obliquely uniseriate, elliptical, hyaline, continuous, 2-nucleate, subinequilateral,  $5-6 \times 2\frac{1}{2}\mu$ .

In drying the margin of the cups becomes incurved, and there is a tendency of the opposite sides to roll together.

**Patinella vagans** E. & E.

On dead twigs of *Lindera Benzoin*, Guyancourt, Del., and on dead stems of *Eupatorium sessilifolium*, Granogue, Del. Aug. 1893. (Commons Nos. 2257 and 2260).

Scattered, erumpent, sessile, small ( $\frac{1}{4}$ - $\frac{1}{3}$  mm.), pale flesh-color, concave, with a darker, slightly raised margin closely embraced by the ruptured epidermis, substance soft, carnose. Asci clavate-cylindrical, short stipitate,  $40-45 \times 6-7\mu$ , 8-spored. Paraphyses stout, gradually thickened to the tips. Sporidia uniseriate or biseriate

**THIS PAGE IS LOCKED TO FREE MEMBERS**

Purchase full membership to immediately unlock this page

# DELVE INTO FANTASY, MAGIC, MYTHOLOGY & FOLKLORE

Forgotten Books'  
Full Membership gives  
access to 797,885 ancient  
and modern, fiction and  
non-fiction books.

**Continue**

\*Fair usage policy applies

ing. Asci 300–400 x 8–10 $\mu$ , with filiform sporidia, multinucleate, becoming multiseptate, nearly as long as the asci, about 1½ $\mu$  thick.

\* \* \* \* **SPHÆROPSIDAE AND MELANCONIEAE.**

*Phyllosticta kalmicola* (Schw).

*Depazea kalmicola* Schw., Syn. N. Am., No. 1812, (pr. p). On living leaves of *Kalmia latifolia*. Newfield, N. J. April, 1893.

Spots amphigenous, orbicular, 1-2 mm. diam., white, with a dark purple margin shading off into reddish-purple. The white is less conspicuous below. Perithecia epiphyllous, depressed globose, subcuticular, black, 100–200 $\mu$  diam., sometimes concentrically arranged on the spots, semi-erumpent, but closely covered by the transparent cuticle which is often stellately cleft, but not reflexed, rather broadly pierced above. Sporules oblong elliptical, hyaline, minute (2–3 x 1 $\mu$ ).

The *Depazea kalmicola* Schw., embraces both a *Septoria* and a *Phyllosticta*, not outwardly distinguishable; the former issued in de Thümen's Mycotheca, No. 1494, Ell. N. A. F. 344, Roum. F. G. 2327 and Rab. F. E. 2792. Ell. and Everhart, N. A. F., 2d Ser. 2661 is a different thing, the spots having a raised border and the sporules being longer. The label to this last No. is erroneous. It should read on *Kalmia angustifolia*, and the Syn., "*Sphaeria kalmiacola*" should be canceled.

*Phyllosticta latifolia* E. & E.

On leaves of *Kalmia latifolia*, Newfield, N. J. May, 1893.

Spots amphigenous, orbicular, 3-5 mm. diam., rusty brown with a shaded, dark red border, indistinctly zonate. Perithecia buried, 150–200 $\mu$  diam., the apex rupturing the epidermis but hardly erumpent, circinate arranged so as to leave an empty space in the center of the spot. Sporules acutely and narrowly elliptical, hyaline, 6–8 x 2½–3½ $\mu$  on basidia about as long as the sporules.

Differs from *Ph. kalmicola* (Schw.) in its brown, subzonate spots, circinate perithecia and larger sporules.

*Phyllosticta discincola* E. & E.

On leaves of *Forsythia* Cult., Washington, D. C., Com. D. G. Fairchild.

Spots amphigeneous, grayish-brown, 1-3 mm. diam., suborbicular, bounded on both sides by a distinct raised line giving the appearance

of a round disk on the face of the leaf. This line is more pronounced and the spots are rather paler below. Perithecia amphigenous, black, 100–110 $\mu$  diam. pierced above, only the apex erumpent. Sporules elliptical, olivaceous, 4–5 x 2½–3 $\mu$ .

Distinguished from *Ph. Forsythiae* Sacc. by its discoid, smaller spots. It also grows on a different species of *Forsythia*.

On the same leaves there is an *Ascochyta* with sporules 7–10 x 2½ $\mu$  and also *Discosia maculicola* Ger.

*Phyllosticta confertissima* E. & E.

On leaves of *Ulmus fulva*, Louisville, Kansas. Oct. 1893. (Bartholomew No. 1186).

Spots amphigenous, orbicular, 4–6 mm. diam., definite, of a uniform dark brick-red color. Perithecia hypophyllous, numerous, minute, 75 $\mu$  diam., perforated above, scarcely visible without a lens. Sporules allantoid, hyaline, 3–4 x 1 $\mu$ .

Has the same habit as *Phyllosticta (Phoma) Virginiana* Ell. and Halst.

*Phyllosticta moricola* E. & E.

On leaves of young seedlings of *Morus rubra*, Belvue, Kansas. Oct., 1883. (Bartholomew No. 1184).

Spots amphigenous, large, red-brown at first, then whitening out with a brick-red, shaded margin, irregular in shape 1–2 cm. diam. Perithecia amphigenous, subdiscoid, brown, perforated above, 100–110 $\mu$  diam. Sporules oblong or clavate-oblong or subelliptical, hyaline, 2-nucleate, 5–8 x 2½–3 $\mu$ .

*Ph. morifolia* Pass. is on discoid spots and has sporules only 3½ x 1½ $\mu$ .

*Phyllosticta orbicula* E. & E.

On leaves of *Nasturtium Armoracia*, London, Canada. July, 1893. (Dearness No. 2132).

Spots amphigenous, orbicular, thin, white, 1–1½ $\mu$  diam. with a narrow, light colored margin on both sides of the leaf. Perithecia mostly epiphyllous, discoid, black, 80–120 $\mu$  diam., erumpent-superficial. Sporules oblong-elliptical or ovate, hyaline or subolivaceous, 4–6 x 2½–3 $\mu$ .

Differs from *Ph. anceps* Sacc. in its broader, differently shaped, subolivaceous sporules.

**Phyllosticta Iridis** E. & M.

On leaves of *Iris versicolor*, Green Cove Springs, Fla. April 12, 1884, (Dr. Martin), and Ann Arbor, Mich. July 12, 1892. (Harriet L. Merrow).

Perithecia amphigenous, minute, buried in the leaf, with only the papilliform apex visible, 4-6 together on small ( $\frac{1}{2}$ -1 mm.), dark purple spots thickly scattered over the leaf which at length becomes reddish-brown and dead at the apex and along the sides. Sporules oblong-cylindrical, hyaline, nucleolate,  $9-11 \times 2\frac{1}{2}\mu$ , abundant. The spots soon become dirty white in the center.

The Florida specc. lack the white center in the spots, and are not as well developed as the Mich. specc. but are evidently the same. Judging from the description and the spec. in F. Gall. 238, this is very distinct from *Asteroma tenerrimum* Grog.

**Dothiorella Hippocastani** E. & E., N. A. F. 2941, F. Columbiana 72.

On dead limbs of *Æsculus Hippocastanum*, Newfield, N. J. May 1893.

Stroma subcuticular, seated on the surface of the inner bark, elliptical, grayish, about 2 mm. diam., often seriate-confluent, the apex erumpent through the slightly raised, irregularly ruptured epidermis. Perithecia 8-12 in a stroma, ovate-globose, whitish inside,  $100-150\mu$  diam., contracted above into short necks with their papilliform ostiola barely erumpent in the dark colored disk. Sporules oblong-fusoid, hyaline, continuous, at first granular with several oil globules,  $20-25 \times 5-6\mu$ , on pedicels shorter than the sporules.

**Dothiorella Mali** E. & E.

On dead apple tree limbs, Cuba, Ills. May 11, 1893. (Bartholomew No. 991).

Stromata scattered, orbicular or elliptical, 1-2 mm. diam., at first covered by the epidermis, finally erumpent and loosely embraced by its ruptured margin. Perithecia globose, white inside,  $\frac{1}{4}-\frac{1}{3}$  mm. diam., buried in the substance of the soft, dark colored stroma, with only their minute papilliform ostiola visible. Sporules oblong, hyaline, granular,  $18-20 \times 4-5\mu$ , on stout basidia about as long as the sporules.

**Vermicularia petalicola** E. & E.

On decaying petals of *Liriodendron Tulipifera*, Wilmington, Del. June, 1893. (A. Commons).

**THIS PAGE IS LOCKED TO FREE MEMBERS**

Purchase full membership to immediately unlock this page

# Know Your Bible

Forgotten Books' Full Membership provides unlimited access to more than 28,000 volumes of Christian literature for \$8.99/month

**HOLY BIBLE**

**Continue**

\*Fair use policy applies

with only the apex erumpent, subglobose, about  $75\mu$  diam., dark colored. Sporules acicular,  $12-20 \times 1-1\frac{1}{4}\mu$ , faintly nucleolate.

*Septoria gigaspora* E. & E.

On leaves of *Celtis occidentalis*, Rockport, Kansas. Sept. 2, 1893. (Bartholomew, No. 1175).

Spots amphigenous, orbicular, dirty brown, zonate, center white, margin definite but irregular, grayish-brown below,  $\frac{1}{2}$ -1 cm. across. Perithecia buried in the substance of the leaf, globose,  $150-200\mu$  diam., covered by the blackened epidermis which is pierced by the subconical, perforated ostium. Sporules vermiform-cylindrical, nearly straight, somewhat narrowed below, hyaline, granular, becoming multiseptate,  $75-100 \times 6-8\mu$ .

Not to be confounded with *Hendersonia celtifolia* Cke., on the same host.

*Septoria Medicaginis* Rob. & Desm.

The spec. of this species in Desm. *Plantes Crypt. de France*, No. 1728, have the sporules mostly 3-septate, and being without any true perithecium are referable to the genus *Septogloeum*. Specimens sent from Canada, by Mr. Dearness, on *Medicago lupulina*, agree with Desm. spec. only the sporules are shorter ( $14-16 \times 3\mu$ ), instead of  $15-20 \times 3\mu$  which is about the size of those in Desm. *Exsicc.* The Canada spec. also have the sporules only nucleate and not distinctly septate, but as nucleate spores often become septate, and as the Canada spec. agree in other respects with those issued by Desm. as *Septoria Medicaginis*, we have no hesitation in calling both the same thing—*Septogloeum Medicaginis* (Rob. & Desm.) *Gloeosporium Medicaginis* E. & K., *Journ. Mycol.*, III p. 104, is probably the same thing, the spec. now having the spores uniseptate.

*Myxosporium luteum* E. & E. N. A. F. 2953. *Fungi Columbiani*, 150.

On bark of *Carya tomentosa*, Nuttallburg, West Va. June, 1893. (L. W. Nuttall, No. 79).

Stroma globose-conical, light yellow,  $\frac{3}{4}$ -1 mm. diam., slightly sunk in the inner bark, unilocular and opening by a single pore. The surface of the inner bark around this pore is of a pale slate color, the colored portion definitely limited by a black line so as to form an irregular circle about 2 mm. across, but this line does not penetrate the bark. Sporules navicular-oblong, hyaline, obtuse,  $10-11 \times$

4–5 $\mu$  with 1-2 large nuclei. Basidia slender-cylindrical 15–20 x 1½ $\mu$ . Mass of exuded sporules flesh-color.

*Gloeosporium apocryptum* E. & E., Journal Mycol. IV, p 52 *var. ramicolum* E. & E. (*Gloeosporium Negundinis* E. & E., in Herb.).

On small dead limbs of *Negundo aceroides*, near Wilmington, Del. June, 1893. (A. Commons, No. 2084).

Acervuli covered by the blackened epidermis, variable in size ⅛-½ mm. diam., round or irregular in shape, pustuliform. Conidia oblong, rounded at the ends, sometimes slightly narrowed in the middle, 12–15 x 4–6 $\mu$ .

*Harknessia thujina* E. & E.

On inner surface of white cedar bark (*Cupressus thyoides*) peeled off and left lying on the ground, Newfield, N. J. Nov. 1893.

Acervuli buried in the bark, short-elliptical, black, about ½ mm. in the longer diameter, opening by a small pore and finally discharging the opaque, acutely elliptical, 12–16 x 9–11 $\mu$  spores with persistent, hyaline pedicels 16–20 $\mu$  long. There is no appendage at the apex of the spore which is merely obtusely pointed. The surface of the bark is only raised into slight pustules which at first are scarcely noticeable.

*Gloeosporium boreale* E. & E.

On *Salix* sp. Newfane, Vt. Sept., 1893. (A. J. Grout, No. 43).

Spots orbicular, large 4-5 mm. diam., brown, soon confluent and occupying the greater part of the leaf which turns light yellow around them. Acervuli numerous, small, hypophyllous. Conidia abundant, clavate-cylindrical, hyaline, continuous, 7–12 x 1½–2 $\mu$  issuing in short light-colored cirrhi which soon become amber colored.

Resembles *G. Salicis* West., but that species is epiphyllous and the conidia (sec. Cavara) are 14–16 x 8 $\mu$ .

*Gloeosporium Osmundæ* E. & E.

On pinnules of *Osmunda cinnamomea*, Munith, Jackson Co., Mich. Aug. 1893. (G. H. Hicks, No. 1795).

Acervuli innate, numerous, minute, on yellow-margined, brown spots, discharging the subglobose, 3 $\mu$  conidia, in short, white cirrhi, on both sides of the pinnule.

*Cylindrosporium Glyceriae* E. & E.

On leaves of *Glyceria nervata*, Racine, Wisconsin. Aug., 1893. (Dr. J. J. Davis, No. 9327).



Spots narrow-elliptical, dirty white, with a purple border, 4-6 mm. long by  $1\frac{1}{2}$ -2 mm. wide, or often confluent for one or more centimeters. Acervuli 1-4 in the center of the spots, amphigenous, but more distinct above, 100-150 $\mu$  diam. Conidia cylindrical, 15-x 30  $2\frac{1}{2}$ -3 $\mu$ , nucleate and apparently becoming 3-septate, hyaline, straight or slightly curved.

This is a very different thing from *Septoria Tritici* Desm., as shown by the diagnosis and spec. of that species, and can not be a *Septoria* as there is no perithecium.

**Cylindrosporium Calamagrostidis** E. & E.

On living leaves of *Calamagrostis Canadensis*, Berryville, Wis. June, 1893. (Dr. J. J. Davis, No. 9316).

Spots linear,  $\frac{2}{3}$ -1 cm. long by 1-1 $\frac{1}{4}$  mm. wide, white, with a purplish border. Acervuli epiphyllous, seriate, 150-200 $\mu$  diam. Conidia filiform, curved, 40-60 x 1 $\frac{1}{2}$ -2 $\mu$ . multinucleate, (becoming multiseptate)?, narrowed to a flagelliform tip at one end, the other end more abruptly narrowed. The conidia ooze out in small, amber colored masses.

This is very different from *Gloeosporium graminicolum* E. & E. in Journ. Mycol. V. p. 154.

**Cylindrosporium Toxicodendri** (Curtis) (in Herb. Curtis).

*Septoria Toxicodendri* Curtis, in Peck's 29th Rep.

*Gloeosporium Toxicodendri* E. & M., Journ. Mycol. I, p. 116.

On leaves of *Rhus Toxicodendron*, not uncommon, Eastern and Middle States, Canada and Iowa.

Spots reddish-brown above, whitish below, subangular, 1 $\frac{1}{2}$ -3 mm. diam., margin darker. Acervuli mostly hypophyllous, 250-400 $\mu$  diam., covered by the blackened epidermis which is raised into prominent pustules resembling perithecia. Conidia cylindrical, greenish hyaline, nucleate and faintly 1-3-septate, 30-60 x 2 $\frac{1}{2}$ -3 $\mu$ .

A re-examination of the spec. of *Gloeosporium Toxicodendri* E. & M., Journ. Mycol. I, p. 116, shows that the spores were erroneously described and that they are in reality as above stated. Prof. A. J. McClatchie sends this from Pasadena, Cal., on leaves of *Rhus diversiloba*, agreeing with the spec. on *Rhus Toxicodendron*, only the acervuli are mostly epiphyllous. In all the spec. the acervuli finally collapse.

**THIS PAGE IS LOCKED TO FREE MEMBERS**

Purchase full membership to immediately unlock this page

# DELVE INTO FANTASY, MAGIC, MYTHOLOGY & FOLKLORE

Forgotten Books'  
Full Membership gives  
access to 797,885 ancient  
and modern, fiction and  
non-fiction books.

**Continue**

\*Fair usage policy applies

sporules, thus forming an orange-colored dusty mass, reminding one of *Peridermium*.

Differs from *M. sitophila* Mont. and *M. Martini* E. & S., in the character of the conidia.

**Ramularia reticulata** E. & E.

On leaves of *Osmorrhiza* Waterford, Wis. June, 1891. (Dr. J. J. Davis, No. 911).

Conidia oblong or cylindrical, hyaline, mostly continuous, 12–25 x  $1\frac{1}{2}$ –2 $\mu$ , on very short hyphae, forming minute, but dense white tufts seriatly arranged along the nervelets of the leaf, on black, dead (often marginal) spots of irregular shape and 1–3 mm. in diameter.

**Piricularia parasitica** E. & E.

Parasitic on *Phyllachora graminis* (Pers.), on *Elymus Virginicus*, Kenosha Co., Wis. Aug. 1893. (Dr. J. J. Davis, No. 9311).

Densely tufted, grayish-white. Hyphae erect, simple or forked above, sparingly septate, hyaline, 70–110 x 3–4 $\mu$ . Conidia terminal, narrow ovate or obclavate, hyaline, becoming 2–3-septate, 15–22 x 5–7 $\mu$ .

The fungus forms a fringe around the margin of the *Phyllachora* stroma. The hyphae and conidia much resemble those of *P. Oryzae* Cavara.

**Menispora acicola** E. & E., N. A. F., 2965.

On fallen leaves of *Pinus rigida*, Newfield, N. J. June, 1893.

Evenly effused so as to form a thin pubescence, gray at first, but soon becoming darker. Hyphae erect, simple, brown, sparingly and distantly septate, slender, 100–110 x 3 $\mu$ . Conidia cylindric-fusoid continuous, slightly curved hyaline, about 12 x  $1\frac{1}{2}$ –2 $\mu$ , with a slender bristle at each end about 8 $\mu$  long.

The conidia are smaller than in *M. ciliata* Cda.

**Dicoccum populinum** E. & E.

On leaves of *Populus grandidentata*, Iowa City, Iowa, June, 1889.

Hypophyllous, on suborbicular, light brown spots, 3–4 mm. diam., with a narrow dark margin.

Conidia ovate-oblong, 1-septate, olivaceous, 14–18 x 6–7 $\mu$ , rounded or subtruncate above, narrowed and subacute below, sessile, without any visible hyphae, forming an olvaceous layer on the spots.

*Diococum nebulosum* E. & E.

On *Fraxinus Americana*, Sept., '93, Wisconsin. (Dr. J. J. Davis).

Hypophyllous, spots none. Conidia obovate-oblong, olivaceous, 1-septate,  $11-13 \times 4\mu$ , apiculate below, rounded above sessile, like the preceding species scarcely constricted, and with the septum above the middle, but differing in the absence of any spots and smaller conidia, which form faint olivaceous, more or less confluent patches, without any distinct hyphae.

*Cladosporium nigrellum* E. & E.

On bark of R. R. ties, Nuttallburg, West Va. Oct., 1893. (L. W. Nuttall, No. 172).

Hyphae densely tufted, septate, subequal,  $150-200 \times 5-6\mu$ , tufts effused, subconfluent, forming a black, velvety coat extending over the surface of the bark indefinitely, with the same habit as *Macrosporium nigrellum* C. & E. Conidia smoky hyaline, becoming pale brown, variable in size, the smaller ones ovate, continuous or uniseptate,  $6-8 \times 5\mu$ , the larger ones oblong-elliptical or subcylindrical, 2-3-septate,  $12-15 \times 5-6\mu$ .

*Clasterisporium olivaceum* E. & E.

On old corn stalks (*Zea Mays*), Newfield, N. J. May 14, 1893.

Forms a thin, dark olive layer (becoming nearly black), composed of much branched, creeping hyphae, hyaline at first, becoming brownish and closely appressed to the matrix. Conidia cylindrical, 4-8-septate, constricted at the septa, obtuse,  $20-25 \times 6\mu$ , arising directly from the creeping hyphae without any visible pedicel.

*Cercospora exotica* E. & E.

On leaves of some cultivated water lily in an aquarium on the World's Fair Grounds, Chicago, Ill. Oct., 1893. (E. F. Smith).

Spots epiphyllous, orbicular, small (2-4 mm.), dirty-brown, with or without a slightly raised border. Hyphae densely fasciculate, subolivaceous, simple or with a short, rudimentary branch above,  $25-40 \times 2\frac{1}{2}-3\mu$ . Conidia slender, linear, multiseptate, hyaline,  $80-150$  (exceptionally 190)  $\times 3-3\frac{1}{2}\mu$ , nearly straight.

Closely allied to *C. nymphaeacea* C. & E., but hyphae and conidia twice as long as in that species. The tufts become effused and appear like a lead-colored, thin tomentum, covering the central part of the spots.

**Cercospora atrogrisea** E. & E.

On dead stems and pods of *Raphanus sativus*, Newfield, N. J. Oct., 1893.

Hyphae cespitose on a small tubercular base, pale brown 1–2-septate, torulose and subundulate above, 60–70 x 4 $\mu$ , forming slaty black, elliptical patches 2–4 mm. long, covered with the minute scattered tufts. Conidia slender-obclavate, hyaline, 80–110 x 3½–4 $\mu$ , 6–12-septate (mostly about 6-septate). The mature conidia are so abundant as to whiten the patches of hyphae. Besides the absence of any spots, and its growth on pods and stems, this differs from *C. Nasturtii* Pass. in its multiseptate conidia, which are not bacillary as in *C. Armoraciae* Fckl., and are narrower and with fewer septa than those of *C. Cruciferarum* E. & E. The hyphae are also shorter than in the last named species. The spece. are overrun with *Macrosporium fasciculatum* C. & E.

**Macrosporium Nelumbii** E. & E.

On leaves of *Nelumbium luteum*, Belvue, Kansas. Oct. '93. (Bartholomew, No. 1180).

Spots dirty brown, suborbicular and subindefinite, 1–6 mm. diam., thickly scattered over the leaf and more or less confluent. Hyphae epiphyllous, scattered and solitary or 2–3 connected at base, brown, 3–4-septate, 60–80 x 5–6 $\mu$ , the upper cell mostly swollen. Conidia clavate, 3–5-septate, with a few faint, partial longitudinal septa, pale brown 35–50 x 10–15 $\mu$ , attenuated below into a slender stipe 12–15 $\mu$  long.

**Macrosporium esculentum** E. & E.

On dried up fruit of egg plant (*Solanum esculentum*), Newfield, N. J. March, 1893.

Forms a dense, olive-brown coating, on the dried up fruit. Hyphae subfasciculate, erect, 15–25 x 4 $\mu$ , rather closely septate, yellowish-brown. Conidia terminal, variable in shape and size, from subglobose 8–15 $\mu$  to oblong-elliptical, 12–22 x 10–15 $\mu$ , or obovate 10–15 x 7–12 $\mu$ , pale yellow-brown, 3-septate becoming more or less distinctly muriform, the globose conidia often sarcinulate-septate, *i. e.*, with septa crossing each other at right angles, running entirely across.

This differs from *M. tomato* Cke. in its shorter hyphae and differently shaped, paler conidia.

**THIS PAGE IS LOCKED TO FREE MEMBERS**

Purchase full membership to immediately unlock this page

# Know Your Bible

Forgotten Books' Full Membership provides unlimited access to more than 28,000 volumes of Christian literature for \$8.99/month

**HOLY  
BIBLE**

**Continue**

\*Fair use policy applies

**Fusarium Pteridis** E. & E. N. A. F. 2982. F. Columbiani 98.

Parasitic on *Phyllachora flabella* (Schw.), on old fronds of *Pteris aquilina*, Newfield, N. J. June, 1893.

Erumpent, forming white specks on the *Phyllachora*. Creeping hyphae septate, branched; erect hyphae branched, bearing the fusoid, hyaline, straight, 1-3-septate, 25-40 x  $3\frac{1}{2}\mu$  conidia.

**Fusarium granulosum** E. & E.

On dead stems of *Smilax hispida*, Mt. Cuba, Del. June, 1893. (Commons, No. 2091).

Sporodochia thickly scattered, erumpent, granuliform, light flesh-color, minute. Hyphae stout, irregularly branched, hyaline, fusoid, moderately curved, 3-septate, 30-55 x  $3-3\frac{1}{2}\mu$ .

Resembles small granules of white sugar, scattered over the stems.

## THE NORTH AMERICAN LARRIDÆ.

BY WILLIAM J. FOX.

The following paper is compiled chiefly for the sake of bringing to light some of the numerous new species contained in the collection of the American Entomological Society. In the arrangement of the genera I have followed that of Kohl, with one exception: the removing of the genus *Lyroda* from among the true Larriens—as I think the regularly formed ocelli are sufficient to justify such a course. The term Larridæ is used simply for the want of another name, as the Bembecidæ, Larridæ and Nyssonidæ seem to merge into one another and are not entitled to family distinction, the connecting links being formed in the genera *Neolarra* and *Bothynostethus*, the position of the latter genus being but a matter of opinion, as it seems to be as much related to *Alyson* as it does to *Dienoplus*, a new genus described herein, which shows the relation of *Bothynostethus* with the *Larridæ* more strongly than ever. It is true that the Bembecidæ offer better characters for their distinction from the Larridæ than do the Nyssonidæ; however, the discovery of *Neolarra*, with its combined Bembecid and Larrid characters, makes an almost complete merging of these three supposed families. I desire to express my thanks to Mr. Wm. H. Ashmead, Prof. C. V. Riley, Mr. J. A. Guignard, Mrs. Annie T. Slosson, Mr. J. Aldrich, Dr. W. A. Nason and T. D. A. Cockerell, all of whom have furnished specimens by means of which this article was possible. Our genera may be distinguished as follows:<sup>1</sup>

- |  |             |
|--|-------------|
| 1—Inner margins of eyes not emarginate; marginal cell with or without an appendiculation.....  | 4           |
| Inner margins of eyes emarginate; marginal cell without an appendiculation .....   | 2           |
| 2—Anterior wings with three cubital cells; abdomen short, sessile...   | 3           |
| Anterior wings with two submarginal cells; abdomen long, clavate.....  | TRYPOXYLON. |
| 3—Female without a pygidial area; marginal cell nearly as long as the three submarginal cells united; antennæ of ♂ not dentate ..... | PISON.      |

<sup>1</sup> In drawing up descriptions of the genera, I have used freely the descriptions in Kohl's paper.



- Female with a well developed pygidial area; marginal cell shorter than the first submarginal; antennæ of ♂ more or less dentate..... PISONOPSIS.
- 4—Anterior wings with but two submarginal cells; mandibles emarginate on outer margin; first and second submarginal cells each receiving a recurrent nervure.....MISCOPHUS.  
Anterior wings with three submarginal cells.....5
- 5—Second submarginal cell petiolate.....6  
Second submarginal cell not petiolate .....8
- 6—First and second submarginal cells each receiving a recurrent nervure; mandibles emarginate without; eyes converging toward the vertex.....PLENOCLUS.  
Both recurrent veins received by the second submarginal cell; mandibles not emarginate.....7
- 7—Antennæ long and slender; eyes strongly converging to the vertex; last dorsal segment of ♀ without a pygidium; ♂ unknown.....  
..... NITELIOPSIS.  
Antennæ rather short, subclavate; eyes diverging towards the vertex; last dorsal segments of both sexes with a pygidium.....  
..... ..BOTHYNOSTETHUS.
- 8—Marginal cell with an appendiculation, lanceolate or truncate.....9  
Marginal cell without an appendiculation, lanceolate; inner eye margins almost parallel; middle tibiæ with two spurs.....  
.....DIENOPLUS.
- 9—Ocelli round, well developed .....10  
Hind ocelli distorted, more or less obsolete.....12
- 10—Middle tibiæ armed with two spurs at apex.....11  
Middle tibiæ with but one spur; mandibles distinctly emarginate on outer margin; second submarginal cell receiving both recurrent nervures.....LYRODA.
- 11—Eyes of the ♀ converging towards the top, those of the ♂ touching on the vertex; marginal cell more than twice longer than broad; second submarginal cell receiving both recurrent nervures..... ASTATUS.  
Eyes of both sexes converging towards the top, those of the ♂ not touching on the vertex; marginal cell not twice as long as broad; first and second submarginal cells each receiving a recurrent nervure..... DIPLOPLECTRON.
- 12—Front and face more or less raised along the eye margins.....13  
Front and face not at all raised along the inner eye margins.....15
- 13—Mandibles armed with one or two teeth within.....14  
Mandibles not dentate within; outer side of anterior tibiæ armed with strong spines; pygidium (♀) not pubescent.....LARRA.
- 14—Pronotum drawn under the dorsulum, especially at the sides; metanotum longer than the dorsulum; anterior femora of ♂ not emarginate near the base; pygidial area covered with a hoarfrost-like pile.....NOTOGONIA.

**THIS PAGE IS LOCKED TO FREE MEMBERS**

Purchase full membership to immediately unlock this page

# DELVE INTO FANTASY, MAGIC, MYTHOLOGY & FOLKLORE

Forgotten Books'  
Full Membership gives  
access to 797,885 ancient  
and modern, fiction and  
non-fiction books.

**Continue**

\*Fair usage policy applies

produced anteriorly into a strong medial tooth, at the base of the tooth the clypeus is transversely impressed; front with close, rather coarse punctures, with a distinct, medial, impressed line; ocelli slightly pitted, forming an equilateral triangle; top of head and cheeks shining, more finely punctured than the front; first joint of flagellum a little shorter than the second, which is longer than the third; dorsulum with distinct punctures, those on the anterior portion finest and closest; scutellum punctured like hind portion of dorsulum; metathorax on sides and posteriorly with coarse striations, the upper surface with a somewhat triangular enclosure, which is on basal portion obliquely ridged, on apical portion transversely ridged; legs strong, the tibiæ and tarsi with a very few weak spines; wings subhyaline, iridescent, the apical margins darker, both recurrent nervures generally received by the second submarginal cell, in one specimen the first recurrent nervure is confluent with the first transversocubital nervure; abdomen finely, though distinctly punctured, the second and third dorsal segments rather strongly transversely depressed basally; pygidial area triangular, finely and closely punctured; black; the abdomen rufous; sides of face, clypeus, sides of thorax more or less, and the apical margins of abdominal segments 1-5, silvery. Length 9 mm.

♂.—Eyes scarcely emarginate within and converging but little towards the vertex; ocelli situated in a low triangle, the distance between the hind pair more than twice greater than the distance between them and the nearest eye-margin; antennæ shorter than in the ♀, joints of the flagellum 1-6 produced into a strong angle or tooth beneath, joints 1-4 much narrowed basally; from joint six the flagellum gradually tapers to the apex; apical portion of abdomen blackish; last ventral segment roundly emarginate at the apex. Length 7 mm.

Nevada.

#### PISON Spin.

*Pison* Spin. Ins. Lig. Spec. nov., t. II, fasc. IV, p. 255, 1808. Kohl, Verh. zool.-bot. Gesell. Wien, XXXIV, p. 180, 1884.

Head as broad or broader than the thorax. Mandibles without emargination on outer edge; eyes converging towards the vertex, strongly emarginate within; ocelli normal, distinct and form a triangle; antennæ tolerably long, placed just behind the clypeus, the flagellum slender, rarely club-shaped; shoulder tubercles not reach-

ing to the tegulæ; metathorax shorter than the dorsulum; marginal cell long, lanceolate, without appendiculation; two or three cubital cells, when there are three the second is petiolated; point of reception of the recurrent nervures by the cubital vein variable; the cubital vein of the hind wings, originates beyond the apex of the submedian cell; armature of the legs very feeble; middle tibiæ with one spur; outer side of anterior tibiæ with or without insignificant spines; second abdominal segment above generally with a transverse depression at base; last dorsal segment of the female conical, without pygidial area, in the male shorter.

But one species of *Pison* has been described from Boreal America, and that I have not succeeded in identifying.

*P. laeve* Sm.

*P. laevis* Sm., Cat. Hym. Brit. Mus. IV, 1856, p. 317. ♀.

*P. laeve* Kohl, l. c. p. 187.

“♀.—Length  $3\frac{1}{2}$  lines (7 mm.) Head opaque, the face covered with silvery pubescence; the metathorax smooth and shining with a few scattered punctures at the sides, the central channel without a carina; a deep elongate-ovate fossula in the middle of the truncation, the margins of the latter rounded; the wings slightly fuscous, the nervures black; the two recurrent nervures uniting with the nervures of the petiolated submarginal cell. Abdomen smooth and shining, very delicately punctured, the margins of the segments slightly depressed.”

Georgia.

#### TRYPOXYLON Latr.

*Trypoxylon* Latr., Préc. car. gén. Ins. 1796; Kohl, l. c. p. 190.

Head as broad or a little broader than the thorax, formed as in *Pison*; mandibles without emargination on outer edge; inner margin of the eyes strongly emarginate; ocelli normal, distinct; antennæ tolerably long, usually clavate, generally more strongly so in the male, last joint almost always elongated, in the female small, in the male strong and exceeds the length in very many cases the third antennal joint; in the hind wings the cubital vein originates on the medial vein beyond the apex of the submedian cell; armature of the legs very poor; middle tibiæ one spurred; claws entire; anterior tarsi without a comb; radial cell of fore wings long, lanceolate, without appendiculation; only one cubital and one discoidal cell; abdomen elongated, clavate; last segment without pygidial area; in the female conical, in the male truncate. Size variable.

Our species were monographed a year or two ago;<sup>2</sup> consequently I have thought it unnecessary to again give the descriptions of the species in full. The following table, which is to be substituted for that in the above mentioned monograph, will assist in identifying the species.

## FEMALES.

1—Metanotum not trisulcate.....	2
Metanotum trisulcate.....	15
2—Abdomen black, not banded with reddish.....	3
Abdomen banded with reddish .....	9
3—Metanotum punctured or with very fine striations.....	4
Metanotum more or less striated or rugose.....	5
4—Wings blue-black, thorax with black pile.....	<i>abbitarse</i> .
Wings with the anterior pair fuscous, posteriors except apex hyaline; thorax with pale pubescence.....	<i>albipilosum</i> .
Wings hyaline, their apical margins and the marginal cell fuscous; thorax and abdomen with a silvery pile.....	<i>excavatum</i> .
5—Metanotum with an enclosed space .....	6
Metanotum without an enclosed space.....	7
6—Anterior portion of clypeus not strongly carinated, wings except apical margin hyaline; posterior tarsi whitish medially .....	<i>clavatum</i> .
Anterior portion of clypeus strongly carinated, wings subfuscous; posterior tarsi black.....	<i>projectum</i> .
7—Metathorax sulcate its entire length, more deeply so posteriorly, the furrow somewhat interrupted at apex of metanotum.....	8
Metathorax sulcate on its posterior face only, the upper surface rugose; clypeus unidentate .....	<i>frigidum</i> .
8—Clypeus with a broad, quadrate tooth medially.....	<i>apicalis</i> .
Clypeus bidentate.....	<i>bidentatum</i> .
9—Metanotum punctured.....	<i>rubrocinctum</i> .
Metanotum more or less striated.....	10
10—Front with a strong projection; anterior half of clypeus strongly carinated .....	<i>tridentatum</i> .
Front with a longitudinal carina above the antennæ.....	11
11—Antennæ entirely black.....	12
Antennæ, except apical portion reddish-fulvous.....	14
12—Posterior tarsi whitish medially; second segment only red.....	<i>rufozonalis</i> .
Posterior tarsi not whitish medially; more than one segment red .....	13
13—Third antennal joint rather strongly curved, in length about equal to the space between the eyes at the clypeus, fourth and fifth joints equal in length.....	<i>arizonense</i> .

<sup>2</sup> Trans. Amer. Ent. Soc. XVIII, p. 136-148.

**THIS PAGE IS LOCKED TO FREE MEMBERS**

Purchase full membership to immediately unlock this page

# Know Your Bible

Forgotten Books' Full Membership provides unlimited access to more than 28,000 volumes of Christian literature for \$8.99/month

**HOLY BIBLE**

**Continue**

\*Fair use policy applies

- Clypeus broadly incurved medially, with a tooth in the middle of the incurvation; base of the tibiæ and the posterior tarsi medially reddish .....*spinosum*.
- 12—Thorax black, with golden pubescence; dorsulum finely punctured.....*texense*.  
Thorax more or less rufous; dorsulum strongly punctured.....*collinum*.
- 13—Front with a Y-shaped carina.....*carinatus*.  
Front with a longitudinal carina.....14
- 14—Four anterior legs fulvous; tarsi ringed with white.....*ornatipes*.  
Legs entirely black; antennæ very strongly clavate.....*fastigium*.

1.—*T. albitarse* Fab.

*T. albitarse* Fab., Syst. Piez. p. 180, 1804.

*T. politus* Say., Bost. Journ. I, p. 373, 1837.

*T. politum* Pack., Proc. Ent. Soc. Phila., VI, p. 413, 1867.

Massachusetts to Central America; Brazil (Smith).

2.—*T. neglectum* Kohl.

*T. neglectum* Kohl., Verh. zool.-bot. Gesell. Wien, XXXIII, p. 340, pl. 18, fig. 3. ♂.

Pennsylvania to Florida; Iowa.

3.—*T. albipilosum* Fox.

*T. albipilosum* Fox, Trans. Amer. Ent. Soc. XVIII, p. 139, ♀ ♂, pl. 3, fig. 2.

Pennsylvania to Texas; Illinois; Kentucky.

4.—*T. excavatum* Sm.

*T. excavatum* Sm., l. c. p. 380, 1856. ♀ ♂

Cuba; Jamaica; New York; Illinois.

5.—*T. clavatum* Say.

*T. clavatus* Say., Bost. Journ. I, p. 374, ♀ ♂.

*T. clavatum* Pack., l. c. p. 414. ♀; Fox, l. c. p. 140, pl. III, fig. 11.

Canada to Texas.

6.—*T. projectum* Fox.

*T. projectum* Fox, l. c. p. 141. ♀ ♂.

Louisiana and Florida.

7.—*T. apicalis* Fox.

*T. apicalis* Fox, l. c. p. 142. ♀, pl. III, f. 10.

Canada; Massachusetts.

8.—*T. frigidum* Sm.

*T. frigidum* Sm., l. c. p. 381. ♀; Pack. l. c. p. 415. ♀ ♂.

Hudson Bay to Virginia, westward to Mt. Hood, Oregon.

9.—*T. bidentatum* Fox.

*T. bidentatum* Fox, l. c. p. 143. ♀ ♂, pl. III, f. 9.

Massachusetts to Mt. Hood, Oregon.

10.—*T. rubrocinctum* Pack.

*T. rubrocinctum* Pack. l. c. p. 416, ♀; Fox, l. c. p. 144, ♂ ♀, pl. III, f. 7.

New York to Florida.

11.—*T. tridentatum* Pack.

*T. tridentatum* Pack., l. c. p. 417, ♀. Fox, l. c. p. 144. ♀ ♂. pl. III, f. 4.

Occurs throughout the United States.

12.—*T. rufozonale* Fox.

*T. rufozonalis* Fox., l. c. p. 145, ♀ ♂ pl. III, f. 3.

Colorado; Piedmont, So. Dakota (Aldrich).

13.—*T. arizonense* Fox.

*T. arizonense* Fox., l. c. p. 145, ♀, pl. III, f. 13.

Arizona.

14.—*T. californicum* Sauss.

*T. californicum* Sauss., Reise d. Novara, Zool. II, 1867, p. 78, ♀.

Closely related to *arizonense*, but may be distinguished by its stouter form, the greater extent of red on abdomen, and by the characters given in the synoptical table. Length 16 mm., somewhat larger than the size indicated by Saussure.

15.—*T. spinosum* Cam.

*T. spinosa* Cam., Biol. Centr. Amer., Hym. II, p. 46, pl. 4, figs. 8, 8a., 8b. ♂.

*T. spinosum* Fox, l. c. p. 145.

Texas and Mexico.

16.—*T. texense* Sauss.

*T. texense* Sauss., l. c. p. 77, ♀; Fox, l. c. p., 146. ♀ ♂.

Texas; Las Cruces. N. Mexico (Cockerell).

17.—*T. collinum* Sm.

*T. collinum* Sm., l. c. p. 381. ♀; Pack. l. c. p. 415. ♀ ♂.

Florida.

18.—*T. carinatum* Say.

*T. carinatus* Say., Bost. Jour. I, p. 374 ♂.

*T. carinatum* Fox, l. c. p. 147.

♀.—Antennæ long, a little thickened apically, the third and fourth joints about equal in length; front strongly convex, with a Y-shaped carina as in the ♂; space between eyes at vertex, if anything a little greater than the length of antennal joints three and four united; anterior margin of the clypeus rounded, entire; abdomen stout, the first segment but little longer than the second, scarcely nodose at apex and furrowed above on basal portion; black; base of four hind tibiæ and the medial tarsi, testaceous; fore-legs——; tibial spurs whitish; face, clypeus, cheeks and thorax more or less, clothed with silvery pubescence; abdomen with a sparse silvery pile. Length  $8\frac{1}{2}$  mm.

Indiana (Say); Philadelphia, Penn. (July 14th, 1891.)

19.—*Trypoxylon Johnsonii* Fox.

*T. Johnsonii* Fox, l. c. p. 147. ♀.

Florida; Texas.



20.—*Trypoxylon ornatipes* Fox.*T. ornatipes* Fox, l. c. p. 148. ♂.

District of Columbia; Pennsylvania.

21.—*Trypoxylon fastigium* Fox.*T. carinifrons* Fox, (nec. Cam.), l. c. p. 142, ♀ ♂.The above name is proposed for *carinifrons*, Fox (nec Cam).  
Texas.

## UNIDENTIFIED SPECIES.

*Trypoxylon pennsylvanicum* Sauss.*T. pennsylvanicum* Sauss., l. c. p. 78, ♀.

“Parvulum nigrum, cinereo-hirtum; mandibulis, apice et tegulis, piceis vel ferrugineis; metanoto basi diviso; calcaribus luteis; alis pellucidis margine apicali griseo; venis fuscis. Long. corp. 0.007; alæ 0.0045.”

“♀ *Tr. mexicanum* simillimum. Differt tamen characteribus variis: Clypeus subangulosus. Caput orbiculare, sinus oculorum minus alte sitis, fere in mediis oculis. Frons convexiusculus sed sinus oculorum haud planatis; thorax coriaceus, impunctatus. Metathorax elongatus, postice acute attenuatus, superne subtilissime punctulatus vel striolatus, sulco nel carinea divisus; pleura canaliculo polito profundo exarata; metapleura superne acute marginate. Abdominus 1m. segmentum distincte longius,  $1\frac{1}{2}$  longitudine secundi et augustius, dimidio basili lineari, sulcato, apice superne paulum tumido. Alæ limpidæ, margine apicali griseo; vena recurrens 2a obsolete perspicua, interstitialis, cum v. transverso-cubitali 1a conjuncta.”

America Borealis, Pennsylvania.

*Trypoxylon striatum* Prov.*T. striatum* Prov., Add. Hym. Quebec. p. 283, ♀.

“♀.—Long., 58 pce. Entièrement noir à l'exception des tarse postérieurs qui sont blancs excepté à la base du premier, article. La face à partir des antennes à pubescence argentée, opaque et chagrinée au dessus avec pubescence pâle peu abondante, plus apparente sur le métathorax, lequel présente une légère dépression longitudinale sur son disque avec fines stries transversales. Ailes passablement enfumées, plus claires à la base et au sommet, les inférieures subhyalines. Abdomen poli, brillant, à pédicule assez long, s'épaississant continuellement du tiers de sa base au sommet le 2e segment plus étroit que le premier à la base, plus large au sommet, tous deux

**THIS PAGE IS LOCKED TO FREE MEMBERS**

Purchase full membership to immediately unlock this page

# DELVE INTO FANTASY, MAGIC, MYTHOLOGY & FOLKLORE

Forgotten Books'  
Full Membership gives  
access to 797,885 ancient  
and modern, fiction and  
non-fiction books.

**Continue**

\*Fair usage policy applies

subtruncate behind, about as long as the dorsulum; radial cell narrowly elongate, truncate, and with an appendiculation; three submarginal or cubital cells, the first much larger than the other two united, *the second triangular, petiolated and receives both recurrent nervures*, the third submarginal oblique and is a little narrower above than below; cubital vein of hind wings originates far beyond the apex of the submedian cell; tibiæ and tarsi scarcely armed with spines, middle tibiæ one-spurred; anterior tarsi without comb; *pulvilli large*, claws small, entire; abdomen narrower and a little shorter than the thorax, dorsal segments 1-3 transversely depressed at base and apex; *second dorsal without any longitudinal impression in the middle*; last segment conical, without pygidial area.

**Niteliopsis plenoculoides** Fox.

*N. plenoculoides* Fox, Psyche, Nov. 1893, p. 555. ♀.

♀.—Clypeus strongly carinated down the middle; front finely granulated, distinctly impressed down the middle, along the inner eye-margins the front is finely punctured; eyes strongly converging to the top, the space between them at the vertex is about equal to one-half of the space at the clypeus; ocelli in a triangle, the lower one situated a little further away from the hind pair, than the hind pair are from each other; from each hind ocellus, there extends down a short furrow, which reaches a little beyond the fore ocellus; antennæ tolerably long, reaching to about the tegulæ, the flagellum tapering on apical half, joints 2 and 3 of the flagellum longest, the first and fourth about equal; dorsulum with exceedingly close and fine punctures; metathorax above and on the sides finely granulated, with indistinct striations when viewed in certain positions, at the extreme base of upper surface there is a transverse series of small foveae and down the middle there is an impressed line (this is not distinct in one specimen), the posterior face transversely rugose; tibiæ and tarsi, with exception of the calcaria unarmed; tarsal claws rather short, stout and not toothed; abdomen elongate-ovate, the first three dorsal segments when viewed from the side are seen to be contracted basally and apically; last dorsal segment without a pygidium; three submarginal cells, the second petiolated, receiving both recurrent nervures, black; two transverse spots on the collar above, posterior half of tubercles, a spot near the middle of hind tibiæ and the tibial spurs, whitish; apex of mandibles tegulæ and tarsi, testaceous; wings

subhyaline, nervures black; face and clypeus, sides of thorax and abdomen, more or less, with silvery pile. Length 6 mm.

New York; Colorado.

#### MISCOPHUS Jurine.

*Miscophus* Jur., Nouv. méth. class. Hym. p. 205; Kohl, l. c. p. 218.

Head wider than the thorax; mandibles strongly emarginate on outer edge, not toothed within and with an acute tip; antennæ filiform, at their insertion rather widely separated and placed immediately behind the clypeus, in the male shorter and thicker; eyes converging but little to the vertex, or not at all; ocelli regular and distinct, and are placed before the line which one may imagine drawn across the vertex from one posterior orbit to the other, and form a triangle; the top of the pronotum lies but little or not at all below the level of the dorsulum; marginal or radial cell lanceolate, not appendiculate, its size varying in the different species; two submarginal cells, the second of which is petiolated and receives the second recurrent nervure, the first recurrent nervure is received by the first submarginal cell near its apex; cubital vein of hind wings originating far beyond the apex of the submedian cell; armature of the legs very variable, in some species with a well developed tarsal comb, in others it is short and inconspicuous; middle tibiæ one spurred; pulvilli medium; metathorax generally longer than broad; last segment in ♀ conical, in the ♂ truncato-conical, both sexes without pygidial area. The ♂ differs further from the ♀ in the thicker antennæ, the feebler and shorter tarsal comb and the obtuse apical segment. But one species has as yet been found in the United States.

#### *M. americanus* Fox.

*M. americanus* Fox, Ent. News, I. p. 138, ♀; *ibid*, II, p. 196, ♂.

♀.—Clypeus seemingly divided to three parts or lobes, the middle one of which is largest, convex, its anterior margin rounded and, as well as the other lobes with a transverse impressed line or furrow anteriorly just behind the anterior margin which gives the latter the appearance of being reflexed; front having the appearance of being exceedingly finely granulated, with an impressed line extending from fore ocellus down to the insertion of antennæ; distance between hind ocelli decidedly greater than that between them and the nearest eye-margin; inner eye-margins distinctly though not very strongly converging to the vertex; antennæ rather long, filiform, the first joint of the flagellum about one-quarter longer than the

second, the third joint is, if anything, slightly longer than the second or fourth; dorsulum with exceedingly fine and close punctures; scutellum strongly convex, not impressed; metanotum with rather strong punctures or granules, with a well-defined raised line extending from base to apex; metapleuræ indistinctly striated; tibiæ and tarsi not at all, the tarsi slightly perhaps, spinose, the fore tarsi without comb; abdomen shining much more finely punctured than the dorsulum; wings hyaline, the anteriors with their apical margin broadly fuscous, nervures black, marginal cell distinctly shorter than the first submarginal, second recurrent nervure received by the second submarginal cell near its apex; black; tegulæ brownish; face, cheeks, thorax and legs more or less clothed with silvery pile; apical margins of abdominal segments 1-4 also with silvery pile. Length  $4\frac{1}{2}$  mm.

♂.—Very much like the ♀ but differs in being slightly smaller, the posterior face of metathorax is transversely wrinkled and the second submarginal cell is sub-angular beneath 3-3½ mm.

Camden County, New Jersey in latter part of July. Not common.

#### LARRA Fab.

*Larra* Fab., Ent. Syst. t. II. p. 220. 1793.

*Larrada* Sm., l. c. p. 274. 1856.

Form robust; head broader than the thorax; mandibles emarginate on outer edge, their apex simple and their inner margin not dentate; antennæ tolerably stout; *eyes converging towards the vertex, along their inner margins there extend ledge-like swellings which are strongest in the middle and are connected to each other by a transverse swelling which extends across the front above the middle, below the transverse swelling there are two longitudinal impressions, evidently for the reception of the scape; anterior ocellus round and regular and lies far before the two posteriors which are quite flat, longish, placed close to each other and are generally indistinct; the collar is transverse, straight and is not, or only in a very slight degree, depressed beneath the level of the dorsulum; marginal cell broadly truncate and with an appendiculation; three submarginals, the first of which is about as great as the two others united, the second trapezoidal or, if the first and second transverse cubital veins are very approximate to each other, subtriangular, and receives both recurrent nervures, the third placed obliquely; in the hind wings the cubital vein originates a little be-*

**THIS PAGE IS LOCKED TO FREE MEMBERS**

Purchase full membership to immediately unlock this page

# Know Your Bible

Forgotten Books' Full Membership provides unlimited access to more than 28,000 volumes of Christian literature for \$8.99/month

**HOLY BIBLE**

**Continue**

\*Fair use policy applies

the hind margin from which place it goes forward to about the middle of the segment and then back again to the hind margin (this is more distinct in some specimens than in others); pygidial area with a few large punctures; black; the last three abdominal segments bright red; face, clypeus, thorax, especially beneath and the legs with a short, appressed, fusco-sericeous pile; wings fuliginous, iridescent, nervures black; width of the second submarginal cell above less than the space between the recurrent nervures on the cubital nervure. Length 17-21 mm.

New York to Florida, westward to Kansas. The deep black and bright red abdomen gives this species a very striking appearance.

2.—*L. Cressonii* Fox.

*L. americana* Cr., (nec. Sauss). Tr. Amer. Ent. Soc. IV, p. 214, ♂. 1872.

♂.—Clypeus sub-truncate medially, distinctly punctured, most closely so posteriorly; first joint of flagellum not over one quarter longer than the second, the latter is a little longer than the third; front and vertex rather coarsely punctured, most sparsely so on the vertex; space between the eyes at the top nearly equal to the length of antennal joints 2-4 united; dorsulum strongly and densely punctured; scutellum distinctly impressed; metanotum more strongly punctured than in *analis*, and the medial raised line is longer, extending about half the length of the metanotum; metapleuræ more finely punctured than the dorsulum; tibiæ and tarsi tolerably well armed with spines; abdomen sub-opaque, very finely and closely punctured, no transverse rows of coarse punctures as in *analis*; black; face, clypeus, cheeks, thorax and legs more or less, with silvery pubescence; apical margins of dorsal abdominal segments 1-5 with silvery pile; wings fuliginous, iridescent. Length 11-16 mm.

Pennsylvania to Louisiana. May be the male of *analis*, though scarcely probable.

UNIDENTIFIED SPECIES.

*Larra laevifrons* Sm.

*Larrada laevifrons* Sm., l. c. p. 291.

*Larra laevifrons* Kohl, l. c. p. 245.

“♀.—Length  $4\frac{1}{2}$  lines.—Head and thorax black; the face thinly covered with silvery pubescence; the vertex with merely a slight elevation above the anterior ocellus, with two smooth spaces behind, between them a smooth, shallow channel which passes a short way upwards towards the vertex terminating in a smooth fovea. Thorax

opaque; the metathorax finely shagreened, and having at the sides a little cinereous pubescence; wings hyaline, the nervures testaceous; the apical joints of the tarsi rufo-testaceous. Abdomen: the three basal segments red, the apical ones black; thinly covered with cinereous pile, the apical segment very smooth and shining."

"East Florida (St. John's Bluff)."

Evidently a *Tachysphex*, and perhaps identical with *T. tarsata*.

**Larra canescens** Sm. (*Tachysphex*?)

*Larrada canescens* Sm., l. c., p. 292. ♀.

*Larra canescens* Kohl, l. c. p. 242.

"♀.—Length 5 lines.—Black: thinly covered with short cinereous pubescence the abdomen being covered above and beneath; the head, mesothorax and scutellum strongly punctured; the metathorax shagreened; the flagellum much thickened towards the base, which is again more slender; the wings brown, the posterior pair clearer at the base; the anterior tibiæ and tarsi obscure ferruginous. Abdomen: on apical margins of segments the pubescence is bright and silvery, observable in different lights."

"Georgia." Also very likely *Tachysphex*.

**Larra arcuata** Sm. (= *Ancistromma*?)

*Larrada arcuata* Sm., l. c. p. 293. ♀.

*Larra arcuata* Patton, l. c. p. 389.

"♀.—Length 4½ lines.—Black; the face with silvery pubescence; the mesothorax subopaque; the scutellum shining and finely punctured; the metathorax with an arcuate striation, the striation curving forwards, interrupted in the middle by a longitudinal carina which runs to the verge of the truncation, the latter has a small triangular shape crossed by coarse arcuate striæ, in the middle of which is a deep fovea; from the fovea a carina runs downwards to the base; on each side of the fovea the truncation is smooth, and covered with silvery white pubescence; wings subhyaline, with a faint cloud at their apical margins. Abdomen smooth and shining, with the apical segment rugose."

"Canada." Seems to closely resemble *Tachysphex quebecensis* Prov., but the rugose apical segment will exclude it from the genus *Tachysphex*. It may be an *Ancistromma*.

**Larra pensylvanica** Bve.

*L. pensylvanica* Pal., Bve., Ins. Afr. et Amer. p. 118, Taf. III, f. 8, 1805.

"Noir-luisante; Ailes ternes."

"Pennsylvanie." From an examination of the figure of this species, given by Beauvois I should refer it to *Tachysphex*.



## NOTOGONIA Costa.

*Larrada* Sm., l. c. p. 274. 1856.

*Notogonia* Costa, Ann. Mus. Zool. Univ. Napoli (Ann. IV), p. 80 et 82. 1867.

*Larra* Patton, Proc. Boston Soc. Nat. History, XX, p. 385. 1880.

Head a little broader than the thorax; mandibles emarginate on outer edge and *with a tooth or inner edge between the middle and the base*, their apex simple; antennæ more slender than in *Larra*; eyes converging to the vertex, the convergence greater in the ♂ than in the ♀ and differing in the various species, generally stronger than the *Larra*, to which this genus agrees in the ledge-like swellings of the front and the disposition of the ocelli; *the collar is smaller than in Larra and moreover differs from it by being depressed beneath the dorsulum*; wings as in the preceding genus; the legs are proportionately longer than in *Larra*, stoutly armed; middle coxæ widely separated from each other; middle tibiæ one-spurred; anterior tibiæ, with exception of their end spurs and a spine not far from the middle of inner side, unarmed; the comb of fore tarsi is formed of only a moderate number of spines, which at the most are not particularly long and only in a few species reach an extraordinary development; *the posterior tibiæ show, though not always, but in almost all the species known, two sharp longitudinal keels<sup>3</sup>, which are spinose. The claws are very long, in rare cases with a tooth not far from the base of inner edge*; pulvilli small; metathorax as long or longer than the dorsulum; abdomen not polished as in *Larra*; second ventral segment in the middle near the base with a convexity, the size and form of which differs considerably; commonly the segment appears almost keeled; to each side of the convexity there is a more or less expanded oval, flat impression of feebler color; these impressions are always present *if the convexity is distinct* and give the hind trochanters a freer motion. The males do not show these relations of the third ventral plate or only very slightly; last dorsal segment with a pygidial area, formed in the ♀ as in *Larra* and covered with a more or less fine, generally hoar-frost-like pubescence, which easily wears off and in old individuals is not at all perceptible; at the apex of the pygidial area there are some stiff little bristles; the last dorsal segment of the ♀ is trapezoidal and often considerably convex and at the apex margined outwardly.

---

<sup>3</sup> Seemingly not evident in our three species.

**THIS PAGE IS LOCKED TO FREE MEMBERS**

Purchase full membership to immediately unlock this page

# DELVE INTO FANTASY, MAGIC, MYTHOLOGY & FOLKLORE

Forgotten Books'  
Full Membership gives  
access to 797,885 ancient  
and modern, fiction and  
non-fiction books.

**Continue**

\*Fair usage policy applies

is more densely clothed with silvery pile and there are four, sometimes five, silvery bands on the abdomen. Length 7-11 mm.

Occurs throughout the entire United States.

2.—*Notogonia nigripennis* n. sp.

♀.—Clypeus rounded anteriorly, slightly emarginate medially, the posterior portion with very fine and close punctures, the middle portion with strong punctures while anteriorly the punctures are distinct; first joint of flagellum shorter than the second, the latter about equal to the third; remaining joints ———; space between eyes at the top is, if anything, a little less than the length of the first joint of flagellum; dorsulum not strongly depressed anteriorly in the middle, with exceeding fine and close punctures; scutellum shining, slightly impressed; metanotum very finely granulated and with a tolerably distinct, medial, impressed line extending from base to apex, the posterior face with transverse wrinkles, the metapleuræ indistinctly sculptured; tibiæ and tarsi strongly spinose; sculpture of abdomen above indistinct, ventral segments 4-6 with strong punctures, those on sixth segment closest; black, tegulæ testaceous posteriorly; front, face, cheeks, legs more or less and dorsal abdominal segments 1-3 (or 4) at apex with silvery pile; wings dark fuliginous, iridescent. Length 18 mm.

New York.

3.—*Notogonia aequalis* n. sp.

♀.—Clypeus rounded anteriorly, emarginate medially, the posterior portion with very fine and close punctures, those on the anterior half more distinct; first joint of flagellum in length about equal to the second, the latter about equal or perhaps slightly longer than the third; the antennæ taken as a whole are long, narrowed to the apex, in length about equal to the head and thorax combined; space between eyes at the top distinctly less than the length of the first joint of flagellum; dorsulum with very fine and close punctures, which are however a little more distinct than in *nigripennis*; dorsulum distinctly impressed; metanotum granulated, more strongly so than in preceding species, and with a distinct, medial, raised line, extending from base to near apex, the posterior face laterally with a few wrinkles; tibiæ and tarsi strongly spinose; abdomen shining, indistinctly sculptured, with exception of the fifth and sixth ventral segments which are strongly punctured; black; front and clypeus

scarcely silvery; head and thorax beneath with long, fuscous pubescence; the abdomen when viewed from behind, shows a sparse silvery pile, which is most obvious at apex of second dorsal segment; the ventral segments of abdomen possess a few long, black hairs or bristles; wings dark fuliginous, iridescent. Length 17 mm.

♂.—Antennæ somewhat shorter and stouter than in the ♀, the first joint of flagellum in length about equal to the second; space between the eyes at the top slightly less than the length of the pedicellum and first joint of the flagellum united; anterior margin of clypeus produced medially; hind femora with scarcely any swelling at base beneath, the remaining femora beneath not at all incurved, strongly convex; apical margins of segments 1-3 when viewed from behind with silvery pile; wings colored like the female. Length 12 mm.

New York and Georgia.

**ANCISTROMMA** gen. nov.

Body tolerably stout, never densely pubescent; mandibles widely emarginate on outer margin, armed with two teeth within; antennæ tolerably stout, in length variable, usually longer than in either *Tachytes* or *Tachysphex*, the scape not elongate as in those two genera, but short and stout; eyes always converging towards the vertex, the convergence different in the various species; *posterior ocelli linear at the top broadened and furrowed, which gives them the appearance of being formed into a hook*; anterior ocellus round, well-developed; the head in front is *distinctly*, though not strongly as in *Larra* and *Notogonia* raised or swollen along the inner eye margin; face behind the base of antennæ *not bituberculate*, at the most presenting a slight swelling; prothorax better developed than in either *Tachytes* or *Tachysphex*, in some species reaching the level of the dorsulum; sculpture of thorax rather coarse; tibiæ and tarsi of all the legs strongly spinose, middle tibiæ with a single spur; pulvilli large; claws long as in *Notogonia*, entire; *fore femora of ♂ near the base emarginate and still nearer the base drawn out into a tooth*, fore tarsi of ♀ with a comb, composed of short stout thorns, in the ♂ this comb is also present but is much weaker, anterior tibiæ on outer side without spines or bristles; last dorsal segment of ♀ with a large, coarsely sculptured and *clothed with pubescence on apical portion*, pygidial area; in the ♂ the eighth ventral segment is not emarginate.<sup>4</sup> Marginal cell of

<sup>4</sup>One species *A. vegeta*, however, has this segment emarginate.

anterior wings either truncate or pointed, the appendiculation usually distinct; three submarginal cells, the second of which receives both recurrent veins; *stigma* larger, and consequently more distinct than in *Tachytes* or *Tachysphex*; cubital vein of hind wings originating beyond the apex of the submedian cell. Size medium.

This genus is erected for a number of species which, although possessing the characters of each to a certain degree cannot be placed either in *Notogonia*, *Tachytes* or *Tachysphex*. The emarginate femora of the ♂ excludes them from *Notogonia*, the raised front along inner eye-margins from *Tachytes* and *Tachysphex* and again from *Tachysphex* by the shape of hind ocelli and stiff tarsal comb. From *Liris*, which does not occur in this country, the emarginate mandibles is sufficient to separate it. Ultimately, it seems to me, that a number of genera, belonging to this group, will have to be reduced to the value of sections as has been done with numerous genera of the Sphecidæ (s. s.). This genus gives promise of being one rich in species as eleven are treated of herein.

#### FEMALES.

- 1—Space between eyes at top less than, or equal to, the length of antennal joints 2 and 3 united . . . . . 2
  - Space between eyes at top decidedly greater than the length of antennal joints 2 and 3 united . . . . . 5
- 2—Space between eyes at top just about equal to the length of antennal joints 2 and 3 united . . . . . 3
  - Space between eyes at top less than the length of antennal joints 2 and 3 united . . . . . 4
- 3—Dorsulum finely and very closely punctured, opaque; anterior margin of clypeus with lateral angles strongly produced. . *aurulenta*.  
Dorsulum finely and somewhat sparsely punctured, shining; anterior margin of clypeus bidentate . . . . . *dolosa*.
- 4—First joint of flagellum not shorter than the second, if anything slightly longer; lateral angles of anterior margin of clypeus strongly produced; wings fuscous . . . . . *capax*.  
First joint of flagellum distinctly shorter than the second; laterally, the anterior margin of clypeus is usually bidentate; wings clear (the abdomen varies from black to red and black) . . . . . *distincta*.
- 5—Abdomen entirely black . . . . . 6
  - Abdomen more or less red . . . . . 8
- 6—Antennæ longer than head and thorax united . . . . . 7
  - Antennæ, when stretched-out, but little longer than the head and that part of thorax preceding the hind margin of tegulæ; form robust . . . . . *vegeta*.

**THIS PAGE IS LOCKED TO FREE MEMBERS**

Purchase full membership to immediately unlock this page

# Know Your Bible

Forgotten Books' Full Membership provides unlimited access to more than 28,000 volumes of Christian literature for \$8.99/month

**HOLY  
BIBLE**

**Continue**

\*Fair use policy applies

1.—*Ancistromma aurantia* Fox.

*Larra aurantia* Fox, Ent. News. p. 194. ♀.

♀.—Anterior margin of clypeus truncate, the lateral angles strongly produced, just before these angles there is a single tooth; front with close punctures, appearing granulated; vertex very finely and closely punctured; space between eyes at top just about equal to the length of antennal joints 2 and 3; antennæ tolerably long and setaceous though scarcely as long as the head and thorax united; first and second joints of flagellum about equal in length; dorsulum with the punctures fine and compact; scutellum impressed; metathorax rugose, most strongly so on upper surface, on which place there is a distinct, longitudinal, medial furrow; tibiæ and tarsi strongly spinose; pygidial area sparsely and strongly punctured, about one-third longer than it is broad at the base, the apical half densely pubescent. Black; abdomen orange, sometimes with some dark blotches dorsally; head and thorax not pubescent and the abdomen not pilose; wings pale fuscous, iridescent, nervures black; marginal cell on apical portion, separated for about one-fifth its entire length from the anterior margin of the wing, therefore being more or less pointed at apex; tarsi testaceous. Length 11-15 mm.

♂.—Anterior margin of clypeus rounded-out, emarginate medially and not dentate laterally; front granulated; vertex very finely and closely punctured; space between the eyes at top about equal to the length of antennal joints 2 and 3 united; first joint of flagellum about equal to or very slightly shorter than the second in length; dorsulum and scutellum sculptured as in the ♀, the scutellum impressed; legs rather feebly spinose; colored like the ♀ but with the apical abdominal segments black and the wings subhyaline, with the nervures testaceous; face and clypeus with silvery pubescence, the thorax and abdomen with a sparse, silvery pile. Length 10-11 mm.

Montana; Nebraska; California (*Coll. Ashmead.*) The distance between the recurrent nervures at the top is usually greater than the distance between the first recurrent nervure and the base of the second submarginal cell.

2.—*Ancistromma capax* n. sp.

♀.—Anterior margin of clypeus emarginate medially, the lateral angles strongly produced, just before these angles there is a small tooth; front finely and closely punctured, rather protuberant on each

side of the medial furrow, which is very strong; vertex with very fine and close punctures; space between the eyes at top distinctly less than the length of antennal joints 2 and 3; antennæ tolerably long and setaceous; first joint of flagellum, if anything, a little longer than the second; dorsulum with fine, even, compact punctures; scutellum much more finely and sparsely punctured than the dorsulum, its apical portion impressed; metathorax striated, most strongly on posterior face the upper surface with the striations irregular; legs strongly spinose; pygidial area in length, when fully exposed, about twice greater than its width at the base, strongly and sparsely punctured. Black; abdomen, except last three segments, bright red; tarsi testaceous; wings subfuscous, iridescent nervures black; marginal cell on apical portion separated for about one-fifth its length from the anterior margin of the wing, being therefore more or less pointed at apex; recurrent nervures with the distance between them at the top less than that between the first recurrent nervure and the base of the second submarginal cell. Length 16-17 mm.

Colorado and Nevada.

3.—*Ancistromma distincta* Sm.

*Larrada distincta* Sm., l. c. p. 292.

*Larra distincta* Patt., l. c. p. XX, p. 390. ♀ ♂.

♀.—Anterior margin of clypeus emarginate medially, bidentate laterally, the lateral angles not strongly produced; front very finely and closely punctured, the medial furrow distinct but not strong; vertex with the punctures finer and closer than those on the front; space between eyes at top a little less than the length of antennal joints 2 and 3 united; antennæ shorter than the head and thorax united, the first joint of the flagellum about one-third shorter than the second; dorsulum with fine, even, distinct punctures; scutellum punctured likewise, not impressed; metathorax striated, most coarsely so on posterior face, the striations on upper surface irregular, i. e., on basal portion they are longitudinal until they reach a little beyond the middle, where they curve and extend to the sides, on the posterior portion of upper surface the striations are transverse, the upper face has a strong furrow; legs tolerably strongly spinose; pygidial area strongly and sparsely punctured, about two and a quarter times longer than it is broad at the base. Black; tarsi testaceous; wings hyaline, slightly dusky at apex, iridescent; marginal cell obliquely truncate. Length 11-13 mm.



♂. — Anterior margin of clypeus rounded-out, indistinctly bidentate laterally; front and vertex sculptured similarly to the ♀; space between eyes at top a little less than the length of antennal joints 2 and 3 united; first joint of flagellum fully one-third shorter than the second; dorsulum more compactly punctured than in the ♀; scutellum impressed, legs feebly spinose; colored like the ♀; front, face, clypeus densely and the thorax very sparsely, clothed with silvery pubescence; abdomen with a silvery pile. Length 8-12 mm.

Var. ♀ ♂. First two, sometimes three, segments of abdomen bright red.

Occurs from Canada (*Harrington*) to Florida, westward to Montana. From the latter locality I have only seen the black and red variety. The female of this species is what we have heretofore called *Larra pensylvanica* Bve., but an examination of Beauvois' figure of this latter species invalidates that supposition; *pensylvanica* is probably a *Tachysphex*.

#### 4.--*Ancistromma dolosa* n. sp.

♀. — Anterior margin of clypeus emarginate medially, bidentate laterally, the outer tooth representing the lateral angles and is by far the largest; front finely and closely punctured; vertex even more finely and closely punctured than the front; space between the eyes at the top about equal to the length of antennal joints 2 and 3 united, if anything it is slightly less; antennæ much shorter than the head and thorax united, the first joint of flagellum, if anything a little longer than the second; dorsulum with fine, rather sparse punctures; scutellum impressed (?); metathorax striated, most strongly so on posterior face, the upper surface with the striations irregular and impressed medially; legs tolerably spinose; pygidial area strongly and sparsely punctured, about twice as long as it is broad at the base. Black; abdomen bright red; tarsi testaceous; wings dark fuscous, iridescent, nervures black; marginal cell apically, separated from the anterior margin of the wing; head, thorax and abdomen entirely destitute of pubescence or pile. Length 13 mm.

California (*Coll. Ashmead*). Resembles very much *Tachysphex triquetrus*, but the form of the ocelli and short, stiff tarsal-comb will at once separate it from that species.

**THIS PAGE IS LOCKED TO FREE MEMBERS**

Purchase full membership to immediately unlock this page

# DELVE INTO FANTASY, MAGIC, MYTHOLOGY & FOLKLORE

Forgotten Books'  
Full Membership gives  
access to 797,885 ancient  
and modern, fiction and  
non-fiction books.

**Continue**

\*Fair usage policy applies

impressed; metathorax above and behind with coarse, transverse plicæ or rugæ, on the metapleuræ becoming obsolete on lower portion, the upper surface strongly furrowed medially and with the transverse, basal row of foveæ very prominent; legs rather feebly spinose for this sex; pygidial area strongly and sparsely punctured, about one-and-a-half times longer than it is wide at the base, its lateral margins somewhat reflexed. Black; clothed with sericeous pile, that on sides of face and thorax beneath, silvery in certain lights; last two joints of tarsi only, testaceous; wings subfuscous, darker at apex, iridescent, nervures testaceous; marginal cell obliquely truncate. Length 15 mm.

Georgia. Easily recognized by coarse sculpture of metathorax and the sericeous pile with which it is clothed.

7.—*Ancistromma conferta* n. sp.

♀.—Anterior margin of clypeus rounded-out, indistinctly dentate laterally; front fine and closely punctured, more sparsely so medially, the medial impressed line rather faint; vertex a little more distinctly punctured than the sides of the front; space between the eyes at top slightly less than the length of antennal joints 3 and 4; antennæ setaceous, but little longer than the head and thorax united, first joint of flagellum nearly one-third shorter than the second; dorsulum finely and very compactly punctured; scutellum more distinctly punctured, slightly impressed; metathorax above rather indistinctly, transversely striated, the striations most distinct in the strong medial furrow, the metapleuræ coriaceous; legs tolerably spinose; pygidial area strongly and sparsely punctured, about one-and-a-half times longer than it is wide at the base, its lateral margins but slightly reflexed. Black; three, sometimes part of the fourth basal segments of abdomen reddish; tarsi testaceous; wings fusco-hyaline; iridescent, nervures black; marginal cell truncate; face, clypeus and thorax covered with a sparse, sericeous pile; abdomen with a sparse, silvery pile. Length 10-15 mm.

♂.—Anterior margin of clypeus rounded-out, not dentate laterally; front and vertex more coarsely punctured than in the ♀; space between eyes at top about equal to the length of antennal joints, 2-4 united; antennæ shorter than the head and thorax, rather stout, first joint of flagellum about one-quarter shorter than the second; scutellum impressed; metathorax above more coarsely sculptured

than in the ♀, the metapleuræ and posterior face coarsely granulated; colored like the ♀; front, face, clypeus, and thorax more or less, with silvery pubescence; abdomen with silvery pile, not distinctly punctured. Length 8-11 mm.

Montana; Kansas. A specimen from San Diego, California, which I take to be simply a variety, has the abdomen entirely red and its sculpture a little finer.

8.—*Ancistromma divisa* Patt.

*Larra divisa* Patt., Bull. U. S. Geol. Survey, V, p. 368. ♀. 1879.

♀.—Anterior margin of clypeus rounded-out, bidentate laterally; front rather coarsely and closely punctured, more sparsely so medially; vertex more distinctly punctured than the sides of the front; space between the eyes at top about equal to the length of antennal joints 2-4; antennæ scarcely as long as the head and thorax united, at any rate not longer, setaceous, the first joint of the flagellum a little more than one-quarter shorter than the second; dorsulum compactly punctured; scutellum impressed, more distinctly punctured than the dorsulum; metathorax above and posteriorly coarsely and transversely striated, the upper surface strongly sulcate medially, metapleuræ granulated; legs tolerably spinose; pygidial area strongly and sparsely punctured, in length nearly twice longer than its width at the base. Black; abdomen varying from red and black to entirely red; tarsi testaceous; wings dark fuscous, iridescent; marginal cell truncate; face, clypeus and abdomen with a sparse sericeous pile; metathorax with sparse, fuscous pubescence. Length 14-16 mm.

♂.—Anterior margin of clypeus rounded-out, not dentate laterally; front and vertex more coarsely sculptured than in the ♀; space between eyes at top somewhat greater than the length of antennal joints 2-4 united; antennæ much shorter than the head and thorax united, the first joint of flagellum about one-quarter shorter than the second; dorsulum with the punctures distinct; scutellum likewise, impressed; metathorax above transversely rugose; legs feebly spinose; abdomen closely and distinctly punctured; last dorsal segment not keeled laterally; first three segments of abdomen red; front, face, clypeus and thorax more or less, with sparse silvery pubescence; abdomen with silvery pile. Length 12-13 mm.

Kansas; Nebraska; Texas.

9.—*Ancistromma consimilis* n. sp.

♀.—Anterior margin of clypeus rounded-out, armed with one tooth laterally; front closely punctured, medially the punctures are more distinct, but not sparse; vertex finely and closely punctured; space between the eyes at top about equal to the length of antennal joints 2-4 united; antennæ much shorter than the head and thorax united, the first and second joints of the flagellum about equal in length; dorsulum compactly punctured; scutellum likewise, impressed; metathorax above indistinctly transversely striated, not strongly furrowed, the striations most distinct in the furrow, the metapleuræ finely granulated, or indistinctly striated; legs strongly spinose; the spines or fore-tarsi longer and stouter than in *divisa*; pygidial area large, strongly and sparsely punctured, only about one-third longer than its width at the base. Black; abdomen entirely red; apical joints of tarsi testaceous; wings dark fuscous, iridescent; marginal cell obliquely truncate; head and thorax destitute of pubescence or pile. Length 14 mm.

♂.—Anterior margin of clypeus rounded-out, not emarginate laterally; space between eyes at top about equal to or slightly greater than, joints 2-4 of antennæ united; antennæ not reaching much beyond tegulæ, rather stout, the first joint of flagellum about one-quarter shorter than the second; dorsulum with the punctures compact; scutellum impressed; legs feebly spinose; basal segments of abdomen above not distinctly punctured, the last dorsal segment distinctly keeled laterally; first three segments of abdomen red; head and thorax without silvery pubescence; abdomen with a sericeous pile. Length 10-13 mm.

Texas. This species and *divisa* resemble each other wonderfully, and at a first glance one would suppose that they are the same species; but the short antennæ and large pygidial area of the female, and the male with the basal abdominal segments impunctate and with the last dorsal segment keeled, will easily distinguish it.

10.—*Ancistromma rugosa* n. sp.

♂.—Anterior margin of clypeus rounded-out, not dentate; front closely punctured, rather sparsely so medially; vertex with the punctures coarser and more separated than those on the front; space between the eyes at top as great or perhaps slightly greater than the length of antennal joints 2-4 united: antennæ fully as long as head

**THIS PAGE IS LOCKED TO FREE MEMBERS**

Purchase full membership to immediately unlock this page

# Know Your Bible

Forgotten Books' Full Membership provides unlimited access to more than 28,000 volumes of Christian literature for \$8.99/month

**HOLY BIBLE**

**Continue**

\*Fair use policy applies

and closely punctured; last dorsal segment not keeled, the eighth ventral segment emarginate; colored like the ♀. Length 11 mm.

Colorado. This species is peculiar in having the eighth ventral plate of the ♂ emarginate, being the only one of our species of *Anacistromma* possessing that character. From all the other species it may be distinguished by the robust form, deep-black color and very short antennæ of ♀.

#### TACHYTES Panzer.

*Tachytes* Panz., Krit. Rev. II. p. 129, 1806.

*Lyrops* Illig. Ross., Faun. Etrusc. ed. 2, II, p. 161, 1807.

*Body generally stout, the amount of pubescence with which it is clothed variable, some of the species resembling, in a certain degree, bees; anterior femora of the ♂ beneath near the base entire or emarginate; comb on fore tarsi composed of short, thorns or spines; pygidial area large, covered with appressed pubescence, mandibles emarginate beneath; their inner margin with one or two teeth; antennæ stout, shorter than in the two following genera; eyes converging towards the vertex, the space between them at that point differing in the various species; fore ocellus round; the hind pair very elongate, placed obliquely and with the upper end forming a hook or flat spiral; front not raised along the inner orbits as in *Notogonia*, etc., if anything it is depressed; sculpture of the thorax not strong; last ventral plate of ♂ with a rounded, wide emargination; marginal cell lanceolate, its apex slightly obtuse, the appendiculation small and often indistinct, three submarginal cells, the second of which receives both recurrent nervures; tibiæ and tarsi of all the legs armed with spines; spines composing comb on fore tarsi generally not longer than the second joint of the said tarsi, and are thorn-like, not at all flexible in appearance; claws not very long; metanotum shorter than the dorsulum.*

Our species of this genus have been monographed previously;<sup>5</sup> therefore I will simply reproduce the synoptical tables here. In the first place the genus may be divided into two sections as follows:

Fore coxæ of ♂ simple, the fore femora of the same sex, beneath at base, entire; thorax of ♀ generally densely pubescent. Appearance bee-like . . . . . SECTION I.  
Fore coxæ of ♂ with an elongated process, the fore femora of the same sex beneath at the base emarginate; thorax of males not densely pubescent. Appearance not bee-like . . . . . SECTION II.

<sup>5</sup>Trans. Amer. Ent. Soc., XIX, p. 234, 1892.

The females of the first section are generally short, robust insects, while those of section II are rather long and slender and never have the clypeus produced medially as in the majority of those of the first section. In some respects section II agrees with *Tachysphex*, but the spines on fore tarsi of female are not long and flexible, and the pygidium is hairy.

## SECTION I.

## FEMALES.

- 1—Clypeus with the anterior margin in the middle, produced into a large quadrate tooth or lobe, and with several smaller teeth laterally . . . . . 2  
 Clypeus with the anterior margin not or scarcely produced into a lobe, at the most thickened in the middle . . . . . 7
- 2—Metanotum strongly sulcate medially. . . . . 6  
 Metanotum not strongly sulcate medially . . . . . 3
- 3—Third joint of antennæ about one-quarter longer than the fourth. 4  
 Third joint of antennæ equal to, or but little longer than the fourth . . . . . 5
- 4—Thorax densely clothed with golden yellow pubescence so that the sculpture of metanotum is hidden. Length 18-22 mm . . . . . *validus*.  
 Thorax sparsely clothed with grayish pubescence; metanotum finely granulated (four hind tibiæ with a dark stripe within). Length 12-14 mm. . . . . *harpax*.
- 5—Median process of clypeus divided into two distinct lobes; space between the eyes at the top equal to the length of joints two and three of antennæ, the latter joint, in length about equal to the fourth; front and thorax with golden pubescence . *predator*.  
 Median process of clypeus not bilobed, its apex simply incurved; third antennal joint slightly longer than the fourth; front and thorax clothed with silvery-gray pubescence . . . . *calcaratus*.
- 6—The sulcus on metanotum very wide; scutellum scarcely impressed; pygidium with a coppery lustre . . . . *mandibularis*.  
 The sulcus on metanotum not wide; scutellum distinctly impressed; pygidium silvery . . . . . *breviventris*.
- 7—Abdomen black . . . . . 8  
 Abdomen in part red; head and thorax clothed with dense silvery pubescence . . . . . *fulviventris*.
- 8—Abdomen dorsally with four silvery bands; front silvery . . . . 9  
 Abdomen dorsally with but three silvery bands; longer spur of hind tibiæ in length about equal to the first joint of the hind tarsi; front golden. . . . . *crassus*.
- 9—Longer spur of hind tibiæ longer than the first joint of the hind tarsi; apex of femora, tibiæ and tarsi, yellowish-ferruginous. . . . . *columbiæ*.



Longer spur of hind tibiæ, in length, about equal to the first joint of hind tarsi; legs black, tibiæ and tarsi with silvery pile, the apical portion of the tarsi ferruginous. . . . . *pepticus*.

## MALES.

- 1—Flagellum with the basal joints not or scarcely rounded out beneath, the apical joints, except in *crassus* and *pepticus*, abnormal . . . . . 8  
 Flagellum with the basal joints distinctly rounded out beneath, the apical joints normal . . . . . 2
- 2—Anterior margin of clypeus, in the middle, not produced into a tooth or lobe, at the most simply thickened. . . . . 4  
 Anterior margin of clypeus in the middle produced into a tooth or lobe . . . . . 3
- 3—Metanotum slightly sulcate; thorax densely pubescent; median process of clypeus not prominent, strongly impressed, having the appearance of being bituberculate . . . . . *validus*.  
 Metanotum distinctly and rather strongly sulcate; thorax sparsely pubescent; median process of clypeus strong, not bituberculate. . . . . *breviventris*.
- 4—Last dorsal abdominal segment tufted laterally with dark hair. 7  
 Last dorsal abdominal segment not tufted with dark hair . . . 5
- 5—Hind tarsi not at all spinose; lateral teeth of clypeus large and distinct. . . . . *mandibularis*.  
 Hind tarsi distinctly spinose . . . . . 6
- 6—First joint of flagellum shorter than the second; space between the eyes at top narrower than usual; head and thorax densely clothed with golden pubescence. . . . . *prædator*.  
 First joint of flagellum not shorter than the second.  
 Space between the eyes at the top not greater than the length of antennal joints 2 and 3 united; longest spur of hind tibiæ longer than the first hind tarsal joint; abdomen not at all red . . . . . *calcaratus*.  
 Space between the eyes at the top greater than the length of antennal joints 2 and 3 united; longest spur of hind tibiæ decidedly shorter than the first joint of hind tarsi; abdominal segments with a transverse band of reddish . . . . . *exornatus*.
- 7—Emargination of last ventral plate very narrow; first joint of flagellum in length about equal to the second; head and thorax with golden pubescence . . . . . *harpax*.  
 Emargination of last ventral plate broad and round; first joint of flagellum shorter than the second; head and thorax with silvery pubescence . . . . . *columbiæ*.
- 8—Apical joints of the antennæ normal . . . . . 9  
 Apical joints of the antennæ abnormal . . . . . 10
- 9—Apex of femora, tibiæ and tarsi, yellow-ferruginous; hind tarsi very feebly spinose . . . . . *crassus*.

**THIS PAGE IS LOCKED TO FREE MEMBERS**

Purchase full membership to immediately unlock this page

# DELVE INTO FANTASY, MAGIC, MYTHOLOGY & FOLKLORE

Forgotten Books'  
Full Membership gives  
access to 797,885 ancient  
and modern, fiction and  
non-fiction books.

**Continue**

\*Fair usage policy applies

7.--*Tachytes praedator* Fox.*T. praedator* Fox, l. c. p. 240, ♀ ♂.

Virginia and Texas.

8.--*Tachytes columbiæ* Fox.*T. columbiæ* Fox, l. c. p. 241, ♀ ♂.

District of Columbia, Virginia, New Jersey.

9.--*Tachytes crassus* Patt.*T. crassus* Patt. l. c. p. 393, ♀; Fox, l. c. p. 241, ♀ ♂.Connecticut, New Jersey (August), So. Dakota, (*Aldrich*).10.--*Tachytes pepticus* Say.*Lyrops pepticus* Say, Bost. Journ. I, p. 371. ♀ ♂.*Tachytes pepticus* Sm., Cat. Brit. Mus. Hym. IV, p. 308.

From Illinois westward.

11.--*Tachytes fulviventris* Cress.*T. fulviventris* Cress., Proc. Ent. Soc. Phila. IV, p. 466. ♀.*T. cælebs* Patt., Bull. U S., Geol. Survey, V, p. 355. ♂.

From Nebraska westward.

12.--*Tachytes spatulatus* Fox.*T. spatulatus* Fox, l. c. p. 243, ♂.

Nevada.

## SECTION II.

## FEMALES.

- 1—Greater part of femora reddish . . . . . 2  
 Greater part of femora or the legs entirely, black . . . . . 3
- 2—Abdomen black, the three first dorsal abdominal segments only  
 with silvery pile at apex . . . . . *distinctus*.  
 Abdomen, except some black blotches on dorsal segments three,  
 four and five, entirely reddish; the first four abdominal seg-  
 ments with silvery pile at apex. . . . . *distinctus* var.
- 3—First joint of fore tarsi much contracted basally, apical portion of  
 first three abdominal segments silvery . . . . . *contractus*.  
 First joint of fore tarsi not contracted . . . . . 4
- 4—First two dorsal segments of abdomen, apically, silvery; legs, ex-  
 cept tarsi, black, the tibiæ with dense silvery pubescence;  
 metanotum distinctly punctured . . . . . *aurulentus*.  
 First four or five segments silvery . . . . . 5
- 5—Space between eyes at top about equal to length of joints 2 and 3  
 of antennæ united . . . . . 6  
 Space between eyes at top greater than length of joints of the an-  
 tennæ 2 and 3 united. . . . . 7
- 6—Abdomen reddish, or red and black; hind tibiæ armed outwardly  
 with a series of short, black, stout and blunt thorns . . . . .  
 . . . . . *abdominalis*.  
 Abdomen black; posterior tibiæ armed outwardly with a series of  
 whitish, long and rather acute thorns . . . . . *sericatus*.

- 7—Mandibles very broad and flat, with an exceedingly narrow notch; abdomen black . . . . . *obscurus*.  
Mandibles of the normal form, with a broad notch . . . . . 8
- 8—Metanotum not at all furrowed; abdomen varying from red and black to entirely ferruginous; size also variable. . *rufofasciatus*.  
Metanotum more or less furrowed . . . . . 9
- 9—Space between eyes at top greater than the length of antennal joints 2 and 3 united; clypeus not dentate . . . . . *obductus*.  
Space between eyes at top a little less than the length of second and third antennal joints united; clypeus armed with a large prong on each side . . . . . *mergus*.

## MALES.

- 1—Wings yellow, with the apical portion dark . . . . . 2  
Wings not yellow, hyaline or subhyaline . . . . . 3
- 2—Third joint of antennæ nearly one-third longer than the fourth; metanotum distinctly punctured; tibiæ and tarsi black . . . . .  
. . . . . *aurulentus*.  
Third joint of antennæ but little longer than the fourth; metanotum not punctured; apex of femora, tibiæ and tarsi yellow ferruginous . . . . . *distinctus*.
- 3—Abdomen and legs more or less red; third joint of antennæ in length about equal to the fourth; metanotum slightly furrowed; femora, except base, reddish . . . . . *rufofasciatus*.  
Abdomen and legs black.<sup>2</sup> . . . . . 4
- 4—Space between eyes at top much less than the length of antennal joints 2-4 united . . . . . 5  
Space between eyes at top about equal to the length of antennal joints 2-4 united; apical margins of the wings fuscous. . *parvus*.
- 5—Notch on outer edge of mandibles very narrow; body not densely silvery sericeous . . . . . *obscurus*.  
Notch on outer edge of mandibles as usual; body rather densely clothed with silvery sericeous pile . . . . . *sericatus*.

13.—*T. aurulentus* Fab.

*Larra aurulenta* Fab., Syst. Piez. p. 220.

*Lyrops aurulenta* Say, Bost. Journ. I, p. 371.

? *Tachytes aurulentus* Lep., Hym. III, p. 247.

*Tachytes aurulentus* Sm., Catal. Brit. Mus. IV, p. 306.

*Liris coxalis* Patton, Ent. News, III, p. 90. ♀ ♂.

New Jersey (July and August) to Florida, westward to Texas and Missouri.

14.—*Tachytes contractus* Fox.

*T. contractus* Fox, l. c. p. 245, ♀.

Georgia.

<sup>2</sup>*T. minimus* has been excluded from this table as it is a species of *Tachysphex*.

15.—*Tachytes distinctus* Sm.*T. distinctus* Sm., Cat. Brit. Mus. Hym. IV, 307. ♀.*T. elongatus* Cr., Tr. Am. Ent. Soc. IV, p. 215. ♂.

Philadelphia (Smith) to Florida, westward to California. *T. elongatus*, is according to Mr. Charles Robertson, who has taken it in copulation with *distinctus*, the male of the latter. A ♀ specimen in the coll. of the U. S. National Museum from Arizona, has the abdomen almost entirely red and the first four dorsal abdominal segments with silvery pile at apex.

16.—*Tachytes sericatus* Cress.*T. sericatus* Cress., *ibid.* p. 216. ♀ ♂.

Texas, Georgia.

17.—*Tachytes rufofasciatus* Cress.*T. rufofasciatus* Cress., *ibid.* p. 217. ♂; Fox, l. c. p. 247. ♀ ♂.

Georgia to Texas, Nebraska, California.

18.—*T. abdominalis* Say.*Larra abdominalis* Say, West. Quart. Rep. II, p. 77, ♀.*Larrada abdominalis* Cr., *loc. cit.* I, p. 379.*Tachytes abdominalis* Cress., *loc. cit.* IV, p. 217.

Arkansas (Say), Texas, Mexico.

19 — *Tachytes obscurus* Cress.*. obscurus* Cress., l. c. p. 217, ♀.*T. texanus* Cress., *ibid.* p. 217, ♂.

District of Columbia to Mexico. *T. texanus* Cress., is the ♂ of this species.

20.—*Tachytes parvus* Fox.*T. parvus* Fox, l. c. p. 249, ♂.

New Jersey (August). May be the ♂ of either of the two following species.

21.—*Tachytes obductus* Fox.*T. obductus* Fox, l. c. p. 250. ♀.

Tennessee.

22.—*Tachytes mergus* Fox.*T. mergus* Fox, l. c. p. 250. ♀.

New Jersey (July).

## UNIDENTIFIED.

*Tachytes dives* Lep.*T. dives* Lep., Hym. III, p. 247, ♀.

"Carolina. Museum of M. Serville."

## TACHYSPHEX Kohl.

*Larrada* Sm., Cat. Hym. Brit. Mus., p. IV, p. 274. 1856.

*Larra* Patton, Proc. Bost. Soc. Nat. Hist. XX, p. 385; Cresson, "Synopsis," p. 114.

*Tachyspex* Kohl, Berl. Ent. Zeitschrift, XXVII, H. 1, 1883.

**THIS PAGE IS LOCKED TO FREE MEMBERS**

Purchase full membership to immediately unlock this page

# Know Your Bible

Forgotten Books' Full Membership provides unlimited access to more than 28,000 volumes of Christian literature for \$8.99/month

**HOLY  
BIBLE**

**Continue**

\*Fair use policy applies

- the base; tarsi strongly spinose, especially the first joint of the posteriors . . . . . *spinus*.
- Hind legs black . . . . . 4
- 4—Anterior margin of the clypeus strongly crenated . . . *crenulatus*.  
Anterior margin of clypeus not crenated, at the most with two teeth laterally . . . . . 5
- 5—Greater part of abdomen reddish . . . . . 6  
Abdomen black, or equally red and black . . . . . 9
- 6—Pygidium scarcely twice as long as it is broad at the base . . . . .  
. . . . . *triquetrus*.  
Pygidium decidedly more than twice longer than it is broad at base . . . . . 7
- 7—Antennæ long, not setaceous scarcely acuminate apically . . . . .  
. . . . . *antennatus*.  
Antennæ as usual, acuminate apically . . . . . 8
- 8—Anterior margin of clypeus not or but very slightly emarginate.  
Dorsulum very closely punctured; metathorax above finely coriaceous; front finely granulated . . . . . *tarsatus*.  
Dorsulum shining, with the punctures separated; metathorax above finely granulated; front rather coarsely granulated . . . . .  
. . . . . *semirufus*.  
Anterior margin of clypeus distinctly emarginate; front exceedingly finely granulated . . . . . *exsectus*.
- 9—Longer spur of hind tibiæ shorter than the first joint of hind tarsi; abdomen about equally red and black . . . . . 10  
Longer spur of hind tibiæ decidedly longer than the first joint of hind tarsi; abdomen with segments broadly testaceous, with at least four silvery bands . . . . . *mundus*.
- 10—Metathorax above granulated; distance between the third transverso-cubital nervure and the apex of marginal cell is usually greater than the width of the third submarginal cell at the top . . . . . *tenuipunctus*.  
Metathorax above more or less longitudinally striated or wrinkled; distance between the third transverso-cubital nervure and the apex of the marginal cell less than the width of the third submarginal cell at the top . . . . . *decorus*.
- 11—Space between eyes at top equal to or greater than the length of antennal joints 3 and 4 united . . . . . 12  
Space between the eyes at top less than the length of antennal joints 3 and 4 united . . . . . 15
- 12—Anterior margin of clypeus produced medially into a short lobe. 13  
Anterior margin of clypeus not at all produced into a lobe . . . 14
- 13—Wings hyaline, iridescent; metathorax granulated above . *fuscus*.  
Wings, except base, fuscous; metathorax above coarsely reticulated . . . . . *fumipennis*.
- 14—Metathorax, above, granulated; usually the last two abdominal segments red . . . . . *terminatus*.

- Metathorax, above, strongly reticulated; usually the last segment only red . . . . . *apicalis*.
- 15—Greater part of abdomen black . . . . . 16  
 Greater part of abdomen red or equally red and black . . . . . 18
- 16—Metanotum reticulated.  
 Vertex and dorsulum coarsely punctured; tarsi black . . *acutus*.  
 Vertex and dorsulum very finely punctured; tarsi reddish on apical half . . . . . *nigrrior*.
- Metanotum smooth or finely granulated, opaque . . . . . 17
- 17—With dense sericeous pile; wings subhyaline . . . . . *punctifrons*.  
 Without sericeous pile, deep black; wings dark fuscous . *aethiops*.
- 18—Tibiæ, tarsi and femora, in part, red . . . . . *posterus*.  
 Tibiæ and femora black . . . . . 19
- 19—Metanotum strongly reticulated . . . . . *asperatus*.  
 Metanotum longitudinally striated . . . . . *sculptilis*.  
 Metanotum granulated or coriaceous . . . . . 20
- 20—Abdomen not at all compressed, depressed throughout . . . . . 21  
 Abdomen compressed apically . . . . . *montanus*.
- 21—Pygidium in length, but little, if anything, greater than twice its width at the base. Length 6 mm. . . . . *pauillus*.  
 Pygidium in length, greater than twice its width at base; metathorax above finely granulated . . . . . *consimilis*.

## MALES.

- 1—Space between the eyes at top about equal to the length of antennal joints 2 and 3 united . . . . . 2  
 Space between the eyes at top greater than the length of antennal joints 2 and 3 united . . . . . 3
- 2—Abdomen black; apex of femora, tibiæ and tarsi entirely, reddish yellow . . . . . *minimus*.  
 Abdomen on basal half red; femora and tibiæ not reddish. *æqualis*.
- 3—Abdomen entirely black, except extreme apex in some few species . . . . . 4  
 Abdomen red or black and red . . . . . 10
- 4—Metathorax above smooth or indistinctly sculptured . . . . . 5  
 Metathorax above coarsely sculptured . . . . . 6
- 5—Lateral angles of produced portion of anterior margin of clypeus obtuse; metathorax above without a longitudinal, impressed line; clothed with sericeous pile . . . . . *punctifrons*.  
 Lateral angles of produced portion of anterior margin of clypeus acute; metathorax above with a distinct, longitudinal, impressed line; deep black, without sericeous pile . . . . . *æthiops*.
- 6—Space between the eyes at top decidedly less than the length of antennal joints 2-4 united, but little greater than the length of joints 2 and 3 . . . . . *mundus*.  
 Space between the eyes at top as great or greater than the length of antennal joints 2-4 united . . . . . 7



- 7—Front, though distinctly punctured, yet not coarsely so; space between eyes at top about equal to the length of antennal joints 2-4 united . . . . . 8  
 Front coarsely punctured; space between eyes at top greater than the length of antennal joints 2-4 united . . . . . 9
- 8—Thorax with silvery pubescence; front with an indistinct, medial impressed line . . . . . *acutus*.  
 Thorax without silvery pubescence; front with a distinct, medial, impressed line . . . . . *nigrrior*.
- 9—Abdomen ventrally rather strongly punctured; metapleuræ coarsely striated . . . . . *apicalis*.  
 Abdomen ventrally very finely punctured; metapleuræ finely striated . . . . . *fusus* and *terminatus*.
- 10—Occiput remarkably depressed in the middle, so that the portion behind each eye is much swollen . . . . . *inusitatus*.  
 Occiput normal . . . . . 11
- 11—Metapleuræ coarsely striated.  
 Antennæ elongate, the third joint fully twice longer than broad; space between the eyes at top less than the length of joints 3 and 4 united . . . . . *amplus*.  
 Antennæ short, stout, the third joint about as broad as long; space between eyes at top about equal to the length of antennal joints 3-5 united . . . . . *texanus*.  
 Metapleuræ not coarsely striated . . . . . 12
- 12—Space between eyes at top about equal to joints 3 and 4 united . 13  
 Space between eyes at top less than the length of joints 3 and 4 . 17
- 13—Flagellum rather short, stout, thickened medially . . . *spissatus*.  
 Flagellum long, slender, not thickened medially . . . . . 14
- 14—Metathorax above reticulated . . . . . *consimilis*.  
 Metathorax above not reticulated, at the most finely granulated. . . . . 15
- 15—Abdomen entirely red . . . . . *tarsatus*.  
 Abdomen black apically . . . . . 16
- 16—Size small, slender; front finely granulated. Length 6 mm. . . . . *parvulus*.  
 Size medium, robust; front more punctured than granulated. Length 10 mm. . . . . *compactus*.
- 17—Upper surface of metathorax as long as the dorsulum; form slender . . . . . *dubius*.  
 Upper surface of metathorax shorter than the dorsulum; form stout . . . . . 18
- 18—Front coarsely and distinctly punctured . . . . . *montanus*.  
 Front granulated, or else it is so very closely punctured that it appears so . . . . . 19
- 19—Upper surface of metathorax coarsely and irregularly wrinkled. . . . . *quebecensis*.  
 Upper surface of metathorax not wrinkled . . . . . 20

**THIS PAGE IS LOCKED TO FREE MEMBERS**

Purchase full membership to immediately unlock this page

# DELVE INTO FANTASY, MAGIC, MYTHOLOGY & FOLKLORE

Forgotten Books'  
Full Membership gives  
access to 797,885 ancient  
and modern, fiction and  
non-fiction books.

**Continue**

\*Fair usage policy applies

each extreme side; front very finely and closely punctured, appearing granulated, the punctures on the vertex are also fine but are not so close as those on the front; space between the eyes at top a little less than the length of antennal joints 2 and 3 united; first joint of the flagellum a little more than one-fifth shorter than the second; dorsulum with distinct, close punctures, its medial portion only depressed anteriorly and then not strongly; scutellum convex, not impressed, punctured like the dorsulum; metathorax above strongly reticulated, especially at the base, the sides and posteriorly finely striated, the posterior face with the fovea elongate, acute beneath and broad at the upper end; legs rather stout, well armed with spines; marginal cell truncate; space between the second and third submarginal cells at the top about equal; abdomen ———?.<sup>6</sup> Black; spot on scape, at apex beneath, mandibles in the middle, and legs except coxæ, trochanters and the fore and medial femora above, red; front, face, clypeus and the thorax more or less clothed with silvery pubescence, brightest and densest on the face, clypeus and mesopleuræ; wings subhyaline, iridescent, nervures testaceous; tegulæ yellow. Length about 9 or 10 mm.

Texas. The type of this species, which seems to be very rare, is in the collection of the United States National Museum.

3.—*Tachysphex posterus* n. sp.

♀.—Clypeus with large, deep punctures, its anterior margin rounded-out, subtruncate medially, and not dentate laterally; front finely and closely punctured below the middle, but above that the punctures are strong and separated; the vertex more finely punctured; space between the eyes at the top greater than the length of antennal joints 2 and 3 united, but less than the length of joints 3 and 4; first joint of the flagellum about one-third shorter than the second; dorsulum with distinct, separated punctures (the punctures are much more distinct than in either of the two preceding species), depressed in the middle for about two-thirds its length, the punctures most compact anteriorly; scutellum convex, not impressed, punctured similarly to the posterior portion of the dorsulum; metathorax above finely

---

<sup>6</sup> The abdomen of the only specimen seen by me, the type of the species, is lost. I take the following from the original description: "abdomen fulvo-ferrugineus, with a very fine silvery sericeous pile, more dense at the sides and apex of the segments, the three apical segments black."

coriaceous, the sides likewise, the posterior face finely and transversely striated; legs ample, tolerably well armed with spines; abdomen above impunctate, the last two ventral segments sparsely punctured; pygidial area flat, with distinct, large, sparse punctures, its length is about two-and-a-half times longer than it is wide at the base. Black; anterior margin of the clypeus, mandibles except base, spot on scape at apex beneath, the tarsi, medial tibiæ, the hind legs except coxæ and trochanters, and the abdomen red; face, front, clypeus and the thorax, especially in the sutures, with silvery pubescence; the femora and abdomen with silvery pile, which is most profuse on the abdomen; tegulæ and nervures testaceous; wings subhyaline, the marginal cell obliquely truncate, width of the third submarginal cell at the top greater than the width of the second at the same place. Length 12 mm.

State of Washington.

4.—*Tachysphex spinosus* n. sp.

♀.—Clypeus with large deep punctures, its fore margin rounded-out, and armed with a tooth laterally; front finely and closely punctured throughout; the vertex with the punctures finer; space between the eyes at the top about equal to the length of antennal joints 2 and 3 united; first joint of the flagellum about one-quarter shorter than the second; dorsulum with tolerably strong and very close punctures, depressed in the middle for about two-thirds its length, the punctures closest anteriorly; scutellum punctured like the dorsulum, not impressed; metathorax above finely coriaceous, the sides likewise, but shining, the posterior face transversely striated; legs strongly armed with spines, especially the first joint of the tarsi; abdomen above impunctate, the last two ventral segments with large, sparse punctures; pygidial area somewhat convex, with indistinct scattered punctures, its length is about twice or perhaps less than twice greater than its width at the base. Black; mandibles in the middle, spot on scape beneath at apex and fore tarsi reddish-testaceous; four hind legs except the coxæ, trochanters and femora and base of tibiæ of medial legs, and the abdomen bright red; face, clypeus and thorax more or less, with silvery pubescence; femora and abdomen with silvery pile, which is most obvious on the abdomen when viewed from behind; tegulæ testaceous; wings subhyaline, iridescent, the nervures black; marginal cell subacute at apex; width of the

third submarginal cell at the top nearly twice greater than the width of the third at the same place. Length 11 mm.

Los Angeles County, California. (Collection U. S. National Museum.)

5.—*Tachysphex crenulatus* n. sp.

♀.—Anterior margin of the clypeus distinctly crenulated; front finely granulated throughout; vertex with very fine and close punctures; space between the eyes at top about equal to the length of antennal joints 2 and 3 united; first and second joints of the flagellum equal in length; dorsulum very closely punctured, the punctures much stronger than those on the vertex; scutellum slightly impressed anteriorly; metathorax above finely granulated, the metapleuræ indistinctly striated, as is likewise the posterior face; legs stout, strongly spinose; abdomen above impunctate, the second and last ventral segments with sparse punctures; pygidial area with large, scattered punctures, depressed on apical half, its length is about twice greater than its width at the base. Black; mandibles in the middle, and indistinct spot on scape at apex beneath and the tarsi, obscure reddish; abdomen dark red; tegulæ testaceous; wings subhyaline, the nervures black; marginal cell subtruncate at apex; space between the second and third submarginal cells at the top about equal. Length 11 mm.

California.

6.—*Tachysphex tarsatus* Say.

*Larra tarsata* Say, Western Quarterly Reporter, II, p. 78.

*Larraða tarsata* Cress., Proc. Ent. Soc. Phila., IV, p. 464. ♀.

♀.—Anterior margin of the clypeus either slightly emarginate in the middle or entire, armed with one tooth laterally; front finely granulated; punctures on the vertex fine; space between the eyes at the top about equal to the length of antennal joints 2 and 3 united, perhaps a little greater; first joint of the flagellum about one-third shorter than the second; dorsulum more finely punctured than the front, depressed in the middle anteriorly; scutellum punctured like the dorsulum, not impressed; metathorax above finely coriaceous, the metapleuræ indistinctly striated, the posterior face transversely striated, with a long, deep, longitudinal fovea in the middle; legs tolerably well armed with spines; abdomen above impunctate, the last two ventral segments sparsely punctured; pygidial area not so distinctly

**THIS PAGE IS LOCKED TO FREE MEMBERS**

Purchase full membership to immediately unlock this page

# Know Your Bible

Forgotten Books' Full Membership provides unlimited access to more than 28,000 volumes of Christian literature for \$8.99/month

**HOLY BIBLE**

**Continue**

\*Fair use policy applies

bright red; head in front and thorax very sparsely clothed with silvery pubescence; abdomen also very sparsely clothed with silvery pile; wings subhyaline, nervures black; marginal cell subtruncate; width of the second submarginal cell at the top decidedly greater than that of the third submarginal at the same place. Length 9-10 mm.

Texas; Colorado. A specimen from Georgia which I refer to this species has the dorsulum punctured similarly to *T. tarsatus* Say. From California there are two specimens, which I at first believed to be distinct, that have the front punctured, the dorsulum rather sparsely punctured and the sculpture of the metanotum bordering on both reticulated and granulated. The male of this California form is as follows:

♂.—Front coarsely granulated; vertex with fine, rather sparse punctures, the clypeus with fine and close punctures; space between the eyes at top about equal to length of antennal joints 2 to 4 united; antennæ short and stout, the first joint of the flagellum scarcely one-half shorter than the second; dorsulum with distinct, tolerably strong punctures; metathorax above coarsely granulated or finely reticulated, on the sides and behind distinctly striated; legs feebly spinose; colored like the ♀; abdomen with distinct silvery pile. Length 7 mm.

8.—*Tachysphex spissatus* n. sp.

♂.—Front strongly granulated; vertex finely and closely punctured; space between the eyes at top about equal to the length of antennal joints 3 and 4 united; clypeus subtruncate, its interior half with coarse punctures; antennæ rather long, distinctly thickened medially, the first joint scarcely greater than one-half the length of the second, which is a little shorter than the third; dorsulum very finely and closely punctured, the scutellum likewise, and not impressed; metathorax above coriaceous, the sides finely and indistinctly striated. the posterior face more distinctly so; legs feebly spinose, the emargination of fore femora large and sub-angular; abdomen impunctuate, the last dorsal segment with distinct punctures. Black; scape beneath at apex, mandibles in the middle and apical joints of the tarsi obscure red; segments 1-3 of the abdomen bright red; tegulæ testaceous; face, front, clypeus and thorax with silvery pubescence; abdomen with silvery pile; wings subhyaline, iridescent.

nervures testaceous, marginal cell subtruncate; second submarginal cell at the top about equal to, or perhaps slightly greater than the width of the third at the same place. Length  $7\frac{1}{2}$  mm.

California.

9.—*Tachysphex dubius* n. sp.

♂.—Front finely granulated; vertex finely and closely punctured; space between the eyes at top greater than the length of antennal joints 2 and 3 united, but less than joints 3 and 4; clypeus in the middle of anterior margin a little produced, not coarsely punctured on anterior half; antennæ not or but very slightly thickened medially; the first joint of the flagellum more than one-third shorter than the second; dorsulum very finely and closely punctured; metathorax above coriaceous, the sides indistinctly striated, the hind face more distinctly so; legs feebly spinose, the emargination of fore femora rounded; last dorsal segment of abdomen finely and distinctly punctured. Black; scape beneath at apex, mandibles medially and last joint of tarsi obscure reddish; segments 1-3 of abdomen bright red; face, front, clypeus and thorax with silvery pubescence; abdomen with silvery pile; wings dark subhyaline, iridescent, nervures black; marginal cell obliquely truncate; width of the second and third submarginal cells at the top variable. Length 8-9 mm.

Camden County, New Jersey, August 24th; Northern Illinois (*Dr. Nason*).

10.—*Tachysphex semirufus* Cress.

*Larrada semirufa* Cr., Proc. Ent. Soc. Phila., IV, p. 464. ♀.

*Larra semirufa* Patt., l. c. p. 389.

♀.—Anterior margin of the clypeus slightly rounded-out, armed with two distinct teeth on each extreme side; front rather coarsely granulated; vertex with fine distinct punctures; space between the eyes at top about equal to the length of antennal joints 2 and 3 united, perhaps a little greater; first joint of the flagellum scarcely one-fourth shorter than the second; dorsulum with fine, close, distinct punctures; scutellum a little more strongly punctured; metathorax above distinctly granulated, indistinctly striated on the sides, the posterior face a little more distinctly striated; legs strongly spinose; abdomen above impunctate, the last ventral segment strongly punctured; pygidial area tolerably well defined, sparsely punctured, its length nearly two and a-half times longer than it is wide at the base. Black;



scape beneath at apex, mandibles in the middle, and the tarsi except basal joint, obscure reddish; abdomen bright red; face, front, clypeus and thorax sparsely clothed with silvery pubescence; abdomen without silvery pile; wings slightly fuscous, iridescent, nervures black; marginal cell obliquely truncate; space between the second and third submarginal cells at the top about equal. Length 8-9 mm.

Colorado.

11.—*Tachysphex asperatus* n. sp.

♀.—Anterior margin of the clypeus a little rounded-out, not dentate laterally; front coarsely granulated; vertex with strong punctures; space between the eyes at top greater than the length of antennal joints 2 and 3 united and less than the length of joints 3 and 4 united; first joint of flagellum but little, if anything, shorter than the second; dorsulum coarsely punctured; metathorax above strongly rugose or rugoso-reticulate, the sides and behind distinctly striated; legs feebly spinose; abdomen above impunctate, the last ventral segment more or less punctured; last dorsal segment with the pygidial area only developed at apex, and then only to a very slight degree, impunctate. Black; mandibles at apex and the tarsi more or less, obscure red; abdomen bright red; face, front, clypeus and thorax, sparsely clothed with silvery pubescence; the abdomen with a sparse silvery pile; wings subhyaline, iridescent, nervures testaceous; marginal cell obliquely truncate; the second submarginal cell at the top greater than the third at the same place. Length 8 mm.

Nevada. The coarser sculpture of the dorsulum and the poorly developed pygidial area will distinguish this species from *semirufus*, which it greatly resembles.

12.—*Tachysphex antennatus* n. sp.

♀.—Anterior margin of the clypeus truncate, armed with a tooth laterally; front finely granulated; vertex finely and closely punctured; space between the eyes at top about equal to the length of antennal joints 2 and 3 united, possibly a little greater; first joint of the flagellum is long, nearly one-fourth shorter than the second, the flagellum not setaceous; dorsulum finely and closely punctured; scutellum likewise; metathorax above finely granulated, the sides indistinctly striated, the posterior face more distinctly so; legs tolerably well armed with spines; pygidial area scarcely two-

**THIS PAGE IS LOCKED TO FREE MEMBERS**

Purchase full membership to immediately unlock this page

# DELVE INTO FANTASY, MAGIC, MYTHOLOGY & FOLKLORE

Forgotten Books'  
Full Membership gives  
access to 797,885 ancient  
and modern, fiction and  
non-fiction books.

**Continue**

\*Fair usage policy applies

about twice as long as it is broad at the base. Black; scape beneath at apex, mandibles medially and apical joints of tarsi, obscure reddish; abdomen bright red, with a sparse silvery pile; front, face and clypeus densely and the thorax sparsely, with silvery pubescence; wings subhyaline, nervures testaceous; marginal cell truncate, second submarginal cell at the top wider than the third at the same place. Length 7 mm.

Colorado. The sculpture of metathorax will readily distinguish this species.

15.—*Tachysphex parvulus* Cress.

*Larrada parvula* Cr., Proc. Ent. Soc., Phila., IV, p. 465. ♂

*Larra montana* Patton, l. c. p. 389; Kohl, l. c. p. 246.

♂.—Front finely granulated; vertex with exceedingly fine and close punctures; space between the eyes at top decidedly greater than the length of antennal joints 2 and 3 united, about equal to joints 3 and 4 united; anterior margin of clypeus subtruncate, armed with a tooth laterally; antennæ rather long, the flagellum not thickened medially, the first joint of the latter scarcely one-third shorter than the second; dorsulum very finely and closely punctured; scutellum likewise; metathorax above coriaceous or finely granulated, the sculpture of sides indistinct, though evidently finely striated, the posterior face transversely striated; legs feebly spinose, the emargination of fore femora large. Black; scape and mandibles colored as usual, the tarsi except first joint, reddish; abdomen bright red, with silvery pile; front, face and clypeus with a tolerably dense silvery pubescence, the thorax sparsely so; wings subhyaline, iridescent, nervures testaceous; marginal cell obliquely truncate; width of second and third submarginal cells at the top variable. Length 7 mm.

Colorado. This species is not the ♂ of *montanus* as has been supposed by some authors.

16.—*Tachysphex fumipennis* n. sp.

♀.—Anterior margin of the clypeus slightly produced medially, not dentate laterally; front coarsely and distinctly punctured, vertex with strong punctures; the furrow which extends back on the occiput deep, giving the latter an emarginate appearance; space between the eyes at the top much greater than the length of antennal joints 2 and 3 united, about equal to the length of joints 3 and 4; first joint of the flagellum but little shorter than the second; dorsulum

with strong, separated punctures; scutellum likewise, not impressed, upper surface of metathorax very strongly reticulated, the sides coarsely striated; legs tolerably well spined; pygidium very sparsely punctured, a little more than twice longer than it is broad at the base. Black; last abdominal segment red; front, face, clypeus and thorax more or less, with silvery pubescence; abdomen with a dense silvery pile; wings fuscous, base broadly hyaline, nervures black; marginal cell obliquely truncate; second submarginal cell at the top much greater than the third at the same place. Length 10–11 mm.

Florida, in the vicinity of St. Augustine (*C. W. Johnson*). The dark wings and sculpture of metathorax will distinguish this species from its allies.

17.—*Tachysphex fusus* n. sp.

♀.—Anterior margin of the clypeus slightly produced medially, not dentate laterally; front with the punctures coarser and closer than in the species just preceding; vertex strongly punctured; occiput when viewed from behind emarginate at the top; space between eyes at top much greater than the length of antennal joints 2 and 3 united about equal to joints 3 and 4 united; first joint of flagellum but little shorter than the second; dorsulum with strong separated punctures; scutellum distinctly impressed; metathorax above strongly granulated, the sides finely, though distinctly striated; legs tolerably well spined; pygidium sparsely punctured, about two and a half times longer than it is broad at the base. Black; scape beneath at apex and the mandibles in the middle reddish; tarsi reddish-testaceous; last two abdominal segments bright red; front, face and clypeus densely clothed with silvery pubescence, the thorax sparsely clothed; abdomen with a rather dense silvery pile; wings subhyaline, iridescent, nervures black; marginal cell obliquely truncate; width of the second submarginal cell at the top usually greater than the third at the same place. Length 9–10 mm.

♂.—Front with coarse, confluent punctures; vertex strongly punctured; space between eyes at top, if anything, greater than the length of antennal joints 2–4 united; anterior margin of the clypeus with the lateral angles sharp and with the medial portion very slightly produced; antennæ rather long, the flagellum a little thickened medially, the first joint of the latter about one-third shorter than the second; dorsulum with strong, separated punctures; scutel-

lum impressed; upper surface of metathorax transversely rugoso-granulated, the sides rather strongly striated; abdomen if punctured ventrally, it is very finely so. Colored and ornamented like the ♀. Length 7–8 mm.

Texas; Las Cruces, N. Mexico (*T. D. A. Cockerell*); Nevada; Montana. The pale wings and sculpture of metathorax will separate this species from the preceding one, while the shape of fore margin of clypeus will distinguish it from *terminatus*, which it most resembles. The ♂ differs from that of *terminatus* by the coarsely sculptured front.

18.—*Tachysphex terminatus* Smith.

*Larrada terminata* Sm., l. c. p. 291.

*Larra terminata* Patton, l. c. p. 389.

*Larra minor* Prov., Add. Hym. Quebec, p. 268. ♀ ♂

♀.—Anterior margin of the clypeus subtruncate, not produced in the middle; front finely granulated; vertex strongly punctured; occiput when viewed from behind not, or very slightly, emarginate above; space between the eyes at top about equal to the length of antennal joints 3 and 4 united, if anything slightly less; first joint of the flagellum nearly one-third shorter than the second; dorsulum with tolerably strong and separated punctures, which become close anteriorly; scutellum very slightly impressed; upper surface of the metathorax granulated, the sides distinctly, though not strongly striated; legs not very strongly spined; pygidial area sparsely punctured, about two and a half times longer than it is broad at the base. Black; mandibles in middle and scape beneath at apex reddish; tarsi apically reddish-testaceous; last two segments of abdomen bright red; wings subhyaline, iridescent, nervures testaceous; marginal cell obliquely subtruncate; second submarginal cell at the top wider than the third. Length 9–10 mm.

♂.—This sex resembles very closely the ♂ of *fuscus* but differs as follows: Space between the eyes at top distinctly greater than the length of antennal joints 2–4 united; front a little more closely and finely punctured; anterior margin of clypeus slightly rounded out, not produced medially, the lateral angles sharp, almost dentiform; dorsulum with the punctures sparser; wings more iridescent; legs less strongly spinose. Length 6 mm.

Canada to District of Columbia; N. Illinois (*Nason*); Vancouver. A ♀ from Nevada which I take to be a variety of this species has

**THIS PAGE IS LOCKED TO FREE MEMBERS**

Purchase full membership to immediately unlock this page

# Know Your Bible

Forgotten Books' Full Membership provides unlimited access to more than 28,000 volumes of Christian literature for \$8.99/month

**HOLY BIBLE**

**Continue**

\*Fair use policy applies

vertex with distinct punctures; occiput when viewed from behind very slightly emarginate; space between the eyes at the top distinctly less than the length of antennal joints 3 and 4 united, but still a little greater than the length of joints 2 and 3 united; first joint of the flagellum about one-third shorter than the second; dorsulum with strong, tolerably well separated punctures, the latter are however closer than in *apicalis*; upper surface of metathorax finely reticulated or reticulato-granulated, the metapleuræ rather strongly striated; tibiæ and tarsi tolerably well armed with spines; pygidial area sparsely punctured, nearly three times as long as it is broad at base. Black; mandibles medially and scape beneath at apex, obscure reddish; apex of abdomen *not* red; wings subfuscous, iridescent, nervures black; marginal cell subtruncate; width of the second and third submarginal cells at the top variable, although the second is usually greatest; face, front and clypeus with silvery pubescence, that on the thorax sparser; abdomen with silvery pile. Length 9 mm.

♂.—Front even more finely punctured than in the ♀; occiput not or very indistinctly emarginate; space between the eyes at top about equal to the length of antennal joints 2–4 united, at any rate not greater; anterior margin of clypeus a little more strongly rounded out than in the ♀; antennæ tolerably long, not thickened, the first joint of the flagellum about one-third shorter than the second; scutellum not impressed; upper surface of metathorax rather coarsely granulated, the metapleuræ finely striated; abdomen closely and finely punctured ventrally; pubescence about as in the ♀; wings paler, the marginal cell more obtuse and narrower at apex. Length  $6\frac{1}{2}$  mm.

Connecticut in August (*Patton*); Georgia; Florida (*Mrs. A. T. Slosson*), Cedar Keys, June (*Coll. A. E. S.*).

21.—*Tachysphex amplus* n. sp.

♀.—Anterior margin of clypeus rounded out, armed with a tooth laterally; front rather strongly and closely punctured becoming granulated towards insertion of antennæ; vertex with distinct, tolerably close punctures; occiput not at all emarginate, in consequence of the impressed line not being strong; space between the eyes at top about equal to the length of the third joint of antennæ; first joint of the flagellum but little shorter than the second; dorsulum with tol-

erably fine and close punctures; scutellum slightly impressed; metathorax above strongly granulated, the metapleuræ rather coarsely striated as is likewise the posterior face; tibiae and tarsi well armed with spines; pygidial area feebly and sparsely punctured, but little, if anything longer than twice its width at the base. Black; mandibles medially, scape beneath at apex and tarsi, except first joint, reddish; abdomen bright red, without silvery pile; wings subhyaline, scarcely iridescent, nervures black; marginal cell obliquely truncate; width of the second submarginal cell at the top decidedly greater than the width of the third at the same place; head and thorax very sparsely clothed with silvery pubescence. Length 14 mm.

♂.—Front coarsely granulated, on upper portion becoming punctured; vertex with distinct, rather sparse punctures, those on the clypeus very fine and close; space between the eyes at top greater than the length of antennal joints 2 and 3 united, but decidedly shorter than 3 and 4 united; antennæ similar to the ♀, the first joint of the flagellum a little more than one-quarter shorter than the second, the second, third and fourth joints about equal; anterior margin of clypeus subtruncate; dorsulum with distinct, tolerably close punctures; metathorax above granulated, on the sides and behind striated; legs feebly spinose; colored like the female. Length 10 mm.

Nevada; New Mexico. This is one of our largest species.

22.—*Tachysphex montanus* Cress.

*Larrada montana* Cr., Proc. Ent. Soc. Phila. IV, p. 465. ♀.

*Larra montana* Patt., l. c. p. 389.

♀.—Anterior margin of clypeus subtruncate, with a large tooth laterally; front with rather fine and close, though distinct punctures; vertex very finely and closely punctured; space between the eyes at top less than the length of antennal joints 3 and 4 united, but greater than the length of joints 2 and 3 united; first joint of the flagellum about one-quarter shorter than the second; dorsulum with very fine and close punctures; scutellum slightly impressed; metathorax above finely coriaceous, the metapleuræ likewise, posterior face indistinctly striated; legs strongly spinose; abdomen stout, more or less compressed, especially apically; pygidial area sparsely punctured, its length a little more than twice greater than it is wide at base. Black; mandibles medially, scape beneath at apex and tarsi, except



first two joints, obscure reddish; abdominal segments 1-3 bright red; wings subhyaline, iridescent, nervures testaceous; marginal cell subtruncate; width of the second and third submarginal cells at the top about equal; head in front and the thorax sparsely clothed with silvery pubescence; abdomen without silvery pile. Length 11-12 mm.

♂.—Front and vertex a little more strongly punctured than in the ♀; anterior margin of clypeus subtruncate, not dentate laterally; space between eyes at top greater than the length of antennal joints 2 and 3 united, but less than the length of joints 3 and 4 united; antennæ long, setaceous; first joint of flagellum about one-quarter shorter than the second; dorsulum with very fine and close punctures; metathorax above and on the sides finely coriaceous; legs tolerably well armed with spines; colored like the ♀, but the wings darker. Length 9-11 mm.

Colorado.

23.—*Tachysphex decorus* n. sp.

♀.—Anterior margin of clypeus subtruncate, dentate laterally; front finely granulated; vertex finely and closely punctured; space between the eyes at top about equal to the length of antennal joints 2 and 3 united; first joint of the flagellum but little shorter than the second; dorsulum very finely and closely punctured; scutellum not impressed; upper surface of metathorax with tolerably strong longitudinal, sinuous striations or folds, the metapleuræ very indistinctly striated, the posterior face more distinctly so; legs rather strongly spinose; pygidial area impunctate, very narrow on apical portion, its length about two-and-a-half times longer than it is wide at the base. Black; mandibles medially, scape beneath at apex and tarsi, except basally, reddish; abdomen without silvery pile, the first three segments bright red; wings subhyaline, iridescent, nervures testaceous; marginal cell broadly and obliquely truncate; second submarginal cell at the top greater than the third at the same place; face and clypeus with sparse silvery pubescence; thorax with a sparse silvery pile. Length 9 mm.

Dakota. Based on a specimen labelled *Larrada dakota* Cress., which is evidently only a manuscript name.

24.—*Tachysphex inusitatus* n. sp.

♂.—Front finely and closely punctured, widely channelled down

**THIS PAGE IS LOCKED TO FREE MEMBERS**

Purchase full membership to immediately unlock this page

# DELVE INTO FANTASY, MAGIC, MYTHOLOGY & FOLKLORE

Forgotten Books'  
Full Membership gives  
access to 797,885 ancient  
and modern, fiction and  
non-fiction books.

**Continue**

\*Fair usage policy applies

differs in the sculpture of metathorax and the form of pygidium. Two specimens from Colorado, I refer with some doubt to this species; they measure 14 mm.

26.—*Tachysphex exsectus* n. sp.

♀.—Anterior margin of the clypeus in the middle distinctly emarginate and armed laterally with at least two strong teeth; front very finely and closely punctured; (it is difficult to determine in some species whether the front is punctured or granulated); vertex even more finely punctured; space between the eyes at top about equal to the length of antennal joints 2 and 3 united; first joint of the flagellum fully one-third shorter than the second; dorsulum very finely and closely punctured; scutellum not impressed; upper surface of metathorax finely granulated, metapleuræ finely coriaceous, the posterior face striated; legs rather strongly spinose; pygidial area strongly and sparsely punctured, its length fully two-and-a-half times greater than it is wide at the base. Black; mandibles medially, scape beneath at apex and the tarsi reddish (the tibiæ are sometimes indistinctly reddish); abdomen with a sparse silvery pile, the first three segments red; wings pale subhyaline, iridescent, nervures testaceous; marginal cell obliquely subtruncate; width of the second and third submarginal cells at the top about equal; front, face, clypeus and thorax with a silvery pubescence densest and brightest on the first mentioned parts. Length 9 mm.

♂.—Space between eyes at top greater than the length of antennal joints 2 and 3 united, but less than that of joints 3 and 4 united; anterior margin of clypeus subtruncate, not emarginate or dentate; upper surface of metathorax striated at the base; colored like the ♀; marginal cell obliquely truncated. Length 7 mm.

Montana; Mt. Hood, Oregon. I am in some doubt whether what I have described as the ♂, really belongs to this species; although agreeing more closely with this, yet their locality would seem to indicate relationship to *tenuipunctus*, to which species I had at first referred it.

27.—*Tachysphex consimilis* n. sp.

♀.—Anterior margin of clypeus subtruncate, not emarginate and not dentate laterally; front finely granulated; vertex finely and closely punctured; space between eyes at top greater than the length of antennal joints 2 and 3 united, but a little less than the combined

length of joints 3 and 4; first joint of flagellum scarcely one-quarter shorter than the second; dorsulum very finely and closely punctured; metathorax above granulated, metapleuræ very finely striated; pygidial area strongly and sparsely punctured, a little more than twice longer than it is wide at the base. Black; mandibles medially, scape beneath at apex and the tarsi, except first joint, reddish; abdomen without silvery pile, the first three segments red; wings pale subhyaline, iridescent, nervures testaceous; marginal cell obliquely subtruncate; second and third submarginal cells at the top about equal, if otherwise, the third is widest; front, face and clypeus with sparse silvery pubescence; thorax on sides and beneath, with a silvery pile. Length 7 mm.

♂.—Front very finely granulated; space between the eyes at top equal to or a little greater than the length of antennal joints 3 and 4 united; antennæ tolerably long and stout, the first joint of flagellum about one-third shorter than the second; the metathorax is more coarsely sculptured than in the female, the upper surface being strongly granulated and the base striated; colored like the female; pubescence on face denser; thorax with distinct silvery pubescence; abdomen with silvery pile. Length 7–8 mm.

Montana. Greatly resembles *exsectus*, but the eyes are more widely separated at the top, etc.

28.—*Tachysphex quebecensis* Prov.

*Larra quebecensis* Prov., Faun., Ent. Can. II, 633. ♀ ♂.

♀.—Anterior margin of clypeus subtruncate, dentate laterally, sometimes indistinctly so; front finely granulated; vertex finely and closely punctured; space between the eyes at the top about equal to length of antennal joints 2 and 3 united; first joint of the flagellum but little shorter than the second; dorsulum very finely and closely punctured; scutellum distinctly impressed; metathorax above coarsely wrinkled, the metapleuræ coarsely striated, the posterior face not so strongly striated; pygidial area strongly and sparsely punctured, nearly two and a half times longer than it is broad at the base. Black; mandibles in the middle, scape beneath at apex and the tarsi apically, reddish; abdomen more or less with silvery pile, the first two segments bright red; wings dark subhyaline, iridescent, nervures blackish; marginal cell obliquely truncate; width of the second and third submarginal cells at the top variable; head in front and thorax with a sparse, silvery pubescence. Length 10–11 mm.

♂.—Front finely granulated; space between eyes at top greater than the length of antennal joints 2 and 3 united, but a little less than that of joints 3 and 4 united; antennæ rather long and slender, the first joint of flagellum about one-third shorter than the second; anterior margin of clypeus slightly emarginate; metathorax more strongly sculptured above than in the ♀, but the striations of metapleuræ are not so strong; colored like the ♀, with the pubescence of head and thorax more profuse. Length 9 mm.

Canada (*J. A. Guignard*); Maine; Massachusetts. Resembles very much *tenuipunctus*, but the sculpture of metathorax will at once distinguish it from that species.

29.—*Tachysphex compactus* n. sp.

♂.—Anterior margin of clypeus subtruncate, not dentate laterally; front with fine and close punctures, appearing somewhat granulated; vertex very finely and closely punctured; space between the eyes at top about equal to the length of antennal joints 3 and 4 united; antennæ tolerably long and slender, the first joint of the flagellum scarcely one-third shorter than the second; dorsulum very finely and closely punctured; scutellum impressed; metathorax above coriaceous, the metapleuræ and posterior face finely and rather indistinctly striated; legs strongly spinose. Black; mandibles medially, scape beneath at apex and the tarsi, except basal joints, reddish; abdomen with a sparse, sericeous pile, the first three segments red; wings subhyaline, not strongly iridescent, nervures testaceous; marginal cell obliquely subtruncate; second submarginal cell a little broader at the top than the third; front, face and clypeus with silvery pubescence, the thorax sparsely so. Length 9 mm.

Vancouver; Colorado. May be the ♂ of *tenuipunctus*, but I scarcely believe it possible. Its robust form will at once distinguish it.

30.—*Tachysphex triquetrus* n. sp.

♀.—Anterior margin of clypeus indistinctly emarginate medially, armed with a large tooth laterally; front very finely and closely punctured, the vertex even more finely so; space between eyes at top about equal to the length of antennal joints 2 and 3 united; first joint of flagellum but very little shorter than the second; dorsulum punctured like the front, perhaps more finely so; scutellum im-

**THIS PAGE IS LOCKED TO FREE MEMBERS**

Purchase full membership to immediately unlock this page

# Know Your Bible

Forgotten Books' Full Membership provides unlimited access to more than 28,000 volumes of Christian literature for \$8.99/month

**HOLY BIBLE**

**Continue**

\*Fair use policy applies

32.—*Tachysphex nigrior* n. sp.

♀.—Anterior margin of clypeus subtruncate, entire, not or indistinctly dentate laterally; front very finely granulated; vertex very finely and closely punctured; space between the eyes at top greater than the length of antennal joints 2 and 3 united, but a little less than that of joints 3 and 4; antennæ long and slender, first joint of flagellum nearly one-third shorter than the second; dorsulum with fine, tolerably close punctures, but neither as fine nor as close as those on the vertex; scutellum not impressed; metathorax above rather delicately reticulated, the metapleuræ and posterior face distinctly, but not strongly, striated; legs, in comparison to *triquetrus* and *cæthiops*, feebly spinose; pygidial area strongly and sparsely punctured, its length about two-and-a-half times greater than it is wide at base. Entirely black, except mandibles medially, scape beneath at apex and last three joints of tarsi, which are reddish; wings subhyaline, iridescent, nervures blackish; marginal cell obliquely subtruncate; second submarginal cell at the top usually somewhat wider than the second; face and clypeus with sparse, silvery pubescence; thorax nude; abdomen sparsely pilose. Length 7–9 mm.

♂.—Anterior margin of clypeus as in the ♀; front likewise; space between the eyes at top about equal to the combined length of antennal joints 2, 3 and 4; antennæ not very long, rather stout, the flagellum thickened somewhat medially, with the first joint not much shorter than the second; scutellum slightly impressed; metathorax sculptured as in the ♀, but more strongly; colored like the opposite sex. Length 6–8 mm.

State of Washington. One specimen, a female, has the basal segments of abdomen obscurely reddish, which would indicate that there may be examples with the abdomen red and black.

33.—*Tachysphex pauxillus* n. sp.

♀.—Anterior margin of the clypeus subtruncate, armed with a distinct tooth laterally; front very finely granulated; vertex very finely and closely punctured; space between the eyes at top greater, but not much, than the length of antennal joints 2 and 3 united, much less than that of joints 3 and 4 united; antennæ long and slender, the first joint of flagellum nearly one-third shorter than the second; dorsulum with very fine, tolerably close punctures, the latter are as fine

as those of the vertex; metathorax above granulated, the metapleuræ and posterior face distinctly, though not strongly, striated; legs feebly spinose; pygidium strongly and sparsely punctured, its length but little greater than twice its width at the base. Black; mandibles medially, scape beneath at apex and the most of tarsi, reddish; abdomen not pilose, and, excepting the last two segments bright red; wings subhyaline, nervures testaceous; marginal cell obliquely truncate; face and clypeus with sparse silvery pubescence. Length 6 mm.

California.

34.—*Tachysphex punctifrons* Fox.

*Larra punctifrons* Fox, Ent. News. II, p. 194. ♀.

♀.—Anterior margin of clypeus with or without an emargination medially, armed with a tooth laterally; front finely and evenly punctured, appearing granulated; the vertex more finely punctured; space between eyes at top somewhat greater than the length of antennal joints 2 and 3 united, but much less than that of joints 3 and 4 united; dorsulum like the vertex; first joint of flagellum but little shorter than the second; scutellum slightly impressed; metathorax coriaceous, the posterior face indistinctly striated; legs strongly spinose; pygidial area sparsely and strongly punctured, its length fully two-and-a-half times, or more, longer than it is wide at base. Entirely black, clothed with a sericeous pile; wings subhyaline, not iridescent, nervures testaceous; marginal cell obliquely subtruncate; face and clypeus without silvery pubescence; apical half of tarsi reddish. Length 12–13 mm.

♂.—Anterior margin of clypeus not emarginate, nor dentate; sides of front and face depressed; space between eyes at top about equal to the length of antennal joints 3 and 4 united; first joint of flagellum not much shorter than the second; wings iridescent; head in front with rather dense silvery pubescence. Length 11–12 mm.

New Jersey, in September; Florida (*Mrs. A. T. Slosson*); Illinois; Colorado; Montana. The dense sericeous pile, with which this insect is clothed, and the large size, will at once distinguish it from the other species of this genus.

35.—*Tachysphex mundus* n. sp.

♀.—Anterior margin of clypeus not strongly, though distinctly



emarginate medially and armed laterally with two teeth; front with exceedingly fine and close punctures; vertex with the punctures more distinct; space between the eyes at top about equal to the length of antennal joints 2 and 3; first joint of flagellum about one-quarter shorter than the second; dorsulum somewhat more coarsely punctured than the front; scutellum not impressed; metathorax coriaceous or else finely granulated, the sides smooth, the posterior face striated; tegs tolerably spinose; longer spur of hind tibiæ in length greater than the first joint of the hind tarsi; pygidial area strongly and sparsely punctured, in length but little greater than twice longer than its width at the base. Black; mandibles medially and scape beneath at apex, reddish; tarsi, tegulæ and the apical margins of segments (more broadly than in the other species) testaceous; wings pale subhyaline, iridescent, nervures testaceous; marginal cell narrowly truncate; head in front and the thorax with dense silvery pubescence; abdomen with a dense silvery pile, which appears as four bands when viewed from behind. Length 8–9 mm.

♂.—Anterior margin of clypeus not emarginate or dentate; front rather coarsely granulated; vertex more distinctly punctured than in the ♀; space between the eyes at top greater than the length of antennal joints 2 and 3 united, but scarcely equal to that of joints 3 and 4; first joint of flagellum nearly one-third shorter than the second; dorsulum with the punctures separated; scutellum distinctly impressed; metathorax above strongly granulated, the sides coriaceous; colored like the ♀, except that the abdomen is entirely testaceous. Length 8 mm.

Illinois; Texas. This species is as densely pilose as *punctifrons*, but the pile is silvery, the sculpture different and the size much smaller.

36.—*Tachysphex minimus* Fox.

*Tachytes minimus* Fox, Tr. Amer. Ent. Soc. XIX, p. 248. ♂.

♂.—Anterior margin of the clypeus subtruncate, not dentate laterally; front with exceedingly fine and close punctures; space between the eyes at top about equal to the length of antennal joints 2 and 3 united; first joint of flagellum about one-quarter shorter than the second; dorsulum with the punctures even and distinct, much stronger than those of the front; scutellum not impressed; metathorax above granulated, the metapleuræ and posterior face finely, though distinctly, striated. Black; mandibles medially and scape

**THIS PAGE IS LOCKED TO FREE MEMBERS**

Purchase full membership to immediately unlock this page

# DELVE INTO FANTASY, MAGIC, MYTHOLOGY & FOLKLORE

Forgotten Books'  
Full Membership gives  
access to 797,885 ancient  
and modern, fiction and  
non-fiction books.

**Continue**

\*Fair usage policy applies

close punctures; first joint of flagellum about one-third longer than the second; distance between hind ocelli somewhat greater than the space between them and the nearest eye-margin; dorsulum finely and closely punctured; metathorax above with a central, longitudinal raised line, from each side of which, extend in an irregular manner coarse folds or rugæ; posterior face coarsely rugose, the metapleuræ finely granulated; legs not very strongly spinose. Black, the tegulæ and tarsi somewhat testaceous; clypeus densely, and thorax more or less, with silvery pubescence; legs and abdomen with a silvery pile, which is most conspicuous on apical margin of segments 1-3; wings subhyaline, apex fuscous, nervures testaceous. Length 11-13 mm.

♂.—Resembles the ♀ but is smaller; anterior margin of clypeus in the middle strongly bilobate, not dentate laterally; antennæ shorter and stouter; legs feebly spinose; colored and ornated like the ♀; dorsulum with the punctures finer. Length 7-9 mm.

Canada to Florida, westward to Montana. *L. caliptera* Say is probably only a variety of this species.

2.—*Lyroda triloba* Say.

*L. triloba* Say. l. c. p. 372.

♀.—Anterior margin of clypeus subtruncate medially, not dentate laterally; front and vertex seemingly impunctate; first joint of flagellum a little more than one-third longer than the second; distance between the hind ocelli, if anything, a little less than the space between them and the nearest eye-margin; dorsulum indistinctly punctured; metathorax above finely rugoso-granulated, with a longitudinal medial raised line, the metapleuræ coarsely striated throughout. Deep black; tegulæ and tarsi somewhat testaceous; head and thorax, especially the face and clypeus, with brownish pile; abdomen also sparsely pilose, but the pile is not silvery or conspicuous; wings dark fuscous, iridescent. Length 14-15 mm.

Canada to Texas; Illinois; Indiana (Say). The large size and dark wings will at once distinguish this species from *subita*.

**DIPLOPLECTRON FOX.**

*Diploplectron* Fox, Tr. Amer. Ent. Soc. XX, p. 38, 1893.

Head broader than the thorax; mandibles bidentate at apex, the outer tooth by far the longest, the outer margin is incurved medially, or very slightly emarginate, in the ♀ the mandibles are shorter, broader

and the outer margin seems to be entire; eyes strongly converging towards the vertex, so that the distance between them at that point is about equal to half of that at the mandibles; *ocelli round, convex, and situated so as to form a rather high triangle*; antennæ situated very low down, the middle lobe of clypeus extending up between them, rather long, very slightly thickened medially (the thickening is more obvious in the ♂) and narrowed to apex, *alike in both sexes, i. e. those of the ♂ are not formed into a spiral as in Dinetus*; prothorax large and very prominent, not emarginate above, and the anterior portion is not cut off so suddenly as in most of the allied genera; when compared with the dorsulum it is fully two-thirds as long; *metathorax longer than the dorsulum, with no distinct enclosure*; anterior wings with an extremely short marginal cell, which is broadly truncate at apex, and has a long and distinct appendiculate cell; *there are three cubital or submarginal cells, the first of which is longer than the two others combined, the second submarginal cell is triangular*; the first and second recurrent nervures are received by the first and second submarginal cells respectively, as in *Dinetus*; anterior tarsi of ♀ with a comb formed of long, slender, widely separated spines; the ♂ has no tarsal comb; *middle tibiae of both sexes with two spurs*. Last dorsal segment of ♀ with an elongate triangular pygidium.

**Diploplectron brunneipes** Cress.

*Liris* (?) *brunneipes* Cress., Proc. Ent. Sect. Acad. Nat. Sci., 1881, p. III, ♂ ♀.

*Diploplectron brunneipes* Fox, l. c. p. 38.

♀.—Middle lobe of clypeus convex, produced a little anteriorly, the lateral lobes depressed; front and vertex polished, seemingly impunctate; antennæ long, setaceous, flagellum with joints 1-4 about equal in length; vertex with a fovea on each side of ocelli; dorsulum and scutellum polished, impunctate; scutellum convex, not impressed; upper surface of metathorax granulated, the metapleuræ coarsely striated; legs tolerably spinose; pygidial area sparsely punctured, not prominent. Black; clypeus medially, mandibles except apex, antennæ, prothorax and four anterior legs, pale brown, the hind legs and abdomen castaneous; tegulæ and humeral tubercles, yellowish; wings subhyaline, nervures testaceous. Length 6 mm.

♂.—Similar to the ♀; first joint of flagellum a little longer than the second; clypeus and sides of face bright yellow; prothorax and

femora, except apex, black; legs feebly spinose. Length  $5\frac{1}{2}$  mm.

Colorado; Nevada. Seems to be very rare.

#### PLENOCULUS Fox.

*Plenoculus* Fox, Psyche, Nov. 1893, p. 554.

*Outer margin of mandibles strongly emarginate; in the ♂ the clypeus has on each side a fringe of hairs as in Cerceris; eyes within not emarginate, distinctly converging towards the vertex; ocelli round and prominent, all three distinct, placed in the form of a triangle; antennæ short and stout, originating immediately behind the clypeus, the flagellum more or less clavate; head transverse, wider than the thorax; pronotum not reaching the level of the dorsulum; metathorax shorter than the dorsulum; legs stout, the femora narrower at apex than at the base, tibiæ and tarsi strongly spinose, anterior tarsi with a tolerably well-developed comb; tibial spurs large, the hind tibiæ with two, the four anteriors with but one; tarsal claws rather long and slender, entire, smaller in the ♂; wings with an elongate marginal cell, which is truncate at apex and with a small though distinct appendiculation, three submarginals of which the first is nearly twice as long as the other two combined, the second petiolate, the third is oblique and slightly narrowed above, first recurrent nervure received by the first submarginal cell near its apex, the second by the second submarginal cell between its middle and apex, the discoidal and basal nervures meet at a short distance from the apex of the submedian cell, this cell being therefore shorter than the median cell on the externo-medial nervure, stigma small, scarcely distinguishable from the costal nervure; last dorsal segment of ♀ with a large and distinct pygidial area.*

Three species of this genus are known at present, all of which occur in the United States.

Clypeus strongly emarginate medially and dentate laterally; first joint of flagellum, if anything, shorter than the second.

On each side of the clypeal emargination there are from three to five small teeth; mandibles, except apex, and hind tibiæ and tarsi (usually) more or less, yellowish; ♂ with the clypeus, tegulæ, tibiæ and tarsi, yellow; abdomen black. . . . *Davisii*.

On each side of the clypeal emargination, though widely separated from it, are two large and prominent teeth; mandibles reddish medially; hind tibiæ and tarsi not at all yellowish; ♂ unknown; abdomen black . . . . . *propinquus*.

**THIS PAGE IS LOCKED TO FREE MEMBERS**

Purchase full membership to immediately unlock this page

# Know Your Bible

Forgotten Books' Full Membership provides unlimited access to more than 28,000 volumes of Christian literature for \$8.99/month

**HOLY BIBLE**

**Continue**

\*Fair use policy applies

than in *Davisii*; scutellum strongly convex; upper surface of metathorax coriaceous or finely granulated, with a longitudinal, medial, impressed line, and at the extreme base with a transverse series of short striæ, the metapleuræ delicately striated; legs tolerably spinose; pygidial area strongly and sparsely punctured, shorter and broader than in *Davisii* (its length is about one-quarter greater than its width at the base). Black; anterior tibiæ in front yellowish; mandibles medially, tegulæ and tarsi reddish testaceous; segments of abdomen testaceous on apical margins; front, face, clypeus and thorax, more or less, clothed with silvery pubescence; abdomen with a sparse silvery pile; wings hyaline, iridescent, nervures testaceous; distance between the first recurrent nervure and the base of the second submarginal cell on the cubital vein greater than the length of the petiole of the second submarginal cell. Length 6–7 mm.

Colorado. Closely resembles *Davisii* but is distinct by the armature of clypeus, shape of pygidium and color of mandibles and legs.

### 3.—*Plenoculus Cockerellii* n. sp.

♀.—Anterior margin of clypeus rounded-out, not emarginate or dentate; first joint of flagellum distinctly longer than the second; dorsulum and scutellum minutely punctured, the latter strongly convex; metathorax coriaceous, or finely granulated, with a longitudinal, medial, impressed line above, and without the series of transverse striæ at base, metapleuræ shining; legs tolerably spinose, the tarsal comb rather strongly developed; pygidial area strongly and sparsely punctured, short and broad, its lateral margins better developed than in either of the two other species. Black; abdomen entirely red; mandibles, except apex, ferruginous; tegulæ, inner side of hindtibiæ and base of the anterior pair, yellowish; a large spot on the four anterior femora beneath near the apex, white; hind tibiæ on outer side and the tarsi, reddish-testaceous; wings hyaline, iridescent, nervures testaceous; distance between the first recurrent nervure and the base of the second submarginal cell on the cubital vein less than the length of the petiole of the second submarginal cell; the third transverso-cubital nervure on its lower portion bulges out towards the apex of wing. Length 6 mm.

Las Cruces, New Mexico (*T. D. A. Cockerell*). A very pretty and distinct species, which may easily be recognized by its coloration.

## ASTATUS Latr.

*Astatus* Latr., Précis. des Car. gén. des Ins. p. 114. 1796.

*Astata* Latr., Hist. Nat. gen. et part. des Crust. et Ins., T. III, p. 336. 1805.

*Astatus* Kohl, Verh. zool.-bot. Gesell. Wien, XXXIV, p. 431. 1885.

Head about as broad as the thorax; mandibles without emargination on outer margin, on their inner side, not far from the apex, with a blunt tooth; eyes in the ♀ but little converging towards the vertex, *in the ♂ they touch each other at that place*; ocelli round and convex; antennæ originating close to the clypeus, the distance between their bases is about equal to that between them and the eye-margin; prothorax much smaller than the mesothorax, the pronotum drawn down deeply under the level of dorsulum; *shoulder tubercles reaching the tegulæ*; wings with a broadly, truncated marginal cell, the length of which varies in the different species, three submarginal and two discoidal cells; *the posterior wings are remarkable by their extraordinarily large and broad basal lobes*; legs thickly and strongly armed; *the middle tibiæ are two-spurred* and the ♀ with a comb on fore tarsi, composed of a few, moderately long thorns; claws entire, the pulvilli of medium-size; the last dorsal segment of both sexes with a pygidium, which in the ♀ is triangular and usually truncated at apex in the ♂, the latter sex has also in some species a tolerably long fringe of hairs.

This genus, remarkable through the eyes of the ♂ meeting on the vertex, is tolerably well represented in Boreal America. With the exception of a synoptical table<sup>7</sup> our species haven ever been treated in a monographic way. Nothing is known of their habits, although it is likely, that they, like the European *A. boops*, store their nests with Hemipterous larvæ.

## FEMALES.

- |  |                  |
|--|------------------|
| 1—Marginal cell as long or longer than the first submarginal (if shorter it is scarcely noticeable) . . . . .  | 2                |
| Marginal cells always distinctly shorter than the first submarginal . . . . .  | 7                |
| 2—Dorsulum strongly and closely punctured throughout . . . . .   | 3                |
| Dorsulum, especially on posterior portion, sparsely punctured .  | 6                |
| 3—Entirely black . . . . .   | 4                |
| Abdomen red . . . . .  | 5                |
| 4—Produced portion of anterior margin of clypeus subtruncate; vertex coarsely punctured; first joint of flagellum one-third or more longer than the second . . . . . | <i>unicolor.</i> |



- Produced portion of anterior margin of clypeus strongly bidentate vertex with a few, large, scattered punctures; first joint of flagellum less than one-third longer than the second . . . . . *Sayi*.
- 5—Pygidial area long, narrow, its length a little more than twice greater than its width at base; wing-stigma black or dark-red. . . . . *bicolor*.
- Pygidial area of a more triangular form, its length not more than twice greater than its base is broad; wing-stigma yellowish. . . . . *pygidialis*.
- 6—Metanotum with a well-marked, triangular depression at apex; the length of the marginal cell fully equal to that of the first submarginal; entirely black, the pubescence of thorax white . . . . . *occidentalis*.
- Metanotum without a well-marked depression at apex (if at all present it is very indistinct); length of marginal cell a little less than that of the first submarginal; abdomen black and red, or entirely black, the pubescence of thorax usually black, though sometimes white . . . . . *nubeculus*.
- 7—Metanotum with coarse, irregular, radiating striations; antennæ and legs stout . . . . . *nevadicus*
- Metanotum finely sculptured . . . . . 8
- 8—Metanotum finely granulated; tegulæ testaceous . . . . . 9
- Metanotum very finely striated; tegulæ whitish. . . . . *elegans*.
- 9—Produced portion of anterior margin of clypeus narrow, elongate, truncate at apex; meso-and metapleuræ finely sculptured. . . . . *montanus*.
- Produced portion of anterior margin of clypeus armed with three large teeth; meso-and metapleuræ very coarsely sculptured . . . . . *asper*.

## MALES.

- 1—Marginal cell as long or longer than the first submarginal (if shorter it is scarcely noticeable) . . . . . 2
- Marginal always distinctly shorter than the first submarginal . 7
- 2—Entirely black . . . . . 3
- More or less red . . . . . 5
- 3—Pubescence of thorax black; fore-wings, except basal third, fuscous; metanotum strongly reticulated. *nubeculus* (= *nigripilosus*)
- Pubescence of thorax white . . . . . 4
- 4—Wings hyaline throughout; first joint of flagellum fully one-third longer than the second; metanotum not depressed . . . . . *unicolor*.
- Fore wings stained fuscous medially; first joint of flagellum about one-quarter longer than the second; metanotum more or less depressed before apex . . . . . *occidentalis*.
- 5—Pubescence of thorax white; metanotum reticulated. . . . . 6
- Pubescence of thorax black . . . . . *nubeculus*.

**THIS PAGE IS LOCKED TO FREE MEMBERS**

Purchase full membership to immediately unlock this page

# DELVE INTO FANTASY, MAGIC, MYTHOLOGY & FOLKLORE

Forgotten Books'  
Full Membership gives  
access to 797,885 ancient  
and modern, fiction and  
non-fiction books.

**Continue**

\*Fair usage policy applies

punctured; colored similar to the ♀, the pubescence denser. Length 9–12 mm.

Canada to Texas; Colorado; Illinois.

2.—*Astatus Sayi* n. sp.

♀.—Produced portion of anterior margin of clypeus strongly tridentate; front with tolerably strong, close punctures, the vertex with very sparse, strong punctures; ocelli placed in pits, especially the anterior one; antennæ tolerably long, the first joint of flagellum less than one-third longer than the second; dorsulum with tolerably strong and not very close punctures; scutellum sparsely punctured, very slightly impressed medially; metathorax above coarsely reticulated, the reticulum closer than in *unicolor*; the metapleuræ rugose; at the base of posterior face of metathorax, in the middle, is a triangular enclosed space, the lower half of which is smooth; tibiæ and tarsi strongly spinose; abdomen very sparsely punctured, including the second ventral segment; pygidial area less than twice longer than it is broad at the base. Black; mandibles medially, tegulæ and the tarsi obscurely, testaceous; head, thorax and legs tolerably clothed with pale pubescence; with exception of the first segment, the abdomen is nude; wings with the apical third fuscous, the marginal cell obliquely truncate. Length 14 mm.

Virginia. Resembles closely *unicolor*, but is easily distinguished by dentate clypeus, larger size, etc.

3.—*Astatus occidentalis* Cress.

*Astata occidentalis* Cr., Kohl, Proc. Ent. Sect. Acad. Nat. Sciences, Phila., 1881, p. III. ♂.

*Astatus occidentalis* Kohl, l. c. p. 448.

♀.—Produced portion of anterior margin of clypeus sinuous, slightly lobate medially; front with tolerably strong and close punctures, which are, however, not so close as in the preceding species; vertex with sparse, strong punctures; ocelli placed in pits, especially the anterior one; first joint of flagellum about one-quarter longer than the second; dorsulum anteriorly closely punctured, the remainder polished, almost impunctate; scutellum sculptured above like the posterior part of dorsulum, with an impressed line on apical half; metathorax above coarsely reticulated and with a triangular depression at the apex in the middle; metapleuræ coarsely striated; posterior face of metathorax with a pyriform depression, situated be-

tween base and middle; tibiæ and tarsi strongly spinose; abdomen very sparsely punctured, dorsal segments 2–5 with a transverse, sinuous row of punctures between middle and apex; pygidial area less than twice longer than it is broad at base. Black; mandibles medially, tegulæ and tarsi obscurely, reddish-testaceous; head, thorax above and first segment of abdomen with pale pubescence, that on legs and thorax beneath, black; wings fuscous, paler basally; marginal cell obliquely subtruncate. Length 11–14 mm.

♂.—Produced portion of anterior margin of clypeus widely and angularly emarginate; front strongly convex and deeply impressed medially; joints 5–8 of flagellum a little rounded-out beneath, the first joint rather strongly bent or curved and about one-quarter longer than the second; dorsulum finely punctured, very closely so anteriorly; scutellum sculptured like posterior portion of dorsulum, impressed medially; metathorax above rather finely rugoso-granulated, the metapleuræ and posterior face coarsely and closely punctured; abdomen beneath rather closely punctured; apical margins of wings broadly hyaline. Length 11–13 mm.

Nevada; Montana; Washington.

4.—*Astatus nubeculus* Cress.

*Astata nubecula* Cr., Proc. Ent. Soc. Phila. IV, p. 466. ♂.

*Astata nigropilosa* Cr., Proc. Ent. Section, Acad. Nat. Sciences, Phila., 1881, p. IV, ♀ (=var.).

*Astatus nubeculus* Kohl, l. c. p. 448.

♀.—Produced portion of anterior margin of clypeus subtruncate; front with tolerably strong and separated punctures; vertex with sparse, strong punctures; first joint of flagellum about one-quarter, or more, longer than the second; dorsulum anteriorly closely punctured, on the remainder polished, almost impunctate; scutellum similar to the posterior portion of dorsulum, impressed medially; metathorax above coarsely reticulated, the metapleuræ, except lower basal portion rugose; tibiæ and tarsi strongly spinose; abdomen scarcely punctured; pygidial area about twice as long as it is broad at base. Black; mandibles medially, tegulæ and tarsi, reddish-testaceous; abdominal segments; 1, 2 and 3 red; head, thorax and legs clothed with black pubescence; apical third of wings fuscous; marginal cell broadly truncate. Length 9 mm.

♂.—Produced portion of anterior margin of clypeus as in the ♀; first joint of flagellum nearly one-third longer than the second; dorsulum finely and evenly punctured throughout, the scutellum

sparsely so medially; metathorax above more finely reticulated than in the ♀; colored like the ♀; abdomen rather densely clothed, especially ventrally, with dark pubescence; wings hyaline, fuscous medially. Length 9–10.

Var. A. ♀ ♂.—Entirely black. Length 9–13.

Var. B. ♀ ♂.—Entirely black; pubescence white; mandibles of ♂ yellow medially.

Colorado (typical form); Montana; Nevada; Calif.; Washington (var. A. = *nigropilosa* Cr.); Montana (var. B.). Algonquin, Illinois (var. B.) taken by Dr. W. A. Nason.

5.—*Astatus bicolor* Say.

*Astata bicolor* Say, Long's Exp. St. Peter's River, p. 78. 1823.

*Astata rufiventris* Cr., Tr. Am. Ent. Soc. IV, p. 218 ♀.

*Astata terminata* Cr., *ibid*, p. 218, ♂.

*Astatus bicolor* Kohl, l. c. p. 447.

♀.—Produced portion of anterior margin of clypeus truncate; front with tolerably strong and close punctures; the vertex with the punctures stronger and sparser than those of the front; first joint of flagellum about or nearly one-third longer than the second; dorsulum strongly punctured, the punctures on posterior portion but little sparser than those of the anterior; scutellum sparsely punctured, impressed medially; metathorax above coarsely reticulated, the metapleuræ, except lower basal portion, rugose; tibiæ and tarsi strongly spinose; with exception of second ventral segment, the abdomen is impunctate; pygidial area more than twice as long as it is broad at the base. Black; abdomen entirely bright red; mandibles medially and tarsi reddish-testaceous; head, thorax, legs and abdomen beneath with long, pale pubescence; apical third of wings fuscous; marginal cell subtruncate, stigma black or testaceous. Length 11–13 mm.

♂.—Produced portion of anterior margin of clypeus truncate; first joint of flagellum about one-third longer than the second; dorsulum finely and evenly punctured throughout, the punctures finer than in *nubeculus*; sculpture of metathorax above much finer than in the ♀; pubescence colored like the ♀; last two or three abdominal segments black; wings subhyaline, stigma yellowish; tarsi reddish. Length 7–9 mm.

Canada and the entire United States. The larger females are the *A. rufiventris* Cresson, while *A. terminata* Cresson, is but a slight variation of the male.

**THIS PAGE IS LOCKED TO FREE MEMBERS**

Purchase full membership to immediately unlock this page

# Know Your Bible

Forgotten Books' Full Membership provides unlimited access to more than 28,000 volumes of Christian literature for \$8.99/month

**HOLY BIBLE**

**Continue**

\*Fair use policy applies

iorly; scutellum sparsely punctured, not impressed; upper surface of metathorax rather finely reticulated, more so than in the ♀; colored like the ♀; no black pubescence on dorsulum anteriorly nor on the face and clypeus; wings subhyaline throughout; marginal cell obliquely truncate. Length  $7\frac{1}{2}$ –8 mm.

Nevada; New Mexico; Washington; Montana. The specimen from the last mentioned locality differs in having the front more closely and finely punctured.

**8.—*Astatus montanus* Cress.**

*Astata montana* Cr., Proc. Ent. Sect. Acad. Nat. Sciences, 1881, p. V, ♀.

*Astatus montanus* Kohl., l. c. p. 448.

♀.—Median lamina of anterior margin of clypeus long and narrow, truncate at apex; front with a few, large, scattered punctures; vertex with large, sparse punctures; first joint of flagellum about one-quarter longer than the second; dorsulum with large, scattered punctures; scutellum above impunctate, not impressed; mesopleuræ sparsely punctured; metathorax above finely granulated or indistinctly reticulated, the metapleuræ striated; legs tolerably spinose; abdomen almost impunctate; pygidial area about twice as long as it is broad at base. Black; abdomen entirely red; mandibles medially, tegulæ and legs testaceous; head, thorax and legs very sparsely clothed with black pubescence; wings subfuscous, marginal cell obtusely truncate. Length  $5\frac{1}{2}$ – $7\frac{1}{2}$  mm.

Nevada; Colorado.

**9.—*Astatus asper* n. sp.**

♀.—Median lamina of anterior margin of clypeus strongly tridentate; front with tolerably large and sparse punctures, which become closer towards the clypeus; vertex with a few scattered punctures; first joint of flagellum more than one-quarter longer than the second; dorsulum, except anterior portion, almost impunctate; scutellum distinctly impressed; metathorax above finely granulated, the meso- and metapleuræ coarsely rugose; tibiæ and tarsi tolerably spinose; abdomen almost impunctate; pygidial area more than twice longer than it is broad at base. Black; abdomen red; mandibles medially, tegulæ and tarsi, testaceous; cheeks and thorax with a very sparse, white pubescence, that on the femora dark; apical half of wings fuscous, the marginal cell truncate. Length 7 mm.

♂.—Median lobe of clypeus produced into a sharp tooth or spur; first joint of flagellum about one-quarter longer than the second;

metathorax above finely granulated, the metapleuræ rugose; transverse mark before ocelli and tegulæ, white; apical third of wings dark fuscous. Length 9 mm.

Montana. The most satisfactory way to separate the males of this species from the male variety of *elegans*, is by the color of apical third of wings and color of humeral tubercles. This species may be but a variety of *A. Kohli* Cam. from Mexico.

10.—*Astatus elegans* Cress.

*Astata elegans* Cr., Proc. Ent. Sect. Acad. Nat. Sciences, Phila. 1881, p. VI, ♂.  
*Astatus elegans* Kohl., l. c. p. 448.

♀.—Median lobe of clypeus tridentate; front with strong, sparse, irregular punctures; vertex with strong, sparse punctures, which are deeper than those of the front; first joint of flagellum more than one-quarter longer than the second; dorsulum with large, scattered punctures; dorsulum with scattered punctures, distinctly impressed; metathorax above rather strongly impressed down the middle, finely and irregularly striated, the metapleuræ more strongly striated; mesopleuræ sparsely punctured; tibiæ and tarsi rather strongly spinose; abdomen almost impunctate; pygidial area more than twice longer than it is broad at base (it is broad basally, then contracting before middle and continuing narrowly to the apex). Black; abdomen entirely red; mandibles medially and legs testaceous; tegulæ, shoulder tubercles and spot at top of mesopleuræ, white; head thorax and legs very sparsely clothed with pale pubescence; wings subhyaline, marginal cell truncate; stigma yellow. Length 8½–9 mm.

♂.—Median lobe of clypeus produced into a sharp tooth or spur; first joint of flagellum not one-quarter longer than the second; dorsulum anteriorly rather finely and closely punctured, on the posterior part sparsely so; scutellum impressed; metathorax above evidently granulated, depressed before apex, the metapleuræ rugose; in addition to the white markings of the ♀, there is a large transverse mark before the ocelli, base of wings, a spot at base of anterior and middle tibiæ, and a band near the apex of the first dorsal segment, which is sometimes interrupted medially, white; wings subhyaline, not darker apically. Length 7–9 mm.

Var. ♂.—No white markings on first abdominal segment.

Washington; Vancouver; Nevada; Colorado. The variety mentioned above may prove to be the male of *nevadicus*.



11.—*Astatus bellus* Cress.*Astata bella* Cr., *ibid*, p. VI. ♂.*Astatus bellus* Kohl., l. c. p. 447.

♂.—Median lobe of clypeus obtuse, or truncate at tip; front rugose; first joint of flagellum about one-quarter longer than the second; dorsulum finely and closely punctured, particularly anteriorly; scutellum slightly impressed; metathorax above very finely and transversely striated, the metapleuræ coarsely so, the posterior face deeply punctured. Black; abdomen, tibiæ and tarsi, red; femora testaceous; two transverse, small spots before ocelli, mandibles medially, tegulæ, base of wings, spot before tegulæ and another at base of fore tibiæ, white; head and thorax with pale pubescence; wings hyaline, with a pale fuscous spot, which includes the marginal, second and third submarginal cells; marginal cell truncate. Length 7 mm.

San Diego, California.

2.—*Astatus caeruleus* Cress.*Astata caerulea* Cr., *ibid*, p. IV. ♂.*Astatus caeruleus* Kohl., l. c. p. 447.

♂.—Median lobe of clypeus produced into a short tooth or spur; front closely punctured throughout; first joint of flagellum not one-quarter longer than the second; dorsulum closely punctured anteriorly, posteriorly the punctures become sparse and stronger; scutellum impressed; metathorax above rather coarsely granulated, the meso- and metapleuræ rugose. Entirely ceruleous; antennæ and greater part of legs black; head and thorax with sparse, black pubescence; tegulæ testaceous; wings dark fuscous; marginal cell truncate; abdomen ventrally strongly punctured. Length 8 mm.

Nevada.

## DIENOPLUS gen. nov.

Similar in form to *Astatus*; head about as broad as the thorax; *inner eye-margins almost parallel in both sexes*; eyes beneath reaching to the base of the mandibles, *which are not emarginate on outer margin*; clypeus large, especially in the ♂, and transverse; the labrum is large and prominent, but not projecting; antennæ situated close to the clypeus, and are separated from each other by a distance much less than that between them and the nearest eye-margin, in the ♀ short and thick, in the ♂ slender and half again as long; ocelli all distinct and prominent, forming a curve; prothorax above not

**THIS PAGE IS LOCKED TO FREE MEMBERS**

Purchase full membership to immediately unlock this page

# DELVE INTO FANTASY, MAGIC, MYTHOLOGY & FOLKLORE

Forgotten Books'  
Full Membership gives  
access to 797,885 ancient  
and modern, fiction and  
non-fiction books.

**Continue**

\*Fair usage policy applies

strong foveæ. Black; dorsal segments 1 and 3 and ventrals 2; 3 and 4, red; inner orbits below middle of front broadly, face, clypeus entirely, scape in front, four anterior tibiæ in front, and a spot near the base of the hind tibiæ, yellow; flagellum beneath fulvous. Length 6 mm.

State of Washington.

**BOTHYNOSTETHUS Kohl.**

*Bothynostethus* Kohl, Verh. zool.-bot. Gesell. Wien, p. 344, Taf. XVIII, f. 5 et 6. 1883.

Body stout; head as broad as the thorax; *eyes diverging towards the vertex; the eyes at the bottom touch the base of the mandibles, on the outer margin of which there is no emargination*; clypeus tolerably stout; antennæ placed close behind the clypeus, the distance between them being twice as great as that between them and the nearest eye-margin, and are short and stout; ocelli regularly round, convex, placed in a low triangle; top of pronotum nearly on the same level with the dorsulum, its lateral angles rounded; shoulder-tubercles not reaching to the tegulæ; wing neuration agreeing very nearly with that of the genus *Nysson*; the stigma is much larger, however, and the basal vein touches a little beyond the apex of the median cell on the discoidal vein, whilst in all the known species of *Nysson* this vein touches before the apex of the above mentioned cell; radial cell broad, lanceolate, large, almost greater than the first submarginal cell, without appendiculation; the second submarginal cell receives both recurrent nervures, *is triangular and distinctly petiolated*; the first submarginal excels by far the combined length of the second and third; the cubital vein of hind wings originates tolerably far beyond the apex of the median cell; the legs, including the tarsi are stout; *middle tibiæ with one spur*; the anterior tarsi have a very short comb, which is composed of slender spines; the remaining tarsi and tibiæ appear, with exception of the spines at apex of joints, unarmed; *the posterior femora reach their greatest breadth at the apex*, which is very rarely the case in other hymenopterous genera; claws not toothed; last dorsal segment of ♀ with a large, triangular pygidium, which is covered with short pubescence; the ♂ is similar to the ♀, except that the pygidial area is much less developed, is short and obtuse at tip.

But one Nearctic species of this genus has been described.

**Bothynostethus distinctus** Fox.

*B. distinctus* Fox, Entom. News. II, p. 31. ♀ ♂ . 1891.

♀.—Anterior margin of clypeus bilobate medially and armed laterally with at least two strong teeth; front finely but not very closely punctured; vertex more sparsely so; flagellum subclavate, the first joint shorter than the second, which joint is about equal to the third; dorsulum punctured about like the front; scutellum impressed; metathorax above with a broad and deep, longitudinal channel, which is connected, or nearly so, with the strong depression at the base of posterior face, a little beyond the base of the upper surface is a strongly foveolate, curved furrow, which extends from side to side, with exception of these furrows the upper surface of metathorax is smooth, or finely punctured, metapleuræ strongly rugose; abdomen indistinctly punctured; pygidium large, rounded at tip. Black; line on prothorax above, tubercles, postscutellum and spot near the base of four posterior tibiæ, whitish; the whole insect more or less covered with silvery pubescence, which is most dense on head in front; wings subhyaline, apical margins broadly fuscous; last ventral segment red. Length 7–8 mm.

“ ♂.—More slender than the ♀, the anterior margin of clypeus subtruncate, or slightly sinuate; the anterior tibiæ in front, and the tarsi are rufous; pygidium short, obtuse at tip, with appressed pubescence, otherwise as in the ♀. Length .30 inch.”

New Jersey (July and August); Montana. With exception of being smaller, I can find no difference worth noting in the Montana specimens.

The following annual reports were read and referred to the Publication Committee:—

#### REPORT OF THE RECORDING SECRETARY.

The meetings of the Academy during the past twelve months have been held without intermission. The average attendance has been forty-four, fewer occasions of special interest having occurred than during the preceding year when the attendance averaged sixty-four. Verbal communications of more or less interest and importance were made at almost every meeting, among the speakers being Messrs. Cope, Chapman, Ryder, Wright, Sharples, Goldsmith, Rand, McCook, Willcox, Lesley, Wistar, Woolman, Pilsbry, Heilprin, Rothrock, Holman, Ives, Allen, Pierce, Dixon, Zuill, Holstein, MacFarlane, Ball, Sharp, Morris, Brinton, A. P. Brown, Morsell, Thomas, Ford, U. C. Smith, Calvert, Moeller, A. E. Brown and Wingate.

Such of these communications as have been reported by their authors have been printed in the Proceedings.

Since my last report 194 pages of the Proceedings for 1892 and 376 for 1893, with eleven plates, have been issued. Seventy-two pages of an elaborately illustrated memoir on the Sand Mounds of Florida by Clarence B. Moore have also been printed as the beginning of the tenth volume of the Journal. These sheets will not be distributed until the completion of the number, which will be published in advance of the last part of the ninth volume in consequence of the character of the communications in the hands of the Publication Committee.

In addition to the matter issued at the direct expense of the Academy, the Conchological Section has continued the publication of the "Manual of Conchology" of which 580 pages and 91 plates have appeared since my last report. Numbers of the Entomological News and of the Transactions of the American Entomological Society embracing 731 pages and 91 plates have appeared under the auspices of the Entomological Section, thus making a total of 1,881 pages and 193 plates, exclusive of the portions of the quarto Journal printed but not yet distributed. The statistics of distribution remain the same as last year.

A new edition of the By-Laws and a new list of members and correspondents have also been published.

**THIS PAGE IS LOCKED TO FREE MEMBERS**

Purchase full membership to immediately unlock this page

# Know Your Bible

Forgotten Books' Full Membership provides unlimited access to more than 28,000 volumes of Christian literature for \$8.99/month

**HOLY BIBLE**

**Continue**

\*Fair use policy applies

general or any special fund in a Trust Company to keep the same invested and reinvested subject to the approval of the Finance Committee and in the name of the Academy and to collect the revenues therefrom and deposit the same upon interest till expended. Such arrangement shall be made by a written article revocable at pleasure of the Finance Committee or of the Council."

Chapter VI, Art. 1. The word "lawful" was stricken out and the words "approved by the Finance Committee" were added after "securities." A like amendment was made to Chapter VII, Art. 1.

Chapter IX, Art. 2. For the words a "semi-annual" the words "an annual" was substituted and for "five" the word "ten" was substituted, the words "and July" being stricken out.

Chapter II, Art. 4. The word "annual" was substituted for "semi-annual" and a like amendment was made in Chapter IX, Art. 6.

On favorable recommendation of the Council an offer from Mr. Maxwell Sommerville of \$2,000 for the Academy's interest in the American reprint of the Encyclopedia Britannica bequeathed to the Academy by the late Mrs. Sommerville, was accepted.

The Academy is indebted to Mrs. Clara Jessup Moore for the sum of \$5,000, the interest derived from which is to be used for the assistance of young women desiring to devote themselves to the study of natural history under the same rules and regulations as those governing the Jessup Fund.

A contribution by the Curators of a number of crania of American aborigines to the ethnological exhibit forming portion of the Columbian Exposition held at Madrid in commemoration of the discovery of America received the recognition of a bronze medal.

With a view to securing a lowering of the rate of postage on specimens of natural history sent through the mails a committee appointed for the purpose prepared and distributed a circular to a number of foreign societies and journals soliciting such influence with their governments as may help to secure the object desired.

Until last summer the accumulated correspondence of the Academy from its foundation, together with a large number of documents and reports relating to the operations of its several departments, were securely placed, but with no systematic arrangement. Having, through the continued kindness of certain friends of the Academy, been again enabled to secure the services of Signor E. Fronani on certain days during a portion of the year, I have availed myself of the

opportunity to have this large accumulation of material of such interest in connection with the history of the society classified and arranged by him. Although the work has not been entirely completed, the material is now in such order as to be available for consultation and reference. The resulting good has already been more than once manifested.

The Hayden Memorial medal and the balance of the interest arising from the endowment fund were this year voted to Professor Thomas Henry Huxley, LL. D., F. R. S. to whom they have been forwarded with an expression of the Academy's hearty endorsement of the action of its awarding Committee. This is the fourth award of the Hayden memorial, the first being to Prof. James Hall of Albany in 1890, the second to Prof. Edw. D. Cope of Philadelphia, 1891, and the third to Prof. Eduard Suess of Vienna in 1892.

The Delaware Valley Ornithological Club and the Geographical Club have held their meetings throughout the year in the Academy.

These facts and figures it is believed prove without comment that the Academic year just closed has been prosperous if uneventful.

EDW. J. NOLAN,

*Recording Secretary.*

---

#### REPORT OF THE CORRESPONDING SECRETARY.

The Corresponding Secretary respectfully reports that during the year commencing December 1st, 1892, he has received from ninety-two societies, museums, etc., one hundred and fifty-four notices of the receipt of the publications of the Academy, and from thirty-nine societies and editors, forty-eight notices of the forwarding of their own publications to the Academy together with fifteen applications to exchange publications for reports and asking for missing numbers of the Academy's publications. Twenty letters on various subjects have been received and thirteen written. Fifteen circulars and invitations to the Academy to participate in congresses, meetings etc., have been received and answered. Two notices of deaths have been also received.

During the year seventeen correspondents have been elected and notices to that effect have been sent. The deaths of nine correspondents have been reported. Forty-seven certificates have been sent to members and twelve to correspondents.



Seven hundred and eighty-two acknowledgements for gifts to the library and 202 for gifts to the museum have been forwarded.

Respectfully submitted,

BENJ. SHARP,  
*Corresponding Secretary.*

### REPORT OF THE LIBRARIAN.

During the past year 4,657 additions have been made to the library. They consisted of 4,128 pamphlets and parts of periodicals, 511 volumes, 12 maps and 6 photographs.

They were derived from the following sources :—

Societies, . . . . .	2,110	Geological Survey of Penn-	
I. V. Williamson Fund, . .	1,042	sylvania, . . . . .	2
Editors, . . . . .	870	George B. England, . . . .	2
Authors, . . . . .	170	Manchester Museum, . . . .	2
Wilson Fund, . . . . .	134	Geological Survey of Arkan-	
U. S. Dept. of the Interior,	59	sas, . . . . .	2
Charles P. Perot, . . . . .	30	Geological Survey of Portu-	
U. S. Dept. of Agriculture,	29	gal, . . . . .	2
U. S. Department of State, .	27	Samuel G. Dixon, M. D., . .	2
Pennsylvania State Library,	15	Trustees of the East Indian	
Geological Survey of Russia,	11	Museum, . . . . .	2
Angelo Heilprin, . . . . .	10	Iowa State Library, . . . .	1
Tennessee Board of Health,	10	William R. Leeds, . . . . .	1
University of Kiel, . . . . .	10	Geological Survey of Iowa,	1
H. A. Pilsbry, . . . . .	9	Hoboken Ferry Co., . . . .	1
Minister of Public Works in		Charles Earl, . . . . .	1
France, . . . . .	8	Geological Surv. of Alabama	1
U. S. War Department, . .	7	Charles E. Smith, . . . . .	1
British Museum, . . . . .	7	Upsal Observatory, . . . . .	1
Conchological Section, . . .	7	British Commission, World's	
Thomas Meehan, . . . . .	6	Fair, . . . . .	1
U. S. Treasury Department,	5	Geological Surv. of Australia	1
East Indian Government, .	5	E. Renevier, . . . . .	1
Department of Mines, New		Benjamin Sharp, M. D., . .	1
South Wales, . . . . .	4	Hungarian Nat. Museum, .	1
Joseph Willcox, . . . . .	4	Mrs. Geo. W. Carpenter, . .	1
Illinois State Board of Agri-		William Sellers & Co., . . .	1
culture, . . . . .	4	Charles W. Johnson, . . . .	1
W. D. Brigham, . . . . .	4	Department of Mines, Nova	
T. H. d'Estrella, . . . . .	4	Scotia, . . . . .	1
Geological Survey of India,	4	Bryant Walker, . . . . .	1
Geological Surv. of Missouri,	3	J. E. Ives, . . . . .	1

**THIS PAGE IS LOCKED TO FREE MEMBERS**

Purchase full membership to immediately unlock this page

# DELVE INTO FANTASY, MAGIC, MYTHOLOGY & FOLKLORE

Forgotten Books'  
Full Membership gives  
access to 797,885 ancient  
and modern, fiction and  
non-fiction books.

**Continue**

\*Fair usage policy applies

to indispensable journals and the purchase of books absolutely needed by our students has been provided for during the past year, yet with the exercise of the strictest economy the amount derived from the library funds has been overdrawn. It is, therefore, evident that a liberal increase in the pecuniary resources of the library is needed if we are to maintain in the future our merited reputation of having the best collection of scientific works in America. Three times the amount now at our disposal could readily be spent annually without involving the slightest waste or extravagance.

All the portraits of presidents and benefactors have been carefully examined by a reliable expert since my last report. They have been cleaned, varnished and, when necessary, as was the case in several instances, rebacked with canvas. The appearance of this interesting collection of paintings has thus been much improved.

We are indebted to Mrs. Ellen M. Carpenter for a good portrait in oil of Mr. Geo. W. Carpenter by whom the Academy was served most efficiently as Treasurer for thirty-four consecutive years.

An interesting oil portrait of Mr. Augustus E. Jessup, the beneficent founder of the Academy's Jessup Fund, has been received from his daughter Mrs. Bloomfield H. Moore, to whose intelligent liberality the Academy is also deeply indebted. The painting represents Mr. Jessup in early manhood and therefore differs widely from the one given to the Academy by his children several years ago. The recent gift formerly belonged to Peale's museum and is now hung in the Librarian's room.

I have received efficient assistance in the current work of the library from Mr. William J. Fox and also, during a portion of the year, from Signor E. Fronani, the greater part of whose time, however, as will be seen by the report of the Recording Secretary, was devoted to the work of another department.

All of which is respectfully submitted.

EDW. J. NOLAN,  
*Librarian.*

---

## REPORT OF THE CURATORS.

It has been the endeavor of the Curators throughout the year to pay particular attention to the examination and renovation of the more perishable collections and to the replacement in the museum of such

specimens or collections as had been temporarily removed or were stored away so as to be inaccessible to the student.

As a result most of the collections are now in an excellent state of preservation.

Lack of space has prevented the proper systematic arrangement of the specimens and in many cases has necessitated the crowding of the collections to a degree entirely inconsistent with their proper display. This state of affairs has continually been an obstacle in the way of the work of the Curators for many years past, but will now very soon be remedied by the opening of the new museum building which will furnish ample space for the proper display of the various collections.

During the past year, although no general rearrangement of the collections was possible, a slight change has been made in the position of some of the cases on the lower floor of the museum and by this means many of the specimens have been displayed to much better advantage.

The collection of fossil fishes has been removed from the upright cases and a series of typical specimens displayed in the flat table cases, while the remainder have been arranged in glass-covered drawers immediately beneath, where they are readily accessible for study.

By this arrangement two large upright cases have been made available for the display of the additions to the mounted collection of mammals. A handsome case presented by the Women's Silk Culture Association has been used for the same purpose.

A great deal of important work has been accomplished in the ornithological department during the year. Almost the entire mounted collection of water birds, numbering about 2,000 specimens, has been thoroughly gone over and all desirable specimens re-mounted and renovated, while many of the duplicates and unsightly specimens have been unmounted and arranged in drawers with the study series of skins.

This work has immensely improved the appearance of the collection and will ensure the preservation of the specimens for many years to come.

A more detailed account of the work in this department will be found in the report of the Ornithological Section.

Mr. McCadden, the taxidermist of the Academy, in addition to

his work in remounting the ornithological collection, has prepared and mounted upwards of 50 birds, mammals and osteological specimens received during the year, thereby adding greatly to the value of these departments.

Several hundred jars of reptiles and fishes which had been stored in the cellar have been examined, relabeled and placed in their proper places in the museum, and a number of osteological specimens which had been removed from their cases have been restored to the museum.

The greater part of the Pennsylvania State Geological Survey collection, which has been stored away in boxes ever since its presentation to the Academy, has been unpacked and placed in drawers in the new cases which were procured for the connecting museum over the lecture hall. For the present these specimens have been arranged according to the State Survey list.

This work is of great importance as it renders this valuable collection, which it has hitherto been impossible to consult, readily accessible to the student.

Early in the year a series of uniform catalogues were procured by the Curators and the attempt made to form a systematic catalogue of all the departments of the museum, something that has hitherto only been attempted in one or two branches. The work entailed in an undertaking of this kind is enormous, and it will be several years at least before it will be possible to bring it to completion.

Throughout the past year, however, all the accessions except in a few special collections have been systematically numbered and catalogued so that the preservation of the data relating to them will be ensured even though the labels become misplaced or lost. Apart from cataloguing the accessions, the work in this direction has mainly been that of verifying and copying such old catalogues as were in existence.

In copying the catalogues of the mammalia it was found necessary to renumber the entire series of osteological specimens in order to bring them into sequence with the mounted specimens and skins. Heretofore they were numbered in different series, which caused much confusion. At the same time all the separate bones of the disarticulated skeletons were numbered so as to prevent their becoming mixed and their identity lost. The importance of this work can readily be appreciated.

**THIS PAGE IS LOCKED TO FREE MEMBERS**

Purchase full membership to immediately unlock this page

# Know Your Bible

Forgotten Books' Full Membership provides unlimited access to more than 28,000 volumes of Christian literature for \$8.99/month

**HOLY BIBLE**

**Continue**

\*Fair use policy applies

are the Rhoads collection of British Columbian birds, comprising about 1,000 specimens, an important collection of birds and mammals from southern California made by R. B. Herron, and the Morelet collection of mollusca.

Through the aid of friends of the Academy, Professor E. D. Cope was also enabled, in company with Dr. A. P. Brown, to carry on explorations in the fossil beds of Dakota and Kansas during the summer. He brought back many valuable specimens which will greatly enrich the department of vertebrate paleontology. These specimens will be placed in the museum as soon as they can be properly mounted.

As heretofore, the Academy's museum has furnished aid to many students and specialists. Besides those who have consulted the collections, specimens have been loaned during the year to Dr. C. Hart Merriam, Dr. J. A. Allen, Dr. Harrison Allen, Mr. William Brewster, Dr. L. Stejneger, Mr. G. D. Harris and Professor W. B. Clarke.

Certain collections which are not arranged in the museum proper have, as in former years, been under the charge of special conservators and to these the Curators desire to express their thanks—to Mr. John H. Redfield, Conservator of the Herbarium; Mr. W. W. Jefferies, Curator of the Vaux Collections, and Dr. Henry Skinner, Conservator of the Entomological Section. Reports on the condition of these collections will be found in the special reports from the Sections.

The thanks of the Curators are also due to Mr. W. W. Jefferies for his valuable assistance in the labeling and arranging of the Carpenter collection of minerals, to Mr. Clarence B. Moore, for the careful arrangement and labeling of his archaeological collection, and to Messrs. Woolman, Schultz and Boyer for valuable assistance in cataloguing the collections of diatoms.

Messrs. H. G. Ives, J. E. Richardson and H. Y. Pennell, students on the Jessup Fund, have rendered important aid during the year in the departments of mineralogy and ornithology.

Approved by the Curators at a meeting held Dec. 20th, 1893.

SAMUEL G. DIXON,

*Executive Curator.*

## REPORT OF THE BIOLOGICAL AND MICROSCOPICAL SECTION.

This Section during the year 1893, has held nine meetings exclusive of those held in conjunction with the Academy.

Four new members have been elected and two contributors have been added to the list. One member and one contributor have resigned.

Interesting communications have been made by Messrs. Ryder, Rex, Sharp, Anders, Brown and Rothermel.

The officers for the ensuing year are :—

<i>Director,</i>	. . . . .	A. P. Brown.
<i>Vice Director,</i>	. . . . .	John C. Wilson.
<i>Recorder,</i>	. . . . .	M. V. Ball, M. D.
<i>Treasurer,</i>	. . . . .	Chas. P. Perot.
<i>Corresponding Secretary,</i>	. . . . .	John G. Rothermel.
<i>Conservator,</i>	. . . . .	Geo. A. Rex, M. D.

Respectfully submitted,

HAROLD WINGATE,  
*Recorder.*

---

## REPORT OF THE CONSERVATOR OF THE CONCHOLOGICAL SECTION.

During the year since the last annual meeting of the Conchological Section the museum has been increased by many valuable accessions. The number of species new to the collection, and of species new to science has been unusually great. The series of mollusks preserved in alcohol has been augmented by a greater number of species than any previous year for probably over a decade. Accessions have been received during the year from 56 persons, a list of whom is included in the additions to the museum.

The total number of trays added is 1,650. About 300 of these having been acquired by purchase, an equal number by exchange, and the remainder by gift to the Academy or the Section. These do not include a collection of over 1,300 species of tertiary fossils obtained from M. Cossmann of Paris in exchange for volumes of the Manual of Conchology, which, with the addition of a collection of fossil Helices received from Dr. Penecke of Germany,



raises the number to a total of over 3,000 trays received and administered upon by the Conservator during the year.

Several accessions of special value to our collection may be mentioned, the collections received from the Peary Relief Expedition, from Dr. J. C. Cox, and that purchased from the Morelet collection being the most important.

The first of these, for which we are indebted to Prof. Angelo Heilprin, leader of the Peary Relief Expedition, adds a considerable number of Arctic forms first described by Friele, Sars and others, which could hardly have been obtained from any other source. This collection, together with that made by the West Greenland Expedition of 1891, gives us an excellent representation of the Greenland marine fauna.

The portion of the collection of the late Arthur Morelet of Dijon, France, which was obtained by us includes over 250 species of land and fresh-water shells, mainly of Africa, India and South America. As they are all new to the collection, and accompanied by reliable data, the great value of the series will be apparent. The additions to our collection of *Helices* are especially notable, many rare and long needed species being secured.

Dr. J. C. Cox of Sydney, N. S. Wales, Australia, has with great liberality made two donations to the Academy. The first, received through the Treasurer of the Section, contains a collection of dry Chitons from the coasts of New South Wales and South Australia; the second was transmitted direct to the Conservator, and consisted of a larger collection of alcoholic Chitons and many rare gastropods. The two sendings give us excellent material for the study of Australian *Polyplacophora*, and include a number of new species.

Other gifts, smaller but of scarcely less value, have been received from Professor F. W. Hutton of Christchurch, New Zealand, and Professor José N. Roviroso of Tabasco, Mexico. A considerable number of fine shells, including a good suite from the Grecian Archipelago, was received from Mrs. G. W. Carpenter of Philadelphia.

A large number of the interesting land shells of New Zealand have been obtained by purchase from Mr. H. Suter of Christchurch, N. Z. A large proportion of them were figured for the first time, in the Manual of Conchology.

The additions to our suites of North American shells have been

**THIS PAGE IS LOCKED TO FREE MEMBERS**

Purchase full membership to immediately unlock this page

# DELVE INTO FANTASY, MAGIC, MYTHOLOGY & FOLKLORE

Forgotten Books'  
Full Membership gives  
access to 797,885 ancient  
and modern, fiction and  
non-fiction books.

**Continue**

\*Fair usage policy applies

At the last meeting the following gentlemen were elected to serve as officers for the coming year:—

<i>Director,</i>	. . . .	George H. Horn, M. D.
<i>Vice-Director,</i>	. . . .	Charles S. Welles.
<i>Treasurer,</i>	. . . .	Ezra T. Cresson.
<i>Conservator,</i>	. . . .	Henry Skinner, M. D.
<i>Recorder,</i>	. . . .	Henry Skinner, M. D.
<i>Publication Committee,</i>	. . . .	{ James H. Ridings. Charles W. Johnson.

### REPORT OF THE BOTANICAL SECTION.

The Vice-Director of the Botanical Section respectfully reports that the general prosperity noted in other years still continues, though the work of the Conservator is seriously hampered by reason of the crowded condition of the Herbarium shelves.

Meetings have been regularly held except during the Summer recess. Discussions on matters of botanical interest have been frequent, and two original papers of value to general science on the botany of the Peary Expeditions and researches relative to the jelly glands of *Brasenia peltata*, have been accepted for publication in the Proceedings of the Academy.

Donations to the Herbarium have been liberal: reaching the number of 2,599 species; 2,344 were of flowering plants and ferns, of which 596 were new to our collection.

The Section is free from debt. The officers elected for the ensuing year are:

<i>Director,</i>	. . . .	W. S. W. Ruschenberger, M. D.
<i>Vice-Director,</i>	. . . .	Thomas Meehan.
<i>Conservator,</i>	. . . .	John H. Redfield.
<i>Recorder,</i>	. . . .	Charles Schaffer, M. D.
<i>Recording Sec'y and Treasurer,</i>		Stewardson Brown.

Respectfully submitted,

THOMAS MEEHAN,  
*Vice-Director.*

### REPORT OF THE MINERALOGICAL AND GEOLOGICAL SECTION.

Meetings of the Section have been held at the Academy regularly during the year, except in the summer and in September and October, when most of the members are absent.

The attendance has not been large, but considerable interest has been manifested and communications of value have been made.

The Section has labored under the disadvantage that very few of the present members of the Academy are sufficiently interested in the study of mineralogy and geology to become members of the Section or to take an interest in its meetings.

The officers elected at the annual meeting are as follows:

<i>Director,</i>	. . . . .	Theo. D. Rand.
<i>Vice-Director,</i>	. . . . .	W. W. Jefferis.
<i>Treasurer,</i>	. . . . .	John Ford.
<i>Conservator,</i>	. . . . .	W. W. Jefferis.
<i>Corresponding Secretary and Recorder,</i>		Charles Schaffer, M. D.
		THEO. D. RAND, <i>Director.</i>

---

## REPORT OF THE ORNITHOLOGICAL SECTION.

A great deal of important work has been accomplished during the past year in the ornithological department of the museum.

The renovation of the collection has been continued in the manner stated in the previous reports of the Section but a much greater advance has been made in the work owing to the fact that during the spring and summer the taxidermist, Mr. McCadden, was enabled to devote all his time to this department.

In all 2,214 mounted specimens, comprising all of the water birds with the exception of the snipes, plovers and storks, have been carefully examined and the best specimens remounted on walnut or stained stands. The unsightly specimens and duplicates unnecessary for display have been labeled and stored in cases of drawers.

The vast improvement in the appearance of the exhibition cases after the specimens have been remounted is at once apparent to anyone visiting the gallery.

All the information contained upon the old stands has been carefully preserved and all the specimens have been numbered and catalogued.

The study collection of skins remains in an excellent condition and has been rearranged during the year in air-tight tin cases especially provided for it. All the accessions to this collection, numbering

1,409 skins, have been labeled and catalogued. For this work the Conservator is largely indebted to Mr. Howard Y. Pennell.

The additions to the ornithological collection during the year have been noteworthy. The Rhoads collection of British Columbian birds, numbering about 1,100 which was generously purchased by friends of the Academy, is of especial importance as it comprises large series of specimens from a region hitherto unrepresented in the museum. Through the liberality of friends of the institution the Section was enabled to have an experienced collector, Mr. R. B. Herron, in the field for a short time in the vicinity of San Bernardino, Southern California, and many valuable specimens of species heretofore wanting or very poorly represented in the collection were obtained.

The collection of mounted birds of the late George W. Carpenter is also a very valuable acquisition, containing examples of many rare species, the most important of which is an adult male specimen of the extinct Labrador duck.

The Delaware Valley Ornithological Club has also added many very instructive groups of native birds with their nests and eggs, to the already large collection presented during previous years. This is now one of the most attractive exhibits in the museum.

At the annual meeting of the Section held December 18, 1893, the following officers were elected:

<i>Director,</i>	.	.	.	.	.	Spencer Trotter, M. D.
<i>Vice-Director,</i>	.	.	.	.	.	George S. Morris.
<i>Recorder,</i>	.	.	.	.	.	Stewardson Brown.
<i>Cor. Secretary,</i>	.	.	.	.	.	Charles E. Ridenour.
<i>Treasurer,</i>	.	.	.	.	.	Samuel G. Dixon, M. D.
<i>Conservator,</i>	.	.	.	.	.	Witmer Stone.

Respectfully submitted,

WITMER STONE,  
*Conservator.*

---

## REPORT OF THE PROFESSOR OF INVERTEBRATE PALEONTOLOGY.

The Professor of Invertebrate Paleontology respectfully reports that, as in past years, he has delivered the usual course of Spring lectures, about twenty-five in number, and he acknowledges a satisfactory attendance for the entire course. A number of the evening lectures

**THIS PAGE IS LOCKED TO FREE MEMBERS**

Purchase full membership to immediately unlock this page

# Know Your Bible

Forgotten Books' Full Membership provides unlimited access to more than 28,000 volumes of Christian literature for \$8.99/month

**HOLY BIBLE**

**Continue**

\*Fair use policy applies

REPORT OF THE PROFESSOR OF ETHNOLOGY AND  
ARCHÆOLOGY.

I have to report that during the early months of 1893 a series of free lectures was delivered by me on ethnology, in the lecture room of the Academy. They were well attended, and a commendable degree of interest was excited among those who were present.

Suggestions have been made looking toward class instruction in this branch when suitable accommodation will be ready in the new building. The subject of physical anthropology, a branch particularly germane to the purpose and collections of the Academy, has attracted considerable attention, and it is possible that a Section may be formed among the members for its special study.

I have the honor to remain,

Very respectfully,

D. G. BRINTON, M. D.,

*Professor of Ethnology and Archæology.*

---

REPORT OF THE PROFESSOR OF LOWER INVER-  
TEBRATA.

The Professor of Lower Invertebrata respectfully reports that during the past year he has delivered twelve lectures upon zoological subjects.

The additions to the museum during the year have been neither numerous nor important.

Work has been carried on in the Carcinological department in re-labeling and rearranging the specimens. A catalogue of the Stomatopoda, Caridea and Penæidea, including forty genera and one hundred and twenty-eight species, has been published in the Proceedings for this year (see pages 194 to 227), and it is hoped that the second part of the catalogue, finishing the Decapoda will soon be ready for the printer.

During a leave of absence on a trip to the Hawaiian Islands, although for Ethnological purposes, a number of invertebrata were collected which have not yet been studied.

Respectfully submitted,

BENJ. SHARP.

*Professor of Lower Invertebrata.*

REPORT OF THE PROFESSOR OF HISTOLOGY AND  
MICROSCOPIC TECHNOLOGY.

I beg to report that the work done as Professor of Histology and Microscopic Technology during the year 1893 has embraced the study of the life history of the tubercle bacillus, the therapeutic effect of its products, the life history of Actinomyces with particular attention to the morphological changes produced by different food stuffs, a careful study of the blood from four cases of Béri-Béri and microscopic work on slides of the bacillus of leprosy which I prepared directly from lepers. Verbal communications have been made to the Academy on Actinomyces and Béri-Béri.

Respectfully,

SAMUEL G. DIXON.

*Prof. of Hist. and Microscopic Technology.*

---

REPORT OF THE CURATOR OF THE WM. S. VAUX  
COLLECTIONS.

The Curator of the William S. Vaux Collections respectfully reports that they are in good condition. Since the last report, made to the Academy in 1890, 134 specimens have been added to the cabinet of minerals at a cost of \$645.05. A number of these are unusually fine specimens of rare species.

Since the death of the late Curator, Mr. Jacob Binder, I have added to the mineral collection from Nov. 2, 1892 to the present date Dec. 15, 291 specimens at a cost of \$1,411.75.

The number of specimens in the collection as reported by Mr. Binder Nov. 30, 1890 was 7,028. He afterwards added 134 to Aug. 13, 1892 and since that time I have added 291, making a total of 7,450.

No additions have been made to the archeological collection since 1885 and the number of specimens remains the same as then reported, 2,940.

Respectfully submitted by

WM. H. JEFFERIS,

*Curator.*



The election of Officers, Councillors and Members of the Finance Committee, to serve during 1894, was held with the following result:—

<i>President,</i>	. . . . .	Isaac J. Wistar.
<i>Vice-Presidents,</i>	. . . . .	Thomas Meehan. Rev. Henry C. McCook, D. D.
<i>Recording Secretary,</i>	. . . . .	Edward J. Nolan, M. D.
<i>Corresponding Secretary,</i>	. . . . .	Benjamin Sharp, M. D.
<i>Treasurer,</i>	. . . . .	Chas. P. Perot.
<i>Librarian,</i>	. . . . .	Edward J. Nolan, M. D.
<i>Curators,</i>	. . . . .	W. S. W. Ruschenberger, M. D. Henry C. Chapman, M. D. Samuel G. Dixon, M. D. Arthur Erwin Brown.
<i>Councillors to serve three years,</i>	. . . . .	Thomas A. Robinson. John H. Redfield. Charles Morris. Harold Wingate.
<i>Finance Committee,</i>	. . . . .	Charles Morris. Charles E. Smith. Uselma C. Smith. William Sellers. George H. Horn, M. D.

---

### ELECTIONS DURING 1893.

#### MEMBERS.

*January 31.*—George W. Warren, M. D., Nelson H. Strong, Norris J. Scott, Thomas Say Speakman, Clarence B. Moore, Mary K. Gibson, Jr., J. Howard Gibson, Thomas Bradley, Edwin Greble Dreer, Richard C. Schiedt, Charles Nicoll Bancker Camac, William Evans Wood, John C. Sims, William D. Winsor, Clement B. Newbold, William H. Joyec, Alexander J. Cassatt, Samuel F. Houston, Alexander C. Harvey, Charles Hacker, Edward S. Buckley, Jr., Frank T. Patterson, George B. Heckel, Benjamin W. Richards, Eugene Delano, Malcolm Lloyd, Charles H. Banes, Theodore C. Search, William H. Ingham, Algernon Sydney Logan.

**THIS PAGE IS LOCKED TO FREE MEMBERS**

Purchase full membership to immediately unlock this page

# DELVE INTO FANTASY, MAGIC, MYTHOLOGY & FOLKLORE

Forgotten Books'  
Full Membership gives  
access to 797,885 ancient  
and modern, fiction and  
non-fiction books.

**Continue**

\*Fair usage policy applies

## ADDITIONS TO THE MUSEUM.

1893.

## ARCHÆOLOGY AND ETHNOLOGY.

- Chas. Ball. Mummied hand, Egypt.
- Mrs. G. W. Carpenter. Twenty-four Indian head dresses and other relics; fifty-five shoes from China, Japan, and other countries; one dissected man, showing circulatory and nervous systems; two human skeletons, man and woman; one human skull.
- Prof. Angelo Heilprin. Pair of Eskimo boy's shoes, Godhavn, Greenland.
- Clarence B. Moore. A collection of about three hundred trays of Indian relics from the mounds of Volusia County, Florida.
- Peary Relief Expedition. Four suits Eskimo clothing, Godhavn, Greenland; fifty-two trays Eskimo implements, Greenland.
- Dr. C. N. Pierce. Twenty human crania and one femur of Hawaiians with wrappings from Sandwich Islands.
- Thos. M. Seeds, Jr. One Mexican horse-hair lariat and one arrow head, Texas.
- Jos. Willcox. A collection of Indian arrow-heads, Iredell Co., N. C.

## MAMMALS.

- Mrs. G. W. Carpenter. Eight mounted mammals and one bison skull.
- Dr. H. C. Chapman. Mounted specimen of *Aplodontia rufa*, Tacoma, Wash.
- W. Coward. Skin of *Mustela americana*, Lycoming County, Pa.
- Dr. S. G. Dixon. Brain of Eskimo dog; mounted skeleton of *Canis familiaris*.
- Capt. E. J. Fish. Piece of horny plate from muzzle of *Balenoptera sieboldii*.
- Peary Relief Expedition. *Lepus timidus arcticus*, mounted specimen, two skins and four skulls, Robinson's Bay, Greenland. *Vulpes lagopus*, skin, *Thalassarctos maritimus*, mounted specimen. *Phoca barbata* McCormick Bay. *Trichechus rosmarus*, brain, Smith's Sound.
- Purchased. Mounted specimen of *Mazama montana*, Cascade Mts., Washington.
- S. N. Rhoads and Witmer Stone. Mounted specimen of *Sciurus hudsonius*, with nest, May's Landing, N. J.

- W. E. Rothery and Prof. A. B. King. Mounted specimen and skeleton of *Chæropsis liberiensis*, Liberia.
- Jos. Willcox. Fragments of lower jaw of *Balaena cisarctica*.
- Zoological Society of Philadelphia. Mounted specimens of *Macacus cynomolgus*, *Hapale penicillata*, *Trichosurus vulpecula*, *Antelope cervicapra*, *Macacus erythreus*, *Cebus hypoleucus*, *Hapale vulgaris*, *Nandinia binotata*, *Lemur varius*, *Felis concolor*, *Equus burchellii*, *Cynocephalus* sp., *Portax pictus*, *Tragelaphus scriptus*, *Galera barbara*, *Equus chapmani*, *Gulo luscus*, *Auchenia llama*, *Tragulus javanicus*.
- Skins of *Macacus cynomolgus*, *Cebus fatuellus*, *Gazella subgutturosa*, *Sciurus hypopyrrhus*, *Gazella* sp., *Vulpes* sp.?
- Skeletons of *Lynx rufus*, *Felis pardus*, *Cariacus virginianus*, *Caprovis* sp., *Phacochoerus æthiopicus*, *Rusa hippelaphus*, *Gazella subgutturosa*, *Gazella* sp.
- Skulls of *Macacus cynomolgus*, *Bison bison*, *Galera barbara*, *Equus burchellii*, *Vulpes* sp.? *Equus chapmani*, *Ursus americanus* and collection of twenty-six miscellaneous skulls.

## BIRDS.

- G. B. Benners. Skins of *Dendroica chrysoparia* and *Vireo atricapillus*.
- Mrs. G. W. Carpenter. A collection of one hundred and ten mounted birds and one hundred and twenty-three skins, including a mounted specimen of the male Labrador duck, *Camptolaimus labradorius*, also two ostrich eggs.
- Dr. S. G. Dixon. Mounted specimen *Meleagris gallopavo*, Virginia.
- Delaware Valley Ornithological Club. Twenty-two mounted birds; thirteen nests, eight sets of eggs, for Delaware Valley Ornithological Club collection.
- Albert Lano, (in exchange). Six bird skins, Minnesota.
- Peary Relief Expedition. Young Eider Duck, (alcoholic), Duck Island, Greenland.
- Purchased. S. N. Rhoads collection of about 1,100 skins from British Columbia and Washington. Four skins *Dendragapus fuliginosus*, Washington, and mounted specimen *Meleagris gallopavo*.
- I. S. Reiff, for late H. K. Jamison, one hundred and eighty-two eggs (twenty-two species), Eastern North America.
- Prof. J. P. Remington. One skin *Puffinus stricklandi*, Atlantic City, N. J.
- S. N. Rhoads. One skin *Merganser americanus*, Washington.
- Louis Schneider. Fifteen young birds in the down, British America.
- Dr. Spencer Trotter. A collection of eleven skins from Beaverkill, Sullivan County, N. Y.
- Zoological Society of Philadelphia. Mounted specimens of *Cygnus* sp., *Psophia* sp., *Otogyps calvus*.

Skins of *Thaumalia picta*, *Metopiana peposaca*, *Palamedea cornuta* with sternum, *Conurus* sp., *Eupochortyx leucotis*, *Leptoptilus dubius*, *Balearica regulorum*. Skulls and sterna of *Grus cinereus*, *Aquila* sp., *Penelope marail*, *Ortalia albiventris*, *Balearica pavonina*, *Psittacus erythræus*, *Otogyps calvus*. Eggs of *Sarcorhampus gryphus* and *Vultur cinereus*.

Dr. Edw. Stone. Bird and nest covered by artificial concretion.

#### REPTILES AND BATRACHIANS.

Mrs. G. W. Carpenter. Four mounted turtles.

Dr. H. C. Chapman. *Cryptobranchius alleghaniensis*, articulated skeleton and one jar of viscera.

W. W. Jefferis. Shed skin of *Crotalus adamanteus*.

Philip Laurent. *Storeria occipitomaculata*, Hamilton County, N. Y. Purchased. *Python sebae*, (2) *Morelia spilotes*, Australia.

S. N. Rhoads. Nineteen jars reptilia and batrachia, British Columbia and Washington.

Zoological Society of Philadelphia. Two eggs *Testudo tabulata*; one jar *Zonurus giganteus*; articulated skeleton and three jars viscera of *Megalobatrachus maximus*; three reptile skulls.

#### FISHES.

Philip Laurent. *Exoglossum maxillingua*, Hamilton Co., N. Y.

Col. Marshall MacDonald. *Lopholatilus chamaeleonticeps*, one hundred miles off Sandy Hook.

Purchased. *Pristis antiquorum*, West Indies.

S. N. Rhoads. One jar of fish, British Columbia.

Seaford Oyster Co. *Batrachus tau*, Seaford, Del.

Prof. Benjamin Sharp. Two lars of fish, Nantucket, Mass.

#### CRUSTACEANS.

Wm. H. Boon. One jar *Penaeus setiferus*, Holly Beach, N. J.

Dr. H. C. Chapman. One jar *Upogebia affinis*, Atlantic City, N. J.

Dr. S. G. Dixon. One jar *Cambarus diogenes*, Virginia.

J. E. Ives and H. A. Pilsbry. Four jars *Cambarus bartonii*, Md. and W. Va.; one jar *Cambarus affinis*, Pa.

Miss M. E. Lyndall. One jar *Cambarus bartonii*, Pa.

Prof. Benj. Sharp. One jar *Carcinus moenas*, Nantucket, Mass.

Miss West. *Balanus tintinabulum*, Panama.

**THIS PAGE IS LOCKED TO FREE MEMBERS**

Purchase full membership to immediately unlock this page

# Know Your Bible

Forgotten Books' Full Membership provides unlimited access to more than 28,000 volumes of Christian literature for \$8.99/month

**HOLY BIBLE**

**Continue**

\*Fair use policy applies

- Prof. F. W. Hutton. Seventeen trays of marine mollusks (Chitons and Pelecypods), from New Zealand.
- Chas. W. Johnson. *Paludomus palawanicus* Brot., and other shells.
- F. H. Lattin. Four species of mollusks.
- Dr. J. P. Lundy. *Neritina jordani* Sow., *Melanopsis costata* Oliv., etc., Palestine.
- H. C. Machette. Twenty species of shells from Samoan Is., etc. *Aplysia* and *Vaginulus* from Florida Keys.
- C. B. Moore. Eighteen trays of shells from the St. John's region, Fla.
- Mrs. M. P. Olney. Three species land and fresh water shells from Washington (alcoholic).
- Peary Relief Expedition of 1892. Twenty-two jars and fifty trays marine mollusks from Greenland, collected by Prof. A. Heilprin.
- H. A. Pilsbry. *Helix fultoni* G. A., *Acmæa dorsuosa* Gid., and other shells.
- H. A. Pilsbry and J. E. Ives. One hundred and fifty-four trays and six bottles of mollusks from Western Maryland. Collection enumerated and described in Proc. Acad. Nat. Sci. Phila. for 1894.
- Henry Prime. Twenty-five species of mollusks from Haiti, part alcoholic.
- J. B. Quintard. Three trays of *Strobilops* from Kansas.
- W. J. Raymond. *Tellina purpurascens* etc., Acapulco.
- S. N. Rhoads. Twelve species of mollusks, Delaware Water Gap, N. J.; thirteen species marine and seven species land mollusks from Nesqually; Washington; six species from Vernon, B. C., etc.
- J. Ritchie, Jr. Twenty-nine species of shells.
- Prof. J. N. Roviroso. Twenty-four species land and fresh water shells from the State of Tabasco, Mexico.
- H. E. Sargent. *Acmæa mesoleuca*, *Cancellaria tessellata* and other marine shells; twenty trays of land and fresh water shells from Alabama.
- Dr. B. Sharp. Three species of fresh water shells from Nantucket; fifteen trays of land shells from Dominica, etc.
- Dr. Henry Skinner. *Pyramidula perspectiva*, *Polygyra palliata* and *P. Andrewsæ* from Mitchell Co., N. C.
- U. C. Smith. *Ampullaria depressa* Say (alcoholic), Florida; *Clione borealis*, Avalon, N. J.
- Frederick Stearns. Several species of Japanese mollusks.
- Dr. R. E. C. Stearns. *Nassa complanata* Powis (two varieties), *Olivella puelchana* Orb., and *Nassa brunneostoma* Stearns.
- Witmer Stone. Six species of mollusks from York and Luzerne Counties, Pa., etc.
- L. H. Streng. Thirteen species of shells.
- H. H. Stupakoff. *Helicina occulta* etc., from Western Pa.
- H. Suter. Sixty-nine species of land shells from New Zealand (purchased).

- G. W. Taylor. *Pupa hoppii* Moller, etc., from British Columbia.
- E. G. Vanetta. Twelve species of mollusks from Philadelphia (alcoholic).
- Bryant Walker. *Strobilops*, etc., from Michigan.
- Robert Walton. Ten species of mollusks from environs of Philadelphia. Darts of *Gastrodonta ligera* Say.
- G. W. Webster. *Strobilops* from Florida and Minnesota.
- Wm. H. Weeks, Jr. Five species of land mollusks.
- A. G. Wetherby. Series of land shells from near Magnetic City, N. C.
- Williard M. Wood. Several species of Japanese and Californian mollusks.
- G. W. Wright (in exchange). One hundred and thirty-four species of marine shells from New Zealand.
- Purchased. Two hundred and fifty-one species of land and fresh-water shells formerly in the collection of the late Arthur Morelet.

#### VERTEBRATE FOSSILS.

- Dr. Sternberg. Nineteen trays cretaceous fossil fish, four trays fossil reptiles.
- Mr. Levy, through Dr. J. C. Morris. Bones and teeth of *Dibelodon humboldtii* and *Megatherium* sp., 120 miles from sea-coast W. of Recife, Brazil.

#### INVERTEBRATE FOSSILS.

- W. C. Borden. Five trays of cretaceous fossils, Lenola, N. J.
- Miss M. E. Holmes. One tray cretaceous fossils, Lenola, N. J.
- Charles Laubach. Seven casts *Monocraterion lesleyi*, Bucks County, Pa.
- Miss McFarlane. One tray Cambrio-silurian fossils.
- Clarence B. Moore. Thirty-four trays post-pliocene fossil mollusca, Florida.
- H. A. Pilsbry and J. E. Ives. Six trays fossils, Maryland.
- Prof. S. P. Sharpless. Two trays phosphate rock, N. Carolina.
- E. Stokes and E. Harmer. Two coral pebbles, Moorestown and New Germania, N. J.
- Jos. Willcox. Fifty trays Miocene and Pliocene fossils, Florida; seventy-four trays Pliocene fossils, Cal. For American Conchological Association collection.
- Lewis Woolman. Three trays fossils, Farmingdale, N. J.; thirty trays fossils, Lenola, N. J.

#### PLANTS.

- Estate of John Ball, through Harvard University. Four hundred and eighty-two species of plants, mostly European and mostly collected by the late John Ball.



- Prof. Charles S. Sargent, of the Arnold Arboretum. Six species of shrubs collected by him in Japan in 1892.
- Roberts Le Boutillier. Four species of tropical orchids.
- Dr. Henry Skinner. *Viscum album* L. from Devonshire, England.
- Peary Relief Expedition, sent to Greenland under the auspices of the Academy in 1892, Angelo Heilprin in charge, William E. Meehan, botanist. Eighty-nine species of phanerogamic plants and thirty-three species of lichens.
- Herbarium, of Columbia College, New York, through Prof. N. L. Britton. One hundred and ninety species of flowering plants and ferns collected mostly in the mountains of southwestern Virginia by N. L. and Mrs. E. G. Britton and Anna M. Vail, in 1892.
- A. A. Heller, Lancaster, Pa. Eighty-eight species of plants from Pennsylvania and North Carolina, including a few species from Idaho.
- Dr. J. Bernard Brinton. Eighteen species of plants collected by A. A. Baldwin on Merritt's Island, southern Florida. Staminate and pistillate forms of *Corema Conradii* from "The Plains," Monmouth Co., N. J.
- Ellis and Everhart. Twenty-ninth and Thirtieth Centuries of North American Fungi, received in exchange for duplicate centuries of the same from estate of George Martin.
- Prof. José N. Rovirosa. Thirty-five species of plants collected by him in the States of Tabasco and Chiapas, Mexico.
- Dr. Charles Schaffer. Hough's Sections of American Woods. Part III.
- J. D. A. Cockerell. *Uredo Violæ*, a fungus destructive to grape vines, from Kingston, Jamaica, collected by A. Hylton.
- E. E. Schantz, Gettysburg collection, Pa. Four species of plants collected by him in Central Kansas.
- Joseph D. Crawford. Series of specimens of *Asplenium montanum* from York Co., Pa.; *Carex triceps* and *Pentstemon Digitalis* from Perkiomen, Pa.
- T. Chalkley Palmer. *Crotonopsis linearis* and cleistogamic form of *Viola bicolor* Pursh.
- Frederick L. Lewton. *Habenaria macroceratidis*, *Habenaria Garberi* and *Microstylis Floridana*, from Sumter Co., Florida.
- Prof. L. H. Bailey, of Cornell University. *Rubus Canadensis* L. var., *coribaccus*, a new variety.
- Uselma C. Smith. *Hydrodictyon*—a fresh water alga.
- Miss H. G. Powers, of Ismid, Turkey-in-Asia. Two hundred and forty species of Bithynian plants collected by her.
- Prof. Thomas C. Porter, Lafayette College. Twenty species of plants from Pennsylvania, New Jersey and Virginia.
- W. W. Jefferis. Twenty-one species plants from Fort Edward, N. Y.

**THIS PAGE IS LOCKED TO FREE MEMBERS**

Purchase full membership to immediately unlock this page

# DELVE INTO FANTASY, MAGIC, MYTHOLOGY & FOLKLORE

Forgotten Books'  
Full Membership gives  
access to 797,885 ancient  
and modern, fiction and  
non-fiction books.

**Continue**

\*Fair usage policy applies

H. G. Ives. One Aquacreptite, one Glockerite, and one folded gneiss, Philadelphia, and four other specimens.

A. Kollner. Two trays rock, Pennsylvania.

Francis James Knauff. Pyrolusite, Podi, Russia.

Abraham Meyer. One tray limestone, Cogan House, Lycoming Co., Pa.

Mineralogical Section. Quartz Pseudomorph after Crocidolite, S. Africa.

Peary Relief Expedition. Granite, Littleton Island, Greenland; one tray Nodular sandstone, Atanekerdruk, Greenland; twelve specimens native iron, Disko, Greenland.

T. D. Rand. Nine trays minerals, one rock.

J. E. Richardson. Series of seven specimens distorted Pyrite, French Creek, Chester Co., Pa.

C. G. Sower. Pyrite, French Creek, Chester Co., Pa.

Rev. J. E. Talmage. Two large Selenites, Wayne Co., Utah.

C. S. Welles. Anthophyllite, Media, Delaware Co., Pa.

G. B. Wilkinson. Nine Magnetites, Essex Co., N. Y.

Lewis Woolman. Hornblende, Orange Co., N. Y.; Byssolite, French Creek, Chester Co., Pa.

Purchased for Vaux collection. One hundred and forty-nine trays and fifty-four specimens of minerals.

# INDEX TO GENERA, ETC.

1893.

Abies . . . . .	213	Antennaria . . . . .	211, 306
Abranchus . . . . .	227	Anthostomiella . . . . .	139
Abromys . . . . .	407	Anthus . . . . .	55, 65
Acanthinula . . . . .	234, 236	Aphelichthys . . . . .	19, 20
Acanthis . . . . .	47, 63	Aphrodina . . . . .	222
Acanthostigma . . . . .	443	Aquila . . . . .	40
Accipiter . . . . .	39, 61	Arabis . . . . .	208
Acer . . . . .	130, 133	Archeopteryx . . . . .	72
Acmaea . . . . .	285-287	Archibuteo . . . . .	40
Acmeidæ . . . . .	285-286	Archilestes . . . . .	377, 379
Actinonema . . . . .	159	Arctagrostis . . . . .	215
Actitis . . . . .	36, 61	Arcyria . . . . .	364-366
Æchmophorus . . . . .	21, 29	Ardea . . . . .	35, 60
Æcidium . . . . .	154	Arenaria . . . . .	22, 31, 209
Aegialitis . . . . .	37, 61	Argis . . . . .	126
Agaricus . . . . .	440	Armeria . . . . .	212
Agelaius . . . . .	23, 47, 63	Arnica . . . . .	211
Aix . . . . .	22, 32	Artemisia . . . . .	131, 211
Alaria . . . . .	220	Asbeferrite . . . . .	174
Alaudinus . . . . .	48	Ascochyta . . . . .	150
Alchemilla . . . . .	210	Asio . . . . .	22, 41, 61
Alectoria . . . . .	216	Asphalius . . . . .	112
Alope . . . . .	112	Astacobdella . . . . .	419
Alopecurus . . . . .	214	Astacus . . . . .	419
Alphaeus . . . . .	112	Astata . . . . .	539-548
Alpheidae . . . . .	112	Astatus . . . . .	468, 539-548
Alpheoides . . . . .	112	Asterina . . . . .	128, 442
Alpheus . . . . .	109	Asterinula . . . . .	159
Alsophis . . . . .	433, 434	Asteroma . . . . .	158
Alyson . . . . .	467	Asterostroma . . . . .	441
Amblystoma . . . . .	77, 181, 184, 383, 386	Athanas . . . . .	114
Amieva . . . . .	77	Atya . . . . .	111
Ammodramus . . . . .	28, 48, 63	Atyidæ . . . . .	111
Ammonites . . . . .	220, 222	Atyodia . . . . .	111
Amorpha . . . . .	140	Atys . . . . .	111
Ampelis . . . . .	53, 64	Aulacomnion . . . . .	217
Amphibolite . . . . .	176	Aulopyge . . . . .	19
Amphioxus . . . . .	80	Autolytus . . . . .	81
Amphipteryx . . . . .	380	Avellana . . . . .	220
Amphisphaeria . . . . .	129	Axinea . . . . .	222
Amyzon . . . . .	401, 402	Aythya . . . . .	23, 32, 60
Anas . . . . .	22, 31, 60	Azalea . . . . .	134
Anchistia . . . . .	118	Bacillus . . . . .	100
Ancistrodon . . . . .	385	Baculites . . . . .	220
Ancistromma . . . . .	487-498	Badhamia . . . . .	372
Andræa . . . . .	217	Bartsia . . . . .	212
Andrias . . . . .	233	Bascanium . . . . .	385, 387
Anomia . . . . .	222	Bassaris . . . . .	413
Anser . . . . .	23, 33	Bassariscus . . . . .	413-418

Batrachia. . . . .	181, 383, 386	Cetraria. . . . .	216
Belogona . . . . .	234	Ceryle . . . . .	42, 62
Belonidium. . . . .	149, 452	Chaerodes . . . . .	185
Betula . . . . .	213	Chaetodipus. . . . .	407
Bidens . . . . .	303	Chaetomium . . . . .	130
Bithynis . . . . .	119	Chætura . . . . .	23, 44
Blitrydium . . . . .	150, 453	Charadrius . . . . .	22, 37, 61
Boa. . . . .	429	Charitonetta . . . . .	33, 60
Bonasa . . . . .	28, 38, 61	Cheiranthus . . . . .	208
Boraginaceæ . . . . .	291	Cheiromyces . . . . .	171, 134
Botaurus . . . . .	35	Chelidon . . . . .	53, 64
Bothrops . . . . .	434, 435	Chelydra . . . . .	386
Bothynostethus. 467, 468, 550, 551		Chlorida . . . . .	107
Botryodiplodia . . . . .	161	Chloridella . . . . .	107
Botrytis . . . . .	168	Chlorosplenium. . . . .	146
Brachyramphus . . . . .	22, 30, 60	Choeropsis. . . . .	185-187
Branchiobdella . . . . .	421-428	Chondestes. . . . .	22, 49
Branta . . . . .	23, 33, 60	Chondrioderma . . . . .	368-370
Brasenia. . . . .	188-193	Chordeiles . . . . .	43, 62
Braya. . . . .	209	Chorphilus . . . . .	386
Brunella. . . . .	297, 298	Cinclus . . . . .	55, 65
Bryanthus . . . . .	212	Cinosternum . . . . .	386
Bryum . . . . .	217	Circus. . . . .	22, 39, 61
Bubo . . . . .	22, 28, 41, 62	Cistothorus. . . . .	57, 65
Buellia . . . . .	216	Cistudo . . . . .	386
Bufo . . . . .	181, 184, 386	Cithara . . . . .	221
Buteo. . . . .	39, 61	Cladonia . . . . .	216
Cacoxenite . . . . .	175	Cladosporium. . . . .	463
Callipepla. . . . .	22, 37, 61	Clangula . . . . .	33
Calliste . . . . .	221	Clasterisporium . . . . .	169, 463
Camarosporium . . . . .	161	Clavagella. . . . .	222
Cambarus . . . . .	419	Clavaria. . . . .	441
Campanula. . . . .	211	Cliola. . . . .	19
Camptonectes. . . . .	221	Clivicola . . . . .	22, 53, 64
Cancer . . . . .	105	Clypeosphæria . . . . .	138
Caradina . . . . .	111	Cnemidophorus . . . . .	387
Carassius . . . . .	78, 85	Coccophacidium. . . . .	151
Cardamine . . . . .	208	Coccyzus . . . . .	27
Cardium . . . . .	221	Cochlearia. . . . .	209
Carex. . . . .	214	Colaptes. . . . .	27, 28, 43, 62
Caridina . . . . .	111	Collema. . . . .	216
Carphophiops. . . . .	385	Coluber . . . . .	385, 387
Carpodacus. . . . .	47, 63	Columba . . . . .	39, 61
Carya. . . . .	132	Colymbus. . . . .	22, 29, 60
Cassiope. . . . .	212	Comarum. . . . .	294
Cathartes . . . . .	22, 39	Comatricha. . . . .	367
Catinula . . . . .	166	Compsognathus. . . . .	72
Cenangella . . . . .	149	Conchodytes . . . . .	119
Cenangium . . . . .	452	Coniocybe. . . . .	216
Ceophloeus. . . . .	43, 62	Contopus. . . . .	44, 62
Cephalopoda . . . . .	220	Cornus . . . . .	211
Cephus . . . . .	22, 30	Coronis. . . . .	106
Ceratostoma. . . . .	444	Corvus . . . . .	23, 46, 63
Cerastium. . . . .	209	Coryneum . . . . .	168
Cercospora. . . . .	170, 463	Cossus . . . . .	282
Cerebella . . . . .	156	Crangon . . . . .	125
Cerithium. . . . .	220, 222	Crangonidae. . . . .	125
Certhia . . . . .	22, 57, 65	Craterium. . . . .	370, 371

**THIS PAGE IS LOCKED TO FREE MEMBERS**

Purchase full membership to immediately unlock this page

# Know Your Bible

Forgotten Books' Full Membership provides unlimited access to more than 28,000 volumes of Christian literature for \$8.99/month

**HOLY BIBLE**

**Continue**

\*Fair use policy applies

Helianthus . . . . .	191	Lepeta . . . . .	285-287
Helicops . . . . .	434	Lepetella . . . . .	287
Heliopsis . . . . .	304	Lepetidæ . . . . .	285-287
Helix . . . . .	234-275, 403	Leptophis . . . . .	432
Helminthophila . . . . .	22, 54, 64	Leptosphæria . . . . .	135, 447
Helotium . . . . .	145	Lestes . . . . .	377-380
Hemiaster . . . . .	222	Leuciscus . . . . .	19
Hendersonia . . . . .	161, 457	Leucosticte . . . . .	47
Hepialus . . . . .	282, 284	Limax . . . . .	389-394
Herpetodryas . . . . .	432	Liris . . . . .	488, 535
Herpotrichia . . . . .	130	Lophiosphæria . . . . .	132
Hesperocichla . . . . .	59, 65	Lophius . . . . .	90
Hesperornis . . . . .	72	Lophodytes . . . . .	22, 31
Heterodon . . . . .	387	Lottia . . . . .	286
Hexaprotodon . . . . .	186	Loxia . . . . .	47, 63
Hierochloë . . . . .	214	Lunatia . . . . .	220
Hippolysmata . . . . .	115	Lunda . . . . .	30
Hippolytidae . . . . .	115	Lumbricus . . . . .	81
Hippolyte . . . . .	115	Luzula . . . . .	214
Hippopotamus . . . . .	185-187	Lychnis . . . . .	209
Histrionicus . . . . .	23, 33	Lycium . . . . .	134
Holbrookia . . . . .	386	Lycopodium . . . . .	215
Homarus . . . . .	76	Lyroda . . . . .	467, 468, 533, 534
Hyalinia . . . . .	236	Lysiosquilla . . . . .	106
Hygraphorus . . . . .	440	Lysmata . . . . .	117
Hyla . . . . .	181, 183	Lythrum . . . . .	301
Hymenocera . . . . .	119	Macrorhamphus . . . . .	35
Hymenoceridae . . . . .	119	Macrosporium . . . . .	464
Hymenomyces . . . . .	440	Malva . . . . .	294, 296
Hymenoptera . . . . .	436	Marasmius . . . . .	441
Hypnum . . . . .	217	Margarita . . . . .	221
Hyphomyceteæ . . . . .	163	Marsonia . . . . .	168
Hyphomyces . . . . .	461	Martesia . . . . .	219, 222
Hypocrea . . . . .	442	Massariovalsa . . . . .	138
Hypoxylon . . . . .	450	Mastodon . . . . .	202, 204
Hysterium . . . . .	132	Matricaria . . . . .	211
Ichthyosaurus . . . . .	71	Meda . . . . .	19
Icteria . . . . .	22, 55, 64	Megalestes . . . . .	377, 379
Icterus . . . . .	25, 47, 63	Megalobatrachus . . . . .	227-232
Idonearca . . . . .	221, 222	Megalosaurus . . . . .	71
Illosporium . . . . .	465	Megascops . . . . .	22, 28, 41, 61
Isaria . . . . .	465	Melanerpes . . . . .	43, 62
Junco . . . . .	28, 50, 63	Melaniconieae . . . . .	454
Karschia . . . . .	453	Melanomma . . . . .	445
Kobesia . . . . .	214	Melanopsamma . . . . .	129, 445
Lachnea . . . . .	145	Melicerta . . . . .	117
Lachnellula . . . . .	451	Melospiza . . . . .	23, 28, 51, 63
Lachnobolus . . . . .	371	Menispora . . . . .	462
Lagopus . . . . .	22, 38	Menopoma . . . . .	228-232
Lanius . . . . .	53, 64	Mephitis . . . . .	280
Larra . . . . .	468, 480-483	Merganser . . . . .	22, 31, 60
Larus . . . . .	22, 30, 60	Mertensia . . . . .	212, 289
Lasiosphæria . . . . .	129, 443	Merula . . . . .	59, 65
Leander . . . . .	119	Metasphæria . . . . .	136
Lecanora . . . . .	216	Micropera . . . . .	165
Lecidia . . . . .	216	Minnilus . . . . .	19
Ledum . . . . .	212	Miscophus . . . . .	468, 479
Leiopistha . . . . .	221	Modulus . . . . .	221

Mollisia . . . . .	147	Pandalus . . . . .	114
Molothrus . . . . .	46, 63	Pandion . . . . .	40
Monilia . . . . .	461	Pannaria . . . . .	216
Monotus . . . . .	81	Panopea . . . . .	222
Montagnella . . . . .	133	Papaver . . . . .	208, 209
Myadestes . . . . .	58, 65	Paracrangon . . . . .	126
Myrianida . . . . .	81	Parmelia . . . . .	216
Mytilidion . . . . .	450	Parus . . . . .	22, 23, 57, 65
Mytilus . . . . .	222	Pasiphæa . . . . .	111
Myxosporium . . . . .	458	Pasiphaeidae . . . . .	111
Næmacyclus . . . . .	151	Passerella . . . . .	23, 51, 63
Natica . . . . .	220	Passerina . . . . .	52, 64
Natrix . . . . .	385	Patellidae . . . . .	285, 286
Nectocrangon . . . . .	126	Patinella . . . . .	452
Nectria . . . . .	129, 443	Patula . . . . .	234, 238, 246, 389, 394, 395
Neitheia . . . . .	221	Pedicularis . . . . .	212
Nematocarcinus . . . . .	121	Pedinogyra . . . . .	242
Neotoma . . . . .	16	Pediocætes . . . . .	39, 61
Neolarra . . . . .	467	Pelecanus . . . . .	31
Nephrodium . . . . .	215	Peltigera . . . . .	216
Nephroma . . . . .	216	Pelycosauria . . . . .	72
Nica . . . . .	124	Penaeidea . . . . .	108
Nika . . . . .	124	Penaeus . . . . .	108
Nikidae . . . . .	124	Perisoreus . . . . .	22, 45, 63
Niptera . . . . .	147	Perodipus . . . . .	409-411
Niteliopsis . . . . .	468, 477, 478	Perognathus . . . . .	404-412
Nothosaurus . . . . .	71	Pertusaria . . . . .	216
Notogonia . . . . .	468, 484-486, 488	Pestalozzia . . . . .	461
Numenius . . . . .	36, 61	Petrochelidon . . . . .	53, 64
Nummularia . . . . .	144	Phalacrocorax . . . . .	22, 31
Nyctala . . . . .	41, 61	Phialea . . . . .	146
Nyssa . . . . .	137	Philonotis . . . . .	217
Odontofusus . . . . .	221	Pholadomya . . . . .	222
Oidemia . . . . .	33, 60	Phoma . . . . .	158
Olana . . . . .	287	Phonolite . . . . .	176
Olor . . . . .	23, 34	Phrynosoma . . . . .	387
Onchophorus . . . . .	217	Phyllosticta . . . . .	156, 454-456
Oplophorus . . . . .	121	Physalospora . . . . .	447
Ophibolus . . . . .	385, 387	Physarum . . . . .	371
Ophiobolus . . . . .	448	Physcia . . . . .	216
Ophiotheca . . . . .	364	Pica . . . . .	23, 45, 62
Ophisaurus . . . . .	385, 387	Picicorvus . . . . .	46, 63
Orbilina . . . . .	145	Pimelite . . . . .	174
Oreortyx . . . . .	22, 37	Pinicola . . . . .	47, 63
Ornithorynchus . . . . .	73	Pinna . . . . .	222
Ortholestes . . . . .	377-382	Pipilo . . . . .	52, 64
Orthothecium . . . . .	217	Piranga . . . . .	52, 64
Orthotrichum . . . . .	217	Piricularia . . . . .	462
Oryzopsis . . . . .	128, 134	Pison . . . . .	467, 470
Ostrya . . . . .	129, 133	Pisonopsis . . . . .	468, 469
Otocoris . . . . .	45, 62	Pistillaria . . . . .	441
Otthia . . . . .	133	Pityophis . . . . .	182, 184, 387
Oxyria . . . . .	213	Placodium . . . . .	216
Palaemon . . . . .	109, 121	Planogyra . . . . .	246
Palaemonella . . . . .	124	Platylestes . . . . .	377, 379
Palaemonetes . . . . .	124	Plenoculus . . . . .	468, 536-538
Palaemonidae . . . . .	119	Pleospora . . . . .	134
Pandalidae . . . . .	114	Plesiosaurus . . . . .	71



Pliauchenia. . . . .	202	Scalaria. . . . .	221
Plicatula . . . . .	222	Scaphites. . . . .	220
Poa. . . . .	214	Sceloporus . . . . .	384
Podilymbus . . . . .	29, 60	Scirpus . . . . .	214
Pogonatum. . . . .	217	Sclerocrangon . . . . .	127
Pohlia. . . . .	217	Scolecophagus . . . . .	47, 63
Polygonum. . . . .	191, 213	Scotiaptex . . . . .	41
Polygyra . . . . .	234, 389, 396	Scutellaria . . . . .	308
Pontonella . . . . .	119	Scurria . . . . .	286
Pontonia . . . . .	119	Scytale . . . . .	434
Pontoniidae. . . . .	118	Seiurus. . . . .	55, 64
Pontophilus . . . . .	126	Sedum . . . . .	211
Poöcaetes . . . . .	48, 63	Selasphorus. . . . .	44
Populus. . . . .	289	Semotilus. . . . .	20
Portulaca. . . . .	307	Septogloeum . . . . .	461
Porzana . . . . .	23, 35, 60	Septoria. . . . .	163, 457
Potentilla. . . . .	209	Sergestes . . . . .	110
Pottia . . . . .	217	Sergestidae . . . . .	110
Primulacæ. . . . .	291	Setophaga . . . . .	55, 65
Processa. . . . .	124	Sialia . . . . .	59, 65
Progne . . . . .	23, 52, 64	Sicyonia . . . . .	110
Propolidium . . . . .	151, 285	Sieboldia . . . . .	227
Proteobranchiata . . . . .	286	Silene. . . . .	209
Proterosaurus. . . . .	71	Silphium. . . . .	306
Psaltriparus . . . . .	27	Simorhynchus. . . . .	22, 30
Pseudogryphus . . . . .	39	Sitta . . . . .	23, 57, 65
Pseudosquilla. . . . .	106	Solanum . . . . .	134
Pseudovalsa . . . . .	450	Solomia. . . . .	216
Ptychoramphus . . . . .	30	Sorosporium . . . . .	156
Puccinia . . . . .	152	Spatula. . . . .	22, 32, 60
Pycnodus. . . . .	219	Spea. . . . .	182, 184
Pyrenomycetes . . . . .	128, 441	Spelerpes. . . . .	383
Pyrola . . . . .	212	Speotyto . . . . .	41
Pyrophyllite . . . . .	197	Spergularia. . . . .	290
Pyropsis . . . . .	221	Sphærella. . . . .	134, 446, 447
Quercus . . . . .	24, 129	Sphæronema . . . . .	158
Racomitrium. . . . .	217	Sphærophorus. . . . .	216
Rallus. . . . .	35	Sphæropdideæ. . . . .	156, 454
Ramularia. . . . .	169, 462	Sphaeropsis. . . . .	150, 457
Rana . . . . .	181-184	Sphagnum . . . . .	217
Ranunculus . . . . .	208	Sphyrapicus . . . . .	22, 42, 62
Regulus. . . . .	28, 58, 65	Spilotes. . . . .	432, 433
Reptilia. . . . .	182, 384, 386	Spinus . . . . .	27, 48, 63
Rhincocynetidae . . . . .	118	Spirontocaris . . . . .	117
Rhincocynetes. . . . .	118	Spizella. . . . .	22, 27, 28, 50, 63
Rhododendron . . . . .	212	Squilla . . . . .	105, 107
Rhynchosaurus. . . . .	71	Squillidae. . . . .	105
Rinodina. . . . .	216	Stagonosphora . . . . .	162, 447, 457
Rosellinia. . . . .	128, 444	Steenhammera . . . . .	289
Rostellites. . . . .	221	Stelgidopteryx. . . . .	53, 64
Sabinea. . . . .	127	Stellaria. . . . .	209
Salamandra. . . . .	227	Stellula . . . . .	44
Salix. . . . .	130, 133, 213	Stenotrema. . . . .	389
Salpinctes . . . . .	25, 27, 56	Stereocaulon . . . . .	216
Salvia . . . . .	191	Sterna . . . . .	31
Samolus . . . . .	291	Stictis. . . . .	150, 453
Saxifraga. . . . .	210	Stigmia . . . . .	171
Sayornis . . . . .	25, 44, 62	Stomatopoda . . . . .	105

**THIS PAGE IS LOCKED TO FREE MEMBERS**

Purchase full membership to immediately unlock this page

# DELVE INTO FANTASY, MAGIC, MYTHOLOGY & FOLKLORE

Forgotten Books'  
Full Membership gives  
access to 797,885 ancient  
and modern, fiction and  
non-fiction books.

**Continue**

\*Fair usage policy applies

# GENERAL INDEX.

1893.

- Additions to Museum, 574.
- Allen, Harrison, M.D. The forms of edentulous jaws in the Human Subject, 11. Note on the mechanism of the act of the expulsion of secretion from the anal sac of *Mephitis*. 280.
- Bancroft, Edward, announcement of death of, 226.
- Binder, Jacob, announcement of death of; resolutions, 66, 67.
- Biological and Microscopical Section, report of, 563.
- Botanical Section, report of, 566.
- Brinton, Daniel G., M. D. Report of the Professor of Ethnology and Archaeology, 570.
- Brown, A. E. Notes on some snakes from Tropical America, lately living in the collection of the Zoological Society of Philadelphia, 363, 429.
- Burk, Isaac, announcement of death of, 201.
- Calvert, Philip P. The Odonate genus *Ortholestes*, 348, 377.
- Chapman, Henry C., M. D. The interpretation of certain verses of the first chapter of Genesis in the light of paleontology, 9, 68. Notes on *Chœropsis liberiensis* Morton, (Plate IV) 173, 185. Observation on the Japanese Salamander, *Cryptobranchus maximus* (Schlegel), (Plates V, VI, VII) 218, 227. Homologies of the alisphenoid and petromastoid bones in vertebrates, 439.
- Chapman, Henry C., M. D. and Albert B. Brubaker, M. D. The radius of curvatures of the cornea, 226, 349.
- Cope, Edw. D. On a new extinct species of Cyprinidae, 11, 19. A contribution to the herpetology of British Columbia, 66, 181. Description of the lower jaw of *Tetrabelodon Shepardii* Leidy, 201, 202. Some new and little known Palæozoic and Jurassic fishes, 218, 280, 362. On a collection of batrachia and reptilia from southwest Missouri, 362, 383. On the batrachia and reptilia of the Plains at latitude 36° 30', 362, 386. On *Cyphornis*, an extinct genus of birds, 362, 363. On extinct Bovidæ, Canidæ and Felidæ from the Plistocene of the Plains, 401, 439. Fossil fishes from British Columbia, 401. Heredity in the social colonies of the Hymenoptera, 436.
- Committee on Hayden Memorial Geological Award, 67. Report of, 403.
- Committees, Standing, for 1893, 9.
- Conchological Section, report of, 563.
- Corresponding Secretary, report of, 555.
- Curator of the Wm. S. Vaux Collections, report of, 571.
- Curators, report of, 558.
- Dall, W. H. The phylogeny of the *Docoglossa*, 280, 285.
- De Candolle, Alphonse, announcement of death of, 201.
- Dixon, S. G., M. D. Involution forms of Tubercle Bacillus and the effect of subcutaneous injection of organic substances on inflammations, 66, 100. Report of Curators, 558. Report of the Professor of Histology and Microscopic Technology, 571.
- Elections during 1893, 572.
- Ellis, J. B. and B. M. Everhart. New species of North American fungi from various localities, 11, 128. New species of fungi from various localities, 402, 440.
- Entomological Section, report of, 565.
- Ford, John. Remarks on a new species of *Cypræa*, 310.

- Fox, Wm. J. North American Larridae, 402, 467.
- Gadolin, Axel, announcement of death of, 15.
- Genth, F. A., M. D., announcement of death of, 66.
- Goldsmith, Edward. Notes on some minerals and rocks, (Plates I and II) 66, 174. A tempered steel meteorite, (Plate IX) 348, 373.
- Hacker, Charles, announcement of death of, 362.
- Hartmann, Robert, announcement of death of, 226.
- Hayden Memorial Geological Award, 67. Report of Committee on, 403.
- Heilprin, Angelo. Report of the Professor of Invertebrate Paleontology, 568.
- Holmes, W. H. Earthenware of Florida, collections of Clarence B. Moore, 436, 439.
- Horn, Geo. H., M. D., election of, as member of Finance Committee, 14.
- Hoy, P. R., announcement of death of, 10.
- Hunt, J. Gibbons, M. D., announcement of death of; resolutions, 218.
- Index to Genera, 583.
- Jefferis, Wm. P. Report of the Curator of the Wm. S. Vaux Collections, 571.
- Keim, Geo. DeB., announcement of death of, 173.
- Keller, Ida A. The glandular hairs of *Brasenia peltata* Pursh, 173, 188.
- Koksharow, Nicholas, announcement of death of, 15.
- Libbey, William, Jr. Physical Geography of the Hawaiian Islands (no abstract) 439.
- Levick, James J., M. D., announcement of death of, 280.
- Librarian, report of, 556.
- Lilly, William, announcement of death of, 439.
- Maisch John M., announcement of death of, 348.
- Markoe, John, announcement of death of, 66.
- Martindale, Isaac C., announcement of death of; resolutions, 10.
- Mason, James Wood, announcement of death of, 439.
- Meehan, Thomas. Contributions to the life histories of plants, No. 9, 280, 289. Report of Botanical Section, 566.
- Meehan, Wm. E. A contribution to the flora of Greenland, 201, 205.
- Meyer, Abraham. Pyrophyllite slate in Northern Pennsylvania 66, 197. Notes on the occurrence of quartz and other minerals in the Chemung Measures near the line of Lycoming and Tioga counties, 66, 194.
- Mineralogical and Geological Section, report of, 566.
- Moore, Clarence B. Certain Sand Mounds of the St. John's river, Florida. Part I, 310.
- Moore, J. Percy. On some leech-like parasites of American Crayfishes, (Plate XII) 401, 419.
- Morsell, F. C. Taking a sunbeam apart, (no abstract) 226.
- Museum, additions to, 574.
- Newberry, J. S., M. D., announcement of death of, 11.
- Nolan, Edward J., M. D. Report of Recording Secretary, 552. Report of Librarian, 556.
- Officers, Councillors and members of Finance Committee for 1894, 572.
- Ornithological Section, report of, 567.
- Owen, Sir Richard, announcement of death of, 11.
- Perot, Chas. P., election of, as Treasurer, 11.
- Pierce, Dr. C. N. Edentulous jaws, 13. Remarks on Hawaiian crania, 224.
- Pilsbry, H. A. Critical list of mollusks collected in the Potomac Valley, 402. Thysanophora coloba, 403. Report of Conchological Section, 563.
- Pine, Wm. S., announcement of death of, 10.
- Professor of Ethnology and Archaeology, report of, 570.
- Professor of Histology and Microscopic Technology, report of, 571.
- Professor of Invertebrate Paleontology, report of, 368.

- Professor of Lower Invertebrata, report of, 570.
- Rand, Theodore D. Report of Mineralogical and Geological Section, 566.
- Recording Secretary, report of, 552.
- Report of Biological and Microscopical Section, 563.
- Report of Botanical Section, 566.
- Report of Committee on Hayden Memorial Geological Award, 403.
- Report of the Conchological Section, 563.
- Report of Corresponding Secretary, 555.
- Report of the Curator of the Wm. S. Vaux Collections, 571.
- Report of Curators, 558.
- Report of Entomological Section, 565.
- Report of Librarian, 556.
- Report of Mineralogical and Geological Section, 566.
- Report of Ornithological Section, 567.
- Report of the Professor of Ethnology and Archæology, 570.
- Report of the Professor of Histology and Microscopic Technology, 571.
- Report of the Professor of Invertebrate Paleontology, 568.
- Report of the Professor of Lower Invertebrata, 570.
- Report of Recording Secretary, 552.
- Rex, Geo. A., M. D. New North American Myxomycetes, 280, 364.
- Rhoads, Samuel N. The birds observed in British Columbia and Washington during the spring and summer 1892, 21. Description of new species of North American mammals with remarks on species of the genus *Perognathus*, 401, 404. Geographic variations in *Basariscus astutus* with description of a new subspecies, 401, 413.
- Roberts, Louisa J., announcement of death of, 173.
- Robinson, Thomas A., election of as member of council, 15.
- Rogers, Wm. B., announcement of death of, 173.
- Ryder, John A. On the inheritance of modifications due to the disturbance of the early stage of development in the Japanese domesticated races of Gold Carp, 11, 75. The vascular respiratory mechanism of the vertical fins in the viviparous Embiotocidæ, 11, 95.
- Semper, Carl, announcement of death of, 280.
- Sharp, Benjamin, M. D. Catalogue of the Crustaceans in the museum of the Academy of Natural Sciences of Philadelphia, 11, 104. Election of, as member of the Committee on Instruction and Lectures, 67. Notes on the Hawaiian Islands (no abstract) 436. Report of Corresponding Secretary, 555. Report of the Professor of Lower Invertebrata, 570.
- Sharpless, Stephen P. Phosphate beds of Florida (no abstract) 201.
- Steel, Francis T., announcement of death of, 401.
- Sterki, V. Observations on Valonia, (Plate VIII) 218, 234. Changes with age in the radula of land mollusca, (Plates X, and XI) 312, 388.
- Stone, Witmer. Description of a new species of *Neotoma*, 11, 16. Report of Ornithological Section, 567.
- Streeker, Herman. Descriptions of two new species of North American Bombycidæ, 226, 282.
- Taggart, Henry L., announcement of death of, 348.
- Tarr, Ralph S. Notes on the physical geography of Texas, 280, 313.
- Turnpenny, Joseph C., announcement of death of, 66.
- Willcox, Jos. Metamorphism of sedimentary rocks, 10.
- Wingate, Harold, report of Biological and Microscopical Section, 563.
- Woolman, Lewis. Cretaceous Ammonites and other fossils near Moorestown, N. J. Their stratigraphic position shown by an artesian well section at Maple Shade, N. J. Incidental reference to water horizons, 219, 388.

**THIS PAGE IS LOCKED TO FREE MEMBERS**

Purchase full membership to immediately unlock this page

# Know Your Bible

Forgotten Books' Full Membership provides unlimited access to more than 28,000 volumes of Christian literature for \$8.99/month

**HOLY BIBLE**

**Continue**

\*Fair use policy applies



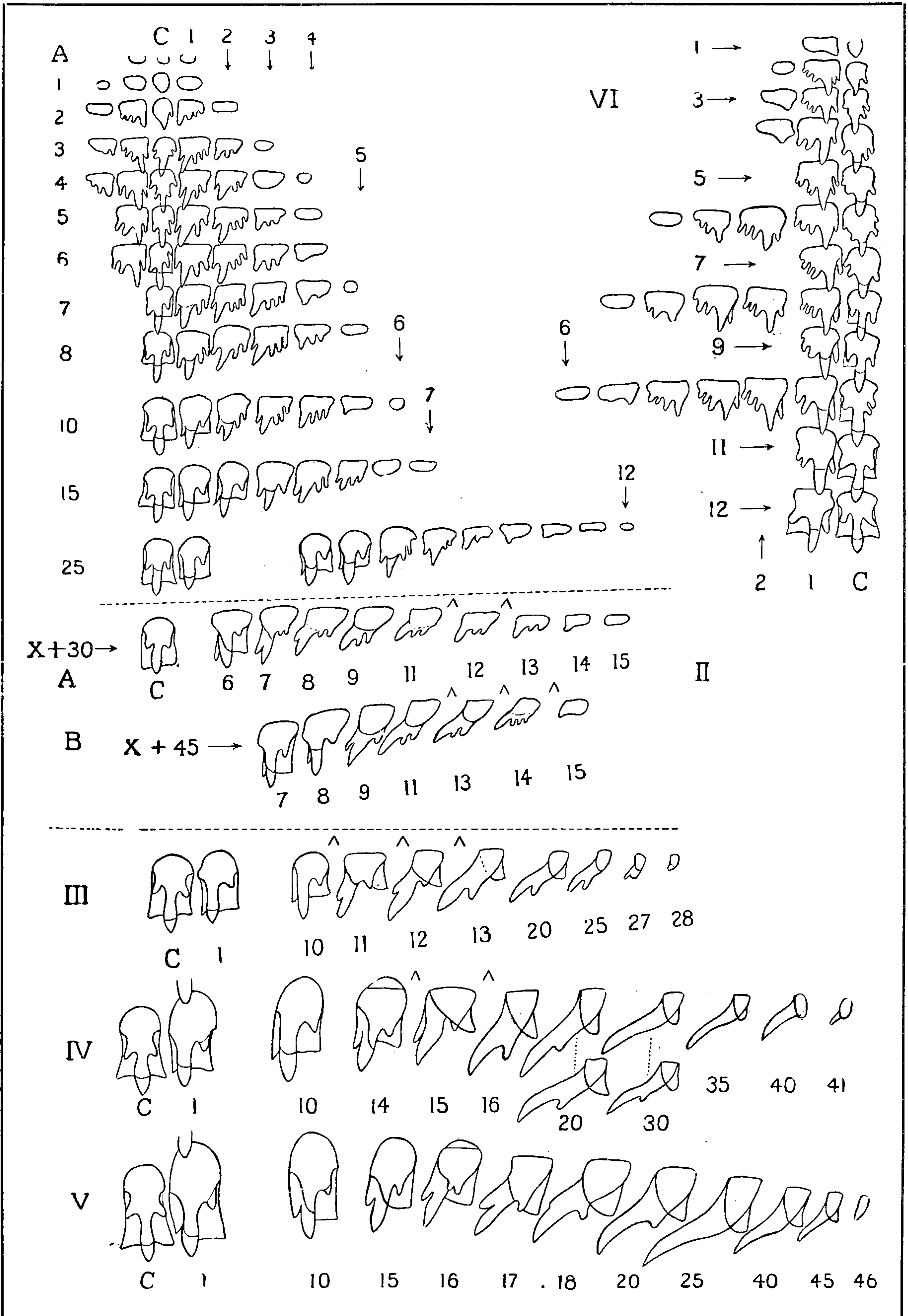

STERKI, RADULA OF LAND MOLLUSKS.





**THIS PAGE IS LOCKED TO FREE MEMBERS**

Purchase full membership to immediately unlock this page

# DELVE INTO FANTASY, MAGIC, MYTHOLOGY & FOLKLORE

Forgotten Books'  
Full Membership gives  
access to 797,885 ancient  
and modern, fiction and  
non-fiction books.

**Continue**

\*Fair usage policy applies



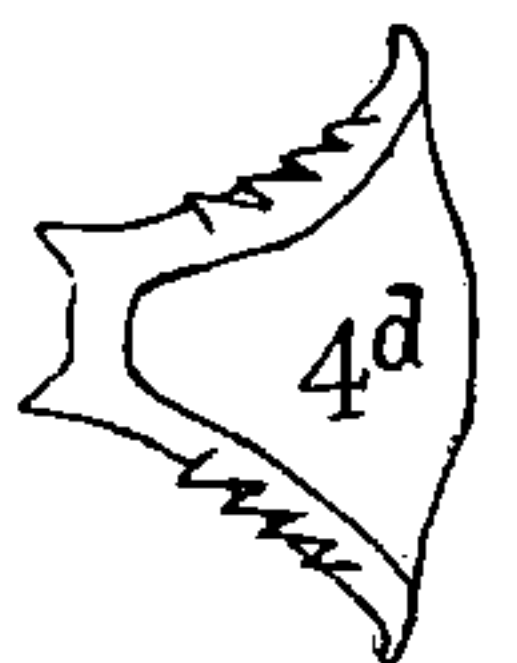
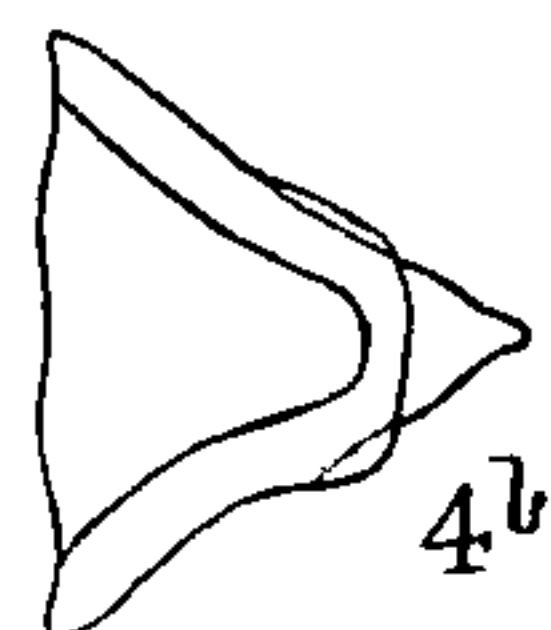
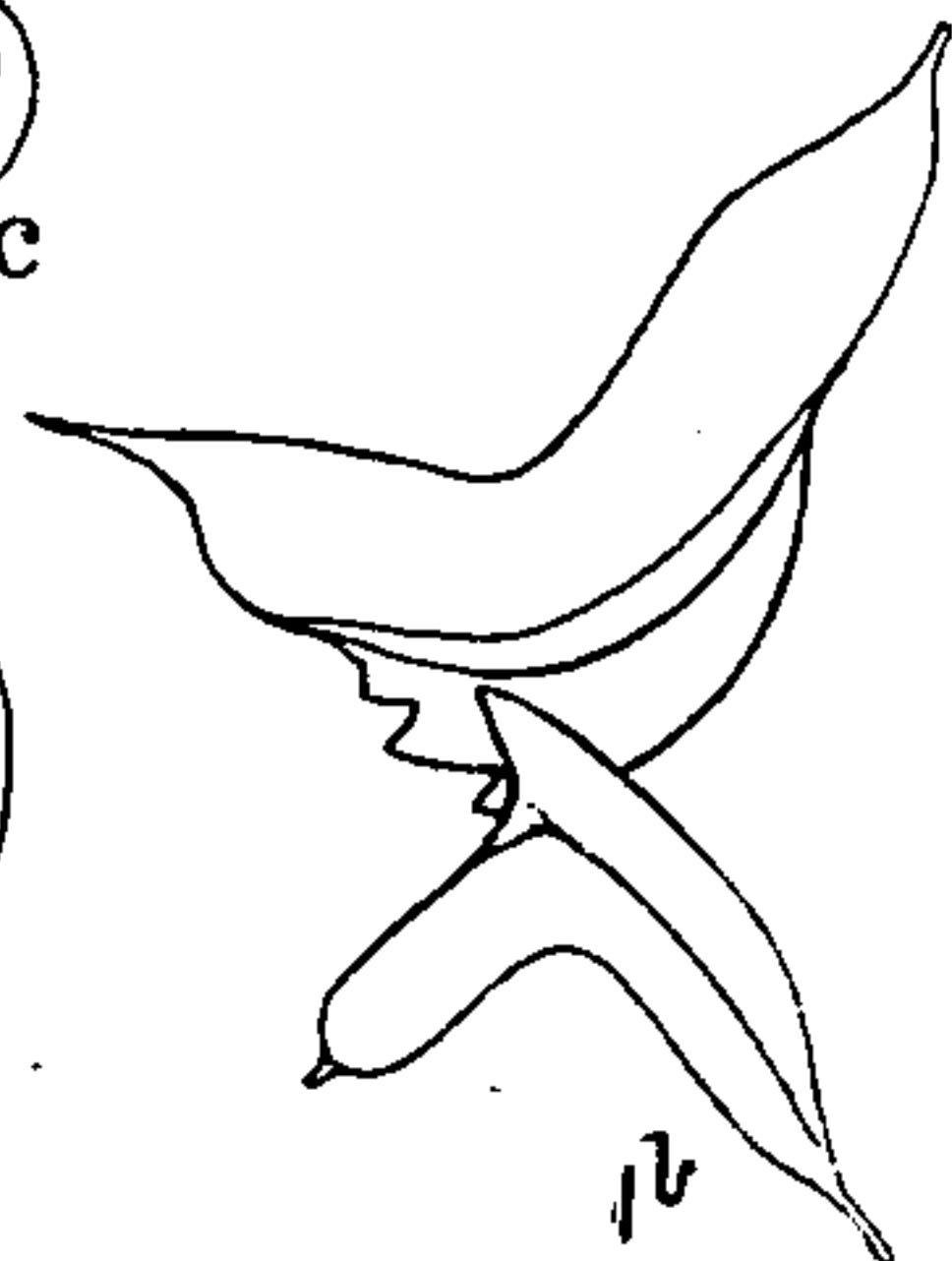
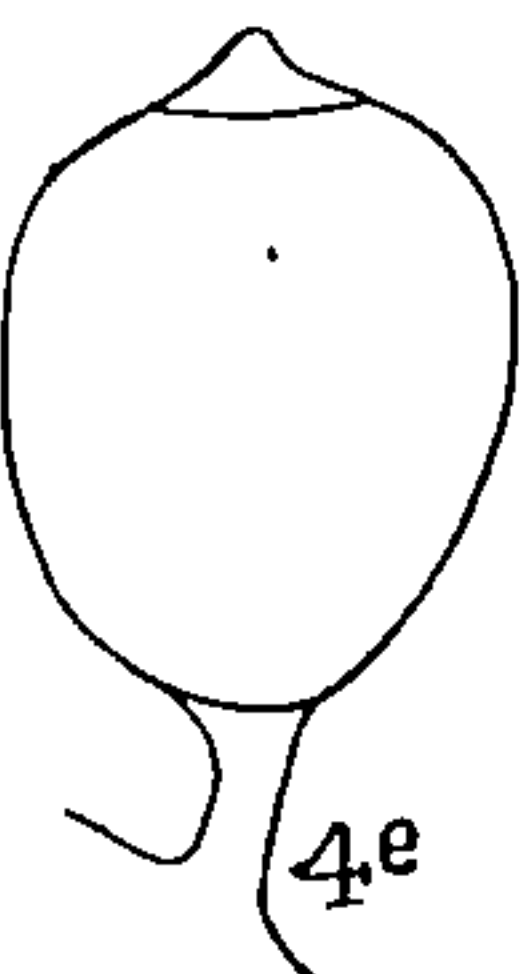
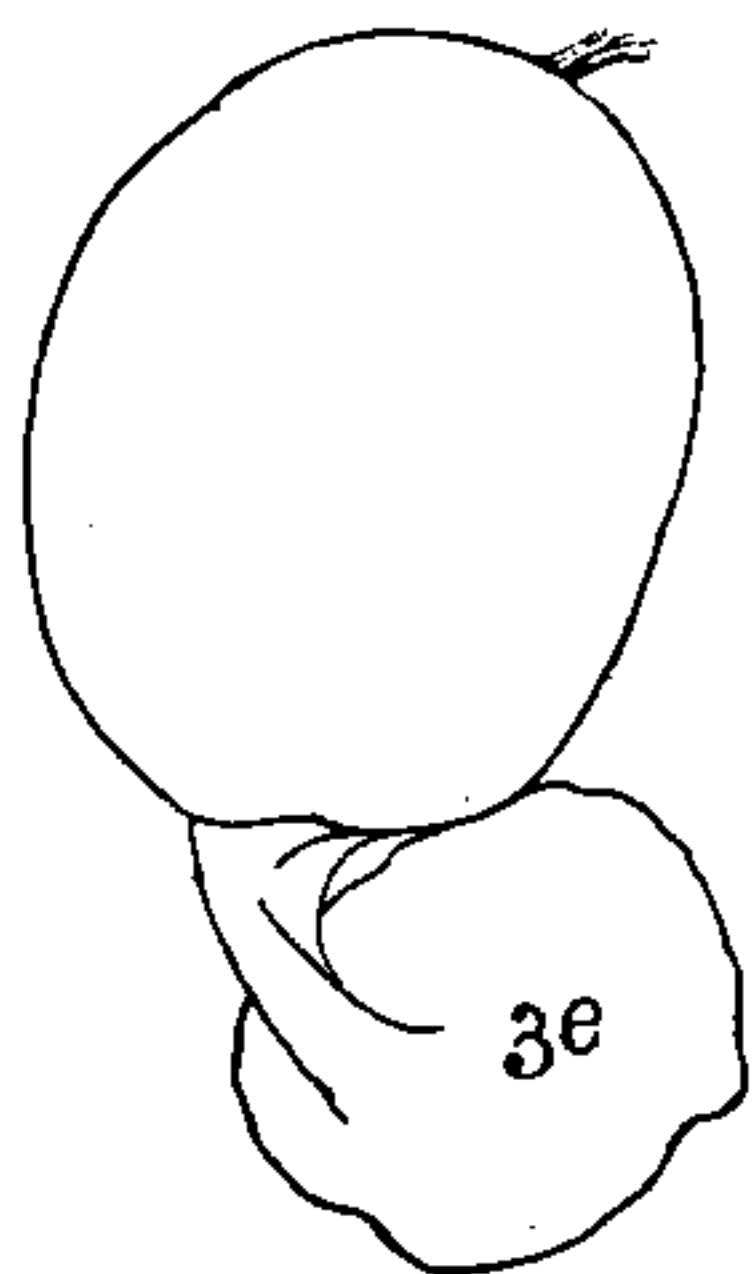
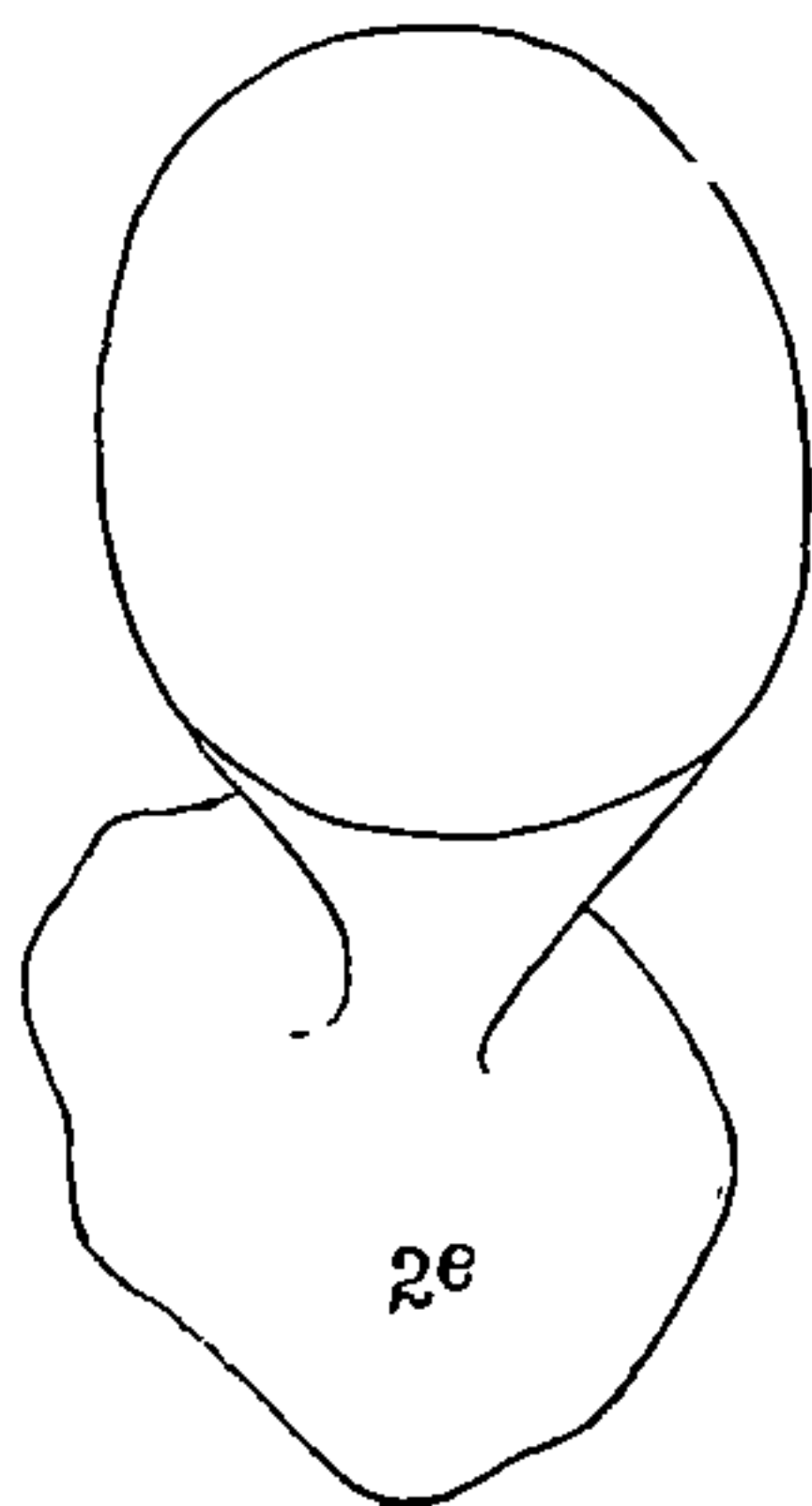
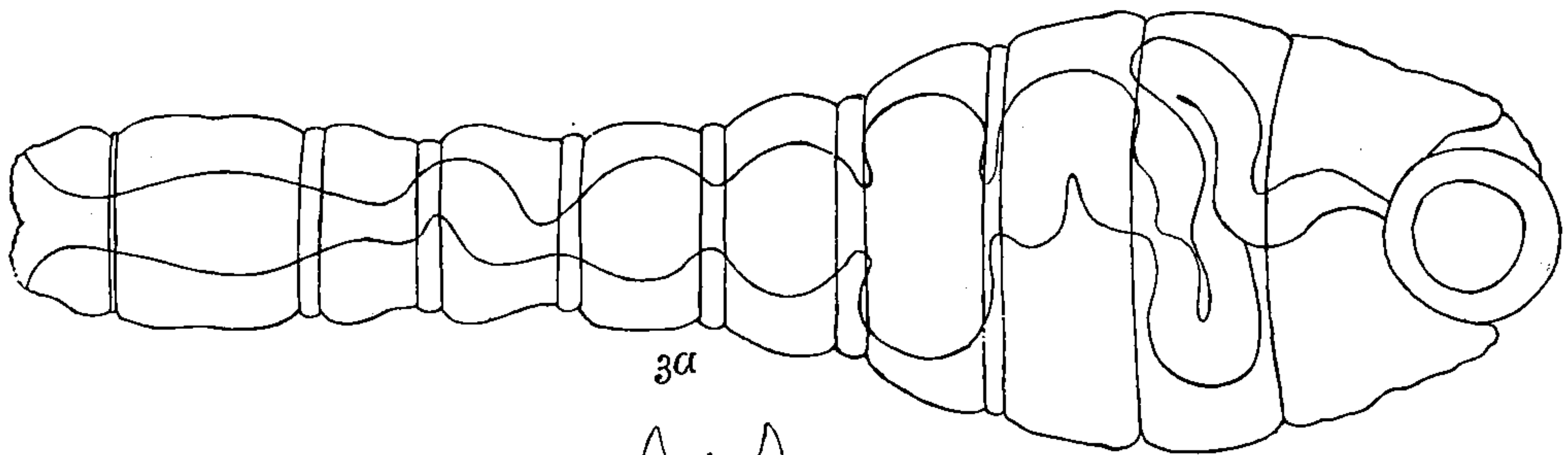
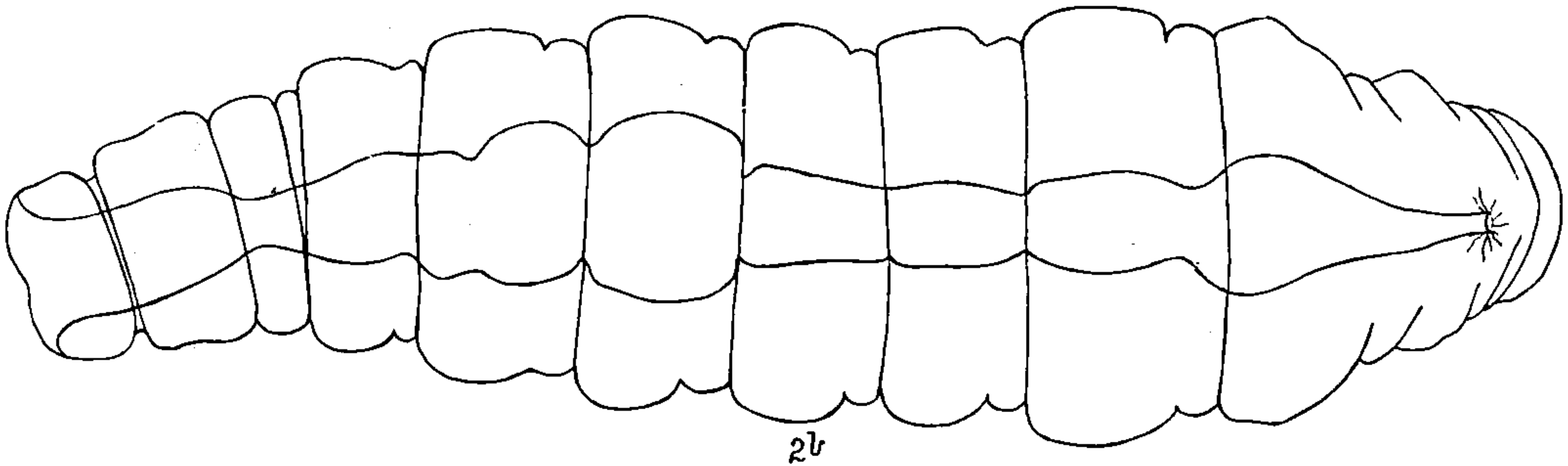
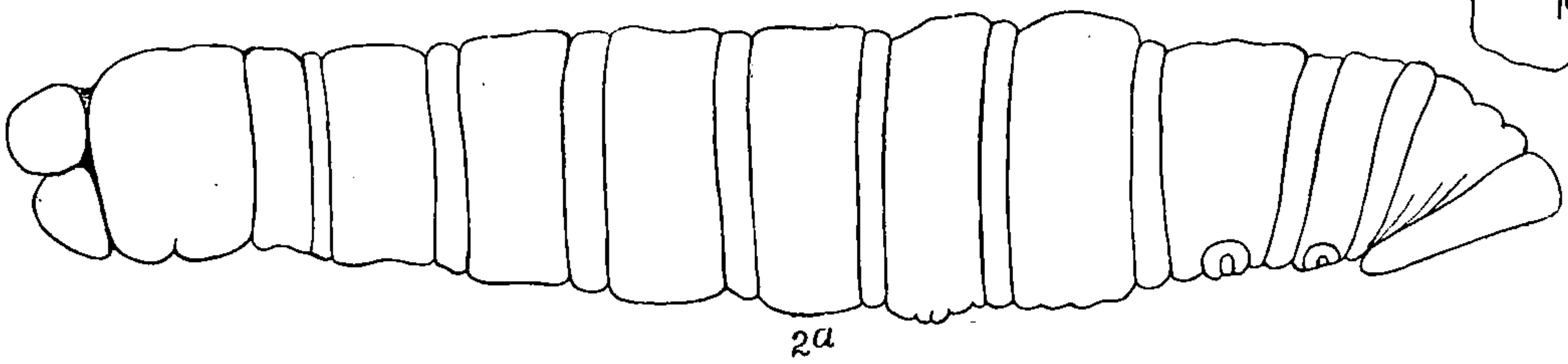
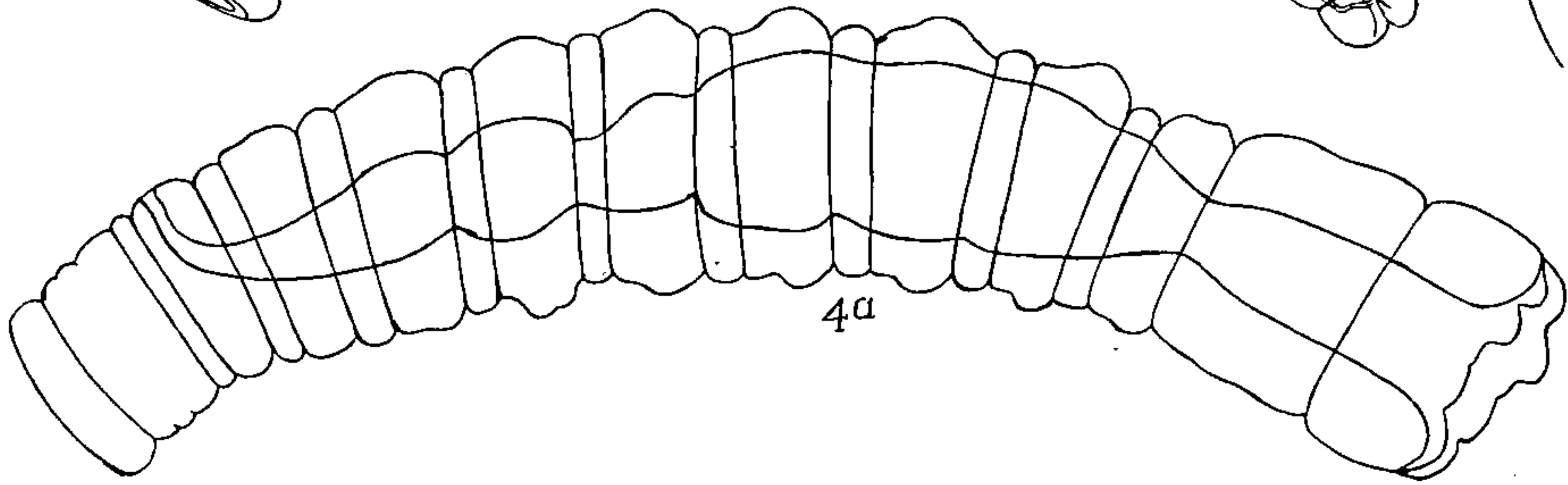
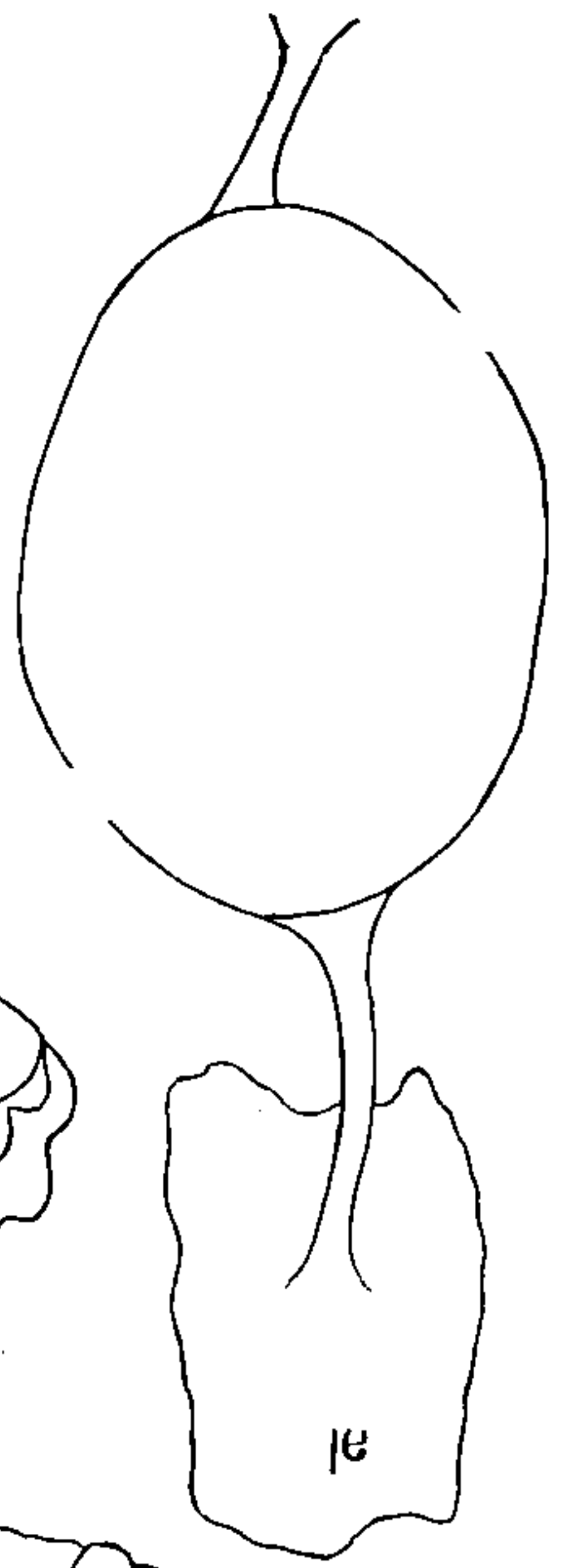
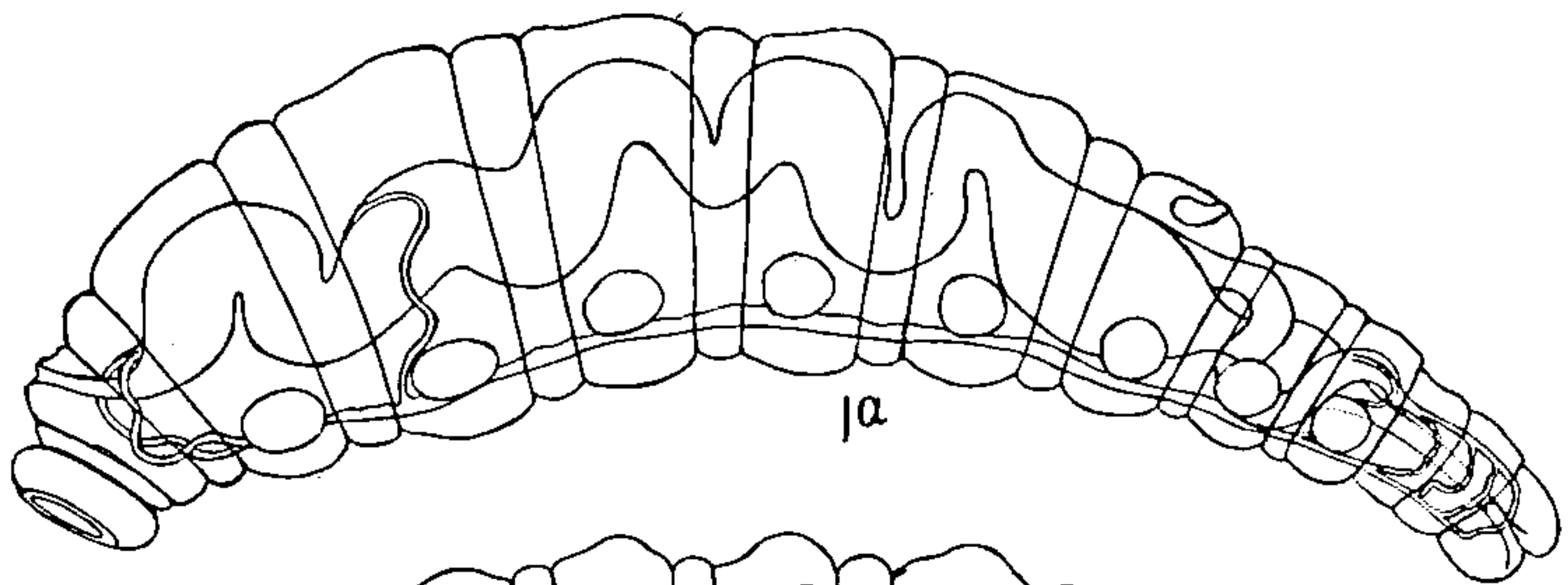



**THIS PAGE IS LOCKED TO FREE MEMBERS**

Purchase full membership to immediately unlock this page

# Know Your Bible

Forgotten Books' Full Membership provides unlimited access to more than 28,000 volumes of Christian literature for \$8.99/month

**HOLY  
BIBLE**

**Continue**

\*Fair use policy applies

## HAYDEN MEMORIAL GEOLOGICAL FUND.

Mrs. Emma W. Hayden has given to the Academy of Natural Sciences of Philadelphia in trust the sum of \$2,500 to be known as the Hayden Memorial Geological Fund, in commemoration of her husband, the late Prof. Ferdinand V. Hayden, M. D., LL. D. According to the terms of the trust, a bronze medal and the balance of the interest arising from the fund are to be awarded annually for the best publication, exploration, discovery or research in the sciences of geology and paleontology, or in such particular branches thereof as may be designated. The award and all matters connected therewith are to be determined by a committee to be selected in an appropriate manner by the Academy. The recognition is not confined to American naturalists.

# PUBLICATIONS OF THE ACADEMY OF NATURAL SCIENCES OF PHILADELPHIA.

---

Eight volumes of the New Series of the JOURNAL and Parts 1, 2 and 3 of volume IX (Quarto) have been issued—1847 to 1892. The price per volume of four parts is \$10, or \$3 per part to subscribers; and to others \$12.50 per volume, or \$3.75 per part. Vol. VII contains "The Extinct Mammalian Fauna of Dakota and Nebraska, with a Synopsis of the Mammalian Remains of North America." Illustrated with thirty plates. By JOSEPH LEIDY, M. D., LL. D.

The FIRST SERIES OF THE JOURNAL, 1817 to 1842, in eight volumes, octavo, may be obtained at \$40 to members, and to the public, \$48.

The FIRST SERIES OF THE PROCEEDINGS of the Academy, published in octavo, 1841 to 1856, of which eight volumes were completed Dec. 31, 1856, may be obtained at \$24 to members; and to the public, \$30.

The SECOND SERIES OF THE PROCEEDINGS, commencing January 1, 1857 (of which fourteen volumes were completed Dec. 31, 1870), may be obtained at \$42 to members, or \$3 per volume separately; and to the public, \$3.75 per volume.

The THIRD SERIES OF THE PROCEEDINGS, illustrated, commencing January 1, 1871 (of which twenty-two volumes were completed Dec. 31, 1892), is published at \$5 per annum, payable in advance, to subscribers; single volumes, \$6.25.

AMERICAN JOURNAL OF CONCHOLOGY, 1865—71. Seven vols., 8vo. Containing 2,500 pages, illustrated by one hundred and fifty plates, many of them colored, besides about a thousand wood engravings. Published at \$70. Price reduced to \$42 for the set. Separate volumes, \$10 each.

## BOOKS FOR SALE.

The ACADEMY has the following works for sale at the prices affixed:

DESCRIPTION OF SHELLS OF NORTH AMERICA, with 68 colored plates. By THOMAS SAY. 1830-34. \$10.50.

MONOGRAPH OF THE TERRESTRIAL MOLLUSCA OF THE UNITED STATES. With illustrations of all the species. By GEO. W. TRYON, JR. Fine edition, plate paper, with duplicate plates, colored and tinted, \$20; colored edition, \$13.50; plain edition, \$8.50. Only one hundred copies printed, which have been mostly sold.

MONOGRAPH OF THE FRESH WATER UNIVALVE MOLLUSCA OF THE UNITED STATES. By S. S. HALDEMAN, 1840-44. With CONTINUATION to 1871. By GEO. W. TRYON, JR. 2 vols., with many colored plates. Fine edition, duplicate plates, \$40; with colored plates, \$25; with plain plates, \$18.

Either the original work or the continuation furnished separately, if desired.

SYNONYMY OF THE SPECIES OF STREPOMATIDÆ (Melanians) OF THE UNITED STATES. By GEO. W. TRYON, JR. Cloth, \$2; paper, \$1.75.

LIST OF AMERICAN WRITERS ON RECENT CONCHOLOGY, with the Titles of their Memoirs and Dates of Publication. By GEO. W. TRYON, JR. Cloth, \$2; paper, \$1.75.

MONOGRAPH OF THE ORDER PHOLADACEA and other Papers. By GEO. W. TRYON, JR. Cloth, \$2; paper, \$1.75.

COMPLETE WRITINGS ON RECENT AND FOSSIL CONCHOLOGY OF C. S. RAFINESQUE. Edited by WM. G. BINNEY and G. W. TRYON, JR. \$2.50.

OBSERVATIONS ON THE GENUS UNIO. By ISAAC LEA, LL. D. 4to, Vols. 1 to 13. With Index, Nos. 1, 2 and 3, complete. Illustrated with several hundred fine lithographic Plates. \$60.

Same, Vols. 2 to 13 inclusive, except Vols. 4 and 12. Each volume separately, \$5.

SYNOPSIS OF THE GENUS UNIO. By ISAAC LEA, LL. D. Fourth edition. \$5.

CONTRIBUTIONS TO GEOLOGY. By ISAAC LEA. \$3.

FOSSIL FOOT-MARKS. By ISAAC LEA. Large folio, text and plate. \$2.

Same, plate alone. 50 cents.

NOTICE TO BOOKSELLERS—All the publications of the Society will be supplied to Booksellers at a discount of 20 per cent on the prices charged to the public.

Application to be made to EDWARD J. NOLAN, M. D., at the Hall of the Academy, Logan Square.



# CONTENTS.

---

STANDING COMMITTEES FOR 1893. . . . .	
MARTINDALE, ISAAC C. Resolutions on death of . . . . .	
WILLCOX, JOSEPH. Metamorphism of Sedimentary Rocks. . . . .	
ALLEN, HARRISON, M. D. The Forms of Edentulous Jaws in the Human Subject.	
PEIRCE, C. N., D. D. S. Forms of Jaws in Man. . . . .	
STONE, WITMER. Description of a new species of Neotoma from Pennsylvania. .	
COPE, EDW. D. A new extinct species of Cyprinidæ. . . . .	
RHOADS, SAMUEL N. The Birds observed in British Columbia and Washington during Spring and Summer, 1892. . . . .	
BINDER, JACOB. Resolutions on death of . . . . .	
CHAPMAN, HENRY C., M. D. The Interpretation of certain verses of the first chapter of Genesis in the light of Paleontology. . . . .	
RYDER, JOHN A. The Inheritance of Modifications due to Disturbances of the early stages of Development, especially in the Japanese domesticated races of G Carp. . . . .	
RYDER, JOHN A. The Vascular Respiratory Mechanism of the Vertical Fins of the Viviparous Embiotocidæ. . . . .	
DIXON, SAMUEL G., M. D. Involution Form of the Tubercle Bacillus and the effect of subcutaneous Injections of Organic Substances on Inflammations. . . . .	
SHARP, BENJAMIN, M. D. Catalogue of the Crustaceans in the Museum of the Academy of Natural Sciences of Philadelphia. . . . .	
ELLIS, J. B. and B. M. EVERHART. New Species of North American Fungi from various Localities . . . . .	
GOLDSMITH, E. Notes on some Minerals and Rocks. (Plates I and II.) . . . . .	
COPE, EDW. D. A Contribution to the Herpetology of British Columbia. . . . .	
CHAPMAN, HENRY C., M. D. Notes on Choeropsis liberiensis (Morton.) (Plate IV.)	
KELLER, IDA A. The Glandular Hairs of Brasenia peltata Pursh. (Plate III.) . .	
MEYER, ABRAHAM. Notes on the occurrence of Quartz and other Minerals in the Chemung Measures near the line of Lycoming and Tioga Counties, Pennsylvania.	
MEYER, ABRAHAM. Pyrophyllite Slates in Northern Pennsylvania. . . . .	



**THIS PAGE IS LOCKED TO FREE MEMBERS**

Purchase full membership to immediately unlock this page

# DELVE INTO FANTASY, MAGIC, MYTHOLOGY & FOLKLORE

Forgotten Books'  
Full Membership gives  
access to 797,885 ancient  
and modern, fiction and  
non-fiction books.

**Continue**

\*Fair usage policy applies

# PUBLICATIONS OF THE ACADEMY OF NATURAL SCIENCES OF PHILADELPHIA.

Eight volumes of the New Series of the JOURNAL and Parts 1, 2 and 3 of volume IX (Quarto) have been issued—1847 to 1892. The price per volume of four parts is \$10, or \$3 per part to subscribers; and to others \$12.50 per volume, or \$3.75 per part. Vol. VII contains "The Extinct Mammalian Fauna of Dakota and Nebraska, with a Synopsis of the Mammalian Remains of North America." Illustrated with thirty plates. By JOSEPH LEIDY, M. D., LL. D.

The FIRST SERIES OF THE JOURNAL, 1817 to 1842, in eight volumes, octavo, may be obtained at \$40 to members, and to the public, \$48.

The FIRST SERIES OF THE PROCEEDINGS of the Academy, published in octavo, 1841 to 1856, of which eight volumes were completed Dec. 31, 1856, may be obtained at \$24 to members; and to the public, \$30.

The SECOND SERIES OF THE PROCEEDINGS, commencing January 1, 1857 (of which fourteen volumes were completed Dec. 31, 1870), may be obtained at \$42 to members, or \$3 per volume separately; and to the public, \$3.75 per volume.

The THIRD SERIES OF THE PROCEEDINGS, illustrated, commencing January 1, 1871 (of which twenty-two volumes were completed Dec. 31, 1892), is published at \$5 per annum, payable in advance, to subscribers; single volumes, \$6.25.

AMERICAN JOURNAL OF CONCHOLOGY, 1865—71. Seven vols., 8vo. Containing 2,500 pages, illustrated by one hundred and fifty plates, many of them colored, besides about a thousand wood engravings. Published at \$70. Price reduced to \$42 for the set. Separate volumes, \$10 each.

## BOOKS FOR SALE.

The ACADEMY has the following works for sale at the prices affixed:

DESCRIPTION OF SHELLS OF NORTH AMERICA, with 68 colored plates. By THOMAS SAY 1830-34. \$10.50.

MONOGRAPH OF THE TERRESTRIAL MOLLUSCA OF THE UNITED STATES. With illustrations of all the species. By GEO. W. TRYON, JR. Fine edition, plate paper, with duplicate plates, colored and tinted, \$20; colored edition, \$13.50; plain edition, \$8.50. Only one hundred copies printed, which have been mostly sold.

MONOGRAPH OF THE FRESH WATER UNIVALVE MOLLUSCA OF THE UNITED STATES. By S. S. HALDEMAN, 1840-44. With CONTINUATION to 1871. By GEO. W. TRYON, JR. 2 vols., with many colored plates. Fine edition, duplicate plates, \$40; with colored plates, \$25; with plain plates, \$18.

Either the original work or the continuation furnished separately, if desired.

SYNONYMY OF THE SPECIES OF STREPOMATIDÆ (Melanians) OF THE UNITED STATES. By GEO. W. TRYON, JR. Cloth, \$2; paper, \$1.75.

LIST OF AMERICAN WRITERS ON RECENT CONCHOLOGY, with the Titles of their Memoirs and Dates of Publication. By GEO. W. TRYON, JR. Cloth, \$2; paper, \$1.75.

MONOGRAPH OF THE ORDER PHOLADACEA and other Papers. By GEO. W. TRYON, JR. Cloth, \$2; paper, \$1.75.

COMPLETE WRITINGS ON RECENT AND FOSSIL CONCHOLOGY OF C. S. RAFINESQUE. Edited by WM. G. BINNEY and G. W. TRYON, JR. \$2.50.

OBSERVATIONS ON THE GENUS UNIO. By ISAAC LEA, LL. D. 4to, Vols. 1 to 13. With Index, Nos. 1, 2 and 3, complete. Illustrated with several hundred fine lithographic Plates. \$60.

Same, Vols. 2 to 13 inclusive, except Vols. 4 and 12. Each volume separately, \$5.

SYNOPSIS OF THE GENUS UNIO. By ISAAC LEA, LL. D. Fourth edition. \$5.

CONTRIBUTIONS TO GEOLOGY. By ISAAC LEA. \$3.

FOSSIL FOOT-MARKS. By ISAAC LEA. Large folio, text and plate. \$2.

Same, plate alone. 50 cents.

NOTICE TO BOOKSELLERS—All the publications of the Society will be supplied to Booksellers at a discount of 20 per cent on the prices charged to the public.

Application to be made to EDWARD J. NOLAN, M. D., at the Hall of the Academy, Logan Square.

November, 1893.

## HAYDEN MEMORIAL GEOLOGICAL FUND.

Mrs. Emma W. Hayden has given to the Academy of Natural Sciences of Philadelphia in trust the sum of \$2,500 to be known as the Hayden Memorial Geological Fund, in commemoration of her husband, the late Prof. Ferdinand V. Hayden, M. D., LL. D. According to the terms of the trust, a bronze medal and the balance of the interest arising from the fund are to be awarded annually for the best publication, exploration, discovery or research in the sciences of geology and paleontology, or in such particular branches thereof as may be designated. The award and all matters connected therewith are to be determined by a committee to be selected in an appropriate manner by the Academy. The recognition is not confined to American naturalists.

# CONTENTS.

---

COPE, EDW. D. Description of a Lower Jaw of <i>Tetrabelodon Shepardii</i> . . . . .	202
MEEHAN, WM. E. A Contribution to the Flora of Greenland. . . . .	205
WOOLMAN, LEWIS. Cretaceous Ammonites and other Fossils near Moorestown, N. J. Their stratigraphic position shown by an Artesian Well Section at Maple Shade, N. J. Incidental reference to Water Horizons. . . . .	219
CHAPMAN, HENRY C., M. D. Observations on the Japanese Salamander, <i>Cryptobranchus maximus</i> (Schlegel) (Plates V, VI and VII). . . . .	227
STERKI, V. Observations on <i>Vallonia</i> (Plate VIII). . . . .	234
ALLEN, HARRISON, M. D. Note on the Mechanism of the Act of the Expulsion of Secretion from the Anal Sac in <i>Mephitis</i> . . . . .	280
STPECKER, HERMAN. Descriptions of two new species of North American Bombycidae.	282
DALL, WM. H. The Phylogeny of the <i>Docoglossa</i> . . . . .	285
MEEHAN, THOMAS: Contributions to the Life Histories of Plants, No. IX. <i>Populus tremuloides</i> —A Monœcious Case. Extra-Axillary Branching in <i>Mertensia maritima</i> . Dichotomous Branching in <i>Spergularia media</i> . Missing Verticil in <i>Glaux maritima</i> . The Relation between Rhythmic Growth and Variety in Citrus Fruits. Morphology of the Stipule in <i>Comarum palustre</i> . Fertilization of <i>Malva rotundifolia</i> . The Peduncle in <i>Streptopus amplexifolius</i> . The Anthesis of <i>Brunella vulgaris</i> . Branching of <i>Euphorbia hypericifolia</i> and <i>E. maculata</i> . Dimorphic Forms of <i>Lythrum Salicaria</i> . Structure of Florets in <i>Bidens bipinnata</i> . Rhythmic Growth in Flowers in <i>Heliopsis lævis</i> . Floccose Leaves of <i>Antennaria plantaginifolia</i> . Endurance of <i>Portulaca oleracea</i> . Early Fertilization of <i>Scutellaria galericulata</i> . Fertilization of <i>Trifolium pratense</i> . . . . .	289
FORD, JOHN. Remarks on a new species of <i>Cypræa</i> . . . . .	310
TARR, RALPH S. Notes on the Physical Geography of Texas. . . . .	313
CHAPMAN, HENRY C., M. D., and ALBERT P. BRUBAKER, M. D. The Radius of Curvatures of the Cornea. . . . .	349

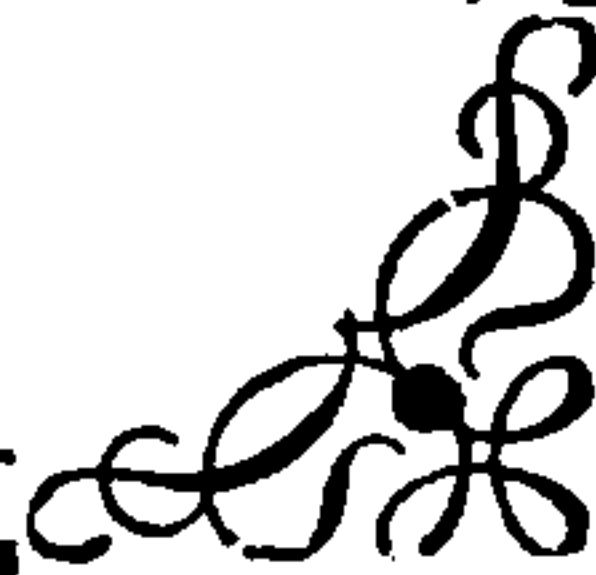

**THIS PAGE IS LOCKED TO FREE MEMBERS**

Purchase full membership to immediately unlock this page

# Know Your Bible

Forgotten Books' Full Membership provides unlimited access to more than 28,000 volumes of Christian literature for \$8.99/month

**HOLY BIBLE**

**Continue**

\*Fair use policy applies

PUBLICATIONS OF THE  
ACADEMY OF NATURAL SCIENCES  
OF PHILADELPHIA.

---

Eight volumes of the New Series of the JOURNAL, Parts 1, 2 and 3 of Volume IX and Part 1 of Volume X (Quarto) have been issued—1847 to 1894. The price per volume of four parts is \$10, or \$3 per part to subscribers, and to others \$12.50 per volume, or \$3.75 per part. Vol. VII contains "The Extinct Mammalian Fauna of Dakota and Nebraska, with a Synopsis of the Mammalian Remains of North America." Illustrated with thirty plates. By JOSEPH LEIDY, M. D., LL. D.

The FIRST SERIES OF THE JOURNAL, 1817 to 1842, in eight volumes octavo, may be obtained at \$40 to members, and to the public \$48.

The FIRST SERIES OF THE PROCEEDINGS of the Academy, published in octavo, 1841 to 1856, of which eight volumes were completed Dec. 31, 1856, may be obtained at \$24 to members, and to the public, \$36.

The SECOND SERIES OF THE PROCEEDINGS, commencing January 1, 1857 (of which fourteen volumes were completed Dec. 31, 1870), may be obtained at \$42 to members, or \$3 per volume separately; and to the public \$3.75 per volume.

The THIRD SERIES OF THE PROCEEDINGS, illustrated, commencing January 1, 1871, (of which twenty-three volumes were completed Dec. 31, 1893), is published at \$5 per annum, payable in advance, to subscribers; single volumes, \$6.25.

AMERICAN JOURNAL OF CONCHOLOGY, 1865—71. Seven vols., 8 vo. Containing 2500 pages, illustrated by one hundred and fifty plates, many of them colored, besides about a thousand wood engravings. Published at \$70. Price reduced to \$40 for the set. Separate volumes, \$10 each.

**BOOKS FOR SALE.**

The ACADEMY has the following works for sale at the prices affixed.

- DESCRIPTION OF SHELLS OF NORTH AMERICA, with 68 colored plates. By THOMAS SAY. 1830-34. \$10.50
- MONOGRAPH OF THE TERRESTRIAL MOLLUSCA OF THE UNITED STATES. With illustrations of all the species. By GEO. W. TRYON, JR. Fine edition, plate paper, with duplicate plates, colored and tinted, \$20; colored edition, \$13.50; plain edition, \$8.50. Only one hundred copies printed, which have been mostly sold.
- MONOGRAPH OF THE FRESH WATER UNIVALVE MOLLUSCA OF THE UNITED STATES. By S. S. HALDEMAN, 1840-44. With CONTINUATION to 1871. By GEO. W. TRYON, JR. 2 vols., with many colored plates. Fine edition, duplicate plates, \$40; with colored plates, \$25; with plain plates, \$19.  
Either the original work or the continuation furnished separately, if desired.
- SYNONYMS OF THE SPECIES OF STREPOMATIDÆ (Melanians) OF THE UNITED STATES. By GEO. W. TRYON, JR. Cloth, \$2; paper, \$1.75.
- LIST OF AMERICAN WRITERS ON RECENT CONCHOLGY, with the Titles of their Memoirs and Dates of Publication. By GEO. W. TRYON, JR. Cloth, \$2; paper, \$1.75.
- MONOGRAPH OF THE ORDER PHOLADACEA and other Papers. By GEO. W. TRYON, JR. Cloth, \$2; paper \$1.75.
- COMPLETE WRITINGS ON RECENT AND FOSSIL CONCHOLOGY OF C. S. RAFINESQUE. Edited by WM. G. BINNEY and G. W. TRYON, JR. \$2.50.
- OBSERVATIONS ON THE GENUS UNIO. By ISAAC LEA, LL. D. 4to, Vols., 1 to 13. With Index. Nos. 1, 2 and 3, complete. Illustrated with several hundred fine lithographic Plates. \$60.  
Same, Vols. 2 to 13 inclusive, except Vols. 4 and 12. Each volume separately, \$5.
- SYNOPSIS OF THE GENUS UNIO. By ISAAC LEA, LL. D. Fourth edition. \$5.
- CONTRIBUTIONS TO GEOLOGY. By ISAAC LEA. \$3.
- FOSSIL FOOT-MARKS. By ISAAC LEA. Large folio, text and plate. \$2.  
Same, plate alone. 50 cents.

NOTICE TO BOOKSELLERS---All the publications of the Society will be supplied to Booksellers at a discount of 20 per cent on the prices charged to the public.

Application to be made to EDWARD J. NOLAN, M. D., at the Hall of the Academy, Logan Square.

*April, 1894.*

## HAYDEN MEMORIAL GEOLOGICAL FUND.

Mrs. Emma W. Hayden has given to the Academy of Natural Sciences of Philadelphia in trust the sum of \$2,500 to be known as the Hayden Memorial Geological Fund, in commemoration of her husband, the late Prof. Ferdinand V. Hayden, M. D., LL. D. According to the terms of the trust, a bronze medal and the balance of the interest arising from the fund are to be awarded annually for the best publication, exploration, discovery or research in the sciences of geology and paleontology, or in such particular branches thereof as may be designated. The award and all matters connected therewith are to be determined by a committee to be selected in an appropriate manner by the Academy. The recognition is not confined to American naturalists.



# CONTENTS.

CHAPMAN, HENRY C., M. D., and ALBERT P. BRUBAKER, M. D. The Radius of Curvatures of the Cornea. (Continued.) . . . . .	3
REX, GEORGE A., M. D. North American Myxomycetes . . . . .	3
GOLDSMITH, E. A Tempered Steel Meteorite. (Plate IX.) . . . . .	37
CALVERT, PHILIP P. The Odonate Genus Ortholestes . . . . .	37
COPE, EDWARD D. On a Collection of Batrachia and Reptilia from Southwest Missouri . . . . .	38
COPE, EDWARD D. On the Batrachia and Reptilia of the Plains of Latitude 36° 30' . . . . .	38
STERKI, V. Growth Changes in the Radula in Land Mollusks. (Plates X and XI.) . . . . .	38
COPE, EDWARD D. Fossil Fishes from British Columbia . . . . .	40
Report of the Committee on the Hayden Memorial Geological Award . . . . .	40
PILSBRY, HENRY A. Thysanophora coloba, n. sp. . . . .	40
RHOADS, SAMUEL N. Descriptions of new species of North American Mammals with remarks on species of the Genus Peroganthus. . . . .	40
RHOADS, SAMUEL N. Geographic Variations in Bassariscus astutus with descriptions of a new subspecies . . . . .	41
MOORE, J. PERCY. On some Leech-like Parasites of American Crayfishes. (Plate XII.) . . . . .	41
BROWN, ARTHUR ERWIN. Notes on some Snakes from Tropical America lately living in the Collection of the Zoological Society of Phila. . . . .	42
COPE, EDWARD D. Heredity in the Social Colonies of the Hymenoptera. . . . .	43
ELLIS, J. B. and B. M. EVERHART. New species of Fungi from various localities . . . . .	44
FOX, WM. J. The North American Larridæ. . . . .	46
Report of the Recording Secretary . . . . .	55
Report of the Corresponding Secretary . . . . .	55
Report of the Librarian . . . . .	55
Report of the Curators . . . . .	55
Report of the Biological and Microscopical Section . . . . .	56
Report of the Conchological Section . . . . .	56
Report of the Entomological Section . . . . .	56
Report of the Botanical Section. . . . .	56
Report of the Mineralogical and Geological Section . . . . .	56
Report of the Ornithological Section. . . . .	56
Report of the Professor of Invertebrate Paleontology . . . . .	56
Report of the Professor of Ethnology and Archæology . . . . .	57
Report of the Professor of the Lower Invertebrata . . . . .	57
Report of the Professor of Histology and Microscopic Technology . . . . .	57
Report of Curator of the Wm. S. Vaux Collections . . . . .	57
Officers, Councillors and Members of the Finance Committee for 1894 . . . . .	57
Elections during 1893 . . . . .	57
Additions to the Museum . . . . .	57
Index to Genera . . . . .	583
General Index . . . . .	590

**THIS PAGE IS LOCKED TO FREE MEMBERS**

Purchase full membership to immediately unlock this page

# DELVE INTO FANTASY, MAGIC, MYTHOLOGY & FOLKLORE

Forgotten Books'  
Full Membership gives  
access to 797,885 ancient  
and modern, fiction and  
non-fiction books.

**Continue**

\*Fair usage policy applies