

# Radio— **HOW TO MAKE KIRLIAN PHOTOGRAPHS**

\$1.95 MAY 1986  
IN CANADA \$2.50

# Electronics®

TECHNOLOGY - VIDEO - STEREO - COMPUTERS - SERVICE

## **BUILD THIS SCRATCH FILTER**

Get rid of unwanted  
clicks and pops  
from your LP's.

## **BUILD A TELETEXT DECODER**

Tune in to a new  
world of information.

## **FREQUENCY COUNTERS**

How to get the most from your counter.

## **BUILD A CAPACITOR LEAKAGE TESTER**

How to test capacitors the right way.

## **NEW SENSOR TECHNOLOGY**

Integrated sensors offer a new way to  
make physical measurements.

## **A REVOLUTION IN ELECTRONICS PACKAGING**

Get ready for surface-mount technology.



A  
**GERNSBACK**  
PUBLICATION

### **PLUS:**

- ★ Ask R-E
- ★ Satellite TV
- ★ **COMPUTERDIGEST**
- ★ PC Service
- ★ Robotics
- ★ Antique Radios
- ★ New Ideas

# 100 MHz scope, counter, timer, multimeter: All one integrated system.

**100 MHz dual time base scope.** 3.5 ns risetime; sweeps from 0.5 s to 5 ns/div; alternate sweep;  $\pm 2\%$  vertical/horizontal accuracy; vertical sensitivity to 2 mV/div @ 90 MHz.

**9-digit fluorescent display.** Digitally accurate readouts accompany the CRT waveform. Error messages and prompts also appear on the display.

**Dc volts and ac coupled true RMS volts.** Measured through the Ch 1 scope input.

**Gated measurements.** Use the scope's intensified marker to measure frequency, period, width and to count events within specified portions of the signal.

**Auto-ranged, auto-averaged counter/timer.** Frequency, period, width, delay time,  $\Delta$ -time, plus totalize to more than 8 million events—with 7 digits plus exponent displayed.

**Auto-ranged DMM.** Use floating DMM side inputs with up to 5000-count resolution. Get precise readouts of average dc and true RMS voltage. Measure resistance from milliohms to gigohms.

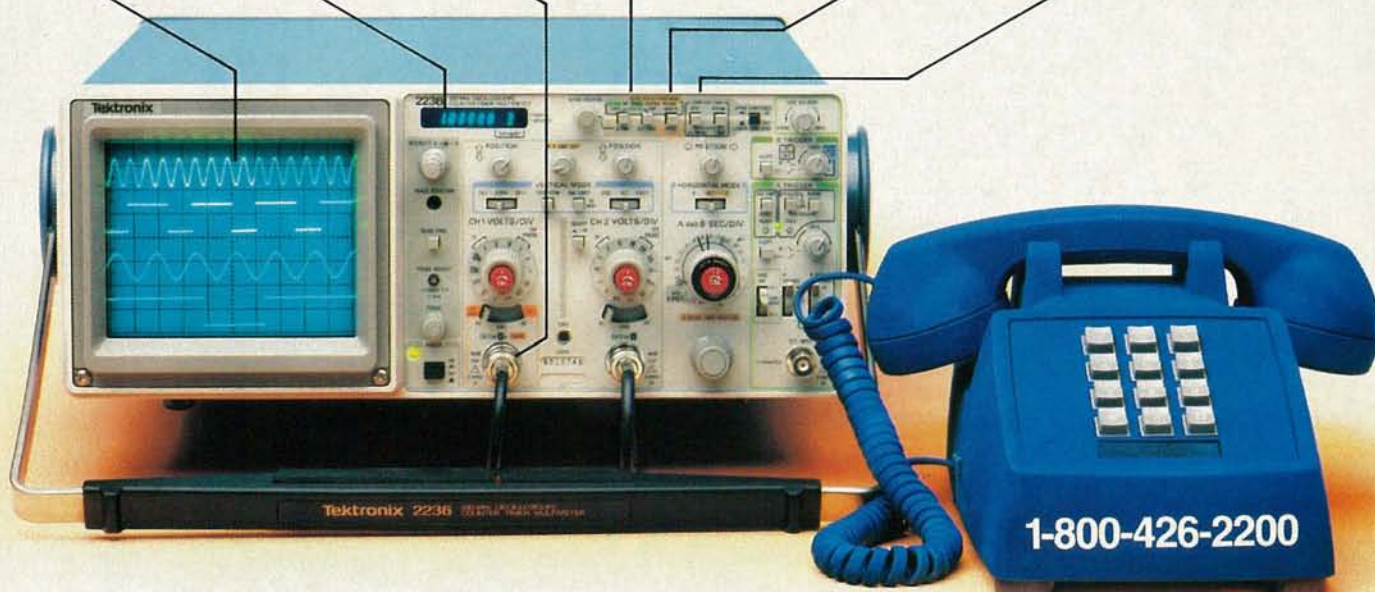

**Now make measurements faster, easier, with greater accuracy and user confidence.**

The Tek 2236 makes gated counter measurements, temperature, time, frequency, resistance and voltage measurements push-button easy. You see results concurrently on the 9-digit numeric readout and CRT display.

Its complete trigger system includes pushbutton trigger view, plus peak-to-peak auto, TV line, TV field, single sweep and normal modes.

At just \$2650\*, the 2236 includes the industry's first 3-year warranty on all parts and labor, including the CRT.

**Integrated measurement system. 3-year warranty. 15-day return policy. And expert advice. One free call gets it all!** You can order, or obtain literature, through the Tek National Marketing Center. Technical personnel, expert in scope applications, can answer your questions and expedite delivery. Direct orders include probes, operating

manual, 15-day return policy, full warranty and worldwide service back-up.

**Order toll-free:  
1-800-426-2200  
Extension 57**

In Oregon call collect:  
(503) 627-9000 Ext. 57  
Or write Tektronix, Inc.  
P.O. Box 1700  
Beaverton, OR 97075

**Tektronix®**  
COMMITTED TO EXCELLENCE

- BUILD THIS**
- 46 CLICK AND POP FILTER FOR YOUR STEREO**  
Get rid of scratches from your LP's electronically. **Joe Gorin**
  - 51 CAPACITOR-LEAKGE TESTER**  
Now you can test capacitors the right way. **Gary McClellan**
  - 67 TELETEXT DECODER**  
Decode World System Teletext signals and find out what you've been missing from TV. **J. Daniel Gifford**
  - 75 PC SERVICE**  
Use the direct-etch foil patterns to make circuit boards for your teletext decoder and capacitor-leakage tester.

- TECHNOLOGY**
- 10 VIDEO NEWS**  
A review of the fast-changing video scene. **David Lachenbruch**
  - 43 HOW TO MAKE KIRLIAN PHOTOGRAPHS**  
Investigate this controversial photographic process yourself. (You don't even need a camera!) **John Iovine**
  - 59 A REVOLUTION IN IC PACKAGING**  
Get ready for surface-mount technology. **TJ Byers**
  - 63 MAKING MEASUREMENTS WITH IC's**  
New integrated sensors promise a revolution in measurement technology. **Harry L. Trietley**
  - 71 ALL ABOUT FREQUENCY COUNTERS**  
Part 2. This month we look at some rather sophisticated applications for your counter. **Vaughn D. Martin**
  - 80 SATELLITE TV**  
An update on satellite scrambling. **Bob Cooper, Jr.**
  - 83 ROBOTICS**  
A look at Heath's Hero 2000. **Mark J. Robillard**

- CIRCUITS AND COMPONENTS**
- 32 NEW IDEAS**  
Ignition cutoff switch
  - 88 DESIGNER'S NOTEBOOK**  
Schmitt triggers. **Robert Grossblatt**
  - 89 STATE OF SOLID STATE**  
New op-amp IC's. **Robert F. Scott**

## RADIO

- 85 ANTIQUE RADIOS**  
Contributions from SWL's. **Richard D. Fitch**
- 90 COMMUNICATIONS CORNER**  
Fiber optics. **Herb Friedman**

## COMPUTERS

- Following page 86
- COMPUTER DIGEST**  
Upgrading your Sinclair, Home remote control.

## EQUIPMENT REPORTS

- 22 Triplet 6500 Cable Tester**
- 26 Regency MX-7000 Scanner**

## DEPARTMENTS

- 118 Advertising and Sales Offices**
- 118 Advertising Index**
- 6 Ask R-E**
- 120 Free Information Card**
- 12 Letters**
- 95 Market Center**
- 38 New Products**
- 4 What's News**

## ANNUAL INDEX JANUARY—DECEMBER 1985

A 4-page brochure containing the 1985 Annual Index is available for those who need one. To get your free copy, send a *stamped self-addressed envelope, (legal size) to:*

**Radio-Electronics**  
Annual Index  
500-B Bi-County Boulevard  
Farmingdale, NY 11735

Any requests postmarked on or before July 31 are free. After that date there is a 50¢ fee. Questions and comments about anything other than the Index that are included with your request cannot be handled. Send them separately to our Editorial Offices.

# COVER 1



Can a conventional LP ever sound like a compact disc? Well, not exactly, but if you build this click and pop filter for your hi-fi, you can make your LP's sound almost as noise-free! The filter lets you rid your LP's of clicks and pops caused by scratches in the vinyl. Yet it still lets you enjoy the full frequency range as recorded.

This month, we'll give you the full circuit details and describe the theory of operation. We'll conclude the article next month with complete construction details. Turn to page 46.

# NEXT MONTH

## THE JUNE ISSUE IS ON SALE MAY 1

### A SPECIAL SECTION ON LASERS

After we introduce you to lasers, we'll show you how to build a helium-neon laser for yourself!

### BUILD AN FET STEREO-AMPLIFIER

This high-quality 100-watt-per-channel amplifier is just what you need to upgrade your stereo system.

### BUILD A 30-VOLT, 1-AMP POWER SUPPLY

Complete your electronics workbench with this adjustable supply.

### HOW THE TELEPHONE WORKS

We'll solve some of the mysteries of telephone hardware and the telephone system.

As a service to readers, Radio-Electronics publishes available plans or information relating to newsworthy products, techniques and scientific and technological developments. Because of possible variances in the quality and condition of materials and workmanship used by readers, Radio-Electronics disclaims any responsibility for the safe and proper functioning of reader-built projects based upon or from plans or information published in this magazine.

Since some of the equipment and circuitry described in RADIO-ELECTRONICS may relate to or be covered by U.S. patents, RADIO-ELECTRONICS disclaims any liability for the infringement of such patents by the making, using, or selling of any such equipment or circuitry, and suggests that anyone interested in such projects consult a patent attorney.

## Radio- Electronics

Hugo Gernsback (1884-1967) founder  
M. Harvey Gernsback,  
editor-in-chief, emeritus

Larry Steckler, EHF, CET, publisher

### EDITORIAL DEPARTMENT

Larry Steckler, editor-in-chief  
Art Kleiman, editorial director  
Brian C. Fenton, managing editor  
Carl Laron, WB2SLR, associate editor  
Jeffrey K. Holtzman,  
assistant technical editor  
Robert A. Young, assistant editor  
Julian S. Martin, editorial associate  
Byron G. Wels, editorial associate  
M. Harvey Gernsback,  
contributing editor  
Jack Darr, CET, service editor  
Robert F. Scott,  
semiconductor editor  
Herb Friedman,  
communications editor  
Bob Cooper, Jr. satellite-TV editor  
Robert Grossblatt, circuits editor  
David Lachenbruch,  
contributing editor  
Richard D. Fitch,  
contributing editor  
Mark J. Robillard, robotics editor  
Teri Scaduto, editorial assistant  
Judith Kaplan, editorial assistant

### PRODUCTION DEPARTMENT

Ruby M. Yee, production director  
Robert A. W. Lowndes,  
editorial production  
Andre Duzant, technical illustrator  
Karen Tucker, advertising production  
Geoffrey S. Weil, production traffic

### CIRCULATION DEPARTMENT

Jacqueline P. Cheeseboro,  
circulation director  
Wendy Alanko,  
circulation analyst  
Theresa Lombardo,  
circulation assistant

Cover photo by Robert Lewis

Typography by Mates Graphics

Radio-Electronics, Gernsback Publications, Inc., Executive Offices, 500-B Bi-County Blvd., Farmingdale, NY 11735, 516-293-3000

Radio-Electronics is indexed in *Applied Science & Technology Index* and *Readers Guide to Periodical Literature*.

Microfilm & Microfiche editions are available. Contact circulation department for details.

Advertising Sales Offices listed on page 118.



# NEW! Lower Price Scanners

Communications Electronics,<sup>™</sup> the world's largest distributor of radio scanners, introduces new lower prices to celebrate our 15th anniversary.

## Regency<sup>®</sup> MX7000-EA

List price \$699.95/CE price \$399.95/SPECIAL  
**10-Band, 20 Channel • Crystalless • AC/DC**  
Frequency range: 25-550 MHz. continuous coverage and 800 MHz. to 1.3 GHz. continuous coverage.  
The Regency MX7000 scanner lets you monitor military, F.B.I., Space Satellites, Police and Fire Departments, Drug Enforcement Agencies, Defense Department, Aeronautical AM band, Aero Navigation Band, Fish & Game, Immigration, Paramedics, Amateur Radio, Justice Department, State Department, plus thousands of other radio frequencies most scanners can't pick up. The Regency MX7000 is the perfect scanner for intelligence agencies that need to monitor the new 800 MHz. cellular telephone band. The MX7000, now at a special price from CE.

## Regency<sup>®</sup> Z60-EA

List price \$299.95/CE price \$179.95/SPECIAL  
**8-Band, 60 Channel • No-crystal scanner**  
Bands: 30-50, 88-108, 118-136, 144-174, 440-512 MHz.  
The Regency Z60 covers all the public service bands plus aircraft and FM music for a total of eight bands. The Z60 also features an alarm clock and priority control as well as AC/DC operation. Order today.

## Regency<sup>®</sup> Z45-EA

List price \$259.95/CE price \$159.95/SPECIAL  
**7-Band, 45 Channel • No-crystal scanner**  
Bands: 30-50, 118-136, 144-174, 440-512 MHz.  
The Regency Z45 is very similar to the Z60 model listed above however it does not have the commercial FM broadcast band. The Z45, now at a special price from Communications Electronics.

## Regency<sup>®</sup> RH250B-EA

List price \$613.00/CE price \$329.95/SPECIAL  
**10 Channel • 25 Watt Transceiver • Priority**  
The Regency RH250B is a ten-channel VHF land mobile transceiver designed to cover any frequency between 150 to 162 MHz. Since this radio is synthesized, no expensive crystals are needed to store up to ten frequencies without battery backup. All radios come with CTCSS tone and scanning capabilities. A monitor and night/day switch is also standard. This transceiver even has a priority function. The RH250 makes an ideal radio for any police or fire department volunteer because of its low cost and high performance. A UHF version of the same radio called the RU150B covers 450-482 MHz. but the cost is \$449.95. To get technician programming instructions, order a service manual from CE with your radio system.

## NEW! Bearcat<sup>®</sup> 50XL-EA

List price \$199.95/CE price \$114.95/SPECIAL  
**10-Band, 10 Channel • Handheld scanner**  
Bands: 29-54, 136-174, 406-512 MHz.  
The Uniden Bearcat 50XL is an economical, hand-held scanner with 10 channels covering ten frequency bands. It features a keyboard lock switch to prevent accidental entry and more. Also order part # BP50 which is a rechargeable battery pack for \$14.95, a plug-in wall charger, part # AD100 for \$14.95, a carrying case part # VC001 for \$14.95 and also order optional cigarette lighter cable part # PS001 for \$14.95.

## NEW! Regency<sup>®</sup> XL156-EA

List price \$239.95/CE price \$129.95/SPECIAL  
**6-Band, 10 Channel • No-crystal Scanner Search • Lockout • Priority • AC/DC**  
Bands: 30-50, 144-174, 440-512 MHz.  
Cover your choice of over 15,000 frequencies on 10 channels at the touch of your finger. Display messages. External speaker jack. Telescoping antenna. External antenna jack. AC/DC.

## NEW! Regency<sup>®</sup> R1060-EA

List price \$149.95/CE price \$92.95/SPECIAL  
**6-Band, 10 Channel • Crystalless • AC only**  
Bands: 30-50, 144-174, 440-512 MHz.  
Now you can enjoy computerized scanner versatility at a price that's less than some crystal units. The Regency R1060 lets you in on all the action of police, fire, weather, and emergency calls. You'll even hear mobile telephones.

## Bearcat<sup>®</sup> DX1000-EA

List price \$649.95/CE price \$349.95/SPECIAL  
Frequency range 10 KHz. to 30 MHz.  
The Bearcat DX1000 shortwave radio makes tuning in London as easy as dialing a phone. It features PLL synthesized accuracy, two time zone 24-hour digital quartz clock and a built-in timer to wake you to your favorite shortwave station. It can be programmed to activate peripheral equipment like a tape recorder to record up to five different broadcasts, any frequency, any mode, while you are asleep or at work. It will receive AM, LSB, USB, CW and FM broadcasts.

There's never been an easier way to hear what the world has to say. With the Bearcat DX1000 shortwave receiver, you now have direct access to the world.

## NEW! Regency<sup>®</sup> HX1200-EA

List price \$369.95/CE price \$214.95/SPECIAL  
**8-Band, 45 Channel • No Crystal scanner Search • Lockout • Priority • Scan Delay Sidelit liquid crystal display • EAROM Memory New Direct Channel Access Feature**  
Bands: 30-50, 118-136, 144-174, 406-420, 440-512 MHz.  
The new handheld Regency HX1200 scanner is fully keyboard programmable for the ultimate in versatility. You can scan up to 45 channels at the same time including the AM aircraft band. The LCD display is even sidelit for night use. Order MA-256-EA rapid charge drop-in battery charger for \$84.95 plus \$3.00 shipping/handling. Includes wall charger, carrying case, belt clip, flexible antenna and nicad battery.

## NEW! Bearcat<sup>®</sup> 100XL-EA

List price \$349.95/CE price \$203.95/SPECIAL  
**9-Band, 16 Channel • Priority • Scan Delay Search • Limit • Hold • Lockout • AC/DC**  
Frequency range: 30-50, 118-174, 406-512 MHz.  
The world's first no-crystal handheld scanner now has a LCD channel display with backlight for low light use and aircraft band coverage at the same low price. Size is 1 3/4" x 7 1/2" x 2 3/4". The Bearcat 100XL has wide frequency coverage that includes all public service bands (Low, High, UHF and "T" bands), the AM aircraft band, the 2-meter and 70 cm. amateur bands, plus military and federal government frequencies. Wow... what a scanner!  
Included in our low CE price is a sturdy carrying case, earphone, battery charger/AC adapter, six AA Ni-cad batteries and flexible antenna. Order your scanner now.

## Bearcat<sup>®</sup> 210XW-EA

List price \$339.95/CE price \$209.95/SPECIAL  
**8-Band, 20 Channel • No-crystal scanner Automatic Weather • Search/Scan • AC/DC**  
Frequency range: 30-50, 136-174, 406-512 MHz.  
The new Bearcat 210XW is an advanced third generation scanner with great performance at a low CE price.

## NEW! Bearcat<sup>®</sup> 145XL-EA

List price \$179.95/CE price \$102.95/SPECIAL  
**10 Band, 16 channel • AC/DC • Instant Weather**  
Frequency range: 29-54, 136-174, 420-512 MHz.  
The Bearcat 145XL makes a great first scanner. Its low cost and high performance lets you hear all the action with the touch of a key. Order your scanner from CE today.

### TEST ANY SCANNER

Test any scanner purchased from Communications Electronics<sup>™</sup> for 31 days before you decide to keep it. If for any reason you are not completely satisfied, return it in original condition with all parts in 31 days, for a prompt refund (less shipping/handling charges and rebate credits).

## NEW! Bearcat<sup>®</sup> 800XL-EA

List price \$499.95/CE price \$317.95  
**12-Band, 40 Channel • No-crystal scanner Priority control • Search/Scan • AC/DC**  
Bands: 29-54, 118-174, 406-512, 806-912 MHz.  
The Uniden 800XL receives 40 channels in two banks. Scans 15 channels per second. Size 9 1/4" x 4 1/2" x 12 1/2".

### OTHER RADIOS AND ACCESSORIES

Panasonic RF-2600-EA Shortwave receiver... \$179.95  
RD95-EA Uniden Remote mount Radar Detector... \$128.95  
RD55-EA Uniden Visor mount Radar Detector... \$98.95  
RD9-EA Uniden "Passport" size Radar Detector... \$239.95  
BC210XW-EA Bearcat 20 channel scanner SALE... \$209.95  
BC-WA-EA Bearcat Weather Alert... \$49.95  
DX1000-EA Bearcat shortwave receiver SALE... \$349.95  
PC22-EA Uniden remote mount CB transceiver... \$99.95  
PC55-EA Uniden mobile mount CB transceiver... \$59.95  
R1060-EA Regency 10 channel scanner SALE... \$92.95  
MX3000-EA Regency 30 channel scanner... \$198.95  
XL156-EA Regency 10 channel scanner SALE... \$129.95  
UC102-EA Regency VHF 2 ch. 1 Watt transceiver... \$124.95  
RH250B-EA Regency 10 ch. 25 Watt VHF trans... \$329.95  
RH600B-EA Regency 10 ch. 60 Watt VHF trans... \$454.95  
RU150B-EA Regency 10 channel UHF transceiver... \$449.95  
RPH410-EA 10 ch. handheld no-crystal trans... \$399.95  
LC10-EA Carrying case for RPH410 transceiver... \$34.95  
MA181-EA Ni-cad battery pack for RPH410 trans... \$34.95  
P1405-EA Regency 5 amp regulated power supply... \$69.95  
P1412-EA Regency 12 amp reg. power supply... \$164.95  
BC10-EA Battery charger for Regency RPH410... \$84.95  
MA256-EA Drop-in charger for HX1000 & HX1200... \$84.95  
MA257-EA Cigarette lighter cord for HX1200... \$19.95  
MA917-EA Ni-Cad battery pack for HX1200... \$34.95  
EC10-EA Programming tool for Regency RPH410... \$24.95  
SMRH250-EA Service man. for Regency RH250... \$24.95  
SMRU150-EA Service man. for Regency RU150... \$24.95  
SMRPH410-EA Service man. for Regency RPH410... \$24.95  
SMMX7000-EA Svc. man. for MX7000 & MX5000... \$19.95  
SMMX3000-EA Service man. for Regency MX3000... \$19.95  
B-4-EA 1.2 V AAA Ni-Cad batteries (set of four)... \$9.95  
FB-E-EA Frequency Directory for Eastern U.S.A... \$12.95  
FB-W-EA Frequency Directory for Western U.S.A... \$12.95  
TSG-EA "Top Secret" Registry of U.S. Govt. Freq... \$14.95  
TIC-EA Techniques for Intercepting Comm... \$14.95  
RRF-EA Railroad frequency directory... \$10.95  
CIE-EA Covert Intelligent, Elect. Eavesdropping... \$14.95  
A60-EA Magnet mount mobile scanner antenna... \$35.00  
A70-EA Base station scanner antenna... \$35.00  
USAMM-EA Mag mount VHF/UHF ant. w/ 12' cable... \$39.95  
USAK-EA 3/4" hole mount VHF/UHF ant. w/ 17' cable... \$35.00  
USATLM-EA Trunk lip mount VHF/UHF antenna... \$35.00  
Add \$3.00 shipping for all accessories ordered at the same time.  
Add \$12.00 shipping per shortwave receiver.  
Add \$7.00 shipping per scanner and \$3.00 per antenna.

### BUY WITH CONFIDENCE

To get the fastest delivery from CE of any scanner, send or phone your order directly to our Scanner Distribution Center. Michigan residents please add 4% sales tax or supply your tax I.D. number. Written purchase orders are accepted from approved government agencies and most well rated firms at a 10% surcharge for net 10 billing. All sales are subject to availability, acceptance and verification. All sales on accessories are final. Prices, terms and specifications are subject to change without notice. All prices are in U.S. dollars. Out of stock items will be placed on backorder automatically unless CE is instructed differently. A \$5.00 additional handling fee will be charged for all orders with a merchandise total under \$50.00. Shipments are F.O.B. Ann Arbor, Michigan. No COD's. Most products that we sell have a manufacturer's warranty. Free copies of warranties on these products are available prior to purchase by writing to CE. Non-certified checks require bank clearance.

Mail orders to: Communications Electronics,<sup>™</sup> Box 1045, Ann Arbor, Michigan 48106 U.S.A. Add \$7.00 per scanner for U.P.S. ground shipping and handling in the continental U.S.A. For Canada, Puerto Rico, Hawaii, Alaska, or APO/FPO delivery, shipping charges are three times continental U.S. rates. If you have a Visa or Master Card, you may call and place a credit card order. Order toll-free in the U.S. Dial 800-USA-SCAN. In Canada, order toll-free by calling 800-221-3475. Telex CE anytime, dial 810-223-2422. If you are outside the U.S. or in Michigan dial 313-973-8888. Order today.

Scanner Distribution Center<sup>™</sup> and CE logos are trademarks of Communications Electronics Inc.

† Bearcat is a registered trademark of Uniden Corporation.  
‡ Regency is a registered trademark of Regency Electronics Inc. AD #040186-EA

Copyright © 1986 Communications Electronics Inc.

For credit card orders call  
**1-800-USA-SCAN**

**COMMUNICATIONS  
ELECTRONICS INC.**

**Consumer Products Division**  
P.O. Box 1045 □ Ann Arbor, Michigan 48106-1045 U.S.A.  
Call 800-USA-SCAN or outside U.S.A. 313-973-8888



CIRCLE 79 ON FREE INFORMATION CARD

# WHAT'S NEWS

## AES prints new standards for audio measurements

The S4 Committee of the Audio Engineering Society (AES) has now been accredited by the American Standards Institute for the development and publication of standards in the audio engineering field. As a result, AES has published five ANSI-approved standards:

AES2-1984 (ANSI S4.26-1984). Recommended practice for specification of loudspeaker components used in professional audio and sound reinforcement;

AES5-1984 (ANSI S4.28-1984). AES recommended practice for professional digital audio applications employing pulse-code modulation—preferred sampling frequencies;

AES7-1982 (ANSI S4.6-1982). Method of measuring recorded flux of magnetic sound records at medium wavelengths;

AES6-1982 (ANSI S4.3-1982). Method for measurement of weighted peak flutter of sound recording and reproducing sound equipment;

AES3-1985 (ANSI S4.40-1985). AES recommended practice for digital audio engineering—serial transmission format for linearly represented digital audio data.

Those documents are available at \$15 each from the Audio Engineering Society, 80 East 42nd St., New York, NY 10165.

## Video cassette recorders making record increases

Over 11 million VCR's have been purchased in 1985, a 55 percent gain over 1984, according to Stephen Stepnes of RCA Consumer Electronics. By 1988, he says, there will be 50 million VCR's in American homes.

The proportion of high-fidelity table-model stereo VCR's is also

increasing. Those comprised about 10 percent of the total VCR market in 1985—up from 5 percent in 1984—and will rise to more than 14 percent in 1986, according to Stepnes.

## Justice Dept cracks down on interference

The Department of Justice has filed suits against two CB operators and one commercial company in Philadelphia for sums totalling more than \$4,000. In addition the suits seek court orders mandating that the violators comply with FCC regulations.

F.C. Roberson was operating a CB radio that caused interference to numerous residents of a Philadelphia neighborhood. The equipment appeared to be operating far over the four-watt legal limit. Roberson repeatedly refused to allow FCC inspection of the radio, thereby accumulating fines totalling \$900. The suit seeks payment of the fines, and a court order directing Roberson to permit inspection of his equipment and to operate it at legal power levels.

Henry O. Jackson was using his CB radio at an estimated power level of 47 watts, interfering with local television reception over a period of several months. A fine of \$750 was levied against him. The suit seeks payment of the \$750, and a court order directing Jackson to bring his equipment within FCC guidelines.

The Department of Justice has also filed suit against Comp-Art, Inc., for unlawfully interfering with TV reception with a computer. The interference occurred over a period of 18 months. Fines of \$3,000 were accumulated. The suit seeks payment of the fines and a court order directing Comp-Art to shield or otherwise modify its computer so that it will not interfere with local TV reception. R-E

## New capacitor used as energy storage device

"A new energy-storage device that never needs replacement" is the way its manufacturer describes the Maxcap Double-Layer Capacitor (DLC), a unit with up to 500 times the energy density of an aluminum electrolytic capacitor of

similar dimensions. It is intended to replace batteries in applications requiring low drain, such as CMOS RAMs, microprocessors, and timers.

The secret of the new capacitor is the electrode material: activated carbon, which can have a surface area of 1,000 square meters per gram. The working voltage is low, necessitating the double-layer principle, in which up to six activated-carbon, liquid-electrolyte units may be stacked to reach the 5-volt rating of the capacitor illustrated.

An ideal application is as backup for CMOS RAM memories, where the capacitor is kept charged during normal operation and where in case of failure "a thimble-sized Maxcap can back up CMOS memories for weeks."



THE SOHIO MAXCAP 1 farad capacitor.



# ELECTRONICS, INC.

New and Used Electronic Test Equipment  
Sales • Service • Rental • Leasing

## HITACHI 3.5 Digit DMM *Free* With Scope Purchase



### FEATURES:

- AC DC voltage
- AC DC current
- Resistance
- Diode test
- Audible Continuity check
- Temperature (Type K, 3510 & 3525)
- Data hold
- Manual or autoranging
- Overload protection
- LCD display
- Built-in stand
- Battery included
- Test leads included

*Special!*

MODEL	BASIC DC VOLTAGE ACCURACY	QTY 1 PRICE	QTY 3+ PRICE	One With Any Scope Purchased From RAG
3550	±.5% ±2 digits	\$49.00	\$42.00	FREE
3525	±.25% ±2 digits	\$64.00	\$54.00	\$19.95
3510	±.1% ±2 digits	\$79.00	\$67.00	\$29.95

*2 year warranty plus carrying case included!*



Model V-422 shown

**MODEL V-222** **\$536.00**  
DC to 20 MHz, 1 mV/div, Dual Trace, D.C. offset for DMM Output, Vertical Mode Trigger, 6" CRT (w/two X1/X10 probes).

**MODEL V-422** **\$694.00**  
DC to 40 MHz, other features same as V-222 (w/two X1/X10 probe).

**MODEL V-1050F** **\$1,276.00**  
DC to 100 MHz, 5 mV/div, Quad Trace, Delayed Sweep, Full T.V. Triggering, alternate time base (w/two X1/X10 probes).

**MODEL V-212** **\$461.00**  
DC to 20 MHz, 1 mV/div, Dual Trace, Features 6" Rectangular CRT (w/two X10 probes).

**MODEL V-650** **\$956.00**  
DC to 60 MHz, 1 mV/div, Triple Trace, Delayed Sweep, Full T.V. Triggering, variable trigger hold-off (w/two X1/X10 probes).

**NEW! 3 year warranty parts and labor on above scopes!**

RAG Electronics is a factory authorized Hitachi repair center.

CIRCLE 126 ON FREE INFORMATION CARD

CALL US TOLL FREE  
**1-800-732-3457**  
IN CALIFORNIA TOLL FREE  
**1-800-272-4225**

- Master Charge
- VISA ■ COD
- Money Order
- Check



ADD FOR SHIPPING AND INSURANCE

\$0 to \$250.00	\$4.50
\$251.00 to \$600.00	\$6.50
\$601.00 to \$750.00	\$8.50
\$751.00 to \$1000.00	\$12.50
over \$1000.00	\$15.00

Prices subject to change without notice.

RAG ELECTRONICS, INC. / 21418 Parthenia Street / Canoga Park, CA 91304 / 1-818-998-6500

# ASK R-E

## PEST-REPELLER QUESTIONS

We thank the many readers who responded to the article "Ultrasonic Pest Repellers" that appeared in the July 1985 issue of *Radio-Electronics*. We will attempt to answer some of the more common questions below. We especially want to thank readers Parke S. Barnard of New Haven, CT, and Harold J. Read of Grove City, FL, for sending copies of the article "Bug Zappers that Don't" that appeared in the July/August 1985 issue of *Science* magazine.

• 1. How can I modify one of the circuits to attract mosquitoes to fly into an electric bug killer? Many flying insects are attracted to it, but mosquitoes seem to ignore it.—S. E., Sacramento, CA.

Personally, I'm not convinced that mosquitoes ignore the UV lights found in typical electric bug killers. During the last week or so, during a particularly heavy infestation of mosquitoes, I've studied the operation of the bug killer at close range. Mosquitoes don't seem to be lured to the UV light as easily as other flying insects, but they are attracted nonetheless. Mosquitos are small, compared with the size of the charged grid, so many are able to fly in to and out of the charged area without harm.

One researcher on bug killers claims that mosquitos are not easily attracted to the UV light source in most bug killers, and that a UV light of 80 to 100 watts is needed for the killer to be effective in attracting mosquitos.

Recently I read the article "Build a Better Mosquito Trap" in *Home Mechanix*, August 1985. The author suggested that mosquitoes are attracted to man and animals



FIG. 1

by odor, moisture, and heat, and he proposed using a candle to heat and thereby evaporate water from a small container placed near the bug killer. As I recall, the author also suggested adding a drop or two of some chemical to create an enticing odor.

• 2. I'm looking for a good tweeter to use in my electronic pest repeller. Radio Shack's piezoelectric tweeter only responds to about 30 kHz. Your circuits oscillate as high as 65 kHz, so it doesn't appear that the Radio Shack unit will work.—S. Z., Brooklyn, NY; J. S., Taunton, MA; and J. N., Morristown, NJ.

There is a lot more to the acoustic output and frequency response of a loudspeaker than you'll find in a Radio Shack catalog. Speakers are usually rated to reproduce either speech or music. Frequency response is often quoted in terms of the low- and high-frequency points where response drops to a specific—and often unspecified—level. In fact, even the manufacturer's performance curves don't tell the full story unless you are also given a full run-down on all test conditions.

A speaker's response is generally tested by applying a constant voltage of a varying frequency in series with a resistance that represents the equivalent source resistance of the driving amplifier. As the speaker's impedance increases, the voice-coil current and acoustic output decrease. By ap-

## WRITE TO:

ASK R-E  
Radio-Electronics  
500-B Bi-County Blvd.  
Farmingdale, NY 11735

plying constant power across a band of frequencies, acoustic power output will be much higher at high frequencies than at, say, 400 Hz.

There are a number of mail-order suppliers that sell inexpensive speakers and tweeters suitable for use in the pest repeller. Among them are MCM Electronics, 856 Congress Park Drive, Centerville, OH 45459, and McGee Electronics, 1901 McGee St., Kansas City, MO 64108. The latest MCM catalog lists dome-type tweeters ranging in price from \$4.50 to around \$26.00, and piezoelectric tweeters made by Motorola ranging from \$7.00 to \$11.00.

• 3. In an attempt to get rid of some pesty black ants, I built the "French" circuit in Fig. 2 of "Ultrasonic Pest Repellers;" that circuit uses a 4011. I finished construction, but I can't tell whether my circuit is oscillating. The 4011 is a delicate CMOS IC, so I'm afraid I may have zapped it. To test my circuit, we caught several ants, placed them in a pail, and aimed the tweeter at them. They scampered around like crazy, so I think the device is working—but I'd like to be sure. Can you suggest a method of testing it? Incidentally, the schematic specified 560 pF capacitors, but I used 680 pF units. I suppose that that altered the frequency. Could the values of those capacitors be a problem?—J. W. D., Corning, NY.

By using a 680-pF capacitor the frequency will be a little lower, but still within the effective ultrasonic range. You can measure frequency with a scope or a frequency counter. Shown in Fig. 1 is a simply way to use a scope to measure both frequency and amplitude.



# Now scan and record temperatures from freezing to scorching.



## The new Fluke 52 goes to great extremes to outperform any other handheld thermometer.

With extra features, like our exclusive SCAN mode. Touch the button, and your Fluke 52 sequentially scans the readouts of two temperature inputs, and their difference.

Hit the RECORD button, walk away, and record the minimum and maximum from any one of these three channels for up to 1,200 hours. For troubleshooting intermittent problems, overnight monitoring, inlet/outlet servicing, and comparing trend information, it can't be beat.

If you don't need the scanning and recording features, you may prefer the single-point Fluke 51. Like the 52, it's easy to use, offers unsurpassed accuracy with resolution to 1/10th of a degree, and can use any K or J type thermocouple probe to fit your application.

Even the warranty goes to great extremes: three years on parts and service — the longest in the industry. And prices start as low as \$119. But you don't have to go to extremes to get one.

Just contact your local supplier now for immediate delivery.

Or for more information, call toll-free **1-800-227-3800, Ext. 229**. From outside the U.S. call 1-402-496-1350, Ext. 229.

## FROM THE WORLD LEADER IN HANDHELD TEST INSTRUMENTS.



### Fluke 51 Single Input      Fluke 52 Dual Input

Measurement range: K-type: -200°C to +1370°C (-328°F to +2498°F) J-type: -200°C to +760°C (-328°F to +1400°F)
Accuracy: K-type is ±(0.1% of reading + 0.7°C or 1.3°F) J-type is ±(0.1% of reading + 0.8°C or 1.4°F)
°C or °F Selectable
Hold Mode
Scan, Differential, and Min/Max Recording Modes (52 only)
Standard mini-connector input
1200 hour 9V battery life
3-year warranty
General-purpose K-type bead probe included (two with 52).

**FLUKE**®

IN THE U.S. AND NON-EUROPEAN COUNTRIES: John Fluke Mfg. Co., Inc., P.O. Box C9090, M/S 250C, Everett, WA 98206. Sales: (206) 356-5400. Other: (206) 347-6100.  
EUROPEAN HEADQUARTERS: Fluke (Holland) B.V., P.O. Box 2269, 5600 CG Eindhoven, The Netherlands. (040) 458045; TLX: 51846

© Copyright 1985 John Fluke Mfg. Co., Inc. All rights reserved. Ad No. 4701-50

CIRCLE 254 ON FREE INFORMATION CARD

MAY 1986

7

# OK Test Equipment



## The Bench Rack

MODEL 2324-R

- Model 203 - 2MHz Function Generator
- Model 510 - 200MHz Multi-Function Counter
- Model 1010 - 10MHz Miniature Oscilloscope
- Model 601 - 3-1/2 Digit DMM
- Model 58150 - Bench rack mounting system

AFFORDABLE EXCELLENCE

3455 Conner Street, Bronx, New York, 10475, U.S.A.  
 Telex 125091 OK NYK, Telex 232395 OK NY LR  
 Phone (212) 994-6600, Fax (212) 994-4755

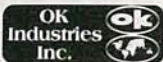

CIRCLE 278 ON FREE INFORMATION CARD

## ATTENTION! ELECTRONICS TECHNICIANS

EARN YOUR B.S.E.E. DEGREE THROUGH HOME STUDY



Our New and Highly Effective Advanced-Placement Program for experienced Electronic Technicians grants credit for previous Schooling and Professional Experience, and can greatly reduce the time required to complete Program and reach graduation. No residence schooling required for qualified Electronic Technicians. Through this Special Program you can pull all of the loose ends of your electronics background together and earn your B.S.E.E. Degree. Upgrade your status and pay to the Engineering Level. Advance Rapidly! Many finish in 12 months or less. Students and graduates in all 50 States and throughout the World. Established Over 40 Years! Write for free Descriptive Literature.

**COOK'S INSTITUTE**  
OF ELECTRONICS ENGINEERING



347 RAYMOND ROAD  
P.O. BOX 20345  
JACKSON, MISSISSIPPI 39209

CIRCLE 280 ON FREE INFORMATION CARD

## SUPER LONG PLAY TAPE RECORDERS

- 10 Hour Model - \$95.00\*
- 14 Hour Model - \$159.00\*

Modified Panasonic Slimline. high quality. AC-DC Recorders provide 5 or 7 continuous hours of quality recording & playback on each side of cassette for a total of 10 or 14 hours depending on model. Built-in features include • Voice level control. • Digital counter. etc. TDK DC 180 Cassette Furnished.

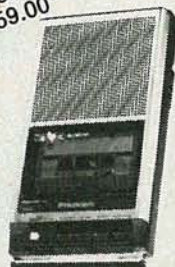

### PHONE RECORDING ADAPTER

Records calls automatically. All Solid state connects to your telephone jack and tape recorder. Starts recording when phone is lifted. Stops when you hang up. **\$24.50\***



### VOX VOICE ACTIVATED CONTROL SWITCH

Solid state. Self contained. Adjustable sensitivity. Voices or other sounds automatically activate and control recorder. Uses either recorder or remote mike. **\$24.95\***



\*Add for ship & hdg. Phone Adapter & Vox \$1.50 ea. Recorders \$4.00 ea. Cal. Res. add tax. Mail order, VISA M/C, COD's OK. Money Back Guarantee. Qty. disc. avail. Dealer Inquiries invited. Free data. © AMC SALES INC. Dept A 9335 Lubec St., Box 928, Downey, CA 90421 (213) 869-8519

CIRCLE 108 ON FREE INFORMATION CARD

● 4. Can you supply the names of firms selling low-cost pest repellers like the one shown in Fig. 1 of "Ultrasonic Pest Repellers?"—C. C. D., Hesperia, CA; E. T., Wilkes Barre, PA; W. V., Clifton, Park, NY; and J. M., Santa Barbara, CA.

A number of firms advertise electronic pest repellers. We can endorse neither products nor manufacturers, so—buyer beware.

Bently's, Box 31445 San Francisco, CA 94131; Hanover Square, Building No. 51, Hanover, PA 17333; Bug-A-Way, Phone (800) 222-0354, or Drawer M, Columbia, SC 29250; The Shelburne Co., 110 Painters Mill Rd., Owings Mill, MD 21117; Fina Merchandise Center, 6310 North Western Ave., Chicago, IL 60659.

● 5. I want to build a pest repeller to use outdoors in order to get rid of bees, gnats, flies, etc. Can you help?—J. A., Forest Hills, NY.

I understand that ultrasonic devices have been used outdoors experimentally. They use special transducers and they have much higher power than the repellers described in our story. In some outdoor units sounds in the audible range are emitted, so the devices are not practical for use around people. However, they do have some agricultural applications. You may be able to get more information on outdoor pest repellers from AV-Alarm Corp., 675-D Conger St., Eugene, OR 97402.

● 6. After breadboarding the circuit in Fig. 1 of *Ultrasonic Pest Repellers*, I removed the modulating voltage that is applied to pin 5 of the 555 from the junction of R3 and R4. I measured the un-swept frequency at about 50.5 kHz. How can I measure the overall sweep range?—R. S., Creve Coeur, MD.

Here's one way. Use a scope or multimeter to measure the peak-to-peak value of the modulating voltage at the junction of R3 and R4. Rig up a DC power supply whose output is equal or higher than the peak value of the modulating voltage—a couple of 9-volt batteries in series should suffice.

Connect a potentiometer across the batteries and connect the wiper to pin 5 of the 555. Vary the voltage from zero to the maximum p-p sweep voltage measured ear-

lier, and monitor the 555's output with a frequency counter. Then reverse the polarity of the supply and measure the frequency swing in the opposite direction.

● 7. I built the circuit in Fig. 1 of *Ultrasonic Pest Repellers* and it works, except that it emits a high-pitched tone that drives some people from the room. What can I do to eliminate that tone?—F. C., Winter Haven, FL.

Evidently, the low end of the sweep frequency is audible and annoying to some people. You can eliminate that annoyance by raising the 555's base frequency of oscillation. Do that by decreasing the value of C1. Try values of 910, 820, or even 750 pF.

### SIMPLE POWER SUPPLY

I need a power supply that delivers plus and minus nine volts to replace two nine-volt batteries in a project I'm building. Do you have a suitable design?—N. J. S., Greensboro, NC

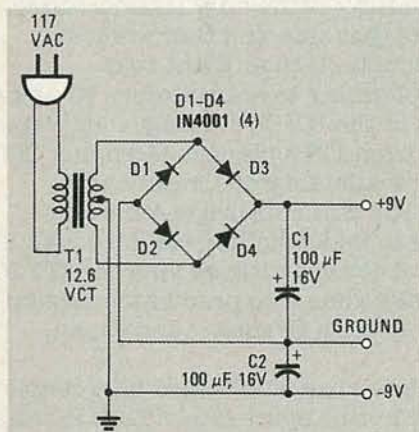

FIG. 2

A  $\pm 9$ -volt supply is shown in Fig. 2. The rectifier circuit is actually two separate full-wave rectifiers fed from the secondary of the transformer. One full-wave rectifier is composed of diodes D1 and D2, which develop +9 volts, and the other is composed of D3 and D4, which develop -9 volts.

Each diode of each diode pair rectifies 6.3 volts AC (half the secondary voltage) and charges the associated filter capacitor to the peak value of the AC waveform,  $6.3 \times 1.414 = 8.9$  volts. Each diode should have a PIV (Peak Inverse Voltage) rating that is at least twice the peak voltage from the transformer,  $2 \times 8.9 = 18$  volts. The 1N4001 has a PIV of 50 volts. R-E

# OK Test Equipment

OK  
Electronics  
Division



## Oscilloscope

**Model 1010** With the super compact 10 MHz oscilloscope (Model 1010) you'll answer your nextservice call with one hand still free. Full featured, the highly portable scope weighs only two pounds, is battery or AC powered, allows internal or external triggering and its CRT maintains a clear brighttrace.

- 12 sensitivity ranges (10mV/div to 50V/div) • 21 timebase settings
- 4 Filtering Modes: AC, DC, TV line and TV frame • 3 Coupling Modes: AC, DC and Ground
- Variable trigger level and slope • Operates on 4 "C" batteries or optional AC adapter • Built-in battery charging circuit • Battery Saver mode.

AFFORDABLE EXCELLENCE

3455 Conner Street, Bronx, New York, 10475, U.S.A.  
Telex 125091 OK NYK. Telex 232395 OK NY UR.  
Phone (212) 994-6600  
Fax (212) 994-4755.



CIRCLE 279 ON FREE INFORMATION CARD

## ELECTRONIC COMPONENTS



176 PAGE  
FREE CATALOG

Manufacturers of Quality  
Electronic Components

- BATTERY HOLDERS & CLIPS • COILS
- CAPACITORS • CONNECTORS • FUSES
- JACKS • KNOBS • LAMPS • PLUGS
- MICROPHONES • POTENTIOMETERS
- RELAYS • RESISTORS • SWITCHES
- TRANSFORMERS • SPEAKERS • LEDS
- SEMICONDUCTORS • RF COILS

OVER 15,000 DIFFERENT ITEMS IN STOCK!

**MOUSER ELECTRONICS**

2401 Hwy 287 No. Mansfield, TX 76063  
Phone: (817) 483-4422 TWX: 510-601-0375

CIRCLE 117 ON FREE INFORMATION CARD

## Learn micro-processing with the new MICRO-PROFESSOR 1P



Students, engineers or technicians—  
upgrade your micro-processing skills  
with the new Micro-Professor 1P.

The MPF-1P features:

- extensive software support
- more built-in memory
- improved keyboard
- larger display

Three tutorial guides help cover all capabilities. The ideal training tool! MPF-1P will deliver you into the growing world of micro-processing. Invest now!

Plus—FREE GIFT Only \$199.95

☐ Check this box for FREE Z-80 Microprocessor Programming and Interfacing textbook when you order within 7 days. \$12.95 value. (Include \$5.00 postage & handling)

**ETRONIX**

Dept. RE0586  
5326 9th Ave. N.E.  
Seattle, WA 98105-3617

For immediate action call TOLL FREE:

**1-800-426-1044**

Full money back guarantee.



CIRCLE 111 ON FREE INFORMATION CARD

# VIDEO NEWS



**DAVID LACHENBRUCH**  
CONTRIBUTING EDITOR

• **Competition for 8mm.** The camcorder wars are heating up, as JVC has completely miniaturized its VHS-C system, tripled its recording time to a full hour by adding an EP speed, and added a CCD pickup to compete with the new 8mm-video camcorders. (You'll recall that VHS-C is JVC's miniature VHS format. VHS-C cassettes can be played back by a standard VHS deck through the use of an adapter.) JVC's new little wonder is a complete record-and-playback unit with electronic viewfinder, autofocus, and power zoom; it weighs 2.9 pounds without cassette or battery. The comparable Sony *Video 8* camcorder weighs 4.5 pounds. Sony's little 8mm *Handycam* weighs only 2.2 pounds, but it doesn't play back, and lacks zoom and autofocus.

• **Pocket-TV grows up.** The first major TV brand to introduce a mini set with a color LCD screen is Panasonic, whose *Pocket Watch* uses a 3-inch color LCD. It has an audio-video input for use with a VCR and a pop-up screen with a backlight for night viewing. Its suggested list price is \$300. Sharp and Toshiba are also expected to enter the color LCD fold. Meanwhile, some manufacturers are planning some not-so-mini LCD color sets. Citizen has shown a 10.6-inch set and Casio both 6- and 12-inch versions.

• **All networks now in stereo.** With CBS joining the fold in February, all four major television broadcast-networks now are broadcasting at least some programs in stereo, and some 250 TV stations are equipped to pass those programs through to viewers. The EIA estimates that some 240,000 TV sets with built-in stereo reception capability were sold in 1984 and 1,500,000 in 1985. The manufacturer's group forecasts that 2,800,000 will be sold this year. Those figures don't include the sales of other devices that can also receive stereo telecasts, such as stereo-equipped VCR's.

• **1985 records.** Americans bought a record 17,261,312 color TV-sets in 1985, including 265,645 projection-TV systems. That total was up

6 percent from 1984, when the previous record was set. They also bought 11,853,188 home VCR's, an increase of 55.6 percent from 1984.

• **Made in the U.S.A.** Two major components, formerly made only abroad, will soon be manufactured in the U.S. RCA says it will make giant 35-inch direct-view color-picture tubes, with production quantities due in 1988. Mitsubishi currently is the only manufacturer making tubes of that size, and they are just starting production on their giant tube.

Also, ITT is planning to manufacture IC sets for digital TV sets in the U.S. Previously, they were available only from ITT's plant in Germany. ITT hopes that the availability of domestically manufactured IC's will encourage American manufacturers to make digital sets. Although U.S. set makers have developed sets using the ITT IC's, none has actually gone into production. Digital sets are being made in Germany and Japan.

• **Update.** Here's the latest word on a couple of items reported in this space lately: Last February, we reported that Eastman Kodak would market a video-image printer that could make prints from any video source. That project was put in limbo as a result of the court ruling that Kodak was infringing on Polaroid's instant-photography patents. The color printer was designed to use the Kodak instant film now banned by the court. However, Kodak still plans to test-market a companion product—the video floppy disc, which can record or play back up to 50 TV fields.

We originally reported here that General Electric will end its manufacture of color-TV sets and instead buy them from Matsushita Electric. Since that report, GE has agreed to purchase RCA. The two events are unrelated. Even though GE is expected eventually to own RCA and its TV-manufacturing facilities, it still plans to buy its sets from Matsushita, which will build a special plant in Mexico for the purpose. Both companies say that they will continue to market sets under their own brand names in two separate marketing organizations after the merger. **R-E**

# Check out the #1 source for technical support: RCA.

- Valuable, time-saving parts literature
- Nationwide distribution with super-fast delivery
- Highest quality exact replacement parts

**1F7827** VCR Key Items Cross Reference from Manufacturer's Model Numbers to RCA Stock Numbers — Covers Magnavox, Panasonic, Philco, Sylvania and RCA.

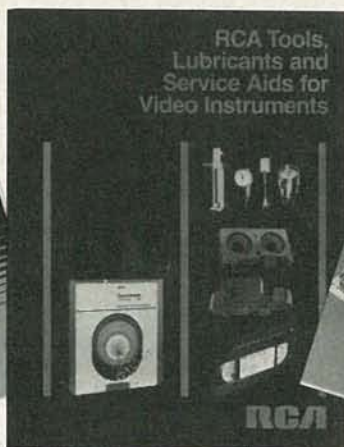

**1F6857** RCA Tools, Lubricants and Service Aids for Video Instruments — Illustrations and descriptions.

**1F6870** Cross Reference TV Modules to RCA Chassis Vol. II — Lists replacement modules by number and functions for most recent color chassis.



RCA offers a wide range of literature highlighting our exact replacement parts. Each booklet is designed to make your job easier and more profitable. They're comprehensive and continually updated. Best of all, they're free. So check off the ones you want to check out. Then send in this coupon/ad today.

- |  |   |
|--|---|
| <p><input type="checkbox"/> <b>1F7297</b> Fastest Moving VHS VCR Parts Chart — Helps you establish and minimize VCR parts inventory.</p> <p><input type="checkbox"/> <b>1F6627</b> Replacement Parts for RCA Video Cassette Recorder Instruments — Helps determine RCA stock number when you know original manufacturer's number.</p> <p><input type="checkbox"/> <b>1F6932</b> RCA Drawing Number to Stock Number Cross-Reference — Relates RCA's manufacturing type number to RCA replacement stock number for all consumer products.</p> <p><input type="checkbox"/> <b>1F5790</b> RCA Remote Controls for TV, VCR, VideoDisc Instruments — Includes illustrations; cross-references stock numbers and instrument model numbers.</p> <p><input type="checkbox"/> <b>1F6541</b> RCA Replacement TV Antennas — Actual size illustrations.</p> | <p><input type="checkbox"/> <b>1F5345</b> QT Parts List — Quick turnover list of the 150 fastest-moving consumer parts.</p> <p><input type="checkbox"/> <b>1F7148</b> Replacement IHVT Chart — Cross-references chassis to replacement integrated high voltage transformer.</p> <p><input type="checkbox"/> <b>1F4163</b> RCA Exchange Program Eligibility List — Lists parts eligible for dud return allowance.</p> <p><input type="checkbox"/> <b>1F3588</b> RCA TV Tuner to Replacement Stock Number Cross-Reference — Lists RCA mechanical tuners and exact replacement stock number.</p> <p><input type="checkbox"/> <b>1F4786</b> Cross-Reference TV Modules to RCA Chassis Vol. I — Lists replacement modules by number and functions for earlier color chassis.</p> |
|--|---|

Please send the RCA Parts literature checked above to:

\_\_\_\_\_  
Firm

\_\_\_\_\_  
Address

\_\_\_\_\_  
City State Zip

\_\_\_\_\_  
Attention

Fill in information at left and mail entire page to:  
**RCA Distributor and Special Products Division**  
 2000 Clements Bridge Road  
 Deptford, NJ 08096-2088  
 Attn: Sales Promotion Services

# RCA

Offer expires July 31, 1986.

# MUST LIQUIDATE Commodore Compatible Total Telecommunications™ MODEM

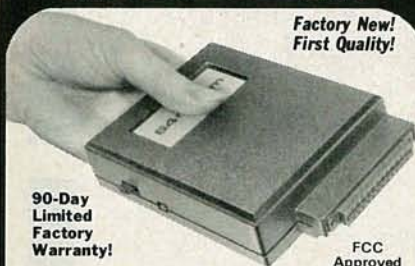

Factory New!  
First Quality!

90-Day  
Limited  
Factory  
Warranty!

FCC  
Approved

- Access the stock market, take college classes, do your shopping, and a whole lot more!
- For Commodore 64K or SX64!
- Has modular jacks for quick, easy hookup to your phone system!
- Works on TouchTone® and Rotary (Pulse) dialing system (not PBX)!

Liquidation due to an overstock! This single communications package connects your Commodore 64K or SX64 for on-line telephone use. No special computer knowledge is required. Super-intelligent software is completely menu-driven!

**Features:** 30K software buffer. 300 Baud, auto dial, auto answer helps eliminate complex modem steps. Works on Tone and Rotary phone systems (not on PBX). Upload and download of text, programs, data files. Prints or stores downloaded files. Captures and displays high resolution, mapped graphics files. Color selection menu. Connect-time clock keeps track of log-on time. ASCII or Commodore characters. Smooth screen rolling. Includes 6-ft. modular phone cord. **Equipment needed:** C64, Monitor, and disk drive or SX64.

**NOTE:** Price includes trial subscription to over 52 data base services for vast information. Initial sign-up fee is FREE. All you pay is the on-line time you use, plus monthly rate.

Mfr. List: \$109.95

Liquidation  
Priced At .....

# \$19

Item H-1149-3646-007 Ship, handling: \$4.00

Sales outside continental U.S. are subject to special conditions. Please call or write to inquire.

Credit card customers can order by phone.  
24 hours a day,  
7 days a week



**Toll-Free: 1-800-328-0609**

Your check is welcome!  
No delays in orders paid by check.

C.O.M.B. Direct Marketing Corp. Item H-1149  
14605 28th Ave. N./Minneapolis, MN 55441-3397  
Send \_\_\_ Modem(s) Item H-1149-3646-007 at \$19 each plus \$4 each for ship, handling. (Minnesota residents add 6% sales tax. Allow 3-4 weeks for delivery. Sorry, no C.O.D. orders.)

My check or money order is enclosed. (No delays in processing orders paid by check, thanks to TeleCheck.)

Charge:  MasterCard®  VISA®

Acct. No. \_\_\_\_\_ Exp. \_\_\_\_\_

PLEASE PRINT CLEARLY

Name \_\_\_\_\_

Address \_\_\_\_\_

City \_\_\_\_\_

State \_\_\_\_\_ ZIP \_\_\_\_\_

Phone (\_\_\_\_) \_\_\_\_\_

Sign Here \_\_\_\_\_

**C.O.M.B. Direct Marketing Corp.**

Authorized Liquidator  
14605 28th Avenue North  
Minneapolis, Minnesota 55441-3397

# LETTERS

WEDNESDAY  
JUNE 23 1987  
500-B BI-COUNTY BOULEVARD  
FARMINGDALE, NY 11735

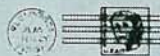

## LETTERS

RADIO-ELECTRONICS  
500-B BI-COUNTY BOULEVARD  
FARMINGDALE, NY 11735

### CHALLENGE TO THE VCR AND CABLE-TV INDUSTRY

I challenge the video and cable-TV industries to establish a standard logic interface for connecting a leased Pay-TV decoder to a subscriber's VCR. The channel selection programmed into the VCR's memory timer would tune the decoder, which would then deliver the baseband video and audio signals to the VCR.

Think of the advantages: 1. Single-point control of channel selection. 2. Elimination of moving parts in the decoder. 3. No need for selector switches or splitters. 4. Better-quality signal due to baseband connection. 5. Simple option to tape one channel and watch another. 6. VCR's with remote controls would have full control.

The technology exists today, since most VCR's and many cable decoders use digital channel selection already. If a simple LSTTL logic interface could be agreed upon, one of cable subscribers' most common beefs would be satisfied.

ERIC G. LEMMON  
Lompoc, CA

### DIGITAL TV CIRCUITS

Recent articles have appeared discussing the various TV formats such as PAL, SECAM, NTSC, advances like HDTV, new PBS proposed formats such as MAC, and associated signal-handling methods. It seems to me that the TV designers are spending a lot of energy in the wrong direction. I refer mainly to the domestic TV receiver designs using analog methods. Let me explain briefly, and perhaps spark some thought.

If the received broadcast signal

were digitized right out of the first IF filter, then the format could be transparent to the display system used. Indeed, the display could be scanless, mapping the data extracted from the signal only as necessary to create the picture; and it would be void of the many interferences caused by relationships between various frequency components in the normal scan and signal elements.

The processor would discover the transmission format, the related color and audio signals, process the data and feed it to the output devices. Thus the TV receiver could be updated easily (with ROM perhaps) to process any new formats and features.

The technology is here today. Why aren't such TV's on the market? Maybe they are, and just not advertised. How about an article on digital TV circuits? I don't mean digital control, I mean real full-scope digital TV from the IF out.

I enjoy **Radio-Electronics!**  
GENE SIMMONS  
Riyadh, Saudi Arabia

### A HAPPY NEW SUBSCRIBER

I am a new subscriber to your magazine and just wanted to let you know what a great surprise your magazine is for me. For years I subscribed to *Popular Electronics*, which became *Computers & Electronics*, and then became extinct. My interest has always been in the digital electronics area, and I thought that *Popular Electronics* was the only magazine that covered the subject. I knew that your magazine existed, but I had always assumed it was strictly for those interested in analog electronics. Well, at the demise of *Popular Electronics* I began to look

# PERFORMANCE

THAT IS OUT OF THIS WORLD...



**\$389<sup>00</sup>**

**MODEL 2000 20MHz  
DUAL TRACE**

**\$549<sup>00</sup>**

**MODEL 3500 35MHz  
DUAL TRACE DELAYED SWEEP**

## ...AT A DOWN TO EARTH PRICE

At last! Truly affordable test equipment with no compromise in design, and features you would expect to find only on oscilloscopes costing hundreds of dollars more! JDR Instruments presents two, new, high-performance models backed by a two year warranty and technical support which is only a phone call away. Perfect for the technician or advanced hobbyist, both models feature Dual Trace capability and a variety of operating and triggering modes, including CH-B Subtract and X-Y operation.

MODEL 2000 has a 20 MHz bandwidth and 20 calibrated sweeps ranging from .2s to .2 $\mu$ s. A convenient built-in component tester provides additional diagnostic power.



INCLUDES TWO HIGH QUALITY  
1x, 10x TEST PROBES

CIRCLE 59 ON FREE INFORMATION CARD

MODEL 3500 features a 35 MHz bandwidth and exceptional 1mV/DIV sensitivity. Delayed sweep and variable holdoff allow stable viewing of complex waveforms.

**ORDER TOLL FREE**  
**800-538-5000**  
**800-662-6279 (CA)**

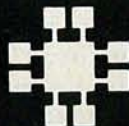

**JDR INSTRUMENTS**  
1224 South Bascom Avenue  
San Jose, California 95128 (408) 995-5430

# Check Digital IC's in-circuit Fast!

In the field or  
on the bench.  
**B&K-PRECISION**  
gives you the  
answers for  
TTL or CMOS



Model 550 (for TTL) \$395  
Model 552 (for CMOS) \$395

New B&K-PRECISION IC Comparator Testers/Logic Monitors put you on the fast track to digital troubleshooting. IC's are tested by comparison to a known good device, allowing you to test hundreds of types with one simple operation.

As logic monitors, they simultaneously indicate the logic states of up to 20 IC pins. No need to check pins singly with a logic probe.

Tests most 14 to 20 pin, 54 and 74 Series TTL (Model 550) or 4000 and 74C Series CMOS (Model 552) devices.

- Convenient one button testing
- Reverse polarity and overvoltage protection
- Uses power from equipment under test
- Memory stores short duration pulses and intermittent events
- Zero insertion force reference IC socket
- LED at each IC pin identifies where fault exists
- Includes 16 and 20 pin DIP clips
- Compact hand-held size

Available from stock at your local B&K-PRECISION distributor. For more information contact your distributor or:

**BK PRECISION**  
**DYNASCAN**  
CORPORATION

6460 West Cortland Street  
Chicago, Illinois 60635 • 312/889-9087

International Sales: 6460 W. Cortland St., Chicago, IL 60635  
Canadian Sales: Atlas Electronics, Ontario  
South and Central American Sales,  
Empire Exporters, Plainville, NY 11803

for an alternative; a friend assured me that my assumptions were wrong and that **Radio Electronics** was for me—and the rest is history.

I am up to my third issue and I haven't been disappointed yet. As a matter of fact, I'm quite pleased and excited. I have a great interest in home-control system design and I'm planning some experiments using the Commodore-64 as the development and control processor, with additional hardware and software that I have designed. I'm looking forward to building the Printer Buffer and EPROM Burner covered in your August and September 1985 issues. I am hoping to download custom software to EPROM's to be used in my control system. Could you recommend kits for making circuit boards from the foil patterns that are included in your articles? I designed circuit boards in college, but the process was tedious, and it involved very expensive equipment. I would greatly appreciate any information you could send me on PC-board design and construction. Is it possible that you will do something on that subject in a future issue?

THOMAS F. DUNIGAN  
Plymouth, NH

*We may do an article on that subject, Tom, but to tide you over, you might check the December 1982, January 1983, and February 1983 issues of **Radio-Electronics** for an excellent three-part article by Robert Grossblatt on that subject. A shorter treatment by the same author appears in the September and October 1985 issues of **Radio-Electronics**. In addition, we have a reprint of several articles on designing and etching PC boards available. See the reprint order form elsewhere in this issue.—Editor*

## RESTORING AN OLD MARCONI

I am trying to restore an old Marconi TV set (TV 500 chassis) to its original working condition, but I am unable to find a schematic or repair manual from the usual sources. The chassis appears to have a problem in the horizontal phase detector circuit, which is a type I have not encountered before. I would appreciate any help you or your readers could give me

in locating information about that chassis.

P.G. DODD  
18 Lakeland Cres.,  
Scarborough, Ontario,  
Canada M1G 2L3

## SMALL LOW-COST PROJECTS

I have been enjoying **Radio Electronics** for about a year now, and I find it to be a worthwhile and enjoyable expenditure of time and money. I read with interest the flap about **Radio-Electronics's** turning into another computer magazine, and I think you are doing rather well on that subject. Ignoring computers at this time would be as ludicrous as leaving out TV because this is a "radio" magazine; but I hope you continue to stick to computer "electronics" and leave the software to someone else.

My reason for writing, however, concerns some of the projects you've published lately. While the \$2500 IBM look-alike ("PC Compatible Computer," July, 1985) would be great to build, and was fun to read, and while a \$200 see-in-the-dark doo-hickey ("See-In-The-Dark Viewer", August, 1985) would be fun for a few weeks, how practical is it really, and how many of your thousands of readers have hundreds of bucks to spend on that type of "tinkering?"

I think I speak for a number of people who would like to see some small, low-cost, beginners' projects for those of us who are still new at this. One suggestion would be tuning and construction of garage door-opener transmitters and receivers. I have two or three of each, but none match. Building a 12-volt transmitter to permanently mount under the hood and match to your existing receiver would be a great little project. Home security seems to be pretty popular right now, also. I don't believe that projects have to be on the cutting edge of technology to be useful and timely.  
TROY B. LAMINACK  
Dumas, Texas

*Troy, we sympathize with you, and that's why we created **Hands-on Electronics**, our sister publication. We like your garage-door-opener idea; get busy, designers! And, by the way, for an interesting*



**CALL TOLL FREE**

CALIFORNIA

800-772-1519

OTHER STATES

800-854-1519

IN SAN DIEGO CALL  
619-560-9676

**FREE  
CATALOG!**



**PROBE  
MASTER**

**YOUR SINGLE SOURCE  
FOR PROBES  
AND ACCESSORIES**

**MODULAR SCOPE PROBES \$36 & UP**

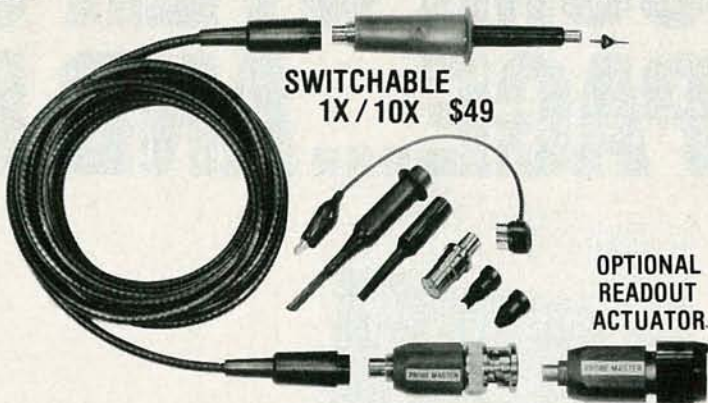

SWITCHABLE  
1X / 10X \$49

OPTIONAL  
READOUT  
ACTUATOR

**BNC ADAPTER KIT \$59**

10 PIECE KIT



**DESIGNER TEST LEAD KIT \$15**

(LEADS ONLY \$6.90)



SWITCHABLE  
1X / 10X  
\$38

**STANDARD SCOPE PROBES**

**\$25 & UP**

**TERMINATIONS &  
ATTENUATORS \$19 & UP**



**IMMEDIATE DELIVERY  
CALL FOR NEAREST DISTRIBUTOR**



**PROBE  
MASTER**

4898 RONSON CT.  
SAN DIEGO, CA 92111

CIRCLE 260 ON FREE INFORMATION CARD

MAY 1986

15

*NRI Trains You At Home—As You Build*

# GET THE KNOW-HOW TO SERVICE EVERY COMPUTER ON THIS PAGE...AND MORE.



IBM is a Registered Trademark of International Business Machines Corporation.

Epson is a Registered Trademark of Epson America, Inc.

Apple and the Apple logo are Registered Trademarks of Apple Computer, Inc.

Compaq is a Registered Trademark of COMPAQ Computer Corporation.

© 1985 AT & T Technologies, Inc.

# Your Own IBM-Compatible Computer

## Learn the Basics the NRI Way—and Earn Good Money Troubleshooting Any Brand of Computer

The biggest growth in jobs between now and 1995, according to Department of Labor estimates, will occur in the computer service and repair business, where demand for trained technicians will actually *double*.

You can cash in on this opportunity—either as a full-time corporate technician or an independent serviceperson—once you've learned all the basics of computers the NRI way. NRI's practical combination of "reason-why" theory and "hands-on" building skills starts you with the fundamentals of electronics, then guides you through advanced electronic circuitry and on into computer electronics. You also learn to program in BASIC and machine language, the essential languages for troubleshooting and repair.

### Total Computer Systems Training, Only From NRI

No computer stands alone . . . it's part of a total system. To successfully service and repair computers, you have to understand computer *systems*. And only NRI includes a complete computer system as part of your training, preparing you for the real world of computer servicing.

You start with the step-by-step assembly of the highly rated, IBM PC compatible Sanyo 550 Series computer. You install and troubleshoot the "intelligent" keyboard. Then you assemble the power supply,

install the disk drive and extra memory that gives you a powerful 256K RAM system. Finally, you interface the high-resolution monitor and dot-matrix printer and begin to use the \$1,000 worth of software that's included. You're learning about, working with, servicing and troubleshooting an entire computer system—monitor, keyboard, computer, disk drive, power supply, and printer—all the essentials you'll meet every day as a computer service professional.

### No Experience Needed, NRI Builds It In

This is the kind of practical, hands-on experience that makes you uniquely prepared, with the skills and confidence you need for success. You learn at your own convenience in your own home. No classroom pressures, no night school, no need to quit your present job until you're ready to make your move. Your training is backed up by your personal NRI instructor and the NRI technical staff, ready to answer your questions and help you when you need it. You get it all from NRI!

- Your NRI course includes the
- IBM PC compatible Sanyo computer with memory expansion to 256K RAM
  - high-resolution monitor
  - double-density/double-sided disk drive
  - "intelligent" keyboard
  - dot-matrix printer with near-letter-quality mode
  - NRI Discovery Lab® to teach circuit design and operations
  - digital multimeter
  - logic probe
  - spreadsheet, word processing software—and more.

### 100-Page Free Catalog Tells More

Send the postage-paid reply card today for NRI's big 100-page color catalog on NRI's electronics training, which gives you all the facts about NRI courses in Microcomputers, Robotics, Digital Electronics Servicing, Data Communications, TV/Audio/Video Servicing, and other growing high-tech career fields. If the reply card is missing, write to the address below.

**NRI** SCHOOLS

McGraw-Hill Continuing Education Center  
3939 Wisconsin Avenue  
Washington, DC 20016



We'll Give You Tomorrow.



# \$ 339.00 LOGIC ANALYZER

Add-on for your  
Oscilloscope



## 8 Channel Logic Analyzer To Be Used With Your Scope As The Display Media

- Featuring -

Pre-settable Triggering  
Sample Rate  
200 Nano Seconds  
2K Memory Per Channel  
Displaying 1K  
Before Trigger And  
1K After Trigger  
Trigger Centered On  
Screen



## Orders

1-800-592-4141

For Information:  
1-307-856-0771

Becktron  
P.O. Box 528  
Riverton, Wyo. 82501

CIRCLE 251 ON FREE INFORMATION CARD

approach to a complete home-security system, see the December, 1985, and January, 1986 issues of *Radio-Electronics*.—Editor

### INTERESTED IN OLD-TIME RADIO EQUIPMENT

Since *Radio-Electronics* readers are interested in old-time radio equipment and pioneers like Tesla, Marconi, DeForest, and Armstrong, I have a request. Does anyone anyone know where to borrow, rent, or buy an Alexanderson Alternator that could be made to work?

How those things operate fascinates me, so any written material on the subject would be welcome. If my understanding is correct, one could get one of those things on the air with little more than a big carbon microphone, and without vacuum tubes. Is that so?

The Alexanderson is a relatively unknown item from radio history, and as such it would make a good display at the Tesla "Unconvention" here in California next July. The attendees will definitely be interested in that type of demonstration.

PETE LEFFERTS  
1640 Decker Ave.  
San Martin, CA 95046.

### COMB FILTERS FOR YOUR TV

In Neil W. Heckt's August, 1985 article, "Comb Filters for your TV," Mr. Heckt derives 3,579,485 Hz. as the chrominance subcarrier (S.C.) frequency. As you can see from the FCC's *Rules and Regulations*, Section 73.682, paragraph five:

*The chrominance subcarrier frequency is 63/88 times precisely 5 MHz (3.57954545...MHz). The tolerance is ±10 Hz and the rate of frequency drift must not exceed 0.1 Hz per second (cycles per second squared)*

The chrominance subcarrier is the only number that is specifically enumerated (3,579,545 Hz.) and all other values are derived from it, not the other way around.

If Mr. Heckt is just using the figures in his article for the sake of clarity in his explanation, he should indicate that usage.

ARBY SCHUMAN  
Megazap Telemetry Systems

*You are indeed correct regarding the derivation of the horizon-*

*tal-scanning frequency from the specified color-burst frequency rather than the other way around as I stated in my article.*

*The relationship of horizontal, vertical, and color burst frequencies, rather than their exact values, is the most important aspect of the spectral nature of the NTSC signal; those relationships define how to separate chrominance from luminance information.*

*I simplified the values of the frequencies and their derivation, and I concentrated on their relationship, most important of which is that the color burst flag is 455/2 times the horizontal sampling frequency (i.e.,  $CBF = (455/2)HSF$ ).*

*You are correct in pointing out that the inverse mathematical relationship is specified by the FCC, (i.e.,  $HSF = (2/455)CBF$ , and that the actual  $CBF = 3.57954545$  MHz.*  
—Neil W. Heckt

### THANKS FOR THE HELP

My recent request for help in your magazine resulted in three responses, one of which was a complete owner's manual for the Sansui AM/FM receiver I was having trouble with! Another response was a full-page typed letter describing practical approaches to trouble-shooting and fault location in the absence of a schematic.

Now I need an address where I can obtain operating instructions for a DORO 311 telephone-answering machine manufactured for Dictan International by Victor Co. of Japan.

M. MCDANIEL  
940 Temple ST.  
San Diego, CA 92106

### CORRECTION

Sharp-eyed reader Chris Bassett, of the Bronx, NY, called my attention to an error that crept into the text of my article, "All About Multipath Distortion" in the October, 1985 issue of *Radio-Electronics*. On page 76, in the center column between the first and second paragraphs, the formula for horizontal spacing (H) is given as  $(\lambda/2) \sin \theta$ . The parentheses were wrongly placed; the formula should be:

$$H = \lambda / (2 \sin \theta)$$

BOB SCOTT  
Darlington, SC

R-E

**United States  
Instrument Rentals, Inc.**



A U.S. Leasing Company

2988 Campus Drive  
San Mateo, CA 94403

Call for Special Prices and  
**Free Catalog**  
**800-824-2873**



**Hitachi Denshi America, Ltd.**

**Beckman Industrial™**



**SCOPES**

**Iwatsu**

- All 14 models in stock
- 2-3 year warranties
- 20-250 MHz

Model 5702—\$ 535  
5705—\$ 899  
5710—\$1245  
5711—\$1695  
7506—\$ 749

**Hitachi**

- All 20 models in stock
- 2-3 year warranties
- 20-100 MHz

Model 1050—\$1299  
509—\$1199  
VC 6041—\$4400  
422—\$ 690  
1100—\$1900  
650—\$ 930  
V209—\$ 725  
1070—\$1595  
1100A—\$2490



Hitachi V-222

**SALE \$535**  
List \$715

**Hitachi V-222**

Portable Dual Trace Scope

- DC-20 MHz
- 3-Way Power Supply
- Lightweight
- High Sensitivity and Fast Sweep Timer

**DIGITAL MULTIMETERS**

**Beckman**

- All 300, HD, and circuitmate series
- All accessories in stock

HD100—\$169 320—\$179  
HD110—\$189 330—\$219  
HD130—\$239 350—\$229  
HD140—\$259 360—\$289  
300—\$120 4410—\$239  
310—\$145

**Fluke**

- Autorange • Analog display
- Touchhold function
- 0.3% accuracy • Heavy duty

Model 73—\$ 79 8010A—\$279  
75—\$ 99 8012A—\$359  
21—\$ 99 8020B—\$199  
23—\$145 8022B—\$154  
25—\$229 8024B—\$249  
27—\$259 8050A—\$389

**SALE \$114**  
List \$139

**Fluke 77**

Analog/Digital Multimeter



**POWER SOURCES**

**POWER DESIGNS**

- Low and high voltage power sources
- 1-5 year warranties

2020B—\$750  
2K20—\$695  
4050—\$660  
6150—\$725

TW5005W—\$595  
TW6050A—\$880  
TW347—\$695  
TP340—\$750  
TP343A—\$795

**Used Test Equipment, too!—Over 3,000 Models Available at  
Huge Discounts with Warranties!**

- Quantity Discounts Available
- Dealers Welcome
- Freight and Tax extra
- Immediate Availability of Equipment

**Call**

**800-824-2873**

Include work address and phone #  
for Free Catalog.

# EQUIPMENT REPORTS

## Triplett Model 6500 Cable Tester

*Finds cable shorts and  
opens in a flash*



CIRCLE 5 ON FREE INFORMATION CARD

ANYONE INVOLVED WITH ELECTRONICS knows that one of the toughest problems to troubleshoot is a cable problem. Often, the only time-effective solution is to junk the cable and replace it.

But what if you are a CATV con-

tractor who has just spent the better part of a week wiring up a new complex, only to find out that a cable fault somewhere along the way is depriving half of your new customers of their signal? Troubleshooting each run of cable

using conventional methods, if even possible, can take forever, and ripping out the cable and starting over means a great deal of wasted effort and money.

A better solution would be to use Triplett's (One Triplett Drive, Bluffton, OH, 45817) new model 6500 cable-fault locator. That device can track down the location of a short or open in a cable to within one foot.

### Finding faults

The model 6500 can detect and identify the location of faults, and measure cable length, for cables that range from 15 to 6000 feet (5 to 2000 meters). It can be used with a variety of cable types including, but not limited to, coax, twisted

Send Purchase Order  
Check, Money Order, or C.O.D.  
or Call Toll Free

**800-223-0826**  
In N.Y. State (212) 865-5580

**Nobody Beats Us!**  
**\$69<sup>95</sup>**

### JERROLD CORDLESS CABLE T.V. CONVERTER

Model DRX3-105/400 (58 CHANNELS)

ALSO AVAILABLE TEKNICA - Model 6510 with volume control \$139<sup>95</sup>



### CO-AXIAL CABLE

Braided bare  
Copper Shield

Bare Copper  
Conductor

RG 59/u

**\$44<sup>50</sup>/1000'**

Foam  
polyethylene  
dielectric

RG-6/u 69<sup>95</sup>/1000

Add \$5.00 per Roll for Shipping

**SANYO**  
2SC1308K  
ORIGINAL

**TOSHIBA**  
2SC1172B  
ORIGINAL

100 up **\$1.49**  
10-29...\$1.99 30-99...\$1.69

**\$10<sup>99</sup>**  
each

**RCA**  
Triplers  
SK3306/Equivalent to ECG-523  
ECG-526  
SK3304/Equivalent to ECG-500A

**2 WAY - 75 ohm u/v  
Splitter**  
49¢/100 lot  
99¢ each

**21¢/100 lot**

**MATCHING  
TRANSFORMER**

**"F" - FITTINGS**  
F-59ALM with attached  
1/2" ring for RG-59/u cable  
12¢/100 9¢/1000 **7¢/5000**

F-56ALM with attached  
1/2" ring for RG-6/u cable  
15¢/100 10¢/1000 **8¢/5000**

**WELLER**  
WTCPR CONTROLLED OUTPUT  
SOLDERING STATION

Model  
WTCP-R

**\$69<sup>95</sup>**

**HITACHI 20 Mhz Dual  
Trace Scopes**

V-212 **\$439<sup>95</sup>** Probes  
V-222 **\$489<sup>95</sup>** included  
V-223 **\$539<sup>95</sup>** DELAYED SWEEP

■ MASTER CARD ■ VISA

## OMNITRON ELECTRONICS

770 Amsterdam Ave., New York, NY 10025

### SHIPPING CHARGES

For Orders	Add
\$25-100	\$6.50
\$100-500	\$8.50
\$500-750	\$10.50
\$750 and up	\$20.00

Write for  
**FREE  
CATALOG**  
136 page

# Take 5 Books for Only \$2<sup>95</sup>























(Values To \$110.75)



## ELECTRONICS BOOK CLUB

Keep In Step With the Future . . . Become a Part of the Fascinating World of Technology!

- High-Tech How-To
- Space Age Projects
- Digital Electronics
- Artificial Intelligence
- Robotics
- Computers
- Telecommunications
- *And much more!*

 1870 List \$19.95	 1183 List \$16.95	 1498P List \$11.95 (paper)	 1875P List \$14.95 (paper)	 1113P List \$7.95 (paper)	 1532P List \$12.95 (paper)	 1241P List \$11.95 (paper)	 1339P List \$7.95 (paper)
 1984 List \$14.95	 1431 List \$17.95	 1539P List \$15.95 (paper)	 1835 List \$15.95	 1605P List \$13.50 (paper)	 1777 List \$21.95	 1665P List \$16.95 (paper)	 1897 List \$18.95
 1593 List \$13.95	 1896 List \$21.95	 1604P List \$15.95 (paper)	 1719 List \$18.95	 1474P List \$12.95 (paper)	 1245P List \$16.95 (paper)		

 1536 List \$14.95	 1996 List \$18.95	 1927 List \$23.95
 1679 List \$17.95	 1977 List \$26.95	 1699 List \$19.95

**FREE**  
Handy, Pocket-Sized  
Resistor and Inductor  
Color Code Calculator



**FREE When You Join Now** →

### 7 very good reasons to join the Electronics Book Club

- **Big Savings.** Save 20% to 75% on books sure to increase your electronics know-how
- **No-Risk Guarantee.** All books returnable within 10 days without obligation
- **Club News Bulletins.** All about current selections—mains, alternates, extras—plus bonus offers. Comes 13 times a year with hundreds of up-to-the-minute titles to pick from
- **Automatic Order.** Do nothing, and the Main selection will be shipped automatically! But . . . if you want an Alternate selection—or no books at all—we'll follow the instructions you give on the reply form provided with every News Bulletin
- **Bonus Books.** Immediately get Dividend Certificates with every book purchased and qualify for big discounts of 60% to 80%
- **Extra Bonuses.** Take advantage of added-value promotions, plus special discounts
- **Exceptional Quality.** All books are first-rate publisher's editions selected by our Editorial Board and filled with useful up-to-the-minute information



**ELECTRONICS BOOK CLUB**  
P.O. Box 10,  
Blue Ridge Summit, PA 17214

Please accept my membership in the Electronics Book Club and send the 5 volumes circled below, plus my FREE Resistor and Inductor Color Code Calculator, billing me only \$2.95 plus shipping and handling charges. If not satisfied, I may return the books within ten days without obligation and have my membership canceled. I agree to purchase 4 or more books at regular Club Prices (plus shipping/handling) during the next 12 months, and may resign any time thereafter.

1113P 1183 1241P 1245P 1339P 1431 1474P 1498P 1532P  
1536 1539P 1593 1604P 1605P 1665P 1679 1699 1719 1777  
1835 1870 1875P 1896 1897 1927 1977 1984 1996

Name \_\_\_\_\_  
Address \_\_\_\_\_  
City \_\_\_\_\_  
State \_\_\_\_\_ Zip \_\_\_\_\_ Phone \_\_\_\_\_

Valid for new members only. Foreign applicants will receive ordering instructions. Canada must remit in U.S. currency. This order subject to acceptance by the Electronics Book Club.

RE-586

CIRCLE 277 ON FREE INFORMATION CARD

pair, power cord, and multi-conductor shielded cable (although in high-density, multi-conductor cables, the range may be somewhat restricted due to high inter-conductor capacitance).

Measurements are displayed on a 4-digit LCD readout. Annunciators on the readout indicate whether a cable fault is a short or open, and whether the displayed distance is in meters or feet.

The cable to be measured is connected to the unit via a front-panel

BNC jack. If more convenient, the cable can be connected via binding posts if the included binding-post-to-BNC adapter is used.

In most ways, the unit is very easy to use; we'll get to the exception in a moment. All operation is controlled via four front-panel controls. Three pushbuttons are used to turn the unit on or off; set the measurement units, either meters or feet, and to set the range, either short (15-600 feet) or long (600-6000 feet).

Triplet		6500									
OVERALL PRICE											
EASE OF USE											
INSTRUCTION MANUAL											
PRICE/VALUE											
		1	2	3	4	5	6	7	8	9	10
		Poor		Fair			Good			Excellent	

The fourth control, a pushbutton counter, requires a bit more explanation. It is used to select the cable's NVP (Normal Velocity of Propagation). That quantity is equal to the reciprocal of the square root of the cable's dielectric constant ( $1/\sqrt{\text{dielectric constant}}$ , and is different for different types of cables. For instance, coax using a polyethylene dielectric usually has an NVP of 66. Often, the NVP can be found in or derived from the cable's data sheets. If not, the value must be determined experimentally. That's the exception that was referred to previously.

To find the NVP of the cable to be tested, a 15- or 30-foot length of the same cable must be connected to the 6500. Then, at an ambient temperature of 23°C ( $\pm 5^\circ\text{C}$ ), different settings of the NVP switch are tried until the readout displays 15 or 30 feet (depending on the length of the test cable). Once the NVP of the cable is determined, it should *definitely* be written down for future reference.

Housed in a black high-impact plastic stand with bale-type handle, the 6500 is powered by 6 C-sized nickel-cadmium batteries. Also included is an AC adapter/battery-charger, and car-cigarette-lighter adapter.

The manual that accompanies the unit is a bit sketchy and sloppily done. It provides a fair explanation of how the unit is used, and gives some specifications, but does little else. Notably, there is no schematic, theory of operation, or similar information.

At a list price of \$550, this is not a product aimed at the hobbyist market. But if you are involved with the installation, maintenance, or repair of cables, the time and aggravation that the 6500 can save you is well worth its cost. R-E

## Build Circuits Faster and Easier With Our \$20 Solderless Breadboard



...and do even more with our \$40 breadboard

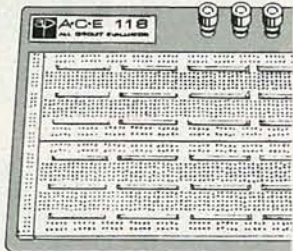

### Introducing the plug-in world of AP Product's versatile, low cost breadboards.

Now you can design, build and test prototype circuits just like the professionals... and make changes in seconds. No messy soldering or desoldering. No more twisted leads or damaged devices.

With our ACE 109 and 118 blue breadboards, you simply plug in components and interconnect them with ordinary hook-up wire. All sizes of DIPs and other discrete components up to 22 gauge lead diameters snap right into the 0.1" x 0.1" matrix of the solderless tie points... anywhere on the layout. You don't need expensive sockets or special tools. Buses of spring clip terminals form a distribution network for power, ground and clock lines.

AP Products 100 series breadboards give you all the functions and flexibility of more expensive circuit evaluators. The spring terminals have mechanically independent contact fingers to accom-

modate most DIPs and discrete components (see diagram).

The ACE 109 has two terminals for separate voltages plus a ground connection. The larger ACE 118 offers the same three terminals, plus an additional terminal which can be used for clocking or another voltage. The backplates are heavy steel to keep the boards stationary.

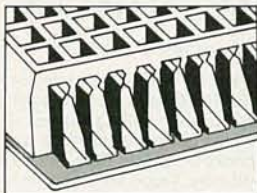

**Don't wait. These low prices won't last forever. See your local AP Products dealer today, or send for a list of dealers in your area. Free information on request.**

**AP PRODUCTS/3M**  
**9325 Progress Parkway**  
**P.O. Box 540**  
**Mentor, Ohio 44060**  
**800-321-9668**  
**(Ohio, 216/354-2101)**

CIRCLE 76 ON FREE INFORMATION CARD



# Two of the best HAMEG-Performers

2 year warranty

high quality at low cost

## HM 205 an outstanding new Oscilloscope with Digital Storage

### Realtime:

2 channels DC – 20 MHz  
max. sensitivity 2 mV/div.  
Timebase 0.2 s – 20 ns/div.  
Trigger: DC – 35 MHz (0.5 div.)  
Built-in Component Tester  
1 kHz / 1 MHz calibrator (3 ns)  
TV sync. separator

### Digital Storage:

max. sampling rate 100 kHz  
Refresh-, Single-Mode  
Storage: 8 bit x 2048 points  
Timebase: 5 s – 0.1 ms/div.

CRT 8x10 cm, int. graticule, 2 kV

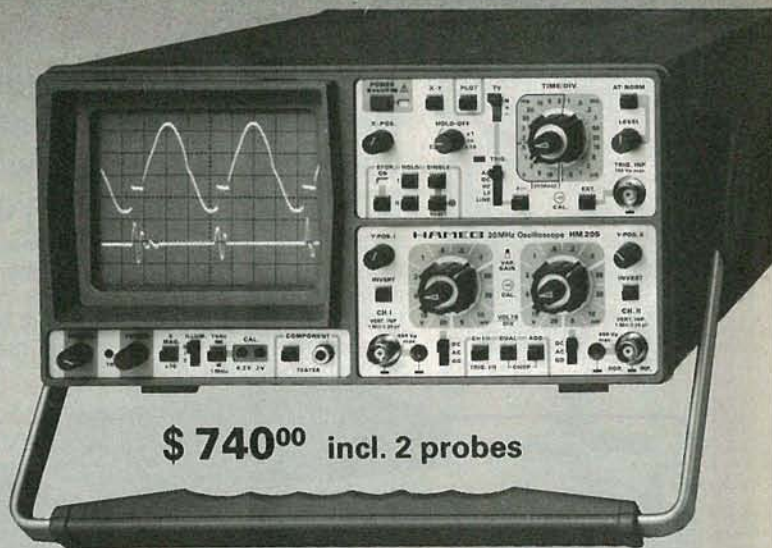

\$ 740<sup>00</sup> incl. 2 probes

## HM 208 the high tech Digital Storage Scope with 20 MHz sampling rate

### Realtime:

2 channels DC – 20 MHz  
max. sensitivity 1 mV/div.  
Timebase 0.1 s – 20 ns/div.  
Trigger: DC – 40 MHz (0.5 div.)

### Digital Storage:

max. sampling rate 20 MHz  
Roll-, Refresh-, Single-, XY-Mode  
Storage: 8 bit x 4096 points  
Timebase: 50 s – 1  $\mu$ s/div.  
Pretrigger: 0-25-50-75-100%

CRT 8x10 cm, int. graticule, 14 kV  
IEEE-488 Interface Option

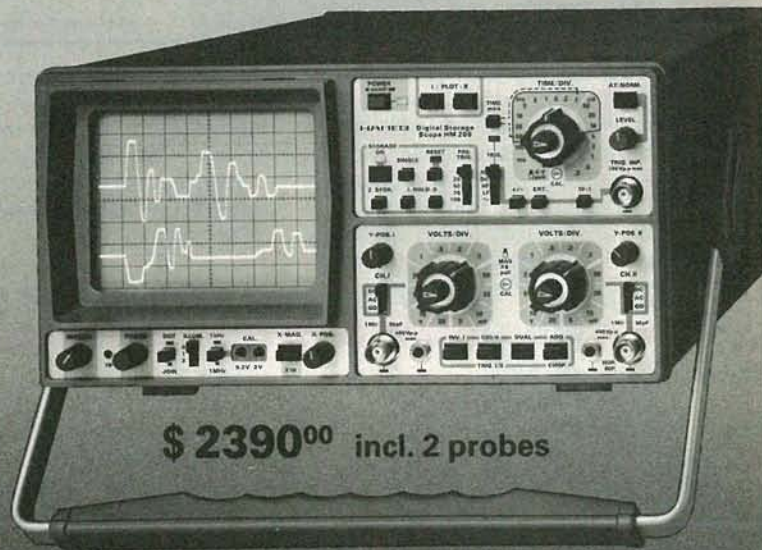

\$ 2390<sup>00</sup> incl. 2 probes

Write or call

**HAMEG**® Inc.

14 day full money back guarantee

88-90 Harbor Road · Port Washington, N.Y. 11050 · ☎ (516) 883.3837 · TWX (510) 223.0889

CIRCLE 271 ON FREE INFORMATION CARD

# Free

Famous **hi-tech** catalog



**A very special computer & electronics guide that shows you what the exciting world of kitbuilding can do for you.**

Challenge. Knowledge. Achievement. Enjoyment. All of these things are yours when you build a Heathkit high-quality product. Our colorful, informative catalog reflects the years of experience and technological expertise that make these things happen for you.



HERO® 2000 Educational Robot and Courseware

IBM-PC Compatible Expandable Computers

Amateur Radio Terminal Node Controller

Precision Test Instruments

Electronic Keyless Doorlock

In our catalog you'll find over 450 interesting and useful items – from computer hardware and software to robots and test instruments, and from home security systems to color tv's and amateur radio equipment.

But what makes Heath Company unique is that we offer you the confi-

dence and pride that you can only get by building a state-of-the-art product yourself. And you're backed by our promise, "We won't let you fail."

The Heathkit Catalog is a simple – and FREE – first step toward this excellent opportunity.

**Send NOW for your FREE Heathkit Catalog**



**Yes!** I want to see what kitbuilding can do for me. Please send me the latest Heathkit Catalog Free.

Send to: Heath Company, Dept. 020-412  
Benton Harbor, Michigan 49022

Name \_\_\_\_\_

Address \_\_\_\_\_

City \_\_\_\_\_ State \_\_\_\_\_

Zip \_\_\_\_\_

A subsidiary of Zenith Electronics Corporation CL-787R1

## Regency MX-7000 Scanner/Receiver

*A top-of-the-line scanner  
for the serious enthusiast*



CIRCLE 6 ON FREE INFORMATION CARD

WHEN WAS THE LAST TIME YOU TOOK A close look at a scanner? Granted, they've been around long enough now to be taken for granted. But some of the new ones, like the Regency (7707 Records St., Indianapolis, IN 46226) MX-7000 merit a closer look; those units feature some innovative uses of state-of-the-art technology.

The MX-7000 is a micro-processor-controlled scanner/receiver. That unit's PLL tuning section features continuous coverage of the frequencies between 25 and 512 MHz, and 800 MHz and 1.1 GHz. Among the scanner's more unusual features are memory retention for up to a week without battery backup, and adjustable bandwidth. Other features include a 20-channel memory, dual scanning speeds, and a built-in clock.

### A powerful package

The MX-7000's technology is packed in a case that measures just 5.4 × 3.1 × 7.9 inches. The unit weighs a light 2.4 pounds. A nice touch is the slanted front panel. That design places the front panel, with its membrane keyboard and LCD readout, at a convenient angle for viewing and use. The front panel also sports a power switch; volume control; squelch control; display-light switch, which allows you to illuminate the readout in less-than-optimum lighting conditions; and keypad lock, which



PHILIPS

KEITHLEY

WESTON



Non-Linear Systems



BK PRECISION

LEADER

# FLUKE 70

SERIES  
MULTIMETERS



- 77**
- 0.3% Accuracy
  - Manual or Autorange
  - 10A + mA Range
  - Beeper
  - "Touch-Hold" Function

Sale  
**\$129<sup>95</sup>**

75 89<sup>95</sup>  
73 69<sup>95</sup>

**WE CARRY A FULL LINE OF FLUKE MULTI-METERS. IN STOCK NOW**

SALE ENDS MAY 31

**BK PRECISION** DYNASCAN CORPORATION

**BREAKS THE PRICE BARRIER WITH THESE HIGH PERFORMANCE OSCILLOSCOPES**

## 100 MHz Dual Trace/ Dual Time Base

- 1 mV/div sensitivity
- 23 calibrated sweeps
- Rectangular CRT with internal graticule and scale illumination
- Signal Delay Line

# \$995

Does not include probes (\$60.00 a pair when purchased with scope)

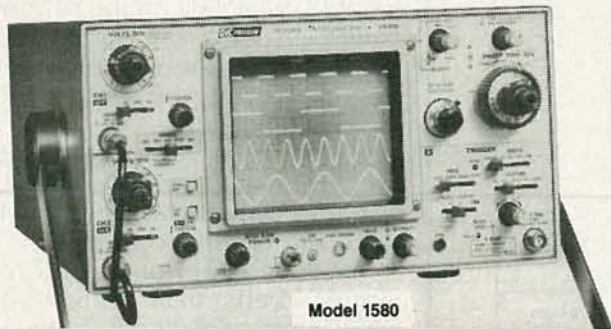

Model 1580

**QUANTITIES ARE LIMITED**

## BECKMAN'S CIRCUITMATE<sup>®</sup> ALL UNDER \$100

AVAILABLE NOW . . .

**\$64<sup>95</sup>**



Circuitmate DM 20—3½-digit, pocket-size multimeter; 0.8% Vdc accuracy, diode test, hFE test, conductance, 10 amps AC and DC ranges, auto-polarity, auto-zero, auto-decimal

**\$79<sup>95</sup>**



Circuitmate DM 25—3½ digit, pocket-size multimeter; 0.5% Vac accuracy, diode test, capacitance, continuity beeper, conductance, 10 amps AC and DC ranges, auto-polarity, auto-zero, auto-decimal

**\$69<sup>95</sup>**



Circuitmate DM 40 — 3½-digit multimeter; 0.8% Vdc accuracy, diode test, auto-polarity, auto-zero, auto-decimal

**\$89<sup>95</sup>**



Circuitmate DM 45 — 3½-digit multimeter; 0.5% Vdc accuracy, diode test, continuity beeper, 10 amps AC and DC ranges, auto-zero, auto-polarity, auto-decimal

**BK PRECISION**

## 100 MHz Dual Time Base SCOPE

MODEL  
1590

**BK PRECISION**

## INDUSTRIAL TRANSISTOR TESTER



**\$219<sup>95</sup>**

MODEL  
520B

- Now with HI/LO Drive
- Works in-circuit when others won't
- Identifies all three transistor leads
- Random lead connection
- Audibly and visually indicates GOOD transistor



**\$1395<sup>00</sup>**

PRICE DOES NOT INCLUDE PROBES

- 1mV/division sensitivity to 70 MHz
- 500 μV/division cascade sensitivity
- Four-input operation provides trigger view on 4 separate inputs
- Alternate time base operation
- Switching power supply delivers best efficiency and regulation at lowest weight



TOLL FREE HOT LINE

**800-223-0474**



212-730-7030

# ADVANCE ELECTRONICS

26 WEST 46th STREET, NEW YORK, N.Y. 10036

when activated locks out the keypad to prevent accidental entries.

The keypad is used to select operating modes as well as frequencies. The available modes include scan, search, frequency lockout, priority and clock. Further, the upper and lower search-limits, receiver bandwidth, scan delay, scan speed, time of day (for the clock), and memory selection are set using the keypad.

The selectable bandwidth is an especially useful feature as it helps ensure clean, clear reception. On scanners that use fixed bandwidths, distortion and adjacent-

channel interference are common problems, especially when monitoring narrow-bandwidth FM transmissions. With the *MX-7000*, if you are listening to an area of the spectrum where most communication is done using 5-kHz narrow-band FM, you can program the scanner for a 5-kHz bandwidths. Other available bandwidths are 12.5 and 25 kHz.

The unit offers 20 memory-locations, or channels; those are pre-programmed for some of the most popular listening frequencies. However not all frequencies are equally popular in all areas. To

Regency		MX-7000												
OVERALL PRICE														
EASE OF USE														
INSTRUCTION MANUAL														
PRICE/VALUE														
		1	2	3	4	5	6	7	8	9	10			
		Poor		Fair		Good		Excellent						

change the frequency stored in one of the channels is not difficult, but the procedure is more complicated than with most other scanners. It involves three different keying sequences, selecting the programming mode (narrowband FM, wideband FM, or AM), frequency, and channel.

On the rear panel of the scanner are found the power, antenna, and external-speaker connectors. The unit requires 13.8-volts DC. For fixed use, that power is provided by the included wall-plug power supply.

Rather than the traditional Motorola connector used by most scanners, the antenna connector on this unit is a BNC type. The advantage of that type of connector is that it is more secure.

Though the unit features its own built-in speaker, a connector is provided if you wish to use an external unit. Note that for best performance only eight-ohm speakers should be used.

Also, a 10-dB attenuator is switch selectable from the rear panel. That allows you to deal with signal-overload problems, such as those that occur when you are near a powerful transmitter.

As to specifications, they are impressive for a unit of this type. For starters, receiver sensitivity is 1.0  $\mu\text{V}$  at 12 dB SINAD on the narrowband-FM setting and 1.5  $\mu\text{V}$  at 12 dB SINAD on the wideband-FM setting. On AM, the sensitivity is 1.5  $\mu\text{V}$  at 10 dB S/N.

Selectivity is 7.5 kHz at 6 dB down for narrowband FM; 50 kHz at 6 dB down for wideband FM, and 5 kHz at 6 dB down for AM.

Image and spurious-signal rejection is better than 50 dB down, while intermodulation rejection is better than 50 dB down.

The instruction manual is com-

## Add a Little Technology to Your Library.

### Solid-State Relay Handbook with Applications

Anthony Bishop

This comprehensive reference work on solid-state relays is what electronics technicians, engineers, and hobbyists have been waiting for. Bishop treats SSRs on a wide range of technical levels, from a tutorial approach on the basics to discussing techniques of installation and designing interface logic signals with power loads. Its up-to-the-minute coverage of the use and application of SSRs discusses improvements in speed and reliability. Readers will find particularly useful the applications of SSRs with microprocessor-based equipment for industrial machines and the use of SSRs in interfacing with microcomputers. A key feature is the separate chapter on testing equipment and procedures. No. 22475, \$19.95

### Handbook of Electronics Tables and Formulas (6th Edition)

Staff of Howard W. Sams

This useful handbook contains the updated information you need to stay abreast of the rapidly changing electronics industry. The new edition contains computer programs (written for Commodore 64<sup>®</sup>, with conversion information for Apple<sup>®</sup>, Radio Shack, and IBM<sup>®</sup>) for calculating many electrical and electronic equations and formulas. The easy-to-access format contains all of the formulas and laws, constants and standards, symbols and codes, service and installation data, design data, and mathematical tables and formulas you would expect to find in this reference standard for the industry. New formulas include power units, graphical reactance relations, power triangle, and decibels/voltage/power diagram. Among the new constants are standard potentiometer tapers and the Kansas City standard. No. 22469, \$16.95.

### IC OP-AMP Cookbook (3rd Edition)

Walter Jung

Hobbyists and design engineers will be especially pleased at this new edition of the industry reference standard on the practical use of IC OP AMPs. This book has earned respect in the industry by its comprehensive coverage of the practical uses of IC OP AMPs, including design approaches and hundreds of working examples. The third edition has been updated to include the latest IC devices, such as chopper stabilized, drift-trimmed BIFETs. The section on instrumentation amps reflects the most recent advances in the field. Jung is recognized as an expert in the fields of IC and audio OP AMPs. No. 22455, \$18.95

### Understanding Digital Logic Circuits

Robert G. Middleton

Designed for the service technician engaged in radio, television, or audio troubleshooting and repair, this book painlessly expands the technician's expertise into digital electronics. Beginning with digital logic diagrams, the reader is introduced to basic adders and subtractors, flip-flops, registers, and encoders and decoders. Memory types are also discussed in detail. No. 21867, \$18.95

Send \$1.00 for Sams book catalog (product No. 903409) with 400 titles covering electronics, computers, engineering, robotics and communications.

To order call  
**800-428-SAMS**

In Indiana  
call 317-298-5566

Ask For Operator 806

**SAMS**

A Division of Macmillan, Inc.



Book No.	Quantity	Price
Shipping & Handling		\$ 2.50
AR, CA, FL, IN, NC, NY, OH, TN, WV residents add local sales tax		\$
Total		\$
Name _____		
Company _____		
Address _____		
City _____		
State _____ Zip _____		
Daytime Telephone No. _____		
Bill my credit card (VISA MC A)		
Account No. _____	Exp. Date _____	
Signature (required) _____		
Check or money order enclosed. Make checks payable to Howard W. Sams & Co. Mail this form with payment to: Howard W. Sams & Co., Inc. Dept. DM • 1300 West 62nd Street • Indianapolis, IN 46248		
DM 806		

Prices subject to change without notice.

# C.O.M.B. BREAKS THE SATELLITE TV PRICE BARRIER! KLM 8-ft. SATELLITE TV RECEIVER SYSTEM HIGH PERFORMANCE! TOP NAME BRAND!

**FACTORY NEW! FIRST QUALITY!**

## COMPLETE, PERFECTLY MATCHED SYSTEM!

- Designed for do-it-yourself installation!
- Fully programmable location of each satellite!
- All motorized!
- Automatic push-button selection of each satellite!
- Includes 120 feet of cable!
- Superior quality throughout!



**REMOTE CONTROL**  
Operates Aimer IV (shown at right). Push-button access to 64 programmed satellites. 6 pre-sets for your favorite programs.

Does not include metal support pipe.

## It opens up a vast new world of TV entertainment! MORE sports! MORE movies! MORE of everything you like to watch! And it provides superior reception capabilities!

The KLM 8-ft. Satellite TV Receiver system picks up signals from more than a dozen communications satellites in the sky. This opens up over 100 channels of TV viewing, with a multitude of programs. And the KLM system provides outstanding reception capabilities throughout the entire 48 states!

**PERFECT FOR SPORTS FANS!** Enjoy much more sports action and thrills than ever before! You'll literally be "in heaven" with the vast selection of football, baseball, basketball, hockey and many other exciting televised sporting events. Plus, no more "blackouts".

**HUGE VARIETY OF ENTERTAINMENT.** Watch popular new films and plenty of classic "oldies" on the movie channels. Keep up with fast-breaking national and international events, any time of day, on all-news networks.

Get important investment "tips" and information from the financial/business channels. View provocative Adults Only programs. Delight in video entertainment of top performers on music channels for rock, pop, country, classical, etc.

**PLUS,** there are entertaining and educational channels specifically for children. Religious and cultural channels. French and Spanish networks. The list goes on and on! And with each new TV satellite placed in the sky, your exciting world of home entertainment keeps growing LARGER and LARGER!

**IDEAL FOR RURAL AREAS!** If TV reception is poor or the variety is very limited where you live, you're in for a HUGE DELIGHT! With the KLM system, reception is as good as in a big city. And the variety is huge!

**GREAT FOR URBAN AND SUBURBAN AREAS!** With the KLM system, you can still pick up all your usual local stations. PLUS, you get greatly expanded selection from all the satellite channels. There's a huge world of viewing pleasure in store for you. Up to 100 or more TV channels are available with the KLM system!

**DO-IT-YOURSELF INSTALLATION!** You don't have to be an electronics "whiz" to install the KLM system. Components come pre-assembled, except for the 8-ft. "dish." Need: 3 1/2" outside dia. support pipe, bag of cement mix and your own TV. KLM has a Toll-Free number to call just in case you need assistance. The "dish" is designed to withstand high winds.

**AN EXCELLENT VALUE!** Don't be fooled by someone else's "low" price on a "dish" that is SMALLER than ours...NOT as high-tech...or is INCOMPLETE and requires costly purchases of additional components. With our KLM 8-ft. "dish" you get a complete, superior quality system from a leader in the industry...at a remarkably low closeout price!

**One year limited factory warranty on parts and labor.**

Mfr. Suggested List Price ..... **\$1900.00**

**ENTIRE SYSTEM Closeout Price ..... \$999**

Item H-1159-5958-004  
F.O.B. Milwaukee, Wisc. metro area  
Shipping weight: approx. 155 lbs.

**FREE WITH YOUR ORDER.** Current issue of SATELLITE ORBIT magazine! PLUS money-saving subscription offer of 15 issues for the price of 12. Each issue packed with over 200 pages of monthly listings for thousands of satellite TV programs to select from.

### ABOUT THE MANUFACTURER

KLM introduced the FIRST satellite TV receiver system for consumers! They designed the FIRST programmable receiver. KLM is one of the largest in the industry and is a leader in advanced technology. Because they are concentrating efforts on new designs, KLM has allowed us to offer a quantity of these current 8-ft. models to the public at an unusually low price! It's a tremendous value!

### INCLUDES ALL THIS, TOO!



#### SKY EYE X BLOCK RECEIVER!

Uncomplicated, easy operation! Fast fingertip selection of channel, polarity, audio tune. Relative signal strength meter lets you hit station right on the button. Separate AFC on/off selector allows precision tuning, even of weak channels.

**INCLUDES breakdown converter** (an expensive option on competitor's models). This splits signals so 2 TV sets in your home can "tune in" on 2 different channels of same satellite at same time. However, you need another receiver (available from regular KLM dealers) for the second TV set.

#### HORIZON TO HORIZON MOUNT

This special mount delivers 180° range for maximum degree of "dish" rotation for access to TV satellites in western hemisphere. 120 feet of cable also included.



#### Fully Programmable AIMER IV REMOTE "DISH" POSITIONER

Microprocessor controlled for pushbutton access to 64 pre-programmed satellite locations. Six pre-sets for favorite satellites. Automatically positions "dish" and channel skew (polarity). Battery backup for three-month memory retention in case of power failure of for unplugging system during vacations. **Parental Lockout prevents** children from viewing restricted channels.

#### HOW TO SELECT A PROPER SITE

Stand in your yard, look due South and side to side. You should have an unobstructed view of the sky. Tree branches and power lines diminish quality of reception.

Credit card customers can order by phone, 24 hours a day, 7 days a week.



**Toll-Free: 1-800-328-0609**

**TeleCheck** Your check is welcome! No delays in orders paid by check.

Sales outside continental U.S. are subject to special conditions. Please call or write to inquire.

C.O.M.B. Direct Marketing Corp. Item H-1159  
14605 28th Ave. N./Minneapolis, MN 55441-3397

Send      KLM 8-ft. Receiver System(s) Item H-1159-5958-004 at \$999 each. I will pay shipping charge to driver upon delivery. (Minnesota residents add 6% sales tax. Allow 3-4 weeks for delivery. Sorry, no C.O.D. orders.)

My check or money order is enclosed. (No delays in processing orders paid by check, thanks to TeleCheck.)

Charge to my:  MasterCard  VISA®

Acct. No. \_\_\_\_\_ Exp. \_\_\_\_\_

PLEASE PRINT CLEARLY

Name \_\_\_\_\_

Address \_\_\_\_\_

City \_\_\_\_\_

State \_\_\_\_\_ ZIP \_\_\_\_\_

Phone \_\_\_\_\_

Sign Here \_\_\_\_\_

**C.O.M.B.  
DIRECT MARKETING CORP.**

**Authorized Liquidator**

14605 28th AVENUE NORTH  
MINNEAPOLIS, MN 55441-3397

# R-E Engineering Admart

Rates: Ads are 2 1/4" x 2 7/8". One insertion \$825. Six insertions \$800 each. Twelve insertions \$775 each. Closing date same as regular rate card. Send order with remittance to Engineering Admart, Radio Electronics Magazine, 500-B Bi-County Blvd., Farmingdale, NY 11735. Direct telephone inquiries to Arline Fishman, area code-516-293-3000. Only 100% Engineering ads are accepted for this Admart.

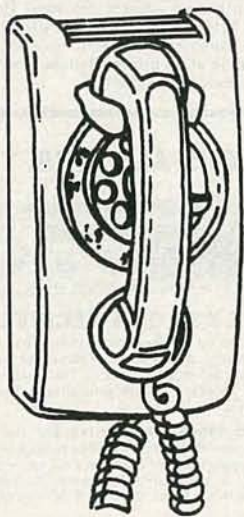

## TOROIDAL POWER TRANSFORMERS

Small size • Low noise • Easy mounting

Made in U.S.A. UL-Recognized

50 standard transformers with 117V-60Hz primaries in stock for 25VA, 45VA, 70VA, 120 VA, 180VA, 360VA, 600VA, 1000VA. Custom sizes: 15VA-3,000VA. Call or write for data sheets



Size	Secondary	Price each*		
		1	2-4	5-24
45VA	2x8.5V/2.59A	\$26.10	\$22.00	\$19.60
OD - 2.8"	2x12V/1.77A	26.10	22.00	19.60
H - 1.3"	2x15V/1.40A	26.10	22.00	19.60
Wt - 1.1 lb	2x18V/1.24A	26.10	22.00	19.60
	2x24V/0.88A	26.10	22.00	19.60
120VA	2x8.5V/7.06A	\$32.20	\$27.50	\$24.45
OD - 3.9"	2x12V/5.00A	32.20	27.50	24.45
H - 1.5"	2x15V/4.00A	32.20	27.50	24.45
Wt - 2.2 lb	2x18V/3.33A	32.20	27.50	24.45
	2x24V/2.50A	32.20	27.50	24.45
	220V/0.55A	32.20	27.50	24.45
600VA	2x24V/12.50A	\$65.90	\$56.00	\$50.00
OD - 5.5"	2x30V/10.00A	65.90	56.00	50.00
H - 2.4"	2x33V/8.64A	65.90	56.00	50.00
Wt - 8.2 lb	2x38V/7.76A	65.90	56.00	50.00
	2x50V/6.00A	65.90	56.00	50.00
	220V/2.59A	65.90	56.00	50.00

Dual secondaries may be used in parallel or in series.  
\*FOB Factory. (Includes mounting washer and rubber pads).  
Terms: VISA, MasterCard, COD or money orders—UPS charges added.

301-464-2100 TOROID CORPORATION OF MARYLAND  
6000 Laurel-Bowie Rd., Bowie, MD 20715-4037

CIRCLE 282 ON FREE INFORMATION CARD

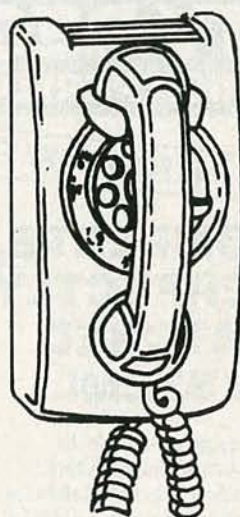

## CALL NOW AND RESERVE YOUR SPACE

- 6 x rate \$800.00 per each insertion.
- Reaches 229,044 readers.
- Fast reader service cycle.
- Short lead time for the placement of ads.

Call 516-293-3000 to reserve space. Ask for Arline Fishman. Limited number of pages available. Mail materials to: Engineering Admart, RADIO-ELECTRONICS, 500-B Bi-County Blvd., Farmingdale, NY 11735.

## LINEAR IC EQUIVALENTS & PIN CONNECTIONS

Linear IC  
Equivalents  
and Pin  
Connections

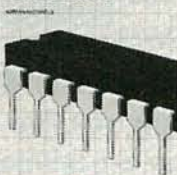

Shows equivalents & pin connections of a popular user-oriented selection of European, American and Japanese linear IC's. 320 pages, 8 x 10 inches. \$13.50 postpaid in USA. ELECTRONIC TECHNOLOGY TODAY INC., PO Box 240, Massapequa Park, New York 11762-0240.

## CALL NOW AND RESERVE YOUR SPACE

- 6 x rate \$800.00 per each insertion.
- Reaches 229,044 readers.
- Fast reader service cycle.
- Short lead time for the placement of ads.

Call 516-293-3000 to reserve space. Ask for Arline Fishman. Limited number of pages available. Mail materials to: Engineering Admart, RADIO-ELECTRONICS, 500-B Bi-County Blvd., Farmingdale, NY 11735.

plete and covers the major features of the scanner completely. It also touches on the major specifications. Overall, it's well done.

As to the price, at a suggested list price of \$699.95, the scanner is not cheap. Even with discounting, it's cost will likely limit the MX-7000's appeal to only the most serious of scanner enthusiasts. But for those serious scanner enthusiasts, the MX-7000 is worth a listen. With its extended frequency coverage and its ability to tailor each receive channel to the particular requirements of the radio service being monitored, it's a powerful unit.

R-E

**“Fighting heart disease and stroke is a life or death matter.”**

Your gift can make a difference.



**American Heart Association**

WE'RE FIGHTING FOR YOUR LIFE

# 2 SIMPLE SOLUTIONS TO 227,000 PROBLEMS.

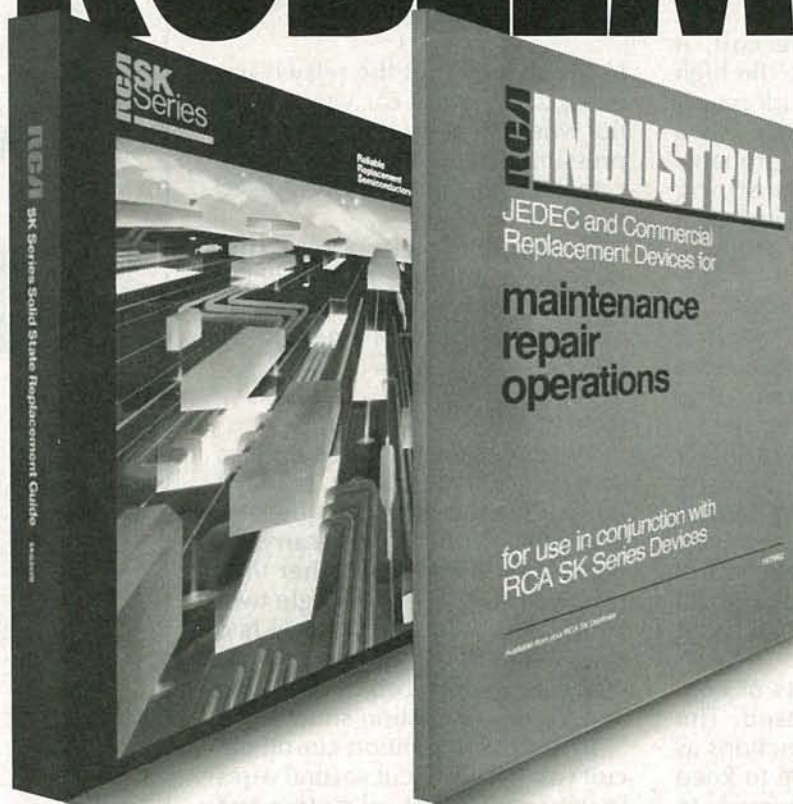

RCA's SK Series Replacement Guide (SKG202D) is your one source for over 206,000 solid state replacements using 2,500 SK and KH types. Integrated circuits, thyristors, rectifiers, transistors, microprocessors — RCA has them all.

Likewise, RCA's Industrial MRO Guide (1K7862) lists over 4,000 devices that replace more than 21,000 JEDEC\* and Commercial types. The Guide also includes Power MOS/FETs, QMOS Integrated Circuits, a combined index/cross reference, and a section on high-reliability devices.

Together, these RCA Guides provide fast, easy answers for 227,000 solid state replacement problems.

For copies, see your local RCA distributor. Or write: Sales Promotion Services, RCA Distributor and Special Products Division, 2000 Clements Bridge Rd., Deptford, NJ 08096-2088.

\*Joint Electron Device Engineering Council

**RCA** SK Replacement  
Solid State

# NEW IDEAS

## Simple circuit foils car thieves

IF YOU LIVE IN A HIGH-CRIME AREA AND operate an automobile, you're probably afraid that someday your car will be stolen. Well, so was I—until I built and installed the ignition cutoff circuit described here. Since then I sleep much easier. And the circuit has another benefit: Many insurance companies will reduce your rates if you install a cutoff circuit like mine.

What my circuit does is give you manual control over the voltage that goes to your car's coil. If 12 volts doesn't reach the coil, it won't be able to provide the high voltage that fires the spark plugs. The starter will still work, so a would-be car thief will probably think that there's something wrong with your car—and he'll leave it alone.

### How it works

As shown in Fig. 1, the heart of the circuit is a 4PDT relay and a hidden pushbutton switch. That switch, the relay's coil, and the ignition switch are all wired in series, so both switches must be closed simultaneously to energize the relay. And since the coil current flows through the relay's contacts, the relay must be energized or current won't get through to the coil.

The relay has four sets of contacts and all four are used. The lowest set of contacts functions as a latch so you don't have to keep your finger on S2 continuously to keep coil current flowing. Those contacts simply keep S2's terminals shorted after the relay has been energized; that short ensures that the relay will remain energized until the ignition switch is opened.

Working upward, the next set of contacts is used to provide visual indication of what's happening. After closing the ignition switch

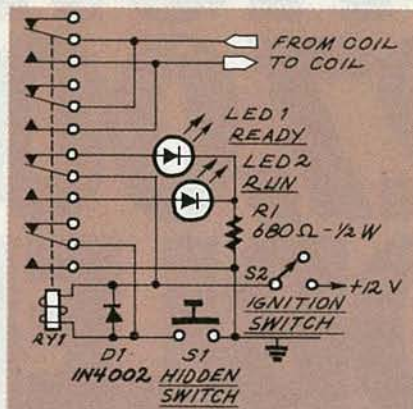

FIG. 1

LED1 turns on, but the relay is unenergized, so the car won't start. But when the relay is energized by pressing S2, LED2 lights up to indicate that you should be able to start the car now.

The upper two sets of relay contacts are simply wired in parallel to provide plenty of current-carrying ability for the coil-energizing pulses.

### Construction

The circuit can be wired up on a scrap piece of perfboard. None of the parts are critical; just be sure that the relay you use can carry the required coil current. Rather than use two LED's, I used a single two-color device. That way I only had to drill one hole. Be sure to wire a diode across the coil of the relay, and in the orientation shown.

To install the ignition cut-off circuit you'll have to cut several wires in your car's electrical system and splice in leads to your circuit board. You'll have to cut the 12-volt ignition-switch wire and the 12-volt coil-supply wire. When you connect your patches to the circuit board, make sure to use wire that is *at least* as large as the wires you just cut. And make sure to make good connections—electrically and mechanically—to the coil wires.—Ronald L. Goers.

### NEW IDEAS

This column is devoted to new ideas, circuits, device applications, construction techniques, helpful hints, etc.

All published entries, upon publication, will earn \$25. In addition, for U.S. residents only, Panavise will donate their model 333—The Rapid Assembly Circuit Board Holder, having a retail price of \$39.95. It features an eight-position rotating adjustment, indexing at 45-degree increments, and six positive lock positions in the vertical plane, giving you a full ten-inch height adjustment for comfortable working.

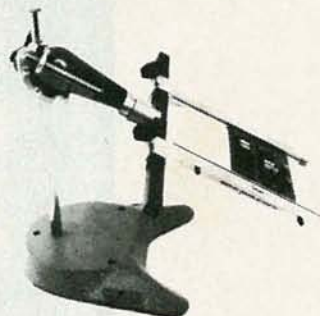

I agree to the above terms, and grant **Radio-Electronics** Magazine the right to publish my idea and to subsequently republish my idea in collections or compilations of reprints of similar articles. I declare that the attached idea is my own original material and that its publication does not violate any other copyright. I also declare that this material has not been previously published.

Title of Idea \_\_\_\_\_

Signature \_\_\_\_\_

Print Name \_\_\_\_\_

Date \_\_\_\_\_

Street \_\_\_\_\_

City \_\_\_\_\_

State \_\_\_\_\_

Zip \_\_\_\_\_

Mail your idea along with this coupon to: **New Ideas Radio-Electronics**,  
500-B Bi-County Blvd.,  
Farmingdale, NY 11735



# Super Disk<sup>TM</sup> Diskettes

**Now...Diskettes you can swear by, not swear at.**

Lucky for you, the diskette buyer, there are many diskette brands to choose from. Some brands are good, some not as good, and some you wouldn't think of trusting with even one byte of your valuable data. Sadly, some manufacturers have put their profit motive ahead of creating quality products. This has resulted in an abundance of low quality but rather expensive diskettes in the marketplace.

## A NEW COMPANY WAS NEEDED AND STARTED

Fortunately, other people in the diskette industry recognized that making ultra-high quality diskettes required the *best* and newest manufacturing equipment as well as the best people to operate this equipment. Since most manufacturers seemed satisfied to give you only the everyday quality now available, an assemblage of quality conscious individuals decided to start a new company to give you a new and better diskette. They called this product the *Super Disk* diskette, and you're going to love them. Now you have a product you can swear by, not swear at.

## HOW THEY MADE THE BEST DISKETTES EVEN BETTER

The management of *Super Disk* diskettes then hired all the top brains in the diskette industry to make the *Super Disk* product. Then these top bananas (sometimes called floppy freaks) created a new standard of diskette quality and reliability. To learn the "manufacturing secrets" of the top diskette makers, they've also hired the remaining "magnetic media moguls" from competitors around the world. Then all these world class, top-dollar engineers, physicists, research scientists and production experts (if they've missed you, send in your resume to *Super Disk*) were given one directive...to pool all their manufacturing know-how and create a new, better diskette.

## HOW SUPER DISK DISKETTES ARE MANUFACTURED

The *Super Disk* crew then assembled the newest, totally quality monitored, automated production line in the industry. Since the manufacturing equipment at *Super Disk* is new, it's easy for *Super Disk* to consistently make better diskettes. You can always be assured of ultra-tight tolerances and superb dependability when you use *Super Disk* diskettes. If all this manufacturing mumbo-jumbo doesn't impress you, we're sure that at least one of these other benefits from using *Super Disk* diskettes will:

- TOTAL SURFACE TESTING** - For maximum reliability, and to lessen the likelihood of disk errors, all diskettes must be totally surface tested. At *Super Disk*, each diskette is 100% surface tested. *Super Disk* is so picky in their testing, they even test the tracks that are in between the regular tracks.
- COMPLETE LINE OF PRODUCTS** - For a diskette to be useful to you and your computer, it must be compatible physically. *Super Disk* has an entire line of 5 1/4-inch and 3 1/2-inch diskettes for your computer.
- SPECIALLY LUBRICATED DISK** - *Super Disk* uses a special oxide lubricant which is added to the base media in the production of their diskettes. This gives you a better disk drive head to media contact and longer head and disk life.
- HIGH TEMPERATURE/LOW-MARRING JACKET** - A unique high temperature and low-marring vinyl jacket allows use of their product where other diskettes won't work. This special jacket is more rigid than other diskettes and helps eliminate dust on the jacket.
- REINFORCED HUB RINGS** - Standard on all 48 TPI *Super Disk* mini-disks, to strengthen the center hub hole. This increases the life of the disk to save you money and increase overall diskette reliability.
- DISK DURABILITY** - *Super Disk* diskettes will beat all industry standards for reliability since they will give you more than 75% of the original signal amplitude remaining even after an average (Weibull B-50) of 30 million passes. They are compatible with all industry specifications as established by ANSI, ECMA, ISO, IBM and JIS.
- CUSTOMER ORIENTED PACKAGING** - All *Super Disk* disks are packaged 10 disks to a carton and 10 cartons to a case. The economy bulk pack is packaged 100 disks to a case without envelopes or labels.
- LIFETIME WARRANTY** - If all else fails, remember, all disks made by *Super Disk* Inc., have a lifetime warranty. If any *Super Disk* diskette fails to meet factory specifications, *Super Disk* Inc. will replace them under the terms of the *Super Disk* warranty.
- SUPERB VALUE** - With *Super Disk*'s automated production line, high-quality, error-free disks are yours without the high cost.

**Order toll free 800-USA-DISK**

## NOW...NAME BRAND QUALITY AT SUPER CE PRICES

Now, you can buy *Super Disk* brand diskettes directly from Communications Electronics at prices less than "unbranded" generic diskettes. Your data is valuable, so why take chances using a diskette that could be so unreliable that the manufacturer refuses to put their name on it. To save you even more, we also offer *Super Disk* bulk product where 100 diskettes are packed in the same box without envelopes or labels. Since we save packaging costs, these savings are passed on to you. 5 1/4" diskette envelopes are also available from us. These super strong and tear resistant envelopes are only \$10.00 per pack of 100. Use order # CV-5 for a 100 pack of 5 1/4" diskette envelopes.

# 39¢ per disk Quantity One

Our diskettes are packed 10 disks to a carton and 10 cartons to a case. The economy bulk pack is packaged 100 disks to a case without envelopes or labels. For best value, you should order in increments of 100 diskettes. Almost all diskettes are immediately available from *Super Disk*. With our efficient warehouse facilities, your order is normally shipped in less than a day.

SAVE ON SUPER DISK <sup>TM</sup> DISKETTES Product Description	Part #	Super Disk price per disc (\$)
5 1/4" SSSD Soft Sector w/Hub Ring	6431-FA	0.64
5 1/4" Same as above, but bulk pack w/o envelope	6437-FA	0.39
5 1/4" SSDD Soft Sector w/Hub Ring	6481-FA	0.68
5 1/4" Same as above, but bulk pack w/o envelope	6487-FA	0.43
5 1/4" DSDD Soft Sector w/Hub Ring	6491-FA	0.74
5 1/4" Same as above, but bulk pack w/o envelope	6497-FA	0.49
5 1/4" DSQD Soft Sector (96 TPI)	6501-FA	1.09
5 1/4" Same as above, but bulk pack w/o envelope	6507-FA	0.84
5 1/4" DSHD for IBM PC/AT - bulk pack	6667-FA	2.07
3 1/2" SSDD (135 TPI) - bulk pack	6317-FA	1.67
3 1/2" DSDD (135 TPI) - bulk pack	6327-FA	1.99

SSSD = Single Sided Single Density; SSDD = Single Sided Double Density; DSDD = Double Sided Double Density; DSQD = Double Sided Quad Density; DSHD = Double Sided High Density; TPI = Tracks per inch.

## BUY YOUR DISKETTES FROM CE WITH CONFIDENCE

To get the fastest delivery of your diskettes, phone your order directly to our order desk and charge it to your credit card. Written purchase orders are accepted from approved government agencies and most well rated firms at a 10% surcharge for net 10 billing. For maximum savings, your order should be prepaid. All sales are subject to availability, acceptance and verification. All sales are final. All prices are in U.S. dollars. Prices, terms and specifications are subject to change without notice. Out of stock items may be placed on backorder or substituted for equivalent product unless we are instructed differently. A \$5.00 additional handling fee will be charged for all orders with a merchandise total under \$50.00. All shipments are F.O.B. CE warehouse in Ann Arbor, Michigan. No COD's. Non-certified checks require bank clearance. Michigan residents add 4% sales tax or supply your tax ID number and reason for tax exemption.

For shipping charges add \$6.00 per 100 diskettes and/or any fraction of 100 5 1/4-inch or 3 1/2-inch diskettes for U.P.S. ground shipping and handling in the continental U.S. For 1,000 or more disks shipped to the continental U.S., shipping charges are \$4.00 per hundred diskettes. UPS 2nd day air rates are three times continental U.S. rates. For Canada, Puerto Rico, Hawaii, Alaska, or APO/FPO delivery, shipping is three times the continental U.S. rate.

**Mail orders to:** Communications Electronics Inc., Box 1045, Ann Arbor, Michigan 48106-1045 U.S.A. If you have a Visa or Master Card, you may call and place a credit card order. Order toll-free in the U.S. Dial 800-USA-DISK. In Canada, order toll-free by calling 800-CA1-DISK. If you are outside the U.S. or in Michigan dial 313-973-8888. Telex anytime 810-223-2422. Order your *Super Disk* diskettes now.

Copyright © 1986 Communications Electronics Inc.

Ad #040186-FA



**Now  
39¢  
a disk**

MAY 1986

33

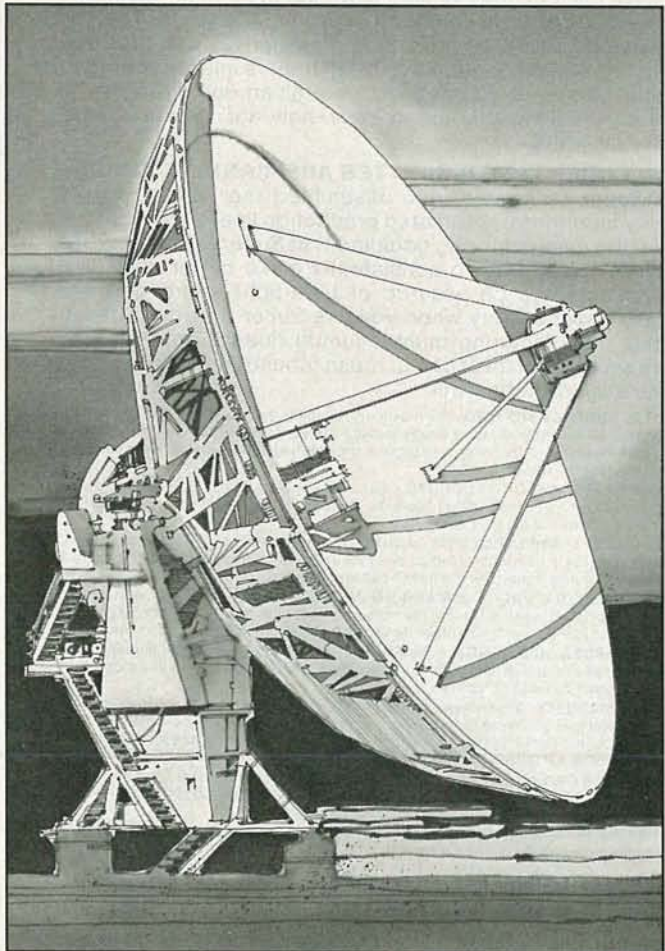
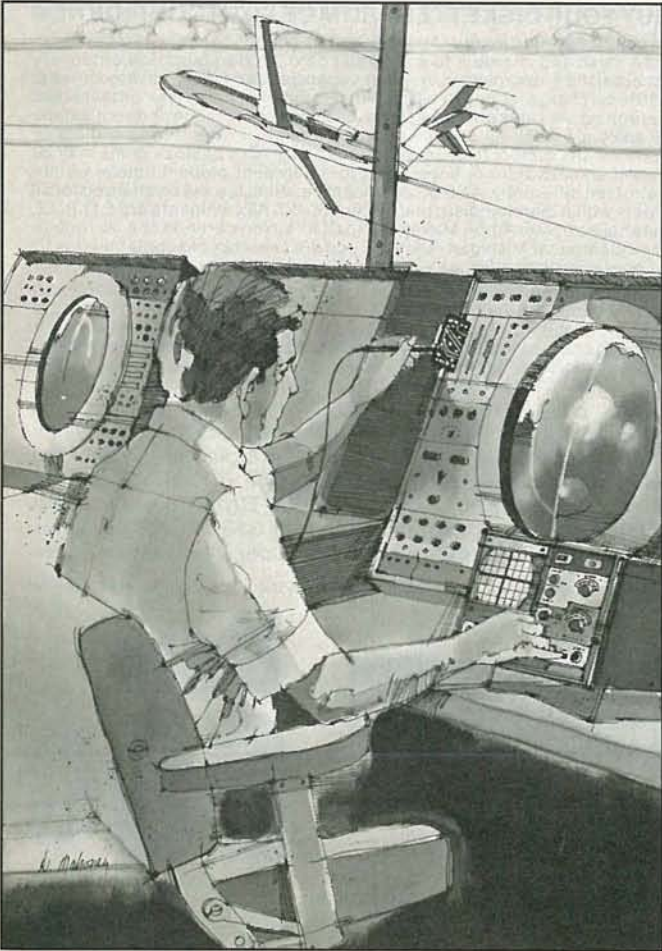
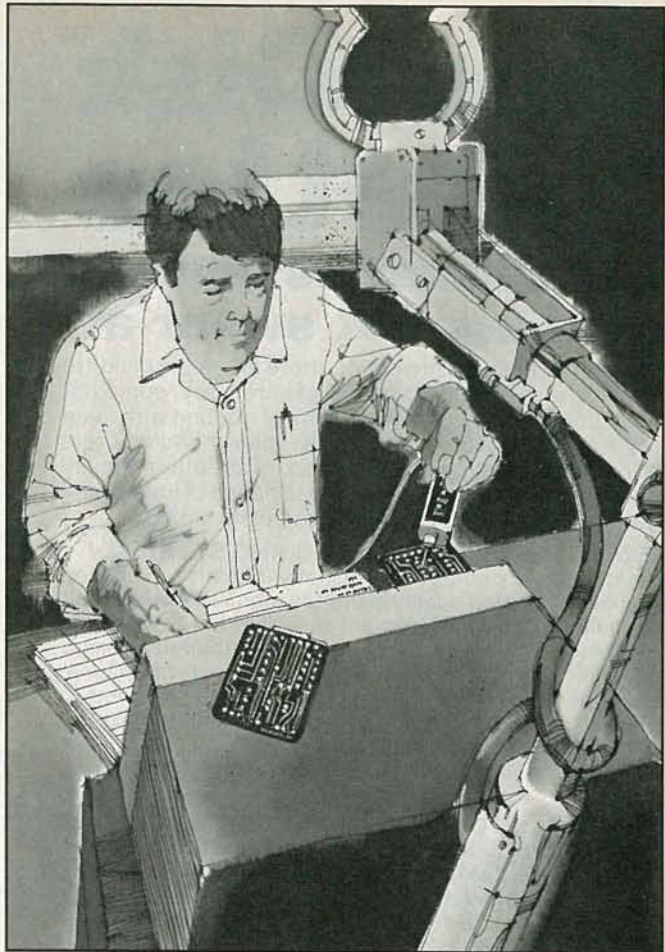

# CIE MAKES THE WORLD OF ELECTRONICS YOURS.

**T**oday's world is the world of electronics. To be part of it, you need the right kind of training, the kind you get from Cleveland Institute of Electronics, the kind that can take you to a fast growing career in business, aerospace, medicine, science, government, communications, and more.

## **Specialized training.**

You learn best from a specialist, and that's CIE. We're the leader in teaching electronics through independent study, we teach only electronics and we've been doing it for over 50 years. You can put that experience to work for you just like more than 25,000 CIE students are currently doing all around the world.

## **Practical training.**

You learn best with practical training, so CIE's Auto-Programmed® lessons are designed to take you step-by-step, principle-by-principle. You also get valuable hands-on experience at every stage with sophisticated electronics tools CIE-designed for teaching. Our 4K RAM Microprocessor Training Laboratory, for example, trains you to work with a broad range of computers in a way that working with a single, stock computer simply can't.

## **Personalized training.**

You learn best with flexible training, so we let you choose from a broad range of courses. You start

with what you know, a little or a lot, and you go wherever you want, as far as you want. With CIE, you can even earn your Associate in Applied Science Degree in Electronics Engineering Technology. Of course, you set your own pace, and, if you ever have questions or problems, our instructors are only a toll-free phone call away.

## **The first step is yours.**

To find out more, mail in the coupon below. Or, if you prefer, call toll-free **1-800-321-2155 (in Ohio, 1-800-523-9109)**. We'll send a copy of CIE's school catalog and a complete package of enrollment information. For your convenience, we'll try to have a representative contact you to answer your questions.

## **CIE** Cleveland Institute of Electronics 1776 East 17th St., Cleveland, Ohio 44114

YES! I want to get started. Send me my CIE school catalog including details about the Associate Degree Program. I am most interested in:

- |  |   |
|--|---|
| <input type="checkbox"/> computer repair     | <input type="checkbox"/> television/high fidelity service |
| <input type="checkbox"/> telecommunications  | <input type="checkbox"/> medical electronics              |
| <input type="checkbox"/> robotics/automation | <input type="checkbox"/> broadcast engineering            |
| <input type="checkbox"/> other _____         |   |

Print Name \_\_\_\_\_

Address \_\_\_\_\_ Apt. \_\_\_\_\_

City \_\_\_\_\_ State \_\_\_\_\_ Zip \_\_\_\_\_

Age \_\_\_\_\_ Area Code/Phone No. \_\_\_\_\_

Check box for G.I. Bulletin on Educational Benefits

- Veteran       Active Duty

**MAIL TODAY!**

**OR CALL TOLL FREE**  
**1-800-321-2155**  
**(In Ohio, 1-800-523-9109)**

RE-36

# NEW PRODUCTS



CIRCLE 21 ON FREE INFORMATION CARD

**SOFTWARE PACKAGES** link the Tektronix model 7854 Digital Storage Oscilloscope and the model 7D20 Programmable Digitizer (shown) to IBM and Hewlett Packard computers. The software packages are designated the 7854/HP Series 200, the 7D20/HP Series 200, and the 7D20/IBM PC time and amplitude measurement software.

With the 7854/HP Series 200 software, laboratories can build programs and issue commands to the 7854 from the computer. Programs can be stored in the computer memory or on disk. Like the other HP program, up to six waveforms can be shown simultaneously in different colors on the HP 9836C. The program is priced at \$950.00.

With the 7D20/HP Series 200 software, laboratories can use the computer to store front-panel setups on the 7D20. When needed, the setups can be recalled for automatic waveform acquisition or other test and measurement functions. The software for the HP computers is written in HP BASIC

3.0. The programs are written in modules, enabling users to break out subroutines, such as the functions necessary for propagation-delay measurements, and append them to their own programs. The package is priced at \$950.00.

The TekMap 7D20/HP IBM PC time and amplitude measurement software operates with autoranging routines that automatically set up the 7D20 for positive or negative edge triggering, or for several repetitions of a signal for period measurements. Hence users can avoid spending time finding optimal settings. Calculating functions for waveform analysis include adding, subtracting, multiplying, dividing, offsetting, integrating, differentiating, or smoothing test and measurement data.

The menu-driven software runs on MS-DOS 2.1 or higher. It is written in C and executes all functions quickly. It is priced at \$450.00.—**Tektronix, Inc.**, P.O. Box 500, Beaverton, OR 97077.

**ANTENNA SWITCH**, the model MFJ-1701, has six positions that enable the user to switch antennas with the turn of a knob. It has SO-239 connectors and there is negligible insertion loss, as well as low VSWR and low crosstalk between adjacent outlets. All unused terminals are automatically grounded for static/lightning/RF protection.



CIRCLE 22 ON FREE INFORMATION CARD

The model MFJ-1701 can be used with 52- to 75-ohm systems, and it can be mounted with equal ease on a desk or on a wall. In addition, it handles 2000 watts SSB, 1000 CW. It is priced at \$29.95, plus \$5.00 shipping and handling.—**MFJ Enterprises, Inc.**, P.O. Box 494, Mississippi State, MS 39762.

**DIGITAL MULTIMETER**, model 4800, can measure DC and AC voltage and current, resistance, frequency (channel A, 10 Hz to 100



CIRCLE 23 ON FREE INFORMATION CARD

MHz; channel B, 10 Hz to 1000 KHz), period, dBm, diode test, continuity test and temperature (with K-type thermocouple). Also

# ELENCO PRODUCTS AT DISCOUNT PRICES!

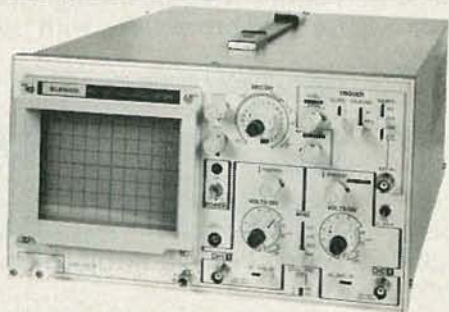

**20 MHz DUAL TRACE OSCILLOSCOPE**  
**\$329** MO-1251



**35 MHz DUAL TRACE OSCILLOSCOPE**  
**\$545** MO-1252

Top quality scopes at a very reasonable price. Contains all the desirable features. Elenco's 2 year guarantee assures you of continuous service. Two 1x, 10x probes, diagrams and manual included. Write for specifications.



**MULTI METER with CAPACITANCE and transistor tester**

**\$65** Model CM-1500

Reads Volts, Ohms, Current, Capacitors Transistors & Diodes



**TRUE RMS 4 1/2 DIGIT MULTIMETER**

**\$135** Model M-7000

.05% DC Accuracy  
 .1 % Resistance with Freq. Counter & Deluxe Case



**3 1/2 DIGIT MULTIMETER**

**\$25** Model M-1600

1% DC Accuracy  
 1% Resistance  
 Reads 10A DC



**GF-8016 Function Generator with Freq. Counter**

**\$219**

- Sine, Square, Triangle, Pulse, Ramp, .2 to 2 MHz
- Frequency .1 thru 10 MHz

GF 8015 without Freq. Meter \$169



**Triple Power Supply XP-660**

**\$14950**

0-20V @ 1A  
 0-20V @ 1A  
 5V @ 5A

Fully Regulated, Short Circuit Protected with 2 Limit Cont. 3 Separate Supplies.

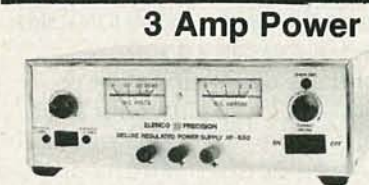

**3 Amp Power Supply XP-650**

**\$11950**

0-40V @ 1.5A  
 0-20V @ 3A

Fully regulated, short circuit protected current limit control

**NEW**

**POWER BLOX**

The Power Supply For Breadboarding



**\$1495**

**\$995**

Now a Power Supply for your Bread Blocks. Snaps into existing units. Fully regulated and short circuit protected.

12V @ .3A, 5V @ 1A, -5V @ .5A

\$22.95 for Both, Power Blox & Breadboard



**DIGITAL LCR METER**

Model LC-1800  
 Measures: Inductors  
 Capacitors, Resistors

**\$148**

Inductors .1μH to 200 H  
 Capacitor .1Pf to 200μf  
 Resistor .01Ω to 20M Ω  
 Ranges 6 Ind, 7 cap, 7 res

C&S SALES, 8744 W. North Ter. Niles, IL 60648  
 800-292-7711 (312) 459-9040



**15 DAY MONEY BACK GUARANTEE** ASK FOR CATALOG

2 Year Limited Guarantee! Add 5% for Postage (\$10 max.), IL Res., 7% Tax

CIRCLE 266 ON FREE INFORMATION CARD

included are comparative, data hold, peak hold, relative, and auto-ranging functions. The 5-digit LCD display indicates pushbutton-selected functions and low line voltage and overrange conditions.

The model 4800 provides multiple-fuse overload protection and recessed lead jacks. Accessories include: power cable, spare fuses, signal cable, alligator test leads, and a comprehensive instruction manual. Optional accessories include various K-type thermocou-

ples, bench "hold" probe, and 10-amp measurement probe.

The model 4800 is priced at \$600.00.—**Triplett Corporation**, One Triplett Drive, Bluffton, OH 45817.

**REMOTE-PROGRAMMABLE VCR**, the model VR4100, is designed to deliver sharper pictures, more natural colors, and less video noise. Its features include a 14-day, eight-event timer that can be programmed, using an onscreen display, with the VCR's infrared

wireless Computer Space Command remote-control transmitter; built-in MTS decoding circuitry (for TV broadcasts with stereo-

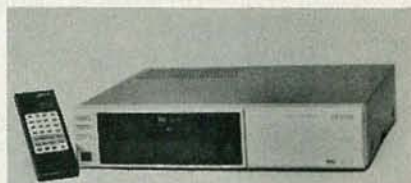

CIRCLE 24 ON FREE INFORMATION CARD

sound or second-language programming) that makes it possible to upgrade any non-stereo TV set to stereo-TV sound, and a 178-channel quartz tuning system.

Recordings made on the model VR4100 can be played back on any VHS deck, and tapes made on other VHS machines can benefit from the model VR100's refinements. Its suggested retail price is \$1099.95.—**Zenith Electronics Corporation**, 1000 Milwaukee Avenue, Glenview, IL 60025.

**ANTI-STATIC BINDERS** are standard 3-ring notebook binders in static dissipative and conductive polyethylene material. They are designed for use anywhere that static may cause problems. Available in blue, black, or yellow matte (non-glare) finishes, the binders are embossed with the words "ESD PROTECTION," and carry the military static/RFI insignia on the front cover.



CIRCLE 25 ON FREE INFORMATION CARD

Standard dimensions are 9" x 11½" in 1" or 3" capacity, with a variety of custom sizes and optional multi-ring configurations available. Customer-specified front-cover embossing is available for an additional charge in minimum-quantity orders of 500. Otherwise, in 500-piece quantities, binders are priced at \$4.28 each.—**Controlled Static**, 9820 Jersey Avenue, Santa Fe Springs, CA 90670. **R-E**

## How to service and repair your television, VCR, and home computer.

### Sams PHOTOFACT and COMPUTERFACTS

For 40 years Sams PHOTOFACT has been the preferred source for television service data. Today, Sams is the preferred source for VCR, computer, and computer peripheral service data. Why? Because Sams service data is accurate, reliable, provided in a consistent format, and available at a very reasonable price. With more than 150,000 different models, you can depend on Sams to have the service data you need.

Sams works from actual production models, disassembling each unit and testing each board. Every component location, every circuit track, and every waveform is checked and rechecked. Sams exclusive time-saving features let you do repairs quickly, without guessing:

- **CAD-Generated Schematics** — our computer-aided design system gives you clear, readable data in Sams Standard Notation format.
- **GridTrace™** — a "roadmap" grid in our circuit board photos for easy parts location and identification.
- **CircuiTrace®** — helps to pinpoint circuit location saving tracking time.
- **Troubleshooting Tips** — solve problems without trial and error.
- **Easy-Read Waveforms** — clear reproductions of actual waveform photos show you exactly what your test waveform should look like.
- **Replacement Parts Cross References** — save costly and time-consuming trial and error.

At \$9.95 for PHOTOFACT and \$19.95 or \$39.95 for COMPUTERFACTS you get all the data you need to service your equipment.

To order call  
**800-428-SAMS**  
Ask for operator 807

In Indiana call 317-287-5566

# SAMS

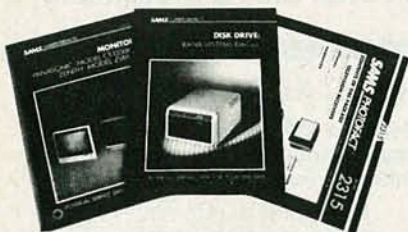

Here's just a few of the brands covered:

#### PHOTOFACT

Curtis-Mathes  
Magnavox  
Panasonic  
RCA  
Sears  
Sony  
Zenith

#### COMPUTERFACTS

Amdek  
Apple  
Commodore  
Epson  
IBM  
Okidata  
Radio Shack

To order the service data you need call 800-428-SAMS or visit your local electronic distributor or computer store.

For a complete listing of Sams PHOTOFACT and COMPUTERFACTS coverage send \$3.00 (Product #22505) and you'll receive a FREE book catalog listing Sams electronic and computer books.

Name \_\_\_\_\_  
Company \_\_\_\_\_  
Address \_\_\_\_\_  
City \_\_\_\_\_  
State \_\_\_\_\_ Zip \_\_\_\_\_  
Daytime Telephone No. \_\_\_\_\_  
 Bill my credit card  VISA  MC  AE  
Account No. \_\_\_\_\_ Exp. Date \_\_\_\_\_  
Signature (required) \_\_\_\_\_  
 Check or money order enclosed. Make checks payable to Howard W. Sams & Co. Mail this form with payment to: Howard W. Sams & Co., Inc. Dept. DM • 4300 West 62nd Street • Indianapolis, IN 46268  
DM807

Prices subject to change without notice.

# Where's Your **ELECTRONICS** Career Headed?

## your move!

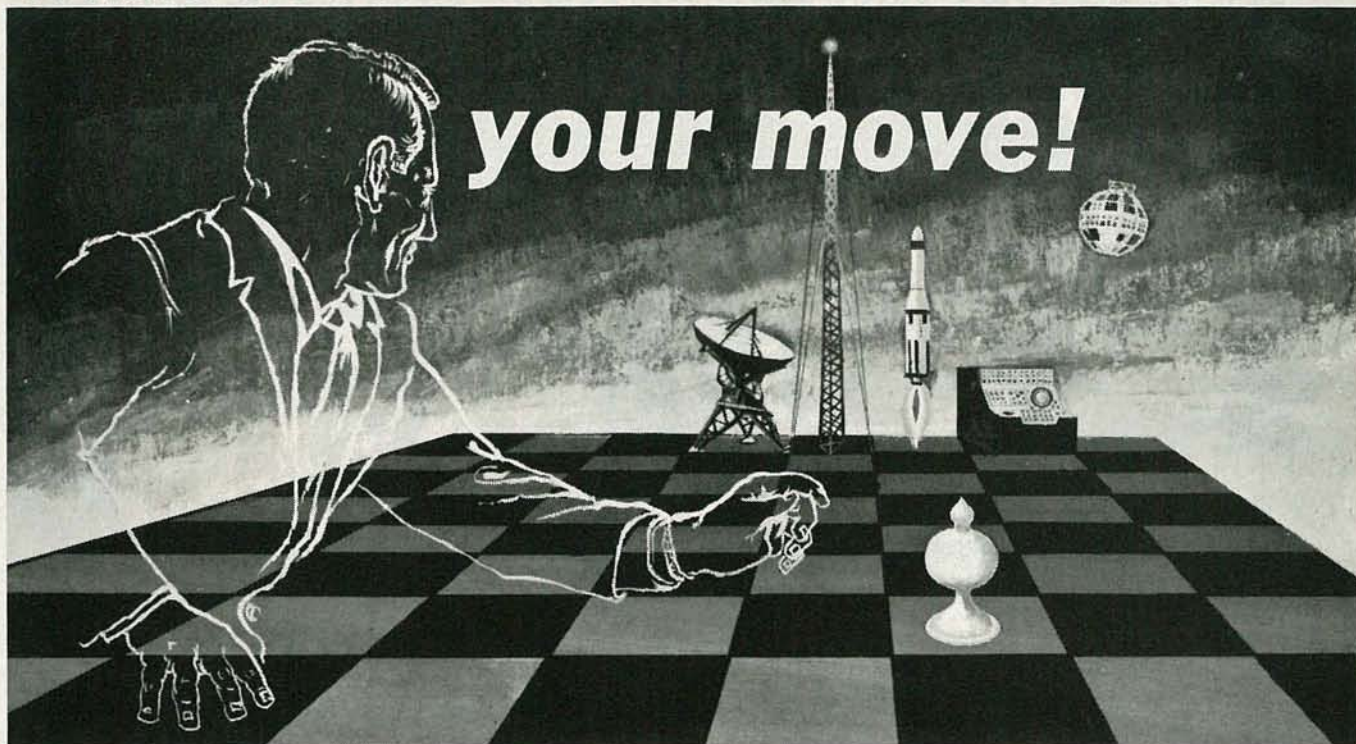

### The Move You Make Today Can Shape Your Future

Yes it's your move. Whether on a chess board or in your career, you should plan each move carefully. In **electronics**, you can *move ahead* faster and further with a

## B. S. DEGREE

Put professional knowledge and a COLLEGE DEGREE in your electronics career. Earn your degree through independent study at home, with Grantham College of Engineering. No commuting to class. Study at your own pace, while continuing your present job.

The accredited Grantham non-traditional degree program is intended for mature, fully employed workers who want to upgrade their careers . . . and who can successfully study electronics and supporting subjects through

### INDEPENDENT STUDY, AT HOME

Free Details Available from:

**Grantham College of Engineering**  
10570 Humbolt Street  
Los Alamitos, California 90720

### Independent Home Study Can Prepare You

Study materials, carefully written by the Grantham staff for independent study at home, are supplied by the College, and your technical questions related to those materials and the lesson tests are promptly answered by the Grantham teaching staff.

### Recognition and Quality Assurance

Grantham College of Engineering is accredited by the Accrediting Commission of the National Home Study Council.

All lessons and other study materials, as well as communications between the college and students, are in the English language. However, we have students in many foreign countries; about 80% of our students live in the United States of America.

**Grantham College of Engineering** R-05-86  
10570 Humbolt Street, Los Alamitos, CA 90720

Please mail me your free catalog which explains your B.S. Degree independent-study program.

Name \_\_\_\_\_ Age \_\_\_\_\_

Address \_\_\_\_\_

City \_\_\_\_\_ State \_\_\_\_\_ Zip \_\_\_\_\_

**JOSEPH ELECTRONICS BRINGS YOU THE LOWEST DISCOUNT PRICES ON HITACHI QUAD, TRIPLE & DUAL CHANNEL SCOPES + FREE DELIVERY\* AND A FREE DMM!**

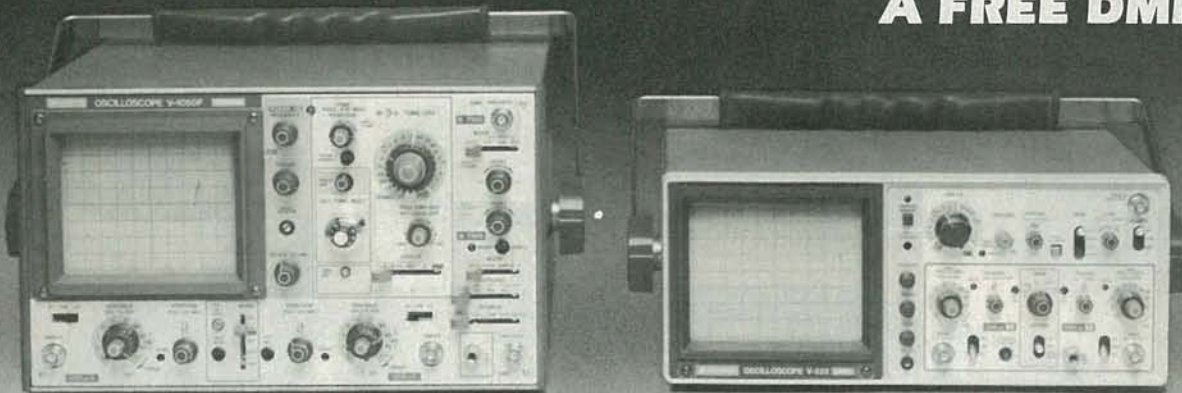

**Model V1050F**  
**Sale \$1,175<sup>00</sup>**  
 Reg. \$1,595<sup>00</sup>

**Model V650F**  
**Sale \$885<sup>00</sup>**  
 Reg. \$1,195<sup>00</sup>

**Model V422**  
**Sale \$645<sup>00</sup>**  
 Reg. 925<sup>00</sup>

**Model V222**  
**Sale \$495<sup>00</sup>**  
 Reg. \$715<sup>00</sup>

- 500uV Sens.
- 2% Accuracy

**V1050F 100MHZ QUAD CHANNEL/8-TRACE DELAYED SWEEP SCOPE.** The features you want and need! 6" CRT has internal graticule. 20KV acceleration. One-touch sync of TV-V, TV-H. Plus: auto-focus; variable hold-off; trace rotation adjust; X-Y operation; 10X magnification. W/probes, dust cover.

Reg. \$1,595<sup>00</sup> ..... SALE \$1,175<sup>00</sup>

**V650F 60MHZ TRIPLE-CHANNEL/DELAYED SWEEP SCOPE.** As above, except has 10KV acceleration, 1MV sensitivity, 3% accuracy, triple trace. W/probes.

Reg. \$1,195<sup>00</sup> ..... SALE \$885<sup>00</sup>

- Low Profile Portable!
- DC Offset

**V422 40MHZ DUAL-CHANNEL SCOPE.** 1MV sensitivity, 3% accuracy. 6" CRT with internal graticule. Alternate magnification for simultaneous display of x1, x10 swept waveforms! Plus vertical mode triggering; auto-focus; TV sync separation circuit; built-in signal delay; X-Y Mode. Only 12 x 5 x 14 1/2" d. (apprx.), 14.3 lbs. light. W/probes.

Reg. \$925<sup>00</sup> ..... SALE \$645<sup>00</sup>

**V222 20MHZ DUAL-CHANNEL SCOPE.** As above, except has 20 MHz bandwidth. W/probes.

Reg. \$715<sup>00</sup> ..... SALE \$495<sup>00</sup>

3-Yr. Factory Warranty on Above Scopes

**BUY ANY SCOPE ABOVE & GET FREE DELIVERY\* AND A FREE \$79<sup>95</sup> VALUE DMM AS OUR SPECIAL THANK-YOU!**

Versatile pocket-size tester boasts 3 1/2 digit, 0.5-height readout, .5% accuracy, 10 MEG input, plus full overload protection to meet UL1244. Auto zero, auto polarity, in-line pushbuttons.

You'll find 116 pages of tremendous discount prices on 25 leading instrumentation lines in Joseph's 1986 TEST EQUIPMENT CATALOG. Write for your FREE copy on your letterhead today!



**Hurry! Quantities limited at above sale prices!** Call: **1 (800) 323-5925**  
 In Illinois: **(312) 297-4200**

**Joseph electronics**

VISA, MASTERCARD & DISCOVER Phone Orders Welcomed!

8830 N. Milwaukee Niles, IL 60648

\*To UPS-Shippable Destinations Only



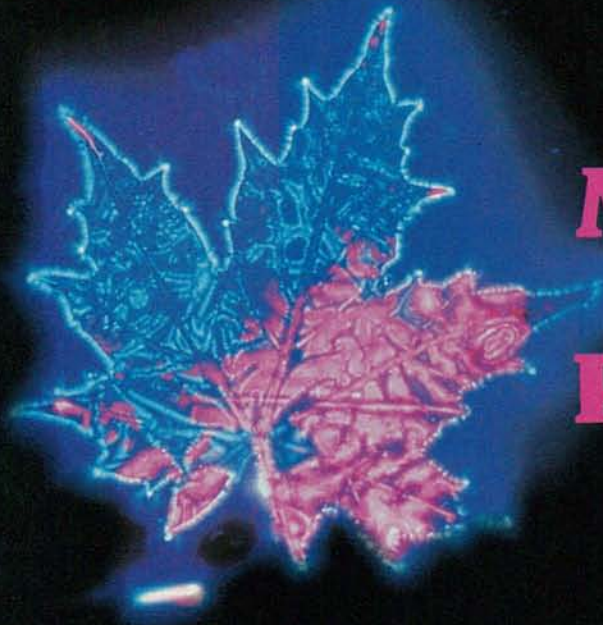

## Make Kirlian Photographs

JOHN IOVINE

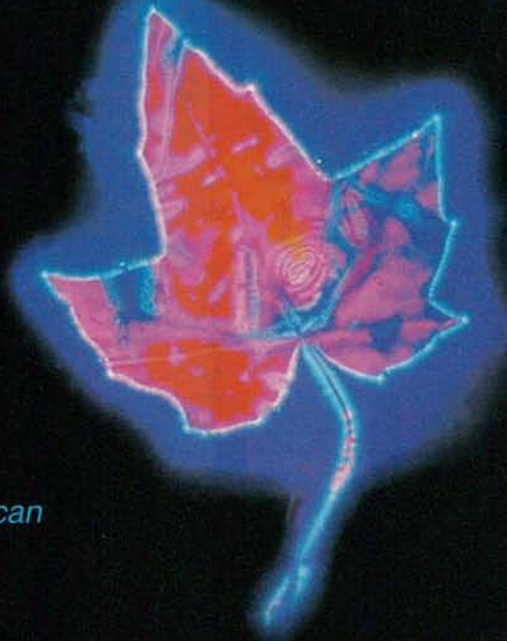

*In this article we explore the mysteries of Kirlian photography and show you how you can investigate the phenomenon yourself!*

LABORING IN RELATIVE OBSCURITY, SEYMON KIRLIAN (pronounced keer-lee-an) began his work in electrophotography in 1939. Over 40 years later, that work is still the source of much speculation and controversy. That's because it has been claimed that Kirlian was able to use auras that surround the subjects in his electrophotographs to detect illness in plants and animals before any other outward symptoms were visible. True or not, those claims sparked a great deal of interest in the field of electrophotography; so much so that electrophotography is today commonly called Kirlian photography.

### What is it?

In Kirlian photography a high-frequency, high-voltage source is used to produce images on photographic film. It does so without the benefit of a camera, lenses, or light, so it can, in some ways, be likened to X-ray photography.

The only thing that is known for certain about the Kirlian auras is that they exist. The nature of those auras is the subject of much conjecture.

Many of the theories used to explain the effect read like

excerpts from a science-fiction novel. One theory is that all substances, and in particular living organic matter, contain and are surrounded by what can be described as a matter-energy field. When a high-frequency, high-voltage charge is introduced in that field, it becomes, or behaves like, a superconductive plasma. The laws of physics that govern such a plasma are complex, involving an extended form of Einstein's Theory of Relativity. The aura that surrounds objects in Kirlian photographs then might be that plasma.

Whatever the nature of the auras, Kirlian photography is getting some serious attention in some very serious places. And the U.S. government has even gotten into the act—one of the leaders in the investigation of the Kirlian aura was the Biochemistry Laboratory at the Naval Air Development Center, in Warminster PA. (Unfortunately, that unit is now disbanded).

While a great deal of research has already been done on the subject, a great deal more still needs to be done before we'll know for certain what Kirlian auras are, and whether or not they can be useful in some applications. Nonetheless, those images have been used experimentally as diagnostic tools in medicine

and for non-destructive testing of materials in engineering.

One interesting aspect of Kirlian photography is that while all objects appear to have a Kirlian "aura," the aura of inanimate objects appears to be constant over time, while living creatures give off an aura that is time-varying. In humans, emotional stress, illness, and consumption of alcohol or drugs all appear to have an effect on the aura.

One of the U.S. government's studies in the area involved using the Kirlian aura to ascertain the physical and mental health of military personnel, and to determine their level of fatigue. That was done by measuring the diameter of the Kirlian aura, or corona, at the fingertip. At the end of the test, the results were analyzed and two statistically valid conclusions could be drawn. One was that the corona of those suffering physical stress (exercise) was larger in diameter than the test average; the other was that those suffering mental stress (fatigue, etc.) had Kirlian coronas that were smaller in diameter than the test average.

While the results of that test were interesting, there is still not enough data to hail Kirlian photography as a "fool-proof" diagnostic tool. Although other similar tests have been reported, the results have been incomplete. For instance, in one study, the fingertip coronas of 120 adult humans were photographed. Of the sample, 20% had a corona diameter that was markedly below the average. Of those, 50% it was later determined suffered from some sort of medical problem.

There are several obvious flaws with that study. For one, no report was made on the health of the 80% whose corona diameter was not reduced; it would have been informative to know what percent if any of those also suffered from some medical problem. Also, no follow-up appears to have been done on those whose corona diameters were decreased and who had no ascertainable medical problems. It would have been interesting to see how many of those later developed some type of difficulty, and in what time frame following the experiment.

One of the most dramatic experiments in Kirlian photography, and one of the ones that has garnered the most attention, is the so-called phantom leaf experiment. In that experiment, a small part (approximately 2% to 10% of the total surface area) is cut off. Kirlian photographs subsequently taken will sometimes show the energy pattern or aura of the missing section. The reason for that is unknown, and the subject of much speculation, but although the effect is exceptionally rare, it has been demonstrated enough times to prove its existence. There have even been studies attempting to correlate the ancient art of acupuncture and the auras seen in Kirlian photographs.

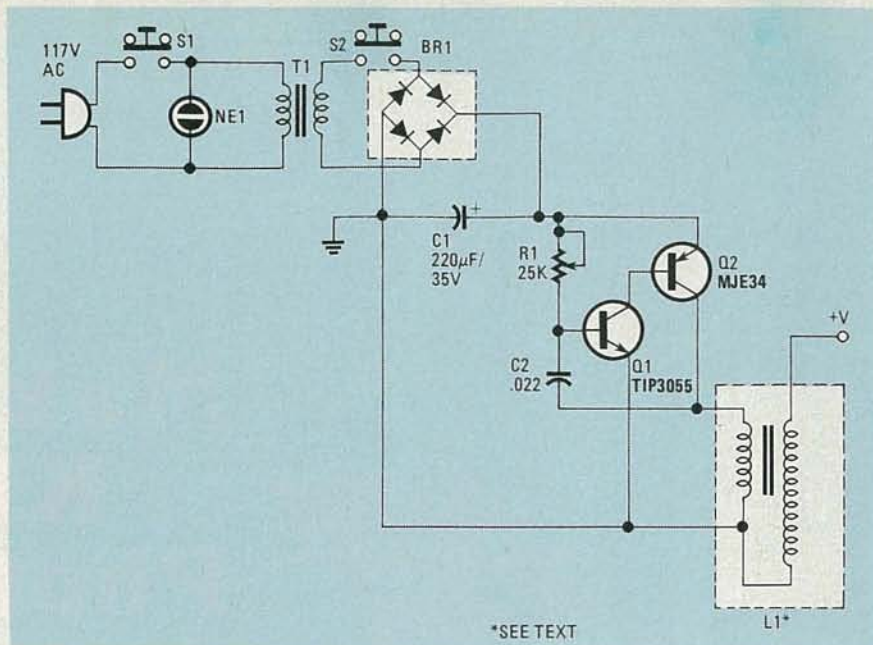

FIG. 1—YOU CAN MAKE YOUR OWN Kirlian photographs using this circuit. Coil L1 is an automotive ignition coil that can be obtained cheaply from almost any automotive junkyard.

#### Making your own

There are probably quite a few doubters still out there. To those we offer the following challenge: Why not build your own Kirlian photography unit and prove or disprove the existence of the effect to yourself? In the balance of this article we will present a simple set-up that will allow you to do just that. Although the equipment is not on a par with those used in research labs, it is still more than sufficient to provide startling results. The color photographs that accompany this article, showing the Kirlian aura of some common leaves, were produced using the apparatus described.

The circuit for the set-up is shown in Fig. 1. The heart of the circuit is a simple oscillator whose output is fed to a standard 12-volt, three-terminal automotive ignition coil, L1.

Construction is straightforward, and the circuit is simple enough that a PC board is not required, although one can be used if you wish. Note that the transistors can get pretty hot, so they should be adequately heat sunk. The only other point that merits special mention is that if a metal chassis is used, special care should be taken to isolate the circuit from the chassis. Otherwise a serious shock hazard could exist.

To further minimize the potential for shock, the ignition coil, L1, should be housed in its own non-conductive chassis. One suitable chassis is shown in Fig. 2. It is fashioned from a cardboard tube, such as those large rolls of gift-wrap paper come on; the ends are circular pieces of plexiglass.

Figure 3 shows the construction details of the coil chassis. The ignition coil is mounted by simply gluing it to one side of



FIG. 2—THE "CABINET" for L1 can be fashioned from a cardboard tube. The endcaps can be made of plexiglass.

the tube so that the high-voltage terminal will protrude slightly when the end caps are installed. A ground lead is provided by soldering a wire to the body of the coil; the other end is terminated in a case-mounted binding post. Note that the inputs from the main part of the circuit enter the coil chassis from the rear and are routed along the body of the coil through a length of plastic tubing. That tubing is used to insulate the leads from the body of the coil. Although the coil could be hard-wired to the balance of the circuit, the use of plugs and sockets allows for greater convenience. Further, the use of the polarized connectors mentioned in the parts list eliminates the guess work when reconnecting the circuit.

Three-terminal ignition coils can be ob-

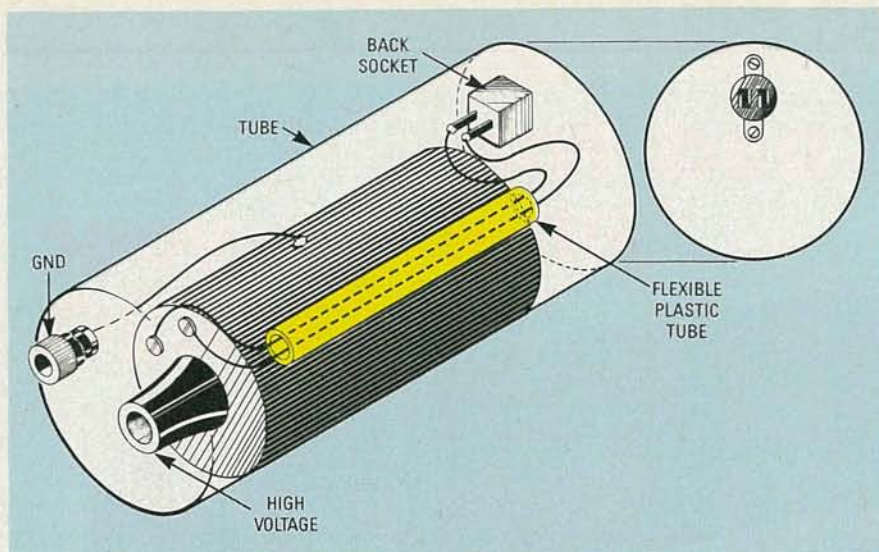

FIG. 3—THE AUTOMOTIVE IGNITION COIL is mounted inside its cabinet by gluing it to one side. Make the ground connection by soldering a wire to the side of the coil housing and connecting the other end to the cabinet-mounted binding post.

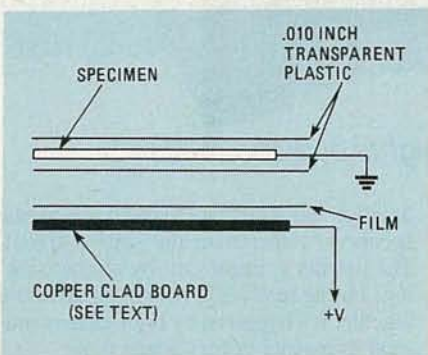

FIG. 4—THE SPECIMEN TO BE PHOTOGRAPHED should be sandwiched between two sheets of thin (.010-inch) transparent plastic.

tained from any automotive supplier. A much cheaper alternative is to pay your local automotive junkyard a visit. A coil can be obtained there for as little as \$5.00. Just about any 12-volt, three-terminal ignition coil will work, so get the least expensive one you can.

There is nothing particularly exotic about the parts required and most can be obtained from your local supplier. With some careful shopping, total cost should not exceed \$60.00 or so. If you have a well stocked junk box, that cost can be reduced further. If you wish, complete kits, as well as wired and tested units can be purchased from the supplier mentioned in the Parts List.

The set-up used in making a Kirlian photograph is shown in Fig. 4. The bottom plate is made from a single-sided piece of copper-clad PC-board material. The board should measure at least 4 × 5 inches so that standard 4- × 5-inch sheet film can be accommodated; more on the film in a moment. That plate is placed inside a thin, transparent plastic bag, copper side up, the bag is taped to prevent

#### PARTS LIST

- R1—25,000 ohms, potentiometer
- C1—220  $\mu$ F, 35 volts, electrolytic
- C2—.022  $\mu$ F, polyester film
- Q1—TIP3055 NPN transistor
- Q2—MJE34 PNP transistor
- BR1—1.5-amp, 50 PIV full-wave bridge rectifier (Radio-Shack 276-1151 or equivalent)
- NE1—neon-lamp assembly (Radio-Shack 272-704 or equivalent)
- S1, S2—SPST pushbutton switch
- T1—117-volt primary, 25-volt 450-mA secondary (Radio-Shack 273-1366 or equivalent)
- L1—three-terminal, 12-volt, automotive ignition coil

**Miscellaneous:** Case; case for ignition coil; perforated construction board, PC board, or prototyping board; single-sided copper-clad board; polarized plugs (Radio-Shack 274-201 or equivalent); polarized sockets (Radio-Shack 274-202 or equivalent); heat sinks for transistors; strain relief; power cord; knob for R1; wire; solder, etc..

**A kit of all parts, including connectors, cords, cases, and prototyping board (no PC board is available) is available from Images Co., PO Box 313, South Richmond Hill Station, Jamaica, NY 11419. The cost is \$90.00. A wired and tested version is available for \$125.00. Add \$2.50 for shipping and handling. NY residents add 8¼% sales tax.**

slippage, and a piece of the photographic film is placed upon it. If the specimen to be "photographed" is inanimate, such as a plant leaf or a piece of metal, it should be grounded (connected to the ground terminal on the coil chassis) for best results (see the important note that follows). In any event, the specimen is placed between two sheets of thin (.010-inch) transparent

plastic, and the "sandwich" is then placed on the film. The copper-clad board is connected to the high-voltage terminal of L1 via a length of wire.

**Important! Never, never ground a living creature, including yourself.** Doing so can subject that "specimen" to a very nasty shock. When dealing with living creatures, take special care to prevent any contact with ground.

One note about the ignition coil's high-voltage terminal: To the uninitiated, the location of that terminal may not be apparent at first glance. It is located within the tube-like protuberance at the top of the coil housing. When the coil is used in its normal application, a heavy-gauge spark-plug wire is placed in the opening at the top of the tube so that it contacts the terminal inside; the wire is held in place by friction. For our application, the lead from the copper-clad board must be placed within the terminal opening such that a sure contact with the high-voltage terminal is maintained at all times.

You will note from Fig. 1 that the circuit uses two ON/OFF switches, S1 and S2. Switch S1 is the unit's main power switch; when it is in the ON position, power is supplied to the neon lamp, NE1, and the circuit is placed in the stand-by mode. The neon lamp does more than give a visual indication of the state of the unit. Since we will be working with photographic film, the circuit must be used in a relatively dark, light-tight room. Obviously, that can present problems in using the unit (you can't use what you can't see). If the controls are clustered



FIG. 5—TO MAKE THEM EASIER TO FIND in the dark, cluster the unit's operating controls around NE1.

about the lamp (as shown in Fig. 5), the lamp gives off just enough light to make identification of the controls possible in a dark room without adversely affecting the film. Switch S2, the DISCHARGE switch, is used to control the operation of the balance of the circuit.

To make a Kirlian photograph, turn on the unit using S1, turn out the lights, place the film and the specimen on the electrode as discussed previously, and make the ex-

*continued on page 94*

## Click and Pop Filter for your STEREO



JOE GORIN

*By eliminating unwanted pops, clicks and other surface noise, this inexpensive scratch filter brings you to new heights of audio realism!*

THE PROLIFERATION OF DIGITALLY-MASTERED record albums might make you think that surface noise is a dead issue. However, even the best modern pressings contain some amount of noise, and, even with scrupulous care, all vinyl recordings deteriorate with age.

You might think that you could avoid the surface-noise problem by buying only compact discs (CD's), which suffer none of the problems endemic to vinyl recordings: hiss, rumble, clicks, and pops. However, many new recordings are unavailable on CD, and thousands of already-released recordings may never be re-issued on CD. So, if you're after the utmost in high-fidelity sound reproduction, you'll want to build our scratch eliminator. It's easy to assemble, and it requires no alignment. Just plug it in and give your ears a treat!

### Why it works

Since commonly-available stereo equipment easily achieves distortion levels below 0.1%, you might think that chopping up a musical signal to delete an occasional scratch would be foolish because of the distortion it would add. However, we have found that even the simplest scratch filters produce a notable improvement in sound quality. The reason is simply that the human ear responds slowly to fast-changing audio signals. One indication of that slowness is the fact that even the best magnetic tape has numerous dropouts of a greater duration than most

scratch deletions—and tape dropouts are seldom noticeable. So deleting a scratch in the midst of a complex musical passage is easily done with no noticeable effect.

The real problem is this: What happens when a large musical transient (like a cymbal crash or closely-miked plucked strings) occurs? Wouldn't it be deleted and thereby take the "bite" out of the transient? The answer is no, given the right design. High-energy musical transients might trigger the detector, but the deletion should be inaudible because the transient usually lasts at least 50 ms, whereas the deletion lasts for only 0.5–1.0 ms. The ear can't react that fast, so the deletion is inaudible.

The human hearing system reacts to transient signals according to a parameter called the "pitch recognition interval." For most frequencies, that interval is about 10 ms. If a signal lasts much less than 10 ms, it sounds pitchless or atonal—you cannot identify its tone. So all very short signals sound like clicks. Musical instruments are designed to make pleasing sounds, so they have decay times long enough to get them through the pitch recognition interval. So even if you delete a fraction of a tone at the beginning of a transient, the tone will still sound natural.

You may find it interesting to know that one commercially-available scratch filter uses the "click" effect to mislead the listener intentionally. That filter has an INVERT button that is used to "evaluate" the unit. In INVERT mode, only the shortened

deletion intervals are passed on to the speakers, rather than the source signal. The listener is impressed by all the clicking, but he really has no way of knowing whether it's triggered by high-energy musical transients or by surface noise.

The point is that pops and clicks can be eliminated, so the question is, how? The answer is somewhat complicated, so let's step back for a moment and examine other ways of cleaning up the sound of vinyl disks.

### Noise-reduction techniques

Essentially, there are three methods of improving the quality of any phonographic recording:

- Noise filter/expander
- Rumble filter
- Scratch filter

A noise filter serves to remove broadband, high-frequency noise, and an expander helps restore the original dynamic range with which most music is performed, if not recorded. The theory behind those signal processors was covered in depth in the author's articles in the January and February, 1981 issues of **Radio-Electronics**; the March and April issues of that same year carry a two-part construction story that details building a noise filter/expander.

A rumble filter removes subsonic signals (less than 20 Hz), and combines somewhat higher frequencies (ranging from 100 Hz to 200 Hz) into a monaural signal. Doing that reduces noise without

reducing intelligible program material. For more information on rumble filters, consult the author's article in the November, 1981 issue of **Radio-Electronics**. That article describes construction of a rumble filter. Kits for both the noise filter/expander and the rumble filter are still available from the source mentioned at the end of this article.

Of the three phonographic noise-reduction techniques the first is probably the most useful for discriminating audiophiles. The second is good for audiophiles whose systems have extended bass response and who have already eliminated most noise with a noise filter. Last, a scratch filter can help reduce unwanted noise from any phono system, and it will be particularly useful to people with large collections of old records. With that under our belts, let's find out how to build a scratch filter.

### Circuit operation

As the block diagram in Fig. 1 shows, the basic idea behind a scratch eliminator is simple. By delaying the input signal for a short time (about 40 microseconds), the detector can "see" a scratch before it

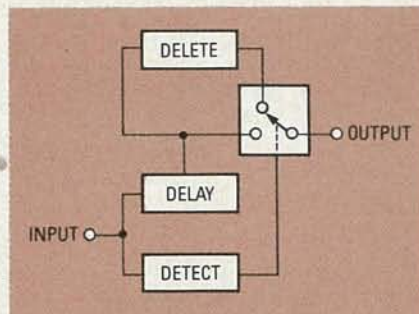

**FIG. 1—THE ESSENCE OF THE FILTER is the delay unit that allows the deleter to remove high-energy transients like pops, clicks, and scratches before they have a chance to reach your ears.**

reaches your amplifier. The detector activates a switch that prevents the input signal from passing through to the output. The switch remains open for the short time that the scratch is present, usually 100–200 microseconds, but sometimes as much as a millisecond, or even more. And rather than leaving a "hole" in the output sound, it would be nice if the deleter could substitute the signal that would have been there, had there been no scratch.

From an engineering point of view, it's

easy to design the delay unit. The delay unit's function is simply to delay all frequencies of interest by 40 microseconds or more. In the process, it should not change the amplitude of any frequency beneath 20 kHz (the limit of human hearing). The circuit may, however, reduce the level of higher frequencies. Delay is accomplished by phase-shifting the input signal and sending it through a low-pass filter.

As shown in Fig. 2, the first three op-amps in each channel, along with their associated passive components, perform the low-pass filtering and phase shifting. We'll talk about the right channel, but bear in mind the fact that the left channel functions identically. Incidentally, corresponding components in the left and right channels are numbered offset by a value of 100. For example, R101 in the right channel corresponds to R201 in the left.

Capacitors C101, C102, and C104–C106 and associated resistors provide low-pass filtering. They pass the audio signal, provide some phase shift, and attenuate ultrasonic signals. In addition, C101 and C105 add controlled amounts of positive feedback to help re-

### PARTS LIST

#### All resistors ¼-watt, 5% unless noted.

R1–R4, R11, R12, R26, R54, R102, R103, R118, R202, R203, R218—22,000 ohms  
 R5, R107, R207—2400 ohms  
 R6—7500 ohms  
 R7, R24—4700 ohms  
 R8, R9, R14, R43, R44, R50, R51, R114, R115, R214, R215, R301–R304—1000 ohms  
 R10, R34, R35—150,000 ohms  
 R13—150 ohms  
 R15—1200 ohms  
 R16, R39, R56, R104, R204, R305, R306—2200 ohms  
 R17, R18, R25, R29, R30, R37, R38—10,000 ohms  
 R19—4.7 megohms  
 R20, R57, R59, R121, R221—560 ohms  
 R21—470 ohms  
 R22, R106, R206—1800 ohms  
 R23—68,000 ohms  
 R27, R60—180,000 ohms  
 R28—3300 ohms  
 R31—330,000 ohms  
 R32—220 ohms  
 R33—15,000 ohms  
 R36—470,000 ohms  
 R40, R49, R62–R100, R123–R200, R223–R300—not used  
 R41, R46—39,000 ohms  
 R42—22 megohms  
 R45—100,000 ohms, linear potentiometer  
 R47, R101, R201—100,000 ohms  
 R48, R61, R122, R222—270,000 ohms  
 R52, R116, R216—36,000 ohms

R53, R58, R111, R117, R211, R217—6200 ohms  
 R55, R119, R219—91,000 ohms  
 R105, R205—100 ohms  
 R108, R208—2700 ohms  
 R109, R209—3000 ohms  
 R110, R210—12,000 ohms  
 R112, R120, R212, R220—33,000 ohms  
 R113, R213—8200 ohms  
 R307, R308—22 ohms

#### Capacitors

C1, C15, C16—0.0033  $\mu$ F, 10%, polyester film  
 C2, C5, C20, C22, C107–C109, C207–C209—0.001  $\mu$ F, 10%, polyester film  
 C3, C4, C8, C24, C111, C113, C211, C213, C305, C306, C308—10  $\mu$ F, 25 volts, aluminum electrolytic  
 C6, C7, C14, C18, C103, C203—0.033  $\mu$ F, 10%, polyester film  
 C9—3.3  $\mu$ F, 35 volts, aluminum electrolytic  
 C10–C12, C301—0.1  $\mu$ F, 10%, polyester film  
 C13, C17, C23, C25, C26, C110, C112, C210, C212—0.01  $\mu$ F, 10%, polyester film  
 C19, C21—680 pF, 10%, ceramic disc  
 C27—see text  
 C28–C100, C114–C200, C214–C300—not used  
 C101, C201—330 pF, 10%, ceramic disc  
 C102, C106, C202, C206—220 pF, 10%, ceramic disc  
 C104, C204—0.0047  $\mu$ F, 10%, polyester film

C105, C205—0.022  $\mu$ F, 10%, polyester film  
 C302—1000  $\mu$ F, 35 volts, aluminum electrolytic  
 C303, C304—1000  $\mu$ F, 25 volts, aluminum electrolytic  
 C307, C309—0.1  $\mu$ F, ceramic disc

#### Semiconductors

IC1–IC3, IC5—RC4136, quad op-amp  
 IC4—LM301A, op-amp  
 IC6—LM393, op-amp

#### Other components

J1–J8—RCA Phono Jacks  
 S1, S2—DPDT toggle Switch

**Note—The following parts are available from Symmetric Sound Systems, Inc., 856 Lynn Rose Ct., Santa Rosa, CA 95404, (707) 546-3895: Complete Kit (No. PS-1) \$79.95; PC Board (No. PS-1PC) \$12.00; All semiconductors (No. PS-1SC) \$13.00; All resistors and capacitors (No. PS-1RC) \$16.00; Transformer (No. PS-1XF) \$7.50; Chassis, endpanels, switches, hardware, jacks and instructions (No. PS-1ETC) \$42.50. Free UPS shipping in U.S. with check; MasterCard and Visa orders must add shipping. PS-1SC, PS-1RC and PS-1ETC will not be available after January 31, 1987. California residents must add appropriate sales tax.**

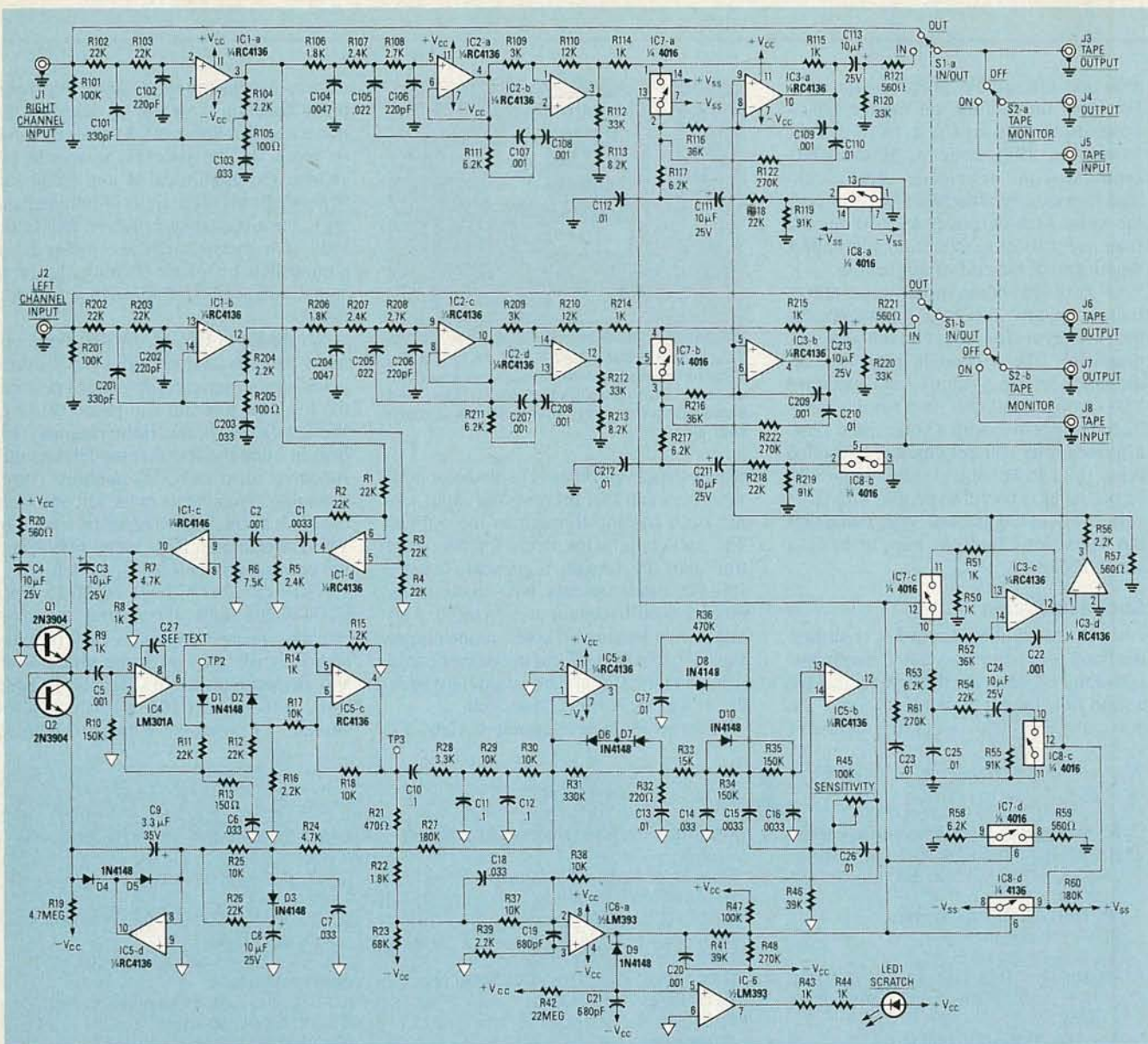

FIG. 2—THE CIRCUIT OF THE SCRATCH FILTER is shown here. Note that components numbered from 0–99 refer to the detector circuit, 100–199 refer to the right channel delay/delete section, and 200–299 refer to the left channel. The triangular symbols here provide a separate “ground” reference for the detector circuit.

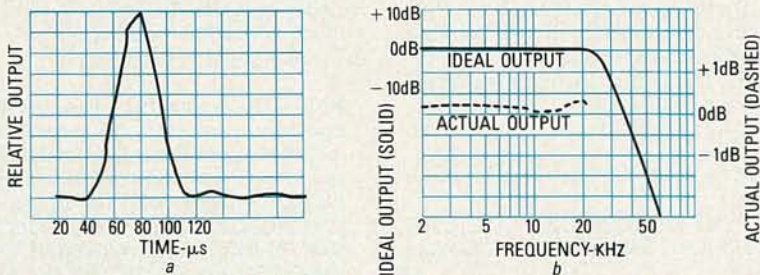

FIG. 3—TIME- AND FREQUENCY-DOMAIN responses of the Filter are shown here. Note that the circuit doesn't respond before at least 40  $\mu$ s have passed, and that output is flat (within  $\frac{1}{2}$  dB) to 20 kHz.

sponse. Further, the network formed by C107 and C108 functions as an “all-pass” network that provides lots of phase shift with little change in amplitude.

Our circuit was simultaneously computer-optimized for both its frequency-do-

main response, which is flat to 20 kHz, and its time-domain response: no reaction to a triangular, scratch-like pulse for at least 40 microseconds. Figure 3-a shows the time-domain response curve, and Fig. 3-b shows the frequency-domain response

curve. The latter is presented with both ideal and actual curves; you can see that the actual output is flat within  $\frac{1}{2}$  dB all the way to 20 kHz.

### Scratch deleter

The deleter has a somewhat more difficult task to accomplish than the delay/phase-shift network. In addition to completely blanking out the scratches found by the detector, it should replace the deleted signal with a signal that sounds as little as possible like a scratch, and as much as possible like the original program material, had there been no scratch. Since the circuit can't know what signal was, it must predict it.

Actually, the deleter's first job is accomplished in the input circuitry discussed above. A 75-microsecond pre-emphasis is provided by R104, R105 and C103. That pre-emphasis boosts audio signals above the corner frequency of

2122 Hz. Explaining the need for that pre-emphasis requires a lengthy digression.

### The RIAA curve

In order to optimize signal-to-noise ratio, phonograph sound-reproduction systems are designed to operate with pre-emphasis at the recording end and de-emphasis at the playback end. The playback response used in your phono pre-amplifier is the RIAA (Record Industry of America Association) curve shown in Fig. 4. That curve is designed to respond cor-

rectly to the output of a magnetic cartridge. Most high-quality cartridges are magnetic, and the output of a magnetic cartridge is a voltage that is proportional to the velocity of the stylus.

Since higher frequencies have higher velocities for the same amplitude, a velocity transducer effectively imparts a 6-dB/octave treble boost over the entire bandwidth. The resulting signal is shown in Fig. 5. Because of that treble boost, the circuit stores energy and releases it slowly. If a pulse of displacement (change in

position from center) occurs on the record, as shown in Fig. 7-a, the response exhibits a settling tail that decays exponentially with a time-constant of 75 microseconds. The breakpoint in the curve is at the reciprocal of  $2\pi \times 75$  microseconds, or 2122 Hz.

Because of that settling time, deleting a scratch can be tricky. If the deletion time isn't long enough, some scratch energy may pass through as noise. But if the deletion time is too long, a distracting audible "hole" would be created.

Our solution is to pre-emphasize the signal before it reaches the deleter. Doing that would cause an input signal like that shown in Fig. 7-a to appear as in Fig. 7-b. A pulse (or scratch) input would appear as in Fig. 7-c. Observe that, although the pulse is larger, it is now constrained to a much shorter period of time.

Pre-emphasis is desirable for another reason besides the elimination of settling tails. The treble boost caused by pre-emphasis reduces the number of scratch-prediction errors in the deleter.

### The deleter

The deleter is the last op-amp stage in each channel (IC3-a). Its operation is controlled by the two analog switches IC7-a and IC8-a. The op-amp in conjunction with R116 and C109 forms an integrator. When the switches close, R114 and R115 apply negative feedback to the integrator. The result is a filter with a de-emphasis corner at the desired 2122Hz.

If that were the entire circuit, when a deletion occurred, the charge stored by feedback capacitor C109 would cause it to act as a sample-and-hold circuit, which works well for short deletions during low-frequency waveforms. However, several components are added to the deleter that improve its operation in two different ways.

First, just before the deletion begins, capacitor C112 stores the input waveform by charging to the voltage at R116. Then, when the deletion begins, switch IC7-a opens. That prevents the signal from the previous stage from getting to IC3-a, so the voltage across C112 is fed through to the output, and that keeps the output at a level approximately equal to the level just before the scratch.

That improves low-frequency performance, but it doesn't help high frequencies at all. However, that's OK, because, even though low-frequency signals mask deletion-errors poorly, high-frequency signals mask deletion well.

To prevent C112 from storing high-frequency signals, R117 limits the charge that can build up on C112. If that charge extended over more than a fraction of a cycle, it could cause severe errors in the deleter. When a deletion occurs, R118 and switch IC8-a discharge C112 rapidly so that the slope estimated by C112 isn't

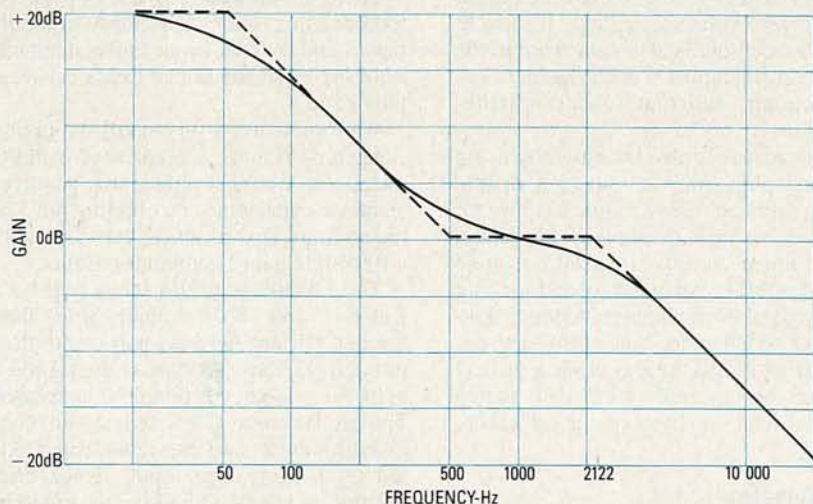

FIG. 4—THE RIAA DE-EMPHASIS curve necessary for processing signals from standard magnetic cartridges.

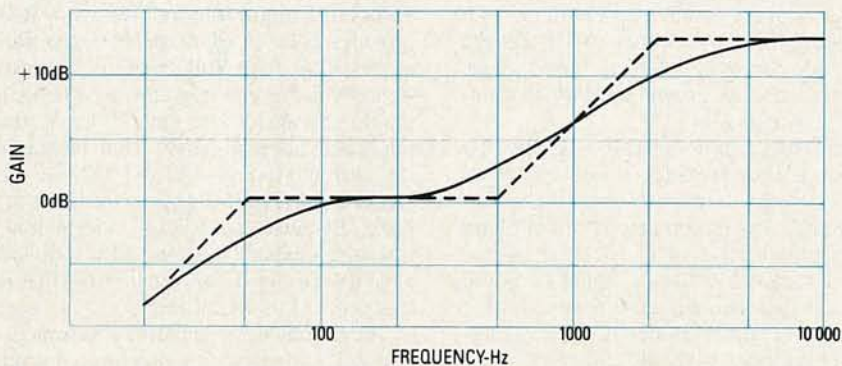

FIG. 5—OUTPUT OF A STANDARD MAGNETIC CARTRIDGE increases at a rate of 6 dB/octave over the audio frequency range.

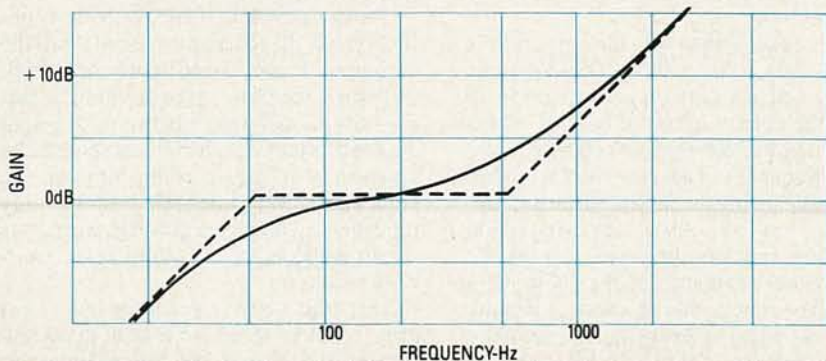

FIG. 6—OUTPUT OF A MAGNETIC CARTRIDGE SHIFTS when the stylus encounters a deformation in the vinyl surface.

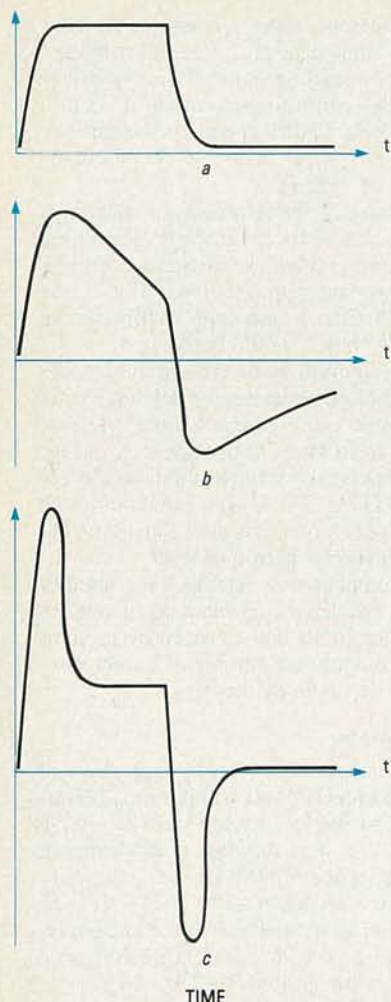

FIG. 7—EXPONENTIAL DECAY of an input signal (a) is lengthened by pre-emphasis (b). Additional pre-emphasis increases the amplitude, but decreases the duration of a scratch (c).

over-corrected. Capacitor C111 prevents IC3's outputs from causing switching transients when IC8-a changes state. Resistor R119 does the same thing for the leakage currents in the switch.

The second means by which the deleter is improved is through the combination of R122 and C110. If the deletion lasts long enough, the sample-and-hold and slope-extension techniques become ineffective. We guard against that condition by using C110 to store the long-term average of the input signal. So, after a long deletion, C110 re-charges C109 to that average voltage, and that prevents the audible "holes" mentioned above from marring the output signal.

#### Glitch cancellation

The combination of sample-and-holding, slope extension, and long-term-average circuits makes most deleter errors inaudible. However, there is another source of error: the signal required to turn the switches off and on. Although that signal is 14-volts p-p, ideally the error at the integrator output is less than 1 mV, a ratio of 14,000/1. Since C109 is 1000 pF,

the capacitor that couples the switching waveform into C109 must be 1000/14,000, or about 0.07 pF—a very small amount. That's achieved by circuit and layout matching.

Circuit matching works by using IC3-c and associated components to duplicate the deleter stage. We call the duplicate the "example" circuit. When the switches change state, they inject transients into the example circuit. Then IC3-d compares the output of the example circuit to the "glitch injection" terminal of the example circuit, the non-inverting input (pin 13) of IC3-c. That forces the output back to zero volts via negative feedback. The glitch output is also connected to the non-inverting inputs of each channel's deleter circuit, and that cancels glitches there too.

Performance is also increased by using matched parts (they're matched in that they're fabricated on the same IC chip) for the switches and op-amps in the deleter and example circuits. In addition, great effort has been expended toward making the layout of each channel identical. Further, we added guard traces between sensitive IC pins, and the legs of some critical resistors are specially formed to match each channel's pickup of the switching signals.

#### The detector

The detector circuitry consists of three parts: a differential amplifier and filter, a full-wave detector with ALC (Automatic Level Control), and a comparator with masking-threshold setting. Note that the detector circuit's ground is raised above the main chassis ground by R308 to minimize noise pick-up.

The *differential amplifier* is formed by IC1-d. It is used to detect scratches, which are 180° out of phase between the two channels. The reason they're out of phase is that the surface of a disk that has had vinyl removed causes a negative-going pulse in one channel, and a positive-going pulse in the other. Hence IC1-d is configured to respond to the difference between the two channels. Next, C1, C2, R5, and R6 form a high-pass filter that passes only the highest audible frequencies, as well as any ultrasonic signals.

The reason for passing the high audible frequencies is that, although the energy in most scratches rolls off slowly above 10 kHz, the energy in music rolls off much more rapidly, but that roll-off starts at a lower frequency. Thus, the "noise-to-signal" ratio is higher in the ultrasonic frequency region. Also, the vinyl that normally contacts the stylus damps the mechanical resonance of the stylus. But during a scratch, that resonance (usually at 20–30 kHz) is excited, and damping decreases because the stylus loses contact with the groove.

The *full-wave detector* (with ALC) is composed of Q1, Q2, IC4, IC5-c and IC5-d. The base of Q1 is biased at the detector reference, so the currents flowing through Q1 and Q2 is controlled by the voltage applied from IC5-d. Hence, those devices form a current-controlled attenuator whose output is fed to IC4, an LM301A op-amp.

Normally the LM301 requires 30 pF of capacitance between pins 1 and 8 for stability. That capacitance completes an internal negative-feedback loop that rolls off the gain at high frequencies and keeps the op-amp stable.

There is, however, internal positive feedback due to the capacitance between pins 5 and 6. That capacitance subtracts from the capacitance that exists between pins 1 and 8.

We want to use a very small stabilizing capacitor—0.3 pF, implemented with PC traces—so we must reduce that positive-feedback capacitance by clipping pin 5 of the op-amp. That results in a op-amp with a 100-MHz gain-bandwidth product.

The LM301 amplifies the signal by a factor of 150. Positive half-cycles flow through D1, and negative half-cycles flow through D2; those signals are then applied to IC5-c, another differential amplifier. The signal from D1 is fed to the non-inverting input, and the signal from D2 is fed to the inverting input. Since both positive and negative half-cycles appear at IC5-c's output as positive-going, IC5-c is a full-wave rectifier.

The ALC loop is closed by IC5-d and associated components. Resistor R21 provides a 100-mV voltage reference. Resistors R24, R25, and capacitor C9 configure IC5-d as an integrator, so if IC5-c's output averages more than 100 mV, the integrator goes negative. That increases the current through Q1 and Q2, so the signal level is reduced via negative feedback. Because the voltage-current relationship is exponential, the ALC loop has a bandwidth (or readjustment rate) that is independent of signal level.

The human ear's sensitivity to scratch-type noise varies with signal level; it is the job of the ALC loop to simulate that variation. That makes the front-panel SENSITIVITY adjustment less critical.

The *comparator*, IC6-a, is the last subsection of the detector. Recall that the output of IC5-c is the level-controlled, full-wave-rectified, high-frequency version of the difference between the right and left channels. If we compared the junction of R22 and R23 to ground, the comparator would register a scratch any time the level there exceeded five times its recent average level, so additional circuitry is necessary.

That's all we have room for now. Next time, we'll finish up our look at the detector circuit and show you how to build our filter.

R-E





## Capacitor Leakage Tester

GARY McCLELLAN

*Find the leaky capacitors that many testers miss with this easy-to-build leakage checker. You can use it to test cables, appliance insulation, and high-voltage diodes, too!*

THOSE NEW DIGITAL CAPACITANCE TESTERS make capacitor checking quick and easy, but they have shortcomings. For instance, does the following sound familiar to you?

You are troubleshooting a piece of equipment and replace some defective capacitors with units from the junk box. After hours of additional troubleshooting you discover that those replacement capacitors are no good after all, even though they checked out OK on your tester. That's because they are leaky, and your meter is one of the many that has no leakage-test function. That "missing feature" wound up costing you much time and aggravation.

Or perhaps you just bought some electrolytic capacitors from your dealer, installed them, and watched as the power-supply fuse blew. You later find that the cause was those "new" capacitors; they had become leaky after sitting on your dealer's shelf for the better part of a decade. If you had only known, those capacitors could have been rejuvenated with a shot of current from the proper source. Instead, you have a blown fuse and some fried capacitors.

Assuming it does everything else well, don't trash your capacitance tester just because it doesn't have a leakage-test function. Instead, supplement it with the leakage tester described here. Our tester checks the all-important leakage parameter quickly and easily, weeding out defective capacitors that otherwise test good. It can also bring those elderly "new" capacitors back to life fast.

Besides checking capacitor leakage, the circuit has many other uses on the bench and in the field. For example, use it to test insulation resistances on power tools and appliances. If you find just one tool or appliance with a dangerous fault before it finds you, you'll be very glad you took the time to build and use the circuit. You can also test suspected lossy cables, as well as high-voltage diodes, rectifiers, neon lamps, and other high-voltage components that are often difficult to troubleshoot with conventional DMM's.

And in a pinch the circuit can serve as a regulated power supply. The output voltage spans 3 to 100 volts, which may make the project useful for temporarily powering devices drawing under 10 mA or so.

The circuit is easy to build and is fairly

inexpensive, too. A small PC board holds the active components, including two IC's, three transistors, and some diodes, while the remaining switches and a meter mount on the cabinet. Parts costs will run about \$45.00 or so, depending upon how well you can shop or scrounge for them. The PC board, and a few harder-to-get components, are available from the source mentioned in the Parts List.

### How it works

The project is basically a regulated DC power supply with a metering circuit to indicate leakage current. Refer to the block diagram in Fig. 1 for details.

There are several noteworthy features of which you should be aware. First, a novel power supply design permits the unit to charge test capacitors with a constant current source. That means they charge faster, saving you testing time, particularly for large capacitors. In addition, an analog meter is used for leakage-current measurements. That allows you to see the charging action and monitor the leakage current easier than with a digital meter. And analog meters are generally much cheaper than digital ones!

From McGraw-Hill . . . the professionals' publisher

Join the **Electronics and Control Engineers' Book Club®**



**SWITCHED CAPACITOR CIRCUITS**  
By P. E. Allen and Edgar Sanchez-Sinencio. 759 pp., 558 illus. and tables. Covering the latest developments in design, analysis, and implementation, this is the first guide to switched capacitor (SC) circuits—an economical way of combining analog sampled data techniques with MOS technology.  
583239-9 Pub. Pr., \$56.50 Club Pr., \$39.45

**TROUBLESHOOTING ELECTRONIC EQUIPMENT WITHOUT SERVICE DATA** By R. G. Middleton. 303 pp., 162 illus. and tables. Packed with charts, diagrams, and case histories, this practical handbook shows you how to pinpoint defective electronic circuitry when no service data is available.  
583134-1 Pub. Pr., \$24.95 Club Pr., \$18.50

**STANDARD HANDBOOK OF ENGINEERING CALCULATIONS** T. G. Hicks, Editor in Chief. 2nd Ed., 1,468 pp., 1,292 illus. and tables. Now revised, updated, and considerably expanded, this huge handbook provides more than 5,100 step-by-step procedures for solving the kinds of engineering problems you encounter most frequently in your work.  
287/35X Pub. Pr., \$59.50 Club Pr., \$44.50

**POWER CONTROL WITH SOLID-STATE DEVICES** By Irving M. Gottlieb. 372 pages, 218 illustrations. This comprehensive book discusses every type of solid-state device and circuitry now available for power electronics. It covers both the proven-in-practice power control systems and the avant garde—as well as some promising combinations of the older and newer devices and circuitries.  
583240-2 Pub. Pr., \$28.95 Club Pr., \$21.95

**CONTROL SYSTEM ENGINEERING** By Mohamed E. El-Hawary. 583 pages, 373 illustrations. This up-to-the-minute guide gives you the latest techniques for the design, analysis, and compensation of today's increasingly complex and sophisticated control systems. All the systems covered are closed-loop time-invariant feedback control systems.  
583224-0 Pub. Pr., \$32.95 Club Pr., \$24.75

**DIGITAL LOGIC DESIGN.** By B. Holdsworth. 338 pp., 192 illus. All of the recent advances in digital design techniques are presented here in depth. It's both a text covering basic concepts and a practical guide to design techniques for combinational, clock-driven, and event-driven circuits.  
582852-9 Pub. Pr., \$39.95 Club Pr., \$27.50

**INTRODUCTION TO RADAR SYSTEMS.** By M. I. Skolnik. 2nd Ed., 698 pp., 244 illus. Covering every radar fundamental and all important changes, this EE text exposes you fully to the systems themselves—and to their applications! Topics include radar equation, CW and frequency-modulated radar, MTI, pulse-doppler, tracking radar, receivers, displays, duplexers, noise, and more.  
579/091 Pub. Pr., \$47.95 Club Pr., \$35.75

Get the competitive edge with the newest and the best information in your field . . . with books from all the leading publishers

New members!  
Any one of these great professional books for only \$2<sup>89</sup> as a premium with your 1st selection!

Spectacular values up to \$105.00

**HANDBOOK OF PRACTICAL ELECTRICAL DESIGN.** By J. F. McPartland. 416 pp., 300 illus. This volume provides a step-by-step explanation of designing electrical systems for industrial, commercial, and residential applications.  
456/95X Pub. Pr., \$44.50 Club Pr., \$30.95

**INTRODUCTION TO MICROWAVE ELECTRONICS.** By T.C. Edwards. 76 pp., illus., softbound. Eliminating unnecessary theory and mathematics, this book provides you with a lucid overview of microwave engineering and the devices and circuits being used today.  
583030-2 Pub. Pr., \$14.95 Club Pr., \$10.95

**ELECTRONICS ENGINEERS' HANDBOOK, 2/e.** Edited by D. G. Fink & D. Christiansen. 2,272 pp., 2,189 illus. This updated and enlarged edition covers all the latest knowledge in the field, including new advances in integrated circuits, pulsed and logic circuits, laser technology, telecommunications, and much more.  
209/812 Pub. Pr., \$83.50 Club Pr., \$63.95

**ANTENNA ENGINEERING HANDBOOK, 2/e.** Edited by R. C. Johnson and H. Jasik, with contributions by 57 recognized authorities. 1,408 pp., 946 illus. This widely acclaimed Handbook gives you the guidance you need to solve problems in antenna design and application.  
322/910 Pub. Pr., \$105.00 Club Pr., \$62.50

**GATE ARRAYS: Design Techniques and Applications.** Edited by J. W. Read. 349 pp., 146 illus. Written by a team of specialists, this book describes the fundamental principles, design techniques, and uses of gate arrays.  
512/868 Pub. Pr., \$35.00 Club Pr., \$24.75

**ELECTRONIC COMMUNICATIONS SYSTEMS.** By W. D. Stanley. 566 pp., illus. Emphasizing the signal-processing functions of modulation and demodulation operation, this book presents the essentials of electronic communications in a logical, step-by-step sequence.  
582834-0 Pub. Pr., \$32.95 Club Pr., \$22.50

**THE ENCYCLOPEDIA OF ELECTRONIC CIRCUITS.** By R. Graf. 760 pp., 1,256 illus. This large volume provides circuits for virtually every type of application in 98 different categories. Each has a clear and concise explanatory text accompanying it.  
583265-8 Pub. Pr., \$50.00 Club Pr., \$39.95

**TELEVISION ENGINEERING HANDBOOK.**—By K. B. Benson. 1,478 pp., 1,091 illus. Packed with the technical information and know-how you need to design, operate and maintain every type of TV equipment in current use.  
047/790 Pub. Pr., \$89.50 Club Pr., \$62.50

**68000 MICROPROCESSOR.** By W. A. Triebel and A. Singh. 335 pp., 129 illus. This guide to Motorola's 68000 microprocessor uses a systems approach that includes extensive coverage of the 68000, its architecture, assembly language programming, and hardware interfacing techniques.  
583613-0 Pub. Pr., \$34.95 Club Pr., \$26.95

**McGRAW-HILL PERSONAL COMPUTER PROGRAMMING ENCYCLOPEDIA.** Edited by W. J. Birnes. 704 pp., 48 illus. This giant reference compares the functional and operational definitions of every command used in 19 high-level computing languages as well as 8-, 16-, and 32-bit assembly languages and machine codes.  
053/898 Pub. Pr., \$80.00 Club Pr., \$52.50

**McGRAW-HILL CONCISE ENCYCLOPEDIA OF SCIENCE AND TECHNOLOGY.** Editor-in-Chief S. P. Parker and the Staff of the McGraw-Hill Encyclopedia of Science and Technology. 2,065 pp., 1,600 illus. This volume serves every need for understanding today's science and technology. Written by over 3,000 of the world's topmost experts, including 19 Nobel Prize winners, it covers 75 disciplines from Acoustics to Zoology.  
454/825 Pub. Pr., \$95.00 Club Pr., \$66.50

**MICROWAVE SEMICONDUCTOR CIRCUIT DESIGN.** By W.A. Davis. 416 pp. heavily illus. Provides in-depth coverage on microwave circuit analysis, passive microwave components, impedance transformers and circuits, broadband directional couplers, mechanical realization of selected transmission lines, CAD, CAM and CAT, characteristics of amplifiers and oscillators, noise, statistical thermodynamics and PN junction theory.  
583044-2 Pub. Pr., \$47.50 Club Pr., \$35.50

**INTRODUCTION TO RADIO FREQUENCY DESIGN.** By W. H. Hayward. 383 pp., illus. This comprehensive volume prepares you to actually design HF, VHF, and UHF equipment and enables you to follow much of the current literature. Structured equation sets make it easy to write programs for small computers or calculators.  
582748-4 Pub. Pr., \$32.95 Club Pr., \$27.25

**McGRAW-HILL ENCYCLOPEDIA OF ELECTRONICS AND COMPUTERS.** By S. P. Parker, Editor-in-Chief. 960 pp., 1,266 illus., outsized 8 1/2 x 11 format. It's a single-volume library that covers the entire world of electronics from Edison's pioneering work in electricity right up to optical fiber communications, control systems, lasers, radar, TV receivers, artificial intelligence, and computer storage technology.  
454/876 Pub. Pr., \$67.50 Club Pr., \$41.50

**ELECTRONICS ENGINEERING FOR PROFESSIONAL ENGINEERS' EXAMINATIONS.** By C. R. Hafer. 336 pp., more than 200 illus. Actually two books in one—a quick preparation manual to help you pass your P.E. exams on the first try and a rich source of practical electronics engineering information and know-how.  
254/303 Pub. Pr., \$32.50 Club Pr., \$25.50

**COMPUTER METHODS FOR CIRCUIT ANALYSIS AND DESIGN.** By J. Vlach and K. Singhal. 656 pp., 148 illus. Computational methods have become an integral part of circuit analysis and design. And a solid understanding of the basics of computer-aided design is a must for engineers who want to achieve their career objectives.  
582855-3 Pub. Pr., \$42.50 Club Pr., \$33.95

**MODERN ELECTRONIC CIRCUITS REFERENCE MANUAL.** By J. Markus. 1,264 pp., 3,666 circuit diagrams. Complete with values of components and suggestions for revisions—plus the original source of each circuit in case you want additional performance or construction details.  
404/461 Pub. Pr., \$79.50 Club Pr., \$57.95

**STANDARD HANDBOOK FOR ELECTRICAL ENGINEERS, 11/e.** By D. G. Fink and H. Beaty. 2,448 pp., 1,414 illus. Today's most widely used source of electrical engineering information and data serves you as no other single work when you need detailed, timely, and reliable facts.  
209/74X Pub. Pr., \$85.00 Club Pr., \$65.50

Be sure to consider these important titles as well!

**DESIGN OF FEEDBACK CONTROL SYSTEMS.** By G. H. Hostetter, C. J. Savant, and R. T. Stefani.  
583206-2 Pub. Pr., \$41.95 Club Pr., \$31.45

**PRACTICAL DIGITAL DESIGN USING ICS, 2/e.** By J. D. Greenfield.  
582853-7 Pub. Pr., \$31.95 Club Pr., \$22.95

**MICROPROCESSOR SUPPORT CHIPS: Theory, Design, and Applications.** By T. J. Byers.  
095/183 Pub. Pr., \$43.50 Club Pr., \$35.25

**DATA COMPRESSION: Techniques and Applications.** By T. J. Lynch.  
583267-4 Pub. Pr., \$44.50 Club Pr., \$31.25

**TRANSDUCERS: Theory and Applications.** By J. A. Allocca and A. Stuart.  
582987-5 Pub. Pr., \$29.95 Club Pr., \$24.95

**ANALYSIS AND DESIGN OF DIGITAL INTEGRATED CIRCUITS.** By D. A. Hodges and H. G. Jackson.  
291/535 Pub. Pr., \$40.00 Club Pr., \$32.50

**HANDBOOK OF OPERATIONAL AMPLIFIER CIRCUIT DESIGN.** By D. E. Stout & M. Kaufman.  
617/97X Pub. Pr., \$48.50 Club Pr., \$34.95

**ENGINEERING MATHEMATICS HANDBOOK, 2/e.** By J. J. Tuma.  
654/298 Pub. Pr., \$41.50 Club Pr., \$31.00

**DIGITAL COMMUNICATIONS.** By J. Proakis  
509/271 Pub. Pr., \$42.95 Club Pr., \$31.50

**CRYSTAL OSCILLATOR CIRCUITS.** By R. J. Matthey.  
583251-8 Pub. Pr., \$37.95 Club Pr., \$26.95

**MAINTAINING AND REPAIRING VIDEOCASSETTE RECORDERS** By R. L. Goodman.  
582895-2 Pub. Pr., \$15.95 Club Pr., \$12.50

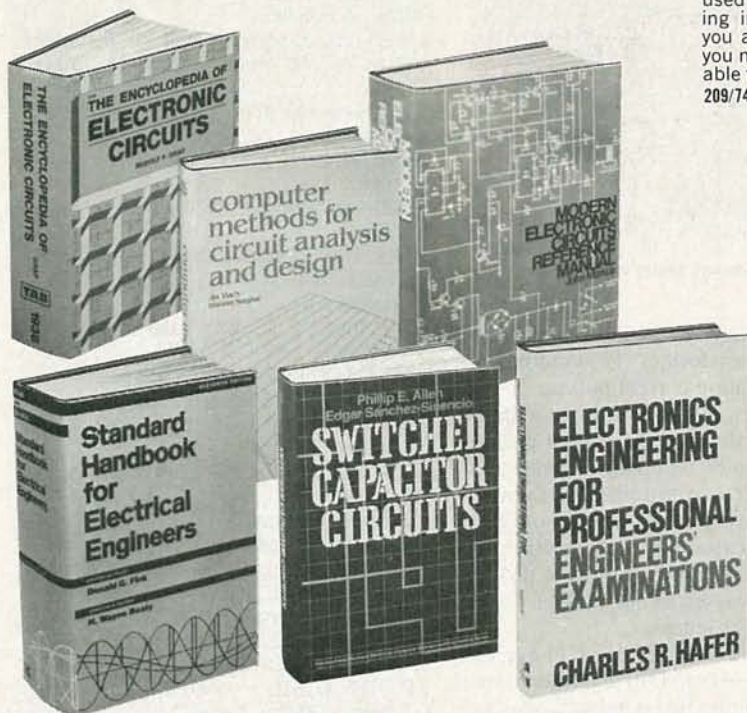

## Why YOU should join now!

■ **BEST AND NEWEST BOOKS IN YOUR FIELD**—Books are selected from a wide range of publishers by expert editors and consultants to give you continuing access to the best and latest books in your field.

■ **BIG SAVINGS**—Build your library and save money too! Savings ranging up to 40% or more off publishers' list prices—usually 20% to 30%.

**BONUS BOOKS**—You will immediately begin to participate in our Bonus Book Plan that allows you savings up to 70% off the publishers' prices of many professional and general interest books!

■ **CONVENIENCE**—12-14 times a year (about once every 3-4 weeks) you receive the Club Bulletin FREE. It fully describes the Main Selection and Alternate Selections. A dated Reply Card is included. If you want the Main Selection, you simply do nothing—it will be shipped automatically. If you want an Alternate Selection—or no book at all—you simply indicate it on the Reply Card and return it by the date specified. You will have at least 10 days to decide. If, because of late delivery of the Bulletin you receive a Main Selection you do not want, you may return it for credit at the Club's expense.

As a Club member you agree only to the purchase of three books (including your first selection) during your first year of membership. Membership may be discontinued by either you or the Club at any time after you have purchased the first selection plus two additional books.

**Other McGraw-Hill Book Clubs:**  
Architects' Book Club • Byte Book Club • Chemical Engineers' Book Club  
• Civil Engineers' Book Club • Mechanical Engineers' Book Club

For more information, write to:  
McGraw-Hill Book Clubs, P.O. Box 582, Hightstown, New Jersey 08520-9959

### MAIL THIS COUPON TODAY

#### McGraw-Hill Book Clubs Electronics and Control Engineers' Book Club®

P.O. Box 582, Hightstown, New Jersey, 08520-9959

Please enroll me as a member and send me the two books indicated, billing me for the \$2.89 premium and my first selection at the discounted member's price, plus local tax, shipping, and handling charges. I agree to purchase a minimum of two additional books during my first year of membership as outlined under the Club plan described in this ad. A shipping and handling charge is added to all shipments.

Write Code No. of  
\$2.89 selection here

Write Code No. of  
first selection here



Signature \_\_\_\_\_

Name \_\_\_\_\_

Address/Apt. # \_\_\_\_\_

City \_\_\_\_\_

State \_\_\_\_\_ Zip \_\_\_\_\_

This order subject to acceptance by McGraw-Hill. All prices subject to change without notice. Offer good only to new members.

E33801

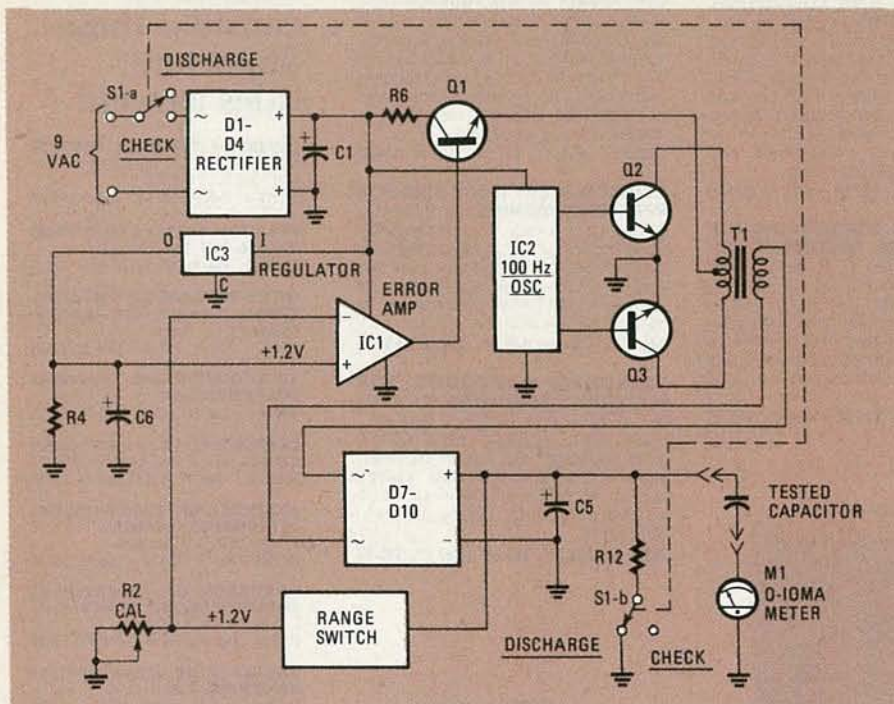

FIG. 1—THIS BLOCK DIAGRAM makes it easier to see how our little leakage tester works.

In operation, 9 volts from a plug-in transformer passes through switch S1-a and is rectified by diodes D1-D4. If field operation is required, it is possible to substitute a 12-volt battery for the plug-in transformer. The switch is a DPST unit that selects either power ON or capacitor DISCHARGE. From the rectifier, the output is filtered by capacitor C1, and is then used to power the rest of the circuitry.

Part of the power output is fed to IC3, a positive voltage regulator, which is used to provide a stable 1.2 volt reference for IC1. That ensures that the output voltage will be stable regardless of how much voltage is used to power the project.

Op-amp IC1 serves as an error amplifier. Its job is to ensure that the voltage applied to the capacitor under test is regulated. It does that by "sampling" the voltage at capacitor C5 through the range switch. The range switch is nothing more than a resistive attenuator network reducing the output voltage to about 1.2. The op-amp simply adjusts the power supply until its minus (inverting) input equals 1.2 volts. That regulates the output voltage.

Transistor Q1 serves as a control element for the rest of the power supply. Since the op-amp can't provide enough current to do the job directly, a Darlington power-transistor is used here to boost the current. Resistor R6 limits current to the rest of the circuitry, preventing transformer damage.

Moving on, the DC output from capacitor C1 powers IC2, which is a CMOS programmable one-shot wired as a 100-Hz oscillator with complimentary outputs. The outputs from IC2 alternately drive transistors Q2 and Q3, which serve

as switches. They alternately switch each side of the transformer T1 winding to ground, generating current pulses.

Transformer T1 performs two purposes. First it steps up the current pulses so that they can be rectified. Second, under heavy load (as from a charging capacitor) it saturates, limiting the output current to the capacitor to about 20 mA. That forms a constant-current type power supply, which is especially effective in charging test capacitors.

The output from transformer T1 is rectified by diodes D7 to D10 and filtered by capacitor C5. From that point the DC output feeds back to the range switch, which is used along with op-amp IC1 to set the output voltage. The DC output also drives the test capacitor, which is connected to the project through binding posts.

Meter M1 is included in the minus leg of the test capacitor for monitoring the charging and discharging currents. Note that resistor R12 and switch S1-b are included to discharge the test capacitor when the power is turned off.

That takes care of the basics. Now turn to the schematic diagram of Fig. 2 for some details on the finer points of the circuitry. You should be able to identify the parts we just discussed on the schematic diagram.

First let's look at the error amplifier, IC1. Basically, that amplifier is set up as an inverting, gain-of-100 unit. Resistors R3 and R5 set the gain value. Although that practice is rather unusual for a power supply (R5 is usually not included), the reduced gain is necessary to permit stable operation when testing very large capacitors (say 15,000  $\mu$ F). Diode D5 serves as

## PARTS LIST

All resistors 1/4-watt, 5%, unless otherwise noted

- R1—8200 ohms
- R2—5000 ohms, potentiometer, PC mount (Circuit Specialists 32JQ305 or equal)
- R3—100,000 ohms
- R4—270 ohms
- R5—10 megohms
- R6—10 ohms, 2 watts
- R7—2200 ohms
- R8—1 megohm
- R9, R10—10,000 ohms
- R11—18,200 ohms, 1/8-watt, 1%, metal-film
- R12—100 ohms, 2 watts
- R13—10 ohms
- R14—68 ohms
- R15—30,100 ohms, 1/8-watt, 1%, metal film
- R16—40,200 ohms, 1/8-watt, 1%, metal film
- R17—49,900 ohms, 1/8-watt, 1%, metal film
- R18, R19—100,000 ohms, 1/8-watt, 1%, metal film
- R20—150,000 ohms, 1/8-watt, 1%, metal film
- R21, R22—249,000 ohms, 1/8-watt, 1%, metal film

### Capacitors

- C1—1000  $\mu$ F, 16 volts, axial leads, electrolytic
- C2, C6—0.1  $\mu$ F, 50 volts, polyester
- C3—0.001  $\mu$ F, 50 volts, polyester
- C4—100  $\mu$ F, 16 volts, radial leads, electrolytic
- C5—2  $\mu$ F, 450 volts, axial leads, electrolytic

### Semiconductors

- IC1—LF356N op-amp (National)
- IC2—4047 CMOS one-shot (RCA)
- IC3—LM317LE adjustable voltage regulator (National)
- Q1-Q3—TIP120 NPN Darlington (Radio Shack 276-2068 or equivalent)
- D1-D4, D7-D12—1N4004 rectifier diodes, 400 PIV, 1 amp
- D5—1N4148 silicon signal diode
- D6—not used

### Other components

- M1—1-mA DC meter
- S1—DPST miniature toggle switch
- S2—12-position, 1-pole rotary switch (Radio Shack 275-1385 or equivalent)
- S3—SPST normally-closed pushbutton switch
- T1—117 volts/12.6 volts, 1.2 amps, center tapped (see text)
- T2—117-volts/9 volts, 300 mA, wall-plug transformer

**Miscellaneous:** PC board, plastic case (Radio Shack 270-627 or equivalent), knob, hookup wire, 4-40 hardware, press-on decals, etc.

An etched and drilled PC board plus all 1% resistors listed above and voltage reference IC3 are available for \$17.50 postpaid from: Mendakota Products, PO Box 2296, 1001 W. Imperial Hwy., La Habra, CA 90631. When ordering request part LC1 and enclose a check or money order for the appropriate amount. California residents include 6% sales tax. Sorry no COD's or credit card purchases.

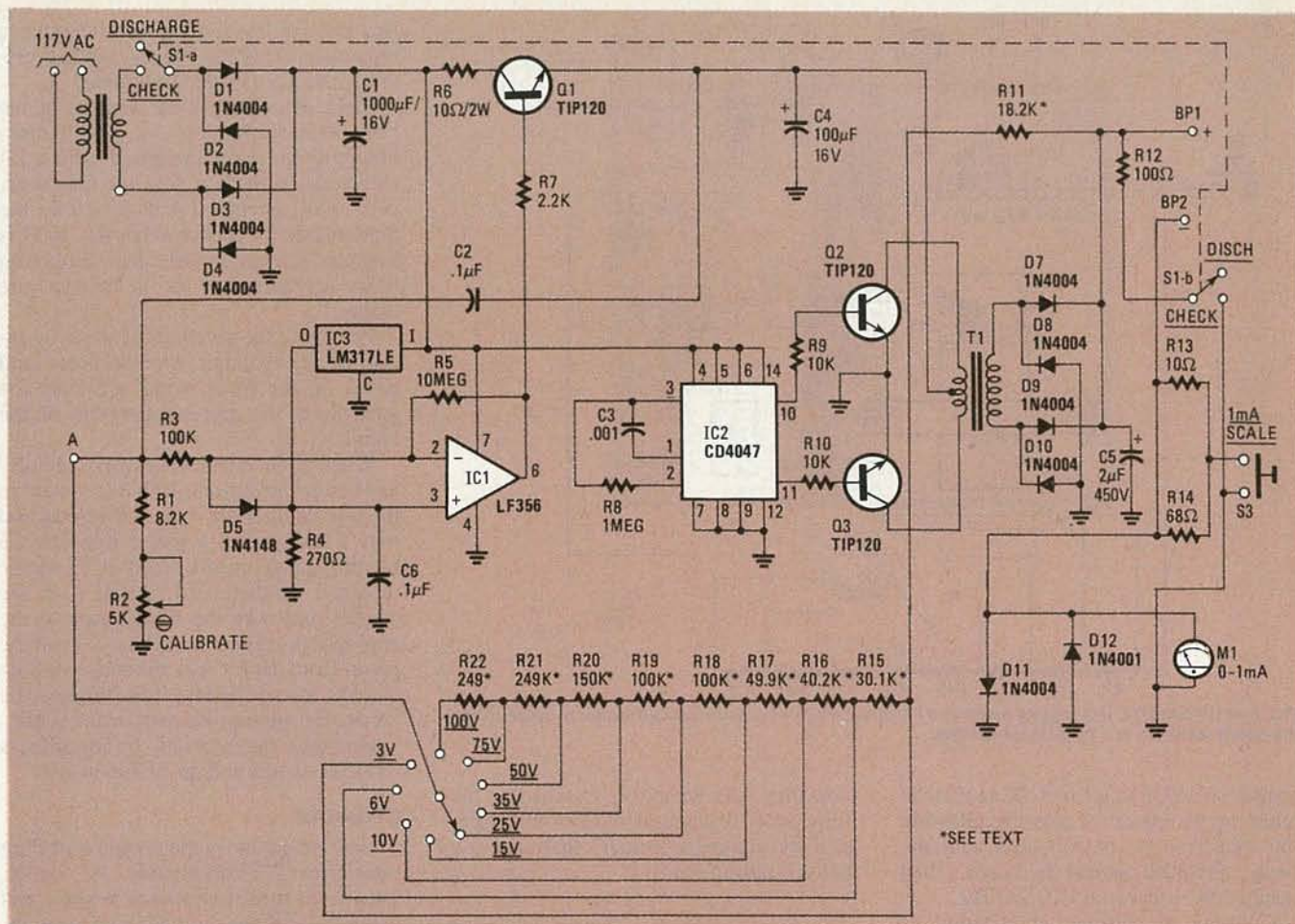

FIG. 2—THE CIRCUIT of our leakage tester is seen in greater detail in this schematic diagram.

overload protection, preventing excessive voltage from RANGE switch S2 from damaging IC1. That condition might occur if you were to switch rapidly from 100 volts to 3 volts. And finally, capacitor C2 provides some AC feedback, insuring stable operation over a wide range of capacitor loads.

Moving on, let's look at IC2. Resistor R8 and capacitor C3 set the operating frequency to 100 Hz. That frequency, while not critical, was chosen to prevent "beats" with the 60 Hz power line and permits increased output from transformer T1.

And finally, let's look at the metering circuit. Diodes D11 and D12 are included to protect the meter from harmful overloads, especially when a large capacitor is being discharged. A 10-mA current shunt consisting of resistors R13 and R14 is also included for measuring currents in non capacitor-testing applications. That shunt can be selected via pushbutton switch S3.

So much for the theory. Now why not get started building your project?

### Construction

We'll describe assembly shortly, but first a few words about obtaining the parts. The circuit uses no exotic parts, and most

should be available from Circuit Specialists (PO Box 3047, Scottsdale, AZ 85257), Radio-Shack, or your favorite electronics parts supplier. If you order the PC board from the supplier listed in the Parts List, you will also get the harder-to-find 1% resistors and voltage regulator. If you have trouble locating some items, try the suppliers that advertise in the back pages of this magazine. If after all of that you are still having difficulty locating a particular part, mail two first class stamps and a self addressed, stamped envelope to the PC-board supplier mentioned in the Parts List for assistance.

A word about T1: The board was designed to accommodate a transformer that was available from a parts supplier that had nationwide outlets. Since then, however, the transformer has been discontinued by that supplier. Fortunately, any 12.6-volt, 1.2-amp center-tapped transformer will do fine, although it likely will have to be mounted off the board.

Substitutions for other parts are also acceptable, providing they are equal or better in quality than the parts specified.

For the sake of both convenience and safety, you should use a PC board. If desired, you can buy one form the supplier listed in the Parts List, or else make one

from the artwork provided in the PC-service section, found elsewhere in this magazine.

Once you have assembled the parts and obtained or made the PC board, you can start construction. Refer to Fig. 3 for details as we discuss assembly.

Start by placing the board in front of you with the foil side down. Then install a 100  $\mu$ F capacitor at C4 along the top left-hand corner.

Continue by installing a wire jumper below C4. If you have been able to obtain a transformer that will fit on the board (see the preceding discussion), install it next. Otherwise, that transformer will have to be mounted off-the-board; in that event the wiring between the transformer and the board will be the among the last steps in the construction process.

Next, install IN4004 diodes at D7 to D10 as shown. After that, install a 2- $\mu$ F capacitor at C5, and a 100-ohm resistor at R12.

Finish up the top half of the board by installing a 18.2K (usually marked 1822F) resistor at R11, then a 10-ohm unit at R13. Also install a 68-ohm resistor at R14 and two IN4004 diodes at D11 and D12.

Move back to the left edge of the board and continue assembly. Install TIP120

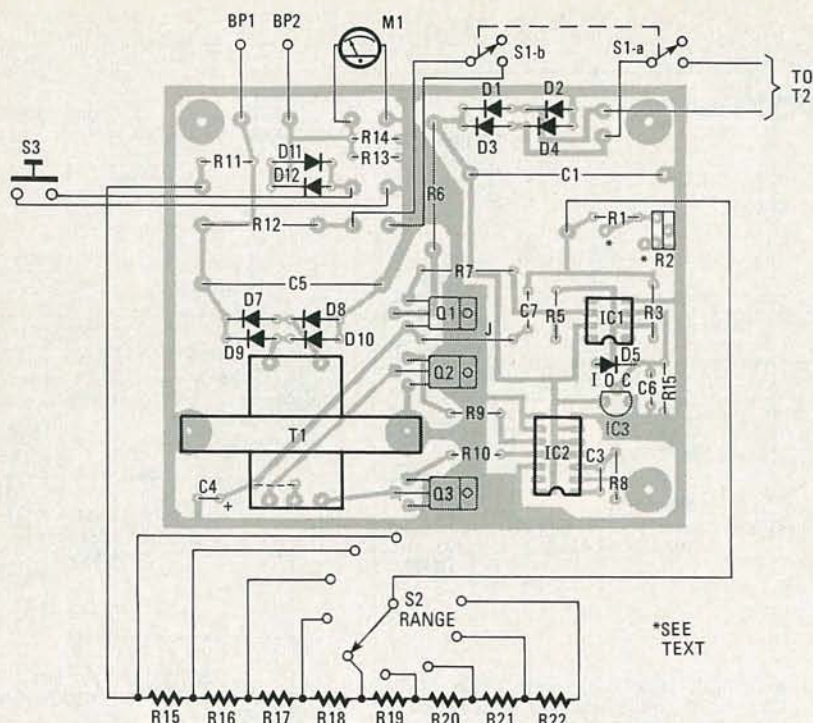

FIG. 3—FOR SAFETY, this project requires a PC board. Here we see the parts-placement diagram for the board shown in our PC Service section.

transistors at Q3 to Q1 first. Note that the leads are bent back 90 degrees, allowing the transistors to be mounted with the metal tabs flush against the board. Then install 10K resistors at R10 and R9.

Continue by cutting a short length of insulated wire and installing it between Q2 and Q1. Position the wire so it doesn't touch the transistors. Then install a 2.2K resistor at R7 and a 10-ohm unit at R6.

Install a 14-pin IC socket at IC2, then an 8-pin unit at IC1. Do not install those IC's until later. Next, install a 0.001- $\mu$ F capacitor at C3 and a 1-megohm resistor at R8. After that, install a 270-ohm resistor at R4, a 0.1- $\mu$ F capacitor at C6, and an LM317LE at IC3.

Finish the board by installing a 1N4148 diode at D5 and a 0.1- $\mu$ F capacitor at C2. Then install a 10-megohm resistor at R5 and a 100K unit at R3. Next install a 5K potentiometer at R2. If the single-turn unit specified in the parts list is used, position the potentiometer with the adjustment screw next to the board edge. The additional pads have been provided around R2 so that a  $\frac{3}{4}$ -inch, multi-turn potentiometer (Radio-Shack 271-343 or equivalent) can be used if desired. After R2 is in place, install an 8.2K resistor at R1 and the 1000- $\mu$ F capacitor at C1. Complete your work by installing IN4004 diodes at D1 to D4.

Check your work carefully, especially diode and capacitor polarities before continuing. Fix any mistakes now, because they will be harder to correct later.

Refer to Fig. 4 to see the construction details for S2 and its associated resistors. Note that it is easier to wire the switch

now than later when it is installed on the front panel. You might find assembly easier if you clamp the switch's shaft in a vise before starting work.

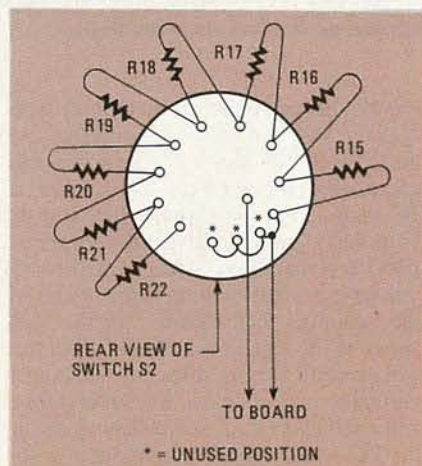

FIG. 4—RESISTORS R15-R22 are mounted on the rear of S2 as shown. Be sure to tie any unused switch positions to R15.

Wire the resistors on the back of switch S2 as shown. Note that most 1% resistors are marked in code; for instance, R15 would typically appear as "3012F."

When the resistors are wired in place, use a piece of bare wire to connect any unused terminals to R15 as shown. That prevents dangerously high voltages from appearing at the output terminals if S2 is set to an unused position. Finish the switch wiring by attaching 6-inch leads.

Set the board and switch aside for a moment and prepare the chassis. Note

that the PC-board (and T1 if required) mounts inside of the chassis, while everything else goes on the front panel.

Place the board in the bottom of the box, against the top side. Drill three mounting holes for the board, plus a 1/4 inch hole in the top side for the power cord. Drill another 1/4 inch hole in the bottom side for access to pot R2. If T1 is mounted off-the-board, drill mounting holes as appropriate for the unit you are using.

Complete the mechanical work by installing the switches, binding posts, and meter on the front panel. Connect the switches to the appropriate points on the board.

When done, check your work carefully and correct any errors. Install the board in the box using 4-40  $\times$  1-inch screws and nuts. Use a nut as a spacer between the board and box on each screw. If T1 is to be mounted off-the-board, install it in the chassis and wire the transformer to the appropriate points on the board. Feed the power cord (from T2) through the hole that has been drilled for it and connect the cord to the appropriate pads on the board.

Finish up the assembly by installing a CD4047 at IC2 and an LF356 at IC1.

### Checkout

Now we get to try the project out. Plug transformer T2 into a nearby AC outlet. Then set S1 to the DISCHARGE position and likewise set S2 to the 100-VOLT position. Set your DMM to its 200-volt DC range and connect it to the binding posts (BP1 and BP2).

Flip S1 to the CHECK position and the DMM will read somewhere between 85 and 120 volts. If so, the project works and you can go to the calibration.

If you are having problems, disconnect the power and discharge capacitor C5 with a jumper wire. Then check over your wiring for errors. Remember—when troubleshooting, always discharge C5 after turning the power off; that can prevent a dangerous shock.

### Calibration

Calibration is easy to perform. First set S1 to DISCHARGE, and then set S2 to the 100-VOLT range. Then set your DMM to its 200-volt DC range and connect it across the binding posts. Flip S1 to the CHECK position and adjust R2 until the DMM reads 100 volts.

To be on the safe side, you should check the output voltage for each position of S2; it should be within 2% of the panel value. If not, the 1% resistor associated with that position should be checked.

### Using the project

**Danger, high voltage!** This project can provide a dangerous electrical shock if misused. Avoid a harmful shock by using

*continued on page 94*

## A Revolution in IC Packaging

*We're in the midst of a revolution now—a packaging revolution!  
Find out what it's all about, and get a glimpse of what lies ahead.*

TJ BYERS

WHAT IS IT ABOUT ELECTRONICS THAT fascinates so many people so deeply? There are probably as many answers to that question as there are people to answer it, but no one could deny that part of our fascination is due to the rapid rate at which innovations are thrust upon the marketplace.

The problem is that today's innovations soon become tomorrow's commonplaces. Consumers quickly learn to take new products for granted, so that what was once superfluous soon becomes necessary. And as users master the use of those now-necessary products, their needs become more sophisticated. In order to meet those needs, electronic circuits must become more complicated. Hence designers find it increasingly difficult to fit the components that are required into the space that is allotted for those components. The space problem is particularly acute in the computer industry where standardized card sizes and limited numbers of expansion slots set artificial limits on expandability.

In order to alleviate space problems designers are constantly on the lookout for ways of cramming more circuitry into the same—or even less—space. The first major breakthrough occurred in the late 1940's when the transistor was invented. The second breakthrough occurred in the early 1960's when the integrated circuit was invented. We're in the midst of the third stage right now; it comes in two parts: VLSI (Very Large Scale Integration) and SMT (Surface Mount Technology).

VLSI refers to the design and manufacture of IC's that contain great numbers of transistors and other circuit elements. SMT refers to extra-small components (resistors, capacitors, transistors, IC's—in fact, most components) that are soldered to the surface of a PC board—but with no legs penetrating to the opposite side of the board! We won't discuss VLSI any further in this article, but we will discuss various SMT packages, how to mount them to PC boards, and how to troubleshoot and repair PC boards built with SMT devices.

### DIP vs. SMT

The success of the semiconductor industry is due, in great part, to the standardization of the DIP (Dual Inline Package) IC. Basically, a DIP is a rectangular block of plastic, ceramic, or other material that encapsulates the silicon chip on which the actual circuit elements are etched. Access to the chip is via metal leads that protrude from both sides of the case at intervals of 0.100 inch. That spacing arose from the need to have a lead strong enough to withstand the rigors of automatic insertion machinery.

The DIP has served the industry well, but as the encapsulated circuitry has become more complex, the package has become larger. The problem is not the size of the silicon chip; it's that highly complex IC's need more connections to the outside world.

Since lead spacing is a fixed quantity, the package grows larger while the chip itself increases very little. We end up with a very small chip in a very large container.

### SMT to the rescue

IC's packaged in the SMT manner have legs spaced on 50-mil (0.050-inch) centers, and that alone allows us to reduce the size of an SMT package from 30 to 60 percent over a comparable DIP device. This means that more IC's can fit in the same amount of PC board space. In fact, we might mount two or three IC's in the space formerly occupied by one. Further, using standard packaging techniques, surface-mount assemblies can approach the density of hybrid circuits, which are the most densely-packed assemblies currently in production. And SMT assemblies can be repaired, whereas hybrids cannot.

The advantages of SMT IC's become apparent when they are used with double-sided PC boards. Using surface-mounting techniques, it is possible to have two completely different circuits on one PC board—one on each side. That, of course, is impossible with through-hole technology. The equivalent of two cards can now occupy the space of one, and signals can be



passed from one circuit to the other using jumpers from one side of the board to the other, and that reduces outside wiring requirements. And since the legs of an SMT device don't penetrate the PC board, boards are both cheaper to manufacture and more reliable in operation.

### Types of SMT devices

There are, basically, three different types of surface-mounted IC's: the SOIC (Small Outline Integrated Circuit), the PLCC (Plastic Leaded Chip Carrier), and the LCCC (Leadless Ceramic Chip Carrier). See Fig. 1 to get an idea how each looks in comparison with a standard DIP package.

The SOIC is probably the most popular SMT package; it was developed in Europe in the mid 1970's for use in electronic watches. The SOIC resembles a small DIP with its leads bent out gull-wing style and spaced at 50-mil intervals. The gull-wing design permits the tips of the leads to lay flat on the surface of the PC board; it also allows easy access to those leads for troubleshooting and repair. The SOIC comes in 8-, 14-, 16-, 20-, 24-, and 28-pin packages, and it can be handled by the same automatic insertion equipment that is used for DIP packages. That makes

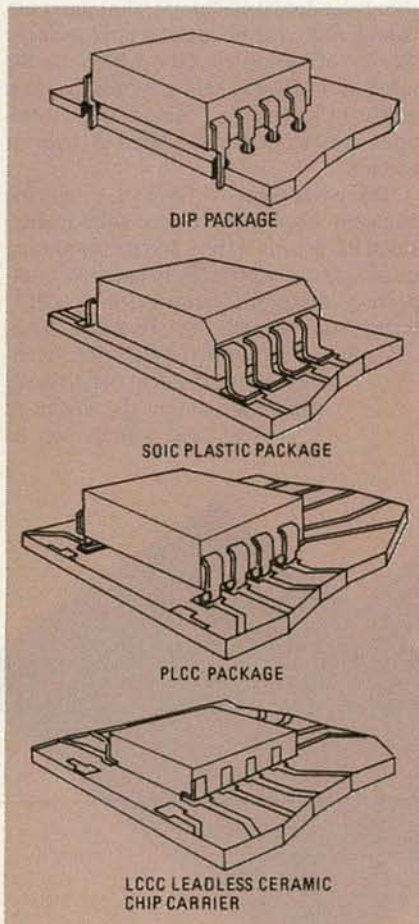

FIG. 1—THE THREE MAIN TYPES OF SMT DEVICE are shown beneath a standard DIP device. The drawing is not to scale.

SOIC the preferred choice when several packaging technologies are used on the same PC board.

### The PLCC

The leads of a PLCC package are formed in a way that is similar to the way SOIC leads are formed. The difference is that the leads are rolled up under the molded plastic body in a J-like shape. Tucking the leads beneath the package reduces the size of the IC; that allows greater component density, and it also provides protection from lead-handling damage. But the tucked-in leads are harder to get at, so PC boards are harder to troubleshoot and repair.

The PLCC's biggest advantage over the SOIC is that a PLCC can have leads on all four sides. To understand how important that can be, consider this: The DIP package grows disproportionately larger than the chip it houses because of the additional width required to route interconnecting wires from the silicon die to the outside world. The more leads a DIP contains, the wider it must be to avoid the possibility of two leads shorting together. Four-sided carriers help alleviate that problem by connecting leads to the previously unused ends of the package. PLCC's have another advantage in that they can be socketed, but SOIC's cannot.

PLCC's are available in 18-, 20-, 28-, 44-, 52-, 68-, and 84-pin packages; they're footprint-compatible with LCCC's, discussed below; and they conform to JEDEC (Joint Electronic Devices Engineering Council) standards. PLCC's currently cost about the same as standard plastic DIP's.

### LCCC's

The third major type of SMT IC burst upon the scene in the early 1970's. The most notable feature of the LCCC is that it has no leads; rather, metallic contacts are molded into its ceramic body. Like the PLCC, the LCCC can have from 20 to 84 contacts on all four sides. LCCC's are the most rugged members of the SMT family, and that explains their preference by the military. An LCCC device mounted on a PC board is shown in Fig. 2, and an LCCC with its "hat" off is shown in Fig. 3.

There is one problem with LCCC's. An LCCC must be bonded to its circuit board rigidly. Although that is desirable mechanically, it creates thermal problems. All things in nature—circuit boards and IC's are no exception—change in size as temperature changes, and different materials have different coefficients of expansion. That is, some things expand more than others for the same change in temperature. For example, the ceramic of an LCCC and the glass epoxy of typical PC boards have different coefficients of expansion. The shearing force that develops because of those different amounts of ex-

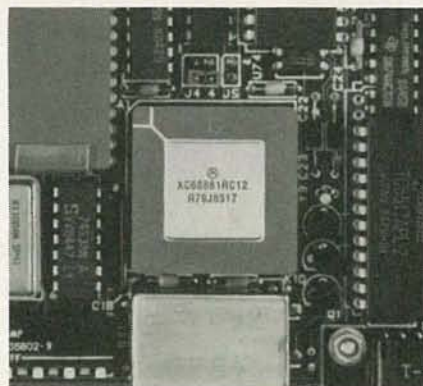

FIG. 2—NEW IC'S OFTEN COME IN SMT FORM, but the bulk of many circuit boards will continue to be DIP IC's.

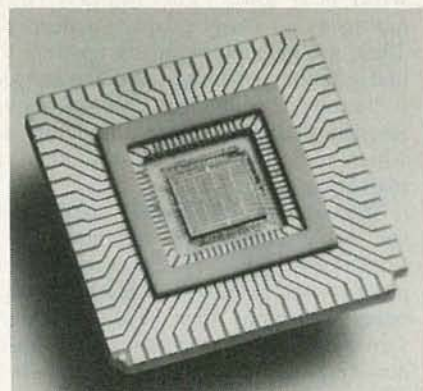

FIG. 3—THE GUTS OF AN LCCC DEVICE reveal the closely-spaced wires that connect the chip to the outside world.

pansion can cause solder bonds to snap. In comparison, SOIC and PLCC packages aren't affected by thermal expansion because the stress is absorbed by their resilient metal legs.

The problem of thermal expansion has plagued the LCCC since its introduction, and it's the major reason why the LCCC has had so little impact on the commercial market. Only by using expensive, thermally-compensated PC boards, made with such exotic materials as Invar, are LCCC's really practical.

To avoid thermal expansion problems, an LCCC can be mounted in a socket. Sockets, however, have problems of their own, and actually defeat some of the advantages gained by the LCCC package.

Now that we've got an idea of the different kinds of SMT IC packages that are available, let's take a look at how we can use them.

### Using SMT IC's

Since SMT devices are soldered directly to PC boards with no additional mechanical support, special handling is required. First, you must realize that the only mechanical bond between the device and the board is the solder connection itself. Consequently, the solder joints must be not only electrically sound, but mechanically strong.

Unfortunately, only the SOIC, with its



gull-wing design, lends itself well to conventional soldering methods. Both the PLCC and the LCCC packages have their solder contacts tucked under the body of the device where they are relatively inaccessible.

Manufacturers have overcome that obstacle by using techniques like reflow soldering. In that process both the pads on the PC board and the leads of the SMT device are pre-tinned. Next, a flux is applied to the solder pads on the PC board; that flux contains a quantity of granulated solder (85-90% by weight) that is held in suspension by the thick flux paste.

The IC is aligned with the solder pads and pressed into place. The entire assembly—PC board, components, and all—is then heated to a temperature where the solder melts and the flux evaporates. At that temperature, the solder on the leads of the device, the solder on the PC pads, and the solder in the paste flow together and become one. Cooling the assembly solidifies the molten solder, and that forms a connection that is (hopefully) electrically and mechanically sound.

Several methods of heating are currently in use, including infra-red, vapor phase, and convection. With minor adjustments, conventional wave-solder machines can also be used for SMT components, but those components must be glued to the PC board prior to immersion.

Part alignment, of course, is critical to the success of reflow soldering. With no leads projecting through holes in the PC board to secure them in place, leads and solder pads can become misaligned. Manufacturers try to counter that problem by adding an adhesive compound to the flux so that the part is held tightly in place until the reflow process heats the flux to the point of evaporation. Most types of flux adhesive are hardened using ultraviolet light, but some permit air drying.

Of the three major types of SMT packages, the LCCC is the most forgiving of misalignment. In fact, as much as 25% misalignment is permitted because the surface tension of the molten solder allows the LCCC to align itself with the PC board's solder pads. SOIC and PLCC devices are not so forgiving. Unless the error is very small, any misalignment in parts of those types could be disastrous. How can we correct such errors?

### SMT troubleshooting

It is estimated that, by 1990, 70 percent of all electronic equipment throughout the world will be manufactured with SMT devices. Consequently, the hobbyist as well as the service technician will soon be faced with a whole new set of fabrication and repair problems.

Size is one such problem. SMT pins are spaced 50 mils apart, so troubleshooting with standard test probes will be like knit-

ting with telephone poles! The narrow width of an SMT lead makes it difficult to get a probe into the test area, and it makes it easy for the probe to slip and to short adjacent pins. The result of such a slip could be devastating to the circuit.

The actual mounting technique itself is the source of another problem. Often, much of the interconnecting circuitry—the etched copper traces—lies buried beneath the SMT components. That makes it hard to perform standard signal tracing. The problem is compounded further by high component density, which leaves few traces between components exposed.

One way of getting at LCCC leads is with an IC test clip, like the one shown in Fig. 4. Since the contacts in the clip are precisely spaced and rigidly fixed, the danger of shorting pins together is reduced. Unfortunately, you need a different test clip for each package size. One thing that could help the IC test-clip crunch is to place strategic test points on the PC board in easily-accessible places.

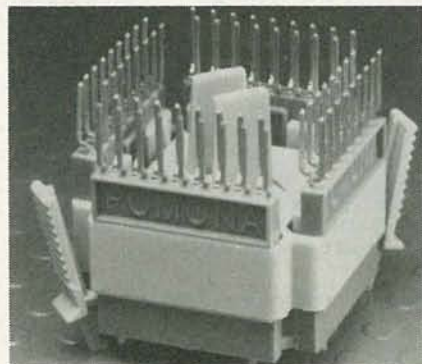

FIG. 4—QUAD CLIP FROM POMONA attaches to a 68-pin PLCC and allows the user easy access to the closely-spaced leads of the device.

Test equipment will also be affected by increased use of SMT devices. For example, we'll need equipment with faster clock speeds and faster rise times. The reason is that, by reducing the size of components, and thereby shortening the signal paths between them, rise and fall times become sharper, and clock rates can increase. You'll find that test equipment that worked well with DIP devices can't monitor the faster events of SMT units.

### SMT repair procedures

Tracking down a bad SMT device will be difficult, but it will be even more difficult to remove that device and mount a new one in its place. One useful tool for SMT removal, the heated collet, is shown in this story's opening photo.

A heated collet is quite similar to a desoldering tool used to remove DIP devices. A DIP-desolderer is a bar of metal that makes contact with, and thereby heats, all pins of a device at the same time. After the solder melts, the part can be removed from the board easily.

SMT soldering collets work somewhat differently than DIP desoldering tools.

First, the collet clamps around the device itself, rather than contacting the through-hole pads of the PC board. So a separate collet is required for each package size. In addition, the collet must heat the entire SMT device, along with the pads on the board, so precise heat regulation is required in order to avoid destroying a heat-sensitive part. And that, of course, results in an expensive tool.

A heated collet can also be used to attach a replacement device. However, the PC board and the SMT device must be prepared for reflow soldering.

Begin by removing excess solder from the pads on the PC board. Braided solder wick works well for that chore. After the pad is completely clean, apply a dab of reflow soldering flux to each pad. Only reflow flux (which contains solder) can be used; conventional flux compounds will not work. The amount of flux that is required varies from brand to brand, so you should read the directions that come with the product. Most surface-mounted devices are pre-tinned, but you should make sure that your device is properly tinned before trying to mount it. If necessary, tin the leads of the new component. In any case, tarnished leads should be thoroughly cleaned and freshly tinned.

Now align the part with the solder pads, taking careful notice of pin orientation. Although at room temperature many reflow fluxes are sticky enough to prevent an SMT device from moving, as the flux is heated, the device may begin to creep. Therefore, you should glue the part in place with a quick-setting adhesive (from a hot-glue gun, for example) to keep things aligned. You must be extremely careful to align the leads with the solder pads perfectly before the glue sets—otherwise you may have a *real* problem!

After the glue has set, apply the heating collet to the replacement IC. Within a few seconds the flux should vaporize and produce a small puff of smoke. Keep the collet pressed against the IC for a second or two longer and then release it. This ensures that the solder from all three sources will flow together smoothly. Don't heat an SMT device for more than about 10 seconds or the device may be damaged. You can remove excess flux from the board with denatured alcohol.

Removing an SOIC device is easier because the gull-wing leg design allows the legs to be accessed individually with a low-powered soldering iron. The problem is that, even though SOIC devices are easy to replace, the industry tends to use PLCC devices more often because they have a smaller footprint, and because they are easier for automatic insertion equipment to handle.

As we mentioned above, IC's aren't the only devices that come in SMT packages. Let's take a look now at how several other devices are packaged.

## One-megabit DRAM

The semiconductor industry is on the verge of perfecting a 1-megabit Dynamic Random Access Memory IC, so manufacturers are designing an appropriate package. To arrive at a standard, manufacturers are looking beyond just package design. Trends indicate that sales of both 256K DRAM's and one-megabit DRAM's could be the largest the semiconductor industry has ever seen. So the configuration arrived at now will affect future DRAM designs considerably.

The problem is simply that the standard DRAM package, which has satisfied memory needs for ten years now, has run out of space. When that package was created, it had more pins than were needed. But as memory chips grew in size, more and more of those pins were used, and the 256K DRAM has claimed the last pin.

In addition to running out of pins, designers also want to take advantage of the benefits provided by SMT packaging. One design that is receiving critical review is the Small Outline J-lead, or SOJ, surface-mounted package that Texas Instruments has proposed; it is shown in Fig. 5.

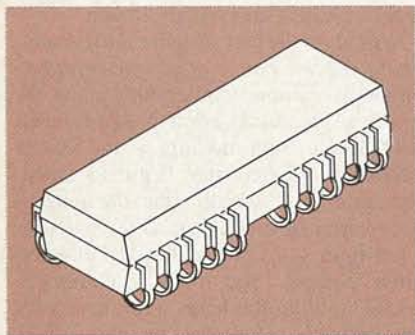

FIG. 5—TI'S PROPOSED ONE-MEGABIT DRAM allows an SMT bypass capacitor to be mounted beneath the IC.

Calling on its years of surface-mount experience, TI has introduced an IC carrier that is a radical departure from mainstream PLCC designs. TI's SOJ device is a 26-pin package in a  $300 \times 675$  mil (width  $\times$  length) configuration. Since the IC uses only 20 pins, TI reasoned, six pins could be removed—from the middle of the carrier. TI thought that, by removing the pins from the center of the carrier, there would be space to mount a decoupling capacitor beneath the IC, as well as to provide room for routing PC traces.

The concept quickly gained wide approval, and the outline has been accepted by JEDEC (Joint Electronic Devices Engineering Council) as the standard configuration for one-megabit DRAM's. The only factor that remains to be decided is the final size of the SOJ device.

## Surface-mounted transistors

Two standard packages, the TO-236/SOT-23 and the TO-243/SOT-89, already

exist for surface-mounted transistors and diodes. The TO-xxx is the designation used in North America, and the SOT-xx is used in Europe. The designations mean the same thing, but SOT is the popularly-accepted nomenclature both in the U.S. and abroad. TO is the acronym for Transistor Outline, and SOT for Small-Outline Transistor.

Originally designed for use in hybrid-circuit construction, SOT packages are normally used to house small-signal transistors; the package can dissipate up to 200 mW in free air. The performance of SOT devices is equal to that of conventionally-packaged ones.

As shown in Fig. 6, the SOT-23 package has three leads, two on one side, and

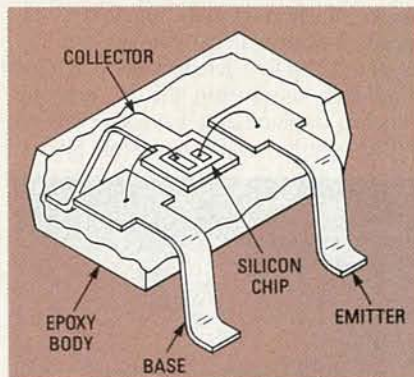

FIG. 6—THE SOT-23 TRANSISTOR package is only about 0.25-inch on a side.

the third in the center of the opposite side. The leads are formed in gull-wing fashion similar to the SOIC. The SOT-23, including leads, is about  $\frac{1}{10}$ -inch on a side—that's about  $\frac{1}{3}$  the size of an ant!

## Other SMT devices

New SMT configurations are introduced often. For example, the SO8 package shown in Fig. 7 is actually about 0.25-inch on a side, but it is functionally equivalent

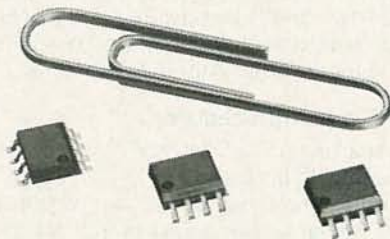

FIG. 7—THE SO8 IC PACKAGE is also about 0.25-inch on a side and it contains the equivalent of a 78L05 regulator.

to a 78L05 voltage regulator. In addition, components other than semiconductors are becoming available in SMT configurations. For example, the devices shown in Fig. 8 are surface-mount trimmer resistors manufactured by Noble



FIG. 8—TRIMMER RESISTORS also come in SMT form; each device is about 4 mm on a side.

U.S.A. (151 Stanley Street, Elk Grove Village, IL 60007). The "chip trimmer" devices can operate at temperatures ranging from  $-30^{\circ}\text{C}$  to  $+100^{\circ}\text{C}$ , and they can handle 200 mW of power at 20 volts. They measure about 4 mm on a side, and they're about 2 mm thick.

## SMT in the real world

To get an idea of how SMT devices may be used, take a look at Fig. 9. Shown there is a 128K  $\times$  eight-bit static RAM module;

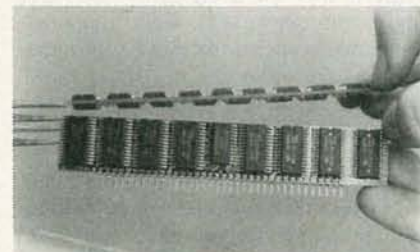

FIG. 9—STATIC RAM MODULE built with SMT devices uses less power than comparable dynamic RAM's.

overall dimensions of the device are less than  $1'' \times 5''$ . There are eight  $8\text{K} \times 8$ -bit static RAM's and a custom decoder IC mounted on one side of the module, and eight more RAM's and four  $10\ \mu\text{F}$  bypass capacitors mounted on the other side.

According to the manufacturer (Advanced Electronic Packaging, 2159 Bay Street, Los Angeles, CA 90021), the module uses 500 times less power bit-for-bit than a conventional  $256\text{K} \times$  one-bit dynamic RAM.

## Conclusions

The watchword in electronics these days is SMT, and what SMT stands for is increased utility that uses less power and that occupies less space. For example, one company is marketing 20-megabyte disk drives for the IBM PC. The complete disk controller electronics, as well as the drive itself, is mounted on a single standard-sized plug-in expansion card.

The increased utility that SMT brings, however, goes hand-in-hand with new problems in manufacturing and troubleshooting. So new tools and techniques will be needed to keep up with SMT. **R-E**

## Making Measurements with IC's

*New IC sensors are revolutionizing the way industry gathers information. In this article we learn about the kinds of devices currently available, and what shape future sensors are likely to take.*

**HARRY L. TRIETLEY**

WE ALL KNOW HOW SEMICONDUCTOR technology has revolutionized electronics. In one generation we have gone from hand-wired assemblies using vacuum tubes to entire computers mass-produced on silicon wafers by largely-automated processes. That revolution has transformed industries, and, indeed, the economy of the world. Needless to say, the effects have also been felt in the fields of consumer and hobby electronics.

The electronics industry is now in the early stages of a similar revolution in sensor manufacture. At present, most devices that measure such variables as temperature, pressure, force, and chemical composition are assembled from discrete components, and often require machining, hand assembly, soldering, welding, gluing, epoxying, etc. Now, however, new techniques for the creation of mechanical microstructures and chemically-sensitive devices in silicon are changing all that. Integrated silicon devices measuring temperature, strain, pressure, and video images already are available from several manufacturers. University and laboratory research is progressing on electrochemical and other complex sensing devices. In this article we'll take a look at today's sensor products, the research that is being done in the field, and what form future sensors might take.

### Temperature sensors

The drop across a forward-biased P-N junction (diode or base-emitter junction) is about 0.7 volts at 25°C. As temperature rises, that voltage drop decreases by about -2millivolts/°C. Because of that, diodes and transistors are sometimes used as temperature sensors, especially in compensation applications where absolute accuracy is not important. The exact temperature sensitivity depends on the semiconductor's doping, the junction's geometry and current density, and resistances in series with the junction. Those characteristics vary from device to device. Manufacturers do not normally control or test for exact temperature coefficient.

Temperature sensor IC's having controlled characteristics are available; they are generally housed in conventional transistor or IC packages. Several different families exist, each with its own unique circuitry and output. Fig. 1 shows the

schematic of one device, an Analog Devices AD590. In that IC, two identical transistors, Q9 and Q11, are connected so that the ratio between their two collector currents is fixed. For a ratio  $r$ , the difference between their base-emitter voltages will be proportional to absolute temperature,  $T$ . More specifically, the difference will be  $(kT/q)(\ln r)$ , where  $k$  is Boltzman's constant,  $q$  is the electron charge and  $(\ln r)$  is the natural logarithm of the current ratio.

That voltage is converted to a current by R5 and R6, which are low-temperature-coefficient thin-film resistors that are

laser-trimmed for proper calibration at 25°C. The collector current of Q10 tracks those of Q9 and Q11. Transistor Q11 supplies all the leakage and substrate current used by the rest of the circuit. That forces the entire current to be proportional to the absolute temperature. The AD590 is a two-terminal device, inserted in series with any DC supply between 4 and 30 volts, regulating the series current to be equal to  $1\mu A/^{\circ}K$ , where  $^{\circ}K$  is the Kelvin temperature ( $1^{\circ}K$  equals  $1^{\circ}C$  plus 273.15.)

The operating range for temperature-sensor IC's is similar to that of other IC's, generally -55 to +150°C. Although lin-

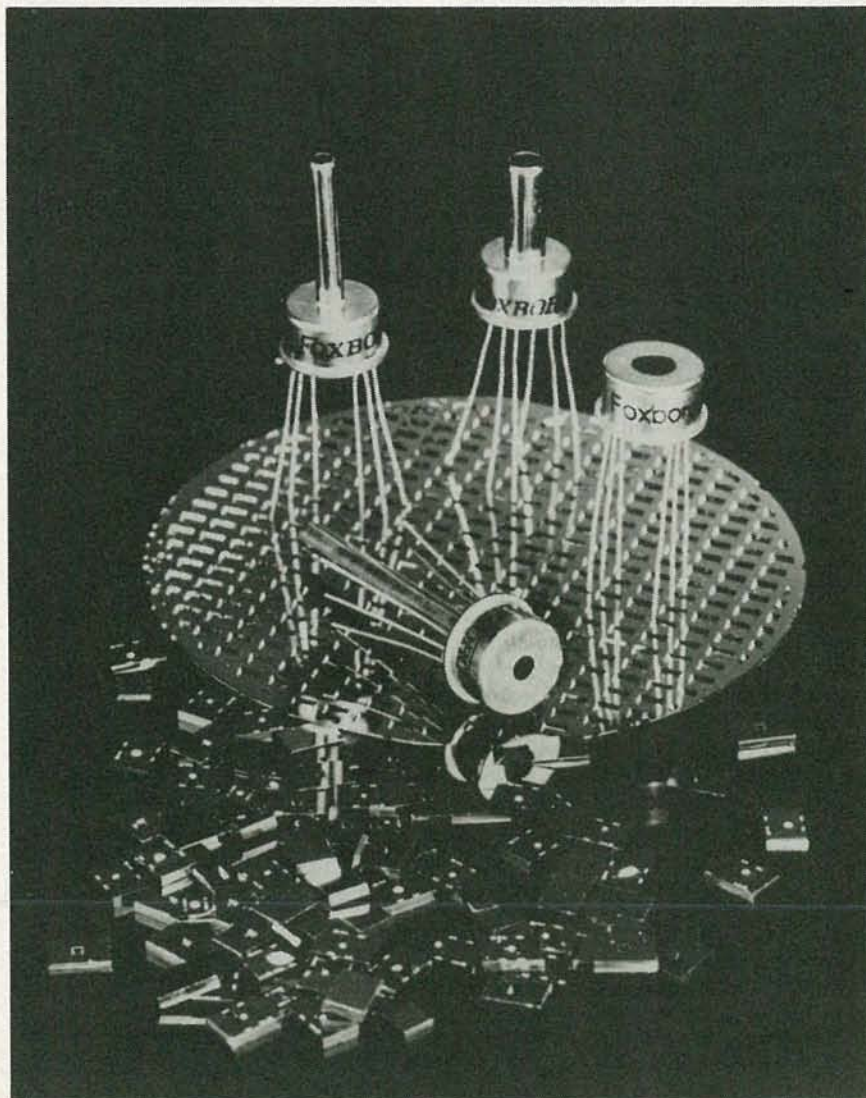

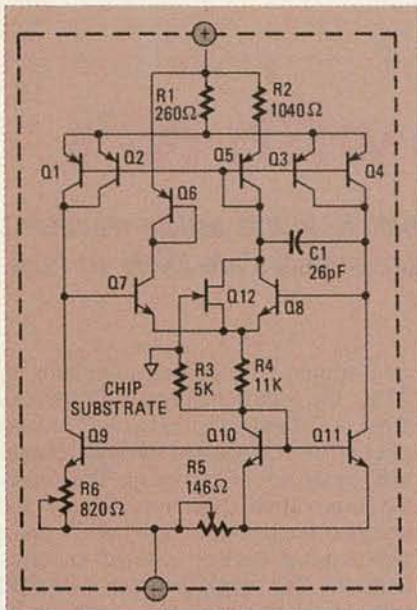

FIG. 1—IN THIS IC TEMPERATURE SENSOR, the AD590, the ratio of the base-emitter voltages of Q9 and Q11 is proportional to the absolute temperature.

ear, their accuracies and stabilities do not yet equal those of other temperature sensors. Remember, however, that those devices have only recently been developed and their performance is likely to improve with continuing research.

### Strain gages

Strain gages respond to mechanical stress, changing their resistances as they are stretched or compressed. Bonded to metal or other slightly elastic surfaces, they are often used to measure mechanical force, weight, or tension. Lengths of doped silicon (that is, silicon resistors) undergo noticeable resistance changes when they are stressed, mainly because distortion of their crystal lattice structure changes both the concentration and the mobility of their charge carriers (electrons or holes).

Strain gages increase (p-type) or decrease (n-type) in resistance as they are stretched. Strain gages may typically be stretched or compressed up to 0.5% of their original length, at which point they will undergo resistance changes of between 25% and 100% depending on their doping.

A multiple strain gage, perhaps configured as a strain-gage bridge as shown in Fig. 2-a, may be diffused into silicon structures. Two such structures are shown in Fig. 2; Fig. 2-a shows a diaphragm while Fig. 2-b shows a beam. The diaphragm is used to measure pressure, as we shall see shortly, while the beam is used to measure force.

Unfortunately, silicon resistors are affected by temperature as well as strain. (In fact, they are also sold as positive-temperature-coefficient thermistors.) Without some sort of compensation, normal

ambient temperature fluctuations can cause significant measurement errors. Also, even at a constant temperature, their sensitivity and calibration will vary from unit to unit. Those effects can be compensated for by using fixed resistors and connecting the gage or gages as a Wheatstone bridge. The value of those fixed resistors is determined by measuring the bridge's behavior at two or more temperatures. That information is then fed to a computerized circuit model to calculate the fixed bridge-resistor values. The resulting circuit generally looks somewhat like the one shown in Fig. 3. Those measurements and calculations are beyond the capabilities of most experimenters and many production facilities; however, manufacturers of the devices (especially integrated devices such as those in Fig. 2) can supply the calculated values for each individual device.

### Pressure sensors

Integrated-circuit pressure sensors are made by etching a thin membrane in sil-

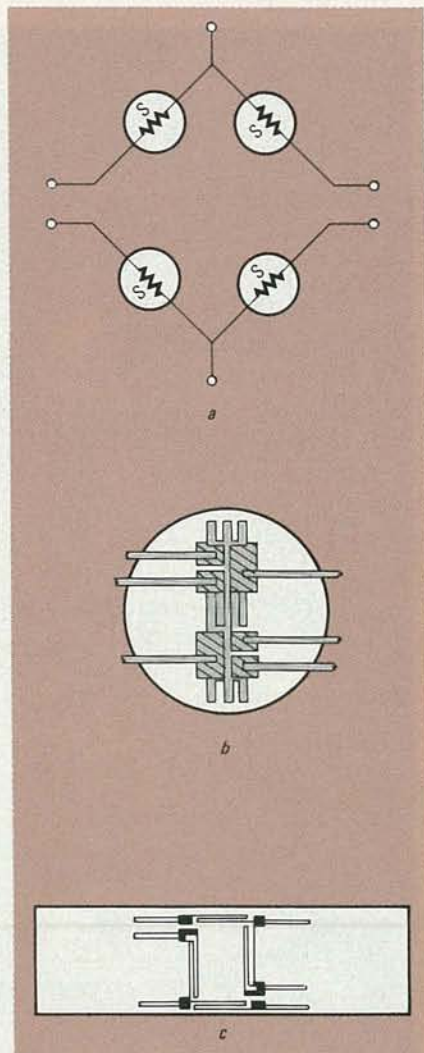

FIG. 2—A STRAIN GAGE BRIDGE (a) can be diffused into a silicon diaphragm to measure pressure (b) or into a beam to measure force (c).

icon. A strain-gage bridge is diffused into the membrane and protected by a grown layer of silicon oxide as shown in Fig. 4. The cavity behind the diaphragm is covered by a Pyrex or silicon backing-plate. Barometers or absolute pressure sensors are created by evacuating and sealing the cavity, while gage-pressure or differential-pressure devices include an opening through the back plate.

Integrated pressure sensors are most often mounted in transistor-type housings. Absolute pressure sensors have a single hole or connection tube; gage- or differential-pressure devices include a second opening. Manufacturers offer assemblies designed for more rugged applications, including industrial assemblies in which the IC is protected from corrosive fluids by stainless-steel diaphragms.

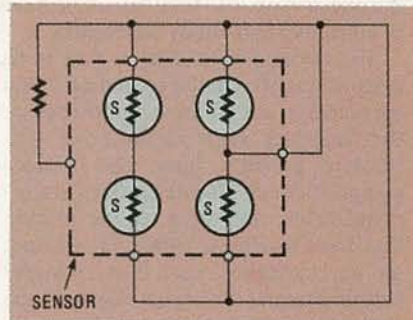

FIG. 3—FIXED RESISTORS can be added to a silicon strain-gage bridge to adjust its sensitivity and minimize its drift with temperature.

Let's look at some typical transducer specifications. Pressure ranges run from 5 to 5,000 psi, with full-scale sensitivities between 50 and 300 mV. Sensitivity tolerances may be  $\pm 25$  or 50% of nominal, with zero-offset tolerances adding another several percent. It is up to the user to calibrate his readout circuitry to match each particular sensor. With some devices it is also necessary to add temperature-compensating resistors using values computed by the manufacturer as mentioned earlier. Some manufacturers do supply calibrated assemblies including electronics; those, however, are not monolithic ICs.

### Acceleration

To simplify things somewhat, acceleration may be measured by attaching a mass to a spring or other elastic device. When the opposite end of the spring is accelerated, the spring stretches or is compressed. The change in length (strain) is proportional to the rate of acceleration.

The basic concept, as applied to an integrated semiconductor-accelerometer, is shown in Fig. 5. A thin cantilever beam is etched into the silicon crystal, using an anisotropic etchant, which dissolves the silicon well in certain direction but poorly in others, to etch a cavity under the beam.

A mass is attached to the unsupported end of the cantilever, either by etching so as to leave a mass of silicon or by adding a heavy electroplated layer of gold. The device is sealed with a protective glass top cover. Typical dimensions of an experimental device reported by Stanford University are  $2 \times 3 \times 0.6$ -mm. The cantilever itself is  $15\mu\text{m}$  thick.

When the device is accelerated perpendicularly to the cantilever, the beam flexes, its displacement being proportional to the acceleration. Displacement may be measured by diffusing a strain gage into the cantilever or by depositing a piezoelectric material on it.

Note that the device discussed here is experimental; as far as the author is aware, no commercial IC accelerometer devices are available at this time.

### Hall-effect sensors

A Hall-effect device (the Hall effect was first demonstrated by E. F. Hall in 1879) measures magnetic-field strength by deflecting moving electrical charges in a semiconductor. The amount of deflection of that moving charge is proportional to the field's strength.

The concept behind the Hall-effect device is shown in Fig. 6. Electrons flowing in an n-type semiconductor are deflected by the magnetic field at right angles to the direction of the current. That causes them to drift to the right, inducing an electric field between the sides of the semiconductor as shown. The electric field's force opposes the magnetic deflection, producing a balanced condition. As a result, the induced voltage is proportional to both the current and the strength of the magnetic field. A similar effect occurs in p-type semiconductors; however, the induced electric field's polarity is opposite that shown in Fig. 6.

Several companies, including Sprague and Texas Instruments, offer commercial devices based on the Hall effect, usually integrating analog or digital signal-conditioning circuitry with the sensor.

Digital-output devices are used in conjunction with permanent magnets as proximity switches and mechanical limit-sensors, and may replace mechanical microswitches in many applications. They are useful in keyboards (the magnet is in the switch cap) and other control devices, having no contacts to wear or bounce. Other applications are as diverse as pinball detectors and ignition switches.

Analog-output Hall-effect devices are used to measure magnetic flux or to sense movement of a permanent magnet. The latter, of course, allows movement to be translated into an electrical signal. A Hall device also can serve as the secondary of a DC transformer to allow the isolated measurement of DC currents. Let's explain further: A winding on a transformer core produces a field proportional to its cur-

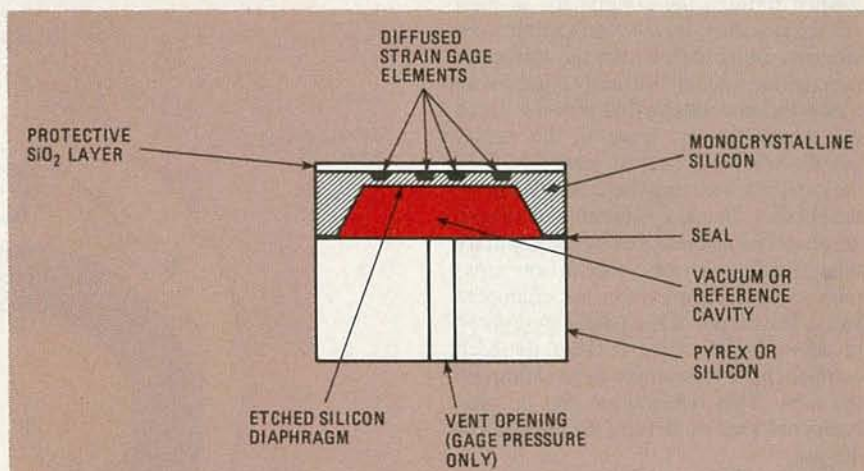

FIG. 4—AN INTEGRATED PRESSURE SENSOR is created in silicon by etching a thin membrane, then diffusing four strain gages in it. The sensor is completed by sealing it with a backing of Pyrex or silicon.

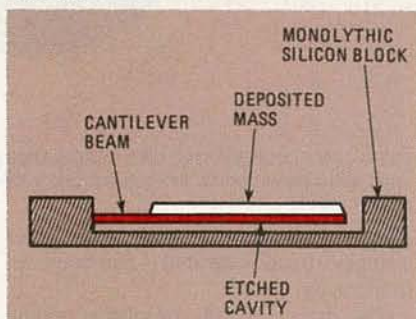

FIG. 5—A COMPLETE ACCELEROMETER can be etched from a single, monolithic crystal of silicon. A strain gage diffused into the cantilever beam detects the flexing of the beam as the device is accelerated or vibrated.

rent; the Hall effect sensor is used to measure the field directly, and the DC current indirectly. In the case of large currents (say, 30 amps or more) the primary can be a single wire inserted through the center of the core.

### Image detectors

TV and image detectors are large-scale photodiode arrays, integrated with switching and shift register circuitry that scans the diodes and produces a serial output. Array sizes run from single-line devices of 64 to 4,096 diodes, to matrix arrays of up to  $256 \times 256$  (65,536 diodes). Applications include optical character-recognition, single-line arrays used in the wands that scan prices and inventory codes at checkout registers, robotics, and other industrial applications, and TV. Arrays are available that detect infrared, X-rays, and visible light.

Photodiode arrays are usually housed in IC packages with ground and polished glass windows. Two single-line arrays, and their associated circuitry, are shown in Fig. 7. In Fig. 7-a, the diode charges are transferred to a charge-coupled device (CCD) analog shift-register (a bucket-brigade device) and then clocked sequentially to the output. The circuit of Fig. 7-b clocks a pulse through a digital shift-regi-

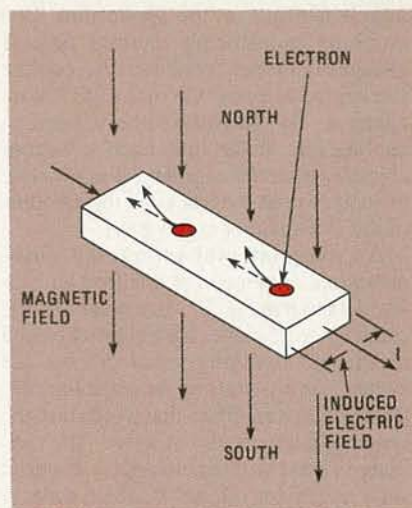

FIG. 6—IN HALL-EFFECT SENSORS, the presence of a magnetic field deflects moving electrical charges, inducing an electrical field and hence a voltage.

ster to connect one diode at a time to the output line. Matrix arrays, of course, use two-dimensional switching arrays.

The sensing elements are diffused-junction pn diodes, which convert light to an electric charge. The charge builds up (integrates) as long as the diode sees any light; the total charge is dumped when each diode is connected to the CCD or output line. The longer the time between frames the more charge builds up. Thus, there is a tradeoff between speed and sensitivity. Clock frequencies of 1 to 5 MHz are common, and devices with speeds of 10 MHz are available.

### Gas chromatograph

Probably the most complex IC sensing device to be designed to date is a gas chromatograph. The gas chromatograph is a device that is used to separate and identify the contents of a sample of a gaseous mixture.

In a gas chromatograph, the sample to be analyzed is injected at the head of a long, thin capillary column. It is then

flushed through the column by an inert carrier gas. As it travels, the sample constituents are absorbed onto the surface of the capillary, which is usually coated with a material that aids in that process. Once the sample passes, however, the carrier gas flushes the absorbed materials from the capillary, carrying them out the end of the column. Because different substances are absorbed and released by the capillary tube at different rates, that action separates the gas sample into its component parts. The output of the tube is monitored to determine the time it takes for each component of the sample to pass through the tube. That information can be analyzed and used to identify the contents of the gas.

Several different techniques are used to monitor the tube's output; the method of monitoring is a matter of choice, and largely depends on the application. One common monitoring method detects changes in thermal conductivity (cooling rate) as the composition of the gas stream changes. By measuring the change in cooling rate at the time each substance emerges from the capillary, it is possible to analyze both the types and the amounts of the constituents of the gas.

An experimental integrated chromatograph developed at Stanford University is shown in Fig. 8. Most notable is the capillary, a 1.5-meter long column etched in silicon. Two long spiral grooves are etched side-by-side and joined at the center, creating a capillary that winds into the center and then back out again. The capillary is lined with an absorptive material such as silicon oil and bonded under a

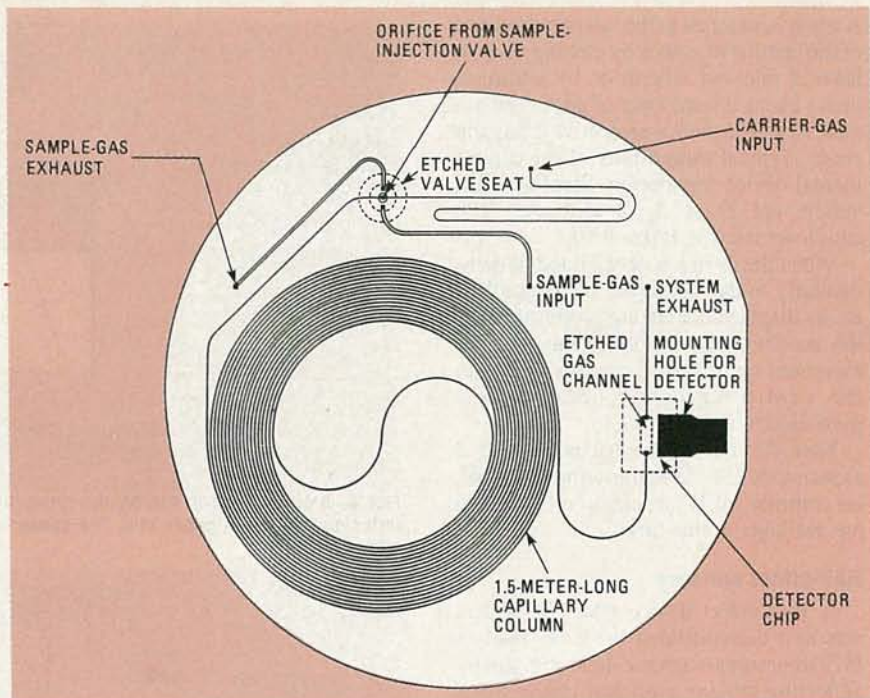

FIG. 8—AN EXPERIMENTAL GAS CHROMATOGRAPH IC integrates a 1.5-meter long capillary column, input and exhaust ports, valve seats, and a thermal gas detector on a single 5-centimeter diameter silicon wafer.

plate of glass. The entire device is built on a single silicon wafer that is 5 centimeters in diameter.

The device is not completely monolithic. The necessary valve seats, inlets, and outlets are etched in the silicon, but the valves themselves are implemented using miniature solenoids, plungers, and diaphragms. The thermal detector is a small thin-film resistor supported on a thermally-isolated Pyrex glass membrane.

Although the Stanford device is not commercially available, Microsensor Technology Inc. (Fremont, CA) has developed a similar silicon mechanism. Their device does not incorporate the capillary column, but it contains most of the Stanford chromatograph's other features. It is not available as a component, but is built into a gas analyzer sold by Microsensor Technology.

#### Future possibilities

Integrated transducers are in their infancy. Potential advantages include size, reliability, and mechanical ruggedness, but perhaps most important is cost. The cost of measurement electronics has been dropping steadily due to advances in microelectronics and microprocessors, but transducer costs have not kept pace. Researchers are working to develop integrated sensors capable of high-volume automated production. Leading research institutions include Stanford University, Case Western Reserve, the University of Pennsylvania's Moore School of Engineering, Delft University of Technology in the Netherlands, and several Japanese

research laboratories.

IC temperature-sensors presently have much looser accuracy specifications than resistance thermometers, precision thermistors, or thermocouples. (Selected precision devices are available, but they are very expensive.) It is reasonable to expect better precision at lower prices in the future.

Experimental pressure and acceleration transducers have been built using variable capacitance to detect motion. The basic diaphragm and cantilever beam designs of those devices are like those described earlier, but the strain gages are eliminated and replaced with metallized surfaces that form the plates of variable capacitors.

Because both the plates and their movements are very small, the capacitance changes generated within such a transducer are small compared to the shunt capacitances of even the shortest external connections. Successful commercial capacitance-type sensors will require measurement circuitry to be integrated on the same chip, something no manufacturer has yet introduced.

It should be expected that, as reliable sensors are developed, active circuitry will be integrated with them. That not only will provide signal conditioning and amplification, but also will allow sensor shortcomings such as nonlinearity and calibration errors to be compensated for by burning the appropriate data into an on-board PROM, making user calibration a thing of the past. Once it becomes practical to integrate sensors with their processing circuitry, the possibilities will be endless.

R-E

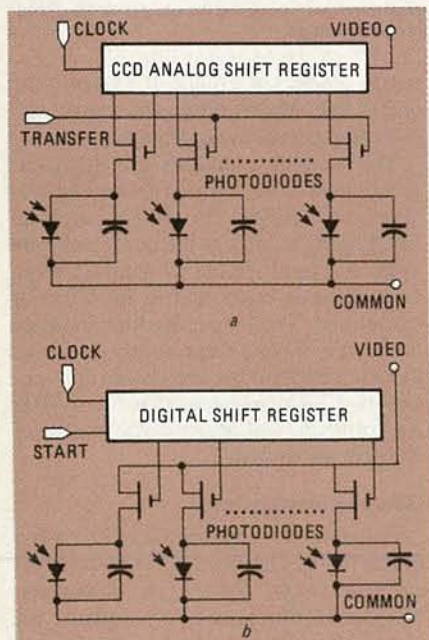

FIG. 7—THE OUTPUTS of an integrated photodiode array can be clocked into an analog CCD shift-register and shifted out (a), or scanned sequentially using analog switches and a digital shift register (b).



## Teletext Decoder

*Build this World System Teletext decoder and tune in to a whole new world of information.*

J. DANIEL GIFFORD

**Part 2** LAST MONTH, WE DESCRIBED what teletext is and how it's broadcast and received. We also described most of the decoder circuit that we're building. But before we get to construction details, we still have a couple of circuit sections to look at: the RGB-to-NTSC encoder and the video switch.

The RGB-to-composite-video decoder is shown in Fig. 10. Although the R, G, B, Y, and blanking outputs of the SAA5050 TROM (of the Mullard teletext module) could be connected directly to an RGB monitor for display, that's not particularly practical because it makes TV/teletext switching impossible. Therefore, the outputs of the module are routed to IC4, a Motorola MC1377 RGB-NTSC encoder IC. That IC combines the module's outputs into a standard NTSC composite-color video signal. The RGB-NTSC encoder is the most complex portion of the circuitry outside the module, but IC4 makes it a good deal simpler than it might otherwise be.

To allow remote switching between TV, teletext, and text-over-TV (mix) modes, the original video signal from the video buffer is sent to a video switch along with the output from the MC1377. That video switch is built around IC5, a 4066 quad analog switch, as shown in Fig. 11. The switch is controlled by the Y

and blanking outputs from the TROM, and by the module's PICTURE ON (PON) signal, which is high when the TV picture is to be displayed and low when teletext only is to be displayed. Two of the gates in IC3, a 74HCOO quad NAND gate IC, are used to invert the blanking and PON signals; only the inverted blanking signal ( $\overline{BL}$ ) is used, but both PON and  $\overline{PON}$  are used to obtain alternate switching.

The third NAND gate in IC3 is used as the active element in the MC1377's oscillator, and the fourth is not used.

The output of the video switch is sent to the video output buffer, the output of which is available at the VIDEO OUT jack, J3. That signal, along with the output of the audio buffer, is used to drive the Astec UM1285-8 video RF modulator. Switch S2 is used to set the modulator's output on Channel 3 or 4.

The power and channel-select switches are the other controls on the decoder itself. All other functions are controlled by the remote handset. That makes this teletext decoder easy to build.

### Building the decoder

Building the decoder is reasonably easy because the decoder itself is a pre-assembled module. The Mullard VM6780-2 teletext decoder module, as discussed last month, performs almost all

### PARTS AND ORDERING INFORMATION

A complete parts list appeared in Part 1 of this article (April, 1986).

A kit of parts (No. K-6315), including PC board, case, and all parts—except those for the wireless remote control circuit, (a wired remote control unit is substituted)—is available for \$199.00 plus \$10.00 shipping from Dick Smith Electronics, Inc., P.O. Box 8021, Redwood City, CA 94063; 800-332-5373 (orders) 415-368-8844 (inquiries). The following parts are also available separately: Case (No. H-2507), \$12.95; Transformer T1 (No. M2155), \$5.95; PC board (H-7001) \$29.95; IC1 (No. Z-6900), \$12.95; IC4 (No. Z-2500), \$1.90; XTAL1 (K-6031), \$1.19; L1 (No. L-0521), \$1.50; L2 (No. L-0520), \$4.95.

A complete kit of parts for the infrared remote control (No. K-3425) is available for \$34.95 plus \$2.75 shipping.

California residents must add 6.5% sales tax. Orders outside U.S. must include U.S. funds and add 15% of merchandise total for shipping.

of the work of decoding teletext signals. As we've seen, it requires only the addition of a power supply, a remote-control circuit, video and audio input buffers, an RGB-composite-video encoder, and a video switch and output buffer to form a complete set-top decoder. We will build that outlying circuitry on a main board, and connect it to the module using four ribbon cables. We should note here that there is a third board required by the decoder: the remote-control receiver pre-amp. Of course, we cannot forget the handheld remote control either. However, we will not present construction details for the handheld unit that was shown schematically last month in Fig. 8.

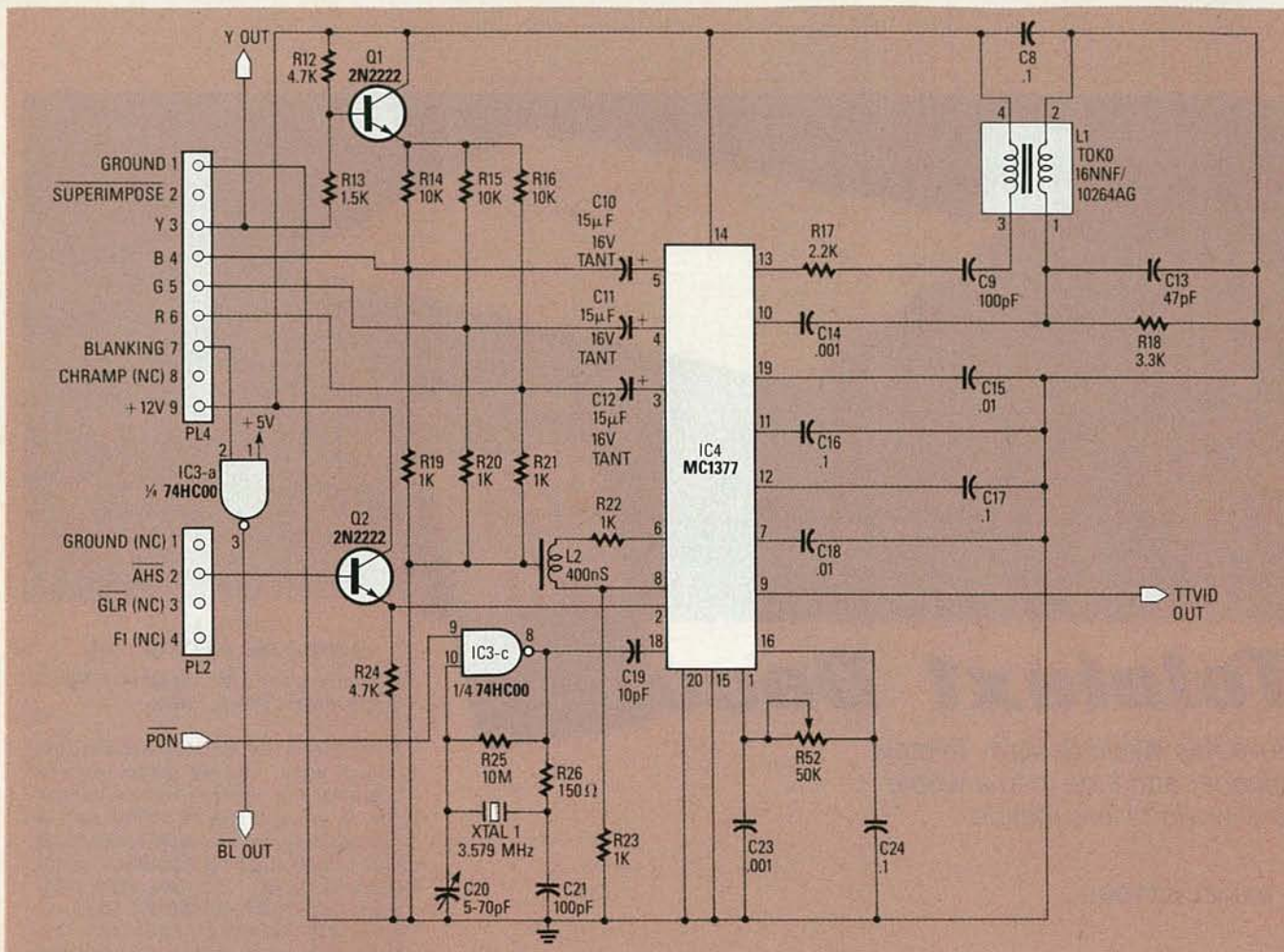

FIG. 10—THE RGB-TO-NTSC composite-video encoder is the most complex circuit outside the Mullard module. IC4 combines the separate R, G, B, and Y signals into a standard composite signal. The After Hours Sync (AHS) output from the module allows the decoder to operate even if the television station goes off the air.

The first step in building the decoder is to make or buy printed-circuit boards. The foil patterns for the main board and the remote-control receiver preamp board are shown in "PC Service." A parts-placement diagram for both boards is shown in Fig. 12.

Once you have the boards, you should start by mounting the 22 jumpers on the main board. Use 22-gauge bus wire and keep the jumpers tight and flat against the board. Next, mount all of the resistors, and then all of the capacitors, using care to orient the polarized electrolytic and tantalum types correctly.

Mount the four 1N4001 diodes D1-D4, the 1N4735 zener diode D5, and the eleven transistors, again making certain that the devices are oriented properly. Install the 5 IC sockets (but not the IC's). Finally, solder in the 400-nanosecond delay line L2, the chroma coil L1, and the 3.58 MHz crystal.

Install the RF modulator on the board. It should be a tight fit; if necessary, twist the lugs to hold it in place. Solder all four lugs to the ground plane. Solder the three input leads closest to the edge of the PC

board (VIDEO IN, +V, and AUDIO IN) in place, leaving the fourth lead (Channel Select) free for the moment.

Bolt the power supply transformer T1 to the PC board, with the primary lugs toward the edge of the board and a ground lug under the rearmost nut. The three short angled PC traces behind the transformer, with their six pads, are to simplify AC power connections. The three pads along the edge of the board are for the incoming power cord; the other three are for the connections to the transformer and the power switch on the front panel.

Solder a short length of 18-gauge wire from the center of these three pads to the solder lug under the transformer's mounting bolt. Solder another piece from the innermost pad to the closest transformer primary lug. Solder a 6" piece of 18-gauge wire to the other primary lug, and a 10" piece to the last PC pad. These two wires will go to the power switch S1.

The three PC pads behind the four 1N4001 rectifier diodes are for the secondary AC hookup. Connect the innermost of these pads to the 15 volt tap of the transformer, the center pad to the 7.5 volt tap,

and the last to the 0 volt tap. Solder two 6" pieces of 22 gauge wire to the 0 and 7.5 volt taps: Those wires will go to S1's internal lamp.

Now it's time to prepare the remote-control preamp board. There are a couple of tricky things about assembling the board. First, you'll have to be sure that the LED and the photodiode will be visible from the front of the decoder. So don't install them until you're sure about how you'll mount the board inside the decoder case. Second, the preamp board needs to be shielded. So after you install the components and the wires that will connect the preamp board to the main board, install four PC terminal posts at the corners of the circuitry. Bend a piece of tin into a U shape and solder it to the posts so that it covers the components on the board. Then mount a flat tin piece to the bottom of the board.

Follow the parts placement diagram (Fig. 12) and wire the CHANNEL SELECT switch, S2, the power cord, the power switch and the input and output jacks. Be sure to use coaxial cable for the jacks.

Finally, prepare the four ribbon cables



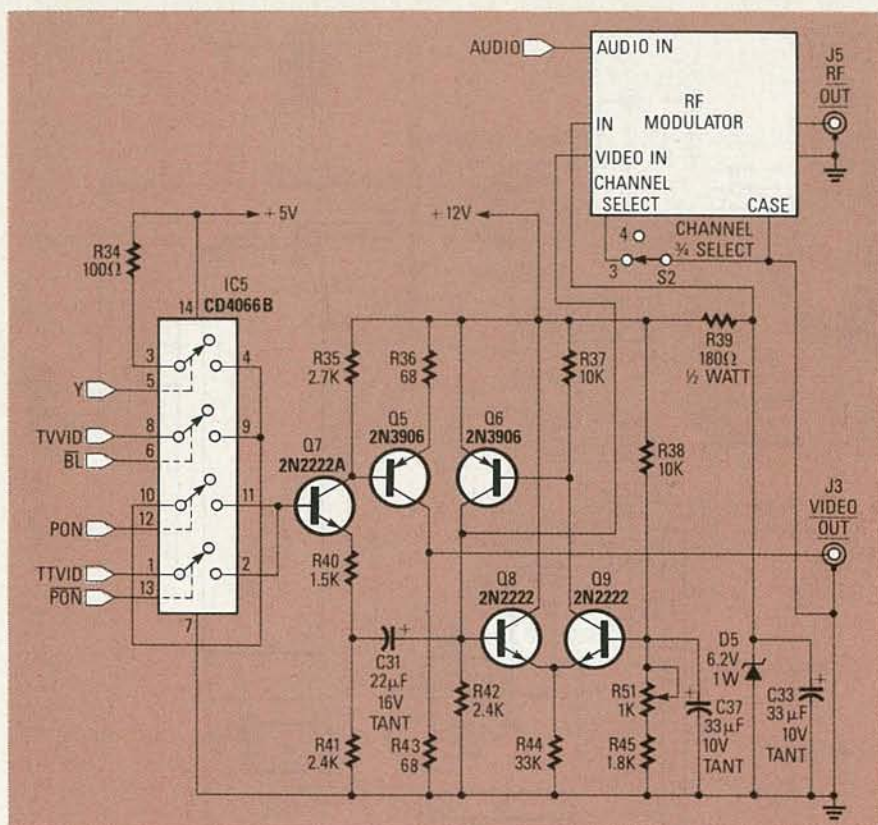

FIG. 11—THE VIDEO SWITCH is used to select, for display, either a regular TV signal (TVVID) or the decoded teletext display (TTVID), or a combination of the two for Mix mode. Note that both RF and composite video outputs are available.

to connect the module to the board by cutting three pieces of 10-conductor ribbon cable and separating them to form one cable each with 4, 6, 9, and 10 conductors. Separate the conductors at one end of each about 1" and strip each conductor 1/4 inch.

Solder the two regulators IC6 and IC7 in place, leaving as much of their leads as possible above the board—only about 1/16 inch should protrude from the bottom, just enough for a secure solder joint. Attach heatsinks and bend the regulators into position, parallel to the PC board.

Put the four 1/2 inch machine screws used to mount the Mullard module in place and secure them with a drop of superglue. Make certain that they remain straight while the glue sets.

The PC board is now complete. After checking all of the solder work for bridges and incomplete joints, the PC board may be installed in the case bottom, along with the rear panel. Secure the AC power cord with a strain relief.

### Testing and final assembly

Plug the decoder in and turn it on; the lamp in S1 should light up. Check the power supply voltages at the regulators' outputs: they should be within 5% of 5 and 12 volts. Check the voltage at the power lead of the RF modulator (the only lead without a plastic insulator): it should

the supply voltages at the IC pins (note that the SAA5010/5012 will not have a 12 volt supply until the Mullard module is connected.) If you have a frequency counter, check the operation of the MC1377's oscillator at pin 18 or at pin 8 of IC3. If all supply voltages are correct and none of the IC's heats up, the Mullard module can now be installed.

**WARNING:** The decoder module is very expensive and it is subject to static-discharge damage. Leave it in its protective sleeve until it is ready for installation, and handle it only while wearing an anti-static wrist strap. Thoroughly discharge all capacitors on the PC board before connecting the ribbon cables.

The Mullard module is mounted to the main board using three bolts and three 1/4-inch spacers. (The mounting holes are not shown on the parts-placement diagram because we chose to show the parts-placement diagram for the remote-control receiver preamp where the module is usually mounted.) Put the module in place on the four bolts and secure it with washers and nuts. Then attach the four cables. Be sure that the wires from PL1 through PL4 are connected correctly—the wire from pin 1 as marked on the parts-placement diagram should go to pin 1 as marked on the module, and so on.

Power up the decoder again. If any of the module's IC's gets more than slightly warm (particularly the two 2114L2's) shut

TELETEXT TUNING GUIDE		
Service	Station	City
Electra Infotext	WKRC, Channel 12	Cincinnati, OH
	WHA, Channel 21	Madison, WI
	WHLA, Channel 31	La Crosse, WI
	WHRM, Channel 20	Wausau, WI
	WHWC, Channel 28	Menomonie, WI
	WLEF, Channel 36	Park Falls, WI
	WMVS, Channel 10	Milwaukee, WI
	WMVT, Channel 36	Milwaukee, WI
	WPNE, Channel 38	Green Bay, WI
	WFLD, Channel 32	Chicago, IL
	KTTV, Channel 11	Los Angeles, CA
	Keyfax Metrotext	
<i>The following services are available on the Galaxy 1 and Satcom 3 satellites, as well as on any cable-TV system carrying WTBS, SPN, or the Discovery Channel:</i>		
Service	Channel/Transponder	
Electra	WTBS/Galaxy 1 TR18 (page 100)	
	SPN/Satcom 3 TR0	
Cabletext	WTBS/Galaxy 1 TR18 (page 201)	
	SPN/Satcom 3 TR6	
Infotext	TDC/Galaxy 1 TR22 (page 100)	

be within 0.3 volts of 6 volts. Turn the decoder off and discharge the power supply capacitors by shorting the regulators' inputs to ground.

Install the remaining IC's in their sockets, making certain that they are oriented correctly and that their pins seat properly. Be careful when handling the IC's: All but the MC1377 are MOS devices and are subject to static-discharge damage.

Power up the decoder again and check

the power off at once, disconnect the module, and trace the problem on the PC board. If everything checks out (it is normal for the two regulator IC's to get quite warm), you're finished building the teletext decoder.

### Aligning the decoder

The decoder can be adjusted, for the most part, without a teletext signal. In fact, the preliminary adjustments are easi-

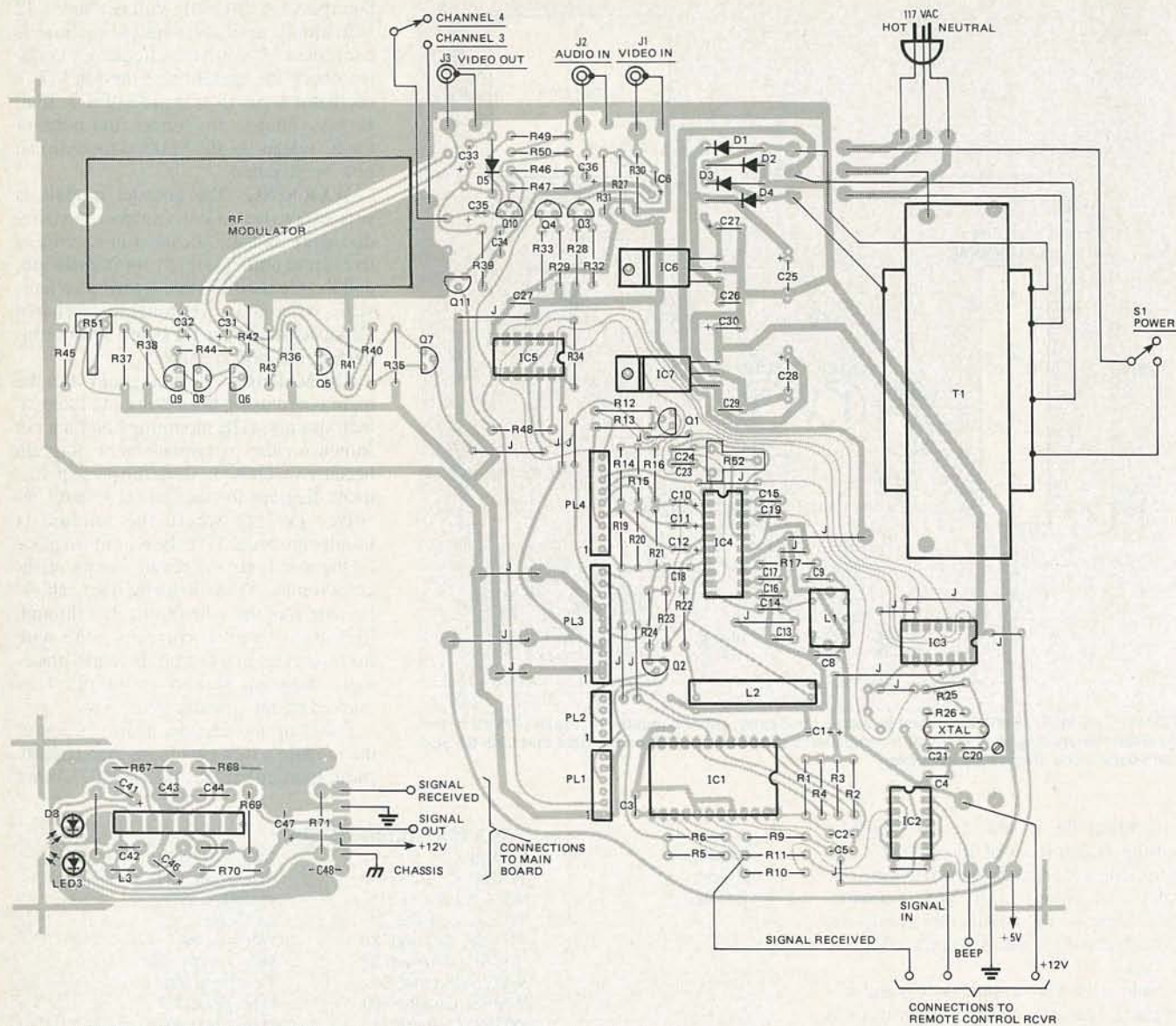

FIG. 12—PARTS PLACEMENT DIAGRAMS for the main board and the remote-control receiver preamp board. Note that the preamp board is shown in the area where the Mullard module is to be mounted. The preamp board is mounted at the front of the case so it can “see” the signals from the handheld remote control and so that you can see LED3.

er with a non-teletext TV broadcast.

Connect the decoder's AUDIO IN and VIDEO IN inputs to the outputs of the tuner, satellite receiver, or VCR, and connect the RF output to the TV's antenna input. (Even if you will normally be using the decoder's composite outputs, connect it via the RF output for adjustment purposes.) Plug in the remote controller and turn the decoder on.

Set the TV to Channel 3 or 4, and set the CHANNEL SELECT switch on the decoder accordingly. Set the tuner to a strong station, preferably one without a teletext signal.

Using a 1/16-inch screwdriver, adjust the tuning slug in the hole closest to the modulator's input leads until the best picture is obtained. Then adjust the modulator bias control R51 (near the modulator) until the image is at its best. Some cross adjust-

ment of those two controls may be necessary to obtain the best picture. Adjust the other tuning slug of the modulator until the best sound is obtained. Slight adjustments of the TV's fine tuning, color, and contrast settings may be needed, but picture and sound should now be perfect.

Press the TT button on the handset. After a brief delay, a blank screen should appear, with “PI00” in the upper left corner should. The TV's horizontal hold control may have to be adjusted slightly.

If the characters are sharply defined, no further adjustments of the picture are necessary. If the figures are not sharp, press MIX to get text-over-TV mode and repeat the previous adjustments until both the text and TV image are sharp.

Return to the teletext (TT) mode again, and set the tuner to a teletext-broadcasting station. The “PI00” should almost in-

stantly be joined on the top line by a 6-digit clock, the day and date, and other characters. If the top line data does not appear or is scrambled, use a small screwdriver to carefully adjust the tall silver coil on the Mullard module. When the line appears correctly, stop adjusting.

When the top line appears, it should be followed almost immediately by the title page of the teletext service. If you're lucky, the page will appear without any errors. More likely, there will be scrambled lines or random characters scattered through the page. Wait for a minute or so to see if the garbage clears away by itself. If not, adjust the module coil again, a fraction of a turn at a time, until the image clears. Wait for 10-15 seconds between adjustments to give the title page time to come around in the data loop.

*continued on page 102*

## All About FREQUENCY COUNTERS

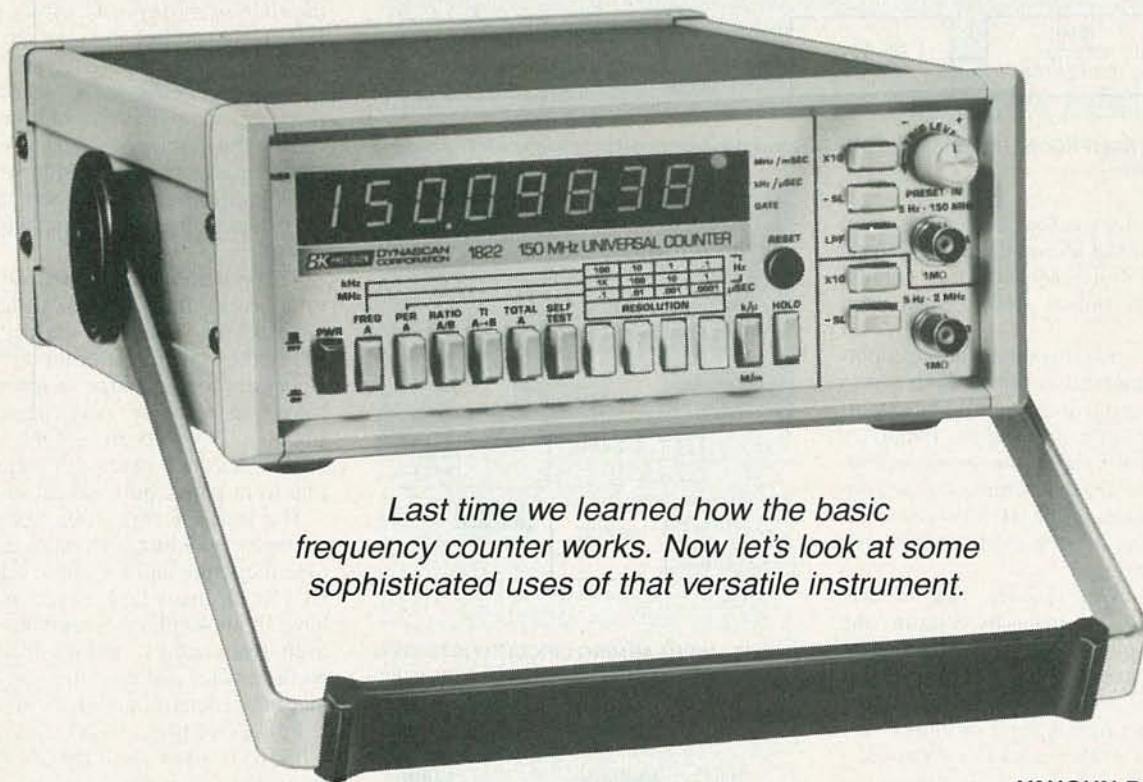

*Last time we learned how the basic frequency counter works. Now let's look at some sophisticated uses of that versatile instrument.*

VAUGHN D. MARTIN

**Part 2** USING A FREQUENCY counter to measure frequency is simple, but how about using one to measure phase or risetime? This month we'll start out by seeing how those measurements may be made.

### Measuring phase

A frequency counter can be used to measure the phase difference between two equal-frequency signals. Actually, we just make a special measurement of *period* (time), and then calculate phase from that time.

Note, in Fig. 15, the values  $T$  and  $T\phi$ ;  $T$  is simply the period of either signal, and  $T\phi$  is the time difference between successive positive-going zero crossings of each signal. You may measure the period of  $T$  in the conventional manner. To measure  $T\phi$ , set the frequency counter up to operate in the STOP/START time-interval mode. The stop and start triggers should be AC-coupled and set for a level of 0-volts DC. The input signals should have the greatest possible amplitude.

When you have values of  $T$  and  $T\phi$ , you can calculate the phase difference ( $\phi$ ) between the two signals from this equation:

$$\phi \text{ (degrees)} = (T\phi/T) \times 360$$

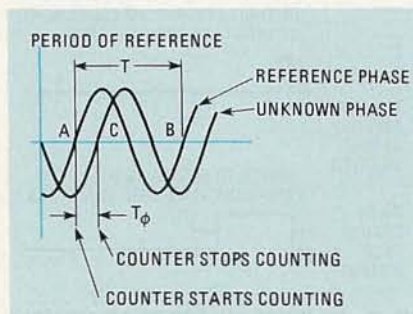

FIG. 15—THE PHASE DIFFERENCE between two equal-frequency signals may be measured with a frequency counter that has adjustable start- and stop-trigger levels.

### Measuring risetime

As shown in Fig. 16, you can use a frequency counter (in the period mode again) to measure the risetime ( $T_R$ ) of a squarewave or other digital signal. Just set the START and STOP trigger-level controls to respond at 10% and 90%, respectively, of the maximum voltage ( $V_M$ ) of your signal. For example, standard TTL gates have a (nominal) high output voltage of 2.4 volts. Measure the risetime by setting the START control to trigger at 0.24 volts and the STOP control to trigger at 2.16 volts.

Now let's look at some sophisticated frequency counters and accessories.

### The reciprocal counter

The reciprocal frequency counter differs from the ordinary frequency counter in that it uses separate registers to accumulate time- and event-counts. The contents of those registers are then processed to provide outputs that represent either period or frequency. A simplified block diagram of a reciprocal frequency counter, Hewlett-Packard's model HP5345A, is shown in Fig 17. It works

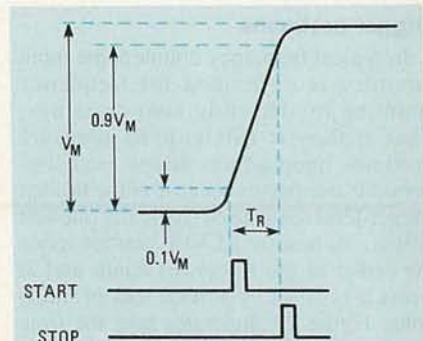

FIG. 16—RISETIME MAY ALSO BE measured with a frequency counter that has adjustable start- and stop-trigger levels.

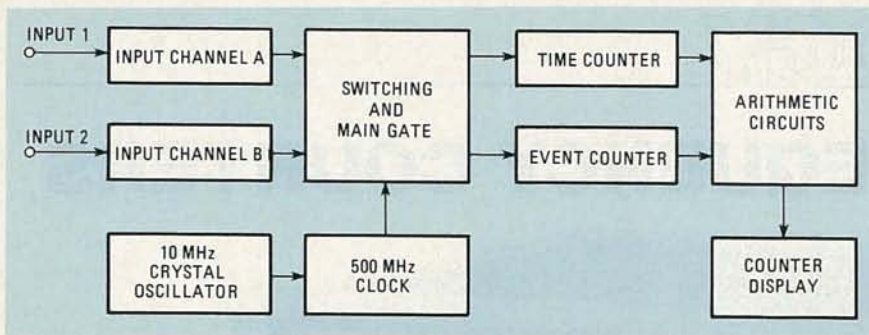

FIG. 17—THE RECIPROCAL FREQUENCY COUNTER provides separate input channels for measuring time and events.

like this: As long as the main gate is open, the event counter accumulates pulses from the external source while the time counter accumulates pulses from the internal clock.

Some reciprocal counters allow counting to be externally armed, as shown in Fig. 18. External arming could be useful, for example, in measuring the frequency of a pulsed-RF signal, as shown in Fig. 19. By setting the measurement-time control to the width of the RF burst, an accurate frequency measurement of the burst could be made.

In a reciprocal counter, time-interval measurements are made by counting the number of pulses between independent START and STOP inputs, as shown in Fig. 20. The resolution is determined by the frequency of the timebase oscillator. For example, a 10-MHz clock could provide a  $1/10^7$ , or 100-nanosecond, resolution.

Some reciprocal counters use *direct* gating, as shown in Fig. 21-a, but direct gating can cause an unacceptable bias by shortening the clock pulses, as shown in Fig. 21-b. Note that part of the clock pulse is shortened when the gate is opened, and that part of the clock is also shortened when the gate is closed.

The solution is to use *synchronous* gating, as shown in Fig. 22-a. As shown in Fig. 22-b, that gating scheme allows the correct number of pulses to pass through the main gate and be counted. With the direct gating circuit above, three pulses would be counted, but here two pulses would be counted.

### Trigger problems

In typical frequency counters the input circuitry is optimized for frequency counting by detecting zero crossings. That makes it difficult to measure risetimes, propagation delays, and low-periodic-rate pulses because of the limited trigger-level range used (typically one volt or less). At best the LEVEL control varies the center of the hysteresis band, and at worst it is offset by several tens of millivolts. Figure 23 illustrates how the time interval actually measured can be distorted by improper triggering.

Sometimes you can compensate for the

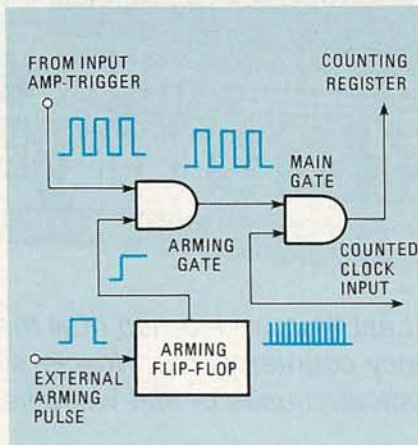

FIG. 18—INPUT-ARMING CIRCUITRY IS USED IN a reciprocal counter for specialized measurements, as shown in Fig. 19.

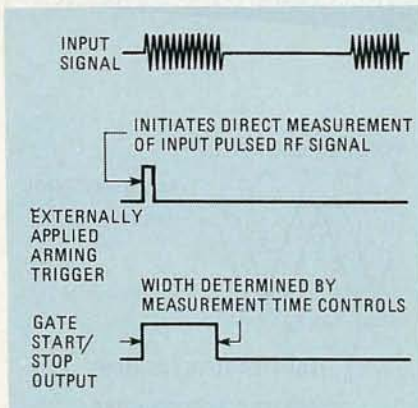

FIG. 19—MEASURE PULSED RF ACCURATELY by using start and stop pulses to limit counting to the width of the burst.

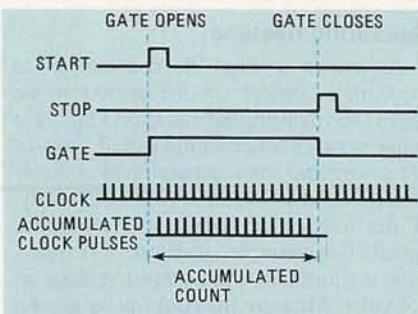

FIG. 20—INDEPENDENT START AND STOP pulses allow a reciprocal frequency counter to measure time interval accurately.

ambiguity in the trigger point by using "hysteresis compensation," in which a DC voltage equal to  $1/2$  the hysteresis band is added to (in the case of a positive-going signal) or subtracted from (in the case of a negative-going signal) the selected trigger level or reference voltage.

Rather than hysteresis compensation, the *time-interval probe* solves the problem of trigger-level ambiguity by using an automatic calibration scheme. The user grounds the probe to be calibrated and then presses a front panel switch. That causes the reference voltage  $V_R$  to decrease in a stair-step fashion in one-mV steps until the device triggers. For negative slope calibration, that voltage increases.

The system then uses that value of  $V_R$  to adjust itself so that the actual trigger voltage corresponds to the trigger level selected by the user. Recalibration, when slopes or probes change, assures constant triggering accuracy. Any trigger voltage from  $-9.99$  volts to  $+9.99$  volts may also be selected, in ten-mV steps, by setting front-panel thumbwheel switches.

The time-interval probe has other advantages including high input impedance (one megohm) and low input capacitance (10 pF). Ordinary high-impedance probes have about 40 pF of capacitance, and, at high frequencies, delays through the probe, cable, and circuitry can cause an inaccurate determination of time interval.

For example, Hewlett-Packard's HP5363B uses two DAC's (Digital-to-Analog Converters) for setting trigger level, and for self calibration. The main DAC, controlled by a thumbwheel switch, supplies the  $+9.99$  to  $-9.99$ V trigger level voltages. The offset DAC, used to compensate for residual offset voltages in the two probes, is initially offset from the main DAC by  $+75$  mV, and it may vary from  $+75$  mV to  $-75$  mV in one-millivolt steps.

When calibrating for a positive slope, the LEVEL CALIBRATE switch clears both DAC's, then internal calibration circuits sweep the offset DAC's voltage output from  $+75$  mV downward in one-millivolt steps until the input channel just switches. That voltage is stored digitally and then it is added to the thumbwheel-controlled DAC to give the true trigger voltage used for subsequent measurements. When calibrating for a negative slope, the process is similar except that the offset DAC starts from  $-75$  mV and scans upward.

### Visual trigger indication

A scope marker gives us a visual indication of the actual voltage at which a frequency counter triggers. We will examine three types of markers: dot, gate, and squarewave markers.

The dot marker is a 100-ns pulse initiated by an input channel's triggering. For example, the dots on the waveform shown

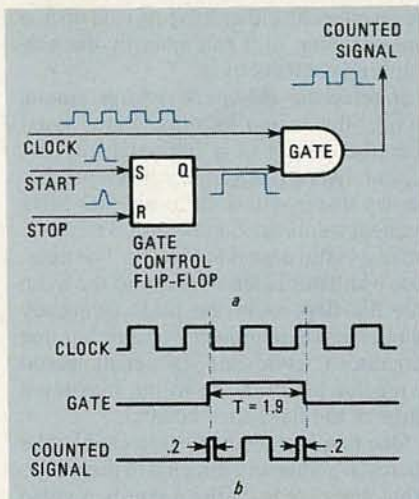

FIG. 21—DIRECT GATING (a) can cause counting errors (b).

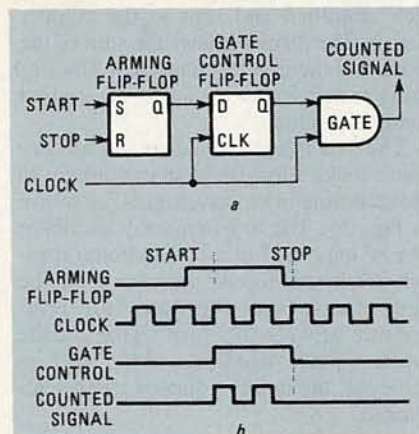

FIG. 22—SYNCHRONOUS GATING (a) eliminates counting errors (b) suffered by direct gating (see Fig. 21).

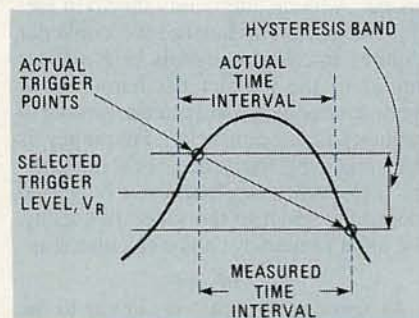

FIG. 23—TIME-INTERVAL MEASUREMENTS can be distorted by improper triggering.

in Fig. 24-a indicate the stop- and start-trigger levels. That pulse is used to intensity-modulate a scope, so it appears as a bright dot on the screen of the scope, as shown in the upper trace of Fig. 24-b.

The gate marker is similar to the dot marker, but it provides continuous output between the START and STOP trigger pulses. The fuzzy portion of the waveform in Fig. 24-c indicates that the same input-voltage range will trigger the gate marker as triggered the dot marker in Fig. 24-a. Its appearance on the scope would resemble the lower trace in Fig. 24-b.

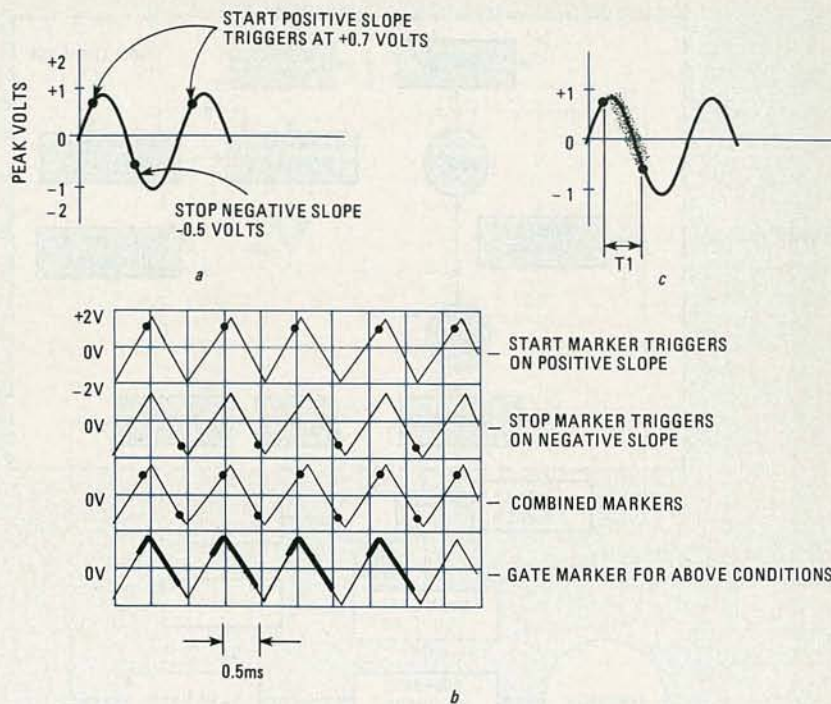

FIG. 24—DOT- AND GATE-MARKERS provide visual indication of trigger level. At a are shown the trigger levels that produce the dot-marker outputs shown in the upper four traces at b. At c is shown the trigger range that is displayed in the gate-marker trace at the bottom of b.

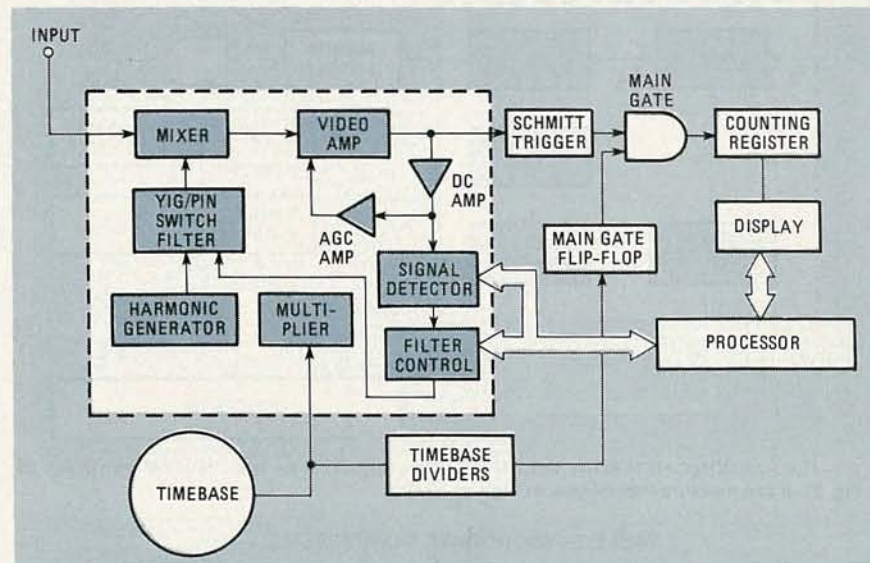

FIG. 25—THE HETERODYNE DOWN-CONVERTER is one way of measuring the frequency of microwave signals as high as 20 GHz.

The squarewave marker usually appears as an inverted replica of the Schmitt-trigger output of the frequency counter. It may be viewed on a multi-trace scope along with the input signal to verify that the input circuitry is triggering properly.

### Microwave frequency counters

To understand how microwave frequency counters work, recall that a frequency counter has a gate that regulates the flow of counting pulses. The switching speed of common gates is limited to signals far short of the microwave region (for our

purposes, about 3 GHz). So how can we measure 10-GHz signals? Basically, there are four methods of measuring the frequency of a microwave signal: 1) Prescaling, which is effective to about 1.5 GHz; 2) Heterodyne down-conversion, good to 20 GHz; 3) Transfer-oscillator techniques, good to 23 GHz; 4) Harmonic-heterodyne converters, which seem to yield reliable results as high as 40 GHz.

Prescaling, as we discussed earlier in this article, is accomplished by inserting a divider ahead of the frequency counter's input. To compensate for a division by  $n$ ,

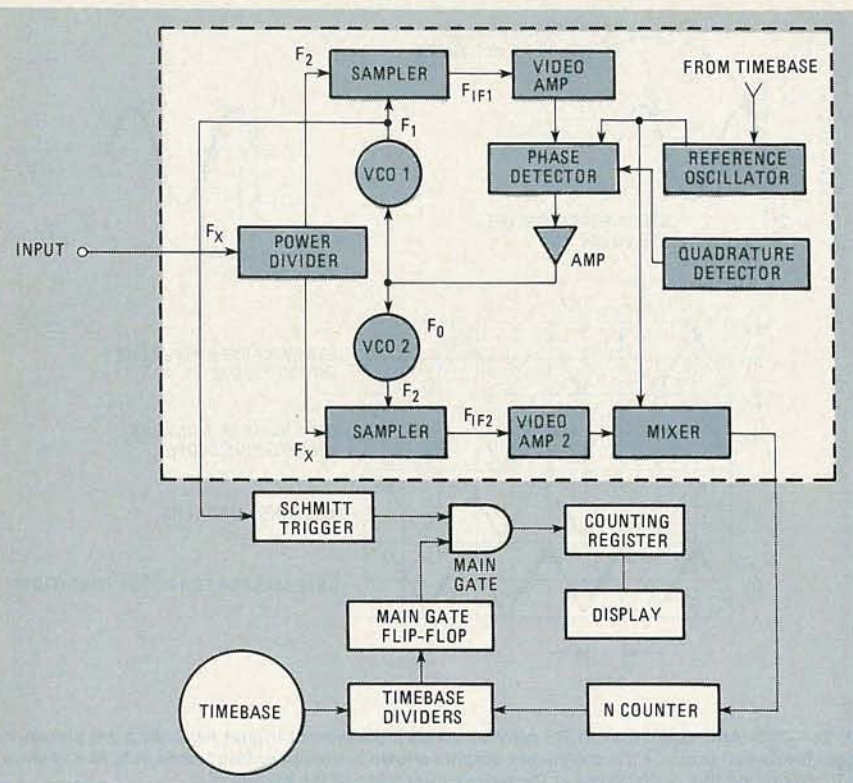

FIG. 26—THE TRANSFER OSCILLATOR can measure microwave signals as high as 23 GHz.

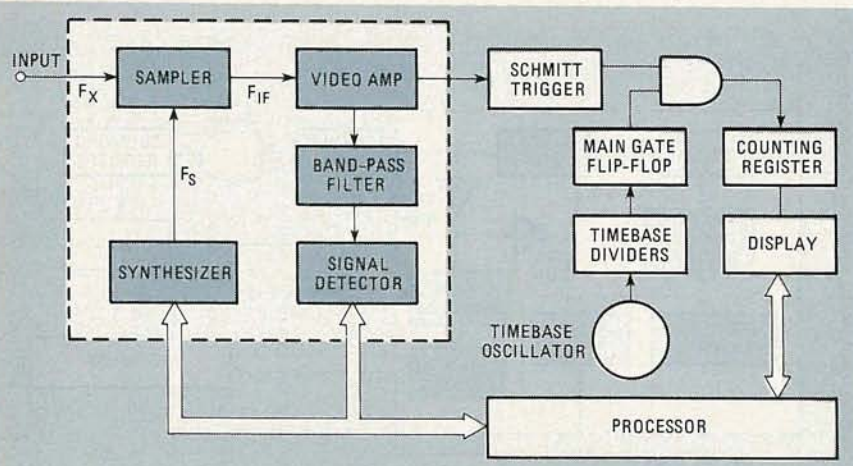

FIG. 27—THE HARMONIC-HETERODYNE CONVERTER is a hybrid of the two circuits shown in Fig. 26 and Fig. 27. It can measure frequencies as high as 40 GHz.

TABLE 3—MICROWAVE CONVERTERS

Characteristic	Heterodyne converter	Transfer oscillator	Harmonic heterodyne converter
Frequency Range	20 GHz	23 GHz	40 GHz
Measurement Speed	150 ms acquisition 1/R gate	150 ms acquisition N/R gate	350 ms acquisition 1/R gate
Accuracy	Timebase limited	Timebase limited	Timebase limited
Sensitivity/ Dynamic Range	-30 dBm/35-50 dB	-35 dBm/40 dB	-30 dBm/35-50 dB
Signal-to-Noise Ratio	40 dB	20 dB	20 dB
FM Tolerance	30-40 MHz peak-peak	1-10 MHz peak-peak	10-50 MHz peak-peak
AM Tolerance	Less than 50%	Greater than 90%	Greater than 90%
Amplitude Discrimination	4-30 dB	2-10 dB	2-10 dB

the counter can either leave its gate open  $n$  times as long, or it can multiply the gate register's contents by  $n$ .

*Heterodyne down-conversion* entails mixing the incoming microwave signal with the output of a high-stability oscillator. Doing that yields a difference frequency that is within the usual 500-MHz frequency-counter bandwidth. The basic process is illustrated in Fig. 25. The timebase oscillator is fed not only to the main gate flip-flop, as in the basic frequency counter, but to a frequency-multiplier that generates a "comb line" of signals spaced at regular intervals out to the maximum range of the frequency counter.

One line of the comb is selected by the microwave filter and directed to the mixer. What emerges from the mixer is a video signal that is equal to the difference between the two input signals. That signal is then amplified and sent to the counter circuit. The display shows the sum of the video and the input frequencies. The signal detector serves to detect the correct comb-line value.

The *transfer-oscillator technique* phase-locks a low-frequency oscillator to the incoming microwave signal, as shown in Fig. 26. The low-frequency oscillator can be measured in a conventional manner, so the microwave frequency can be determined from the harmonic relationship between the input signal and the low-frequency oscillator. After lock is achieved, the input frequency can be calculated:

$$F_X = nF_1 - F_{IF1}$$

The *harmonic-heterodyne converter* is a hybrid of the two techniques just discussed. A block diagram is shown in Fig. 27. The harmonic-heterodyne converter acquires microwave signals in a manner similar to the transfer oscillator, but it measures frequency in a manner similar to the heterodyne converter. Frequency is determined by the processor's multiplying the synthesizer frequency by  $n$  and adding the result to the video frequency. The input frequency can be calculated as:

$$F_X = nF_S + F_{IF}$$

As you can see, that is similar to the way the heterodyne converter works, in that the  $n$ th harmonic of a stable oscillator is mixed with the input to produce a video difference frequency.

Most microwave frequency counters can measure frequency-modulated signals, but the heterodyne converter and harmonic-heterodyne frequency counters have a distinct advantage in making that measurement, as shown in Table 3. Also shown in that table is the fact that the heterodyne converter has a limited tolerance to AM due to its AGC circuitry. The transfer oscillator and harmonic-heterodyne converters do not suffer that limitation, and they can measure a carrier at -10 dBm with 95% modulation. **R-E**

# PC SERVICE

One of the most difficult tasks in building any construction project featured in **Radio-Electronics** is making the PC board using just the foil pattern provided with the article. Well, we're doing something about it.

We've moved all the foil patterns to this new section where they're printed by themselves, full sized, with nothing on the back side of the page. What that means for you is that the printed page can be used directly to produce PC boards!

**Note:** The patterns provided can be used directly only for *direct positive photoresist methods*.

In order to produce a board directly from the magazine page, remove the page and carefully inspect it under a strong light and/or on a light table. Look for breaks in the traces, bridges between traces, and in general, all the kinds of things you look for in the final etched board. You can clean up the published artwork the same way you clean up your own artwork. Drafting tape

and graphic aids can fix incomplete traces and doughnuts, and you can use a hobby knife to get rid of bridges and dirt.

An optional step, once you're satisfied that the artwork is clean, is to take a little bit of mineral oil and carefully wipe it across the back of the artwork. That helps make the paper translucent. Don't get any on the front side of the paper (the side with the pattern) because you'll contaminate the sensitized surface of the copper blank. After the oil has "dried" a

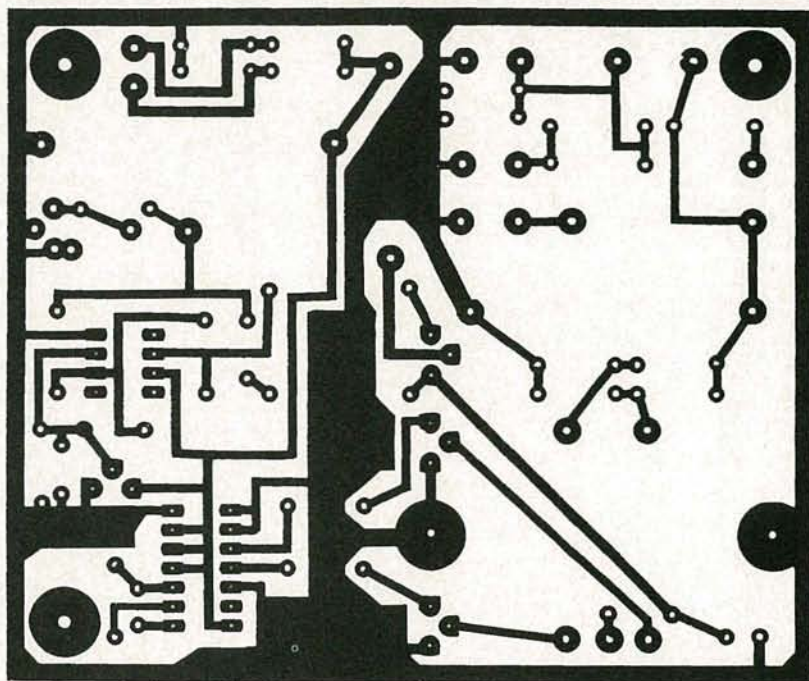

4-3/16 INCHES

**BUILD OUR LITTLE LEAKAGE CHECKER** and find the leaky capacitors that have been eluding your capacitor tester. The pattern for the PC board is shown here; the story begins on page 51.

# PC SERVICE

bit—patting with a paper towel will help speed up the process—place the pattern front side down on the sensitized copper blank, and make the exposure. You'll probably have to use a longer exposure time than you are probably used to.

We can't tell you exactly how long an exposure time you will need but, as a starting point, figure that there's a 50 percent

increase in exposure time over lithographic film. But you'll have to experiment to find the best method for you. And once you find it, stick with it. Don't forget the "three C's" of making PC boards—care, cleanliness, and consistency.

Finally, we would like to hear how you make out using our method. Write and tell us of your successes, and failures, and

what techniques work best for you. Address your letters to:

**Radio-Electronics**  
Department PCB  
500-B Bi-County Blvd.  
Farmingdale, NY 11735

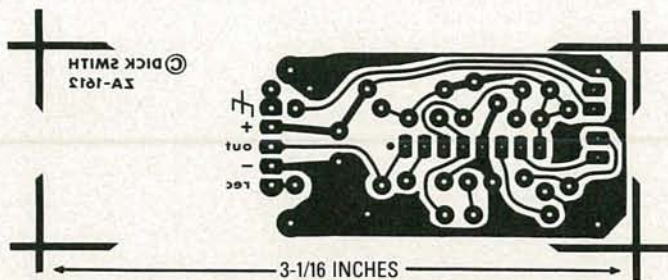

THE REMOTE CONTROL PREAMP BOARD for the teletext decoder is shown here full size mirror image.



# PC SERVICE

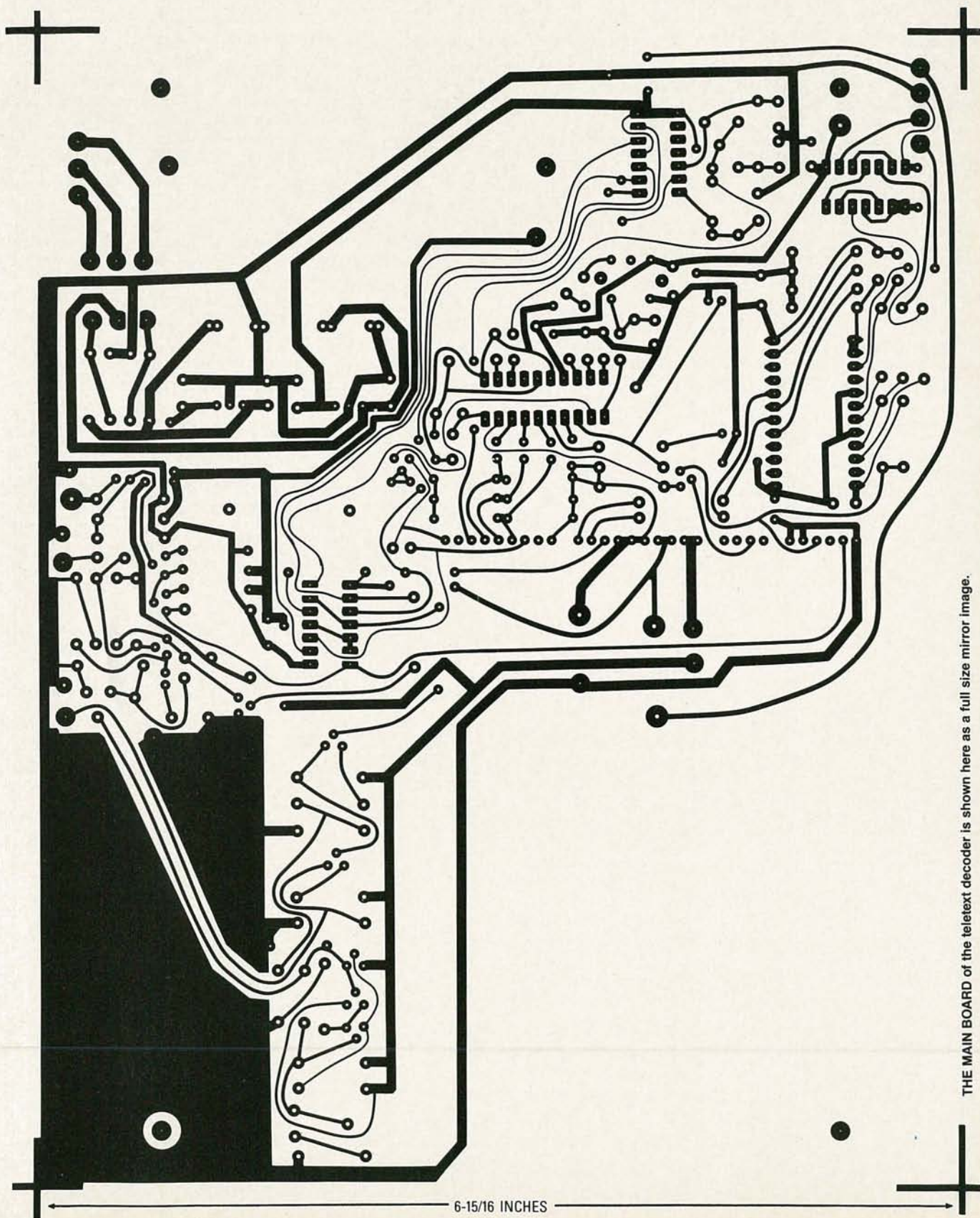

THE MAIN BOARD of the teletext decoder is shown here as a full size mirror image.

---

---

# PC SERVICE

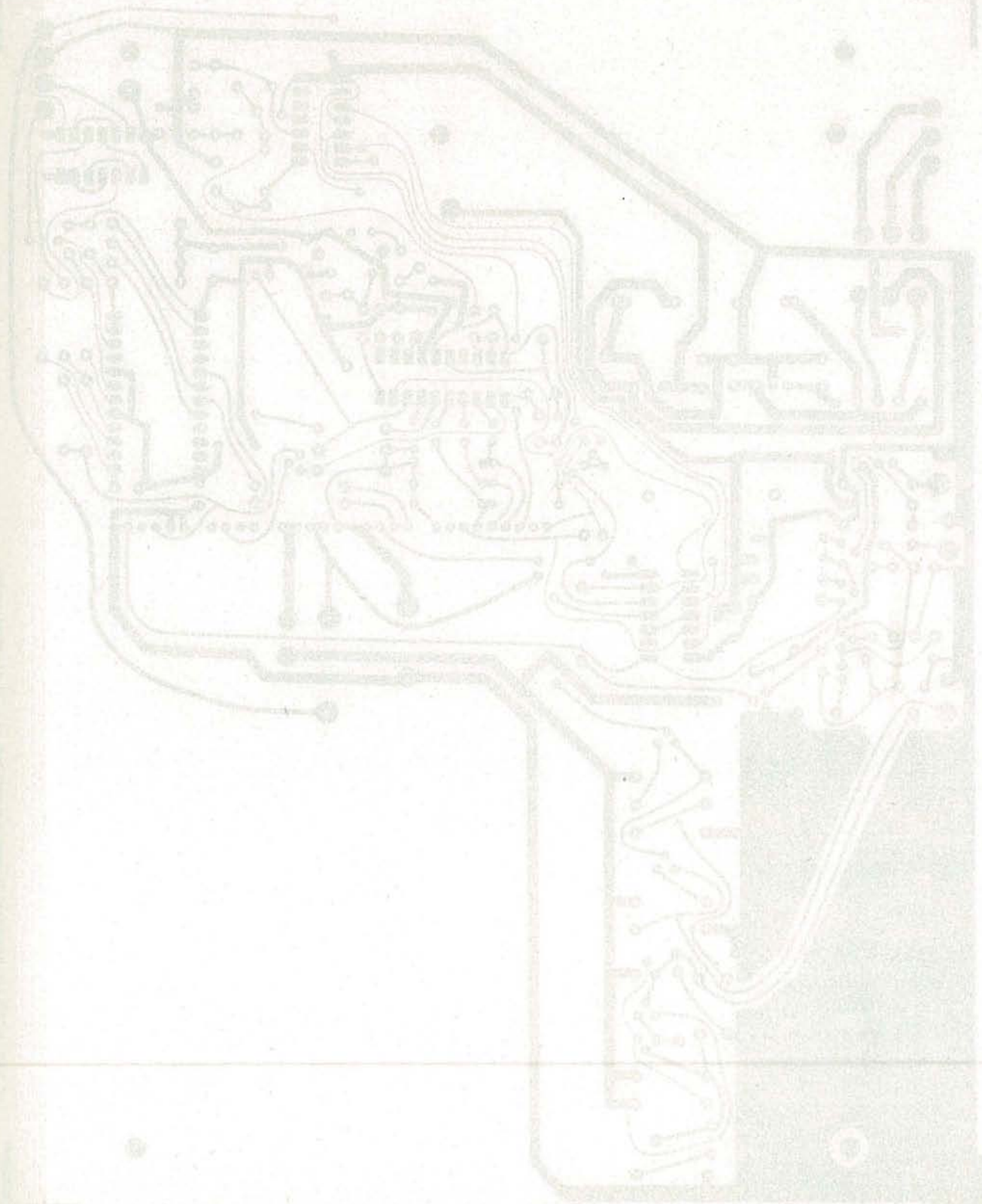



**APPLIANCE REPAIR HANDBOOKS**—13 volumes by service experts; easy-to-understand diagrams, illustrations. For major appliances (air conditioners, refrigerators, washers, dryers, microwaves, etc.), elec. housewares, personal-care appliances. Basics of solid state, setting up shop, test instruments. **\$2.65 to \$5.90 each**. Free brochure. **APPLIANCE SERVICE, PO Box 789, Lombard, IL 60148. 1-(312) 932-9550.**  
**CIRCLE 84 ON FREE INFORMATION CARD**

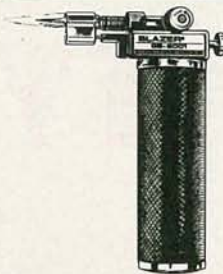

**MICRO TORCH—W/BUILT IN PIEZO ELECTRIC IGNITOR.** Finest auto-lighting, hand held, refillable, butane gas micro torch available. Soft solder, silver solder, sweat tubing joints, bend glass, plastic metal tubing and any other applications requiring a precision micro flame. 1 1/8" diameter, 5 1/2" high, weighs 9 oz. **ORDER #GB2001 \$49.95 + \$3.00 SHIPPING (NO COD'S) NY RES ADD TAX. BUYUS, INC., DEPT. RE586, 10 White Birch Dr., Ossining, NY 10562. VISA, MasterCard (914) 762-4799.**  
**CIRCLE 53 ON FREE INFORMATION CARD**

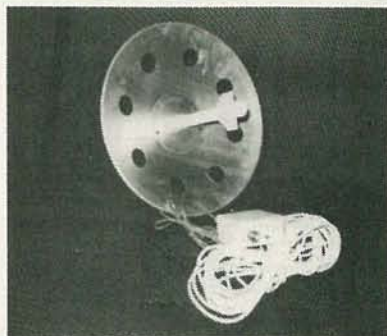

**MICROWAVE ANTENNAS \$69.95 + shipping, lifetime warranty.** We repair all types of downconverters. Satellite Dishes and parts complete 9' dish with block system, 80° LNA by arcfinder **\$995.00**. Coax cable T.V. parts, accessories connectors, T.V. amplifiers. Write for free catalog or call for prices. **BLUE STAR IND., Dept. RE5-86, 4712 Ave. N, Brooklyn, N.Y. 11234 (718) 338-8318 Ext. 105.**  
**CIRCLE 274 ON FREE INFORMATION CARD**



**NEW PUBLICATION, "5 Great Ways to Use the SSAVI":** a complete guide for all uses, including conversion to a stereo TV decoder **\$6.50** ppd. ZENITH SSAVI Descramblers only **\$169**. Gated pulse **\$199**. Reconditioned original equipment for UHF chs. 48,50,51,54,60, etc. Quantity discounts. Surplus TV equipment: Oak N-12, Hamlin MLD-1200, etc. Warranty. Catalog **\$1. AIS SATELLITE, P.O. Box 1226-A, Dublin, PA, 18917. 215-249-9411.**  
**CIRCLE 269 ON FREE INFORMATION CARD**



**SAY GOOD-BYE TO BORING ONE-DIMENSIONAL TV SOUND.** Say hello to dynamic MTS (Multichannel Television Sound) MTS is the only FCC approved method of broadcasting all the new stereo TV programs into your home with cinema-like quality. Recoton V622 **\$129.95** & 6.50 S & H. Visa/MasterCard 1 (800) 522-2636 Order only, (617) 871-5611 for information. **CAMEO ENTERPRISES INC., 45 Accord Pk., Norwell, MA 02061.**  
**CIRCLE 275 ON FREE INFORMATION CARD**

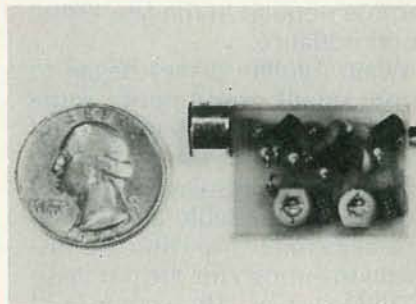

**THE MOST EXCITING KIT YOU WILL EVER BUILD** The model WAT-50 miniature FM transmitter uses a 4-stage circuit NOT to be confused with a simple wireless microphone. Up to 1 mile range. So sensitive, it will pick-up a whisper 50 feet away! Use with any FM radio. Complete kit only **\$29.95** tax incl. VISA and MasterCard accepted. **FREE SHIPPING. DECO INDUSTRIES, Box 607, Bedford Hills, NY 10507. (914) 241-2827.**  
**CIRCLE 127 ON FREE INFORMATION CARD**



**FREE CATALOG OF HARD-TO-FIND TOOLS** is packed with more than 2000 quality items. Your single source for precision tools used by electronic technicians, engineers, instrument mechanics, schools, laboratories and government agencies. Also contains Jensen's line of more than 40 tool kits. Send for your free copy today! **JENSEN TOOLS INC., 7815 46th St., Phoenix, AZ 85044. (602) 968-6231.**

**CIRCLE 115 ON FREE INFORMATION CARD**



**THE WIRELESS TELEPHONE TRANSMITTER** model WTT-20 is only the size of a dime, yet transmits both sides of a telephone conversation with crystal clarity. Completely automatic. Uses power from the telephone line itself. Never needs a battery! Up to 1/4 mile range. Use with any FM radio. Complete kit only **\$29.95**. Tax included. VISA and MasterCard accepted. **FREE SHIPPING. DECO INDUSTRIES, Box 607, Bedford Hills, NY 10507. (914) 241-2827.**  
**CIRCLE 127 ON FREE INFORMATION CARD**



**SUBSCRIPTION TV MANUAL.** This information packed book details the methods used by subscription TV companies to scramble and descramble video signals. Covers the Sinewave, Gated Pulse, SSAVI system, and the methods used by most cable companies. Includes circuit schematics, theory, and trouble shooting hints. **Only \$12.95 plus \$2.00 first class P&H. ELEPHANT ELECTRONICS INC., (formerly Random Access) Box 41770-R, Phoenix, AZ 85080**  
**CIRCLE 120 ON FREE INFORMATION CARD**

# SATELLITE TV



**BOB COOPER, JR.**  
SATELLITE TV EDITOR

## Scrambling update

IT FINALLY HAPPENED. ALL SIGNALS transmitted by HBO and sister service Cinemax after midnight, January 15th will be scrambled. Gone forever is the free programming enjoyed by more than 1.5 million satellite-dish owners since TVRO became popular in the late 1970's. Good riddance.

When satellite dishes began to sprout up all over America some seven years ago, you could count on HBO to provide the best uncut, un-interrupted display of late-run movies of all the cable services. So the ability to receive HBO was justification enough for the purchase a TVRO system. The sentence "I have a dish" was almost always followed by "And I get HBO."

In theory, anyone who wishes to continue receiving HBO can do so by adding a descrambler to his or her present system. The descrambler is shown in Fig. 1; it is called *Videocipher*, and it was designed by the Linkabit division of M/A-Com. During 1985, HBO provided, free of charge, more than 10,000 *Videocipher* descramblers to authorized affiliates. And for home viewers, several less-complicated versions of *Videocipher* have been introduced.

The devices are available in two models: the *VC2000E* and the *VC2000E/B*. You can purchase a descrambler for under \$400, and, for an extra charge, sign up for HBO, Cinemax or both. You can sign up by calling (800) 845-2748 and giving the operator your *Videocipher* serial number and a VISA or MasterCard number. Or you may contact a local distributor.

If you sign up for descrambling



FIG. 1

directly from HBO, it will cost you \$12.95 per month for either HBO or Cinemax, or \$19.95 per month for both. However, it seems that you can get the same service from a local distributor for as little as \$12.95 per month for both services.

### TVRO dealer "Starter Kit" available

Bob Cooper's *CSD Magazine* has arranged with a number of TVRO equipment suppliers to provide a single-package of material that will help introduce you to the world of TVRO dealership. A short booklet written by Bob Cooper describes the start-up pitfalls to be avoided by any would-be TVRO dealer, in addition, product data and pricing sheets from prominent suppliers in the field are included. That package of material is free of charge and is supplied to firms or individuals in the electronics service business as an introduction to the 1984/85 world of selling TVRO systems retail.

You may obtain your *TVRO Dealer Starter Kit* free of charge by writing on company letterhead, or by enclosing a business card with your request. Address your inquiries to: *TVRO STARTER KIT*, P.O. Box 100858, Fort Lauderdale, FL 33310. That kit *not* available to individuals not involved in some form of electronics sales and service.

## How they work

The *VC2000E* descrambler accepts a 70-MHz signal from a TVRO receiver (which must have a straight-through 70-MHz connection). The descrambler demodulates the 70-MHz signal and then recovers the descrambling codes from the baseband video. The digitally-encrypted audio signal is also recovered from the baseband video. The descrambler can properly decode fairly "sloppy" input signals.

The *VC2000E/B* is not so forgiving. That unit performs the same decoding, but it uses the baseband video signal rather than the 70-MHz IF signal. The *VC2000E/B* requires a relatively pure baseband signal. The signal must have little phase shift and group delay; other video parameters are equally tight. The problem is that few currently-available receivers can readily supply signals of that sort.

There is no difference in price between the two units, even though the *VC2000E* is more complex, uses more parts, and costs more to build than the *VC2000E/B*. Unfortunately, the *VC2000E* was not made available at the same time as the *VC2000E/B*, and the marketplace is confused about why only some receivers work with the descramblers initially made available.

## Problems

HBO had promised that, when full-time scrambling began, suppliers would have an adequate supply of descramblers in the distribution pipeline. Unfortunately, they didn't.

In fact, fewer than 1,000 de-

\* Editor-in-chief, Coop's Satellite Digest

scramblers (all VC2000E/B's) were actually in distributor's hands on January 15th. In addition, those descramblers worked with few receivers. HBO blamed its supplier, M/A-Com, for the snafu, and M/A-Com refused to answer desperate queries from either users or suppliers. All things considered, scrambling did not get off to a very good start.

In fact, M/A-Com has provided no hard information on the descrambler product for over a year. Meanwhile, HBO was advertising their scrambling plans for months, and they advised TVRO owners to contact their local M/A-Com distributors for additional information and to order descramblers. HBO's failure to provide distributors and dealers with any information has left luckless TVRO owners with nothing. And HBO had originally promised that things would get off to a smoother start.

So the TVRO industry is incensed by the lack of concern shown by both HBO and M/A-Com about the scrambling switch-over. Congressional hearings requested by SPACE (the Society for Private And Commercial Earth stations, the industry trade association) are scheduled to occur around the time you read this report. At stake here is the way consumers (i.e. TVRO owners) are to be treated by cable programmers. Those programmers, to date, have shown considerable reluctance to deal with TVRO owners at all.

### Bootleg descramblers

The truth is that bootleg descramblers are already on the market. However, the ones I have seen so far recover only the video portion of the transmission. That's no great trick, since the Videocipher system merely inverts the polarity of the baseband video signals and retards the sync signal. That's similar to the way that many of the terrestrial (subscription TV) systems scramble their signals. That system does not pose much of an obstacle to someone determined to unscramble a transmission. So far so good.

Audio recovery, however, is another matter. It's difficult for the following reasons. Audio is sent

digitally. That fact alone prevents use of a simple demodulator. Next, the digital pulse sequence is varied using a key that is transmitted with the digital audio. The key itself is also encrypted; it's part of a master key that is burned in a custom set of IC's inside each Videocipher. The balance of the master key is transmitted with the signal. The key/master-key information is changed several times per minute, so unlocking the key sequence at any point in time only

provides the user with momentary audio recovery. Hence it seems unlikely that a simple method of recovering Videocipher audio will be developed soon.

Another point is that if M/A-Com has its way, eventually all cable-TV transmissions will use the same scrambling technique. In that scheme, every descrambler is addressable by the program supplier who can lock and unlock individual decoder boxes on command. Ideally—for the cable operator—

## SATELLITE TV/

### The First Five Years!



**THE MOST COMPLETE** report on the mushrooming home 'TVRO' industry ever compiled, written as only the 'father of TVRO' could have prepared. More than **1000 pages** (!) tracing the complete story of home TVRO, lavishly illustrated with equipment photos, schematic diagrams, equipment analysis reports. **Bob Cooper**, the first private individual to own and operate a TVRO (1976) has collected and polished hundreds of individual reports into a unique 'collector's edition' which clearly explains the TVRO phenomenon in North America. From Coop's first 20 foot 'monster' dish to the present day 5 foot 'C-band' TVROs, the fascinating growth of TVRO equipment and its legal status unfolds for you.

**THIS TWO VOLUME SET** totaling more than 1,000 pages is available for the first time to readers of **Radio-Electronics** at special discount pricing. **Originally sold** at \$100 per two-volume set, a limited supply is now available **ONLY** through this advertisement. **PLUS**, you will also receive a special extraordinary bonus; the 200 page (+) **October 1984** edition of **CSD/Coop's Satellite Digest**. This very special edition of CSD is a best-seller in the TVRO industry, with the most comprehensive collection of TVRO facts and figures ever compiled. Combined with the 1,000 page 'CSD ANTHOLOGY' report, you have instant reference to **everything** you will ever need to know about the state of the home TVRO industry. It is **MUST** reading for every person in, or thinking about 'getting into,' **any** segment of the home TVRO world.



\_\_\_\_ **SEND CSD ANTHOLOGY/2 Vols. + CSD Bonus.**  
 \_\_\_\_ **SEND CSD October '84 Special Issue ONLY.**

NAME \_\_\_\_\_ COMPANY \_\_\_\_\_  
 ADDRESS \_\_\_\_\_  
 CITY \_\_\_\_\_ STATE \_\_\_\_\_ ZIP \_\_\_\_\_

Payment: \$60 US funds (Anthology + Bonus), \$15 US funds CSD Oct. ONLY; payable "CSD ANTHOLOGY."  
 Shipping charges prepaid. Enter order to: **CSD Anthology**, Radio-Electronics Magazine, 200 Park Av. S., New York, NY 10003; or call 305-771-0505 for credit card orders ONLY.

# Capacitance, logic and more. For less.

Now, a fully-loaded DMM combines a capacitance meter, logic probe, and an hFE meter, all for the price of a DMM.

**TTL Logic Probe:** 20 MHz

Hi/lo/off indications

Detects 25nS pulse width

**Capacitance:** 5 ranges (2nF to 20μF)

**hFE (NPN or PNP):** 1 range (1000)

**DMM:** DCV-5 ranges (.2V to 1kV)

ACV-5 ranges (.2V to 750V)

DCA-4 ranges (200μA to 10A)

ACA-3 ranges (20mA to 10A)

Ohms-7 ranges (200 Ohms

to 2000 Megohms)

Continuity beeper

Diode check

Built-in bail

Anti-skid pads

See one now at your local Beckman Industrial distributor.

**DM25L... \$89.95\***



\*Suggested list price (\$US) with battery, test leads and manual.

**Beckman Industrial™**

Beckman Industrial Corporation  
A Subsidiary of Emerson Electric Company  
630 Puenta Street, Brea, CA 92621  
(714) 671-4800

© Copyright 1985 Beckman Industrial Corporation

CIRCLE 98 ON FREE INFORMATION CARD

SEE YOUR DEALER TODAY

FROM

**'Firestik'®**  
ANTENNAS  
ACCESSORIES

HERE'S A TIP  
THAT'S PERFECT!

AM/FM AUTO RADIO  
AND CB

**'Firestik'® II**  
GOLDEN SERIES

BARE-HANDS TUNABLE  
"NO TOOLS NEEDED"  
HIGH PERFORMANCE ANTENNAS

ALSO ANTENNAS FOR  
CORDLESS TELEPHONES  
MONITOR SCANNERS

Dealer & Distributor Inquiries Invited  
SEND FOR FREE CATALOG

'Firestik' Antenna Company  
2614 East Adams/Phoenix, AZ 85034

Name \_\_\_\_\_

Street \_\_\_\_\_

City \_\_\_\_\_

State \_\_\_\_\_ Zip \_\_\_\_\_

Serving the CB and  
Communications Market Since 1962.

**5-YEAR REPLACEMENT WARRANTY**

CIRCLE 100 ON FREE INFORMATION CARD

Learn the IBM PC's secrets with the  
**MICROPROFESSOR I/88**



Students, engineers, or technicians—  
Now you can learn micro-processing and  
understand the technology which made  
the IBM PC famous.

The MPF-I/88 features:

- extensive documentation
- 16-bit central processor
- full-size keyboard
- special options

Three tutorial guides cover all capabilities.  
The ideal training tool! If the IBM PC or  
micro-processing are in your future, you owe  
yourself an MPF-I/88. Invest now!

Only **\$349.95**

Plus—

- Check this box for a  
10% discount when you  
purchase within twelve  
days.

**ETRONIX**

Dept. RE0586  
5326 9th Ave. NE  
Seattle, WA 98105-3617

For immediate action call TOLL FREE:  
**1-800-426-1044**

Full money back  
guarantee.



CIRCLE 253 ON FREE INFORMATION CARD

all channels delivered to a home would be equipped with a combination converter/decoder with cable-operator control over which homes receive which services. That addressable system is the pay-TV delivery system of the future, and it's operating now in the satellite portion of the pay-TV distribution system.

## Other problems

When HBO began scrambling there were some bugs. Early home subscribers discovered several things:

- It was impossible to subscribe to just HBO; consumers received Cinemax whether they wanted it or not. However, if a subscriber had not ordered Cinemax, HBO decided not to charge for that service in that situation.
- The HBO descrambler also decoded test transmissions from its competitor, Showtime, as well as a new scrambled Pay-Per-View first-run movie service carried on satellite.

Those unintentional freebies were caused by a malfunctioning addressing computer in HBO's master control system.

And you might find it interesting to know that there are fail-safe routines built into the M/A-Com system in the event of a major equipment failure. For example, suppose the whole addressing portion failed at the satellite uplink. All descramblers in the system—there could be millions of them—turn off, so only scrambled audio and video would be received. HBO could then reactivate all decoders in the system *en masse* using a special "open" command. Then, as the addressing computer was repaired, individual descramblers could be re-addressed and the appropriate services enabled or disabled.

In sum, 1986 is going to be a shake-down year for an exciting new technology. There have been glitches in the system already, but none appear to be sufficiently serious to cause the system to be abandoned at this late date. Showtime and The Movie Channel are scheduled to begin scrambling in late spring or early summer. We'll keep you up to date about what happens.

R-E

# ROBOTICS



MARK J. ROBILLARD,  
ROBOTICS EDITOR

## Heath's new Hero

THE HEATH COMPANY (BENTON HARBOR, MI 49022) has finally released the latest member of its family of *Hero* robots. The new addition, *Hero 2000*, is shown in Fig. 1; he differs significantly from his predecessors. For one thing, *Hero 2000* is 32.4 inches tall and weighs about 78 pounds—considerably greater than *Hero 1*. The additional size and weight makes *Hero 2000* much more powerful than *Hero 1*; let's get an idea of what that power consists of.

### Mechanical features

*Hero 2000's* ability to move is provided by a two-wheel drive system that uses several casters for balance. Each drive motor is coupled via optical feedback into a closed-loop system that provides precise control. It's interesting to note that, if the robot is moved from a rest position, it immediately attempts to return to the point of origin.

Heath can supply an optional arm for *Hero 2000*, and it's simply exquisite. Forget you ever laid eyes on *Hero 1's* arm. The new one is as precise as anything currently available. It's driven by the same closed-loop system that is used in all the robot's joints. The driving mechanism is a combination of chains and cables. Although the arm can lift only one pound, it can do so even with the arm fully extended. The weight limitation is due more to safety factors than technical ones; Heath has restricted *Hero 2000's* weight-lifting ability in order to reduce the possibility of accident. For example, if the arm were too strong, a child's (or adult's!) finger could be severed in the robot's elbow joint if it

were accidentally inserted there. Heath should be commended for showing such a responsible engineering decision.



FIG. 1

The gripper is composed of two parallel jaws. However, removable finger pieces are provided, and that allows custom grips to be inserted. Heath intends to provide a variety of fingers in their training courses. In addition, there is a unique touch/force-sensing mechanism built into the gripper. In fact, it's so special, that Heath has patented it.

*Hero 2000's* head does not rotate (unlike *Hero 1's* head). Instead, the entire torso, from the waist up, rotates. That gives the arm another degree of freedom. A hex keypad is mounted in the head for manual entry of data or commands; also, you can move the robot by pressing direction keys in the head. There is a "status indicator" area of the head that has eight user-de-

finable LED's. They can be used to show the progress of your program, to add "personality" to your robot, etc.

The internal gel-cell battery can be recharged using a clever charger that *Hero 2000* can find on its own. The recharging hardware is provided with the basic robot, but the software will be sold separately.

Inside the torso rests the heart of the system. As shown in Fig. 2, there is a twelve-slot S100-like motherboard. It is through that bus that all the electronics of the robot communicate. Even the CPU card is plugged in the bus, so it is conceivable that you could use a different microprocessor to control your *Hero 2000* than the one supplied. In the basic system only three of those slots are used, and that leaves nine to play with!

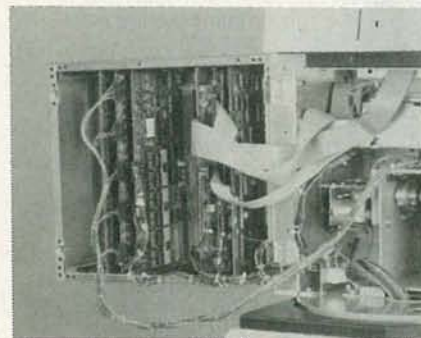

FIG. 2

### Robot brains

The main microprocessor is an 8088—the same as in the IBM PC. Is the *Hero 2000* IBM compatible? Heath officials are reluctant to answer that question, but I got a glimpse of a *Hero 2000* running a system that printed out "MS-

*continued on page 84*

# the Boardworks Pocket-Size Soldering

- Safe, no open flame.
- Only 7 inches long.
- Adjustable, with 10-60 W power.
- 3 tip sizes.
- No cords or batteries.
- Runs 60 minutes on one refill.
- Heats and cools in seconds.

Portasol™ is the first butane-powered, portable soldering iron that's safe, convenient and economical. Not much larger than a felt marker and as easy to use as a cigarette

lighter, Portasol is the ideal tool for soldering and desoldering in tight spots or where no electrical outlets are available. And because it's static free, Portasol is ideal for use with CMOS and other static-sensitive components.

See the flameless, static-free Portasol soldering iron at your nearest Boardworks electronics supply dealer. For the location of the Boardworks dealer nearest you, call or write to:

**The Boardworks**  
1077 E. Edna Place  
P.O. Box 1678  
Covina, CA 91722  
Telephone (818) 967-3681

Pat. No. 899064  
ACTUAL SIZE

DOS." That brings up another thing. *Hero 2000* will be offered with an optional disk drive. The controller will support four drives, but only two can fit in the torso.

Helping out the 8088 are 11—that's right, 11—8042 eight-bit slave microprocessors. They perform the tasks of servo control and sensor management. Most auxiliary tasks are distributed among those processors, and that gives the 8088 time to do the really complex tasks like those involved in artificial intelligence. In addition, the *Hero 2000's* built-in 24K of battery-backed-up CMOS RAM can be expanded to as much as 576K!

The sensor compliment is as follows. There are two Polaroid-like ultrasonic rangers on board. (See the "Robotics" columns in the November and December 1985 issues of *Radio-Electronics* for a discussion of ultrasonic rangers.) They're "intelligent" through use of the 8042's. The main ranger is

located on the robot's head. It is connected to a stepper motor that can rotate it 360°. The second sensor is located on the front of the base.

Integrally mounted with the ultrasonic sensor on the *Hero 2000's* head is a light sensor. It too can measure light levels in a 360° area. A sound-level detector can measure ambient sound within the range of normal human hearing. A temperature sensor can measure temperatures from 60°F to 90°F.

Voice communication is vastly improved in the new *Hero*. The new voice synthesizer is absolutely amazing. They have a demo that makes the robot appear to breathe! You've got to hear it to believe it!

You can communicate with the robot in two different ways. There is a built-in bi-directional RF link, and an RS-232C port on the CPU card. A portable console that includes a full QWERTY keyboard and a two-line 40-character LCD display is used to talk with *Hero 2000* via the RF link. You can use that remote terminal to program the robot just as if you were typing at a directly-connected terminal. There is also an RS-232C port on the console so that a different computer can communicate with the *Hero 2000* via the RF link.

Programming *Hero 2000* is a dream. The robot comes with a full-featured implementation of BASIC that includes statements and functions that allow easy control of the robot's motion and sensors. One nice feature of *Hero* BASIC is that it allows interrupt control. In addition, you can call machine-language subroutines for those times when BASIC is just not fast enough.

## Conclusions

Now that you're all excited, here's the bad news. A kit that includes everything mentioned above except a disk drive goes for just under \$3000. I hope that didn't spoil your enthusiasm. Actually, several kits are offered starting as low as \$1999.95. To find out whether the *Hero 2000* is really worth it, I suggest that you visit your nearest Heath store and ask for a demonstration. I'm sure you'll be impressed. **R-E**

## Be an FCC LICENSED ELECTRONIC TECHNICIAN!

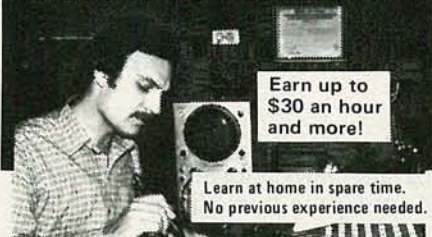

No costly school. No commuting to class. The Original Home-Study course prepares you for the "FCC Commercial Radiotelephone License". This valuable license is your "ticket" to thousands of exciting jobs in Communications, Radio-TV, Microwave, Computers, Radar, Avionics and more! You don't need a college degree to qualify, but you do need an FCC License.

**No Need to Quit Your Job or Go To School**  
This proven course is easy, fast and low cost! **GUARANTEED PASS** - You get your FCC License or money refunded. **Send for FREE facts now. MAIL COUPON TODAY!**

### COMMAND PRODUCTIONS

FCC LICENSE TRAINING, Dept. 90  
P.O. Box 2223, San Francisco, CA 94126

Please rush FREE details immediately!

NAME \_\_\_\_\_  
ADDRESS \_\_\_\_\_  
CITY \_\_\_\_\_ STATE \_\_\_\_\_ ZIP \_\_\_\_\_



# ANTIQUE RADIOS



RICHARD D. FITCH  
CONTRIBUTING EDITOR

## Contributions by hams and SWL's

COLLECTING ANTIQUE RADIOS IS A FASCINATING hobby for everyone. Younger collectors, to whom an "antique" radio is a set from the 1950's, can learn much about the history of radio, and more senior collectors can appreciate the amount of change the radio industry has gone through in less than a century. So, for the benefit of our younger readers, we'll discuss equipment from their era occasionally. Today, for example, our antique of the month is an interesting set from the 1950's; after discussing it we'll go on to talk about how ham operators and SWL's influenced the development of radio.

### The antique of the month

The Belmont Model 5-D-128 Series A, shown in Fig. 1, is our (to-be-restored) antique of the month. As you can see, the case style of that radio is considerably different than that of the radios we usually display here. But its variable tuning control and five push-buttons for automatic station selection make the Belmont an interesting relic of its period.

### Hams and SWL's

We can't discuss antique radio without mentioning amateur radio and shortwave listening. Senior readers of this column are well aware of the importance of the connections between the developing radio industry and hams and SWL's. Hams were communicating via the airwaves well before the 1920's; they used spark-gap transmitters for that communication. The U. S. Navy had to

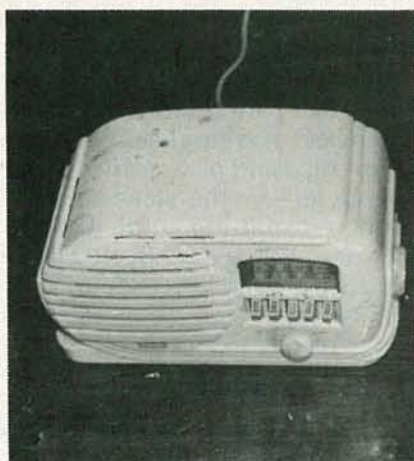

FIG. 1

exercise considerable control over those devices.

During the war (WWI), all amateur radio transmitting and experimenting had to be suspended. But after the war ended, radio returned to its pre-war status. And that's when things really began to mushroom. Again, during WWII radio experimenting was forbidden, but afterwards a new surge of growth brought things to a higher level than ever before.

In the early period, there was some discussion about whether listening devices should be licensed. Finally licensing requirements were dropped after it was decided that receiving antennas didn't interfere with other radio signals. That turned out to be a good decision; otherwise there would have been few listeners for KDKA's famous broadcasts—or for anything else.

While everyone is familiar with the way hams help out in a time of emergency, their contributions to

the advancement of radio are often overlooked. The number of amateur radio operators continued increasing through the 1940's when their ranks grew to some 50,000. That number includes only the licensed operators; you might multiply that number several times to include all those who just listened to shortwave signals. The reason is that, while amateur radio was suspended during WWII, shortwave listening became even more popular.

By the 40's, most commercially-sold receivers had shortwave bands. Many of us recall picking up heart-rending messages from foreign countries on our home radios during the war years. An operator would beg for help in broken English, and then his signal would fade as enemy troops overran his area.

Amateur radio resumed, more popular than ever, when hostilities ceased. However, shortwave listening didn't fare so well; the listening public soon found other interests including Hi-Fi and stereo, FM radio, CB, and television, of course.

Returning to the early 1920's, interest in receiving shortwave also faded after the end of the first World War. There were enough regular broadcast stations on the air to keep the listener occupied, although the shortwave bands were still busy for those inclined to listen. By the late 1920's, few new receivers (most of which had elaborate, artistic cabinets) could receive a shortwave band without some sort of adapter. Aesthetic

considerations were put to good use later on in the 30's, when intricate turning dials marked the shortwave (and other) bands. Those dials were surely a selling point for the radio salesmen of the thirties.

However, after six or seven years of listening to regularly-scheduled broadcasts, people's interest in shortwave began to revive. Alert manufacturers then began to offer shortwave adapters, sometimes in kit form, that allowed shortwave signals to be received on broadcast-band radios. At first, band selection was accomplished by plugging in different coils, rather than by rotating a switch.

Early radio enthusiasts usually made whatever parts they could, and that included winding their own coils. Perhaps they bought the coil form and the wire, but a pre-wound coil was seldom purchased. Some built coils out of old tube bases and sockets. Or the cardboard cover from a flashlight battery could be used as a coil form.

Sometimes it wasn't clear which coil you needed. Frequency as-

signments were varied often. In the early days, the Department of Commerce assigned those bands. Later it was the duty of the Federal Radio Commission, which came to life in 1927.

### Band scrambling

At the end of 1921, entertainment programs (music shows, for example) were consigned to 360 meters, and public service reports to 485 meters. A year later, "high-powered" stations (over 500 watts) were assigned to one band, and a year later, they were re-assigned to 375-545 meters. Low-powered stations were placed on the 230-300 meter band.

Later, because of overcrowding, a problem developed at the low end of the dial. Broadcast stations there had to monitor nearby frequencies for emergency messages from ships and planes. If anything was detected, the station had to stop transmitting until that frequency was clear. By 1925 the broadcast band was extended to 200 meters. That gave it a total range of 200-545 meters.

Since most receivers sold in the

late 20's could receive the broadcast band only, adapter kits and plans were plentiful. However, many of those adapters didn't meet expectations. Some simply didn't bring in the desired signals, and others worked, but only with certain radios. Disappointment in those adapters surely led to loss of interest in shortwave listening.

A manufactured set (or even a suitable kit) that covered both the broadcast band and various shortwave bands was needed. A radio made by National Co., of Malden, Massachusetts, was one which met that need.

### The Thrill Box

National's receiver tuned the entire 15-550 meter range, which included the most often listened to shortwave bands, as well as the broadcast band. Complete battery operation was recommended for that early (about 1929) four-tube receiver. The tubes include a 222, a 200A, a 240, and a 171A.

Working backwards from the output stage, first comes the 171A, a power tube. The loudspeaker is connected directly to the plate cir-

## NOISE REDUCTION FOR UNDER \$10.

SWITCHES & RELAYS



**CRAMOLIN<sup>®</sup>**  
SPRAY  
**R-2**

• CLEANS  
• PRESERVES  
• LUBRICATES

SPEAKER TERMINALS

POTS & FADERS

TERMINAL STRIPS

ALL PLUGS & JACKS

BATTERY CONTACTS

CABLE CONNECTORS

COMPONENT SOCKETS

### CRAMOLIN<sup>®</sup>

Even the finest equipment in the world can't guarantee noise-free operation. One "dirty" connection anywhere in the audio/video chain can cause unwanted noise or signal loss.

**"MORE THAN A CONTACT CLEANER"**

**CRAMOLIN<sup>®</sup>** is a fast-acting, anti-oxidizing lubricant that cleans and preserves all metal surfaces, including gold.

When applied to metal contacts and connectors, **CRAMOLIN<sup>®</sup>** removes resistive oxides as it forms a protective molecular layer that adheres to the metal surfaces and maintains maximum electrical conductivity.

**CRAMOLIN<sup>®</sup> - USED BY THOSE WHO DEMAND THE BEST:**

Ampex	General Electric	MCI(Sony)	RCA
Capitol Records	Hewlett Packard	Motorola	Studer-Revox
Dolby Laboratories	McIntosh Labs	NASA	Switchcraft

SINCE 1956

**CAIG LABORATORIES INC**

1175-O Industrial Ave., (P.O. Box J) - Escondido, CA 92025-0051 U.S.A. • (619) 743-7143

## Put Your Electronic Skills to Work UNDERWATER!

### BECOME A ROBOT VEHICLE PILOT/TECHNICIAN



Accredited by NATTS  
Approved for Training  
of Veterans  
Approved for Various  
Loan & Grant Programs

## HIGH PAY—WORLDWIDE TRAVEL

Call or Write Today for **FREE BROCHURE**

# CALL (212) 885-0600

**UNDERWATER VEHICLE TRAINING CENTER**  
10046 CHICKASAW, HOUSTON, TX 77041  
IN TEXAS CALL: 713-690-0405, TELEX 4620684

CIRCLE 276 ON FREE INFORMATION CARD

# COMPUTER DIGEST

VOL. 3 NO. 5

May 1986

A NEW KIND OF MAGAZINE FOR ELECTRONICS PROFESSIONALS

## REMOTE POWER CONTROLLER For The Commodore-64

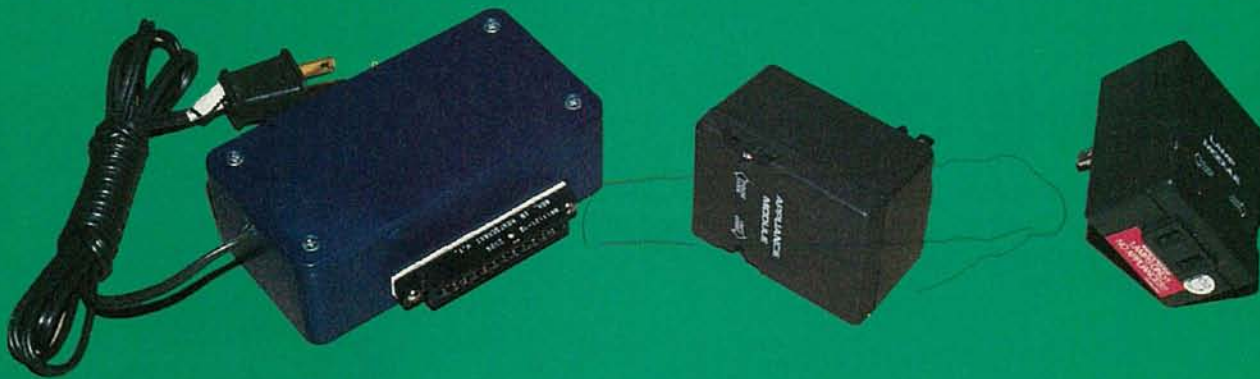

## ADAPTING THE TI99-4A KEYBOARD

To The Sinclair ZX-81

A  
**GERNSBACK**  
PUBLICATION

## USING YOUR COMPUTER

To Select Power Supply Components

# CONTENTS

Vol. 3 No. 5

May 1986

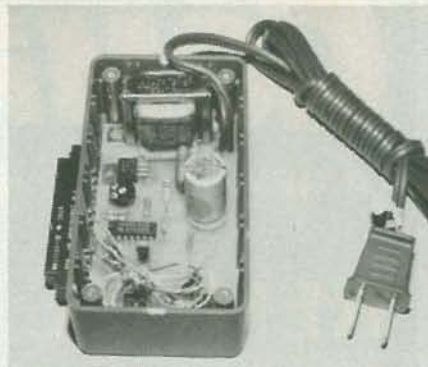

See Page 11

- 7 Using A TI-99/4A Keyboard On A Sinclair ZX-81**  
All it takes is a little simple modification, some fancywork with your soldering iron, and you've got it cold. **Robert Grossblatt**
  
- 11 Your Commodore-64 Can Remote Control Your Home.**  
With this small circuit and a bit of ingenuity, you can totally computerize your dwelling place. **Chandler Sowden**
  
- 15 Computer-Designed Power Supply Components**  
Cut-and-try becomes a thing of the past as you feed the parameters into your computer using this handy program. It picks the components for you! **By Jack Cunkelman**
  
- 3 Editorial**
  
- 4 Letters**
  
- 4 Computer Products**

FULL WAVE BRIDGE CAPACITOR INPUT FILTER			
TRANSFORMER VOLTAGE (RMS)	DC VOLTS	DIODE PIV	CAPACITOR VOLTAGE
5	6	12	7
6	8	16	10
7	9	18	11
8	10	20	13
9	12	24	15
10	13	26	16
11	14	28	18
12	16	32	20
13	17	34	22
14	18	36	23
15	20	40	26
16	21	42	27
17	22	44	28
18	24	48	31
19	25	50	32
20	26	52	33
21	28	56	36
22	29	58	37
23	30	60	39
24	32	64	41
25	33	66	42
26	34	68	44
27	36	72	46
28	37	74	48
29	38	76	49

See Page 15

## ON THE COVER

Here's the completed Remote Controller to automate your home. We imposed on the author to get his photographed and he couldn't wait to get it installed once again! For additional information, see page 11.

## COMING NEXT MONTH

It's "alphabet soup" time, with a story on GPIB, the General Purpose Interface Bus, and then we've got a story on LAN, Local Area Networking. To round out the issue, you'll be reading a most-interesting piece on what can happen when lightning strikes, as far as your computer equipment is concerned. It happened to one of our authors! Of course, you'll also enjoy all of the regular departments, including our Editorial, the Letters Column, and the latest in Computer Products.

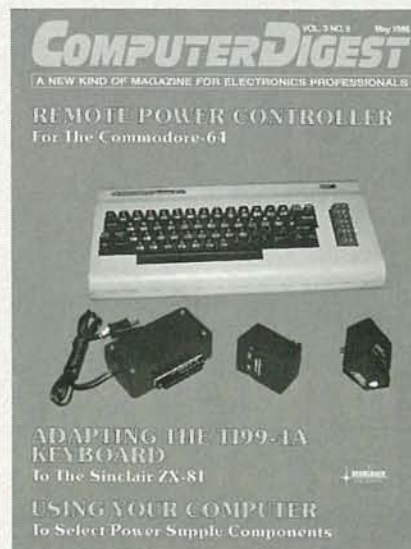

# EDITORIAL

## Who are you fooling?

■There are some basic, fundamental tenets in engineering that we are forced to live with. The first of these, is that you "don't get something for nothing." Whatever you gain must be paid for with a sacrifice elsewhere. In computer design, for example, if you want the miniaturization offered by a liquid crystal display, you can't at the same time, have the easy readability of a cathode ray tube. And if you want low cost you'll usually give up several nice little options that you might also like to have. After all, these things *do* cost money, and somebody has to pay the piper.

A friend of mine called last night to tell me that his new hard disk system was now installed and working. From his enthusiasm, as he read the display, there was no question that he was delighted with the seemingly unlimited workspace he had attained. And the numbers were indeed impressive. Even with his operating systems on the disk, there was still more than ample room left for at least a year's worth of work, and I *know* this guy really cranks it out. Frankly, it left me feeling a trifle envious. It also made me think. The more convenience you build into your system, the less effort you have to exert. Unfortunately, our own "Murphy's Law" that you don't get something for nothing, was working here too. Hard disk systems cost. There are other things we'd like to add to our own system. Things have to be prioritized.

Frankly, I'm as much a sucker for a bargain as anybody else. Offer me a "deal," and you've probably got me hooked. But in retrospect, there are few deals that are worthwhile, and these come far between. You want to buy the most for your money, the seller wants to give as little as possible to improve his own profit picture. Nobody is in business on an altruistic basis. You know how much you've got to spend; the seller knows what he has to offer. He may show you something with fewer of the "extras" that will save you some bucks, and you probably figured to add the extras later on.

That's why we figured out a new version of the Law... "Buy the best you can afford and make your first expense your last."



Byron G. Wels  
Editor

# COMPUTER DIGEST

M. Harvey Gernsback,  
editor-in-chief, emeritus

**Larry Steckler**, EHF, CET  
publisher & editor in chief

**Art Kleiman**, editorial director

**Byron G. Wels**, editor

**Brian C. Fenton**, managing editor

**Carl Laron**, associate editor

**Robert A. Young**, assistant editor

**Ruby M. Yee**, production director

**Karen Tucker**,

production advertising

**Robert A. W. Lowndes**,

production associate

**Geoffrey S. Weil**,

production assistant

**Andre Duzant**, technical illustrator

**Jacqueline P. Cheeseboro**

circulation director

**Arline R. Fishman**,

advertising director

Computer Digest  
Gernsback Publications, Inc.

Executive offices

500-B Bi-County Blvd.,

Farmingdale, NY 11735

516-293-3000

President: Larry Steckler

Vice President: Cathy Steckler

## ADVERTISING SALES 516-293-3000

Larry Steckler

Publisher

## NATIONAL SALES

Joe Shere

1507 Bonnie Doone Terrace

Corona Del Mar, CA 92625

714-760-8697

ComputerDigest is published monthly as an insert in Radio-Electronics magazine by Gernsback Publications, Inc., 500-B Bi-County Blvd., Farmingdale, N.Y. 11735. Second-Class Postage Paid at New York, N.Y. and additional mailing offices. Copyright © 1986 Gernsback Publications, Inc. All rights reserved. Printed in U.S.A.

A stamped self-addressed envelope must accompany all submitted manuscripts and/or artwork or photographs if their return is desired should they be rejected. We disclaim any responsibility for the loss or damage of manuscripts and/or artwork or photographs while in our possession or otherwise.

# LETTERS

## More Plus 4

I just acquired a Commodore Plus 4 and can't seem to get any information at all on the unit. Can anybody out there help me?

—FK., Rowayton, CT.

*FK., we've gotten a lot of mail on this. It seems that somebody's pushing these units at a low price on TV. We've done a bit of digging around, and suggest that you write to ETT Book Club, Department CD, P.O. Box 240, Massapequa Park, N.Y. 11762. Send 'em \$6.50 plus \$1.00 shipping and handling, and they'll send you a book on programming the Plus 4 and C-16.*

## Valuable tool

I just wanted to write and say that I count **ComputerDigest Magazine** as one of my more valuable tools. I save every issue and refer to them constantly. Thanks for the good job!—T. J., Oklahoma City, OK.

*Thank YOU T.J. We appreciate the kind words.*

## Moving

I see from your last issue that you've moved or are moving. Will this have any effect on my subscription?—S. L., Taos, N.M.

*No, S. L. By the time you read these words, the move will have been accomplished. Since it's the nature of a magazine to work ahead, we're well backed-up with ready-to-go material, so your issues will continue as though nothing happened.*

## Dilletante?

It seems that interest in electronics comes in waves. First it was hi-fi, then stereo, followed by the CB craze. After that it was computers, and as suddenly, interest shifted to satellite. Magazines suddenly burst out to cater to those interests, the

electronic shops stock up for them, and as suddenly, they die out. From where you sit, can you tell me what's coming next?

—P.T., Princeton, NJ.

*Wish I could, P.T. I'd be laying out a new magazine right now! But I don't have a crystal ball either. Incidentally, you can eliminate computers from your list of "drop-outs." Because the computer has such enormous practical value to so many, it isn't just a passing fad. We're here to stay!*

## Help?

Can anybody help with a service manual or schematic for a Commodore SX-64? (Not a C-64). I'll pay any reasonable fee for this information. It's not available from Commodore or Sams.—P. S., Boynton Beach, FL.

*If you can help, write to Paul Schultz, 9535 Listow Terrace, Boynton Beach, FL 33437.*

# COMPUTER PRODUCTS

For more details use the free information card inside the back cover

**TOUCH SCREEN**, is a 19-inch capacitive touch screen, designed for OEM's and systems integrators. The *MicroTouch Screen* comes fabricated in the standard spherical shape to fit most 19-inch monitors, or in cylindrical form to fit the line of 19-inch Sony monitors. It more than doubles the display area of the 13-inch screen, providing better visibility, greater visual impact, and more touch area to manipulative data.

The *MicroTouch Screen* allows users to interact with the computer intuitively by simply touching images on

the CRT screen. The screen operates by automatically sensing the location of a capacitive coupling when it is touched by a finger or conductive stylus. Constructed of solid glass with a resistive coating bonded to its surface, the screen is virtually impervious to damage under normal conditions, and will not distort the display image.

The *MicroTouch Screen* is priced at \$1395.00 for single units.—**Micro-touch Systems, Inc.**, 400 West Cummings Park, Woburn, MA 01801.

**TALKING MODEM**, the *Intelligent Talking Terminal*, lets the user receive modem-transmitted data verbally, just as if he or she were listening to a telegram on the phone. The user can also receive information the ordinary way: text-on-screen or printed. The *Intelligent Talking Terminal* enunciates data transmitted over phone lines—even if transmitted at high baud rates—and talks in clear, understandable speech.

With a talking modem, one can now

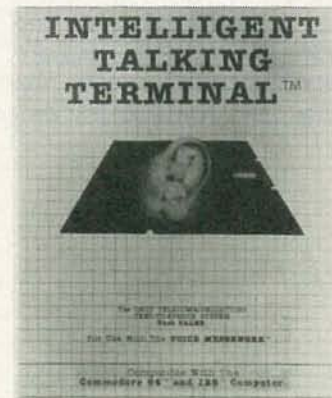

CIRCLE 12 ON FREE INFORMATION CARD

read and hear stock market quotes or the latest business news. It can also be tapped into a wide range of other library data bases for educational, research, and reference materials, financial information, or news updates.

The *Intelligent Talking Terminal* has a suggested retail price of \$29.95.—

**Welwyn Currah**, 104 W. Fourth Street, Royal Oak, MI 48067.

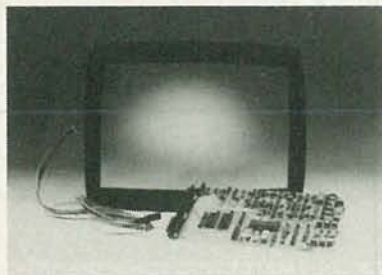

CIRCLE 11 ON FREE INFORMATION CARD

# SOFTWARE REVIEW

## WORD FINDER—An Electronic Thesaurus.

■ Depending on how it's used, a word can be dull or exciting, or even take on a different meaning. And the repeated use of words can turn even the most-exciting thoughts into eyelid-closers.

Because of this, one of the most-important tools a writer has, is a "thesaurus" which is a collection of words arranged according to the ideas they are meant to express. The author looks up the word he is considering and the thesaurus suggests synonyms. For example, if you want to avoid using the word "impair" four times in a short sentence, a thesaurus will suggest such words as "damage," "hurt," "harm," "injure," "mar," "prejudice," "tarnish," and perhaps a handful of others if the thesaurus is sufficiently large.

Writers find it difficult to create text at lightning speed on a word processor and then have to stop and go through the pages of a thesaurus to locate a suitable synonym. To meet the pace of the electronic age, the *electronic thesaurus* was created which allows the user to call up synonyms from the word processing program. One of the best we've seen, and the easiest to use, is WORD FINDER, designed for use with WordStar, WordStar 2000, Multimate, Word Perfect, pfs:WRITE, Microsoft Word, and Easy Writer 2. We tested the WordStar version because WordStar remains the most-popular word processor.

WORD FINDER consists of a 30K control program which is loaded into RAM prior to the word processor and a 90,000 word dictionary that requires 157K of disk storage. In a two-drive system, the thesaurus' dictionary must be on the same disk as the word processor. If you're using WordStar either MailMerge or the spelling checker can't be on the same disk. If you want direct access of the thesaurus, a spelling checker and MailMerge, the best arrangement is a hard disk or a RAMdisk for the thesaurus' dictionary.

The program responds to 9000 keywords which can call up an average of ten synonyms each: It means you may get anywhere from one to 50 synonyms for each keyword.

WORD FINDER works at "lightning" speed whether running from a hard disk, a floppy or a RAMdisk. To use the thesaurus while composing a document, you mark

a word by placing the cursor on *any* character and press a control key (which you can pre-program). WORD FINDER creates a window on the screen with a list of synonyms. If a suitable synonym is displayed, you move the cursor in the window to the synonym, press RETURN: The synonym substitutes for the marked word, the window vanishes and the word processing display is restored to full size. If there is no direct synonym the window displays the alphabetically-closest spelling of 30 words and the selection process is repeated, only this time it's for the words in the window. You can call up the synonyms for any of the 30 words, and pressing the RETURN key installs the selected synonym into the word processing text. Even if the window doesn't show the desired word or a close synonym there's a good chance that something in the window will suggest precisely what's needed. In this instance, you simply type it into the word processing text.

Obviously, a 90,000 word thesaurus is not equal to a printed version, but WORD FINDER is done well: We had few omissions for commonly-used words. While you might have to refer to a printed version, there is no question that WORD FINDER is a major enhancement for a personal computer's word processor.

Although WORD FINDER can be installed only once—for your particular word processor—the working program isn't protected and you can make as many copies as you like; you simply cannot reinstall the program for another word processor. WORD FINDER automatically determines whether your monitor is color or monochrome from the computer's monitor adapter bit and sets itself accordingly. However, if you are driving a monochrome monitor from a color adapter's composite video output the program will assume you're using a color monitor and key on the color adapter, and the display will appear as garbage. If this happens, run the DOS's MODE BW80 before you load WORD FINDER.

WORD FINDER is priced at \$129.95 for both PC/MS-DOS and CP/M computers. It is available direct from Writing Consultants, 11 Creek Bend Drive, Fairport, NY 14450. If you have any questions, phone them at (716) 377-0130. ◀▶

# R-E Books Admart

**Rates:** Ads are 2 1/4" x 2 7/8". **One** insertion \$825. **Six** insertions \$800 each. **Twelve** insertions \$775 each. Closing date same as regular rate card. Send order with remittance to **Books Admart**, Radio Electronics Magazine, 500-B Bi-County Blvd., Farmingdale, NY 11735. Direct telephone inquiries to Arline Fishman, area code-516-293-3000. **Only 100% Book ads are accepted for this Admart.**

## CONFIDENTIAL FREQUENCY LIST, 6th Edition

Latest available information on the most interesting communications stations operating on the short-wave bands. Includes SLB's, Phonetic Alphabet Stations, Numbers Stations, Military, Police, FBI, Government Agencies and more. 304 pages, 6 x 9 inches. Get your own copy for **\$15.95** plus \$1 postage in USA. **ELECTRONIC TECHNOLOGY TODAY INC.**, PO Box 240, Massapequa Park NY 11762-0240.



CIRCLE 284 ON FREE INFORMATION CARD

## ELECTRONIC SCIENCE PROJECTS



Soft cover; 12 projects, each one with a strong scientific flavor. Projects range from a color-temperature meter to an oscilloscope with a solid-state display to an infrared laser. **\$5.75** plus \$1 postage in USA. **ELECTRONIC TECHNOLOGY TODAY INC.**, PO Box 240, Massapequa Park, NY 11762-0240.

CIRCLE 284 ON FREE INFORMATION CARD

## 32 ELECTRONIC POWER SUPPLY PROJECTS

Soft cover; 291 pages of practical DC circuit applications for a wide variety of hobby and experimental purposes! Circuits range from the very simple (like a half-wave supply) to more advanced units (like a 12-volt inverter). **\$10.95** plus \$1 postage in USA. **ELECTRONIC TECHNOLOGY TODAY INC.**, PO Box 240, Massapequa Park, NY 11762-0240.

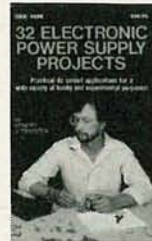

CIRCLE 284 ON FREE INFORMATION CARD

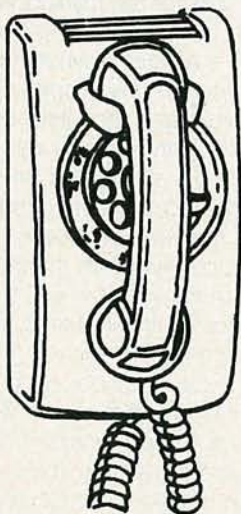

## CALL NOW AND RESERVE YOUR SPACE

- 6 x rate \$800.00 per each insertion.
- Reaches 229,044 readers.
- Fast reader service cycle.
- Short lead time for the placement of ads.

Call **516-293-3000** to reserve space. Ask for Arline Fishman. Limited number of pages available. Mail materials to: Books Admart, RADIO-ELECTRONICS, 500-B Bi-County Blvd., Farmingdale, NY 11735.

## LINEAR IC EQUIVALENTS & PIN CONNECTIONS

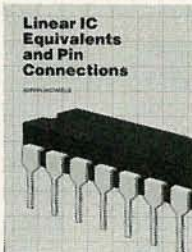

Shows equivalents & pin connections of a popular user-oriented selection of European, American and Japanese linear IC's. 320 pages, 8 x 10 inches. **\$13.50** postpaid in USA. **ELECTRONIC TECHNOLOGY TODAY INC.**, PO Box 240, Massapequa Park, New York 11762-0240.

CIRCLE 284 ON FREE INFORMATION CARD

## WHITE'S RADIO LOG



An up-to-date directory of North American AM, FM and TV stations including special section on world-wide shortwave stations. 136 pages, 5 1/2 x 7 1/2 inches, soft cover. **\$4.95** plus \$1 postage in USA. **ELECTRONIC TECHNOLOGY TODAY INC.**, PO Box 240, Massapequa Park, NY 11762-0240.

CIRCLE 284 ON FREE INFORMATION CARD

## 25 SIMPLE AMATEUR BAND ANTENNAS



Simple and inexpensive to build; yet perform well. Dipoles, beam, triangle and even a mini-rhombic made from 4TV masts and about 400 feet of wire. Includes dimension tables to help you spot an antenna on a particular frequency. **\$5.00** plus \$1 postage in USA. **ELECTRONIC TECHNOLOGY INC.** PO Box 240, Massapequa Park, NY 11762-0240.

CIRCLE 284 ON FREE INFORMATION CARD

## 103 PROJECTS FOR ELECTRONICS EXPERIMENTERS

Soft cover; 308 pages of practical, proven plans for the electronics hobbyist...circuits, converters, amplifiers, synthesizers, optoelectronics, power supplies and more. Written and designed by Forrest M. Mims, III. **\$11.50** plus \$1 postage in USA. **ELECTRONIC TECHNOLOGY TODAY INC.**, PO Box 240, Massapequa Park, NY 11762-0240.



CIRCLE 284 ON FREE INFORMATION CARD



# USING A TI-99 KEYBOARD ON A SINCLAIR ZX-81

*You push the middle key down,  
and the signals go round and round,  
whoa-ho-ho-ho, ho-ho.*

## Robert Grosblatt

■The Sinclair ZX-80 and ZX-81 got more people hooked on computers than any machine ever made. For under a hundred bucks you could connect it to a TV, power it up, and find out what computers were about. If you were interested you moved to a bigger machine. If not, it was worth it to satisfy your curiosity.

Even though technology has increased, prices have decreased, and the lowly Sinclair is no more, the fact remains that it's still a powerful machine. Now that it's available on the surplus market for under twenty bucks, what was a good deal has become a bargain.

The biggest drawback to the Sinclair is the membrane keyboard. Not only is it a pain to use but, unless you're gentle with it, it breaks. Replacing the keyboard is a good idea but it seems ridiculous to spend some \$50 on a keyboard for a twenty dollar computer. Well, things are looking better.

When Texas Instruments dropped the TI-99/4A, a huge inventory of keyboards were dumped on the surplus market. Modifying them for use on the Sinclair is easy...easier, in fact, than adapting some of the more expensive keyboards. In order to understand what has to be done, let's take a look at the Sinclair.

## The Sinclair

Both the Sinclair and the TI use a simple matrix-type keyboard. This means that each key returns a unique row and column code every time the computer looks at the keyboard to find out which key was pressed. Unfortunately, these keyboard codes have nothing to do with standard ASCII. However, TI's oddball keycodes are so close to Sinclair's oddball codes that it only requires minor keyboard surgery to make them the same.

### Sinclair Keyboard Horizontal Grouping Showing Connector Numbers

#8	1	2	3	4	5	6	7	8	9	0	#6
#7	Q	W	E	R	T	Y	U	I	O	P	#4
#5	A	S	D	F	G	H	J	K	L	ENT	#2
#3	SHFT	Z	X	C	V	B	N	M	.	SPC	#1

### Sinclair Keyboard Vertical Grouping Showing Connector Numbers

#9	#10	#11	#12	#13	#13	#12	#11	#10	#9
1	2	3	4	5	6	7	8	9	0
Q	W	E	R	T	Y	U	I	O	P
A	S	D	F	G	H	J	K	L	ENT
SHFT	Z	X	C	V	B	N	M	.	SPC

### TI Keyboard Horizontal Grouping Showing Connector Numbers

#9	LCK	FCTN	1	2	3	4	5	6	7	8	9	0	#14	
#6		CNRL	Q	W	E	R	T	Y	U	I	O	P	ENT	#15
#13		SHFT	A	S	D	F	G	H	J	K	L	;	SPC	#12
#5			Z	X	C	V	B	N	M	,	.	/	=	#11

### TI Keyboard Vertical Grouping Showing Connector Numbers

#10	#4	#8	#3	#2	#1	#7	#7	#1	#2	#3	#8	#4
LCK	FCTN	1	2	3	4	5	6	7	8	9	0	
	CTRL	Q	W	E	R	T	Y	U	I	O	P	ENT
	SHFT	A	S	D	F	G	H	J	K	L	;	SPC
		Z	X	C	V	B	N	M	,	.	/	=

FIG. 1—COMPARING THE LAYOUTS of the two keyboards. Both have eight horizontal sections but the TI has two extra vertical sections.

In Figure 1 you can compare the layout of the two keyboards. The first thing you should notice is that while both keyboards have eight horizontal sections, the TI has two extra vertical sections. One of them, #10, is for "Alpha Lock" and the other, #4, contains most of the operator keys. Figure 2 shows you how these section numbers relate to the connectors going from the keyboard to the computer's motherboard.

There are a couple of ways to go about adapting the TI keyboard to the Sinclair. The most elegant is to design some circuitry that converts TI code to Sinclair code. Put the translation tables in an EPROM and the circuit does everything for you. This lets you add goodies like auto repeat, macros, and function keys. After all, the TI keyboard has seven extra keys to play around with. The disadvantage is that you have to design circuitry, build a board, and burn EPROMs.

The easiest way is to do a bit of cutting and pasting to the TI board to make it put out the codes the Sinclair expects to see. Most of the extra keys will go to waste but it's less work. Especially since the two keyboards have really similar arrangements to start with. Figure 3 is a list of the changes that have to be made to the TI keyboard. There are fourteen keys that have to be moved. The "Alpha Lock" key, a push on - push off switch, can be isolated and put in parallel with the "Shift" key to give a quick and dirty Shift lock.

Unfortunately, the rest of the TI's extra keys won't do anything at all. They can't be used for extra characters because the ZX-81 won't recognize any additional keycodes. All you can do is put them in parallel with

other keys to make the keyboard more convenient to use. Once you've made these changes to the TI keyboard all that's left is making the connections to the ZX-81 motherboard.

Turn the ZX-81 upside down and locate the five screws that hold the case together. Three of them are located under the rubber feet as shown in Figure 4. Once the case is open, lift out the mother board by removing the two retaining screws, pull the two keyboard connectors from their sockets and tape them out of the way on the underside of the case. Solder 12-

#### Sinclair Keyboard Connectors Viewed from the Back of the Keyboard

1	2	3	4	5	6	7	8	9	10	11	12	13
---	---	---	---	---	---	---	---	---	---	---	---	---
---	---	---	---	---	---	---	---	---	---	---	---	---
---	---	---	---	---	---	---	---	---	---	---	---	---
---	---	---	---	---	---	---	---	---	---	---	---	---
Vertical											Horizontal	
Connectors											Connectors	

#### TI Keyboard Connectors Viewed from the Back of the Keyboard

1	2	3	4	5	6	7	8	9	10	11	12	13	14	15
---	---	---	---	---	---	---	---	---	---	---	---	---	---	---
---	---	---	---	---	---	---	---	---	---	---	---	---	---	---
---	---	---	---	---	---	---	---	---	---	---	---	---	---	---
---	---	---	---	---	---	---	---	---	---	---	---	---	---	---
Horizontal														
Connectors														
Vertical														
Connectors														

FIG. 2—HOW THE SECTION NUMBERS relate to the connectors from the keyboard to the computer's motherboard.

#### Cut and Paste Guide for Adapting the TI Keyboard at the Sinclair

Key	Original Location	New Location
B	Horizontal #15	Horizontal #11
SPC	Horizontal #12	Horizontal #11
SHFT	Horizontal #13	Horizontal #5
ENT	Horizontal #15	Horizontal #12
LOCK	Horizontal #9	Horizontal #11
Z	Vertical #8	Vertical #3
X	Vertical #3	Vertical #2
C	Vertical #2	Vertical #1
V	Vertical #1	Vertical #7
N	Vertical #7	Vertical #1
M	Vertical #1	Vertical #2
ENT	Vertical #4	Vertical #8
SPC	Vertical #4	Vertical #8
SHFT	Vertical #4	Vertical #8
LOCK	Vertical #10	Vertical #8

#### TI Keyboard to ZX-81 Motherboard Connection Guide

T1 Keyboard	ZX-81 Motherboard
1	12
2	11
3	10
4	NOT USED
5	3
6	7
7	13
8	9
9	8
10	NOT USED
11	1
12	2
13	5
14	6
15	4

FIG. 3—A LIST OF CHANGES to be made in the TI keyboard. A total of fourteen keys have to be moved.

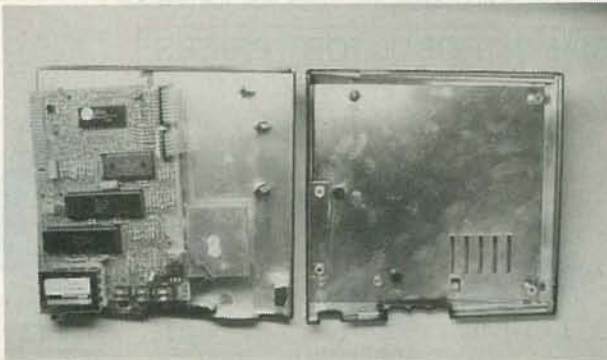

FIG. 4—TURN THE ZX-81 upside-down and you'll see the five screws that hold the case together.

inch lengths of hookup wire to each of the thirteen keyboard connectors on the bottom of the motherboard. You can remove the original keyboard connectors but it's easier to lap solder directly to the motherboard. The same is true of the TI keyboard.

As you can see from Figure 5, I used male and female DB-25 connectors to connect the TI keyboard to the Sinclair motherboard but you can connect them directly together. Since the ZX-81 motherboard is smaller than the keyboard, you can get rid of the case and put the whole thing together in a small utility case. If so, use an aluminum case and connect the case to the housing around the RF modulator. The Sinclair has a problem with RF and you'll have trouble with the video if you use a plastic box.

I can't show you exactly how to do the surgery on the keyboard. TI used several manufacturers to make the boards and though all the keyboards are functionally the same, the traces are different from manufacturer to manufacturer. As long as you identify the switches on the printed circuit board you should have no trouble altering it to use on the Sinclair.

When you finish, don't throw away the old Sinclair keyboard. You can cut out the key tops with a hobby knife and glue them to the tops of the keys on the TI keyboard. A new keyboard is nicer if the keys are properly labeled.



FIG. 5—MALE AND FEMALE DB-25 connectors connect the TI keyboard to the Sinclair motherboard.

### Sinclair Keyboard Keycodes

Key Location Pressed	Keycode	Register
None	FF	L
Horizontal #1	7F	L
Horizontal #2	BF	L
Horizontal #3	FE	L
Horizontal #4	DF	L
Horizontal #5	FD	L
Horizontal #6	EF	L
Horizontal #7	FB	L
Horizontal #8	F7	L

None	FF	H
Vertical #9	FD	H
Vertical #10	FB	H
Vertical #11	F7	H
Vertical #12	H	H
Vertical #13	DF	H

If the SHIFT key is pressed with another key bit 0 is reset to 0 in the H register so that FF=FE, FD=FC, F7=F6, etc.

FIG. 6—HERE ARE THE CODES put out by the Sinclair keyboard. This will be of great help if you're building translation circuitry.

### Translation circuitry

If you're set on building translation circuitry you'll find Figure 6 helpful. I've listed the codes put out by the Sinclair keyboard. The keyboard scanning routine in the Sinclair ROM (located at 022B hex) returns with the keycode in the Z-80's HL register. The key's row (horizontal) location is stored in L and the column (vertical) location is stored in H. Once the computer has the complete keycode, it uses a routine located at 07BD hex to translate the code into the character it represents. The lookup table is stored from 007E to 00CB hex.

Building circuitry to do the job means bringing power and ground out from the motherboard. Since the data bus has to be 13 bits wide, you'll have to think about the 8 bit limitation of the EPROM. There are two ways of handling the problem. You can use two locations in the EPROM to store each keycode and let your circuit clock the data out in order or use two EPROMs to widen the bus to 16 bits. This last approach is easier and even though it means burning two EPROMs it will cut the circuitry needed down to a much more manageable size.

The Sinclair is a great first computer and a good choice for a dedicated controller. Once you get your software straight, you can burn the program into an EPROM and replace the ZX-81's 2k RAM chip with the EPROM. Although I've been skimpy on the details of designing the EPROM circuitry needed to do a nifty keyboard adaptation, if there's enough interest I can deal with it much more thoroughly in a separate article. ◀▶

# Electronics Paperback Books

EXCITING OFFERINGS AT SPECIAL INTRODUCTORY PRICES



**COMPUTER MUSIC PROJECTS** ..... \$7.50. Shows how to use your home computer to produce electronic music. Many circuits. Mostly jargon free. (NO CHARGE for shipping)



**AN INTRODUCTION TO COMPUTER PERIPHERALS** ..... \$6.50. Describes and explains how to use a variety of different computer equipment in as non-technical a way as possible. (shipping FREE)



**103 PROJECTS FOR ELECTRONICS EXPERIMENTERS** from TAB book ..... \$11.50. by Forrest M. Mims. More than 100 projects you'll want to build. (shipping FREE)



**LINEAR IC EQUIVALENTS AND PIN CONNECTIONS** ..... \$12.50 (shipping free) 247 pages. 7" x 10" in. shows equivs & pin connections for popular user oriented ICs.



**DIGITAL IC EQUIVALENTS AND PIN CONNECTIONS** ..... \$12.50 (shipping free) 312 pages. 7" x 10" in. shows equivs & pin connections for popular user oriented ICs.



**32 ELECTRONIC POWER SUPPLY PROJECTS** ..... \$10.95. From TAB books. Provides power supply construction info for almost any application. (WE PAY for shipping)



**THE PRE-BASIC BOOK** ..... \$7.50. A book on the BASIC programming for those who have not yet bought a computer as well as those who have trouble learning how to program. (shipping FREE)



**FIRST BOOK OF DIODE CHARACTERISTICS** ..... \$5.00. Full interchangeability data and characteristics for thousands of diodes. (shipping FREE)

- 30 SOLDERLESS BREADBOARD PROJECTS. Reg. \$5.75. Now \$5.00.
- 30 SOLDERLESS BREADBOARD, Book 2. Reg. \$5.75. Now \$5.00.
- ELEMENTS OF ELECTRONICS, AUDIO. Reg. \$9.00. Now \$7.50
- MINI-MATRIX BOARD PROJECTS. Reg. \$5.00. Now \$4.00

Save an extra \$2.00. Order both IC EQUIVALENTS editions and pay only \$23.00. We also include shipping free. You get a complete 2-volume library. (shipping FREE)

- REMOTE CONTROL PROJECTS. Reg. \$5.00. Now \$4.50
- PROJECTS USING SOLAR CELLS. Reg. \$5.00. Now \$4.25
- DIGITAL IC PROJECTS. Reg. \$5.00. Now \$4.25
- ELECTRONICS PROJECTS FOR BEGINNERS. Reg. \$5.00. Now \$4.00



**SECRETS OF THE COMMODORE 64** ..... \$5.00. Masses of useful info and programming tips not found in any user's manual.



**INTRO TO PROGRAMMING THE ATARI 600/800 XL** ..... \$5.00. Perfect complement to the Atari user's manual. Even shows how to use animated graphics.



**COMPUTER TECHNOLOGY EXPLAINED** ..... \$5.00. Explanations for computer terms often encountered. A dictionary for computer lingo.



**INTRO TO Z-80 MACHINE CODE** ..... \$5.75. Speed up your programs. They may be harder to write, but it's worth learning how. Some demo programs are included.



**ANTENNA PROJECTS** ..... \$5.00. Practical radio antenna designs that deliver good performance and are relatively simple and inexpensive to build.



**WHITE'S RADIO LOG** ..... \$4.95 An up-to-date directory of AM, FM and TV stations, including a section on worldwide shortwave stations.



**CONFIDENTIAL FREQUENCY LIST, 6th edition** ..... \$15.95. Latest info on usual and exotic shortwave broadcast stations.



**INTRODUCTION TO RADIO DIXING** ..... \$5.00. How to optimize the reception of distant short-wave broadcast and amateur stations.

**MICRO INTERFACING CIRCUITS—BOOK 1** ..... \$5.00. Practical add-ons transform your computer into control or measurement equipment.

**MICRO INTERFACING CIRCUITS—BOOK 2** ..... \$5.75. Interfacing sound and speech generators, temperature and optical sensors, motor controllers, and more.

## Quality Paperbacks



**50 FET PROJECTS** ..... \$4.50. Projects include if amplifiers & converters, test equipment, receiver aids, tuners, receivers and more.



**HOW TO DESIGN ELECTRONIC PROJECTS** ..... \$5.75. How to use standard circuit elements to make custom electronic projects.



**HOW TO GET YOUR ELECTRONIC PROJECTS WORKING** ..... \$5.00. How to find the faults in your projects, repair them and get them working.



**DESIGN & MAKE YOUR OWN PCBs** ..... \$5.75. Everything you need to know before you make printed-circuit boards for your projects.



**ELECTRONIC SECURITY DEVICES** ..... \$5.00. Three basic sections: Switch activated alarms, infrared & ultrasonic systems, smoke, gas, water detection.



**INTERNATIONAL TRANSISTOR EQUIVALENTS** ..... \$7.50. Locates possible substitutes for a popular user-oriented selection of modern transistors. Japanese, European and American types.



**PRACTICAL ELECTRONIC BUILDING BLOCKS, Book 1** ..... \$5.75. Build the blocks and then combine them to form almost any custom project of your choice.



**PRACTICAL ELECTRONIC BUILDING BLOCKS, Book 2** ..... \$5.75. Amplifiers of all kinds to add to the circuits from Book 1 of this series.

**ELECTRONIC SCIENCE PROJECTS** ..... \$5.75. Simple to complex, a group of projects with a strongly scientific flavor.

**CRYSTAL SET CONSTRUCTION** ..... \$4.50. A variety of crystal radio receivers for the experimenter and hobbyist.

## Affordable Prices



**20 PROGRAMS FOR THE ZX SPECTRUM & 16K ZX81** ..... \$5.00. All programs run on both machines. Include flow charts and info on how to modify to run on other computers.



**MODERN OP-AMP PROJECTS** ..... \$5.00. Includes a Slide Timer, AF Signal Gen, Mike Pre-amp, Scratch Filter, and much more.



**ELECTRONIC SYNTHESIZER PROJECTS** ..... \$4.50. How to assemble the elements of a synthesizer and then put them all together.



**ELECTRONIC TIMER PROJECTS** ..... \$5.00. Timing circuits to fit just about every application. Required for every experimenter.



**SINGLE IC PROJECTS** ..... \$4.25. All projects in this book are based on one IC and are simple to construct. Great way to get started with ICs.



**POPULAR ELECTRONIC PROJECTS** ..... \$4.75. A collection of a wide range of electronic projects and circuits for the experimenter.



**IC PROJECTS FOR BEGINNERS** ..... \$5.00. Written especially for the less experienced experimenter. Complete parts layouts and wiring diagrams.



**INTO THE QL ARCHIVE** ..... \$6.50. Presents the powerful database for the Sinclair QL. Step-by-step approach includes practical examples.

**ELECTRONIC MUSIC AND CREATIVE TAPE RECORDING** ..... \$5.00. Shows how you can make electronic music at home with simple and inexpensive equip.

**COUNTER DRIVER & NUMERICAL DISPLAY PROJECTS** ..... \$4.50. Numerical indicator devices make it easy to count, divide and display.

CHECK OFF THE BOOKS YOU WANT

**POPULAR ELECTRONIC CIRCUITS, Book 1** ..... \$5.00. More circuits for hobbyists. Audio, radio, test music, household and more.

**POPULAR ELECTRONIC CIRCUITS, Book 2** ..... \$5.75. More useful circuits. None of these projects duplicate those in Book 1 of this series.

ELECTRONIC TECHNOLOGY TODAY INC.  
P.O. Box 240, Massapequa Park, NY 11762-0240

Name \_\_\_\_\_  
Address \_\_\_\_\_  
City \_\_\_\_\_ State \_\_\_\_\_ Zip \_\_\_\_\_

\*Canadian Shipping (\$1.50 1st two books 50c ea. additional)

Number of books ordered   
Total Price of Books ..... \$ \_\_\_\_\_  
Sales Tax (NY State Residents) ..... \$ \_\_\_\_\_  
\*Shipping in U.S. only (\$1.00 1st two books, 40c ea additional) ..... \$ \_\_\_\_\_  
TOTAL ENCLOSED ..... \$ \_\_\_\_\_

RE586

# REMOTE POWER CONTROLLER FOR YOUR COMMODORE-64

Couple a wireless remote and your computer. Instant automation!

Chandler Sowden

One of the useful things a home computer can do is control things around the house. Unfortunately, this usually involves stringing control wires from the computer to the device being controlled.

Enter the home wireless remote control system, as manufactured and sold by BSR and Radio Shack. With this system, lights and appliances can be controlled (manually) from a central location without wires.

## How it works

The wireless remote modules respond to a pulse

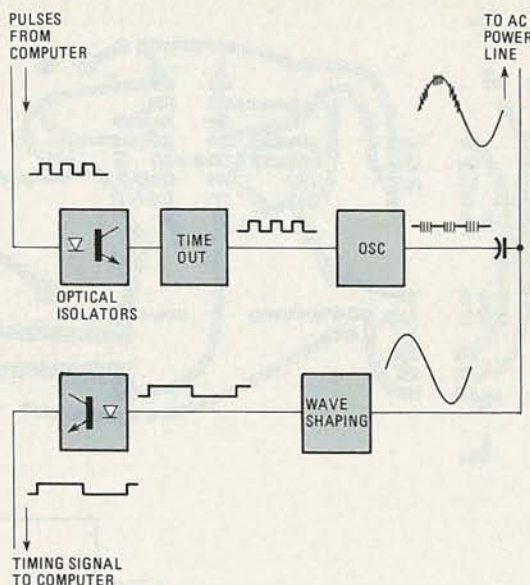

FIG. 1—BLOCK DIAGRAM reveals simplicity of the circuit. Opto-isolators keep AC out of the computer.

coded 125kHz signal placed on the AC power line. The pulses occur in groups of three and are synchronized to the power line. As shown in Figure 1, the device consists of a 60 Hz wave shaping circuit, an

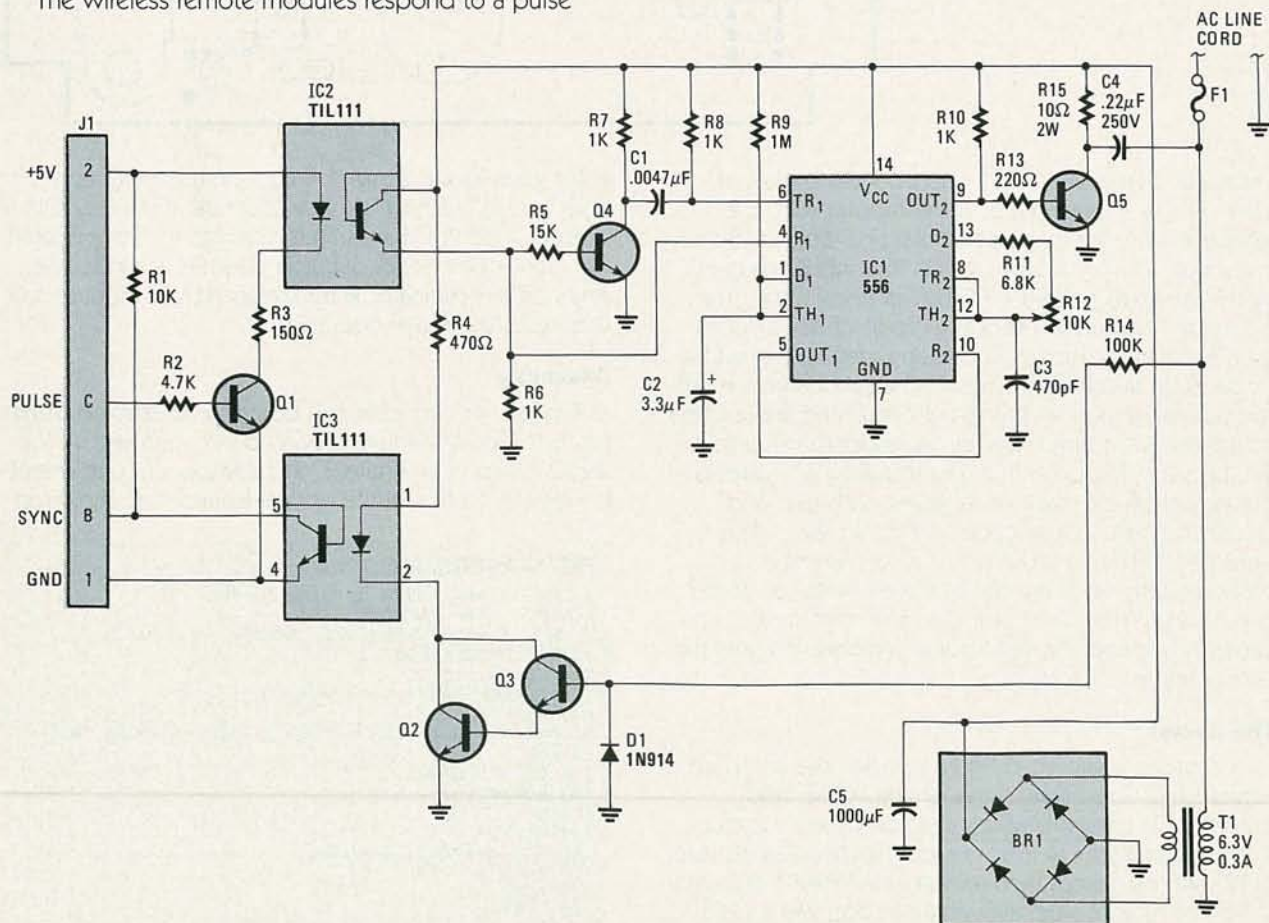

FIG. 2—SCHEMATIC DIAGRAM is simplified because circuit uses computer software to provide many of the necessary functions. Refer to text for in-depth explanation.

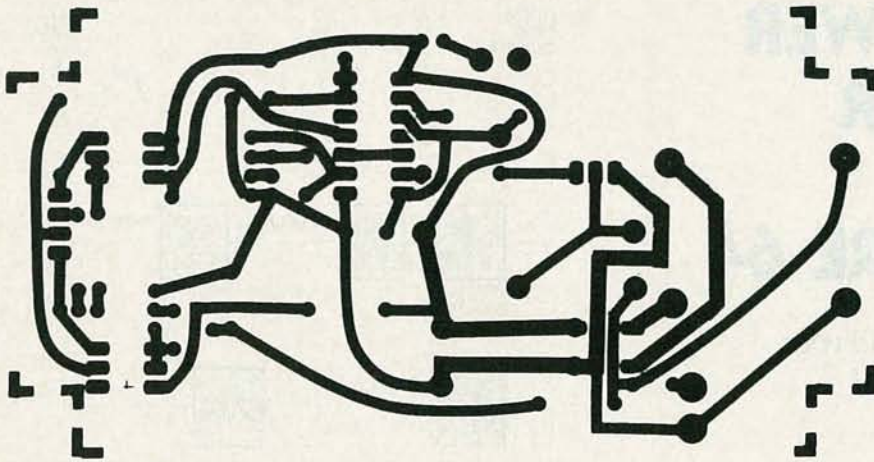
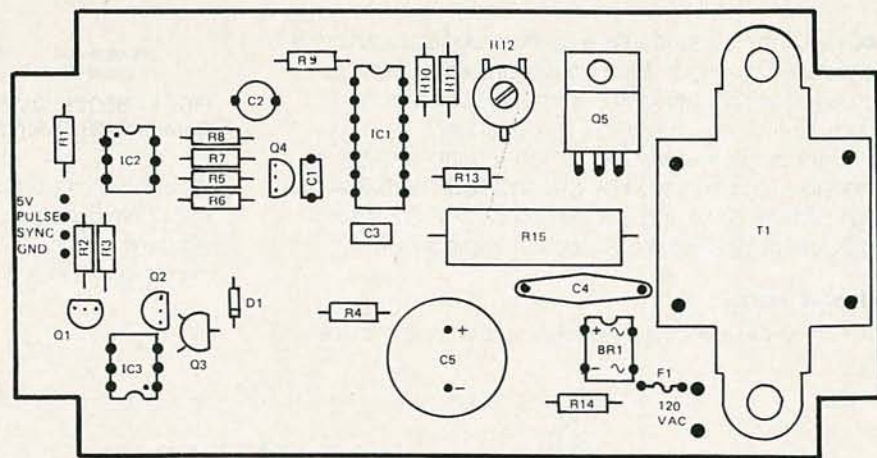

FIG. 3—HERE'S THE FOIL PATTERN for those of our readers who desire to do their own circuit-board etching.

FIG. 4—...AND WHEN YOU'VE GOT THE BOARD etched, here's where all the parts go.



oscillator, a time-out circuit, and optical isolators to keep AC line power out of the computer. Machine language software in the computer first looks at the 60 Hz square wave from the device. This input changes at each zero crossing of the AC power line voltage. The computer then either outputs a group of three pulses or waits until the next zero crossing, depending on the code to be transmitted. These pulse groups go through the optical isolator and time-out circuit and are applied to the oscillator, which places corresponding bursts of 125 KHz on the power line. The grouping of pulses is controlled by the machine language software, and depends on the house code, unit code, etc., to be transmitted. The time-out circuit is to prevent a software hang-up from leaving the oscillator on. If the pulse output from the computer stays high for 2 seconds or more, the oscillator is switched off until the output returns to zero.

### The circuit

The circuit is shown in Figure 2. When the computer sends a high logic level signal on the PULSE input, transistor Q1 turns on, which turns on optical isolator IC2 and transistor Q4. This triggers the monostable side of IC1, whose output then releases the RESET input (pin 10) of the astable side, allowing it to oscillate. Its 125 KHz output is amplified by Q5 and then applied to the AC power line through capacitor C4. When the PULSE

input goes low, IC2 turns off and the monostable is reset through resistor R6, thus shutting off the 125 KHz output. If the PULSE input remains high for some reason, the monostable times out after about 2 seconds and shuts off the oscillator. Returning the PULSE input to low then restores normal operation.

### Assembly

The power controller can be easily assembled using point-to-point wiring or a printed circuit board. A foil layout is shown in Figure 3, and component placement in Figure 4. Note that the optical isolators are mounted

### FIG. 7—PROGRAM LISTING.

```

1 REM   BSR POWER CONTROLLER PROGRAM
2 REM   FOR COMMODORE 64
3 REM   WRITTEN BY G.C. SOWDEN 6/14/85
10 LET P=PEEK(56577)
20 FOR I=1 TO 20
30 IF PEEK(56577)<>P THEN GO TO 100
40 NEXT I
50 PRINT "POWER CONTROLLER IS NOT PLUGGED IN"
60 END
100 POKE 56579,1
102 GOSUB 109
104 GO TO 600
109 RESTORE
110 FOR A=49152 TO 49336
120 READ D
130 POKE A,D
140 NEXT A
142 RETURN
145 REM BSR
150 DATA 169,2,141,42,192

```

```

160 DATA 32,47,192,173,43,192
170 DATA 141,44,192,32,68,192
180 DATA 173,45,192,208,3,32,94,192
190 DATA 173,46,192,141,44,192,32,68
200 DATA 192,206,42,192,208,222,96,0,0
210 DATA 0,105,0,0,171
220 REM SC
230 DATA 32,94,192,169,3
240 DATA 141,67,192,32,120,192
250 DATA 206,67,192,208,248,32,94,192
260 DATA 96,0
270 REM BITS
280 DATA 169,8,141,93,192,14,44,192
290 DATA 144,6,32,120,192,76,87,192
300 DATA 32,94,192,206,93,192,208,237
310 DATA 96,0
320 REM TZ
330 DATA 169,0,141,119,192,206,119,192
340 DATA 208,251
350 DATA 173,1,221,141,119,192
360 DATA 173,1,221,205,119,192,240,248
370 DATA 96,0
380 REM T1
390 DATA 169,3,141,160,192,173,161,192
400 DATA 9,1,141,1,221,162,186,202
410 DATA 208,253,173,161,192,141,1,221
420 DATA 169,183,141,162,192
430 DATA 206,162,192,208,251
440 DATA 206,160,192,208,222,96,0,0,0
450 REM UNIT CODES
460 DATA 105,169,89,153,86,150,102,166
470 DATA 106,170,90,154,85,149,101,165
480 DATA 179,181,173,171,205,203
600 LET N=100
610 DIM T(N),U(N),F(N),S*(16)
620 FOR I=1 TO N
630 READ T(I),U(I),F(I)
635 IF T(I)>2359 THEN GO TO 1000
640 NEXT I
650 DATA 1201,1,1
651 DATA 1202,1,2
999 DATA 9999,0,0
1000 LET C$="A"
1010 PRINT "TIME(HHMM)"
1020 INPUT T$
1030 LET TI$=T$+"00"
1040 LET T$=LEFT$(TI$,4)
1060 LET H$=LEFT$(T$,2)
1070 LET M$=RIGHT$(T$,2)
1090 LET T1=VAL(T$)
1100 FOR I=1 TO N
1105 IF T(I)>2359 THEN GO TO 1160
1110 IF T(I)<>T1 THEN GO TO 1150
1120 LET U1=U(I)
1130 LET F1=F(I)
1140 GOSUB 8000
1150 NEXT I
1160 GOSUB 7000
1170 LET T$=LEFT$(TI$,4)
1180 IF PEEK(197)<>64 THEN GO TO 1220
1190 IF T$=T0$ THEN GO TO 1170
1200 LET T$=T0$
1210 GO TO 1060
1220 IF PEEK(197)<>64 THEN GO TO 1220
1230 INPUT D$
1240 INPUT "TYPE DEVICE NUMBER:";U1
1250 IF U1=0 THEN END
1260 INPUT "FUNCTION?(TYPE 1 FOR ON, 2 FOR OFF)";F1
1270 GOSUB 8000
1280 GO TO 1160
7000 PRINT "(CLR)"
7010 PRINT H$;" ";M$
7020 PRINT
7030 PRINT "DEVICE NUMBER AND STATUS:"
7040 PRINT
7050 FOR K=1 TO 16
7060 PRINT S$(K),
7065 NEXT K
7070 PRINT
7080 PRINT "PRESS RETURN FOR MANUAL CONTROL"
7090 RETURN
8000 LET S1$=" OFF"
8030 IF F1=1 THEN LET S1$=" ON "
8040 LET S$(U1)=STR$(U1)+S1$
8050 GOSUB 9000
8060 RETURN
9000 GOSUB 109
9002 POKE 49195,PEEK(49250+ASC(C$))
9008 POKE 49198,PEEK(49314+U1)
9010 POKE 49197,1
9020 SYS 49152
9030 FOR J=1 TO 10

```

```

9031 NEXT J
9032 IF F1<5 THEN GO TO 9050
9034 LET F2=2*(F1-100*INT(F1/100))
9036 LET F1=INT(F1/100)
9040 POKE 49153,F2
9050 POKE 49198,PEEK(49330+F1)
9060 POKE 49197,0
9070 SYS 49152
9075 POKE 49153,2
9080 PRINT U1,F1
9082 FOR J=1 TO 200
9084 NEXT J
9090 RETURN

```

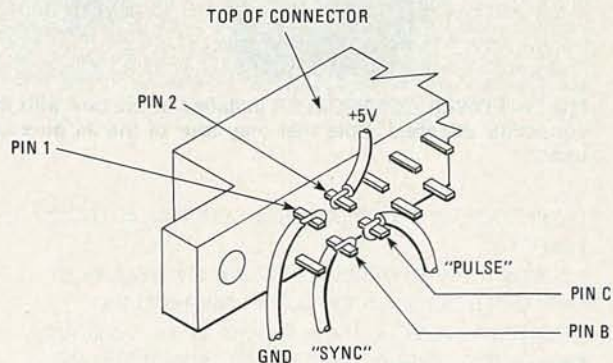

FIG. 5—WIRING FOR THE CONNECTOR is shown above. Provide good mechanical connections for all leads and then carefully solder.

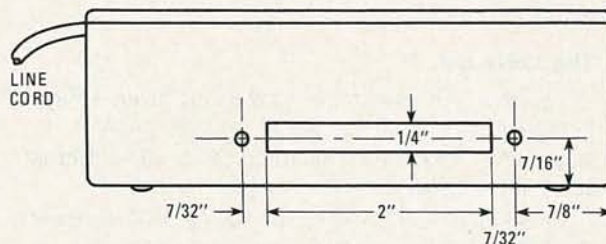

FIG. 6—DIMENSIONS ARE PROVIDED here for openings in the connector. See text for additional explanation.

facing opposite directions. You'll have to cut openings for the AC cord and the computer card-edge connector. The connector mounts on the side of the box, and it then plugs into the Commodore User Port.

After the components are in place, install the power cord. Solder hookup wire to the card-edge connector, as shown in figure 5. Cut a rectangular opening in the



FIG. 8—THE CIRCUIT BOARD completely wired, ready for installation in the box.

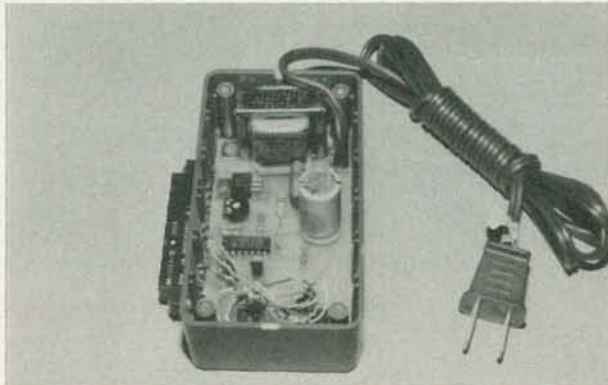

**FIG. 9—POWER CONTROLLER** installed in the box with the connector attached. Note that only four of the 24 pins are used.

plastic box for the card-edge connector, as shown in Figure 6.

Using a volt-ohmmeter, measure the resistance between a blade on the power plug and the connector contacts. There should be no continuity between the power plug and any contact on the connector. Next, plug the unit into a wall outlet and CAREFULLY measure the DC voltage at the output of the bridge rectifier. It should be about 8 volts. Be careful, because most of the components have power line voltage on them.

### The software

Type the software in from the listing given in Figure 7. Double check the listing, especially the DATA statements. Save the program on tape or disk before you run the program.

The program is designed as a clock-time controller, but it also allows manual control of the remote modules from the computer keyboard. The program allows up to 100 on or off operations in a day, but this could be changed by changing line 600. The desired on/off times are in DATA statements is: (line number) DATA time, unit, code where "code" is a 1 for on, 2 for off. In the program, line 650 means "At 12:01 (24 hour time), turn unit 1, ON (code 1)," while line 651 says "At 12:02, turn unit 1, OFF (code 2)."

The "house code" for the power controller is set at line 1000. Sixteen different house codes are provided,



**FIG. 10—POWER CONTROLLER** plugs into the user port at the rear of the cabinet.



**FIG. 11—THIS ILLUSTRATES** the power controller connected to the computer. Be sure the connector location is such that the box does not cover the opening for the cassette interface.

in case your neighbor uses a similar system.

Take a remote module, set it to House Code "A" and unit code "1." Plug it in and plug a lamp into it. Run the program. It will then ask for the time. Type in the time in 4-digit, 24-hour format, then return. The program will clear the screen, print a heading, then a line which asks you to "press return for manual control." Press RETURN. It will say "type device number;" type 1 (and return); it

### PARTS LIST

#### Semiconductors

- BR1—1 ampere, 50V. bridge rectifier
- IC1—LM555 dual timer
- IC2, IC3—TIL111 (or similar) optical isolator
- Q1-Q4—2N3904 or similar transistor
- Q5—TIP31 transistor

#### Resistors

(All resistors 1/4 watt unless otherwise indicated)

- R1—10,000-ohm
- R2—4700-ohm
- R3—150-ohm
- R4—470-ohm
- R5—15,000-ohm
- R6-R8, R10—1000-ohm
- R9—1-megohm
- R11—6800-ohm
- R12—10,000-ohm 1/8 watt potentiometer
- R13—220-ohm
- R14—100,000-ohm
- R15—10-ohm, 2 watts

#### Capacitors

(All capacitors at least 16V.)

- C1—.0047 $\mu$ F.
- C2—3.3 $\mu$ F. C3—470pF
- C4—.22 $\mu$ F.
- C5—1000 $\mu$ F.

#### Miscellaneous parts and equipment

- F1—1/4 a. fuse (see text)
- J1—Card-edge connector, Texas Instruments No. H411121-12 (available from Digi-Key Corp., P. O. Box 577, Thief River Falls, MN 56701-9988)
- T1—6.3V 300mA transformer
- Line cord, box, etc.

will ask "Function? (Type 1 for on, 2 for off)." Type 1 (and return). The lamp should turn on. If it doesn't, try checking the house and unit codes, then check the program for typos. If that doesn't help, then try tweaking potentiometer R12. ◀▶



# COMPUTERIZED POWER SUPPLY COMPONENT SELECTION

*Let your computer choose  
your power-supply components.*

## Jack Cunkelman

■As critical as a power supply may be, it seems to be the last thing to be considered. Only after a project is working, using the bench supply, do we think about the power supply and how we are going to fit it into the enclosure. This is where this program comes into play. It will make component selection faster and easier.

A power supply can consist of a battery or a transformer/rectifier assembly to power it from 120 volt AC sources. The linear type of power supply seems to be the most popular transformer/rectifier combination and that is what we will deal with here.

There are only a few ways to obtain DC power from AC sources using linear power supplies. One of the following three circuits are used by most experimenters: full wave bridge, full wave-center tapped, and full wave bridge -center tapped. We will limit ourselves to these three circuits.

Once the program is running there are two options available, output to the screen or output to a printer. The printer output will generate a list of component rating values for various power supply voltages and configurations.

The screen option treats the transformer as the variable element. Plugging in the values from those transformers in your "junk box" will enable you to quickly determine if they can be used or not. The screen display also deals with current ratings. A 0 entry when a question is asked will return you to the menu. A 0 entry on the menu will stop the program.

All ratings are conservative for cool running, reliable operation. If you cannot find components with the exact rating, always step up to the next highest rated component available.

TRANSFORMER VOLTAGE (RMS)	FULL WAVE BRIDGE CAPACITOR INPUT FILTER		
	DC VOLTS	DIODE PIV	CAPACITOR VOLTAGE
5	6	12	7
6	8	16	10
7	9	18	11
8	10	20	13
9	12	24	15
10	13	26	16
11	14	28	18
12	16	32	20
13	17	34	22
14	18	36	23
15	20	40	26
16	21	42	27
17	22	44	28
18	24	48	31
19	25	50	32
20	26	52	33
21	28	56	36
22	29	58	37
23	30	60	39
24	32	64	41
25	33	66	42
26	34	68	44
27	36	72	46
28	37	74	48
29	38	76	49
30	40	80	52
31	41	82	53
32	43	86	55
33	44	88	57
34	45	90	58
35	47	94	61
36	48	96	62
37	49	98	63
38	51	102	66
39	52	104	67
40	53	106	68
41	55	110	71
42	56	112	72
43	57	114	74
44	59	118	76
45	60	120	78
46	61	122	79
47	63	126	81
48	64	128	83
49	65	130	84
50	67	134	87
51	68	136	88
52	69	138	89
53	71	142	92
54	72	144	93
55	73	146	94

```

10 CLS
20 REM POWER SUPPLY SPECIFICATION PR
OGRAM
30 REM BY JACK CUNKELMAN
40 REM JUNE 1985
50 INPUT "DO YOU WANT SCREEN DISPLAY
(S) OR PRINTER OUTPUT (P)";D$
60 IF D$="S" THEN 80
70 IF D$="P" THEN 500
75 PRINT "INPUT ERROR" : GOTO 50
80 CLS
85 PRINT"POWER SUPPLY TYPE"
90 PRINT"    FULL WAVE BRIDGE (1)"
100 PRINT"    FULL WAVE CENTER TAP (
2)"
110 PRINT"    FULL WAVE BRIDGE CENTE
R TAP (3)"
120 PRINT" ALL USING CAPACITOR INPUT
FILTERING"
130 INPUT" SELECT TYPE 1 , 2 , 3 OR
0 TO QUIT";T
135 IF T=0 THEN END
140 ON T GOTO 1000,2000,3000
150 GOTO 80
500 CLS
510 PRINT "THE PRINTER OPTION PRINTS

```

```

A TABLE OF VALUES FOR VARIOUS
TRANSFORMERS"
520 PRINT "TYPE OF CIRCUIT;"
530 PRINT"    FULL WAVE BRIDGE (1)"
540 PRINT"    FULL WAVE CENTER TAP (
2)"
550 PRINT"    FULL WAVE BRIDGE CENTE
R TAP (3)"
560 PRINT" ALL USING CAPACITOR INPUT
FILTERING"
570 INPUT" SELECT TYPE 1 , 2 , 3 OR
0 TO QUIT";T
580 IF T=0 THEN END
590 ON T GOTO 1500,2500,3500
1000 CLS
1010 PRINT"FULL WAVE BRIDGE , CAPACI
TOR INPUT FILTER"
1020 INPUT"TRANSFORMER RMS VOLTAGE";
V
1025 IF V=0 THEN 80
1030 INPUT"TRANSFORMER CURRENT RATIN
G (AMPS)";C
1040 RV=INT((V*.95*1.414)+.04)
1050 DV=INT(2*RV)
1060 CV=INT(1.3*RV)
1070 OC = INT(C/1.8*10)
1080 GOSUB 5000

1090 PRINT V;TAB(21)RV;TAB(31)DV;TAB
(41)CV;TAB(52)OC/10
1100 GOTO 1010
1500 CLS
1510 INPUT"MINIMUM TRANSFORMER VOLTA
GE";M
1522 T$="FULL WAVE BRIDGE"
1524 GOSUB 6000
1530 FOR V = M TO M+50
1540 RV=INT((V*.95*1.414)+.04)
1550 DV=INT(2*RV)
1560 CV=INT(1.3*RV)
1580 LPRINT TAB(8)V;TAB(20)RV;TAB(31
)DV;TAB(41)CV
1590 NEXT V
1600 GOTO 500
2000 CLS
2010 PRINT"FULL WAVE CENTER TAPPED ,
CAPACITOR INPUT FILTER"
2020 INPUT"TRANSFORMER RMS VOLTAGE (
ENTIRE SECONDARY)";V
2025 IF V=0 THEN 80
2030 INPUT"TRANSFORMER CURRENT RATIN
G (AMPS)";C
2040 RV=INT((V*.95*1.414)+.04)/2
2050 DV=INT(4*RV)
2060 CV=INT(1.3*RV)
2070 DV=INT(4*RV)
2075 OC=INT(C/1.2*10)
2080 GOSUB 5000
2090 PRINT V;TAB(21)RV;TAB(31)DV;TAB
(41)CV;TAB(52)OC/10
2110 GOTO 2010
2500 CLS
2510 INPUT"MINIMUN TRANSFORMER VOLTA
GE (ENTIRE SECONDARY)";M
2520 T$="FULL WAVE CENTER TAP"

```

```

2524 GOSUB 6000
2530 FOR V = M TO M+50
2540 RV=INT((V*.95*1.414)+.04)/2
2550 DV=INT(4*RV)
2560 CV=INT(1.3*RV)
2580 LPRINT TAB(8)V;TAB(20)RV;TAB(31
)DV;TAB(41)CV
2590 NEXT V
2600 GOTO 500
3000 CLS
3010 PRINT "FULL WAVE BRIDGE CENTER
TAP,CAPACITOR INPUT FILTER"
3020 INPUT"TRANSFORMER RMS VOLTAGE (
ENTIRE SECONDARY)";V
3025 IF V=0 THEN 80
3030 INPUT "TRANSFORMER CURRENT RATI
NG (AMPS)";C
3040 RV =INT((V*.95*1.414)+.04)/2
3050 DV = INT(4*RV)
3060 CV =INT(1.3*RV)
3070 OC =INT((C/1.8)/2*10)
3080 GOSUB 5000
3090 PRINTV;TAB(18)"+/-"RV;TAB(31)DV
;TAB(41)CV;TAB(49)"+/-"OC/10
3100 GOTO 3010
3500 CLS
3510 INPUT"MINIMUM TRANSFORMER VOLTA
GE (ENTIRE SECONDARY)";M
3520 T$="FULL WAVE BRIDGE CENTER TAP
"
3525 GOSUB 6000
3530 FOR V = M TO M+50
3540 RV = INT((V*.95*1.414)+.04)/2
3550 DV = INT(4*RV)
3560 CV = INT(1.3*RV)
3580 LPRINT TAB(8)V;TAB(19)"+/-"RV;T
AB(31)DV;TAB(41)CV
3590 NEXT V
3600 GOTO 500
5000 PRINT"TRANSFORMER";TAB(20)" DC
";TAB(30)"DIODE";TAB(40)"CAPACITOR";
TAB(52)" DC "
5010 PRINT"VOLTAGE (RMS)";TAB(20)"VOL
TS";TAB(30)" PIV ";TAB(40)"VOLTAGE";
TAB(51)" CURRENT (AMPS)"
5020 RETURN
6000 LPRINT:LPRINT:LPRINT
6005 LPRINT TAB(20) T$
6010 LPRINT TAB(20)"CAPACITOR INPUT
FILTER"
6015 LPRINT
6020 LPRINTTAB(5)"TRANSFORMER";TAB(
20)" DC ";TAB(30)"DIODE"TAB(40)"CAPA
CITOR"
6030 LPRINTTAB(5)"VOLTAGE (RMS)";TAB
(20)"VOLTS";TAB(30)" PIV ";TAB(40)"V
OLTAGE"
6035 LPRINT
6040 RETURN

```

The biggest variable seems to be the transformer and how it is rated. I have always been within 10% of the desired output value using the transformer's published ratings. ◀▶

cuit of that tube. A dynamic speaker probably gave the best audio output.

Next comes the 240, a high- $\mu$  (high-amplification) tube functioning as the first audio stage. The 200A is a sensitive detector, and the 222 is a screen-grid RF amplifier. The tuning coil is connected directly to the grid cap of that tube, and the plate circuit has a special tuned circuit to increase efficiency. There was also a dial lamp across the filament circuit, and a small switch on the tuning capacitor to cut out the larger section when tuning a high-frequency (shortwave) signal.

That's one of the early *Thrill Boxes*, but there were half a dozen variations sold in different configurations. If a *Thrill Box* was purchased pre-assembled, it included a certificate guaranteeing that it would bring in foreign stations. Unassembled, it cost about \$30, and that included a metal cabinet. Of course, early kits seldom included tubes or an output device (headphones or speaker), so the inclusion of the metal cabinet was a plus. By following the enclosed

instructions, the hobbyist of that era could have the receiver assembled and operating in about two hours.

As the 1930's wore on, interest in shortwave listening increased. Around 1940, most home radios had shortwave listening bands, and band-switching had most replaced plug-in coils. What were people listening to on all those radios?

Besides the hams, anyone who needed instantaneous communications was on the shortwave bands: ship captains, airplane pilots, and police, to name a few. Even the regular broadcast stations transmitted on the shortwave bands. One well-known broadcast (by KDKA) was received by the Byrd Expedition in 1929. It was sent via shortwaves a distance greater than 20,000 miles to Little America, Antarctica. It was even possible to pick up the audio portion of some early TV transmissions. An announcer would interrupt occasionally to explain what was going on for those who were receiving only the audio portion of the broadcast.

Many governments started transmitting on the shortwave bands. The U. S. led the way with over a dozen stations. And, unlike many foreign countries, the U. S. continually encouraged the growth of Amateur Radio.

One thing that fascinated many SWL's was the reception of Morse code. Code could be received on all bands, including the regular broadcast band. Many broadcasts were worthwhile copying for anyone who was able to, and many listeners who never became hams were nevertheless expert at receiving code. Learning code was itself a hobby. A code practice oscillator (CPO) could be built from plans or kits; pre-assembled units could also be purchased.

### Winding up

That's about all for now; next month we'll discuss the Grunow table model *Type 5* with the tele-dial, an automatic tuner that resembles a telephone dial.

I hope to present the much improved and expanded tube substitution chart soon. Thanks to all who sent information. R-E

**DESOLDER-IT,  
CLEAN-IT, COAT-IT,  
FREEZ-IT...SEND FOR IT!**  
Our new electronic problem solving catalog!

**Chemtronics**  
681 Old Willets Path  
Hauppauge, N.Y. 11788  
800-645-5244  
In NY 516-582-3322  
Telex 968567

CIRCLE 54 ON FREE INFORMATION CARD

Call us FREE **1-800-626-6343**  
or write for FREE Flyer.

**COPPER ELECTRONICS**  
4200 PRODUCE ROAD - LOUISVILLE, KENTUCKY 40218

<p><b>WESTPORT WCB40 40 CHANNEL CB TRANSCEIVER</b></p> <p>Dynamic "Push-To-Talk" LED Digital Microphone Channel Display</p> <p>Volume and CF 70 Automatic Channel Search Controls Selector Noise Limiter Selector</p> <p>Retail 89.95 <b>29.95</b> Limited Quantities</p>	<p>WAWASEE <b>JB 1001 SFC/M</b> SCOPE/COUNTER/WATTMETER/ SWR BRIDGE</p> <p>Retail \$349.95 <b>269.95</b></p>
<p>AV-261 Permanent Mount 1/2" hole mount <b>26.95</b></p> <p>AV-261M Magnet Mount <b>29.95</b></p> <p>AV-261T No-Hole Trunk Mount <b>26.95</b></p>	<p><b>uniden</b> <b>Bearcat</b></p> <p>800XLT AIR/POLICE/800 MHz SCANNING RADIO</p> <p>Retail \$349.95 <b>199.95</b></p>

**LOWEST PRICES IN THE COUNTRY!**  
We have a national factory warranty service on many brands, and we service All CB, Amateur, and Commercial Equipment.

CIRCLE 268 ON FREE INFORMATION CARD

# DESIGNER'S NOTEBOOK



ROBERT GROSSBLATT  
CIRCUITS EDITOR

## Schmitt triggers

ONE OF THE MAIN ADVANTAGES DIGITAL has over analog electronics is the ease with which signals can be processed. After you've captured a signal, you can do just about anything you want with it. But it's often a problem in digital (and in analog) circuits to capture the signal in the first place.

The nice, logical circuit elements on the PC board want nice, clean input signals. And a clean input signal can be hard to come by. Often a signal from the "real world" must be conditioned before it can be handled by the electronics on your board. If the signal is dirty, it's a safe bet that even the world's best-designed circuit will take one look, turn up its electronic nose, and refuse to deal with it.

Probably the best, and simplest, way to condition a signal is to use a Schmitt trigger. All logic families (TTL, LSTTL, CMOS, HCMOS, etc.) have a collection of Schmitt trigger IC's in several different gate configurations. In Table 1 we list several popular, off-the-shelf devices. They're very easy to use, but sometimes you don't have room for another IC on a PC board, or

TABLE 1—SCHMITT TRIGGERS		
IC	Type	Description
4093	CMOS	Quad 2-Input NAND Gate
4584	CMOS	Hex Inverter
40106	CMOS	Hex Inverter
74C14	CMOS	Hex Inverter
7413	TTL	Quad 2-Input NAND Gate
7414	TTL	Hex Inverter

cost considerations prevent you from adding another IC, and so on. So what you can do is build your own Schmitt trigger using an

unused gate (and there's almost always one of those on a board).

### Rolling your own

The circuit shown in Fig. 1 illus-

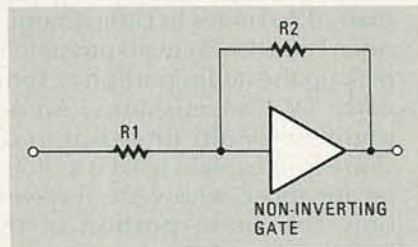

FIG. 1

trates one way of converting a standard non-inverting gate into a Schmitt trigger. To understand how it works, assume that we're working with a CMOS gate, and that its input (and its output) are both low. What happens when we bring the input high? If R1 weren't connected to the input, the gate would change state at  $\frac{1}{2} V_{CC}$ , the normal CMOS trip point.

However, with the resistors connected, as the input begins to go positive, the output of the gate remains low. The resistors function as a voltage divider that keeps the voltage at the gate's input lower than the actual input voltage. The inverter will only change state when the voltage at its input is equal to half the supply voltage. The two resistors make that trip voltage greater than half the supply voltage.

When the gate finally changes state, its output goes high, and that output voltage will be higher than the gate's input voltage. When that happens, the voltage divider helps pull the gate's input high. So, if you think for a mo-

ment, you'll realize that what we've just described are the two basic characteristics of a Schmitt trigger—hysteresis and snap action.

The same sort of dynamics occur when the circuit goes the other way. The circuit's trip point will be less than  $\frac{1}{2} V_{CC}$  by the amount of hysteresis generated by the resistors.

One advantage of designing your own Schmitt trigger is that you can play around with the values of the resistors and thereby create a Schmitt trigger with just as much hysteresis as you want. The range of hysteresis, H, you get is controlled by the supply voltage as well as by the values of the resistors:

$$H = (R1/R2)V_{CC}$$

There are limits to the values the resistors can have. You'll get no Schmitt-trigger action at all if R1's value is very small compared with R2's value, or if the resistors are inadvertently switched. A sensible limit for the values of the resistors is about 200K for R2, and a maximum R1:R2 ratio of 5:1.

Since the circuit is so easy to rig up, the best approach to finding the right resistor values for a particular application is probably the empirical one. Breadboard the circuit and then experiment with values for the two resistors. Just keep those values within the limits just mentioned. You could also create a chart of the amount of hysteresis produced by different combinations of resistors. Keep it handy so you can use it to build a custom Schmitt trigger whenever the need arises.

R-E

# STATE OF SOLID STATE



ROBERT F. SCOTT,  
SEMICONDUCTOR EDITOR

## New op-amps

THE OP-AMP IS STILL ONE OF THE MOST widely used linear IC's. The OP-41 op-amp from PMI (Precision Monolithics, Inc., P.O. Box 58020, Santa Clara, CA 95052) is a new device that features a cascode FET-input stage that has a CMRR (Common-Mode Rejection Ratio) of greater than 100 dB. The OP-41 also has improved linearity, and stabilized bias current with changing common-mode voltage.

The OP-41 consumes only 750  $\mu$ A and it has a power-supply rejection ratio of 25  $\mu$ V/V. Those factors make the OP-41 ideal for use in battery-powered systems. Slew rate is symmetrical, and, despite the device's low current drain, is a respectable 1.3 V/ $\mu$ s. Offset voltage has been reduced to less than 500  $\mu$ V so external nulling is unnecessary in many applications.

Other features include a maximum bias current of five pA, and a

guaranteed gain of 1 million into a 2K load. Linearity is good in both high- and low-gain configurations. As a voltage follower, the CMRR effects dominate linearity, and, in high-gain service, open-loop gain dominates linearity.

Further, the OP-41 recovers rapidly from signal overload. Following saturation at the positive supply, the output recovers in only 6  $\mu$ s, and recovery from a negative overdrive takes only 100 ns.

The superior performance characteristics of the OP-41 make it an excellent output amplifier for a CMOS DAC (Digital-to-Analog Converter). The OP-41's low, stable bias current would make it an excellent choice as a photodiode amplifier in medical applications. At unity gain, the output can drive 250 pF without oscillating.

The OP-41's superior characteristics and a pin-out that is iden-

tical to the industry-standard 741 make it simple for the designer to up-grade an existing low-power bipolar/JFET design.

An 11-page data sheet contains performance curves for various characteristics including bias current vs. temperature, bias current vs. common-mode voltage, supply current vs. supply voltage, and power-supply rejection vs. frequency. Also included in the data sheet are circuits for testing and measuring performance characteristics.

In addition, several applications diagrams, including a high-Q notch filter, a current-to-voltage converter, and an amplifier for piezoelectric transducers, are included. But perhaps the most interesting and useful application is the low-current ammeter shown here in Fig. 1. The circuit can measure current as low as a few pA and as high as 100  $\mu$ A in six switch ranges.

Unlike many low-current ammeters, the one shown here does not require high-value precision resistors. As you can see, the desired range is selected from a tap on a voltage divider made up of six 1% (or better) 511-ohm resistors. The ammeter's accuracy is 1% or better over most of its range; accuracy depends on the decade resistors (R6-R11) and on the OP-41's input bias current.

Any good ammeter should cause very little voltage drop across its input terminals. The voltage drop across the input of the OP-41 is less than 500  $\mu$ V, so that makes it effective as a low-current metering device.

The circuit works as follows.

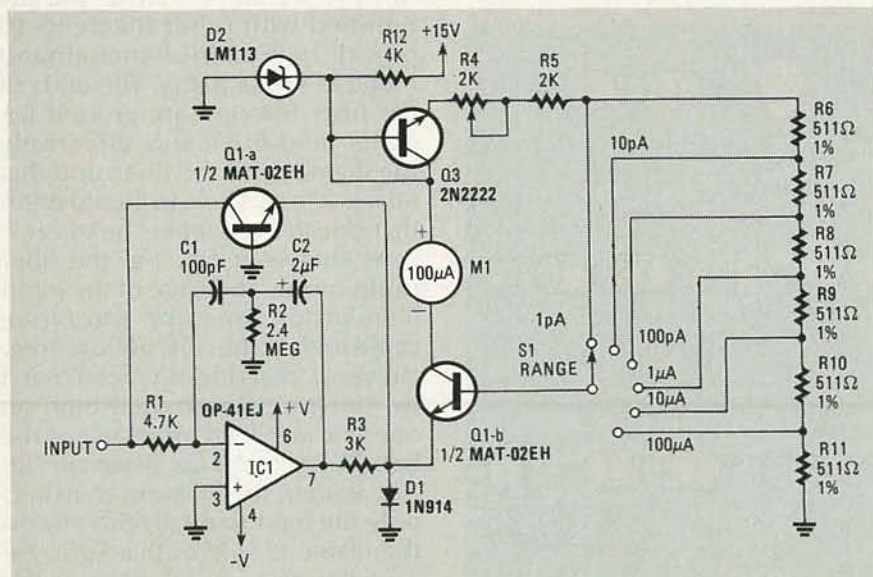

FIG. 1

# COMMUNICATIONS CORNER



HERB FRIEDMAN

COMMUNICATIONS EDITOR

## Fiber-optic communications

IT'S HARD TO STAY ON TOP OF THINGS in consumer communications because we often find out that tomorrow came yesterday. In other words, we discover that technology we thought would take several years to become economically competitive has actually been available in ordinary consumer appliances for years.

Fiber optics is just such a technology. It's been around for some time in high-technology hardware, and many news magazines and newspapers have discussed how it is used for interstate telephone circuits buried in railroad rights-of-way, in computerized telephone-switching equipment, and in *Teleport*, the super-duper satellite-communications center being built in New York City.

But those are very sophisticated applications, so I assumed that I could delay getting involved in yet another new technology until it became available in common, everyday hardware. Unfortunately, fiber optics came in the basement window while I was watching the front door.

I discovered that my pocket camera, my flashlight, and even my home photocopier all use fiber optics as a low-cost way to move information from one point to another. The key fact is that, while fiber-optic technology is expensive for mega-buck industrial uses, it often turns out to be an inexpensive way to do things in consumer hardware. To illustrate the savings made possible by fiber optics, think about those home copiers. For a few hundred dollars you can get a copier that turns out copies equal to those produced by

units costing well over \$1000 only a few years ago.

Naturally I was interested to see how that feat was achieved. I found that, instead of an expensive camera and lens mechanism, the copier uses fiber-optic filaments to move the image from the original to the copy. In a way, the only difference between the copier and fancy telecommunications gear is that the signal ends up on paper rather than in an electronic circuit.

So I thought that, if the technology was now low-cost enough to be used in a home copier, it must also be available in conventional communication equipment. Sure enough, seek and ye shall find. Buried in the week's mail—under the copier's manuals—were computer-supply catalogs listing moderately-priced fiber-optic modem for personal

computers. A fiber-optic modem can couple a PC into a fiber-optic communications cable; they transmit data by light beam rather than by electric current.

The reason why fiber optics can serve equally well in desk-copier and desk-computer applications is that the fiber cable is really just a means of conveying a signal from one point to another. But unlike wire, fiber-optic cable is wide-band, essentially lossless, and 100% free of induced ground-loop current. In addition, fiber-optic cable causes no interference to adjacent circuits. Here's an example of the power of fiber optics: a single fiber thread about the thickness of a human hair can simultaneously carry as many as 8000 multiplexed telephone conversations.

### How it's done

In actual use the fiber is a thin, flexible filament that is usually bundled with other filaments to provide both physical strength and multiple signal paths. The ends of the fiber filament are ground flat so its field-of-view is effectively the diameter of the fiber, and that makes it insensitive to illumination that doesn't originate "head on."

As shown in Fig. 1-a, the fiber cable carries an image of the input illumination from one end of the cable to the other almost loss-free. However, that doesn't mean that if we shine a 100-watt light bulb on one end we'll get an image of the bulb at the other (as shown in Fig. 1-b). Rather, the filament transmits only the light that falls directly on the filament; and of that light, essentially 100% is delivered at the output. The reason for that high

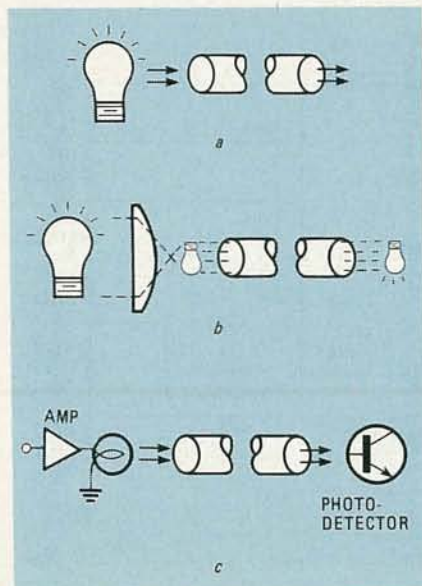

FIG. 1

## STATE OF SOLID STATE

*continued from page 89*

efficiency is that there is no internal loss due to heat, nor external loss caused by spill outside of the filament. All the light is contained within the filament, and that permits two adjacent filaments to carry independent signals without interfering with each other.

A big problem in many electrically-wired communications circuits is that of ground loops, which are caused by circuit grounds that are not true "earth" grounds. In general, circuit grounds are rarely true earth grounds; hence there is a potential difference between grounds at different points in a circuit, and that can cause current to flow in conventional cable-shields that are grounded on both ends. The current flowing between those grounds often induces "hum" and "hash" in the internal signal wires. The fiber-optic filament is not subject to ground loops because fiber-optic circuits use no shields or ground wires: It's all done with light.

A basic fiber-optic communications circuit is shown in Fig. 1-c. The input signal is coupled into the fiber filament by a light source driven by an amplifier. At the receiving end, the fiber filament points at a photo detector whose output current (or voltage) is proportional to the illumination from the filament.

When the signal is analog—continuously variable across a range of voltage—both the transmitter and the detector must have a linear response. Otherwise, the input signal could be digitized so that the fiber-optic system would handle only two states: on and off.

For example, in a fiber-optic modem the computer drives a small lamp that shines on the end of a fiber filament. At the receiver the filament shines directly on a phototransistor, thereby coupling the digital signal directly into the receiving computer without the need for a lot of complex analog hardware.

Fiber-optic communications hardware is still relatively esoteric and expensive. But since it can be used in home copiers, pocket cameras, and flashlights, it won't be long before we'll all be communicating by beams of light. **R-E**

Transistor Q1-a is in the op-amp's feedback loop. That causes the transistor's collector current to equal the input current. Hence its base-emitter voltage is proportional to the log of the input current. That logarithmic output drives the emitter of Q1-b; that transistor performs an antilog function to provide linear output for meter M1. The output of Q1-b is scaled according to the position of RANGE SWITCH S1.

The voltage across the divider string (R6-R11) is stabilized by an LM113 voltage reference diode. That voltage is fed to the voltage divider through a 2N2222 transistor configured as a diode, then through CALIBRATION potentiometer R4, and R5. The output of the LM113 varies with absolute temperature; that provides temperature compensation.

To calibrate the circuit, potentiometer R4 is adjusted for full-scale deflection of the meter when a 1  $\mu$ A current is applied to the circuit. That provides maximum accuracy over all six ranges.

### Micropower voltage regulator

The LP2950 micropower voltage regulator is a recent addition to National Semiconductor's line of low-dropout regulators. The LP2950 features a quiescent current of only 75  $\mu$ A and a dropout voltage that is as low as 40 mv under a light load. One advantage of the LP2950 regulator is that its quiescent current increases very little under most conditions, and it even stays low when battery voltage drops.

The LP2950 is available in 3-pin and 8-pin versions. The former is a 5-volt, 100-mA regulator with a temperature coefficient of 50 ppm/ $^{\circ}$ C. Load and line regulation are typically within 0.05%.

The output voltage of the 8-pin version can be programmed from 1.24 to 29 volts with the addition of an external pair of resistors. And, by shorting pins 1 and 2, the LP2950 becomes a 5-volt regulator. The 8-pin version has several other interesting features including an ERROR

output to warn of low output voltage and a SHUTDOWN input that permits the user to switch the regulator on and off using logic-level drivers (a TTL gate, for example).

Both versions feature short-circuit protection and thermal shutdown, and both require a 1- $\mu$ F capacitor on the output pin for stability. The LP2950 costs \$1.08 in lots of 100 or more.—**National Semiconductor**, 2900 Semiconductor Drive, Santa Clara, CA 95051.

### Eight-switch JFET array

The Sil800 from Siliconix is a hybrid array of eight N-Channel, high-speed JFET switches in a hermetically-sealed package. It is designed for 64K core-memory circuits as a sense/drive switch for military and industrial applications.

Each switch features high switching speed (less than five ns), low on-resistance (seven ohms), high continuous drain current (400 mA), high maximum power dissipation (300 mW), and a minimum gate-source voltage of -25 volts.

The 16-pin flat package measures 0.285  $\times$  0.44 inch (not including leads), and it can operate over the full military temperature range. Unit cost of the Sil800 is \$24.96 in 1000-piece lots.—**Siliconix Inc.**, 2201 Laurelwood Road, Santa Clara, CA 95054.

### Circuit design handbook

*Circuit Ideas For Linear IC's* is a new 34-page handbook that offers 102 practical circuits using linear IC's and MOSFET's. Each circuit uses one or more of each type of device.

The handbook is divided into nine sections of industrial and consumer applications. Among them are sections on timing, measurement, modulation, power control, data conversion, communications, and alarm/monitoring. Several indexes are provided; one lists each circuit and the devices it uses. A second index is arranged by device number, the page on which the circuit appears, and RCA's data-sheet number.

A full schematic of each circuit idea is shown along with a brief circuit description. For a free copy write to **RCA Solid State**, P.O. Box 2900, Somerville, NJ 08876. **R-E**

# TAKE ADVANTAGE OF TELETEXT



As  
Featured  
in this  
Issue!

## Build this Low-Cost Decoder and SAVE A FORTUNE!



ONLY  
**\$199**



Cat K-6315

**"This new teletext decoder... is the simplest and best performing world system teletext decoder that I have found to date."**

—Thomas Harrington, quoted from the best-selling *Hidden Signals on Satellite TV* (Cat B-1843)

### Look at These Features!

Easy to build circuit board with screened overlay showing component layout for easy assembly • Comes with pre-adjusted and pre-assembled decoder module • Requires very little adjustment • Housed in attractive case with screened front and rear panels • You'll be proud to have it on your video shelf • Just wait until your friends ask what it is! • Comes complete with 21 button remote control • Teletext services are FREE — no user fees, no scrambled signals • Watch regular TV, view Teletext pages, or see the text over the regular TV picture • Decoder can be set to newflash page warning you of hot news stories.

### A note about Teletext

Teletext refers to digital data transmitted in the Vertical Blanking Interval (VBI) between broadcast frames on your ordinary TV. Taft Broadcasting of Cincinnati produces the largest teletext service, ELECTRA, a 100 page magazine of news, information, & entertainment. It is carried by WTBS, along with CABLETEXT, 11 pages of stock & business data. Other services include the University of Wisconsin's INFOTEXT, and METROTEXT in Los Angeles (KTTV). And this is only the beginning — we believe Teletext will be the hottest communications issue of the late '80's!

NOTE: This kit requires pre-tuned composite video & audio outputs from VCR, tuner, (some) cable-TV decoders, or TV (some newer models feature composite tuner outputs).

LATEST NEWS • BUSINESS HEADLINES • SPORTS SCORES • WEATHER • NYSE, AMEX AND OTC STOCK PRICES • COMMODITY REPORTS • STATISTICS • SPORTS QUIZ • NEWS FLASHES • AND MUCH MORE



### Want to Learn More about Teletext!



### The Hidden Signals on Satellite TV

by Harrington & Cooper  
240 pages  
\$19.95  
Cat B-1843

NEW  
EXPANDED  
1986  
EDITION

### Infra-red REMOTE CONTROL for your Teletext Decoder



No more messy leads & wires to trip over! This sleek remote is designed especially for our Teletext Decoder (K-6315), duplicating all its control keys. It requires only a handful of parts, so it's easy to build. At this low price remote control is not an option, it's a necessity!

NEW  
KIT!

AMAZING!  
ONLY **\$34.95**  
Cat K-3425



### Rack- Mounting Cabinets

Professional quality black instrument cases that fit standard 19" racks. Supplied flat, assembly takes only minutes. Heavy gauge (0.12") front panel; top & bottom pre-punched for ventilation.

Cat H-2483 \$24.95 Cat H-2481 \$29.95  
16.75" x 9.8" x 1.5" 16.75" x 9.8" x 5.5"  
Cat H-2482 \$27.50  
16.75" x 9.8" x 3.25"

**STOP THE PRESS!  
IMPORTANT NOTE  
TO DSE CUSTOMERS**

Due to the overwhelming popularity of the Teletext Kit, our Production Dept. is having difficulty keeping up with demand. Please call for latest delivery information.

A New Range of  
"OK" BRAND  
WIRE WRAP TOOLS  
See our 86 Catalog!

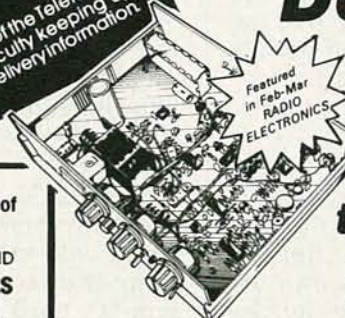

Featured  
in Feb-Mar  
RADIO  
ELECTRONICS

## Don't buy a Satellite Receiver until you see the Australis 1

"The performance rivals commercial receivers costing hundreds of dollars more. The ease of assembly & ...field proven circuitry is fantastic. The quality...better than expensive commercial units...."

Richard Maddox, author of  
*Troubleshooting & Repairing Satellite TV Systems*

only **\$99.95**  
Cat K-6316

### When you're ready for some serious soldering

Get this professional station at a hobbyist's price! Features fully variable temperature control; lightweight and detachable iron; holder & cleaning sponge.



\$59.95  
Cat T-2100

**DSE**  
SOLDERING  
STATION

The Australis 1 Satellite Receiver Kit can be assembled in just hours - why wait any longer? Buy a complete system from Dick Smith Electronics and save even more!

### DSE SATELLITE TV SYSTEMS

Install your own for as low as \$699!  
Call or write today for more information on our custom systems & components!





# The Dick Smith Bookshop

Our selection of electronics books & publications is unmatched!  
From elementary to expert, we have the information you need!



356 pp.

## FIBER OPTICS & LASERS

by Edward L. Safford, Jr.

This fascinating new sourcebook presents the amazing applications of this space-age field in state-of-the-art detail. Excellent information for engineers and ideas for experimenters. The author is a retired mathematics professor and senior member of Robotics International.

Cat B-3810 **\$16<sup>95</sup>**

## MASTER IC COOKBOOK

by Clayton L. Hallmark

Here's a "one-stop" source of descriptions, pinouts, & absolute maximum ratings for all classifications of IC's - 7400 series, 4000 series, linear IC's & more. Contains specific info on subjects pertinent to each individual group or family as well as data on all families.

**\$14<sup>95</sup>** Cat B-1240



476 pp.

**NEW TITLES**

## FIBEROPTICS

by John A. Kuecken, 364 pp.  
Fundamentals, hardware, applications & projects

**\$13<sup>95</sup>**  
Cat B-3800

## LASER EXPERIMENTERS' HANDBOOK

by Frank McAloose, 210 pp.  
All the background and theory needed to build working lasers!

**\$16<sup>95</sup>**  
Cat B-3900

## NATIONAL DATA BOOKS

Cat. No.	Title	Price
B-4050	CMOS Data Book	\$11.95
B-4056	Linear Supplement	8.95
B-4060	Logic Data Book, Vol. 1	14.95
B-4061	Logic Data Book, Vol. 2	14.95
B-4065	MOS Memory Data Book	5.95
B-4070	Transistor Data Book	6.95
B-4075	Voltage Regulator Handbook	6.95

## TTL COOKBOOK

by Don Lancaster, 328 pp.  
Understand & use Transistor Transistor Logic (TTL) IC's

**\$12<sup>95</sup>**  
Cat B-1246

## CMOS COOKBOOK

by Don Lancaster, 416 pp.  
CMOS - What it is, how it works, catalog of devices & more.

**\$14<sup>95</sup>**  
Cat B-1248

## ENCYCLOPEDIA OF ELECTRONIC CIRCUITS

by Rudolf F. Graf, 768 pp.  
A must-have reference for every builder & designer - over 1700 of the most needed circuit schematics!

**\$29<sup>95</sup>**  
Cat B-1781

## FUNWAY into ELECTRONICS

Our ever-popular series of entertaining educational texts!

**Volume 1: for beginners**, requires no soldering or prior knowledge  
Cat B-2600 **\$4.95**

**Volume 2: 20 Exciting New Projects!**  
Learn soldering & the use of printed circuit boards. Projects include a universal timer, wireless mic, home/car alarm, and many others. Hours of enjoyment & education.  
Cat B-2605 **\$6.95**

**Volume 3: Introducing Integrated Circuits**  
10 sophisticated projects for advanced hobbyists. Includes a mini color organ, a mini stereo amp, and a mini synthesizer and more — the fun won't stop when they're built!  
Cat B-2610 **\$6.95**

## THE TRUTH ABOUT CB ANTENNAS

Exposes false antenna claims. **CAT B-2327 \$8.95**

## ARRL HANDBOOK 1986

64th edition with 27 new projects **Cat B-2219 \$18.00**

## TUNE IN THE WORLD WITH HAM RADIO

Book & cassette help you get your license **Cat B-2240 \$8.50**

## COMPUTER PROGRAMS FOR AMATEUR RADIO

In BASIC for Apple, TRS-80, C-64; IBM conversion guide **Cat B-2320 \$17.95**

## WORLD RADIO TV HANDBOOK

40th anniversary edition-1986 **Cat B-2086 \$19.95**

## MONITOR AMERICA

582 page communications/travel guide **Cat B-9603 \$14.95**

## "SCREWDRIVER EXPERT'S GUIDE"

CB repairs & modifications for non-experts **Cat B-2324 \$12.50**

## ARRL ANTENNA COMPENDIUM

Previously unpublished articles from QST. **Cat B-2206 \$9.95**

## CONFIDENTIAL FREQUENCY LIST

Over 8500 international stations **Cat B-9602 \$13.95**

## Too busy to build your own?

Get great value with **DSE Gel Cell Chargers!** **SAVE UP TO \$10.00**



## DSE GEL CELLS

Get all the advantages of lead-acid batteries with virtually none of the hassles—no leaks, no mess!

Cat S-3313 6V/1.2 Ah \$6.95  
Cat S-3315 12V/1.2 Ah \$7.95  
Cat S-3320 12V/2.6 Ah \$13.95  
Cat S-3321 12V/9 Ah \$34.95

When you are recharging Gel Cells it is most important that careful attention is paid to the charge rate duration of charge as exceeding the recommended limits may severely reduce the battery life. We stock two regulated chargers to suit Gel Cell batteries. Two new models are due in stock soon.

2 types available:  
M-9520 Suitable for charging 1 **\$34<sup>95</sup>**  
12V gel cell battery with 1.2 Ah capacity.  
M-9522 Suitable for charging 1 **\$36<sup>00</sup>**  
12V gel cell battery with 2.6 Ah capacity.

**NOW ON SPECIAL ONLY \$25.00 EACH**

## FUNWAY PROJECTS

Want an amplifier for your walkie stereo or radio? Don't be tied to phones: use this project and listen in comfort! Or you can build this into a mini PA Amplifier.

It's a real beauty, this one: a real 'live' musical synthesizer — and it's live because it uses YOU as the note generator! You get an amazing range of control over the sound.

**MINI AMP KIT\* \$14<sup>95</sup>**  
Cat K-2667

**MINI SYNTH KIT\* \$19<sup>95</sup>**  
Cat K-2669

\*These projects require FUNWAY book, Volume 3 (Cat B-2610 for complete construction details.

**NOW OPEN IN L.A.**

Orders Only — Call Toll Free:  
**1-800-332-5373**  
(Monday-Friday, 7am-6pm PACIFIC TIME)  
IN CALIFORNIA CALL: 1-415-368-1066

STORES AT:  
BERKELEY: 2474 Shattuck Ave. (415)486-0755  
REDWOOD CITY: 390 Convention Way (415)368-8844  
SAN JOSE: 4980 Stevens Creek Blvd (408)241-2266  
LOS ANGELES: 1830 Westwood Blvd. (213)474-0626  
HEAD OFFICE: 390 Convention Way, Redwood City, CA 94063

WHERE THE ELECTRONIC ENTHUSIAST IS # 1!  
**DICK SMITH ELECTRONICS**

**MAIL ORDERS**  
P.O. Box 8021 Redwood City CA 94063  
**14 DAY MONEY-BACK GUARANTEE**  
**SHIPPING & HANDLING:**

We ship UPS Ground unless otherwise requested.  
Add 5% of order total (\$1.50 minimum) for shipping (20% outside the U.S.A. - \$4.00 minimum).  
There is an additional \$1.50 handling fee.  
California residents please add sales tax.

**YES!** PLEASE RESERVE MY COPY of the 1986 DICK SMITH ELECTRONICS Catalog! Enclosed is \$1.00 for postage & handling.

NAME \_\_\_\_\_ ADDRESS \_\_\_\_\_ CITY \_\_\_\_\_ STATE \_\_\_\_\_ ZIP \_\_\_\_\_

CIRCLE 95 ON FREE INFORMATION CARD

## KIRLIAN

*continued from page 45*

posure using S2. As a guideline, start with an exposure time of about 10–15 seconds, but it is likely that you will have to do a lot of trial-and-error experimentation with both exposure time and oscillator frequency, which is adjusted using R1, before you will obtain results that you are satisfied with.

The author has had good success with two types of film: Kodak 6118 Ektachrome

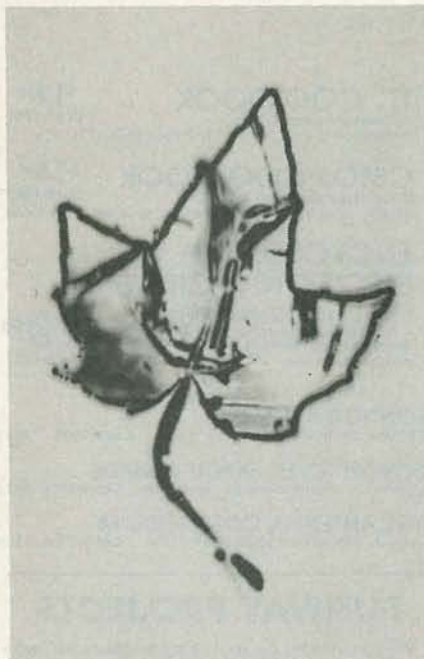

**FIG. 6—ALTHOUGH THE RESULTS are not visually striking, Kodalith film is easy to work with. Here is a Kirlian aura captured on that film.**

and Kodalith 2556 or the film, type 3.

The Ektachrome film will give you spectacular color transparencies, such as the ones that accompany this article. However, it can be difficult to work with (a dark room is absolutely required) and to develop. Unless you have a photographic darkroom and are equipped for developing that type of film, you will probably want to take it to a professional.

Kodalith 2556 ortho film, type 3 is a high-contrast, black-and-white graphic arts film that may be familiar to those who use the photographic method to make their own PC-board masks. The results are less spectacular, as shown in Fig. 6, but that film's light requirements are less exacting (a photographic safelight can be left on when handling the unexposed film or making exposures) and the processing procedure is much simpler, requiring just three basic chemicals. The author has had success finding the right exposure time and frequency using the Kodalith, and then turning to the Ektachrome for the final exposure. **R-E**

## LEAKAGE TESTER

*continued from page 58*

it only for the test purposes intended, and discharge tested capacitors with a screwdriver when finished. In addition, use of this project is recommended by technically qualified personnel only.

Now that that's out of the way, the unit is a cinch to use. Let's look at some typical applications for the project:

Testing capacitors is easy. If applicable, remove the suspect unit from the circuit first, as any external leakage can cause a good capacitor to test leaky. Set S1 to the DISCHARGE position. Then set S2 to the working voltage of the capacitor. If the voltage is greater than the project can provide, use the 100-volt position.

Then use insulated clips to connect the capacitor to the project.

Flip S1 to the CHECK position. The meter needle will "kick" upscale and drop to zero for a good capacitor. If desired, press S3 for more sensitivity; that will give you 0-1 mA readings instead of the nominal 0-10 mA readings.

Note that the meter needle may kick upscale many times before settling down. That indicates that the capacitor has excessive leakage at the test voltage and requires "forming." That is a common situation with capacitors that are used at a voltage far lower than the working voltage, like, say, a 50-volt part in a 12 volt circuit. That is not a fault of the project. However, if the meter doesn't stop kicking after several minutes, the capacitor isn't forming and should be replaced.

When the testing is finished, return S1 to the DISCHARGE position. The meter will read negative, indicating discharge. When the needle returns to zero, remove the capacitor.

So how much leakage should a good capacitor have? There is no simple answer, as it depends upon the capacitor type and circuit requirements. However, here are a few rules of thumb you can use.

Paper, mica, polyester, and tantalum capacitors should display no leakage. Electrolytic capacitors up to 50  $\mu\text{F}$  should show less than 25  $\mu\text{A}$  of leakage current. Electrolytic capacitors from 51  $\mu\text{F}$  to 500  $\mu\text{F}$  should show less than 50  $\mu\text{A}$  leakage. Electrolytic capacitors from 501  $\mu\text{F}$  to 1,000  $\mu\text{F}$  should show less than 100  $\mu\text{A}$  leakage. Electrolytic capacitors from 1,001  $\mu\text{F}$  to 20,000  $\mu\text{F}$  should show less than 500  $\mu\text{A}$  leakage.

Another use for the project is forming new capacitors. Understand that electrolytic capacitors chemically deteriorate when they sit unused. The capacitor's electrolytic film, essential to capacitor operation, deteriorates, causing very high leakage currents. If you apply a voltage to the capacitor, the film can reform. But if that voltage is too high, that is, close to

the device's rating, the film may not be able to form fast enough. So the capacitor will consume power, get hot, and possibly explode. Here's how to solve that problem:

Set S1 to the DISCHARGE position and S2 to the 3-VOLT position. Then use insulated clips to connect the capacitor.

Flip S1 to the CHECK position and note the meter reading. When the meter reads minimum current, change S2 to the 6-VOLT position. Continue increasing the voltage until the working voltage is reached. Discard any capacitor that takes over five minutes to form, or still has high leakage when checked at its working voltage.

Appliance safety is easy to check. Here's how: Set S1 to DISCHARGE and S2 to 100-VOLTS. Assuming the device to be tested uses a three-wire power cord, use an insulated clip lead to connect the "hot" side of the power cord to the positive binding post. After that, connect the ground lead of the power cord to the negative binding post. The return or common side of the power cord is unconnected. If the appliance does not use a three-wire power cord, connect the negative binding post to any exposed case screws or other metal surfaces on the unit to be tested.

To test, flip S1 to the CHECK position. Press S3 for more meter sensitivity. The meter must read under 50  $\mu\text{A}$ . For higher readings repairs are indicated.

Cables may be easily checked for leakage problems. Simply perform the checks the same way you did for appliance leakage. Remember to always connect the positive binding post to the center conductor and the negative binding post to the shield; that prevents a shock hazard.

If you need more sensitivity when performing leakage testing, try using your DMM if it has a 200- $\mu\text{A}$  DC range. Simply set it to the 200- $\mu\text{A}$  range and connect it in series with the positive binding post and the cable under test. That technique works great for other applications, except testing high-value capacitors. With those, when you switch to DISCHARGE, the current from the capacitor passes through the DMM, overloading it.

Another use for the project is quickly checking those special high voltage diodes used in TV sets and microwave ovens. Usually a DMM can't check those components because it can't supply enough voltage to turn on the device.

To test the diode, set S1 to DISCHARGE and S2 to 100-VOLTS. Then remove the diode from the circuit and connect it to the project's binding posts. Flip S1 to CHECK and note the reading. Then return S1 to DISCHARGE and reverse the diode. Flip S1 to CHECK again and note the reading. With most silicon diodes we expect a full-scale reading when the diode is connected one way and zero when it is reversed. With selenium diodes, the difference should be at least 100 to 1. **R-E**

# MARKET CENTER

## BUSINESS OPPORTUNITIES

**PROJECTION TV**...Make \$\$\$'s assembling Projectors...Easy...Results comparable to \$2,500 projectors...Your total cost less than \$200...**PLANS, 8" LENS & Dealers information \$17.50**...Illustrated information **FREE**...**MACROCOMA-GIX**, Washington Crossing, PA 18977. Creditcard orders 24 Hours (215) 736-2880.

**\$10-\$360 WEEKLY/UP, MAILING CIRCULARS!** No Quotas. Sincerely interested, rush stamped envelope: **NATIONAL MAILING**, Box 20728-RA5, San Diego, CA 92120.

**MECHANICALLY** inclined individuals desiring ownership of small Electronics Manufacturing Business - without investment. Write: **BUSINESSES**, 92-R, Brighton 11th, Brooklyn, NY 11235.

## CLASSIFIED AD ORDER FORM

To run your own classified ad, put one word on each of the lines below and send this form along with your check to:

**Radio-Electronics Classified Ads**, 500-B Bi-County Boulevard, Farmingdale, NY 11735

**PLEASE INDICATE** in which category of classified advertising you wish your ad to appear. For special headings, there is a surcharge of **\$23.00**.

( ) Plans/Kits ( ) Business Opportunities ( ) For Sale  
( ) Education/Instruction ( ) Wanted ( ) Satellite Television

Special Category: \$23.00

### PLEASE PRINT EACH WORD SEPARATELY, IN BLOCK LETTERS.

(No refunds or credits for typesetting errors can be made unless you clearly print or type your copy.) Rates indicated are for standard style classified ads only. See below for additional charges for special ads. **Minimum: 15 words.**

1	2	3	4	5
6	7	8	9	10
11	12	13	14	15 (\$42.75)
16 (\$45.60)	17 (\$48.45)	18 (\$51.30)	19 (\$54.15)	20 (\$57.00)
21 (\$59.85)	22 (\$62.70)	23 (\$65.55)	24 (\$68.40)	25 (\$71.25)
26 (\$74.10)	27 (\$76.95)	28 (\$79.80)	29 (\$82.65)	30 (\$85.50)
31 (\$88.35)	32 (\$91.10)	33 (\$94.05)	34 (\$96.90)	35 (\$99.75)

We accept MasterCard and Visa for payment of orders. If you wish to use your credit card to pay for your ad fill in the following additional information (Sorry, no telephone orders can be accepted.):

Card Number

Expiration Date

Please Print Name

Signature

**IF YOU USE A BOX NUMBER YOU MUST INCLUDE YOUR PERMANENT ADDRESS AND PHONE NUMBER FOR OUR FILES. ADS SUBMITTED WITHOUT THIS INFORMATION WILL NOT BE ACCEPTED.**

**CLASSIFIED COMMERCIAL RATE:** (for firms or individuals offering commercial products or services) \$2.85 per word prepaid (no charge for zip code)...**MINIMUM 15 WORDS.** 5% discount for same ad in 6 issues; 10% discount for same ad in 12 issues within one year; if prepaid. **NON-COMMERCIAL RATE:** (for individuals who want to buy or sell a personal item) \$2.30 per word, prepaid...no minimum. **ONLY FIRST WORD AND NAME** set in bold caps at no extra charge. Additional bold face (not available as all caps) **50c per word additional (20% premium).** Entire ad in boldface, **add 20% premium** to total price. **TINT SCREEN BEHIND ENTIRE AD:** add 25% premium to total price. **TINT SCREEN BEHIND ENTIRE AD PLUS ALL BOLD FACE AD:** add 45% premium to total price. **EXPANDED TYPE AD:** \$4.30 per word prepaid. All other items same as for STANDARD COMMERCIAL RATE. **TINT SCREEN BEHIND ENTIRE EXPANDED TYPE AD:** add 25% premium to total price. **TINT SCREEN BEHIND ENTIRE EXPANDED TYPE AD PLUS ALL BOLD FACE AD:** add 45% premium to total price. **DISPLAY ADS:** 1" x 2 1/4" — \$310.00; 2" x 2 1/4" — \$620.00; 3" x 2 1/4" — \$930.00. **General Information:** Frequency rates and prepayment discounts are available. **ALL COPY SUBJECT TO PUBLISHERS APPROVAL. ADVERTISEMENTS USING P.O. BOX ADDRESS WILL NOT BE ACCEPTED UNTIL ADVERTISER SUPPLIES PUBLISHER WITH PERMANENT ADDRESS AND PHONE NUMBER.** Copy to be in our hands on the 12th of the third month preceding the date of the issue. (i.e., August issue copy must be received by May 12th). When normal closing date falls on Saturday, Sunday or Holiday, issue closes on preceding working day.

**BIG PROFITS**

## ELECTRONIC ASSEMBLY BUSINESS

Start home. spare time. Investment knowledge or experience unnecessary. **BIG DEMAND** assembling electronic devices. Sales handled by professionals. Unusual business opportunity.

**FREE: Complete illustrated literature**  
BARTA, RE-O Box 248  
Wainut Creek, Calif. 94597

**RECOVER** silver from home and industrial junk. Free silver with my \$10.00 booklet of items that contain silver.**DON FOWLER**, Box-4401, Cleveland, TN 37311.

**U.S. Government Research Grants** for small businesses and individuals. \$5.00 for starter kit.**ER-DAX-RE**, Box 1179, Woodstock, GA 30188.

**BUY** direct from Hong Kong, Taiwan and Singapore. Free details. **BUY DIRECT**, 51 SW 69th Ave., Miami, FL 33144-2809.

## WANTED

## AMBITIOUS INDIVIDUALS

To operate Very profitable Electronics Assembly Business. Part time, Full time. No Experience or investment required. Excellent home business Products sold for you. **FREE** Information package

SCORPION ENTERPRISES  
Station 2 Box 27  
Houma, LA 70360

**MASTERCARD AND VISA** are now accepted for payment of your advertising. Simply complete the form on the first page of the Market Center and we will bill.

**Hi-profit CRT** rebuilding machinery. **ONE MAN. EASY. CRT**, 1909 Louise, Crystalake, IL. 60014. (815) 459-0666.

**REPORT** on 10 best business opportunities in 1986. \$3.00 **logicalife. CAPITAL GROUP**, 3471 Tony Drive, San Diego, CA 92122.

**YOUR OWN RADIO STATION!** AM, FM, TV, Cable. Licensed/unlicensed. **BROADCASTING**, Box 130-F5 Paradise, CA 95969.

**LINEARS** export radios parts send \$15 cash **WASHINGTON ENTP.**, 1725 North Bond Street, Baltimore, MD 21213.

## PRINTED CIRCUIT BOARD

**PRINTED**-circuit boards. Quick prototypes, production, design, reflow solder send print or description for quote to **KIT CIRCUITS**, Box 235 Clawson, MI 480717.

**PCB** 15 cents sq-in. Free drilling. Quantity discounts. Professional work. **INTERNATIONAL ENTERPRISE**, 6452 Hazelcircle, Simivalley, CA 93063.

## EDUCATION/INSTRUCTION

**UNSCRAMBLE** satellite signals the easy way. Parts available from Radio Shack. Send \$19.95 for plans & catalog. Board & plans \$39.95, kits from \$99.95. **VIDEO RESEARCH** P.O. Box 2, Kingsport, TN 37660.

**GET A BETTER JOB. LEARN ELECTRONICS ON TV.** All the basics on a two hour VHS or Beta video tape. Send \$49.95 or write for free details. **E.I.T. Co.**, PO Box 2891, Norman, OK 73070

## ATTENTION ELECTRONIC TECHNICIANS

Highly Effective Home Study BSEE Degree Program for Experienced Electronic Technicians Our New Advanced Placement Program grants Credit for previous Schooling & Professional Experience. Advance Rapidly! Our 40th Year!  
**FREE DESCRIPTIVE LITERATURE!**  
**Cook's Institute of Electronics Engineering**  
P.O. BOX 20345, JACKSON, MS 39209

MAY 1986





# WRITE FOR McGEE'S

**SPEAKER & ELECTRONICS CATALOG**

**1001 BARGAINS IN SPEAKERS**

toll free 1-800-346-2433 for ordering only.

1901 MCGEE STREET KANSAS CITY, MO. 64108

**RESISTORS** ¼ W, ½ W 5% C.F. 3 cents 1% Metal-films, custom wirewounds, capacitors and other components. **JR INDUSTRIES**, 5834-H Swan creek, Toledo, OH 43614.

**CATALOG:** Electronic components at budget prices for students, hobbyists and industry. Send \$2.00 P & H (refundable) **BUDGET ELECTRONICS**, Box 1477, Moreno Valley, CA 92388.

**TEST** equipment, reconditioned. For sale. \$1.25 for catalog. **WALTER'S**, 2697 Nickel, San Pablo, CA 94806 (415) 724-0587.

**SOLAR ELECTRIC PANELS** from \$250! Inverters, 95% efficient. **GIL ELECTRONICS**, P.O. Box 1628, Soquel, CA 95073.

**RESISTORS** .01, 2N3904 .05, 1N4148 .02, more. Flyer, 2 stamps. **DIGIMATION**, Box 1479, Cullowhee, NC 28723.

**PARTS. IC's, Transistors, Capacitors, Resistors, Solar Cells, Plans, Kits, More.** **GIL ELECTRONICS** Box 1628, Soquel, CA 95073.

**ELECTRONICS** Bonanza large lot excessed equipment closed circuit TV, medical/scientific, computer testing, ground-to-air communication, navigation aid apparatus, many miscellaneous items, **HAROLD GARRETT** OKC OK call for complete list (405) 686-0031.

**MINIATURE FM Transmitter**, size of postage stamp. Up to 1 mile range. Kit \$24.95 includes PC board and all board mounted parts. Catalog \$1.00 refundable with order. (CA residents add 6.5%) **CAS ELECTRONICS**, 1559-J Amar Road Suite 457, West Covina, CA 91792.

**WHOLESALE MATV/CATV Equipments**, antenna, accessories, cartridges, radios, speakers, cables (718) 897-0509 **D&WR**, 68-12 110 St. Flushing, NY 11375.

**OP AMPS** - Lowest prices for popular types. Send for list. **ELAN TECHNOLOGY**, RD1 Box 546, Ringoes, NJ 08551.

**35-70% Savings-Bargain** catalog for 39 cents stamp. **APEX ELECTRONICS MOD**, 8909 San Fernando Sun Valley, CA 91352.

**RECTIFIERS**. Parts for automotive battery charges. **A&E EQUIPMENT**, 4617 Highway Jacksonville, FL 32205 (904) 388-2953.

**DESCRAMBLER** - Complete Zenith SSAV1-1 system (can't be disabled) \$150.00. **WATSON**, 342 Franklin Framingham, MA 01701.

**LASERS** and nightvision surplus components. free catalog. **M.J. NEAL COMPANY**, 6672 Mallard Ct., Orient, OH 43146.

**CB** tune-up manual volume II. Specific adjustments and modifications for peaking all popular CB's. Covers over 1300 radios \$19.95, Visa, Mastercard to: **THOMAS PUBLISHING**, 127 Westwood Paris, IL 61944.

**ELECTROLYTICS** 10,000 µF 70WVDC individually tested \$3.50-\$12.4 add \$1.00 postage per order. **C.L. MARCH**, 3010 Briarwood, Hornlake, MS 38637.

**SCIENTIFIC** Atlanta stand alone descrambler priced under \$100. Details \$2. **DIGITEK**, Box 195, Levittown, PA 19059.

**RADAR** Jammer- \$195.00 interface for radar detect, optional Visa, Mastercard, COD. Quantity discount **V-G ELECTRONIC**, 2724 Bonnie Drive Cincinnati, Ohio.

**CABLE and SUBSCRIPTION TV** secret manual. Build your own **DESCRAMBLERS**, converters. Instructions, schematics for sinewave, inband/outband. Gated sync, SSAV1-(HBO, Showtime, Cinemax, UHF, etc.) Send \$8.95 to **CABLETRONICS**, Box 30502R, Bethesda, MD 20814.

"**CABLE** converters, satellite receivers, descramblers, & other audio/video equipment. Federal sales law enforced. **CEB**, Box 16305, Davenport, IA 52806. (319) 322-6668."

# CABLE-TV

**WE'LL MATCH OR BEAT ANYONE'S  
ADVERTISED RETAIL OR WHOLESALE PRICES!**

# BONANZA!

ITEM	SINGLE UNIT PRICE	DEALER 10-UNIT PRICE
RCA 36 CHANNEL CONVERTER (CH. 3 OUTPUT ONLY)	29.95	18.00 ea.
PIONEER WIRELESS CONVERTER (OUR BEST BUY)	88.95	72.00 ea.
LCC-58 WIRELESS CONVERTER	92.95	76.00 ea.
JERROLD 450 WIRELESS CONVERTER (CH. 3 OUTPUT ONLY)	105.95	90.00 ea.
SB ADD-ON UNIT	109.95	58.00 ea.
<b>BRAND NEW — TRIMODE UNIT FOR JERROLDS</b>	Call for specifics	
MINICODE (N-12)	109.95	58.00 ea.
MINICODE (N-12) VARISYNC	119.95	62.00 ea.
MINICODE VARISYNC W/AUTO ON-OFF	179.95	115.00 ea.
M-35 B (CH. 3 OUTPUT ONLY)	139.95	70.00 ea.
M-35 B W/AUTO ON-OFF (CALL FOR AVAILABILITY)	199.95	125.00 ea.
MLD-1200-3 (CALL IF CH. 2 OUTPUT)	109.95	58.00 ea.
INTERFERENCE FILTERS — CH. 3	24.95	14.00 ea.
JERROLD 400 OR 450 REMOTE CONTROLLER	29.95	18.00 ea.
ZENITH SSAVI CABLE READY (DEALER PRICE BASED ON 5 UNITS)	225.00	185.00 ea.
<b>SPECIFY CHANNEL 2 or 3 OUTPUT Other products available — Please Call</b>		

Quantity	Item	Output Channel	Price Each	TOTAL PRICE
California Penal Code #593-D forbids us from shipping any cable descrambling unit to anyone residing in the state of California. Prices subject to change without notice.			<b>SUBTOTAL</b>	
			Shipping Add \$3.00 per unit	
			COD & Credit Cards — Add 5%	
			<b>TOTAL</b>	

PLEASE PRINT

Name \_\_\_\_\_

Address \_\_\_\_\_ City \_\_\_\_\_

State \_\_\_\_\_ Zip \_\_\_\_\_ Phone Number ( \_\_\_\_\_ ) \_\_\_\_\_

Cashier's Check     Money Order     COD     Visa     Mastercard

Acct # \_\_\_\_\_ Exp. Date \_\_\_\_\_

Signature \_\_\_\_\_

FOR OUR RECORDS:

**DECLARATION OF AUTHORIZED USE** — I, the undersigned, do hereby declare under penalty of perjury that all products purchased, now and in the future, will only be used on cable TV systems with proper authorization from local officials or cable company officials in accordance with all applicable federal and state laws.

Dated: \_\_\_\_\_ Signed: \_\_\_\_\_

# Pacific Cable Company, Inc.

7325½ RESEDA BLVD., DEPT. # R-4 • RESEDA, CA 91335  
(818) 716-5914 • No Collect Calls • (818) 716-5140

**IMPORTANT: WHEN CALLING FOR INFORMATION**  
Please have the make and model # of the equipment used in your area. *Thank You*

# Saratoga Electronics



ORDER TOLL FREE

**800-621-0854**

**ext.245**

## DYNAMIC RAMS

4164 - 150NS	\$1.25
41256 - 150NS	\$3.25

## I.C.'s

M58725	\$1.49
9114EPC	\$ .90
74S374	\$ .39
74S280	\$ .39
8237A-5	\$3.50

## EPROMS

2716 - 450NS	\$2.95
2732A - 450NS	\$2.25
2764 - 450NS	\$3.00
2764 - 250NS	\$3.75
27256 - 300NS	\$6.75

## PC/AT COMPATIBLE SYSTEM BOARD

**\$895**

★ 1 Megabyte Installed

## DRIVES

MIT 4853 QUAD/DS 96 TPI ½HT.	\$69.95
TM848-2 8" DS/DD ½HT.	\$99.95
SEAGATE 20MB ½HT.	\$375.00
QUANTUM 40MB FULL HT.	\$795.00
HARD DISK CONTROLLER (OMTI 5510)	\$139.00

## PC/XT COMPATIBLE SYSTEM BOARD

★ 256/640 KB w/o Bios & Ram

**\$160**

## Ask About Our PC/XT System Kit

**\$895**

**\$25 MINIMUM ORDER  
PRICES SUBJECT TO CHANGE**

12380 SARATOGA - SUNNYVALE ROAD  
SARATOGA, CA 95070  
(408) 446 - 4949



TI-99/4A software/hardware bargains. Hard to find items. Huge selection. Fast service. Phone catalog. DYNA, Box 690 Hicksville, NY 11801.



**REMOVES VOCALS FROM RECORDS!**  
Now You can sing with the world's best bands!  
The Thompson Vocal Eliminator can remove most or virtually all of a lead vocal from a standard stereo record and leave the background!  
Write or call for a free brochure and demo record.  
**LT Sound, Dept. R-1, P.O. Box 338,  
Stone Mountain, GA 30086 (404) 493-1258**

## PLANS AND KITS

CATALOG: Hobby/broadcasting/1750 Meters/Ham/CB: Transmitters, amplifiers, antennas, scramblers, bugging devices, more! PANAXIS, Box 130-F5 Paradise, CA 95969.

**CABLE TV CONVERTERS:** Jerrold products include "New Jerrold TRI-MODE", SB-3, Hamlin, Oak VN-12, M-35-B, Zenith, and more. UHF deluxe II Kits. (Quantity discounts) 60 day warranty. Service converters sold here. For fast service COD orders accepted. Send S.A.S.E. (60 cents postage) or call for info. (312) 637-4408. HIGGINS ELECTRONICS 5143-R W. Diversey, Chicago, IL. 60639. No Illinois orders accepted.

Hi-Fi speaker kits, auto speaker systems and speaker components from the world's finest manufacturers. For beginners and audiophiles. Free literature. A&S SPEAKERS, Box 7462R, Denver, CO 80207 (303) 399-8609.

8' DISH \$69 fabrication cost. Polar mount, attractive, easy construction. Stock hardware items used. COMPLETE instructions, plans, fabrication, assembly, setup, drawings, photos. \$14.95 Plus \$2.00 shipping. DIRIJO DISH, Box 212 Lowell, NC 28098.

FREE catalog 99-cent kits—audio, video, TV computer parts. ALLKIT, 434 W. 4th St., West Islip, NY 11795.

CRYSTAL radio sets, plans, parts, kits, catalog \$1.00. MIDCO, 660 North Dixie Highway, Hollywood, FL 33020.

PROJECTION TV...Convert your TV to project 7 Foot picture...Results comparable to \$2,500 projectors...total Cost less than \$30.00...Plans and 8" Lens \$19.95. Illustrated information FREE. MACROMA-GI, Washington Crossings, PA 18977. Creditcard orders 24 Hours (215) 736-3979.

FILTER DESIGNER KIT a variable gain state variable filter. May be reconfigured to build most of the circuits in Don Lancaster's book "Active Filter Cookbook". Send for free brochure, KEY ELECTRONICS, Box 1, Red Key, IN 47373.

DESCRAMBLER plans, New design decodes gated sync suppressed signals—newest pilotless method. Circuit boards, most parts from Radio Shack. Detailed theory, drawings, schematics, instructions \$14.95 plus \$2.00 shipping. DIRIJO CORP., Box 212, Lowell, NC 28098.

## FREE EVALUATION and ADVISORY SERVICE



A NON PROFIT ORGANIZATION

For professional electronic technicians by prestigious non-profit organization. Earn University Degree (Bachelors or Masters) through Home Study! Credit given for previous schooling and professional experience. Upgrade your earning power. Free Details!  
CONTINENTAL EDUCATION ASSOCIATES  
P.O. Box 1197 - Champlain, NY 12019-1197

C-64 interface boards, plans and software. Control robotics, ultrasonic security, appliances, phone answering, and more, with ease you never thought possible. Put your computer to work! Send SASE to BYTEX, 189 Western Avenue Lynn, MA 01902

MASTERCARD AND VISA are now accepted for payment of your advertising. Simply complete the form on the first page of the Market Center and we will bill.

## SATELLITE TV

SUPER LNA kits, dx tv preamps, microwave components, ir detectors. LSI, Box 7553, Jackson, MS 39204.

DESIGN and build Satellite dish antennas, easily, economically, illustrated manual, \$9.95, DNF, 6690 7 Mile, S. Lyon, MI 48178.

STEREO TV ADAPTER KIT Easily converts any TV/VCR to receive the new stereo TV sound. Contains all parts PCB and instructions to build a quality stereo decoder. For additional information send SASE to SOKOLOWSKI,—Box 150, Elmont, NY 11003

DO-IT-YOURSELF complete 10' Satellite System \$1143.00 UPS shippable. Easy to understand instructions. MIKE'S SATELLITE & ELECTRONICS, 605 E. Willow, Duncan, OK 73533 1-405-255-2234.

E-Z Satellite Kit™ computer print-out of your location, compass, angle finder \$19.95 Free catalog, Mastercard/Visa IN-X-SALES, Box 45, Tilton, NH 03276 (603)286-3082.

55 DEGREE LNA's! Brand name! Improve your Satellite System! Convert block systems to Ku-Band. Replacement LNB's. Discount pricing: LNA, 201 E Southern Suite 100A, Tempe, AZ 85282.

BUILD YOUR OWN SATELLITE TV RECEIVING SYSTEM AND SAVE! Instruction manuals, schematics, circuit board, parts kits! Send stamped envelope for complete product listing: XANDI, Box 25647, Dept. 21A, Tempe AZ 85282.

CABLE TV SECRETS—the outlaw publication the cable companies tried to ban. HBO, Movie Channel, Showtime, descramblers, converters, etc. suppliers list included. \$8.95. CABLE FACTS, Box 711-R, Pataskala, OH 43062.

SATELLITE systems \$449 catalog \$2. Also: KU band systems. STARLINK, INC., 2603-16R Artie, Huntsville, AL, 35805.

## PAY TV and Satellite Descrambling.

73 pages of theory and schematics for all major systems. Fantasy and Anik-D schematics included. Most complete reference available on satellite scrambling \$12.95. MDS Handbook \$10. Stungun schematics \$5. Satellite systems under \$600., \$11.95. Printed circuits, kits catalog \$1.

SHOJIKI ELECTRONICS CORP. 1327R Niagara Street, Niagara Falls, NY 14303 COD's 716-284-2163

## REEL-TO-REEL TAPES

AMPEX professional series open reel tape. 1800-or 2400-feet on 7-inch reels. Used once. Case of 40. \$45.00. 10 1/2 x 3600 feet and cassettes available. MasterCard Visa. VALTECH ELECTRONICS, Box 6-RE, Richboro, PA 18954. (215) 322-4866.

## EPROM PROGRAMMING

HOBBYISTS: Pretested EPROMs sold with your programming installed. Program listing provide. Fast Service. Write or call: ROMULUS MICRO-CONTROL, Box 8669, Rockville, MD 20856; (301) 540-8863.

## ALARMS/HOME PROTECTION

BURGLARIZED? Professional Quality Infrared Motion Detector Kits. Easy Installation. Wireless Equipment available. REFUNDABLE Catalog \$1.25. GTECH SECURITY RE-1, 11221 Interstate-10, New Orleans, LA 70128.

## INVENTORS

INVENTORS! Can you profit from your idea? Call AMERICAN INVENTORS CORPORATION for free information. Over a decade of service. 1-800-338-5656. In Massachusetts call (413) 568-3753.

★ QUALITY PARTS ★ DISCOUNT PRICES ★ FAST SHIPPING!

SEND FOR FREE NEW 1986 CATALOG... 48 PAGES!

# ALL ELECTRONICS CORP.

## EDGE CONNECTORS

ALL ARE 1.56" SPACING.

- 22/44 EDGE CONNECTOR PC style \$2.00 each 10 for \$18.00
- 22/44 EDGE CONNECTOR solder lug style \$2.50 each
- 28/56 EDGE CONNECTOR PC style \$2.50 each 10 for \$22.00
- 36/72 EDGE CONNECTOR PC style \$3.00 each
- 43/86 EDGE CONNECTOR PC style \$4.50 each

- ## TRANSISTORS
- 2N706 4 for \$1.00
  - 2N2222A 3 for \$1.00
  - PN2222A 4 for \$1.00
  - 2N2904 3 for \$1.00
  - 2N2904 3 for \$1.00
  - 2N2905 3 for \$1.00
  - MJ2955 \$1.50
  - 2N3055 \$1.00
  - PMD 10K40 \$1.00
  - TIP 121 75¢
  - TIP 125 75¢

- ## TRANSFORMERS
- 120 volt primaries
- 5.6 volts @ 750 ma. \$3.00
  - 6 volts @ 150 ma. \$1.25
  - 6.3 volt @ 500 ma. \$3.00
  - 12 V.C.T. @ 200 ma. \$2.00
  - 12 V.C.T. @ 400 ma. \$3.00
  - 12 V.C.T. @ 1 amp \$4.00
  - 12 V.C.T. @ 2 amp \$4.85
  - 12 V.C.T. @ 4 amp \$7.00
  - 18 volts @ 850 ma. \$3.50
  - 24 V.C.T. @ 200 ma. \$2.50
  - 24 V.C.T. @ 1 amp \$4.85
  - 24 V.C.T. @ 2 amp \$6.75
  - 24 V.C.T. @ 3 amp \$9.50
  - 24 V.C.T. @ 4 amp \$11.00
  - 36 V.C.T. @ 135 ma. \$3.00

- ## WALL TRANSFORMERS
- all plug directly into 120 vac outlet
- 4 VDC @ 70 ma. \$2.00
  - 6 VDC @ 500 ma. \$3.50
  - 6 VDC @ 750 ma. \$4.50
  - 9 VDC @ 500 ma. \$5.00
  - 12.5 VDC @ 265 ma. \$3.00
  - 18 VDC @ 18 VA and 8.5 VAC @ 1.28 VA \$4.50
  - 24 VAC @ 250 ma. \$3.00
  - MULTI-VOLTAGE @ 500 ma. \$7.50
  - 3.4, 6, 7.5, 9 or 12 VDC

- ## MINI-BOX
- Pomona #2104. \$1.00 EACH
- Heavy-duty black phenolic project box with cover and screws. 2 1/4" X 1 1/2" X 1 1/2"

- ## FUSES
- 3AG (AGC) SIZE 1, 1 1/2, 2, 2 1/2, 3, 4, 5, 6 AMP  
GMA SIZE 1, 2, 3, 4, 5 AMP  
5 of any ONE amperage 75¢

## SOUND AND VIDEO MODULATOR FOR T.I. COMPUTER

T.I. # UM1381-1. Designed for use with T.I. computers. Can be used with video sources. Built-in A/B switch. Channel 3 or 4 selection switch. Operate on 12 vdc. Hook-up diagram included.

CAT# AVMOD WERE \$10.00 REDUCED TO \$5.00 EACH

## SPECIALS

### 1 AMP 50 VOLT DIODES

IN4001 TAPE AND REEL 100 for \$4.50  
1000 for \$30.00

### SOLDER TAIL I.C. SOCKETS

24 PIN 10 for \$2.50  
100 for \$22.00  
1000 for \$200.00

## \*SPECIAL PRICE\* TRANSISTOR

plastic transistor PN3569 TO-92 N.P.N.

100 for \$8.00  
1000 for \$60.00  
LARGE QUANTITIES AVAILABLE

## 48 KEY ASSEMBLY FOR COMPUTER OR HOBBYIST

NEW T.I. KEYBOARDS. Originally used on computers, these keyboards contain 48 S.P.S.T. mechanical switches. Terminates to 15 pin connector. Frame 4" x 9" CAT # KP-48 \$6.50 each 2 for \$11.00

## TI SWITCHING POWER SUPPLY

Compact, well-regulated switching power supply designed to power Texas Instruments computer equipment.

INPUT: 14 - 25 vac @ 1 amp  
OUTPUT: +12 vdc @ 350 ma.  
+5 vdc @ 1.2 amp  
-5 vdc @ 200 ma.

SIZE: 4 1/4" x 4 1/4" x 1 1/4" high \$5.00 each

## 13.8 VDC REGULATED POWER SUPPLY

These are solid state, fully regulated 13.8 vdc power supplies. Both feature 100% solid state construction, fuse protection, and L.E.D. power indicator. U.L. listed.

2 amp constant, 4 amp surge \$18.00 each  
3 amp constant, 5 amp surge \$25.00 each

## D.C. CONVERTER

Designed to provide a steady = 5 vdc @ 240 ma. from a battery supply of 3.5 to 6.25 volts.

2 1/16" x 1 1/16" x 1 1/16" \$1.50 each

## MICRO-CASSETTE MECHANISM

Micro-cassette tape transport for standard MC60 or MC45 micro-cassettes. 3 Vdc operation. Contains: drive motor, belt, head, capstan, pinch wheel and other components. 3 1/2" X 2 1/4" X 5/8"

CAT# MCMEC \$3.00 each 10 for \$27.50

## COMPUTER GRADE CAPACITORS

- 2,000 mfd. 200 Vdc 1 3/4" x 5" high \$2.00
- 6,400 mfd. 60 Vdc 1 3/8" x 3 3/4" high \$2.50
- 9,700 mfd. 50 Vdc 1 3/8" x 4 1/2" high \$3.00
- 31,000 mfd. 15 Vdc 1 3/4" x 4" high \$2.50
- 50,000 mfd. 40 Vdc 3" x 5 3/4" high \$4.50
- 66,000 mfd. 15 Vdc 3" X 3 3/4" high \$3.00
- 60,000 mfd. 40 Vdc 3" x 5" high \$3.50
- 66,000 mfd. 15 Vdc 3" x 3 3/4" high \$3.00
- 86,000 mfd. 30 Vdc 3" x 5 1/4" high \$3.50
- 5,500 mfd. 30 Vdc 1 3/8" x 3 1/2" high \$1.00
- 5,900 mfd. 30 Vdc 1 3/8" x 2 1/4" high \$1.00
- 9,300 mfd. 50 Vdc 2" x 4 1/2" high \$1.00
- 18,000 mfd. 10 Vdc 1 3/8" x 2 5/8" high \$1.00
- 48,000 mfd. 10 Vdc 2 1/2" x 3 1/4" high \$1.00
- 100,000 mfd. 10 Vdc 2 1/2" x 6" high \$1.00
- 185,000 mfd. 6 Vdc 2 1/2" x 4 1/2" high \$1.00

## SLIM LINE COOLING FAN

Etri # 99XM182 low noise fan. Measures 3 3/4" square x 1" deep. 21 cfm, 23 db, 1700 rpm.

SPECIAL PRICE .. \$12.50 each

## 2K 10 TURN MULTI-TURN POT

SPECTROL # MOD 534-7161 \$5.00 EACH

## SOLID STATE BUZZER

Star # SMB-06L 6 vdc TTL compatible. \$1.00 each 10 for \$9.00

## ± 12 Vdc or 24Vdc POWER SUPPLY

DELTRON MODEL QD12/15-1.7 Dual plus and minus 12Vdc open frame power supply. Can be used as 24Vdc @ 1.5 amp. INPUT: either 115 Vac or 230 Vac. Fully regulated computer grade supply. 7" x 4 3/4" x 2 1/4"

\$12.50 each 10 for \$110.00

## 220 Vac COOLING FAN

ROTRON # MX77A3 Muffin XL 220 Vac 4 1/8" square metal frame fan.

CAT# CF-220 \$6.50 ea 10 for \$60.00 / 100 for \$500.00 QUANTITIES AVAILABLE

## LINE CORDS

### TWO WIRE

- 6' 18/2 SPT-1 flat 3 for \$1.00
- 6' 18/2 SPT-2 flat 2 for \$1.00
- 6' 16/2 SJT round \$1.25 each

### THREE WIRE

- 6' 18/3 flat \$1.50 each
- 8' 18/3 round \$2.00 each

## 3 1/2" SPEAKER

8 ohm impedance. Full range speaker. 8 oz magnet 4" diagonal mounting centers.

\$2.50 each 10 for \$20.00

## 7 CONDUCTOR RIBBON CABLE

Spectra-strip red marker strip, 28 ga. stranded wire. \$5.00 per 100' roll

## SPRING LEVER TERMINALS

Two color coded terminals on a sturdy 2 1/4" x 3 3/4" bakelite plate. Great for speaker enclosures or power supplies.

75¢ EACH 10 for \$6.00

## XENON FLASH TUBE

3/4" long X 1/8" dia. Flash tube designed for use in compact camera flash units. Ideal for experimenters.

CAT# FLT-1 2 for \$1.00

## MINIATURE TOGGLE SWITCHES

ALL ARE RATED 5 AMPS @ 125 VAC

- S.P.D.T. (on-on) PC style non-threaded bushing. 75¢ each 10 for \$7.00
- S.P.D.T. (on-on) Solder lug terminals. \$1.00 each 10 for \$9.00
- S.P.D.T. (on-off-on) Solder lug terminals. \$1.00 each 10 for \$9.00
- S.P.D.T. (on-off-on) PC style non-threaded bushing. 75¢ each 10 for \$7.00
- S.P.D.T. (on-on) PC lugs threaded bushing. \$1.00 each 10 for \$9.00
- D.P.D.T. (on-on) Solder lug terminals. \$2.00 each 10 for \$19.00
- D.P.D.T. (on-on) Solder lug terminals. \$2.00 each 10 for \$18.00

## STANDARD JUMBO DIFFUSED T 1-3/4

- RED 10 for \$1.50 100 for \$13.00
- GREEN 10 for \$2.00 100 for \$17.00
- YELLOW 10 for \$2.00 100 for \$17.00

## D.P.S.T. LIGHTED ROCKER SWITCH

115 vac lighted rocker. snap mounts in 1 1/2" x 1 1/2" hole. Orange lens. 16 amp contact.

\$1.50

## FLASHER LED

5 volt operation red jumbo T 1 3/4 size \$1.00 each

NEW GREEN FLASHER CAT# LED-4G \$1.00

## MINI-PUSH BUTTON

S.P.S.T. momentary normally open 1/4" bushing. Red button. 35¢ each 10 for \$3.00

## BI-POLAR LED HOLDERS

Two piece holder for jumbo LED 10 for 85¢ 100 for \$5.00

CLEAR CLIPLITE LED HOLDER Make LED a fancy indicator. Clear. 4 for \$1.00

## SNAP ACTION SWITCH

Cherry elect. #E-21. N.O. or N.C. 0.1A contacts. Suitable for alarms and other low energy circuits. 1 1/2" lever.

45¢ EACH 10 FOR \$4.20

## RECHARGEABLE NI-CAD BATTERIES

- AAA SIZE 1.25V 500MAH \$1.85
- AA SIZE 1.25V 500MAH \$1.85
- AA with solder tab \$2.00
- C SIZE 1.2V 1200MAH \$3.50
- D SIZE 1.2V 1200MAH \$3.50

## UNIVERSAL CHARGER

Will charge 4-AA, C, D, or AAA ni-cads or one 9 volt ni-cad at one time... \$11.00 per charger

MAIL ORDERS TO: PO BOX 20406 Los Angeles, CA 90006

TWX - 510101063 ALL ELECTRONIC EASYLINK MBX - 62887748



TOLL FREE ORDERS ONLY 1-800-826-5432 (ORDER ONLY) (IN CALIFORNIA 1-800-258-6666) ALASKA, HAWAII, OR INFORMATION (213) 380-8000 NO C.O.D.!

QUANTITIES LIMITED MINIMUM ORDER \$10.00 USA \$3.00 SHIPPING FOREIGN ORDERS INCLUDING SUFFICIENT SHIPPING CALIF RES. ADD 6 1/2 %

OMRON #C-563-C41 Clockwise action micro used in coin operated mechanisms and low torque operations. RATED: 5 amps @ 125 Vac. \$1.25 each 10 for \$11.00 LARGE QUANTITIES AVAILABLE

ALL ELECTRONICS CORP. LOS ANGELES, CA STORE 905 S Vermont Ave 213 380-8000 VAN NUYS, CA STORE 6228 Sepulveda Blvd. 818 997-1806

CIRCLE 107 ON FREE INFORMATION CARD

MAY 1986

THE BEST PLACE to BUY, SELL or TRADE NEW and USED EQUIPMENT  
**NUTS & VOLTS MAGAZINE**  
 BOX 1111-E • PLACENTIA, CA 92670  
 (714) 632-7721  
 Join Thousands of Readers Nationwide  
 Every Month  
**ONE YEAR U.S. SUBSCRIPTIONS**  
 \$10.00 - 3rd Class • \$15.00 - 1st Class  
 \$35.00 - Lifetime - 3rd Class

**NUTS & VOLTS**

HIGH GEAR COMPUTERS SOFTWARE SCANNERS • OPTICS TEST EQUIPMENT MICROWAVE SATELLITE AUDIO VISUAL NEW PRODUCTS COMPONENTS • KITS ANTIQUE ELECT. PUBLICATIONS PLANS • SERVICES

**BUILD** this five digit panel meter and square wave generator including an ohms, capacitance and frequency meter. Detailed instructions \$2.50 refundable plus 50 cents. **BAGNALL ELECTRONICS**, 179 May, Fairfield, CT 06430.

**CIRCUIT BOARDS** guaranteed lowest quotes. Single and Double Sided Boards. Prototypes through large production quantities. Mail specifications for quotes. **HOBBYISTS**: Print your own circuit board. Kits of all sizes, low prices. Basic Kit. \$3.00, materials for two 3"x4" boards (included), or SASE for catalog **T.O.R.C.C.C. ELECTRONICS**, Box 47148, Chicago, IL 60647, (312) 342-9171.

**LOW** cost modern, easy to build, 300 baud direct connect, simple interface. \$5. for plans. **OMNISTAR DESIGNS**, Box 398, Columbus, NE 68601.

**METAL** detector, sensitive, easy to build. Plans \$5.00. **POWELL**, 1162 June Drive, Xenia, OH 45385.

**FREE** electronic tool kit, with membership in Electronic Project Club. Info and catalog \$2.00. **AEWS**, PO Box 746, Delvalle, TX 78617.

**KEYPAD** Control: Centralized digital control of all automobile electrical functions. Detailed schematics/instructions. \$5.00. **BAYSIDE ELECTRONICS** Box 71, Patuxent River, MD 20670.

**CABLE-TV**

**DEALERS** wanted: Channel 2,3, and 4 notch filters. Money back guarantee. Send \$15.00 for sample and quantity price list. Specify channel(s). **GARY KURTZ**, Box 291394, Davie, FL 33329.

**WORLDS BEST CHANNEL 3 NOTCH FILTER.** \$39.95. (DEALER INQUIRES INVITED). **CROSLEY(A)**, Box 840, Champlain, NY 12919.

**SB3 DESCRAMBLER PARTS** to construct project in Feb/84 Radio Electronics. \$49.95 (Dealer inquires invited). **CROSLEY**, Box 840, Champlain, NY 12919.

**NEW JERROLD STARCOM-CS 60** channel, wireless, remote control cable converter. Volume and "commercial killer" mute control. Programmable time switch turns TV on/off and can change channel. Programmable favorite channel scan. Instant channel recall. Automatic fine tuning with manual override. Video and audio outputs. Works with all descramblers. 1 year warranty. \$169. Dealers wanted. **CROSLEY**, Box 840, Champlain, NY 12919 (518) 561-8700.

**VIDEO SPECIAL EFFECT PLANS**



Actual B/W photo of Color Effect

Exciting **COLOR** Special Effect used in Music Videos - works with any video camera or VCR - inexpensive to build, easy to use - Send check or money order for \$98 plus \$199 shipping and handling for complete package including schematic, PCB artwork, theory & instructions (Ohio Res. add 1.65 sales tax) or send S.A.S.E. for Free Brochure to:

**VIDEO EFFECTS**  
 8969 BRECKSVILLE ROAD  
 CLEVELAND, OHIO 44131

**SPEAKER REPAIR**

**SPEAKER** reconing-radio, hi-fi, musical instrument. All work guaranteed. **SSI**, 1925 Chartwell, Ft. Wayne, IN 46816. (219) 42-MUSIC.

**ELECTRONIC COMPONENTS**

**ELECTRONIC COMPONENTS**—Resistors, any value/quantity (Minimum 20/value), 1/4 watt \$.01 1/2 watt \$.02 - \$1.25 shipping. Quantity discounts, 1,000-. Send wattage(s), value(s) Quantity(s) and remittance. Capacitors - 50V Ceramic Disk, all values \$.10@, minimum order \$1.00 - \$1.25 shipping. **T.O.R.C.C.C. ELECTRONICS**, Box 47148, Chicago, IL 60647. (312) 342-9171.

**WANTED**

**INVENTORS!** AIM wants—ideas, inventions, new products, improvements on existing products. We present ideas to manufacturers. Confidentiality guaranteed. Call toll free 1-800-225-5800 for information kit.

**INVENTIONS.** ideas, new products wanted! Industry presentation/national exposition. Call free 1-800-528-6050. Canada, 1-800-528-6060. X831.

**U.S. Savings Bonds**  
 Now Paying  
**8.36%**

U.S. Savings Bonds now pay market-based interest rates—like the money markets. Plus, you get a guaranteed return!

For more information, call toll-free 1-800-US-BONDS.

**U.S. SAVINGS BONDS**  
 Paying Better Than Ever

Market-based interest rates apply to Bonds purchased on and after 11/1/82 and held at least five years. Bonds purchased before 11/1/82 earn market-based rates when held beyond 10/31/87. Bonds held less than five years earn lower rates.

**THE NEW 65/9028 VT ANSI VIDEO TERMINAL BOARD!**

\* FROM LINGER ENTERPRISES \*

A second generation, low cost, high performance, mini sized, single board for making your own RS232 Video Terminal. Use as a computer console or with a MODEM for hook up to any of the telephone-line computer services.

**FEATURES:**

- \* Uses the new SMC 9028 Video Controller Chip coupled with a 6502A CPU.
- \* RS-232 at 16 Baud Rates from 50 to 19,200
- \* On board printer port!
- \* 24 X 80 format (50/60 Hz).
- \* For 15,750 Hz (Horiz.) monitors.
- \* 3 Terminal Modes: H-19, ADM3A, and ANSI X 3.64-1979
- \* Wide and thin-line graphics.
- \* White characters on black background or reversed.
- \* Character Attributes: De-Inten, Inverse or Underline.
- \* Low Power: 5VDC @ .7A, ± 12VDC @ 20MA.
- \* Mini size: 6.5 X 5 inches.
- \* Composite or split video.
- \* 5 X 8 Dot Matrix characters (U/L case).
- \* Answer back capability.
- \* Battery backed up status memory.
- \* For ASCII parallel keyboard.

**MICRO SIZE!**

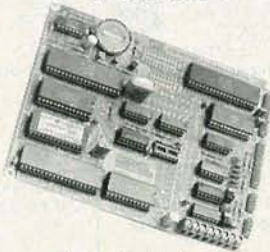

**\$99.95**  
 (Full Kit)

**SOURCE DISKETTE:**  
 PC/XT FORMAT  
 5 1/4 IN. \$15

**ADD \$40 FOR A&T**

**Digital Research Computers**

(OF TEXAS)

P.O. BOX 381450 • DUNCANVILLE TX 75138 • (214) 225-2309

Call or write for a free catalog on Z-80 or 6809 Single Board Computers, SS-50 Boards, and other S-100 products.

**TERMS:** Add \$3.00 postage. We pay balance. Orders under \$15 add 75¢ handling. No C.O.D. We accept Visa and MasterCard. Texas Res. add 5-1/8% Tax. Foreign orders (except Canada) add 20% P & H. Orders over \$50 add 85¢ for insurance.

**This publication is available in microform.**



**University Microfilms**

International reproduces this publication in microform: microfiche and 16mm or 35mm film. For information about this publication or any of the more than 13,000 titles

we offer, complete and mail the coupon to: University Microfilms International, 300 N. Zeeb Road, Ann Arbor, MI 48106. Call us toll-free for an immediate response: 800-521-3044. Or call collect in Michigan, Alaska and Hawaii: 313-761-4700.

Please send information about these titles:

Name \_\_\_\_\_  
 Company/Institution \_\_\_\_\_  
 Address \_\_\_\_\_  
 City \_\_\_\_\_  
 State \_\_\_\_\_ Zip \_\_\_\_\_  
 Phone ( ) \_\_\_\_\_

**University Microfilms International**



# cable tv

## DESCRAMBLER PARTS!

We stock the exact parts, PC board and AC adaptor for Radio Electronics February 1984 article on building your own **Cable TV Descrambler**.

- #701 **PARTS PACKAGE**.....\$29.95  
Includes all the original resistors, capacitors, diodes, transistors, integrated circuits, coils, IF transformers (toko BKAN-K5552AXX).
- #702 **PC BOARD**.....\$12.95  
Original etched & drilled silk-screened PC board used in the article.
- #704 **AC ADAPTOR**.....\$12.95  
Original (14 volts DC @ 285ma) ac adaptor used in the article.

### S □ P □ E □ C □ I □ A □ L □ S

- BOTH #701 & #702..... NOW \$39
- ALL THREE #701, #702 & #704 ..... NOW \$49

Add \$2.50 shipping and handling — \$4.50 for Canadian orders  
We also offer quantity Discounts on 5 or more units

**FREE** Reprint of Radio Electronics article (February 1984) on Building Your Own **CABLE TV DESCRAMBLER** with any purchase of above.

**60-CHANNEL  
CABLE  
CONVERTER**  
WITH INFRARED REMOTE CONTROL



SC-60R CONVERTER.....\$69.95

Thousands of these converters sold nationally for \$119.95  
We offer you this same type of converter for only \$69.95  
All converters are NEW, with Full manufacturer's WARRANTY.

FEATURES:

- Full 60 Channel Capability
- Cordless Infrared remote control
- Ultra-Stable Synthesized tuning
- Microprocessor controlled PLL
- Works on all TV models, channel 3 output
- Standard/HRC Switch for compatibility with all Cable Systems
- Will work with all types of external descramblers

Add \$3.50 Shipping and Handling  
\$4.50 on Canadian Orders

**ORDER  
TOLL FREE  
1-800-227-8529**



inside MA 617-339-5372  
VISA, MASTERCARD or C.O.D.



**J & W  
ELECTRONICS, INC.**

P.O. BOX 800R • MANSFIELD, MA 02048

## TELETEXT DECODER

continued from page 70

Once the page appears correctly, alternate between TV and teletext modes several times, making certain that the page comes up properly each time.

If you have trouble getting a clear image and you have a static-and snow-free TV image, adjust the module's oscillator so that it will lock onto the incoming data. This is done by adjusting the trimmer capacitor near the crystal on the module. The module coil and that trimmer may have to be adjusted in concert to get a clear teletext image; go slowly, and allow the page time to clear between adjustments.

When you have a stable teletext image, adjust the trimmer capacitor C38 on the PC board until the color appears in the teletext page. Don't worry about color values; adjust for clear, even colors across the display. Then adjust the chroma balance control R52, near IC4 (MC1377), until the colors are acceptable. Again, some cross adjustment of C38 and R52 may be necessary to obtain the best color.

### Using the decoder

Using the DSE Teletext is as easy as turning it on—even a child can use it without more than brief instruction. How you

connect it into your video system depends on whether you want to be able to bypass the decoder; if it cannot be bypassed, it will have to be on whenever you watch TV.

The decoder can be used in three modes: teletext, mix, and newflash. If you simply want to scan through the pages of a teletext service, press **TT** to enter teletext mode and select the page you want to see by simply entering its number. If you want to view the pages and monitor the TV image at the same time (during a commercial, for example, or while check-

ing sports scores in the middle of a game), press **MIX** and the text will appear in white over the TV image. Finally, if you just want to watch TV, but want to be alert for news, you can set the decoder to a teletext service's newflash page in mix mode.

The newflash page is normally held blank, so that the TV image will remain undisturbed in the mix mode. If a news story breaks, the service inserts one or two lines of text at the bottom of the page, usually a brief headline and the page to see for details.

When the decoder is switched from TV to teletext mode, it will always come up on page 100, which has been chosen as the universal index page for World System Teletext. From that page you can go to any other, be it an index or a feature page, simply by entering that page number. When the page comes around in the loop, the decoder will store it in RAM and display it on the screen.

If you want to go to another magazine broadcast within the same VBI, simply enter a page that is within that magazine's loop. On WTBS and SPN, *Electra's* title page will always come up on page 100, and any page between 100 and 199 is within *Electra's* loop. If you want *Cabletext*, enter any page number between 201 and 212, and the decoder will enter *Cabletext's* loop and present the selected page from that magazine.

When you select a new page, the previous page remains in RAM and on the screen until the new one appears—there is no blank screen time. The wait for a new page can be 15 to 20 seconds, but is about 4 seconds on the average. If you don't want to wait, or if you want to check the TV image without disturbing the teletext's operation, press **CANCEL**. That will return the display to regular TV, without interrupting the decoder's operation. At your convenience, you can return to teletext or mix mode, right where you left off. All of the remaining decoder commands are summarized in Table 1.

Now, get started and enjoy your decoder!

TABLE 1—REMOTE CONTROL FUNCTIONS

Key	Function
0-9	Enters desired page number
TT	Switches decoder to teletext mode
TV	Switches decoder to regular TV display mode and clears teletext settings
MIX	Superimposes teletext display over regular TV image
CANCEL	Returns display to regular TV image without interrupting teletext operation
TOP	Expands top 12 lines of teletext display to fill screen
BOT	Expands bottom 12 lines of teletext display to fill screen
FULL REVEAL	Restores teletext display to full 24 lines
HOLD	Causes hidden portion of display to appear
	Causes page in RAM to be held despite changes in broadcast signal.
TIME ON/TIME OFF	For timed-page and rolling-page systems only.

## FLOURESCENT DISPLAY 40 CHARACTER PROGRAMMABLE



This VACUUM FLOURESCENT DISPLAY is completely self contained. The unit consists of a power supply, and all the electronics necessary to provide unidirectional operation utilizing the standard 7 bit ASCII code. All inputs are TTL compatible. The ASCII coded English font employs a 96 character set. Useful wherever alpha-numeric information must be continuously displayed. Comes with required 26 pin connector and 2 ft. of ribbon cable. Also included are 14 pages of data. All you need is a 5VDC supply and the ASCII code input. Displays were removed from unused, new equipment.

STOCK No. 50437 \$ 39.95 each + \$4.00 S/H

## GE TRANSFORMER

Primary 120/240  
Secondary 12/24  
Power .25 KVA  
Completely Enclosed  
Dry Type, UL Listed  
Model # 9T51B107  
STOCK No. 90124



\$ 39.50 each + \$7.00 S/H

MASTER CARD & VISA WELCOME

DELTA SURPLUS ELECTRONICS  
7 Oakland St., Amesbury MA. 01913  
Tel. AC 617 388-4705

CIRCLE 270 ON FREE INFORMATION CARD

## AMAZING DEVICES

PERSONAL DEFENSE AND PROPERTY PROTECTION  
UTILIZE SPACE AGE TECHNOLOGY.  
CAUTION THESE DEVICES CAN BE HAZARDOUS AND MAY SOON  
BE ILLEGAL.

**POCKET PAIN FIELD GENERATOR — IPG50**

Assembled.....\$64.50  
IPG5.....Plans.....\$8.00 IPG5K.....Kit/Plans.....\$44.50

**PHASOR PAIN FIELD CROWD CONTROLLER — PPF10**

Assembled.....\$250.00  
PPF1.....Plans.....\$15.00 PPF1K.....Kit/Plans.....\$175.00

**BLASTER** - Provides a plasma discharge capable of puncturing a can. Produces a 100,000 WATT PULSE.

BLS10.....ASSEMBLED.....\$89.50

BLS1.....PLANS.....\$10.00 BLS1K.....KIT/PLANS.....\$69.50

**PLASMA STUN GUN** - Very intimidating and affective 5 to 10 feet 100,000 VOLTS

ITM10.....ASSEMBLED.....\$99.50

ITM1.....PLANS.....\$10.00 ITM1K.....KIT/PLANS.....\$69.50

**RUBY LASER RAY GUN** — Intense visible red beam burns and welds hardest of metals. **MAY BE HAZARDOUS.**

**RUB3 All Parts Available for Completing Device** \$20.00

**CARBON DIOXIDE BURNING, CUTTING LASER** — Produces a continuous beam of high energy. **MAY BE HAZARDOUS.**

**LCS. All Parts Available for Completing Device.** \$20.00

**VISIBLE LASER LIGHT GUN** — produces intense red beam for sighting, spotting, etc. Hand held complete.

LGU3.....Plans.....\$10.00 (Kit & Assembled Units Available)

**IR PULSED LASER RIFLE** — Produces 15-30 watt infra-red pulses at 200-2000 per sec.

LRG3.....All Parts & Diodes Available.....\$10.00

**BEGINNERS LOW POWER VISIBLE LASER** — Choice of red, yellow, green — provides an excellent source of monochromatic light.

LHC2.....Plans.....\$5.00 LHC2K.....Kit.....\$34.50

**SNOOPER PHONE** — Allows user to call his premises and listen in without phone ever ringing.

SNP20.....Assembled.....\$89.50

SNP2.....Plans.....\$9.00 SNP2K.....Plans/Kit.....\$59.50

**LONG RANGE WIRELESS MIKE** — Miniature device clearly transmits well over one mile. Super sensitive, powerful.

MFT1.....Plans.....\$7.00 MFT1K.....Plans/Kit.....\$49.50

**WIRELESS TELEPHONE TRANSMITTER** — Transmits both sides of phone conversation over one mile, shuts off automatically.

VWPM5.....Plans.....\$8.00 VWPM5K.....Plans/Kit.....\$39.50

**PWM5—LONG RANGE SUPER EAR WITH WIRELESS ATTACHMENT**

PWM5.....Plans.....\$10.00 PWM5K.....Kit.....\$139.50

PWM50.....Assembled and Tested.....\$169.50

Our phone is open for orders anytime. Technicians are available 9-11 a.m., Mon-Thurs for those needing assistance or information. Send \$1.00 for catalog of hundreds more similar devices. Send check, cash, MO, Visa, MC, COD to: **INFORMATION UNLIMITED**

DEPT R8, P.O. Box 716, Amherst, N. H. 03031 Tel: 603-673-4730

CIRCLE 72 ON FREE INFORMATION CARD

OPEN SATURDAYS 8 A.M. TO 1 P.M. WITH 24 HOUR ANSWERING TO TAKE YOUR ORDER ANYTIME

# WM. B. ALLEN SUPPLY COMPANY

## TEST EQUIPMENT SPECIALS

COMPLETE INVENTORY OF MULTIMETERS  
AND SCOPES FROM 18 MANUFACTURERS

**NEW**

### 50 SERIES THERMOMETERS



51 DIGITAL ..... \$108  
52 DIGITAL ..... \$ 171

Includes Battery & Bead Probe.  
Other Probes & Accessories Available



### 8020B SERIES 3½ DIGIT DMM



5 Functions • 24 Ranges • UL Listed

8021B ... \$137 Audible Cont.  
8020B ... \$172 Conductance  
8026B ... \$172 True RMS  
8024B ... \$215 11 Functions

### 20 SERIES Analog/Digital

FLUKE 25 ... \$198

0.1% Basic DC Accuracy • 100 uV-1000V AC & DC 0.1 uA-10A, All Fused • -15°C-55°C



FLUKE 27 ... \$223

Same Features as 25 Plus MIN/MAX Recording Mode • Relative (difference) Mode



FLUKE 21 ..... \$86

### 70 SERIES Analog/Digital

FLUKE 73 ..... \$68

3200-Count Digital Display • Sleep Mode • 18 Ranges • 0.7% DC Accuracy • Diode Test • Current 10A, AC or DC • Resist 320 ohm to 32 M ohm

FLUKE 75 ..... \$86

All features of 73 Plus 0.5% Accuracy • Autorange • 300 MA Range • Continuity & Diode Test Beeper

FLUKE 77 ..... \$120

All features of 73 and 75 plus 0.3% Accuracy • Touch Hold • Holster Included

### 8060A SERIES 4½ Digit

8060A ..... \$301

4½ Digit • 0.04% Accuracy DC • 0.02% AC • dBm or relative dB measure • 200 KHz Freq. Counter



8062A ..... \$254

4½ Digit 0.05% Accuracy DC • True-rms AC to 30 kHz • Resist to 300 M ohm.

### TEMPERATURE MODULE & PROBES



80TK Module ..... \$51

80TK Immersion Probe ..... \$33

80PK3 Surface Probe ..... \$68

**WM. B. ALLEN  
ELECTRONICS  
CATALOG  
FREE  
WITH EVERY  
PURCHASE**



\$15.00  
VALUE

### BENCH DMM 4½ Digit



8050A ..... \$335

8050A-01 ..... \$378



**800 535-9593**  
LOUISIANA TOLL FREE 800 462-9520

**WM. B. ALLEN  
SUPPLY COMPANY**  
ALLEN SQUARE

300 BLOCK NORTH RAMPART, NEW ORLEANS, LA 70112

CIRCLE 103 ON FREE INFORMATION CARD

MAY 1986

# BUILD A COMPLETE XT SYSTEM—\$698

## STATIC RAMS

2101	256x4 (450ns)	1.95
5101	256x4 (450ns)(CMOS)	3.95
2102L-4	1024x1 (450ns)(LP)	.99
2102L-2	1024x1 (250ns)(LP)	1.45
2112	256x4 (450ns)	2.99
2114	1024x4 (450ns)	.99
2114L-4	1024x4 (450ns)(LP)	1.09
2114L-2	1024x4 (200ns)(LP)	1.49
2114L-15	1024x4 (150ns)(LP)	1.95
TMS4044-4	4096x1 (450ns)	1.95
TMM2016-150	2048x8 (150ns)	1.49
TMM2016-100	2048x8 (100ns)	1.95
HM6116-4	2048x8 (200ns)(CMOS)	1.39
HM6116-3	2048x8 (150ns)(CMOS)	1.49
HM6116LP-4	2048x8 (200ns)(CMOS)(LP)	1.49
HM6116LP-3	2048x8 (150ns)(CMOS)(LP)	1.59
HM6116LP-2	2048x8 (120ns)(CMOS)(LP)	2.95
HM6264P-15	8192x8 (150ns)(CMOS)	3.89
HM6264LP-15	8192x8 (150ns)(CMOS)(LP)	3.95
HM6264LP-12	8192x8 (120ns)(CMOS)(LP)	4.49

LP—Low power

## DYNAMIC RAMS

4116-250	16384x1 (250ns)	.49
4116-200	16384x1 (200ns)	.69
4116-150	16384x1 (150ns)	.89
4116-120	16384x1 (120ns)	1.49
MK4332	32768x1 (200ns)	6.95
4164-200	65536x1 (200ns)(5V)	1.19
4164-150	65536x1 (150ns)(5V)	1.29
4164-120	65536x1 (120ns)(5V)	1.95
MCM6665	65536x1 (200ns)(5V)	1.95
TMS4164	65536x1 (150ns)(5V)	1.95
4164-REFRESH	65536x1 (150ns)(5V)(REFRESH)	2.95
TMS4416	16384x4 (150ns)(5V)	4.95
41128-150	131072x1 (150ns)(5V)	5.95
41256-200	262144x1 (200ns)(5V)	2.95
41256-150	262144x1 (150ns)(5V)	2.95

5V—Single 5 Volt Supply REFRESH—Pin 1 Refresh

## ★★★★HIGH-TECH★★★★

### NEC V20 UPD70108 \$14.95

REPLACES 8088 TO SPEED UP IBM PC 10-40%

\* HIGH-SPEED ADDRESS CALCULATION IN HARDWARE

\* PIN COMPATIBLE WITH 8088

\* SUPERSET OF 8086/8088 INSTRUCTION SET

\* LOW POWER CMOS

8 MHZ V20 UPD70108-8 \$24.95

8 MHZ V30 UPD70116-8 \$26.95

## ★★★★SPOTLIGHT★★★★

ORDER TOLL FREE  
800-538-5000  
800-662-6279 (CA)



## EPROMS

2708	1024x8 (450ns)	3.95
2716-6	2048x8 (650ns)	2.29
2716	2048x8 (450ns)(5V)	2.25
2716-1	2048x8 (350ns)(5V)	2.79
TMS2532	4096x8 (450ns)(5V)	3.95
2732	4096x8 (450ns)(5V)	2.45
2732A	250ns(5V)(21V PGM)	2.75
2732A-2	4096x8 (200ns)(5V)(21V PGM)	3.95
27C64	8192x8 (250ns)(5V)(CMOS)	5.95
2764	8192x8 (450ns)(5V)	2.45
2764-250	8192x8 (250ns)(5V)	2.85
2764-200	8192x8 (200ns)(5V)	3.49
TMS2564	8192x8 (450ns)(5V)	8.95
MCM68766	8192x8 (350ns)(5V)(24 PIN)	17.95
27128	16384x8 (250ns)(5V)	2.79
27C256	32768x8 (250ns)(5V)(CMOS)	12.95
27256	32768x8 (250ns)(5V)	7.49

5V—Single 5 Volt Supply

21V PGM—Program at 21 Volts

## SPECTRONICS CORPORATION EPROM ERASERS



Model	Timer	Capacity Chip	Intensity (uW/Cm <sup>2</sup> )	Unit Price
PE-14	NO	9	8,000	\$83.00
PE-14T	YES	9	8,000	\$119.00
PE-24T	YES	12	9,600	\$175.00

## 8000

8035	1.49
8039	1.95
8080	2.95
8085	2.49
8087-2	139.95
8087	109.00
8088	6.95
8088-2	9.95
8155	2.49
8155-2	3.95
8748	7.95
8755	19.95
80286	129.95
80287	185.00

## 6500

### 1.0 MHZ

6502	2.79
65C02 (CMOS)	12.95
6507	9.95
6520	1.95
6522	4.95
6526	26.95
6532	6.95
6545	6.95
6551	5.95
6561	19.95
6581	34.95

### 2.0 MHZ

6502A	2.95
6520A	2.95
6522A	5.95
6532A	11.95
6545A	7.95
6551A	6.95

### 3.0 MHZ

6502B	6.95
-------	------

## 8200

8203	29.95
8205	3.29
8212	1.49
8216	1.49
8224	2.25
8237	4.95
8237-5	5.49
8250	6.95
8251	1.69
8251A	1.89
8253	1.89
8253-5	1.95
8255	1.69
8255-5	1.89
8259	1.95
8259-5	2.29
8272	4.95
8279	2.49
8279-5	3.95
8282	3.95
8284	2.95
8286	3.95
8288	4.95

## Z-80

Z80-CPU 2.5 MHZ 1.69
4.0 MHZ
Z80A-CPU 1.79
Z80A-CTC 1.89
Z80A-DART 5.95
Z80A-DMA 5.95
Z80A-PIO 1.89
Z80A-SIO/0 5.95
Z80A-SIO/1 5.95
Z80A-SIO/2 5.95

## 6800

### 1.0 MHZ

6800	1.95
6802	4.95
6803	9.95
6809	5.95
6809E	5.95
6810	1.95
6820	2.95
6821	1.95
6840	6.95
6843	19.95
6844	12.95
6845	4.95
6847	11.95
6850	1.95
6883	22.95

### 2.0 MHZ

68B00	4.95
68B02	5.95
68B09E	6.95
68B09	6.45
68B21	3.50
68B45	6.75
68B50	3.95
68B54	7.95

## CLOCK CIRCUITS

MM5369	1.95
MM5369-EST	1.95
MM58167	12.95
MM58174	11.95
MSM5832	2.95

## CRT CONTROLLERS

6845	4.95
68B45	8.95
6847	11.95
HD46505SP	6.95
MC1372	2.95
8275	26.95
7220	19.95
CRT5027	12.95
CRT5037	9.95
TMS9918A	19.95

## DISK CONTROLLERS

1771	4.95
1791	3.95
1793	9.95
1795	12.95
1797	12.95
2791	19.95
2793	19.95
2797	29.95
6843	19.95
8272	4.95
UPD765	4.95
MB8876	12.95
MB8877	12.95
1691	6.95
2143	6.95

## BIT RATE GENERATORS

MC14411	9.95
BR1941	4.95
4702	9.95
COM8116	8.95
MM5307	4.95

## UARTS

AY5-1013	3.95
AY3-1015	4.95
TR1602	3.95
2651	4.95
IM6402	6.95
IM6403	9.95
INS8250	6.95

## SOUND CHIPS

76477	3.95
76489	8.95
SSI-263	39.95
AY3-8910	12.95
AY3-8912	12.95
SP1000	39.00

## CRYSTALS

32.768 KHz	.95
1.0 MHZ	2.95
1.8432	2.95
2.0	1.95
2.097152	1.95
2.4576	1.95
3.2768	1.95
3.579545	1.95
4.0	1.95
4.032	1.95
5.0	1.95
5.0688	1.95
6.0	1.95
6.144	1.95
6.5536	1.95
8.0	1.95
10.0	1.95
10.738635	1.95
12.0	1.95
14.31818	1.95
15.0	1.95
16.0	1.95
17.430	1.95
18.0	1.95
18.432	1.95
20.0	1.95
22.1184	1.95
24.0	1.95
32.0	1.95

## CRYSTAL OSCILLATORS

1.0MHZ	5.95
1.8432	5.95
2.0	5.95
2.4576	5.95
2.5	4.95
4.0	4.95
5.0688	4.95
6.0	4.95
6.144	4.95
8.0	4.95
10.0	4.95
12.0	4.95
12.480	4.95
15.0	4.95
16.0	4.95
18.432	4.95
20.0	4.95
24.0	4.95

## MISC.

TMS99531	9.95
TMS99532	19.95
ULN2003	.79
3242	7.95
3341	4.95
MC3470	1.95
MC3480	8.95
MC3487	2.95
11C90	13.95
2513-001 UP	6.95
AY5-2376	11.95
AY5-3600 PRO	11.95

## 74LS00

74LS00	.16
74LS01	.17
74LS02	.17
74LS03	.18
74LS04	.16
74LS05	.18
74LS08	.18
74LS09	.18
74LS10	.16
74LS11	.22
74LS12	.22
74LS13	.18
74LS14	.39
74LS15	.26
74LS20	.17
74LS21	.22
74LS22	.22
74LS27	.23
74LS28	.26
74LS30	.17
74LS32	.18
74LS33	.28
74LS37	.26
74LS38	.26
74LS42	.39
74LS47	.39
74LS48	.69
74LS51	.17
74LS53	.29
74LS74	.24
74LS75	.29
74LS76	.29
74LS83	.49
74LS84	.49
74LS86	.22
74LS90	.39
74LS92	.49
74LS93	.39
74LS95	.49
74LS107	.34
74LS109	.39
74LS112	.39
74LS122	.45
74LS123	.49
74LS124	2.75
74LS125	.39
74LS126	.39
74LS132	.39
74LS133	.69
74LS136	.39
74LS138	.39
74LS139	.39
74LS145	.99
74LS147	.99
74LS148	.99
74LS151	.39
74LS153	.39
74LS154	1.49
74LS155	.59
74LS156	.49
74LS157	.35
74LS158	.29
74LS160	.29
74LS161	.39
74LS162	.49
74LS163	.39
74LS164	.49

## 74LS165

74LS165	.65
74LS166	.95
74LS169	.95
74LS173	.49
74LS174	.39
74LS175	.39
74LS191	.49
74LS192	.69
74LS193	.69
74LS194	.69
74LS195	.69
74LS196	.59
74LS197	.59
74LS221	.59
74LS240	.69
74LS241	.69
74LS242	.69
74LS243	.69
74LS244	.69
74LS245	.79
74LS251	.49
74LS253	.49
74LS256	1.79
74LS257	.39
74LS258	.49
74LS259	1.29
74LS260	.49
74LS266	.39
74LS273	.79
74LS279	

# PARTIAL LISTING ONLY — CALL FOR A FREE CATALOG

CMOS		
4001	.19	14419 4.95
4011	.19	14433 14.95
4012	.25	4503 .49
4013	.35	4511 .69
4015	.29	4516 .79
4016	.29	4518 .85
4017	.49	4522 .79
4018	.69	4526 .79
4020	.59	4527 1.95
4021	.69	4528 .79
4024	.49	4529 2.95
4025	.25	4532 1.95
4027	.49	4538 .85
4028	.65	4541 1.29
4035	.69	4553 5.79
4040	.69	4585 .75
4041	.75	4702 12.95
4042	.59	74C00 .29
4043	.85	74C14 .59
4044	.69	74C74 .59
4045	1.95	74C83 1.95
4046	.69	74C85 1.49
4047	.69	74C95 .99
4049	.29	74C150 5.75
4050	.29	74C151 2.25
4051	.69	74C161 .99
4052	.69	74C163 .99
4053	.69	74C164 1.95
4056	2.19	74C192 1.49
4060	.69	74C193 1.49
4066	.29	74C221 1.75
4069	.19	74C240 1.89
4076	.59	74C244 1.89
4077	.29	74C374 1.99
4081	.22	74C905 10.95
4085	.79	74C911 8.95
4086	.89	74C917 8.95
4093	.49	74C922 4.49
4094	2.49	74C923 4.95
14411	9.95	74C926 7.95
14412	6.95	80C97 .95

7400/9000		
7400	.19	74147 2.49
7402	.19	74148 1.20
7404	.19	74150 1.35
7406	.29	74151 .55
7407	.29	74153 .55
7408	.24	74154 1.49
7410	.19	74155 .75
7411	.25	74157 .55
7414	.49	74159 1.65
7416	.25	74161 .69
7417	.25	74163 .69
7420	.19	74164 .85
7423	.29	74165 .85
7430	.19	74166 1.00
7432	.29	74175 .89
7438	.29	74177 .75
7442	.49	74178 1.15
7445	.69	74181 2.25
7447	.89	74182 .75
7470	.35	74184 2.00
7473	.34	74191 1.15
7474	.33	74192 .79
7475	.45	74194 .85
7476	.35	74196 .79
7483	.50	74197 .75
7485	.59	74199 1.35
7486	.35	74221 1.35
7489	2.15	74246 1.35
7490	.39	74247 1.25
7492	.50	74248 1.85
7493	.35	74249 1.95
7495	.55	74251 .75
7497	2.75	74265 1.35
74100	2.29	74273 1.95
74121	.29	74278 3.11
74123	.49	74367 .65
74125	.45	74368 .65
74141	.65	9368 3.95
74143	5.95	9602 1.50
74144	2.95	9637 2.95
74145	.60	96502 1.95

74S00		
74S00	.29	74S163 1.29
74S02	.29	74S168 3.95
74S03	.29	74S174 .79
74S04	.29	74S175 .79
74S05	.29	74S188 1.95
74S08	.35	74S189 1.95
74S10	.29	74S195 1.49
74S15	.35	74S196 1.49
74S30	.29	74S197 1.49
74S32	.35	74S226 3.99
74S37	.69	74S240 1.49
74S38	.69	74S241 1.49
74S40	.35	74S244 1.95
74S85	.95	74S257 .79
74S86	.35	74S253 .75
74S112	.50	74S258 .95
74S124	2.75	74S280 1.95
74S138	.79	74S287 1.69
74S140	.55	74S288 1.69
74S151	.79	74S299 2.95
74S153	.79	74S373 1.69
74S157	.79	74S374 1.69
74S158	.95	74S471 4.95
74S161	1.29	74S571 2.95

VOLTAGE REGULATORS		
TO-220 CASE		
7805K	.49	7905T .59
7808T	.49	7908T .59
7812T	.49	7912T .59
7815T	.49	7915T .59
TO-3 CASE		
7805K	1.39	7905K 1.49
7812K	1.39	7912K 1.49
TO-92 CASE		
78L05	.49	79L05 .69
78L12	.49	79L12 .69
OTHER VOLTAGE REGS		
LM323K	5V 3A	TO-3 4.79
LM338K	A4 5A	TO-3 3.95
78H05K	5V 5A	TO-3 7.95
78H12K	12V 5A	TO-3 8.95
78P05K	5V 10A	TO-3 14.95

LINEAR		
TL066	.99	LM733 .98
TL071	.69	LM741 .29
TL072	1.09	LM747 .69
TL074	1.95	LM748 .59
TL081	.59	MC1330 1.69
TL082	.39	MC1350 1.19
TL084	1.49	MC1372 6.95
LM301	.34	LM1414 1.59
LM309K	1.25	LM1458 .49
LM311	.59	LM1488 .49
LM311H	.89	LM1489 .49
LM317K	3.49	LM1496 .85
LM317T	.95	LM1812 8.25
LM318	1.49	LM1889 1.95
LM319	1.25	ULN2003 .79
LM320	see 7900	LM3200 3.75
LM322	1.65	XR2211 2.95
LM323K	4.79	XR2240 1.95
LM324	.49	MPQ2907 1.95
LM331	3.95	LM2917 1.95
LM334	1.19	CA3046 .89
LM335	1.40	CA3081 .99
LM336	1.75	CA3082 .99
LM337K	3.95	CA3086 .80
LM338K	3.95	CA3089 1.95
LM339	.59	CA310E .99
LM340	see 7800	CA3146 1.29
LM350T	4.60	CA3160 2.99
LF35	.59	MC3470 1.95
LF35E	.59	MC3480 8.95
LF357	.99	MC3487 2.95
LM358	.59	LM3900 .49
LM380	.89	LM3909 .98
LM383	1.95	LM3911 2.25
LM384	.29	LM3914 2.39
LM386	4.65	MC4024 3.99
LM393	4.60	MC4044 3.99
TL494	4.20	RC4136 1.25
TL497	3.25	RC4558 6.69
NE555	.29	LM13600 1.49
NE556	.49	75107 1.49
NE558	1.29	75110 1.95
NE564	.95	75120 1.95
LM565	.95	75154 1.95
LM566	1.49	75188 1.25
LM567	.79	75189 1.25
NE570	2.95	75451 .39
NE590	2.50	75452 .39
NE592	.98	75453 .39
LM720	.75	75477 1.99
LM723	.49	75492 .79
H-TO-5 CAN, K-TO-3, T-TO-220		

DATA ACQ INTERFACE		
ADC0800	15.55	8T26 1.29
ADC0804	3.49	8T28 1.29
ADC0809	4.49	8T95 .89
ADC0816	14.95	8T96 .89
ADC0817	9.95	8T97 .59
ADC0831	8.95	8T98 .89
DAC0800	4.49	DM8131 2.95
DAC0806	1.95	DP8304 2.29
DAC0808	2.95	DS8833 2.25
DAC1020	8.25	DS8835 1.99
DAC1022	5.95	DS8836 .99
MC1408L8	2.95	DS8837 1.65

IC SOCKETS		
8 PIN ST	1.99	100
14 PIN ST	.11	.10
16 PIN ST	.12	.10
18 PIN ST	.15	.13
20 PIN ST	.18	.15
22 PIN ST	.15	.12
24 PIN ST	.20	.15
28 PIN ST	.22	.16
40 PIN ST	.30	.22
64 PIN ST	1.95	1.49
ST-SOLDERTAIL		
8 PIN WW	.59	.49
14 PIN WW	.69	.52
16 PIN WW	.69	.58
18 PIN WW	.99	.90
20 PIN WW	1.09	.98
22 PIN WW	1.39	1.28
24 PIN WW	1.49	1.35
28 PIN WW	1.69	1.49
40 PIN WW	1.99	1.80
WW-WIREWRAP		
16 PIN ZIF	4.95	CALL
24 PIN ZIF	5.95	CALL
28 PIN ZIF	6.95	CALL
40 PIN ZIF	9.95	CALL
ZIF-TEXT TOOL (ZERO INSERTION FORCE)		

EDGE CARD CONNECTORS		
100 PIN ST	S-100	.125 3.95
100 PIN WW	S-100	.125 4.95
62 PIN ST	IBM PC	.100 1.95
50 PIN ST	APPLE	.100 2.95
44 PIN ST	STD	.156 1.95
44 PIN WW	STD	.156 4.95

36 PIN CENTRONICS		
MALE		
ICDCN36	RIBBON CABLE	6.95
CEN36	SOLDER CUP	4.95
FEMALE		
ICDCN36/F	RIBBON CABLE	7.95
CEN36PC	RT ANGLE PC MOUNT	4.95

INTERFIL		
ICL7106	9.95	
ICL7107	12.95	
ICL7660	2.95	
ICL8038	4.95	
ICM7207A	5.95	
ICM7208	15.95	

DIP CONNECTORS										
DESCRIPTION										
CONTACTS										
	8	14	16	18	20	22	24	28	40	
HIGH RELIABILITY TOOLED ST IC SOCKETS	AUGATxxST	.62	.79	.89	1.09	1.29	1.39	1.49	1.69	2.49
HIGH RELIABILITY TOOLED WW IC SOCKETS	AUGATxxWW	1.30	1.80	2.10	2.40	2.50	2.90	3.15	3.70	5.40
COMPONENT CARRIES (DIP HEADERS)	ICCxx	.49	.59	.69	.99	.99	.99	.99	1.09	1.49
RIBBON CABLE DIP PLUGS (IDC)	IDPxx	---	.95	.95	---	---	---	1.75	---	2.95

DIP CONNECTORS								
DESCRIPTION								
ORDER BY								
CONTACTS								
	9	15	19	25	37	50		
SOLDER CUP	MALE	DBxxP	.82	.90	1.25	1.80	3.48	
	FEMALE	DBxxS	.95	1.15	1.50	1.50	2.35	4.32
RIGHT ANGLE PC SOLDER	MALE	DBxxPR	1.20	1.49	---	1.95	2.65	---
	FEMALE	DBxxSR	1.25	1.55	---	2.00	2.79	---
WIRE WRAP	MALE	DBxxPWW	1.69	2.56	---	3.89	5.60	---
	FEMALE	DBxxSww	2.76	4.27	---	6.84	9.95	---
IDC	MALE	IDBxxP	2.70	2.95	---	3.98	5.70	---
RIBBON CABLE	FEMALE	IDBxxS	2.92	3.20	---	4.33	6.76	---
HOODS	METAL	MHOODxx	1.25	1.25	1.30	1.30	---	---
	GREY	HOODxx	.65	.65	---	.65	.75	.95

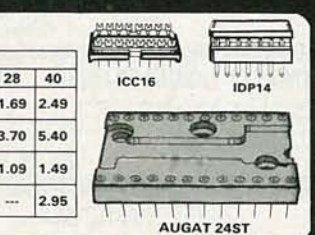

DIODES/OPTO/TRANSISTORS		
1N751	.25	4N26 .69
1N759	.25	4N27 .69
1N4148	25/1.00	4N28 .69
1N4004	10/1.00	4N33 .89
1N5402	.25	4N37 1.19
KB904	.55	MCT-2 .59
MBUSA	.95	MCT-5 1.99
MDA990-2	.35	TIL-111 .99
N2222	.25	2N3906 .10
PN2222	.10	2N4401 .25
2N2905	.50	2N4402 .25
2N2907	.25	2N4403 .25
2N3055	.79	2N6045 1.75
2N3904	.10	TIP31 .49

D-SUBMINIATURE								
DESCRIPTION								
ORDER BY								
CONTACTS								
	9	15	19	25	37	50		
SOLDER CUP	MALE	DBxxP	.82	.90	1.25	1.80	3.48	
	FEMALE	DBxxS	.95	1.15	1.50	1.50	2.35	4.32
RIGHT ANGLE PC SOLDER	MALE	DBxxPR	1.20	1.49	---	1.95	2.65	---
	FEMALE	DBxxSR	1.25	1.55	---	2.00	2.79	---
WIRE WRAP	MALE	DBxxPWW	1.69	2.56	---	3.89	5.60	---
	FEMALE	DBxxSww	2.76	4.27	---	6.84	9.95	---
IDC	MALE	IDBxxP	2.70	2.95	---	3.98	5.70	---
RIBBON CABLE	FEMALE	IDBxxS	2.92	3.20	---	4.33	6.76	---
HOODS	METAL	MHOODxx	1.25	1.25	1.30	1.30	---	---
	GREY	HOODxx	.65	.65	---	.65	.75	.95

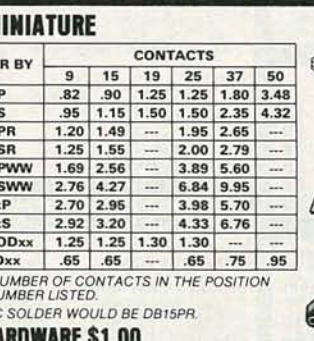

LED DISPLAYS		
FND-357(359)	COM CATHODE	.362" 1.25
FND-500(503)	COM CATHODE	.5" 1.49
FND-507(510)	COM ANODE	.5" 1.49
MAN-72	COM ANODE	.3" .99
MAN-74	COM CATHODE	.3" .99
MAN-8940	COM CATHODE	.3" 1.99
TIL-313	COM CATHODE	.3" .45
HP5082-7760	COM CATHODE	.43" 1.29
TIL-311	4x7 HEX W/LOGIC	.270" 9.95
HP5082-7340	4x7 HEX W/LOGIC	.290" 7.95

||
||
||

ORDER TOLL FREE

800-538-5000

800-662-6279 (CA)

## BARGAIN HUNTERS CORNER FRANKLIN ACE-10 DISK DRIVE FOR APPLE II

- \* RELIABLE, DIRECT DRIVE MECHANISM MADE FOR FRANKLIN BY MITAC. A WORLD LEADER IN FDDs FOR APPLE
- \* 100% COMPATIBLE WITH APPLE II, II+, AND IIe; USE W/STANDARD APPLE CONTROLLER OR OPTIONAL \$49.95 CONTROLLER
- \* FULL HEIGHT BEIGE ENCLOSURE MATCHES APPLE; BAKED ENAMEL FINISH RESISTS SCRATCHES
- \* SHIELDED CABLE WITH GROUNDING LUG FOR EMI-FREE OPERATION

ONE YEAR WARRANTY  
**ONLY \$79.95**  
HURRY — QUANTITIES ARE LIMITED!  
SPECIALS END 4/30/86

## PAGE WIRE WRAP WIRE PRECUT ASSORTMENT IN ASSORTED COLORS \$27.50

100ea: 5.5", 6.0", 6.5", 7.0"  
250ea: 2.5", 4.5", 5.0"  
500ea: 3.0", 3.5", 4.0"

### SPOOLS

100 feet \$4.30 250 feet \$7.25  
500 feet \$13.25 1000 feet \$21.95

Please specify color:  
Blue, Black, Yellow or Red

## EMI FILTER \$4.95

- \* MANUFACTURED BY CORCOM
- \* LOW COST
- \* FITS LC-HP BELOW
- \* 6 AMP 120/240 VOLT



## 6 FOOT LINE CORDS

LC-2 2 CONDUCTOR .39  
LC-3 2 CONDUCTOR .99  
LC-HP 3 CONDUCTOR W/STD FEMALE SOCKET 1.49

## MUFFIN FANS

3.15" SQ ROTRON 14.95  
3.63" SQ ETRI 14.95  
3.18" SQ MASUSHITA 16.95

## WIRE WRAP PROTOTYPE CARDS FR-4 EPOXY GLASS LAMINATE WITH GOLD-PLATED EDGE-CARD FINGERS



IBM-PR2

## IBM

BOTH CARDS HAVE SILK SCREENED LEGENDS AND INCLUDES MOUNTING BRACKET

IBM-PR1 WITH +5V AND GROUND PLANE \$27.95  
IBM-PR2 AS ABOVE WITH DECODING LAYOUT \$29.95

## S-100

P100-1 BARE - NO FOIL PADS \$15.15  
P100-2 HORIZONTAL BUS \$21.80  
P100-3 VERTICAL BUS \$21.80  
P100-4 SINGLE FOIL PADS PER HOLE \$22.75

## APPLE

P500-1 BARE - NO FOIL PADS \$15.15  
P500-3 HORIZONTAL BUS \$22.75  
P500-4 SINGLE FOIL PADS PER HOLE \$21.80  
7060-45 FOR APPLE IIe AUX SLOT \$30.00

## SOCKET-WRAP I.D.™

- \* SLIPS OVER WIRE WRAP PINS
- \* IDENTIFIES PIN NUMBERS ON WRAP SIDE OF BOARD
- \* CAN WRITE ON PLASTIC; SUCH AS IC #

PINS	PART#	PCK. OF	PRICE
8	IDWRAP 08	10	1.95
14	IDWRAP 14	10	1.95
16	IDWRAP 16	10	1.95
18	IDWRAP 18	5	1.95
20	IDWRAP 20	5	1.95
22	IDWRAP 22	5	1.95
24	IDWRAP 24	5	1.95
28	IDWRAP 28	5	1.95
40	IDWRAP 40	5	1.95

PLEASE ORDER BY NUMBER OF PACKAGES (PCK. OF)

ID WRAP 24

## FRAME STYLE TRANSFORMERS

12.6V AC CT 2 AMP 5.95  
12.6V AC CT 4 AMP 7.95  
12.6V AC CT 8 AMP 10.95  
25.2V AC CT 2 AMP 7.95

## 25 PIN D-SUB GENDER CHANGERS \$7.95



## SWITCHING POWER SUPPLIES

### PS-IBM \$99.95

- \* FOR IBM PC-XT COMPATIBLE
- \* 135 WATTS
- \* +5V @ 15A, +12V @ 4.2A
- \* -5V @ .5A, -12V @ .5A
- \* ONE YEAR WARRANTY

PS-IBM



### PS-IBM-150 \$129.95

- \* FOR IBM PC-XT COMPATIBLE
- \* 150 WATTS
- \* +12V @ 5.2A, +5V @ 16A
- \* -12V @ .5A, -5V @ .5A
- \* ONE YEAR WARRANTY

PS-130



### PS-130 \$99.95

- \* 130 WATTS
- \* SWITCH ON REAR
- \* FOR USE IN OTHER IBM TYPE MACHINES
- \* 90 DAY WARRANTY

PS-A



### PS-A \$49.95

- \* USE TO POWER APPLE TYPE SYSTEMS
- \* +5V @ 4A, +12V @ 2.5A
- \* -5V @ .5A, -12V @ .5A
- \* APPLE POWER CONNECTOR



### PS-SPL200 \$49.95

- \* +5V @ 25A, +12V @ 3.5A
- \* -5V @ 1A, -12V @ 1A
- \* UL APPROVED
- \* ALUMINUM ENCLOSURE

PS-SPL200

## BOOKS BY STEVE CIARCIA

BUILD YOUR OWN Z80 COMPUTER \$19.95  
CIRCUIT CELLAR VOL 1 \$17.95  
CIRCUIT CELLAR VOL 2 \$18.95  
CIRCUIT CELLAR VOL 3 \$18.95  
CIRCUIT CELLAR VOL 4 \$18.95  
CIRCUIT CELLAR VOL 5 \$19.95

## MICROCOMPUTER HARDWARE HANDBOOK FROM ELCOMP \$14.95

OVER 800 PAGES OF DATA SHEETS ON THE MOST COMMONLY USED ICs. INCLUDES TTL, CMOS, 74LS00, MEMORY, CPUs, MPU SUPPORT, AND MUCH MORE!

## CAPACITORS

### TANTALUM

1.0µf	15V .35	.47µf	35V .45
6.8	15V .70	1.0	35V .45
10	15V .80	2.2	35V .65
22	15V 1.35	4.7	35V .85
.22	35V .40	10	35V 1.00

### DISC

10µf	50V .05	680	50V .05
22	50V .05	.001µf	50V .05
27	50V .05	.0022	50V .05
33	50V .05	.005	50V .05
47	50V .05	.01	50V .07
68	50V .05	.02	50V .07
100	50V .05	.05	50V .07
220	50V .05	.1	12V .10
560	50V .05	.1	50V .12

### MONOLITHIC

.01µf	50V .14	.1µf	50V .18
.047µf	50V .15	.47µf	50V .25

### ELECTROLYTIC

RADIAL		AXIAL	
1µf	25V .14	1µf	50V .14
2.2	35V .15	10	50V .16
4.7	50V .15	22	16V .14
10	50V .15	47	50V .20
47	35V .18	100	35V .25
100	16V .18	220	25V .30
220	35V .20	470	50V .50
470	25V .30	1000	16V .60
2200	16V .70	2200	16V .70
4700	25V 1.45	4700	16V 1.25
COMPUTER GRADE	44,000µf	30V	3.95

## DATARASE EPROM ERASER \$34.95

- \* ERASES TWO EPROMS IN 10 MINUTES
- \* COMPACT-NO DRAWER
- \* THIN METAL SHUTTER PREVENTS UV LIGHT FROM ESCAPING



## 1/4 WATT RESISTORS

5% CARBON FILM ALL STANDARD VALUES FROM 1 OHM TO 10 MEG. OHM

10 PCS same value .05 100 PCS same value .02  
50 PCS same value .025 1000 PCS same value .015

## RESISTOR NETWORKS

SIP 10 PIN 9 RESISTOR .69  
SIP 8 PIN 7 RESISTOR .59  
DIP 16 PIN 8 RESISTOR 1.09  
DIP 16 PIN 15 RESISTOR 1.09  
DIP 14 PIN 7 RESISTOR .99  
DIP 14 PIN 13 RESISTOR .99

## SPECIALS ON BYPASS CAPACITORS

.01 µf CERAMIC DISC 100/\$5.00  
.01 µf MONOLITHIC 100/\$10.00  
.1 µf CERAMIC DISC 100/\$6.50  
.1 µf MONOLITHIC 100/\$12.50

## WISH SOLDERLESS BREADBOARDS

PART NUMBER	DIMENSIONS	DISTRIBUTION STRIP(S)	TIE POINTS	TERMINAL STRIP(S)	TIE POINTS	BINDING POSTS	PRICE
WBU-D	.38 x 6.50"	1	100	---	---	---	2.95
WBU-T	1.38 x 6.50"	---	---	1	630	---	6.95
WBU-204-3	3.94 x 8.45"	1	100	2	1260	2	17.95
WBU-204	5.13 x 8.45"	4	400	2	1260	3	24.95
WBU-206	6.88 x 9.06"	5	500	3	1890	4	29.95
WBU-208	8.25 x 9.45"	7	700	4	2520	4	39.95



WBU-208

## LITHIUM BATTERY AS USED IN CLOCK CIRCUITS

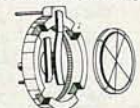

3 VOLT BATTERY \$3.95  
BATTERY HOLDER \$1.49

## NEW EDITION!

1986 IC MASTER  
THE INDUSTRY STANDARD  
**\$129.95**

VISIT OUR RETAIL STORE LOCATED AT 1256 SOUTH BASCOM AVENUE IN SAN JOSE

# JDR Microdevices

1224 S. Bascom Avenue, San Jose, CA 95128  
800-538-5000 • 800-662-6279 (CA) • (408) 995-5430  
FAX (408) 275-8415 • Telex 171-110

HOURS: M-W-F, 9-5 TU-TH, 9-9 SAT, 10-3  
PLEASE USE YOUR CUSTOMER NUMBER WHEN ORDERING

TERMS: Minimum order \$10.00. For shipping and handling include \$2.50 for UPS Ground and \$3.50 for UPS Air. Orders over 1 lb. and foreign orders may require additional shipping charges - please contact our sales department for the amount. CA residents must include applicable sales tax. All merchandise is warranted for 90 day unless otherwise stated. Prices are subject to change without notice. We are not responsible for typographical errors. We reserve the right to limit quantities and to substitute manufacturer. All merchandise subject to prior sale.

© COPYRIGHT 1986 JDR MICRODEVICES

CIRCLE 256 ON FREE INFORMATION CARD

# PARTIAL LISTING ONLY — CALL FOR A FREE CATALOG

## DISK DRIVES FOR APPLE COMPUTERS

**AP-150**  
**\$99.95**

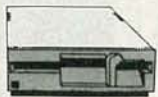

- 1/2 HT. DIRECT DRIVE
- 100% APPLE COMPATIBLE
- SIX MONTH WARRANTY

**BAL-500**  
**\$129.95**

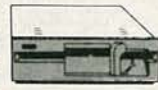

- TEAC MECHANISM-DIRECT DRIVE
- 100% APPLE COMPATIBLE
- FULL ONE YEAR WARRANTY

**AP-135**  
**\$129.95**



- FULL HT SHUGART MECHANISM
- DIRECT REPLACEMENT FOR APPLE DISK II
- SIX MONTH WARRANTY

**DOUBLE SIDED!**  
**MAC535**  
**\$249.95**

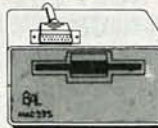

- 3.5" ADD-ON DISK DRIVE
- 100% MACINTOSH COMPATIBLE
- DOUBLE SIDED 800K BYTE STORAGE
- HIGH RELIABILITY DRIVE
- HAS AUTO-EJECT MECHANISM
- FULL ONE YEAR WARRANTY

**AD-3C**  
**\$139.95**

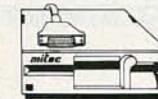

- 100% APPLE IIc COMPATIBLE, READY TO PLUG IN, W/ SHIELDED CABLE & MOLDED 19 PIN CONNECTOR
- FAST, RELIABLE SLIMLINE DIRECT DRIVE
- SIX MONTH WARRANTY

**DISK DRIVE ACCESSORIES**  
FDD CONTROLLER CARD \$49.95  
IIc ADAPTOR CABLE \$19.95  
ADAPTS STANDARD APPLE DRIVES FOR USE WITH APPLE IIc

**KB-1000** \$79.95

- CASE WITH KEYBOARD FOR APPLE TYPE MOTHERBOARD
- USER DEFINED FUNCTION KEYS
  - NUMERIC KEYPAD WITH CURSOR CONTROL
  - CAPS LOCK
  - AUTO-REPEAT



**KEYBOARD-AP** \$49.95

- REPLACEMENT FOR APPLE II KEYBOARD
- CAPS LOCK KEY, AUTO-REPEAT
- ONE KEY ENTRY OF BASIC OR CP/M COMMANDS



**EXTENDER CARDS**

IBM-PC	\$45.00
IBM-AT	\$68.00
APPLE II	\$45.00
APPLE IIe	\$45.00
MULTIBUS	\$86.00

## APPLE COMPATIBLE INTERFACE CARDS

**EPROM PROGRAMMER \$59.95**

**MODEL RP525**



- DUPLICATE OR BURN ANY STANDARD 27xx SERIES EPROM
- EASY TO USE MENU-DRIVEN SOFTWARE IS INCLUDED
- MENU SELECTION FOR 2716, 2732, 2732A, 2764 AND 27128
- HIGH SPEED WRITE ALGORITHM
- LED INDICATORS FOR ACTIVITY
- NO EXTERNAL POWER SUPPLY NEEDED
- ONE YEAR WARRANTY

**16K RAMCARD \$39.95**



- FULL TWO YEAR WARRANTY
- EXPAND YOUR 48K APPLE TO 64K
- USE IN PLACE OF APPLE LANGUAGE CARD

BARE PC CARD W/INSTRUCTIONS \$9.95

**IC TEST CARD \$99.95**



- QUICKLY TESTS MANY COMMON ICs
- DISPLAYS PASS OR FAIL
- ONE YEAR WARRANTY
- TESTS: 4000 SERIES CMOS, 74HC SERIES CMOS, 7400, 74LS, 74L, 74H & 74S

**300B MODEM \$49.95**  
FOR APPLE OR IBM

INCLUDES ASCII PRO-EZ SOFTWARE

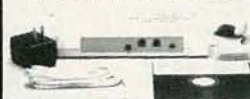

- FCC APPROVED
- BELL SYSTEMS 103 COMPATIBLE
- INCLUDES AC ADAPTOR
- AUTO-DIAL
- DIRECT CONNECT

CABLE FOR APPLE IIc \$14.95

**JOYSTICK CR-401 \$7.95**

FOR ATARI 400, 800, 2600, VIC 20/64 AND APPLE IIe

**DISKFILE**  
HOLDS 70 5 1/4" DISKETTES



**\$895**  
3.5" DISKFILE HOLDS 40 \$995

**POWER STRIP**

• UL APPROVED  
• 15A CIRCUIT BREAKER  
**\$12.95**



## 3-WAY SWITCH BOXES

- SERIAL OR PARALLEL
- CONNECTS 3 PRINTERS TO ONE COMPUTER OR VICE VERSA
- ALL LINES SWITCHES
- HIGH QUALITY ROTARY SWITCH MOUNTED ON PCB
- GOLD CONTACTS
- STURDY METAL ENCLOSURE



**SWITCH-3P CENTRONICS PARALLEL \$99.95**  
**SWITCH-3S RS232 SERIAL \$99.95**

## PRINTER BUFFERS

- FREES COMPUTER FOR OTHER TASKS WHILE PRINTING LONG DOCUMENTS
- STAND-ALONE DESIGN; WORKS WITH ANY COMPUTER OR PRINTER
- ALL MODELS FEATURE PRINT PAUSE MEMORY CHECK, GRAPHICS CAPABILITY

**SP120P PARALLEL \$139.95**

- 64K UPGRADABLE TO 256K
- LED INDICATOR SHOWS VOLUME OF DATA IN BUFFER

**SP120S RS232 SERIAL \$159.95**

- 64K UPGRADABLE TO 256K
- 6 SELECTABLE BAUD RATES, FROM 600B—19,200B

**SP110P PARALLEL \$249.95**

- 64K UPGRADABLE TO 512K
- SPOOLS OUTPUT OF UP TO 3 COMPUTERS
- LED BARGRAPH DISPLAYS AMOUNT OF DATA IN BUFFER
- RESET FUNCTION CLEARS DATA IN BUFFER
- REPEAT FUNCTION CAN PRODUCE MULTIPLE COPIES OF A DOCUMENT



SP120 SP110

## NASHUA DISKETTES DEALS

5 1/4" SOFT SECTOR DS/DD WITH HUB RINGS

**\$990** BOX OF 10  
**69c<sup>ea</sup>** BULK QTY 50  
**59c<sup>ea</sup>** BULK QTY 250

NASHUA DISKETTES WERE JUDGED TO HAVE THE HIGHEST POLISH AND RECORDED AMPLITUDE OF ANY DISKETTES TESTED ACCORDING TO "COMPARING FLOPPY DISKS", BYTE 9/84

## DISKETTES NASHUA 5 1/4"

N-MD2D DS/DD SOFT \$9.90  
N-MD2F DS/QUAD SOFT \$34.95  
N-MD2H DS/HD FOR AT \$49.95

## NASHUA 8"

N-FD1 SS/DD SOFT \$27.95  
N-FD2D DS/DD SOFT \$34.95

## NASHUA 3.5"

N-3.5SS 3.5" SS/DD FOR MAC \$32.95

## VERBATIM 5 1/4"

V-MD1D SS/DD SOFT \$23.95  
V-MD2D DS/DD SOFT \$29.95  
V-MD110D SS/DD 10 SECTOR HARD \$23.95

## TEST EQUIPMENT FROM JDR INSTRUMENTS

**DIGITAL MULTIMETER PEN DPM-1000**  
AUTO RANGING, POLARITY AND DECIMAL!

**\$54.95**

- LARGE 3.5 DIGIT DISPLAY
- DATA HOLD SWITCH
- FREEZES READING
- FAST, AUDIBLE CONTINUITY TEST
- LOW BATTERY INDICATOR
- OVERLOAD PROTECTION



**20MHZ DUAL TRACE OSCILLOSCOPE MODEL 2000 \$389.00**  
**35MHZ DUAL TRACE OSCILLOSCOPE MODEL 3500 \$549.00**

FOR MORE INFORMATION ON THE OSCILLOSCOPES, SEE OUR FULL PAGE AD ON PAGE 13.

## Sakata 120 CPS DOT MATRIX PRINTER



**MODEL SP-1200 \$169.95**

- EPSON/IBM COMPATIBLE
- 9-WIRE PRINTHEAD
- 120 CPS-BIDIRECTIONAL, 80 COL.
- FRICTION AND TRACTOR FEED
- PROPORTIONAL SPACING
- CENTRONICS PARALLEL INTERFACE
- 8 CHARACTER SETS AND GRAPHICS

6 FOOT IBM PRINTER CABLE \$9.95  
REPLACEMENT RIBBON CARTRIDGE \$11.95

## 5 1/4" FLOPPY DISK DRIVES

TEAC FD-55B 1/2 HT DS/DD (FOR IBM) \$109.95  
TEAC FD-55F 1/2 HT DS/QUAD (FOR IBM) \$109.95  
TEAC FD-55GFV 1/2 HT DS/HD (FOR IBM AT) \$154.95  
TANDON TM100-2 DS/DD (FOR IBM) \$99.95  
TANDON TM50-2 1/2 HT DS/DD (FOR IBM) \$89.95  
MPI-B52 DS/DD (FOR IBM) \$89.95  
QUME QT-142 1/2 HT DS/DD (FOR IBM) \$79.95

## 8" FLOPPY DISK DRIVES

FD 100-8 SS/DD (SA/801 EQUIV) \$119.00  
FD 200-8 DS/DD (SA/851R EQUIV) \$159.00

## DISK DRIVE ACCESSORIES

TEAC SPECIFICATION MANUAL \$5.00  
TEAC MAINTENANCE MANUAL \$25.00  
1/2 HT MOUNTING HARDWARE \$2.95  
MOUNTING RAILS FOR IBM AT \$4.95  
"Y" POWER CABLE FOR 5 1/4" FDDs \$2.95  
5 1/4" FDD POWER CONNECTORS \$1.19



TEAC FD-55 TANDON TM100-2

## DISK DRIVE ENCLOSURES

**CAB-APPLE \$24.95**  
APPLE TYPE CABINET W/OUT POWER SUPPLY

**CAB-1FH5 \$69.95**  
FULL HT 5 1/4" BEIGE CABINET W/POWER SUPPLY

**CAB-2SV5 \$49.95**  
DUAL SLIMLINE 5 1/4" CABINET W/POWER SUPPLY

**CAB-2SV8 \$209.95**  
DUAL SLIMLINE 8" VERTICAL CABINET W/POWER SUPPLY

**CAB-2FH8 \$219.95**  
DUAL FULL HT 8" CABINET W/POWER SUPPLY



CAB-2SV5 CAB-1FH5

CALL FOR VOLUME QUOTES

© COPYRIGHT 1986 JDR MICRODEVICES

CIRCLE 257 ON FREE INFORMATION CARD

MAY 1986

107

# BUILD A COMPLETE XT SYSTEM—\$698

## XT COMPATIBLE MOTHERBOARD

### \$159.95

- 4.77 MHz 8088 CPU, OPTIONAL 8087 CO-PROCESSOR
- 8 EXPANSION SLOTS
- 0K RAM INSTALLED, EXPANDABLE TO 640K ON-BOARD MEMORY
- ALL ICs SOCKETED-HIGHEST QUALITY PC BOARD
- ACCEPTS 2764 OR 27128 ROMS

**PRO-BIOS \$29.95**

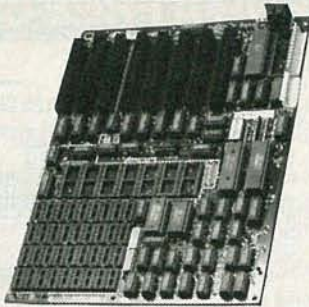

## CRT MONITORS FOR ALL APPLICATIONS



**TAXAN RGB VISION III**  
MODEL 415

- MADE BY TAXAN FOR ACORN
- 640 x 262 PIXEL RESOLUTION
- 16 COLORS
- 18 MHz BANDWIDTH
- 12" BLACK MATRIX
- IBM AND LOTUS COMPATIBLE
- CABLE FOR IBM \$15.95

**\$289.95**



**SAKATA COMPOSITE COLOR**  
MODEL SC-100

- TOP RATED FOR APPLE
- 13" COMPOSITE VIDEO
- RESOLUTION: 280H x 300V
- INTERNAL AUDIO AMPLIFIER
- ONE YEAR WARRANTY

**\$169.95**



**CENTER SYSTEMS MONOCHROME**  
MODEL KLM-1211

- IBM COMPATIBLE TTL INPUT
- 12" NON-GLARE SCREEN
- P39 GREEN PHOSPHOR
- VERY HIGH RESOLUTION: 25 MHz BANDWIDTH 1100 LINES (CENTER)

**\$99.95**

## 20 Mb HARD DISK SYSTEM

INCLUDES HALF LENGTH HD CONTROLLER, CABLES, MOUNTING HARDWARE AND INSTRUCTIONS. ALL DRIVES ARE PRE-TESTED AND COME WITH A ONE YEAR WARRANTY.

**SEAGATE ST-225**  
**\$489.00**

## IBM COMPATIBLE INTERFACE CARDS

ALL WITH A ONE YEAR WARRANTY

### MULTI I/O FLOPPY CARD

**\$129.95**

PERFECT FOR THE 640K MOTHERBOARD

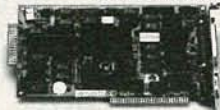

- 2 DRIVE FLOPPY DISK CONTROLLER
- 1 RS232 SERIAL PORT; OPTIONAL 2nd SERIAL PORT
- PARALLEL PRINTER PORT
- GAME PORT
- CLOCK/CALENDAR
- SOFTWARE: CLOCK UTILITIES, RAMDISK, SPOOLER

### MULTIFUNCTION CARD

**\$119.95**

ALL THE FEATURES OF AST'S 6 PACK PLUS AT HALF THE PRICE



- CLOCK/CALENDAR
- 0.384K RAM
- SERIAL PORT
- PARALLEL PORT
- GAME PORT
- SOFTWARE INCLUDED

\$9.95

9/\$8.91

### COLOR GRAPHICS ADAPTOR

**\$99.95**

FULLY COMPATIBLE WITH IBM COLOR CARD



- 4 VIDEO INTERFACES: RGB, COMPOSITE COLOR, HI-RES COMPOSITE MONOCHROME, CONNECTOR FOR RF MODULATOR
- COLOR GRAPHICS MODE: 320 x 200
- MONO GRAPHICS MODE: 640 x 200
- LIGHT PEN INTERFACE

### MONOCHROME GRAPHICS CARD

**\$119.95**

FULLY COMPATIBLE W/IBM MONOCHROME ADAPTOR & HERCULES GRAPHICS



- LOTUS COMPATIBLE
- TEXT MODE: 80 x 25
- GRAPHICS MODE: 720 x 348
- PARALLEL PRINTER INTERFACE
- OPTIONAL SERIAL PORT \$19.95

### MONOCHROME ADAPTOR

**\$49.95**

ANOTHER FANTASTIC VALUE FROM JDR!

- IBM COMPATIBLE TTL OUTPUT
  - 720 x 350 PIXEL DISPLAY
- PLEASE NOTE: THIS CARD WILL NOT RUN LOTUS GRAPHICS AND DOES NOT INCLUDE A PARALLEL PORT

### FLOPPY DISK DRIVE ADAPTOR

**\$49.95**



- INTERFACES UP TO FOUR STANDARD FDDs TO IBM PC OR COMPATIBLES
- INCLUDES CABLE FOR TWO INTERNAL DRIVES
- STANDARD DB37 FOR EXTERNAL DRIVES
- RUNS QUAD DENSITY DRIVES WHEN USED WITH JFORMAT

## EASYDATA 1200 BAUD MODEM FOR IBM

INCLUDES PC TALK III COMMUNICATIONS SOFTWARE



- Hayes COMPATIBLE
- AUTO DIAL/AUTO ANSWER
- AUTO RE-DIAL ON BUSY
- INCLUDES SERIAL PORT!
- ONE YEAR WARRANTY

**\$169.95**

## BUILD YOUR OWN XT COMPATIBLE SYSTEM!

- XT MOTHERBOARD **\$159.95**
- PRO-BIOS **\$29.95**
- 64K RAM **\$8.91**
- 130 WATT POWER SUPPLY **\$89.95**
- FLIP-TOP CASE **\$49.95**
- DKM-2000 KEYBOARD **\$79.95**
- 1/2 HEIGHT QUME DRIVE **\$79.95**
- FLOPPY DISK CONTROLLER **\$49.95**
- MONOCHROME ADAPTOR **\$49.95**
- MONOCHROME MONITOR **\$99.95**

**TOTAL: \$697.51**

## MONITOR STAND



TILTS AND SWIVELS

**ONLY \$12.95**

## IBM PRINTER CABLE



- DB25 TO CENTRONICS
- SHIELDED CABLE **\$9.95**

## IBM STYLE COMPUTER CASE

AN ATTRACTIVE STEEL CASE WITH A HINGED LID FITS THE POPULAR PC/XT COMPATIBLE MOTHERBOARDS

- SWITCH CUT-OUT ON SIDE FOR PC/XT STYLE POWER SUPPLY
- CUT-OUT FOR 8 EXPANSION SLOTS
- ALL HARDWARE INCLUDED

**\$49.95**



## IBM COMPATIBLE KEYBOARDS

DKM-2000 **\$79.95**

IBM-5151 **\$99.95**



- "5150" STYLE KEYBOARD
- FULLY IBM COMPATIBLE
- LED STATUS INDICATORS FOR CAPS & NUMBER LOCK
- 83 KEY — SAME LAYOUT AS IBM PC/XT KEYBOARD



- REPLACEMENT FOR KEYTRONICS KB-5151™
- SEPARATE CURSOR & NUMERIC KEYPAD
- CAPS LOCK & NUMBER LOCK INDICATORS
- IMPROVED KEYBOARD LAYOUT

## POWER SUPPLY



**NOW ONLY \$89.95**

- FOR IBM PC-XT COMPATIBLE
- 135 WATTS
- +5V @ 15A, +12V @ 4.2A
- -5V @ .5A, -12V @ .5A

**150 WATT MODEL \$99.95**

## DISK DRIVES

TANDON TM50-2

**\$89.95**

- 1/2 HT DS/DD
- IBM COMPATIBLE
- EXTREMELY QUIET!

TEAC FD-55B	DS/DD	\$109.95
TEAC FD-55F	DS/QUAD	\$109.95
TEAC FD-55G	DS/HD	\$154.95
QUME QT-142	DS/DD	\$79.95
MOUNTING HARDWARE		\$2.95
AT/RAILS		\$4.95

**JDR Microdevices**

1224 South Bascom Avenue, San Jose, CA 95128  
800-538-5000 • 800-662-6279 (CA) • (408) 995-5430 • FAX (408) 275-8415 • Telex 171-110

© COPYRIGHT 1986 JDR MICRODEVICES

CIRCLE 258 ON FREE INFORMATION CARD



# TENMA

## THE NAME YOU CAN TRUST IN ELECTRONIC TEST EQUIPMENT

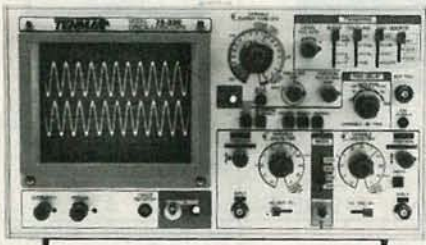

### TENMA 35MHz Dual Trace Oscilloscope

- Two high quality 10:1 probes included
- For additional specifications see MCM Catalog #11

#72-330  
**\$56900**  
(ea.)



**NEW**  
TENMA  
0-18V 3A  
Power Supply

- Regulated outputs — constant volt or constant current, both are continuously variable
- Can be connected in series or parallel for more voltage or current output
- Reverse polarity and overload protected
- Isolated output

#72-330 Available Mid May!

**\$9950**  
(ea.)



### TENMA Combination Function Generator and Frequency Counter

- 6 digit display
- Output range: 2Hz-2MHz: seven ranges
- Counter range: .1Hz-10MHz
- 5-15V TTL and CMOS output
- Wave forms: sine, triangle, square, pulse, and ramp.

#72-380

**\$21990**  
(ea.)

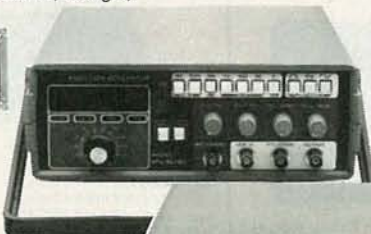

### TENMA Frequency Counter

- 8 digit LED display
- Measurement range: 1Hz-120MHz
- High input sensitivity of 20mV RMS

#72-375

**NEW**

**\$18995**  
(ea.)

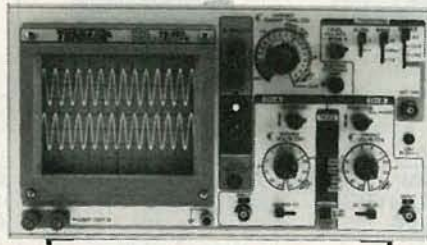

### TENMA 20MHz Dual Trace Oscilloscope

- Two high quality 10:1 probes included
- For additional specifications see MCM Catalog #11

#72-320  
**\$38995**  
(ea.)

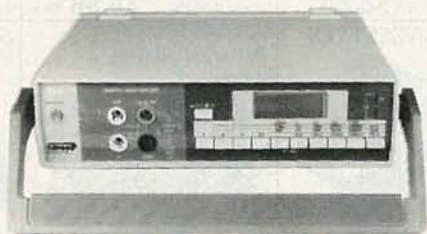

### TENMA Bench Top DMM

- 3 1/2 digit
- Eight function DCV, ACV, DCA (up to 20A), ACA (up to 20A), Resistance (up to 20Mohm), Audible continuity test, diode test, capacitance test (up to 20µF)

Available Mid May!

#72-410

**\$14980**  
(ea.)



**NEW**



**NEW**  
TENMA Rotary Dial DMM

- 3 1/2 digit LCD display
- Rotary dial for rapid selection of functions and ranges
- 20 amp AC-DC current
- .1ohm resolution
- Carrying case included

#72-075 \$44.80 (ea.)

**\$4195**  
(2-up)



**NEW**  
TENMA Digital LCR Meter

- Measures inductance, capacitance and resistance
- L = 1µH-200H, C = .1pF-200µF, R = .01ohm-20Mohm
- Carrying case included.

#72-370

**\$14995**  
(ea.)



**Be Sure To Call For Your FREE Catalog! Over 6,000 Items!**

We also have ... a full line of test equipment, computer accessories, telephone accessories, speakers, television parts, flybacks, yokes, switches, fuses, lamps, capacitors, resistors, cartridges, styli, wire, CATV equipment, the largest selection of original Japanese semiconductors in the country and more.

**MCM ELECTRONICS**  
858 E. Congress Park Dr.  
Centerville, Ohio 45459-4072  
(513) 434-0031

SOURCE NO. RE-20

**Terms:**

- \$10 minimum order. \$1.00 charge for orders under \$10.
- \$20 minimum charge card order.
- Orders shipped UPS C.O.D.
- Most orders shipped within 24 hours.
- Sales office open 9:30 am to 7:00 pm Saturdays 10:00 am to 3 pm EST.
- For prepaid orders add \$2.75 for shipping and handling.
- Should shipping and handling charges exceed \$2.75, the balance due will be sent C.O.D.



**CALL TOLL FREE 1-800-543-4330**

In Ohio 1-800-726-4315 • In Alaska and Hawaii 1-800-858-1849

CIRCLE 87 ON FREE INFORMATION CARD

MAY 1986

# What's New at AMERICAN DESIGN COMPONENTS?

"The Source" of the  
electro-mechanical components  
for the hobbyist.

**W**e warehouse 60,000 items at American Design Components — expensive, often hard-to-find components for sale at a fraction of their original cost!

You'll find every part you need — either brand new, or removed from equipment (RFE) in excellent condition. But quantities are limited. Order from this ad, or visit our retail showroom and find exactly what you need from the thousands of items on display.

Open Mon. — Sat., 9-5

## THERE'S NO RISK.

With our full 90-day warranty, any purchase can be returned for any reason for full credit or refund.

### 19" COLOR

### X-Y DISPLAY

Originally designed for use in Atari coin-operated games. Contains 3-gun color tube, focus and brightness controls. Requires external X-Y inputs, 250-0-24V transformer for power. May be used for oscilloscopes, re-programmed for game use, or modified with the use of external vertical and horizontal oscillators to a raster scan display or TV monitor for computer use. (IBM compatible.) Transformer supplied.

Item #5449 \$99.00 New

### ADAM COMPUTER KIT! (Less printer & w/o cabinet)

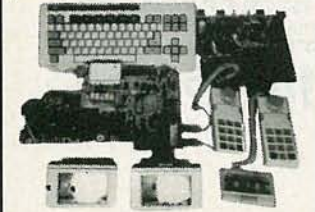

Build it yourself from subassemblies. No wiring necessary (just plugs together). Hook-up diagram included. Includes: Keyboard, 2 cassette digital data drives, 2 game controllers, power supply, all memory boards, and one cassette. Is capable of running CP/M, has built-in word processor.

Item #7410 \$99.00 (complete)

### COLECO VISION KIT (Assemble yourself, diagram incl.)

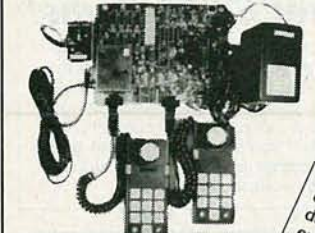

Complete unit, without housing. Can be easily mounted on any base. Contains: game board, 2 controllers, power supply, TV game switch & connecting coaxial cable.

Item #7411 \$19.95

### 5 1/4" DISK DRIVES



1/2 HT  
96 TPI  
DS/Quad  
Tandon #TM55-4

Item #1904 \$79.50 ea.  
or 2 for \$150.00



FULL HT  
96 TPI  
DS/Quad  
Tandon #TM101-4

Item #1901 \$99.00 ea.

### MPI 52S (IBM® Compatible) 5 1/4" FULL HEIGHT DISK DRIVE



Double sided/double density, full height drive. 48 T.P.I., 80 tracks.  
Item #7928 \$79.95 New  
2 for \$150.00

### 75-KEY MECHANICAL KEYBOARD — For Adam



For computer upgrade. . . . 21 user-defined keys, SPST mechanical switches, 21-pin ribbon cable connection. General instructions for replacement of membrane keyboards incl. Update computers such as the Timex Sinclair Z81/1000. Dim.: 13 1/2" W x 1 1/4" H x 5" D.

Item #7429 \$5.95 New

### ADAM CASSETTES (Assorted)



Buck Rogers, BASIC — plus others!  
Can be easily erased.  
Item #7786 — Bakers Dozen  
13 for \$19.95 New

### ADAM PRINTER POWER SUPPLY (Linear)



DC Output: -5V @ 200 ma.  
+5V @ 3 amps  
+12V @ 2.9 amps  
+18V (inductive) @ 1 amp  
Input: 115V/60 Hz.  
Chassis Dim: 11" W x 4" H x 8" D  
Item #6642 \$14.95 New

### COMPUTER TAPE DRIVE (For Adam)

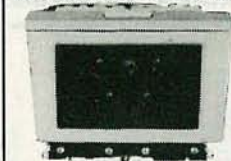

Serial format. Search 80IPS — Read/Write 20IPS. 12V motor, 5V logic, 8 & 9 pin connector cables. Originally designed for the Adam. Dim: 5" W x 3 3/4" H x 4" deep  
Item #6641 \$9.95 New

### 12" COMPOSITE VIDEO MONITOR



Green phosphor; 40/80 column, 1000-line resolution. 18MHz bandwidth. Compatible with IBM, Apple, Commodore, and more. Includes external transformer for operation on 115 VAC & video cable. Mfr — Elston Elec. #DM30  
Item #6602 \$29.95 New

### Rechargeable NICAD BATTERY BACKUPS



12V @ 450 ma  
Contains 10 AA cells. Recharge rate: 45 ma. 16-18 hours. Case with tab output connections. Dim.: 2 1/8" H x 1 1/4" W x 2 1/8" L  
Mfr — GE 123233 or equiv.  
Item #5443 \$5.95 RFE

### 13.2V @ 1.65 AH

Contains 11 C cells.  
For model boats, toys, etc.  
Mfr — GE #41B0358B00101  
Item #5444 \$19.95 New

### ADC KITS

ROBOTICS KIT (Springs, Belts, Pulleys & Gears) Consists of: 9 Timing Belts (7.5" to 13"); 2 Round Belts (12" to 15"); 15 Nylon & Plastic Spur & Drive Gears; 22 Torsion Springs; 6 Compression Pulleys; 19 Tension Springs  
Item #5306 \$14.95 New

TOY MOTOR KIT  
For Robotics —  
Consists of: 18 asst. toy motors, from 1.5V to 12VDC.  
Item #7229 \$9.95 New

### SWITCHING POWER SUPPLY



115 & 230V, 47-440 Hz.  
Input: 90-135V/180-270V  
Output: 5VDC @ 5.5A  
+12VDC @ 4A  
-12VDC @ 3A  
Perforated metal case enclosure.  
Dim.: 9 1/2" L x 3 1/2" W x 2" H.  
Mfr — General Instrument  
Item #7983 \$14.95 New

### SWITCH KIT 35 Ass't. Switches

Consisting of 35 assorted: Dip, Toggle, Slide, and Sensitive Miniature and Standard Size Switches  
Item #5307 \$9.95 New

## PUMPS — COMPRESSORS — BLOWERS — MOTORS — POTENTIOMETERS — COUNTERS TIMERS — RELAYS — VOLTAGE REGULATORS — POWER SUPPLIES

### 115 CFM MUFFIN FAN



115 VAC/60 Hz., 21W., 28A., 3100 RPM; 5-blade model, aluminum housing. Can be mounted for blowing or exhaust.  
Dim.: 4 1/8" sq. x 1 1/2" deep.  
Item #5345 \$7.95 RFE

### 30 CFM MINI FAN 12 VDC



Low noise level. Can be mounted for cooling or exhaust. 12VDC.  
Dim.: 3 1/2" sq. x 1 1/2" deep  
Mfr — Papst #8312  
Item #7017 \$12.95 New

### REPLACEMENT BOARDS FOR ADAM (For Parts Only)



Logic board for the Adam computer. Includes the following components: 8 ea. 4164-4s, 74LS157, 74LS541, LS273N; 2 ea. LM339s, plus micro-processors with ROMs.  
Mfr — Coleco  
Item #7231 \$9.95 RFE

GAME BOARD  
Contains over 150 components!  
8 ea. 4116s, Z80A; 14 ea. 74LSs; 3 connectors, capacitors, diodes, etc.  
Dim.: 9 3/4" L x 10" W x 1" H  
Item #7679 \$6.95

## AMERICAN DESIGN COMPONENTS, 62 JOSEPH STREET, MOONACHIE, N.J. 07074

YES! Please send me the following items:

Item No.	How Many?	Description	Price	Total

Shipping & handling, we ship UPS unless otherwise specified. Add \$3 plus 10% total. Canadian: \$3 plus P.O. cost. Charge only. Sales Tax (N.J. residents only, please add 6% of total)  
ORDER TOTAL

My check or money order is enclosed. MINIMUM ORDER \$15.  
 Charge my credit card. RE-56  
 Visa  Master Card  Amex  
 Card No. \_\_\_\_\_  
 Exp. Date \_\_\_\_\_  
 Signature \_\_\_\_\_  
 Telephone: Area Code \_\_\_\_\_ Number \_\_\_\_\_  
 Name \_\_\_\_\_  
 Address \_\_\_\_\_  
 City \_\_\_\_\_  
 State \_\_\_\_\_ Zip \_\_\_\_\_  
 All inquiries and free catalog requests call 201-939-2710.

For all phone orders, call TOLL-FREE 800-524-0809. In New Jersey, 201-939-2710.

# Radio Shack Parts Place™

THE BUILDER'S STORE! OVER 1000 COMPONENTS IN STOCK

## Plug-In PC Boards



(1) Board With RS-232 Ports. Accepts two RS-232 connectors. Predrilled DIP pattern.  $4\frac{5}{16} \times 5\frac{5}{16}$ ". #276-187 ..... 3.99  
 90° RS-232 Connector. #276-1521 ..... 3.29  
 (2) Multipurpose Two-Bus Board. Predrilled DIP pattern.  $4\frac{1}{2} \times 4$ ". #276-152 ..... 2.99

(3) Three-Bus Version of Fig. 2. #276-154 ..... 2.99  
 (3) Jumbo Two-Bus Board. Accepts up to 24 16-pin DIPs.  $4\frac{1}{2} \times 9\frac{9}{16}$ ". #276-190 ..... 5.95  
 Jumbo IC/Discrete Board. Accepts up to 40 sixteen-pin DIP ICs. #276-191 ..... 5.95  
 (4) 44-Position Socket. #276-1551 ..... 2.99

## Battery Guidebook

NEW!  
1.99

Helps You Select The Right Battery

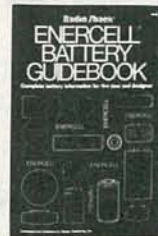

Learn how batteries work, how to recharge and test them, and how to choose the best values. Includes complete technical data on all ENERCELL® batteries. 160 pages. #62-1396

## Add Some Action With Our Bargain-Priced DC Motors

### SPECIAL PURCHASE!

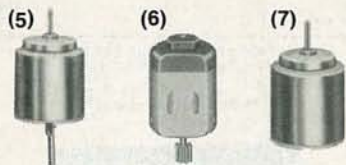

Fig.	DC Volts	Cat. No.	Only
5	1.5 to 4.5	273-225	99¢ Each
6	1.5 to 3	273-226	Pkg. 2/1.19
7	3 to 4.5	273-228	Pkg. 2/1.29

## Fine-Tune Your Circuits



(8) PC-Mount 15-Turn Pots.  $\frac{3}{4}$ -watt, Each 1.49

Ohms	1000	10k	20k
Cat. No.	271-342	271-343	271-340

(9) PC Board Pots.  $\frac{1}{4}$ -watt ..... Each 59¢

Ohms	Cat. No.	Ohms	Cat. No.
500	271-226	50k	271-219
1k	271-227	100k	271-220
5k	271-217	1 meg	271-229
10k	271-218		

(10) Miniature PC Pots.  $\frac{1}{8}$ -watt ..... 49¢ Each

Ohms	Cat. No.	Ohms	Cat. No.
1k	271-333	25k	271-336
10k	271-335	100k	271-338

## Learn as You Build With Our Project Books and Parts Kits

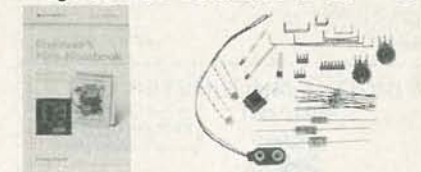

Timer IC Mini-Notebook. #276-5010 ..... 99  
 Timer Project Parts. #277-061 ..... 11.95  
 Op Amp Mini Notebook. #276-5011 ..... 1.49  
 Op Amp Project Parts. #277-062 ..... 11.95

## Breadboard Socket.

#276-174 .. 11.95



## Values in Sight and Sound

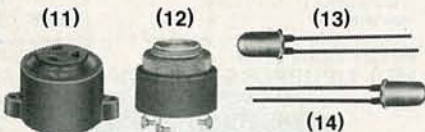

(11) Two-Tone Piezo Buzzer. Super-loud 100 dB sound level. 8-16 VDC. #273-070 ..... 8.95  
 (12) Piezo Buzzer. Steady or pulsed output. 90 dB level at 12 VDC, only 10 mA. #273-068, 6.95  
 (13) NEW! Super-Bright Red LED. A breakthrough! Typically 300 mcd at 20 mA. T-1 $\frac{3}{4}$  size. #276-066 ..... 99¢  
 (14) CQX21 Blinking LED. IC driver and red LED in a T-1 $\frac{3}{4}$  housing. Great for electronic jewelry. #276-036 ..... 1.59

## CMOS and TTL Digital ICs

- Top Quality
- With Pin-Out and Specs

Description	Type	Cat. No.	Each
Quad 2-Input NOR Gate	4001	276-2401	.99
Quad 2-Input NAND Gate	4011	276-2411	.99
Dual Type-D Flip Flop	4013	276-2413	1.19
Decade Counter/Divider	4017	276-2417	1.49
Inverting Hex Buffer	4049	276-2449	1.19
Quad Bilateral Switch	4066	276-2466	1.19

  

Description	Type	Cat. No.	Each
Quad 2-Input NAND Gate	7400	276-1801	.89
Hex Inverter	7404	276-1802	.99
Quad 2-Input AND Gate	7408	276-1822	1.29
BCD to 7-Segment Driver	7447	276-1805	1.69
Divide by 2/5 BCD Counter	7490	276-1808	1.19

## Heavy-Duty Automotive Relay

### Automotive Relay

Only  
4.99

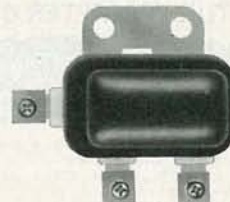

Here's the safe way to control high-power lighting, ham radio power supplies and other heavy-current auto accessories. SPST contacts are rated 30 amps at 12 VDC. 12 VDC coil. With mounting bracket. #275-225

## Modern Testers for Your Workbench



**Digital Multimeter With Autoranging.** Just select the function and our accurate Micronta® DVM does the rest! Features easy-to-read LC display, fuse and overload protection. Measures AC and DC voltage, DC current, resistance, and has a "diode-check" mode for semiconductor junctions. With probes, spare fuse. #22-188 ..... 34.95  
**Sale! Digital Logic Probe Now \$3 Off.** The fast way to test TTL, LS and CMOS circuits. LEDs and tone output indicate high, low or pulsed logic states. Reg. \$19.95. #22-302 ..... Sale 16.95

## Put These High-Tech ICs to Work

Give Your Computer a Voice!

New Touch-Tone Decoder



**SPO256-AL2 Speech Synthesis IC.** This 28-pin MOS LSI device uses a stored program to produce natural sounding speech. With circuit examples and detailed data. #276-1784 ..... 12.95  
**CTS256-AL2 Text-to-Speech IC.** This 40-pin device translates ASCII characters into control data for the synthesizer above. Makes it easy to add voice to most computers and terminals. With data. #276-1786, 16.95  
**NEW! SSI 202 Touch-Tone Decoder IC.** The "missing link" between the phone line and a device you want to control remotely. 18-pin package contains a complete DTMF receiver that detects either 12 or 16-digit formats. With data and circuit examples. #276-1303 ..... 12.95

Over 1000 items in stock: Binding posts, Books, Breadboards, Buzzers, Capacitors, Chokes, Clips, Connectors, Fuses, Hardware, ICs, Jacks, Knobs, Lamps, Multitesters, PC Boards, Plugs, Rectifiers, Relays, Resistors, Switches, Tools, Transformers, Transistors, Wire, Zener Diodes, more!

**Radio Shack®**

A DIVISION OF TANDY CORPORATION

Prices apply at participating Radio Shack stores and dealers

THE MOST POPULAR PRODUCTS IN EUROPE & ASIA ARE COMING NOW! 50 HOT ITEMS FOR YOUR SELECTION. SEND \$1.00 FOR MARK V CATALOG, REFUND UPON ORDER

### CORDLESS SOLDERING IRON RECHARGEABLE

No. 620



The most perfect handy, lightweight soldering iron for Workshop, Home, Hobby & Outdoor work... Includes UL approval charger & cleaning sponge. With built-in solder point illumination.

Each set ..... \$22.80

### TALKING CLOCK NEW FOR 86'



1. Talk: push button for voice announcement of time.
2. Read out: twelve hours system display for hour, minute, second (by color flash), AM & PM.
3. Display: three display modes of time, alarm time & date.
4. Alarm: on-off switch with thirty seconds voice alarm.
5. Snooze: reminder voice alarm of thirty seconds after 4 minutes of first voice alarm.
6. Volume: two level of voice output.
7. Language available: English.

Mynah 8504 ..... \$25.00 NOT A KIT!

### 3 1/2 DIGITAL MULTIMETER

YAMATO 4001



SPECIAL OFFER!

The YAMATO 4001 is a 3 1/2 DIGIT COMPACT DIGITAL MULTIMETER, it employs FE type LCD, with large figures. Its ADVANTAGES: High accuracy in measuring. High impedance assures min. measuring error. One rotary switch allows fast & convenient operation. 26 measurement range enable wider application. Over-input indication & low battery life appears on display. LSI-circuit use provides high reliability and durability. Measurement possible even under strong magnetic field.

Not a KIT, assembled with tested ..... \$33.80

### LCD THERMOMETER CLOCK NEW!



Features:  
0.34" DIGITAL thermometer with Hi & Low temperature alarm function and 12 hours clock combination.  
Measuring range: 0°F to 160°F or -20°C to +70°C.  
Resolution reading: ±1.8°F.  
Dimension: 3.2" x 0.86" x 2.08".

T-1 with In/Out Door sensor ..... \$20.00  
T-2 with Fahrenheit/Celsius measuring ..... \$18.00 NOT A KIT!

### 100W DYNAMIC CLASS "A" MAIN POWER AMPLIFIER

TA-1000A



This powerful dynamic bias class "A" circuit makes this unit unique in its class. Crystal clear 100W R.M.S. POWER output will satisfy the most picky HI-FI fans. This is a single channel amplifier. If you need a stereo effect you can buy two to make a total of 200W DYNAMIC POWER!

Over 3000 KITS ARE SOLD IN THE STATE!  
Ass. with tested ..... \$51.95

### 80W + 80W PURE DC STEREO POWER AMPLIFIER TA-802

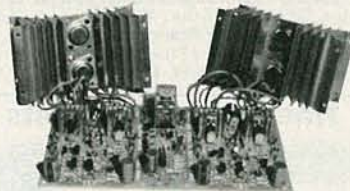

Kit ..... \$39.95

### NF-CR BI-FET PRE-AMP TA-2800



The heart of this Pre-amplifier is TL-984 IC which contains 4 BI-FET operational amplifier and has very good transient response and low distortion.

High precision NF-CR MM cartridge amplifier has a superior distortion characteristic (less than 0.005%) and RIAA equalization (0.2dB). It reproduces melodical sound.

It has 40 steps volume control, separate high, middle and low tone control, tone compensation and tone defeat system.

It is compatible with any power amplifiers which are made by our company such as TA-1000A, TA-477, TA-802.

Kit ..... \$44.50

### STEREO SIMULATOR

TA-3000



SPECIAL KITS OFFER!

KIT ONLY \$25.00

You can own a stereo TV from today! This simulator is a special design of using the most advanceable monoepoled L.S.I. It produced a superior analog stereo effect since the L.S.I. is equalled 60 pcs. of LOW NOISE FET & TRANSISTOR. The simulator can even help you to promote your television from a normal one to a special one with a HI-FI STEREO function. Our simulator is also applicable to any other 'mono sources' in covering it to ANALOG STEREO. Undoubtedly, it is the most advanced equipment for every family, while it should contribute to your listening pleasure.

Ass. with tested ..... \$30.00

### 10W AC/DC SHOULDER AMPLIFIER TA-008



TA-008 employs the most advanced I.C. of TOSHIBA, as a main device, the sound is powerful, it can be supplied by only 4 pieces of 'UM-1' 1.5V battery or AC to DC 9-9V adaptor. It is simple to operate, just 'press-to-talk', and with ON-OFF power switch on the mike. Besides, while it is well-packaged and with light weight, so it is convenient to bring along in both indoor and outdoor activities. Please Read our catalog for details.

Assembled with tested ..... \$48.00

### COLOR LIGHT CONTROLLER TY-23B



As a result of the advanced technology, this unit can control various colorful light bulbs, the visual effect of which is most suitable in places like party, disco, electronic game centre and also in lightings for advertisement. Total output power is 3000W (1000W/Ch.) which means that it can control 30 pieces of 100W or 600 pieces of 5W color light which is enough for most usages.

Kit ..... \$65.00  
Ass. with tested ..... \$75.00

### TA-2400A ELECTRONIC ECHO AND REVERBERATION AMPLIFIER

REMIX records yourself!



This unit combines the most advanced computer V.L.S.I. technique with high quality Japan Made component, so it has the following FEATURES:

It can generate various reflection and reverb effect such as that in valley and music hall. It has a 3 section effect control which includes reverb control, delay control and depth control. Special effect can be made in your record tapes by using this model. All kinds of infield sound effect can be obtained by skillful use of this control. It has LED display to show reflection and reverbation.

Ass. with tested ..... \$99.85

### HIGH QUALITY MULTIPURPOSE PRE-AMPLIFIER TA-2500



This specially designed pre-amplifier includes a professional GRAPH EQUALIZER TONE control system and has a gain to 12dB. Frequency response extends from 5Hz to 20KHz, so even in bad listening condition it can improve well. It can accept input from various magnetic cartridge, record deck and tuner, its output can be connected to all kinds of power amplifier! The following combinations are good examples.

Assembled with tested ..... \$90.00

Model No.	Description	Kit/Assembled	Unit Price	Model No.	Description	Kit/Assembled	Unit Price
TA-001	1W Mini Amplifier	Kit	\$3.90	TR-355 A, B	3-5A REGULATED DC POWER SUPPLY	Kit	\$8.90
TA-006	6W Mini Amplifier	Kit	\$4.92	TR-503	0-15V/3A POWER SUPPLY WITH SHORT CIRCUIT BREAK & OVERLOAD PROTECTOR	Kit	\$10.25
TA-007	12W Stereo Power Booster	Kit	\$8.00	TR-100	0-15V 2A REGULATED DC POWER SUPPLY	Ass	\$69.50
TA-008	AC/DC SHOULDER AMPLIFIER	Ass	\$48.00	TY-1A MK4	BATTERY FLUORESCENT LIGHT	Kit	\$59.50
TA-10	STEREO PRE-AMPLIFIER WITH MAGNETIC MIC AMP	Kit	\$6.00	TY-7	ELECTRONIC TOUCH SWITCH	Kit	\$3.99
TA-50 A, B	MULTI-PURPOSE MELODY GENERATOR	Kit	\$10.76	TY-11A	MULTI-FUNCTIONAL CONTROL RELAY	Kit	\$5.50
TA-120	PURE CLASS "A" MAIN POWER AMPLIFIER	Kit	\$25.00	TY-12A	DIGITAL CLOCK WITH TWO TIMER	Kit	\$3.99
TA-202	20W AC/DC STEREO AMPLIFIER	Ass	\$60.00	TY-13	COLOR LED VU METER	Kit	\$13.86
TA-300	30W Multi-Purpose Single Channel Amp.	Kit	\$11.07	TY-14	ELECTRONIC SHOCK	Kit	\$3.00
TA-302	60W Stereo Power Booster	Ass	\$50.00	TY-18	HIGH PRECISION SOUND CONTROL SWITCH	Kit	\$7.68
TA-323A	High Quality 30W+30W Stereo Amplifier	Kit	\$24.60	TY-20	SUPER SENSITIVE COLOR POWER LEVEL INDICATOR	Kit	\$19.50
TA-322i	60W IC Stereo Pre-Amplifier & Power Amplifier	Kit	\$29.50	TY-23B	COLOR LIGHT CONTROLLER	Kit	\$65.00
TA-400	40W TRANSISTORIZED MONO-AMPLIFIER	Kit	\$13.84	TY-25	SPEAKER PROTECTOR	Ass	\$75.00
TA-477	120W MOSFET POWER AMPLIFIER	Kit	\$61.28	TY-35	FM WIRELESS MICROPHONE	Kit	\$9.50
TA-800	80W+80W DC LOW TIM PRE-AMPLIFIER & POWER AMP.	Kit	\$55.38	TY-36	AC/DC QUARTZ DIGITAL CLOCK	Kit	\$7.68
TA-802	80W+80W PURE DC STEREO POWER AMP. (W/SPEAKER)	Kit	\$39.95	TY-38	SOUND OR TOUCH CONTROL SWITCH	Kit	\$10.00
TA-820A	60W+60W OCL DC PRE-MAIN & STEREO AMPLIFIER	Kit	\$43.00	TY-41 MKIII	INFRARED REMOTE CONTROL UNIT	Kit	\$25.00
TA-1000A	100W DYNAMIC CLASS "A" MAIN POWER AMP (MONO)	Kit	\$51.95	TY-42	BAR/DOT LEVEL METER	Ass	\$30.00
TA-1500	100Wx2 NEW CLASS "A" DC STEREO PRE-MAIN AMP	Kit	\$67.00	TY-45	BAR/DOT AUDIO LEVEL DISPLAY	Kit	\$21.00
TA-2400A	ELECTRONIC ECHO AND REVERBERATION AMP	Ass	\$99.85	TY-47	SUPERIOR ELECTRONIC ROULETTE	Kit	\$16.92
TA-2500	HIGH QUALITY MULTI-PURPOSE PRE-AMPLIFIER	Ass	\$90.00	YAMATO 4001	3 1/2 DIGITAL MULTIMETER	© SET	\$33.80
TA-2200	DC FET SUPER CLASS "A" PRE-AMPLIFIER	Kit	\$38.00	T2	LCD THERMOMETER CLOCK W/IN/OUT DOOR SENSOR	© SET	\$20.00
TA-2800	NF-CR BI-FET PRE-AMP (WITH 3WAY TONE CONTROL)	Kit	\$44.50	8504	TALKING CLOCK W/F/°C MEASURING	© SET	\$18.00
TA-3000	STEREO SIMULATOR	Ass	\$30.00	8502	TALKING CLOCK COCKATOO	© SET	\$25.00
SM-43	3 1/2 MULTI-FUNCTIONAL LED D.P.M.	Kit	\$25.00	NO. 620	CORDLESS SOLDERING IRON RECHARGEABLE	© SET	\$22.80
SM-48	4 1/2 HI-PRECISION D.P.M.	Ass	\$29.23	NO. 988	TURBO SCREW DRIVER RECHARGEABLE	© SET	\$30.00
SM-100	150MC UNIVERSAL DIGITAL FREQUENCY COUNTER	Ass	\$35.00				
TY-43	3 1/2 DIGITAL PANEL METER	Kit	\$38.00				

#### TERMS:

Min order: \$10.00  
Charge card order: \$20.00  
NO C. O. D. | Cashier's check, phone orders accept.  
Calif. Res Add 6.5% Sales Tax.  
Prices are subject to change without notice.

All merchandises are subject to prior sale.  
Shipping & Handling: Inside L. A. 5% of total order (Min 1.50). Outside L. A. 10% of total order (Min 2.50). Outside U.S.A. 20% of total order (Min 5.00).

Shipped by UPS



MARK V ELECTRONICS INC.  
248 E. Main Street,  
Suite 100,  
Alhambra, CA91801  
Information (818) 282-1130  
Orders (818) 282-1196  
P. O. BOX 7065 ALHAMBRA, CA 91802  
TELEX: 3716914 MARK 5

HOURS: MON - FRI 10:00 TO 5:00  
SATURDAYS 9:00 TO 12:00

CIRCLE 259 ON FREE INFORMATION CARD



### 7400

Part No.	Price	Part No.	Price
SN7400N	19	SN7485N	55
SN7402N	19	SN7486N	35
SN7404N	25	SN7488N	1.95
SN7405N	29	SN7490N	39
SN7406N	29	SN7493N	35
SN7407N	29	SN74121N	29
SN7408N	25	SN74123N	49
SN7410N	19	SN74125N	45
SN7414N	45	SN74126N	49
SN7416N	35	SN74143N	3.95
SN7417N	35	SN74150N	1.29
SN7420N	19	SN74154N	1.25
SN7430N	19	SN74158N	1.39
SN7432N	29	SN74193N	.75
SN7438N	29	SN74174N	.59
SN7442N	45	SN74175N	.59
SN7445N	.69	SN74176N	.89
SN7446N	.79	SN74181N	1.95
SN7447N	.79	SN74189N	.95
SN7448N	.79	SN74193N	.69
SN7472N	.39	SN74198N	1.35
SN7473N	.35	SN74221N	.89
SN7474N	.35	SN74273N	1.95
SN7475N	.39	SN74365N	.59
SN7476N	.35	SN74367N	.59

### 74LS

Part No.	Price	Part No.	Price
74LS00	19	74LS165	.79
74LS02	19	74LS173	.49
74LS04	25	74LS174	.39
74LS05	25	74LS175	.39
74LS06	.99	74LS175	.39
74LS07	.99	74LS189	3.95
74LS08	19	74LS191	.49
74LS10	19	74LS193	.59
74LS14	.39	74LS221	.69
74LS27	.25	74LS240	.69
74LS30	.19	74LS243	.69
74LS32	.25	74LS244	.79
74LS33	.39	74LS245	.69
74LS47	.39	74LS259	1.19
74LS73	.35	74LS273	.39
74LS74	.25	74LS279	.39
74LS75	.29	74LS322	2.95
74LS76	.29	74LS365	.39
74LS85	.49	74LS366	.39
74LS86	.49	74LS367	.39
74LS90	.39	74LS368	.39
74LS93	.39	74LS373	.79
74LS123	.49	74LS374	.79
74LS125	.39	74LS393	.79
74LS138	.39	74LS590	5.95
74LS139	.39	74LS624	1.95
74LS154	1.49	74LS625	2.49
74LS157	.35	74LS640	.99
74LS158	.35	74LS645	.99
74LS163	.49	74LS670	.99
74LS164	.49	74LS688	1.95

### 74S/PROMS\*

Part No.	Price	Part No.	Price
74S00	.29	74S188*	1.75
74S04	.35	74S189	1.95
74S08	.35	74S193	1.49
74S10	.29	74S240	1.49
74S32	.35	74S244	1.49
74S74	.49	74S253	.79
74S85	1.49	74S287*	1.69
74S86	.35	74S288*	1.69
74S124	.29	74S373	1.69
74S174	.79	74S374	1.69
74S175	.79	74S472*	3.49

### 74ALS

Part No.	Price	Part No.	Price
74ALS00	.35	74ALS138	.89
74ALS02	.35	74ALS174	.89
74ALS04	.39	74ALS175	.89
74ALS08	.35	74ALS240	1.79
74ALS10	.35	74ALS244	1.79
74ALS27	.39	74ALS245	2.49
74ALS30	.35	74ALS373	1.95
74ALS32	.39	74ALS374	1.95
74ALS74	.55	74ALS573	1.95

### 74F

Part No.	Price	Part No.	Price
74F00	.59	74F139	1.29
74F04	.65	74F157	1.29
74F08	.59	74F193	4.95
74F10	.59	74F240	2.49
74F32	.65	74F244	2.49
74F74	.69	74F253	1.79
74F86	.89	74F373	2.95
74F138	1.19	74F374	2.95

### CD - CMOS

Part No.	Price	Part No.	Price
CD4001	.19	CD4081	.25
CD4001	.19	CD4082	.25
CD4013	.35	CD4093	.39
CD4016	.29	CD4094	1.49
CD4017	.49	CD40103	2.95
CD4018	.69	CD4503	.49
CD4020	.59	CD4510	.69
CD4024	.49	CD4511	.69
CD4027	.39	CD4515	1.39
CD4030	.39	CD4518	.79
CD4040	.65	CD4520	.79
CD4049	.29	CD4522	.79
CD4050	.29	CD4538	.89
CD4051	.65	CD4541	.89
CD4052	.65	CD4543	.99
CD4053	.65	CD4553	4.95
CD4059	3.49	CD4555	.89
CD4060	.89	CD4566	1.95
CD4066	.29	CD4583	1.19
CD4069	.25	CD4584	.59
CD4070	.29	CD4585	.75
CD4071	.25	MC14411	9.95
CD4072	.25	MC14490P	4.49
CD4076	.89	MC14572	.89

### PRICE BREAKTHROUGH!

**CUSTOM COMMODORE CHIPS**  
for VIC-20, C-64 and C-128 Personal Computers

Part No.	Price	Part No.	Price	Part No.	Price
*6510CPU	49.95	*6526CIA	26.95	*6581SID	92.95
*6525TPI	20.95	*6560VIC-I	29.95	82S100PLA	97.95
*Specs. Available @ \$1.50 ea.		*6567VIC-II	44.95		

NOTE: 82S100 = U17 (C-64)

### MC68701 - Microcomputer with EPROM

**MOTOROLA**  
The MC68701 is an 8-bit single chip microcomputer unit (MPU) which significantly enhances the capabilities of the MC6800 family of parts. On-chip resources include 2048 bytes of EPROM, 128 bytes of RAM, Serial Communications Interface (SCI), parallel I/O, and a three function Programmable Timer.



MC68701.....\$24.95

### MICROPROCESSOR COMPONENTS

MICROPROCESSOR CHIPS		6500/6800/68000 Cont.		8000 SERIES Cont.	
Part No.	Price	Part No.	Price	Part No.	Price
D765AC	4.95	6840	6.75	8243	2.49
CDP1802CE	9.95	6843	19.95	8250A	6.95
2661-3	6.95	6845	4.95	8250B (For IBM)	5.95
<b>Z80, Z80A, Z80B, SERIES</b>					
Z80	1.75	6850	1.95	8251A	2.25
Z80-CTC	1.79	6852	4.75	8253-5	2.25
Z80-DART	4.95	69000LB	9.95	8254	9.95
Z80-F10	1.79	68661	8.95	8255A-5	2.25
Z80A	1.85	8031	6.95	8257-5	2.49
Z80A-CTC	1.89	80C31BH	19.95	8259-5	2.49
Z80A-DART	5.25	8035	1.95	8272	4.95
Z80A-P10	1.95	8073N	29.95	8279-5	2.95
Z80A-S10/0	5.25	8080A	3.95	8741	8.95
Z80B	3.95	8085A	2.75	8748	7.95
Z80B-CTC	4.95	8086-2	8.95	8749	9.95
Z80B-P10	4.95	8087 (5MHz)	129.95	8751	29.95
<b>6500/6800/68000 SER.</b>					
6502	2.75	8088	7.95	8755	14.95
6520	2.95	811E	8.95	<b>DATA ACQUISITION</b>	
6522	4.95	8155	2.75	ADC0804	3.49
6532	6.49	8156	2.75	ADC0808	8.95
6551	6.95	8203	29.95	ADC0809	3.95
6801-2	1.95	8212	1.95	ADC0817	8.95
6824	4.95	8224	4.25	DAC0808	1.95
6810	1.95	8228	3.49	DAC1008	7.95
6821	1.95	8237-5	6.95	AY-3-1015D	4.95
<b>DYNAMIC RAMS</b>					
Part No.	Function		Price		
4116N-15	16,384 x 1	(150ns)	.89		
4128	131,072 x 1	(200ns)	4.95		
4164N-150	65,536 x 1	(150ns)	1.25		
4164N-200	65,536 x 1	(200ns)	1.19		
TMS4416-12	16,384 x 4	(120ns)	4.95		
MM5280	4096 x 1	(200ns) 2107	1.95		
8118	16,384 x 1	(120ns) (+5V Only Required)	1.95		
4158-150	282,144 x 1	(150ns)	3.29		
T0464-15	65,536 x 4	(150ns) (4464) (41464)	7.95		
<b>STATIC RAMS</b>					
MM2016-12	2048 x 8	(120ns)	1.69		
2102	1024 x 1	(350ns)	.89		
2102-2L	1024 x 1	(250ns) LP (91L02)	1.49		
2114N	1024 x 4	(450ns)	.99		
2114N-L	1024 x 4	(450ns) LP	1.19		
2114N-2	1024 x 4	(200ns)	1.05		
2114N-2L	1024 x 4	(200ns) LP	1.49		
21C14	1024 x 4	(200ns) CMOS.	1.69		
2149	1024 x 4	(45ns)	4.95		
5101	256 x 4	(450ns) CMOS.	3.95		
HM6116P-3	2048 x 8	(150ns) CMOS.	1.79		
HM1616P-3	2048 x 8	(150ns) LP CMOS.	1.89		
HM6264P-12	8192 x 8	(120ns) CMOS.	4.69		
HM6264LP-12	8192 x 8	(120ns) LP CMOS.	4.79		
HM6264P-15	8192 x 8	(150ns) CMOS.	4.49		
HM6264LP-15	8192 x 8	(150ns) LP CMOS.	4.59		
6514	1024 x 4	(350ns) CMOS (UPD444C).	4.49		
<b>PROMS/EPROMS</b>					
1702A	256 x 8	(1µs)	3.95		
2708	1024 x 8	(450ns)	3.95		
TMS2716	2048 x 8	(450ns) 3 voltage	6.49		
2716	2048 x 8	(450ns)	2.49		
27C16	2048 x 8	CMOS.	9.95		
2732	4096 x 8	(450ns)	2.49		
2732A-20	4096 x 8	(200ns) 21V.	3.95		
2732A-45	4096 x 8	(450ns) 21V.	2.75		
27C32	4096 x 8	CMOS.	10.95		
2758	1024 x 8	(450ns) Single +5V.	3.95		
2764-20	8192 x 8	(200ns) 21V.	3.95		
2764A-25	8192 x 8	(250ns) 12.5V.	2.95		
2764-45	8192 x 8	(450ns) 21V.	2.19		
27C64	8192 x 8	CMOS 21V.	6.95		
27128-25	16,384 x 8	(250ns) 28K 21V.	2.95		
27256-25	32,768 x 8	(250ns) 256K (12.5V).	7.95		
27C256-25	32,768 x 8	(250ns) 256K (CMOS) (12.5V).	13.95		
68764	8192 x 8	(450ns) 25V.	15.95		
68766	8192 x 8	(350ns) 25V.	16.95		
74CS87	256 x 4	PROM O.C.	1.69		
74S471	256 x 8	PROM TS.	4.95		
82S123	32 x 8	PROM TS.	2.95		
82S129	256 x 4	PROM TS.	2.95		
<b>LOW PROFILE (TIN) SOCKETS</b>					
Part No.	1-9	10-99	100-up		
8 pin LP.	13	12	11		
14 pin LP.	15	13	11		
16 pin LP.	17	15	13		
18 pin LP.	25	23	21		
20 pin LP.	28	26	23		
22 pin LP.	30	28	26		
24 pin LP.	31	30	29		
28 pin LP.	39	37	35		
40 pin LP.	49	46	43		
<b>WIRE WRAP SOCKETS (GOLD) LEVEL #3</b>					
Part No.	1-9	10-99	100-up		
8 pin WW.	55	49	45		
10 pin WW.	65	59	55		
14 pin WW.	69	65	59		
16 pin WW.	75	69	65		
18 pin WW.	85	79	75		
20 pin WW.	95	89	85		
22 pin WW.	99	95	89		
24 pin WW.	119	109	99		
28 pin WW.	139	129	119		
36 pin WW.	149	139	129		
40 pin WW.	179	169	159		

- SOLDERTAIL STANDARD (GOLD & TIN) AND HEADER PLUG SOCKETS ALSO AVAILABLE -

### SATELLITE TV DESCRAMBLER

The MM5321 is a TV camera sync generator designed to supply the basic sync functions for either color or monochrome 525 line/60Hz interfaced and camera video recorder applications.

COLOR BURST GATE & SYNC  
ALLOW STABLE COLOR OPERATION  
**MM5321.....\$9.95**

### DIGITAL TALKER™

**DT1050** — Applications: Teaching aids, appliances, clocks, automotive, telecommunications, language translation, etc. The DT1050 is a standard DIGITAL TALKER kit enclosed with 137 separate and useful words, 2 tones, and 5 different silence durations. The words and tones have been assigned discrete addresses, making it possible to output single words or words concatenated into phrases or even sentences. The "voice" output of the DT1050 is a highly intelligible male voice.

The DT1050 consists of a Speech Processor Chip, MM54104 (40-pin) and two (2) Speech ROMs MM52164SSR1 and MM52164SSR2 (24-pin) along with a Master Word list and a recommended schematic diagram on the application sheet.

# Worldwide • Since 1974

## • QUALITY COMPONENTS • COMPETITIVE PRICING

### • PROMPT DELIVERY

Mail Order Electronics • Worldwide

# Jameco

## ELECTRONICS

### COMMODORE® COMPATIBLE ACCESSORIES



**RS232 Adapter**  
for VIC-20 and  
Commodore 64

The JE232CM allows connection of standard serial RS232 printers, modems, etc. to your VIC-20 and C-64 (excluding the SX-64 Portable). A 4-pole switch allows the inversion of the 4 control lines. Complete installation and operation instructions included.

• Plugs into User Port • Provides Standard RS232 signal levels  
• Uses 6 signals (Transmit, Receive, Clear to Send, Request to Send, Data Terminal Ready, Data Set Ready).

**JE232CM**.....\$39.95

**Voice Synthesizer VIC-20 & C-64**  
Plug-In — Talking in Minutes!

**JE520CM**.....\$99.95

**300 Baud Auto Modem**  
**Mitey-Mo** (For C-64).....\$74.95

**Parallel Printer Interface**  
**FREE 4K Buffer Included!**  
**MW350** (For VIC-20, C-64 & C-128).....\$69.95

### TRS-80 COMPATIBLE ACCESSORIES

**E-X-P-A-N-D TRS-80 MEMORY**  
All kits come complete with documentation

**TRS-80 MODEL I, III**  
TRS-16K3 200ns (Model III).....\$5.95  
TRS-16K4 250ns (Model I).....\$5.49

**TRS-80 COLOR AND COLOR II**  
TRS-64K-2.....\$11.95  
New models only —  
TRS-CoCo-Incl. 2-50464's (41464's).....\$19.95

**TRS-80 MODEL 4, 4P**  
TRS-64K-2.....\$11.95  
Expands Model 4 from 16K-64K or Model 4P from 64K-128K

**TRS-80 Model 100 • NEC • Olivetti**  
**M1008K**.....\$29.95 ea. or 3 for \$79.95  
TRS-80 Model 100 Expansion

**NEC8KR**.....\$29.95 ea. or 3 for \$79.95  
NEC Model PC-8201A Expansion

**OM108K**.....\$29.95 ea. or 3 for \$79.95  
Olivetti Model M10 Expansion

**TANDY 200**  
**M200R**.....\$99.95 ea. or 2 for \$189.95  
Tandy Model 200 Expansion

### PROMETHEUS MODEMS

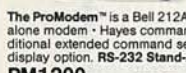

**Intelligent**  
**1200/300 Baud**  
**Modem with**  
**Real Time**  
**Clock/Calendar**

The ProModem™ is a Bell 212A (1200/300) intelligent stand-alone modem • Hayes command set compatible plus an additional extended command set • Shown with alphanumeric display option. RS-232 Stand-Alone Unit:

**PM1200**.....\$299.95

**Options for ProModem 1200**  
**PM-COM**.....\$79.95  
ProCom Communications Software. Please specify Operating System — Apple: ProDOS or CP/M — IBM: PC DOS or MS DOS

**PM-OP512K**.....\$129.95  
Communications Buffer Option

**BUF512K**.....\$54.95  
512K Memory for PM-OP512K

**PM-ALP**.....\$79.95  
Alphanumeric Display for ProModem 1200

**PM-SPECIAL #2**.....\$249.95  
Includes PM-OP512K, BUF512K and PM-ALP

### APPLE® COMPATIBLE ACCESSORIES

All Apple Cards come complete with instructions. **MADE IN THE USA!**

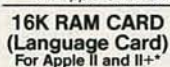

**16K RAM CARD (Language Card)**  
For Apple II and II+



**CONTROLLER CARD**  
For Apple II, II+ and IIe\*



**EXTENDED 80-COLUMN CARD**  
For Apple IIe\*

Expand from 48K-64K. Runs AppleSoft: DOS, CP/M and Pascal. (ARC-16K/MEM-1)  
**JE860\*\***.....\$39.95

Capable of handling up to two drives. Recommended drives: ADD-514 or ADD-12. (ACC-1)  
**JE875**.....\$49.95

JE864 is an extended 80-column/64K RAM Card. Ultra-high resolution capability.  
**JE864**.....\$69.95



**128K RAM CARD**  
For Apple II, II+ and IIe\*  
Four key software programs are included: Utilities, Diagnostics, Demos, and RAM Disk Emulators for DOS 3.3, CP/M and Apple Pascal. Expand-A-RAM:  
**JE868\*\***.....\$119.95



**APPLESURANCE DIAGNOSTIC DISK CONTROLLER CARD**  
For Apple II, II+ and IIe\*  
**PREVENTS CRASHES!**  
Test your RAM, ROM, CPU and Disk Drives. DRV-1/Applesurance II:  
**JE877**.....\$69.95



**PARALLEL PRINTER CARD**  
For Apple II, II+ and IIe\*  
Fully compatible with Apple CP/M, Apple Pascal (or FORTRAN), and most other operating systems and software packages. Available for Apple II, II+ and IIe\* PRT-1:  
**JE880**.....\$59.95



**PARALLEL/SERIAL 64K BUFFER CARD**  
For Apple II, II+ and IIe\*  
Using the parallel jumper cable supplied, the JE883 will attach to the JE880 (above). Parallel Card needed for operation. The JE883 includes a standard parallel input with both parallel and serial (RS232) buffered outputs. P/S Buffer:  
**JE883**.....\$79.95

\*APPLE, APPLE II, II+ and IIe are registered trademarks of Apple Computers.

\*\*When using CP/M, the JE860 and JE868 will only function with Version 2.20 or earlier: PASCAL (JE868) Version 1.1 or earlier.

### ADDITIONAL APPLE® COMPATIBLE PRODUCTS

- APF-1 Cooling Fan with Surge Protection • Key: (a,b).....\$39.95
- KHP4007 Switching Power Supply • Key: (a,b).....\$39.95
- JE614 Numeric/Aux. Keypad - 11 accessible functions • Key: (b).....\$49.95
- AMON 12" Green Monitor with Swivel Stand • Key: (a, b and IIc).....\$99.95
- KB-EA1 Apple Keyboard and Case • Key: (a).....\$99.95
- JE520AP Voice Synthesizer — Plug-In, User Ready • Key: (a,b).....\$119.95
- ADD-12 5¼" Half-Height Disk Drive • Key: (a,b).....\$129.95
- ADD-11c 5¼" Half-Height Disk Drive • Key: (I/c).....\$129.95
- ADD-514 5¼" Full Height Disk Drive • Key: (a,b).....\$139.95
- PM1200A Prometheus Internal Modem - 2 Cards • Key: (a,b).....\$299.95
- PM1200M Prometheus Macintosh Ext. Modem • Key: (Macintosh).....\$349.95

### GENERAL APPLICATION POWER SUPPLIES

Part No.	Output	Size (Inches)	Weight	PRICE
EMAS/6B	5V@3A / 6V@2.5A	4¼L x 4W x 2½H	2 lbs.	\$29.95
EMAS/6C	5V@6A / 6V@5A	5¼L x 4¼W x 2½H	4 lbs.	\$39.95

**Power/Mate Corp. REGULATED POWER SUPPLY**  
• Input: 105-125/210-250VAC @ 47-63Hz • Line regulation: ±0.05% • 3 mounting surfaces • Overvoltage protection • UL recognized • CSA certified

**4-CHANNEL SWITCHING POWER SUPPLY**  
• Microprocessor, mini-computer, terminal, medical equipment and process control applications • Input: 90-130VAC, 47-440Hz • Output: +5VDC @ 5A, -5VDC @ 1A; +12VDC @ 1A, -12VDC @ 1A • Line regulation: ±0.2% • Ripple: 30mV p-p  
• Load regulation: ±1% • Overcurrent protection • Adjustment: 5V main output ±10% • Size: 6¼L x 1¼W x 4-15/16"H • Weight: 1½ lbs.  
**FCS-604A**.....\$59.95

### IBM® COMPATIBLE ACCESSORIES



**83-KEY KEYBOARD**

• Identical layout as original IBM PC Keyboard • Highly desirable case with palm rest • Complete with cable and data • **JUST PLUG IN!**

**KB83**.....\$49.95

**Build an IBM PC/XT Compatible!**

- IBM-64K 64K RAM Chips (9).....\$10.49
- KB-83 83-Key Keyboard.....\$49.95
- IBM-FCC Floppy Controller Card.....\$59.95
- IBM-Case Case.....\$59.95
- IBM-MCC Monochrome Card.....\$89.95
- IBM-PS Power Supply.....\$99.95
- FD55B Disk Drive.....\$119.95
- IBM-MON Monochrome Monitor.....\$109.95
- IBM-MB Motherboard.....\$269.95

Regular List \$870.09

**IBM™-Special (Incl. 9 items above) ..\$749.95**



**IBM PC/XT Equivalent 130 Watt Power Supply**  
Upgrade Your PC!

• Input: 110V@60Hz • Output: +5VDC @ 15A, -5VDC @ 0.5A, +12VDC @ 4.2A, -12VDC @ 0.5A • Plug compatible connectors • Fits into IBM PC • Weight: 6 lbs.

**IBM-PS**.....\$99.95



**IBM Compatible! DISK DRIVES**  
Documentation Included

- FD55B Teac 5¼" DS ½-Height.....\$119.95
- SA455 Shugart 5¼" DS ½-Height.....\$119.95
- TM100-2 Tandon 5¼" DS Full-Height.....\$119.95

**JMR 5¼" DISK DRIVE ENCLOSURES**  
Complete with power supply, switch, power cord, fuseholder and connectors.

- DDE-1FH.....\$69.95  
Houses 1 Full-Height 5¼" Floppy Drive.
- DDE-2HH.....\$79.95  
Houses 2 Half-Height 5¼" Floppy Drives — Vertical
- HDDE-1FH.....\$199.95  
Houses 1 Hard Disk Drive

### UV-EPROM ERASER



Erases all EPROMs. Erases up to 8 chips within 21 minutes (1 chip in 15 minutes). Maintains constant exposure distance of 1". Special conductive foam liner eliminates static build-up. Built-in safety lock to prevent UV exposure. Compact - 9.00"L x 3.70"W x 2.60"H. Complete with holding tray for 8 chips.

- DE-4 UV-EPROM Eraser.....\$74.95
- UVS-11EL Replacement Bulb.....\$17.95

### DATA BOOKS

- 30003 National Linear Data Book (82).....\$14.95
- 30009 Intersil Data Book (85).....\$9.95
- 30013 Zilog Data Book (85).....\$14.95
- 30022 Nat'l. Logic Data Book Set (84).....\$24.95
- 210830 Intel Memory Handbook (83/84).....\$19.95
- 230843 Intel Microsystem Hndbk. (83/84).....\$19.95

### MUFFIN/SPRITE-STYLE FANS

- MUF60 (SPN3-15-2462).....\$9.95
- Howard Industries (4.68" sq., 60 cfm)
- SUC27.....\$9.95
- EG&G Rotron (3.125" square, 20 cfm)

**\$20 Minimum Order — U.S. Funds Only**  
Shipping: Add 5% plus \$1.50 Insurance

California Residents: Add 6% or 6½% Sales Tax

Spec. Sheets — 30¢ each  
Prices Subject to Change

Send stamped, self-addressed envelope to receive a Quarterly Sales Flyer — FREE!



Send \$1.00 Postage for a FREE 1986 JAMECO CATALOG

1355 SHOREWAY ROAD, BELMONT, CA 94002 • PHONE ORDERS WELCOME 415-592-8097 Telex: 176043

# GREAT PRICES! GUARANTEED 100%

★ ★ ★ **CALL TOLL FREE (800) 245-8555** ★ ★ ★

74 SERIES		CMOS
74 xx	.20	any 4000 series .24
741xx	.30	any 4500 series .45
742xx	.35	
743xx	.40	
74LSxx	.20	Z80 Series
74LS1xx	.30	2.5 mhz
74LS2xx	.40	CPU, CTC, PIO .75
74LS3xx	.45	DMA, DART, SIO 1.95
74Fxx	.25	4.0mhz (A)
74F1xx	.35	CPU, CTC, PIO 1.50
74F2xx	.50	DMA, DART, SIO 3.95
74F3xx	.55	
74HCTxx	.30	6.0mhz (B)
74HCT1xx	.40	CPU, CTC, PIO 2.50
74HCT2xx	.55	DMA, DART, SIO 6.95
74HCT3xx	.65	

DIGITAL IC SPECIALS			
Your Choice .17 ea.			
74LS00	74LS02	74LS08	74LS10
74LS11	74LS20	74LS30	74LS32
74LS74	74LS109		
Your Choice .22 ea.			
74LS153	74LS157	74LS161	74LS138
74LS139	74LS174	74LS166	74LS175
Your Choice .29 ea.			
74LS240	74LS241	74LS244	74LS245
74LS257	74LS273	74LS279	74LS280
74LS283	74LS368	74LS367	74LS393
74LS373	74LS374	74LS377	

**64K DRAM**

**Set of 9**

200ns .....\$8.99  
150ns .....\$9.99

**256K DRAM..... 150ns**

**Set of 9**

**29.95**

6500 / 6800 Series			
Any 65xx	1.50	Any 65xxA	2.00
Any 68xx	1.50	Any 65xxB	2.75
Any 68Axx	2.25	Any 68Bxx	2.95

**RAMS**			
2101	256x4	Static	450ns .39
2102	1Kx1	Static	450ns .39
2016-20	2Kx8	Static	200ns .95
2016-15	2Kx8	Static	150ns 1.45
2111	256x4	Static	450ns 1.65
2112	256x4	Static	450ns .75
2114-2	1Kx4	Static	200ns .37
2114-3	1Kx4	Static	300ns .35
2114-4	1Kx4	Static	450ns .32
2118	16Kx1	Static	150ns .49
2147	4x1	Static	55ns 1.49
4044-4	4Kx1	Static	450ns .45

E-Proms			
4044-2	4Kx1	Static	200ns .75
MK4118	1Kx8	Static	250ns .75
TMS4027	4Kx1	Static	250ns .25
UPD411	4Kx1	Static	300ns .69
MMS280	4Kx1	Static	300ns .45
6116-4	2Kx8	Static	200ns .95
6116-3	2Kx8	Static	150ns 1.25
4116-2	16Kx1	Dynamic	200ns .29
4116-25	16Kx1	Dynamic	250ns .25
6264LP-15	8Kx8	Static	150ns 4.75

2708	1Kx8	450ns	.55
2716-	2Kx8	450ns	.95
2716-3	2Kx8	350ns	1.25
2716-2	2Kx8	250ns	1.55
2732	4Kx8	450ns	1.25
2732-3	4Kx8	350ns	1.45
2732-3	4Kx8	250ns	1.75
2764	8Kx8	450ns	1.75
2764-3	8Kx8	350ns	1.95
2764-2	8Kx8	250ns	2.25
27128	16Kx8	350ns	2.75
27128-3	16Kx8	300ns	2.95
27128-2	16Kx8	200ns	3.15
27256	32Kx8	250ns	7.95

**\*\*CUT LEAD IC PROGRAM\*\*** These IC's are cut lead types - Useable in PC Boards or Sockets\*\*\*\*  
\*=- Used in IBM Clone Mother Boards any @ .12 ea.

7400	7402	7403	7404	7406	*7407	7408	7410	74109	7411	74123	74125
7414	74148	74153	74157	7416	74160	74161	74163	74165	74166	7417	74173
74174	74175	7491	74193	74195	74221	7425	7426	7427	74276	74279	74298
7430	7432	74367	74368	74368	74393	7440	7442	7445	7451	7473	7474
7486	7475	7489	7493	7493	*LS02	LS03	*LS04	LS05	*LS08	*LS10	LS107
LS112	*LS138	LS139	*LS14	*LS14	LS153	LS155	LS156	LS157	LS158	LS161	LS163
LS164	LS165	LS166	LS169	LS169	LS175	LS191	LS193	LS194	LS195	*LS20	LS221
LS240	LS241	*LS244	*LS245	LS251	LS253	LS257	LS266	*LS27	LS273	LS279	LS280
LS283	LS298	*LS30	*LS32	LS365	LS367	LS37	*LS374	LS375	LS377	LS378	LS38
LS393	*LS670	*LS74	LS86	*S00	S04	*S138	S161	S240	S241	S74	

8000's	
8031	3.95
8035	2.95
8039	2.45
INS8060	9.95
INS8073	9.95
8080A	.70
8085	3.95
8085A-2	9.95
8086	4.50
8086-2	5.25
8087-3	129.95
8087-2	169.95
8088	6.95
8089	29.95

8200's	
8202	9.95
8203	19.95
8205	2.50
8212	.90
8214	.95
8216	.90
8224	1.90
8226	1.90
8228	2.20
8237	2.90
8238	2.35
8243	1.25
8250	3.70
8251	1.75
8251A	1.85
8253	1.75
8253-5	1.75

8255	
8255	1.75
8255-5	1.75
8257	1.75
8259	1.75
8271	39.95
8272	3.95
8274	8.95
8275	8.95
8279	2.50
8282	2.95
8283	5.95
8284	2.45
8286	3.45
8287	5.95
8288	3.95
8289	3.95
8292	9.95

8300's	
8303	2.70
8304	1.70
8307	2.70
8308	2.70
8310	3.50
8311	3.50

8700's	
8741	7.95
8748	7.95
8749	7.95
8755	16.95

DISC CONTROLLERS		
1691	5.95	2795 19.95
1771	4.50	2797 19.95
1791	4.95	6843 12.95
1793	8.95	8272 3.95
1795	9.95	MB8876 9.95
1797	9.95	MB8877 9.95
2143	6.95	MC3470 1.50
2791	12.95	UPD765 4.25
2793	12.95	

CRT CONTROLLERS		
6845	1.75	CRT5057 1.95
6847	9.50	CRT5037 4.95
68B45	6.95	DP8350 19.95
7220	12.95	MC1372 1.95
8275	8.95	TMS9918A 14.95

**ALL ITEMS  
SUBJECT  
TO PRIOR  
SALE!**

**SPEED UP YOUR IBM BY 33%**  
New V-20 CPU Mfg. by NEC replaces the 8088 in your system. No compatibility problem.

\$15.95

---

**BIOS ROM**

FOR **\$9.97**

IBM CLONE Mother Boards

IBM CLONE MOTHER BOARD IC COMPLEMENT 8000's			
Part No.	IC's/B'd	Part No.	IC's/B'd
8088	1	7407	1
8284	1	8085	1
8288	1	74LS373	2
8255	1	74LS332	1
8237	1	74LS244	4
8253	1	74LS245	6
8259	1	74LS27	1
64K DRAMS	36	74LS20	2
Digital's 74 S#		74LS24	3
74S280	1	74LS02	2
74S74	1	74LS04	3
74S157	1	74LS08	1
74S138	1	74LS670	1
74S00	2	74LS175	2
		74LS32	1
		74LS10	1
		74LS00	2

When Purchase Individually \$99.00  
**SPECIAL \$79.95 for Entire Set of IC's**

** MISCELLANEOUS IC SPECIALS **							
TR1602	.95	2652	.65	CD4049	.19	75454	.19
WD1100	.65	D2817	.95	CD4077	.19	TLO-71	.19
MC1776CPI	.65	2901PC	.95	CD4081	.19	COM8017	.95
MC12002L	.65	2910PC	.95	MMS262	.19	N8T25	.19
AY5-1013	.95	D3232	.65	NE555	.19	P8254-2	.95
IMS1420-	.75	MK3887N	.95	NE556	.39	N82S115T	.95
MC1458	.22	CD4008	.17	SV5520	.79	8602	.29
MC1488	.26	CD4011	.17	HM6116	.75	Z8001ADC	.95
MC1489	.26	CD4013	.19	HM6147	.29	CRT9006	.95
AM2167	.75	CD4019	.19	TLO-62	.19	CRT9007	.95
MN27580	.55	CD4025	.19	SV6545	.95	CRT9212	.95
26LS31	.19	TMS4027	.29	MC6810	.35	MC10104P	.65
26LS32	.19	TMS4050	.19	MC6845	.79	AM9602	.29
2651P2	.65	TMS4060	.19	UA709CP	.19	TMS9937	.95
SCM2661A	.75	CD4042	.19	75451BP	.19	AM9517A4	.95

**ELECTRONIC PARTS OUTLET**  
2515 N. Scottsdale Road  
Scottsdale, AZ 85257 (602) 941-9357  
(SEND FOR OUR FREE CATALOGUE)  
**TOLL FREE!!**  
CALL (800) 245-8555

In Phoenix, AZ  
**ELECTRONIC PARTS OUTLET**  
1921C W. Thunderbird  
Phoenix, AZ 85023  
602-375-0181 , 2

In Florida  
**ELECTRONIC PARTS OUTLET**  
2275 So. Federal Hwy  
DelRay Beach, FL 33444  
305-265-1206 , 7



# RAMSEY

# THE FIRST NAME IN ELECTRONIC TEST GEAR

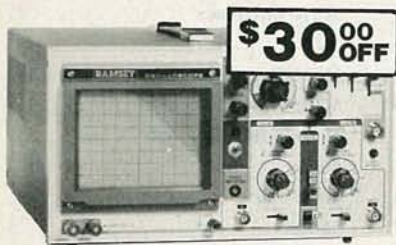

**\$30 OFF**

### Save \$30 on the RAMSEY 20MHz Dual Trace Oscilloscope

Unsurpassed quality at an unbeatable price, the Ramsey oscilloscope compares to others costing hundreds more. Features include a component testing circuit for resistor,

capacitor, digital circuit and diode testing • TV video sync filter • wide bandwidth & high sensitivity • internal graticule • front panel trace rotator • Z axis • high sensitivity x-y mode • regulated power supply • built-in calibrator • rock solid triggering

Was \$399.95 NOW ONLY **\$369.95** high quality hook on probes included



### NEW RAMSEY 1200VOM MULTITESTER

Check transistors, diodes and LEDs with this professional quality meter. Other features include, decibel scale • 20K volt metering system • 3/4" mirrored scale • polarity switch • 20 measuring ranges • safety probes • high impact plastic case

**\$1.995** test leads and battery included



**NEW**

### RAMSEY D-4100 COMPACT DIGITAL MULTITESTER

Compact sized reliability and accuracy. This LCD digital multitester easily fits in your pocket, you can take it anywhere. It features full overload protection • 3 1/2 digit LCD readout • recessed input jacks • safety probes • diode check function • 2000 hours battery life

**\$2.295** test leads and battery included

### NEW 35 MHz DUAL TRACE OSCILLOSCOPE



A heavy duty and accurate scope for service as well as production use. Features include • wide frequency bandwidth • optimal sensitivity • extremely bright display • delayed triggering sweep • hold off • ALT trigger • single sweep • TV sync • 5X magnification • XY or XYZ operation • HF/LF noise reduction

### 3500 Dual Trace Oscilloscope

**\$499.95** includes 2 high quality probes

**ALL OSCILLOSCOPES INCLUDE 2 PROBES**

### NEW 15 MHz DUAL TRACE PORTABLE OSCILLOSCOPE

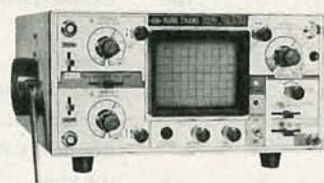

Ideal for field/bench applications, this scope can display up to 15 MHz signals. Internal battery pack allows up to 2 hours operation on a single charge.

Features include • built-in battery charger • 5X horizontal magnification • high brightness CRT • front panel trace rotator • internal rechargeable battery pack

### 2500 Portable Oscilloscope

**\$449.95** includes 2 high quality probes

## MINI KITS—EASY TO ASSEMBLE, FUN TO USE BEGINNERS & PROS WILL HAVE A GREAT TIME WITH THESE KITS

### FM MINI MIKE



A super high performance FM wireless mike kit! Transmits a stable signal up to 300 yards with exceptional audio quality by means of its built-in electret mike. Kit includes case, mike, on-off switch, antenna, battery and super instructions. This is the finest unit available.

FM-3 Kit **\$14.95**  
FM-3 Wired and Tested **19.95**

### Color Organ

See music come alive! 3 different lights flicker with music. One light each for, high, mid-range and lows. Each individually adjustable and drives up to 300 W. runs on 110VAC.

Complete kit, ML-1 **\$8.95**

**Video Modulator Kit**  
Converts any TV to video monitor. Super stable, tunable over ch. 4-6. Runs on 5-15V accepts std. video signal. Best unit on the market! Complete kit, VD-1 **\$7.95**



### Led Blinky Kit

A great attention getter which alternately flashes 2 jumbo LEDs. Use for name badges, buttons, warning panel lights, anything! Runs on 3 to 15 volts. Complete kit, BL-1 **\$2.95**

### Super Sleuth

A super sensitive amplifier which will pick up a pin drop at 15 feet! Great for monitoring baby's room or as general purpose amplifier. Full 2W rms output, runs on 6 to 15 volts, uses 8-45 ohm speaker. Complete kit, BN-9 **\$5.95**

### CPO-1

Runs on 3-12 Vdc 1 wall out, 1 KHZ good for CPO, Alarm, Audio Oscillator. Complete kit **\$2.95**

### FM Wireless Mike Kit

Transmits up to 300' to any FM broadcast radio, uses any type of mike. Runs on 3 to 9V. Type FM-2 has added sensitive mike preamp stage.

FM-1 Kit **\$3.95** FM-2 Kit **\$4.95**

### Universal Timer Kit

Provides the basic parts and PC board required to provide a source of precision timing and pulse generation. Uses 555 timer IC and includes a range of parts for most timing needs.

UT-5 Kit **\$5.95**

### Whisper Light Kit

An interesting kit, small mike picks up sounds and converts them to light. The louder the sound, the brighter the light. Includes mike, controls up to 300 W, runs on 110 VAC. Complete kit, WL-1 **\$6.95**

### Tone Decoder

A complete tone decoder on a single PC board. Features: 400-5000 Hz adjustable range via 20 turn pot, voltage regulation, 567 IC. Useful for touch-tone burst detection, FSK, etc. (Can also be used as a stable tone encoder. Runs on 5 to 12 volts. Complete kit, TD-1 **\$5.95**

### Mad Blaster Kit

Produces LOUD ear shattering and attention getting siren like sound. Can supply up to 15 watts of obnoxious audio. Runs on 6-15VDC. Complete kit, MB-1 **\$4.95**

### Siren Kit

Produces upward and downward wail characteristic of a police siren. 5 W peak audio output, runs on 3-15 volts, uses 3-45 ohm speaker. Complete kit, SM-3 **\$2.95**

**60 Hz Time Base**  
Runs on 5-15 VDC. Low current (25ma) 1 min/month accuracy TB-7 Kit **\$5.95**  
TB-7 Assy **\$3.95**

### 30 Watt 2 mtr PWR AMP

Simple Class C power amp features 8 times power gain, 1 W in for 8 out, 2 W in for 15 out, 4 W in for 30 out. Max output of 35 W, incredible value, complete with all parts, less case and T-R relay.

PA-1, 30 W pwr amp kit **\$22.95**  
TR-1, RF sensed T-R relay kit **6.95**

### Power Supply Kit

Complete triple regulated power supply provides variable 6 to 18 volts at 200 ma and +5 at 1 Amp. Excellent load regulation, good filtering and small size. Less transformers, requires 6-9V (a 1 A and 24 VCT. Complete kit, PS-3LT **\$6.95**

### CT-70 7 DIGIT 525 MHz COUNTER

Lab quality at a breakthrough price. Features • 3 frequency ranges each with pre amp • dual selectable gate times • gate activity indicator • 50mV @ 150 MHz typical sensitivity • wide frequency range • 1 ppm accuracy

**\$11.995** wired includes AC adapter

CT-70 kit ..... **\$99.95**  
BP-4 nicad pack ..... **8.95**

### CT-50 8 DIGIT 600 MHz COUNTER

**\$16.995** wired

CT-50 kit ..... **\$139.95**  
RA-1 receiver adapter kit ..... **14.95**

### CT-90 9 DIGIT 600 MHz COUNTER

The most versatile for less than \$300. Features 3 selectable gate times • 9 digits • gate indicator • display hold • 25mV @ 150 MHz typical sensitivity • 10 MHz timebase for VVW calibration • 1 ppm accuracy

**\$14.995** wired includes AC adapter

CT-90 kit ..... **\$129.95**  
OV-1 0.1 PPM oven timebase ..... **59.95**  
BP-4 nicad pack ..... **8.95**

### CT-125 9 DIGIT 1.2 GHz COUNTER

**\$16.995** wired includes AC adapter

BP-4 nicad ..... **\$8.95**



### DM-700 DIGITAL MULTIMETER

Professional quality at a hobbyist price. Features include 26 different ranges and 5 functions • 3 1/2 digit, 1/2 inch LED display • automatic decimal placement • automatic polarity

**\$11.995** wired includes AC adapter

DM-700 kit ..... **\$99.95**  
MP-1 probe set ..... **4.95**



### PR-2 COUNTER PREAMP

The PR-2 is ideal for measuring weak signals from 10 to 1,000 MHz • flat 25 db gain • BNC connectors • great for shifting RF • ideal receiver/TV preamp

**\$4.495** wired includes AC adapter

PR-2 kit ..... **\$34.95**

### PS-2 AUDIO MULTIPLIER

The PS-2 is handy for high resolution audio resolution measurements, multiplies up in frequency • great for PL tone measurements • multiplies by 10 or 100 • 0.01 Hz resolution & built-in signal preamp/conditioner

**\$4.995** wired

PR-2 kit ..... **\$39.95**

### PS-10B 1.5 GHz PRESCALER

Extends the range of your present counter to 1.5 GHz • 2 stage preamp • divide by 1000 circuitry • super sensitive (50 mV typical) • BNC connectors • 1 GHz in, 1 MHz out • drive any counter

**\$7.995**

PS-10-B Prescaler ..... **\$7.995**  
wired includes AC adapter

### ACCESSORIES FOR RAMSEY COUNTERS

- Telescopic whip antenna—BNC plug ..... **\$ 8.95**
- High impedance probe, light loading ..... **16.95**
- Low pass probe, audio use ..... **16.95**
- Direct probe, general purpose use ..... **13.95**
- Tilt ball, for CT-70, 90, 125 ..... **3.95**

VISA MasterCard  
**PHONE ORDERS CALL 716-586-3950**  
TELEX 466735 RAMSEY CI

TERMS: • satisfaction guaranteed • examine for 10 days, if not pleased, return in original form for refund • add 6% for shipping and insurance to a maximum of \$10.00 • overseas add 15% for surface mail • COD add \$2.50 (COD in USA only) • orders under \$15.00 add \$1.50 • NY residents add 7% sales tax • 90 day parts warranty on all kits • 1 year parts & labor warranty on all wired units.

**RAMSEY**  
RAMSEY ELECTRONICS, INC.  
2575 Baird Rd.  
Penfield, N.Y. 14626

# ADVERTISING INDEX

RADIO-ELECTRONICS does not assume any responsibility for errors that may appear in the index below.

Free Information Number	Page		Page		Page
269	A.I.S. Satellite	79	268	Coop's Satellite Digest	81
108	AMC Sales	8	267	Copper Electronics	87
76	AP Products	24	127	Deco Industries	79
—	Ad Mart	CD6	270	Delta Electronics	102
—	Advanced Electronics	27	95	Dick Smith Electronics	92,93
107	All Electronics	99	82	Digi-Key	113
72	Amazing Devices	102	—	Digital Research Computers	100
—	American Design Components	110	252	Electronic Parts Outlet	116
84	Appliance Service	79	277	Electronics Book Club	23
77	B&K Precision	14	—	Electronics Technology Today	CD10
53	BUYUS	79	120	Elephant Electronics	79
98	Beckman Industrial	82	111,253	Etronix	9,82
251	Becktron	20	100	Firestik II	82
274	Blue Star Industries	79	254	Fluke Manufacturing	7
265	Boardworks	84	—	Fordham Radio	CV4
266	C & S Sales	39	—	Grantham College of Engineering	41
—	C.O.M.B.	12,29	—	HW Sams	28,40
—	CIE	34	271	Hameg	25
264	Caig Laboratories	86	86	Heath	26
275	Cameo Enterprises	79	59	JDR Instruments	13
54	Chemtronics	87	113,255,	JDR Microdevices	104,105
—	Command Productions	84	256,257	JDR Microdevices	106,107
79	Communications Electronics	3,33	258	JDR Microdevices	108
280	Cook's Institute	8	114	Jameco	114,115
			115	Jensen Tools	79
				Joseph Electronics	42
				J&W	101
				MCM Electronics	109
				Mark V. Electronics	112
				McGraw Hill Book Club	52
				Mercer	CV3
				Micro-Mart	96
				Mouser	9
				NRI	16
				O.K. Industries	8,9
				Omnitron	22
				Pacific Cable	97
				Probemaster	15
				Prof. Diving School of N.Y.	86
				RAG Electronics	5
				RCA D&SP	11,31
				Radio Shack	111
				Ramsey	117
				Saratoga Electronics	98
				Spartan Electronics	118
				Tektronix	CV2
				Toroid Corp. of Maryland	30
				U.S. Instrument Rentals	21
				Wm B. Allen	103

**SPARTAN PRICE BUSTER**



(516) 499-9500  
6094 Jericho Tpke.  
Commack, N.Y. 11725

**WELLER Temperature Controlled Soldering Station**



**\$97.95**

- Control Ranges 600 F, 700 F, 800 F
- Change temperature by simply changing the heat sensing tip
- Safe for IC Soldering
- Storage Tray for extra tips and tip cleaning sponge with receptacle
- Comes with 1/8" screwdriver tip 700 F, 3 wire 4.5' long cord

**SGL WABER DATAGARD Spike & Noise Suppressor**



**\$37.95**

**PROTECT YOUR COMPUTER WITH DATAGARD**

Datagard DG115S provides a single-stage spike filter and a single-stage noise filter to protect against moderate and catastrophic spikes and virtually all unwanted noise interference coming through the wall outlet.

**NEW 12" DIAGONAL MONITOR**



Green **\$90.95**  
Amber **\$95.95**

- Monochrome display
- Composite video
- 80 characters & 25 lines
- 700 line resolution at center
- Non-glare CRT

**HAYES Smartmodem 1200**



**\$390.95**

- Full or Half Duplex
- 300 BPS or up to 1200 BPS operation
- Auto Answer and Auto Dial
- Connects directly to telephone lines

**XCELITE** **\$33.00**



Multipurpose fourteen piece nut and screwdriver set.

**RS232 TRANSMISSION LINE TESTER**



**\$18.95**

Features: \*Male to Female connector for easy insertion into RS232 Line \*Test 7 Lines (TD, RD, RTS, CIS, DSR, CD, DTR) using LED's to indicate status of each \*Directly powered by RS232 Line no AC power needed.

**GENERAL INSTRUMENT 58 Channel Remote Controller**



LCC-58  
**\$75.95**

- On/off fine tune
- Wireless
- Installs in minutes

**PHILIPS REMOTE CABLE CONVERTER**



**\$121.95**

- Micro computer technology
- Quartz controlled IC's lock in picture & prevent drift
- 60 channel selection
- Programmable time on & off
- 24 hour LED digital clock
- Favorite channel memory & recall plus scan
- Wireless hand held "infra-red" transmitter system
- Automatic fine tune
- Adaptable to any brand television
- One year warranty service

**Dealers Welcome**

Prices subject to change without notice. COD \$2.00 Extra

We accept MC, Visa, Amex. COD (w \$10 deposit) Shipping charges as follows:

to 75.00	\$2.50
76.00 to 250.00	\$4.50
251.00 to 500.00	\$6.00
501.00 to 750.00	\$8.50
751.00 to 1000.00	\$12.00
Over 1000.00	\$12.50

**Store Hours:**  
Mon-Fri 9-6 Sat. 9:30-5  
**(516) 499-9500**  
TELEX: 551427 SPARTAN

Gernsback Publications, Inc.  
500-B Bi-County Blvd.  
Farmingdale, NY 11735  
(516) 293-3000  
President: Larry Steckler  
Vice President: Cathy Steckler

**For Advertising ONLY 516-293-3000**

Larry Steckler  
publisher

Arline Fishman  
advertising coordinator

Shelli Weinman  
advertising associate

Lisa Strassman  
credit manager

Donna Sala  
credit associate

Christina Estrada  
advertising assistant

**SALES OFFICES**

**EAST/SOUTHEAST**  
Stanley Levitan  
Eastern Sales Manager  
Radio-Electronics  
259-23 57th Avenue  
Little Neck, NY 11362  
718-428-6037, 516-293-3000

**MIDWEST/Texas/Arkansas/Okla.**  
Ralph Bergen  
Midwest Sales Manager  
Radio-Electronics  
540 Frontage Road—Suite 339  
Northfield, IL 60093  
312-446-1444

**PACIFIC COAST/ Mountain States**  
Marvin Green  
Pacific Sales Manager  
Radio-Electronics  
15335 Morrison St.—Suite 227  
Sherman Oaks, CA 91403  
818-986-2001

CIRCLE 75 ON FREE INFORMATION CARD

RADIO-ELECTRONICS

Simpson Electric Co.  
Introduces

# mercer

## The Ultimate in Low-Cost Test Equipment

At last! Here is your opportunity to take your pick from a new test equipment line that has all the features you need and more... and at a price that is unbelievably low.

**MODEL 9340**  
Pocket size, 3½-digit  
DMM with 20 megohm  
range and 10 megohm  
input resistance  
**\$44<sup>00</sup>**

**MODEL 9670**  
Digital capacitance  
tester covering 0.1 pF  
to 20,000 µF  
**\$99<sup>00</sup>**

**MODEL 9101**  
Compact VOM with 27  
ranges, including a  
100 megohm range  
**\$29<sup>00</sup>**

**MODEL 9301**  
3½-digit, hand-held  
DMM with 0.25%  
basic accuracy and  
2,000-hour battery life  
**\$69<sup>00</sup>**

**MODEL 9120**  
Analog VOM with 12 A  
DC range and output  
jack  
**\$39<sup>00</sup>**

**MODEL 9401**  
4½-digit, full function,  
hand-held DMM with  
.05% accuracy and  
data hold  
**\$129<sup>00</sup>**

**MODEL 9701**  
digi-clamp™ compact  
AC clamp-on volt-ohm-  
ammeter with data hold  
**\$69<sup>00</sup>**

**MODEL 9370**  
3½-digit autoranging  
DMM with a memory  
mode and 0.5% basic  
DC accuracy  
**\$59<sup>00</sup>**

# mercer

ELECTRONICS

Division of Simpson Electric Company

859 Dundee Avenue, Elgin, IL 60120-3090  
(312) 697-2265 • Telex 72-2416

Mercer Electronics products reflect the design and quality standards established by Simpson Electric Company, an industry leader for over 50 years and known worldwide for its integrity and product excellence.

**In Stock... Available Now!** Stop in at your nearest distributor and see this new, complete line of Mercer test instruments. For the name of the MERCER distributor in your area, call (312) 697-2265, or send for our new line catalog.

CIRCLE 267 ON FREE INFORMATION CARD



# SCOPE 3 1/2 DIGIT LCD MINI-METER WITH THE MAXI-SPECS

Small enough to fit in your shirt pocket

**\$29.95**  
ONLY Model DVM-630

Model CC-30 Deluxe  
Zippered Carrying Case \$4.50

- 0.5% DC accuracy
- 6 Functions, 19 Ranges
  - DC Voltage, 0.1 mV to 1000 V
  - DC Current, 0.1 uA to 2A
  - Resistance, 0.1 ohm to 2 M ohm
  - Diode Test
  - Battery Test
- Measures approx. 5 x 2 3/4 x 7/8 in.
- 300 hour battery life
- Automatic zero adjust
- Low battery indication
- Test leads included



Model DCM-602

**\$69.95**

### 3 1/2 Digit Capacitance Meter

8 ranges with full scale values to 2000 uF

- FEATURES** • Broad test range - 1 pF to 2000 uF • LSI circuit provides high reliability and durability • Lower power consumption • Crystal time base
- Protected from charged capacitors
  - Frequency range - 800 Hz to 8 Hz

### SCOPE HAND-HELD DIGITAL CAPACITANCE and MULTIMETERS

- 0.5% DC Accuracy
- Highest Quality
- Highest Performance
- Lowest Prices



Model DVM-634

**\$48.75**

7 functions, 32 ranges.  
Transistor measurement included.

Model DVM-638

**\$79.95**

11 functions, 38 ranges.  
Includes logic level detector,  
audible visual continuity,  
capacitance and conductance  
measurement.

Model DVM-636

**\$62.75**

8 functions, 37 ranges.  
Capacitance measurement  
included.

### 3 1/2 Digital Multimeters

- FEATURES** • DC Voltage 100 uV - 1000 V • AC Voltage 100 uV - 750 V • AC/DC Current 200 uA - 10 Amps • Resistance 20 Megohms • Capacitance (DVM 636/638) 1 pF - 20 uF • Overload Protection • Auto-decimal LCD readout • Polarity indication • 300 hour battery life with 9V transistor battery • Low battery indication

ASK FOR FREE CATALOG.

Money orders, checks accepted. C.O.D.'s require 25% deposit.



Toll Free  
**800-645-9518**  
In NY State 800-832-1446

# Fordham

260 Motor Parkway, Hauppauge, NY 11788

#### Service & Shipping Charge Schedule Continental U.S.A.

FOR ORDERS	ADD
\$25-\$100	\$4.50
\$101-\$250	\$6.00
\$251-\$500	\$8.00
\$501-\$750	\$10.50
\$751-\$1,000	\$12.50
\$1,001-\$1,500	\$16.50
\$1,501-\$2,000	\$20.00
\$2,001 and Up	\$25.00