

Lexium™ 32 Servo Drives

Motion control

Catalog
2014





Lexium™ 32 Servo Drives Motion control

■ Product data website	4
------------------------------	---

Lexium 32 motion control

■ Overview	6
■ Selection guide: Servo motor/servo drive combinations	10

Lexium 32 servo drives

■ References	
□ Servo drives	18
□ Accessories and documentation	20
□ Dialog tools	21
□ Configuration tools	22
□ Connection accessories	24
■ Communication buses and networks	26
■ Options	
□ Encoder cards for Lexium 32M servo drives	32
□ Safety card for Lexium 32M servo drives	34
□ Input/output extension card for Lexium 32M servo drives	35
□ Braking resistors	36
□ Line chokes	37
□ Integrated and additional EMC input filters	38
■ SoMove setup software	40
■ Motor starters	44

BMH servo motors

■ Introduction	46
■ References	48
■ Options	
□ Integrated holding brake	54
□ Integrated encoder	55
□ GB● planetary gearboxes	56
□ GBY angular planetary gearboxes	58

BSH servo motors

■ Introduction	60
■ References	62
■ Options	
□ Integrated holding brake	66
□ Integrated encoder	67
□ GB● planetary gearboxes	68
□ GBY angular planetary gearboxes	70

Index

■ Product reference index	72
---------------------------------	----



Go online to www.schneider-electric.com for information about Lexium™ products listed in this catalog, including:

- 1 Go to: www.schneider-electric.com and select **“Products”** on the **“Products and Services”** tab.

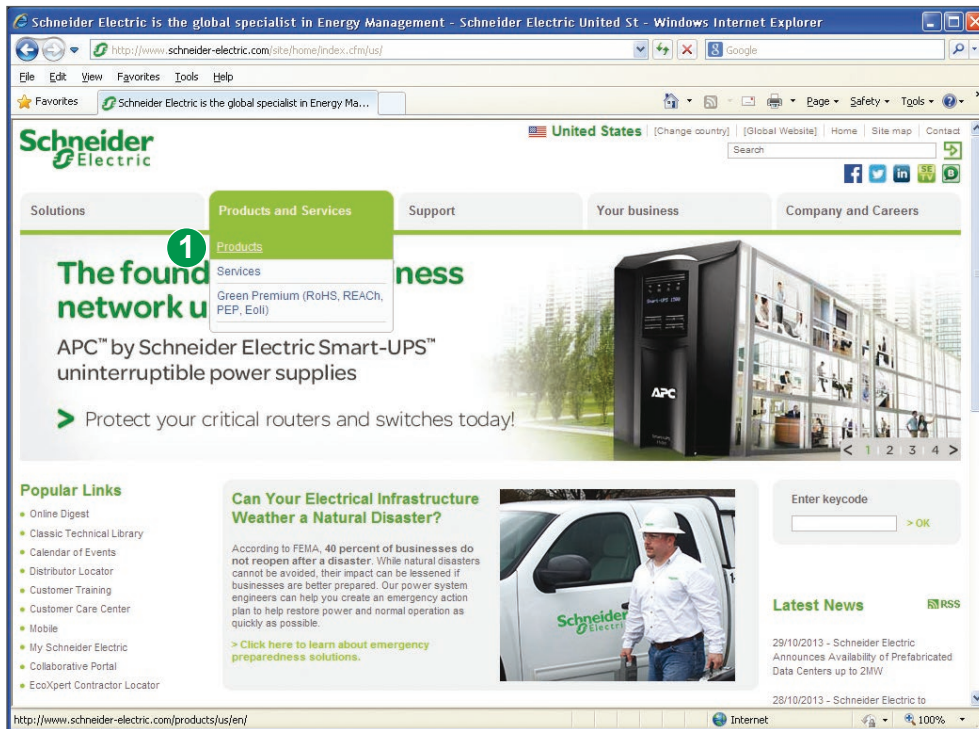

- 2 On the **“Products”** page, find the **“Motion Control”** icon and select **“All Motion Control”**.

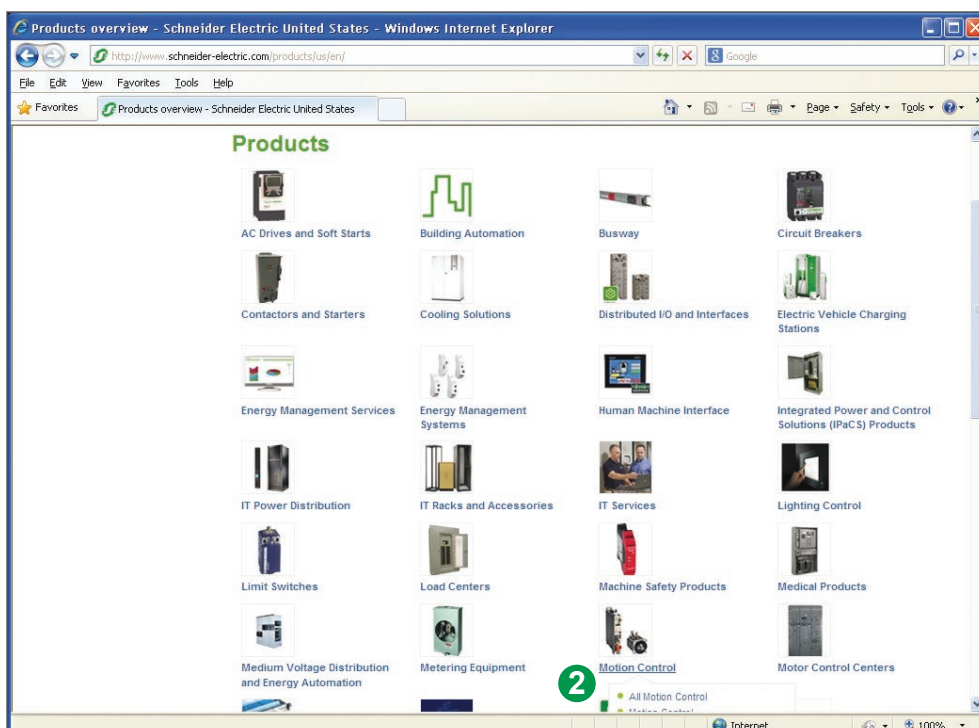

> Specifications > Dimensions > References
> Curves > Links to user guides and CAD files



3 On the “Motion Control” page, select “Lexium 32 & Motors”.

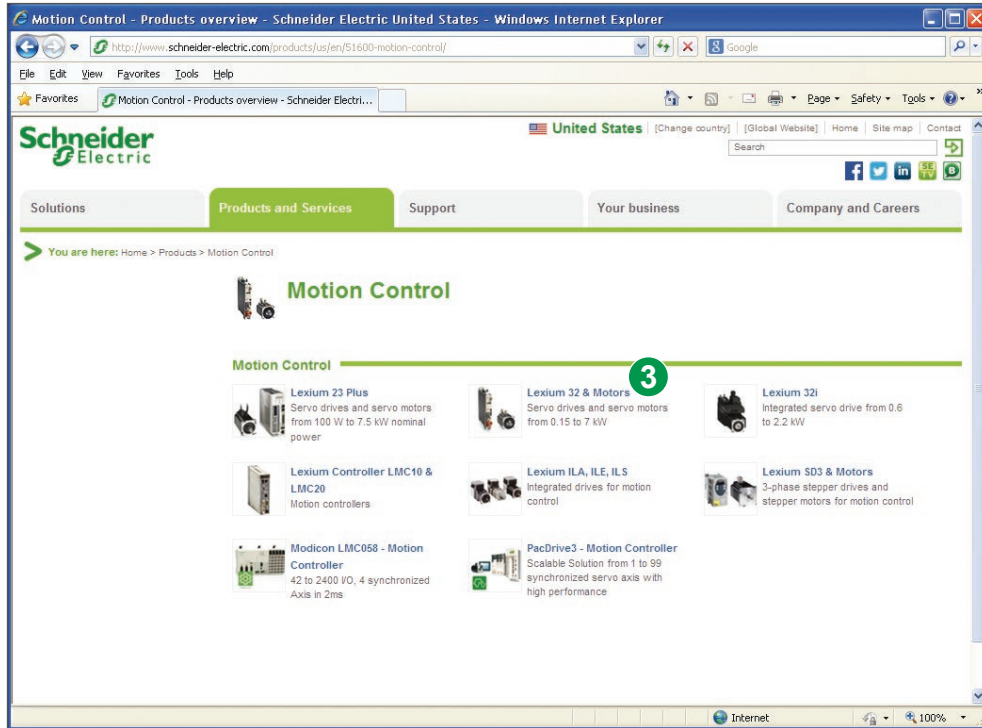

4 Explore the Lexium 32 & Motors product page, including the “Product Information” tabs: “Product Configurator” and “Product Selector”.

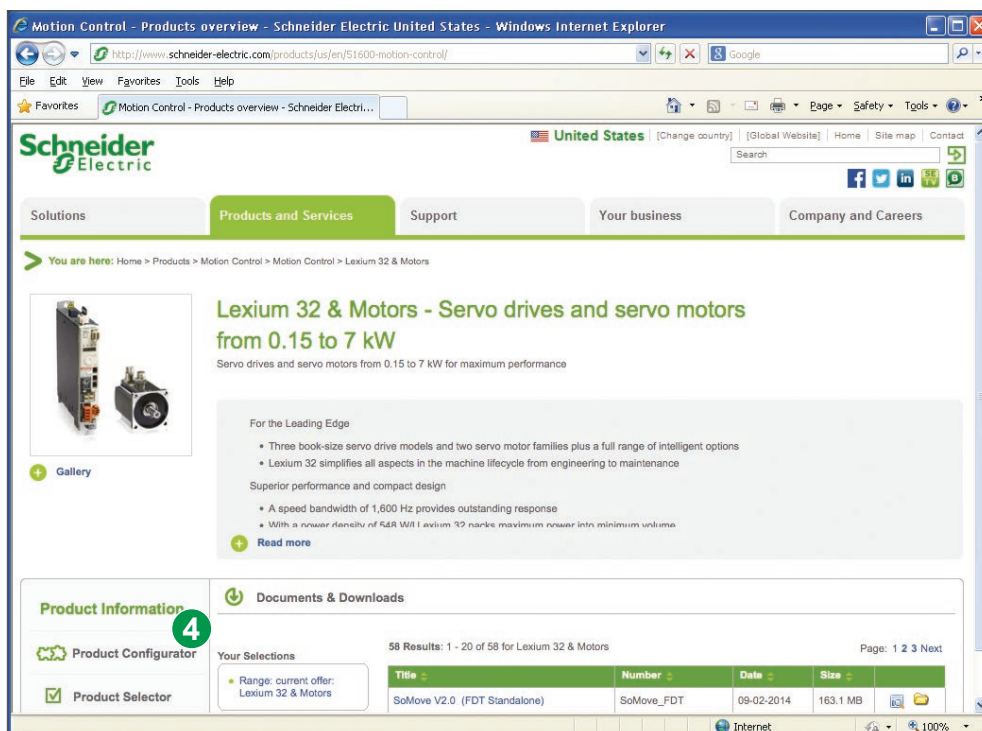

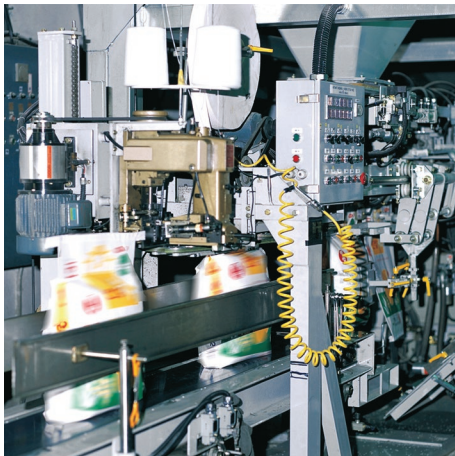

Lexium 32 servo drive controlling a packaging machine

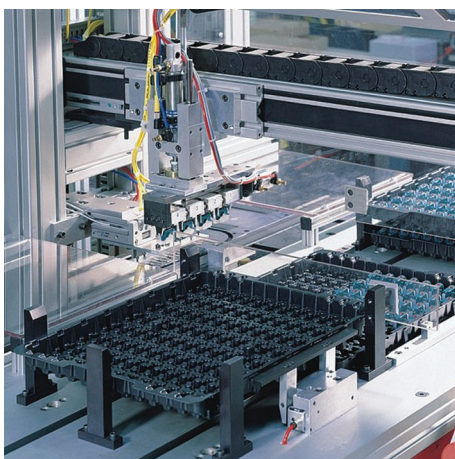

Lexium 32 servo drive controlling a material handling machine

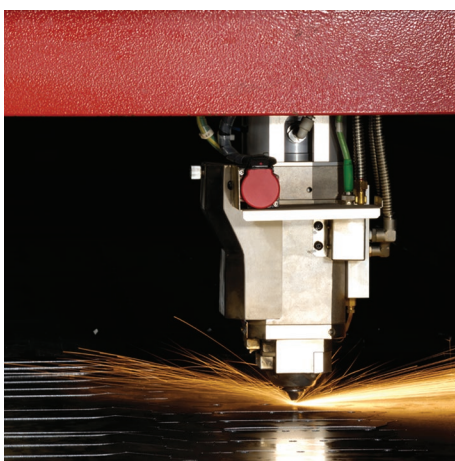

Lexium 32 servo drive controlling a materials processing machine

Overview

The Lexium 32 product range of servo drives includes 4 servo drive models and 2 servo motor ranges that provide high performance, power, and simplicity of use in motion control applications. This product range covers power ratings from 0.15 to 11 kW.

This Lexium 32 servo drive product offer is designed to extend the life cycle of machines. SoMove setup software, SoMove Mobile software, side-by-side mounting, and color-coded plug-in connectors – easily accessible on the front panel or on top of the servo drives – all help to make installation, setup, and maintenance easier. Maintenance is also faster and lower in cost, thanks to the new duplication and backup tools, such as the memory card.

Performance is improved through optimized motor control, achieved by reducing vibration with automatic parameter calculation, a speed observer, and an additional band-stop filter. This optimized motor control helps to increase machine productivity.

The compact size of the servo drives and servo motors provides maximum power in the minimum space, helping to reduce overall machine size and costs.

Integrated communication or optional communication cards, as well as standard encoders, enable adaptation to numerous types of control system architectures for industry.

An integrated safety function and access to additional safety functions reduce design times by making it easier to comply with safety standards.

Applications for industrial machines

The Lexium 32 servo drive incorporates functions suitable for applications including:

- Printing: cutting and machines with position control
- Packaging and wrapping: cutting to length, rotary knife, bottling, capsuling, and labeling
- Textiles: winding, spinning, weaving, and embroidery
- Handling: conveying, palletization, warehousing, and pick and place
- Transfer machines: gantry cranes and hoists
- Clamping and “on the fly” cutting operations (flying shear, printing, marking)
- Materials processing

Product offer

The Lexium 32 product range of servo drives covers motor power ratings between 0.15 kW and 11 kW with three types of power supply:

- 110 to 120 V single-phase, 0.15 kW to 0.8 kW (**LXM32●●●●M2**)
- 200 to 240 V single-phase, 0.3 kW to 1.6 kW (**LXM32●●●●M2**)
- 208 to 480 V three-phase, 0.4 kW to 11 kW (**LXM32●●●●N4**)

Compliance with international standards and certifications

The entire product range conforms to international standards IEC/EN 61800-5-1, IEC/EN 61800-3, and is UL and CSA certified. It has been developed to meet directives regarding protection of the environment (RoHS), as well as European directives needed to obtain the CE mark.

Compliance with electromagnetic compatibility (EMC) requirements

The integration of a category C3 EMC filter in Lexium 32 servo drives, and compliance with EMC simplifies installation, and lowers the cost of bringing the device into conformity to obtain the CE mark.

Additional filters, available as an option, can be installed by the customer to reduce the level of conducted and radiated emissions (see page 38). They also enable the servo drive to be used with cable lengths of up to 100 meters/328 feet, to meet the requirements of applications in a wide variety of fields.

Accessories and options

External accessories and options such as braking resistors and line chokes enhance this offer.

Simplicity, from installation to maintenance

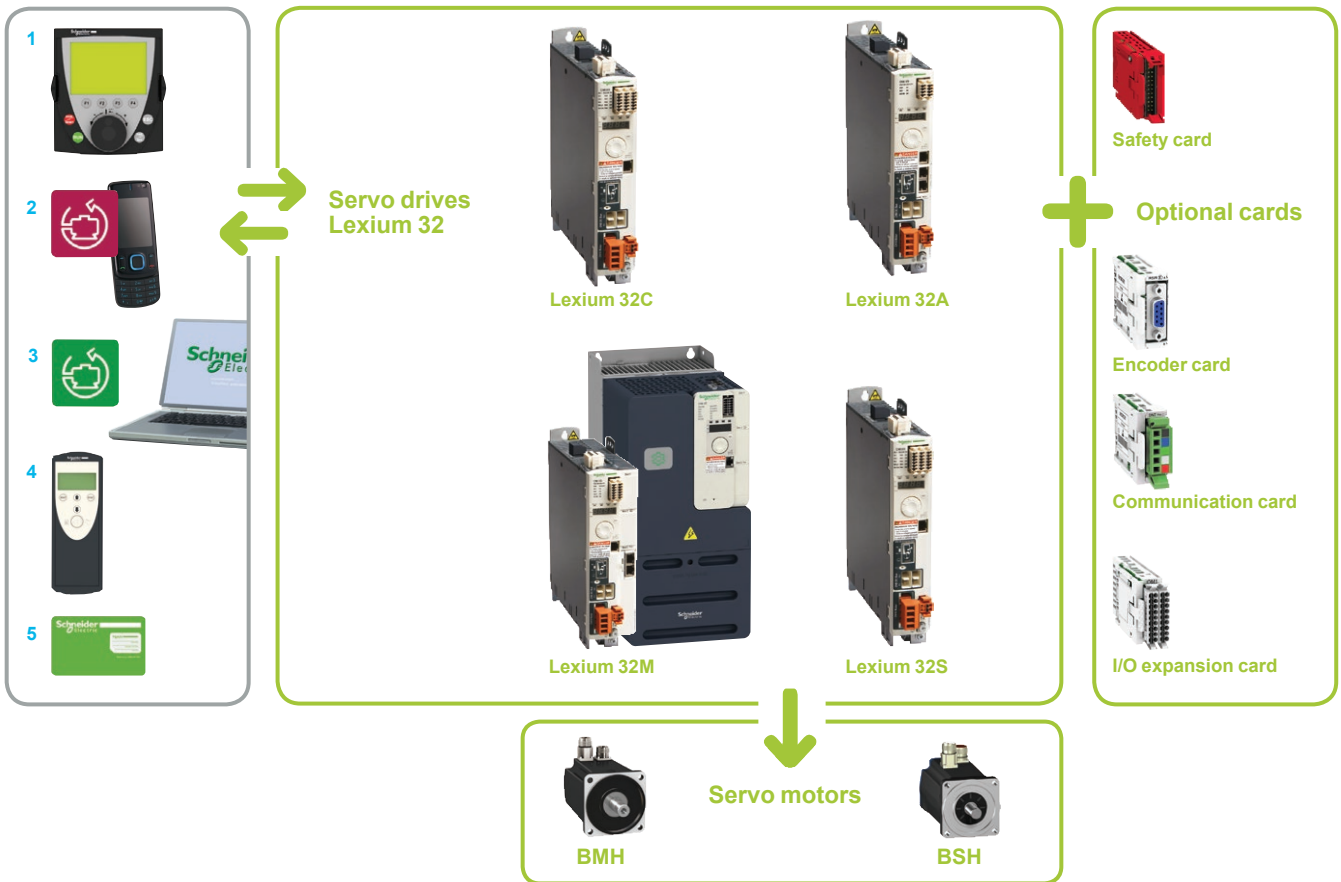

Human-Machine Interface (HMI)	The display can be used to control and configure the servo drive, display states and detected faults. It can also access parameters and modify them in manual mode using the navigation button.
Remote graphic display terminal 1	The Lexium 32 servo drive can be connected to an optional remote display terminal. This terminal can be mounted on an enclosure door with IP 54 degree of protection. It provides access to the same functions as the Human-Machine interface with some additional functions (see page 21).
SoMove Mobile software 2	SoMove Mobile software converts any cell phone into a remote graphic display terminal, offering an identical Human-Machine Interface (see page 22).
SoMove setup software 3	SoMove setup software is used in exactly the same way as it is with other Schneider Electric drives and starters – to configure and optimize control loops in automatic or manual mode using the Oscilloscope function – and for maintenance of the Lexium 32 drive. It can also be used with a Bluetooth® wireless connection (see page 22).
Multi-Loader tool 4	The Multi-Loader tool enables configurations to be copied from a PC or a servo drive and loaded onto another servo drive, even when the servo drives are powered-down (see page 23).
Memory card 5	This stores the servo drive parameters. When replacing a Lexium 32 servo drive, this function helps to ensure immediate startup by removing the need to program the drive. This decreases maintenance time, reducing costs (see page 23).
Auto-tuning	Adapted to each user, the 3 auto-tuning levels - automatic, semi-automatic, and expert - allow you to achieve a high level of machine performance, whatever the application.
Mounting and maintenance	Several Lexium 32 servo drives can be mounted side by side to save space. Connecting the servo drives is simplified by color-coded plug-in connectors, which are easily accessed on the front panel or on top of the drive.

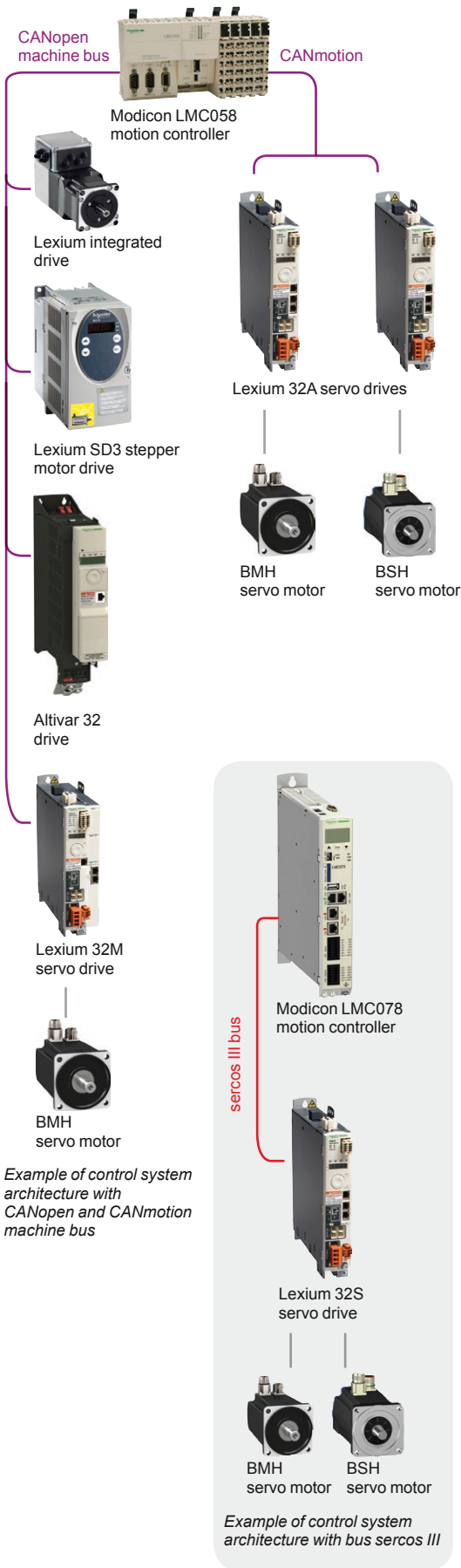

High performance

The Lexium 32 servo drives increase machine performance by providing:

- **Overload capacity:** The high peak current (up to 4 times the direct current) increases the range of movement.
- **Power density:** The compact size of the servo drives offers maximum efficiency in a small space.
- **High bandwidth:** Better speed stability and faster acceleration improve the quality of control.
- **Motor control:** Less vibration, a speed observer, and an additional band-stop filter enhance the quality of control.

Design suitable for different control system structures

The Lexium 32 product range of servo drives provides excellent flexibility for integration in different control system structures.

Depending on the model, the Lexium 32 servo drive has logic or analog inputs and outputs as standard, which can be configured to adapt better to applications. It also has control interfaces for easy access to various architecture levels:

- Control interface for control via pulse train.
- Sercos interface.
- Integrated, combined CANopen/CANmotion port for enhanced control system performance.
- Can also be connected to the main industrial communication networks and buses using various communication cards.

The following protocols are available: PROFIBUS DP V1, DeviceNet, EtherNet/IP, and EtherCAT.

Dedicated safety functions

The Lexium 32 servo drives can be an integral part of a control system's safety system, featuring an integrated Safe Torque Off (STO) function, which helps to prevent unintended servo motor operation. This function complies with standard IEC/EN 61508 level SIL3 governing electrical installations and the power drive systems standard IEC/EN 61800-1. This function also simplifies the setup of installations requiring complex safety equipment and it improves performance during maintenance operations by reducing the time required for servicing.

An additional eSM module is available for accessing enhanced safety functions.

BMH and BSH servo motors - dynamic and powerful

BMH and BSH servo motors are synchronous three-phase motors. They feature a SinCos Hiperface® encoder for automatic transmission of data from the servo motor to the servo drive, and are available with or without a holding brake.

BMH servo motors

BMH servo motors are medium inertia motors. They are particularly suitable for high-load applications and allow the movement to be adjusted in a more robust manner.

This product offer covers a continuous stall torque range from 1.2 N•m to 84 N•m for nominal speeds from 1,200 to 5,000 rpm.

BSH servo motors

BSH servo motors satisfy requirements for precision and high dynamic performance, due to the low rotor inertia. They are compact, and offer a high power density.

This product offer covers a continuous stall torque range from 0.5 N•m to 33.4 N•m for nominal speeds from 2,500 to 6,000 rpm.

Main functions					
Type of servo drive		LXM32C	LXM32A	LXM32M	LXM32S
Communication	Integrated	<input type="checkbox"/> Modbus serial link, <input type="checkbox"/> Pulse train, <input type="checkbox"/> ± 10 V	<input type="checkbox"/> Modbus serial link, <input type="checkbox"/> CANopen/CANmotion machine bus	<input type="checkbox"/> Modbus serial link, <input type="checkbox"/> Pulse train	<input type="checkbox"/> Modbus serial link, <input type="checkbox"/> sercos III
	As an option	–	–	<input type="checkbox"/> CANopen/CANmotion machine bus, <input type="checkbox"/> DeviceNet, <input type="checkbox"/> EtherNet/IP, <input type="checkbox"/> PROFIBUS DP V1, <input type="checkbox"/> EtherCAT	–
	Operating modes	<input type="checkbox"/> Manual mode (JOG), <input type="checkbox"/> Electronic gearbox, <input type="checkbox"/> Speed control, <input type="checkbox"/> Current control	<input type="checkbox"/> Homing, <input type="checkbox"/> Manual mode (JOG), <input type="checkbox"/> Speed control, <input type="checkbox"/> Current control, <input type="checkbox"/> Position control	<input type="checkbox"/> Homing, <input type="checkbox"/> Manual mode (JOG), <input type="checkbox"/> Motion sequence, <input type="checkbox"/> Electronic gearbox, <input type="checkbox"/> Speed control, <input type="checkbox"/> Current control, <input type="checkbox"/> Position control	<input type="checkbox"/> Homing, <input type="checkbox"/> Manual mode (JOG), <input type="checkbox"/> Speed control, <input type="checkbox"/> Current control, <input type="checkbox"/> Position control
	Functions	<input type="checkbox"/> Auto-tuning, <input type="checkbox"/> Monitoring, <input type="checkbox"/> Stopping, <input type="checkbox"/> Conversion	–	<input type="checkbox"/> Stop window, <input type="checkbox"/> Rapid entry of position values, <input type="checkbox"/> Rotary axes, <input type="checkbox"/> Position register	<input type="checkbox"/> Stop window, <input type="checkbox"/> Rapid entry of position values, <input type="checkbox"/> Rotary axes, <input type="checkbox"/> Position register
		–	<input type="checkbox"/> Stop window, <input type="checkbox"/> Rapid entry of position values	–	<input type="checkbox"/> Stop window, <input type="checkbox"/> Rapid entry of position values
24 V ∴ logic inputs (1)	6, reassignable	4, reassignable	4, reassignable	4, reassignable	
24 V ∴ capture inputs (1) (2)	–	1	2	2	
24 V ∴ logic outputs (1)	5, reassignable	2, reassignable	3, reassignable	3, reassignable	
Analog inputs	2	–	–	–	
Pulse control input	1, configurable as: <input type="checkbox"/> RS 422 link <input type="checkbox"/> 5 V or 24 V push-pull <input type="checkbox"/> 5 V or 24 V open collector	–	1, configurable as: <input type="checkbox"/> RS 422 link <input type="checkbox"/> 5 V or 24 V push-pull <input type="checkbox"/> 5 V or 24 V open collector	–	
ESIM PTO output	RS 422 link	–	RS 422 link	–	
Human/Machine Interface (via integrated display terminal)	<input type="checkbox"/> Manual mode (positive/negative, fast/slow), <input type="checkbox"/> Auto-tuning, <input type="checkbox"/> Simple startup, <input type="checkbox"/> Display of information and detected errors	<input type="checkbox"/> Manual mode (positive/negative, fast/slow), <input type="checkbox"/> Auto-tuning, <input type="checkbox"/> Simple startup, <input type="checkbox"/> Display of information and detected errors, <input type="checkbox"/> Homing	–	–	
Safety functions	Integrated	Safe Torque Off STO			
	As an option	–	–	<input type="checkbox"/> Safe Stop 1 (SS1) and Safe Stop 2 (SS2), <input type="checkbox"/> Safe Operating Stop (SOS), <input type="checkbox"/> Safe Limited Speed (SLS)	–
Sensor	Integrated	SinCos Hiperface® sensor			
	As an option	–	–	<input type="checkbox"/> Resolver encoder, <input type="checkbox"/> Analog encoder, <input type="checkbox"/> Digital encoder	–
Architecture	Control via	Logic or analog I/O	Motion controller via CANopen and CANmotion machine bus	Schneider Electric or third-party PLCs via communication buses and networks	Modicon LMC078 motion controller on sercos III network

Type of servo motor		BMH	BSH
Application type		<input type="checkbox"/> High load , <input type="checkbox"/> With robust adjustment of the movement	<input type="checkbox"/> High dynamic response, <input type="checkbox"/> Power density
Flange size		70, 100, 140, 190, and 205 mm (2.76, 3.94, 5.51, 7.48, and 8.07 in.)	55, 70, 100, and 140 mm (2.17, 2.76, 3.94 and 5.51 in.)
Continuous stall torque		1.2 to 84 N•m	0.5 to 33.4 N•m
Encoder type	Single-turn SinCos	32,768 points/turn and 131,072 points/turn	131,072 points/turn
	Multi-turn SinCos	32,768 points/turn x 4,096 turns and 131,072 points/turn x 4,096 turns	131,072 points/turn x 4,096 turns
Degree of protection	Casing	IP 65 (IP 67 conformity kit as an option)	
	Shaft end	IP 54: horizontal mounting (IMB5) or vertical mounting (IMV1 with shaft end at the top) IP 50: vertical mounting IMV3 with shaft end at the bottom, or IP 65 (IP 67 conformity kit as an option)	

(1) Unless otherwise stated, the logic I/O can be used in positive logic (Sink inputs, Source outputs) or negative logic (Source inputs, Sink outputs).
 (2) The capture inputs can be used as standard logic inputs.

Lexium™ 32 Servo Drives Motion control

100 to 120 V single phase supply voltage
Servo drive/servo motor combinations

Lexium 32 servo drive/BMH or BSH servo motor combinations

Servo motors

Lexium 32C, 32A, 32M and 32S servo drives

100 to 120 V single-phase supply voltage with integrated EMC filter



BMH (IP 50 or IP 65)		BSH (IP 50 or IP 65)	
Type of servo motor	Rotor inertia kgcm ²	Type of servo motor	Rotor inertia kgcm ²
		BSH0551T	0.06
		BSH0552T	0.10
		BSH0553T	0.13
BMH0701T	0.59		
		BSH0701T	0.25
		BSH0702T	0.41
BMH0702T	1.13		
BMH0703T	1.67		
		BSH1001T	1.40
BMH1001T	3.2		
BMH1002T	6.3		

LXM32•U90M2 Continuous output current: 3 A rms			
Nominal operating point (1)			Stall torques
Nominal torque	Nominal speed	Nominal power	M ₀ /M _{max} (2)
N•m	rpm	W	N•m/N•m
0.49	3,000	150	0.5/1.5
0.77	3,000	250	0.8/1.9

(1) These values are given for a supply voltage of 120 V single phase.

(2) - M₀: Continuous stall torque

- M_{max}: Peak stall torque



LXM32D18M2 Continuous output current: 6 A rms			
Nominal operating point (1)			Stall torques
Nominal torque	Nominal speed	Nominal power	M_0/M_{max} (2)
N•m	rpm	W	N•m/N•m
1.14	3,000	350	1.2/3.3
1.35	2,500	350	1.4/4.2
1.36	2,500	350	1.4/3.5

LXM32D30M2 Continuous output current: 10 A rms			
Nominal operating point (1)			Stall torques
Nominal torque	Nominal speed	Nominal power	M_0/M_{max} (2)
N•m	rpm	W	N•m/N•m
2.07	2,500	550	2.2/6.1
2.3	2,500	600	2.5/6.4
3.1	2,000	650	3.4/8.7
2.75	2,500	700	3.3/6.3
3.3	2,000	700	3.4/8.9
3.5	2,000	750	6/10.3

(1) These values are given for a supply voltage of 120 V single phase.

(2) - M_0 : Continuous stall torque
 - M_{max} : Peak stall torque

Lexium™ 32 Servo Drives

Motion control

200 to 240 V single phase supply voltage
 Servo drive/servo motor combinations

Lexium 32 servo drive/BMH or BSH servo motor combinations

Servo motors

Lexium 32C, 32A, 32M and 32S servo drives
 200 to 240 V single-phase supply voltage with integrated EMC filter



BMH (IP 50 or IP 65)		BSH (IP 50 or IP 65)	
Type of servo motor	Rotor inertia kgcm ²	Type of servo motor	Rotor inertia kgcm ²
		BSH0551T	0.06
		BSH0552T	0.10
		BSH0553T	0.13
		BSH0701T	0.25
BMH0701T	0.59		
		BSH0702T	0.41
		BSH0703T	0.58
BMH0702T	1.13		
		BSH1001T	1.40
BMH0703T	1.67		
BMH1001T	3.2		
		BSH1002T	2.31
BMH1002T	6.3		
BMH1003T	9.4		
BMH1401P	16.5		

LXM32●U45M2 Continuous output current: 1.5 A rms			
Nominal operating point (1)			Stall torques
Nominal torque	Nominal speed	Nominal power	M ⁰ /M _{max} (2)
N·m	rpm	W	N·m/N·m
0.45	6,000	300	0.5/1.4

(1) These values are given for a supply voltage of 240 V single phase.
 (2) - M₀: Continuous stall torque
 - M_{max}: Peak stall torque



LXM32●U90M2 Continuous output current: 3 A rms				LXM32●D18M2 Continuous output current: 6 A rms				LXM32●D30M2 Continuous output current: 10 A rms			
Nominal operating point (1)			Stall torques	Nominal operating point (1)			Stall torques	Nominal operating point (1)			Stall torques
Nominal torque	Nominal speed	Nominal power	M_o/M_{max} (2)	Nominal torque	Nominal speed	Nominal power	M_o/M_{max} (2)	Nominal torque	Nominal speed	Nominal power	M_o/M_{max} (2)
N·m	rpm	W	N·m/N·m	N·m	rpm	W	N·m/N·m	N·m	rpm	W	N·m/N·m
0.74	6,000	450	0.8/2.5								
0.84	6,000	550	1.2/3								
0.94	5,000	500	1.3/3.5								
1.1	4,000	450	1.4/4								
				1.8	5,000	950	2.2/7.2				
				2.1	4,000	900	2.6/7.4				
				2.1	4,000	900	2.5/7.4				
				2.2	4,000	900	2.7/7.5				
				2.9	3,000	900	3.4/10.2				
				2.8	3,000	900	3.4/10.2				
								3.7	4,000	1,500	5.8/16.4
								4.6	3,000	1,450	6/18.4
								5.6	2,500	1,450	8/23.5
								8.9	1,500	1,450	10.3/30.8

(1) These values are given for a supply voltage of 240 V single phase.

(2) - M_o : Continuous stall torque

- M_{max} : Peak stall torque

Lexium™ 32 Servo Drives Motion control

208 to 480 V three-phase supply voltage
Servo drive/servo motor combinations

Lexium 32 servo drive/BMH or BSH servo motor combinations

Servo motors

Lexium 32C, 32A, 32M and 32S servo drives

208 to 480 V three-phase supply voltage with integrated EMC filter



BMH (IP 50 or IP 65)		BSH (IP 50 or IP 65)		LXM32•U60N4 Continuous output current: 1.5 A rms				LXM32•D12N4 Continuous output current: 3 A rms			
Motor type	Rotor inertia	Motor type	Rotor inertia	Nominal operating point (1)			Stall torques	Nominal operating point (1)			Stall torques
	kgcm ²		kgcm ²	Nominal torque	Nominal speed	Nominal power	M ⁰ /M ^{max} (2)	Nominal torque	Nominal speed	Nominal power	M ⁰ /M ^{max} (2)
				N•m	rpm	W	N•m/ N•m	N•m	rpm	W	N•m/ N•m
		BSH0551P	0.06	0.48	6,000	300	0.5/1.5				
		BSH0552P	0.10	0.65	6,000	400	0.8/2.5				
		BSH0553P	0.13	0.65	6,000	400	1.05/3.5				
BMH0701P	0.59			1.1	3,000	350	1.2/4.2				
BMH0701P	0.59							1.3	5,000	700	1.4/4.2
		BSH0701P	0.25					1.32	5,000	700	1.4/3.5
		BSH0702P	0.41					1.64	5,000	850	2.2/7.6
BMH1001P	3.2							1.9	4,000	800	3.3/10.8
BMH0702P	1.13							2.2	3,000	700	2.5/7.4
BMH0703P	1.67										
		BSH0703P	0.58								
		BSH1001P	1.40								
BMH1001P	3.2										
BMH1002P	6.3										
		BSH1002P	2.31								
BMH1003P	9.4										
		BSH1003P	3.2								
BMH1401P	16.5										
		BSH1004P	4.2								
		BSH1401P	7.4								
BMH1402P	32.0										
		BSH1402T	12.7								
		BSH1403T	17.9								
BMH1403P	47.5										
		BSH1404P	23.7								
BMH1901P	67.7										
BMH1902P	130										
BMH1903P	194										
BMH2053P	190										

(1) These values are given for a supply voltage of 400 V single phase.

(2) - M₀: Continuous stall torque

- M_{max}: Peak stall torque



LXM32MC10N4 Continuous output current: 40 A rms			
Nominal operating point (1)			Stall torques
Nominal torque	Nominal speed	Nominal power	M^0/M^{\max} (2)
N•m	rpm	W	N•m/N•m
16.5	3,000	5,180	30/89.7
29	2,000	6,070	48/130.7
37	2,000	7,750	65/162.7
57.5	1,500	9,060	88/306

(1) These values are given for a supply voltage of 400 V single phase.

(2) - M^0 : Continuous stall torque

- M^{\max} : Peak stall torque

Lexium™ 32 Servo Drives

Motion control

Servo drives



LXM32C●●●●●●



LXM32A●●●●●●



LXM32S●●●●●●

Lexium 32C, 32A, 32M and 32S servo drives						
Output current at 8 kHz		Nominal power at 8 kHz	Line current (2)	Max. prospective line Isc	Reference	Weight
Continuous (rms)	Peak (rms) (1)					
A	A	kW	A	kA		kg/lb
Single-phase supply voltage: 115 V ~ 50/60 Hz, with integrated EMC filter (3)						
1.5	3	0.15	2.9	1	LXM32CU45M2	1.600/3.527
					LXM32AU45M2	
					LXM32MU45M2	1.700/3.748
					LXM32SU45M2	3.748
3	6	0.3	5.4	1	LXM32CU90M2	1.700/3.748
					LXM32AU90M2	
					LXM32MU90M2	1.800/3.968
					LXM32SU90M2	3.968
6	10	0.5	8.5	1	LXM32CD18M2	1.800/3.968
					LXM32AD18M2	
					LXM32MD18M2	1.900/4.189
					LXM32SD18M2	4.189
10	15	0.8	12.9	1	LXM32CD30M2	2.000/4.409
					LXM32AD30M2	
					LXM32MD30M2	2.100/4.630
					LXM32SD30M2	4.630
Single-phase supply voltage: 230 V ~ 50/60 Hz, with integrated EMC filter (3)						
1.5	4.5	0.3	2.9	1	LXM32CU45M2	1.600/3.527
					LXM32AU45M2	
					LXM32MU45M2	1.700/3.748
					LXM32SU45M2	3.748
3	9	0.5	4.5	1	LXM32CU90M2	1.700/3.748
					LXM32AU90M2	
					LXM32MU90M2	1.800/3.968
					LXM32SU90M2	3.968
6	18	1	8.4	1	LXM32CD18M2	1.800/3.968
					LXM32AD18M2	
					LXM32MD18M2	1.900/4.189
					LXM32SD18M2	4.189
10	30	1.6	12.7	1	LXM32CD30M2	2.000/4.409
					LXM32AD30M2	
					LXM32MD30M2	2.100/4.630
					LXM32SD30M2	4.630

(1) Maximum value for 5 seconds
 (2) Without line choke (see page 37)
 (3) Additional EMC filters available as an option (see page 38)

Lexium™ 32 Servo Drives

Motion control

Servo drives



LXM32M●●●●●●

Lexium 32C, 32A, 32M and 32S servo drives (continued)						
Output current at 8 kHz		Nominal power at 8 kHz	Line current (2)	Max. prospective line Isc	Reference	Weight
Continuous (rms)	Peak (rms)(1)					
A	A	kW	A	kA		kg/lb
Three-phase supply voltage: 208 V ~ 50/60 Hz, with integrated EMC filter (3)						
1.8	6	0.35	1.8	5	LXM32CU60N4	1.700/ 3.748
					LXM32AU60N4	1.800/ 3.968
					LXM32MU60N4	1.800/ 3.968
					LXM32SU60N4	1.800/ 3.968
3.6	12	0.7	3.6	5	LXM32CD12N4	1.800/ 3.968
					LXM32AD12N4	1.900/ 4.189
					LXM32MD12N4	1.900/ 4.189
					LXM32SD12N4	2.000/ 4.409
6.2	18	1.2	6.2	5	LXM32CD18N4	2.000/ 4.409
					LXM32AD18N4	2.100/ 4.630
					LXM32MD18N4	2.100/ 4.630
					LXM32SD18N4	2.600/ 5.732
9.8	30	2	9.8	5	LXM32CD30N4	2.600/ 5.732
					LXM32AD30N4	2.700/ 5.952
					LXM32MD30N4	2.700/ 5.952
					LXM32SD30N4	4.800/ 10.582
21.9	72	5	21.9	5	LXM32CD72N4	4.800/ 10.582
					LXM32AD72N4	4.800/ 10.582
					LXM32MD72N4	4.800/ 10.582
					LXM32SD72N4	
Three-phase supply voltage: 480 V ~ 50/60 Hz, with integrated EMC filter (3)						
1.5	6	0.4	1.2	5	LXM32CU60N4	1.700/ 3.748
					LXM32AU60N4	1.800/ 3.968
					LXM32MU60N4	1.800/ 3.968
					LXM32SU60N4	1.800/ 3.968
3	12	0.9	2.4	5	LXM32CD12N4	1.800/ 3.968
					LXM32AD12N4	1.900/ 4.189
					LXM32MD12N4	1.900/ 4.189
					LXM32SD12N4	2.000/ 4.409
6	18	1.8	4.5	5	LXM32CD18N4	2.000/ 4.409
					LXM32AD18N4	2.100/ 4.630
					LXM32MD18N4	2.100/ 4.630
					LXM32SD18N4	2.600/ 5.732
10	30	3	7	5	LXM32CD30N4	2.600/ 5.732
					LXM32AD30N4	2.700/ 5.952
					LXM32MD30N4	2.700/ 5.952
					LXM32SD30N4	4.800/ 10.582
24	72	7	14.6	5	LXM32CD72N4	4.800/ 10.582
					LXM32AD72N4	4.800/ 10.582
					LXM32MD72N4	4.800/ 10.582
					LXM32SD72N4	
32	85	9	19.9	5	LMX32MD85N4	9.600/ 21.164
40	100	11	23.3	5	LXM32MC10N4	9.600/ 21.164

(1) Maximum value for 5 seconds

(2) Without line choke (see page 37)

(3) Additional EMC filters available as an option (see page 38)

LMX32MD85N4
LXM32MC10N4

Lexium™ 32 Servo Drives

Motion control

Servo drives

Dimensions, accessories, and documentation

Lexium 32C, 32A, 32M and 32S servo drives (continued)

Dimensions (overall)	W x H x D mm/in.
LXM32CU60N4, CD12N4, CD18N4 LXM32AU60N4, AD12N4, AD18N4	48 x 270 x 237/ 1.89 x 10.63 x 9.33
LXM32MU60N4, MD12N4, MD18N4, MD30N4 LXM32CD30N4 LXM32AD30N4 LXM32SD60N4, SD12N4, SD18N4, SD30N4	68 x 270 x 237/ 2.68 x 10.63 x 9.33
LXM32D72N4	108 x 270 x 237/ 4.25 x 10.63 x 9.33
LMX32MD85N4, LXM32MC10N4	180 x 385 x 240/ 7.08 x 15.18 x 9.45

Servo drive name plate

Description	Use	Dimensions mm/in.	Unit reference	Weight kg/lb
Name plate (sold in multiples of 50)	This contains information about the servo drive. To be clipped onto the top right-hand part of the servo drive	385 x 130/ 15.16 x 5.12	VW3M2501	–

Mounting accessories

Description	Compatibility	Reference	Weight kg/lb
EMC kit , This contains: <input type="checkbox"/> 1 EMC plate top <input type="checkbox"/> 1 EMC plate bottom <input type="checkbox"/> Screws and mounting collars <input type="checkbox"/> 1 user manual	LMX32MD85N4, LXM32MC10N4	VW3M2106	0.300/ 0.661
Flush mounting kit For mounting the drive power section outside the enclosure This contains: <input type="checkbox"/> 4 mounting accessories <input type="checkbox"/> 1 metal frame <input type="checkbox"/> Screws and Seals <input type="checkbox"/> 1 user manual	LMX32MD85N4, LXM32MC10N4	VW3M2606	2.100/ 4.630

Documentation

The documentation for the servo drives and servo motors is available on our website www.schneider-electric.com.

Lexium™ 32 Servo Drives

Motion control

Servo drives

Dialog tools

Remote graphic display terminal (to be ordered separately) (1)

Lexium 32 servo drives can be connected to a remote graphic display terminal, using remote mounting accessories. It can be mounted on an enclosure door with IP 54 degree of protection.

This terminal is common to various ranges of variable speed drives or servo drives. It has a graphic screen and is used to access the same functions as the integrated display and control keys on the servo drive, as well as some additional functions.

For example, this terminal can be used to:

- Configure, adjust, and control the servo drive remotely
- Display the servo drive status and detected faults remotely
- Override the servo drive I/O
- Execute motion sequences
- Load configurations

This remote graphic display terminal features:

- Graphic screen displaying 8 lines of 24 characters of plain text.
- Navigation button providing quick and easy access to the drop-down menus.
- Six languages installed as standard (Chinese, English, French, German, Italian, and Spanish). Other languages can be downloaded to the flash memory using the VW3A8121 Multi-Loader configuration tool (see page 23).
- Maximum operating temperature of 60 °C/140 °F.



Graphic display terminal
+
remote-mounting cordset
+
female/female RJ45 adapter

Description

- 1 Graphic display:
 - 8 lines of 24 characters, 240 x 160 pixels
 - Large digit display
 - Bar chart display
- 2 Function keys F1, F2, F3, F4
- 3 "ESC" key: aborts a value, a parameter, or a menu to return to the previous selection
- 4 "FWD/REV" key: Local control for reversing the direction of rotation of the motor
- 5 Navigation button:
 - Rotate ±: Goes to the next or previous line, increases or decreases the value
 - Press: Saves the current value ("ENT")
- 6 Motor local control keys:
 - "RUN": Starts the motor
 - "STOP/RESET": Local control of motor stopping/clearing drive detected faults
- 7 Remote graphic display terminal
- 8 Remote-mounting cordset
- 9 Female/female RJ45 adapter

References

Description	Item no.	Length m/ft	Reference	Weight kg/lb
Remote graphic display terminal A remote-mounting cordset (VW3A1104R●●) and an RJ45 adapter (VW3A1105) are also required	7	–	VW3A1101	–
Remote-mounting cordsets equipped with 2 RJ45 connectors	8	1/ 3.28	VW3A1104R10	0.050/ 0.110
		3/ 9.84	VW3A1104R30	0.150/ 0.331
		5/ 16.40	VW3A1104R50	0.250/ 0.551
		10/ 32.81	VW3A1104R100	0.500/ 1.102
		–	VW3A1105	0.010/ 0.022

(1) This terminal may require a software upgrade using the VW3A8121 Multi-Loader configuration tool (see page 23).

Lexium™ 32 Servo Drives

Motion control

Servo drives

Configuration tools



Configuration with SoMove Mobile software for cell phones via Bluetooth®

SoMove Mobile software for cell phones

SoMove Mobile software converts any compatible cell phone into a remote graphic display terminal, providing an identical Human-Machine Interface (see page 21).

Particularly suitable for on-site or remote maintenance operations, SoMove Mobile software can be used to print out and save configurations, import them from a PC and export them to a PC or servo drive equipped with the Modbus adapter via the Bluetooth® wireless link.

This software requires a cell phone with specific features. Please consult our website www.schneider-electric.com.

SoMove Mobile software and the drive configuration files can be downloaded from our website www.schneider-electric.com.

Reference	Reference	Weight kg/lb
SoMove Mobile software for cell phones Download from our website www.schneider-electric.com .	-	-
Modbus-Bluetooth® adapter Enables any non-Bluetooth® device to communicate using this technology.	TCSWAAC13FB	0.032/ 0.071

Includes (1):
 1 Bluetooth® adapter (range 20 m/65.61 ft, class 2) with an RJ45 connector
 For SoMove: 1 x 0.1 m/0.33 ft cordset with 2 x RJ45 connectors

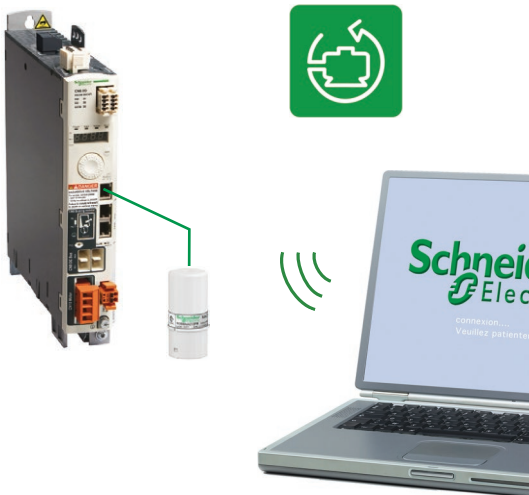

Configuration with the SoMove setup software via Bluetooth®

SoMove setup software

SoMove setup software is used on Lexium 32 servo drives in the same way it's used on other Schneider Electric drives and starters... to configure, adjust, debug, and maintain the drive.

It communicates via a Bluetooth® wireless link with the servo drive, which is equipped with the Modbus-Bluetooth® adapter (VW3A8114).

This software can be downloaded from our website www.schneider-electric.com or is available on the "Description of the Motion & Drives Offer" DVD ROM (VW3A8200).

For Introduction, description, and references, see page 40.

(1) Also includes other components for connecting compatible Schneider Electric devices.

Lexium™ 32 Servo Drives

Motion control

Servo drives

Configuration tools



Configuration of a Lexium 32 in its packaging with the VW3A8121 Multi-Loader tool + VW3A8126 cordset

Multi-Loader configuration tool

The Multi-Loader configuration tool enables several configurations to be copied from a PC or a servo drive and loaded onto another servo drive. The Lexium 32 servo drives do not need to be powered up to execute this process.

References

Description	Reference	Weight kg/lb
Multi-Loader configuration tool Supplied with: 1 cordset equipped with 2 RJ45 connectors 1 cordset equipped with one type A USB connector and one mini B USB connector 1 x 2 GB SD memory card 1 x female/female RJ 45 adapter 4 AA 1.5 V LR6 round batteries	VW3A8121	–
Cordset for Multi-Loader tool For connecting the Multi-Loader tool to the Lexium 32 servo drive in its packaging. Equipped with: Non-locking RJ45 connector with special mechanical catch on the drive end and RJ45 connector on the Multi-Loader end	VW3A8126	–

Memory card

Description	Reference	Weight kg/lb
Memory card Used to store the parameters of the Lexium 32 servo drive. Another Lexium 32 servo drive can be commissioned immediately in the event of maintenance or duplication.	VW3M8705	–
Pack of 25 memory cards	VW3M8704	–



Duplication of an application with the VW3M8705 memory card

Lexium™ 32 Servo Drives

Motion control

Servo drives

Connection accessories

Connection accessories				
Replacement connectors				
Designation	For use with	Description	Reference	Weight kg/lb
Set of connectors	Lexium 32C	Featuring: 4 connectors for the line supply 3 connectors for the I/O 2 connectors for the motor power supply 1 connector for the holding brake	VW3M2201	–
	Lexium 32A	Featuring: 4 connectors for the line supply 2 connectors for the I/O 2 connectors for the motor power supply 1 connector for the holding brake	VW3M2202	–
	Lexium 32M	Featuring: 4 connectors for the line supply 2 connectors for the I/O 2 connectors for the motor power supply 1 connector for the holding brake	VW3M2203	–
	Lexium 32 (all types)	Featuring: 10 connectors for creating extension cordsets for the DC bus	VW3M2207	–

Cordsets					
For use with	Description	Length m/ft	Unit reference	Weight kg/lb	
Daisy chain connection of the DC bus	Between 1 Altivar 32 drive (1) and 1 Lexium 32 servo drive: (sold in lots of 5) ATV32H●●●32M2/ LXM32●●●M2 ATV32H●●●32N4/ LXM32●●●N4	0.1/ 0.33	VW3M7101R01	–	
Daisy chain connection or pulse control	For Lexium 32C and 32M servo drives (2)	Equipped with 2 RJ45 connectors	0.3/ 0.98	VW3M8502R03	0.025/ 0.055
			1.5/ 4.92	VW3M8502R15	0.062/ 0.137
		Equipped with 1 RJ45 connector and a free end	3/ 9.84	VW3M8223R30	–
Adapter for motor encoder cable	Replacement of a Lexium 05 servo drive with a Lexium 32 servo drive	Equipped with one 10-way Molex connector and one RJ45 connector (Lexium 32 servo drive end).	1/3,28	VW3M8111R10	–
	Replacement of a Lexium 15 servo drive with a Lexium 32 servo drive	Equipped with one 15-way male SUB-D connector and one RJ45 connector (Lexium 32 servo drive end).	1/3,28	VW3M8112R10	–

Cable and cordsets					
Designation	For use with	Length m/ft	Reference	Weight kg/lb	
Daisy chain DC bus cable	Between 1 Altivar 32 drive (1) and 1 servo drive Lexium 32 : ATV32H●●●M2/LXM32●●●M2 ATV32H●●●N4/LXM32●●●N4	15/ 49.21	VW3M7102R150	–	
sercos III cordsets for redundant ring	Preassembled cordsets with an RJ 45 connector at each end	Between Modicon LMC078 motion controller and LXM32S●●●M2, LXM32S●●●N4 servo drives	0.5/ 1.64	VW3E5001R005	–
			1/ 3.28	VW3E5001R010	–
			1.5/ 4.92	VW3E5001R015	–
			2/ 6.56	VW3E5001R020	–
			3/ 9.84	VW3E5001R030	–
			5/ 16.40	VW3E5001R050	–
			10/ 32.81	VW3E5001R100	–
			15/ 49.21	VW3E5001R150	–
			20/ 65.62	VW3E5001R200	–
			25/ 82.02	VW3E5001R250	–
	30/ 98.42	VW3E5001R300	–		
	40/ 131.23	VW3E5001R400	–		
	50/ 164.04	VW3E5001R500	–		

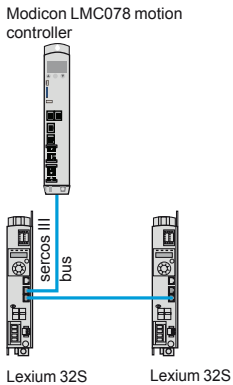

Example of architecture on sercos III with control by Modicon LMC078 motion controller



(1) Variable speed offer, see the "Altivar 32 variable speed drives" catalog or consult our website www.schneider-electric.com.
 (2) Except for LXM32MD85N4 and LXM32MC10N4 servo drives

Lexium™ 32 Servo Drives

Motion control

Lexium 32A servo drives
Connection accessories

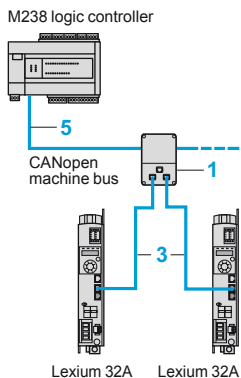

Example of architecture with control by M238 logic controller

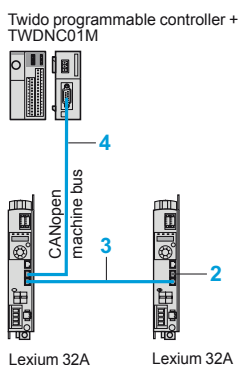

Example of architecture with control by Twido programmable controller

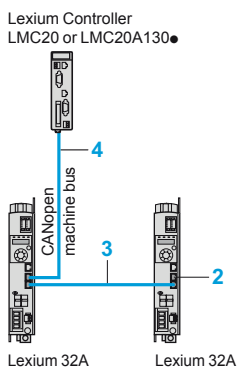

Example of architecture with control by LMC Lexium Controller

CANopen and CANmotion machine bus for Lexium 32A servo drives

Lexium 32A servo drives can be directly connected to the CANopen machine bus using an RJ45 connector. To simplify daisy chain connection, each servo drive is equipped with two connectors of this type (marked CN4 and CN5).

The communication function provides access to the servo drive's configuration, adjustment, control, and monitoring functions.

Used with a Lexium Controller motion controller, the CANmotion bus can be used to control motion for applications with up to 8 Lexium 32A servo drives.

Connection accessories (1)

Description	Use	Item no.	Reference	Weight kg/lb
IP 20 CANopen tap junction 2 RJ45 ports	Tap-off from trunk cable for RJ45 wiring	1	VW3CANTAP2	0.480/ 1.058
Line terminator 120 Ω (equipped with one RJ45 connector)	Connection to the RJ45 connector	2	TCSCAR013M120	0.009/ 0.020

Cordsets and cables (1)

Description	Use	Item no.	Length m/ft	Reference	Weight kg/lb
CANopen cordsets (1) equipped with 2 RJ45 connectors	VW3CANTAP2 tap junction LXM32A servo drive (CN4 and CN5 connectors)	3	0.3/ 0.98	VW3CANCARR03	0.320/ 0.705
			1/ 3.28	VW3CANCARR1	0.500/ 1.102
CANopen cordsets (1) equipped with one 9-way female SUB-D connector with integrated line terminator and one RJ45 connector	Twido programmable controller Lexium Controller LMC20, LMC20A130●	4	1/ 3.28	VW3M3805R010	–
			3/ 9.843	VW3M3805R030	–
CANopen cables (1) Standard cables, CE marking Low smoke, zero halogen Flame retardant (IEC 60332-1)	PLC	5	50/ 164.04	TSXCANCA50	4.930/ 10.869
			100/ 328.08	TSXCANCA100	8.800/ 19.401
			300/ 984.25	TSXCANCA300	24.560/ 54.145
CANopen cables (1) UL certification, CE marking Flame retardant (IEC 60332-2)	PLC	5	50/ 164.04	TSXCANCB50	3.580/ 7.893
			100/ 328.08	TSXCANCB100	7.840/ 17.284
			300/ 984.25	TSXCANCB300	21.870/ 48.215
CANopen cables (1) Cables for harsh environments (2) or mobile installation, CE marking Low smoke, zero halogen Flame retardant (IEC 60332-1)	PLC	5	50/ 164.04	TSXCANCD50	3.510/ 7.738
			100/ 328.08	TSXCANCD100	7.770/ 17.130
			300/ 984.25	TSXCANCD300	21.700/ 47.840

(1) For other CANopen machine bus connection accessories, please consult our website www.schneider-electric.com.

(2) Harsh environment:

- Resistance to hydrocarbons, industrial oils, detergents, solder splashes
- Relative humidity up to 100%
- Saline atmosphere
- Significant temperature variations
- Operating temperature between - 10 °C/+ 14 °F and + 70 °C/+ 158 °F

Lexium™ 32 Servo Drives

Motion control

Communication buses and networks

CANopen/CANmotion machine bus

Lexium 32A servo drives integrate the CANopen communication protocol as standard (see page 25).

If one of the communication cards (available as options) is added, the Lexium32M servo drive can be connected to the following communication buses and networks:

- CANopen and CANmotion machine bus
- PROFIBUS DP V1 fieldbus
- DeviceNet fieldbus
- EtherNet/IP network
- EtherCAT fieldbus

The Lexium 32M servo drive can only take one communication card.

CANopen and CANmotion machine bus

Introduction

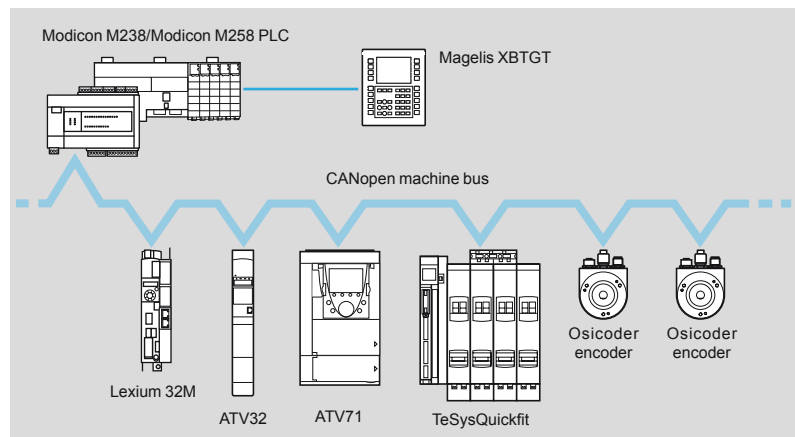

Installing the CANopen communication card VW3A3608

The CANopen machine bus is specifically designed for integration in control system architectures. It provides openness and interoperability for various devices (drives, motor starters, smart sensors).

A tiered CANopen connectivity solution reduces costs and allows the creation of a control system architecture, providing:

- Reduced cabling time
- Greater reliability of the load
- Flexibility should you need to add or remove equipment
- Easy setup.

The same communication card provides access to either the CANopen or CANmotion machine bus. The features of the cards are available on our website www.schneider-electric.com.

Optimized solution for connection to the CANopen/CANmotion machine bus

To simplify the setup of Lexium32M servo drives, 3 communication cards are available, each with different connectors:

- CANopen/CANmotion daisy chain card with connection to the bus via 2 RJ45 connectors, providing an optimized solution for daisy chain connection to the CANopen machine bus (see page 27)
- CANopen/CANmotion card with connection to the bus via screw terminals (see page 27)
- CANopen/CANmotion card with connection to the bus via 9-way male SUB-Dconnector (see page 28)

Lexium™ 32 Servo Drives

Motion control

Communication buses and networks
CANopen/CANmotion machine bus



VW3A3608 CANopen communication card

Twido programmable controller or Lexium Controller

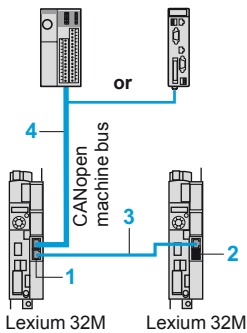

Daisy chain connection with VW3A3608 CANopen card



VW3A3628 CANopen communication card

Modicon M328/M258 programmable controller

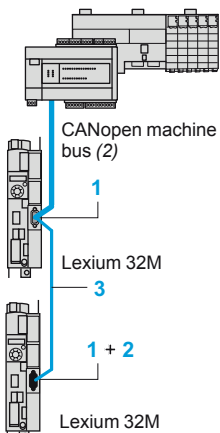

Example of connecting Lexium 32M with VW3A3628 card

CANopen/CANmotion machine bus: connection via RJ45 connector

CANopen/CANmotion daisy chain communication card

Description	Type of port	Item no.	Unit reference	Weight kg/lb
CANopen/CANmotion daisy chain card for Lexium32M servo drives	2 RJ45 connectors	1	VW3A3608	-

Connection accessories for VW3A3608 CANopen daisy chain card

CANopen line terminator (1)	With RJ45 connector	2	TCSCAR013M120	0.009/ 0.020
CANopen IP20 tap junctions	2 RJ45 connectors	-	VW3CANTAP2	0.250/ 0.551

Cordsets for VW3A3608 CANopen/CANmotion daisy chain card

Description	Use		Item no.	Length m/ft	Reference	Weight kg/lb
	From	To				
CANopen cordsets equipped with one RJ45 connector at each end	LXM32A servo drive	VW3A3608 card	3	0.3/ 0.98	VW3CANCARR03	0.320/ 0.705
	LXM32M servo drive	LXM32M servo drive				
CANopen cordsets equipped with one 9-way female SUB-D connector with integrated line terminator and one RJ45 connector	VW3A3608 card	VW3CANTAP2 tap junction	4	1/ 3.28	VW3CANCARR1	0.500/ 1.102
	Twido programmable controller	LXM32A servo drive				
Lexium Controller: LMC20 LMC20A130	LXM32M servo drive	LXM32M servo drive	4	1/ 3.28	VW3M3805R010	-
	LXM32M servo drive	LXM32M servo drive				
Lexium Controller: LMC20 LMC20A130	LXM32M servo drive	LXM32M servo drive	4	3/ 9.84	VW3M3805R030	-
	LXM32M servo drive	LXM32M servo drive				

CANopen/CANmotion machine bus: connection via screw terminals

CANopen/CANmotion communication card

Description	Type of port	Item no.	Unit reference	Weight kg/lb
CANopen/CANmotion card for Lexium32M servo drives	One 5-way screw terminal block	1	VW3A3628	-

Connection accessory for VW3A3628 CANopen/CANmotion communication card

CANopen line terminator (1)	Stripped wires for screw terminal connector	2	TCSCAR013M120	-
-----------------------------	---------------------------------------------	---	---------------	---

Connection cables for VW3A3628 CANopen/CANmotion communication card

Description	Use		Item no.	Length m/ft	Reference	Weight kg/lb
	From	To				
CANopen cables Standard cables, CE marking Low smoke zero halogen Flame retardant (IEC60332-1)	Programmable controller	VW3A3628 card	3	50/	TSXCANCA50	4.930/
				164.04		10.869
				100/		8.800/
328.08	19.401					
300/	24.560/					
984.25	54.145					
CANopen cables UL certification, CE marking Flame retardant (IEC60332-2)	Programmable controller	VW3A3628 card	3	50/	TSXCANCB50	3.580/
				164.04		7.893
				100/		7.840/
328.08	17.284					
300/	21.870/					
984.25	48.215					
CANopen cables Cable for harsh environment (3) or mobile installation, CE marking Low smoke zero halogen Flame retardant (IEC 60332-1)	Programmable controller	VW3A3628 card	3	50/	TSXCANCD50	3.510/
				164.04		7.738
				100/		7.770/
328.08	17.130					
300/	21.700/					
984.25	47.840					

(1) Sold in lots of 2.

(2) Cable dependent on the type of controller or PLC; please refer to the corresponding catalog.

(3) Harsh environment:

- resistance to hydrocarbons, industrial oils, detergents, solder splashes
- relative humidity up to 100%
- saline atmosphere
- significant temperature variations, operating temperature between - 10 °C/+ 14 °F and + 70 °C/+ 158 °F

Lexium™ 32 Servo Drives

Motion control

Communication buses and networks
CANopen/CANmotion machine bus



VW3A3618 CANopen communication card

Twido programmable controller or Lexium Controller

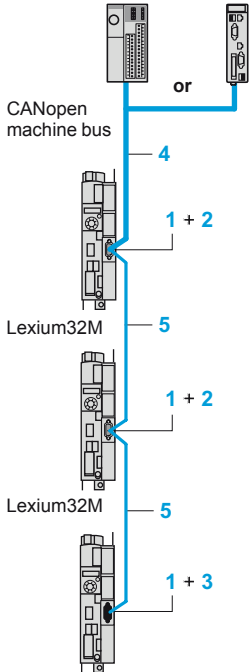

Example of connection to the CANopen machine bus with VW3A3618 card

CANopen/CANmotion machine bus: connection via SUB-D connector

CANopen/CANmotion communication card

Description	Type of port	Item no.	Reference	Weight kg/lb
CANopen/CANmotion card for Lexium32M servo drives	One 9-way male SUB-D connector	1	VW3A3618	–

Connection accessories for VW3A3618 CANopen/CANmotion card

Description	Type of port	Item no.	Unit reference	Weight kg/lb
9-way female SUB-D connector with screw terminals. Line termination switch that can be deactivated	–	2	VW3M3802	–
CANopen line terminator (1)	Stripped wires for screw terminal connector	3	TCSCAR01NM120	–
CANopen IP20 connectors, 9-way female SUB-D Line termination switch that can be deactivated	Straight	–	TSXCANKCDF180T	0.049/0.108
	Right angle elbow	–	TSXCANKCDF90T	0.046/0.101
	Right angle elbow with 9-way SUB-D for connecting PC or diagnostics tool	–	TSXCANKCDF90TP	0.051/0.112

Cordsets for VW3A3618 CANopen/CANmotion card

Description	Use		Item no.	Length m/ft	Reference	Weight kg/lb
	From	To				
CANopen IP20 cordsets equipped with one 9-way female SUB-D 9 connector at each end. Standard cables, C€ marking Low smoke zero halogen Flame retardant (IEC60332-1)	Lexium Controller: LMC20	VW3A3618 card	4	0.3/0.98	TSXCANCADD03	0.091/0.201
	LMC20A130			1/3.28	TSXCANCADD1	0.143/0.315
				3/9.84	TSXCANCADD3	0.295/0.650
				5/16.40	TSXCANCADD5	0.440/0.970
CANopen IP20 cordsets equipped with one 9-way female SUB-D 9 connector at each end. Standard cables, UL certification, C€ marking Flame retardant (IEC60332-2)	Lexium Controller: LMC20	VW3A3618 card	4	0.3/0.98	TSXCANCBDD03	0.086/0.190
	LMC20A130			1/3.28	TSXCANCBDD1	0.131/0.289
				3/9.84	TSXCANCBDD3	0.268/0.591
				5/16.40	TSXCANCBDD5	0.400/0.882

CANopen/CANmotion machine bus: other connection accessories

Description	Use		Item no.	Length m/ft	Reference	Weight kg/lb
	From	To				
CANopen cables Standard cables, C€ marking Low smoke zero halogen Flame retardant (IEC60332-1)	VW3M3802 connector	VW3M3802 connector	5	50/164.04	TSXCANCA50	4.930/10.869
	TSXCANKCDF90T connector	TSXCANKCDF90T connector		100/328.08	TSXCANCA100	8.800/19.401
	M238 logic controller	M238 logic controller		300/984.25	TSXCANCA300	24.560/54.145
CANopen cables UL certification, C€ marking Flame retardant (IEC60332-2)	VW3M3802 connector	VW3M3802 connector	5	50/164.04	TSXCANCB50	3.580/7.893
	TSXCANKCDF90T connector	TSXCANKCDF90T connector		100/328.08	TSXCANCB100	7.840/17.284
	M238 logic controller	VW3CANTAP2 tap junction		300/984.25	TSXCANCB300	21.870/48.215
CANopen cables Cable for harsh environment (2) or mobile installation, C€ marking Low smoke zero halogen Flame retardant (IEC 60332-1)	VW3M3802 connector	VW3M3802 connector	5	50/164.04	TSXCANCD50	3.510/7.738
	TSXCANKCDF90T connector	TSXCANKCDF90T connector		100/328.08	TSXCANCD100	7.770/17.130
	M238 logic controller	VW3CANTAP2 tap junction		300/984.25	TSXCANCD300	21.700/47.840

(1) Sold in lots of 2.

(2) Harsh environment:

- resistance to hydrocarbons, industrial oils, detergents, solder splashes
- relative humidity up to 100%
- saline atmosphere

- significant temperature variations, operating temperature between - 10 °C/+ 14 °F and + 70 °C/+ 158 °F

Lexium™ 32 Servo Drives Motion control

Communication buses and networks
PROFIBUS DP V1 and DeviceNet fieldbuses

PROFIBUS DP V1 fieldbus

Introduction



VW3A3607 PROFIBUS DP V1 communication card

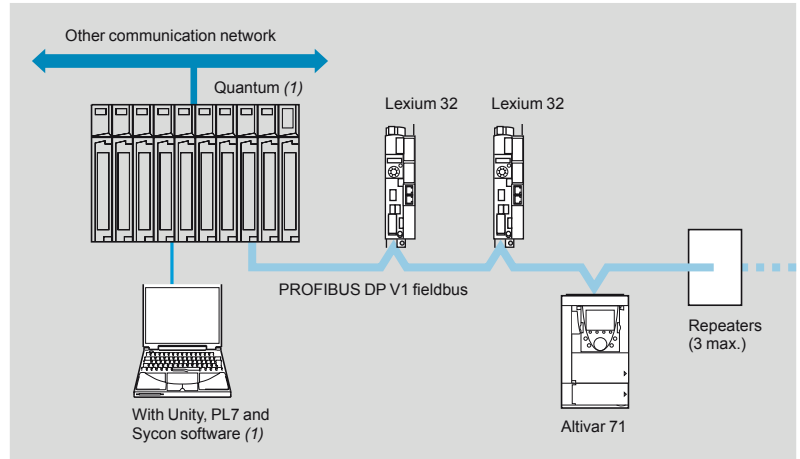

PROFIBUS DP is a fieldbus for industrial communication.

The Lexium 32M servo drive is connected to the PROFIBUS DP V1 fieldbus via the VW3A3607 communication card.

Other devices can be connected to the PROFIBUS DP V1 bus such as PLCs (1), STB I/O (2), Altivar variable speed drives (3), and Osicoder rotary encoders (4).

Reference

Description	For use with	Type of port	Reference	Weight kg/lb
PROFIBUS DPV1 card	Lexium 32M servo drives	One 9-way female SUB-D connector	VW3A3607	0.140/ 0.309

DeviceNet fieldbus

Introduction



VW3M3301 DeviceNet communication card

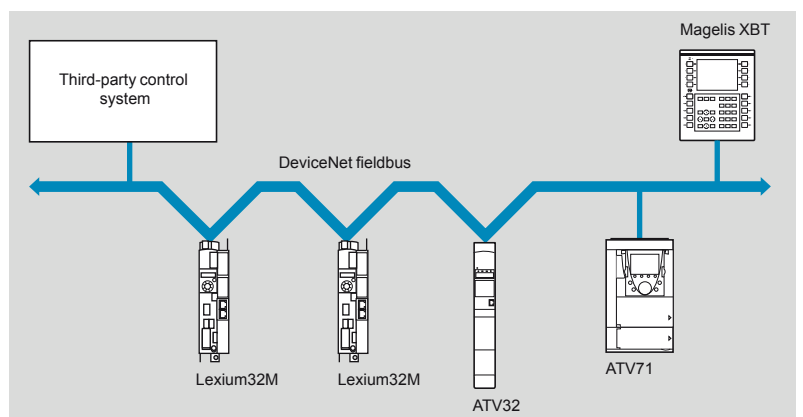

The DeviceNet fieldbus is used in industrial applications to manage a large number of devices remotely.

Connection to the DeviceNet fieldbus allows Lexium32M servo drives to standardize motion control solutions, while remaining independent of the system controlling the machine.

Reference

Description	For use with	Type of port	Profiles supported	Reference	Weight kg/lb
DeviceNet card	Lexium32M servo drive	One removable screw connector, 5 contacts with 5.08 pitch	CIPmotion profile Profile compatible with PLCopen libraries	VW3M3301	–

(1) Please refer to the "Automation platform Modicon Quantum and Unity" catalog or our website www.schneider-electric.com.

(2) Please refer to the "Human-Machine interfaces" catalog or our website www.schneider-electric.com.

(3) Please refer to the "Altivar variable speed drives" catalogs or our website www.schneider-electric.com.

(4) Please refer to the "Detection for automation solutions - OsiSense" catalog or the website www.tesensors.com.

EtherNet/IP network

Introduction



VW3A3616 EtherNet/IP communication card

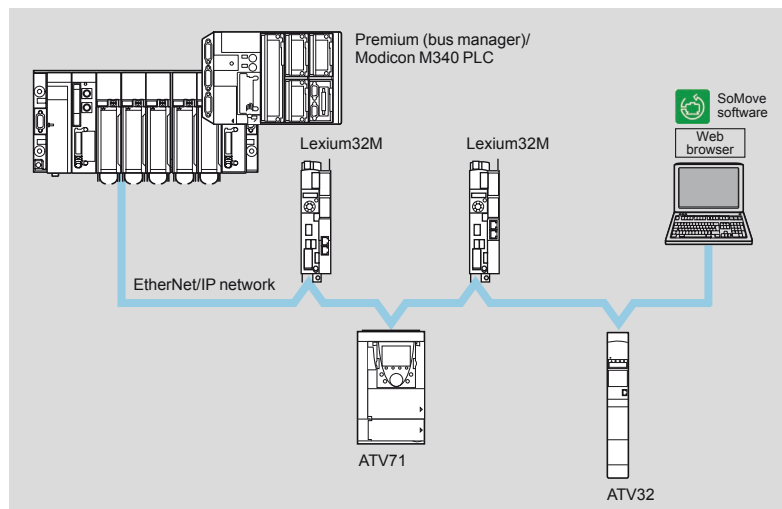

The EtherNet/IP network is a protocol specially designed for industrial environments. It uses the widely implemented Ethernet protocols TCP (Transmission Control Protocol) and IP (Internet Protocol), offering an integrated transparent connection system to the company network.

Thanks to its high speed, the network no longer restricts the application's performance. It is the pre-eminent open protocol and supports the following types of communication:

- Web pages
- File transfers
- Messaging

Reference

Description	For use with	Type of port	Reference	Weight kg/lb
EtherNet/IP card 10/100 Mbps, half and full duplex Embedded Web server	Lexium 32M servo drives	2 RJ45 connectors	VW3A3616	0.300/ 0.661

EtherNet/IP network connection accessories

Description	Type of port	Length m/ft (1)	Reference	Weight kg/lb
ConneXium cordsets (conforming to EIA/TIA-568, category 5 and IEC1180/EN50173, class D, standards)				
Straight shielded twisted pair cordsets	2 RJ45 connectors	2/ 6.56	490NTW00002	–
		5/ 16.40	490NTW00005	–
		12/ 39.37	490NTW00012	–
Crossed shielded twisted pair cordsets	2 RJ45 connectors	5/ 16.40	490NTC00005	–
		15/ 49.21	490NTC00015	–
		5/ 16.40	490NTW00002U	–
Straight shielded twisted pair cordsets	2 RJ45 connectors	5/ 16.40	490NTW00005U	–
		15/ 49.21	490NTW00012U	–
		5/ 16.40	490NTC00005U	–
Crossed shielded twisted pair cordsets	2 RJ45 connectors	5/ 16.40	490NTC00005U	–

(1) Also available in 40 and 80 m/131 and 262 ft lengths.

To order other ConneXium connection components, please refer to our website www.schneider-electric.com.

EtherCAT fieldbus

Introduction



VW3A3601 EtherCAT communication card

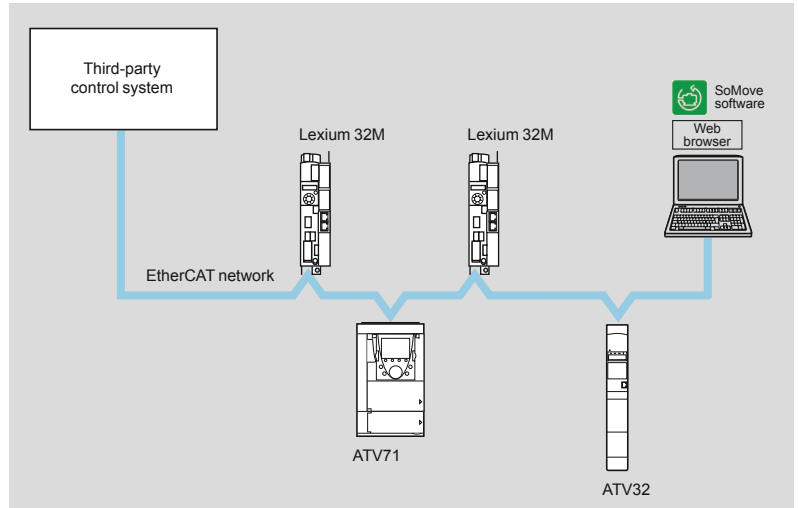

EtherCAT (EtherNet for Control Automation Technology) is an EtherNet-based open fieldbus system. This means that EtherNet technologies, such as embedded Web server, e-mail, and FTP transfer, can be used in the EtherCAT environment.

The EtherCAT fieldbus is intended for applications requiring very short cycle times ($\leq 250 \mu\text{s}$) with low jitter ($\leq 1 \mu\text{s}$) for synchronization purposes.

These characteristics enable the EtherCAT network to achieve very high performance levels in the control systems field, with low equipment costs.

Reference

Description	For use with	Type of port	Reference	Weight kg/lb
EtherCAT card	Lexium 32M servo drives	2 RJ45 connectors	VW3A3601	0.300/ 0.661

EtherCAT fieldbus connection accessories

Description	Type of port	Length m/ft (1)	Reference	Weight kg/lb
ConneXium cordsets (conforming to EIA/TIA-568, category 5, and IEC1180/EN50173, class D, standards)				
Straight shielded twisted pair cordsets	2 RJ45 connectors	2/	490NTW00002	–
		6.56		
		5/	490NTW00005	–
		16.40		
		12/	490NTW00012	–
		39.37		
Crossed shielded twisted pair cordsets	2 RJ45 connectors	5/	490NTC00005	–
		16.40		
		15/	490NTC00015	–
		49.21		
ConneXium cordsets (conforming to UL and CSA 22.1 standards)				
Straight shielded twisted pair cordsets	2 RJ45 connectors	2/	490NTW00002U	–
		6.56		
		5/	490NTW00005U	–
		16.40		
		15/	490NTW00012U	–
		49.21		
Crossed shielded twisted pair cordsets	2 RJ45 connectors	5/	490NTC00005U	–
		16.40		

(1) Also available in 40 and 80 m/131 and 262 ft lengths.

To order other ConneXium connection components, please refer to our website www.schneider-electric.com.

Lexium™ 32 Servo Drives Motion control

Option: Encoder cards for Lexium 32M
servo drives



VW3M3401 resolver card



VW3M3402 encoder interface card
(digital output)



VW3M3403 encoder interface card
(analog output)

Introduction

The Lexium 32M servo drive can take an encoder interface card. This has an input available for an additional encoder, offering the following advantages:

- Ability to connect to third-party motors, which increases the installation's flexibility
- Ability to improve positioning accuracy by reducing the effect of mechanical backlash, and also to meet the requirements of simple applications or complex systems that need a very quick response or very accurate path following

3 cards are available depending on the encoder technology:

- Resolver encoder
- Encoder with digital output
- Encoder with analog output

References

Description	Technology type	Power supply	Encoder type		Reference	Weight
			Machine encoder	Motor encoder		
		V ...				kg/lb
Resolver card					VW3M3401	–
Encoder interface card with digital output	A/B/I	5			VW3M3402	–
	SSI	12				
	BISS	5				
	EnDat 2.2	5				
Encoder interface card with analog output	1 Vpp	5			VW3M3403	–
	1 Vpp/Hall	5				
	Hiperface	12				

Connection accessories

Description	Composition	Length m/ft	Reference	Weight kg/lb
Cordset				
Cordset equipped with 1 x 15-way high density male SUB-D connector For card with digital or analog output	–	1/ 3.28	VW3M4701	–
Connecting cable				
Cable for creating cordsets for encoder interface cards	[5 x (2 x 0.25 mm ² / AWG 24) + (2 x 0.5 mm ² / AWG 20)]	100/ 328.08	VW3M8221R1000	21.000/ 46.297

Lexium™ 32 Servo Drives Motion control

Option: Encoder cards for Lexium 32M
servo drives

Osicoder® machine encoders for VW3M3402 encoder card

Introduction

To meet requirements for machine encoders, Schneider Electric offers the Osicoder® range of encoders. They connect to the VW3M3402 encoder interface card with digital output.

The Osicoder® offer consists of incremental encoders and absolute encoders.

The proposed incremental encoder, with its configurable resolution, satisfies many requirements for machine encoders with A/B/I output signal.

The proposed absolute encoders are among the most commonly used machine encoders with SSI interface.

For more information on the Osicoder® offer, please refer to the “Rotary encoders - Osicoder®” catalog or our website www.schneider-electric.com.



XCC1510PSM50X incremental encoder

58 mm/2.28 in. incremental encoder

Operating on the principle of in-line differential optical reading, XCC incremental encoders are extremely rugged, thanks to their technology-based photo-sensitive cells and triple light source.

The cyclic ratio is maintained even in the event of:

- Detected fault on one of the sender components
- Reduced efficiency of the sender components (up to 30%)
- Deposit of fine dust on the optical elements

Configurable encoder with 10 mm/0.39 in. solid shaft

Resolution	Type of connection	Type of output stage	Supply voltage	Reference	Weight kg/lb
5,000 to 80,000 points	Male M23 radial connector	5 V, RS 422	4.75 to 30 V	XCC1510PSM50X	0.465/ 1.025

Note: XCC incremental encoders can also be used as a master encoder on Lexium 32C and Lexium 32M servo drives, when connected to the PTI input.

58 mm/2.28 in. absolute encoders

An absolute encoder continuously delivers a code that is the image of the actual position of the moving part to be controlled. On the first power-up or on return of the power after a power outage, the encoder will deliver a data item that can be used directly by the processing system.

Resolution	Type of connection	Type of output stage	Supply voltage	Reference	Weight kg/lb
------------	--------------------	----------------------	----------------	-----------	--------------

Single turn encoder with 10 mm/0.39 in. solid shaft

8,192 points	Male M23 radial connector	SSI, 13 bits, binary	11 to 30 V	XCC2510PS81SBN	0.460/ 1.014
--------------	---------------------------	----------------------	------------	----------------	-----------------

Multiturn encoder with 10 mm/0.39 in. solid shaft

8,192 points x 4,096 turns	Male M23 radial connector	SSI, 25 bits, binary	11 to 30 V	XCC3510PS84SBN	0.685/ 1.510
----------------------------	---------------------------	----------------------	------------	----------------	-----------------



XCC2510PS81SBN absolute encoder

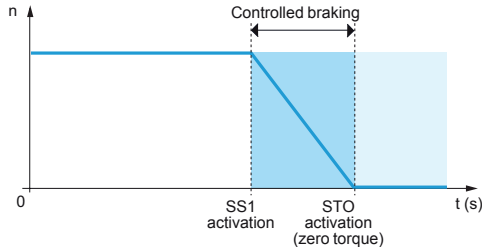

Activation of the Safe Stop 1 (SS1) function

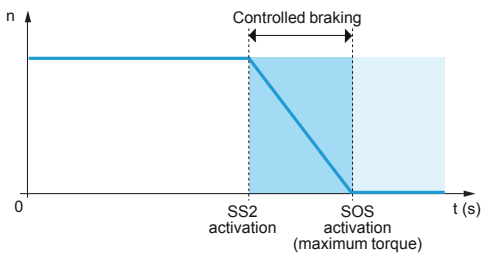

Activation of the Safe Stop 2 (SS2) function

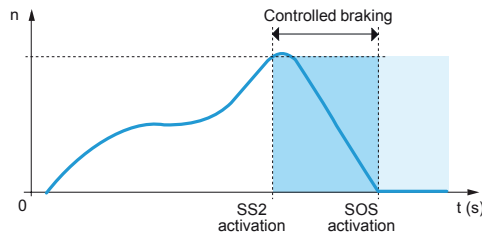

Activation of the Safe Limited Speed (SLS) function

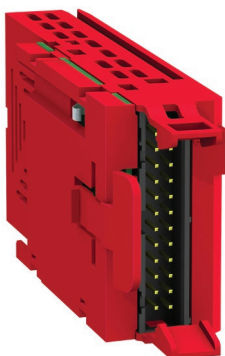

VW3M3501 safety card

Introduction

The eSM safety card allows Lexium 32 servo drives to access additional safety functions as well as the Safety Torque Off (STO) function. This offers a complex safety device that helps to provide installation monitoring.

Using the eSM card helps reduce the overall cost of the installation by avoiding the need for additional external devices, while conforming to international safety standards. As a result, wiring is faster and less expensive.

It also improves performance during maintenance by reducing machine or installation downtime and increases the safety of any work carried out.

The eSM card complies with the machinery standard ISO 13849-1, performance level "e" (PL e), functional safety standard IEC/EN 61508, SIL 3 capability, and functional safety standard IEC/EN 62061, SIL 3 capability.

It includes safety functions compliant with standard IEC/EN 61800-5-2. These functions, required in the majority of applications, are as follows:

- Safe Torque Off (STO)
- Safe Stop 1 (SS1)
- Safe Stop 2 (SS2)
- Safe Limited Speed (SLS)
- Safe Operating Stop (SOS)

Safety functions

Safe Stop 1 (SS1) function

The SS1 function is used to achieve a category 1 safe stop. After activation of the function, the servo motor is braked in a controlled manner, maintaining the power on the actuators. The power is then removed when the actuators stop after the machine has come to a halt.

Safe Stop 2 (SS2) function

The SS2 function is used to achieve a category 2 safe stop. After activation of the function, the servo motor is braked in a controlled manner, maintaining the power on the actuators. Once the motor has come to a halt, it is kept at a standstill with the Safe Operating Stop (SOS) function.

Safe Limited Speed (SLS) function

The SLS function is used to monitor the configured maximum speed. If this speed is exceeded, the servo motor will be stopped in accordance with SS2.

Safe Operating Stop (SOS) function

The SOS function is used to monitor any deviation from the standstill position once the servo motor has come to a halt.

References

Description	Power supply	Cable length	Unit reference	Weight
	V	m/ft		kg/lb
eSM safety card for Lexium 32M servo drives	24 --- (min. 19, max. 30)	–	VW3M3501	–
Cordset preassembled with a 24-way female connector (safety card end) and a free end	–	3/ 9.84	VW3M8801R30	–
Cordsets preassembled with 2 x 24-way female connectors	–	1.5/ 4.92	VW3M8802R15	–
		3/ 9.84	VW3M8802R30	–
eSM distribution unit equipped with 5 connectors	–	–	VW3M8810	–
Removable connector for connecting an additional eSM distribution unit Sold in lots of 4	–	–	VW3M8820	–

Lexium™ 32 Servo Drives Motion control

Options: I/O expansion card for Lexium 32M servo drives and braking resistors for servo drives

Introduction



VW3M3302 I/O expansion card

Lexium 32M (1) servo drives can be adapted for more complex or more extensive applications by installing an I/O expansion card.

This expansion card has the same functions as the Lexium 32M servo drive I/O.

The I/O expansion card is inserted into a dedicated slot (port no. 1). It is compatible with servo drives supporting version V01.06 minimum.

The card has logic and analog I/O:

- 4 x 24 V $\overline{\text{---}}$ positive logic (Source) or negative logic (Sink) inputs
- 2 positive logic (Source) or negative logic (Sink) open collector outputs
- 2 software-configurable voltage (0 to 10 V $\overline{\text{---}}$) analog inputs, 14-bit resolution
- 2 software-configurable voltage (0 to 10 V $\overline{\text{---}}$) or current (0 to 20 mA) analog outputs, 12-bit resolution

Reference

Description	Type of I/O				Type of connection	Reference	Weight
	Logic input	Logic output	Analog input	Analog output			
I/O expansion card for Lexium 32M (1) servo drives	4	2	2	2	Spring terminals	VW3M3302	0.400/ 0.882

Introduction

Internal braking resistor

A braking resistor is built into the servo drive to absorb the braking energy. If the DC bus voltage in the servo drive exceeds a specified value, this braking resistor is activated. The restored energy is converted into heat by the braking resistor. This enables maximum transient braking torque.

External braking resistor

When the servo motor has to be braked frequently, an external braking resistor is required to dissipate the excess braking energy. In this case, the internal braking resistor must be deactivated.

Several external braking resistors can be connected in parallel. The servo drive monitors the power dissipated in the braking resistor.

The degree of protection of the casing is IP 65 for VW3A7601R●● to VW3A7608R●● braking resistors and IP 20 for VW3A770● braking resistors.

The operating temperature around the unit can be between 0 and + 50 °C/+ 32 and + 122 °F.

To optimize the size of the braking resistor, the DC buses on Lexium 32 servo drives in the same installation can be connected in parallel (see page 24).

Applications

Machines with high inertia, driving loads, and machines with fast cycles.

(1) Except with LXM32MD85N4 and LXM32CD10N4 servo drives.

Lexium™ 32 Servo Drives Motion control

Option: Braking resistors for servo drives

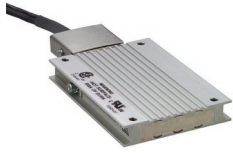

VW3A760●R●●



VW3A770●

References								
Ohmic value	Continuous power PPr	Peak energy EPk				Length of connection cable	Reference	Weight
		115 V	230 V	400 V	480 V			
Ω	W	Ws	Ws	Ws	Ws	m/ft	kg/lb	
10	400	18,800	13,300	7,300	7,300	0.75/ 2.46	VW3A7601R07	1.420/ 3.131
						2/ 6.56	VW3A7601R20	1.470/ 3.241
						3/ 9.84	VW3A7601R30	1.620/ 3.571
	1,000	36,500	36,500	22,500	22,500	–	VW3A7705	11.000/ 24.251
15	1,000	43,100	43,100	26,500	26,500	–	VW3A7704	11.000/ 24.251
27	100	4,200	3,800	1,900	1,900	0.75/ 2.46	VW3A7602R07	0.630/ 1.389
						2/ 6.56	VW3A7602R20	0.780/ 1.720
						3/ 9.84	VW3A7602R30	0.930/ 2.050
	200	9,700	7,400	4,900	4,300	0.75/ 2.46	VW3A7603R07	0.930/ 2.050
						2/ 6.56	VW3A7603R20	1.080/ 2.381
						3/ 9.84	VW3A7603R30	1.200/ 2.646
	400	25,500	18,100	11,400	10,500	0.75/ 2.46	VW3A7604R07	1.420/ 3.131
						2/ 6.56	VW3A7604R20	1.470/ 3.241
						3/ 9.84	VW3A7604R30	1.620/ 3.571
72	100	5,500	3,700	2,500	2,300	0.75/ 2.46	VW3A7605R07	0.620/ 3.571
						2/ 6.56	VW3A7605R20	0.750/ 1.653
						3/ 9.84	VW3A7605R30	0.850/ 1.874
	200	14,600	9,600	6,600	6,000	0.75/ 2.46	VW3A7606R07	0.930/ 2.050
						2/ 6.56	VW3A7606R20	1.080/ 2.381
						3/ 9.84	VW3A7606R30	1.200/ 2.646
	400	36,600	24,700	16,200	15,500	0.75/ 2.46	VW3A7607R07	1.420/ 3.131
						2/ 6.56	VW3A7607R20	1.470/ 3.241
						3/ 9.84	VW3A7607R30	1.620/ 3.571
100	100	4,400	4,400	2,900	2,900	0.75/ 2.46	VW3A7608R07	0.410/ 0.904
						2/ 6.56	VW3A7608R20	0.560/ 1.235
						3/ 9.84	VW3A7608R30	0.760/ 1.676

Note: The total continuous power dissipated in the external braking resistor(s) must be less than or equal to the nominal power of the Lexium 32 servo drive (see pages 18 and 19).

Introduction

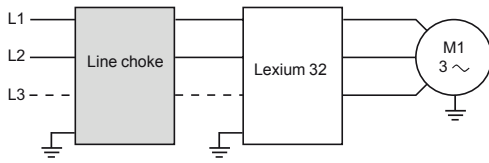

A line choke can be used to provide improved protection against overvoltages on the line supply and to reduce harmonic distortion of the current produced by the servo drive.

Recommended chokes limit the line current. They have been developed in line with standard IEC 61800-5-1 (VDE 0160 level 1 high-energy overvoltages on the line supply).

Inductance values are defined for a voltage drop between 3% and 5% of the nominal line voltage. Values higher than this will cause loss of torque.

These chokes must be installed upstream of the servo drive. One line choke can be connected to a number of servo drives. In such cases, the current consumption of all the servo drives at nominal voltage must not exceed the nominal current of the line choke.

The use of line chokes is recommended in particular under the following circumstances:

- Close connection of several servo drives in parallel
- Line supply with significant disturbance from other equipment (interference, overvoltages)
- Line supply with voltage unbalance between phases that is more than 1.8% of the nominal voltage
- Servo drive supplied by a line with very low impedance (in the vicinity of a power transformer 10 times more powerful than the servo drive rating)
- Installation of a large number of servo drives on the same line
- Reduction of overloads on the $\cos \varphi$ correction capacitors, if the installation includes a power factor correction unit.

References

For servo drive	Inductance value	Losses	Line current and THD				Reference	Weight
			Without choke		With choke			
	mH	W	A	%	A	%	kg/lb	
Single-phase supply voltage: 115 V ~ 50/60 Hz								
LXM32●U45M2	5	20	2.9	173	2.6	85	VZ1L007UM50	0.880/ 1.940
LXM32●U90M2	2	30	5.4	159	5.2	90	VZ1L018UM20	1.990/ 4.387
LXM32●D18M2	2	30	8.5	147	9.9	74		
LXM32●D30M2	2	30	12.9	135	9.9	72		
Single-phase supply voltage: 230 V ~ 50/60 Hz								
LXM32●U45M2	5	20	2.9	181	3.4	100	VZ1L007UM50	0.880/ 1.940
LXM32●U90M2	2	30	4.5	166	6.3	107	VZ1L018UM20	1.990/ 4.387
LXM32●D18M2	2	30	8.4	148	10.6	93		
LXM32●D30M2	2	30	12.7	135	14.1	86		
Three-phase supply voltage: 380 V ~ 50/60 Hz								
LXM32●U60N4	2	75	1.4	187	1.9	106	VW3A4553	3.500/ 7.716
LXM32●D12N4	2	75	3	174	3.5	88		
LXM32●D18N4	1	90	5.5	159	7.2	88	VW3A4554	6.000/ 13.228
LXM32●D30N4	1	90	8.7	146	11.6	74		
LXM32●D72N4	1	90	18.1	124	23.5	43		
LMX32MD85N4	1	90	23.3	139	25	45		
LXM32MC10N4	0.5	94	27.8	133	38.1	70	VW3A4555	11.000/ 24.251
Three-phase supply voltage: 480 V ~ 50/60 Hz								
LXM32●U60N4	2	75	1.2	201	1.6	116	VW3A4553	3.500/ 7.716
LXM32●D12N4	2	75	2.4	182	2.9	98		
LXM32●D18N4	1	90	4.5	165	6	98	VW3A4554	6.000/ 13.228
LXM32●D30N4	1	90	7	152	9.6	85		
LXM32●D72N4	1	90	14.6	129	19.5	55		
LMX32MD85N4	1	90	19.9	145	21	45		
LXM32MC10N4	0.5	94	23.7	140	32	54	VW3A4555	11.000/ 24.251

Lexium™ 32 Servo Drives Motion control

Integrated EMC filters and additional EMC input filters for servo drives

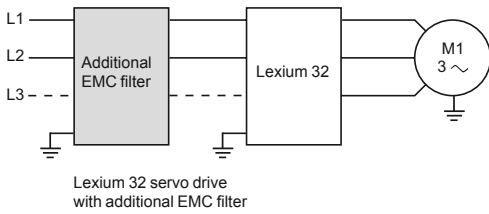
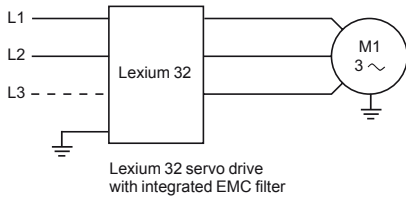

Additional EMC filter mounted on a Lexium 32M servo drive

Integrated EMC filter

Function

Lexium 32 servo drives have integrated radio interference input filters – to comply with the EMC standard for variable speed electrical power drive “products” IEC/EN 61800-3, edition 2, category C3 in environment 2 – and to comply with the European directive on EMC (electromagnetic compatibility).

For servo drive

Maximum servo motor cable length conforming to

EN 55011, class A, Gr2
IEC/EN 61800-3, category C3 in environment 2 (1)
Switching frequency: 8 kHz

m/ft

Single-phase supply voltage: 115 V ~ 50/60 Hz

LXM32●●●●M2 20/65.62 (10 m/32.81 ft in category C2, environment 1)

Single-phase supply voltage: 230 V ~ 50/60 Hz

LXM32●●●●M2 20/65.62 (10 m/32.81 ft in category C2, environment 1)

Three-phase supply voltage: 380 V ~ 50/60 Hz

LXM32●●●●N4 20/65.62

Three-phase supply voltage: 480 V ~ 50/60 Hz

LXM32●●●●N4 20/65.62

Additional EMC input filters

Applications

Used with Lexium 32 servo drives, additional EMC input filters can be used to meet more stringent requirements and are designed to reduce conducted emissions on the line supply below the limits of standard IEC/EN 61800-3 edition 2, category C2 or C3 (see page 39).

Additional EMC filters are mounted on the side of the device. They have tapped holes for mounting in an enclosure.

Use according to the type of line supply

Integrated or additional EMC filters can only be used on TN (neutral connection) or TT (neutral to ground) systems.

Lexium 32 servo drives cannot be used on IT (impedance grounded or isolated neutral) systems. Standard IEC/EN 61800-3, appendix D2.1, states that on IT systems, filters can cause permanent insulation monitors to operate in a random manner.

If a machine has to be installed on an IT system, an isolation transformer must be inserted in order to re-create a TT system on the secondary side.

(1) Standard IEC/EN 61800-3: EMC immunity and conducted and radiated EMC emissions: - Category C3 in environment 2: industrial premises.

Lexium™ 32 Servo Drives

Motion control

Option: Additional EMC input filters for servo drives



VW3A4422



VW3A4424

References

For servo drive	Maximum servo motor shielded cable length conforming to			Reference	Weight
	EN 55011 class A Gr1	EN 55011 class A Gr2			
	IEC/EN 61800-3 category C2 (1) in environment 1	IEC/EN 61800-3 category C3 (1) in environment 2			
	Switching frequency	Switching frequency			
	8 kHz	4 kHz	8 kHz		
	m/ft	m/ft	m/ft		kg/lb
Single-phase supply voltage					
LXM32●U45M2	50/	–	100/	VW3A4420	0.600/
LXM32●U90M2	164		330		1.323
LXM32●D18M2	50/	–	100/	VW3A4421	0.775/
LXM32●D30M2	164		330		1.709
Three-phase supply voltage					
LXM32●U60N4	50/	–	100/	VW3A4422	0.900/
LXM32●D12N4	164		330		1.984
LXM32●D18N4					
LXM32●D30N4					
LXM32●D72N4	50/	–	100/	VW3A4423	1.350/
	164		330		2.976
LMX32MD85N4, LXM32MC10N4	50/	100/	–	VW3A4424	3.150/
	164	330			6.945

(1) Standard IEC/EN 61800-3: EMC immunity and conducted and radiated EMC emissions:
 - Category C2 in environment 1: restricted distribution, for domestic use, sale conditional on the competence of the user and the distributor in terms of reduction of current harmonics
 - Category C3 in environment 2: industrial premises.

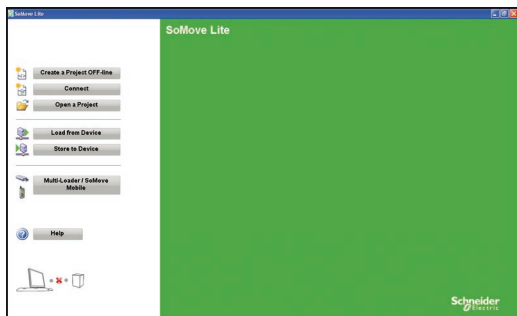

SoMove start page

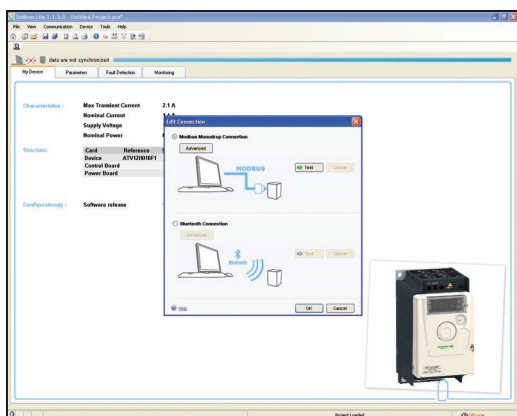

Example of connecting SoMove software to an ATV 12 drive

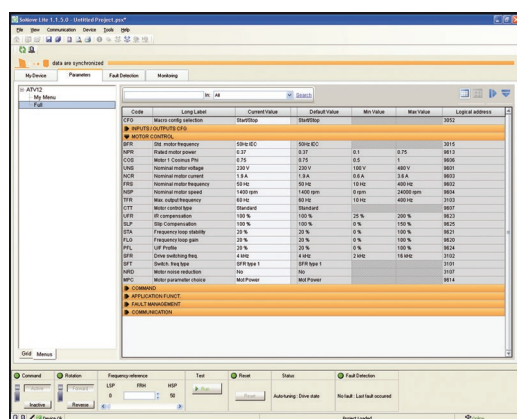

SoMove control panel

Introduction

SoMove is user-friendly setup software for PCs, designed for configuring the following Schneider Electric motor control devices:

- ATV 12, ATV 312, ATV 31, ATV 32, ATV 61 and ATV 71 drives
- ATS 22 and ATS 48 soft starters
- TeSys U starter-controllers
- TeSys T motor management system
- Lexium 32 servo drives
- Lexium 32i integrated servo drives

SoMove software incorporates various functions for the device setup phases, such as:

- Configuration preparation
- Start-up
- Maintenance

To facilitate setup and maintenance, SoMove software can use a direct USB/RJ45 cable link or a Bluetooth® wireless link.

SoMove software is also compatible with the Multi-Loader configuration tool and SoMove Mobile software for mobile phones.

These tools can save a significant amount of time when loading, duplicating or editing configurations on a device.

SoMove software and the DTMs (Device Type Managers) associated with the devices can be downloaded from our website www.schneider-electric.com.

Functions

Configuration preparation in disconnected mode

SoMove software has a genuine disconnected mode which provides access to the device parameters. This mode can be used to generate the device configuration. The configuration can be saved, printed and exported to office automation software.

SoMove software also checks the consistency of the parameters, validating the configurations created in disconnected mode.

A large number of functions are available in disconnected mode, in particular:

- The device configuration software wizard
- The configuration comparison function
- Saving, copying, printing and creating configuration files for export to Multi-Loader, SoMove Mobile or Microsoft Excel® tools, and sending configurations by e-mail

Setup

When the PC is connected directly to the device or to the communication bus (1), SoMove software can be used for:

- Transferring the generated configuration onto the device
- Adjustment and monitoring, which includes such functions as:
 - Oscilloscope
 - Display of communication parameters
- Easy control via the control panel user interface
- Saving the final configuration

Maintenance

In order to simplify maintenance operations, SoMove software can be used to:

- Compare the configuration of a device currently being used with a configuration saved on the PC
- Transfer a configuration to a device
- Compare oscilloscope curves
- Save oscilloscope curves and faults

(1) Requires a specific connection accessory. For further information, please consult our Customer Care Center.

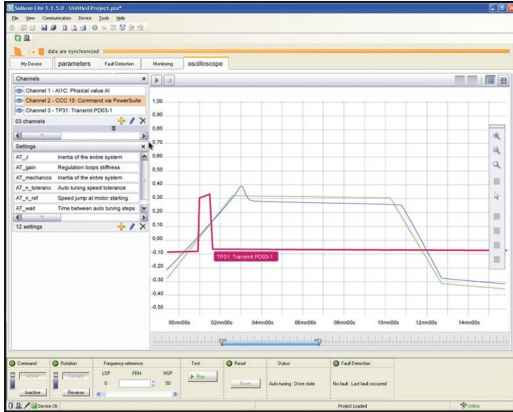

SoMove oscilloscope function

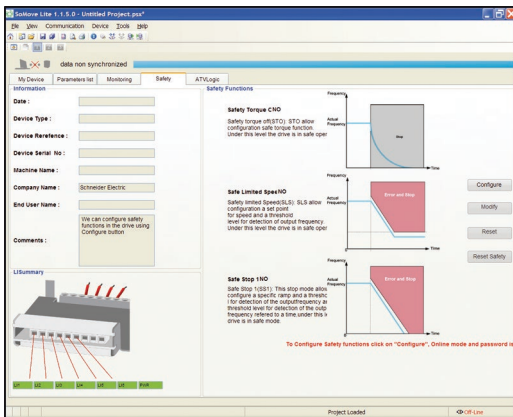

SoMove Safety function

Functions (continued)

User interface

SoMove software provides fast, direct access to information on the device via five tabs:

- **My Device:** Displays the device information (type, reference, software versions, option cards)
- **Parameters:** Displays the device adjustment parameters, shown in a table or in the form of diagrams
- **Faults:** Displays a list of the faults that may be encountered with the device, the fault log and any current faults or alarms
- **Monitoring:** Provides a realtime display of the device status, its I/O and the monitoring parameters. It is possible to create your own control panel by selecting your parameters and how they are to be represented.
- **Oscilloscope:** Provides a high-speed oscilloscope (for recording traces in the device) or low-speed oscilloscope (for recording traces in the software for devices that do not have an integrated oscilloscope)

SoMove's user interface automatically adapts to the specific configured device by offering additional tabs:

- **Safety:** For configuring the Safety functions on ATV 32 variable speed drives and Lexium 32 servo drives. It can also be used to:
 - Display the I/O
 - Compile and print a report
- **ATVLogic:** For accessing the ATV 32 drive's programmable function blocks. It can also be used to:
 - Develop a program and transfer it to the drive
 - Display and debug the program already on the drive
- **Auto-tuning:** For accessing the servo control settings for the three different operating modes of the Lexium 32 servo drive's auto-tuning function:
 - Automatic mode for quick setup, designed for simple applications
 - Semi-automatic mode for quick setup, with the option of optimizing the servo drive/servo motor combination (access to the mechanical and dynamic behavior parameters)
 - Expert mode for optimizing the adjustment parameters, designed for complex applications

Connections

Modbus serial link

The PC running SoMove software can be connected directly via the RJ45 connector on the device and the USB port on the PC using the USB/RJ45 cable.

See the product references on page 42.

Bluetooth® wireless link

SoMove software can communicate via Bluetooth® wireless link with any Bluetooth® enabled device.

If the device is not Bluetooth® enabled, use the Modbus-Bluetooth® adaptor (1). This adaptor is connected to the terminal port or the Modbus network port on the device. It has a 20 m/65 ft range (class 2).

If the PC does not have Bluetooth® technology, use the USB-Bluetooth® adaptor.

(1) See the list of the available devices on page 42.

Lexium™ 32 Servo Drives

Motion control

SoMove setup software



SoMove setup software



TCSWAAC13FB:
Bluetooth® adaptor

References

Description	Reference	Weight kg/lb
SoMove Lite setup software Includes: SoMove setup software for PC in English, French, German, Italian, Spanish and Chinese DTMs (Device Type Managers) and technical documentation for variable speed drives, starters and servo motors	(1)	–
USB/RJ45 cable Used to connect a PC to the device. This cable is 2.5 m long and has a USB connector (PC end) and an RJ45 connector (device end).	TCSMCNAM3M002P	–
Modbus/Uni-Telway-Bluetooth® adaptor Used to enable any non-Bluetooth® device to communicate via Bluetooth® wireless link (2). Includes: 1 Bluetooth® adaptor (range 20 m, class 2) with an RJ45 connector For SoMove: 1 x 0.1 m cordset with 2 x RJ45 connectors For TwidoSuite: 1 x 0.1 m cordset with 1 RJ45 connector and 1 mini DIN connector	TCSWAAC13FB	0.032/ 0.071
USB-Bluetooth® adaptor for PC Used to enable any non-Bluetooth® PC to communicate via Bluetooth® wireless link (3). It connects to a USB port on the PC. Range 10 m, class 2	VW3A8115	0.290/ 0.639

(1) Available on our website www.schneider-electric.com.

(2) Available only for the following devices:

- ATV 12, ATV 312, ATV 31, ATV 61 and ATV 71 drives
- ATS 22 and ATS 48 soft starters
- TeSys U starter-controllers
- TeSys T motor management system
- Lexium 32 servo drives

(3) Check the manufacturer's specification.

Compatibility of SoMove software with specific devices

Device	Range	Version of software on the device
Variable speed drive	ATV 12, ATV 312, ATV 32	≥ 1.0
	ATV 31	≥ 1.1
	ATV 61, ATV 71	≥ 1.6
Soft starter	ATS 22	≥ 1.0
	ATS 48	≥ 1.5
Starter-controller	TeSys U	≥ 1.0
Motor management system	TeSys T	≥ 1.0
Servo drive	Lexium 32	≥ 1.0
Integrated servo drive	Lexium 32i	≥ 1.0

Environments

SoMove operates in the following PC environments and configurations:

- Microsoft Windows® 7 Professional
- Microsoft Windows® XP Professional SP3
- Microsoft Windows® Vista Business SP2
- Pentium IV (or equivalent), 1 GHz, hard disk with 1 GB available space, 1 GB of RAM (minimum configuration)

Lexium™ 32 Servo Drives

Motion control

Motor starters

Applications

The combinations listed below can be used to create a complete motor starter unit featuring a contactor and a Lexium 32 servo drive.

The contactor turns on and manages any safety functions, as well as isolating the servo motor on stopping.

The servo drive controls the servo motor, provides protection against short-circuits between the servo drive and the servo motor, and helps to protect the motor cable against overloads. The overload protection is provided by the motor thermal protection of the servo drive.



Motor starters for Lexium 32 servo drives

Servo drive	Max. prospective line Isc	Contactor
Reference	Nominal power	Reference (1) (2)
	kW	kA
Single-phase supply voltage: ~ 100 to 120 V 50/60 Hz		
LXM32●U45M2	0.15	1
LXM32●U90M2	0.3	1
LXM32●D18M2	0.5	1
LXM32●D30M2	0.8	1

Single-phase supply voltage: ~ 200 to 240 V 50/60 Hz		
LXM32●U45M2	0.3	1
LXM32●U90M2	0.5	1
LXM32●D18M2	1	1
LXM32●D30M2	1.6	1

Three-phase supply voltage: ~ 400 V 50/60 Hz		
LXM32●U60N4	0.4	5
LXM32●D12N4	0.9	5
LXM32●D18N4	1.8	5
LXM32●D30N4	3	5
LXM32●D72N4	7	5
LMX32MD85N4	9	22
LXM32MC10N4	11	22

Three-phase supply voltage: ~ 480 V 50/60 Hz		
LXM32●U60N4	0.4	5
LXM32●D12N4	0.9	5
LXM32●D18N4	1.8	5
LXM32●D30N4	3	5
LXM32●D72N4	7	5
LMX32MD85N4	9	22
LXM32MC10N4	11	22

(1) Composition of contactors :

LC1D●●: 3 poles + 1 NO auxiliary contact and 1 NC auxiliary contact.

In certain solutions, it is possible to use an LC1K contactor with 1 NC auxiliary contact.

Please refer to the "Control and protection components" catalog.

(2) Replace ●● with the control circuit voltage reference given in the table below:

	Volts ~	24	48	110	220/230	230	230/240
LC1D●●	50 Hz	B5	E5	F5	M5	P5	U5
	50 Hz	B6	E6	F6	M6	–	U6
	50/60 Hz	B7	E7	F7	M7	P7	U7

For other available voltages between 24 and 660 V, or for a DC control circuit, please consult our website www.schneider-electric.com.

Lexium™ 32 Servo Drives

Motion control

Motor starters

Protection using fuses

Protection using class J fuses (UL certification)			
Servo drive		Fuse to be placed upstream	
Reference	Nominal power kW	min. A	max. A
Single-phase supply voltage: ~ 100 to 120 V 50/60 Hz			
LXM32●U45M2	0.15	4	25
LXM32●U90M2	0.3	6	25
LXM32●D18M2	0.5	10	25
LXM32●D30M2	0.8	15	25
Single-phase supply voltage: ~ 200 to 240 V 50/60 Hz			
LXM32●U45M2	0.3	4	25
LXM32●U90M2	0.5	6	25
LXM32●D18M2	1	10	25
LXM32●D30M2	1.6	15	25
Three-phase supply voltage: ~ 400 V 50/60 Hz			
LXM32●U60N4	0.4	2	30/32 (1)
LXM32●D12N4	0.9	4	30/32 (1)
LXM32●D18N4	1.8	8	30/32 (1)
LXM32●D30N4	3	10	30/32 (1)
LXM32●D72N4	7	20	30/32 (1)
LMX32MD85N4	9	30	60/63 (2)
LMX32MC10N4	11	40	60/63 (2)
Three-phase supply voltage: ~ 480 V 50/60 Hz			
LXM32●U60N4	0.4	2	30/32 (1)
LXM32●D12N4	0.9	3	30/32 (1)
LXM32●D18N4	1.8	8	30/32 (1)
LXM32●D30N4	3	10	30/32 (1)
LXM32●D72N4	7	20	30/32 (1)
LMX32MD85N4	9	30	60/63 (2)
LMX32MC10N4	11	40	60/63 (2)

(1) Europe: 30 A fuse; US: 32 A fuse.

(2) Europe: 60 A fuse; US: 63 A fuse.

Lexium™ 32 Servo Drives

Motion control

BMH servo motors

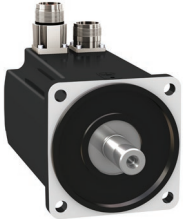

BMH servo motor with straight connectors



BMH servo motor with rotatable elbow connectors

Introduction

BMH servo motors provide excellent power density values to meet the requirements of compact machines. With four flange sizes and three different lengths for each flange size, they are suitable for many applications, covering a continuous stall range from 1.2 to 84 N·m for speeds up to 8,000 rpm.

The new BMH servo motors have a medium inertia motor, which means they are particularly suitable for high-load applications. They help to simplify installation and adjustment through a more robust adjustment of the movement.

BMH servo motors are UL Recognized  and conform to standard UL1004 as well as to European directives (CE marking).

They are available with the following variants:

- 5 flange sizes: 70, 100, 140, 190, and 205 mm/2.76, 3.94, 5.51, 7.48, and 8.07 in.
- 2 degrees of protection for the shaft end: IP 50 or IP 65 (IP 67 with the conformity kit, which is available as an option) in accordance with standard IEC/EN 60529. The degree of protection of the casing is IP 65 (IP 67 with the conformity kit, which is available as an option).
- With or without holding brake
- Straight or elbow connectors for power and encoder connection
- Integrated single-turn or multi-turn SinCos Hiperface® encoder (medium or high resolution)
- Smooth or keyed shaft end

Special features

BMH servo motors have been developed to comply with the following main specifications:

- The ambient operating temperature is - 20 to + 40 °C / - 4 to + 104 °F without derating, in accordance with standard IEC 60721-3-3, category 3K3, and up to 55 °C/131 °F with derating of 1% of the nominal output power per additional °C above 40 °C/104 °F.
- The maximum operating altitude is 1,000 m/3,280 ft without derating, 2,000 m/6,561 ft with $k = 0.86$, and 3,000 m/9,842 ft with $k = 0.8$ (1).
The relative humidity that the servo motor can withstand is in line with standard IEC 60721-3-3, categories 3K3, 3Z12, and 3Z2.
- The windings are insulation class F (maximum temperature for windings 155 °C/311 °F) in accordance with standard IEC 60034-1.
- Thermal protection is provided and controlled by the Lexium 32 servo drive via the motor temperature control algorithm.
- All mounting positions are permitted (horizontal mounting (IMB5) or vertical mounting (IMV1 with shaft end at the top and IMV3 with shaft end at the bottom) in accordance with standard IEC 60034-7.

Sizing

The Lexium Sizer tool is available on our website www.schneider-electric.com to help you size your servo motor.

(1) *k*: derating factor

Introduction (continued)

Holding brake

BMH servo motors can be equipped with an electromagnetic holding brake.

⚠ Do not use the holding brake as a dynamic brake for deceleration, as this will quickly damage the brake.

Integrated encoder

BMH servo motors are equipped as standard with an absolute encoder.

This encoder performs the following functions:

- Gives the absolute position of the motor so that flows can be synchronized
- Measures the servo motor speed via the associated Lexium 32 servo drive (this information is used by the servo drive's speed controller)
- Measures the position information for the servo drive's position controller
- Sends data from the servo motor to the servo drive, which provides automatic identification of the motor when the servo drive starts

Four types of encoder are available:

- High resolution SinCos Hiperface® encoder:
 - Single-turn (131,072 points/turn) (1)
 - Multi-turn (131,072 points/turn x 4,096 turns) (1)These encoders give an angular shaft position precise to less than ± 1.3 arc minutes.
- Medium resolution SinCos Hiperface® encoder:
 - Single-turn (32,768 points/turn) (1)
 - Multi-turn (32,768 points/turn x 4,096 turns) (1)These encoders give an angular shaft position precise to less than ± 4.8 arc minutes.

Description

BMH servo motors, with a 3-phase stator and a 10-pole rotor with Neodymium Iron Boron (NdFeB) magnets, consist of:

- 1 Casing with RAL 9005 opaque black paint protective coating
- 2 4-point axial mounting flange
- 3 Smooth or keyed shaft end (depending on the model)
- 4 Threaded sealed male straight connector for the power cable (2)
- 5 Threaded sealed male straight connector for the control cable (encoder) (2)

Cables and connectors to be ordered separately, for connection to Lexium 32 servo drives (see page 50).

Schneider Electric has taken particular care over the compatibility of BMH servo motors and Lexium 32 servo drives.

This can only be ensured by using cables and connectors sold by Schneider Electric (see page 50).

(1) Encoder resolution given for use with a Lexium 32 servo drive.

(2) For other model with rotatable elbow connector, see page 48.

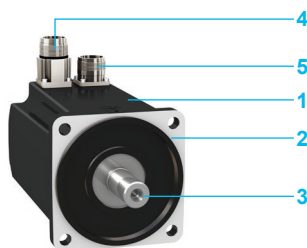

Lexium™ 32 Servo Drives

Motion control

BMH servo motors



Front of the BMH070●●●●●1A

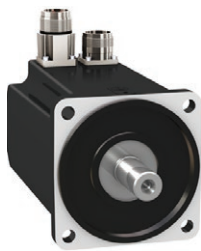

Front of the BMH100●●●●●1A



Front of the BMH1401P●●●●1A



Rear view of the BMH1901P●●●●2A

BMH servo motors

The BMH servo motors shown below are supplied without a gearbox. For GBX and GBY gearboxes see pages 57 and 58.

Continuous stall torque	Peak stall torque	Nominal servo motor output power	Nominal speed	Maximum mechanical speed	Associated LXM32 servo drive	Reference (1)	Weight (2)
N·m	N·m	W	rpm	rpm			kg/lb
1.2	4.2	350	3,000	8,000	●U60N4	BMH0701P●●●●A	1.600/ 3.527
1.4	4	450	4,000	8,000	●U90M2	BMH0701T●●●●A	1.600/ 3.527
		350	2,500	8,000	●D18M2	BMH0701T●●●●A	1.600/ 3.527
	700	5,000	8,000	●D12N4	BMH0701P●●●●A	1.600/ 3.527	
2.5	6.4	600	2,500	8,000	●D30M2	BMH0702T●●●●A	1.800/ 3.968
	7.4	900	4,000	8,000	●D18M2		
		700	3,000	8,000	●D12N4	BMH0702P●●●●A	1.800/ 3.968
3.4	8.7	650	2,000	8,000	●D30M2	BMH0703T●●●●A	2.000/ 4.409
		900	3,000	8,000	●D18M2	BMH0703T●●●●A	2.000/ 4.409
	1,300	5,000	8,000	●D18N4	BMH0703P●●●●A	2.000/ 4.409	
3.3	10.8	800	4,000	6,000	●D12N4	BMH1001P●●●●A	3.340/ 7.363
3.4	8.9	700	2,000	6,000	●D30M2	BMH1001T●●●●A	3.340/ 7.363
	10.8	900	3,000	6,000	●D18M2		
		1,300	4,000	6,000	●D18N4	BMH1001P●●●●A	3.340/ 7.363
6	10.3	750	2,000	6,000	●D30M2	BMH1002T●●●●A	4.920/ 10.847
	18.4	1,450	3,000	6,000	●D30M2		
5.9	18.4	1,600	4,000	6,000	●D18N4	BMH1002P●●●●A	4.920/ 10.847
8	23.5	1,450	2,500	5,000	●D30M2	BMH1003T●●●●A	6.500/ 14.330
8.4	25.1	2,600	4,000	5,000	●D30N4	BMH1003P●●●●A	6.500/ 14.330
10.3	30.8	1,450	1,500	4,000	●D30M2	BMH1401P●●●●A	8.000/ 17.637
		2,400	3,000	4,000	●D30N4		
16.8	50.3	3,800	3,000	4,000	●D72N4	BMH1402P●●●●A	12.000/ 26.455
24	71.8	4,500	3,000	4,000	●D72N4	BMH1403P●●●●A	16.000/ 35.274
30	77.7	4,800	2,500	4,000	●D72N4	BMH1901P●●●●A	19.000/ 41.888
	86.6	5,180	3,000	4,000	MD85N4		
	89.7	5,180	3,000	4,000	MC10N4		
37.4	101	5,900	2,500	4,000	●D72N4	BMH1902P●●●●A	31.000/ 68.343
48	115.5	6,070	2,000	4,000	MD85N4		
	130.7	6,070	2,000	4,000	MC10N4		
43.2	123	5,700	1,500	3,500	●D72N4	BMH1903P●●●●A	43.000/ 94.799
57.6	141.3	7,330	2,000	3,500	MD85N4		
65	162.7	7,750	2,000	3,500	MC10N4		
84	232	6,500	1,200	3,800	●D72N4	BMH2053P●●●●A	67.000/ 147.71
88	266	8,330	1,500	3,800	MD85N4		
	306	9,060	1,500	3,800	MC10N4		

(1) To complete each reference see the table on page 49.

(2) Weight of servo motor without brake, no packaging. To obtain the weight of the servo motor with holding brake, please visit our website www.schneider-electric.com.

Lexium™ 32 Servo Drives

Motion control

BMH servo motors

BMH servo motors (continued)							
To order a BMH servo motor, complete each reference with:							
		BMH0701P	●	●	●	●	A
Shaft end	IP 54	Smooth (1)	0				
		Keyed (1)	1				
	IP 65/IP 67 (2)	Smooth	2				
		Keyed	3				
Integrated sensor High resolution, optical	Single-turn, SinCos Hiperface® 131,072 points/turn (3) 128 sine/cosine periods per turn			1			
	Multi-turn, SinCos Hiperface® 131,072 points/turn x 4,096 turns (3) 128 sine/cosine periods per turn			2			
Integrated sensor Medium resolution, capacitive	Single-turn, SinCos Hiperface® 32,768 points/turn (3) 16 sine/cosine periods per turn			6			
	Multi-turn, SinCos Hiperface® 32,768 points/turn x 4,096 turns (3) 16 sine/cosine periods per turn			7			
Holding brake	Without				A		
	With				F		
Connections	Straight connectors (1)					1	
	Rotatable right angle elbow connectors					2	
Flange	International standard						A
Dimensions (overall)							
Servo motors	Flange	W x H x D (4)					
		Without holding brake		With holding brake			
	mm/in.	mm/in.	mm/in.				
BMH0701●	70 x 70/ 2.76 x 2.76	70 x 109.5 x 122/ 2.76 x 4.31 x 4.80	70 x 109.5 x 161/ 2.76 x 4.31 x 6.34				
BMH0702●	70 x 70/ 2.76 x 2.76	70 x 109.5 x 154/ 2.76 x 4.31 x 6.06	70 x 109.5 x 193/ 2.76 x 4.31 x 7.60				
BMH0703●	70 x 70/ 2.76 x 2.76	70 x 109.5 x 186/ 2.76 x 4.31 x 7.32	70 x 109.5 x 225/ 2.76 x 4.31 x 8.86				
BMH1001●	100 x 100/ 3.94 x 3.94	100 x 139.5 x 128/ 3.94 x 5.49 x 5.04	100 x 139.5 x 170/ 3.94 x 5.49 x 6.69				
BMH1002●	100 x 100/ 3.94 x 3.94	100 x 139.5 x 160/ 3.94 x 5.49 x 6.30	100 x 139.5 x 202/ 3.94 x 5.49 x 7.95				
BMH1003●	100 x 100/ 3.94 x 3.94	100 x 139.5 x 192/ 3.94 x 5.49 x 7.60	100 x 139.5 x 234/ 3.94 x 5.49 x 9.21				
BMH1401P	140 x 140/ 5.51 x 5.51	140 x 179.5 x 152/ 5.51 x 7.07 x 5.98	140 x 179.5 x 187/ 5.51 x 7.07 x 7.36				
BMH1402P	140 x 140/ 5.51 x 5.51	140 x 179.5 x 192/ 5.51 x 7.07 x 7.60	140 x 179.5 x 227/ 5.51 x 7.07 x 8.94				
BMH1403P	140 x 140/ 5.51 x 5.51	140 x 179.5 x 232/ 5.51 x 7.07 x 9.13	140 x 179.5 x 267/ 5.51 x 7.07 x 10.51				
BMH1901P	190 x 190/ 7.48 x 7.48	190 x 257 x 190/ 7.48 x 10.12 x 7.48	190 x 257 x 248/ 7.48 x 10.12 x 9.76				
BMH1902P	190 x 190/ 7.48 x 7.48	190 x 257 x 250/ 7.48 x 10.12 x 9.84	190 x 257 x 308/ 7.48 x 10.12 x 12.13				
BMH1903P	190 x 190/ 7.48 x 7.48	190 x 257 x 310/ 7.48 x 10.12 x 12.21	190 x 257 x 368/ 7.48 x 10.12 x 14.49				
BMH2053P	205 x 205/ 8.07 x 8.07	205 x 259(5) x 489/ 8.07 x 10.20 (5) x 19.25	205 x 259(5) x 538.5/ 8.07 x 10.20 (5) x 21.20				

Note: The example above is for a **BMH0701P** servo motor. For other servo motors, replace **BMH0701P** with the relevant reference.

(1) Not available for BMH190 servo motors.

(2) IP 67 with the VW3M230● IP 67 conformity kit supplied as an option (see page 50).

(3) Sensor resolution given for use with a Lexium 32 servo drive.

(4) D: motor length (excluding shaft end).

(5) Height of the servo motor equipped with straight connectors. The height is 265 mm/10.43 in. when the servo motor is equipped with rotatable elbow connectors.

Lexium™ 32 Servo Drives

Motion control

BMH servo motors



VW3M230●

IP 67 conformity kits

This kit can be used to provide IP 67 degree of protection. It is mounted in place of the motor backplate.

Description	For use with	Reference	Weight kg/lb
IP 67 conformity kits (supplied as an option)	BMH070●●	VW3M2301	0.100/ 0.220
	BMH100●●	VW3M2302	0.150/ 0.331
	BMH140●●	VW3M2303	0.300/ 0.661
	BMH190●●	(1)	0.003/ 0.007
	BMH205●●	VW3M2304	0.750/ 1.65

Connection components

Power cordsets

Description	From servo motor	To servo drive	Composition	Length	Reference	Weight	
				m/ft		kg/lb	
Cordsets equipped with one M23 industrial connector (servo motor end)	BMH070●● BMH100●● BMH1401P	LXM32●●●●●●●● See combinations on pages 10 to 17	[[4 x 1.5 mm ² / AWG 16] + (2 x 1 mm ² / AWG 17)]	1.5/	VW3M5101R15	0.600/	
				3.28		1.323	
				3/		VW3M5101R30	0.810/
				9.84			1.786
				5/			VW3M5101R50
				16.40		2.668	
				10/		VW3M5101R100	2.290/
				32.81			5.049
				15/		VW3M5101R150	3.400/
				49.21			7.496
				20/		VW3M5101R200	4.510/
				65.62			9.943
				25/		VW3M5101R250	6.200/
				82.02			13.669
50/	VW3M5101R500	12.325/					
164.04		26.974					
75/	VW3M5101R750	18.450/					
246.06		40.675					
BMH1402P BMH1403P	LXM32●D72N4	[[4 x 2.5 mm ² / AWG 14] + (2 x 1 mm ² / AWG 17)]	3/	VW3M5102R30	1.070/		
			9.84		2.359		
			5/		VW3M5102R50	1.670/	
			16.40			3.682	
			10/		VW3M5102R100	3.210/	
			32.81			7.077	
			15/		VW3M5102R150	4.760/	
			49.21			10.494	
			20/		VW3M5102R200	6.300/	
			65.62			13.889	
25/	VW3M5102R250	7.945/					
82.02		17.516					
50/	VW3M5102R500	16.170/					
164.04		35.649					
75/	VW3M5102R750	24.095/					
246.06		53.120					

(1) IP 67 conformity kit sold by Festo AG under reference QSML-B-M3-4-20.

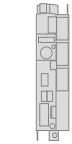

VW3M510●R●●●

Lexium™ 32 Servo Drives

Motion control

BMH servo motors

Connection components (continued)										
Power cordsets										
Description	From servo motor	To servo drive	Composition	Length	Reference	Weight				
				m/ft		kg/lb				
Cordsets equipped with one M40 industrial connector (servo motor end)										
E type mounting with open cable ducts, conforming to standard EN 60204-1										
BMH1901P BMH2053P	LXM32D72N4, LXM32MD85N4, LXM32MC10N4	+ (2 x 1 mm ² / AWG 17)]	[[4 x 4 mm ² / AWG 12)	3/ 9.84	VW3M5103R30	2.000/ 4.409				
				5/ 16.40	VW3M5103R50	3.400/ 7.496				
				10/ 32.81	VW3M5103R100	6.500/ 14.330				
				15/ 49.21	VW3M5103R150	9.500/ 20.944				
				20/ 65.62	VW3M5103R200	12.100/ 26.676				
				25/ 82.02	VW3M5103R250	15.500/ 34.172				
				50/ 164.04	VW3M5103R500	30.300/ 66.800				
				75/ 246.06	VW3M5103R750	45.000/ 99.208				
				BMH1902P BMH1903P	LXM32D72N4, LXM32MD85N4, LXM32MC10N4	+ (2 x 1 mm ² / AWG 17)]	[[4 x 6 mm ² / AWG 10)	3/ 9.84	VW3M5105R30	2.000/ 4.409
								5/ 16.40	VW3M5105R50	3.400/ 7.496
10/ 32.81	VW3M5105R100	6.500/ 14.330								
15/ 49.21	VW3M5105R150	9.500/ 20.944								
20/ 65.62	VW3M5105R200	12.100/ 26.676								
25/ 82.02	VW3M5105R250	15.500/ 34.172								
50/ 164.04	VW3M5105R500	30.300/ 66.800								
75/ 246.06	VW3M5105R750	45.000/ 99.208								
B2 type mounting, in conduits or distribution trunking, conforming to standard EN 60204-1										
BMH1901P BMH2053P	LXM32D72N4, LXM32MD85N4, LXM32MC10N4	+ (2 x 1 mm ² / AWG 17)]	[[4 x 6 mm ² / AWG 10)					3/ 9.84	VW3M5105R30	2.000/ 4.409
				5/ 16.40	VW3M5105R50	3.400/ 7.496				
				10/ 32.81	VW3M5105R100	6.500/ 14.330				
				15/ 49.21	VW3M5105R150	9.500/ 20.944				
				20/ 65.62	VW3M5105R200	12.100/ 26.676				
				25/ 82.02	VW3M5105R250	15.500/ 34.172				
				50/ 164.04	VW3M5105R500	30.300/ 66.800				
				75/ 246.06	VW3M5105R750	45.000/ 99.208				
				BMH1902P BMH1903P	LXM32D72N4, LXM32MD85N4, LXM32MC10N4	+ (2 x 1 mm ² / AWG 17)]	[[4 x 10 mm ² / AWG 8)	3/ 9.84	VW3M5104R30	3.600/ 7.937
								5/ 16.40	VW3M5104R50	5.600/ 12.346
10/ 32.81	VW3M5104R100	10.500/ 23.149								
15/ 49.21	VW3M5104R150	15.500/ 34.172								
20/ 65.62	VW3M5104R200	20.300/ 44.754								
25/ 82.02	VW3M5104R250	24.500/ 54.013								
50/ 164.04	VW3M5104R500	49.700/ 109.570								
75/ 246.06	VW3M5104R750	74.200/ 163.583								

Lexium™ 32 Servo Drives

Motion control

BMH servo motors

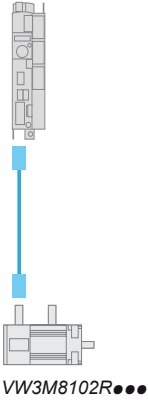

Connection components (continued)								
Control cordsets								
Description	For use with	To servo drive	Composition	Length	Reference	Weight		
				m/ft		kg/lb		
SinCos Hiperface® encoder cordsets equipped with an M23 industrial connector (servo motor end) and an RJ45 connector with 8 + 2 contacts (servo drive end)	BMH●●●●●	LXM32●●●●●. See references on pages 18 and 19	[3 x (2 x 0.14 mm ² /AWG 26) + (2 x 0.34 mm ² /AWG 22)]	1.5/	VW3M8102R15	0.400/		
				4.92		0.882		
				3/		VW3M8102R30	0.500/	
				9.84			1.102	
				5/		VW3M8102R50	0.600/	
				16.40			1.323	
				10/		VW3M8102R100	0.900/	
				32.81			1.984	
				15/		VW3M8102R150	1.100/	
				49.21			2.425	
20/	VW3M8102R200	1.400/						
65.62		3.086						
25/	VW3M8102R250	1.700/						
82.02		3.748						
50/	VW3M8102R500	3.100/						
164.04		6.834						
75/	VW3M8102R750	4.500/						
246.06		9.921						

Connectors for creating power and control cordsets							
Description	For use with	Sold in lots of	Item no.	For cable cross-section	Unit reference	Weight	
				mm ² / AWG		kg/lb	
M23 industrial connector for creating power cordsets	BMH070●●, BMH100●●, and BMH140●P servo motors	5	1	1.5 or 2.5/16 or 14	VW3M8215	0.350/0.772	
M40 industrial connector for creating power cordsets	BMH1901P (1) and BMH2053P (1) servo motors	5	1	4/12	VW3M8217	0.850/1.874	
	BMH1901P (2), BMH1902P (1) (2), BMH1903P (1) (2), and BMH2053P (2) servo motors	5	1	6 or 10/10 or 8	VW3M8218	0.850/1.874	
RJ45 connector with 8 + 2 contacts for creating control cordsets	LXM32●●●●● servo drives (CN3 connector)	5	2	–	VW3M2208	0.200/0.441	
M23 industrial connector for creating control cordsets	BMH●●●●● servo motors	5	3	–	VW3M8214	0.350/0.772	

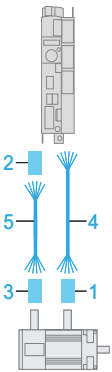

Connectors and cables for connecting the servo motor

(1) E type mounting with open cable ducts, conforming to standard EN 60204-1.
 (2) B2 type mounting in conduits or distribution trunking, conforming to standard EN 60204-1.

Lexium™ 32 Servo Drives

Motion control

BMH servo motors

Connection components (continued)								
Cables for creating power and control cordsets								
Description	From servo motor	To servo drive	Composition	Item no.	Length	Reference	Weight	
					m/ft		kg/lb	
Cables for creating power cordsets	BMH070●● BMH100●● BMH1401P	LXM32●●●●●●●● See combinations on pages 10 to 17	[(4 x 1.5 mm ² / AWG 16) + (2 x 1 mm ² / AWG 17)]	4	25/	VW3M5301R250	5.550/	
					82.02		328.08	
					50/		11.100/	
						164.04	VW3M5301R500	24.471
						100/	VW3M5301R1000	22.200/
						328.08		48.943
	BMH1402P BMH1403P	LXM32●D72N4	[(4 x 2.5 mm ² / AWG 14) + (2 x 1 mm ² / AWG 17)]	4	25/	VW3M5302R250	7.725/	
					82.02		17.031	
					50/		15.450/	
						164.04	VW3M5302R500	34.061
						100/	VW3M5302R1000	30.900/
						328.08		68.123
BMH1901P (1) BMH2053P (1)	LXM32●D72N4, LXM32MD85N4, LXM32MC10N4	[(4 x 4 mm ² / AWG 12) + (2 x 1 mm ² / AWG 17)]	4	25/	VW3M5303R250	9.900/		
				82.02		21.826		
				50/		19.800/		
					164.04	VW3M5303R500	43.651	
					100/	VW3M5303R1000	39.600/	
					328.08		87.303	
BMH1901P (2) BMH1902P (1) BMH1903P (1) BMH2053P (2)	LXM32●D72N4, LXM32MD85N4, LXM32MC10N4	[(4 x 6 mm ² / AWG 10) + (2 x 1 mm ² / AWG 17)]	4	25/	VW3M5305R250	14.750/		
				82.02		32.518		
				50/		29.500/		
					164.04	VW3M5305R500	65.036	
					100/	VW3M5305R1000	59.000/	
					328.08		130.073	
BMH1902P (2) BMH1903P (2)	LXM32●D72N4, LXM32MD85N4, LXM32MC10N4	[(4 x 10 mm ² / AWG 8) + (2 x 1 mm ² / AWG 17)]	4	25/	VW3M5304R250	24.500/		
				82.02		54.013		
				50/		49.000/		
					164.04	VW3M5304R500	108.026	
					100/	VW3M5304R1000	98.000/	
					328.08		216.053	
Cables for creating control cordsets for SinCos Hiperface® encoders	BMH●●●●●	LXM32●●●●●●●● See references on pages 18 and 19	[(3 x (2 x 0.14 mm ² / AWG 26) + (2 x 0.34 mm ² / AWG 22)]	5	25/	VW3M8222R250	1.400/	
					82.02		3.086	
					50/		2.800/	
					164.04	VW3M8222R500	6.173	
					100/	VW3M8222R1000	5.600/	
					328.08		12.346	

(1) E type mounting with open cable ducts, conforming to standard EN 60204-1.

(2) B2 type mounting in conduits or distribution trunking, conforming to standard EN 60204-1.

Holding brake

Introduction

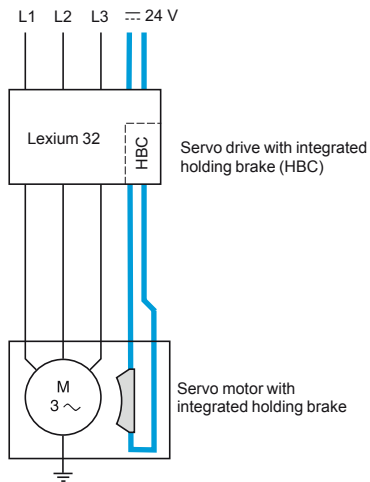

The holding brake integrated in the BMH servo motor is an electromagnetic pressure spring brake that blocks the servo motor axis once the output current has been turned off.

In the event of an emergency, such as a power outage or an emergency stop, the drive is immobilized.

Blocking the servo motor axis is also necessary in cases of torque overload, such as in the event of vertical axis movement.

As standard, the Lexium 32 servo drive has a holding brake controller to amplify the braking control signal and help ensure the brake is deactivated quickly. The controller then reduces the control signal so as to decrease the power dissipated by the holding brake.

References

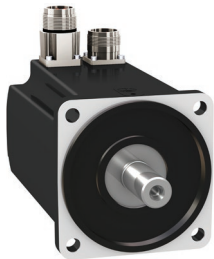

BMH servo motor

To select a BMH servo motor with or without holding brake, see the references on page 48.

For any additional information about holding brake characteristics, visit our website www.schneider-electric.com.

Integrated encoder in BMH servo motors

Presentation

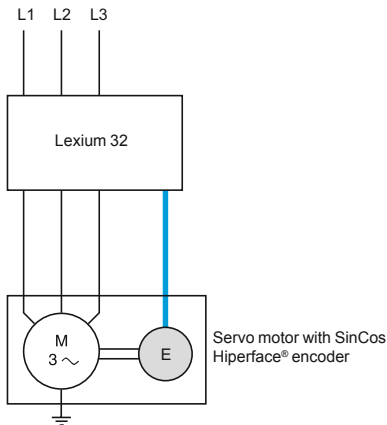

The standard measurement device is the SinCos Hiperface® single-turn or multi-turn encoder integrated in BMH servo motors. This measurement device is particularly suited to the Lexium 32 range of servo drives.

Depending on the model, single-turn and multi-turn SinCos encoders are available with medium resolution and capacitive sensing, or high resolution and optical sensing.

Use of this interface enables:

- Automatic identification of BMH servo motor data by the servo drive
- Automatic initialization of the servo drive control loops, simplifying installation of the motion control device

References

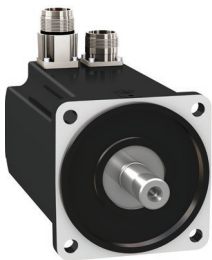

BMH servo motor

To select the type of SinCos Hiperface® encoder integrated in the BMH servo motor (single-turn or multi-turn), see the references on page 48.

For any additional information about integrated encoder characteristics, visit our website www.schneider-electric.com.

Lexium™ 32 Servo Drives Motion control

BMH servo motors

Option: GB● planetary gearboxes



GBX planetary gearboxes



GBY angular planetary gearbox

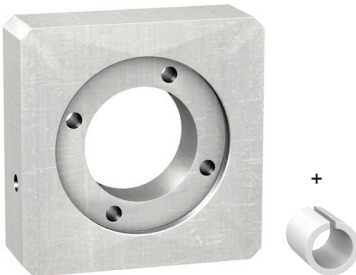

GBK adapter kit

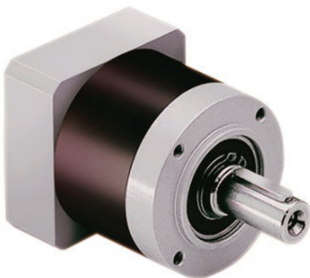

GBX160 planetary gearbox

Introduction

In many cases, motion control requires the use of planetary gearboxes to adapt speeds and torques, while providing the precision demanded by the application.

Schneider Electric has chosen to use GBX planetary gearboxes and GBY angular planetary gearboxes (made by Neugart) with the BMH range of servo motors. This combination of BMH servo motors with these best-applicable planetary gearboxes makes them very easy to mount and set up.

The gearboxes are designed for applications that are not susceptible to mechanical backlash. They have a keyed shaft, are lubricated for life, and conform to IP 54 degree of protection.

Available in 4 sizes (GBX60 to GBX160), GBX planetary gearboxes are offered with 15 reduction ratios (3:1 to 100:1).

GBY angular planetary gearboxes are available in 3 sizes (GBY60 to GBY120) with 7 reduction ratios (3:1 to 40:1).

The tables on pages 57 and 58 show the most suitable combinations of servo motor and GBX or GBY planetary gearbox.

For other combinations or any additional information about planetary gearbox characteristics refer to the servo motor data sheets or visit our website www.schneider-electric.com.

A GBK adapter kit is available for mounting BMH servo motors with GBX60 to GBX120 or GBY60 to GBY120 planetary gearboxes (see page 59). The GBX160 planetary gearbox is equipped as standard with an integrated adapter kit.

The adapter kit includes:

- Adapter plate
- Shaft end adapter, depending on the model (depends on the servo motor/ planetary gearbox combination)
- Accessories for mounting the plate on the planetary gearbox
- Accessories for mounting the servo motor

Lexium™ 32 Servo Drives Motion control

BMH servo motors

Option: GBX●●●K planetary gearboxes

References



GBX●●●●●K planetary gearbox

Size	Reduction ratio	Reference	Weight kg/lb
GBX60	3:1, 4:1, 5:1, 8:1, and 10:1	GBX060●●●K	0.900/ 1.984
	9:1, 12:1, 15:1, and 16:1	GBX060●●●K	1.000/ 2.205
GBX80	3:1, 4:1, 5:1, 8:1, and 10:1	GBX080●●●K	2.100/ 4.630
	9:1, 12:1, 15:1, 16:1, 20:1, 25:1, 32:1, and 40:1	GBX080●●●K	2.600/ 5.732
GBX120	3:1, 4:1, 5:1, 8:1, and 10:1	GBX120●●●K	6.000/ 13.228
	9:1, 12:1, 15:1, 16:1, 20:1, 25:1, 32:1, and 40:1	GBX120●●●K	8.000/ 17.637
	60:1, 80:1, and 100:1	GBX120●●●K	10.000/ 22.046
GBX160	8:1	GBX160●●●●●F	18.000/ 39.683
	12:1, 15:1, 16:1, 20:1, 25:1, 32:1, and 40:1	GBX160●●●●●F	22.000/ 48.502

To order a GBX60 to GBX120 planetary gearbox, complete each reference above as follows:

Size	Casing diameter	GBX	●●●	●●●	K
Size	60 mm/ 2.36 in.		060		
	80 mm/ 3.15 in.		080		
	120 mm/ 4.72 in.		120		
Reduction ratio	3:1			003	
	4:1			004	
	5:1			005	
	8:1			008	
	9:1			009	
	10:1			010	
	12:1			012	
	15:1			015	
	16:1			016	
	20:1			020	
	25:1			025	
	32:1			032	
	40:1			040	
60:1			060		
80:1			080		
100:1			100		
Mounting with GBK adapter kit (see page 59)					K

To order a GBX160 planetary gearbox, complete each reference above as follows:

Size	Casing diameter	GBX	●●●	●●●	●●●	●	F
Size	160 mm/ 6.30 in.		160				
Reduction ratio	8:1 and 12:1 to 40:1			008 to 040 (as in the table above)			
Associated BMH servo motor	Type				100		
					140		
	Model					1	
						2	
						3	
Integrated servo motor adapter							F

BMH servo motor/GBX planetary gearbox combinations

Reduction ratios from 3:1 to 100:1

Servo motor	Reduction ratio												
	3:1 4:1	5:1	8:1	9:1	10:1	12:1	15:1 16:1	20:1	25:1	32:1	40:1	60:1 80:1	100:1
BMH0701	GBX060	GBX060	GBX060	GBX060	GBX060	GBX060	GBX060	GBX080	GBX080	GBX080	GBX080	GBX120	GBX120
BMH0702	GBX060	GBX060	GBX080	GBX060	GBX060	GBX060	GBX080	GBX080	GBX080	GBX120	GBX120	GBX120	GBX120
BMH0703	GBX060	GBX060	GBX080	GBX060	GBX080	GBX080	GBX080	GBX080	GBX080	GBX120	GBX120	GBX120	GBX120
BMH1001	GBX080	GBX080	GBX080	GBX080	GBX080	GBX080	GBX080	GBX080	GBX120	GBX120	GBX120	-	-
BMH1002	GBX080	GBX080	GBX120	GBX080	GBX080	GBX080	GBX120	GBX120	GBX160	GBX160	GBX160	-	-
BMH1003	GBX080	GBX080	GBX120	GBX080	GBX120	GBX120	GBX120	GBX120	GBX160	GBX160	GBX160	-	-
BMH1401	GBX120	GBX120	GBX120	GBX120	-	GBX120	GBX160	GBX160	GBX160	GBX160	GBX160	-	-
BMH1402	GBX120	GBX120	GBX160	-	-	GBX160	GBX160	GBX160	GBX160	GBX160	GBX160	-	-
BMH1403	GBX120	GBX120	GBX160	-	-	GBX160	GBX160	GBX160	GBX160	GBX160	GBX160	-	-

GBX060

For these combinations, you must check that the application will not exceed the maximum gearbox output torque; refer to the values on our website www.schneider-electric.com.

Lexium™ 32 Servo Drives

Motion control

BMH servo motors

Option: GBY angular planetary gearboxes

References



GBY●●●●●●K angular planetary gearbox

Size	Reduction ratio	Reference	Weight kg/lb
GBY60	3:1, 4:1, 5:1, and 8:1	GBY060●●●K	1.700/ 3.748
	12:1	GBY060●●●K	1.900/ 4.189
GBY80	3:1, 4:1, 5:1, and 8:1	GBY080●●●K	4.400/ 9.700
	12:1, 20:1, 25:1, and 40:1	GBY080●●●K	5.000/ 11.023
GBY120	3:1, 4:1, 5:1, and 8:1	GBY120●●●K	12.000/ 26.455
	12:1, 20:1, and 40:1	GBY120●●●K	14.000/ 30.865

To order a GBY angular planetary gearbox, complete each reference above as follows:

Size	Casing diameter	GBY	●●●	●●●	K
	60 mm/ 2.36 in.		060		
	80 mm/ 3.15 in.		080		
	120 mm/ 4.72 in.		120		
Reduction ratio	3:1			003	
	4:1			004	
	5:1			005	
	8:1			008	
	12:1			012	
	20:1			020	
	25:1			025	
Mounting with GBK adapter kit (see page 59)					K

BMH servo motor/GBX angular planetary gearbox combinations

Reduction ratios from 3:1 to 40:1

Servo motor	Reduction ratio							
	3:1	4:1	5:1	8:1	12:1	20:1	25:1	40:1
BMH0701	GBY060	GBY060	GBY060	GBY060	GBY060	GBY080	GBY080	GBY080
BMH0702	GBY060	GBY060	GBY060	GBY080	GBY080	GBY080	GBY080	GBY120
BMH0703	GBY080	GBY080	GBY080	GBY080	GBY080	GBY080	GBY080	GBY120
BMH1001	GBY080	GBY080	GBY080	GBY080	GBY080	GBY080	–	GBY120
BMH1002	GBY080	GBY080	GBY080	GBY120	GBY080	GBY120	–	–
BMH1003	GBY120	GBY120	GBY120	GBY120	GBY120	GBY120	–	–
BMH1401	GBY120	GBY120	GBY120	GBY120	GBY120	–	–	–

GBY060

For these combinations, you must check that the application will not exceed the maximum gearbox output torque; refer to the values on our website www.schneider-electric.com.

Lexium™ 32 Servo Drives Motion control

BMH servo motors

Option: Adapter kit for GB● planetary gearboxes



References

To order a GBK adapter kit (1), complete each reference as follows:

		GBK	●●●	●●●	●	F
Size of GBX or GBY planetary gearbox	Casing diameter	60 mm/ 2.36 in.	060			
		80 mm/ 3.15 in.	080			
		120 mm/ 4.72 in.	120			
Associated servo motor		BMH070		070		
		BMH100		100		
		BMH140		140		
Compatibility	All types of motor				0	
	1 or 2 stage motors				2	
	1, 2, or 3 stage motors				3	
BMH servo motor adapter						F

GBK adapter kit/BMH servo motor combination

Gearbox	BMH servo motor								
	0701●	0702●	0703●	1001●	1002●	1003●	1401●	1402●	1403●
GBK0600702F	Compatible	Compatible	Compatible	Not compatible	Not compatible	Not compatible	Not compatible	Not compatible	Not compatible
GBK0600703F	Compatible	Compatible	Compatible	Not compatible	Not compatible	Not compatible	Not compatible	Not compatible	Not compatible
GBK0800702F	Compatible	Compatible	Compatible	Not compatible	Not compatible	Not compatible	Not compatible	Not compatible	Not compatible
GBK0800703F	Compatible	Compatible	Compatible	Not compatible	Not compatible	Not compatible	Not compatible	Not compatible	Not compatible
GBK0801003F	Not compatible	Not compatible	Not compatible	Compatible	Compatible	Compatible	Not compatible	Not compatible	Not compatible
GBK1200702F	Compatible	Compatible	Compatible	Not compatible	Not compatible	Not compatible	Not compatible	Not compatible	Not compatible
GBK1200703F	Compatible	Compatible	Compatible	Not compatible	Not compatible	Not compatible	Not compatible	Not compatible	Not compatible
GBK1201003F	Not compatible	Not compatible	Not compatible	Compatible	Compatible	Compatible	Not compatible	Not compatible	Not compatible
GBK1201400F	Not compatible	Not compatible	Not compatible	Not compatible	Not compatible	Not compatible	Compatible	Compatible	Compatible

 Compatible
 Not compatible

(1) Weight of adapter kit:
 GBK060●●●F: 0.200 kg/0.441 lb
 GBK080●●●F: 0.450 kg/0.992 lb
 GBK120●●●F: 0.650 kg/1.433 lb

Lexium™ 32 Servo Drives

Motion control

BSH servo motors

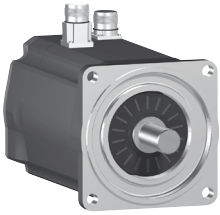

BSH servo motor with straight connectors



BSH servo motor with rotatable angled connectors

Introduction

BSH servo motors offer an excellent solution to the need for high dynamic performance. With five flange sizes and a variety of lengths, there is a suitable solution for many applications, covering a continuous stall torque range from 0.5 to 33.4 N·m for speeds up to 9,000 rpm.

Thanks to their new winding technology based on salient poles, BSH servo motors are far more compact and offer a higher power density than conventional servo motors.

BSH servo motors are UL Recognized  and conform to standard UL1004 as well as to European directives (CE marking).

They are available with the following variants:

- 4 flange sizes: 55, 70, 100, and 140 mm/2.28, 2.76, 3.94, and 5.51 in.
- 2 degrees of protection for the shaft end: IP 50 or IP 65 in accordance with standard IEC/EN 60529. The degree of protection of the casing is IP 65 (IP 67 with the conformity kit, which is available as an option).
- With or without holding brake
- Straight or elbow connectors for power and encoder connection
- Integrated single-turn or multi-turn SinCos Hiperface® encoder (medium or high resolution)
- Smooth or keyed shaft end

Special features

BSH servo motors have been developed to comply with the following main specifications:

- The ambient operating temperature is - 20 to + 40 °C / - 4 to + 104 °F without derating, in accordance with standard IEC 60721-3-3, category 3K3, and up to 55 °C/131 °F with derating of 1% of the nominal output power per additional °C above 40 °C/104 °F.
- The maximum operating altitude is 1,000 m/3,280 ft without derating, 2,000 m/6,561 ft with k = 0.86, and 3,000 m/9,842 ft with k = 0.8 (1).
The relative humidity that the servo motor can withstand is in line with standard IEC 60721-3-3, categories 3K3, 3Z12, and 3Z2.
- The windings are insulation class F (maximum temperature for windings 155 °C/311 °F) in accordance with standard IEC 60034-1.
- All mounting positions are permitted (horizontal mounting (IMB5) or vertical mounting (IMV1 with shaft end at the top and IMV3 with shaft end at the bottom) in accordance with standard IEC 60034-7.

Sizing

The Lexium Sizer tool is available on our website www.schneider-electric.com to help you size your servo motor.

(1) k: derating factor

Introduction (continued)

Holding brake

BSH servo motors can be equipped with an electromagnetic holding brake.



Do not use the holding brake as a dynamic brake for deceleration, as this will quickly damage the brake.

Integrated encoder

BSH servo motors are equipped with a single-turn (131,072 points/turn) (1) or multi-turn (131,072 points/turn x 4,096 turns) (1) SinCos Hiperface® high-resolution absolute encoder giving an angular shaft position precise to less than ± 1.3 arc minutes.

This encoder performs the following functions:

- Gives the absolute position of the motor so that flows can be synchronized
- Measures the servo motor speed via the associated Lexium 32 servo drive (this information is used by the servo drive's speed controller)
- Measures the position information for the servo drive's position controller
- Sends data from the servo motor to the servo drive, which provides automatic identification of the motor when the servo drive starts

Description

BSH servo motors, with a 3-phase stator and a 6 to 10-pole rotor (depending on model) with Neodymium Iron Borium (NdFeB) magnets, consist of:

- 1 Casing with RAL 9005 opaque black paint protective coating
- 2 4-point axial mounting flange
- 3 Smooth or keyed shaft end (depending on the model)
- 4 Threaded sealed male straight connector for the power cable (2)
- 5 Threaded sealed male straight connector for the control cable (encoder) (2)

Cables and connectors to be ordered separately, for connection to Lexium 32 servo drives (see page 64).

Schneider Electric has taken particular care over the compatibility of BSH servo motors and Lexium 32 servo drives. This can only be ensured by using cables and connectors sold by Schneider Electric (see page 64).

(1) Encoder resolution given for use with a Lexium 32 servo drive.

(2) For other model with rotatable elbow connector, see page 63.

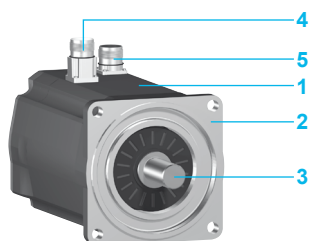

Lexium™ 32 Servo Drives

Motion control

BSH servo motors



BSH055●●●●●1A

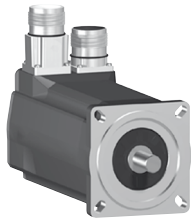

BSH070●●●●●1A



BSH100●●●●●1A

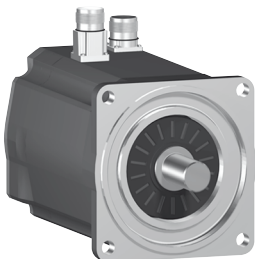

BSH1401P●●●●1A

BSH servo motors

The BSH servo motors shown below are supplied without a gearbox. For GBX and GBY gearboxes, see pages 69 and 70.

Continuous stall torque	Peak stall torque	Nominal servo motor output power	Nominal speed	Maximum mechanical speed	Associated LXM32 servo drive	Reference (1)	Weight (2)
N·m	N·m	W	rpm	rpm			kg/lb
0.5	1.4	300	6,000	9,000	●U45M2	BSH0551T●●●●A	1.160/ 2.557
		150	3,000	9,000	●U90M2	BSH0551T●●●●A	1.160/ 2.557
	300	6,000	9,000	●U60N4	BSH0551P●●●●A	1.160/ 2.557	
0.8	1.9	250	3,000	9,000	●U90M2	BSH0552T●●●●A	1.470/ 3.241
		450	6,000	9,000	●U90M2	BSH0552T●●●●A	1.470/ 3.241
	400	6,000	9,000	●U60N4	BSH0552P●●●●A	1.470/ 3.241	
1.05	3.5	400	6,000	9,000	●U60N4	BSH0553P●●●●A	1.760/ 3.880
1.2	3	550	6,000	9,000	●U90M2	BSH0553T●●●●A	1.760/ 3.880
		350	3,000	9,000	●D18M2		
1.3	3.5	500	5,000	8,000	●U90M2	BSH0701T●●●●A	2.200/ 4.850
1.4	3.5	350	2,500	8,000	●D18M2	BSH0701T●●●●A	2.200/ 4.850
		700	5,000	8,000	●D12N4	BSH0701P●●●●A	2.200/ 4.850
2.2	6.1	550	2,500	8,000	●D30M2	BSH0702T●●●●A	2.890/ 6.371
		950	5,000	8,000	●D18M2		
	7.6	850	5,000	8,000	●D12N4	BSH0702P●●●●A	2.890/ 6.371
2.6	7.4	900	4,000	8,000	●D18M2	BSH0703T●●●●A	3.620/ 7.981
2.7	7.5	900	4,000	6,000	●D18M2	BSH1001T●●●●A	4.200/ 9.259
3.1	11.3	1,300	5,000	8,000	●D18N4	BSH0703P●●●●A	3.620/ 7.981
		700	2,500	6,000	●D30M2	BSH1001T●●●●A	4.200/ 9.259
3.3	6.3	1,100	4,000	6,000	●D18N4	BSH1001P●●●●A	4.200/ 9.259
		1,500	4,000	6,000	●D30M2	BSH1002T●●●●A	5.900/ 13.007
5.8	16.4	1,700	4,000	6,000	●D18N4	BSH1002P●●●●A	5.900/ 13.007
		2,000	3,000	6,000	●D30N4	BSH1003P●●●●A	7.400/ 16.314
8	28.3	2,600	4,000	6,000	●D30N4	BSH1003P●●●●A	7.400/ 16.314
		2,100	2,500	6,000	●D30N4	BSH1004P●●●●A	9.500/ 20.944
10	37.9	2,600	3,000	6,000	●D30N4	BSH1004P●●●●A	9.500/ 20.944
		2,500	2,500	4,000	●D30N4	BSH1401P●●●●A	11.200/ 24.692
11.1	27	3,000	3,000	4,000	●D30N4	BSH1401P●●●●A	11.200/ 24.692
		3,900	3,000	4,000	●D72N4	BSH1402T●●●●P	16.000/ 35.274
27.8	90.2	4,100	3,000	4,000	●D72N4	BSH1403T●●●●P	21.200/ 48.738
33.4	103.6	5,000	2,500	4,000	●D72N4	BSH1404P●●●●P	26.500/ 58.422

(1) To complete each reference see the table on page 63.

(2) Weight of servo motor without brake, no packaging. To obtain the weight of the servo motor with holding brake, please consult our website www.schneider-electric.com.

Lexium™ 32 Servo Drives

Motion control

BSH servo motors

BSH servo motors (continued)								
To order a BSH servo motor, complete each reference with:								
			BSH0551T	•	•	•	•	•
Shaft end	IP 50	Smooth	0					
		Keyed	1					
	IP 65/IP 67 (1)	Smooth	2					
		Keyed	3					
Integrated sensor High resolution, optical	Single-turn, SinCos Hiperface® 131,072 points/turn (2)			1				
	Multi-turn, SinCos Hiperface® 131,072 points/turn x 4,096 turns (2)			2				
Holding brake	Without				A			
	With				F			
Connections	Straight connectors						1	
	Rotatable right angle elbow connectors						2	
Flange	International standard							A or P (3)

Note: The example above is for a BSH0551T servo motor. For other servo motors, replace BSH0551T with the relevant reference.

Dimensions (overall)			
Servo motors	Flange	W x H x D (4)	
		Without holding brake	With holding brake
	mm/in.	mm/in.	mm/in.
BSH0551●	55 x 55/ 2.16 x 2.16	55 x 94.5 x 132.5/ 2.16 x 3.72 x 5.22	55 x 94.5 x 159/ 2.16 x 3.72 x 6.26
BSH0552●	55 x 55/ 2.16 x 2.16	55 x 94.5 x 154.5/ 2.16 x 3.72 x 6.08	55 x 94.5 x 181/ 2.16 x 3.72 x 7.13
BSH0553●	55 x 55/ 2.16 x 2.16	55 x 94.5 x 176.5/ 2.16 x 3.72 x 6.95	55 x 94.5 x 203/ 2.16 x 3.72 x 7.99
BSH0701●	70 x 70/ 2.76 x 2.76	70 x 111.5 x 154/ 2.76 x 4.39 x 6.06	70 x 111.5 x 180/ 2.76 x 4.39 x 7.09
BSH0702●	70 x 70/ 2.76 x 2.76	70 x 111.5 x 187/ 2.76 x 4.39 x 7.36	70 x 111.5 x 213/ 2.76 x 4.39 x 8.39
BSH0703●	70 x 70/ 2.76 x 2.76	70 x 111.5 x 220/ 2.76 x 4.39 x 8.66	70 x 111.5 x 254/ 2.76 x 4.39 x 10.00
BSH1001●	100 x 100/ 3.94 x 3.94	100 x 138.5 x 169/ 3.94 x 5.45 x 6.65	100 x 138.5 x 200/ 3.94 x 5.45 x 7.87
BSH1002●	100 x 100/ 3.94 x 3.94	100 x 138.5 x 205/ 3.94 x 5.45 x 8.07	100 x 138.5 x 236/ 3.94 x 5.45 x 9.29
BSH1003●	100 x 100/ 3.94 x 3.94	100 x 138.5 x 241/ 3.94 x 5.45 x 9.49	100 x 138.5 x 272/ 3.94 x 5.45 x 10.71
BSH1004●	100 x 100/ 3.94 x 3.94	100 x 138.5 x 277/ 3.94 x 5.45 x 10.91	100 x 138.5 x 308/ 3.94 x 5.45 x 12.13
BSH1401●	140 x 140/ 5.51 x 5.51	140 x 178 x 218/ 5.51 x 7.01 x 8.58	140 x 178 x 256/ 5.51 x 7.01 x 10.08
BSH1402●	140 x 140/ 5.51 x 5.51	140 x 192.5(5) x 273/ 5.51 x 7.58(5) x 10.75	140 x 192.5(5) x 311/ 5.51 x 7.58(5) x 12.24
BSH1403●	140 x 140/ 5.51 x 5.51	140 x 192.5(5) x 328/ 5.51 x 7.58(5) x 12.91	140 x 192.5(5) x 366/ 5.51 x 7.58(5) x 14.41
BSH1404●	140 x 140/ 5.51 x 5.51	140 x 192.5(5) x 383/ 5.51 x 7.58(5) x 15.08	140 x 192.5(5) x 421/ 5.51 x 7.58(5) x 16.58

(1) IP 67 with the VW3M230● IP 67 conformity kit supplied as an option (see page 64).

(2) Sensor resolution given for use with a Lexium 32 servo drive.

(3) "A" or "P" depending on the model (see table of references on page 62).

(4) D = motor length (excluding shaft end).

(5) 192.5 mm/7.58 in. with straight connector, 198.5 mm/7.82 in. with rotatable elbow connector.

Lexium™ 32 Servo Drives

Motion control

BSH servo motors



VW3M230●

BSH servo motors (continued)

IP 67 conformity kits

This kit can be used to provide IP 67 degree of protection. It is mounted in place of the motor backplate.

Description	For use with	Reference	Weight kg/lb
IP 67 conformity kits (supplied as an option)	BSH055●●	VW3M2305 (1)	0.050/ 0.110
		VW3M2300 (2)	0.050/ 0.110
	BSH070●●	VW3M2306 (1)	0.100/ 0.220
		VW3M2301 (2)	0.100/ 0.220
	BSH100●●	VW3M2307 (1)	0.150/ 0.331
		VW3M2302 (2)	0.150/ 0.331
	BSH140●●	VW3M2308 (1)	0.300/ 0.661
		VW3M2303 (2)	0.300/ 0.661

Connection components

Power cordsets

Description	From servo motor	To servo drive	Composition	Length	Reference	Weight
				m/ft		
Cordsets equipped with one M23 industrial connector (servo motor end)	BSH055●● BSH070●● BSH100●● BSH1401P	LXM32●●●●●□ See combinations pages 10 to 17	[(4 x 1.5 mm ² / AWG 16) + (2 x 1 mm ² / AWG 17)]	1.5/ 4.92	VW3M5101R15	0.600/ 1.323
				3/ 9.84	VW3M5101R30	0.810/ 1.786
				5/ 16.40	VW3M5101R50	1.210/ 2.668
				10/ 32.81	VW3M5101R100	2.290/ 5.049
				15/ 49.21	VW3M5101R150	3.400/ 7.496
				20/ 65.62	VW3M5101R200	4.510/ 9.943
				25/ 82.02	VW3M5101R250	6.200/ 13.669
				50/ 164.04	VW3M5101R500	12.325/ 27.172
				75/ 246.06	VW3M5101R750	18.450/ 40.675
				Cordsets equipped with one M40 industrial connector (servo motor end)	BSH1402T BSH1403T BSH1404P	LXM32●D72N4
5/ 16.40	VW3M5103R50	2.130/ 4.696				
10/ 32.81	VW3M5103R100	4.130/ 9.105				
15/ 49.21	VW3M5103R150	6.120/ 13.492				
20/ 65.62	VW3M5103R200	8.090/ 17.835				
25/ 82.02	VW3M5103R250	11.625/ 25.629				
50/ 164.04	VW3M5103R500	23.175/ 51.092				
75/ 246.06	VW3M5103R750	34.725/ 76.555				

(1) For a RS01 hardware version BSH motor. The version number is visible on the motor nameplate. For further information, please contact our Customer Care Center.

(2) For a RS02 hardware version BSH motor. The version number is visible on the motor nameplate. For further information, please contact our Customer Care Center.

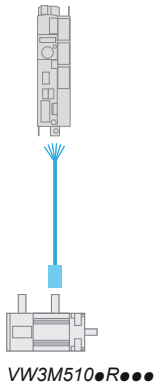

VW3M510●R●●●

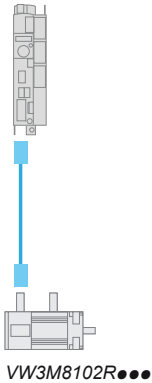

Connection components (continued)

Control cordsets

Description	From servo motor	To servo drive	Composition	Length	Reference	Weight	
				m/ft		kg/lb	
SinCos Hiperface® encoder cordsets equipped with an M23 industrial connector (servo motor end) and an RJ45 connector with 8+2 contacts (servo drive end)	BSH●●●●●	LXM32●●●●●●●● See references pages 18 and 19	[3 x (2 x 0.14 mm ² / AWG 26) + (2 x 0.34 mm ² / AWG 22)]	1.5/	VW3M8102R15	0.400/	
				4.92		0.882	
				3/		VW3M8102R30	0.500/
				9.84			1.102
				5/		VW3M8102R50	0.600/
				16.40			1.323
				10/		VW3M8102R100	0.900/
				32.81			1.984
				15/		VW3M8102R150	1.100/
				49.21			2.425
20/	VW3M8102R200	1.400/					
65.62		3.086					
25/	VW3M8102R250	1.700/					
82.02		3.748					
50/	VW3M8102R500	3.100/					
164.04		6.834					
75/	VW3M8102R750	4.500/					
246.06		9.921					

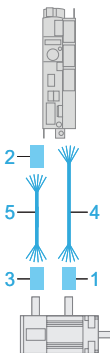

Connectors for creating power and control cordsets

Description	For use with	Item no.	For cable cross-section	Reference	Weight
			mm ² /AWG		kg/lb
M23 industrial connector for creating power cordsets (sold in multiples of 5)	BSH055●●, BSH070●●, BSH100●●, and BSH1401P servo motors	1	1.5/16	VW3M8215	0.350/0.772
M40 industrial connector for creating power cordsets (sold in multiples of 5)	BSH1402T, BSH1403T, and BSH1404P servo motors	1	4/12	VW3M8217	0.850/0.772
RJ45 connector with 8+2 contacts for creating control cordsets (sold in multiples of 5)	LXM32●●●●●●●● servo drives (CN3 connector)	2	–	VW3M2208	0.200/0.441
M23 industrial connector for creating control cordsets (sold in multiples of 5)	BSH●●●●● servo motors	3	–	VW3M8214	0.350/0.772

Cables for creating power and control cordsets

Description	From servo motor	To servo drive	Composition	Item no.	Length	Reference	Weight	
					m/ft		kg/lb	
Cables for creating power cordsets	BSH055●●, BSH070●●, BSH100●●, BSH1401P	LXM32●●●●●●●● See combinations pages 10 to 17	[(4 x 1.5 mm ² / AWG 16) + (2 x 1 mm ² / AWG 17)]	4	25/	VW3M5301R250	5.550/	
					82.02		12.125	
					50/		VW3M5301R500	11.100/
					164.04			24.471
					100/		VW3M5301R1000	22.200/
					328.08			48.943
Cables for creating control cordsets for SinCos Hiperface® encoders	BSH●●●●●	LXM32●●●●●●●● See references pages 18 and 19	[3 x (2 x 0.14 mm ² / AWG 26) + (2 x 0.34 mm ² / AWG 22)]	5	25/	VW3M8222R250	1.400/	
					82.02		3.086	
					50/		VW3M8222R500	2.800/
					164.04			6.173
					100/		VW3M8222R1000	5.600/
					328.08			12.346

Holding brake

Presentation

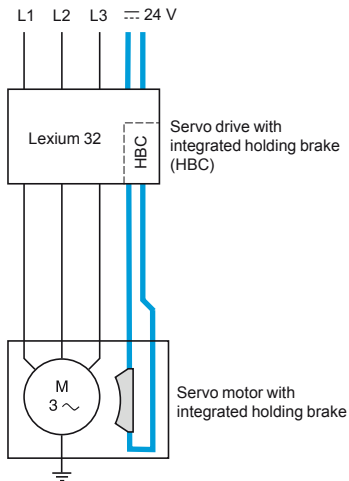

The holding brake integrated in the BSH servo motor is an electromagnetic pressure spring brake that blocks the servo motor axis once the output current has been turned off.

In the event of an emergency, such as a power outage or an emergency stop, the drive is immobilized.

Blocking the servo motor axis is also necessary in cases of torque overload, such as in the event of vertical axis movement.

As standard, the Lexium 32 servo drive has a holding brake controller to amplify the braking control signal and help ensure the brake is deactivated quickly. The controller then reduces the control signal so as to decrease the power dissipated by the holding brake.

References



BSH servo motor

To select a BSH servo motor with or without holding brake, see the references on page 63.

For any additional information about holding brake characteristics, visit our website www.schneider-electric.com.

Integrated encoder in BSH servo motors

Introduction

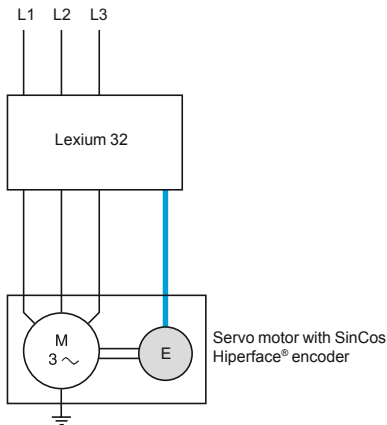

The standard measurement device is the SinCos Hiperface® single-turn or multi-turn encoder integrated in BSH servo motors. This measurement device is particularly suited to the Lexium 32 range of servo drives.

Use of this interface enables:

- Automatic identification of BSH servo motor data by the servo drive
- Automatic initialization of the servo drive control loops, simplifying installation of the motion control device

References



BSH servo motor

To select the type of SinCos Hiperface® encoder integrated in the BSH servo motor (single-turn or multi-turn), see the references on page 63.

For any additional information about integrated encoder characteristics, visit our website www.schneider-electric.com.

Lexium™ 32 Servo Drives

Motion control

BSH servo motors

Option: GB● planetary gearboxes



GBX planetary gearboxes



GBY angular planetary gearbox

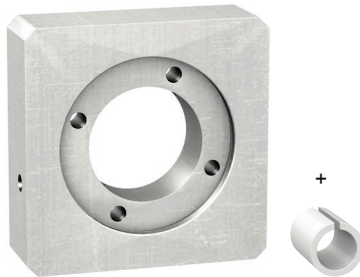

GBK adapter kit

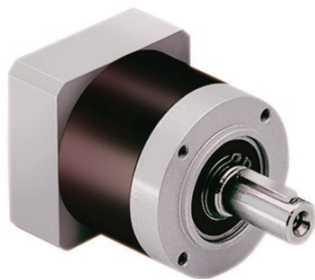

GBX160 planetary gearbox

Introduction

In many cases, motion control requires the use of planetary gearboxes to adapt speeds and torques, while providing the precision demanded by the application.

Schneider Electric has chosen to use GBX planetary gearboxes and GBY angular planetary gearboxes (made by Neugart) with the BSH range of servo motors. The combination of BSH servo motors with these best-applicable planetary gearboxes makes them very easy to mount and set up.

The gearboxes are designed for applications that are not susceptible to mechanical backlash. They have a keyed shaft, are lubricated for life, and conform to IP 54 degree of protection.

Available in 4 sizes (GBX60 to GBX160), planetary gearboxes are offered with 15 reduction ratios (3:1 to 100:1).

GBY angular planetary gearboxes are available in 3 sizes (GBY60 to GBY120) with 7 reduction ratios (3:1 to 40:1).

The tables on pages 69 and 70 show the most suitable combinations of servo motor and GBX or GBY planetary gearbox.

For other combinations or any additional information about planetary gearbox characteristics, refer to the servo motor data sheets or visit our website www.schneider-electric.com.

A GBK adapter kit is available for mounting the BSH servo motors with GBX60 to GBX120 or GBY60 to GBY120 planetary gearboxes (see page 71). The GBX160 planetary gearbox is equipped as standard with an integrated adapter kit.

The adapter kit includes:

- Adapter plate
- Shaft end adapter, depending on the model (depends on the servo motor/ planetary gearbox combination)
- Accessories for mounting the plate on the planetary gearbox
- Accessories for mounting the servo motor

References

Size	Reduction ratio	Reference	Weight kg/lb
GBX60	3:1, 4:1, 5:1, 8:1, and 10:1	GBX060●●●K	0.900/ 1.984
	9:1, 12:1, 15:1, 16:1, 20:1, 25:1, 32:1, and 40:1	GBX060●●●K	1.000/ 2.205
	60:1	GBX060●●●K	1.300/ 2.866
GBX80	3:1, 4:1, 5:1, 8:1, and 10:1	GBX080●●●K	2.100/ 4.630
	9:1, 12:1, 15:1, 16:1, 20:1, 25:1, 32:1, and 40:1	GBX080●●●K	2.600/ 5.732
GBX120	3:1, 4:1, 5:1, 8:1, and 10:1	GBX120●●●K	6.000/ 13.228
	9:1, 12:1, 15:1, 16:1, 20:1, 25:1, 32:1, and 40:1	GBX120●●●K	8.000/ 17.637
	60:1, 80:1, and 100:1	GBX120●●●K	10.000/ 22.046
GBX160	8:1	GBX160●●●●●●F	18.000/ 39.683
	12:1, 15:1, 16:1, 20:1, 25:1, 32:1, and 40:1	GBX160●●●●●●F	22.000/ 48.502

Lexium™ 32 Servo Drives Motion control

BSH servo motors

Option: GBX planetary gearboxes

References

To order a GBX060 to GBX120 planetary gearbox, complete each reference as follows:

		GBX	●●●	●●●	K
Size	Casing diameter	60 mm/ 2.36 in.	060		
		80 mm/ 3.15 in.	080		
		120 mm/ 4.72 in.	120		
Reduction ratio	3:1			003	
	4:1			004	
	5:1			005	
	8:1			008	
	9:1			009	
	10:1			010	
	12:1			012	
	15:1			015	
	16:1			016	
	20:1			020	
	25:1			025	
	32:1			032	
	40:1			040	
60:1			060		
80:1			080		
100:1			100		
Mounting with GBK adapter kit (see page 71)					K

To order a GBX160 planetary gearbox, complete each reference above as follows:

		GBX	●●●	●●●	●●●	●	F
Size	Casing diameter	160 mm/ 6.30 in.	160				
		Reduction ratio	8:1 and 12:1 to 40:1		008 to 040 (as in the table above)		
Associated BSH servo motor	Type				100		
					140		
	Motor					1	
						2	
						3	
					4		
Integrated servo motor adapter							F

BSH servo motor/GBX gearbox combinations

Reduction ratios from 3:1 to 100:1

Servo motor	Reduction ratio														
	3:1 4:1	5:1	8:1	9:1	10:1	12:1	15:1 16:1	20:1	25:1	32:1	40:1	60:1	80:1	100:1	
BSH0551	GBX060	GBX060	GBX060	GBX060	GBX060	GBX060	GBX060	GBX060	GBX060	GBX060	GBX060	GBX060	GBX060	–	–
BSH0552	GBX060	GBX060	GBX060	GBX060	GBX060	GBX060	GBX060	GBX060	GBX060	GBX060	GBX060	–	–	–	–
BSH0553	GBX060	GBX060	GBX060	GBX060	GBX060	GBX060	GBX060	GBX060	–	–	–	–	–	–	–
BSH0701	GBX060	GBX060	GBX060	GBX060	GBX060	GBX060	GBX060	GBX080	GBX080	GBX080	GBX080	GBX120	GBX120	GBX120	
BSH0702	GBX060	GBX060	GBX080	GBX060	GBX080	GBX060	GBX080	GBX080	GBX080	GBX120	GBX120	GBX120	GBX120	GBX120	GBX120
BSH0703	GBX060	GBX060	GBX080	GBX060	GBX080	GBX080	GBX080	GBX080	GBX120	GBX120	GBX120	GBX120	GBX120	GBX120	GBX120
BSH1001	GBX080	GBX080	GBX080	GBX080	GBX120	GBX080	GBX080	GBX080	GBX120	GBX120	GBX120	–	–	–	–
BSH1002	GBX080	GBX080	GBX120	GBX080	GBX120	GBX080	GBX120	GBX120	GBX160	GBX160	GBX160	–	–	–	–
BSH1003	GBX080	GBX080	GBX120	GBX080	GBX120	GBX120	GBX120	GBX120	GBX160	GBX160	GBX160	–	–	–	–
BSH1004	GBX120	GBX120	GBX120	GBX120	–	GBX120	GBX160	GBX160	GBX160	GBX160	GBX160	–	–	–	–
BSH1401	GBX120	GBX120	GBX120	GBX120	–	GBX120	GBX160	GBX160	GBX160	GBX160	GBX160	–	–	–	–
BSH1402	GBX120	GBX120	GBX160	–	–	GBX160	GBX160	GBX160	GBX160	GBX160	GBX160	–	–	–	–
BSH1403	GBX120	GBX120	GBX160	–	–	GBX160	GBX160	GBX160	GBX160	GBX160	GBX160	–	–	–	–
BSH1404	GBX120	GBX120	GBX160	–	–	GBX160	GBX160	GBX160	–	–	–	–	–	–	–

GBX060 For these combinations, you must check that the application will not exceed the maximum gearbox output torque; refer to the values on our website www.schneider-electric.com.

Lexium™ 32 Servo Drives Motion control

BSH servo motors

Option: GBY angular planetary gearboxes

References



GBY●●●●●K angular planetary gearbox

Size	Reduction ratio	Reference	Weight kg/lb
GBY60	3:1, 4:1, 5:1, and 8:1	GBY060●●●K	1.700/ 3.748
	12:1, 20:1, and 40:1	GBY060●●●K	1.900/ 4.189
GBY80	3:1, 4:1, 5:1, and 8:1	GBY080●●●K	4.400/ 9.700
	12:1, 20:1, 25:1, and 40:1	GBY080●●●K	5.000/ 11.023
GBY120	3:1, 4:1, 5:1, and 8:1	GBY120●●●K	12.000/ 26.455
	12:1, 20:1, and 40:1	GBY120●●●K	14.000/ 30.865

To order a GBY angular planetary gearbox, complete each reference above as follows:

Size	Casing diameter	GBY	●●●	●●●	K
	60 mm/ 2.36 in.		060		
	80 mm/ 3.15 in.		080		
	120 mm 4.72 in.		120		
Reduction ratio	3:1			003	
	4:1			004	
	5:1			005	
	8:1			008	
	12:1			012	
	20:1			020	
	25:1			025	
	40:1			040	
Mounting with GBK adapter kit (see page 71)					K

BSH servo motor/GBY gearbox combinations

Reduction ratios from 3:1 to 40:1

Servo motor	Reduction ratio							
	3:1	4:1	5:1	8:1	12:1	20:1	25:1	40:1
BSH0551	GBY060	GBY060	GBY060	GBY060	GBY060	GBY060	-	GBY060
BSH0552	GBY060	GBY060	GBY060	GBY060	GBY060	GBY060	-	-
BSH0553	GBY060	GBY060	GBY060	GBY060	GBY060	GBY060	-	-
BSH0701	GBY060	GBY060	GBY060	GBY060	GBY060	GBY080	GBY080	GBY080
BSH0702	GBY060	GBY060	GBY060	GBY080	GBY080	GBY080	GBY080	GBY120
BSH0703	GBY080	GBY080	GBY080	GBY080	GBY080	GBY080	GBY080	GBY120
BSH1001	GBY080	GBY080	GBY080	GBY080	GBY080	GBY080	-	GBY120
BSH1002	GBY080	GBY080	GBY080	GBY120	GBY080	GBY120	-	-
BSH1003	GBY120	GBY120	GBY120	GBY120	GBY120	GBY120	-	-
BSH1004	GBY120	GBY120	GBY120	-	GBY120	-	-	-
BSH1401	GBY120	GBY120	GBY120	GBY120	GBY120	-	-	-

GBY060

For these combinations, you must check that the application will not exceed the maximum gearbox output torque; refer to the values on our website www.schneider-electric.com.

Lexium™ 32 Servo Drives Motion control

BSH servo motors

Option: Adapter kit for GB● planetary gearboxes



References

To order a GBK adapter kit, complete each reference as follows:

		GBK	●●●	●●●	●	F
Size of GBX or GBY planetary gearbox	Casing diameter	60 mm/ 2.36 in.	060			
		80 mm/ 3.15 in.	080			
		120 mm/ 4.72 in.	120			
Associated BSH servo motor		BSH055		055		
		BSH070		070		
		BSH100		100		
		BSH140		140		
Compatibility		All types of motor			0	
		1 or 2 stage motors			2	
		1, 2, or 3 stage motors			3	
		4 stage motor			4	
BSH servo motor adapter						F

GBK adapter kit/BSH servo motor combination

Gearbox	BSH servo motor													
	0551●	0552●	0553●	0701●	0702●	0703●	1001●	1002●	1003●	1004●	1401●	1402●	1403●	1404●
GBK0600550F	Compatible	Compatible	Compatible	Not compatible	Not compatible	Not compatible	Not compatible	Not compatible	Not compatible	Not compatible	Not compatible	Not compatible	Not compatible	Not compatible
GBK0600702F	Not compatible	Not compatible	Not compatible	Compatible	Compatible	Not compatible	Not compatible	Not compatible	Not compatible	Not compatible	Not compatible	Not compatible	Not compatible	Not compatible
GBK0600703F	Not compatible	Not compatible	Not compatible	Not compatible	Not compatible	Compatible	Not compatible	Not compatible	Not compatible	Not compatible	Not compatible	Not compatible	Not compatible	Not compatible
GBK0800702F	Not compatible	Not compatible	Not compatible	Compatible	Compatible	Not compatible	Not compatible	Not compatible	Not compatible	Not compatible	Not compatible	Not compatible	Not compatible	Not compatible
GBK0800703F	Not compatible	Not compatible	Not compatible	Not compatible	Not compatible	Compatible	Not compatible	Not compatible	Not compatible	Not compatible	Not compatible	Not compatible	Not compatible	Not compatible
GBK0801003F	Not compatible	Not compatible	Not compatible	Not compatible	Not compatible	Not compatible	Compatible	Compatible	Compatible	Not compatible	Not compatible	Not compatible	Not compatible	Not compatible
GBK1200702F	Not compatible	Not compatible	Not compatible	Compatible	Compatible	Not compatible	Not compatible	Not compatible	Not compatible	Not compatible	Not compatible	Not compatible	Not compatible	Not compatible
GBK1200703F	Not compatible	Not compatible	Not compatible	Not compatible	Not compatible	Compatible	Not compatible	Not compatible	Not compatible	Not compatible	Not compatible	Not compatible	Not compatible	Not compatible
GBK1201003F	Not compatible	Not compatible	Not compatible	Not compatible	Not compatible	Not compatible	Compatible	Compatible	Compatible	Not compatible	Not compatible	Not compatible	Not compatible	Not compatible
GBK1201004F	Not compatible	Not compatible	Not compatible	Not compatible	Not compatible	Not compatible	Not compatible	Not compatible	Not compatible	Compatible	Not compatible	Not compatible	Not compatible	Not compatible
GBK1201400F	Not compatible	Not compatible	Not compatible	Not compatible	Not compatible	Not compatible	Not compatible	Not compatible	Not compatible	Not compatible	Compatible	Compatible	Compatible	Compatible

 Compatible
 Not compatible

(1) Weight of adapter kit:
 GBK060●●●F: 0.200 kg/0.441 lb
 GBK080●●●F: 0.450 kg/0.992 lb
 GBK120●●●F: 0.650 kg/1.433 lb

4					
490NTC00005	30	GBX080●●●K	57	TSXCANCA300	25
	31		68		27
490NTC00005U	30	GBX120●●●K	57		28
	31		68	TSXCANCA50	25
490NTC00015	30	GBX160●●●●●●F	57		27
	31		68		28
490NTW00002	30	GBY060●●●K	58	TSXCANCADD03	28
	31		70	TSXCANCADD1	28
490NTW00002U	30	GBY080●●●K	58	TSXCANCADD3	28
	31		70	TSXCANCADD5	28
490NTW00005	30	GBY120●●●K	58	TSXCANCB100	25
	31		70		27
490NTW00005U	30	L			28
	31	LC1D09●●	44	TSXCANCB300	25
490NTW00012	30	LC1D12●●	44		27
	31	LC1D18●●	44		28
490NTW00012U	30	LC1D25●●	44	TSXCANCB50	25
	31	LXM32AD12N4	19		27
		LXM32AD18M2	18		28
		LXM32AD18N4	19	TSXCANCBDD03	28
		LXM32AD30M2	18	TSXCANCBDD1	28
		LXM32AD30N4	19	TSXCANCBDD3	28
		LXM32AD72N4	19	TSXCANCBDD5	28
		LXM32AU45M2	18	TSXCANCD100	25
		LXM32AU60N4	19		27
		LXM32AU90M2	18		28
		LXM32CD12N4	19	TSXCANCD300	25
		LXM32CD18M2	18		27
		LXM32CD18N4	19		28
		LXM32CD30M2	18	TSXCANCD50	25
		LXM32CD30N4	19		27
		LXM32CD72N4	19	TSXCANKCDF180T	28
		LXM32CU45M2	18	TSXCANKCDF90T	28
		LXM32CU60N4	19	TSXCANKCDF90TP	28
		LXM32CU90M2	18	V	
		LXM32MC10N4	19	VW3A1101	21
		LXM32MD12N4	19	VW3A1104R10	21
		LXM32MD18M2	18	VW3A1104R100	21
		LXM32MD18N4	19	VW3A1104R30	21
		LXM32MD30M2	18	VW3A1104R50	21
		LXM32MD30N4	19	VW3A1105	21
		LXM32MD72N4	19	VW3A3601	31
		LXM32MD85N4	19	VW3A3607	29
		LXM32MU45M2	18	VW3A3608	27
		LXM32MU60N4	19	VW3A3616	30
		LXM32MU90M2	18	VW3A3618	28
		LXM32SD12N4	19	VW3A3628	27
		LXM32SD18M2	18	VW3A4420	39
		LXM32SD18N4	19	VW3A4421	39
		LXM32SD30M2	18	VW3A4422	39
		LXM32SD30N4	19	VW3A4423	39
		LXM32SD72N4	19	VW3A4424	39
		LXM32SU45M2	18	VW3A4553	37
		LXM32SU60N4	19	VW3A4554	37
		LXM32SU90M2	18	VW3A4555	37
		T		VW3A7601R07	36
		TCSCAR013M120	25	VW3A7601R20	36
			27	VW3A7601R30	36
		TCSCAR01NM120	28	VW3A7602R07	36
		TCSMCNAM3M002P	42	VW3A7602R20	36
		TCSWAAC13FB	22	VW3A7603R07	36
			42	VW3A7603R20	36
		TSXCANCA100	25	VW3A7603R30	36
			27	VW3A7604R07	36
			28		
				VW3A7604R20	36
				VW3A7604R30	36
				VW3A7605R07	36
				VW3A7605R20	36
				VW3A7605R30	36
				VW3A7606R07	36
				VW3A7606R20	36
				VW3A7606R30	36
				VW3A7607R07	36
				VW3A7607R20	36
				VW3A7607R30	36
				VW3A7608R07	36
				VW3A7608R20	36
				VW3A7608R30	36
				VW3A7704	36
				VW3A7705	36
				VW3A8115	42
				VW3A8121	23
				VW3A8126	23
				VW3CANCARR03	25
					27
				VW3CANCARR1	25
					27
				VW3CANTAP2	25
					27
				VW3E5001R005	24
				VW3E5001R010	24
				VW3E5001R015	24
				VW3E5001R020	24
				VW3E5001R030	24
				VW3E5001R050	24
				VW3E5001R100	24
				VW3E5001R150	24
				VW3E5001R200	24
				VW3E5001R250	24
				VW3E5001R300	24
				VW3E5001R400	24
				VW3E5001R500	24
				VW3M2106	20
				VW3M2201	24
				VW3M2202	24
				VW3M2203	24
				VW3M2207	24
				VW3M2208	52
					65
				VW3M2300	64
				VW3M2301	50
					64
				VW3M2302	50
					64
				VW3M2303	50
					64
				VW3M2304	50
				VW3M2305	64
				VW3M2306	64
				VW3M2307	64
				VW3M2308	64
				VW3M2501	20
				VW3M2606	20
				VW3M3301	29
				VW3M3302	35
				VW3M3401	32
				VW3M3402	32
				VW3M3403	32
				VW3M3501	34
				VW3M3802	28
				VW3M3805R010	25
					27
				VW3M3805R030	25
					27
				VW3M4701	32
				VW3M5101R100	50
					64
				VW3M5101R15	50
					64
				VW3M5101R150	50
					64
				VW3M5101R200	50
					64
				VW3M5101R250	50
					64
				VW3M5101R30	50
					64
				VW3M5101R50	50
					64
				VW3M5101R500	50
					64
				VW3M5101R750	50
					64
				VW3M5102R100	50
				VW3M5102R150	50
				VW3M5102R200	50
				VW3M5102R250	50
				VW3M5102R30	50
				VW3M5102R50	50
				VW3M5102R500	50
				VW3M5102R750	50
				VW3M5103R100	51
					64
				VW3M5103R150	51
					64
				VW3M5103R200	51
					64
				VW3M5103R250	51
					64
				VW3M5103R30	51
					64
				VW3M5103R50	51
					64
				VW3M5103R500	51
					64
				VW3M5103R750	51
					64
				VW3M5104R100	51
				VW3M5104R150	51
				VW3M5104R200	51
				VW3M5104R250	51
				VW3M5104R30	51
				VW3M5104R50	51
				VW3M5104R500	51
				VW3M5104R750	51
				VW3M5105R100	51
				VW3M5105R150	51
				VW3M5105R200	51
				VW3M5105R250	51
				VW3M5105R30	51
				VW3M5105R50	51
				VW3M5105R500	51
				VW3M5105R750	51
				VW3M5301R1000	53
					65

VW3M5301R250	53	X	XCC1510PSM50X	33
	65		XCC2510PS81SBN	33
VW3M5301R500	53		XCC3510PS84SBN	33
	65			
VW3M5302R1000	53			
VW3M5302R250	53			
VW3M5302R500	53			
VW3M5303R1000	53			
	65			
VW3M5303R250	53			
	65			
VW3M5303R500	53			
	65			
VW3M5304R1000	53			
VW3M5304R250	53			
VW3M5304R500	53			
VW3M5305R1000	53			
VW3M5305R250	53			
VW3M5305R500	53			
VW3M7101R01	24			
VW3M7102R150	24			
VW3M8102R100	52			
	65			
VW3M8102R15	52			
	65			
VW3M8102R150	52			
	65			
VW3M8102R200	52			
	65			
VW3M8102R250	52			
	65			
VW3M8102R30	52			
	65			
VW3M8102R50	52			
	65			
VW3M8102R500	52			
	65			
VW3M8102R750	52			
	65			
VW3M8111R10	24			
VW3M8112R10	24			
VW3M8214	52			
	65			
VW3M8215	52			
	65			
VW3M8217	52			
	65			
VW3M8218	52			
VW3M8221R1000	32			
VW3M8222R1000	53			
VW3M8222R250	53			
	65			
VW3M8222R500	53			
	65			
VW3M8223R30	24			
VW3M8502R03	24			
VW3M8502R15	24			
VW3M8704	23			
VW3M8705	23			
VW3M8801R30	34			
VW3M8802R15	34			
VW3M8802R30	34			
VW3M8810	34			
VW3M8820	34			
VZ1L007UM50	37			
VZ1L018UM20	37			





Schneider Electric USA

Motion Competency Center
1300 S. Wolf Road
Des Plaines, IL 60018-1300 USA
Tel: 847-789-5424

USA Customer Care Center
Tel: 888-778-2733

Schneider Electric Canada

5985 McLaughlin Rd.
Mississauga, Ontario, Canada L5R 1B8

Canada Customer Care Center
Tel: 800-565-6699

www.schneider-electric.com

© 2014 Schneider Electric. All rights reserved. Schneider Electric, Lexium, and “Make the most of your energy” are trademarks owned by Schneider Electric Industries SAS or its affiliated companies. All other trademarks are property of their respective owners.

Design: Schneider Electric
Photos: Schneider Electric

DIA7ED2140501EN-US
9/2014