

Copyright is owned by the Author of the thesis. Permission is given for a copy to be downloaded by an individual for the purpose of research and private study only. The thesis may not be reproduced elsewhere without the permission of the Author.

**A STUDY OF STEM-END SPLITTING  
IN APPLES**

**UMETZURUIKE LINUS OPARA**

**1993**

*But, my son, be warned:  
there is no end of opinions  
ready to be expressed.  
Studying them can go on forever,  
and become very exhausting.*

*Ecclesiastes 12:12*

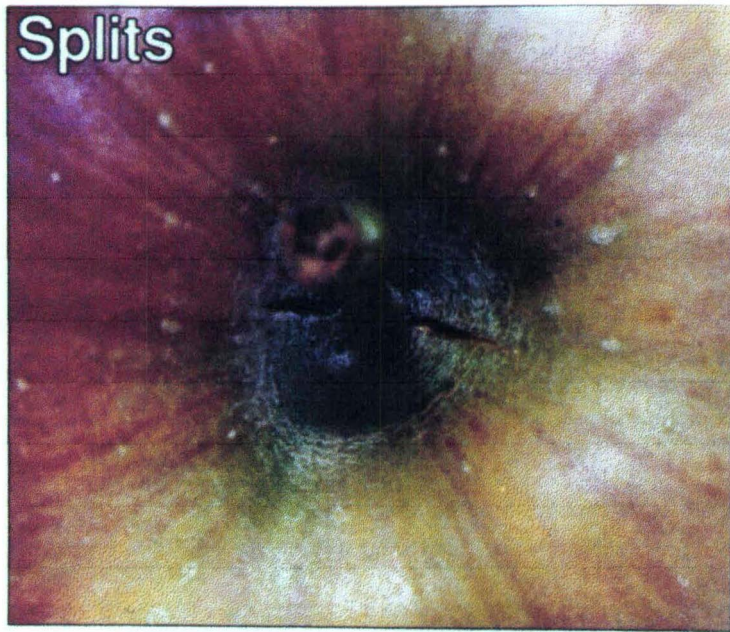

Apple with stem-end splits.

(NZAPMB, 1989)

When Newton saw an apple fall, he found ...  
A mode of proving that the earth turn'd round  
In a most natural swirl, called gravitation,  
And thus is the sole mortal who could grapple  
Since Adam, with a fall or with an apple.

*Don Juan 10, 11*

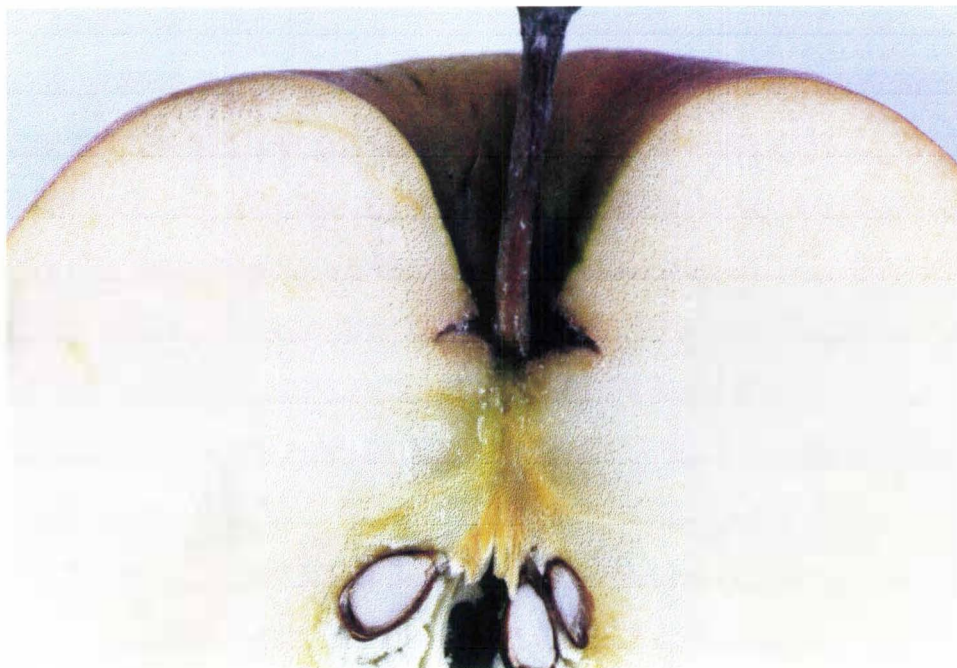

Apple with internal ring-crack.

... like a villain with a smiling cheek,  
A goodly apple rotten at the heart:  
O, what a goodly outside falsehood hath!

*Shakespeare*

**A STUDY OF STEM-END SPLITTING  
IN APPLES**

A thesis submitted in partial fulfilment  
of the requirements for the degree of

**Doctor of Philosophy**

in Agricultural Engineering

at

Massey University

New Zealand

**Umetzuruike Linus Opara**

**1993**

## ABSTRACT

One of the most widespread physical defects limiting the production and delivery of sound, blemish-free fruits is the cracking of the skin and splitting of the underlying flesh while the fruit is still attached to the tree. This occurs extensively in both pome and stone fruits. Of particular concern in this study is the problem of stem-end splitting which occurs in 'Gala', 'Royal Gala', and 'Fuji' apples. The production of these cultivars has expanded rapidly in New Zealand and overseas due to their productivity, good quality and high consumer acceptance. Thus, orchardists continue to produce these apples, accepting the risk that in some years splitting may be a serious quality problem.

The objective of this thesis was to investigate the causes and mechanism of occurrence of stem-end splitting in apples by (1) providing a detailed review of the literature on fruit cracking and splitting in apples, (2) studying the effects of orchard management practices on the incidence of stem-end splitting and making field observations to determine the physical characteristics of stem-end splitting of fruit, and (3) studying the growth characteristics and physical properties of fruit.

A review of the literature showed a dearth of information focused towards understanding the phenomenon of stem-end splitting whereas a considerable amount of literature was found on the causes of other forms of fruit cracking in apples, namely skin-cracking, star-cracking and general splitting of the fruit. Frequently in the literature, the information did not clearly differentiate the types of fruit cracking in apples and the word "cracking" was often used as a generic term to refer to several disorders, possibly including stem-end splitting.

This study has confirmed preliminary observations which suggested possible association between stem-end splitting and the presence of an internal "ring-crack" in fruit. Ring-cracks extended from the base of the stem outwards into the flesh of the apple in a plane at an angle of 90 degrees to the stem. By sectioning fruit at different stages of maturity, it was found that every fruit with stem-end splitting had internal ring-cracking at the stem-end but that some fruit without stem-end splitting had internal ring-cracks. No published research was found which noted the presence of this internal ring-cracking and it was concluded that ring-

cracking was a necessary precursor to the development of stem-end splitting.

Experimental studies on the effects of management practices showed that frequent irrigation significantly increased the incidence of stem-end splitting and ring-cracking by about 50% compared to a no irrigation treatment. Neither crop load nor foliar nitrogen had a significant effect on stem-end splitting or ring-cracking, although low crop load slightly increased both defects. Results from mechanical tests on fruit suggested that the increase in stem-end splitting due to frequent irrigation may be attributable to its effects in reducing the stress required to crush the flesh as well as increasing fruit size. These results suggested that orchard management practices which increase fruit size and reduce the mechanical strength of the flesh are likely to increase the susceptibility to stem-end splitting.

None of the management practices had a significant effect on the mineral status of fruit. However, comparison of good and damaged fruit showed significantly higher concentrations of calcium, phosphorous and potassium in fruit with ring-cracking or stem-end splitting. These findings contradicted previously published results which implicated mineral deficiencies (such as calcium) or excessive concentrations (such as nitrogen) as the cause of fruit cracking and similar physiological disorders in apples. The present results do not suggest any possible direct involvement of calcium and the other minerals with respect to resistance to stem-end splitting and it is probable that the higher concentration of minerals in affected fruit is a secondary response which may have occurred after cortical cells began to break down rather than before the onset of ring-cracking.

By monitoring the chronological development of stem-end splitting using random samples of fruit at 2-week intervals, both stem-end splitting and ring-cracking were first observed on the same day, about 3 weeks before the first commercial harvest or 115 days after full bloom (DAFB). The higher incidence of internal ring-cracking compared to stem-end splitting on this day supported the conclusion that stem-end splits develop from ring-cracks. It also suggested that the initiation of both defects occurred some days or hours earlier.

Evidence from studies on the growth and development of 'Gala' apples showed that the onset of stem-end splitting coincided with critical growth periods during the season. This suggested

that the development of stem-end splitting may be related to the imbalance in growth of the whole fruit or its constituent parts. No profound changes were observed in lineal dimensions of fruit size (length and diameter) at the onset of stem-end splitting; however, this period was associated with disproportionate growth rates of fruit length and diameter on the one hand, and the attainment of the final shape of fruit on the other. Also during this period, there was a sudden increase in longitudinal growth strain. It is suggested that ring-cracking might well arise due to greater tensile stresses that are exerted upon the fruit due to the growth imbalance at a time when each affected cell is least able to accommodate itself to withstand the additional stress. The presence of a ring-crack, therefore, forms a free edge of the fruit skin which is then predisposed to crack as predicted by fracture mechanics.

Results obtained from the end of season harvest of 'Gala' apples showed that fruit exposed to sunlight during growth (compared to shaded fruit) had a 45% higher incidence of ring-cracking although there were no significant differences in the amount of stem-end splitting. The insignificant effect on the amount of stem-end splitting was attributed to the loss of about 35% of the initial samples of the well exposed shading treatment.

From laboratory immersion tests using water and four non-ionic surfactants, it was shown that submerging fruit in surfactant solutions increased both the rate and total amount of water uptake compared with the water treatment (control). During the time-course of immersion, the cumulative water uptake (percent weight gain) of fruit increased significantly while the daily rate of water uptake declined, with the maximum intake occurring during the first 24 hours of immersion. Significant uptakes of water did not induce stem-end splitting although skin-cracking occurred. These results suggested that stem-end splitting and skin-cracking are distinct phenomena and that excessive water absorption alone does not appear to be the whole explanation for the incidence of stem-end splitting in apples. It was concluded that while skin-cracking may result from excessive swelling and bursting of the skin following sudden and rapid intake of water by the underlying flesh, a stem-end split is a growth crack which appears to be related more to changes associated with disproportionate fruit growth rates.

A tentative model of stem-end splitting in apples is presented based on the cumulative relationships between management practices and fruit properties. The model identifies factors



which increase or reduce the risk of stem-end splitting, and emphasises the significance of fruit growth rates and the influence of the micro-environment. Possible mechanisms of stem-end splitting and skin-cracking are also discussed based on theoretical considerations of cell failure and the pathway of water uptake in both intact growing fruit or detached fruit.

*DEDICATED TO*

*Papa Uzoma Opara*  
for his love for education and  
selfless community service;

*Mama Okaraonyemma? Opara, (nee Nwokoma)*  
for her prayers, love and patience;

*Dede Agbakwuruibe Opara*  
for his invaluable advice and  
sacrifices towards my education;

and in memory of

*Opem Azunnaya Opara (B.A. Hons.)*  
for his foresight, courage  
and exemplary fortitude.

## ACKNOWLEDGEMENTS

I would like to express my sincere gratitude and indebtedness to my chief supervisor, Dr. Cliff J. Studman, for his thoughtful advice, guidance, kind assistance and support at every stage of this study. My sincere thanks and appreciation are due to Professor Nigel H. Banks, my co-supervisor, for his valuable suggestions during the investigations and review of the manuscript. The completion of this study could not have been possible without the friendship, inspiration and encouragement that I received from both supervisors and for these, I am particularly grateful.

Thanks are also due to the following who contributed in various ways to this study:

Dr. Sandy Lang, Scientist at HortResearch, Palmerston North, for his interest and advice, especially on the fruit growth studies;

Mr. and Mrs. Crauford, owners of Crauford Orchard, Havelock North, for permission to conduct the field experiments in their commercial orchard;

Mr. Andrew Hodson, formerly at MAFTech., Lawn Road, Hastings, for assistance in setting up the field experiments on 'Gala' and 'Royal Gala' during the 1990/91 season, collection of some fruit samples, and for the data on fruit mineral analysis;

Dr. Hossein Behboudian of the Department of Plant Science, for his suggestions and advice on design of the 'Royal Gala' field experiment;

Mr. Greg Arnold and Dr. Ganesh of the Department of Statistics and staff at the Computer Centre for statistical advice, and Dr. Bruce Christie of the Department of Plant Science for assistance with GLE graphics program;

Professor Gavin L. Wall, Head of the Department, for his interest and financial support during this research, and the members of the Department of Agricultural Engineering, for their encouragement; to Mr. Ian Painter, Leo Bolter and Les Boyd for their help in constructing

experimental equipment; and to Mrs. Helen Harker and Christine Bond for their assistance with secretarial work during this project.

I would like to thank Professor Ken S. Milne, Head of the Department of Plant Science, for his encouragement and support which were always forthcoming when the going seemed rather tough, and Professor Uche G.N Anazodo, Dean of the Faculty of Engineering, University of Nigeria, for his love and prayers. I would also wish to recognize the encouragement from the Chancellor of Massey University, Master Hughes Williams, Q.C., and numerous friends and colleagues in the Massey University Council, Academic Board, Academic Committee, and the Executive Committee of the Students' Association.

My special thanks are due to the former University Grants Committee (UGC) of New Zealand for the award of a 1987 Postgraduate Scholarship which made it possible for me to pursue this PhD study. Thanks are also due to the New Zealand Government through the Overseas Development Assistance (ODA) programme for assistance with my tuition fees and travel to New Zealand.

The final stage of this project was partly supported by a Contract Research on Stem-end Splitting in 'Gala' Strains funded by the New Zealand Apple and Pear Marketing Board (NZAPMB) and this financial support of the Board is gratefully acknowledged. I also wish to recognize the help of staff at the Board at various stages of this research, and in particular, Ms Stella McLeod, former National Research Manager and Mr. Duncan Park of the Fresh Fruits Laboratory in Hastings.

The grant-in-aid received from the Massey University Graduate Research Fund on "Fruit Mechanical Properties" is also gratefully acknowledged.

During my PhD studies, I was a recipient of a Helen Akers Postgraduate Scholarship and the Dean's Prize of the Faculty of Agricultural and Horticultural Sciences for which I would like to express my thanks.

I would also like to thank Mr. and Mrs. S.S Nwachukwu, Mr. Clifford Heshiulo and Mr.

Leonard Uba for their generous financial support towards my academic studies. The contributions and sacrifices of all members of my family are hereby acknowledged, in particular, Dede Regi, Dede Uneze, Ndaa Nwanyinna and Okey.

I am grateful for the moral support of numerous friends and in particular Faye, Basdore, Louis, David and Rev. Cliff Thomas. The fellowship with brothers and sisters at the All Saints Anglican Church in Palmerston North provided "spiritual food" for me and I would like to thank God and the members for this.

Finally, I am indebted to Gina and the Malifa family for their support and understanding, especially during the writing of this thesis.

## CONTENTS

<b>CHAPTER</b>	<b>PAGE</b>
ABSTRACT	ii
DEDICATION	vi
ACKNOWLEDGEMENTS	vii
TABLE OF CONTENTS	x
LIST OF FIGURES	xvii
LIST OF TABLES	xxi
LIST OF ABBREVIATIONS	xxiii
<b>CHAPTER 1</b>	<b>GENERAL INTRODUCTION</b>
1.1	Statement of the Problem <span style="float: right;">1</span>
1.2	Objectives of Study <span style="float: right;">4</span>
<b>CHAPTER 2</b>	<b>REVIEW OF FRUIT CRACKING AND SPLITTING IN APPLES, INCLUDING A CONSIDERATION OF CAUSES OBSERVED IN OTHER FRUITS</b>
2.1	Introduction <span style="float: right;">6</span>
2.1.1	General <span style="float: right;">6</span>
2.1.2	Terminology <span style="float: right;">7</span>
2.1.3	History and Occurrence <span style="float: right;">9</span>
2.2	Types of Fruit Cracking in Apples <span style="float: right;">11</span>
2.2.1	Skin-cracking <span style="float: right;">12</span>
2.2.2	Star-cracking <span style="float: right;">13</span>
2.2.3	Splitting <span style="float: right;">13</span>
2.3	Causes of Fruit Cracking <span style="float: right;">14</span>
2.3.1	General <span style="float: right;">14</span>

2.3.2	Diseases and Skin Abnormalities	16
2.3.3	Genetic Factors	19
2.3.4	Fruit External Factors	20
2.3.5	Fruit Internal Factors	29
2.4	Reduction and Control of Apple Cracking	32
2.4.1	Cultural Measures	33
2.4.2	Application of Plant Growth Regulators and Other Chemicals	35
2.5	Techniques for Assessing Extent of Fruit Cracking and Splitting	37
2.6	Objective Measurement of Crack Susceptibility	37
2.6.1	Apples	38
2.6.2	Cherries	38
2.6.3	Grapes	39
2.6.4	Tomatoes	40
2.7	General Summary and Concluding Remarks	42
2.7.1	General Summary	42
2.7.2	Concluding Remarks	44

## **CHAPTER 3      GENERAL MATERIALS AND METHODS**

3.1	Introduction	46
3.2	Experimental Designs	46
3.2.1	Stem-end Splitting and Mechanical Properties of 'Gala' Apples As Affected By Orchard Management Practices	46
3.2.2	Stem-end Splitting and Mechanical Properties of 'Royal Gala' Apples As Affected By Water Stress	47
3.3	Supply of Fruit	49
3.3.1	'Gala' Apples	49
3.3.2	'Royal Gala' Apples	49
3.3.3	'Fuji' Apples	50

3.4	Measurement of Physico-chemical and Mechanical Properties of Fruit	50
3.4.1	Fruit Size	50
3.4.2	Soluble Solids	50
3.4.3	Fruit Firmness	51
3.4.4	Flesh Crushing Stress	51
3.4.5	Flesh Tensile Properties	56
3.4.6	Skin Bursting Stress	60
3.4.7	Fruit-stem Adhesion Force	63
3.5	Analysis of Data	63

## **CHAPTER 4      EXPERIMENTAL STUDIES ON MANAGEMENT CAUSES OF STEM-END SPLITTING IN APPLES**

4.1	INTRODUCTION	66
4.2	EXPERIMENTAL DESIGNS, MATERIALS AND METHODS	67
4.2.1	Experimental Designs	67
4.2.2	Materials and Methods	67
4.2.3	Determination of Leaf Water Potential	68
4.3	ANALYSIS OF DATA	68
4.4	RESULTS	70
4.4.1	Effects of Irrigation, Crop load and Nitrogen on Stem-end of 'Gala' Apple	70
4.4.2	Effects of Irrigation Water Deficits on Stem-end Splitting of 'Royal Gala' Apple	75
4.4.3	General Observations on Fruit and the Characteristics of Stem-end Splitting	77
4.5	DISCUSSION	80
4.5.1	Stem-end Splitting of 'Gala' Apple	80
4.5.2	Stem-end Splitting of 'Royal Gala' Apple	83
4.5.3	Relationship Between Nutrient Concentration and Stem-end Splitting	84
4.6	CONCLUSIONS	85



## CHAPTER 5      MECHANICAL      AND      PHYSICO-CHEMICAL PROPERTIES OF APPLES IN RELATION TO ORCHARD MANAGEMENT PRACTICES AND STEM-END SPLITTING

5.1	INTRODUCTION	87
5.2	EXPERIMENTAL DESIGNS, MATERIALS AND METHODS	89
5.2.1	Experimental Designs and Supply of Fruit Materials	89
5.2.2	Equipment and Methods	89
5.2.3	Sample Preparation	90
5.2.4	Statistical Analysis	91
5.3	RESULTS	92
5.3.1	Effects of Irrigation, Crop Load and Nitrogen on the Mechanical and Physico-chemical Properties of 'Gala' Apples	92
5.3.2	Effects of Stem-end Splitting on the Mechanical and Physico-chemical Properties of 'Gala' Apples	92
5.3.3	Effects of Four Irrigation Treatments on the Mechanical and Physico-chemical Properties of 'Royal Gala' Apples	95
5.3.2	Effects of Stem-end Splitting on the Mechanical and Physico-chemical Properties of 'Fuji' Apples	95
5.4	DISCUSSION	99
5.4.1	Effects of Orchard Management Factors on the Mechanical Properties of 'Gala' Apples	99
5.4.2	Effects of Irrigation Treatments on the Mechanical Properties of 'Royal Gala' Apples	102
5.4.3	Comparison of the Mechanical, Physical, and Chemical Properties of 'Gala' and 'Fuji' Apples With and Without Stem-end Splitting	104

## **CHAPTER 6 FRUIT GROWTH, GROWTH STRESS, AND CHRONOLOGICAL DEVELOPMENT OF STEM-END SPLITTING IN 'GALA' APPLES**

6.1	INTRODUCTION	109
6.2	MATERIALS AND METHODS	111
6.2.1	Chronological Development of Stem-end Splitting	112
6.2.2	Non-destructive Measurement of Whole Fruit Growth	113
6.2.3	Measurement of Stem-end Cavity Depth	113
6.2.4	The Distribution of Fruit Growth	113
6.2.5	Measurement of Fruit Growth Stress	114
6.3	DATA ANALYSIS	114
6.3.1	Fruit Shape and Growth Dynamics	114
6.3.2	Growth Stress	119
6.4	RESULTS	119
6.4.1	Chronological Development of Stem-end Splitting in 'Gala' Apples	119
6.4.2	Fruit Growth Stress	121
6.4.3	Whole Fruit Growth Curves	121
6.4.4	Fruit Shape	125
6.4.5	Growth of Stem-end Cavity	131
6.4.6	Distribution of Surface Fruit Growth	131
6.5	DISCUSSION	140
6.5.1	Chronological Development of Stem-end Splitting	140
6.5.2	Development of Fruit Growth Stress in Relation to the Onset of Stem-end Splitting	144
6.5.3	Whole Fruit Growth Curve As Related to Stem-end Splitting	146
6.5.4	Fruit Shape in Relation to Stem-end Splitting	147

6.5.5	Fruit Growth Rates	
6.5.6	Distribution of Growth in the Fruit of 'Gala' Apples	146
6.6	CONCLUSIONS	150

## **CHAPTER 7      CHANGES IN MECHANICAL AND PHYSICO-CHEMICAL PROPERTIES OF 'GALA' APPLES DURING GROWTH AND MATURATION**

7.1	INTRODUCTION	152
7.2	MATERIALS AND METHODS	153
7.3	DATA ANALYSIS	153
7.4	RESULTS	154
7.4.1	Fruit Size	154
7.4.2	Flesh Crushing Stress	154
7.4.3	Soluble Solids Concentration	158
7.5	DISCUSSION	163
7.5.1	Changes in Fruit Weight	163
7.5.2	Changes in Flesh Crushing Stress and Soluble Solids	165
7.6	CONCLUSIONS	167

## **CHAPTER 8      WATER ABSORPTION, STEM-END SPLITTING, AND OTHER QUALITY ATTRIBUTES OF 'GALA' APPLES AS AFFECTED BY SUBMERGING FRUIT IN NON-IONIC SURFACTANT WATER SOLUTIONS**

8.1	INTRODUCTION	168
8.2	MATERIALS AND METHODS	171
8.2.1	Chemical Supplies	171

8.2.2	Fruit Materials	172
8.2.3	Methods	172
8.3	ANALYSIS OF DATA	174
8.4	RESULTS	174
8.4.1	Experiment 1 - Effects of Non-ionic Surfactants at 1.25 ml/litre on Water Absorption, Stem-end Splitting, Changes in Flesh Crushing Stress and Visual Quality of 'Gala' Apples	174
8.4.2	Experiment 2 - Effects of Non-ionic Surfactants at Recommended Manufacturers' Concentrations on Water Absorption, Stem-end Splitting, Appearance Quality and Changes in Flesh Crushing Stress of 'Gala' Apples	181
8.4.3	Experiment 3 - Effects of Submerging 'Gala' Apples in Water or Different Concentrations of Various Non-ionic Surfactant Solutions on Water Uptake and Fruit Cracking	187
8.5	DISCUSSION	194
8.6	SUMMARY AND CONCLUSIONS	200

## **CHAPTER 9      EFFECTS OF DEGREE OF FRUIT EXPOSURE TO SUNLIGHT DURING GROWTH ON STEM-END SPLITTING AND MECHANICAL PROPERTIES OF 'GALA' APPLES**

9.1	INTRODUCTION	202
9.2	MATERIALS AND METHODS	204
9.2.1	Fruit Materials	204
9.2.2	Incidence of Stem-end Splitting and Internal Ring-cracking	204
9.2.3	Determination of Fruit Mechanical Properties	205

	xvii
9.2.3 Data Analysis	205
9.3 RESULTS	205
9.3.1 Stem-end Splitting, Internal Ring-cracking and Fruit size	205
9.3.2 Fruit Mechanical and Physico-chemical Properties	207
9.4 DISCUSSION	208
9.5 CONCLUSIONS	209

## **CHAPTER 10 GENERAL DISCUSSION AND CONCLUSIONS**

10.1 GENERAL DISCUSSION	211
10.2 SUMMARY OF FACTORS ASSOCIATED WITH STEM-END SPLITTING IN APPLES	215
10.3 A TENTATIVE MODEL OF STEM-END SPLITTING IN APPLES BASED ON THE IDENTIFIED RELATIONSHIPS BETWEEN MANAGEMENT PRACTICES AND FRUIT PROPERTIES	219
10.4 POSSIBLE MECHANISMS OF STEM-END SPLITTING AND SKIN-CRACKING IN APPLES BASED ON PATHWAY OF WATER UPTAKE BY FRUIT	221
10.5 RECOMMENDATIONS FOR FURTHER STUDIES	227
10.6 GENERAL CONCLUSIONS	227

<b>LIST OF REFERENCES CITED</b>	231
---------------------------------	-----

<b>APPENDIX</b>	263
-----------------	-----

## LIST OF FIGURES

FIGURE	PAGE	
3.1	Prototype twist testers used in experiments. Mark I (top) and Mark II (bottom).	52
3.2	Principle of twist tester (a) General layout (b) Enlargement of blade. [Studman and Yuwana, 1992].	53
3.3	Photograph of the experimental tensile tester used (top); and principle of the tensile tester (bottom).	57
3.4	Photograph of apple tested for skin bursting stress.	62
3.5	Experimental setup of the stem-puller.	64
4.1	Soil moisture deficits in irrigated and unirrigated treatments of the 'Gala' block.	71
4.2	Photographs showing : [top] an apple with medium stem-end splits, and [bottom] an apple on the tree in which a stem-end split has developed into a complete longitudinal split.	78
4.3	Photographs of sections through apples showing internal ring-cracks.	79
6.1	Photographs showing (top) how marks were made to measure the distribution of growth on fruit and (bottom) the appearance of a mark after 70 days.	115
6.2	Measurement of growth stress in fruit: (top) photograph to show how cuts were made in the fruit and (bottom) the measurements taken.	116
6.3	Development of stem-end splitting and internal ring-cracking in the 'Gala' experimental orchard during the 1991 season.	120
6.4	Growth stresses in 'Gala' apples during the season measured as strains.	122
6.5	Size of gape expressed as percentage of mean fruit diameter of 'Gala' apples measured at two time intervals (0 and 30 mins after cutting fruit).	123
6.6	Cumulative whole fruit growth of 'Gala' apples.	124
6.7	Absolute fruit growth rate (AGR) of 'Gala' apples.	126
6.8	Relative fruit growth rate (RGR) of 'Gala' apples.	127
6.9	Mean relative fruit growth rate (MRGR) of 'Gala' apples.	128
6.10	Difference between fruit diameter and length of 'Gala' apples during growth.	129

6.11	Fruit shape of 'Gala' apples during growth.	130
6.12	Stem cavity:fruit diameter ratio (C/D) of 'Gala' apples during growth.	132
6.13	Stem cavity:fruit length ratio (C/L) of 'Gala' apples during growth.	133
6.14	Cumulative growth of stem-end cavity of 'Gala' apples.	134
6.15	Absolute growth rate (AGR) of stem-end cavity of 'Gala' apples.	135
6.16	Relative and mean relative growth rates of stem-end cavity of 'Gala' apples.	136
6.17	Fruit growth at the stem-end of 'Gala' apples.	137
6.18	Fruit growth at the cheek of 'Gala' apples.	138
6.19	Fruit growth at the calyx-end of 'Gala' apples.	139
6.20	Distribution of fruit growth at three locations on 'Gala' apples.	141
6.21	Fruit growth in the horizontal axis at three locations on 'Gala' apples.	142
6.22	Fruit growth in the vertical axis at three locations on 'Gala' apples.	143
7.1	Cumulative weight of 'Gala' apples during the season.	155
7.2	Absolute growth rate (AGR, weight) of 'Gala' apples during the season.	156
7.3	Flesh crushing stress (kPa) of 'Gala' apples during growth and maturation.	157
7.4	Absolute rates of change in flesh crushing stress of 'Gala' apples during growth and maturation.	159
7.5	Percentage absolute changes in flesh crushing stress of 'Gala' apples during growth and maturation.	160
7.6	Soluble solids concentration ( $^{\circ}$ Brix) of 'Gala' apples during growth and maturation.	161
7.7	Absolute rates of change in soluble solids of 'Gala' apples during growth and maturation.	162
8.1	Cumulative percentage weight increase of 'Gala' apples during 4 days of immersion in water (control) and various surfactant water solutions at 1.25 ml per litre.	177
8.2	Rate of water absorption (daily % weight gain) of 'Gala' apples in water (control) and various surfactant water solutions at 1.25 ml per litre.	178
8.3	Cumulative percentage weight increase of 'Gala' apples during 4 days of immersion in tap water, distilled water (control) and various surfactant water solutions at manufacturers' recommended spraying	

	concentrations.	182
8.4	Rate of water absorption (daily % weight gain) of 'Gala' apples in distilled water (control), tap water, and various surfactant water solutions at manufacturers' horticultural spraying concentrations.	182
8.5	Effects of surfactant concentration on water absorption (% weight gain) of 'Gala' apples submerged in various aqueous solutions for 24 hours.	185
8.6	Effects of surfactant concentration on water absorption (% weight gain on day 4 alone) of 'Gala' apples submerged in various aqueous solutions.	190
8.7	Effects of surfacatant concentration on percentage fruit cracking (on day 4 alone) of 'Gala' apples submerged in various aqueous solutions.	191
8.8	Effects of surfactant concentration on water absorption (% weight gain) of 'Gala' apples after 4 days of immersion in various aqueous solutions.	192
8.9	Effects of surfactant concentration on percentage fruit cracking of 'Gala' apples after 4 days of submersion in various aqueous solutions.	193
8.10	Effects of type of surfactant water solution on water absorption (percent weight gain) of 'Gala' apples at different intervals of immersion.	195
8.11	Effects of type of surfactant water solution on percentage fruit cracking of 'Gala' apples at different intervals of immersion.	196
10.1	A tentative model of the relationships between orchard management practices, fruit properties and the development of stem-end splitting.	220
10.2	Possible mechanism of stem-end splitting in apples based on pathway of water uptake by fruit.	222
10.3	Possible mechanism of skin-cracking in apples based on pathway of water uptake by fruit.	224



## LIST OF TABLES

TABLE	PAGE
4.1 Effects of orchard management practices on stem-end splitting, internal ring-cracking, and fruit size of 'Gala' apples.	72
4.2 Variability of percentage incidence of stem-end splitting and internal ring-cracking expressed by the minimum and maximum values for single tree replicates.	73
4.3 Major nutrient concentration (mg/100g fresh weight) in good, ring-cracked and stem-end split fruit of 'Gala' apple [Data supplied by Hodson, 1991; pers. comm.].	74
4.4 Effects of four irrigation treatments on leaf water potential, stem-end splitting and internal ring-cracking of 'Royal Gala' apple.	76
5.1 Effects of orchard management practices on fruit mechanical and physico-chemical properties of 'Gala' apples.	93
5.2 Comparison of the mechanical and physico-chemical properties of good and stem-end split fruit of 'Gala' apples at three harvest dates.	94
5.3 Effects of four irrigation treatments on the mechanical and physico-chemical properties of 'Royal Gala' apples.	96
5.4 Comparison of the size, stem adhesion force and skin mechanical properties of good and stem-end split fruit of 'Fuji' apples.	97
5.5 Comparison of the flesh firmness, crushing stress and soluble solids concentration of good and stem-end split fruit of 'Fuji' apples.	98
5.6 Flesh tensile properties of good and stem-end split fruit of 'Fuji' apples.	99
8.1 Description of the non-ionic surfactants used in the experiments.	171
8.2 Effects of submerging 'Gala' apples in tap water or various surfactants at 1.25 ml.litre <sup>-1</sup> on fruit cracking, water absorption (weight gain), appearance quality and flesh crushing stress (kPa) of fruit [Expt 1a : Fruit picked 24 Jan. 1992 and tested 25-29 Jan. 1992].	175
8.3 Effects of submerging 'Gala' apples in tap water, distilled water or various surfactants at 1.25 ml.litre <sup>-1</sup> on fruit cracking, water absorption (weight	

	gain) and visual quality of fruit [Expt 1b : Picked Feb. 7 and tested Feb. 8-12, 1992].	180
8.4	Pearson's correlation coefficients between fruit quality attributes and the levels of significance, in brackets [Expt 1b].	181
8.5	Percentage fruit cracking, water absorption (weight gain), flesh crushing stress and visual quality of 'Gala' apples after 4 days following submersion in water or surfactant solutions at recommended manufacturers' spraying concentrations.	184
8.6	Daily rate of fruit cracking of 'Gala' apples submerged in water or surfactant water solutions at manufacturers' recommended spraying concentrations.	186
8.7	Pearson's correlation coefficients between solution concentration and fruit quality factors [Expt 2].	187
8.8	Effects of surfactant concentration on percentage fruit cracking of 'Gala' apples after 24 hours of submersion in various aqueous solutions [Expt 3].	189
9.1	Effects of shading treatments on stem-end splitting, internal ring-cracking, and fruit size of 'Gala' apples.	206
9.2	Effects of shading treatments on mechanical and physico-chemical properties of 'Gala' apples.	207
10.1	Summary of results of relationships obtained between high incidence of stem-end splitting and factors that have been associated with cracking and splitting in fruit.	217
10.2	Summary of significant changes in fruit properties which coincided with the onset of stem-end splitting in 'Gala' apple during the season.	218

## LIST OF ABBREVIATIONS

$\alpha_{af}$	=	fruit-stem adhesion force, N
$\beta$	=	maximum twist angle at failure, degrees
$\Gamma_{max}$	=	maximum tensile stress, Pa
$\epsilon$	=	tensile strain
$\epsilon_{max}$	=	maximum tensile strain
$\zeta_{bs}$	=	skin bursting stress, Pa
$\theta$	=	angle of rotating arm, degrees
$\Pi$	=	pi, 3.1416
$\sigma_{cr}$	=	flesh crushing stress, Pa
$\sigma_t$	=	tensile stress, N.m <sup>-2</sup>
$\chi^2$	=	chi-square
$\Psi$	=	moment of couple, N.m
$\Omega_{br}$	=	skin bursting force, <b>N</b>
a	=	blade radius, m
A	=	arcsin transform of percentage ring-cracked fruit
AGR	=	absolute growth rate
ANOVA	=	analysis of variance
b	=	width of twist blade, m
$b_a$	=	width of apple specimen, m
B	=	percentage ring-cracked fruit
C/D	=	cavity:diameter ratio of fruit
C/L	=	cavity:length ratio of fruit
Ca	=	Calcium
CG	=	cumulative growth
Cu	=	Copper
d	=	distance from the centre of the pivot to the point of support in the horizontal position, m
D	=	thickness of apple specimen, m
D-L	=	difference between fruit diameter and length
DAFB	=	days after full bloom

DMRT	=	Duncan's Multiple Range Test
$d_p$	=	diameter of penetrometer probe, m
E	=	Young's Modulus, Pa
F	=	tensile force, N
FC	=	Field capacity
Fe	=	Iron
$F_{max}$	=	maximum tensile force, N
g	=	acceleration due to gravity, $9.807 \text{ m.s}^{-2}$
I	=	second moment of area, $\text{m}^4$
IRC	=	Internal ring-cracking
K	=	Potassium
kg	=	kilogramme
l	=	length of rectangular fruit specimen, m
L	=	total length of rotating arm, m
L/D	=	length:diameter ratio or fruit shape
LSD	=	least significant difference
$L_{wp}$	=	leaf water potential, Pa
m	=	mass of arm, kg
m	=	metre
M	=	maximum moment produced when the arm is horizontal (i.e. $\theta = 90^\circ$ ), N.m
Ma	=	Moment of the rotating arm, N.m
MAF	=	Ministry of Agriculture and Fisheries
Mb	=	Moment of the whole blade, N.m
Mg	=	Magnesium
Mn	=	Manganese
MRGR	=	mean relative growth rate
N	=	Nitrogen
N	=	Newtons
p	=	distance from the lower end of the arm to the centre of the axle, m
P	=	Phosphorous

q	=	distance from the top end of the arm to the centre of the axle, m
R	=	radius of curvature of the neutral axis, m
RCBD	=	randomized complete block design
RGR	=	relative growth rate
s	=	second
SAS	=	Statistical Analysis Systems
SES	=	Stem-end splitting
SPD	=	split plot design
T1	=	Treatment one - low water
T2	=	Treatment two - low to high water
T3	=	Treatment three - medium water
T4	=	Treatment four - high water
TDR	=	Time Domain Reflectometer
$t_{sk}$	=	thickness of fruit skin, m
vs	=	versus
$W_t$	=	total weight of arm, N
x	=	deformation of apple specimen, m
X	=	percentage stem-end split fruit
$x_1$	=	mass of fruit, kg
$x_2$	=	penetrometer reading, kg
y	=	distance to fibre from neutral axis, m
Y	=	arcsin of the square-root transform of percentage stem-end split fruit
Zn	=	Zinc
°C	=	Degrees Centigrade

# CHAPTER ONE

## GENERAL INTRODUCTION

### 1.1 Statement of the Problem

Appearance and freedom from physical defects are important quality attributes in the fruit industry which affect product attractiveness and therefore its acceptability to the consumer. In addition, the need to store fruit longer during transportation overseas, especially under strict quarantine regulations, requires that fruit be delivered in sound and blemish-free conditions. Thus, the production and availability of top quality fruit is important to both growers and consumers.

Numerous quality defects in fruit are induced during harvest and postharvest handling and these appear as bruises, cuts and abrasions. However, one of the most widespread physical defects limiting the production and delivery of sound, blemish-free fruit is the cracking of the skin and splitting of the underlying flesh while the fruit is still attached to the tree. This occurs extensively in both pome and stone fruits (Beattie et al., 1989), kernels (Lague and Jenkins, 1991a,b; Srinivas et al., 1977 and 1978), and vegetables (Lutz et al., 1949). The cracking of detached fruit during postharvest handling (Mohsenin, 1972; Khan and Vincent, 1990) and in cold storage (Mezzeti, 1959) have also been reported.

The presence of a crack alters the structural integrity of the food material and lowers its mechanical strength (Lague and Jenkins, 1991a). These cracks produce lines of weakness along which the otherwise intact food material is more likely to undergo further damage when subjected to mechanical stresses. The presence of these cracks accounts for excessive crushing of soft, fleshy fruits in harvesting containers and loss of fruit juices (Reynard, 1960).

Cracks or splits provide open wounds which facilitate rapid loss of moisture and excessive shrivelling which lower the quality of fruit in storage (Meyer, 1944; Mezzeti, 1959; Goode et al., 1975). Severe storage losses also arise through the action of decay-causing microbes (Iverson, 1938; Meyer, 1944) which infect the injured parts. Fruits with cracks are prone to chemical injury during washing to remove spray materials (Fisher, 1937a,b). Prior to harvest, insects and chemical sprays may also contaminate the cracked or split fruit (Shear, 1971).

Because cracking or splitting is usually more severe as the fruit approaches its peak of ripeness, there is a tendency to pick early to avoid cracked fruit. This results in the delivery of fruit of non-uniform quality and under-coloured fruit to the market and processing plants.

The continued success of the New Zealand horticultural industry, and the contribution of pip fruits in particular, has been partly attributed to the high quality of New Zealand apples and the introduction of new varieties such as 'Gala', 'Royal Gala', 'Fuji' and Braeburn (McCliskie, 1991). The production of these varieties has continued to expand rapidly both in New Zealand and overseas (Walsh et al., 1991) thanks to their precocity, productivity, price, and consumer acceptance. Unfortunately, some of these varieties can be subject to disorders which affect quality. Of particular concern in this study is the problem of stem-end splitting which occurs in 'Gala', 'Royal Gala', and 'Fuji'. In a recent study of fruit characteristics of five strains of 'Gala', Greene and Autio (1993) reported that all five strains developed stem-end splitting on the third harvest. Extensive stem-end splitting of fruit has also been observed in several mutation breeds of 'Royal Gala' apples (Opara et al., 1993a). This defect occurred while the fruit was still attached to the tree, and appeared to intensify when fruit harvesting was delayed to enhance size and colour. Despite the importance of these new varieties, little effort has been made so far to address the problem of stem-end splitting which adversely affects their fruit quality.

Stem-end splitting of fruit is a problem in the New Zealand Apple industry because the affected fruit are classed as unsound. Most new and early maturity varieties are susceptible and tolerances for this defect are low. The economic cost of this has been conservatively estimated at NZ\$1.00 per 18.5 kg carton for lines with stem-end splits (Stanley, pers. comm., 1990). This assessment does not include the costs of re-packing any rejected lines, nor does

it include costs which arise from the loss of machine capacity, and the losses which occur due the inability of the packer to plan processing schedules while packing susceptible lines (Foster et al., 1991).

Notwithstanding variability within and between regions in New Zealand, it has been estimated that up to 50% of lines of 'Gala', 'Royal Gala', and 'Fuji' are currently affected by stem-end splitting and these varieties contribute up to 35% of the total apple packout from the affected regions (Stanley, pers. comm., 1990). Recent field investigations in New Zealand (Hodson, pers. comm., 1991b) and the United States (Walsh et al., 1991) have found that up to 12% and 40%, respectively, of the 'Gala' apples in one orchard were affected by stem-end splitting. The scale of this problem has substantial economic implications for the grower, packhouse operator, and the entire apple industry.

A survey conducted in 1990 by the New Zealand Apple and Pear Marketing Board (NZAPMB) on the problem of stem-end splitting in the Hawke's Bay district found that the packed tray carton export (TCE) affected by stem-end splitting at fruit packers ranged from 27.72% for 'Royal Gala' to 62.37% and 78.08%, respectively, for 'Fuji' and 'Gala' (McLeod, pers. comm., 1992). The total export value of packed fruit affected and "at risk" from stem-end splitting was estimated to be over \$10 million for the three varieties during the season.

In general, fruit cracking and splitting affect the quality grade of apples for both export and local markets. In 1992 the NZAPMB allowed a maximum of 2% of apples in a box to contain splits (Foster et al., 1991) and the maximum allowable aggregate length of cracks on an apple for both export and local fancy was 1 centimetre (NZAPMB, 1989). The consequence of any box checked exceeding 2% of split fruit was that the packer must re-pack the entire batch at considerable costs to the packer and/or grower. Therefore, packhouse staff must be trained to sort out split fruit, even though this occurs in a relatively small percentage of an entire batch.

In order to avoid re-packing, grading machines are slowed down when packing varieties susceptible to cracking or splitting. Even then, splits are very hard to detect because most apple varieties susceptible to splitting are striped and the splits tend to blend in with these



stripes. This leads to reduced throughput, increased handling costs, and greater difficulties in scheduling operations. Although image analysis techniques have been developed to detect stem-end splits (Studman et al., 1991; Foster et al., 1991), machine inspection is currently not deemed to be economic (Stanley, pers. comm., 1990).

The problem of apple cracking and splitting is by no means a new problem in New Zealand and other apple producing areas in the world. It has affected the New Zealand apple industry for nearly a century (Kirk, 1907; Cunningham, 1925), and the causes are still poorly understood. In a recent breeding programme on clones derived from 'Royal Gala' apple, White et al. (1992) and Selby and White (1992) found that on five trees of one clone, nearly every fruit showed splitting at harvest maturity. There is clearly a need for research to understand the origin and causes of the problem so that strategies can be developed to reduce or control the problem.

Pre-harvest cracking and splitting also affects a wide range of different fruits and is also considered a serious economic problem such as in tomatoes (Reynard, 1960), cherries (Trought and Lang, 1991; Trought et al., 1992; Edwards et al., 1992); grapes (Considine, 1979; Meynhardt, 1964a), prunes (Mrozek and Burdhardt, 1973), avocados (Haas, 1936), dates (Haas and Bliss, 1935), and citrus (Randhawa et al., 1958; Taylor et al., 1957 and 1958). These are discussed in Chapter 2.

## **1.2 Objectives of Study**

Growers of apple varieties susceptible to stem-end splitting have attempted several management practices to control the incidence of the defect. Although these individual efforts may or may not alleviate the problem for a particular grower, there is currently no guaranteed strategy to control the disorder. There is still no satisfactory explanation for the occurrence of this particular phenomenon.

To reduce losses, preventive measures are necessary, but these measures can only be prescribed confidently when the phenomenon of stem-end splitting is well understood.

Knowledge of the conditions which induce fruit splitting as well as the fruit physical factors that are involved or affected would also assist plant breeders to identify varieties that are susceptible to splitting. At the moment, there is clearly a dearth of information on stem-end splitting in apples or any other fruit.

The main goal of this study was to enhance our knowledge of the causes and mechanisms which lead to stem-end splitting in apples by investigating the effects of orchard management practices on the incidence of fruit splitting, and studying the growth characteristics and physical properties of the fruit of susceptible cultivars. Specifically, the objectives of this study were :

- (1) to provide a detailed review of the literature on fruit cracking and splitting in apples with a consideration of other fruits;
- (2) to study the effects of orchard management practices on the amount of stem-end splitting;
- (3) to determine the effects of these management practices and stem-end splitting on fruit physical and mechanical properties;
- (4) to determine the chronological development of stem-end splitting during the growing season;
- (5) to study the growth of the apple fruit and the changes in physical and mechanical properties in relation to the onset of stem-end splitting.

An attempt was made to develop a conceptual model of stem-end splitting which accommodates the observed relationships between fruit mechanical properties and incidence of splitting. It is hoped that further this model provides some worthwhile insight into the mechanisms by which fruit develop stem-end splits and some potential strategies for controlling the disorder.

## CHAPTER TWO

### REVIEW OF FRUIT CRACKING AND SPLITTING IN APPLES, INCLUDING A CONSIDERATION OF CAUSES OBSERVED IN OTHER FRUITS.

#### 2.1 Introduction

##### 2.1.1 General

Scientific interest in the problem of apple fruit cracking and splitting has grown remarkably since the beginning of this century. This development has not guaranteed an understanding of the exact nature of the problem and possible control measures. A review devoted to fruit cracking was reported over 20 years ago in India by Teatota and Singh (1970). This review discussed mainly the causes of the problem. Walter (1967) presented a review of the literature on russeting and cracking in apples.

A number of authors have also provided valuable summaries of previous research together with original work on apple fruit cracking and splitting (Cunningham, 1925; Verner, 1935 and 1938; Shutak and Schrader, 1948; Byers et al., 1990). More general reviews on disorders and diseases of fruits include cracking and splitting of apples (Posnette, 1963; Salter and Goode, 1967), and those on mineral-related disorders (Shear, 1971 and 1975; Bangerth, 1976 and 1979).

Research reports on the problem of fruit cracking in tomatoes (Frazier, 1947; Reynard, 1960), cherries (Bullock, 1952; Christensen, 1976), prunes (Uriu et al., 1962; Mrozek and Burkhardt, 1973), grapes (Meynhardt, 1964b; Considine, 1979; Considine and Brown, 1981) and citrus fruit (Randhawa et al., 1958) have included information on apple fruit cracking in their literature reviews.

In comparison, few workers have reported convincing evidence concerning factors involved in the initiation and development of cracking and spitting in apples, though many have addressed the cracking of tomatoes, cherries and grapes. As part of a research programme to fill this gap and to facilitate further investigation, the objectives of this review were to document the existing knowledge, indicate the present limitations of our understanding of this subject, and to suggest possible areas for further research. The literature on fruits other than apples is considered only in order to discuss mechanisms of failure.

### **2.1.2 Terminology**

"Cracking" is a general term that has been applied to certain physical disorders of fruits which are expressed as fractures in the cuticle or skin. These fractures may be microscopic or easily seen, sometimes extending deep into the inner tissues of the fruit as well defined cavities.

Cracking has been defined as the physical failure of the fruit skin (Milad and Shackel, 1992), and is generally believed to result from stresses acting on the skin. It could be normal (mainly due to normal processes of growth) or damaged-induced (Walter, 1967). Stiles et al. (1959) classified any 'Stayman' apple fruit having visible cracks in the skin 6 mm or longer as cracked.

Splitting is an extreme form of cracking in which the cracks penetrate deep into the flesh of the fruit. They range in size from thin splits, a few millimetres long, to wide splits which have been observed to attain a length of about 60 millimetres in apples (Verner, 1935). Thus, a practical difference between splitting and other forms of fruit cracking is that a split causes gross exposure of the internal tissue to the atmosphere whereas in a crack the interior is not completely exposed (that is, it is contained in the cuticular layers).

Cracking and splitting in apples have been described by many terms which usually reflect either the perceived cause or symptom of the problem, or both. During the early part of this century, apple cracking was synonymous with the terms blister, blister-disease and

Coniothecium-blister (Cunningham, 1925 and Goodwin, 1929). These terms were derived from the symptoms of the fungus *Coniothecium chomastosporum* Cordia, which was widely reported in South Africa (Evans, 1907 and Bijl, 1914), New Zealand and Australia (Kirk, 1907; Cunningham, 1925; Campbell, 1928; Goodwin, 1929) and Britain (Moore, 1931) as the causative agent.

In Canada, Hockey (1941) used the term "false sting" to describe a virus disease of apples in which the affected fruit exhibited a degree of deformity with well defined cracks, but he did not make any reference to fruit cracking. Jenkins and Storey (1955), Schmid (1960 and 1961), and Cropley (1963 and 1968) used the term star-cracking to refer to a viral disease of apples.

The term "boron deficiency pitting" which is widely used to describe various mineral disorders of pears including cracking (Raese, 1989) has been applied to the cracking of Rymer apples in India (Dube et al., 1969). Other terminologies have been used which derive from the position of the crack on the fruit surface. Skin- or lenticel-cracking has been used by many authors to describe fruit cracking in many cultivars (Fisher, 1937a,b; Schrader and Haut, 1948; Jackson et al., 1977).

Stem-end splitting refers to splitting in apples which originates from the base of the stem and radiates towards the crown (shoulder) of the fruit. A stem-end split is a breach of both the skin and the underlying tissue of the fruit. It occurs extensively in three new commercial cultivars, namely 'Gala', 'Royal Gala', and 'Fuji' varieties grown in New Zealand.

In other countries, crack defects which occur at the stem-end of fruit have been reported. Verner (1935) observed that late in the growing season of Stayman Winesap apples, cracks originating near the fruit stem and extending outward in straight meridional lines towards the cheek were common. Masden and Bailey (1959) also reported the presence of severe cracking around the stem-end of Winesap apples grown in the United States. From Britain, severe stalk-end cracking of Cox's Orange Pippin apples has been reported by Montgomery (1959).

Although the word cracking is evidently popular, it may not be appropriate for all physical

failures which breach the skin of the fruit. At the moment, there is a great deal of confusion and sometimes the term cracking is incorrectly applied to clearly different symptoms and this makes it difficult to compare results from different research workers. For consistency, the terminology of the original researcher will be used in the following sections of this review unless indicated otherwise where the original terms are altered in order to categorize the failure more clearly.

### 2.1.3 History and Occurrence

Cracking or splitting occurs in practically all important apple-growing areas of the world. It has been reported by researchers from South Africa (Evans, 1907; Bijl, 1914), New Zealand and Australia (Kirk, 1907; Carne, 1925; Cunningham, 1925; Campbell, 1928; Goodwin, 1929; Irving and Drost, 1987), Britain (Tetley, 1930; Moore, 1931; Jenkins and Storey, 1955; Skene, 1965 and 1980), the United States (Verner, 1935 and 1938; Fisher, 1937a,b; Schrader and Haut, 1938; Shutak and Schrader, 1948; Stiles et al., 1959; Byers et al., 1990; Unrath, 1991), Russia (Fischer 1955; Schmid, 1960 and 1961), and Canada ( Mezzetti, 1959; Proctor and Loughheed, 1980).

The cracking of apples has also been recorded in Japan (Tomana, 1961; Watanabe, 1987), Korea (Kim et al., 1991), India (Dube et al., 1969; Teatota and Singh, 1970), Italy (Costa et al., 1983; Visai and Marro, 1986; Visai et al., 1989), Denmark (Pilgaard, 1957), and Sweden (Nilsson and Fernqvist, 1956; Nilsson and Bjurman, 1958; Rootsi, 1962; Goldschmidt, 1962).

Apparently, reports from New Zealand (Kirk, 1907 and later, Cunningham, 1925) and South Africa (Evans, 1907 and later, Bijl, 1914) are probably the first records devoted to apple cracking and the *Coniothecium* disease which was then believed to be the main cause of the problem. Cunningham (1925) confirmed the prevalence of the disorder in New Zealand with limited distribution elsewhere. In Australia, Carne (1925) concluded that the cracking and russeting disorders of Dunn's and other apples are connected with climatic and growth conditions.

Other early reports from New Zealand extended the focus to include the cultural causes of the problem and possible remedial measures (Campbell, 1928; Goodwin, 1929). In a study of the epidermal structure of the apple, Tetley (1930) observed extensive cracking on the sunny side of James Grieve and Beauty of Bath varieties in the summer of 1928 in Britain. Also in Britain, Moore (1931) carried out detailed investigations on the fungus *Coniothecium chomastosporum* Cordia, in association with cracking and russeting of apple fruit and blistering of the twigs. He concluded that the existence of other similar fungi complicated the investigations.

Recognition of cracking as a major commercial problem coincided with expanding apple production in the United States, and particularly in countries like New Zealand and Australia, which exported apples to Europe and elsewhere with increasing quality requirements. A disorder which developed prior to harvest (Verner, 1935) and during storage (Mezzetti, 1959; Goode et al., 1975) was particularly galling to growers who relied heavily on markets around the world (Goodwin, 1929).

Verner (1935) documented the first detailed field and laboratory studies on the problem of fruit cracking in apples. His pioneering work and those of other researchers on cherries (Hartman and Bullis, 1929; Verner and Blodgett, 1931), and tomatoes (Frazier, 1934; Brown and Price, 1934) laid the foundation for further in-depth studies on cracking and splitting in these and other fruits.

Cracking and splitting are erratic in occurrence, causing heavy losses in some years, seasons and locations, and almost none in others (Cunningham, 1925; Campbell, 1928; Goodwin, 1929; Tetley, 1930; Moore, 1931; Verner, 1935 and 1938; Hockey, 1941; Jenkins and Storey, 1955; Montgomery, 1967; Teatota et al., 1970). In New Zealand, the stem-end splitting of 'Gala' and 'Fuji' apples has been observed in Hawke's Bay and Canterbury, but has not been reported in Central Hawke's Bay, Nelson or Blenheim (Hodson, 1991a). During the 1920s, the cracking of Dunn's Favourite and Cox's Orange Pippin was reported throughout New Zealand irrespective of climatic conditions or quality of soil (Campbell, 1928; Goodwin, 1929). With few exceptions (Verner, 1935), most observers seem to agree that cracking and splitting occur only later in the season in mature apples.

Susceptibility to cracking and splitting varies distinctively from fruit to fruit, and is partly cultivar dependent. Cunningham (1925) noted that although the *Coniothecium* disease causing apple cracking was prevalent in New Zealand, it was common on certain varieties.

Within susceptible fruit cultivars, the amount of cracking and splitting varies considerably among individual trees in the same orchard, branches of the same tree, and even spurs on the same branch (Verner, 1935 and 1938; Posnette and Copley, 1963). During a three-year study of cracking in Stayman apples, Stiles et al. (1959) found that during one year, cracking varied widely from tree to tree, ranging from 3.6 to 24.9 per cent.

In Sweden, Nilsson and Fernqvist (1956) observed that vigorous rootstocks, such as M.XVI and seedlings were more conducive to the development of fruit cracking in 'Ingrid Marie' apples. Studying the splitting of 'Mutsu' apples in Japan, Watanabe et al.(1987) found rootstock effects, with trees grown on MM.106, Maruba Kaido and M.7 having greater levels than M.26.

## **2.2 Types of Fruit Cracking in Apples**

The cracking of apples can occur in a number of ways to produce different types of cracks. Skene (1965) presented a summary of three mechanisms: first, there is the formation of cuticle cracks associated with the initiation of russet; secondly, there is the cracking of the outer layers of skin when these are sloughed off during the final stages of russet development; and thirdly, there are cracks which penetrate deeply into the flesh and are responsible for serious down-grading of fruit quality. This third mechanism would account for the splitting defined in Section 2.1.2 which occurs mainly as stem-end splitting in apples. According to Walter (1967), the various types of cracking which occur in apples appear to be partly varietal characteristics. In broad terms, these kinds of fruit cracks can be classified into skin-cracks, star-cracks, and splits.



### **2.2.1 Skin-cracking** (also referred to as lenticel- or cuticle cracking).

This is characterised by the presence of numerous minute superficial cracks on the fruit surface, followed by the gradual peeling-off of the skin in patches, giving the affected apple a russeted appearance (Kirk, 1907; Reed and Crabill, 1915; Goodwin, 1929; Moore, 1931; Fisher, 1937a,b; Schrader and Haut, 1938; Gourley and Howlett, 1941; Meyer, 1944; Shutak and Schrader, 1948; Pilgaard, 1957; Fischer, 1955; Tomana, 1961; Montgomery, 1967; Jackson et al., 1977; Taylor and Knight, 1986). Some of these cracks heal over during the growth of the apple (Schrader and Haut, 1948) by cork formation with a light deposit of suberin on the cell walls. Meyer (1944) noted that the unhealed shallow cracks accounted for the excessive shrivelling of apples during storage.

Fisher (1937a) described the skin-cracking of 'York' apples as varying from barely noticeable to as much as 1.5 mm wide. According to Schrader and Haut (1938), skin-cracks on 'York' apples may show as slight checking of the skin, resulting in a rough feel or so-called poor finish of the fruit, but in severe cases, many small open cracks usually 3 mm or less in length may occur.

Several authors noted that skin-cracking was limited almost entirely to the green (shaded) side of the fruit (Reed and Crabill, 1915; Fisher, 1937a,b; Schrader and Haut, 1938; Shutak and Schrader, 1948). These workers and Pilgaard (1957) have also reported that skin-cracking is prevalent in the calyx region of the fruit. Skin-cracks usually developed perpendicular to the axis of the apple but, if insect or some similar injury was present, cracks generally ran concentrically around the injured spot (Fisher, 1937a,b; Schrader and Haut, 1938; Shutak and Schrader, 1948).

The presence of extensive cuticular cracks has been associated with the development of extensive russeting although some russeted varieties have virtually no cuticle cracks during their early stages of development (Skene, 1965; Costa et al., 1983).

### **2.2.2 Star-cracking**

Affected fruit are marked with star-shaped cracks in the skin, sometimes on the side of the fruit, but more frequently near the calyx-end (Jenkins and Storey, 1955; Gilmer and Einset, 1959; Schmid, 1960 and 1961; Copley, 1963 and 1968). Fruit are usually under-sized and become heavily russeted when about half grown (Posnette and Copley, 1963).

In severely affected fruit, the star-cracks develop deep cracks which usually heal, resulting in severely scarred fruit (Jenkins and Storey, 1955; Copley, 1963; Posnette and Copley, 1963), and the affected fruit also tend to have irregular shape (Jenkins and Storey, 1955). These researchers agreed that star-cracking is caused by virus diseases.

### **2.2.3 Splitting** (also referred to as flesh cracking)

This occurs in the form of breaks in both the skin and flesh of the affected fruit (Verner, 1935). Individual splits vary from almost invisible short slits to splits several millimetres deep that extend around the fruit. Proctor and Lougheed (1980) observed extensive early season fruit cracking of Golden Russet which consisted of deep (up to 40.3 mm) and wide (up to 20 mm) equatorial furrows containing easily detached cork tissue, and occurred mainly on the stem half of the fruit.

On the basis of evidence provided by Verner (1935), splits on apples can be classified into those originating in regions with structural deformities (such as russet and scar lesions), and those originating in or near the stem depression. Unlike the other types of fruit cracking which occur on parts of the fruit with certain injuries and virus diseases that alter the fruit surface, stem-end splitting often occurs on apples that appear from the outside to be in excellent condition except for the presence of the split (Verner, 1936; Montgomery, 1959; Opara et al., 1992). Recent studies on fruit characteristics of five strains of 'Gala' apples showed that all five strains developed stem-end splitting on the third harvest (Greene and Aution, 1993). In another study, Opara et al. (1993a) have recorded extensive stem-end

splitting in several mutation breeds of 'Royal Gala' apples. It appears from the foregoing observations that strains of 'Gala' apple are particularly susceptible to stem-end splitting.

## **2.3 Causes of Fruit Cracking and Splitting**

### **2.3.1 General**

It is commonly believed or implied that, for a wide range of fruits such as cherries and tomatoes (Verner and Blodgett, 1931; Frazier and Bowers, 1947; Reynard, 1960; Niiuchi et al., 1960; Westwood and Bjornstad 1970; Christensen, 1972d), cracking and splitting occur as a result of a sudden increase in the water content of the soil, atmospheric humidity and temperature. However, it has been shown that in addition to excessive water absorption by the roots, cracking in many kinds of fruit such as apples, peaches, and cherries is also caused by the osmotic absorption of water through the skin of the fruit (Bohlmann 1962).

Discussing the causes of splitting in oranges, Coit (1917) stated that "the most common theory in regard to the cause of splits is that an irregular water supply causing wide variations in the moisture content of the soil, produces a greater fluctuation in the growth of the interior than in the skin of the orange." He maintained, however, that such a cause should be regarded as only a contributing factor, because only a proportion of the fruit on any given tree would split.

Chandler (1925) discussed the water relations of deciduous fruits in general and stated that "certain injuries, such as cracking of fruit, may result from a heavy irrigation late in its development, if growth has been checked by lack of water earlier." Gardner et al., (1922) concluded that splitting in apples and in some stone fruits was most likely to occur shortly before maturity when rain or late irrigation occurred following a long period of drought.

Hartman and Bullis (1929) reported that cracking of cherries occurred as a result of excessive water absorption by the fruit, either directly through the skin in wet weather or by way of the

root system and vessels. However, Verner and Blodgett (1931) were unable to observe any relationship between soil moisture and cracking in three varieties of sweet cherries. Similarly, Sawada (1931) concluded that extremes of soil moisture played no direct part on the splitting of sweet cherries.

The rupture of fleshy parts in general was discussed by Sorauer (1922), who considered the causal relations to be much alike for fruit cracking in cherry, plum, and grape, bursting of carrots and beets, and splitting of stems in kohlrabi, rape, bean, and potato. The author was of the opinion that "all these phenomena have one characteristic in common - that they are initiated only when, after a considerable period of normal development, or still more after a dry period, an unusual supply of water is given suddenly."

Rixford (1918) stated that figs have been observed to split under conditions of high atmospheric humidity without rain or irrigation. Frazier (1947) found that tomatoes cracked most severely after heavy irrigation at the end of a prolonged dry period. Cracking was less severe in plots with frequent irrigation, which prevented excessive drying of the soil, and it was least severe in plots where the soil-moisture content remained low throughout the growing season. Shaded fruits cracked much less than those exposed to the sun.

The causes of cracking in grapes has been studied extensively in South Africa (Meynhardt, 1957 and 1964a,b) and Australia (Considine and Kriedman, 1972; Considine et al., 1974; Considine, 1979 and 1982; Considine and Brown, 1981). Studies by Meynhardt (1957 and 1964a) show that spray irrigation can increase the incidence of berry cracking in certain varieties of grapes when the atmospheric moisture content is high. The splitting of grapes and other fruit by unseasonal rainfall has been attributed to the development, under conditions of high availability of water and low evaporative demand, of a high hydrostatic pressure in the fruit (turgor pressure) in excess of the tensile strength of the cell walls (Considine and Kriedman, 1972 ; Considine et al., 1974).

According to Gourley and Howlett (1941) the cracking of fruit in apples and sweet cherries occurs due to excessive cell enlargement of the fruits following a marked increase in the soil moisture. Mrozek and Burkhardt (1973) identified twenty-three factors believed to be

associated with the cracking of apples, tomatoes, avocados, cherries and prunes. Fruit cracking in water, high humidity, rain during cracking and fruit maturity were factors applicable to all types of fruit.

As pointed out in sections 2.1.2 and 2.2, fruit cracking in apples is varied in extent, and the various types of cracking appear to be partly varietal characteristics. Therefore, the following review, with main emphasis on apples, is based on the underlying causes rather than on symptoms. Nearly one hundred years of observation, speculation, and research have implicated no less than twenty factors correlated with apple fruit cracking. With the exception of the "viral disease" theory (Powers and Bollen, 1947; Posnette, 1963; Montgomery, 1959; Cropley, 1968), none of these may be summarily discarded, and it is likely that the cause is due to the interaction of several factors.

The causes of fruit cracking and splitting in apples established by various workers can be summarised under diseases and skin abnormalities, genetic factors, fruit internal, and external factors.

### **2.3.2 Diseases and Skin Abnormalities**

#### **Diseases**

Most early researchers on fruit cracking in apples concluded that the disorder is caused by the fungus *Coniothecium chomatosporum* Cordia (Evans, 1907; Kirk, 1907; Bijl, 1914; Cunningham, 1925; Moore, 1931). However, factors other than fungal infection were later implicated. In a survey of twenty-one apple growers in New Zealand, Campbell (1928) found that nineteen were of the opinion that the trouble was physiological, and two believed that it was due to disease. Similarly, Goodwin (1929) concluded that the *Coniothecium* disease was an after-effect, and that the problem could be regarded as due more to general debility of the tree. According to Bijl (1914), the fact that apples crack does not show that the fungus *Coniothecium* is present because cracking is also brought about by uneven growth of the fruit, due to climatic conditions.

Fruit cracking in apples has also been ascribed to virus diseases (Jenkins and Storey, 1955; Fischer, 1955; Schmid, 1960 and 1961; Posnette, 1963; Croyley, 1968), and the disorder has been claimed to be transmissible (Schmid, 1960 and 1961; Croyley, 1963).

Virus diseases which cause cracking of apples have been reported from many countries (Croyley, 1963 and 1968). However, the relationship between the viruses and the susceptibility to fruit cracking has remained obscure. In Switzerland, viruses causing fruit cracking and russetting have been transmitted within and between apple varieties (Schmid, 1960 and 1961), but according to Croyley (1963), it is not yet possible to assess with certainty the relationship of these diseases to the disorder. In Britain, Granny Smith apples from New Zealand and Australia were not affected when inoculated with four strains of star-crack virus and similarly, Boskoop and Glockenapfel scions grafted on star crack-diseased Cox were unaffected (Croyley, 1963).

Powers and Bollen (1947) found no correlation between cracking and the number and kinds of micro-organisms in cherries. No recent literature associates cracking and splitting in apples and other fruits with viral or fungal diseases. For example, Montgomery (1959) ignored forms of fruit cracking in Cox's Orange Pippin apples due to virus diseases to investigate the "more serious" cracking due to unusual climatic conditions.

According to Fawcett and Lee (1926), splitting in citrus fruit is commonly associated with diseased tissues, such as lesions. These diseased tissues absorb water exceptionally when the water supply is plentiful and cause rupture through abnormal swelling. Gardner et al. (1927) and Goodwin (1929) found fruit cracking in apple and pear fruit to be associated with the severe attack of scab, blotch and russetting.

### **Skin Abnormalities**

Physical defects on fruit constitute points of weakness where rupture generally occurs first. These defects may arise from either physiological disorders, diseases, insects or mechanical injury (Fisher, 1937a,b; Schrader and Haut, 1938; Shutak and Schrader, 1948; Montgomery,

1959; Walter, 1967; Teatonia and Singh, 1970). Fruit cracking and splitting are both associated with a disintegration or breakdown of the cuticular layer, in one case localised, and in the other general (Walter, 1967). In samples of Stayman Winesap apples, Gardner and Christ (1953) noted an eight-fold increase in the number of incipient cracks and splits which subsequently developed on severely russeted specimens compared with smooth-skinned specimens. The authors also noted increased skin permeability to water vapour in russeted areas.

Simons and Aubertin (1959) studied the effect of wounding on the development of fruit tissues by inducing damage by cutting, abrading, or scraping fruits of Golden Delicious at various stages of growth. Cutting the skin two days after fruit-set stimulated periderm formation, accompanied by sloughing-off of cells in the exposed tissues, and this persisted throughout the fruit development. On the normal areas adjacent to the injury, macroscopic effects were not pronounced, but cuticular cracks developed as a result of irregular growth. There was no malformation of the fruit, and consequently no secondary cracks when fruits were injured during later stages of development, but periderm activity was insufficient to form a protective covering over the wound.

The effects of abnormalities of peripheral tissues in relation to the cracking of apples was studied extensively by Verner (1935), and he concluded that cracking is less likely to occur on sound apples than on those with some abnormality. During one season Verner found that 88 per cent of the cracks formed on the fruits of one tree were directly associated with russeted skin, sunburn, or scab spots. The remaining 12 per cent were most often on the sound cheek of fruit surfaces that was most exposed to sunlight. However, the author noted that the cracking was not dependent on the abnormalities themselves, but that they merely rendered affected portions of the fruit more susceptible to cracking than normal portions when environmental influences tended to promote cracking in both.

Stiles et al. (1959) found that cracking of Stayman apples increased with an increase in russet or other injury to the fruit. According to Montgomery (1959), the mechanism would be that uptake of water through the skin may rupture the cells. In addition, moisture fluctuations may cause the cracking of skin already finely russeted, or in combination with temperature changes

lead to uneven cell division or enlargement, with consequent stresses that might lead to cracking.

Other authors have found a histological analogy between cracking and russetting of apples (Walter, 1967; Skene, 1982a,b; Proctor and Loughheed, 1980), and according to Visai et al.(1989), cracking could be considered the last and the more serious stage of skin russet.

On the basis of observations on "Stayman Red" apples, Costa et al. (1983) found it difficult to relate fruit cracking to russetting. However, they pointed out that fruit cracking originates from small russetting plates and /or hypertrophic lenticels . They argued that these anatomical features led to a reduction of cell elasticity which, associated with high fruit growth rate, could be a basic factor in determining the onset of cracking.

### **2.3.3 Genetic Factors**

The genetic constitution of fruits and fruit varieties affect the susceptibility of particular fruits or parts of fruits to cracking. Posnette and Cropley (1963) attributed fruit cracking in apples to a genetical disorder. Visai et al. (1989) quoted unpublished data which showed that cracked Neipling Stayman apple fruit had less gibberellic-acid-like (GA-like) substances than intact ones. The authors believed that such genetic factors were associated with the cracking of the 'Stayman' group of apples.

In Canada, Proctor and Loughheed (1980) found extensive early season fruit cracking of Golden Russet apple but not on Pomograte Russet. The variety Cox's Orange Pippin is more frequently affected by apple star-crack than other varieties in England (Jenkins and Storey, 1955). Researchers in the United States have found that the "York Imperial" apple variety is associated with severe skin-cracking (Fisher, 1937a,b; Schrader and Haut, 1938; Shutak and Schrader, 1948).

Several geneticists have confirmed that fruit cracking is governed by genes. Reynard (1951) and Young (1957 and 1959) observed a two recessive gene pair mode of inheritance for radial



crack-resistance in tomatoes. Radial cracking was found to be determined by two major gene pairs designated as *cr cr* and *rl rl* and heritable. During subsequent studies, Young (1959 and 1960) found crack-resistant genes to be associated with pink fruit colour, high number of fruits per plant, low average number of locules per fruit, and small fruit diameter and determinate plant growth habit. Resistance to fruit cracking in tomatoes has also been associated with wide calyx base and lobes (Frazier, 1951 and 1958).

Prashar and Lambeth (1960) studied the inheritance of radial cracking in tomatoes and found that resistance is not controlled by the same gene in all varieties. Reynard (1960) found that radial and concentric cracks in tomatoes are governed by separate gene systems, and through cross-breeding, crack-resistant tomato varieties have been produced (Frazier, 1959; Reynard, 1960).

Zielinski (1964) found genetic variability of considerable magnitude for resistance to fruit cracking among sweet cherries and concluded that breeding programmes could offer some potential for solving the problem.

#### **2.3.4 Fruit External Factors**

The incidence of fruit cracking and splitting varies remarkably not only between different climatic regions, but from year to year (section 2.1.3). It is generally accepted that certain environmental conditions of weather at certain times of the year and orchard cultural practices are important factors (Verner, 1935 and 1938; Walter, 1967; Teatonia and Singh, 1970).

Environmental factors associated with fruit cracking include soil moisture, rainfall, relative humidity, temperature and the amount of exposure to sunlight. The cultural factors that have been implicated include rootstock influence, irrigation, pruning and thinning, mineral nutrition, and the effects of chemical sprays.

## Weather Conditions and Fruit Water Relations

### *Soil Moisture Content*

It has often been suggested that the major factor responsible for the splitting of various fruits is a sudden marked increase in soil moisture content late in their development, if growth has been checked by lack of water earlier (Gardner et al., 1922; Chandler, 1925; Bohlmann, 1962; Walter, 1967). In Sweden, Nilsson and Bjurman (1958) observed that the cracking of Ingrid Marie apples was promoted by rapidly changing weather conditions. In Japan, the fluctuation of soil moisture from low to high induced more cracks on tomato fruit (Niiuchi et al., 1960).

Proctor and Loughheed (1980) suggested that cracking of Golden Russet apples in Canada was related to fluctuating water supply in the early part of the growing season. The cracking disorder of stone fruits (mainly cherries and apricots) and grapes has been attributed to excess uptake of water by fruit shortly before harvest leading to cell rupture (Beattie et al., 1989).

Verner (1935) observed no increase in the incidence of splitting when he caused sudden and pronounced soil moisture fluctuations by artificially droughting trees of Stayman Winesap followed by flood irrigation. He attempted to induce splitting by forcing water into the cut ends of detached fruit-bearing branches when these were exposed to air. He was unable to induce splitting even though the treatment continued up to three hours.

In a study of fruit splitting in ten cultivars of Mutsu apples, Watanabe et al. (1987) reported that soil types, moisture content and bagging had no clear effects on the incidence of the disorder. Irving and Drost (1987) found that water deficit imposed during phase one of fruit growth increased the proportion of cracked Cox's apples by 2-3 fold. The incidence of bitter pit was marginally reduced, but mean fruit size and titratable acidity were not altered.

Trought and Lang (1991) investigated the role of water in cherry splitting and observed that significant fruit splitting occurred on blocks where fruit were protected from rain with plastic covers. The authors suggested that water uptake by the plant, through the root systems, may be of greater significance in causing fruit splitting than had been realised in the past.

### *Rainfall and Irrigation*

Although the experiments of Verner (1935) showed no relation between apple cracking and soil moisture, he succeeded in inducing severe splitting both when branches bearing attached fruit alone were submerged in water for several days. In further experiments in which rain was artificially diverted from large branches, some of the fruit on those branches cracked, indicating that the presence of a film of water on foliage or fruit was not a necessary condition to promote cracking.

From these, Verner concluded that wetting of fruit and leaf surfaces for a long period might aggravate the tendency to crack, but it was not the primary factor concerned. Reed and Crabill (1915) found that skin-cracking of apples occurred 'very rarely in dry seasons' but usually after late rains following drought.

Gardner and Christ (1953) kept detached half-grown fruit of several apple varieties continually covered with a film of water for 4 or 11 days and found that no cracking was induced in either Rome Beauty or Delicious, but in Stayman Winesap some splitting occurred after 4 day's soaking. After 11 days, half the fruit of this variety showed splits.

Montgomery (1959) associated the widespread cracking and russetting of Cox's in England in 1958 with the exceptionally heavy rainfall during June and August. In addition to excessive water absorption by the roots, Bohlmann (1962) found that many kinds of fruit such as peaches, apples, and cherries tend to crack more easily when they come into contact with rain or mist or when immersed in water. He concluded that fruit protected from rain will not crack.

Goode et al. (1975) were able to induce skin-cracking of Cox's apples by maintaining water stress. In experiments with 'Stayman' apples, Byers et al. (1990) found that over-tree or under-tree sprinkling for one 12-hr night period did not cause fruit cracking. After 6 nights of sprinkling, over-tree and under-tree sprinkling caused 9% and 7.6%, respectively, of the fruit to crack. Fruit covered with bags or petroleum jelly on over-tree sprinkled trees did not crack, while 7.6% of the wetted fruit cracked. These results agree with the conclusion of

Bohlmann (1962) on apples, peaches, and cherries but disagree with those of Verner (1935) also on 'Stayman' apples, and Trought and Lang (1991) on sweet cherries, where fruit under a tarpaulin cracked.

### ***Relative Humidity and Evaporation Rate***

Tukey (1959b) found that prolonged periods of high relative humidity, especially while the apples are small, may inhibit the potential formation or modify the composition of the cuticle sufficiently to cause it to lose its protective capacity. Increase in water supply and decrease in water loss from leaves due to saturated relative humidity promoted fruit cracking and splitting in apples (Verner, 1935 and 1938) and several other fruits (Teaotia and Singh, 1970). Verner (1935) obtained a fairly close relationship between fruit cracking and relative humidity when a heavier rain accompanied by humidity well below 90% caused no cracking while relative humidity between 99-100% caused severe cracking.

Under natural orchard conditions, Verner (1935) found a definite association between low rates of evaporation and the incidence of fruit splitting in apples. There was extensive splitting during several periods of prolonged slow evaporation rates, even when there had been no rain for up to 6 days. Outbreaks of splitting were generally preceded by marked depressed transpiration, maintained for six hours or more. Verner concluded that in Stayman apples, splitting is promoted by increased water supply to the fruit tissues as a result of reduced transpiration under conditions of high humidity.

Low humidity during fruit development has been associated with the cracking of apples (Mrozek and Burkhardt, 1973; Walter, 1967). Under conditions of water stress, low relative humidity would accentuate the effects of drought, and thus tend to promote cracking associated with the outer tissues of the fruit. The combination of these factors accounted for the greater incidence of cracking of Ohenimuri apples in drier inland regions in South Africa compared with humid regions (Louw, 1948).

Evidence from the foregoing section reveals that despite the popular belief that susceptibility

to cracking is associated with fruit water relations and other environmental factors, there is a general lack of information on the effect of water management practices in the orchard on apple fruit splitting even though irrigation remains a crucial component of most fruit production systems.

### *Temperature Fluctuation and Exposure of Fruit to Sunlight*

Verner (1935) found that the occurrence and severity of cracking of Stayman Winesap apples were not related in any way to air-temperature fluctuations; however, the author also noted that cracks on otherwise sound fruits most often were on the cheek that was most exposed to sunlight. Bohlmann (1962) noted that in many kinds of fruit, notably apples, peaches and cherries, there is increased tendency to crack as the temperature of the rises.

Koske et al. (1980) found that increasing growing bed temperature of tomatoes up to 32 °C, had no effect on fruit yield, cracking, skin strength, or plant growth. Peet and Willits (1991) tested the effects of solar energy and temperature on tomato fruit cracking. When night time temperatures were maintained below 21 °C by air conditioners, the percentage of fruit cracking decreased significantly because the total number and weight of fruit increased more than the number and weight of cracked fruit.

The degree of sun exposure of fruit has been associated with the cracking of apples, tomatoes and cherries (Fisher, 1937a,b; Verner, 1938; Mrozek and Burkhardt, 1973). In 'Rome Beauty' apples, Magness and Diehl (1924) found that the exposed side of the fruit developed a thicker skin than the shaded side. Reed and Crabill (1915), and Fisher (1937a,b) noted that the skin-cracking of 'York' apples is limited almost entirely to the green (shaded) side of the fruit. Reed and Crabill suggested that perhaps "the skin on the shaded side of the fruit may be actually stretched to bursting by the unusual rapid multiplication and growth of pulp cells due to a sudden increase in water supply." The prevalence of skin-cracking of 'York' apples on the shaded side of fruit has been reported by other workers (Schrader and Haut, 1938 ; Shutak and Schrader, 1948).

The above findings disagree with the results obtained by Tetley (1930) who found that in 'James Grieve' and 'Beauty of Bath' varieties, most of the cracks were formed on the sunny side of the apple. The author also noted that the season which had extensive fruit cracking also had a long dry, cold period when the fruit was setting, followed by a warm rainy period when the apple was ready to swell. Tetley concluded that the cold period had produced a comparatively thick inelastic cuticle especially on the exposed side of the apple with the result that the epidermis was unable to resist the rapid swelling of the cells within and had consequently cracked.

During three years of observation with Stayman Winesap apples, Verner (1938) found that in sound, densely shaded fruit growing in the innermost parts of the tree there was virtually no cracking. When apples in different parts of the tree were enclosed in brown paper bags for three to four weeks before harvest, the incidence of splitting was reduced from 41.0% to 5.2%.

Surveys in Sweden by Rootsli (1962) showed that direct exposure to sunlight may increase the incidence of apple fruit cracking. Rootsli also found that the resistance to pressure of the skin of several varieties was lower on the shaded side of the fruit, and he concluded that the lower incidence of cracking was related to the greater elasticity of the shaded tissues.

The foregoing review shows apparent cultivar differences on the effect of exposure of fruit to sunlight on the occurrence of cracking. However, even though cracking occurs predominantly on the shaded side of 'York' cultivars (Shutak and Schrader, 1948), and on the exposed side of many other cultivars such as 'James Grieve' and 'Beauty of Bath' (Tetley, 1930), and the 'Stayman' cultivars (Verner, 1935 and 1938), the authors agree that the side where the cracking is more common had thicker inelastic cuticle.

In prunes, Mrozek and Burkhardt (1973) found that the exposed side of the fruit located on the south side of the tree experienced the highest temperatures. Side cracking was most prevalent on the south side of the tree and on the side of the prune exposed to the sun.

## **Cultural Factors**

Several cultural factors such as choice of rootstock, supplemental water supply, mineral nutrition and chemical sprays, pruning, thinning, and other cultural practices which influence the nature of fruit growth exert much influence on fruit cracking and splitting. Cultural measures which increase fruit size are apt to accentuate cracking in apples (Nilsson and Bjurman, 1959). In stone fruits, cracking disorder is also negatively related to fruit load (Beattie et al., 1989).

### ***Rootstock and Tree Vigour***

The association between rootstock, tree vigour and the incidence of fruit cracking have received continued attention from several researchers. Goodwin (1929) attributed the cracking or blister disease of apples to a general debility of the tree, rather than from other causes. He found that practically all sound fruit on affected trees were located near the top where the growth was stronger. Goodwin concluded that the lower buds have become so weakened and immature through the debility of the trees that it is impossible for them to maintain sufficient vigour to produce sound fruit.

Verner (1935) observed that among trees and branches otherwise comparable, splitting was more pronounced and extensive when the foliage was sparse than when it was dense. The greater incidence of skin abnormalities on the sparsely foliated branches was also believed to be a contributory factor.

Fisher (1937a,b) found that the tendency of apples to crack increased as the fruit approached maturity and with greater severity on trees low in vigour and bearing a light crop. Investigations by Schrader and Haut (1938), and Shutak and Schrader (1948) on the cracking of York Imperial apples confirmed that low vigour and light crop were conducive to cracking. In addition, small, highly finished fruit with deep green ground colour was less susceptible to skin-cracking.

Louw (1948) provided further evidence from South Africa that vigorous growth was

conducive to reduced incidence of cracking in apples. When trees of the Ohenimuri variety in a neglected orchard which had not been pruned for a number of years were severely pruned, fruit cracking was almost entirely eliminated as a result of vigorous growth and luxuriant foliage which developed. On well-tended trees in which growth was not a limiting factor, severe pruning did not affect the incidence of the trouble.

Reports from the East Malling Research Station in England also showed that cracking and russetting of Cox's apples were more frequent on poorly grown trees having inadequate leaf cover (Anon, 1961a). In Canada, Proctor and Loughheed (1980) found that rootstock and crop load influenced the cracking of Golden Russet apples. Fruit cracking was more severe in trees on the more dwarfing rootstocks, which were also younger and bore fewer fruit per cm of trunk circumference.

In contrast to the above results, Nilsson and Fernqvist (1957) found that the incidence of cracking in 'Ingrid Marie' apples was higher on trees on vigorous rootstock (such as M.XVI) or from vigorous seedlings. However, cracking was more marked in large and red-coloured fruits than in small and green fruits, respectively. This agreed with the findings of Shutak and Schrader (1948).

Watanabe et al.(1987) associated fruit splitting in ten apple cultivars with very early flowering and suggested that conditions conducive to rapid fruit growth were related to splitting. In addition to rootstock effects (with trees grown on MM.106, Maruba Kaido and M.7 having greater levels than M.26), large fruits were also more susceptible to splitting.

### *Mineral Nutrition and Chemical Sprays*

#### *Fruit Mineral Nutrition*

Calcium, nitrogen, and boron appear to be the mineral nutrients which affect fruit cracking (Tomana, 1961; Dube et al., 1969; Shear, 1971 and 1975; Bangerth, 1976 and 1979). Deficiencies in Ca and B may lead to the development of cracks, while high N would



aggravate the disorder (Shear, 1971). Fischer (1955) found no evidence to attribute apple fruit cracking to nutrient deficiency or spray damage.

Nutritional conditions of the tree and fruit have been suggested to account for the differences in the cracking susceptibility of fruit on different trees, or even on the same tree (Schrader and Haut, 1938). Shallow soil conditions and inadequate soil moisture have been indicated as factors influencing tree nutrition, leading to susceptibility to fruit cracking.

Stiles et al. (1959) found no influence of urea sprays on cracking of Stayman Winesap apple. Experiments on Cox's Orange Pippin showed that cracking was worse on clean cultivated plots, especially where nitrogen and potash were applied (Montgomery, 1959). Cracking was very much less where the trees were in grass or were receiving potash only. Later results from long-term manurial trials on dessert apples obtained similar results (Greenham, 1965).

Tomana (1961) found that in Jonathan apples, when seed development ceased and the fruit began to enlarge, the nitrogen content of the flesh increased rapidly, causing cracking of the skin around the lenticels. A positive relationship between nitrogen manuring and the cracking of Holstein Cox apple fruit was reported by Weissenborn and Gottwald (1965). Fruit cracking in Rymer apples has been attributed to boron deficiency (Dube et al., 1969).

### *Effects of Chemical Sprays*

Fruit cracking has been reported to be aggravated by spray materials (Schrader and Haut, 1938; Asquith, 1957; Anon, 1962a). However, in other cases, both sprayed and unsprayed fruit have been affected alike (Reed and Crabill, 1915; Moore, 1931; Fischer, 1955; Byers et al., 1990).

Applications of Bordeaux mixture caused cracking and general distortion of apple fruits (Moore, 1931). Similar injury was also observed on fruit from unsprayed "control" trees or those sprayed with lead arsenate only, although the injury was greatest where Bordeaux mixture was used. Schrader and Haut (1938) obtained similar results on the cracking of "York Imperial" aggravated by late arsenate sprays.

Fungicide sprays have been observed to affect the cracking of apples (Asquith, 1957). In trials to control mites in Stayman Winesap apple orchards, phosdrin caused severe cracking round the stem-end while captan caused the least cracking. In trials to control fruit pests (Anon, 1962b), high volume sprays of 2,2,2-trichloro-1,1-bis(4-chlorophenyl) ethanol at petal-fall caused the cracking and russetting of Cox's Orange Pippin fruits.

Surfactants, often applied with herbicides, fungicides or insecticides as emulsifying, dispensing and spreading agents may cause distinctive stress symptoms which affect fruit quality. They are known to increase the penetration of water, spray chemicals, and nutrients through fruit cuticles (Marios et al., 1987; Westwood and Batjer., 1960; Byers et al., 1990). Many authors have found that the use of surfactant enhances fruit cracking in apples (Noga and Bukovac, 1986; Noga and Wolter, 1990; Byers et al., 1990).

Submerging 'Stayman' apples in several non-ionic and anionic surfactant-water solutions caused increased water uptake and fruit cracking (Byers et al., 1990). The authors found that submerging apples in pesticide combinations or nutrient solutions generally did not affect fruit splitting while a nutrient-surfactant combination did increase fruit cracking. It was concluded that the surfactant was the constituent primarily responsible for the cracking.

### **2.3.5 Fruit Internal Factors**

The anatomical and physiological conditions of roots, branches and fruit have major effects on the splitting of apples (Tetley, 1930; Verner, 1935 and 1938; Rootsi, 1962; Goldschmidt, 1962; Skene, 1965) and other fruits, including cherries (Verner and Blodgett, 1931; Christensen, 1972d), grapes (Meynhardt, 1964b; Considine, 1979), and tomatoes (Cotner et al., 1969; Hankinson and Rao, 1979).

Verner (1935) and Teotia and Singh (1970) have reported that some incipient cracks originated at hypertrophied lenticels which may be caused or promoted by greatly retarded transpiration from the plant, accompanied by a plentiful water supply to the regions of hypertrophy. Schilberszky (1918) concluded that hypertrophy of lenticels in apple fruits is

related to an excessive water supply in the soil. According to the author as reviewed by Verner (1935) and Teatonia and Singh (1970), the proliferation that constitutes lenticel hypertrophy may decrease the extensibility of the neighbouring peripheral cell layers and lower their mechanical resistance to being torn apart; and if that be true, lenticels might be expected to make the weakest point, at which rupture should begin, whenever peripheral tissue strain became sufficiently excessive.

Periods of drought result in the development of strengthening tissues, which usually appear first in the xylem and phloem (Graebner, 1920). He suggested that as a general rule, strengthened cells have lost their ability to divide and most of their capacity to enlarge. In this condition, if water supply is greatly increased after a dry period, the meristematic group quickly resume growth but not the strengthened cells. Resultant differences in growth rates between contiguous mechanical and meristematic tissues may thus lead to excessive tensions and failure of the mechanical tissue.

In some fruits, the structure of the cutin may have a definite correlation with cracking. Tetley (1930) found that apple varieties having cutin deposited on the tangential wall so that it only touches the apex of mature epidermal cells on the radial wall are less susceptible to cracking than varieties having their cutin deposit extended throughout the length of radial wall or even completely surrounding the cell.

Shutak and Schrader (1948) obtained a significant positive correlation between thickness of cutin and the percentage of cracked apple fruits on a given tree. The red side of the fruit, which is less subject to skin-cracking, possessed thin, regular cutin and showed little distortion of the epidermal and sub-epidermal layers of cells. On the shaded side with the greater incidence of cracking, the cuticle was thicker and more regular than on the exposed side. The thickened cuticle was usually sharply indented, and thick wedges of cutin were often found between the epidermal cells. Such irregularities in the structure of the cuticle and the underlying epidermis were considered to be the main factors involved in the increased susceptibility to cracking of these tissues. The greater thickness of the cuticle on the shaded side of 'York' apples found by these authors disagrees with the results of Magnes and Diehl (1924) who found that the exposed side of 'Rome Beauty' apples developed a thicker skin

than the shaded side.

By enclosing young fruit in polythene bags, Tukey (1960) found that Rome Beauty, which has a moderately thick cuticle, cracked less than Golden Delicious, which has a thin cuticle. Nikitina (1959) did not find any consistent correlation between skin thickness and keeping quality of apples.

Physiological studies on fruit cracking in Stayman Winesap apples (Verner, 1935) showed that cracks generally appeared first in restricted areas which indicated that peripheral tissues became exceptionally weak in such regions. On two separate branches of a single tree, Verner found 31% and 70% fruit cracking in each branch and concluded that physiological conditions within the tree or fruit not directly related to current weather conditions were also influential.

Histological studies by Verner (1938a) suggested that the susceptibility of Stayman apples to cracking was due chiefly to premature cessation or restriction of growth in the hypodermal layer. Verner maintained that the phenomenon of cracking is due to the failure of the peripheral fruit tissues to keep pace in growth with that of the cortex, rather than their inability to repress and contain excessively rapid growth of this region. According to Skene (1965), the variations in fruit growth rate may account for the time at which cracking occurs.

Microscopic examinations of cool stored apples showed that dissolution of the intercellular pectic membranes allowed excessive swelling and separation of the pulp cells and the resulting pressure caused cracking of the fruit skin (Mezzetti, 1959). A possible explanation for loss of cell cohesion derives from the increase in air space which in turn implies a decrease in average average area of contact between cells (Hatfield and Knee, 1988).

Anatomical studies by Costa et al. (1983) showed that the fruits of "Stayman" cultivars (highly susceptible to cracking), were characterised by a lack of transition cells between the hypodermis and fruit parenchyma. The hypodermic cells were small, thick-walled, tangentially oriented and depressed. The fruit parenchyma had large isodiametric cells with thin walls. Cell division in the hypodermic tissue ceased earlier than in the fruit parenchyma and as a consequence, the outer part of the fruit could not follow the growth of its inner part. During

the high growth periods, cracking of the hypodermic cells could occur. This agreed with the results of Verner (1938a).

Weiser (1990) obtained similar results and hypothesized that the inability of the hypodermis to keep pace with the expansion of the fruit was due to a difference in cell wall composition and the consequent effect on wall extensibility.

Taylor and Knight (1986) studied the cuticular morphology of apple fruits and found a greater occurrence of deep flanges protruding between epidermal cells. This suggested that there were areas of weakness where cracking could arise and which would also cause russet development.

It has been suggested that the splitting of 'Gala' apple is induced by high internal turgor of the fruit, and that the additional stress caused by the wrenching of the stalk may cause the cortex cells about the peduncle entry area to pull apart (Trought, pers. comm., 1991).

In cherries, Kertesz and Nebel (1935) found that those varieties which crack most readily had smaller cells and thus, presumably, more cell-wall material than those resistant to cracking. Greater retention of liquid by pulp of the varieties that cracked badly was attributed to the imbibitional properties of the greater amount of colloidal substance in these fruit.

Histological studies by Hankinson and Rao (1979) found that tomato cultivars particularly resistant to concentric cracking possessed flattened epidermal and hypodermal cells for their first few rows while for the cultivars resistant to radial cracking, the cutin penetrated into the third layer of cells.

## **2.4 Reduction and Control of Apple Fruit Cracking**

Many orchard management practices have been recommended to control or reduce fruit cracking, but their effectiveness varied with the degree of susceptibility, and this in turn varied greatly among fruits, cultivars, growing areas and conditions, and seasons (section

2.1.3). To date, success achieved in reducing fruit splitting during research has not been translated into the commercial fruit industry due partly to the difficulties of reproducing controlled conditions in the field. In some instances, the cost of implementation would not be justified by the economic value of the crop (Bohlmann, 1962).

Despite increasing contributions to our knowledge and awareness of the phenomenon of fruit cracking in apples and other fruits, there is still a lack of agreement in the literature on the exact origin or cause of the problem, and to date, the search for reliable methods to adequately control the problem remains elusive. Just recently, Peet and Willits (1991) referred to the problem of tomato fruit cracking as a puzzle!

Fruit growers have adopted a number of strategies to minimise losses such as harvesting fruit early, avoiding irrigation when thought necessary, protecting fruit from rain by installing temporary covers or shades, and applying spray materials to minimise water uptake by fruit. In severe cases, growers rework the susceptible varieties, plant new varieties that are resistant to cracking, or choose orchards only where the probability of rainfall at the critical stage of the season is low (Schmid, 1960; Trought and Lang, 1991).

The factors that have been reported in the literature to reduce or control fruit cracking and splitting in apples can be summarised as either cultural measures, or the application of growth regulators.

#### **2.4.1 Cultural Measures**

As discussed above, it is generally agreed that cultural measures resulting in the promotion of tree vigour reduce fruit cracking. Earliest control measures advocated spraying with certain chemicals, manuring, and severe pruning (Kirk, 1907; Evans, 1907; Carne, 1925; Cunningham, 1925; Campbell, 1928; Goodwin, 1929).

### Nutrient Sprays

Spraying trees at various stages of fruit development with bordeaux mixture, copper sulphate, or slaked lime has been recommended (Kirk, 1907; Evans, 1907; Bijl, 1914; Cunningham, 1925; Powers and Bollen, 1947). The calcium in the mixture is believed to prevent fruit cracking (Verner, 1939; Bohlmann, 1962); however, Powers and Bollen (1947) concluded that the benefit reported from the use of Bourdeaux spray appears to be due more to the copper than the calcium. Because these materials cause spray damage on certain varieties and leave a harmful residue on the fruit (Moore, 1931; Bohlmann, 1962), it is desirable that such spraying be carried out early in the season so that the concentration of the residue may decrease as a result of weathering and an increase in fruit size.

On soil suffering from a boron deficiency, the percentage of cracking has been reduced by boron applications (Bohlmann, 1962); however, in a trial with Rymer apples, Dube et al. (1969) found that soil application of boron was ineffective. Foliar sprays of 0.3% boric acid reduced fruit cracking considerably. Foliar or injection applications  $\text{CaCl}_2$  solution reduced fruit cracking of 'Sekaichi' apples (Kim et al., 1991).

### Manuring, Pruning and Scoring

Campbell (1928) and Goodwin (1929) recommended that in order to produce fruit free from cracking, the stamina of the tree should receive first consideration by practising a system of heavy pruning, combined with manuring and cultivation. Following the system of pruning advocated, Goodwin obtained an increase from 65 to 250 cases of export apples from the same trees in the subsequent year.

According to Schmid (1960), growers may be able to overcome the russeting and cracking of apples by top-working affected trees. Byers et al. (1990) found that two scores around the trunk of 'Stayman' apple trees with a carpet knife reduced fruit cracking by 22% and they noted that neither fruit size, fruit colour, nor return bloom were affected by the treatment. Although no explanation was given for the effectiveness of the treatment, the authors claimed

that a greater effect on fruit cracking might have been realized if scoring had been done every 2 to 3 weeks.

### **Moisture Management**

Maintaining an adequate moisture supply has been found to reduce fruit cracking in apples (Rootsi, 1962 ; Goode et al.,1975). Mezzetti (1959) suggested that cracking in stored apples could be prevented by reducing the intensity and duration of the yellowing process and by keeping the humidity in the coldstore relatively low. Protecting apples from rain by shading during critical growth periods produced fruit with less russet and cracking (Jackson et al., 1977).

The cracking of sweet cherries on the tree has been prevented by enclosing fruit in paraffined paper (Sawada, 1931) or by excluding rain by means of waterproof tarpaulins (Verner and Blodgett, 1931) when severe cracking occurred on the exposed parts of the tree. However, Trought and Lang (1991) observed a significant percentage splitting of cherry fruit on blocks that were protected from rain by plastic covers. They concluded that water uptake through the root system may be of greater significance in causing fruit splitting because the small vapour pressure deficits that occur under covers can reduce transpirational rate, causing fruit growth to increase towards the sum of the transpiration and growth rates.

Other field practices recommended for reducing fruit cracking include shaking the water drops from the tree after rain using strong wind machines or space heaters (Levin et al., 1959; Bohlmann, 1962). No evidence was found from these or subsequent reports which suggest that these practices reduce fruit cracking.

#### **2.4.2 Application of Plant Growth Regulators and Other Chemicals**

There has been increased attention on the use of growth hormones and other nutrient sprays; however, these are often applied at maximum recommended concentrations to assure against high susceptibility and this often impairs fruit quality. Poor skin finish, spray residues, and



in some instances, a reduction in crop yield, are some of the difficulties encountered while using these sprays (Moore, 1931; Zielinski, 1964; Costa et al., 1983).

It has been proposed that cracking is likely to occur when there are high tensions in the fruit skin and the outermost flesh (Verner, 1938), as, for example, when the fruit is growing most rapidly in surface area (Skene, 1965). Taylor and Knight (1986) found that the application of growth hormones reduced fruit cracking by modifying cuticular and epidermal morphology such as to increase the plasticity of fruitlet skin.

Growth hormones which have successfully reduced fruit splitting in apples include alar (Sullivan and Widmayer, 1970; Costa et al., 1983). Trials with promalin failed to reduce fruit cracking (Costa et al., 1983; Visai et al., 1989), while paclobutrazol significantly increased it. Visai et al. attributed the ineffectiveness of promalin to wrong timing or to early interruption of treatments.

Taylor and Knight (1986) reduced russeting and cracking in Cox, Discovery and Golden Delicious apples using the gibberellin mixture of A<sub>4</sub> and A<sub>7</sub>. The authors believe that alleviation of stress within the fruitlet was the primary effect of GA<sub>4+7</sub> treatment.

Byers et al. (1990) found that four airblast spray applications of gibberellic acid (GA<sub>4+7</sub>) in July, August and September, 1988, reduced cracking from 56% to 21%, and five applications during the same period reduced fruit cracking from 93% to 75%. In 1987, daminozide reduced cracking, but in 1988, neither daminozide, naphthaleneacetic acid (NAA), nor Vapor Gard (anti-transpirant) reduced fruit cracking. However, in 1988, a combination treatments of GA<sub>4+7</sub>, daminozide, NAA, and Vapor Gard reduced fruit cracking from 93% to 22%.

Waxing attached fruits of York apples by immersion in a solution of Brytene 489-A reduced the development of cracks (Schrader and Haut, 1938); however, waxed fruits did not develop good colour. Other sprays which have been recommended are aluminum solutions and the sodium salt of alpha-naphthalene acetic acid (Bohlmann, 1962).

## 2.5 Techniques For Assessing Extent of Fruit Cracking and Splitting

White and Whatley (1955) have suggested the use of a map measure (planimeter) to measure the length of cracks in apples and tomatoes. This method has the advantage of being objective but the disadvantage of being slow, and limits the number of fruit that can be evaluated. Furthermore, it gives only a measure of the amount of cracking on fruit but does not provide a measure of the tendency of the fruit to crack under certain conditions.

Ordinarily, investigators classify cracked fruit arbitrarily as slight, moderate, or severe. Several numerical rating systems have also been used to evaluate crack susceptibility of fruit (Iverson, 1938; Reynard, 1951; Prashar and Lamberth, 1960). These systems are rapid and suitable for distinguishing between relatively large differences in crack resistance (Armstrong and Thompson, 1969).

Proctor and Loughheed (1980) assessed the cracking of Golden Russet apples by using a severity rating on a scale of 1 - no cracking, to 5 - severe cracking while Reynard (1951) used "crack resistant scores" of 10 to 100. Fruits with no visible cracks were given a score of 100. Reynard (1951) suggested that a crack resistant score near 75 was the dividing line between resistant and susceptible tomatoes. In a later study, Reynard (1960) applied a weighted average using the number of plants falling within each class times the value of each class.

## 2.6 Objective Measurement of Crack Susceptibility

Unless preceded by some method of crack induction, the methods above remain dependent on the effects of the environment of single plants or groups of plants on which the fruits may not crack, even though they are genetically susceptible.

Most objective techniques used involve the induction of cracking under conditions more precise than is possible in the field while the others are based on the measurement of known physical properties of fruit in relation to cracking. Different techniques have been applied to

different fruits, and for purposes of clarity, the following review will be based on the individual fruit types.

If susceptibility could be discerned at any stage during fruit growth and development, then control measures could be tailored to need. It would aid in identifying management practices which affect fruit splitting and to test new varieties for crack-susceptibility during breeding.

### **2.6.1 Measurement of Crack Susceptibility in Apples**

Byers et al. (1990) induced water uptake and cracking of 'Stayman' apples in the laboratory by submerging fruit in nonionic and anionic surfactant-water solutions. Within 24 hours, both water uptake and fruit cracking increased linearly with increasing concentrations of X-77 surfactant solution, and the authors suggested that submerging apples in X-77 solution could be used to predict the potential for fruit to crack under field conditions.

### **2.6.2 Measurement of Crack Susceptibility in Cherries**

#### **Verner's "Cracking Index"**

Verner and Blodgett (1931) developed a laboratory procedure for determining the susceptibility of cherries to cracking based upon submersion of fruit in water for 10 hours. Fifty cherries, free of blemishes, were randomly chosen and immersed in 3 litres of water under controlled conditions. At each 2-hour interval, all cracked cherries were counted and discarded. A "cracking index" was computed by multiplying the number of cracked cherries at each reading by the average number of hours during which those cherries had cracked. The maximum possible index would result if all the fruit cracked during the first 2-hour period of submersion and this reading would be  $50 \times 9$  or 450, where 9 is the weighting factor for fruit that cracked during the first two hours. The authors recommend that all samples be collected in the early hours of the morning.

Verner (1957) standardized this procedure and expressed the cracking index as a percentage of the maximum reading obtainable by the original method. In addition, the author emphasized that it was important to use distilled water at 20 °C because small amounts of certain cations may modify the incidence of cracking.

Following the method of Verner and Blodgett (1931) and the standardized procedure (Verner, 1957), several investigators have evaluated the cracking index of a number of cherry varieties (Tucker, 1934; Zielinski, 1964; Christensen, 1970a and 1972a,c).

Christensen (1972c and 1976) subsequently modified this procedure, shortening the immersion time to 6 hours. He concluded that the cracking index of a cultivar should be the average of two annual indices, while a final assessment should be based upon the average of three annual indices, measured as the fruit become ripe.

An installation for indoor determination of crack formation under artificial rain was reported briefly by Christensen (1976). This had the advantage that it gave the possibility of simulating different conditions, such as showers of different length. According to the author, this method was suitable for experiments in preventing fruit cracking.

### **2.6.3 Measurement of Crack Susceptibility in Grapes**

#### **The Critical Turgor Pressure Method**

Considine and Kriedman (1972) devised a laboratory-based technique to measure the internal turgor pressure required for fruit rupture as an objective assessment of resistance to splitting. In this technique, fruit of uniform maturity and known osmotic potential were immersed in a range of osmotica to create a known turgor pressure at equilibrium. The critical turgor ( $P_{50}$ ), was determined as the pressure which resulted in 50% of the berries splitting.

This method was applied by the authors and Christensen (1979), and results showed that the  $P_{50}$  was approximately 15 atmospheres in grape cultivars prone to splitting and 40 atmospheres in those resistant to splitting.

### **Mechanical Properties of Grape Berry Skin**

Lustig and Bernstein (1985) employed the injection tester reported by Bernstein and Lustig (1985) to study the behaviour of grape berry skin under conditions of splitting. It was possible to raise the internal pressure of the berries until splitting occurred, and the authors suggested that the technique may be used to select cultivars resistant to splitting.

In this technique, water under pressure was slowly injected into the grape berry and the pressure and the increase in volume was measured. The water injection was continued until the burst pressure of the berry was reached. The pressure-volume recording of the injection tester, in conjunction with the measured values of the skin thickness and fruit radius, were used to calculate the stress and strain values of the berry skin.

#### **2.6.4 Measurement of Crack Susceptibility in Tomatoes**

##### **The Use of Overhead Irrigation**

Young (1957) induced cracking experimentally in field staked tomatoes by fluctuating overhead irrigation. Reynard (1960) recommended this as a test method for selecting the very highest degree of resistance. In one test, Reynard induced severe cracking in tomatoes by applying approximately eleven inches of overhead irrigation water within a 48-hour period to plants in the field with red-ripe fruit.

##### **Water Immersion Method**

Reynard (1960) has reviewed the work of several researchers who have induced cracks in green and ripe tomato fruit by spraying the stem end with water and by complete immersion (Thomas, 1949; Johannessen, 1950; Ryder, 1954). Cracks were measured at intervals of 2, 8, 24, 48 and 72 hours following treatment. Using a 28-hour water soak with red-ripe fruit, Johannessen (1950) obtained results that were highly correlated with field behaviour. According to Reynard (1960), this water immersion method is effective in differentiating large differences in resistance, but not minor differences between strains or varieties.

### **The Illinois Vacuum-Immersion Method**

The vacuum-immersion method was developed for testing the resistance to stress caused by water absorption (Hepler, 1961; Thompson, et al., 1962; Thompson, 1965). Fruits were evacuated at specified levels of vacuum (usually 13.3 kPa, 23.3 kPa, or 33.3 kPa) and immersed in water maintained at 70°F for 3 hours. The resulting cracks were classified as radial or concentric, and measured with a map measure.

The vacuum immersion method has been successfully used to evaluate crack resistance in a number of varieties and breeding lines (Thompson et al., 1962; Thompson, 1965), and to test the effectiveness of treatments designed to increase crack resistance (Dickinson and McCollum, 1964). Very often, the square-root transformation,  $(x+0.5)^{1/2}$ , has been applied on the data for length of cracks ( $x$ ) to obtain a more normal distribution (Dickinson and McCollum, 1964; Armstrong and Thompson, 1967 and 1969).

This method had the advantage in that it could differentiate crack resistance among lines that appeared resistant to cracking in the field, and it was possible to control the conditions under which cracking occurred, thereby eliminating a large part of environmental effects (Armstrong and Thompson, 1969). The method was rapid as far as inducing cracking was concerned, but measurement was extremely time-consuming.

Based on the obvious need to reduce the time required for the vacuum immersion test, Armstrong and Thompson (1969) developed a rating system that could be used either with or without the vacuum-immersion treatment. It consisted of assigning visual scores ranging from 0 to 6, where 0 denoted no cracking.

### **Relationship With Fruit Mechanical Properties**

The mechanical properties of tomato skins have been recommended and used as a measure of resistance to cracking (Rosenbaum and Sand, 1920; Frazier, 1934; Johannessen, 1949; Thompson et al., 1962; Voisey and MacDonald, 1964 and 1966; Voisey et al., 1964; Voisey and Lyall, 1965a,b; Voisey et al., 1970; Batal et al., 1970; Hankinson and Rao, 1979). This

method was based on the correlation between crack resistance and measurable mechanical properties such as skin toughness (Johannessen, 1950; Reynard, 1960).

Voisey and Lyall (1965a,b) described three methods for measuring the skin strengths of tomatoes in relation to cracking, and concluded that the puncture test was a suitable objective method for determining the susceptibility of fruit to radial cracking. The puncture tester used a probe of known diameter to measure the force required to break the skin of fruit and an electronic device was used to record the output. Susceptibility of fruit to radial cracking was related to the stress required to break the skin inside the stem end creases. As susceptibility increased, puncture resistance decreased. Thirty fruit were found sufficient to classify a variety.

Batal et al. (1970) found that skin ultimate force and breaking elongation showed inverse relationships to fruit cracking. The authors recommended that breaking elongation, which reflects both elasticity and plasticity of the skin, should be of value in estimating crack resistance of tomato fruit.

Hankinson and Rao (1979) recommended the use of stress relaxation tests and histological analysis when screening new tomato cultivars for susceptibility to cracking. Test results showed that resistant cultivars exhibited shorter relaxation times and higher instantaneous moduli of elasticity.

## **2.7 General Summary and Concluding Remarks**

### **2.7.1 General Summary**

The problem of pre-harvest cracking and splitting occurs widely in many cultivars of apples and other fruits. Published recognition of the problem in a commercial sense dates back to the early part of this century, especially with increasing field losses in some varieties and the need to produce top quality fruit for export (Kirk, 1907; Cunningham, 1925; Goodwin, 1929).

Fruit cracking has been reported from all major fruit growing areas in the world. Various terms have been used to describe the disorder, and most terms reflect the perceived cause or symptom. The term "cracking" has been generally used to refer to many forms of breakage on the fruit surface.

In apples, three types of cracking are clearly identifiable : skin-cracking, star-cracking, and splitting. A practical difference is that a split causes gross exposure of the internal tissue to the atmosphere whereas in other forms of cracking the defect is contained in the outer cell layers. Each type of crack is most prevalent in particular cultivars, with peculiar mechanisms of occurrence (Skene, 1965). Skin-cracks occur mainly on the green (shaded) side of the fruit and are most common in 'York' and 'Cox' apple cultivars (Fisher, 1937a,b; Shutak and Schrader, 1948; Goode et al., 1975). Star-cracks occur on fruit infected with certain virus diseases (Montgomery, 1959; Posnette, 1963; Cropley, 1968), and the variety Cox's Orange Pippin is more frequently affected than other varieties (Jenkins and Storey, 1955). Fruit splitting occurs mainly on the red (exposed or sunny) side of fruit (Tetley, 1930; Verner, 1935; Rootsi, 1962), and is very common in 'Stayman', 'Gala', and 'Fuji' varieties.

Despite the above apparent cultivar differences on the effect of fruit exposure to sunlight on cracking, researchers agree that both skin-cracking (Shutak and Schrader, 1948) and splitting (Tetley, 1930; Verner, 1935) occur on the side which has a thicker inelastic cuticle (shaded or exposed).

Fruit cracking occurs sporadically across orchards, seasons, cultivars, trees of the same cultivar, branches of the same tree, and spurs on the same branch. In all types of fruit, the problem has been attributed to a multitude of cultural, environmental, and fruit internal factors. Viral and fungal diseases have also been associated with fruit cracking. There is a general belief that fruits crack when there is a sudden, marked increase in soil moisture content, and atmospheric water content or excess free water on the fruit skin following a period of dry weather. However, experimental results on apples by some researchers failed to confirm this belief (Verner, 1935; Watanabe et al., 1987).

It is evident from the literature that the causes of cracking cannot be considered satisfactorily



in terms of environmental conditions alone or in terms of fruit internal conditions alone. Both external and internal influences need to be taken into account. It is proposed that factors associated with cracking be classified into : (a) genetic or fruit internal factors (which account for varietal differences), and (b) external or environmental factors (which influence the degree of splitting within susceptible cultivars).

Efforts to control or reduce fruit cracking in apples and other fruits include cultural measures, and the use of plant regulators and other chemicals which modify the fruit growth process. Most laboratory methods which have successfully reduced fruit cracking have not been translated into commercial use due to problems of controlling field conditions. Spray chemicals that reduce cracking also have adverse effects on fruit quality, and may reduce crop yield (Powers and Bollen, 1947; Costa et al., 1983). Although differences in cultivar susceptibilities are well known, the possibilities of genetic control of fruit splitting in apples has not been exploited or documented in the literature.

To date, there is no guaranteed strategy recommended or widely accepted for commercial growers to control fruit cracking and splitting in apples and other fruits successfully. However, crack-resistant tomatoes have been developed by cross-breeding (Frazier, 1947; Reynard 1960), but most commercial cultivars still crack.

Several techniques have been developed to assess fruit susceptibility to splitting in apples (Byers et al., 1990), cherries (Verner, 1957), grapes (Considine and Kriedman, 1972), and tomatoes (Thompson et al., 1962) objectively. With the exception of using fruit mechanical properties as a measure of varietal susceptibility to cracking, these techniques have been developed and applied only to specific types of fruit.

### **2.7.2 Concluding Remarks**

Progress in our understanding of cracking in fruits, and apples in particular, has been hindered by many factors. In addition to the difficulties of the apple (or any other fruit) as an experimental material, especially in fluctuating weather conditions, there has been a general

lack of controlled research studies in this area.

Although current efforts by growers to reduce fruit cracking may be useful, the continued popularity of susceptible cultivars, especially in the export market, assures a future concern with the problem. Apart from the earliest efforts to control the apple cracking through a series of cultural measures (Cunningham, 1925; Campbell, 1928; Goodwin, 1929), there is barely any published information or further research dealing with the problem of fruit cracking in New Zealand apples. Of particular interest in this thesis is the phenomenon of stem-end splitting which affects some export apple cultivars such as 'Gala', 'Royal Gala' and 'Fuji'.

# CHAPTER THREE

## GENERAL MATERIALS AND METHODS

### 3.1 Introduction

In this chapter, the materials and methods which apply to more than one chapter of the thesis are presented. The others which are specifically relevant to individual chapters are included in those chapters.

### 3.2 Experimental Designs

#### 3.2.1 Stem-end Splitting and Mechanical Properties of 'Gala' Apples As Affected By Orchard Management Practices

##### Location

This experiment was conducted during the 1991 season on a private commercial orchard in Hastings, Hawke's Bay, New Zealand. The site was chosen on two basic criteria. These were an historical incidence of stem-end splitting and a uniform soil profile. The trees were mature centre leader Gala and had undergone recent extensive tree restructuring in the upper limbs to improve light levels within the tree canopy.

##### Treatments and Layout

There were three main factors :

- (1) Irrigation (frequent irrigation vs no irrigation)
- (2) Cropload (hand thinning fruit to singles vs no hand thinning)
- (3) Nitrogen (Weekly 1% foliar urea sprays vs no urea)

The experiment was laid out as a split plot with irrigation on each main plot of 8 trees (4 trees frequently irrigated and 4 trees with no irrigation), and with crop load and urea treatments arranged in factorial combinations within the main plots. This was replicated 4 times, giving a total of 16 trees for one level of each main treatment and 4 trees for each full factorial combination. There was one guard tree between each plot and within each subplot. The entire experiment was set up on two adjacent rows, each containing two main plots. There were two guard trees at both ends of each row. All treatments were randomly assigned to the main plots and subplots.

The objective of the frequent irrigation treatment was to maintain soil moisture levels close to field capacity up to commercial harvest. Soil moisture levels were monitored with a Time Domain Reflectometer (**TDR**) which gave a direct estimate of percent moisture to a depth of 70 cm. Two sites were monitored within each subplot.

Urea fertilizer was applied as 1% sprays at weekly intervals from 2/12/90 to 28/1/91 (9 sprays). This was applied with a motorised knapsack sprayer to run-off. Total urea applied to each tree was estimated to be 6.25g/tree/spray. A hand thinning treatment was applied on 18/12/91, when all clusters were thinned to single fruit.

### **3.2.2 Stem-end Splitting and Mechanical Properties of 'Royal Gala' Apples As Affected By Water Stress**

#### **Location**

This experiment was carried out at the research orchard of the Hawke's Bay Horticultural Research Centre (formerly MAFTechnology), Hastings, New Zealand. The soil at the experimental site had an average field capacity (**FC**) of 36%. Initial soil moisture readings were taken randomly at 13 locations in the field with the **TDR**. This gave an average soil moisture content of 18.6%.

### Treatments and Layout

Four irrigation water treatments were applied in a randomized complete block design to induce four levels of water stress to the crop. These water treatments were :

- (1) **T1** - low water.

Initially, no irrigation until crop was badly stressed, then irrigated to **FC**. Thereafter, only irrigated to **FC** when crop was badly stressed.

- (2) **T2** - low to high water.

Initially, no irrigation until crop was badly stressed, then irrigated to **FC**. Thereafter, irrigated at short intervals (weekly) to return soil moisture content to field to **FC**.

- (3) **T3** - medium water.

Initially, irrigated to **FC**. Thereafter, irrigated to **FC** whenever the soil moisture content decreased to approximately one-half the **FC**.

- (4) **T4** - high water.

Soil moisture content maintained close to **FC** throughout the season up to commercial harvest.

Each treatment was randomly assigned to a block of 5 trees with two guard trees on each side of the block. This was replicated five times in a randomized block design, giving a total of 25 trees per treatment.

The **TDR** was used to monitor soil moisture content levels at weekly intervals and after any significant rainfall during the week. The value of the soil moisture content obtained after each block was compared with the value of soil **FC** and whenever necessary, supplemental irrigation water was applied to maintain the soil moisture content at the required level. In this experiment, the low water treatment (**T1**) was considered to induce the highest level of water stress to the apple trees.

### **3.3 Supply of Fruit**

#### **3.3.1 'Gala' Apples**

Fruit samples were carefully hand-picked during the morning hours from experimental trees in the commercial orchard in Hastings described in section **3.2.1**. During each harvest, fruit were randomly picked from the base, middle, and top parts of the tree. After harvest, fruit samples were separated according to the treatments they had received and packed into standard apple cartons using appropriate tray sizes. Fruit were transported to Massey University by car. At the fruit research laboratory, all samples were examined for the presence of stem-end splits and any other physical defects and sorted accordingly. Samples to be used for future experiments were immediately selected and put in the cold store at about **1°C** until required. Tests on fresh fruit were conducted within 24 hours of harvest.

Fruit samples were collected at commercial maturity on 14/2/91, 25/2/91, and 6/3/91 based on background colour (Watkins et al., 1989; Brookfield et al., 1993). The first commercial harvest date for 'Gala' during the 1991 season in the Hawke's Bay region was on 14/2/91.

#### **3.3.2 'Royal Gala' Apples**

Fruit samples were carefully hand-picked during the morning hours from the experimental trees in the research orchard of Hawke's Bay Research Centre described in section **3.2.2**. During each harvest, fruit were picked randomly from the base, middle, and top parts of the tree. After harvest, fruit samples were separated according to the treatments they had received and packed into standard apple cartons using appropriate tray sizes. Fruit were transported to Massey University by car. At the fruit research laboratory, all samples were examined for the presence of stem-end splits and any other physical defect and sorted accordingly. Samples to be used for future experiments were immediately selected and put in the cold store at about **1°C** until required. Tests on fresh fruit were conducted within 24 hours of the harvest time. Fruit samples were collected five times on 31/1/91, 14/2/91, 25/2/91, 6/3/91 and 13/3/91. The first commercial harvest date for 'Royal Gala' in the Hawke's Bay region was on 25/2/91.

### **3.3.3 'Fuji' Apples**

Samples of Fuji apples were hand-picked during the morning hours from a private commercial orchard located close to the Hawke's Bay Research Centre. Trees had received standard management practices during the season. Fruit samples were collected during commercial harvesting on 6/3/91 and 13/3/91. During each harvest, fruit were picked randomly from the base, middle, and top parts of the tree. After harvest, all samples were packed into standard apple cartons using appropriate tray sizes, and transported to Massey University by car. At the fruit research laboratory, all samples were examined for the presence of stem-end splits and any other physical defect and separated accordingly. Samples to be used for future tests were selected and stored immediately at about 1°C until required, while tests on fresh fruit were conducted within 24 hours of the harvest time.

## **3.4 Measurement of Physico-chemical and Mechanical Properties of Fruit**

### **3.4.1 Fruit Size**

Fruit mass and diameter were used to characterise fruit size. The mass of fruit was measured using a desk-top balance (Mettler E2000, max.  $2000 \pm 0.1$  g), while fruit diameter was measured using a pair of Vernier callipers (Mitutoyo Corp. Digimatic, max.  $150 \pm 0.01$  mm). Fruit diameter was measured twice at the middle point of the equatorial region on the opposite sides of each fruit. In some experiments, the length of the fruit along the stem-calyx axis was also measured along two opposite sides.

### **3.4.2 Soluble Solids Concentration**

The soluble solids of expressed fruit juice (%**Brix**) was measured using a hand-held Atago refractometer (Model N1, Brix 0 ~ 32% at 20°C). Before starting each test, the refractometer was zeroed using distilled water. Two measurements were made on the opposite sides of the equatorial surface of each fruit. After each measurement, the surfaces of the refractometer

were cleaned using tissue paper.

### 3.4.3 Fruit Firmness

Fruit flesh firmness was measured using a hand-held Effegi penetrometer (Model FT 327) fitted with a 7.97 mm diameter probe. Measurements were taken on two opposite sides on the equatorial surface of the fruit after removing the skin using a potato peeler. Flesh firmness was recorded as the force (**kg**) required to penetrate the cortical tissue and converted to Newtons (**N**) by multiplying by the gravitational constant  $g$  ( $9.807 \text{ m s}^{-2}$ ).

Skin firmness was determined by testing fruit with skin intact and after removing the skin on a new site. The same fruit samples were used for both tests and the difference in penetrometer reading between the two tests was taken as a measure of the firmness of the skin. Two measurements were made for each type of test, giving a total of four measurements on one fruit.

### 3.4.4 Flesh Crushing Stress

The Massey Twist Tester developed by Studman (1991a) was used to measure the crushing stress ( $\sigma_{cr}$ ) of fruit flesh. Details of the principle and theoretical analysis of this alternative test for the mechanical properties of fruit has been documented elsewhere (Yuwana, 1991; Studman and Yuwana, 1992). Essentially, this device measures the moment required to crush fruit cells using a blade and this moment is converted to a crushing stress figure for the tissue by calculation.

Two prototype experimental twist testers (Marks I and II) were used as shown in Figure 3.1. Mark I was used during the 1991 fruit season. The mechanical principle of the twist tester is presented in Figure 3.2 and by integrating over the radius ( $a$ ) of the blade, the moment of the whole blade ( $M_b$ ) is given by :



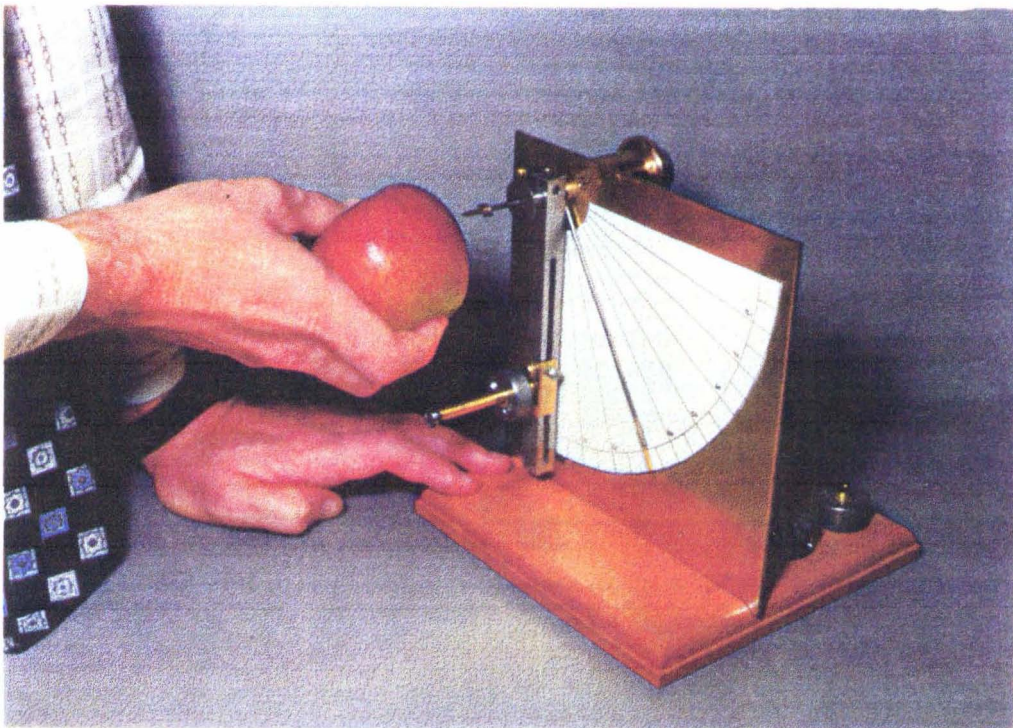
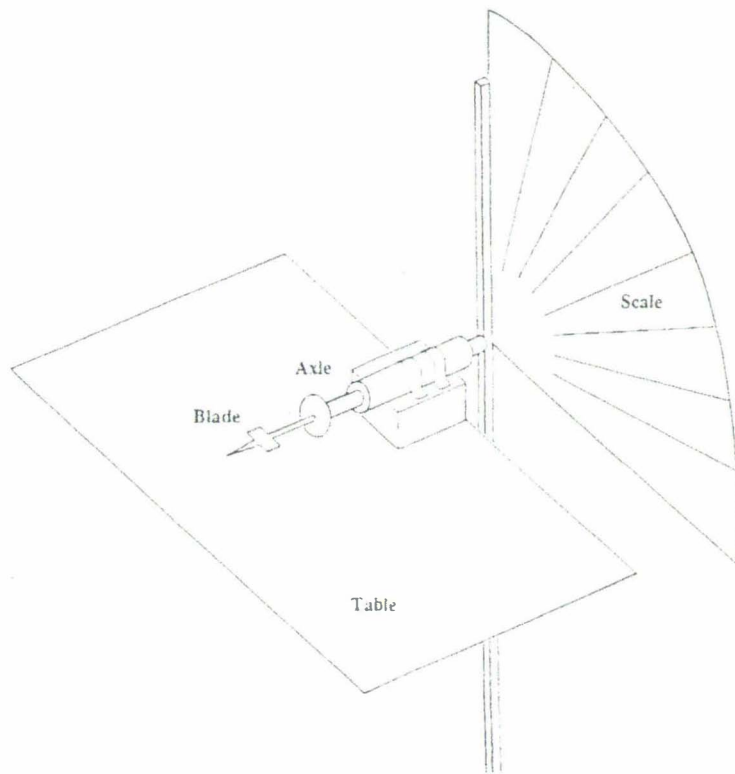

Figure 3.1 Prototype Twist Testers Used In Experiments.  
Mark I (top) and Mark II (bottom).

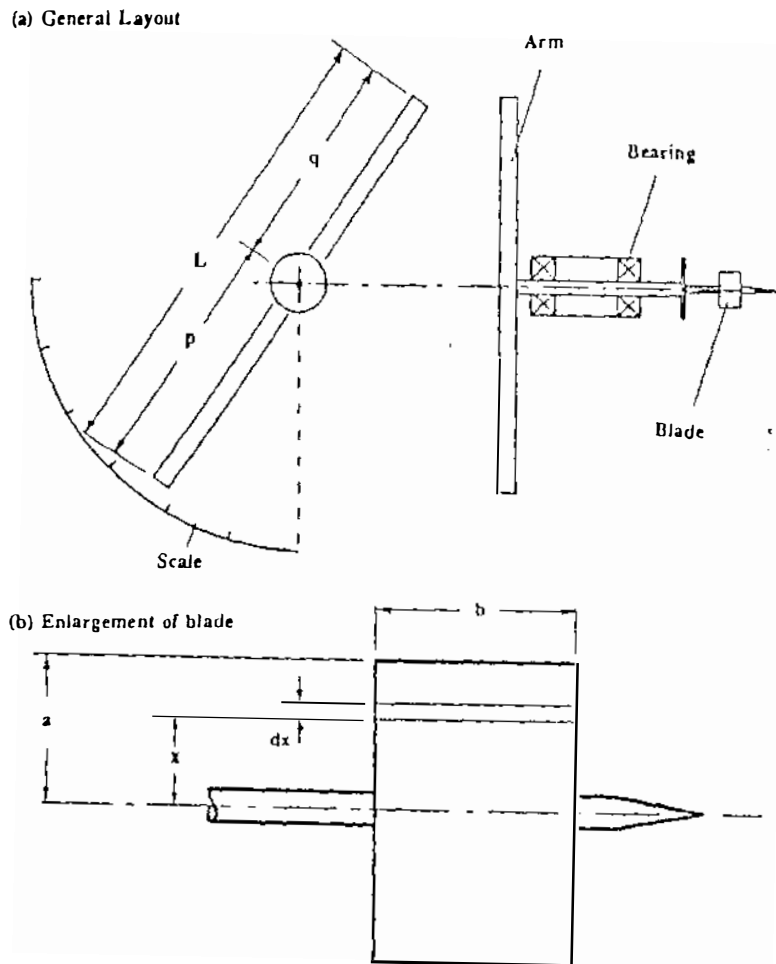

Figure 3.2 Principle of Twist Tester (a) General layout.  
(b) Enlargement of blade. [Studman and Yuwana, 1992].

$$M_b = \sigma_{cr} \times a^2 \times b \quad , \quad \text{N.m} \quad (3.1)$$

where :

$\sigma_{cr}$  = flesh crushing stress, Pa

a = blade radius, m

b = blade width, m

The moment of the rotating arm ( $M_a$ ) is given by :

$$M_a = \frac{m \times g (p^2 - q^2) \sin\theta}{2 \times L} \quad , \quad \text{N.m} \quad (3.2)$$

where :

$m$  = mass of arm, kg

L = total length of the rotating arm, m

p,q = distance from the lower and top ends of the arm to the centre of the axle, respectively,

m

$\theta$  = angle of rotation of the arm, degrees

g = acceleration due to gravity,  $9.807 \text{ ms}^{-2}$

Since  $M_b = M_a$ , using equations (3.1) and (3.2) the flesh crushing stress ( $\sigma_{cr}$ ) is given by :

$$\sigma_{cr} = \frac{M_a}{a^2 \times b} \quad , \quad \text{Pa} \quad (3.3)$$

During the 1992 season, Mark II of the prototype experimental twist tester was used. From the same mechanical principles shown in Figure 3.2 (Studman and Yuwana, 1992), and for an element of fruit flesh with a radial width  $dx$  and length  $b$ , the flesh crushing stress is obtained as :

$$\sigma_{cr} = \frac{M \times \sin \theta}{a^2 \times b}, \text{ Pa} \quad (3.4)$$

where :

$\sigma_{cr}$  = flesh crushing stress, Pa

$M$  = the maximum moment produced when the arm is horizontal (i.e.  $\theta = 90^\circ$ ),  
N.m

$\theta$  = angle of rotation of twist arm at full crushing, m

$a$  = blade radius, m

$b$  = blade width, m

The value of  $M$  is obtained by calibration by measuring the force produced when the arm is resting in the horizontal position on a point support placed in the centre of scale. The maximum moment is then given by :

$$M = m \times d \times g, \text{ (N.m)} \quad (3.5)$$

where :

$m$  = mass of the arm, kg

$d$  = distance from the centre of the pivot to the point of support in the horizontal position, m

$g$  = gravitational constant,  $9.807 \text{ ms}^{-2}$ .

### **Experimental Procedure**

Before each experiment, preliminary tests were conducted to determine suitable test parameters of the equipment. For experiments using Mark I, a sample of five fruits was used to determine the suitable dimensions of  $p$  and  $q$  on the rotating arm. The values of  $p$ ,  $q$  and the dimensions of the blade ( $a$  and  $b$ ) were recorded. For experiments using Mark II of the tester, the equipment was calibrated as described above and the maximum moment calculated using equation (3.5).

Each fruit was tested by pushing it onto the blade using a firm pressure, supporting the tester with the other hand, and slowly rotating the fruit until the pointer just began to return to its rest position. Each test lasted for about 15 seconds, and the maximum angle ( $\theta$ ) was recorded. Two tests were conducted on the opposite sides of the equatorial surface of each fruit. Flesh crushing stress was calculated by substituting the maximum angle ( $\theta$ ) into equations (3.2) and (3.3) for Mark I Tester or equation (3.4) for the Mark II Tester.

#### **3.4.5 Flesh Tensile Properties**

Tensile properties of fruit flesh were measured using a rapid tensile testing system developed by Studman (1991c). The properties determined were the maximum deformation, maximum tensile stress ( $\Gamma_{\max}$ ), tensile strain ( $\epsilon_{\max}$ ), and Young's Modulus ( $E$ ). Figure (3.3) shows the equipment used and illustrates the mechanical principle involved. The equipment comprised

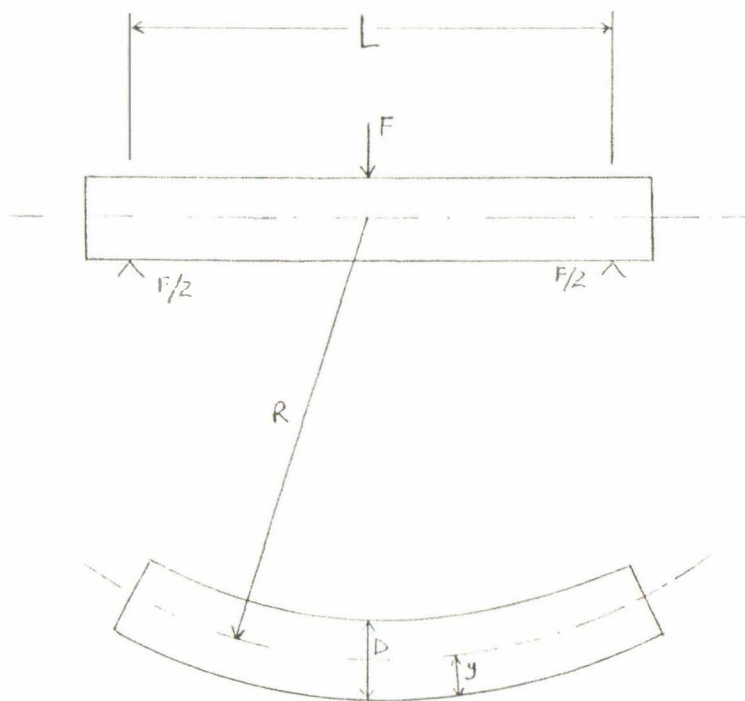
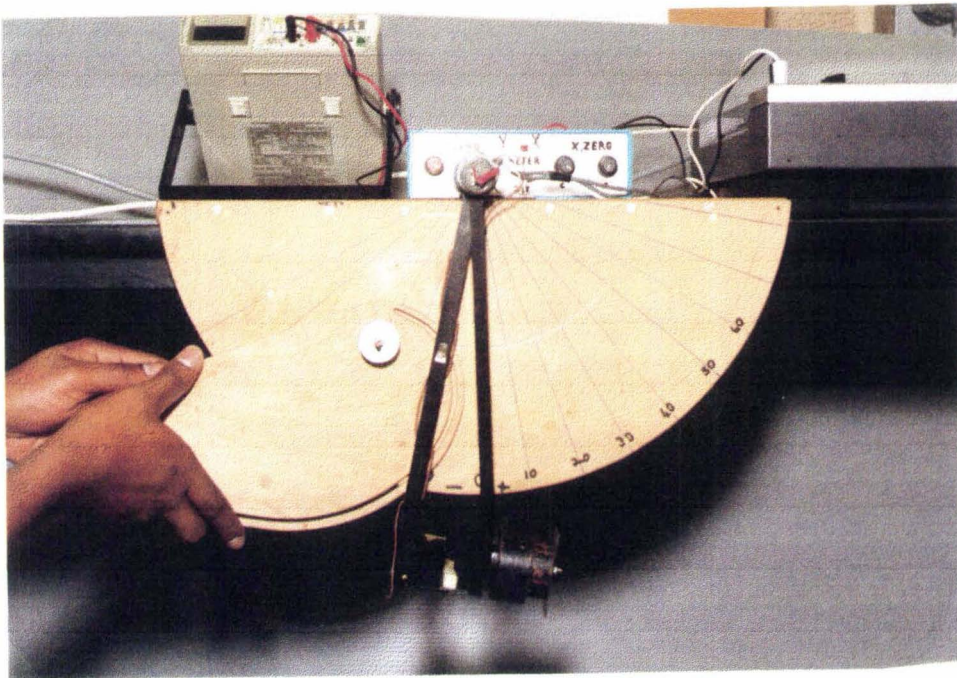

Figure 3.3 Top Photograph of the Experimental Tensile Tester Used (top); and Principle of the Tensile Tester (bottom).

of a platform for holding the specimen, a digital voltmeter on 20V DC, a control switch, and a chart recorder.

From mechanical theory, strain in the outer fibre of the specimen ( $\epsilon$ ) as shown in the bottom of Figure 3.3 is given by :

$$\epsilon = \frac{y}{R} \quad (3.6)$$

where :

- $y$  = distance to fibre from neutral axis, mm  
 $R$  = radius of curvature of the neutral axis, mm

Similarly,

$$\frac{\Psi}{I} = \frac{E}{R} = \frac{\sigma_t}{y} \quad (3.7)$$

and

$$\sigma_t = \frac{y \times \Psi}{I} = \frac{3 \times F \times L \times y}{b_a \times D^3} \quad (3.8)$$

where :

- $\Psi$  = moment of couple =  $FL / 4$   
 $I$  = 2nd moment of area =  $BD^3 / 12$   
 $\sigma_t$  = tensile stress,  $N.m^{-2}$   
 $F$  = tensile force, N  
 $L$  = length of rectangular fruit specimen, m  
 $b_a$  = width of specimen, m  
 $D$  = thickness of specimen, m.

**R** is calculated by trigonometry from :

$$R^2 = (L/2)^2 + (R-x)^2 \quad (3.9)$$

After expansion and rearranging,

$$R = \frac{\left(\frac{L^2}{4} + x^2\right)}{(2x)} \quad (3.10)$$

where **x** is the amount of deformation (mm) of the specimen.

From equations (3.8) and (3.10), the maximum tensile strain is obtained as :

$$\epsilon_{\max} = \frac{2xy}{\left(\frac{L^2}{4} + x^2\right)} \quad (3.11)$$

The maximum tensile force at failure,  $F_{\max}$ , is calculated from the equation :

$$F_{\max} = W_t \times \sin\beta \quad , \quad (N) \quad (3.12)$$

where :

$W_t$  = total weight of arm , N

$\beta$  = maximum angle at failure, degrees.



At maximum deformation,  $\sigma_t = \Gamma_{\max}$  and  $F = F_{\max}$ . Substituting equation (3.12) into (3.8), the maximum flesh tensile stress ( $\Gamma_{\max}$ ) is obtained as:

$$\Gamma_{\max} = \frac{3W_t \times L \times y \times \sin\beta}{B \times D^3}, \quad (\text{Pa}) \quad (3.13)$$

### Experimental Procedure

Before each experiment, the equipment was calibrated by testing five specimens in a preliminary trial and recording the voltage output and the equivalent distances along the vertical axis (force) and horizontal axis (deformation) on the output of the chart recorder. During this trial test, suitable jaw size to accommodate the length of specimens was selected. Additional weights were added when testing 'hard' fruit. These sizes were recorded and used for the calculation of the tensile properties.

For all experiments, a 10-mm rectangular cork borer was used to obtain test samples from fruit. Each fruit was sampled on two opposite sides along the vertical axis. During testing, the core sample was placed on the platform jaw and the cam was moved slowly and steadily in the anti-clockwise direction until the sample broke.

After testing, the maximum deformation ( $x$ ) and the angle at failure ( $\beta$ ) were evaluated from the force-deformation curve produced by the chart recorder. These results were then used to calculate the flesh tensile strain and stress from equations (3.11) and (3.13), respectively. Young's modulus of elasticity ( $E$ ) was calculated as the ratio of stress to strain.

#### **3.4.6 Skin Bursting Stress**

A new technique was devised for testing the skin bursting stress of fruit. The equipment comprised an Effegi penetrometer fitted with a 7.97 mm head and an electric drill press fitted

with an 8 mm drill bit. This technique involved removing the flesh from the test site using the drill and 'bursting' the skin with a penetrometer probe in a way that mimics the splitting of the skin due to excessive internal pressure. In addition to the obvious advantage of testing the skin in the intact condition, this technique also obviates the traditional problems of specimen preparation and handling which have continued to raise questions on existing test methods. This technique was found to be simple and quick, and it gave fairly consistent results during preliminary testing. By this technique, it was also possible to test fruit with different amounts of flesh attached to the skin.

### General Testing Procedure

First, the fruit sample was sectioned into two equal halves along the vertical axis. Each half was placed on a flat surface and an 8mm diameter drill bit connected to an electric motor was used to make a hole through the fruit flesh by lowering the drill bit onto the cut surface. The vertical displacement of the drill was pre-set to leave a gap between the drill tip and the flat surface on which the fruit skin made contact. After making the hole, the sample was then placed on a non-hard surface with a hole bigger than that in the fruit and the probe of a penetrometer was passed through the hole in the fruit to burst the skin. The scale reading ( $\Omega_p$ ) of the penetrometer was recorded. Figure 3.4 shows the photograph of apple sections tested for skin bursting stress.

The skin bursting stress ( $\zeta_{bs}$ ) is related to the probe diameter and skin thickness by:

$$\zeta_{bs} = \frac{\Omega_{bf}}{\pi \times d_p \times t_{sk}}, \quad (\text{Pa}) \quad (3.14)$$

where :

- $\Omega_{bf}$  = ( $\Omega_p \times g$ ) = bursting force, N
- $\Pi$  = pi
- $d_p$  = diameter of penetrometer probe, m
- $t_{sk}$  = thickness of skin, m

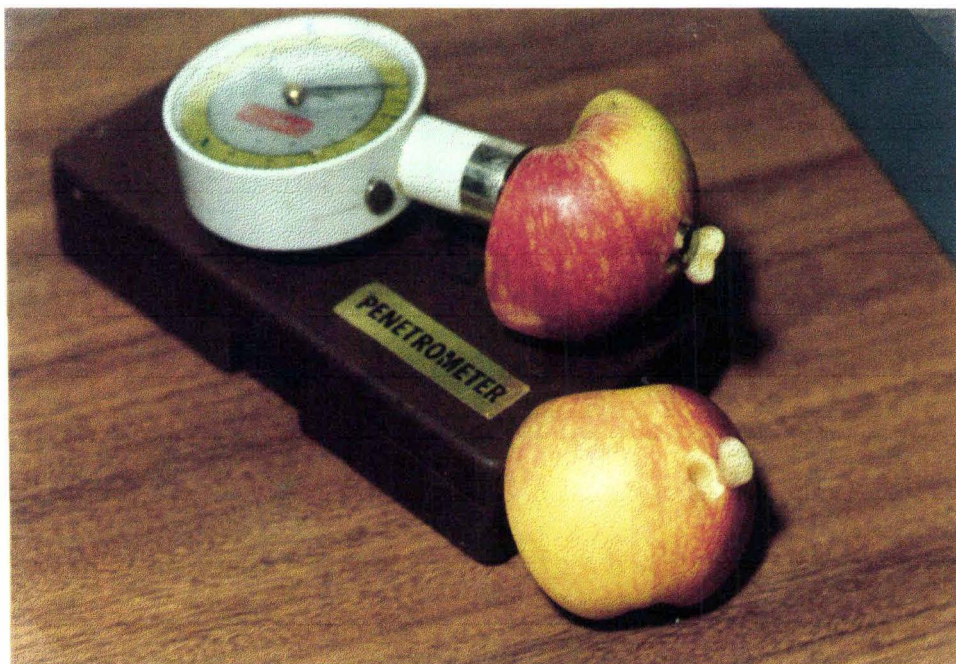

Figure 3.4 Photograph of Apple Tested for Skin Bursting Stress.

### 3.4.7 Fruit-stem Adhesion Force

A technique was developed to measure the force required to detach the stem from already harvested fruit. The system was made up of penetrometer and a device to grip the stem using a drill chuck. Figure 3.5 shows the arrangement of the system called a "stem-puller". Fruit were tested as follows : the stem was inserted into a chuck and securely gripped by locking the chuck; the penetrometer was zeroed, and the fruit was held by both hands and pulled vertically downwards until the stem was detached. The penetrometer reading (**kg**) at this point was recorded.

It was important that the pulling was done slowly and steadily until detachment occurred in order to minimise the effect of loading rate on the results. Also, care was taken to observe accurately the penetrometer reading at the time of stem detachment as this varied when the chain oscillated about its original position.

The fruit-stem adhesion force ( $\alpha_{af}$ ) was determined from the relationship :

$$\alpha_{af} = (x_1 + x_2) \times g, \quad (\text{N}) \quad (3.15)$$

where :

- $x_1$  = mass of fruit, kg
- $x_2$  = penetrometer reading, kg

## 3.5 Analysis of Data

Experimental data were analyzed for variance, means, and standard errors using the Statistical Analysis Systems (SAS) programmes (SAS/STAT User' Guide, 1988). Prior to any analysis

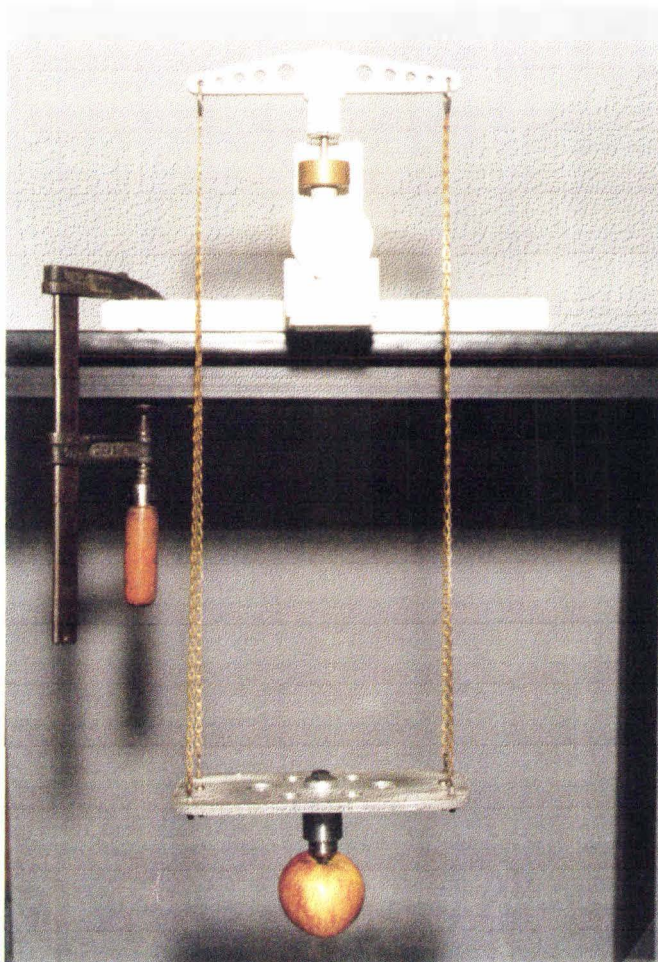

Figure 3.5 Experimental Setup of the Stem-puller

of variance, data were tested for normality and homogeneity of variance. Where necessary, appropriate transformations of the original data were performed before statistical analysis and back transformed for presentation (Little, 1985). Means were compared using the Duncan's Multiple Range Test (Duncan, 1955). For tests involving only two treatments, the means were compared using a standard t-test (Cochran and Cox, 1957).

Graphs were plotted using Cgile (Version 3.2 ) graphics packages (Pugmire,1992). Where applicable, regression and correlation analyses were carried out using the method of Steel and Torrie (1980) and the SAS package (SAS/STAT User' Guide, 1988).

## CHAPTER FOUR

### EXPERIMENTAL STUDIES ON MANAGEMENT CAUSES OF STEM-END SPLITTING IN APPLES.

#### 4.1 Introduction

The literature on factors causing fruit cracking and splitting, particularly in apples, has been reviewed earlier in chapter two of this thesis. It was found that the amount of fruit cracking varied remarkably with cultivar, growing season, and even across fruit growing regions. Evidence from the review also showed that for all fruit types and forms of cracking, the most widely held hypothesis was that cracking occurs when there is a plentiful supply of water to the crop (Chandler, 1925; Meynhardt, 1957; USDA, 1967; Claypool et al., 1972). Several early investigators have also attributed the disorder to general debility of the crop (Campbell, 1928; Goodwin, 1929; Fisher, 1937a,b; Schrader and Haut, 1938).

In line with these hypotheses, these researchers and others have recommended certain cultural measures to control or reduce the cracking disorder (chapter 2, section 2.4.1). In general, there is a lack of agreement as to the real causes of fruit cracking in apples and, to date, there are no guaranteed management strategies to control the disorder in the commercial fruit industry.

The literature review also showed that the level of irrigation, nitrogen fertilizer, thinning (or crop load) and other orchard management factors affect some types of fruit cracking and other quality attributes of several apple cultivars (see Section 2.3.4). However, there are considerable differences and inconsistencies in the literature on the effects of these management practices on cracking in apples and other fruits. Part of this anomaly could be attributed to the fact that various forms of cracking in each type of fruit respond differently to the same field treatments, as vividly shown by Uriu et al. (1962) on side-cracking and end-cracking in prunes. The study in this Chapter was therefore initiated to investigate the relationships between stem-end splitting and irrigation practice, crop load and nitrogen treatments.

## **4.2 Experimental Designs, Materials and Methods**

### **4.2.1 Experimental Designs**

Details of experimental sites, experimental designs, and layout of the treatments were discussed in Chapter Three (section 3.2). For the studies on stem-end splitting of 'Gala' apples, the experiment was set up as a split plot design (SPD) with four replicate blocks. The main treatments were irrigation (frequent vs none), crop load (hand thinning to singles vs none), and nitrogen (weekly 1% foliar urea sprays vs none).

Treatment combinations with hand thinning of fruit to singles were considered as low crop load while those that received no hand thinning were considered as high crop load. The irrigation levels were randomly assigned to the main plots while crop load and nitrogen were arranged in factorial combinations within each main plot. For the studies on 'Royal Gala', four irrigation treatments were applied in a randomized complete block design (RCBD) with five replicates. The treatments were low water, low-to-high water, medium water, and high water.

### **4.2.2 Materials and Methods**

Fruit were hand-picked according to standard commercial practice. Section 3.3 of the previous chapter described the general supply of fruit material. For the 'Gala' experimental blocks set up in a commercial orchard, fruit were harvested three times, commencing on the day of first commercial harvest of 14/2/91. The other harvests were made on 25/2/91 and 6/3/91, respectively. After harvest, fruit samples were transported to the Fruit Research Laboratory and within 12 hours of harvest, each fruit was examined for stem-end splitting and any other physical defect. For all three harvests, a total of 11,511 fruit were examined for stem-end splitting. A sub-sample of 65 fruit per tree was assessed for internal ring-cracking by cutting the fruit into two or four equal parts along the stem-calyx axis.

Only samples which did not show any signs of internal ring-cracking in the first two halves were sectioned further into four parts. Usually, the first cut was sufficient to reveal the



presence of a ring-crack or lack of it.

For the 'Royal Gala' experimental blocks in the experimental orchard, fruit samples were collected five times on 31/1/91, 14/2/91, 25/2/91, 6/3/91, and 13/3/91. The first commercial harvest date for 'Royal Gala' in the Hawke's Bay region was on 25/2/91. The procedure outlined above for 'Gala' was also used to assess fruit for stem-end splitting and internal ring-cracking using a total of 906 fruit picked on 25/2/91 and 6/3/91.

#### **4.2.3 Determination of Leaf water potential**

Before to the first harvest of Royal Gala samples on 31/1/91, a portable Teltherm pressure bomb was used to estimate leaf water potential in the field (Turner, 1981; Irving and Drost, 1987; Milad and Shackel, 1992). Measurements were made on three exposed leaves per tree between 12:00 and 14:00 (New Zealand Summer Time). The aim of this measurement was to determine if the irrigation treatments had any effect on the stress level of the experimental trees.

### **4.3 Analysis of Data**

For numerical analysis, the original data of split and ring-cracked fruits given in percentages, were subjected to residual analysis (Fernandez, 1992) and the data was transformed if the assumptions of analysis of variance (ANOVA) were violated (Barlett, 1947; Little, 1985). Transformation using the arcsin of the square-root was applied to the data on stem-end split fruit of 'Gala' using the expression :

$$Y = \text{Arcsin} \left( \sqrt{\frac{X}{100}} \right) \quad (4.1)$$

where the Ys were the transformed data and the Xs were the percentages of split fruit. If the data included values of 0% and 100%, these values were replaced by  $(1/4n)$  and  $[100-(1/4n)]$ , respectively, where n is the total number of fruit upon which the percentage data were based (Steel and Torrie, 1980; Gomez and Gomez, 1984; Evert et al., 1988; Fernandez, 1992). Also, for 'Gala' apples, the original data of ring-cracked fruit given in percentages were adjusted using the arcsin transformation (Claypool et al., 1972; Cortes et al., 1983; Wade, 1988) by means of the expression :

$$A = \frac{180}{\pi} \text{Arcsin}\left(\frac{B}{100}\right) \quad (4.2)$$

where the As were the transformed data and the Bs were the percentage ring-cracked fruit.

ANOVA and correlation analysis were carried out on the transformed data using the Statistical Analysis Systems (SAS), and means were tested for significance using the least-significant-difference (LSD) test (Steel and Torrie, 1960; Cody and Smith, 1987; SAS/STAT User's Guide, 1988). Data were analyzed as a split-plot design arranged in blocks. Irrigation was the main plot and variation between blocks within irrigation [block(irrigation)] was the main plot error term. Factorial combinations of crop load and nitrogen were the sub-plot, and the sub-plot error term was block(irrigation\*cropload\*nitrogen).

The amount of stem-end splitting and internal ring-cracking were generally very small in the 'Royal Gala' experimental blocks and the data obtained were not suitable for ANOVA procedures. The amount of fruit splitting and internal ring-cracking from this experiment are presented as percentages of the total fruit picked.

## 4.4 Results

### 4.4.1 Effects of irrigation, crop load and nitrogen on stem-end splitting of 'Gala' apple

#### Soil moisture content

Figure 4.1 shows the soil moisture levels of the Gala trial under the two irrigation regimes during the experimental period. There were no significant differences in the soil moisture content of the irrigation treatments over the first three weeks but soil moisture levels in the unirrigated treatment declined progressively throughout the period. The only significant rainfall event during the period was a 30 mm rainfall on 28/2/91 and this caused the soil moisture levels in the unirrigated plots to rise sharply. However, this did not cause the soil moisture levels in this treatment to return to field capacity.

#### Treatment effects on stem-end splitting and ring-cracking

The effects of the orchard management practices on stem-end splitting, internal ring-cracking and fruit weight are presented in Table 4.1. Of the three cultural factors (irrigation, crop load and nitrogen), only irrigation affected stem-end splitting and ring-cracking (**frequent > none**,  $P \leq 0.05$ ). Frequent irrigation produced over twice as many split and ring-cracked fruit, respectively, compared to no irrigation. There were no significant interactions between the main effects on the incidence of splitting and cracking. Mean fruit weight at harvest (including split and unsplit fruit) was significantly affected only by crop load (**low > high**;  $P \leq 0.05$ ).

Another clear finding obtained from the present study was the high degree of variability in the amount of stem-end splitting and internal ring-cracking between the experimental blocks, trees, and even branches on the same tree. Three of the 16 unirrigated trees had a high incidence of stem-end splitting and internal ring-cracking within the treatment and the incidence of splitting was also extremely variable in the irrigated treatment. Table 4.2 shows the range of fruit splitting and ring-cracking, in percent, among the experimental trees.

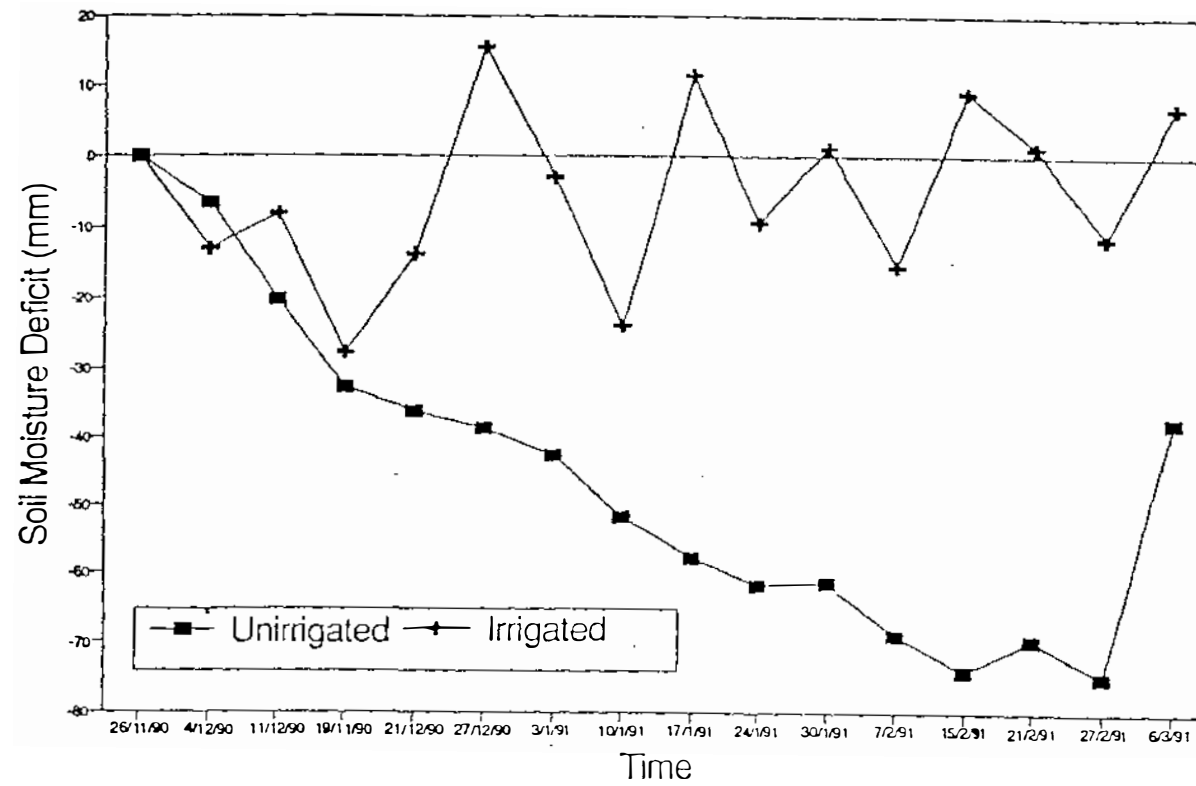

Figure 4.1 Soil moisture deficits in irrigated and unirrigated treatments  
(Hodson, 1991b).

**Table 4.1** Effects of orchard management practices on percentage of fruit with stem-end splitting and internal ring-cracking and weight of 'Gala' apple. Data are presented as means of arcsin-transformed percentages; figures in brackets are back-transformed means.

Treatment	Split Fruit <sup>f</sup> (radians) (n=11,511)	Ring-cracked Fruit <sup>y</sup> (radians) (n=2,080)	Weight (gm) <sup>z</sup> (n=5,400)
<u>Irrigation</u>			
Frequent	0.33 (11.17)	9.50 (16.49)	155.19
None	0.21 (4.95)	4.92 (8.57)	151.38
	*	*	NS
<u>Nitrogen</u>			
Urea spray	0.27 (8.17)	6.73 (11.70)	152.94
None	0.27 (7.95)	7.69 (13.36)	153.63
	NS	NS	NS
<u>Crop Load</u>			
Low	0.29 (9.39)	7.68 (13.34)	156.00
High	0.24 (6.74)	6.74 (11.71)	150.56
	NS	NS	*

Notes

<sup>f</sup>Percent stem-end split fruit transformed using the arcsin of the square root. Back-transformed means are shown in parentheses.

<sup>y</sup>Percent ring-cracked fruit transformed using the arcsin.

<sup>z</sup>Includes both split and unsplit fruit.

NS - not significant; \* means significant at  $P \leq 0.05$ .

**Table 4.2** Variability of percentage incidence of stem-end splitting and internal ring-cracking expressed by the minimum and maximum values for single tree replicates (sample size = 120 for both stem-end splitting and ring-cracking).

Type of Fruit	Irrigation Level	Minimum (%)	Maximum (%)	Mean <sup>y</sup> (%)
Stem-end Split	Frequent	2.58	28.02	8.1 ± 1.2
	None	0.66	17.27	
Ring-cracked	Frequent	8.47	25.71	12.5 ± 1.1
	None	1.54	20.34	

**Note**

<sup>y</sup>Figure represents the percentage mean ± the standard error of the mean of total split and ring-cracked fruit, respectively.

**Effect of Fruit Maturity (Harvest Date)**

Two sub-samples of 832 Gala apples were randomly collected on each of two respective harvest dates and used to evaluate the effect of advancing fruit maturity on the incidence of stem-end splitting. Total split fruit increased significantly ( $P \leq 0.001$ ) from 5.9% on the day of first commercial harvest (14/2/91) to approximately 27% three weeks later (6/3/91).

### Fruit Nutrient Levels in Relation to Stem-end Splitting

Results of nutrient analysis using fruit samples from the Gala experimental blocks (Hodson, 1991a; pers. comm.) showed that the urea spray treatment did not have any significant effect on the nitrogen concentration in fruit. Analysis for the major nutrients (P, K, Ca, and Mg) also showed that no treatment had any effect on fruit nutrient concentrations (data not shown). On the other hand, both stem-end split fruit and ring-cracked fruit had significantly higher concentrations of P, K, and Ca than good fruit (Table 4.3).

**Table 4.3** Major nutrient concentration (mg/100g fresh weight) in good, ring-cracked and stem-end split fruit of 'Gala' apple (n=20 for each type of fruit)<sup>#</sup>  
[Data Supplied by Hodson, 1991b; pers. comm.]

Nutrient	Good	Ring- Cracked	Stem-end Split	Significance
N	31.3	28.9	30.5	N.S.
P	7.1	8.2	8.0	**
K	100.5	106.8	105.1	*
Ca	3.4	3.9	4.3	**
Mg	3.2	3.5	3.2	N.S.

#### Notes

<sup>#</sup>6 mm cores from equatorial slices were taken from each fruit, bulked and analyzed for major nutrients.

N.S. = not significant; \*, \*\* = Significantly different at 5% and 1%, respectively.

## Relationships Between Stem-end Splitting, Internal Ring-cracking and Fruit Weight

First, longitudinal sections through all stem-end split fruit confirmed that every fruit with stem-end splitting had internal ring-cracking although the reverse was not necessarily true : ring-cracked fruit did not always display a stem-end split. In this trial, 64.4% of ring-cracked fruit displayed stem-end splits at the time of inspection.

Correlation analysis was used to examine the relationships between the amount of stem-end splitting, ring-cracking and fruit weight. The results obtained showed a highly significant positive correlation between the amount of stem-end splitting (transformed by the arcsin of the square root) and internal ring-cracking (transformed by the arcsin) ( $r^2 = 0.77$ ;  $P \leq 0.0001$ ). Also, the mean fruit weight of all picked fruit (including split and unsplit fruit) was positively correlated with both stem-end splitting ( $r^2 = 0.46$ ;  $P \leq 0.01$ ) and internal ring-cracking ( $r^2 = 0.38$ ;  $P \leq 0.05$ ). That is, the greater the weight, the more stem-end splitting and ring-cracking. However, the correlation coefficient with stem-end splitting was more significant than with internal ring-cracking ( $P \leq 0.01$  compared to  $P \leq 0.05$ ).

### 4.4.2 Effects of Irrigation Water Deficits on Stem-end Splitting of 'Royal Gala' Apple

#### Tree Water Status

Results of the ANOVA for the mid-afternoon leaf water potentials for the Royal Gala trial are shown in Table 4.4. There was no significant difference ( $P > 0.05$ ) between the low-to-high water treatment and the control (low water). However, for the trees that received medium and high water, respectively, leaf water potential was significantly less negative ( $P \leq 0.01$ ) than the control. There was, also, a significant interaction ( $P \leq 0.01$ ) between the treatments and the blocks, indicating that tree water status may have been influenced by the water deficit treatments. In general, the treatments that received less water, especially at the early stage of fruit growth (low water and low-to-high water), had more negative leaf water potential. Leaf water potentials were in the range -1.85 to -2.13 MPa in the control (low water treatment), and -1.63 to -2.13 MPa in the other irrigation treatments (low-to-high, medium, and high).



**Table 4.4** Effects of the four irrigation treatments on leaf water potential, stem-end splitting and internal ring-cracking of 'Royal Gala' apple<sup>z</sup>  
(n = 906 for stem-end splitting and ring-cracking, respectively).

Irrigation Treatment	Leaf Water Potential <sup>@</sup> (MPa)	Percentage Split Fruit <sup>x</sup>	Percentage Ring-Cracked Fruit <sup>y</sup>
T1 - Low	-2.01a	1.78	6.00
T2 - Low to high	-1.98a	2.22	4.00
T3 - Medium	-1.80b	1.78	6.00
T4 - High	-1.65c	5.77	9.00
Mean	-1.85	2.90	6.25

#### Notes

<sup>z</sup>Total incidence of stem-end splitting and internal ring-cracking were generally very low and the data collected were unsuitable for ANOVA.

<sup>@</sup>Measured during the first fruit sampling on 31/1/91. Treatment means followed by different letters are significantly different at  $P \leq 0.01$ .

<sup>x,y</sup>Both stem-end splitting and ring-cracking were only observed on fruit samples collected on 25/2/91 and 6/3/91.

## Stem-end Splitting and Ring-cracking

A sample of over 440 Royal Gala apples were hand-picked four times at two-week intervals commencing on 31/1/91 and examined for both stem-end splitting and internal ring-cracking. Following the fruit sampling interval, the first observation of stem-end splitting and internal ring-cracking occurred on the day of first commercial harvest (25/2/91), and on this date, there was no split fruit from the low water treatment (control). The effects of the irrigation treatments on the amount of stem-end splitting and ring-cracking are presented in Table 4.4 based on fruit harvests on 25/2/91 and 6/3/91. These results show that the high water treatment produced over three times more split fruit than both the control (low water) and medium water, respectively. This difference between the irrigation treatments was less clearly marked on the amount of ring-cracking.

The total amount of ring-cracked fruit was over twice the amount of stem-end split fruit during the season (6.25% compared to 2.90%), and the amount of stem-end splitting increased from 1.36% on the day of first commercial harvest (25/2/91) to 4.55% two weeks later (6/3/91). Within this period, the only remarkable changes on the effects of the treatments were the increase in the amount of stem-end splitting due to low water (0.0 to 3.5%) and high water (1.8 to 10.0%).

### 4.4.3 General Observations on Fruit and the Characteristics of Stem-end Splitting

Figure 4.2 shows an apple with medium-sized stem-end splits (top), and an apple on the tree with severe stem-end splitting. By sectioning all stem-end split fruit along the stem-calyx axis, it was verified that a ring-crack was always present and that every stem-end split was joined to the ring-crack. Figure 4.3 shows sections through apples with internal ring-cracks. There was no consistent point on the ring-crack at which the splitting developed; however, ring-cracks occurred at about 1 mm above the fruit-stem joint extending into the fruit flesh.

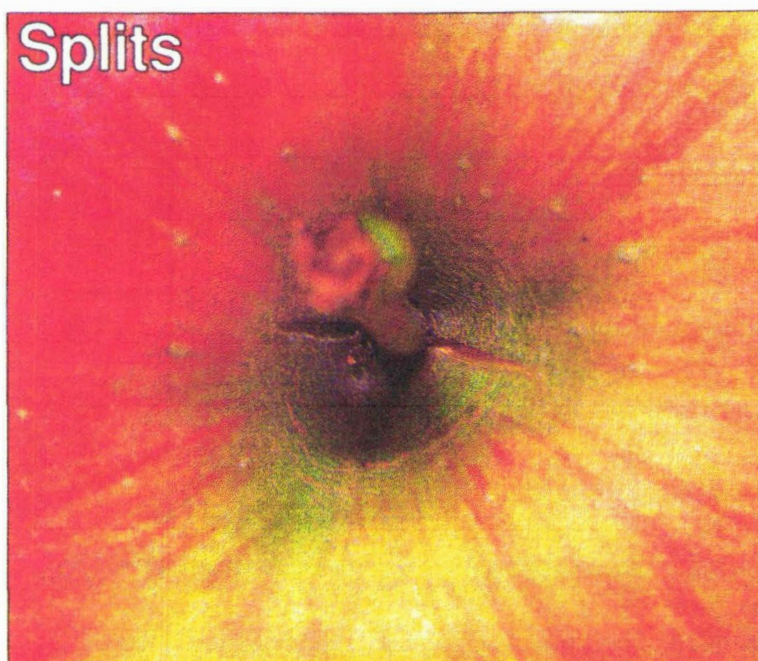

Figure 4.2 Photographs showing : [top] an apple with medium stem-end splits (APMB. 1989), and [bottom] and apple on the tree in which a stem-end split has developed into a complete longitudinal split.

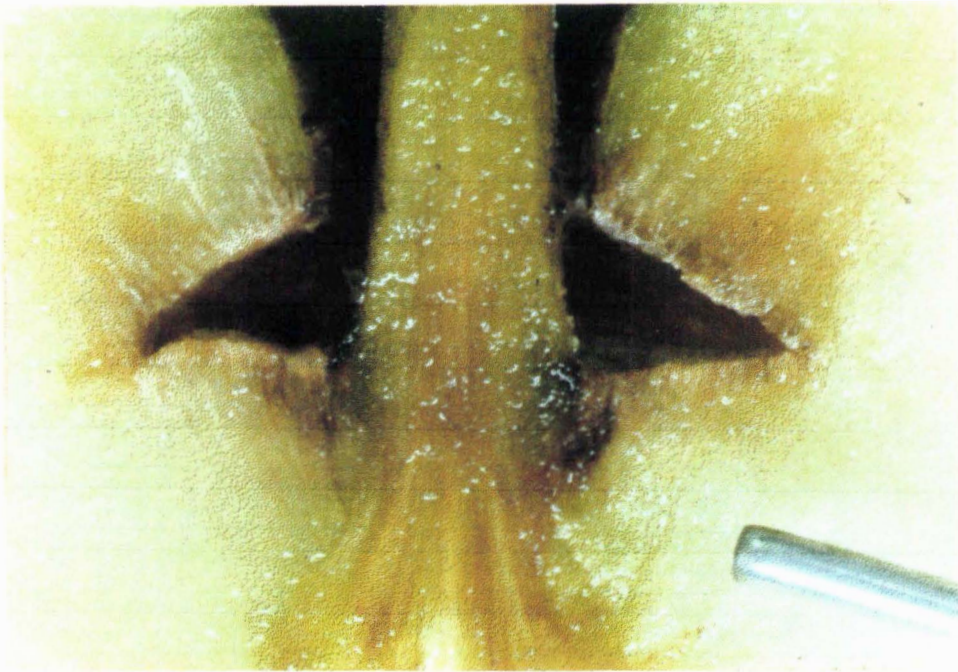

Figure 4.3 Photographs of sections through apples showing internal ring-cracks.

In affected fruit, the splits originated at the fruit-stem joint and extended in straight lines towards the cheek. In some severely affected fruit, up to three splits had developed, with some splits penetrating about 50 mm deep into the flesh. Most fruit had single splits which occurred predominantly on the exposed, blush side of the fruit. In contrast to the skin-cracking common in other apple varieties, stem-end splitting occurred in fruit that otherwise appeared from the outside to be in excellent condition. Furthermore, and quite importantly too, the type of cavity characteristic of stem-end splitting was not found to originate at any other part of the affected fruit except at the stem-end.

Field and laboratory observations on fruit during the present study also showed that stem-end splitting occurred in all sizes of fruit, including mature (red-striped) and immature (green) fruit. In both fruit types, stem-end splitting was also found to occur predominantly on the exposed (striped, red or sunny) side of the fruit.

## **4.5 Discussion**

### **4.5.1 Stem-end splitting of 'Gala' apple**

This study has shown that the use of irrigation water in the orchard has a significant effect on the amount of stem-end splitting and internal ring-cracking of fruit. Frequent irrigation applied to 'Gala' apple trees 12 weeks before and through to commercial maturity significantly increased the proportion of fruit with the disorders compared to those from trees with no irrigation (high soil moisture deficit) (Table 4.1).

This contrasts with the findings of Verner (1935) on 'Stayman Winesap' and Watanabe et al. (1987) on 'Mutsu' apples, who reported that soil moisture content had no clear effects on the incidence of fruit cracking in those varieties. Verner (1935) induced soil moisture fluctuations by artificially droughting trees followed by flood irrigation. However, it has also been shown (Bohlmann, 1962) that in addition to excessive water absorption through the roots, many kinds of fruit such as apples, peaches, and cherries tend to crack more easily when they come in contact with moisture. This is further supported by the report of Byers et al. (1990) who

found that fruit of 'Stayman' apples covered with bags or petroleum jelly on over-tree sprinkled trees did not crack, while 7.6% of the wetted fruit cracked.

From their study on skin-cracking of Cox's Orange Pippin apples, Goode et al. (1975) reported that the disorder was induced by water stress and that irrigation late in the season reduced the damage considerably. The authors concluded that consistent watering will reduce very considerably, and may prevent, the occurrence of fruit-cracking due to fluctuating weather conditions. This result and their conclusions do not fit the evidence obtained in the present study in which consistent watering caused the highest proportion of stem-end split fruit of both 'Gala' (frequent irrigation) and 'Royal Gala' (high water). This could well mean that skin-cracking and stem-end splitting of apples are different, though related, physical phenomena.

The results obtained in the present study are similar with the findings of researchers on peach pit-splitting (Davis, 1941; Claypool et al. (1972) and tomato fruit cracking (Frazier, 1934; Molenaar and Vincent, 1951; Peet and Willits, 1991), who found a positive correlation between the disorder and heavy irrigation.

Both stem-end splitting and ring-cracking were not significantly affected by crop load, although the amounts of both defects appeared marginally higher in fruit from the low crop load treatment. This result, therefore, supports the findings of Nilsson and Bjurman (1959) and Claypool et al. (1972) that cultural measures which increase fruit size such as thinning, are apt to accentuate cracking. The literature on skin-cracking of 'York Imperial' apples (Fisher 1937a,b; Schrader and Haut, 1937; Shutak and Schrader, 1948) has also shown that the tendency of fruit to crack was more severe on trees bearing a light crop. Work on cherries (Bullock, 1952; Zielinski, 1964; Way, 1967;) show that fruits on heavily cropping trees tend to crack less than fruit of the same cultivar on a tree carrying a light crop.

Contrary to the results obtained in this thesis that nitrogen had no significant effect on stem-end splitting of 'Gala' apples, positive relationships have been reported by previous researchers between nitrogen manuring and cracking of the fruit of 'Holstein Cox' (Wesseiborn and Gottwald, 1965), and skin-cracking of 'Cox's Orange Pippin' (Montgomery,

1959; Goode et al., 1975) apples. Tomana (1961) also found that in 'Jonathan' apples, when seed development ceased and the fruit began to enlarge, the nitrogen content of the flesh increased rapidly, causing cracking of the skin around the lenticels. However, results obtained in this thesis are similar to those of Stiles et al. (1959) who found through tests over a 3-year period that nitrogen applied as urea, either alone or in combination with various spray materials, had no significant effect on fruit cracking of 'Stayman' apple. It appears therefore, that the phenomenon of stem-end splitting in 'Gala' apples is affected by nitrogen in the same way as cracking in 'Stayman' apples. However, the insignificant effect of nitrogen on the amount of stem-end splitting may have been because there were no differences in mineral concentrations brought about by the treatments. This possibility implies that nutrient treatments may only have an effect if they alter fruit mineral composition.

The only treatment that had a significant effect on the mean fruit weight of 'Gala' apple was crop load ( $P \leq 0.05$ ), with a negative correlation coefficient. Frequent irrigation also enhanced fruit weight at harvest. Barden (1992) obtained similar results between crop load and fruit weight of 'Smoothie Golden Delicious' apples. The significant positive correlation coefficients obtained in the present study between fruit size and stem-end splitting and ring-cracking parallel the results of Watanabe et al. (1987), Nilsson and Fernqvist (1957) and Shutak and Schrader (1948) on apple cultivars 'Mutsu', 'Ingrid Marie' and 'York Imperial', respectively. These researchers found that large apple fruit were most susceptible to cracking.

However, the results obtained in the present study do not support the conclusion drawn by Shutak and Schrader (1948) on skin-cracking of 'York Imperial' apples: that 'small-sized fruit rarely cracked'. In fact, field observations during the present study showed that stem-end splitting occurred in all sizes of fruit, including mature (red-striped) and immature (green) fruit. In both fruit types, stem-end splitting was also found to occur predominantly on the exposed (striped, red or sunny) side of the fruit.

Evidence from the literature indicates that the time of fruit thinning influences fruit size at harvest (Jones et al., 1992; McArtney et al., 1993) and the effect of crop load on fruit cracking and splitting in apples (Proctor and Loughheed, 1980). It is thus possible that the date of application of the thinning treatment in the 'Gala' experiment may have influenced the

effect of the low crop load on stem-end splitting. Proctor and Loughheed (1980) found that the cracking of 'Golden Russet' apples was related to crop load and fluctuating water supply in the early part of the growing season. Similarly, Watanabe et al. (1987) found that the splitting of 'Mutsu' apple was associated with conditions conducive to rapid early fruit growth.

The increase in the incidence stem-end splitting from 5.9% on the day of first commercial harvest (14/2/91) up to 27% three weeks later (6/3/91) suggests that the susceptibility of fruit increases with advancing maturity. This result also reflects a decrease in capacity of fruit to withstand physical and physiological stress due probably to the associated changes in firmness and textural strength (Westwood, 1978). Similar high incidence of stem-end splitting in 'Gala' apples has also been reported from recent investigations in the United States by Walsh et al. (1991). The authors found that 'stem-cavity' cracking of 'Gala' apples increased from zero to 12% within three days (28/8 to 31/8/90) in a research orchard in Maryland. During the same season, up to 40% of the 'Gala' fruit in one orchard located in Virginia cracked.

#### **4.5.2 Stem-end Splitting of 'Royal Gala' Apple**

In general, there was a low occurrence of stem-end splitting and ring-cracking, with a total incidence of 2.9 and 6.3%, respectively. In fact, the total amount of stem-end splitting was affected by the dramatic increase in split fruit due to the high water treatment from 1.8 to 10.0% between 25/2/91 and 6/3/91. This sudden increase in splitting could have been induced by the 30 mm rainfall recorded at the experimental site on 28/2/91, and this was the only significant environmental event recorded during the period of the experiment.

Moisture deficit imposed during the early part of the growing season (low water and low-to-high water) caused more negative leaf water potential at commercial fruit maturity, but also produced less fruit with stem-end splitting and internal ring-cracking, respectively. Assaf et al. (1975) and Lotter et al. (1985) did not obtain any effect of soil water deficit on skin-cracking of cvs 'Delicious', 'Granny Smith' or a 'Grand cv of Calville de St Sauver', respectively. In 'Stayman Winesap' apples, Verner (1935) observed no increase in the incidence of fruit splitting when he caused sudden and pronounced soil moisture fluctuations by artificially droughting trees followed by irrigation. Uriu et al. (1962) found



that very little end-cracking of prunes occurred on trees adequately supplied with water throughout the growing season. However, results obtained by Irving and Drost (1987) showed that water deficit treatment imposed early in fruitlet growth increased the proportion of cracked fruit of 'Cox's Orange Pippin' apples 2-3 fold. Also on 'Cox's Orange Pippin' apples, Goode et al. (1975) found that water stress (no irrigation) induced more skin-cracking of fruit than a treatment combining early and late irrigation.

These different results and the very low incidence of stem-end splitting in the 'Royal Gala' blocks indicate that both stem-end splitting and skin-cracking are different physical phenomena, and also that other factors, perhaps related to the climate, may have been involved. Changes in relative humidity have been shown to cause cracking and splitting in apples (Verner, 1935 and 1938; Mrozek and Burkhardt, 1973; Louw, 1948) and Navel oranges (Taylor et al., 1957). It is thus possible that the significant effect of water deficit on fruit cracking obtained by Goode et al. (1975) and Irving and Drost (1987) could be that 'Cox's Orange Pippin' may just be especially sensitive to water stress.

#### **4.5.3 Relationship between nutrient concentration and stem-end splitting**

The literature on concentration gradients of elements within apple fruit is well documented (Wilkinson and Perring, 1964; Perring and Wilkinson, 1965; Perring and Clijsters, 1974). It has also been shown that certain corking disorders of apples and pears are related to a mineral imbalance within the fruit (Faust and Shear, 1968; Woodbridge, 1968 and 1971). In relation to apple cracking, Schrader and Haut (1938) suggested that nutritional conditions of the tree and fruit accounted for differences in cracking susceptibility of fruits on different trees, or even on the same tree. Fischer (1955) found no evidence to attribute apple fruit cracking to nutrient deficiency. Since none of the cultural treatments in the present study had any effect on the fruit nutrient concentrations, and given that there were no significant differences in the nitrogen concentration of good, split and cracked fruit, this trial provides no evidence for a role for nitrogen in stem-end splitting.

It is generally recognised that the parts of apple fruit affected by bitter pit have a higher concentration of some elements, including Ca and Mg (Perring and Plochanski, 1975;

Hopfinger and Poovaiah, 1978; Ford, 1979). Faust and Shear (1968) and Faust et al. (1969) considered that the accumulation of minerals was a secondary response in the development of corking disorders. Although the results obtained in this study (Table 4.3) show that stem-end splitting and internal ring-cracking are associated with increased levels of Ca, K, and P, it seems unlikely that these nutrients are directly involved in stem-end splitting. Bearing in mind that Ca, for instance, strengthens cell-wall integrity and adhesion (Clarkson and Hanson, 1980), it seems that the conclusion drawn by Faust et al. would apply to the results obtained in this study. It is possible that these minerals accumulate after cortical cells begin to disorganise, and not before the stem-end splitting appears. However, whether or not certain levels of Calcium or any other minerals could significantly affect the incidence of stem-end splitting cannot be concluded from the present study and further investigation is recommended in this area.

#### **4.6 Conclusions**

The broad aim of this chapter of the thesis was to elucidate the relationships between stem-end splitting and the most widely suspected orchard management practices. In experimental field studies with 'Gala' and 'Royal Gala' apples, it was found that frequent supply of water to the crop throughout the season increased the amount of stem-end splitting. It was also found that this disorder occurred in all sizes of fruit, but the tendency to split increased with increasing fruit size within a susceptible cultivar. In general, orchard management practices which enhanced fruit size contributed to increased stem-end splitting.

This research has confirmed the initial preliminary observation that a stem-end split is associated with the presence of an internal ring-crack which extends from the base of the stem outwards into the flesh of the apple at an angle of 90 degrees. The ring-crack was also present in many fruit which did not have stem-end splits. References were found in the literature which reported the presence of severe "stem-end" or "stalk-end" cracking of apples (Verner, 1935; Montgomery, 1959; Masden and Bailey, 1959); however, none of these authors noted the presence of internal ring-cracks. It is hypothesized that the presence of this ring-crack is the precursor to the development of stem-end splits.

The amount of both stem-end splitting and internal ring-cracking varied considerably within the experimental blocks, between trees that received the same treatment and even branches on the same tree. This suggests that within tree and fruit variations could have important implications on the mechanism of stem-end splitting in general, and in particular, on the susceptibility of individual fruit to splitting. Thus, the effect of any management factor (such as frequent irrigation) in increasing the incidence of stem-end splitting should be regarded at best as contributory, inasmuch as only a fraction of the fruit on any given tree will split under similar conditions.

Stem-end splitting commenced before commercial harvest, and susceptibility to this quality defect increased with advancing fruit maturity. Within this critical period, the timing of water application may be an important factor in the amount and rate of splitting that occurs. Evidence from this study is not sufficient to determine this critical time of onset of both stem-end splitting and ring-cracking. Shorter fruit sampling intervals would be required to properly determine this time.

It is considered that the accumulation of significant concentrations of Ca, P, and K in stem-end split fruit may be a secondary response which probably occurs after cortical cells begin to breakdown, and not before the internal ring-cracking occurs. By this process, it seems unlikely that these minerals are directly involved in stem-end splitting.

In conclusion, it appears unlikely that stem-end splitting can be effectively controlled by the manipulation of irrigation alone considering the large variation of stem-end splitting and ring-cracking within the experimental treatments and because of the possible effects of climatic and crop load factors on fruit growth characteristics. Further studies would be needed to test this.

## CHAPTER FIVE

### MECHANICAL AND PHYSICO-CHEMICAL PROPERTIES OF APPLES IN RELATION TO ORCHARD MANAGEMENT PRACTICES AND STEM-END SPLITTING.

#### 5.1 Introduction

In fruits and vegetables, the mechanical properties of the flesh are often the chief determinants of textural characteristics (Finney, 1967). In addition to evaluating kinaesthetic and textural qualities (Vincent, 1990; Vincent et al., 1991; Sakurai and Nevins, 1992), the mechanical properties of fruits are also of interest from the standpoint of reducing mechanical damage during harvesting, postharvest handling and processing operations (Mohsenin and Gohlich, 1962; Mohsenin, 1977) and predicting "readiness for harvest" (Mohsenin et al., 1965). Crack resistance is a useful property of vegetables such as cabbages and potatoes, and has been suggested as a criterion to evaluate cabbage varieties for texture and handling systems for damage (Mohsenin, 1970; Holt and Schoorl, 1983a,b,c).

In chapter two of this thesis, the literature on the causes of fruit cracking and splitting in apples was reviewed. It was shown that external factors to the fruit such as weather condition and water relations, and cultural factors influence the amount of fruit affected. It was also found that resistance to fruit cracking and splitting in other fruit, notably tomatoes (Frazier, 1934; Thompson et al., 1962; Voisey and MacDonald, 1964 and 1966; Voisey et al., 1964; Voisey and Lyall, 1965a,b; Voisey et al., 1970; Batal et al., 1970; Hankinson and Rao, 1979), and grape berries (Lugstin and Berstein, 1985; Berstein and Lugstin, 1985) was related to certain mechanical properties of the skin. In vegetables such as potatoes and cabbages, the extent of cracking is determined by the fracture toughness of the tissue (Holt and Schoorl, 1983; Schoorl and Holt, 1983a,b).

The problem of stem-end splitting in apples is as a form of mechanical failure in the structural integrity of the affected fruit. In addition to the inherent genetic design of the species, the mechanical attributes are also influenced by the growth environment and stage of maturity of the fruit. The fruit has to be able to withstand the mechanical effects of wind, water, temperature, humidity and gravity and grow in such a way that it remains intact and does not split (Callow, 1990; Vincent, 1990). The evaluation and understanding of such mechanical properties would shed light on the developmental pressures that the fruits have been subjected to under the growth environment, and also, provide an understanding of the possible consequences of modifying management practices to reduce and/or control stem-end splitting without adversely compromising yield and other fruit quality attributes.

Since cracking and splitting are normal stress phenomena (Schoorl and Holt, 1983), one of the important properties of apple fruit in relation to stem-end splitting may be the strength of the underlying flesh and the skin. It can be expected that an understanding of these mechanical properties important to texture in apples will also be fundamental for the rational assessment of the way variety and environmental or management factors affect the susceptibility of fruit to damage by stem-end splitting. Knowledge of fruit mechanical properties could also provide useful indicators of the amounts and types of internal and external forces that fruits can withstand without damage during growth and development (preharvest), and also during postharvest handling.

The objectives of this chapter, therefore, were :

- (i) to determine the effects of the orchard management practices studied in the previous chapter on the mechanical and physico-chemical properties of apples; and
- (ii) to further investigate the possible role of these properties on stem-end splitting by comparing the mechanical properties of good and stem-end split fruit.

## 5.2 Experimental Designs, Materials and Methods

### 5.2.1 *Experimental Designs and Supply of Fruit Materials*

'Gala', 'Royal Gala', and 'Fuji' apples grown in the Hawke's Bay region in New Zealand were collected during commercial harvest from the experimental orchards described earlier in Section 3.2. The 'Gala' splitting experiment was set up in a private commercial orchard as a split plot design with four replicate blocks. Irrigation (frequent vs none) was the main plot treatment and factorial combinations of crop load (high vs low) and urea fertilizer (nitrogen vs none) were the sub-plot treatments.

The 'Royal Gala' splitting experiment was set up at the HortResearch experimental orchard at Lawn Road, Hawke's Bay. The experimental design was a randomized complete block design (RCBD) with five replicate blocks. The treatments were low water, low-to-high water, medium water, and high water.

Three fruit samples of 'Gala' and 'Royal Gala' were collected during commercial harvesting (14/2/91, 25/2/91 and 6/3/91) and the data were combined to determine treatment effects. Samples of 'Fuji' apples were collected twice (6/3/91 and 13/3/91) from a private commercial orchard in Hawke's Bay as described in Section 3.3.3. The trees had received standard management practices during the season. For all three varieties, tests on fresh fruit were conducted within 24 hours of the harvest time while other samples were kept in the cold store at 1 °C until required.

### 5.2.2 *Equipment and Methods*

The equipment and methods used to measure fruit size (weight and diameter), soluble solids concentration (SSC, °Brix), fruit firmness and skin firmness, flesh crushing stress, skin bursting stress, fruit-stem adhesion force and flesh tensile properties have been fully described in Section 3.4.

### 5.2.3 *Sample Preparation*

Two sets of test were conducted. First, samples of good 'Gala' and 'Royal Gala' apples free from any noticeable physical defects were used to determine the effects of the management practices on fruit mechanical properties. In the second set of experiments, fruit samples of 'Gala' and 'Fuji' containing a stem-end split were used. Similar tests were not carried out on 'Royal Gala' apple because of insufficient numbers of split fruit. Both tests were carried out at the same time and the data were combined to determine the effects of stem-end splitting on mechanical and physico-chemical properties.

During each experiment, the same fruit samples were used to measure fruit-stem adhesion force, fruit firmness, flesh crushing stress, skin firmness, and SSC. For tests on 'Gala', a sample of 32 fruit were randomly selected from each treatment level (i.e. 32 from frequent irrigation and 32 from no irrigation), giving a total of 64 fruit for each harvest date experiment. Also for tests on 'Royal Gala', a sample of 25 fruit was randomly selected from each irrigation treatment, giving a total of 100 fruit for each harvest date.

Skin bursting stresses of 'Gala' and 'Royal Gala' apples were determined after 88 days of cold storage at 1°C using random samples of 128 'Gala' and 80 'Royal Gala'. The skin bursting stress of 'Fuji' apple within 24 hours of harvest was determined using samples of 20 good and 20 split fruit.

Fruit samples were weighed individually before each experiment. Mean fruit diameters were obtained from the measurement of the minimum and maximum diameters of the cheek (equatorial) region. Measurement of SSC, fruit firmness, flesh crushing stress, and skin bursting stress were made mid-way along the radial axis of fruit cheek. Two measurements were made on the opposite sides of each fruit. Skin firmness was calculated by subtracting flesh firmness from whole fruit firmness.

Flesh tensile tests were carried out using 20 samples of good and 20 split 'Fuji' apples harvested on 13/3/91. Test specimens were collected using a 10-mm rectangular cork borer and two specimens were tested from opposite locations along the stem-calyx axis of fruit.

### 5.3 Statistical Analysis

Data from tests to determine the effects of the orchard management practices on fruit mechanical properties were subjected to analysis of variance (ANOVA) using the General Linear Models (GLM) of the Statistical Analysis Systems (SAS) programmes (SAS/STAT User' Guide, 1988). Prior to the ANOVA, univariate analysis was used to check the data for possible disagreements with the assumptions of ANOVA (Steel and Torrie, 1960; Fernandez, 1992).

For the experiment on the effects of irrigation, crop load and urea fertilizer (nitrogen) on the stem-end splitting of 'Gala' apples, data were analyzed as split-plot designs. Irrigation was the main plot and variation between blocks within irrigation [block(irrigation)] was the main plot error term. Factorial combinations of crop load and nitrogen were the sub-plot and the sub-plot error term was block(irrigation\*cropload\*nitrogen). It is important to note that one feature of the split-plot design is that it results in reduced accuracy on the main plot treatment and increased accuracy on the sub-plot treatments and interactions because of the different error terms employed to test main plot, sub-plot and interaction effects (Mead and Curnow, 1983; Gomez and Gomez, 1984). Main treatment means were compared using the Least Significant Difference (LSD) test (SAS, 1988).

Data from the experiments on the effects of four irrigation treatments on the stem-end splitting of 'Royal Gala' apples were analyzed according to a randomized complete block design (RCBD) (John, 1971; Mead and Curnow, 1983; Gomez and Gomez, 1984). To determine treatment effects on the mechanical properties of 'Gala' and 'Royal Gala' apples, the data from all three harvests were combined. Treatment means were compared using Duncan's multiple range test (Duncan, 1955; SAS, 1988).

For the analyses to evaluate the effects of stem-end splitting on fruit properties of 'Gala' and 'Fuji' apples, the data on good and damaged fruit of each cultivar was subjected to standard t-test (Cochran and Cox, 1957; Cody and Smith, 1987). The SAS statistical package was used for all analyses.



## 5.4 Results

### 5.4.1 Effects of Irrigation, Crop Load and Nitrogen on the Mechanical and Physico-chemical Properties of 'Gala' Apples

The treatment effects on fruit properties are presented in **Table 5.1**. None of the three management practices had a significant effect on the fruit-stem adhesion force and skin bursting stress. However, the application of foliar nitrogen fertilizer significantly ( $P \leq 0.05$ ) reduced skin firmness while the effects of irrigation and crop load treatments were not significant.

Both irrigation and crop load treatments significantly affected the flesh crushing stress of fruit. Frequent irrigation lowered flesh crushing stress significantly while low crop load increased it. Nitrogen fertilizer had no significant effect ( $P > 0.05$ ).

Whole fruit firmness was significantly affected by crop load and nitrogen fertilizer while the irrigation treatment had no significant effect. Low crop load increased whole fruit firmness while nitrogen lowered it. Similarly, low crop load also increased firmness while the irrigation and nitrogen treatments had no significant effect ( $P > 0.05$ ).

Both the irrigation and crop load treatments had significant effects on the sugar content of fruit ( $P \leq 0.05$ ). Low crop load significantly increased SSC while frequent irrigation lowered it. On the other hand, the foliar nitrogen sprays had no significant effect on SSC.

### 5.4.2 Effects of Stem-end Splitting on the Mechanical and Physico-chemical Properties of 'Gala' Apples.

The results are presented in **Table 5.2**. One consistent significant effect for each harvest date and when the data for all harvests were combined was the higher force required to detach the stem in fruit with stem-end splitting. Both whole fruit firmness and flesh firmness were also lower in stem-end split fruit and this effect was significant for harvests one and three, and

when all harvests were combined.

**Table 5.1** Effects of Orchard Management Practices on Fruit Mechanical and Physico-chemical Properties of 'Gala' Apples (Sample size = 192).

Fruit Property	Management Practices					
	Irrigation*		Crop Load		Fertilizer	
	Frequent	None	High	Low	Nitrogen	None
<b>Adhesion</b>						
Force (N)	42.29a	41.83a	42.10a	42.03a	41.58a	42.55a
<b>Skin Bursting</b>						
Stress (kPa)	962.82a	969.65a	968.26a	964.21a	963.39a	969.07a
<b>Skin Firmness</b>						
(N)	19.79a	19.29a	19.33a	19.75a	18.87b	20.11a
<b>Flesh</b>						
Crushing Stress (kPa)	779.63b	800.47a	778.32b	801.78a	785.63a	794.48a
<b>Whole Fruit</b>						
Firmness (N)	65.06a	65.09a	64.38b	65.77a	64.47b	65.69a
<b>Flesh</b>						
Firmness (N)	45.27a	45.81a	45.05b	46.02a	45.50a	45.57a
SSC (Brix)	12.25b	12.94a	12.28b	12.91a	12.42a	12.28a

**Note**

\*Levels of treatment means followed by different letters are significantly different ( $P \leq 0.05$ )

There was no significant difference in the skin firmness of good and stem-end split fruit for each harvest date and when the data were combined. Similarly, the SSC of good and affected fruit was not statistically different.

**Table 5.2** Comparison of the Mechanical and Physico-chemical Properties of Good and Stem-end Split Fruit of 'Gala' Apples at Three Harvest Dates<sup>#</sup>.

Harvest Date and Type of Fruit	Stem Adhesion Force (N)	Skin Firmness (N)	Flesh Firmness (N)	Whole Fruit Firmness (N)	Flesh Crushing Stress (kPa)	Soluble Solids (°Brix)
<b>14/2/91</b>						
Good	42.08b	21.13a	48.22a	69.35a	792.13a	11.98a
Split	58.78a	19.33a	40.70b	60.12b	642.60b	12.11a
<b>25/2/91</b>						
Good	41.11b	18.92a	44.93a	63.85a	745.20a	12.61a
Split	57.46a	20.05a	44.80a	64.85a	737.91a	12.40a
<b>6/3/91</b>						
Good	43.00b	18.57a	43.46a	62.03a	725.43a	12.75a
Split	59.08a	19.12a	40.56b	59.68b	703.70b	12.55a
<b>Mean<sup>@</sup></b>						
Good	42.06b	19.54a	45.54a	65.08a	754.25a	12.44a
Split	58.80a	19.29a	41.24b	60.53b	694.74b	12.46a
	***	NS	*	*	*	NS

<sup>#</sup>For each fruit property, means on each harvest date followed by different letters are significantly different at  $P \leq 0.05$ .

<sup>@</sup>Significantly different at  $P \leq 0.001$  (\*\*\*),  $P \leq 0.05$  (\*) and not different (NS).

### 5.4.3 Effects of Four Irrigation Treatments on Mechanical and Physico-chemical Properties of 'Royal Gala' Apples

The results are presented in Table 5.3. In general, fruit size increased gradually from the low water treatment to the high water treatment and both medium and high water treatments increased fruit weight significantly ( $P \leq 0.05$ ) more than low or low-to-high water. There were no significant differences between the mean fruit weights of medium and high water, and low and low-to-high water, respectively.

None of the irrigation treatments had a significant effect on fruit-stem adhesion force, skin firmness, skin bursting stress and flesh crushing stress. However, flesh crushing stress decreased gradually from the low water treatment towards the high water treatment. Furthermore, there were no treatment effects on whole fruit firmness and flesh firmness but fruit soluble solids concentration (SSC) was significantly affected. Both the low water and low-to-high water treatments increased SSC significantly ( $P \leq 0.05$ ) compared to medium and high water and there were no significant differences between the low and low-to-high water, and the medium and high water treatments, respectively.

### 5.4.4 Effects of Stem-end Splitting on the Mechanical and Physico-chemical Properties of 'Fuji' Apples

Due to obvious size differences observed in random samples of good and split 'Fuji' apples, both fruit weight and mean cheek diameter of the two samples were compared in a t-test. Fruit weight, mean diameter and stem detachment force of stem-end split fruit were significantly higher ( $P \leq 0.05$ ) than those of good fruit during harvest two and when data for both harvests were combined (Table 5.4). However, none of these three characteristics were significantly different during the first harvest.

Whole fruit firmness, flesh firmness and skin firmness of fruit with stem-end splitting were not significantly different compared with fruit without the defect ( $P > 0.05$ ), although both

properties were slightly lower in affected fruit than in good fruit (Table 5.5). Both skin bursting stress, flesh crushing stress and soluble solids content were significantly less in stem-end fruit than in good fruit.

**Table 5.3** Effects of Four Irrigation Treatments on the Mechanical and Physico-chemical Properties of 'Royal Gala' Apples (Sample Size = 300).

Fruit Property <sup>#</sup>	Irrigation Treatment			
	Low	Low-to-high	Medium	High
Weight (gm)	130.77b	133.29b	139.65a	141.80a
Adhesion Force (N)	50.74a	50.03a	50.48a	50.33a
Skin Bursting Stress (kPa)	1010.79a	1016.01a	1007.52a	1014.44a
Skin Firmness (N)	23.08a	22.26a	22.47a	23.05a
Flesh Crushing Stress (kPa)	894.08a	893.85a	886.76a	864.42a
Whole Fruit Firmness (N)	75.26a	74.24a	75.26a	75.12a
Flesh Firmness (N)	52.18a	51.97a	52.79a	52.06a
SSC (Brix)	13.96a	14.00a	13.56b	13.25c

**Note**

<sup>#</sup>Treatment means followed by different letters are significantly different ( $P \leq 0.05$ ).

**Table 5.4** Comparison of the Size, Stem Adhesion Force and Skin Mechanical Properties of Good and Stem-end Split Fruit of 'Fuji' Apples.

Property <sup>#</sup>	Harvest One (6/3/91)		Harvest Two (24/4/91)		Mean	
	Good Fruit	Split Fruit	Good Fruit	Split Fruit	Good Fruit	Split Fruit
Weight (gm)	273.35a	269.98a	253.09b	272.58a	263.22b	271.28a
Diameter (mm)	86.00a	85.83a	82.95b	86.60a	84.48b	86.21a
Stem Adhesion (N)	34.47a	33.74a	36.19b	45.41a	35.33b	39.57a
Skin Firmness (N)	21.28a	21.05a	19.49a	19.34a	20.39a	20.19a
Skin Bursting Stress (kPa)	841.34a	796.63b	760.41a	696.12b	800.88a	746.37b

Notes

<sup>#</sup>Means on each harvest date followed by different letters are significantly different at  $P \leq 0.05$

**Table 5.5** Comparison of the Flesh Firmness, Crushing Stress and Soluble Solids Concentration of Good and Stem-end Split Fruit of 'Fuji' Apples.

Property <sup>#</sup>	Harvest One (6/3/91)		Harvest Two (24/4/91)		Total Harvests	
	Good Fruit	Split Fruit	Good Fruit	Split Fruit	Good Fruit	Split Fruit
Whole Firmness (N)	59.41a	58.84a	54.89a	54.39a	57.15a	56.61a
Flesh Firmness (N)	38.12a	37.79a	35.40a	35.05a	36.76a	36.42a
Crushing Stress (kPa)	948.28a	854.13b	956.95a	864.46b	952.61a	859.30b
Soluble Solids (Brix)	14.65a	14.51a	13.95a	13.24b	14.30a	13.88b

**Notes**

#Means on each harvest date followed by different letters are significantly different at  $P \leq 0.05$

Both the maximum deformation, failure stress, and strain were significantly less in stem-end split fruit than in good fruit ( $P \leq 0.01$ ). On the other hand, the modulus of elasticity of split fruit was significantly higher ( $P \leq 0.001$ ) as shown in **Table 5.6**.

**Table 5.6** Flesh Tensile Properties of Good and Stem-end Split Fruit of 'Fuji' Apples

Tensile Property	Good Fruit	Stem-end Split Fruit	Level of Significance
Maximum Deformation (mm)	3.1 ± 0.1 <sup>&amp;</sup>	2.3 ± 0.1	0.001
Failure Stress (kPa)	1.6 ± 0.1	1.5 ± 0.1	0.01
Failure Strain	0.08 ± 0.002	0.06 ± 0.002	0.001
Modulus of Elasticity (kPa)	21.7 ± 0.6	26.7 ± 0.6	0.001

**Note**

<sup>&</sup>Mean ± standard error of the mean.

## 5.5 Discussion

### 5.5.1 Effects of Orchard Management Factors on the Mechanical Properties of 'Gala' Apples

None of the irrigation, crop load and nitrogen treatments in the 'Gala' experiment had significant effects on the amount of force required to detach the stem from the fruit (Table 5.1). These results indicate that the stem detachment force was not affected by those factors which increase the amount of stem-end splitting namely; namely frequent irrigation and (to a lesser extent) low crop load (Section 4.4 of Chapter Four). Therefore, they may not be related to fruit susceptibility to stem-end splitting. The original hypothesis that prompted this mechanical test was that since stem-end splitting was always preceded by an internal ring-



crack near the stem (Section 4.4.3 of Chapter Four), the presence of such physical defect or any factors causing it would weaken the fruit-stem adhesion. Therefore, the force required to detach the stem may provide a measure of the mechanical stresses of the tissues in this region.

The fact that split fruit had a higher stem detachment force does not support this hypothesis. This further suggests that any possible alterations in the mechanical strength of the fruit-stem adhesion are a consequence of the presence of the ring-cracks and/or stem-end splits and not due to those treatments which may have caused them *ab initio*.

Skin bursting stress and skin firmness of 'Gala' apples were not significantly affected by the irrigation and crop load treatments. However, nitrogen reduced skin firmness significantly (Table 5.1). This result has an important implication on the mechanism of stem-end splitting in apples because results obtained in Chapter Four showed that both frequent irrigation and low crop load promoted higher incidence of stem-end splitting and internal ring-cracking (Section 4.4.1), while nitrogen had no effects. Contrary to the results on skin-cracking in apples (Shutak and Schrader, 1948), splitting in grape berries (Lustig and Bernstein, 1985; Bernstein and Lustig, 1985), and tomatoes (Frazier, 1934; Reynard, 1960; Voisey et al., 1964 and 1970; Voisey and Lyall, 1965a,b; Batal et al., 1970; Hankinson and Rao, 1979), the evidence from the present study suggests that stem-end splitting may not be related to the strength of fruit skin. This could well be the case because unlike the other types of fruit cracking in apples and other fruit which originate on the skin, the fact that stem-end splitting in apples is preceded by internal ring-cracking of the underlying flesh suggests that it occurs by an entirely different mechanism, perhaps, not directly related to such surface properties as skin strength. This argument is further supported by the inconsistent relationships in the literature between nitrogen and fruit cracking in other apple cultivars (Stiles et al., 1959; Montgomery, 1959; Tomana, 1961; Weissenborn and Gottwald, 1965; Shear, 1971).

Frequent irrigation reduced flesh strength significantly (Table 5.1), and as shown earlier in Chapter Four of this thesis, the only management practice which significantly increased the amount of stem-end splitting and internal ring-cracking was frequent irrigation (Section 4.4.1). These results indicate that any management factor which reduces the flesh crushing stress

significantly in 'Gala' apples is apt to increase the amount of internal ring-cracking and stem-end splitting. In addition, the results also indicate that the flesh crushing stress measured by the Massey Twist Test could provide a useful measure of the degree of mechanical stressing of the fruit. With further refinements, this could provide a rationale research tool for assessing fruit response to treatments aimed at reducing or controlling stem-end splitting, and for monitoring susceptibility to stem-end splitting during the season. The criterion would be that fruit susceptibility to stem-end splitting is inversely related to the flesh crushing stress during growth and development.

The effects of crop load on flesh crushing stress was less clear than that of irrigation. Low crop load increased flesh crushing stress of fruit (Table 5.1) although it also slightly increased ( $P > 0.05$ ) the incidence of both ring-cracking and stem-end splitting (Chapter Four). These inconsistent results of low crop load may be related, in part, to its effects on fruit size. As shown in Section 4.4 of Chapter Four, only the low crop load treatment increased fruit weight significantly (Table 4.1), and there were significant positive correlations between normalized percentage stem-end splitting and fruit weight (Table 4.4).

Thus, these different effects of crop load on stem-end splitting, fruit size and flesh crushing stress may be associated with the effects of size and number of cells which combine differently to determine fruit size and quality (Westwood, 1978). Bain and Robertson (1951) reported from Australia that large apples had more and not larger cells than small fruit from the same tree. Also, large fruit from light-cropping trees always had larger cells than did smaller fruit from heavy-cropping trees and sometimes contained fewer cells than small fruit from heavy-cropping trees. In England, Denne (1960) found that heavy pre-bloom thinning of apples resulted in larger fruit, in part because the cells were larger but mostly because there were more cells per fruit. The results of Westwood et al. (1967) in the United States generally agree with Bain and Robertson that large fruit usually have more cells than small ones from the same tree and that early thinning usually stimulates cell division and sometimes cell enlargement. Although evidence from the literature does not explain the role of cell size and number on fruit mechanical properties, it seems likely that the insignificant effect of low crop load on the incidence of stem-end splitting despite significant increases in fruit size (Table 4.1) may be related to its effect in increasing flesh crushing stress since large fruit size was

also found to be significantly correlated with higher incidence of stem-end splitting (Table 4.4).

The reduction of whole fruit firmness by nitrogen (Table 5.1) and the insignificant effect of nitrogen on the amount of stem-end splitting (Table 4.1) supports the previous discussion on similar effects of nitrogen on skin bursting stress and skin firmness which suggested that skin strength may not be a critical factor in susceptibility to stem-end splitting. The significantly higher whole fruit firmness of split fruit compared with good fruit (Table 5.2) despite the fact that this attribute was not significantly affected by frequent irrigation (which increased stem-end splitting significantly, see Table 4.1) therefore, suggests that this effect may have been a more direct consequence of the presence of splits on fruit. Another important implication of these results is that they question the sensitivity of testing intact fruit with a penetrometer as a reliable method of measuring fruit response to internal and external loads in relation to stem-end splitting and similar defects which may be more related to internal or flesh properties of fruit strength.

Frequent irrigation treatment significantly reduced sugar content (Table 5.1). This result may have been caused by an osmotic dilution of the contents of fruit following long durations of water intake. Low crop load increased fruit soluble solids content and it is likely that this effect may be due partly to reduced competition for available nutrients, a condition which is known to stimulate cell division in the remaining fruit, resulting in increased growth activities which in turn enhances the accumulation of solutes in trees bearing a light crop (Westwood, 1978).

### **5.5.2 Effects of Irrigation Treatments on the Mechanical Properties of 'Royal Gala' Apples**

Fruit size (weight) increased with increasing levels of water treatment (Table 5.3) and the highest increase in fruit size was due to the high water treatment. Although there was a generally low incidence of stem-end splitting and ring-cracking in the experimental blocks during the season (2.9% and 6.3%, respectively) as shown earlier in Chapter Four (Section

4.4), the high water treatment alone accounted for 50% and 36%, respectively, of the total amount of split and ring-cracked fruit. These results agree with the conclusion on 'Gala' apples in Chapter Four (Section 4.6) that management factors which enhanced fruit size contributed to increased stem-end splitting.

No treatment had a significant effect on the force required to detach the stem from fruit. This result suggests that similar to 'Gala' apples, fruit-stem adhesion force of 'Royal Gala' may not be a good indicator of the mechanical stressing of fruit in relation to the occurrence of stem-end splitting. Similarly, none of the four irrigation treatments had a significant effect on skin bursting stress. This result agrees with those obtained with 'Gala' apples in this thesis, and indicates that the watering regimes applied in this study have insignificant effects on skin bursting stress. Furthermore, the fact that frequent watering (or high water) reduced flesh strength and increased stem-end splitting in both 'Gala' and 'Royal Gala' clearly suggests that flesh strength is critical to stem-end splitting and that the strength of fruit skin may not be a good measure of its susceptibility to stem-end splitting in the varieties studied.

Likewise, skin firmness was not significantly affected by any of the water treatments. The fact that the high water treatment which produced the greater amount of fruit splitting had no significant effect on skin firmness (Table 5.3) supports the earlier conclusion that this property is less likely to be crucial to susceptibility to stem-end splitting.

No treatment had a significant effect on flesh crushing stress (Table 5.3). This result reflects also the low incidence of stem-end splitting (2.9%) in the 'Royal Gala' trial contrary to the results obtained in 'Gala', and suggests that the water treatments did not stress the plants sufficiently to induce stem-end splitting. Similar explanations may also account for the insignificant treatment effects on whole fruit firmness and flesh firmness. On this basis, it is perhaps not surprising that even the high water treatment did not have any significant effects on flesh crushing stress although it accounted for nearly 50% of the total split fruit in the trial block.

There was a significant effect of the water treatments on fruit soluble solids concentration (SSC) and the low and low-to-high water treatments increased SSC ( $P \leq 0.05$ ) compared to

medium and high water (Table 5.3). In addition, there were no significant differences between low and low-to-high water on one hand, and medium and high water on the other hand. These results reflect the water stress of the crop during the first harvest (31/1/91) as measured by the leaf water potential ( $L_{wp}$ ) presented in Table 4.5 of Chapter Four. This showed that there were no significant differences between the  $L_{wp}$  of the low and low-to-high water (-2.01MPa and -1.98MPa, respectively), while both the high and medium treatment had significantly lower negative  $L_{wp}$  (-1.65MPa and -1.80MPa, respectively).

All these results indicate less dilution of soluble sugars in the fruit under conditions of high water stress (high negative  $L_{wp}$ ). This result is similar to previous findings on the effects of water stress on fruit quality in 'Royal Gala' (Duran, 1990), and recently in 'Braeburn' apples (Mills et al. (1993), which showed that water deficit resulted in an increase in soluble solids.

### 5.5. Comparison of the Mechanical, Physical, and Chemical Properties of 'Gala' and 'Fuji' Apples With and Without Stem-end Splits

The difference in the mechanical properties of good and stem-end split fruit varied remarkably depending on the property considered. The significantly higher weight and diameter of stem-end split fruit (Table 5.4) are consistent with the significant positive correlation coefficients obtained in Chapter Four (Table 4.4) between fruit weight and stem-end splitting and ring-cracking in 'Gala' apples. These results indicate that stem-end splitting is affected by fruit size in the same way as cracking in other apple cultivars (Shutak and Schrader, 1948; Nilsson and Fernqvist, 1957; Watanabe et al., 1987). That is, within a susceptible cultivar, big fruit are more susceptible to splitting than small fruit. However, further studies would be required to ascertain whether this effect may be more directly related to higher level of maturity in big fruit than size effect alone.

Contrary to initial expectations, the force required to detach the stem was higher in stem-end split fruit (Table 5.2). This result suggests that the stem/apple joint is undamaged so the fruit will not fall off the tree or lose the stem during picking more easily than unsplit fruit. In fact, the reverse is likely to be the case. The significant increase in fruit-stem adhesion force may

be related to activities associated with wound (internal ring-crack) healing and aging in the affected tissues. It was shown earlier in Chapter Four (Table 4.3) that stem-end splitting was associated with a significant (nearly 21% increase) accumulation of Ca in fruit and this result is consistent with the evidence that mechanical wounding and corking disorders induce minerals to move into the affected parts (Faust and Shear, 1968; Faust et al., 1969).

Since Ca is known to strengthen cell-wall integrity and adhesion (Clarkson and Hanson, 1980), the significant increase in fruit-stem adhesion force in split fruit could, therefore, be attributed to the significant accumulation of the mineral as a secondary response to the development of internal ring-cracking and stem-end splitting. In cherries, several researchers have reported the phenomenon known as "firming" which occurred when fruit were bruised and aged (Wittenberger, 1952; Hills et al., 1953; Currier, 1957; LaBelle and Moyer, 1960; Buch et al., 1961; LaBelle et al., 1964; Dekazos and Worley, 1967; Lidster and Tung, 1979). The firming effect following damage was ascribed to the strengthening of intercellular "cement" and cell wall structures due to callose (plant cell constituent) formation. It seems plausible that the increase in fruit-stem adhesion force in split apples and the firming of sweet cherries due to mechanical damage occur by a similar mechanism although the physiological processes responsible for this effect are not known.

The values obtained for mechanical properties of fruit flesh were generally lower in stem-end split fruit than good fruit although the significance levels varied from cultivar to cultivar and the property considered. Both flesh crushing stress and whole fruit firmness were significantly less in split fruit of both varieties (Tables 5.2 and 5.3).

The generally lower flesh strength of fruit with stem-end splitting raises a major question: did the changes occur before or after splitting had occurred? If they occurred beforehand, then they are relevant factors to be considered in assessing fruit susceptibility to stem-end splitting. If they are an effect rather than a possible cause, then the change may not be relevant to the splitting mechanism. In the absence of experimental evidence, it is reasonable to assume that any fruit properties affected by the management factors which increased the incidence of stem-end splitting, may be related to the susceptibility to stem-end splitting, providing their measured values have also changed in the same way in split fruit. Therefore, both low flesh

crushing and flesh firmness may be considered conducive to fruit splitting.

There were inconsistent relationships between skin strength and stem-end splitting (Tables 5.2 and 5.4) and the only significant effect on SSC was a lower concentration in split 'Fuji' apples (Table 5.5). As suggested earlier in this Section, these results do not suggest a relationship between stem-end splitting and soluble solids concentration or skin firmness. However, the significant reduction in the sugar content of stem-end split 'Fuji' apples (Table 5.5) may have resulted from more rapid and sudden absorption of water by the fruit following the exposure of the flesh after splitting.

Both failure stress and failure strain of 'Fuji' apples were significantly less in stem-end split fruit compared to good fruit while the effect on Young's Modulus of elasticity was reversed (Table 5.6). Since Young's modulus of elasticity is a measure of the ability of a material to resist bending (Wilson and Archer, 1979; Chazdon, 1986), it appears that failure strain (stretchability) which reflects both elasticity and plasticity (Batal et al., 1970) should be more relevant to stem-end splitting. The results from this study suggest that fruit with stem-end splitting (high modulus of elasticity) had become relatively stiff and had a high resistance to bending (Chazdon, 1986), but had lost its ability to elongate because of the increased stiffness. The results obtained in this thesis were similar to those reported by Batal et al. (1970) who found no relationship between modulus of elasticity of skin and fruit cracking in tomatoes, but reported that ultimate force and breaking elongation showed inverse relationships to fruit cracking among several cultivars. In fact, the authors showed that among some tomato varieties, the modulus of elasticity increased as the percentage of radial and total cracked fruit increased.

In summary, this study showed that stem-end split fruit had less flesh crushing stress, firmness, and failure strain. Stem detachment force increased, and there were inconsistent effects on skin strength and soluble solids concentration across the three varieties studied. The decrease in flesh texture and increase in fruit detachment force was similar to that occurring in ripening or maturing fruit as shown elsewhere by Westwood (1978). In this respect, apples with stem-end splits may be regarded as more advanced physiologically than normal apples. Those mechanical properties (such as flesh crushing stress and firmness) which express these

changes consistently during maturation and in split fruit, and which were affected in a similar way by those orchard factors which increased stem-end splitting, are most probably critical to the stem-end splitting phenomenon.

Conversely, those mechanical and physico-chemical properties which also change with advancing fruit maturity (such as skin bursting stress, firmness and SSC) but which exhibit inconsistent relationships with the management factors and in split fruit are considered to be unlikely to be critical to fruit susceptibility to stem-end splitting. The fact that the fruit-stem adhesion force was not significantly affected by the management factors but was significantly increased in split fruit suggests that this strengthening effect is a secondary "firming" response which probably occurs after the significant accumulation of calcium (**Chapter Four, Section 4.4**) following the appearance of ring-cracks and/or stem-end splits.

## 5.6 Conclusions

This study investigated the relationships between orchard management practices, the incidence of stem-end splitting, and fruit mechanical properties. In this chapter, the effects of these management practices on fruit mechanical properties were studied. It has been shown that the factors which increased the amount of stem-end splitting (such as frequent irrigation) also reduced the mechanical strength of fruit flesh as measured by the flesh crushing stress and flesh firmness. Thus, watering regimes may affect the incidence of splitting by affecting the mechanical strength of the fruit tissue.

Nitrogen had no effect on stem-end splitting, but reduced the skin strength of fruit significantly. Thus, those treatments which mainly reduce skin strength may not affect the incidence of stem-end splitting, indicating that both flesh strength and skin strength are independent properties of the fruit with respect to stem-end splitting in apples, and that skin strength is not critical to stem-end splitting in apples.

Fruit size had a marked effect on the stem-end splitting of 'Fuji' apples. Comparison of good



and stem-end split fruit showed that larger fruit are more susceptible to splitting than smaller fruit. Earlier in Chapter Four (Section 4.4), it was shown that high water treatments increased fruit weight and also caused more stem-end splitting in both 'Gala' and 'Royal Gala' apples. These results and the significantly higher fruit weight of split 'Fuji' apples supported the view that within a susceptible cultivar, larger fruit were more prone to stem-end splitting than smaller fruit.

Fruit with stem-end splits had lower flesh crushing stress and soluble solids concentration due probably to the acceleration of physiological processes associated with maturity and a dilution of solutes following the exposure of fruit flesh. In this respect, apples with stem-end splits are considered to be more advanced physiologically than normal fruit.

The fruit-stem adhesion force did not provide a reliable measure of the tendency of fruit to split because the stem detachment force was not affected by the orchard management practices which increased fruit susceptibility to stem-end splitting. It has been argued that the increase in stem detachment force of fruit with stem-end splits was probably a consequence of the accumulation of calcium and other cell wall strengthening materials in damaged fruit.

Finally, this study has provided an increased understanding of the stem-end splitting phenomenon with respect to the role of fruit mechanical properties. There is also a need to understand the period of onset and chronological development of stem-end splitting in relation to fruit growth and development during the season. Further research should be extended towards an understanding of the growth patterns and the development of growth stresses in individual fruit. These possibilities were explored in the following chapters.

## CHAPTER SIX

### FRUIT GROWTH, GROWTH STRESS, AND THE CHRONOLOGICAL DEVELOPMENT OF STEM-END SPLITTING IN 'GALA' APPLES.

#### 6.1 Introduction

There is considerable literature on the growth and development of apple fruit. These include studies on several aspects of the physiology of growth such as the relation of cell division, cell size, cell number, and cell shape to developing fruits (Tetley, 1931; Tukey and Young, 1942; Smith 1950; Bain and Robertson, 1951; Robertson and Turner, 1951; Martin and Lewis, 1952; Pearson and Robertson, 1953 and 1954; McKee and Urbach, 1953; Martin et al., 1954; Blanpied and Wilde, 1968; Westwood, 1978).

The development of apple fruit in relation to climatic, non-climatic and tree factors affecting it have also been studied (Westwood, 1962; Westwood and Blaney, 1963; Denne, 1963). Westwood (1962) showed that very young fruit of 'Delicious' apple were distinctly elongated but became more flattened as they grew, the ultimate shape being determined about 100 days after full bloom.

Over the years, the rate of fruit enlargement has been used as an index of tree response to various orchard management factors and the value of such fruit measurements as an aid in interpreting environmental influences is quite evident (Harley and Masure, 1938). For instance, according to Askew (1935), there is a distinct tendency for fruit to increase in weight and diameter after heavy rain and for a slight slowing down of growth during relatively dry periods. With reference to the phenomenon of stem-end splitting in apples, knowledge of the fruit growth pattern could be particularly relevant to the understanding of the mechanism by which certain environmental and management factors such water supply predispose and/or increase the susceptibility of fruit to split.

During fruit growth and development, growth stresses are likely to be present at any time due to the processes of cell expansion and elongation. The presence of stress can be important in relation to the development of physical defects such as russetting and cracking. Verner (1938) made reference to the limit of extensibility of the hypodermal layer of Stayman Winesap apples and suggested that a greater imbalance in the growth of the inner and outer tissues may explain the susceptibility of Stayman apples to cracking. Shutak and Schrader (1948) referred to the smooth cuticle of York Imperial apples being more resistant to the stress caused by the internal increase in volume.

Apparently, any cracking or splitting of fruit would involve stress, as pointed out in the preceding chapter. According to Skene (1980), splitting occurs when stress causes cells or tissues to be strained (or stretched) beyond their yield point, and it was also noted that for stress to develop in fruit, the tissues must be elastic and growth must be unevenly distributed. Skene suggested that especially in cherries which remain wet from rain or washing, the resulting expansion of the inner tissues gives rise to splitting unless the skin can grow or stretch enough to accommodate the expansion or unless the skin can withstand sufficient stress to resist the uptake of water. If neither of these two conditions holds then the skin splits when its yield point is reached.

Size and shape have been associated with susceptibility to various forms of cracking and splitting in fruits. For instance, in tomatoes, Thompson et al. (1962) concluded that the fruit shape of the variety Roma undoubtedly has an important influence on the measured high resistance to both radial and concentric cracking. Frazier (1951) found good resistance to cracking in a tomato stock with wide calyx base and thick lobes. It has also been suggested that cracking and splitting may arise from internal pressure created by the growth of deeper cell layers (Wertheim, 1982). In nectarines, Fogle and Faust (1975) suggested that relative growth rates at certain stages of fruit development might explain differences in the amount of fruit surface cracking observed in the field and of minute cracking seen under a scanning electron microscope.

The foregoing review demonstrates that an understanding of the degree of interrelatedness of fruit size, shape, growth rates, growth stress and the distribution of growth on a fruit surface

may provide clues to identifying the critical growth periods of fruit in relation to the development of stem-end splitting. Knowledge of fruit growth characteristics could also provide some explanation as to why only certain fruits on a tree may split or why there was a high variability of stem-end splitting incidence even within trees that received the same treatments in Chapter Four (Section 4.4).

Therefore, the present research was initiated to quantify the growth characteristics of 'Gala' apples and to identify any differences in growth at the stem-end, cheek and calyx-end which might shed light as to why the splitting is confined to the stem-end of fruit. The specific objectives of the studies were:

1. to evaluate the growth characteristics of 'Gala' apples in relation to the onset of internal ring-cracking and stem-end splitting;
2. to determine the distribution of growth on the fruit surface along the stem-calyx axis; and
3. to investigate the development of growth stresses in fruit during the growth season.

## 6.2 Materials and Methods

The experiment was set up in the same commercial orchard used in the preceding chapter to study the effects of management practices on stem-end splitting of 'Gala' apples. In the present study, the trees received normal management treatments during the season. Rainfall, irrigation and spray dates were recorded. Fruit samples were collected from the same block of 32 trees to assess the onset and chronological development of stem-end splitting. Each tree was sampled at the lower, middle and top branches of the inner and outer canopy.

For fruit growth measurements, two trees in adjacent rows which received frequent water treatment the previous season (1990-1991) were selected because of their high incidence of

stem-end splitting. Fruit used for measuring growth rates were selected from the middle and lower branches of the outer canopy in order to minimize obstructions during measurements.

When choosing fruit to be tagged for growth measurement, any king fruit (arising from the terminal flower of the inflorescence) or clearly small fruit in the cluster were removed leaving the large fruitlets. This procedure was adopted so as to minimize the chances of fruit dropping. However, this meant that the fruit measured were not necessarily representative of the whole crop, but mainly of the larger and commercially more valuable crop.

### *6.2.1 Chronological Development of Stem-end Splitting*

On each sampling date, over 700 apples were randomly hand-picked with stalk intact and used to evaluate the presence of stem-end splitting and internal ring-cracking. All fruit were picked between 8 am to 12 noon, transported to the laboratory at Massey University and examined within 24 hours. Fruit samples were picked at two-week intervals initially, commencing on the 45th day after full bloom (DAFB), and later at weekly intervals. A random sample of 600 apples were used to determine the incidence of stem-end splitting. Each fruit was assessed by examining the stem-end under normal daylight in the laboratory. Only fruit with visible splits at the stem-end were counted and the incidence of splitting was determined as the percentage of the total fruit sample.

The development of internal ring-cracking was assessed one day after harvest. Additional fruit were added to the samples used for mechanical testing to obtain a sample of 600 fruit on each date. Each fruit was cut into two halves along the longitudinal axis and examined for the presence of a ring-crack. Each half was further cut only if the first cut did not reveal a ring-crack. Fruit with ring-cracks were counted and expressed as the percentage of the total fruit examined.

### **6.2.2**            *Non-destructive Measurement of Whole Fruit Growth*

A random sample of 18 fruit was selected and tagged on November 15, 1991 (45 DAFB). Each fruit was marked with Indian ink at two points, one along the cheek and the other on the shoulder. Fruit length and diameter were measured using a Vernier calliper. Both the length and diameter of each fruit were measured twice, one at the point marked and again on the opposite side.

Measurements were made at two-week intervals initially and later at weekly intervals after the onset of stem-end splitting. At the end of the experimental period, the data on fruit which had fallen off the tree during the season were discarded and the measurements on the remaining 11 fruit were used to analyze the growth of the apples.

### **6.2.3**            *Measurement of Stem-end Cavity Depth*

Stem-end cavity depth was measured from the union of flesh and the stem to the point at which a razor placed on the apple shoulder touched a V-shaped thin cardboard paper which was inserted into the fruit cavity. This shape of the cardboard paper enabled measurements to be taken with minimum disturbance to the fruit-stem joint.

### **6.2.4**            *Distribution of Fruit Growth*

The distribution of growth along the fruit axis was measured by marking intact growing fruit at the stem-end, cheek and calyx-end using a 4-mm diameter cork borer. Different samples were used to measure growth at each part of fruit. Initially, samples of 18 fruit were selected and at the end of the experiment, only fruit which did not fall off were used for analyzing growth. This resulted in a total of 13, 11, and 15 fruit marked at the stem-end, cheek, and calyx-end, respectively.

Figure 6.1 shows an example of how the marks were made on fruit and the appearance of a mark on growing fruit after 70 days. Measurements were made at the outer parts of the mark, and each mark was measured in the transverse and longitudinal directions. A Vernier calliper was used for measuring the size of the marks.

### **6.2.5**            *Measurement of Fruit Growth Stress*

A sample of 20-23 fruit were hand-picked with stalk intact between 7 am and 8 am on each sampling date and tested immediately in the field. Fruit maximum diameter and length were measured with Vernier callipers, and elastic strain was assessed from the gape of deep cuts in the fruit. Transverse (equatorial) and longitudinal (axial) cuts were made at right angles through to the centre of the fruit with a razor blade and the gape of both cuts were measured at the widest point as shown in Figure 6.2.

The width of each gape was measured twice with Vernier callipers under a magnifying lens, immediately after the cutting and after thirty minutes, since the split is apt to widen as time elapses (Sawada, 1934). The mean of the two measurements was used to represent the amount of gape in the whole fruit. Although the Gape test measures strain, the amount of gape was considered as a reliable index of the tensile stress in the corresponding axis of fruit by assuming that stress is proportional to strain (Sawada, 1934; Skene, 1980 and 1982a,b; Hatfield and Knee, 1988).

## **6.3**            **Data Analysis**

### **6.3.1**    *Fruit Shape and Growth Dynamics*

Whole fruit shape was calculated as the length:diameter ratio (L/D). According to Westwood (1978), this non-destructive expression of shape may be thought of as *relative* fruit length: the higher the value, the more elongated is the fruit. The difference between fruit diameter

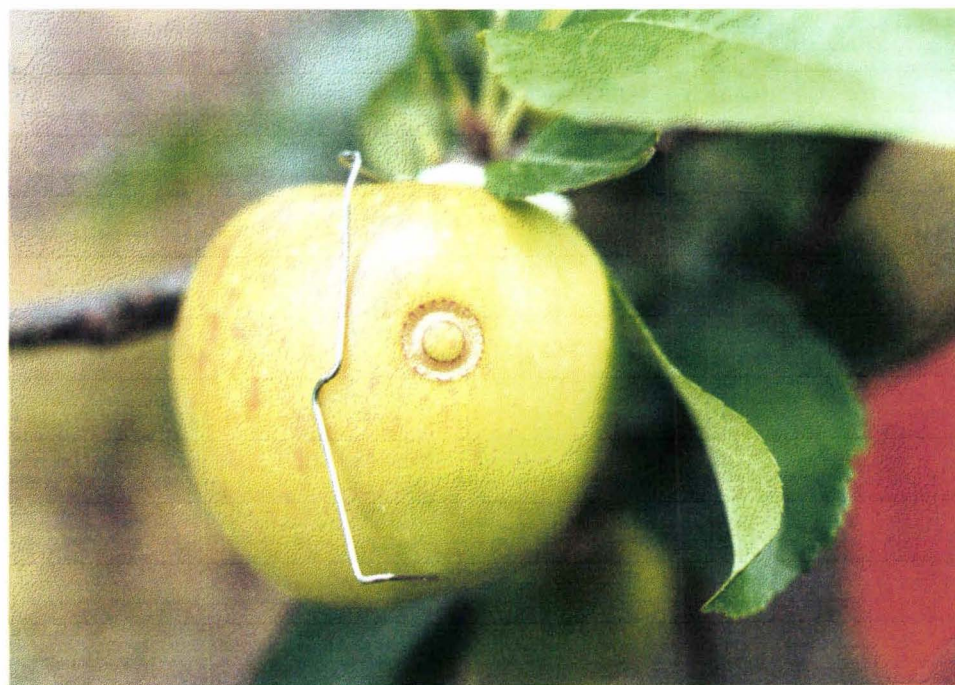
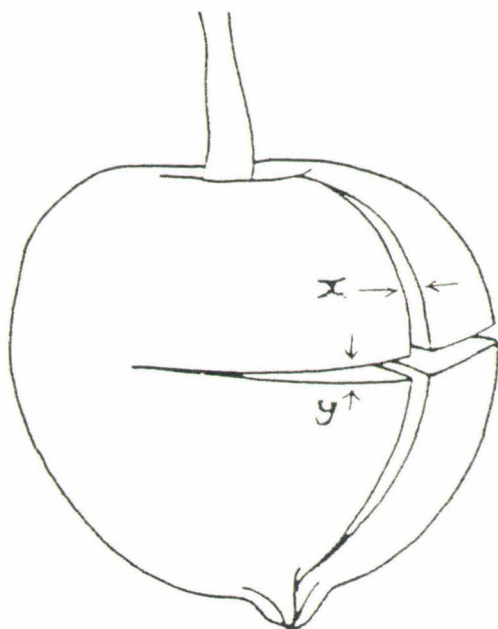
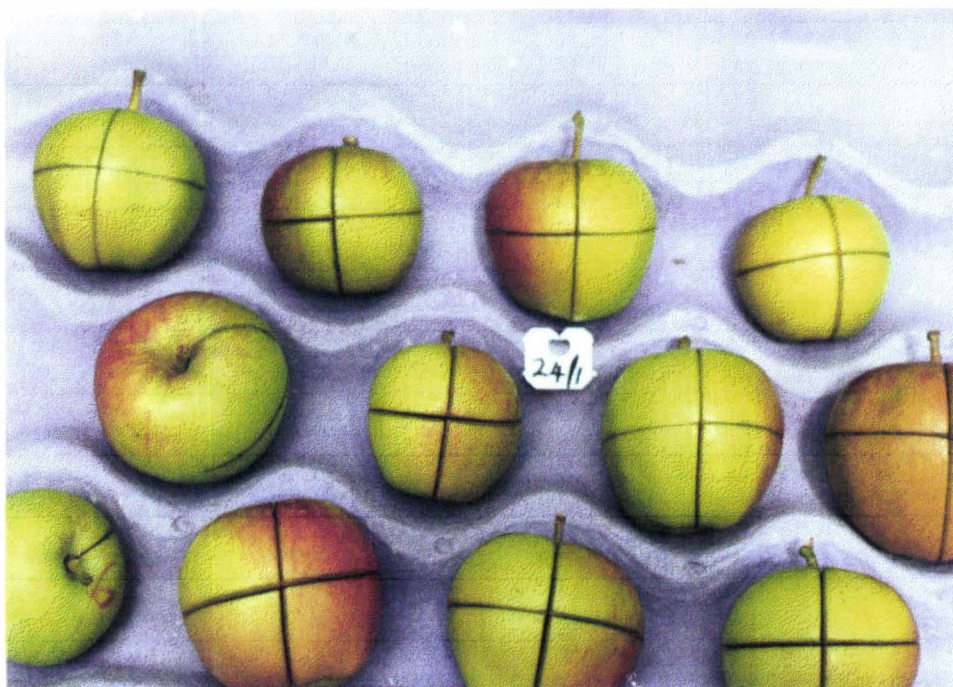

Figure 6.1 Photographs showing : [top] how marks were made to measure the distribution of growth on fruit, and [bottom] the appearance of a mark after 70 days.





x = transverse strain from longitudinal cut  
y = longitudinal strain from transverse cut

Figure 6.2 Measurement of growth stress in fruit : [Top] photograph to show how cuts were made in fruit and [bottom] the measurements taken.

and length ( $D - L$ ) was also introduced as an index of fruit shape in the present study since it also provided a measure of the deviation from the initial shape at the start of the experiment. Stem-end cavity shape was derived from the cavity:diameter ( $C/D$ ) and cavity:length ( $C/L$ ) ratios of each fruit.

The longitudinal *length* ( $L$ ) and transverse *diameter* ( $D$ ) measurements of intact growing fruit were used to represent the cumulative growth ( $CG$ ) of fruit. Both measurements were plotted against days after full bloom (DAFB) to obtain fruit growth curves.

A description of total growth purely in terms of lineal dimensions clearly leaves out a great deal of information (Fogg, 1963), because it takes no account of changes in form which invariably accompany growth. Thus, quite different interpretations can emerge if data are calculated on different bases or if rates are made relative to a previous reference (Coombe, 1976). Therefore, the data obtained from the lineal growth measurements in the present study were subjected to further analysis using several growth rate functions.

The general characterization of growth dynamics, based on retrospective reconstitution of evolution (from full bloom to harvest) of the average length or diameter of the fruit is obtained through the absolute growth rate (AGR) (Magein, 1989). It is defined as the increase of plant material per unit of time (Radford, 1967). The instantaneous absolute growth rate at any time  $t$  can be written as  $dX/dt$  where  $X$  is the total size (e.g., length, diameter, weight). Absolute growth rate is therefore obtained as follows:

$$\text{AGR} = \frac{dX}{dt} = \frac{X_n - X_{n-1}}{t_n - t_{n-1}} \quad (6.1)$$

where  $X_n$  stands for the average size of the fruit (mm) at a present time  $t_n$  in days;

$X_{n-1}$  stands for the average diameter at time  $t_{n-1}$ .

The relative growth rate (RGR) has been noted to provide better information on the physiological performance of the organ (Volz, 1991), and at any instant in time ( $t$ ) is defined as the increase of plant material per unit of material present per unit of time (Radford, 1967).

$$\text{i.e., RGR} = \frac{1}{X} \cdot \frac{dX}{dt} = \frac{1}{X_n} \cdot \frac{X_n - X_{n-1}}{t_n - t_{n-1}} \quad (6.2)$$

The amount of new material produced by a plant depends both on relative growth rate and on the amount of growing material, so that actual growth is greatest after relative growth rate has already begun to decline (Fogg, 1963). The mean relative growth rate (MRGR) represents the efficiency of a plant as a producer of new material and was calculated according to the following equation (Hunt, 1982; Radford, 1967):

$$\text{MRGR} = \frac{\log_e X - \log_e X_0}{t_1 - t_0} \quad (6.3)$$

where  $X$  is the final size after growth for a period of time,  $t_1 - t_0$ , at the beginning of which the size was  $X_0$ .

Equations 6.1, 6.2 and 6.3 were used to calculate AGR, RGR, and MRGR for both fruit diameter and length, respectively.

### **6.3.2**            *Growth Stress*

Growth stress in fruit as measured by the width of gape (mm) was expressed as percentage of fruit size since it has been shown elsewhere that the amount of gape is affected by fruit size (Skene, 1980). The terminologies used to describe the growth stress in the vertical and horizontal axis of fruit are presented in Figure 6.2.

A standard t-test was conducted to evaluate the effect of time after cutting on the size of gape measured on fruit. Statistical analyses were carried out using the Statistical Analysis Systems (SAS) programmes (SAS, 1988) and graphs were plotted using Cgile (Version 3.2) graphics package (Pugmire, 1992).

## **6.4**     **Results**

### **6.4.1**            *Chronological Development of Stem-end Splitting in 'Gala' Apples.*

The percentage incidence of stem-end splitting and internal ring-cracking in the experimental orchard during the season is presented in Figure 6.3. Both defects were first observed on the same day on January 24, 1992, that is 115 days after full bloom and three weeks before the first commercial harvest of 'Gala' in the Hawke's Bay region.

After the onset, the percentage of ring-cracking increased rapidly while stem-end splitting increased more slowly initially and later rapidly. Throughout the fruit sampling period and on each harvest date, the amount of ring-cracked fruit was always higher than the amount of fruit with stem-end splitting. Both defects increased with advancing fruit maturity.

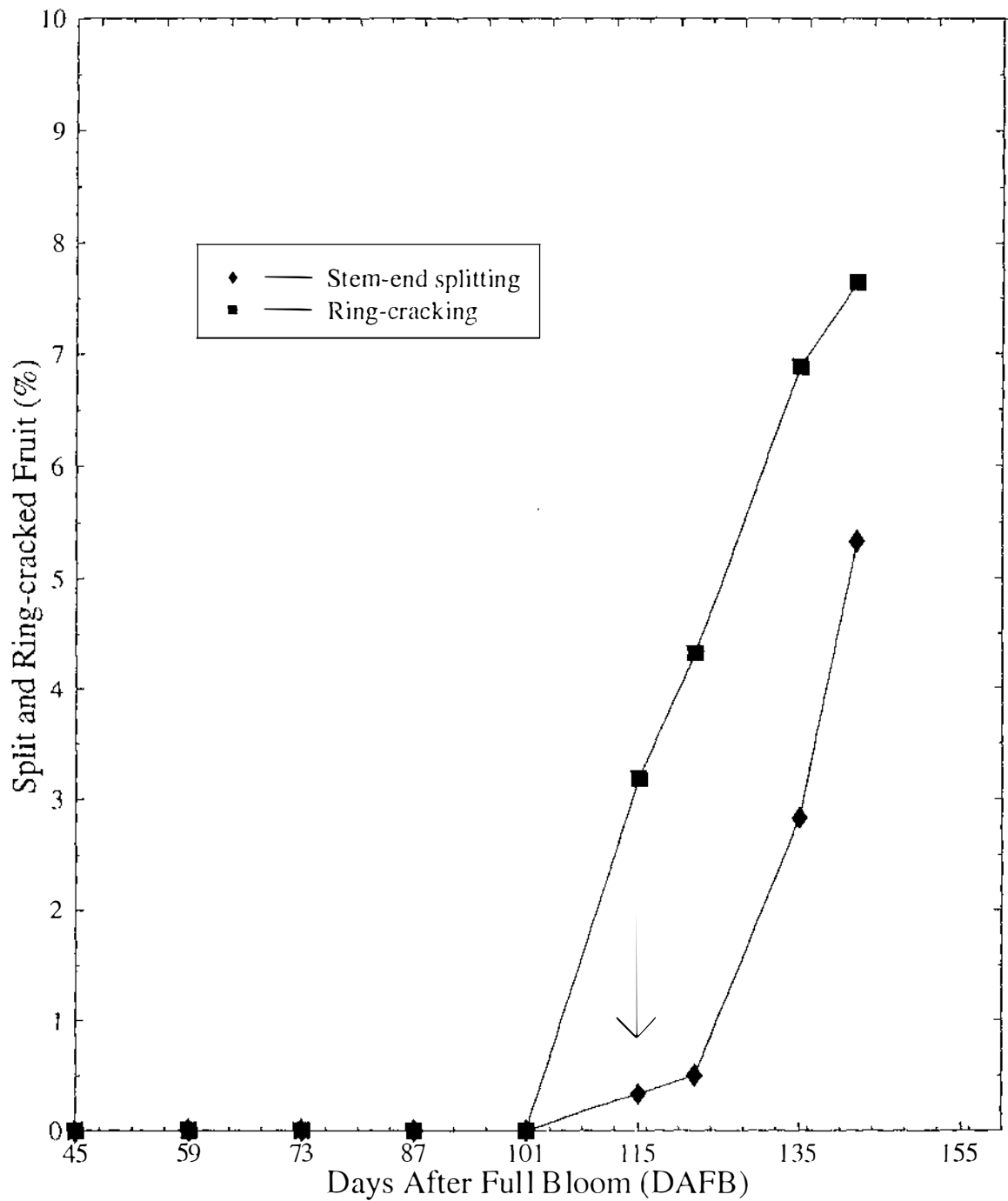

Figure 6.3 Development stem-end splitting and internal ring-cracking in the 'Gala' experimental orchard. Sample at each date = 600 fruit. Arrow indicates when both defects were first observed.

### 6.4.2 *Fruit Growth Stress*

Up to 59 days after full bloom, there was no measurable growth stress in fruit but this increased rapidly afterwards throughout the season (Figure 6.4). Longitudinal cuts gaped more than transverse cuts indicating that growth stress (elastic strain) was greatest in the transverse (equatorial) axis of fruit. The unusual rise at 87 DAFB may have been related to water or pesticide application as discussed later in the next section.

From Figure 6.4, the development of growth stress during the season can be classified into three distinct stages :

- (a) a period of no measurable growth stress from fruit set to about 60 DAFB;
- (b) rapid increase in growth stress in both transverse and longitudinal directions up to about 122 DAFB when longitudinal stress became equal to transverse stress;
- (c) general increase in growth stress throughout the harvest period in both the transverse and longitudinal axes of fruit.

Results of the t-test on the effect of the time of measurement on the gape size showed a significant increase ( $P \leq 0.001$ ) in gape between the time after cutting fruit (zero minutes) and 30 minutes later (Figure 6.5).

### 6.4.3 *Whole Fruit Growth Curves*

The cumulative growth of fruit during the season as measured by the increase in length and diameter is presented in Figure 6.6; and none of the measured fruit developed stem-end splitting. The first measurements were made on November 15, 1991 (i.e. 45 DAFB) when the average fruit length and diameter both reached about 27mm. Thereafter, both measurements increased rapidly through the week after the first commercial harvest date on 13/2/91 (i.e.

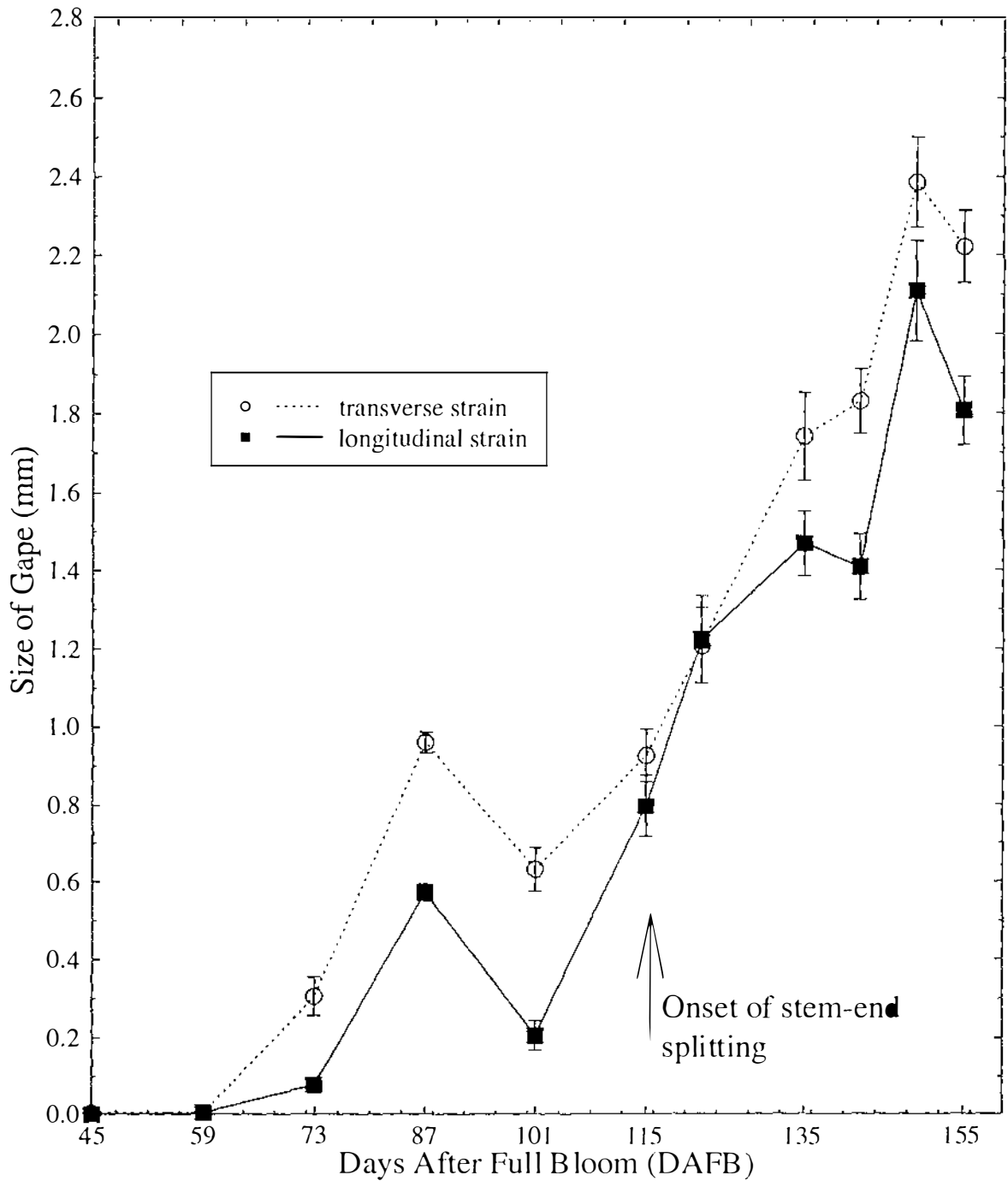

Figure 6.4 Growth stresses in 'Gala' apples during the season measured as strains. The line with circles shows transverse strain (gape of a longitudinal cut) and the other line shows longitudinal strain (gape of transverse cut). Vertical bars indicate standard errors of the means.

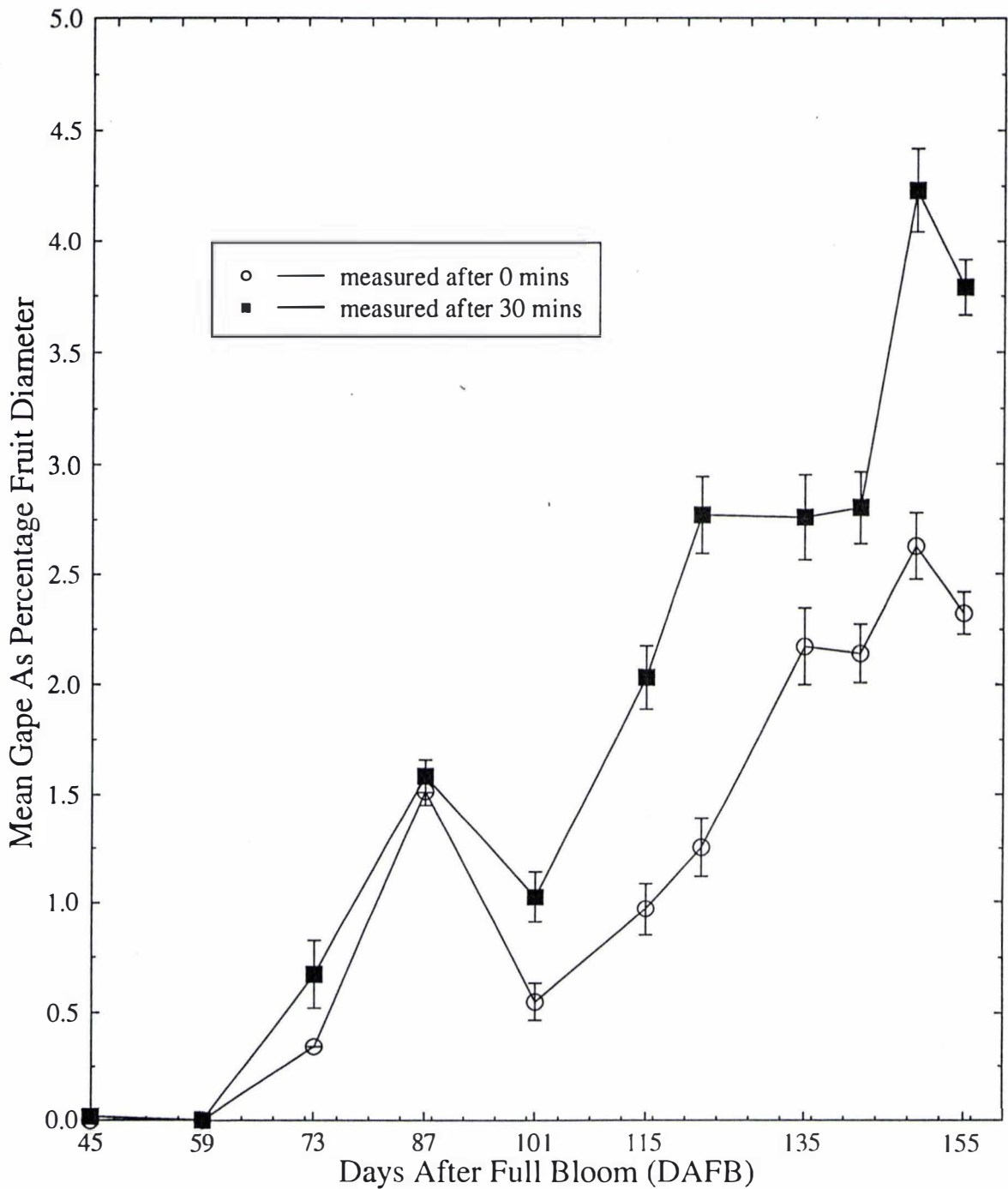

Figure 6.5 Size of gape expressed as percentage of mean fruit size of 'Gala' apples measured at two time intervals (0 and 30 mins after cutting fruit). Vertical bars indicate standard errors of the means.



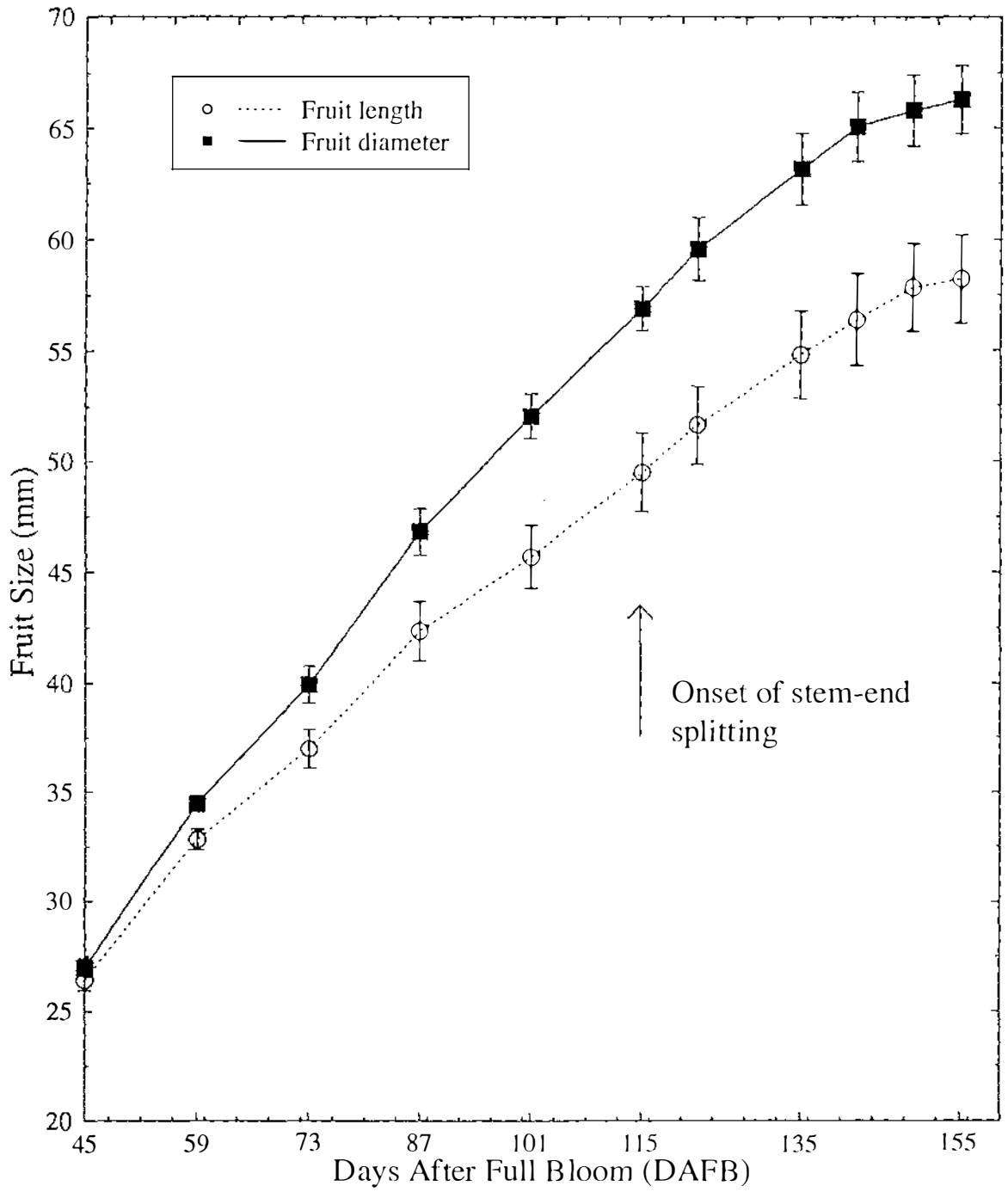

Figure 6.6 Cumulative whole fruit growth of 'Gala' apples. Vertical bars indicate standard errors of the means.

142 DAFB). From this date, fruit size continued to rise but at a slower rate. Throughout the experimental period, fruit diameter was greater than fruit length and the difference between the two measurements increased from 2.1% at 45 DAFB to over 12.2% at 155 DAFB (i.e., 21 days after the first commercial harvest).

The growth curve of 'Gala' fruit obtained in this study (Figure 6.6) followed an exponential pattern over the period of measurement. The absolute, relative and mean relative growth rates of fruit as defined by Equations 6.1 to 6.3 are presented in Figures [6.7-6.9]. In general, all three measures of fruit growth rate decreased during the season. A striking change that occurred during this period was the difference in the growth rate of the fruit length and the fruit diameter just prior to the onset of stem-end splitting : the growth rate of fruit diameter declined while the growth rate of the fruit length increased. Apart from this point, the growth rate of both fruit length and diameter changed in the same directions throughout the growth period.

#### **6.4.4 Fruit Shape**

Changes in fruit shape as measured by the difference between the length and diameter produced three distinct periods as shown in Figure 6.10. Initially, the difference increased rapidly up to the onset of stem-end splitting (i.e. 115 DAFB), followed by a more gradual and slow increase, and finally, a sharp decline from one week after the first commercial harvest on 13/2/91 (i.e. 142 DAFB).

Fruit shape expressed as the length:diameter ratio ( $L/D$ ) began with a high ratio (*ca.* 0.98) and declined during the season as shown in Figure 6.11. Three growth periods are clearly distinguishable. First is a period of sharp decline in the  $L/D$  ratio (from 0.98 to 0.87) (i.e. 11.4% change in shape) prior to the onset of fruit splitting, followed by a 4-week period (115 to 142 DAFB) of nearly uniform fruit shape (about 0.3% change). Thereafter, there was also a slight sudden increase in the  $L/D$  ratio (about 1.5%) which remained essentially unchanged throughout the last measurements.

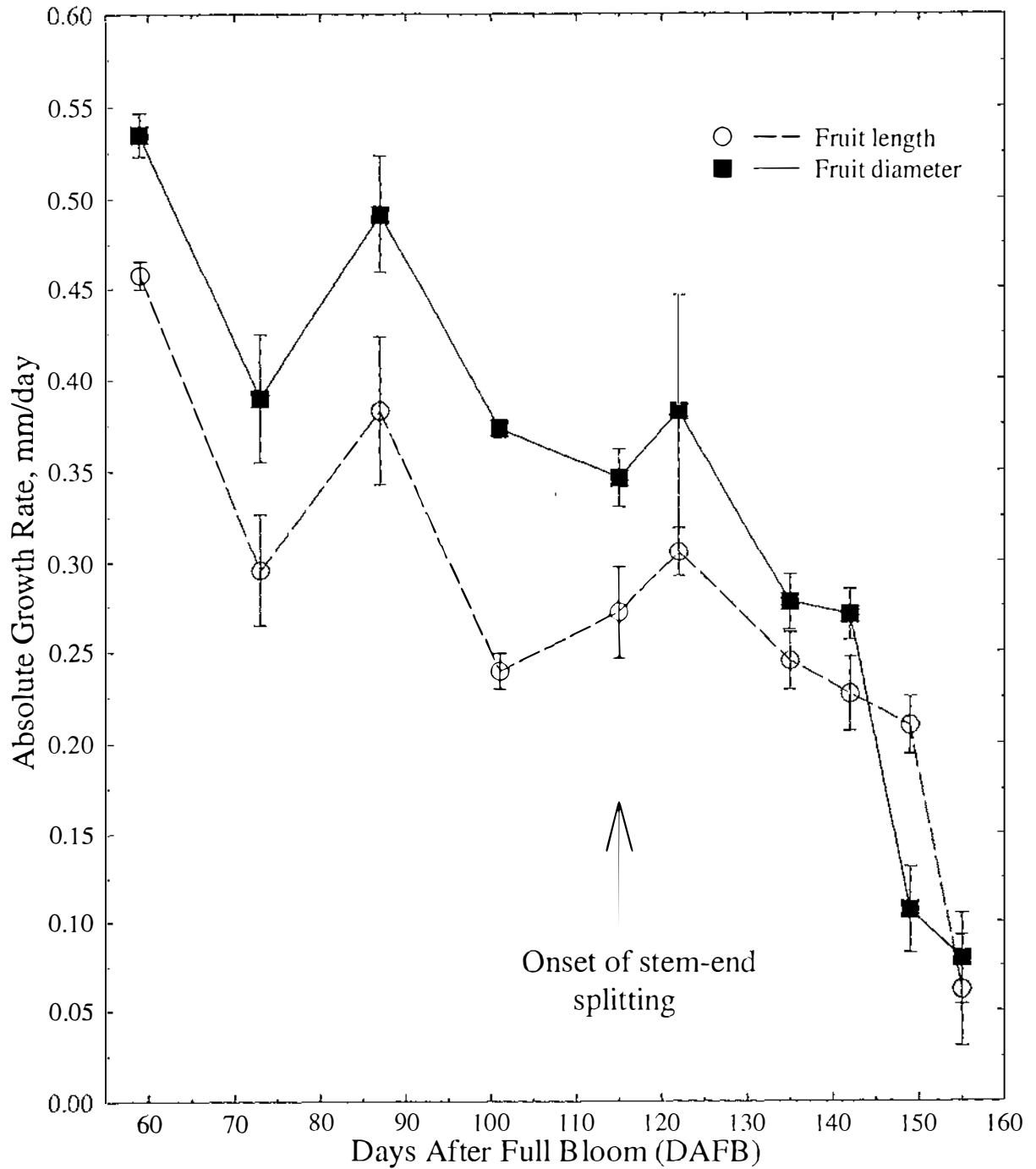

Figure 6.7 Absolute fruit growth rate (AGR) of 'Gala' apples. Vertical bars indicate standard errors of the means.

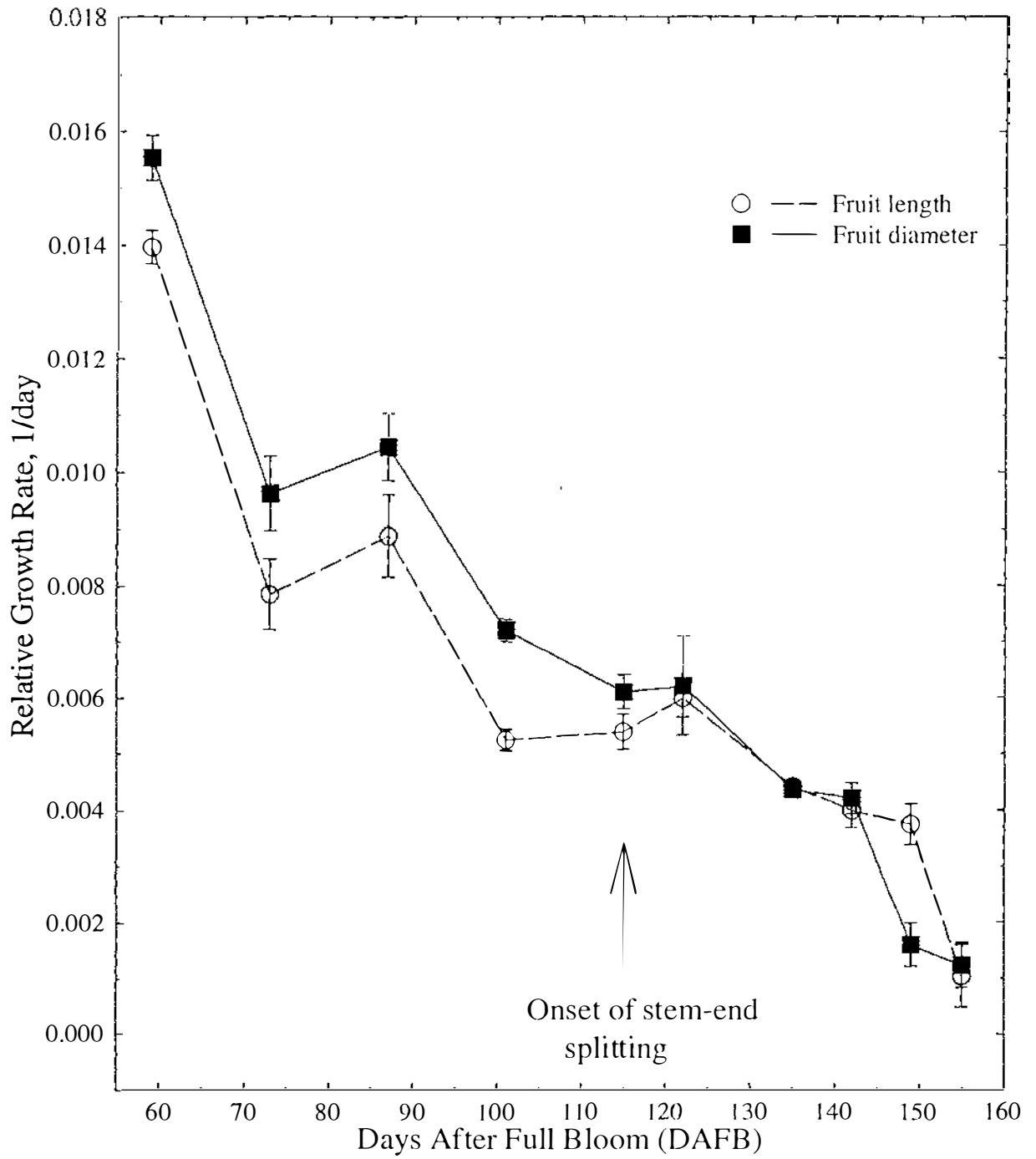

Figure 6.8 Relative fruit growth rate (RGR) of 'Gala' apples. Vertical bars indicate standard errors of the means.

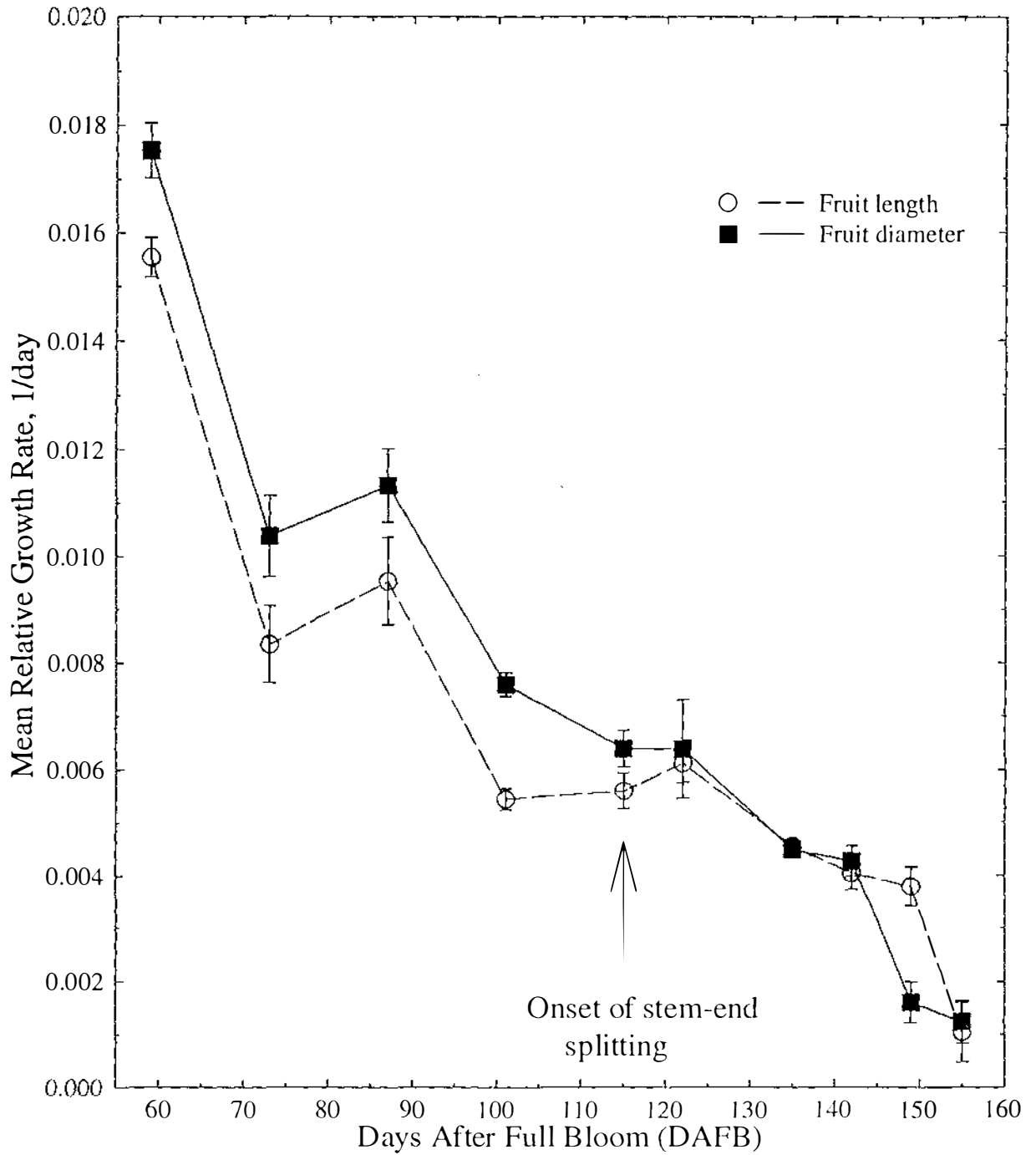

Figure 6.9 Mean relative fruit growth rate (MRGR) of 'Gala' apples. Vertical bars indicate standard errors of the means.

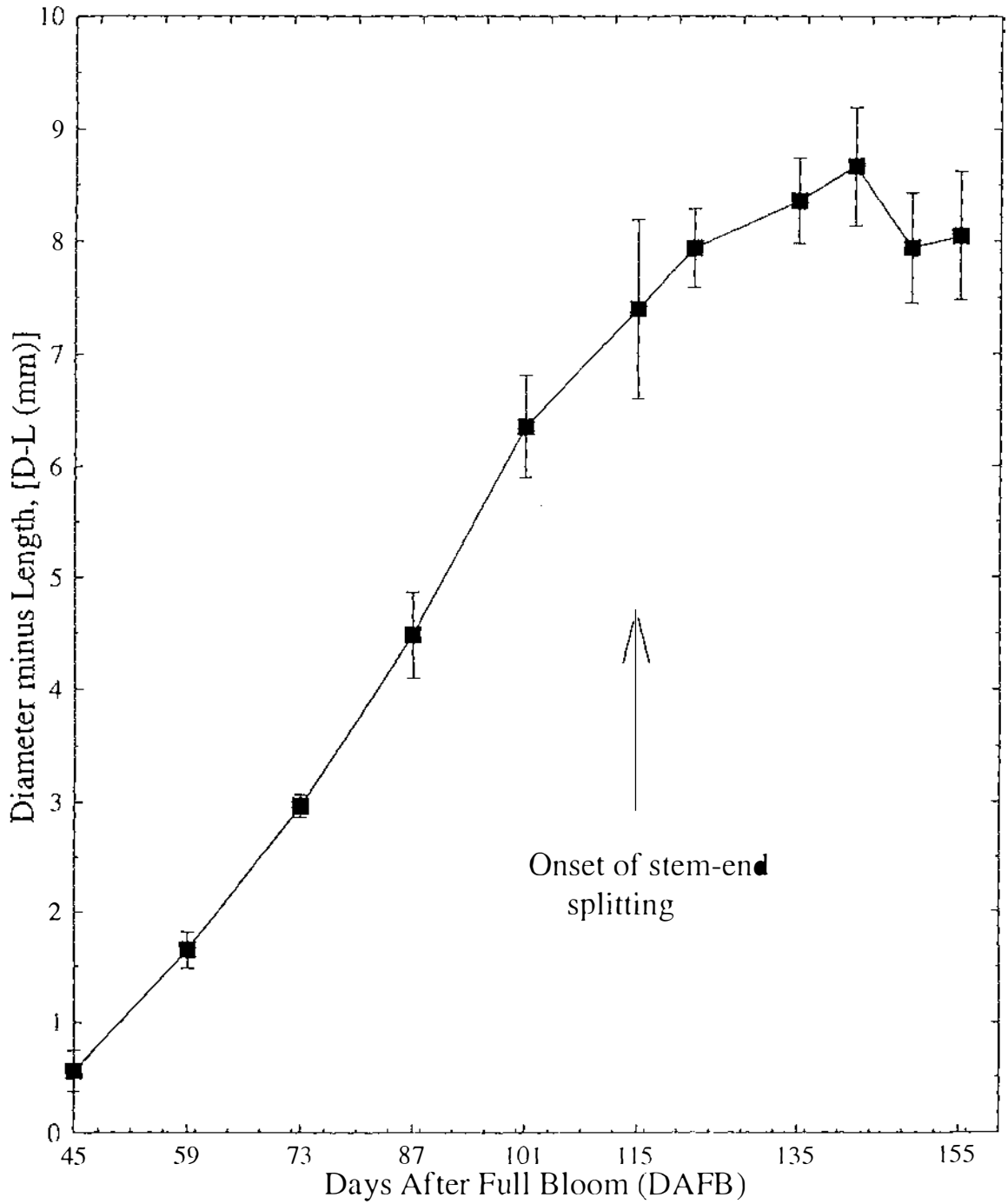

Figure 6.10 Difference between fruit diameter and length of 'Gala' apples during growth. Vertical bars indicate standard errors of the means.

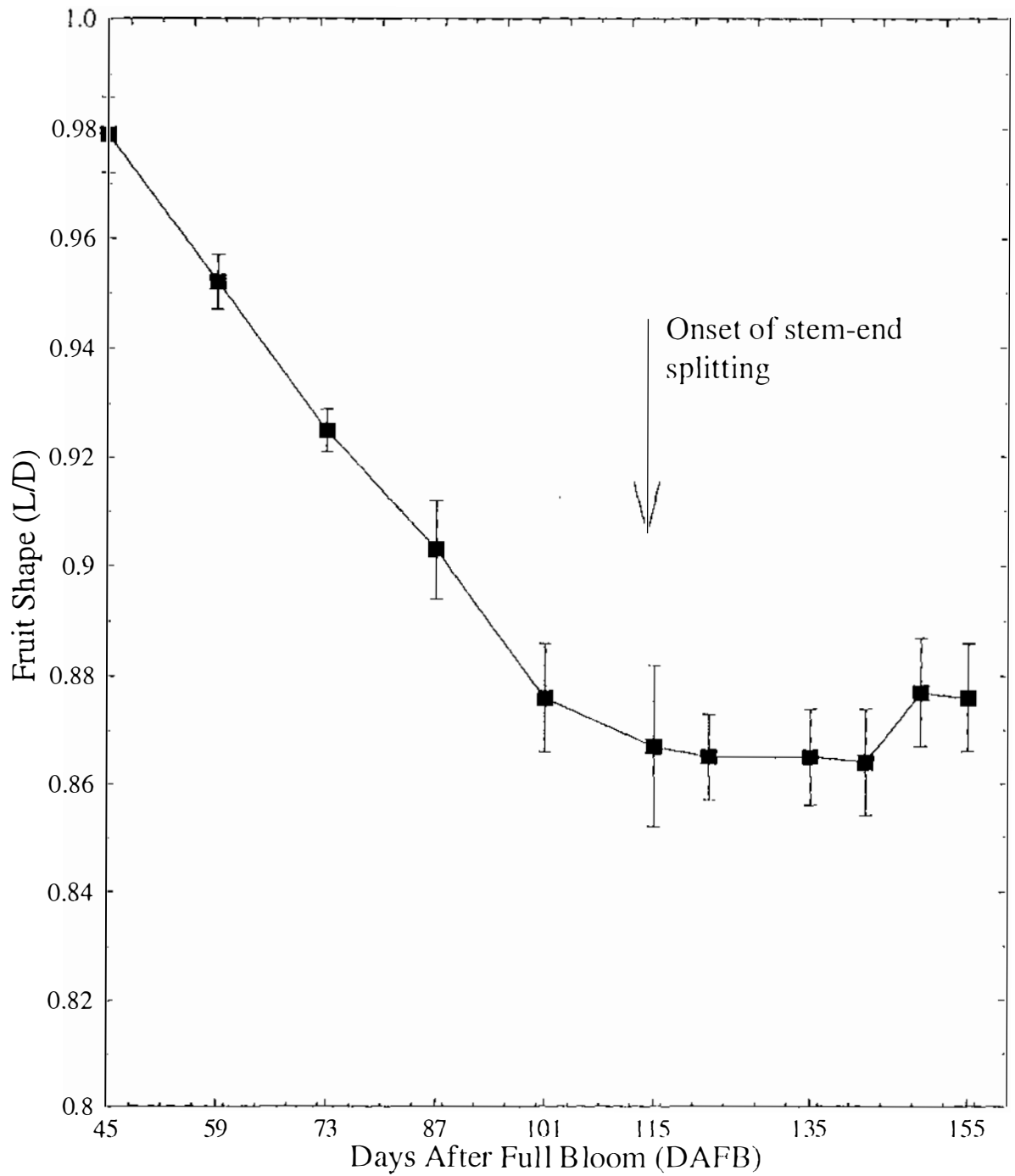

Figure 6.11 Fruit shape of 'Gala' apples during growth. Vertical bars indicate standard errors of the means.

Changes in shape of the stem-end cavity during the season expressed as the ratio of cavity depth to fruit length and diameter, respectively, produced a double sigmoid curve as shown in Figures 6.12 and 6.13. Phase one (up to 73 DAFB), was marked by a sharp increase in both C:D and C:L ratios. During phase two, the C:D ratio declined whereas the C:L increased slowly. Phase three was marked by the resumption of a sharp increase in both ratios and the onset of stem-end splitting occurred at this point. Phase four coincided with the fruit harvest period and was characterised by nearly uniform shape of the stem-end cavity.

#### **6.4.5**            *Growth of Stem-end Cavity*

The cumulative increase in the depth of the stem-end cavity versus the days after full bloom followed a double sigmoid growth pattern as presented in Figure 6.14. It is clear from this figure that measurements were started during the second half of the first sigmoid growth when the growth rate had started to decline (see also Figures 6.15 and 6.16).

By considering both the cumulative and rate curves, the growth of the stem-end cavity can be described in three stages. Initially, there was a rapid growth phase, followed by a slow growth phase, and then a final rapid growth phase which ended with fairly uniform cumulative growth of the cavity. The slow growth phase consists of the final deceleration of the first cycle of rapid and delayed growth (Figures 6.15 and 6.16) and the beginning of the second cycle. An inflexion marks the inception of this second growth cycle which also coincides with the onset of stem-end splitting (Figure 6.14).

#### **6.4.6**            *Distribution of Surface Fruit Growth*

The distribution of fruit growth externally at the stem-end, check, and calyx-end of fruit in the transverse and longitudinal directions were compared by plotting the cumulative size of the marks against the days after full bloom as shown in Figures [6.17-6.19].

At the stem-end, growth of the longitudinal diameter proceeded faster than the transverse



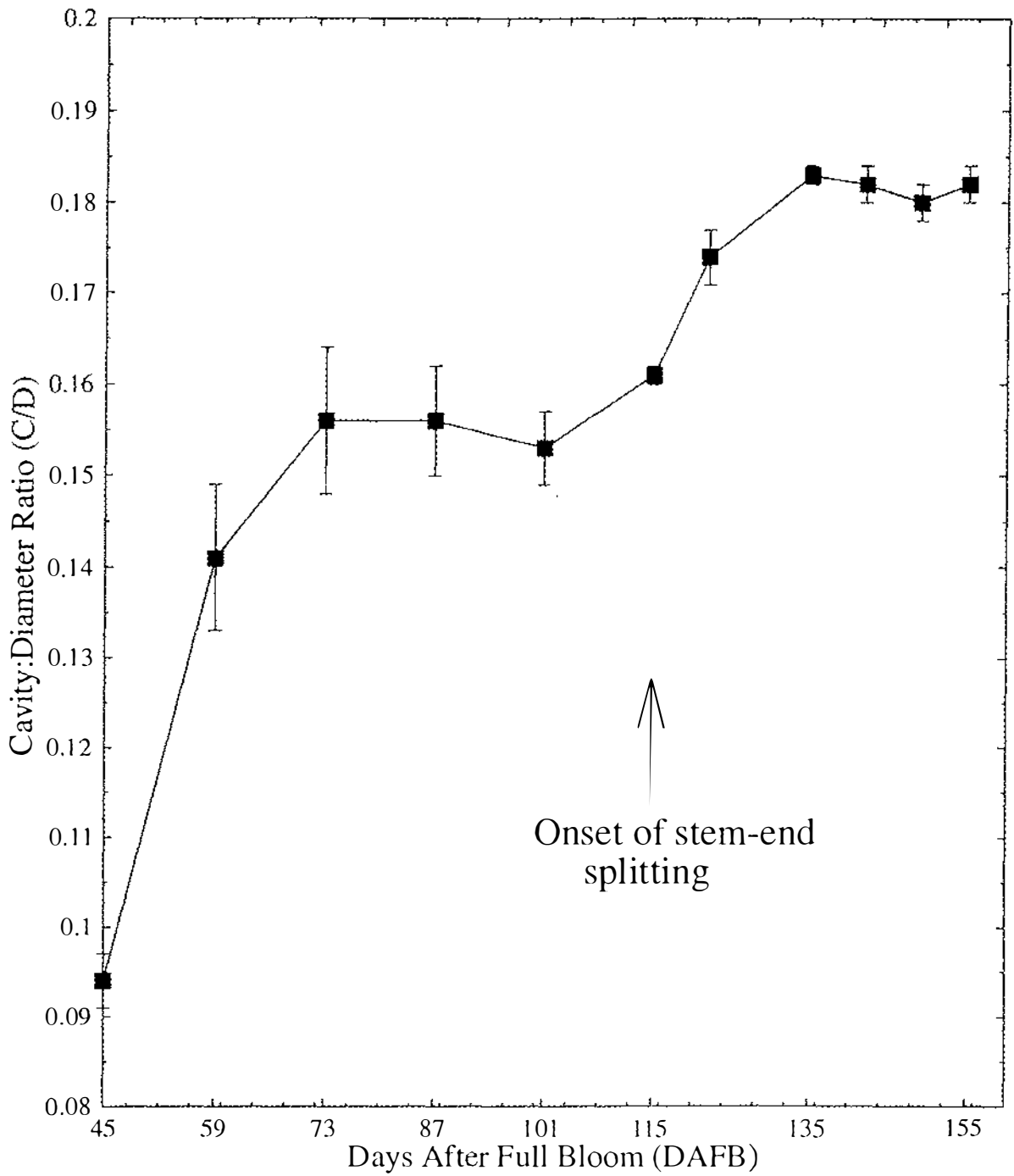

Figure 6.12 Stem cavity:fruit diameter (transverse) ratio of 'Gala' apples during growth. Vertical bars indicate standard errors of the means.

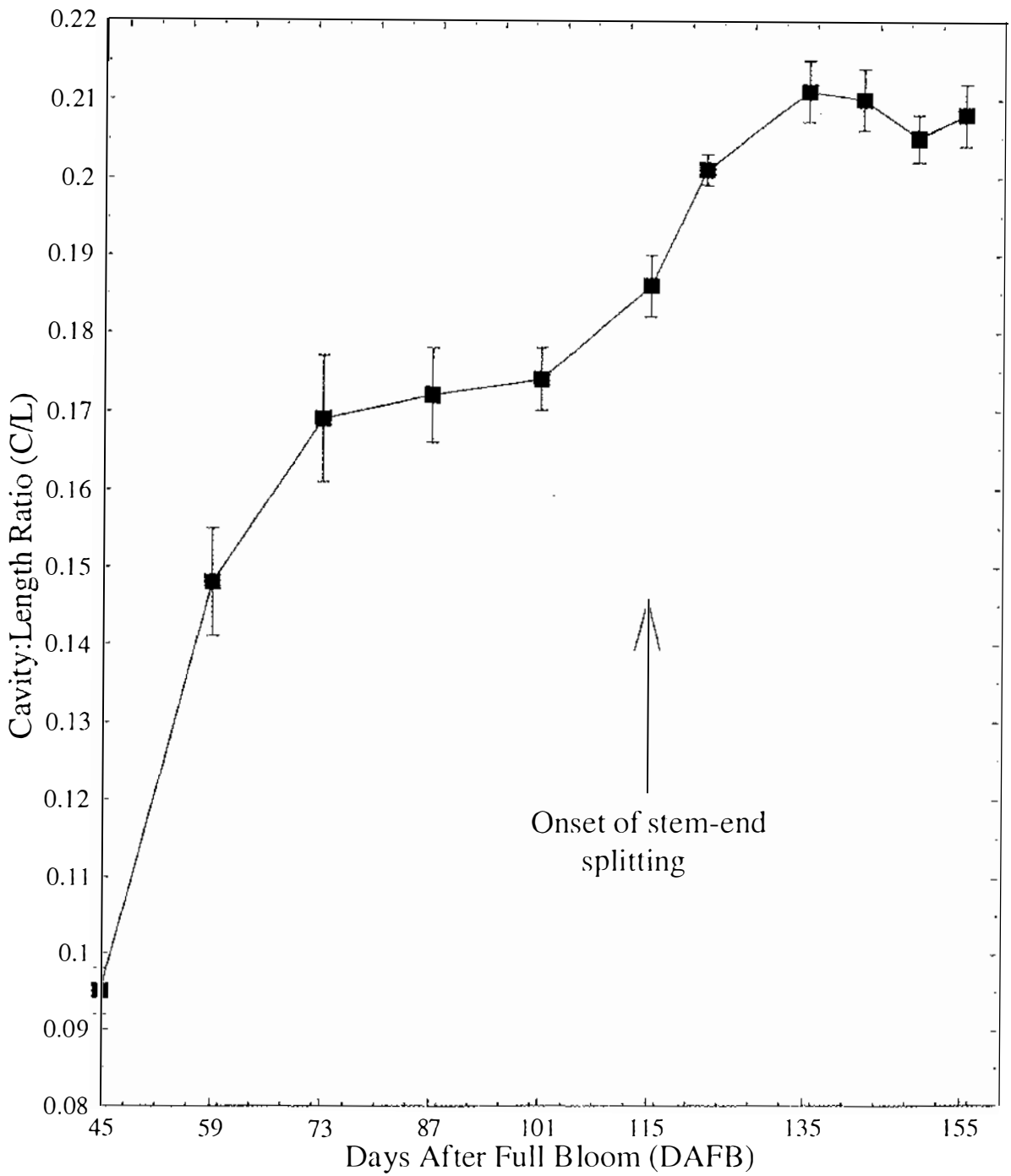

Figure 6.13 Stem cavity:fruit length (longitudinal) ratio of 'Gala' apples during growth. Vertical bars indicate standard errors of the means.

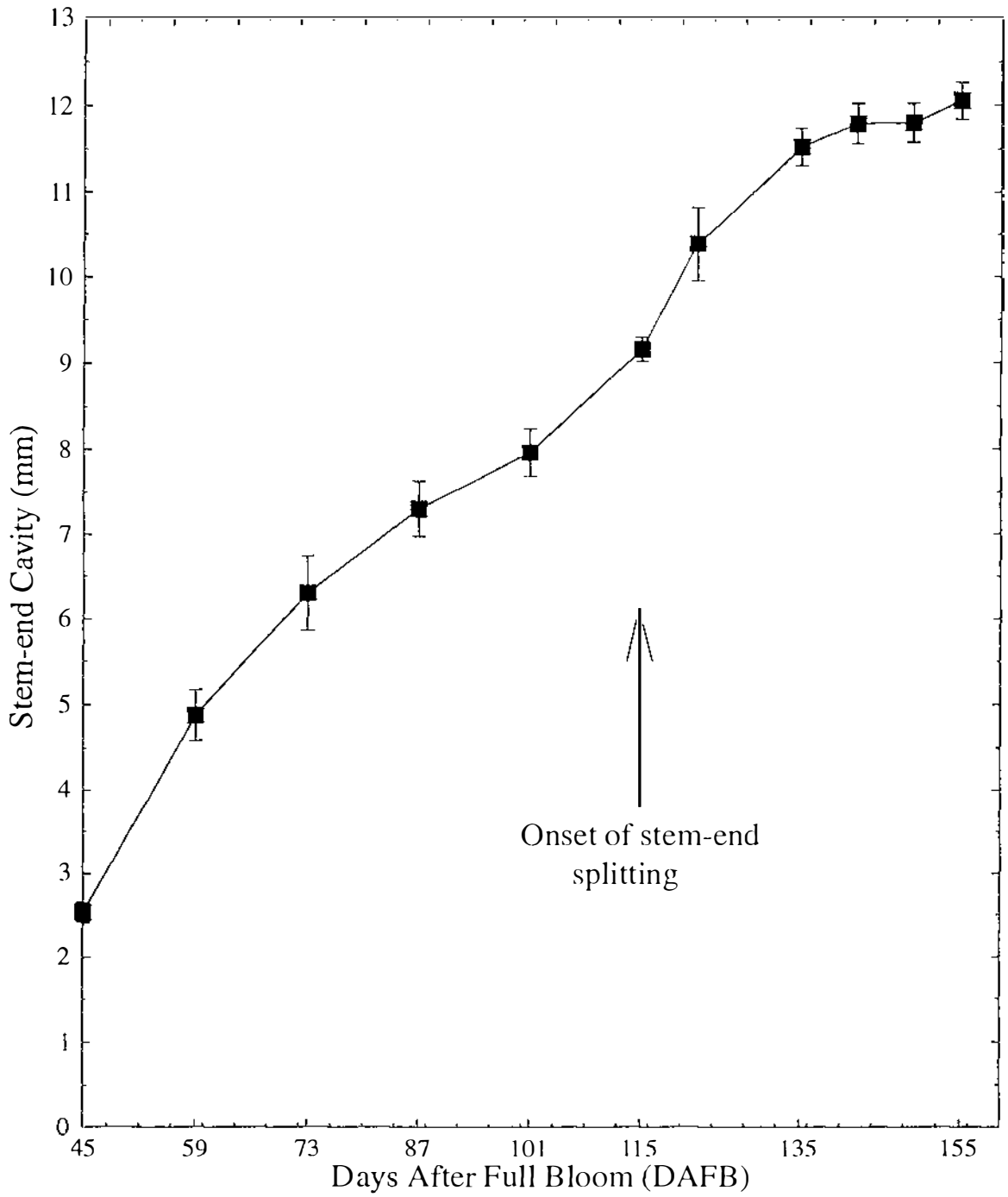

Figure 6.14 Cumulative growth of stem-end cavity of 'Gala' apples. Vertical bars indicate standard errors of the means.

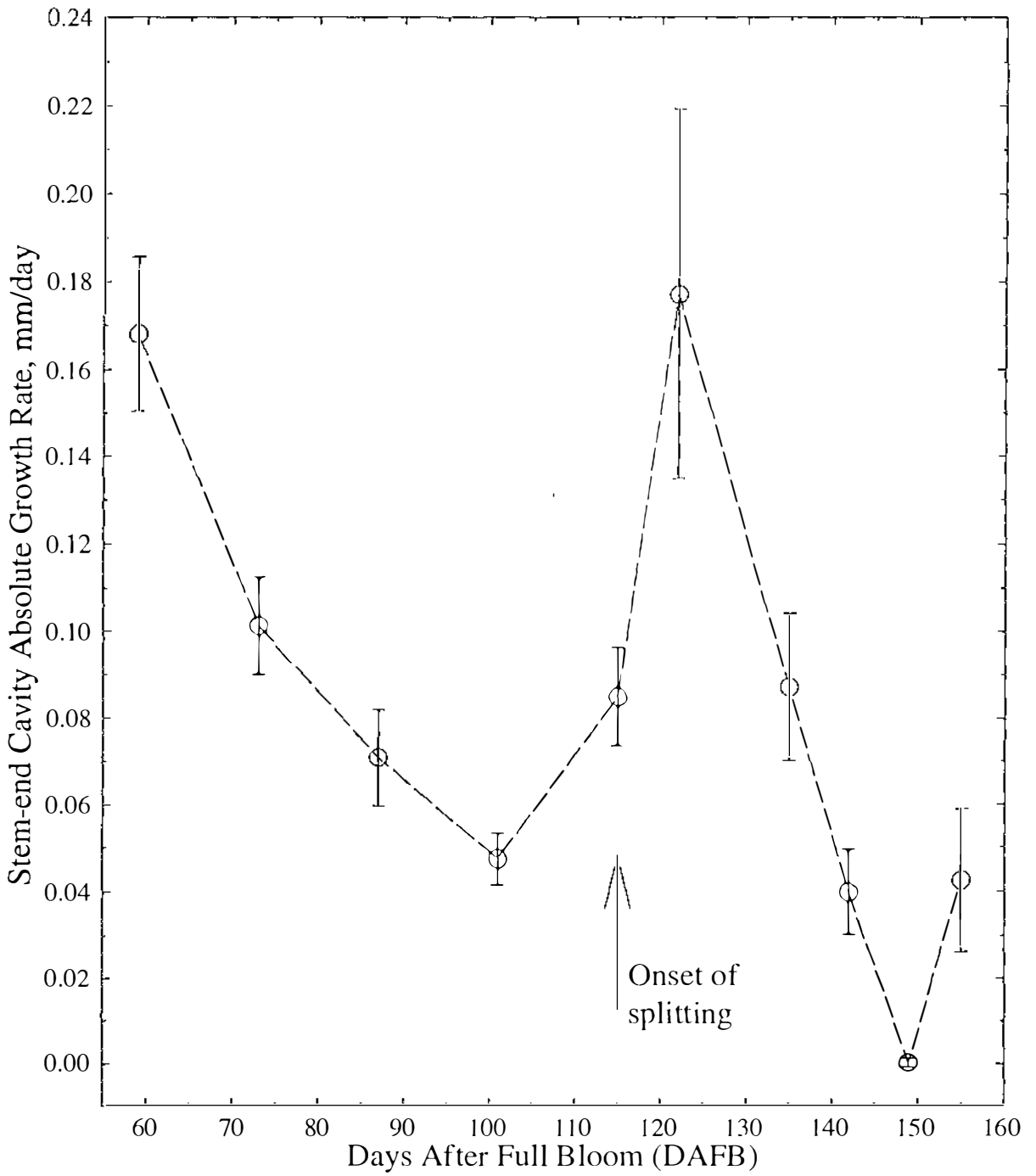

Figure 6.15 Absolute growth rate (AGR) of stem-end cavity of 'Gala' apples. Vertical bars indicate standard errors of the means.

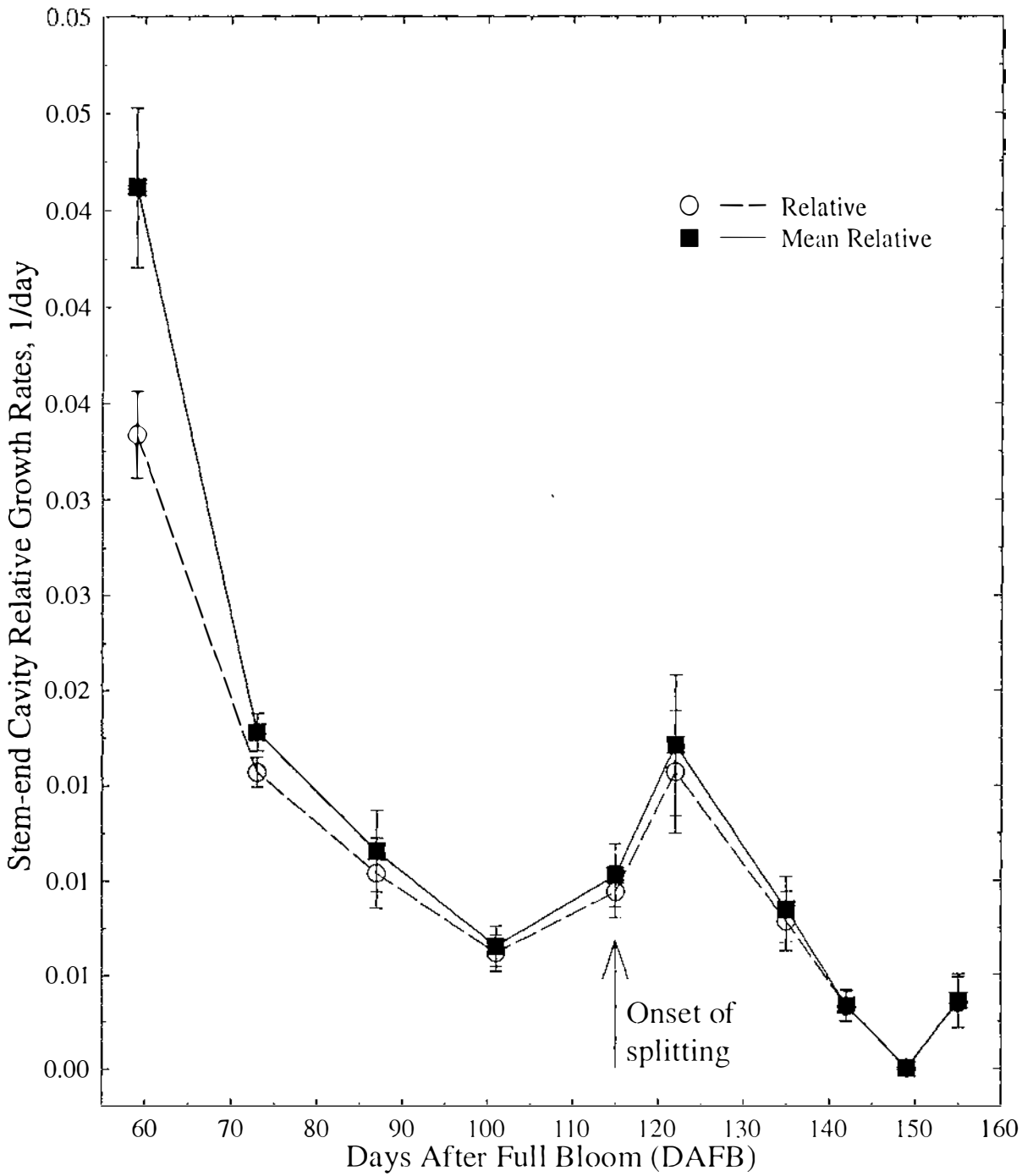

Figure 6.16 Relative and mean relative growth rates of stem-end cavity of 'Gala' apples. Vertical bars indicate standard errors of the means.

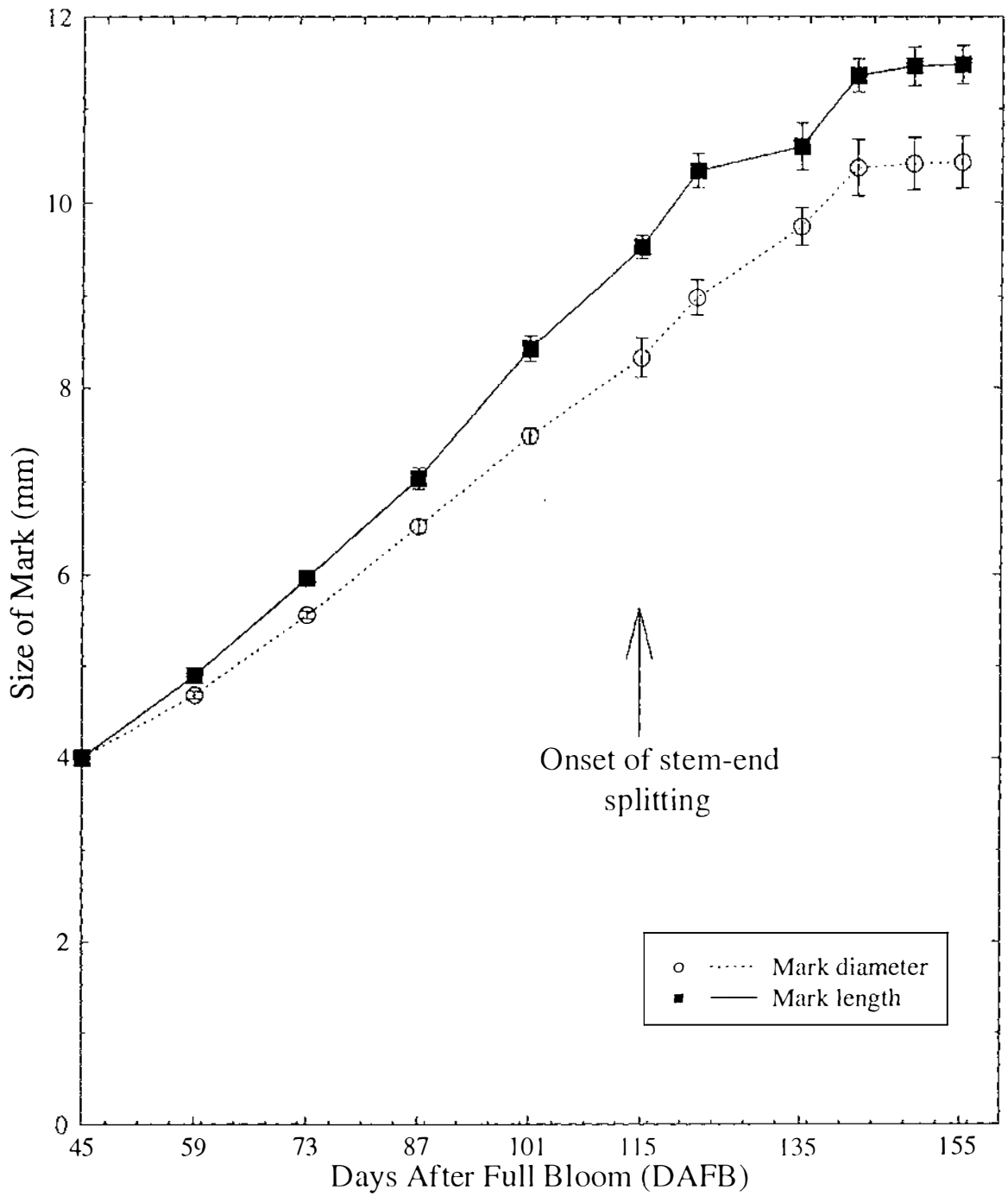

Figure 6.17 Fruit growth at the stem-end of 'Gala' apples. Vertical bars indicate standard errors of the means.

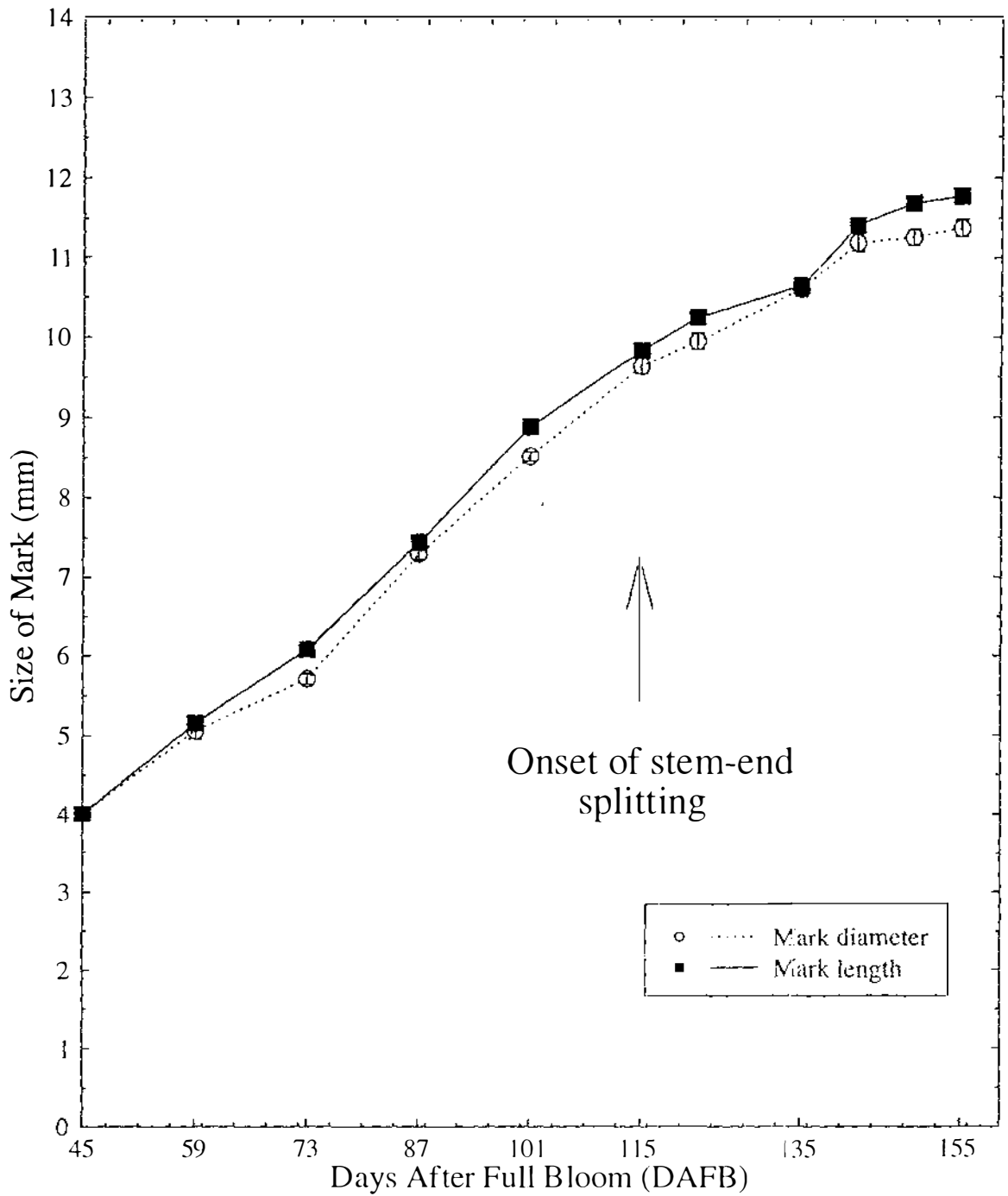

Figure 6.18 Fruit growth at the cheek of 'Gala' apples. Vertical bars indicate standard errors of the means.

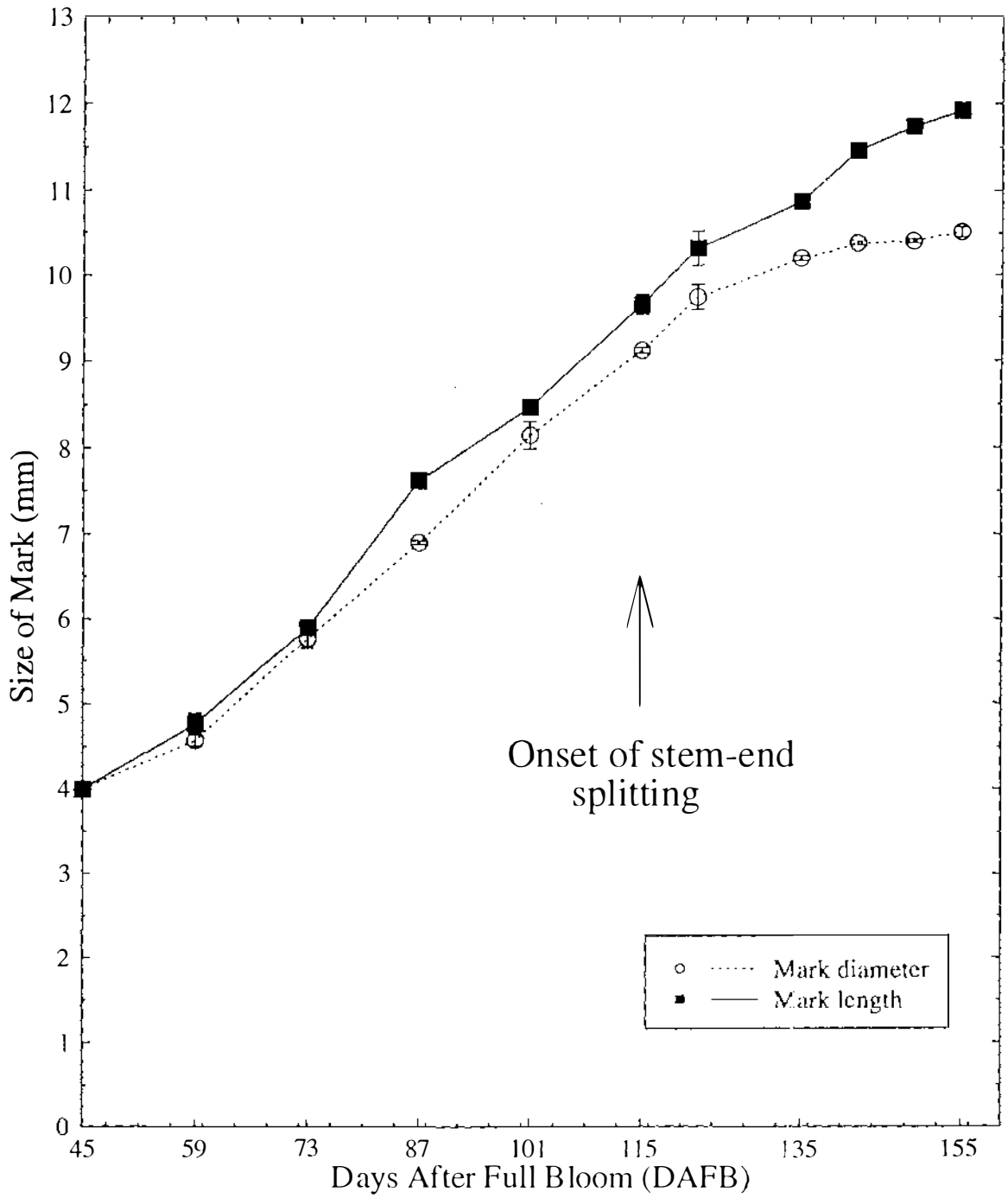

Figure 6.19 Fruit growth at the calyx-end of 'Gala' apples. Vertical bars indicate standard errors of the means.



diameter (Figure 6.17), while at the cheek, fruit grew uniformly in both directions (Figure 6.18). At the calyx-end, fruit grew fairly equally in both axes up to the first commercial harvest (135 DAFB) after which growth in the longitudinal diameter continued at a clearly much faster rate (Figure 6.19).

When the growth in the transverse and longitudinal directions were averaged to obtain the mean growth at the different locations, fruit grew most rapidly at the cheek, and most slowly at the stem-end (Figure 6.20). By considering growth in the two directions separately, it was found that in the transverse axis (Figure 6.21), fruit grew most rapidly at the cheek and most slowly at the stem-end. Up to 73 DAFB and after 142 DAFB, both the stem-end and the cheek grew equally in the transverse direction. In the longitudinal axis, all three locations on fruit grew equally during the season (Figure 6.22).

## 6.5 Discussion

### 6.5.1 *Chronological Development of Stem-end Splitting*

An estimate of the time when stem-end splitting occurs would be of value in an analysis of the factors causing or contributing to the phenomenon. Results obtained in this study showed that both stem-end splitting and internal stem-end ring-cracking were observed on the same day (115 DAFB) following a 2-week fruit sampling interval. Although both defects were first observed on the same day, the incidence of ring-cracking was much greater than stem-end splitting throughout the subsequent fruit sampling period (Figure 6.3). This higher incidence of internal ring-cracking compared to stem-end splitting supports the earlier conclusion drawn in Chapter Four that stem-end splitting is preceded by internal ring-cracking. The relationship would be such that only a percentage of ring-cracked fruit on the tree at any time would eventually split when the conditions which promote stem-end splitting occur.

Further examination of Figure 6.3 shows that both defects proceeded at different rates. Ring-cracking increased linearly and rapidly from the onset to the first commercial harvest (135 DAFB) and possibly slowed slightly during the next sampling a week later. On the other

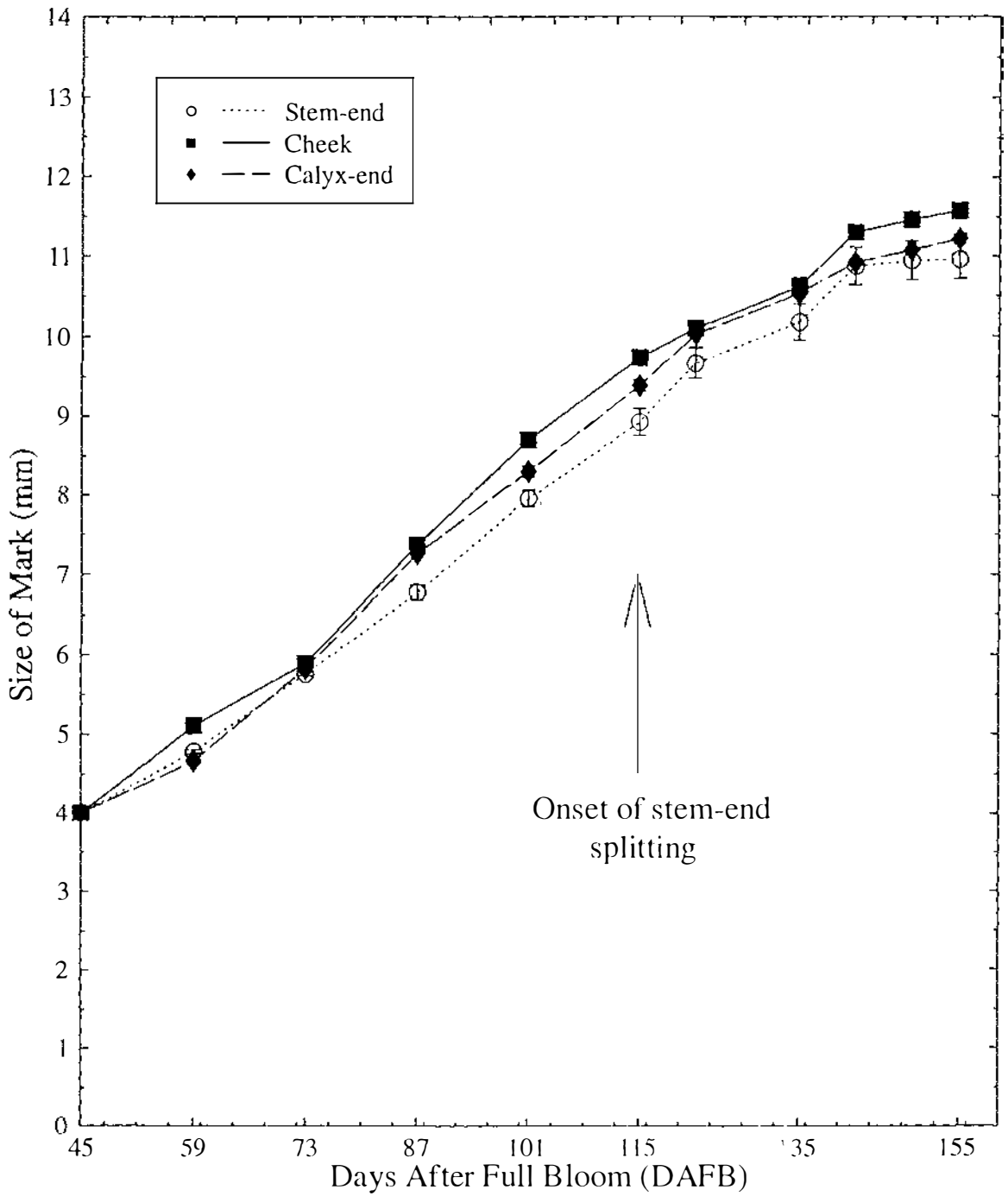

Figure 6.20 Distribution of fruit growth at three locations on 'Gala' apples. Vertical bars indicate standard errors of the means.

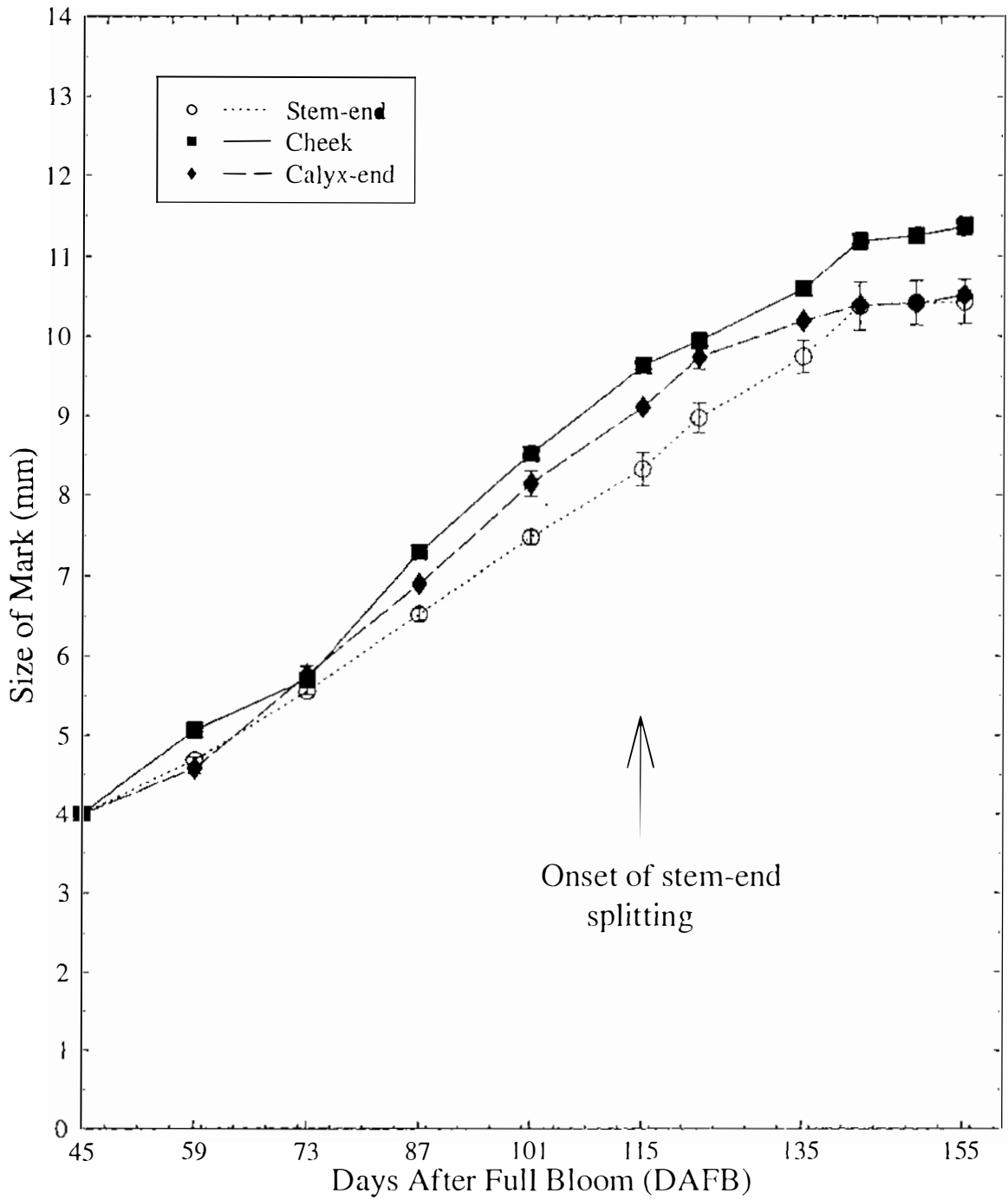

Figure 6.21 Fruit growth in the transverse axis at three locations on 'Gala' apples. Vertical bars indicate standard errors of the means.

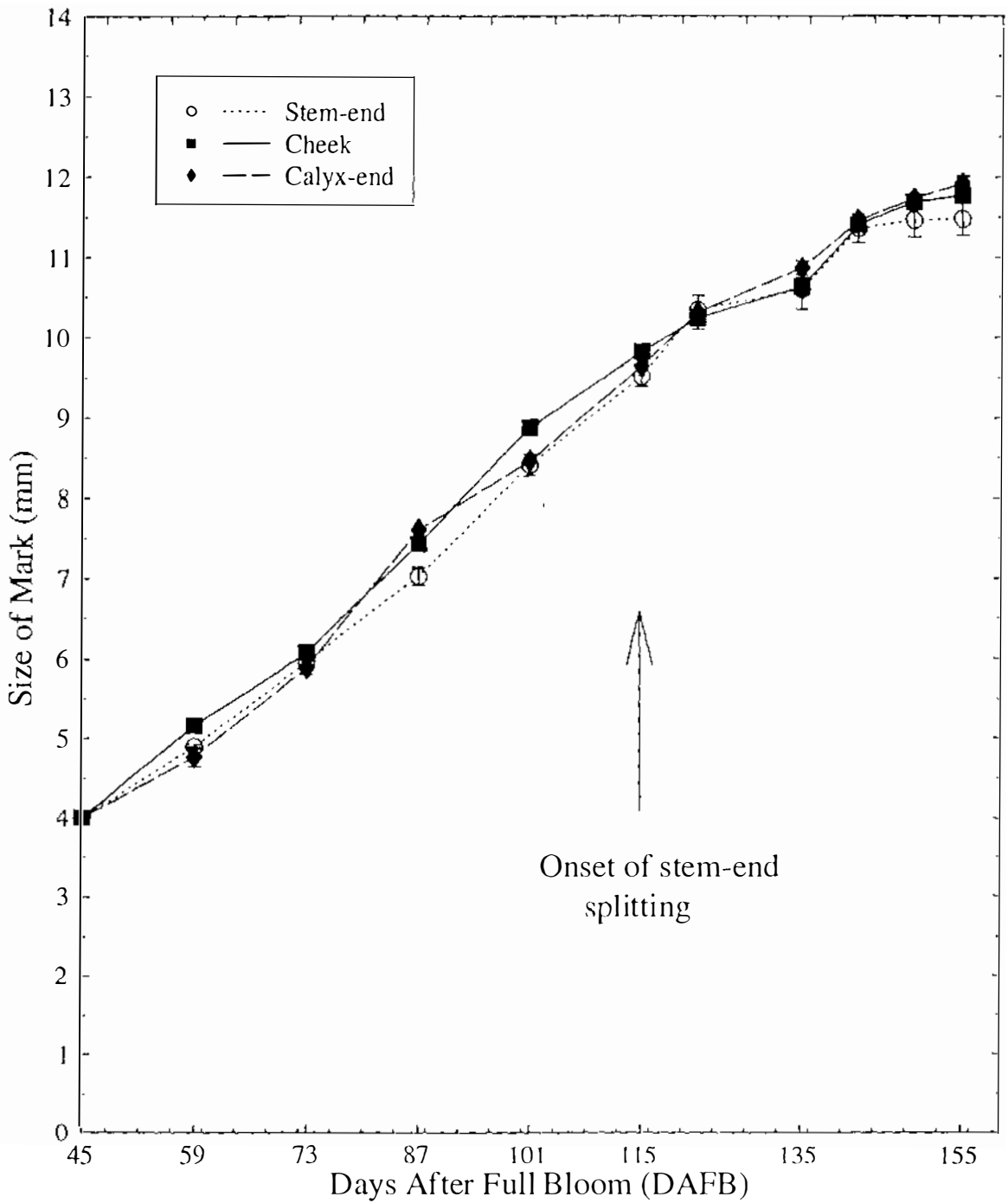

Figure 6.22 Fruit growth along the longitudinal axis at three locations on 'Gala' apples. Vertical bars indicate standard errors of the means.

hand, the development of stem-end splitting progressed slowly initially (up to 122 DAFB) and then increased rapidly afterwards.

This pattern of development has implications on the economics of stem-end splitting in apples. First, it confirms the popular belief and observation that the incidence of the disorder is apt to increase if fruit are allowed to hang late for colour and size (Walsh et al., 1991). Secondly, since it seems feasible that every fruit with internal ring-cracking has acquired the potential to split, it appears that the incidence of internal ring-cracking would be a rational index of the amount of fruit "at risk" from stem-end splitting.

Furthermore, since stem-end splitting is preceded by ring-cracking (Chapter Four) and both defects were observed on the same day in the present study following a 2-week sampling interval, it appears that the development of stem-end splits from ring-cracks may have occurred within a few days or hours. Therefore, to determine the timing of the onset of ring-cracking more precisely, fruit would have to be sampled at shorter time intervals. Similarly, to be sure when stem-end splitting first starts to form from ring-cracks and to follow its subsequent development, individual fruit need be labelled and examined equally at short intervals until harvest.

Clearly, the three-week period between the onset of stem-end splitting (115 DAFB) and the first commercial harvest (135 DAFB) is critical to obtaining a fuller understanding of the mechanism of both stem-end splitting in 'Gala' apples and the precursor (internal ring-cracking) on the one hand, and the tailoring of management practices to reduce and/or control the disorders on the other.

### **6.5.2            *Development of Fruit Growth Stress in Relation to the Onset of Stem-end Splitting***

Although reference is frequently made to growth stresses in the literature (Shutak and Schrader, 1948), as far as fruits are concerned we can only measure strain and take this as an indication of stress (Sawada, 1934; Skene, 1980; Hatfield and Knee, 1989).

In this thesis, growth stresses in 'Gala' apples were studied by cutting fruit through to the core with a razor blade and then measuring the gape of the cut (as a measure of strain).

The finding that fruit were free from growth stress early in the season (up to 59 DAFB) when the average fruit diameter had reached about 40 mm and stress reached a maximum when the average fruit diameter reached about 66 mm (149 DAFB) indicates that fruits attain a certain minimum size before there can be a measurable growth stress. This may be explained following Skene's argument (1980), that for stress to occur during fruit growth, the tissues must be elastic and growth must be unevenly distributed. Skene further noted that the greater the growth, the greater the imbalance and total potential stress.

Thus, it appears that fruits may need to have attained a threshold size before there can be an appreciable imbalance of growth within the fruit. Verner (1938) suggested that a greater imbalance in the growth of the inner and outer tissues may explain the susceptibility of Stayman Winesap apples to cracking. Therefore, since cell walls are not perfectly elastic and tend to relax or creep (Probine and Preston, 1962), stress will be a transient phenomenon and depend on growth rates (or imbalance) rather than on cumulative growth.

After its initiation, stress in fruit increased throughout the growth period. This result indicated that although stem-end splitting is an indication of stress in apples, growth stresses can occur without splitting at any time during their growth and development. Hence, the relationship between growth stress and stem-end splitting may be a complex one since the active growth processes allow considerable strains to be accommodated as an essential feature of growth.

Thus, whether or not a particular stress will exceed the yield point of a fruit must depend not only on the rate of straining, but also on the rate at which active growth processes can repair, replace, or accommodate the strained material. It has also been suggested elsewhere that the periodicity and intensity of these processes associated with fruit growth also affect both the size of fruit and the structure of the flesh (Smith, 1950).

Throughout the growth period, it was shown that transverse stress developed more than longitudinal stress (Figure 6.4). However, the time of onset of stem-end splitting was

characterised by a progressive build-up of longitudinal stress until the stress in both axes became nearly equal at 122 DAFB. Obviously, there can be a direct causal connection between splitting and stress because stem-end splitting is a mechanical process which is not possible in the absence of stress.

Another notable result from the study of fruit growth stress was the dramatic rise of both transverse and longitudinal stress in fruit tested at 87 DAFB (Figure 6.4). The fact that the width of gape was expressed as percentage of fruit size indicated that this result could not be attributed to differences in fruit samples used on that day. However, an examination of the grower's weather and spray diary (Appendix I) revealed that the predawn weather was "good" on that day and the only significant event prior to and on that day (December 27, 1991) was that about three hours before fruit were tested, the farmer had sprayed the trees with the pesticide orthocide at 150 mL/100L and Calcium Chloride at 360 gm/100L. The trees were also irrigated at 2500 l/ha.

It appears, therefore, that the sudden high growth stress obtained on this date could be attributed to these treatments and in particular, the possibility of a sudden cell expansion caused by the uptake of water and solutes. This view supports the hypothesis of Hatfield and Knee (1988) who noted that "the size of gape which develops between the cut (fruit) surfaces depends on the water status of the tree and is a measure of growth stress."

### 6.5.3 *Whole Fruit Growth Curve As Related to Stem-end Splitting*

By periodic measurements of the growth of fruit attached to the tree, it was thought that valuable information might be obtained on the onset of stem-end splitting relative to rate of increase in fruit size. It would also show the period within the normal growth curve at which stem-end splitting occurred, at least for this given set of standard management conditions. A critical examination of the cumulative growth curve of both fruit length and diameter (Figure 6.6) shows that fruit grew exponentially over the period of measurement. These growth curves do not provide any distinct phase or period in relation to the onset of stem-end splitting.

However, it is worth noting that stem-end splitting commenced during the period of final rapid growth when the average fruit size had reached about 50 and 57 mm in length and diameter, respectively. The first commercial harvest (135 DAFB, 13/3/91) was three weeks after the first observation of stem-end splitting and ring-cracking.

#### **6.5.4**            *Fruit Shape in Relation to Stem-end Splitting*

The result obtained in the present study showed that the onset of stem-end splitting coincided with the short period of most rapid deceleration in fruit shape when the average L:D ratio declined negatively from  $0.98 \pm 0.01$  mm to  $0.87 \pm 0.01$  mm (Figure 6.11). After this point, fruit shape remained fairly uniform for four weeks while the amount of ring-cracking and stem-end splitting increased dramatically (Figure 6.3). These results have some exciting implications in the current efforts to understand the origin, mechanism of occurrence and causes of stem-end splitting in apples.

First, it appears that the initiation of stem-end splitting was not related to fruit length and diameter separately since growth as measured by increases in length and diameter did not provide any distinct periods in relation to the development of splitting. Secondly, it also appears that there was a relationship between the initiation of fruit splitting on the one hand, with the combination of an increasing build-up of longitudinal stress relative to transverse stress (Figure 6.4) and a stagnation of fruit shape (Figure 6.11). A crucial question that emerges from this relates to why the fruit suddenly stopped changing shape during this time and/or why there was a sudden build-up of longitudinal stress.

Theoretical studies by Considine (1979) and Considine and Brown (1981) have demonstrated the potential effects of fruit shape, fruit structure and dermal system structure on the degree and orientation of stress in the dermal system of grape. The analysis of fruit shape and structure showed that neither radius nor shape contributed significantly to resistance to stress (Considine, 1979), but they did provide an explanation of the fracture pattern (Considine and Brown, 1981).



The results in the present study suggest an equivocal relationship between the *development* of fruit shape in 'Gala' apples and the *initiation or onset* of stem-end splitting. There is a need to extend this study to other apple cultivars in order to ascertain the relevance of this relationship to the susceptibility of fruit to stem-end splitting.

Results on the growth of the stem-end cavity showed that the pattern followed a double sigmoid curve and stem-end splitting coincided with the transition from a period of depressed growth to the last period of accelerated growth prior to commercial maturity (Figure 6.13). This result is quite remarkable because it provides us with entirely new information on the differential growth and development of the various parts of the apple. While the entire fruit growth curve was exponential, the stem-end cavity developed in a double sigmoid manner similar to most stone fruits (Coombe, 1976; Westwood, 1978). Again, this growth pattern provides us with a distinguishing growth characteristic of 'Gala' apple and the possibility of this growth curve in other varieties needs to be investigated.

### **6.5.5            *Fruit Growth Rates***

It has often been suggested that relative growth rates at certain stages of fruit development might explain differences in the amount of fruit cracking observed in the field and of minute cracking seen under a scanning electron microscope (Fogle and Faust, 1975 and 1976). However, in an analysis of the development of the components of fleshy fruits, Coombe (1976) has noted that quite different interpretations can emerge if data are calculated on different bases, or if fruit growth rate is calculated by different methods. Nii reported that the interpretation of fruit growth in peach (1979), citrus (1980a), persimmon (1980b) and Japanese pear fruit (1980c) by growth rate and relative growth rate throughout the growing season greatly helps in understanding the morphological and physiological changes during each fruit developmental stage.

Results on the absolute, relative and mean relative fruit growth rates of 'Gala' apples showed that the growth rates tended to fluctuate continuously throughout the season and the time of onset of stem-end splitting was not related to the time of maximum growth rates of both the

diameter or fruit length (Figures 6.7-6.9). In general, both the relative and mean relative growth rates declined parabolically during the season and the magnitude of the difference between the growth rates of fruit diameter and length decreased in a similar pattern.

The most significant result on fruit growth rates occurred prior to the onset of ring-cracking (and stem-end splitting) when there was a variation in the direction of the growth rate of fruit length relative to the diameter. The growth rate of fruit transverse diameter decreased while that of the longitudinal diameter increased and apart from this period, the growth rate in both fruit axes fluctuated in the same directions throughout the season. This result suggests a cause-effect relationship between the initiation of internal ring-cracking and the growth rate of the fruit about its coordinate axes. In this respect, it is important to note that this relationship could not have been discernible or contemplated if fruit growth rate had been expressed in either length or diameter alone.

#### **6.5.6**            *Distribution of Growth in 'Gala' Apples*

Fruit grew differently at the stem-end, cheek and calyx-end (Figures 6.17-6.19). At the stem-end, fruit grew faster in the longitudinal axis and the difference between longitudinal and transverse growth increased with time up to the first commercial harvest and remained fairly constant afterwards. On the other hand, the cheek grew equally (isotropically) in both directions while the longitudinal axis of the calyx-end grew slightly faster initially and later began to grow faster than the transverse axis after the first commercial harvest.

If growth stress is higher in the direction of highest growth as indicated by Figures 6.4 and 6.6, it appears that the stem-end of fruit would experience higher tensile stress while the fruit cheek would maintain steady growth stress due to its isotropic growth pattern. This condition would probably render the stem-end of the fruit particularly susceptible to internal ring-cracking which provides a weak point for further splitting of the fruit.

## 6.6 Conclusions

In this chapter, the growth of 'Gala' apples in relation to the development of stem-end splitting has been considered. This approach to the understanding of the mechanism of stem-end splitting was adopted because the results and field observations on the incidence of stem-end splitting in the previous chapter suggested that factors other than the orchard management practices could account for the high amount of variability in stem-end splitting within the same experimental blocks and even within trees that received the same treatments.

By monitoring the chronological development of stem-end splitting using periodic random sampling of fruit, it has been shown that the development of both stem-end splitting and internal ring-cracking progress at different rates which suggested that only a percentage of fruit with internal ring-cracking would develop stem-end splitting at any time. This result confirms earlier observations in the previous chapter that fruit first develop internal stem-end ring-cracks from which stem-end splits may arise.

Following a 2-week sampling interval, both stem-end splitting and internal ring-cracking were first observed on the same day. The higher incidence of internal ring-cracking compared to stem-end splitting on this day (115 DAFB) suggested that the initiation of both defects may have occurred some days or hours earlier. Therefore, the initiation of ring-cracking may be determined more precisely by sampling fruit at shorter time intervals. Similarly, the onset of the development of stem-end splits from ring-cracks may be determined more precisely by tagging large fruit samples and examining them at shorter intervals for the presence of stem-end splits while still attached to the tree.

In conclusion, periodic sampling of fruit during growth has been used to determine the chronological development of stem-end splitting during the season and to estimate the critical growth period when stem-end splitting commences in 'Gala' apples. It has been found that the onset of fruit splitting occurs at about 115 days after full bloom when the final shape of fruit was established, or about three weeks prior to commercial fruit maturity. Studies on fruit growth rates suggested that the development of stem-end splitting may be related to an imbalance in growth of the whole fruit or its constituent parts. The extent of this asymmetry

may account for the degree of susceptibility of individual fruit.

In the next chapter, the changes in fruit mechanical and physico-chemical properties during growth and development will be investigated in order to explore possible relationships between the textural characteristics of the fruit and the onset of stem-end splitting.

## CHAPTER SEVEN

### CHANGES IN MECHANICAL AND PHYSICO-CHEMICAL PROPERTIES OF 'GALA' APPLES DURING GROWTH AND MATURATION

#### 7.1 Introduction

The fundamental importance of fruit mechanical properties as quality attributes and in the maintenance of the structural integrity of the fruit both during growth and postharvest handling was briefly reviewed in Chapter Six (Section 6.1). The understanding of the changes in these properties in relation to fruit growth and the onset of stem-end splitting is therefore important in trying to enhance our understanding of their role in stem-end splitting as well as gain a better knowledge of the mechanism of the splitting phenomenon.

Since stem-end splitting is exacerbated as the season progresses (Chapter Six, Section 6.4.1), especially when fruit are allowed to hang late on the tree for colour and size (Walsh et., 1992), knowledge of the changes in growth pattern and mechanical quality attributes of fruit in relation to the onset of stem-end splitting is particularly important from the standpoint of harvesting fruit at suitable maturity levels so as to minimize the overall amount of fruit damage due to splitting during the season. The possibility of early harvests to reduce fruit cracking in other fruits such as tomatoes (Frazier, 1947) and cherries (Trought and Lang, 1991) has been suggested. Furthermore, knowledge of the changes in fruit properties during growth and development may indicate why fruit are inclined to split due to stresses which accompany these changes.

This chapter of the thesis investigates changes in fruit mechanical and physico-chemical properties during growth and maturation and in relation to the onset of stem-end splitting.

## 7.2 Materials and Methods

From a sample of 600 fruit used to assess the incidence of stem-end splitting on each sampling date (Section 6.2), 25 fruit without any visible physical defects were randomly selected and used for measuring fruit mechanical properties. Fruit were picked at two-week intervals initially and later at weekly intervals after the onset of stem-end splitting.

Prior to testing, each fruit was weighed using a desk-top balance (Section 3.4.1). Soluble solids concentration (SSC) was measured with a Atago Refractometer while the flesh crushing stress was measured using Mark II of the prototype Massey Twist Tester (Studman and Yuwana, 1992) as described in Sections 3.4.2 and 3.4.4, respectively. Both properties were measured once on each of two sides (blushed and pale) along the fruit equatorial diameter.

During the first experiment on November 15, 1991 (45 DAFB) when fruit were generally "hard", preliminary tests were carried out on fruit to select a suitable size of twist blade and an additional weight that was attached to the arm of the twist tester so as to ensure the failure of fruit flesh. An additional weight of 200 gm was selected and used up to January 24, 1992 (115 DAFB) and this was reduced to 150 gm during subsequent tests when the fruit "softened" considerably. During all tests, the same twist blade of 3.15 mm radius and 4.40 mm axial length was used. Fruit were tested at a depth of 6.40 mm from the surface to the middle of the blade length.

## 7.3 Data Analysis

Fresh crushing stress was calculated using Equation 3.4. The absolute rate of change in fruit weight, soluble solids concentration and flesh crushing stress, respectively, was calculated by dividing the difference in measurement between two measuring dates by the number of days in the interval. Percentage change in fruit property during each sampling interval was calculated as follows:

$$\frac{(\text{Final measurement} - \text{Previous measurement})}{\text{Previous measurement}} \times 100 \quad (7.1)$$

## 7.4 Results

### 7.4.1 Fruit Size

The cumulative increase in the weight of fruit samples during the season is presented in Figure 7.1 and the growth pattern suggests a double sigmoid curve. Fruit weight increased slowly initially up to 73 days after full bloom (DAFB) and then increased rapidly during the following two weeks. Within this period, the absolute fruit growth rate increased from nearly zero to about 2.5 gm/day, after which it decreased to about 1.0 gm/day at 115 DAFB (Figure 7.2).

The transition from this period of decline in growth rate to a period of sharp rise in growth rate up to one week before the first commercial harvest (135 DAFB) coincided with the onset of stem-end splitting. There was no significant difference ( $P \leq 0.05$ ) in the cumulative fruit weight of fruit picked on the first commercial harvest (135 DAFB) and a week earlier (Figure 7.1) but the absolute fruit growth rate was nearly zero (Figure 7.2).

### 7.4.2 Flesh Crushing Stress

Flesh crushing stress decreased with advancing fruit maturity (Figure 7.3), from  $2594 \pm 22$  kPa at 45 DAFB to  $1321 \pm 17$  kPa during the onset of stem-end splitting (115 DAFB), and  $1014 \pm 18$  kPa on the day of first commercial harvest (135 DAFB). The changes in flesh crushing stress during the season can be divided into two stages. First, there was a period of

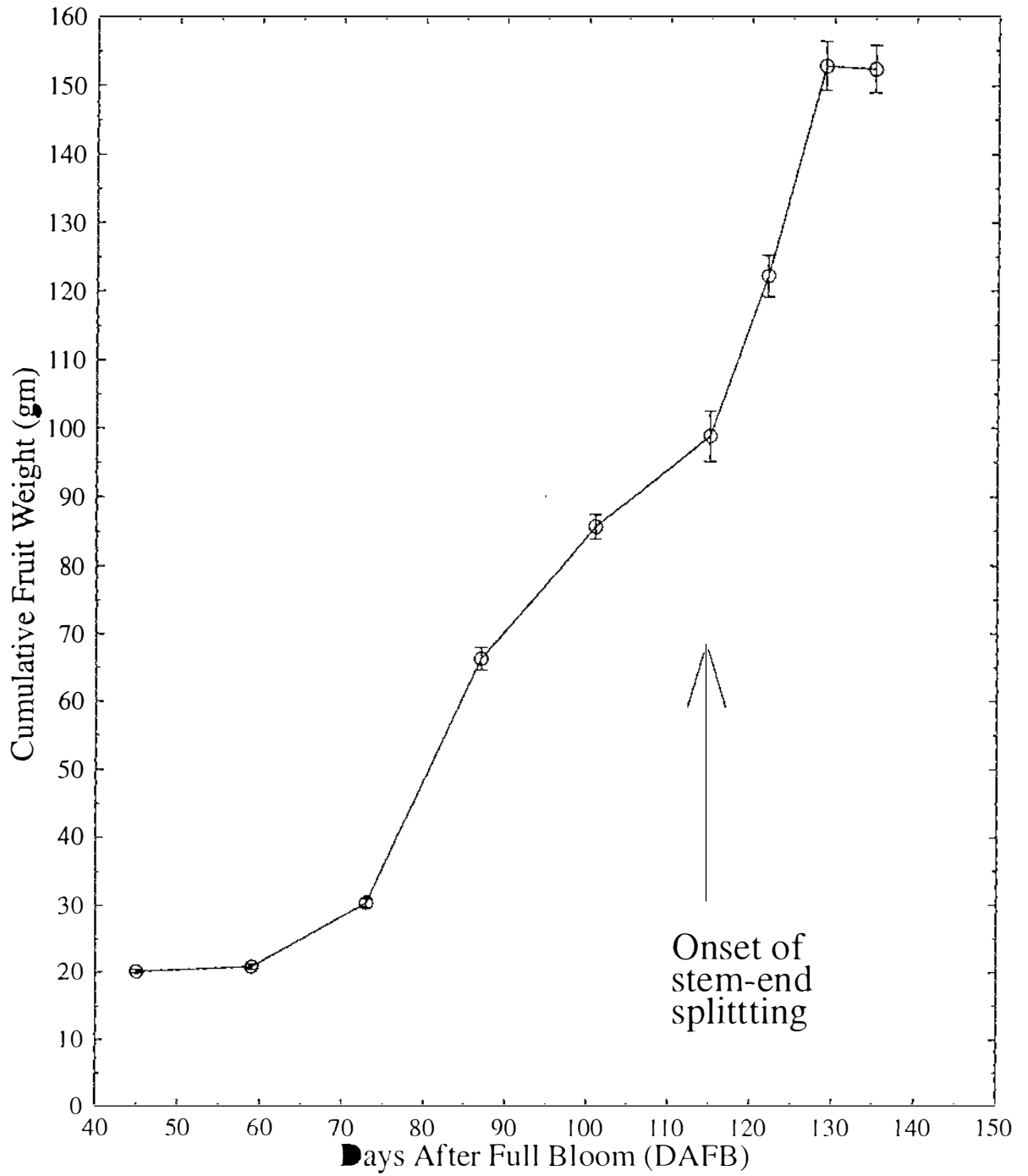

Figure 7.1 Cumulative weight of 'Gala' apples during the season. Vertical bars indicate standard errors of the means.



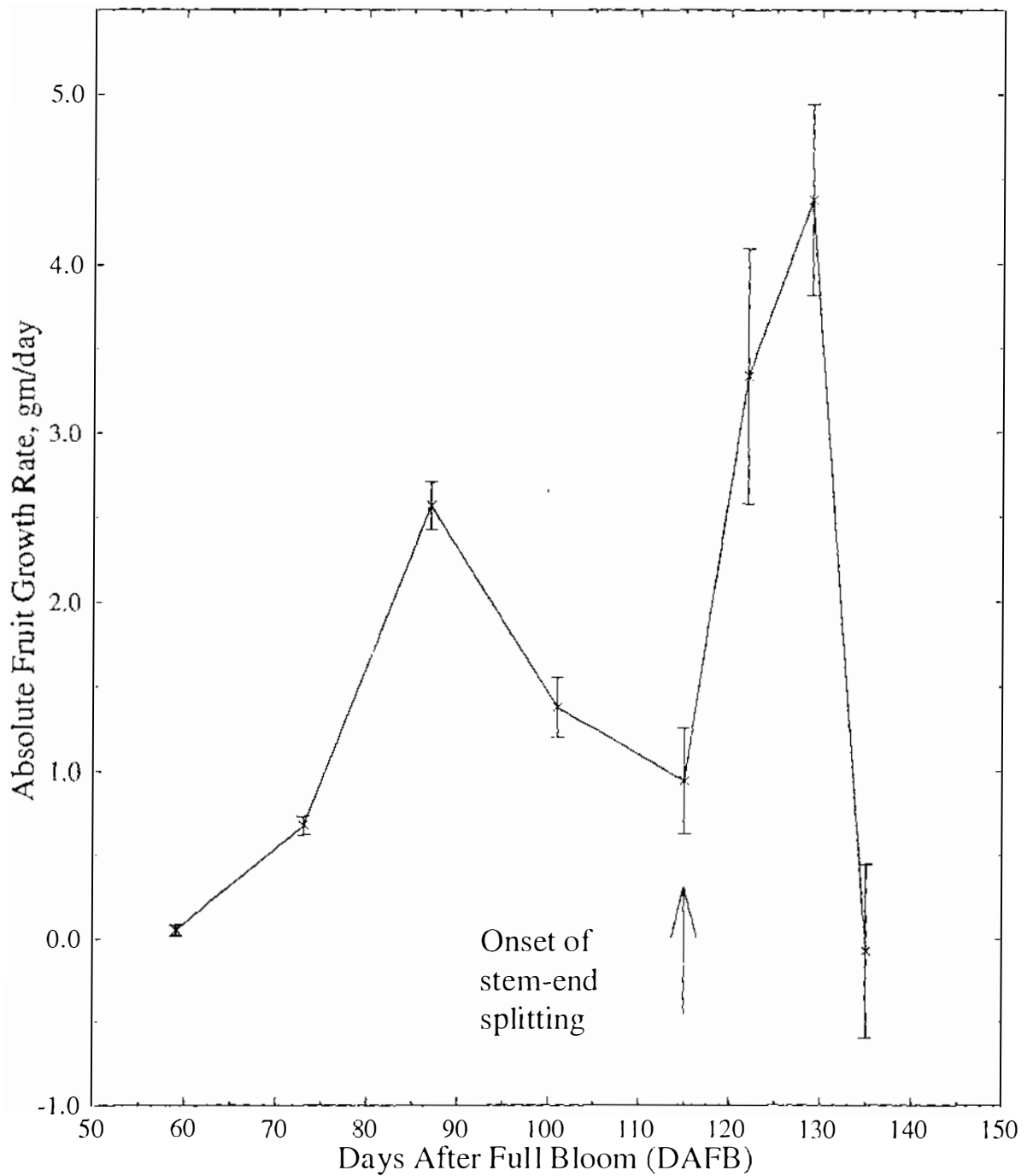

Figure 7.2 Absolute growth rate (weight) of 'Gala' apples during the season. Vertical bars indicate standard errors of the means.

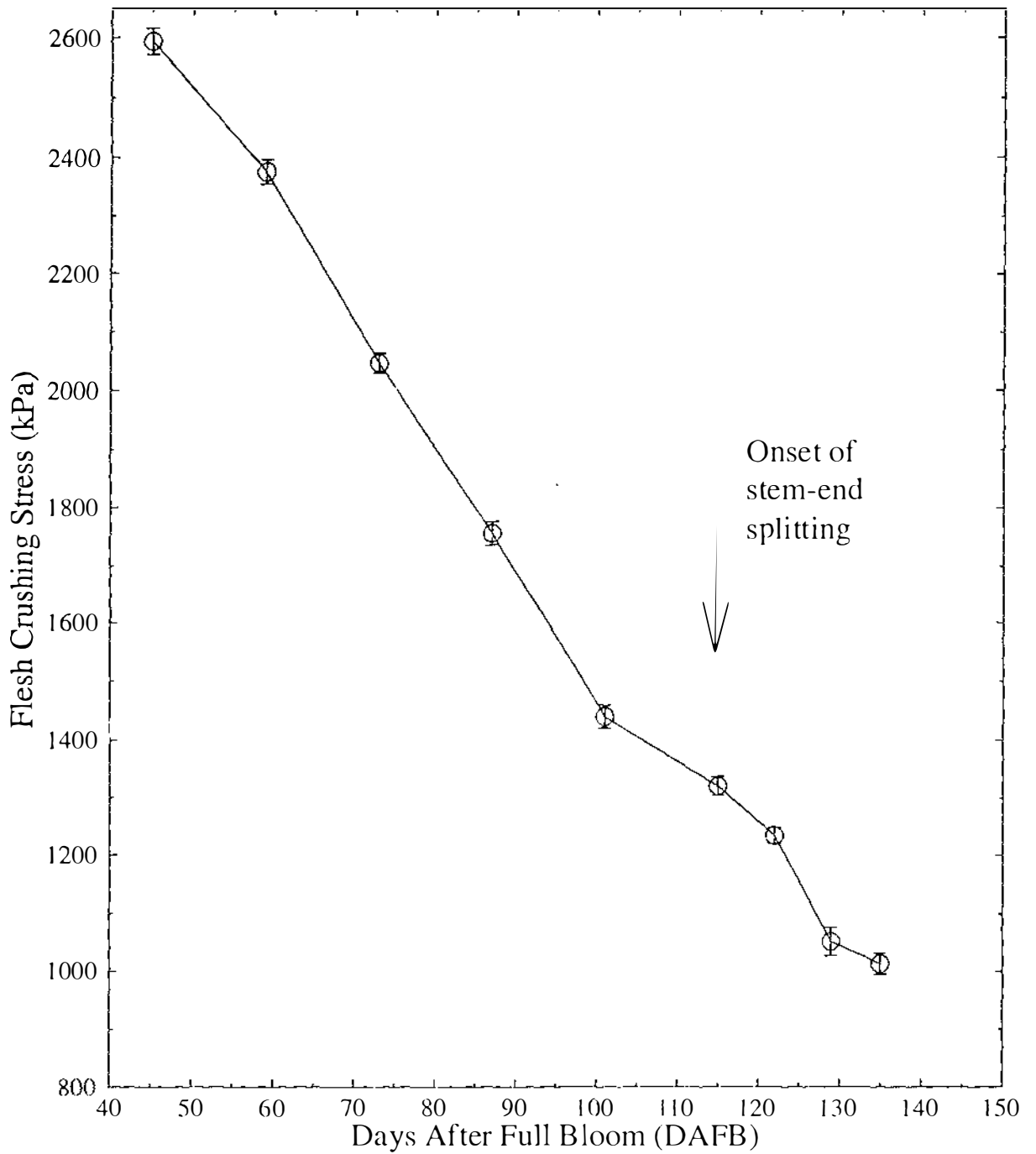

Figure 7.3 Flesh crushing stress (kPa) of 'Gala' apples during growth and maturation. Vertical bars indicate standard errors of the means.

rapid and fairly uniform decline in flesh strength which lasted to about two weeks before the onset of stem-end splitting (45 to 101 DAFB). During this period, there were minimal fluctuations in the absolute rate of decrease in flesh crushing stress (kPa/day) (Figure 7.4). However, the end of this period was marked by the maximum percentage change (about 17%) in flesh crushing stress between any two sampling intervals (Figure 7.5).

The second stage was characterised by a fairly moderate decline in flesh strength which lasted between 101 to 135 DAFB (Figure 7.3). This period commenced with a sharp decline in the rate of decrease in flesh crushing stress from about 22.5 kPa/day to 7.5 kPa/day (Fig 7.4), and was also marked by the first decrease in the percentage change in flesh crushing stress (Figure 7.5). These changes coincided with the onset of stem-end splitting at 115 DAFB.

### **7.4.3 Soluble Solids Concentration**

Soluble solids concentration (SSC) increased parabolically with advancing fruit maturity (Figure 7.6) from  $8.7 \pm 0.1$  °Brix at 45 DAFB to  $9.7 \pm 0.1$  °Brix at the onset of stem-end splitting (115 DAFB), and  $12.8 \pm 0.2$  °Brix on the day of first commercial harvest (135 DAFB). Initially, SSC remained fairly uniform up to about 87 DAFB and this was followed by a period of rapid accumulation during which the onset of stem-end splitting occurred.

Analysis of the rate of accumulation of soluble solids (Figure 7.7) showed that fruit soluble solids increased gradually from nearly zero °Brix/day at 59 DAFB to about 0.05 °Brix/day at 122 DAFB, followed by a suddenly rapid increase in the rate of accumulation of soluble solids. There was no clear relationship between the onset of stem-end splitting and the absolute rate of change in fruit soluble solids as shown in Figure 7.7.

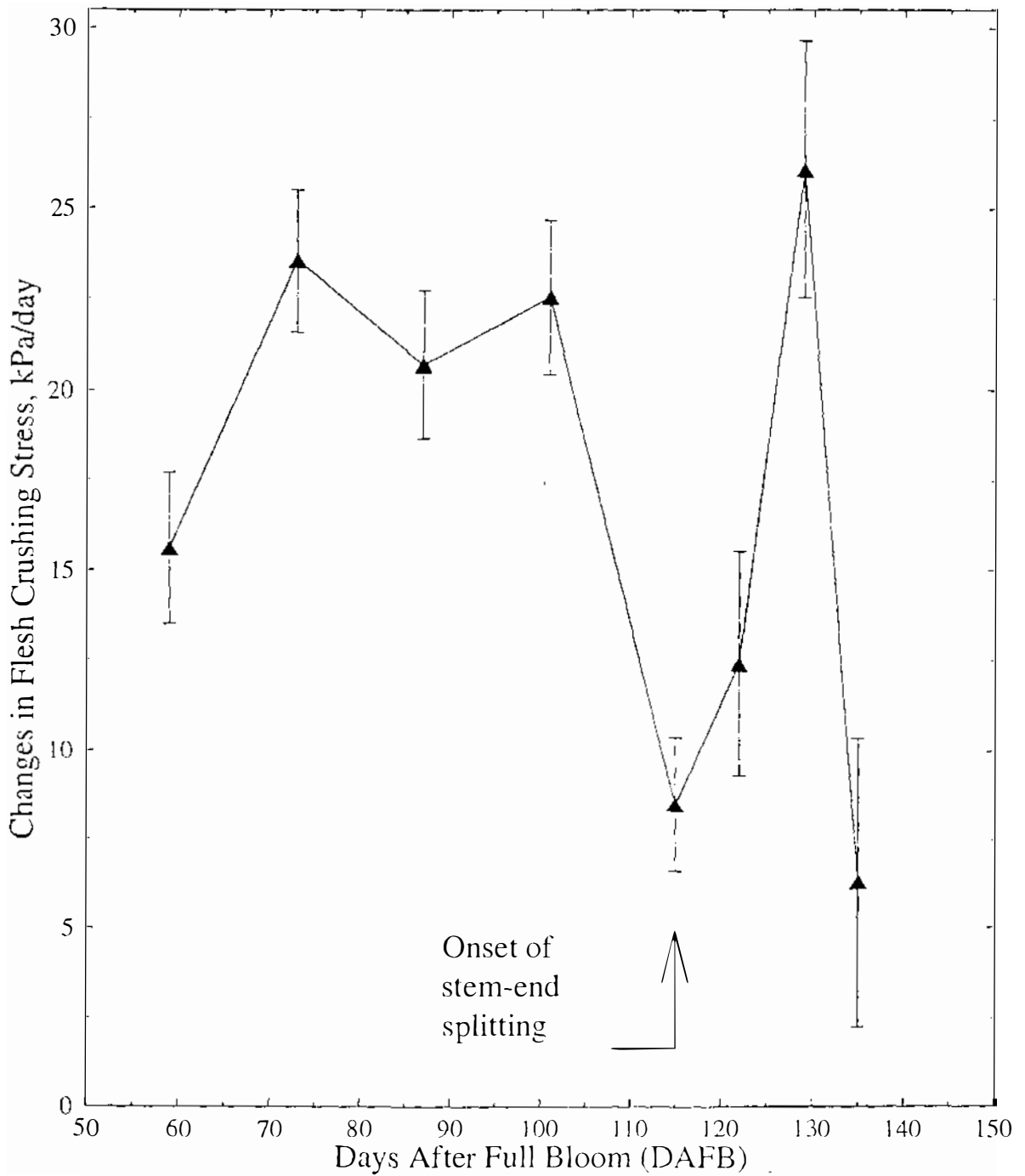

Figure 7.4 Absolute rates of change in flesh crushing stress of 'Gala' apples during growth and maturation. Vertical bars indicate standard errors of the means.

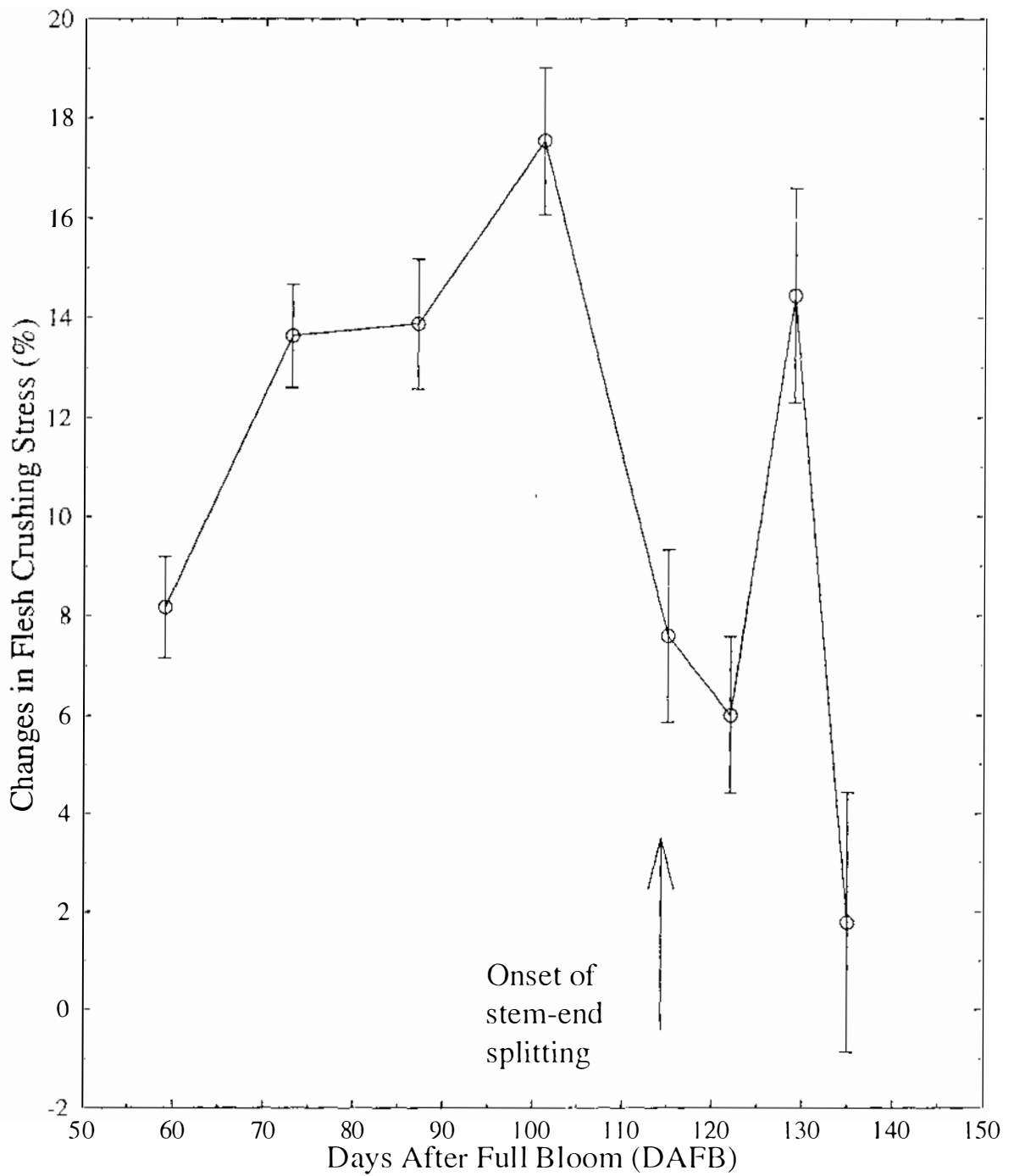

Figure 7.5 Percentage absolute changes in flesh crushing stress of 'Gala' apples during growth and maturation. Vertical bars indicate standard errors of the means.

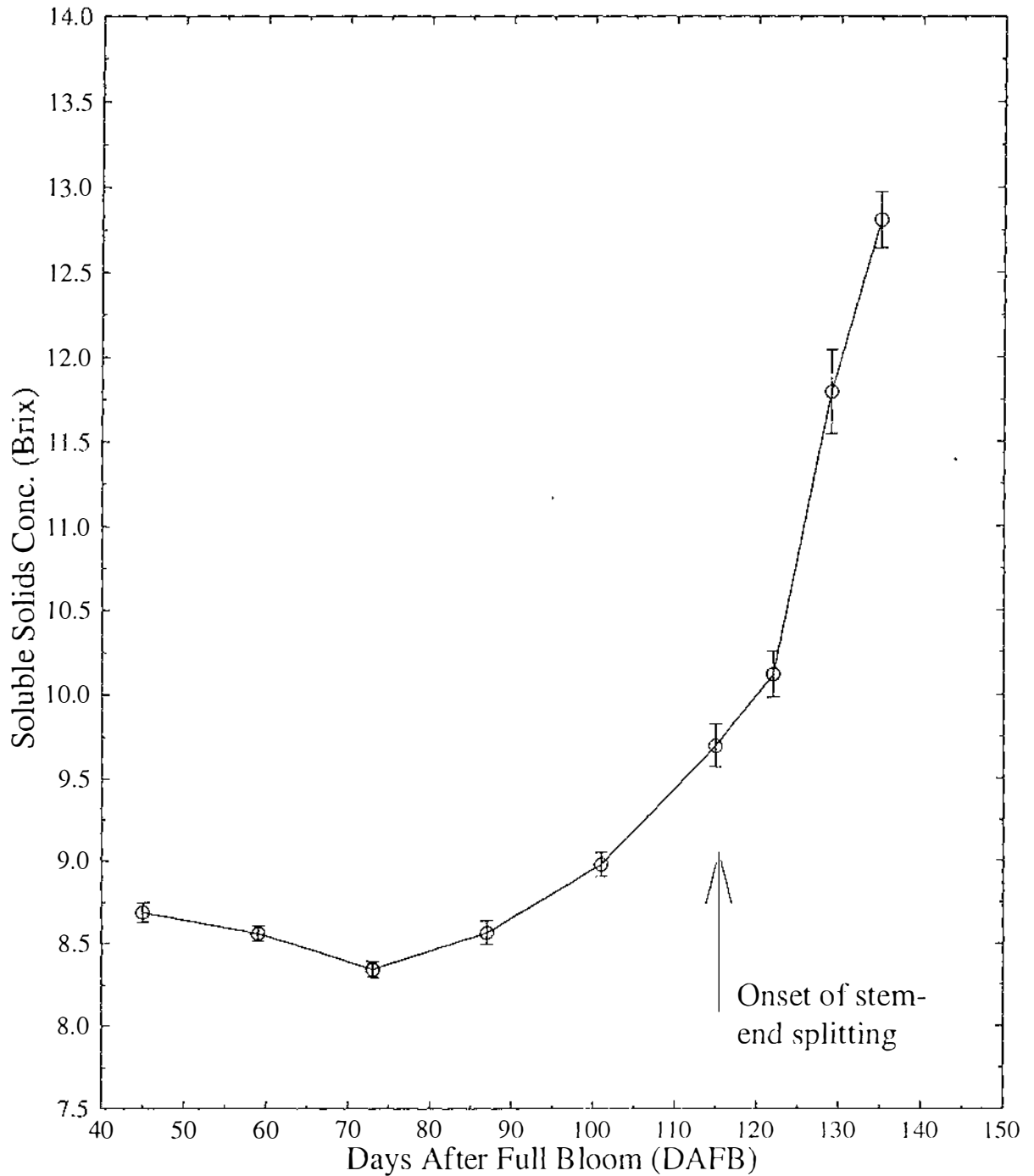

Figure 7.6 Soluble solids concentration (Brix) of 'Gala' apples during growth and maturation. Vertical bars indicate standard errors of the means.

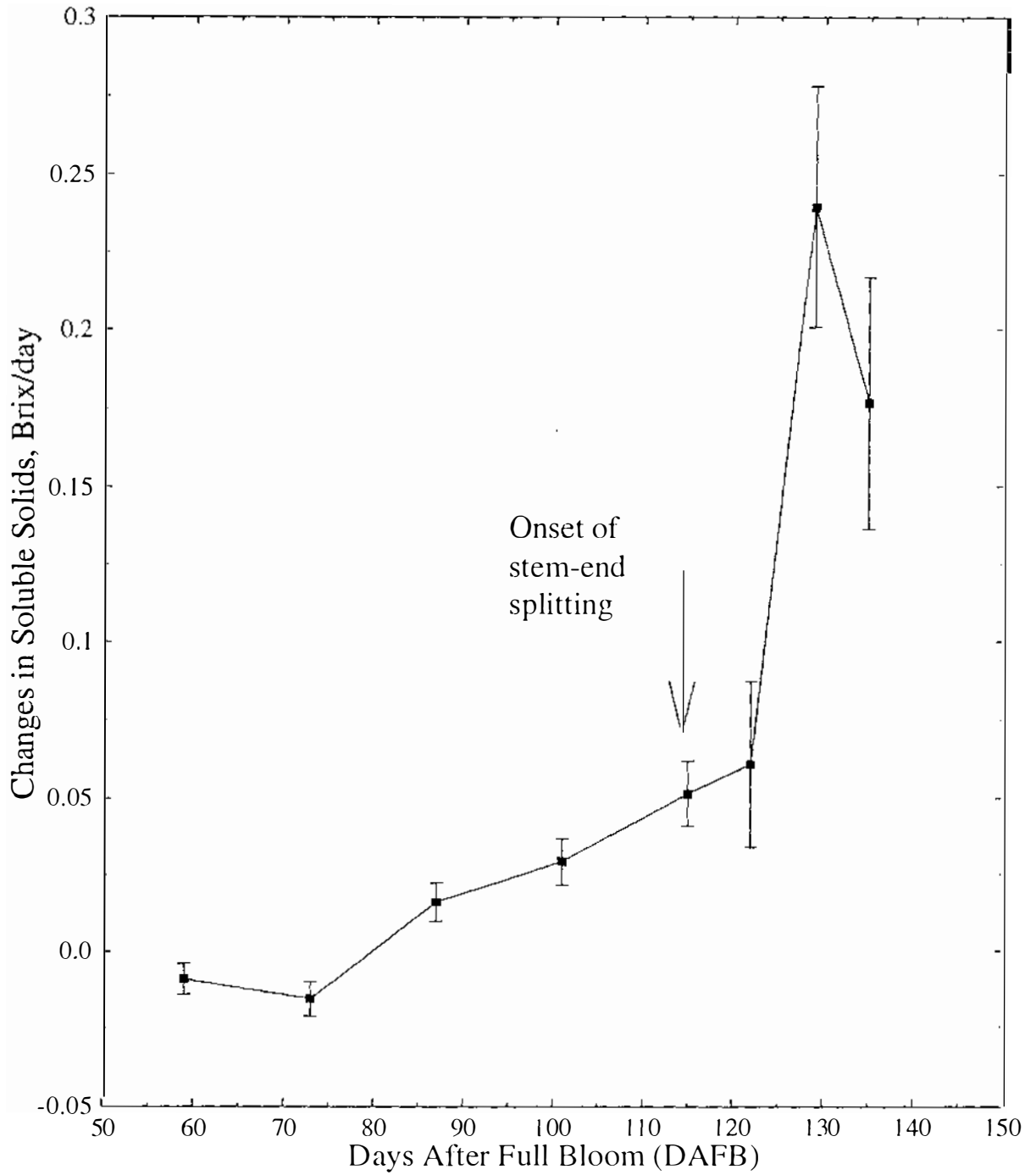

Figure 7.7 Absolute rates of change in soluble solids of 'Gala' apples during growth and maturation. Vertical bars indicate standard errors of the means.

## 7.5 Discussion

### 7.5.1 Changes in Fruit Weight

The cumulative growth pattern (fruit weight) of detached 'Gala' apples obtained in this study suggests a double sigmoidal growth curve (Figure 7.1) and the transition between the two S-shaped curves coincided with the onset of stem-end splitting. This result contrasts the exponential cumulative growth of fruit length and diameter obtained earlier in Chapter Six (Figure 6.9) which also did not indicate any changes in growth pattern at the onset of stem-end splitting. It appears, therefore, that the growth of fruit diameter and weight (both measures of fruit size) proceed in different patterns during fruit development and maturation and the cumulative changes in fruit weight may be more related to the development of stem-end splitting than diameter. This finding that the growth of fruit diameter and weight occurred at different rates might explain the conclusion of Coombe (1976) that quite different interpretations can emerge if fruit growth data are calculated on different bases.

Lott (1933) obtained similar differences in the growth pattern of peach fruit when diameter and weight measurements were compared. It therefore appears that the variation in growth pattern obtained from different measures of size is a property of most fleshy fruits. Although this proposal needs to be further tested by comparing measurements in other fruits and their varieties, it does however, pose the phenomenological question of how to compare the growth pattern of fruit, especially when different measurements are used to express growth.

Westwood (1978) reported the seasonal growth of several types of fruit and found that the fresh weight of apples increased in a typical sigmoidal pattern but the author did not include the variety of apple used to obtain the growth curve. If most apple varieties follow this S-shaped growth pattern as suggested by several other authors for some varieties (Tetley, 1930; Smith, 1950; Bain and Robertson, 1951; Denne, 1960; Pratt, 1988; Volz, 1991), it appears that the slow growth period of 'Gala' apples prior to 115 DAFB (Figure 7.1) is a characteristic attribute of the variety and may be related to the susceptibility of fruit to stem-end splitting. In stone fruits (which exhibit a double sigmoidal growth pattern), this period of slow growth about mid-way during the season corresponds with the



period of pit hardening (Miki, 1932; Coombe, 1976; Westwood, 1978), which precedes the onset of pit-splitting in peaches (Woodbridge, 1978).

Analysis of fruit growth rate (Figure 7.2) reveals the existence of two distinct periods of strong development (45 to 87 DAFB and 115 to 129 DAFB) mediated by a sudden slowing down, rather than a single period of more or less steady growth as suggested by Figure 7.1. The time of splitting onset coincided with a very substantial change in fruit growth rate (section 7.4.1). This finding is similar to the change in fruit growth rate (longitudinal and transverse diameters) obtained in Section 6.4.4 during the same period. These results support the conclusion that the development of stem-end splitting may be related to growth asymmetry of the whole fruit or its constituent parts (Section 6.6).

The growth curve in Figure 7.2 suggests four stages in fruit development, each characterised by a well-defined growth rate:

-Stage I relates to a rapid acceleration of growth which can exceed 2.5 gm/day. The onset of this stage could not be accurately determined from the curve because measurements were started at 45 DAFB when fruit had attained considerable growth in both weight and diameter.

-Stage II corresponds to the period when the absolute growth rate (daily gain in weight) was reduced sharply and abruptly, and this stage lasted for 4 weeks. Analysis of the growth rates (length and diameter) of individual fruit on the tree in the preceding Chapter (Figures 6.10 - 6.12) showed that this stage was clearly present in the development of fruit diameter but during the last two weeks, the growth rate of fruit length increased. The end of stage II coincided with the onset of stem-end splitting.

-Stage III began with an appreciable resumption of growth and ended with the maximum seasonal fruit growth rate (4.5 gm/day) which occurred at about one week prior to the first commercial harvest.

-Stage IV marked the end of active fruit growth and lasted between the maximum growth rate and nearly zero absolute growth rate (Figure 7.2) which coincided with the first commercial

harvest during the season (i.e. date of horticultural maturity). Since physiological maturity of fruit depicts the completeness of major physical growth which is characterised by the point where growth rate ceases (Lee and Young, 1983), the coincidence between the point of zero absolute fruit growth rate and the day of first commercial harvesting (135 DAFB) of 'Gala' suggests a good relationship between physiological and horticultural maturity of the fruit.

## **7.5.2 Changes in Flesh Crushing Stress and Soluble Solids**

It is generally known that fruit maturation comprises physical, biochemical, and physiological changes (Westwood, 1978). Physical changes include a decrease in textural strength, while internal chemical and physiological changes include an increase in soluble solids (as shown earlier in Chapter Five using samples of 'Gala' apples collected at different dates from the start of commercial harvesting). The present results using fruit samples from the period of fruit growth to maturation provide further insights related to the rate of decrease in fruit textural strength and accumulation of soluble solids in relation to the development of stem-end splitting during the season.

### ***Flesh Crushing Stress***

Although flesh crushing stress reduced significantly during fruit development, results shown in Section 7.4.2 reveal that this proceeded at two distinct stages. During the first period, the reduction in flesh strength occurred at fairly uniform rate (Figure 7.4) and the end of this period was marked by the maximum percentage change in flesh strength between any two sampling dates (Figure 7.5). Also during this period, flesh crushing stress had a strong linear relationship with the DAFB ( $R^2=99.64\%$ ). Stage two commenced with a sudden drop in the rate of decline of flesh strength from about 22.5 kPa/day to 7.5 kPa/day and this coincided with the onset of stem-end splitting (Figure 7.4).

The abrupt change in the rate of reduction of flesh strength during stage two occurred at the same time when the growth rate of fruit length increased while the growth rate of fruit diameter reduced. This imbalance in the rate of enlargement of the whole fruit during this period would suggest that additional internal stresses occurred within the fruit which may especially be indicated by a sudden change in fruit shape (see Chapter Six) and the minimal change of stress in fruit cells as measured by the crushing stress. The reduction in the rate of decline in flesh strength may also reflect the ability of the fruit to accommodate the sudden generation of internal stresses from the asymmetric growth of the flesh.

Since the decline in fruit texture with advancing maturity reflects a decrease in the capacity of fruit to accommodate itself and withstand outside physical and physiological stresses (Ragland, 1934; Westwood, 1978), the internal ring-cracking which precedes stem-end splitting might very well be caused by tensile growth stresses exerted upon fruit flesh, at a time when it is least able to accommodate them. This suggestion is further supported by the fact that the direction of the internal ring-cracking (axial cracking) corresponds with the direction of increasing growth rate (i.e, fruit length).

### *Accumulation of Soluble Solids*

An examination of the increase in soluble solids concentration during fruit development (Figure 7.6) does not reveal any possible relationship between SSC and the onset of stem-end splitting except that fruit splitting started during the period of increasing fruit soluble solids. However, from the analysis of the absolute changes in SSC during the season (Figure 7.7), the onset of stem-end splitting occurred one week prior to the resumption of rapid increases in SSC. Although further evidence would be required to demonstrate the mechanism by which any changes in SSC might contribute to stem-end splitting, results from the present study do not indicate the substantial involvement of SSC in stem-end splitting in 'Gala' apples.

## 7.6 Conclusions

Changes in the mechanical and physico-chemical properties of detached fruit of 'Gala' apples during growth and maturation were determined. Fruit weight, flesh crushing stress and soluble solids concentration were measured, initially at two-week intervals and later at one-week intervals, from 45 days after full bloom up to the first commercial harvest. The results obtained showed that both fruit weight and soluble solids increased with advancing fruit maturity whereas flesh crushing stress decreased.

There were no characteristic changes in soluble solids concentration in relation to the period of onset of stem-end splitting; however, this period coincided with the transition between two sigmoidal growth patterns of fruit weight. Earlier in Chapter Six, it was found that the onset of stem-end splitting was not related to fruit length and diameter separately but with the length to diameter ratio. These results indicate that with respect to cumulative fruit growth, the development of stem-end splitting may be related to changes in fruit weight rather than length or diameter separately.

Analysis of the changes in fruit textural strength with advancing fruit maturity showed that a sharp decline in the rate of reduction of flesh crushing stress (Figures 7.4 and 7.5) corresponded with the period of asymmetrical whole fruit growth which was characterised by a sudden change in fruit shape as found in Chapter Six. It was suggested that the reduction in the rate of decrease in flesh crushing stress may be related to the presence of additional tensile growth stress induced by the imbalance in growth rate. It was thus hypothesized that the decreased ability of fast maturing and expanding fruit cells to accommodate the resulting stress may account for the failure of cortical tissues, giving rise to internal ring-cracking which is a precursor to stem-end splitting. Further studies would be required to validate this hypothesis using properties of both resistant and susceptible apple cultivars.

## CHAPTER EIGHT

### WATER ABSORPTION, STEM-END SPLITTING, AND OTHER QUALITY ATTRIBUTES OF 'GALA' APPLES AS AFFECTED BY SUBMERSION IN NON-IONIC SURFACTANT WATER SOLUTIONS.

#### 8.1 Introduction

In the horticultural industry, spray chemicals are frequently formulated with a surfactant or spray adjuvant and other surface-active agents to improve uniform coating and ensure maximum contact between the droplet and the fruit or leaves (Monsanto, 1988). These surfactants are known to reduce the surface tension of water (Rohm and Haas, 1982; Union Carbide, undated), thereby preventing the formation of discrete droplets on waxy surfaces (Byers et al., 1990).

Unfortunately, the application of herbicides, fungicides, insecticides or mineral nutrients with a surfactant as emulsifying, dispensing and spreading agents may cause distinctive stress symptoms which affect fruit quality. They are known to enhance the penetration of water, spray chemicals, and nutrients through the fruit cuticle of apples (Westwood and Batjer, 1960; Byers et al., 1990), and several authors have reported that the use of certain surfactants increased the cracking of apples (Noga and Bukovac, 1986; Noga and Wolter, 1990; Byers et al; 1990). Furmidge (1959a) found that certain surface-active agents caused considerable damage to apple and plum leaves, and in a subsequent study on the phytotoxicity and wetting ability of 61 surface-active chemicals, he found that the non-ionic materials caused little damage while anionic and cationic materials caused variable damage depending on their chemical structure and on the nature of the leaf surface (Furmidge, 1959b).

The literature on the effects of chemical sprays on fruit cracking and splitting in apples was reviewed briefly earlier in Chapter Two of this thesis. It was found that in some cases, fruit cracking was increased by some spray materials (Schrader and Haut, 1938; Asquith, 1957)

and in other cases, both sprayed and non-sprayed fruit were affected alike (Moore, 1931; Fischer, 1955; Byers et al., 1990). Correspondingly, efforts to reduce fruit cracking and splitting in apples using growth regulators and other chemicals have been successful in some instances (Sullivan and Widmayer, 1970; Costa et al., 1983; Taylor and Knight, 1986; Byers et al., 1990) and unsuccessful in others (Costa et al., 1983; Visai et al., 1989; Byers et al., 1990). Reductions of fruit cracking in other fruits such as sweet cherries (Bullock, 1952; Davenport et al., 1972; Harrington et al., 1978; Callan, 1986) and tomatoes (Batal et al., 1972) using various growth chemicals and nutrient sprays have also been reported.

Because cracking and splitting usually occur in various fruits following rainfall (Hockey, 1945; Harrington et al., 1978), there has been continued interest in understanding the relationships between water absorption and fruit cracking on the one hand, and between fruit cracking and surface-active chemicals which alter the permeation of water into the fruit. Verner (1935) reported that 'Stayman' apples, attached to or detached from the tree, cracked after submersion in water for one to three days, and recently, Byers et al. (1990) observed that 'Stayman' fruit cracking usually occurred only during relatively long rainy periods after fruit have attained considerable size. The authors found that submerging 'Stayman' apples in several anionic and non-ionic surfactant-water solutions caused increased water uptake and fruit cracking, and it was suggested that submerging apples in 1.25 mL X-77/litre surfactant (a non-ionic) could be used to predict the potential for 'Stayman' fruit to crack under field conditions.

Byers et al. (1990) also found that submerging apples in pesticide combinations or nutrient solutions generally did not affect fruit cracking while a nutrient-surfactant combination did increase fruit cracking; it was concluded that the surfactant was the constituent primarily responsible for the cracking. Wade (1988) found that prior treatment with respiration inhibitors reduced water uptake and cracking of sweet cherry fruit in water. In grapes, Marios et al. (1987) have shown that certain surfactants increased water absorption and fruit cracking in the laboratory following the immersion of fruit in surfactant solutions.

It is a common belief among apple growers that excessive availability of water by rain or irrigation is the primary cause of stem-end splitting, especially when fruit are harvested late

for colour and size. Although the results in Chapter Four showed that frequent irrigation increased stem-end splitting significantly, the high variability of the incidence within the orchard and especially among trees that received the same frequent irrigation treatment suggested that excessive availability of water may not be the primary cause of stem-end splitting in apples. It was considered that the role of excessive water could be to enhance the susceptibility of fruit when the conditions which predispose fruit to stem-end splitting occur. There was, therefore, a need to investigate further the role of water intake on stem-end splitting and the possibility of inducing stem-end splitting in the laboratory by enhancing the movement of water into fruit.

The work described in this Chapter examines the proposition that excessive water intake is the primary cause of stem-end splitting in apples. The effects of several non-ionic surfactants on water uptake and induction of stem-end splitting in 'Gala' apples in the laboratory were investigated using surfactants that are commonly employed in the New Zealand horticultural industry. The specific objectives were to:

- (1) evaluate the effects of various non-ionic surfactants on the rate of water absorption, induction of stem-end splitting, changes in flesh crushing stress and visual quality of fruit;
- (2) determine the effects of submerging fruit in the recommended concentrations of the surfactants used in horticultural sprays on fruit water intake, amount of stem-end splitting, changes in flesh crushing stress, and visual quality; and
- (3) investigate the effects of different surfactant-water concentrations on water uptake and stem-end splitting of fruit.

## 8.2 MATERIALS AND METHODS

### 8.2.1 Chemical Supplies

Table 8.1 shows a description of the trade and chemical names, active ingredients, and manufacturers of the surfactants used. All surfactants were purchased from Fruitfed Supplies Limited, Hastings.

Table 8.1 Description of the Non-ionic Surfactants Used in the Experiments.

Trade Name	Class or Type	Chemical Name and Active Ingredient	Manufacturer
Citowett	Spreader-Sticker	Alkylaryl polyglycol ether / 100%	BASF Ltd
Pulse	Penetrant	Modified polydimethylsiloxane / Silwet M	Monsanto Inc.
Regulaid	Spreader-Activator	Polyoxyethylenepolypropoxypropanol, Dihydroxypropane, Alkyl 2-ethoxyethanol / 90.6%.	KALO Agric Chemicals Inc.
		Constituents ineffective as spray adjuvant / 9.4%	
Triton X-45	Penetrant	Octylphenoxypolyethoxyethanol, Alkyl aryl polyether alcohol / 100%	ICI Crop Care

Trade names are provided solely for information. Mention of a trade name does not constitute a guarantee, warranty or endorsement of the product.



## 8.2.2 Fruit Materials

Samples of 'Gala' apples were collected during the 1991/92 season at different stages of maturity and used for testing. All fruit samples were hand-picked from a commercial orchard in the Hawke's bay region in New Zealand. Fruit were randomly picked from 32 mature trees which were used during the previous season (1990-91) to study the effects of orchard management practices on stem-end splitting (Section 3.2.1). In the present study, the trees received standard management practices. On each sampling date, only sound fruit with stems attached were selected.

## 8.2.3 Methods

### Experiment One

'Gala' apples of uniform maturity (skin colour) and size were hand-picked on January 24, 1992 following the first observation of stem-end splitting in the orchard during the season. Fruit were randomized into ten buckets each containing 20 fruit. Fruit were numbered on the skin with a marker and weighed individually on a balance ( $\pm 0.01$  g). Two replicate samples per treatment were submerged in the following treatments: (1) tap water (control), (2) 1.25 mL Citowett/litre, (3) 1.25 mL Pulse/litre, (4) 1.25 mL Regulaid/litre, and (5) 1.25 mL X-45/litre. The surfactant solutions were aqueous.

At 24-hourly intervals up to 4 days, fruit were removed from the buckets, blotted dry with paper towels and weighed individually. Each fruit was examined for stem-end splitting and other types of cracking by inspecting under a bright light. The percentage of fruit on each day with one or more fractures of any size or shape was determined. Water uptake at each 24-hour interval and after the entire soaking period was calculated as the percentage gain in fruit weight during the period of immersion. Flesh crushing stress was determined after 4 days of immersion, using the Massey Twist Tester as described Chapter Three (Section 3.4.4).

Visual quality was assessed after 4 days of immersion by assigning a quality score to each treatment sample, ranging from 0 for no noticeable damage to 5 for highly unacceptable. The

adverse visual changes were tissue browning and lenticle blotches.

To examine the effect of the stage of fruit maturity, samples were harvested 2 weeks later (Feb. 7, 1992) and tested as described above. Soaking fruit in distilled water was also included as the sixth treatment. Fruit were examined for cracking at the end of the 4-day soaking period. Mean weight gain was determined for cracked and non-cracked fruit separately.

### Experiment Two

'Gala' apples were harvested on 31 Jan. 1992 and randomized into 6 buckets containing 25 apples each. The sample of twenty-five fruit in each bucket were numbered on the skin with a marker, weighed individually, and submerged in various aqueous surfactant solutions at the recommended horticultural concentrations. The treatments were as follows: (1) distilled water (control), (2) tap water, (3) 0.25 mL Citowet/litre, (4) 2.00 mL Pulse/litre, (5) 2.50 mL Regulaid/litre, and (6) 2.00 mL X-45/litre.

At 24-hour intervals up to 4 days, each apple was blotted dry with paper towels and examined for cracks and reweighed. Both percentage weight gain and fruit cracking were determined for each 24-hour interval while visual quality and flesh crushing stress were determined at the end of the 4-day soaking period.

### Experiment Three

Fruit samples harvested on 5 March, 1992 were randomized into 102 buckets containing 25 fruit. Each fruit was numbered, weighed individually and submerged in distilled water, tap water, or various aqueous solutions of the five non-ionic surfactants; namely Citowett, Pulse, Regulaid, and Triton X-45. Five concentrations of each surfactant were used ranging from 0.08 to 2.00 mL/litre. Each fruit was examined for cracking and weighed after one and four days of submersion.

### 8.3 Analysis of Data

Cracks on fruit resulting from the immersion tests were classified into : (1) 'stem-end splits' which originated from the fruit-stalk joint, extending into fruit flesh along the stalk-calyx axis (as occurring in the field) or (2) general 'skin-cracks' which occurred at any part of the fruit and were confined mainly to superficial fractures in the cuticle.

Statistical analyses of data were carried out using the SAS/STATS package (Cody and Smith, 1987; SAS, 1988). Analysis of proportions using Chi-square tests was employed to compare the means of percentage cracked fruit. SAS General Linear Model (GLM) procedures were used to analyze the effect of surfactant treatments on water uptake (percentage weight gain) and Duncan's multiple range tests were used to separate the means ( $P \leq 0.05$ ). Prior to statistical analysis, data on percentage fruit cracking and weight gain were transformed using the arcsin and back-transformed for presentation (Steel and Torrie, 1980; Mead and Curnow, 1983; Little, 1985).

Correlation analysis using the SAS package was used to determine the strength of relationships between percentage fruit cracking, percentage weight gain, and other measured fruit properties. Graphs and nonlinear regression lines were fitted using the GLE (Version 3.2) general purpose graphics package (Pugmire, 1992).

### 8.4 Results

#### 8.4.1 *Experiment 1 - Effects of non-ionic surfactants at 1.25 mL/litre on water absorption, stem-end splitting, changes in flesh crushing stress and visual quality of 'Gala' apples.*

None of the treatments induced stem-end splitting or any form of fruit cracking after 24 hours of submersion (harvested 24 Jan. and tested 25-29 Jan. 1991). After 4 days, Citowett and Pulse caused 5% and 3% fruit cracking, respectively, while all the fruit in the other treatments remained uncracked (Table 8.2). There were no significant differences ( $P \leq 0.05$ ) between the

amount of fruit cracking caused by Citowett or Pulse and the control (water). None of the fractures on cracked fruit was a 'stem-end split' and the cracks occurred randomly at the cheek, calyx-end, stem-end or as concentric cracks at the stem-end and calyx-end. These were generally classified as 'skin-cracks'.

**Table 8.2** Effects of Submerging 'Gala' Apples in Tap Water or Various Surfactants at 1.25 mL.litre<sup>-1</sup> on Fruit Cracking, Water Absorption (Weight Gain), Visual Quality and Flesh Crushing Stress (kPa) of Fruit [Expt 1a : Fruit Picked 24 Jan. 1992 and Tested 25-29 Jan. 1992].

Surfactant	Fruit Cracked (%) After 4 Days ( <sup>q</sup> )	Mean Weight Gain (%) <sup>x</sup> After 4 Days (Non-cracked)	Flesh Crushing Stress (kPa) <sup>q</sup> After 4 Days (Non-cracked)	Visual Quality Score After 4 Days <sup>w</sup>
Control (tap water)	0	0.44 ± 0.03c	1055.67 ± 8.66 a	0
Citowett	5	2.13 ± 0.09b	989.72 ± 8.79 c	3
Pulse	3	4.53 ± 0.20a	952.06 ± 7.59 d	4
Regulaid	0	2.51 ± 0.37b	1014.97 ± 9.26 b	0
Triton X-45	0	2.02 ± 0.07b	968.59 ± 7.97 cd	5

<sup>q</sup>Chi-square comparison of each surfactant treatment with the control showed no significant effects.

<sup>x</sup>Mean separation within columns by Duncan's multiple range tests,  $P \leq 0.05$ .

<sup>q</sup>Flesh crushing stress of fresh fruit determined using a random sample of 25 apples within 24 hours of harvest = 1321.46 ± 10.24 kPa

<sup>w</sup>Based on subjective visual assessment of skin appearance; 0 means no adverse effect on fruit while 5 means unacceptable fruit.

After the 4-day immersion period, each fruit was sectioned along the stem-calyx axis and examined for internal cracks which have been shown earlier to be present in every fruit with

stem-end splitting (Chapter Four). No fresh ring-cracks were observed. However, some fruit had stem-end internal ring-cracks which were characterised by extensive browning of the exposed surface and surrounding tissues and this suggested that these cracks had occurred prior to the immersion of fruit in the solutions. Although there is a possibility that browning might be complete within a few hours if oxygen is not limiting (Banks, 1993; pers. comm.), the fact that none of the fruit that developed skin-cracking after the immersion test had an internal ring-crack and the flesh of fruit without internal ring-cracks did not show any sign of browning after the soaking treatments further supported the result that internal ring-cracking was not induced by the surfactant treatments.

The cumulative water absorption of fruit (percentage weight gain) increased with the time of soaking in water and all types of surfactant solution (Fig. 8.1). For both the water and the surfactant treatments, the percentage mean weight gain during each 24-hour interval declined from a maximum on day 1 towards a minimum on day 4 (Fig. 8.2). The percentages of the total 4-day weight gain occurring in the first 24 hours were 72% in Citowett, 80% in X-45, 82% in both Pulse and Regulaid, and 93% for fruit submerged in tap water.

At each 24-hour soaking interval (Fig. 8.2) and after 4 days (Table 8.2), all surfactant water solutions induced significant water intake compared to the control (tap water). Pulse induced the highest water intake, followed by Regulaid, Citowett, and Triton X-45. There were no significant differences in the water intake of apples in Citowett or Triton X-45 solutions within 24 hours and after the 4-day immersion period.

Both the internal and external quality of fruit were significantly affected by the surfactant treatments. For example flesh crush strength fell by 20% after 4 days in tap water and by 28% in pulse. The flesh crushing stress of the control fruit (tap water) was significantly higher than each surfactant water treatment. Pulse (which induced the highest percentage weight gain) caused the most significant reduction in flesh crushing stress (Table 8.2). Citowett, Pulse and Triton X-45 reduced fruit visual quality while Regulaid and the control (tap water) did not have any effects. Triton X-45 had the worst effect on fruit visual quality although it did not induce fruit cracking, and also it did not induce the highest water intake. By combining the data for all surfactants for each quality attribute (percent fruit cracking, percent weight

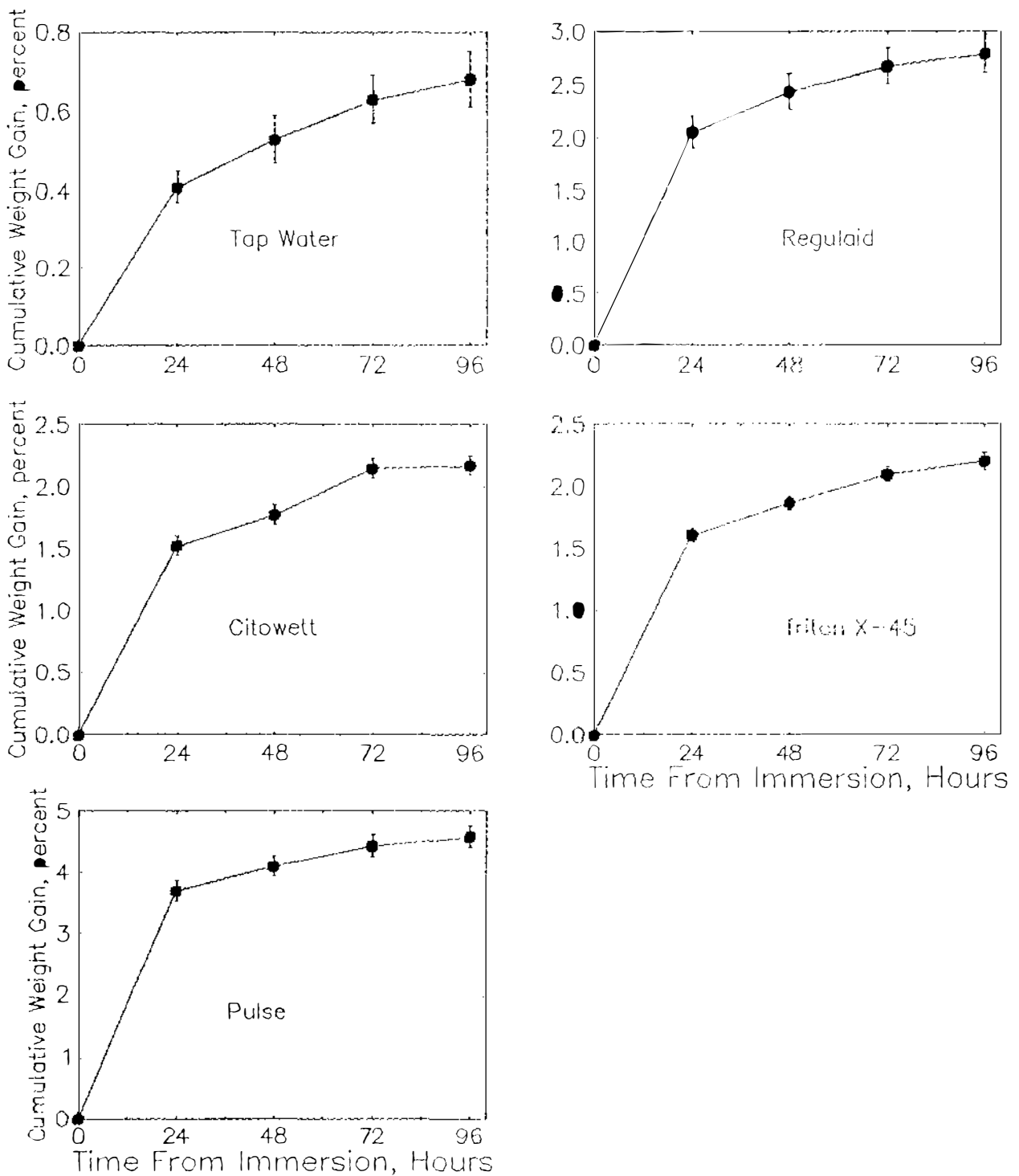

Figure 8.1 Cumulative percentage weight increase of 'Gala' apples during 4 days of immersion in water (control) and various surfactant water solutions at 1.25 mL per litre [Expt1a : Fruit picked 24 Jan. and tested 25–29 Jan. 1992]

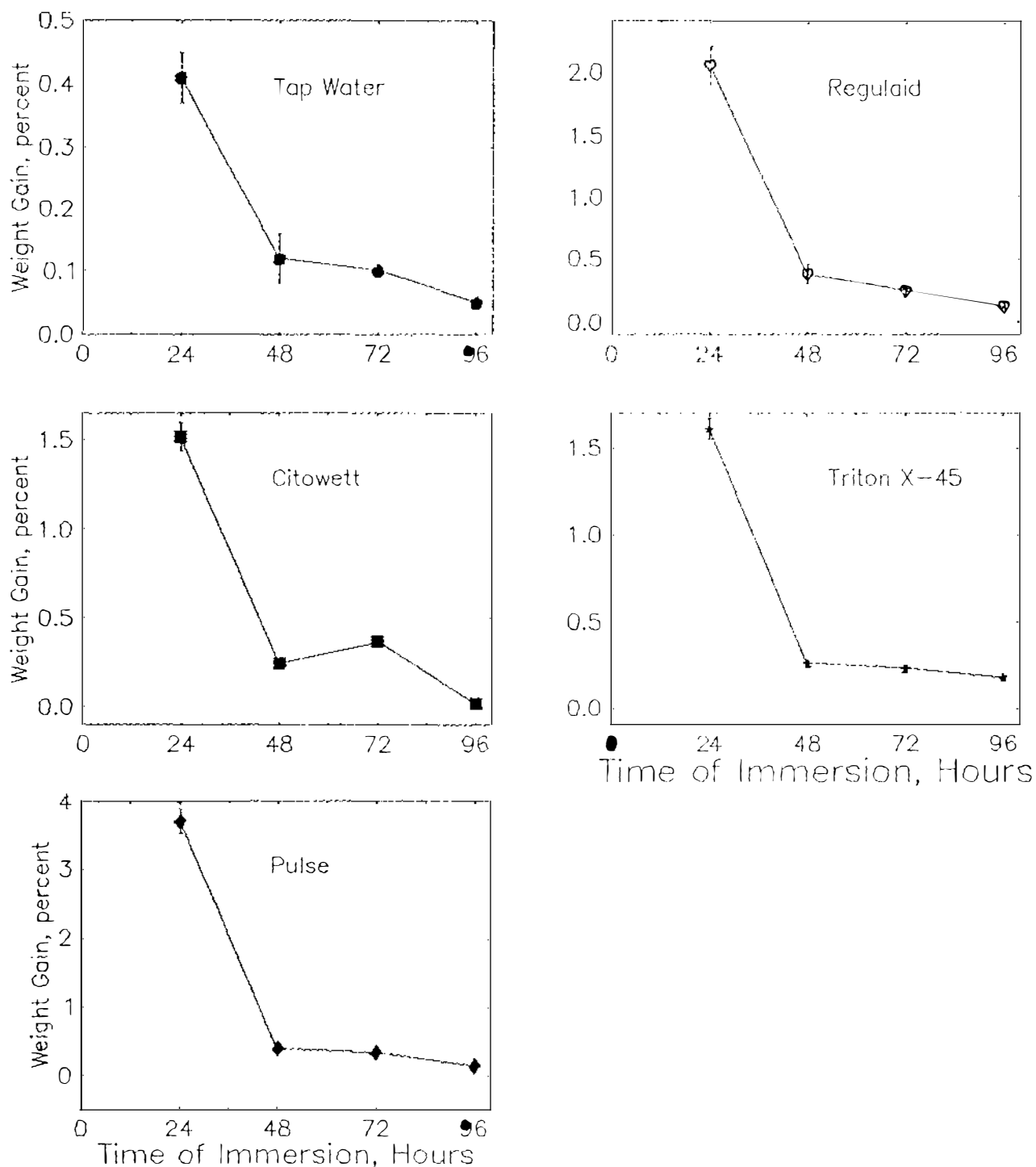

Figure 8.2 Rate of water absorption (daily % weight gain) of 'Gala' apples in water (control) and various surfactant water solutions at 1.25 mL per litre [Expt1a : Fruit picked 24 Jan. and tested 25–29 Jan. 1992]

gain, flesh crushing stress and quality score), there was no significant correlation coefficients between fruit cracking and any of the other attributes. However, flesh crushing stress was inversely correlated with percentage weight gain ( $r = -0.82$ ,  $P \leq 0.05$ ) and the quality score ( $r = -0.89$ ,  $P \leq 0.05$ ).

When the experiment was conducted using samples harvested 2 weeks later (Table 8.3), both Citowett, Pulse and Regulaid induced significant increases in fruit cracking compared to the control (water). None of the cracks on fruit was a 'stem-end split' and cracks occurred randomly at any location on fruit and resulted mainly in superficial fractures on the skin. These were classified as 'skin-cracks' and not 'stem-end splits'. There was no fruit cracking in either the distilled or tap water treatment, and the 8% fruit cracking due to the Triton X-45 treatment was not significantly different from the water treatments (control).

All surfactant treatments induced significant weight gain compared to the water treatments, and there were no significant differences in weight gain between tap water and distilled water. Regulaid and Pulse solutions which caused the highest mean weight gain for both cracked, non-cracked, and all fruit, also caused the highest percentage fruit cracking after the 4-day soaking period, although Pulse had more adverse effect on fruit visual quality. For each type of surfactant solution, cracked fruit gained more weight than non-cracked fruit.

Correlation analysis showed that percentage fruit cracking was significantly correlated ( $P \leq 0.01$ ) with percentage weight gain of non-cracked fruit, cracked fruit and all fruit combined (Table 8.4). However, percentage fruit cracking was more correlated with the weight gain of cracked fruit ( $r = 0.99$ ) than non-cracked ( $r = 0.89$ ) and all fruit ( $r = 0.97$ ). There were no significant correlations between fruit visual quality and percentage fruit cracking, or weight gain of fruit.



**Table 8.3** Effects of Submerging 'Gala' Apples in Tap Water, Distilled Water or Various Surfactants at 1.25 mL.litre<sup>-1</sup> on Fruit Cracking, Water Absorption (Weight Gain) and Visual Quality of Fruit [Expt 1b : Picked Feb. 7 and Tested Feb. 8-12, 1992. Fruit Examined After 4 Days of Submersion].

Surfactant	Fruit Cracked (%) <sup>x</sup>	Mean Weight Gain (%)			Visual Quality Score <sup>w</sup>
		Non-cracked Fruit	Cracked Fruit	All Fruit <sup>y</sup>	
Control / Dist. H <sub>2</sub> O	0	0.67 ± 0.07	--	0.67 ± 0.07 c	0
None / Tap H <sub>2</sub> O	0 <sup>n.s</sup>	0.61 ± 0.04	--	0.61 ± 0.04 c	0
Citowett	20 <sup>*</sup>	2.52 ± 0.16	3.66 ± 0.44	2.75 ± 0.18 b	4
Pulse	68 <sup>***</sup>	5.88 ± 0.36	6.12 ± 0.36	6.04 ± 0.27 a	4
Regulaid	92 <sup>***</sup>	4.50 ± 0.59	6.60 ± 0.42	6.43 ± 0.41 a	2
Triton X-45	8 <sup>n.s</sup>	2.45 ± 0.09	2.81 ± 0.15	2.48 ± 0.85 b	5

<sup>x</sup>Chi-square comparison of each surfactant treatment with the control, P ≤ 0.05 (\*) or 0.001 (\*\*\*); n.s = not significant.

<sup>y</sup>Mean separation within columns by Duncan's multiple range tests, P ≤ 0.05.

<sup>w</sup>Based on subjective visual assessment of skin appearance; 0 means no adverse effect on fruit while 5 means unacceptable fruit.

**Table 8.4** Pearson's Correlation Coefficients Between Fruit Quality Attributes and the Levels of Significance, in brackets [Expt 1b : Picked Feb. 7 and Tested Feb. 8-12, 1992. Fruit Examined After 4 Days of Submersion].

Attribute <sup>p</sup>	Weight gain - noncracked	Weight gain - cracked	Weight gain - All fruit	Quality Score
Fruit cracking	0.89 (0.01)	0.99 (0.01)	0.97 (0.001)	0.25 (0.63)
Weight gain (noncracked)	-	0.89 (0.11)	0.96 (0.001)	0.59 (0.22)
Weight gain (cracked)	-	-	0.99 (0.01)	-0.80 (0.19)

<sup>p</sup>All attributes in percent, except quality scores which were numbers ranging from 0 to 5 as described in Table 8.3 above.

#### **8.4.2 Experiment 2 - Effects of non-ionic surfactants at recommended manufacturers' concentrations on water absorption, stem-end splitting, visual quality and changes in flesh crushing stress of 'Gala' apples.**

For each treatment, the cumulative gain in fruit weight increased with increased period of submersion (Fig. 8.3). As shown in Figure 8.4, the daily rate of weight gain was maximum during the first 24 hours and reduced significantly ( $P \leq 0.01$ ) to a minimum on the last day of the 4-day soaking period. Unlike the other treatments, the decline in daily percentage weight gain of fruit submerged in Citowett solution proceeded rather uniformly during the first 2 days of submersion.

After the 4-day submersion period, all the treatments except Triton X-45, induced skin-cracking of fruit (Table 8.5), although only the effect of Regulaid was significantly different from the control ( $P \leq 0.05$ ). All surfactant treatments induced significant ( $P \leq 0.05$ ) water

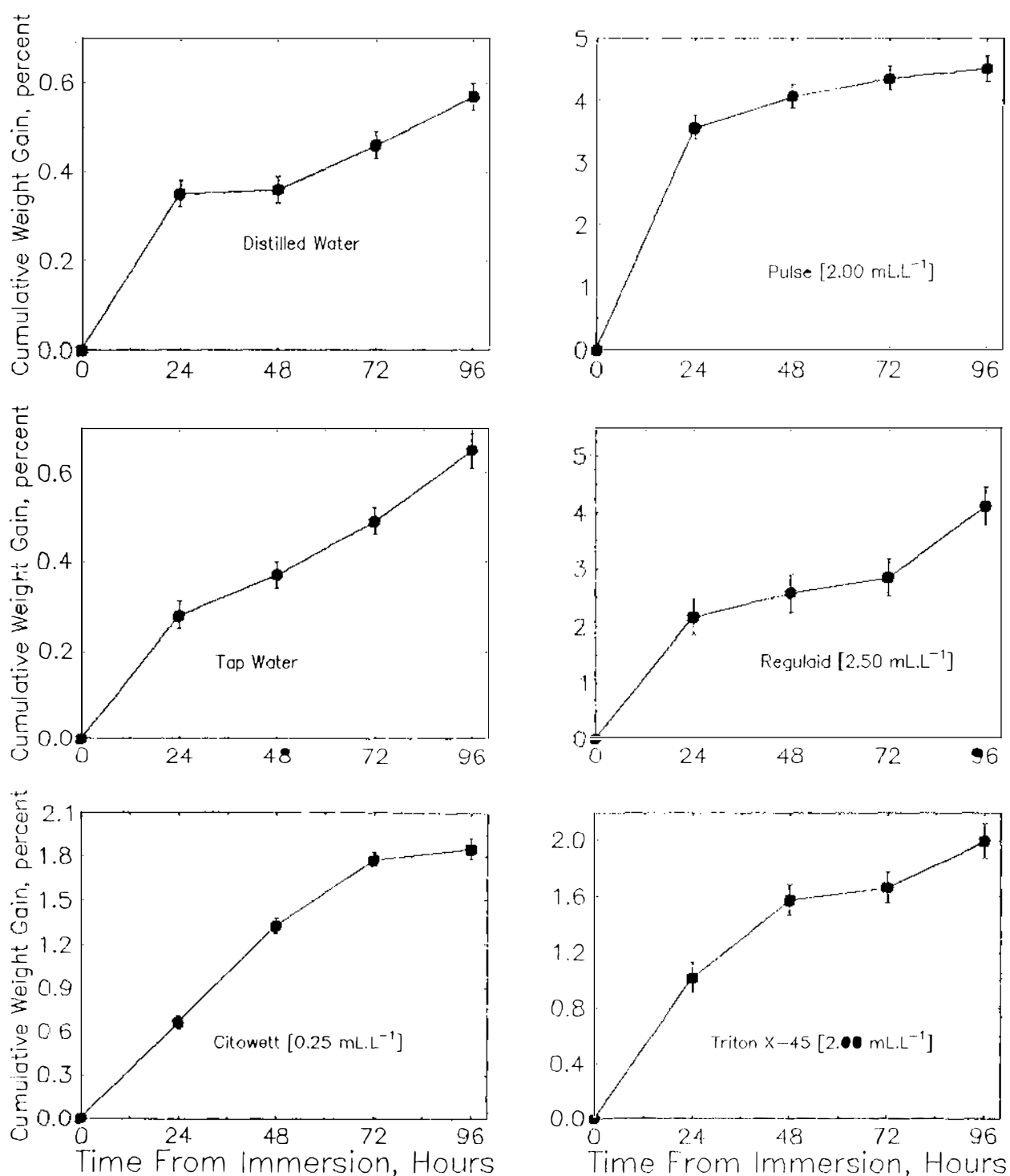

Figure 8.3 Cumulative percentage weight increase of 'Gala' apples during 4 days of immersion in tap water, distilled water (control) and various surfactant water solutions at manufacturers' recommended spraying concentrations [Expt 2 : Fruit picked 31 Jan. and tested 1-5 Feb. 1992]

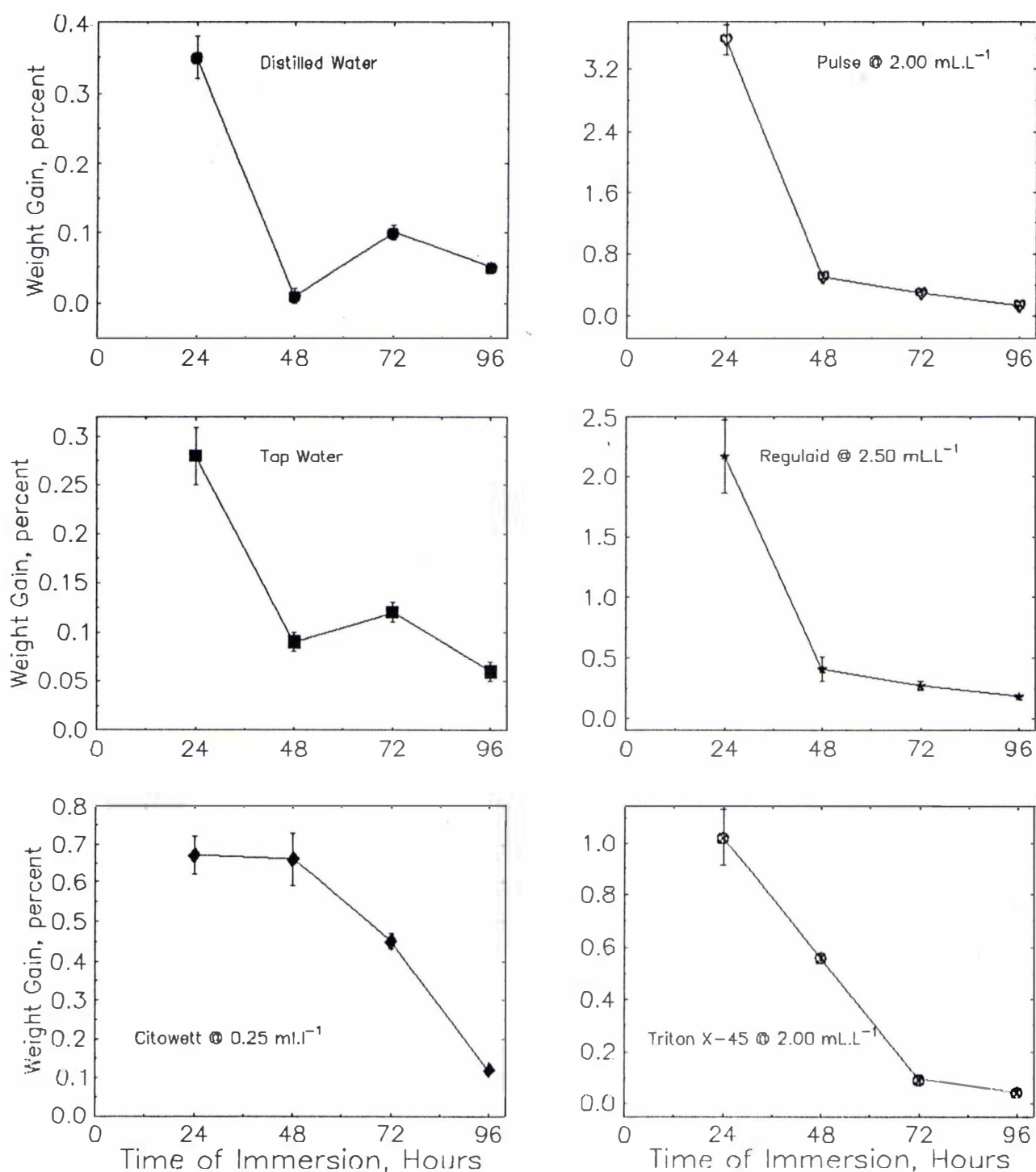

Figure 8.4 Rate of water absorption (daily % weight gain) of 'Gala' apples in distilled water (control), tap water, and various surfactant water solutions at manufacturers' recommended spraying concentrations [Expt 2 : Fruit Picked 31 Jan. and Tested 1–5 Feb. 1992]

**Table 8.5** Percentage Fruit Cracking, Water Absorption (Weight Gain), Flesh Crushing Stress and Visual Quality of 'Gala' Apples After 4 Days Following Submersion in Water or Surfactant Solutions at Recommended Manufacturers' Horticultural Spraying Concentrations [Expt 2: Fruit Picked Jan. 31 and Tested Feb. 1-5, 1992]<sup>w</sup>.

Surfactant	Conc. (mL/L)	Cracked Fruit (%) <sup>x</sup>	Mean Weight Gain (%) ( <sup>y</sup> )	Flesh Crushing Stress (kPa)	Quality Score ( <sup>z</sup> )
Control / Dist. H <sub>2</sub> O	--	8	0.57 ± 0.03 c	1214.48 ± 18.77 a	0
None / Tap H <sub>2</sub> O	--	4	0.65 ± 0.04 c	1198.09 ± 19.64 ab	0
Citowett	0.25	4	1.85 ± 0.07 b	1148.25 ± 18.96 bc	3
Pulse	2.00	28	4.52 ± 0.20 a	1046.41 ± 19.83 d	5
Regulaid	2.50	36*	4.11 ± 1.14 a	1103.93 ± 20.43 c	2
Triton X-45	2.00	0	2.00 ± 0.12 b	1112.31 ± 15.81 c	4

<sup>w</sup>Mean weight gain, flesh crushing stress and appearance score included both cracked and non-cracked fruit.

<sup>x</sup>Chi-square comparison of each treatment with the control,  $P \leq 0.05$  (\*). Means not followed by (\*) are not significantly different from the control.

<sup>y</sup>Mean separation within columns by Duncan's multiple range tests,  $P \leq 0.05$ .

<sup>z</sup>Based on subjective visual assessment of skin appearance; 0 means no adverse effect on fruit while 5 means unacceptable fruit.

absorption expressed as percentage fruit weight gain. Pulse and Regulaid, which induced the

absorption expressed as percentage fruit weight gain. Pulse and Regulaid, which induced the highest amount of fruit cracking, also induced the highest weight gain, and there was no significant difference between the weight gain of fruit submerged in tap water and the control (distilled water).

Flesh crushing stress was reduced significantly by all surfactant treatments. Pulse solution which induced the highest mean weight gain also caused the highest reduction in both flesh crushing stress and visual quality. Although the Regulaid solution caused the highest percentage of fruit cracking and also induced high water intake, it had minimal adverse effect on fruit visual quality. Other surfactant treatments reduced fruit visual quality but fruit submerged in water alone were not affected.

On a 24-hourly basis, none of the fruit in the surfactant solutions cracked after the first 24 hours (Table 8.6) despite significant increases in weight (Fig. 8.4). The only fruit cracking (4%) during this period was due to the tap water treatment and this was not significantly different from the zero cracking from the other treatments. The proportion of cracked fruit increased on days 2 and 4, respectively.

Correlation analysis showed that there was a strong relationship between solution concentration and weight gain ( $r = 0.86$ ,  $P \leq 0.05$ ), and flesh crushing stress ( $r = -0.86$ ,  $P \leq 0.05$ ) (Table 8.7). Percentage weight gain was significantly correlated with percentage fruit cracking ( $r = 0.85$ ,  $P \leq 0.05$ ) and flesh crushing stress ( $r = -0.93$ ,  $P \leq 0.01$ ).

**Table 8.6** Daily Rate of Fruit Cracking of 'Gala' Apples Submerged in Water or Surfactant Water Solutions at Manufacturers' Recommended Concentrations [Expt 2 : Fruit Picked 31 Jan. and Tested 1-5 Feb. 1992].

Surfactant	Concentration mL.L <sup>-1</sup>	Fruit Cracked (%) on Each Day <sup>z</sup>			
		Day 1 <sup>x</sup>	Day 2	Day 3	Day 4
Control -Distilled Water	--	0	4	4	0
None - Tap Water	--	4	0	0	0
Citowett	0.25	0	0	0	4
Pulse	2.00	0	16	0	14
Regulaid	2.50	0	12	5	24
Triton X-45	2.00	0	0	0	0

<sup>z</sup>For percentage cracked fruit on each day, n = one replicate of 25 fruit on day 1 and for subsequent days n = the portion of noncracked fruit from the previous day.

<sup>x</sup>Chi-square comparison of each treatment with the control for each day interval showed no significant effects,  $P \leq 0.05$ .

**Table 8.7** Pearson's Correlation Coefficients Between Solution Concentration and Fruit Quality Attributes (Levels of Significance in brackets). [Expt 2: Fruit Picked Jan. 31 and Tested Feb. 1-5, 1992]

Attribute <sup>p</sup>	Fruit cracked	Weight gain	Crushing stress	Quality Score
Concentration	0.66 (0.15)	0.86 (0.03)	-0.86 (0.03)	0.67 (0.15)
Fruit cracked	-	0.85 (0.03)	-0.61 (0.20)	0.24 (0.64)
Weight gain	-	-	-0.93 (0.01)	0.71 (0.11)
Crushing stress	-	-	-	-0.90 (0.01)

<sup>p</sup>Attributes were expressed in the following units: concentration in mL.L<sup>-1</sup>, fruit cracking and weight gain in %, flesh crushing stress in kPa, and quality score in numbers ranging from 0 to 5 as explained previously in Table 5. All quality attributes included both cracked and non-cracked fruit.

#### **8.4.3 *Experiments 3 - Effects of submerging 'Gala' apples in water or different concentrations of various non-ionic surfactant solutions on water uptake and fruit cracking.***

After the first 24 hours of immersion, water uptake (percent weight gain) increased with increasing concentration of the surfactant water solution (Fig. 8.5) but there were no corresponding increases in fruit cracking (Table 8.8). In fact, there was no fruit cracking in both distilled and tap water, and in the 0.08 mL.L<sup>-1</sup> concentration of all four surfactants. As shown in Table 8.8, chi-square comparison of each surfactant concentration with the control showed that the only significant effect on percentage fruit cracking was due to Pulse at 0.65 mL.L<sup>-1</sup> ( $P \leq 0.05$ ).



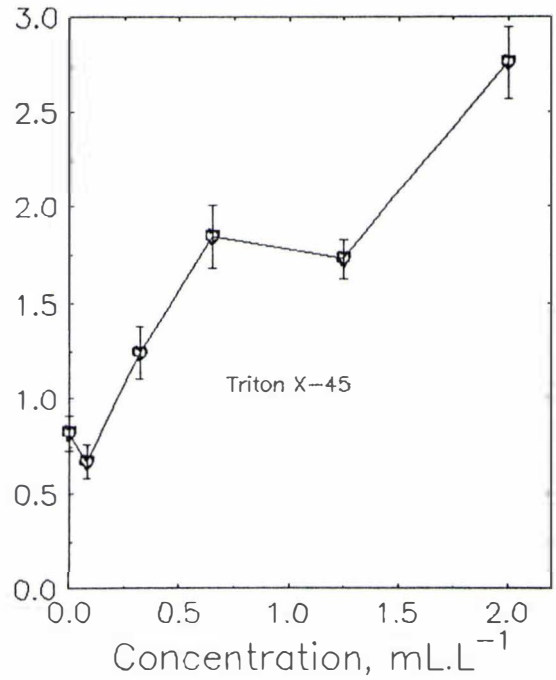
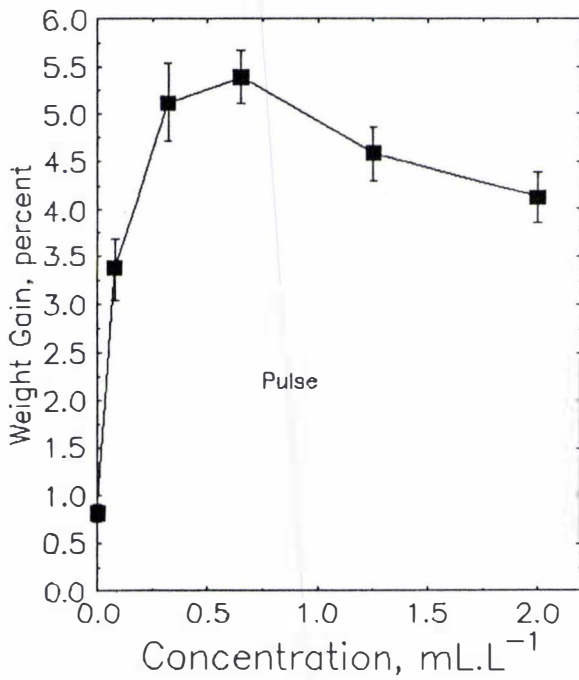
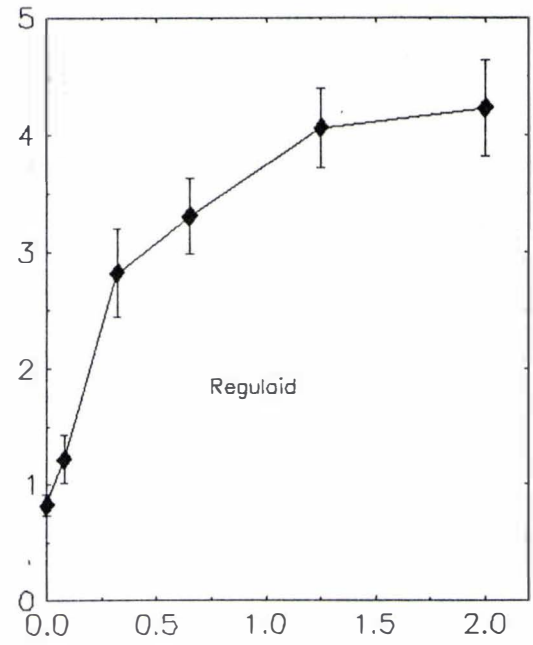
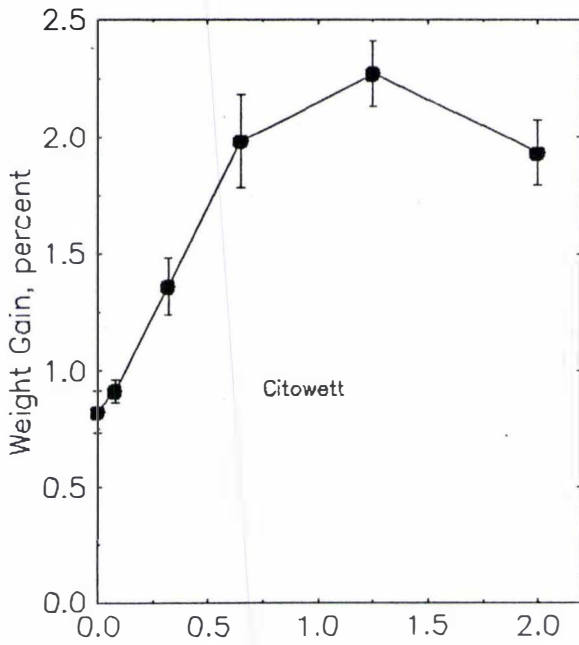

Figure 8.5 Effects of surfactant concentration on Water absorption (% weight gain) of 'Gala' apples submerged in various surfactant water solutions for 24 Hours [Expt 3: Fruit picked 5 Mar. and tested 6–10 Mar. 1992]

**Table 8.8** Effects of Solution Concentration on Percentage Fruit Cracking of 'Gala' Apples After 24 Hours of Submersion in Various Surfactant Water Solutions [Expt 3 : Fruit Picked 5 Mar. and Tested 6-10 Mar. 1992].

Surfactant	Concentration, mL.litre <sup>-1</sup>					Distilled Water (Control)	Tap Water
	0.08	0.32	0.65	1.25	2.00		
Citowett <sup>*</sup>	0	0	4	4	4	0	0
Pulse	0	13	17 <sup>*</sup>	8	8	0	0
Regulaid	0	8	0	0	0	0	0
Triton X-45	0	0	0	4	0	0	0

<sup>\*</sup>Chi-square comparison of each surfactant concentration with the control showed that the only significant effect on percentage fruit cracking was due to Pulse at 0.65 mL.L<sup>-1</sup>,  $P \leq 0.05$ .

On the 4th day of immersion alone (Fig. 8.6), percentage weight gain increased initially with increasing solution concentration up to 0.65 mL.L<sup>-1</sup> for Citowett and Regulaid, or 0.32 mL.L<sup>-1</sup> for Pulse and Triton X-45, and declined afterwards. Similarly, percentage fruit cracking increased with increasing solution concentration of Citowett and Triton X-45 up to 0.32 mL.L<sup>-1</sup> and then declined. Percentage fruit cracking in Pulse increased with solution concentration up to 0.65 mL.L<sup>-1</sup> and declined, while fruit cracking generally increased with increasing concentration of Regulaid (Fig. 8.7).

After 4 days of immersion, the mean percentage weight gain increased initially with increasing solution concentration and then declined (Fig. 8.8). The relationship between weight gain and solution concentration was less clear with Triton X-45. Similarly, percentage fruit cracking increased initially with increasing solution concentration and then declined at high concentrations (Fig. 8.9). Figure 8.9 also shows that maximum fruit cracking occurred at different concentration for each type of surfactant.

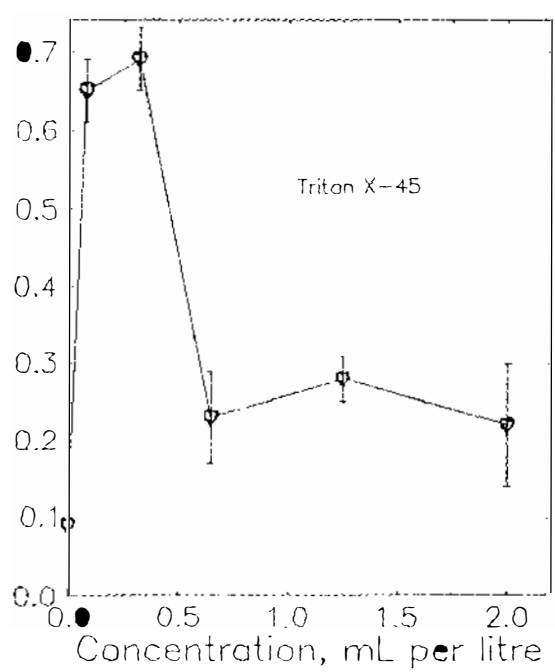
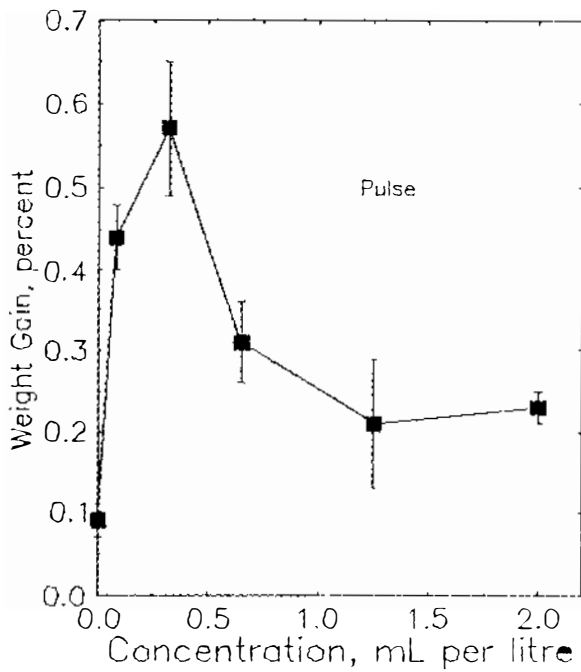
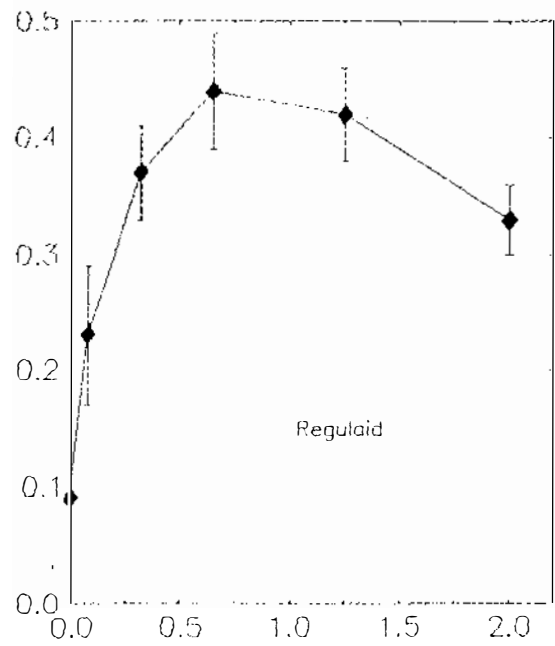
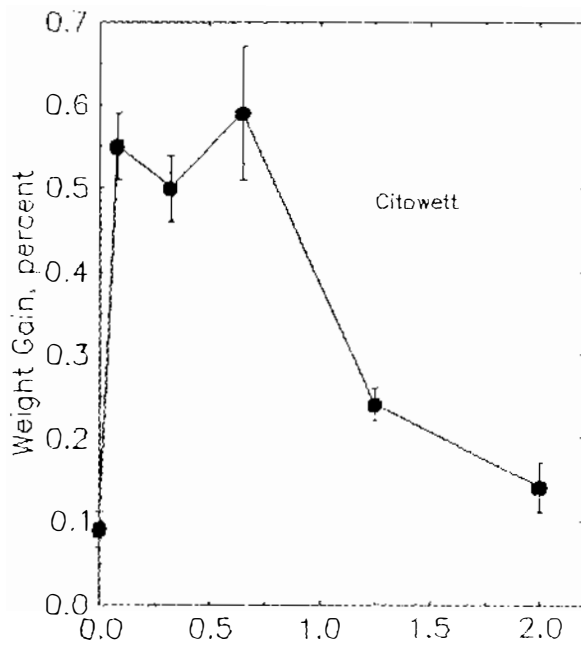

Figure 8.6 Effects of surfactant concentration on water absorption (% weight gain on day 4 alone) of 'Gala' apples submerged in various surfactant water solutions [Expt 3: Fruit picked 5 Mar. and tested 6-10 Mar. 1992]

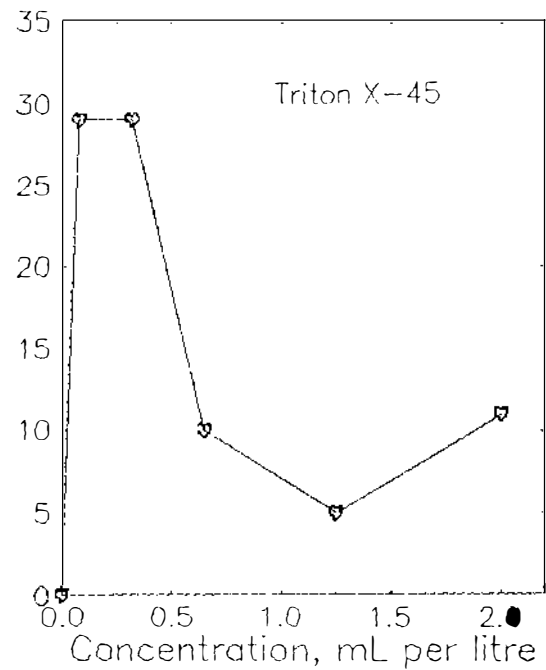
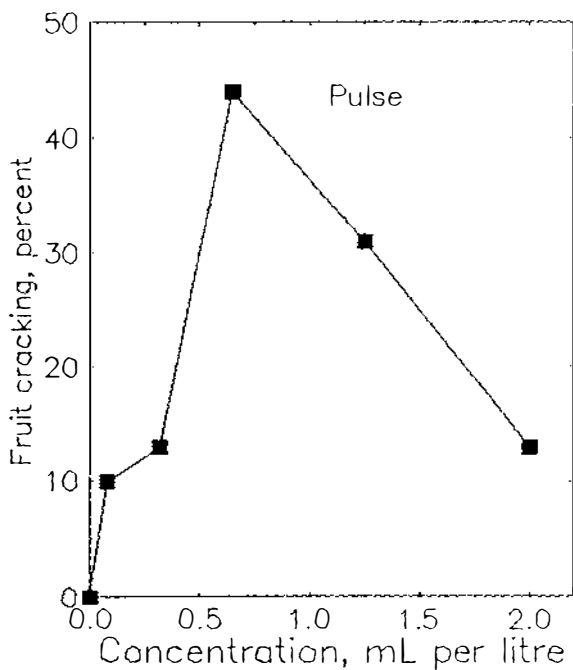
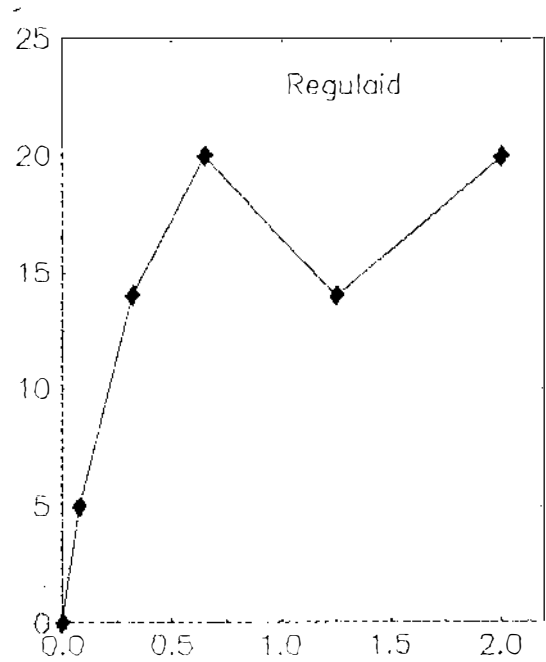
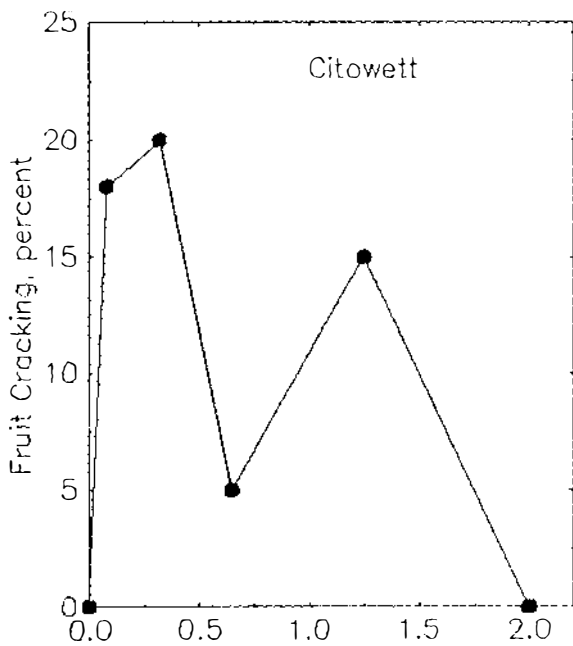

Figure 8.7 Effects of surfactant concentration on percentage fruit cracking (on day 4 alone) of 'Gala' apples submerged in various surfactant water solutions [Expt 3 : Fruit picked 5 Mar. and tested 6-10 Mar.1992]

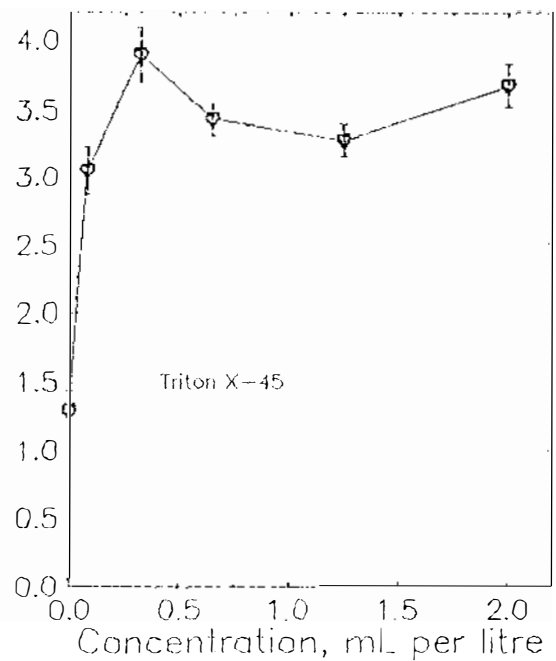
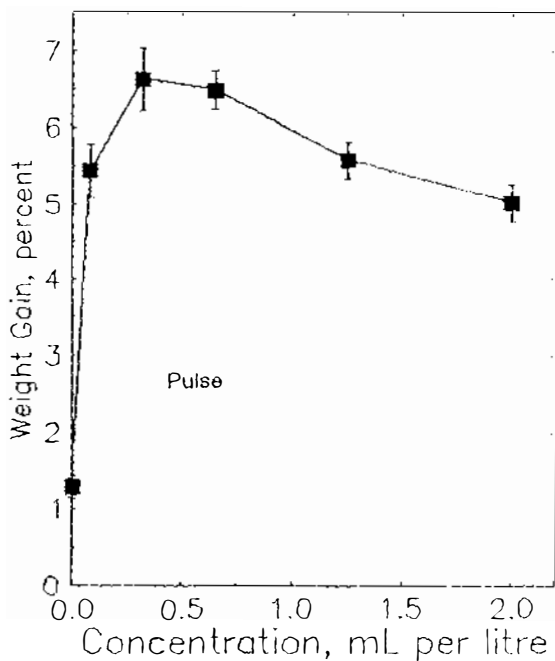
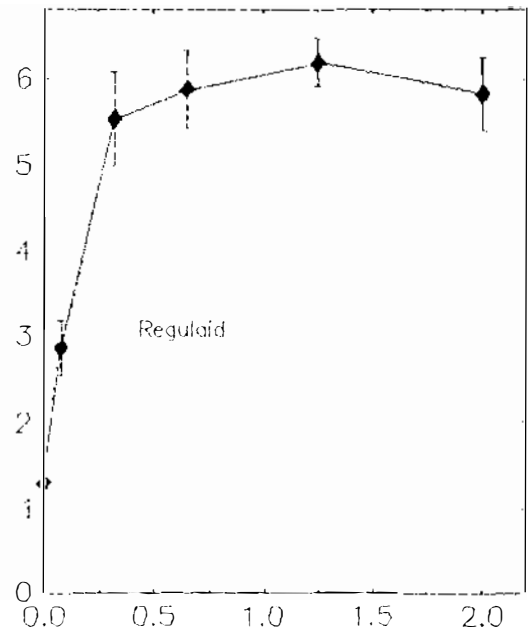
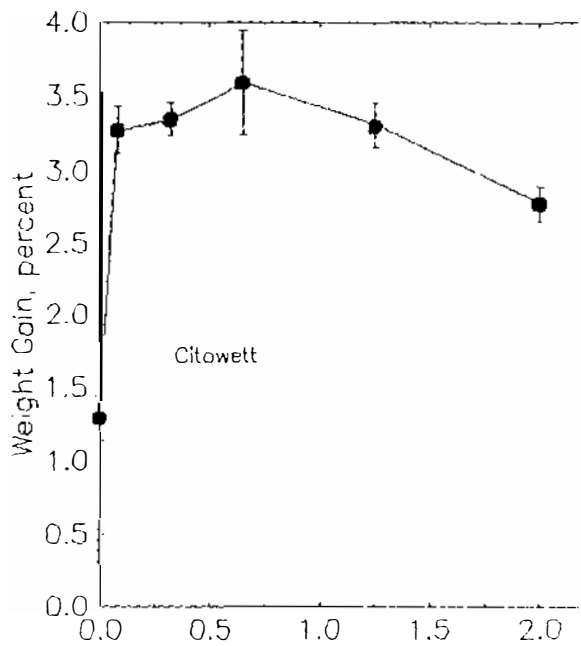

Figure 8.8 Effects of surfactant concentration on water absorption (% weight gain) of 'Gala' apples after 4 days of immersion in various surfactant water solutions [Expt 3: Fruit picked 5 Mar. and tested 6–10 Mar. 1992]

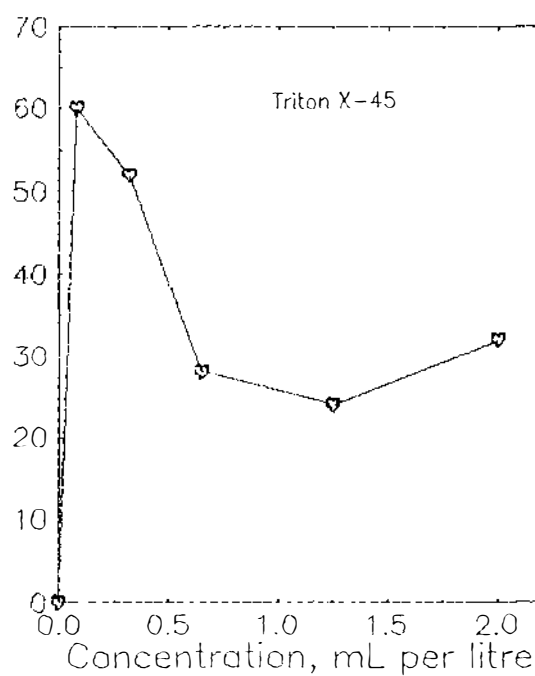
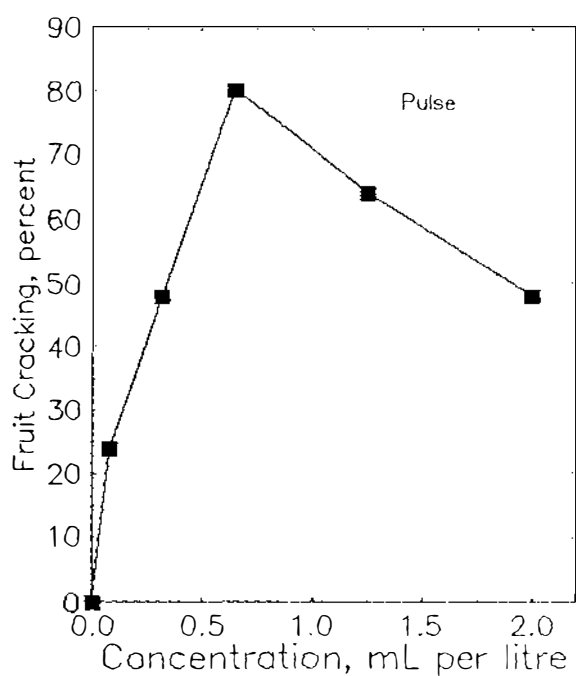
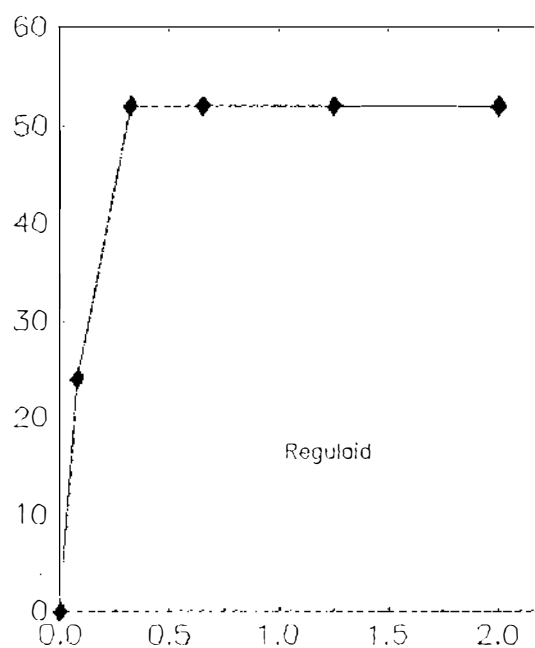
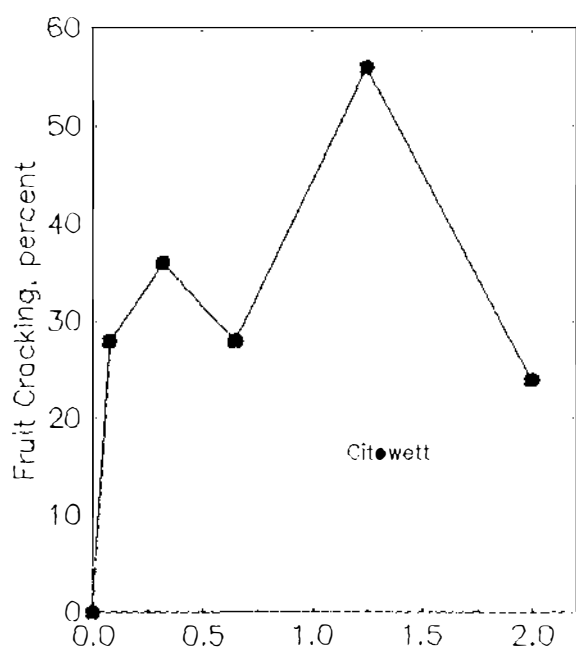

Figure 8.9 Effects of surfactant concentration on percentage fruit cracking of 'Gala' apples after 4 days of submersion in various surfactant water solutions [Expt 3 : Fruit Picked 5 Mar. and tested 6-10 Mar. 1992]

When the data for all surfactant concentrations were combined for each type of surfactant, there were significant increases ( $P \leq 0.001$ ) in both weight gain (Fig. 8.10) and fruit cracking (Fig. 8.11) due to the surfactant treatments compared to the water treatments. Within the first 24 hours of immersion, Pulse induced the highest percentage weight gain and fruit cracking and there were no significant differences between Citowett and Triton X-45 on the one hand, and tap water and distilled water on the other hand. On day 4 of immersion alone, there were no significant differences in the percentage weight gain of fruit soaked in the different types of surfactant (Fig. 8.10), however, Pulse induced significantly higher percentage fruit cracking (Fig. 8.11).

At the end of the 4-day immersion period, Pulse induced the highest weight gain and fruit cracking although these were not significantly different from weight gain and fruit cracking, due to Regulaid ( $P \leq 0.05$ ). Similarly, there were no significant differences in percentage weight gain and fruit cracking between Citowett and Triton X-45. Although fruit submerged in distilled water and tap water gained up to  $1.29 \pm 0.15$  and  $0.95 \pm 0.04\%$  in weight, respectively, none of the fruit cracked. The fruit samples were left submerged and examined at daily intervals until cracking of fruit occurred. After additional 2 days of immersion, 20% of the fruit submerged in distilled water cracked while none of those submerged in tap water cracked. Total weight gain of fruit submerged in distilled water and tap water increased to 1.57% and 1.12%, respectively. Further 2 days of immersion resulted in additional 5% fruit cracking in distilled water and still no cracking of fruit in tap water.

## 8.5 Discussion

There is widespread belief among apple growers that stem-end splitting of fruit occurs primarily due to excessive intake of water during rainfall or irrigation. In other fruits such as sweet cherries and grapes, it is generally accepted that fruit cracking is caused primarily by direct osmotic absorption of water through the fruit skin (Verner and Blodgett, 1931; Kertesz and Nebel, 1935; Verner, 1939; Gerhardt et al., 1945; Westwood and Bjornstad, 1970). On the basis of earlier experiments, Christensen (1972a) concluded that water absorption resulting

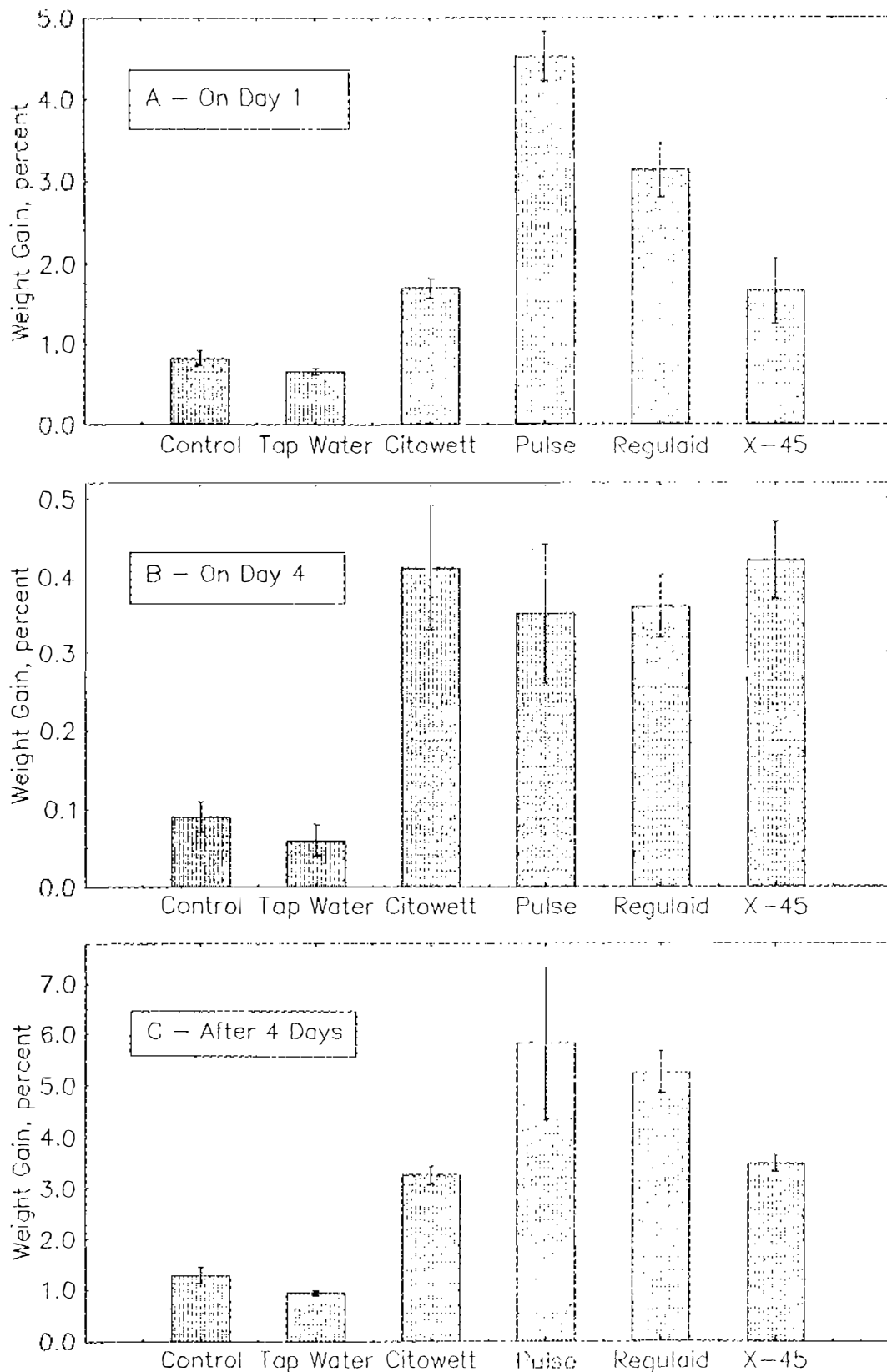

Figure 8.10 Effects of type of surfactant solution on water absorption (percent weight gain) of 'Gala' apples at different intervals of immersion [A - on day 1; B - on day 4; C - After 4 Days]. The control treatment was distilled water.



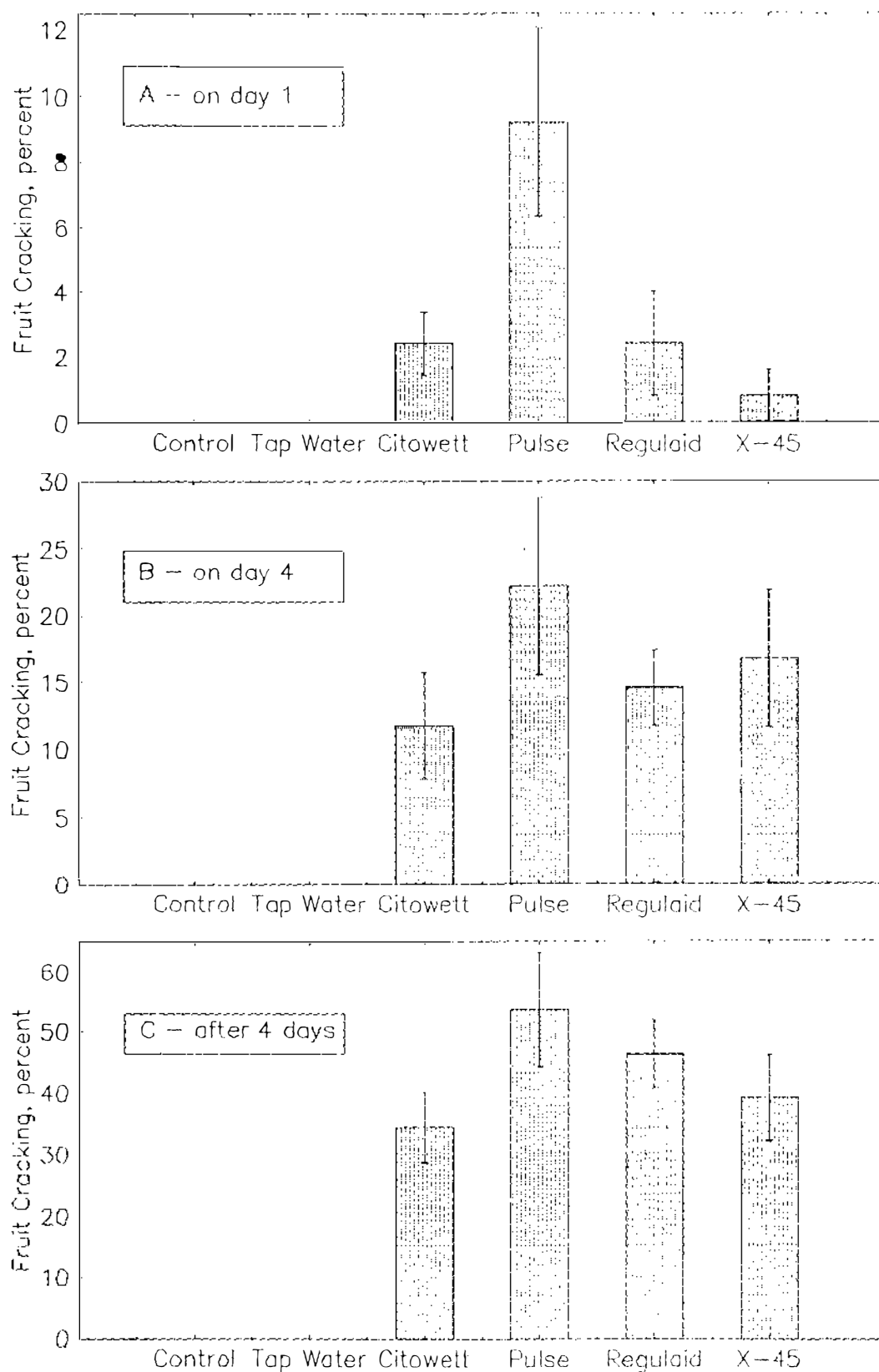

Figure 8.11 Effects of type of surfactant solution on percentage fruit cracking of 'Gala' apples at different intervals of immersion [A – on day 1; B – on day 4; C – after 4 days]. The control treatment was distilled water.

in cracking of cherries takes place only through the skin of the fruit. However, results from the present study on 'Gala' apples have shown that despite significant increases in water absorption by fruit submerged in surfactant-water solutions which resulted in skin-cracking of fruit, no stem-end splits were induced.

This result has significant implications in understanding the mechanism of water intake and the role of water in promoting stem-end splitting in apples. While fruit may absorb water through the skin following exposure to moisture, it appears from the present results that this does not cause stem-end splitting. Rather, water intake through the fruit stem may be the only pathway of importance in inducing stem-end splitting in apples. In this case, stem-end splitting could be clearly distinguished from the 'skin-cracking' of apples (Verner, 1935; Shutak and Schrader, 1948; Byers et al., 1990) and other fruits (Davenport et al., 1972) which result mainly from excessive "swelling and bursting" of fruit cuticle.

Trought and Lang (1991) reported that significant splitting of sweet cherry varieties continued to occur when fruit were protected from rain with covers, and the authors concluded that the small vapour pressure deficit which occurred under the covers could potentially reduce transpiration, causing fruit growth to increase toward the sum of the transpiration and growth rates. Under these conditions which may lead to cherry splitting (Trought and Lang, 1991; Edwards et al., 1992), stem-end splitting may also be induced if fruit growth in apples exhibit similar growth response.

Furthermore, a transposition from the global description of the behaviour of the entire fruit to the analysis of the behaviour of the individual cells may also explain the failure to induce stem-end splitting despite significant water intake by fruit submerged in water or surfactant water solutions. It is generally known that damage to plant and animal tissues and to fruits and vegetables is usually initiated at the cellular level (Cook et al., 1976; Puri and Anantheswaram, 1993), and that the physiological processes of the living plant cell are responsible for producing and maintaining turgor pressure. Bourne (1983) reported that living plant tissue has the ability to absorb water through the cell walls which causes the vacuoles to enlarge and press against the partially elastic cell walls causing them to stretch. However, during immersion tests with detached 'Stayman', Byers et al. (1990) found that apples

submerged in methylene blue dye (with or without surfactant) and peeled indicated that the primary uptake of water was through the lenticels and injured parts of the fruit cuticle. In addition, some sides of the fruit showed no dye penetrating into apple flesh and other sides showed blue spots in proportion to the lenticel size and injury.

From this evidence in the literature, it appears that the primary path for water uptake in intact growing fruit and detached fruit are different and this may influence the direction of stretching and mode of failure of the affected tissues. During normal physiological processes of growth, excessive water intake through the fruit stem may enter the vacuoles and cause the cellular volume to enlarge and fracture by bursting. On the other hand, water intake through the lenticels and injured parts of detached fruit may cause an increase in extracellular volume (cell wall plus intercellular space). This in turn causes a decrease in cellular volume to maintain a constant total volume. As more water moves into the fruit, the lenticels and extracellular volume may become water-logged leading to a loss of integrity and rupture of the cuticle and the cell walls. From fruit immersion tests using sweet cherries, Glenn and Poovaiah (1989) found that water penetration caused separation of the cuticle from the epidermal cell wall and the swelling in the epidermal cell wall region resulted in cuticular fracturing that preceded fruit cracking.

Under the foregoing two scenarios that water entering through different routes could cause different stress symptoms, a stem-end split could be classified as a growth crack which arises from the interaction between fruit growth factors and the physiological processes of fruit development. If differences in growth rates affect both water holding capacity and mechanical properties of apple flesh as found by Bauvineau et al. (1993) for animal flesh, it then appears that differences in relative growth rates of fruit may exert more primary influence on fruit susceptibility to stem-end splitting than excessive water intake only. Further field and laboratory experimental studies are required to validate these hypotheses through a better understanding of the transport and volumetric repartitioning (cellular and extracellular) of water inside fruit.

The studies on rate of water intake showed that maximum water intake occurred within 24 hours for both fruit submerged in water and in each type of surfactant solution (Figure 8.2

and 8.4). Presumably, the main reason for the decline in fruit's capacity for water uptake is that it is approaching full turgor. This may also be related to changes in the osmotic concentration of the cell sap during the time-course of immersion. Initially, a high osmotic concentration of the cell sap could promote the rapid movement of water into the fruit. The presence of additional water may fill the intercellular voids and also dilute the concentration of cell sap, thereby reducing the osmotic potential of the cell matrix. Under these conditions, both the movement of water into fruit and the capacity of fruit to hold more water may decline considerably.

Although fruit attained up to 0.95 and 1.3% weight gain after 4 days of immersion in tap water and distilled water, respectively, no fruit cracked (Figures 8.10 and 8.11). On the other hand, at about 3.5% weight gain, 35% of fruit submerged in Citowett solutions cracked. Maximum fruit cracking (60%) occurred in the Pulse solutions. It is not clearly understood whether the failure to induce skin-cracking in water is due to insufficient water absorption or whether the cracking in surfactant-water solutions is due primarily to the phytotoxic effects of the active ingredients. However, the significantly high correlation between percent weight gain and percent fruit cracking in Tables 8.4 ( $r = 0.97$ ,  $P \leq 0.001$ ) and 8.7 ( $r = 0.85$ ,  $P \leq 0.05$ ) suggest that low water intake by fruit submerged only in water may explain the failure of fruit to crack after 4 days of immersion. This explanation is further supported by the fact that after additional 48 hours of immersion, 20% of the fruit in distilled water cracked when the percentage weight gain increased to 1.6%.

It therefore appears from these results that there is a critical amount of water absorption which may induce skin-cracking and this may be equivalent to about 1.6% weight gain in 'Gala' apples, although such a "threshold" will vary with initial water status of the fruit. In addition, these results also indicate that although the phytotoxic effects of surfactant may induce distinctive stress symptoms which result in skin-cracking, the high incidence of fruit cracking in surfactant water solutions may be more attributable to the enhancement of the rate of water penetration into fruit.

Furthermore, the difficulty in inducing stem-end splitting following the immersion of fruit in water or surfactant water solutions also suggests that moisture (e.g. rain water) trapped in the

stem cavity is unlikely to be a critical factor in inducing ring-cracking but may enhance the development of stem-end splitting from ring-cracks by reducing the mechanical strength of the affected tissues similar to the effect of submerging fruit in water (Table 8.2).

## 8.6 Summary and Conclusions

The primary purpose of the work described in this chapter was to examine the hypothesis that excessive water intake is the primary cause of stem-end splitting in apples and to investigate the possibility of inducing stem-end splitting in detached 'Gala' apples through the enhancement of water uptake by submerging fruit in several non-ionic surfactant-water solutions. During the time-course of the immersion period, the cumulative water intake (percent weight gain) of fruit increased significantly while the daily rate of water uptake declined, with the maximum intake occurring during the first 24 hours of immersion. The amount of water intake, however, varied considerably between types of surfactant and was significantly correlated with the percentage fruit that developed skin-cracking. No stem-end splits were induced and sections through soaked fruit did not reveal the presence of new internal ring-cracks.

These results suggested that although direct absorption of water through fruit skin has been known to be an important mode of water penetration that causes cracking and splitting in fruits such as cherries, grapes, tomatoes and skin-cracking in apples (see Literature Review in Chapter Two), this is not the case with stem-end splitting. Rather, it appears that a stem-end split is a form of growth crack which may be associated with the complex physiological processes of fruit growth and development. The failure to induce stem-end splitting despite significant amounts of water uptake also has considerable implications in understanding the mechanism by which frequent irrigation promotes the incidence of stem-end splitting. In this respect, it was suggested that water intake through the stem via the root system may be more relevant to stem-end splitting than through the cuticle. Furthermore, it was concluded that excessive water absorption alone did not appear to be the whole explanation for the incidence of stem-end splitting in apples.

Although fruit gained weight when submerged in water, skin-cracking did not occur after 4 days of immersion when fruit had attained up to 1.3% weight gain. This result suggested that there is a threshold amount of water intake which may induce skin-cracking and this amounted to about 1.6% weight gain for 'Gala' apples submerged in distilled water for 6 days.

In conclusion, it has been shown through laboratory immersion tests that the commonly used non-ionic surfactants affect the amount of water uptake and quality of fruit. The resultant changes in fruit quality (e.g., increased water uptake, reduced flesh crushing stress, skin-cracking, poor skin appearance) mimic some of the physiological processes of maturity which occur during fruit growth and development (Westwood, 1978). Since surfactants have been shown to affect a number of physiological processes of fruit in the field (Noga and Bukovac, 1986), it is not conclusive from the present study whether or not the use of these surfactants in the orchard may enhance the incidence of stem-end splitting by altering the growth-mediating processes. However, it is considered unlikely that surface water alone, such as water trapped in the stem cavity, would induce internal ring-cracking and lead to stem-end splitting.

On the other hand, it is more probable that other fruit quality attributes may be affected following the use of the surfactants in the field. Detailed field studies would be required to ascertain whether the surfactant-induced enhancement of water absorption by 'Gala' apples obtained in the present study using detached fruit translates into a biological response in the orchard at the whole-plant level which may induce stem-end splitting.

## CHAPTER NINE

### EFFECTS OF DEGREE OF FRUIT EXPOSURE TO SUNLIGHT DURING GROWTH ON STEM-END SPLITTING AND MECHANICAL PROPERTIES OF 'GALA' APPLES

#### 9.1 Introduction

One of the consequences of the inherent architecture of tree plants is that individual fruit receive different amounts of exposure to direct sunlight due to the presence of leaves, tree branches and other fruit. Consequently, fruit on the same tree may exhibit different physical characteristics due probably to differences in nearness and availability of nutrients, and due to variations in the degree of interaction between the fruit and the environmental/external factors which influence fruit growth.

It is generally known that the quality of apples depends on their varietal characteristics and the external conditions (Jacyna and Soczek, 1980), and the degree of exposure of apples to sunlight plays an important role, with particular reference to its effect on the intensity of red colour and the size of the blush (Fletcher, 1929; Arthur, 1936; Reger, 1944). Fruit firmness has been shown to be inversely related to the intensity of exposure to sunlight (Heinicke, 1963) in comparison to colour, size or soluble solids which exhibit direct relationships with exposure (Schrader and Marth, 1931; Smock, 1953; Heinicke, 1963). The positive correlation between the amount of total sunlight and fruit weight indicates the importance of the position in the tree crown (Jackson, 1967). Recognition of the importance of exposure of apple fruit to light on quality attributes has led to studies on effective wave lengths (Pearce and Streeter, 1931; Streeter and Pearce, 1931; Siegelman and Hendricks, 1957).

In Chapter Two of this thesis, the effects of exposure of fruit to sunlight and temperature fluctuation on fruit cracking and splitting in apples and other fruit was discussed (Section

2.3.4). There were apparent cultivar differences, with cracking occurring predominantly on the shaded side of 'York' apples (Shutak and Schrader, 1948), and on the exposed side of many other cultivars such as 'James Grieve', 'Beauty of Bath' and the 'Stayman' group (Tetley, 1930; Verner, 1935 and 1938). Despite the apparent cultivar differences, the authors agreed that the side where the cracking is more common had a thicker inelastic cuticle (Shutak and Schrader, 1948; Verner, 1938). Rootsi (1962) found that the resistance to pressure on the skin and refractometer readings of several apple varieties were higher on the side of fruit exposed to sunlight than on the shaded side, and it was concluded that the lower incidence of cracking was related to the greater elasticity of the shaded tissues.

Histological studies by Verner (1938) suggested that the susceptibility of 'Stayman Winesap' apples to cracking was due chiefly to premature cessation or restriction of growth in the hypodermal layer, and the author concluded that this retardation of growth appeared to be related to exposure of the fruit to sun and general air movement which was virtually absent in tissues of heavily shaded fruit. Field observations by Verner (1935) also showed that cracking of 'Stayman' apples was more pronounced and extensive when the foliage was sparse than when it was dense and this difference was attributed to the greater incidence of sunscald, russeting, and intense coloration in the fruit of trees and branches with poor foliage.

No information was found in the literature on the effects of the degree of fruit exposure to sunlight on the size and quality attributes of 'Gala' apples. Since field and laboratory observations have shown that stem-end splitting is characteristically different from the other forms of fruit cracking in apples (Section 4.4.3), there is a need to understand the association between the defect and the degree of fruit exposure. This is particularly important because the high variability in the incidence of stem-end splitting obtained within the experimental blocks, trees and branches on the same tree suggested that within tree and fruit variations could have important implications on the susceptibility of individual fruit (Section 4.4.1). The study reported in this Chapter was, therefore, conducted to examine the effects of two levels of shading under normal orchard conditions (naturally shaded vs well exposed) on the incidence of stem-end splitting and the mechanical and physico-chemical properties of fruit.



## **9.2 Materials and Methods**

### **9.2.1 Fruit Materials**

The experiment was conducted during the 1992 apple season at the private commercial orchard described in Section 3.2.1. Five 'Gala' apple trees in the same block were selected because they had high incidence of stem-end splitting of fruit during the previous season. On each tree, over 100 naturally shaded and 100 well exposed fruit were randomly selected and tagged on 24 January. All tagged fruit were hand-picked on 27 February (two weeks after the first commercial harvest on 13 February), separated according to the degree of exposure (well exposed or shaded) and examined for stem-end splitting before storage at 1 °C.

After picking, it was observed that about 35% of the well exposed fruit and 22% of the shaded fruit had been lost. This mid-season loss suggested that the samples were collected after the ripest fruit had been picked during commercial harvesting on 13 February. Additional fruit were then collected to replace the corresponding numbers of lost samples. Prior to testing on 6 April, fruit were brought out of storage and allowed to room temperature (about 20 °C).

### **9.2.2 Incidence of Stem-end Splitting and Internal Ring-cracking**

Immediately after harvest, a total of 500 apples from each shading treatment was examined individually for the presence of stem-end splits and separated accordingly. The incidence of internal ring-cracking was determined after carrying out mechanical tests on fruit. A total of 500 fruit from each shading treatment without stem-end splits was used including samples of fruit used for testing mechanical properties. Each fruit was sectioned into two halves along the stem-calyx axis and examined for the presence of ring-cracking. The number of affected fruit affected was recorded.

### 9.2.3 Determination of Fruit Mechanical Properties

Fruit size (mass and diameter), soluble solids concentration (SSC), skin bursting stress, and flesh crushing stress were determined as described previously in Chapter Three. Each fruit property was measured on a sample of 25 apples for each treatment giving a total of 50 apples tested. Both fruit diameter, soluble solids, skin bursting stress and flesh crushing stress were measured on the red and pale side of fruit and averaged for each fruit.

Starch Index was determined on fresh fruit (after about 3 hours of harvest) by cutting individual fruit in half equatorially and placing the stem-end half in Starch/Iodine solution for 2 minutes. Upon removal, the value of the Starch Index was determined by comparison with appropriate starch index patterns and the corresponding number was recorded, ranging from 0 for immature (high starch) to 6 for ripe fruit (no starch) (Duncan, 1992).

### 9.2.4 Data Analysis

Statistical analyses of data were carried out using the SAS/STATS package (Cody and Smith, 1987; SAS, 1988). Analyses of proportions using  $\chi^2$  tests were employed to compare the treatment means of percentage fruit with stem-end splitting or internal ring-cracking. The data on fruit mechanical properties were subjected to a standard t-test. Graphs were plotted using GLE general purpose graphics package (Pugmire, 1992).

## 9.3 Results

### 9.3.1 Stem-end Splitting, Internal Ring-cracking and Fruit Size

The effects of the shading treatments on fruit size and the incidence of fruit splitting are shown in Table 9.1. There was a significantly higher percentage occurrence of internal ring-cracking in well exposed fruit than in shaded fruit (12.5% > 8.6% at  $P \leq 0.01$ ), amounting

to more than a 45% increase in internal ring-cracking. However, the amount of stem-end splitting from both treatments were not significantly different ( $P > 0.05$ ). Well exposed fruit had significantly higher mean fruit weight and diameter ( $P \leq 0.001$ ), representing more than 19.2% and 5.8% increases respectively in fruit weight and cheek diameter due to high exposure of fruit to sunlight.

**Table 9.1** Effects of Shading Treatments on Stem-end Splitting, Internal Ring-cracking, and Fruit Size of 'Gala' Apples<sup>z</sup>

Treatment	Stem-end Splitting <sup>p</sup> (%)	Internal Ring-cracking (%)	Fruit Weight <sup>h</sup> (gm)	Fruit Diameter (mm)
Natural Shading	4.0	8.6	126.08 ± 3.31	65.71 ± 0.60
Well Exposed	3.8	12.5	150.24 ± 5.64	69.49 ± 0.85
Significance Level	P>0.05	P≤0.01	P≤0.001	P≤0.001

<sup>z</sup>For the incidence of stem-end splitting and internal ring-cracking, respectively, samples of 500 apples from each treatment were used, while fruit weight and diameter were determined using treatment samples of 25 apples.

<sup>h</sup>Values shown represent the mean ± the standard error of the mean.

### 9.3.2 Fruit Mechanical and Physico-chemical Properties

The effects of the shading treatments on fruit mechanical and physico-chemical properties varied considerably depending on the property examined (Table 9.2). There were no significant treatment effects on skin bursting stress and Starch Index ( $P \leq 0.05$ ). Flesh crushing stress was significantly higher in shaded fruit ( $P \leq 0.001$ ) and this difference amounted to a more than 9.7% increase in flesh crushing stress compared to exposed fruit. Conversely, total soluble solids content was significantly higher in fruit that were well exposed than in the naturally shaded treatment ( $P \leq 0.001$ ), representing a 6.9% increase in the accumulation of soluble solids.

**Table 9.2** Effects of Shading Treatments on Mechanical and Physico-chemical Properties of 'Gala' Apples<sup>z</sup>

Treatment	Skin Bursting Stress <sup>p</sup> (kPa)	Flesh Crushing Stress (kPa)	Starch Index	Soluble Solids Concentration (°Brix)
Natural	865.49 ± 21.00	508.46 ± 8.24	5.1 ± 0.1	12.38 ± 0.13
Shading				
Well Exposed	910.92 ± 24.46	463.62 ± 10.01	5.2 ± 0.2	13.23 ± 0.12
Significance Level	P>0.05	P≤0.001	P>0.05	P≤0.001

<sup>z</sup>Fruit properties were determined using samples of 25 apples per treatment.

<sup>p</sup>Values shown represent the mean ± the standard error of the mean.

## 9.4 Discussion

In interpreting the results obtained in this study, it should be considered that the percentage of full sunlight intensity actually striking the fruit at any one time was not measured but that the results obtained indicate the cumulative plant response in relation to the degrees of exposure to light during the entire growth period. Thus, the influences of fruit exposure to sunlight obtained in this way may result from the exposure of light to foliage providing the fruit with carbohydrates and also of temperature differences resulting from the exposure of the fruit itself (Heinicke, 1966).

Well exposed fruit had significantly more incidence of internal ring-cracking (45% increase) than shaded fruit but there were no significant treatment effects on the amount of stem-end splitting. Since internal ring-cracking has been shown to be the precursor to the development of stem-end splitting in apples (Section 4.4.3), indicating that every fruit with internal ring-cracking has acquired some of the potential required to split, the present results suggest that well exposed fruit may be more susceptible to stem-end splitting than the shaded ones.

The loss of some of the initially tagged fruit during commercial harvesting may account for the insignificant effect on percentage stem-end splitting since fruit were harvested selectively for colour and size (Crauford, 1992, pers. comm.; Brookfield et al., 1993). If ripest fruit are taken out of the initial sample, then what remains is less mature and would be expected to develop stem-end splitting later since it has been shown in Section 4.4.1 that the incidence of stem-end splitting increased with advanced fruit maturity.

The exposure of fruit to sunlight had profound effects on fruit size and soluble solids content (Tables 9.1 and 9.2). The significant increases in fruit weight, diameter and soluble solids may be related to greater photosynthetic activity in the fruiting areas which leads to higher accumulation of carbohydrates (Heinicke, 1966; Jackson, 1967) and increase in growth rates (Pearce et. al., 1993). Thus, the smaller fruit from the well shaded treatment may also have resulted from late blooms and slow growth rates. Furthermore, the increased incidence of internal ring-cracking in well exposed fruit may, therefore, be related to the effect of exposure to sunlight on fruit size and maturity since it has been shown earlier that factors which

increase fruit size are apt to accentuate stem-end splitting in apples (Section 4.4.1).

Flesh crushing stress was inversely related to exposure to sunlight while skin bursting stress and Starch Index were not significantly affected (Table 9.2). This result is probably an indirect consequence of the treatments on the overall stage of fruit maturity rather than actual effect of exposure to sunlight since increasing fruit ripeness is associated with reduction in flesh textural strength (Westwood, 1978; Studman and Yuwana, 1992).

In addition to the overall effects of the shading treatments, the significant reduction in flesh crushing stress and increase in the SSC of well exposed fruit compared to the insignificant effects on both skin bursting stress and the Starch Index may also be related to the relative sensitivities of the measuring devices and their consequent ability to detect small changes in fruit quality. On the other hand, it could mean that the skin bursting stress in particular, may not be related to fruit susceptibility to stem-end splitting as suggested earlier in Chapter Five.

Since a reduction in fruit texture (e.g., flesh crushing stress) and increase in soluble solids have been shown to be characteristic features of advancing fruit maturity (Sections 7.4.2 and 7.4.3; Westwood, 1978), it appears that well exposed fruit may grow and mature faster than shaded fruit due to increased photosynthetic activities (Heinicke, 1966; Jackson, 1967; Pearce et al., 1993). The interaction between faster or abnormal fruit growth rates and changes in flesh strength due to advancing fruit maturity may lead to the development of some physical defects such as stem-end splitting, and this may in part explain the particularly high susceptibility of early maturing varieties such as 'Gala' and 'Royal Gala' grown in certain regions.

## 9.5 Conclusions

The influence of two levels of exposure to sunlight on the incidence of stem-end splitting and changes in fruit mechanical properties of 'Gala' apples was studied. The amount of stem-end splitting and internal ring-cracking were assessed externally and internally by examining samples of fruit from late harvest. The exposure of fruit to sunlight significantly increased the

incidence of internal ring-cracking by over 45% compared to shaded fruit, although there was no significant effect on percentage stem-end splitting. This latter result was probably due to the removal of mature fruit by commercial harvesting operations. It has therefore been suggested that the degree of exposure to sunlight may be related to the incidence of stem-end splitting since fruit with internal ring-cracks has acquired at least some of the potential required to develop stem-end splitting.

Fruit size and soluble solids concentration were directly related to exposure to sunlight while flesh crushing stress showed an inverse relationship. Both skin bursting stress and Starch Index were not significantly affected by the shading treatments. The results on fruit size were related to the effects of exposure to sunlight on fruit growth rates and the accumulation of carbohydrates based on reports in the literature. The effects of the shading treatments on texture, stem-end splitting and other quality attributes of fruit were related, in part, to the overall treatment effects on late maturity, rather than the direct effects of exposure alone.

In conclusion, it has been shown that the quality of 'Gala' apples at harvest is affected by the degree of cumulative exposure to sunlight during growth and maturation. The development of a high incidence of internal ring-cracking in well exposed fruit compared to shaded fruit may be related to possible interactions between faster or abnormal growth rates (Watanabe et al., 1987) and a concomitant reduction in flesh strength and integrity due to rapid fruit maturity (Westwood, 1978; Studman and Yuwana, 1992).

## CHAPTER TEN

### GENERAL DISCUSSION AND CONCLUSIONS

The primary aim of this thesis was to investigate the origin and causes of stem-end splitting in apples. Research carried out included field studies on the effects of orchard management factors and fruit shading on the incidence of stem-end splitting and the determination of relationships between fruit growth rates and the onset of stem-end splitting. The effects of the management practices and shading on fruit mechanical properties and the changes in these properties during growth were also determined. Attempts were made to induce stem-end splitting in detached apples by submerging fruit in various non-ionic surfactant water solutions. Results obtained from these studies have been discussed in the relevant sections of the previous Chapters.

The objective of the present Chapter is to provide a general discussion of these results and to formulate a preliminary model of the mechanism of stem-end splitting in apples. Recommendations are also made for future studies aimed at reducing the occurrence of stem-end splitting in apples.

#### 10.1 General Discussion

Fruit quality at harvest depends on internal and external fruit factors. Depending on the magnitude of these external influences and their interaction with internal growth factors, certain physical defects may arise which impair appearance and texture. In apples, one of the physical defects which may develop prior to harvest is splitting at the stem-end. Field and laboratory observations in this study have shown that this quality defect occurs in 'Gala', 'Royal Gala' and 'Fuji'.



An extensive review of the literature showed a dearth of information focused towards understanding the phenomenon of stem-end splitting in apples. However, a considerable amount of literature was found on the causes of other forms of fruit cracking in apples, namely skin-cracking, star-cracking and general splitting of the fruit. Whereas skin-cracking of apples occurs mainly on the shaded or green side of fruit (Fisher, 1937a,b; Shutak and Schrader, 1948; Goode et al., 1975), star-cracking occurs on fruit infected with certain virus diseases (Posnette, 1963; Copley, 1968), while general fruit splitting (Verner, 1935; Rootsi, 1961) and stem-end splitting occurred mainly on the exposed (blush) side of fruit (Section 4.4.3).

This study has confirmed preliminary observations which suggested a possible association between stem-end splitting and the presence of ring-cracking in fruit (Hodson, 1990). By sectioning fruit at different stages of maturity (Chapters 4 and 6), it has been found that every fruit with stem-end splitting had internal ring-cracking at the stem-end and some fruit without stem-end splitting also had internal ring-cracks. The size of these ring-cracks varied from about a quadrant to a full ring-crack circumscribing the pedicel. Full 360° ring-cracks were seldom and occurred mainly during late harvested fruit. The increase in the incidence of stem-end splitting and size of ring-cracks with advancing fruit maturity may be related to the reduction in flesh mechanical strength with increasing fruit ripeness (Sections 5.4.2 and 7.4.2; Studman and Yuwana, 1992). The fact that every stem-end split emanated from a ring-crack further confirmed that the presence of these internal ring-cracks predispose the fruit to stem-end splitting.

Although the incidence of stem-end splitting increased with advancing fruit maturity and bigger fruit were more susceptible (see Chapter Four), the defect was found in both mature (red-ripe) and immature (green) fruit, and in all sizes of fruit. Within trees that received the same orchard management treatments, the incidence of stem-end splitting ranged from about 1% to over 27%. These results suggested that factors other than the treatments, especially within orchard and tree variations, may account for the differences in the susceptibility of individual fruit.

Experimental studies on the effects of orchard management practices on internal ring-cracking

and stem-end splitting showed that frequent irrigation significantly increased the incidence of both defects while both crop load and foliar application of nitrogen had no significant effects (Table 4.1). Results from mechanical tests on fruit suggested that the increase in stem-end splitting due to frequent irrigation may be attributable to its effects in reducing flesh crushing stress and increasing fruit size. Thus, orchard management factors which increase fruit size and reduce the mechanical strength of the flesh are likely to increase the susceptibility to stem-end splitting. This proposition may account for the insignificant effect of low crop load on percentage stem-end splitting since this treatment significantly increased both fruit size (Table 4.1) as well as flesh crushing stress (Table 5.4).

Mineral deficiencies (such as calcium) or excessive concentrations (such as nitrogen) have often been suspected or implicated as the cause of certain pre- and post-harvest physiological defects in fruits, including cracking in apples (Chapter 2). Similarly, many storage disorders that develop in apples have been associated with low calcium and phosphorus concentrations, and with high nitrogen (Waller, 1980; Webster and Lidster, 1986; Ingle and D'Souza, 1989). The argument for calcium is usually based on its essential role in normal plant growth and development especially in maintaining cell-wall integrity and adhesion (Clarkson and Hanson, 1980; Moorby and Besford, 1983; Kirby and Pilbeam, 1984). This is contrary to the findings of this study that higher concentrations of calcium, phosphorus and potassium occurred in fruit with internal ring-cracking or stem-end splitting (Table 4.3). However, these results do not suggest any possible direct involvement of calcium and the other minerals with respect to resistance to stem-end splitting, but it is probable that the accumulation of significant concentration of minerals in fruit with stem-end splitting is a secondary response which probably occurs after cortical cells begin to breakdown, and not before the internal ring-cracking occurs. Nevertheless, a relationship between stem-end splitting and mineral concentration cannot be ruled out, in view of the many factors which may affect fruit mineral status such as cultivar, transpiration rates and the efficiency of mineral partitioning (Bangerth, 1976 and 1979; Wiersum, 1979).

Studies on fruit growth rates showed that the onset of stem-end splitting coincided with a period of imbalance between the growth rates of fruit length and diameter (Figures 6.10-6.12), and the attainment of final fruit shape (Figure 6.14). Also during this period, there was a

sudden increase in longitudinal growth strain which equalled the latitudinal growth strain at about one week after the onset of stem-end splitting (Figure 6.6). It appears that internal ring-cracking might very well arise due to greater tensile (longitudinal) stresses that are exerted upon the fruit due to the sudden surge in longitudinal growth at a time when each affected cell is least able to accommodate the additional stress. With the presence of these fractured cells, stem-end splitting may ensue due to further latitudinal expansion of the neighbouring cells (direction of highest growth; See section 6.5.6) during normal processes of growth.

Although it is generally known that the quality of apples at harvest, including fruit cracking, is affected by the degree of fruit exposure to sunlight (Shutak and Schrader, 1948; Heinicke, 1963; Jacyna and Soczek, 1980), there were apparent cultivar differences (Tetley, 1930; Verner, 1935 and 1938) and no information was found in the literature on the varieties that are susceptible to stem-end splitting. Results obtained in this study from end of season harvest of 'Gala' apples showed that fruit exposed to sunlight during growth (compared to shaded fruit) had a 45% higher incidence of internal ring-cracking although there were no significant differences in the amount of stem-end splitting (Table 9.1). The insignificant effect on stem-end splitting was attributed to the loss of about 35% of the initial samples from the well exposed shading treatment due to commercial harvesting since it has been confirmed earlier that internal ring-cracking is the precursor to stem-end splitting (Section 4.4).

Both large fruit size and advanced maturity were found to increase the incidence of stem-end splitting in apples (see Chapter Four, section 4.4 and Chapter Six, section 6.4). Thus, the increased susceptibility of well exposed fruit to internal ring-cracking (and stem-end splitting) may be related to the significant treatment effects in increasing fruit size and in promoting early maturity (Tables 9.1 and 9.2).

Results obtained from submerging 'Gala' apples in water and several non-ionic surfactant water solutions showed that all types of surfactant increased both the rate and the total amount of water uptake compared with the water (control) treatment (Figure 8.10). However, the significant uptake of water did not induce stem-end splitting even though skin-cracking occurred (Figure 8.11). Previous researchers have also reported that surfactants enhanced the penetration of water through the fruit cuticle and increased the cracking of apples both in the

laboratory (Byers et al., 1990) and in the field (Noga and Bukovac, 1986; Noga and Wolter, 1990). The results obtained in this study have implications in understanding the mechanism of stem-end splitting in apples. First, they suggest that skin-cracking and stem-end splitting are distinct phenomena: while skin-cracking may result from excessive swelling and bursting of the skin following sudden and rapid intake of water by the underlying flesh, stem-end splitting appears to be related more to changes associated with disproportionate growth rates.

The above hypothesis leads to the second question of the primary path or mode of water uptake by growing fruit (whether through the skin or fruit stem) which is involved in inducing stem-end splitting. Although fruit may absorb water through the skin following exposure to moisture, it appears from the results of the immersion tests in this study that water uptake through the fruit stem may be of greater significance in inducing stem-end splitting in apples than through the skin. Because of the possibility of complex interactions between water-logging, water uptake and changes in fruit properties in the water-logged region, it is not certain from this hypothesis whether or not rain water trapped in the stem cavity may induce stem-end splitting. Nevertheless, the results obtained from the total immersion tests suggest that stem-end splitting is not likely to be affected by rain drops in the cavity.

Furthermore, although the present results suggest that surfactants alone may not induce stem-end splitting in apples, it is not conclusive from this study whether or not the use of these surfactants as spray adjuvants in the orchard may enhance the incidence of stem-end splitting by altering growth-mediating processes (Chapter 6), such as ethylene production (Pallas and Kays, 1982).

## **10.2 Summary of Factors Associated with Stem-end Splitting in Apples**

The results reported in this thesis have shown that the occurrence of stem-end splitting in apples may be affected by several factors which may be attributable to orchard management practices, the environment (external) and fruit growth (internal) characteristics. In order to facilitate further studies in this area and the development of a model of stem-end splitting in apples, the results of the relationships between management practices, environmental factors,

fruit properties and the occurrence of stem-end splitting are summarized in Table 10.1.

Factors which are associated with increased incidence of stem-end splitting include frequent irrigation, low crop load, good exposure of fruit to sunlight during growth, large fruit size and over-maturity. It is important to note from Table 10.1 that frequent irrigation and good exposure to sunlight which significantly enhanced fruit size (Tables 4.1 and 9.1) and lowered flesh crushing stress (Tables 5.4 and 9.2) also increased the incidence of stem-end splitting.

Evidence from studies on the growth of 'Gala' apples (Chapter Six) in relation to the onset of stem-end splitting has identified critical growth periods during the season when fruit splitting began. This occurred about 3 weeks before the first commercial harvest or 115 days after full bloom (DAFB). A summary of the significant changes in fruit properties during growth and development which coincided with the onset of stem-end splitting is presented in Table 10.2. No profound changes were observed in lineal dimensions of fruit size (length and diameter) and soluble solids concentration at the onset of stem-end splitting. However, this critical growth period was associated with significant changes in fruit shape, growth rates, growth strain and flesh crushing stress. It is proposed that the magnitude of these changes may account, in part, for differences in the susceptibility to stem-end splitting of individual fruit on the same tree.

Although the changes in fruit growth observed during the critical growth period of 'Gala' apples may account for the degree of susceptibility of individual fruit within the susceptible cultivar, further studies on resistant cultivars would be required to understand the relationship between these changes and the resistance to stem-end splitting across cultivars. This is particularly important because there is conflicting evidence in the literature on the shape of fruit growth curves of apples as discussed earlier in Chapter 6.

In summary, the overall results and discussion presented in the various Chapters of this thesis provide greater insights into the origin and development of stem-end splitting in apples. However, these results may not entirely explain why certain cultivars are susceptible as pointed out in the foregoing paragraph. The question of cultivar resistance to stem-end splitting is beyond the scope of this study and requires a major survey of several varieties.

It is hoped that the findings of the present study will facilitate such further investigations in this area.

**Table 10.1** Summary of results of relationships obtained between high incidence of stem-end splitting and factors that have been associated with cracking and splitting in fruit.<sup>#</sup>

Management factor or Fruit property	Level of factor related to high incidence of stem-end splitting <sup>&amp;</sup>	Degree of association <sup>&amp;</sup>
1. Irrigation	frequent/heavy	definite
2. Fruit thinning	heavy/low crop load	slight
3. Nitrogen fertilizer	no effect	none
4. Exposure to sunlight	high exposure	definite
5. Mineral deficiency	no effect	none
6. Fruit Size	large size	definite
7. Soluble solids content	high	indefinite
8. Textural strength	low	definite
9. Skin bursting strength	no effect	none
10. Stem adhesion force	no effect	none
11. Immersion of detached fruit in solution	no effect	none
12. Maturity stage	over-maturity	definite

<sup>#</sup>Literature review of the association between these factors and fruit cracking and splitting in apples was discussed in detail in Chapter Two.

<sup>&</sup>Based on results obtained in this study.

**Table 10.2** Summary of significant changes in fruit properties which coincided with the onset of stem-end in 'Gala' apple during the season.

Fruit Property	Change at onset of stem-end splitting
1. Length (L)	steady increase
2. Diameter (D)	steady increase
3. Weight	sudden increase which corresponded with the resumption of final period of rapid expansion
4. Shape (L:D ratio)	abrupt stagnation; transition between a period of linear decline in ratio to a period of no significant change (i.e. attainment of final shape)
5. Growth rate	
- length and diameter	length increased while diameter decreased
- weight	transition between declining growth and resumption of rapid increases in growth
6. Stem-end cavity	
-depth (C)	beginning of a period of rapid increase which coincided with second phase of a double-sigmoid growth curve
-growth rate	sudden increase preceded by a period of decline
-shape (C:D or C:L ratio)	sudden change following a period of fairly uniform shape
7. Growth strain (gape size)	longitudinal strain approximately equal to latitudinal strain but was less prior to and after this period
8. Flesh crushing stress	sudden reduction in rate of decline (kPa/day)
9. Soluble solids concentration	increase

### **10.3 A Tentative Model of Stem-end Splitting in Apples Based On the Identified Relationships Between Management Factors and Fruit Properties**

A tentative model that describes the relationships between the orchard management practices, fruit external environment, fruit physical properties and the development of stem-end splitting in apples is presented in Figure 10.1. The model describes the general relationships between factors which affect the incidence of stem-end splitting in a susceptible cultivar, emphasising the significance of fruit growth rates and the influence of the micro-environment. These environmental factors include temperature, relative humidity, water vapour pressure deficit and irradiation (Verner, 1935). The model thus assumes that the incidence of stem-end splitting depends on a number of factors which are synergistic in their effect. Consequently, each factor is associated with a risk component and the more factors that are present, the higher the amount of stem-end splitting. Both pathways in Figure 10.1 indicate that factors which promote early, rapid or excessive growth of fruit may be related to high incidence of internal ring-cracking and stem-end splitting.

The right hand pathway describes the situation that may lead to a high incidence of stem-end splitting. Under the conditions of high growth rates, increasing concentration of soluble solids and declining flesh crushing stress (factors which promote high incidence of stem-end splitting), it could be expected that careful timing of management practices such as frequent irrigation and low crop load (which enhance fruit growth rates), may affect the extent of fruit splitting during the season. The purpose would be to apply these treatments at times which minimise the rate of change of these physical properties. Similarly, timely harvesting of fruit for size and colour may also reduce the possibility of a high incidence of stem-end splitting (as in Chapter 9) that may occur if fruit are allowed to become over-mature (Walsh et al., 1992).

The left hand pathway applies to the condition under which there is less incidence of stem-end splitting and this may occur under conditions of adequate supply of water, optimum crop load and proper management of tree canopy to ensure optimum exposure of fruit to sunlight. In either pathway of Figure 10.1, the critical factors which appear to determine the degree of stem-end splitting are disproportionate growth rates, fruit size, stage of maturity, and



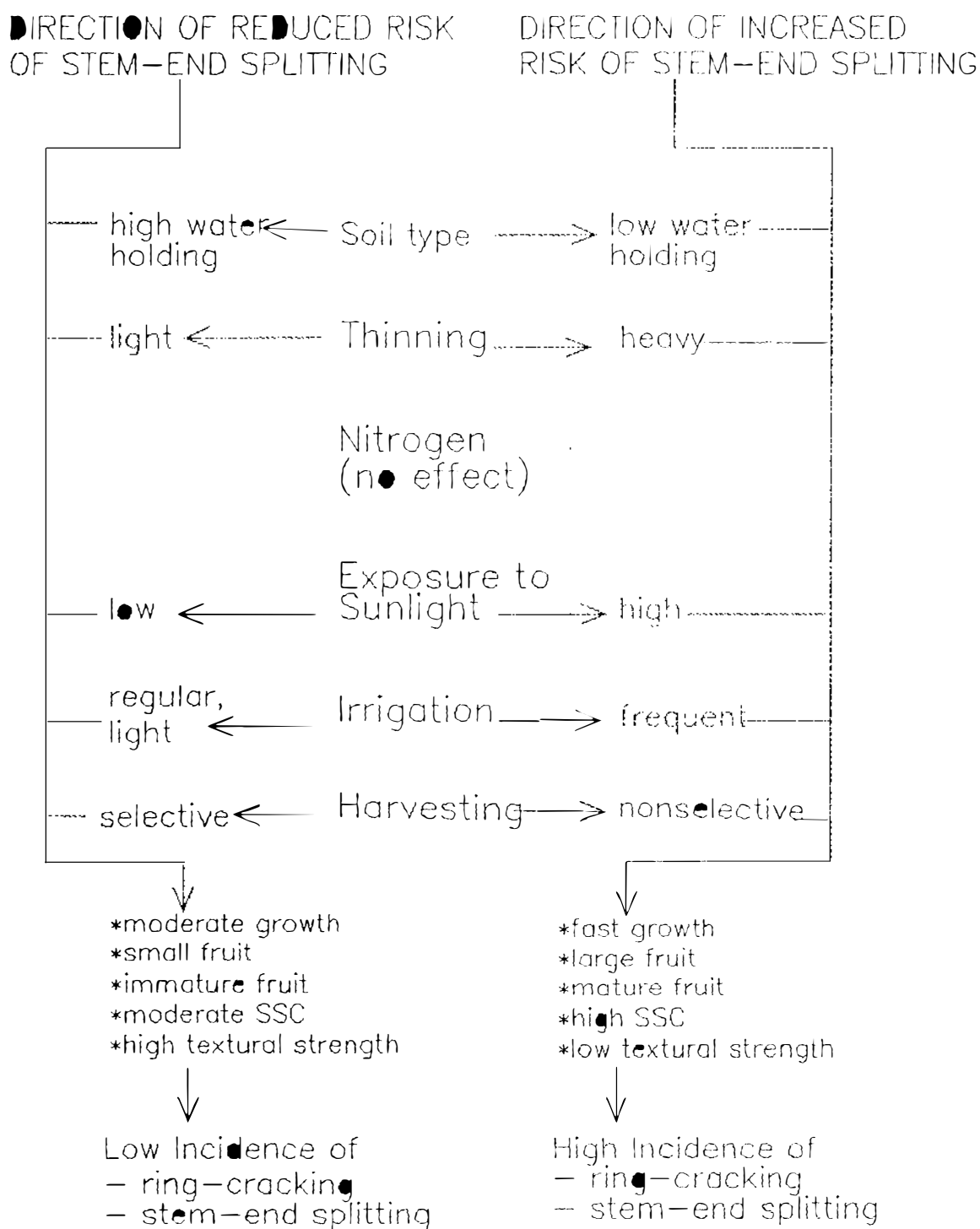

Figure 10.1 A tentative model of the cumulative relationships between orchard management factors, fruit properties and the development of stem-end splitting.

mechanical strength of fruit flesh. The model in Figure 10.1 could be expanded to include a component or "barrel" sub-model at the top to account for cultivar differences and in which case a cultivar is either susceptible or resistant to stem-end splitting.

#### **10.4 Possible Mechanisms of Stem-end Splitting in Apples Based on Pathway of Water Uptake by Fruit**

The results reported in Chapter Four of this thesis have shown that frequency of irrigation is important in the development of internal ring-cracks and the incidence of stem-end splitting. However, the failure to induce stem-end splitting in detached fruit of 'Gala' apples despite significant water absorption (weight gain) when fruit were submerged in non-ionic surfactant water solutions suggests that the pathway of water uptake by fruit may be critical.

Figure 10.2 describes the possible mechanism of stem-end splitting based on the premise that stem-end splitting is a *growth crack* that initiates inside the cells and leads to bursting similar to the cell-rupture theory (McAlpine, 1921; Heald, 1926; Pitt and Chen, 1983; Holt and School, 1983b; Vincent, 1990) rather than cell crushing (Herbert, 1922; Altisent, 1991), or due to the dissolution of the intercellular pectic membranes which may induce excessive swelling and separation of the pulp cells resulting in skin-cracking (Mezzetti, 1959). It is hypothesized that stem-end splitting develops from internal ring-cracks which are induced primarily by the greater imbalance in fruit growth rates and that frequent water uptake through the fruit stem is more critical than through the skin in promoting the incidence of stem-end splitting.

The pathway presented in Figure 10.2 applies to the situation whereby growing fruit may develop stem-end splitting following water uptake primarily through the fruit stem and via the vascular system. The mechanism would be such that under conditions of high cell turgidity and rapid growth rates, the cells absorb water *in vivo* through the vascular system and swell further. The increase in cell size by expansion and rise in solute content as fruit matures raises the cell turgor pressure and the walls of individual cells may fracture (Knee,

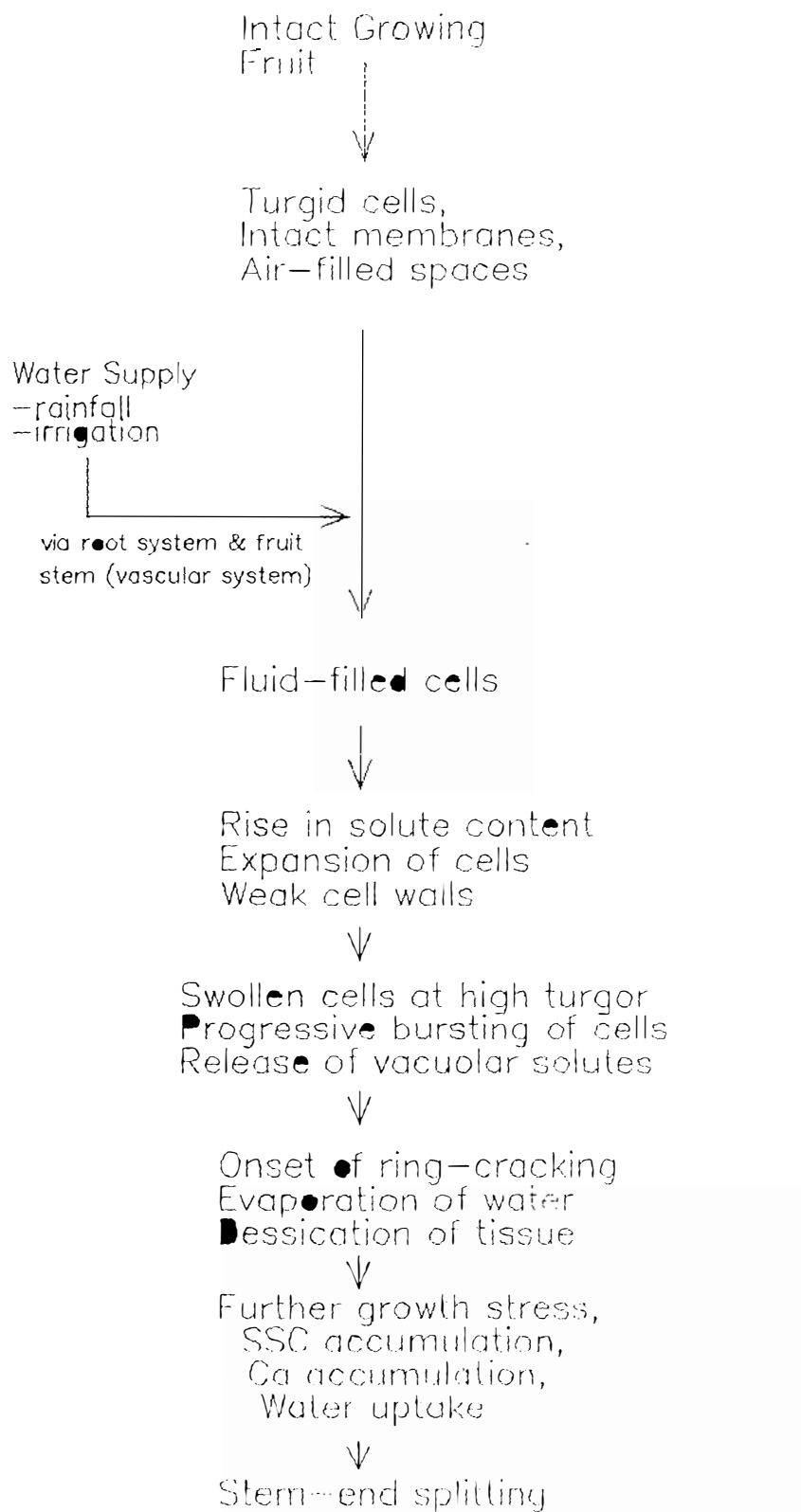

Figure 10.2 Possible mechanisms of stem-end splitting in apples based on pathway of water uptake by fruit

1975; Pitt and Chen, 1983; Holt and Schoorl, 1983b; Vincent, 1990). Individual cells may burst when the internal stresses reach a critical level more than the cell walls can withstand. The yielding of the cell walls under osmotic pressure generated by cell solutes continues until they finally rupture allowing the protoplast within to swell and burst at the same time (Simon, 1977a,b). The above mechanism of cell wall fracture followed by cell bursting is similar (at the cellular level) to that suggested for impact bruising in apples (Holt and Schoorl, 1983b; Pitt and Chen, 1983; Vincent, 1990) and splitting (longitudinal cracking) in carrots (McGarry, 1993).

In addition to the cell fracture theory described, mechanical failure in fruits and vegetables may also occur by debonding (cell separation) (Lin and Pitt, 1986) or the crushing of cells (Herbert, 1922). Failure by cell crushing is not considered as fracture (Altisent, 1991), and recently, McGarry (1993) showed from scanning electron micrograph studies that cell wall rupture, as opposed to inter-cellular separation along the middle lamella, was the mode of failure causing splitting in carrots. It is proposed that the initiation of internal ring-cracking in apples may occur primarily through the mechanism of cell fracture or in combination with cell debonding (rupture by splitting of cell walls; see Holt and Schoorl, 1983b). The weakest cell walls burst first and the progressive bursting of nearby cells results in exposed tissue surfaces which become desiccated as in dry lesions due to the browning reaction and the evaporation of the vacuolar fluid. The cracking will be a catastrophic event resulting in the release of stresses between different zones of the area around the stem.

The presence of these ring-cracks provide points of structural weakness and it is proposed that stem-end splitting may develop from these cracks due to growth stresses which accompany further expansion of the fruit at a time when there is a significant reduction in the structural integrity of the ripening fruit due to advancing maturity (Section 7.4). Once splitting begins, its propagation will be explosive in nature and continues as long as there is sufficient stored energy available to feed the split's progress (Holt and Schoorl, 1983a,b).

In contrast, the pathway shown in Figure 10.3 describes the mechanism which may result in skin-cracking apples. In this situation, water enters through the fruit primarily through the lenticels, injured parts and minute cracks on the fruit skin. These are the primary modes of

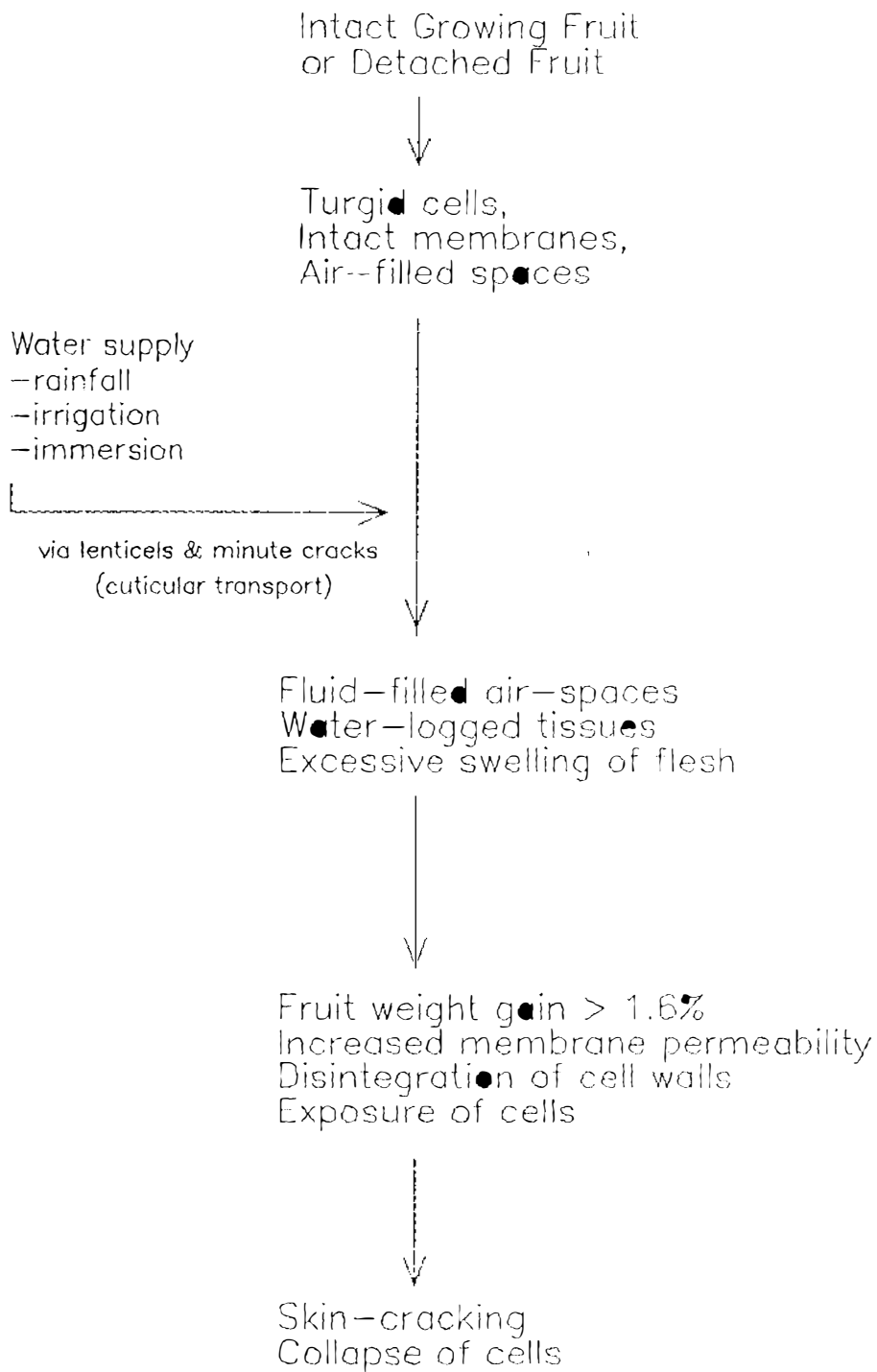

Figure 10.3 Possible mechanism of skin-cracking in apples based on pathway of water uptake by fruit

water uptake when detached fruit are submerged in water solutions (as in Chapter Eight; Byers et al., 1990) and may also occur in intact growing fruit as surface water following a period of rain or overhead irrigation. Water uptake occurring mainly via the lenticels and injured parts of fruit (such as superficial cracks and sunburn) floods the air spaces. Further intake of water caused by submergence in water or surfactants may lead to water-logged tissues. The resulting pressure from excessive swelling and separation of the pulp cells may lead to loss of integrity and cracking of fruit skin, similar to that observed in stored apples (Mezzetti, 1959). The pre-harvest rain-induced cracking and splitting of tomatoes, cherries, grapes (Dickinson and McCollum, 1964; Bullock, 1952; Meynhardt, 1964) and skin-cracking of apples (Verner, 1935 and 1938; Shutak and Schrader, 1948) have been generally attributed to this mode of failure.

There is a widely accepted hypothesis that cells of ripe fruit may burst under pressure generated when they are placed under hypotonic media (low osmotic potential) such as water or dilute solutions, a condition termed plasmolysis (Crafts et al., 1949; Kuster, 1958; Simon, 1977a,b). Under the conditions described in Figure 10.3 which may initiate skin-cracking, there is the possibility that the presence of minute superficial cracks and water-logging of intercellular spaces due to water uptake through the lenticels may expose the cells to similar hypotonic conditions which may lead to leakage of cell contents, loss of cell integrity and breakdown of the cell compartment. Pitt and Chen (1983) obtained rupture of parenchyma cells of 'Ida Red' apple by soaking tissues in tap water and recent studies by Harker and Hallett (1992) using disks of cortical tissue of 'Braeburn' apples also showed that the cells burst when placed in similar solutions. It was presumed that the rupture of cells was induced by very high turgor pressures induced by the hypotonic solutions (Vincent, 1990; Harker and Hallett, 1992).

However, it has also been observed that fruit cells do not burst *in situ* because they are under pressure from surrounding cells, and that they are not generally exposed to hypotonic conditions (Simon, 1978). This may be related in part to the fact that hydrostatic pressures applied exogenously to plant tissue do not raise membrane permeability to such an extent that vacuolar solutes leak out of the cells (Kuiper, 1972).

Nevertheless, it has been suggested that such events described above may underlie the development of other physiological disorders in apples characterised by 'cell collapse' such as russetting and internal breakdown, conditions favoured by high humidity, frequent rain or dew (Faust and Shear, 1968 and 1972; Simon, 1977a). Prolonged exposure of cells to water due to water-logged intercellular spaces may weaken the cell walls and cause rupture, and the release of cell fluids into the air spaces. It may also suggest that the phellogen which gives rise to the appearance of russet develops under such collapsed epidermal cells (Faust and Shear, 1972).

The models of fruit cracking developed in this study have been formulated based on transformation of the results to the cellular level. Using a ruptured cell theory (cell bursting or in combination with cell separation) (McAlpine, 1921; Simon, 1977b and 1978; Holt and Schoorl, 1983b; Pitt and Chen, 1983; Lin and Pitt, 1986; Vincent, 1990; McGary, 1993) as opposed to the crushed cell (Herbert, 1922; Altisent, 1991) and starved cell theories (Heald, 1926), it is proposed that under unfavourable imbalance of growth rates and high water uptake through the stem, internal ring-cracking may arise. The presence of a ring-crack therefore, forms a free edge of the skin which is then predisposed to crack, as is predicted by fracture mechanics (Atkins and Mai, 1985; Kanninen and Popelar, 1985; Broek, 1989). It is proposed that stem-end splits develop from internal ring-cracks by a similar mechanism.

In contrast, water uptake through the skin (lenticels and injured parts) of detached or intact growing fruit may lead to rapid swelling of the underlying flesh beyond the limit of extensibility of the protective outer skin (Verner, 1938). Under this condition, skin-cracking may occur. Thus, while stem-end splitting arises from ring-cracks which may be initiated by progressive bursting of cells or in combination with inter-cellular separation, skin-cracking may arise due to general loss of structural integrity and separation of the pulp cells in water-soaked fruit tissues.

## 10.5 Recommendations for Further Studies

The studies reported in this thesis have provided a greater understanding of the origin and causes of stem-end splitting in apples. However, they have also raised some questions which deserve further investigation. At the conclusion of some of the preceding chapters, specific suggestions for further studies have been made so as to facilitate more in-depth understanding of this subject. Based on the observations made in this study and in light of the overall results obtained, the following areas of further research are suggested.

### (i) *Onset of internal ring-cracking*

There is a need for more accurate determination of the onset of ring-cracking and stem-end splitting. Results obtained in Chapter Four confirmed that stem-end splits are formed from internal ring-cracks, and following a 2-week sampling interval (Chapter Six), both defects were first observed on the same day (which occurred at about 115 DAFB in the 1992 harvest). The higher incidence of internal ring-cracking recorded on this day compared to stem-end splitting suggested that the initiation of both defects may have occurred some days or hours earlier. The present results on the chronological development of stem-end splitting indicate the critical period when the development of stem-end splitting began. This occurred about 3 weeks before the first commercial harvest of 'Gala' in the Hawke's Bay region. However, both the initiation of ring-cracking and the onset of stem-end splitting may be determined more precisely by sampling fruit at shorter time intervals. This additional information would assist in specifying management strategies to reduce stem-end splitting.

### (ii) *Growth studies and internal structures of fruit*

In order to validate the relationships between the development of stem-end splitting and the imbalance in fruit growth rates, it is recommended that the present studies on 'Gala' be extended to other susceptible cultivars as well as to resistant ones. The current studies have been based on measurement of fruit size externally. It is also recommended that future studies



include the development of internal structures such as cell size, shape and orientation. Results from such a study would provide vital evidence to aid in understanding differences in resistance to stem-end splitting between cultivars. This is particularly relevant to stem-end splitting because a more complete understanding of the processes which determine size and shape in fruits requires elucidation of the sites and orientation of cells (Green, 1976). For instance, studies by Vincent (1989 and 1990) and Vincent et al. (1991) have shown that in parenchymatous tissues, the mode of failure is can be dependent on the anisotropic arrangement of the cells, the presence of air spaces and the ratio of thickness of the cell wall to the diameter of the cell. Similarly, histological studies in grapes by Meynhardt (1964a) indicated that in cultivars susceptible to berry-splitting, the ratio between the longitudinal to radial sub-epidermal cell dimensions of the berry was comparatively small and such berries usually had an epidermal cell layer consisting of relatively few cells.

*(iii) Analysis of how growth stresses develop at the stem-end*

Further work is needed to understand how stresses develop in the stem-end of apples and this may well explain, in part, how any differences in shape and other physical attributes of cultivars may be related to susceptibility to internal ring-cracking (and stem-end splitting). In grapes, theoretical analysis of surface growth forces suggested that fruit shape and structural attributes can cause stresses which affect the occurrence of rain-induced splitting (Considine, 1979; Considine and Brown, 1981). In a separate study (Opara et al., 1993d), preliminary investigations on the use of finite element analysis to model the stress pattern in apples have begun and further work is recommended in this area.

*(iv) Measurement of susceptibility to stem-end splitting*

There is a need for an objective method to assess the susceptibility of fruit to stem-end splitting. Attempts in this study to induce stem-end splitting in detached fruit by enhancing the rate of water uptake produced only skin-cracks despite significant increases in the rate and amount of water uptake (Chapter Eight). Perhaps, more attention needs to be given to identifying tests which measure some mechanical or biophysical properties of fruit.

(v) *Reduction of stem-end splitting in apples*

It is premature at this stage to attempt to recommend reliable strategies to reduce the problem of stem-end splitting because there is a need for better understanding of the relationships between overall fruit quality, growth characteristics and orchard management practices which affect the incidence of stem-end splitting. In view of the many orchard factors and changes in fruit properties which are associated with high incidence of stem-end splitting (Tables 10.1 and 10.2), it is recommended that experimental studies be conducted to determine how these factors may interact with fruit growth rates to induce stem-end splitting. Of particular interest in this proposal would include the effects of frequent water supply, low crop load, and degree of fruit exposure on growth rates, and the effects of irrigation treatments applied during the critical growth period when ring-cracking and stem-end splitting are initiated. It is expected that a major outcome from this study would be the recommendation of practical measures to reduce the incidence of stem-end splitting in apples.

(vi) *Causes of cultivar resistance to stem-end splitting*

In order to eliminate the problem of stem-end splitting in apples, it is important to understand why certain cultivars do not split while others are particularly susceptible. This would require a major study to compare several cultivars in order to identify fruit properties which govern resistance to splitting. It is recommended that future work be carried out in this area to determine the relevant fruit characteristics which could assist plant breeders to identify susceptible lines.

## 10.6 General Conclusions

In conclusion, the phenomenon of stem-end splitting in apples has been studied extensively using both field and laboratory observations on the one hand, and the measurement of fruit mechanical and physico-chemical properties on the other. In addition, fruit growth dynamics have been analysed. The literature on fruit cracking and splitting in apples has been reviewed,

including a consideration of a range of fruits. It was found that, frequently, the information in the literature did not clearly differentiate the different types of fruit cracking in apples and the word "cracking" was often used in generic terms to include skin-cracking, star-cracking, general splitting of the flesh, and possibly, stem-end splitting.

This study has provided new evidence that the initiation of stem-end splitting in apples is preceded by the development of internal ring-cracks. These are frequently present in fruit without stem-end splits. These ring-cracks extend from the base of the stem outwards into the flesh of the apple in a plane at an angle of 90 degrees to the stem. Both ring-cracking and stem-end splitting were observed in some commercially grown apple cultivars, namely 'Gala', 'Royal Gala', and 'Fuji'. References have been made in the literature to the type of fruit cracking in apples which commonly occurred around the stem (Chapter 2). However, no published research has noted the presence of internal ring-cracks. Results obtained in this study suggested that internal ring-cracking (and stem-end splitting) is a growth crack rather than swelling and bursting of the fruit skin often associated with excessive water uptake through the skin into the underlying tissue.

It is apparent from the overall results of this study that several external and internal fruit factors affect the incidence of stem-end splitting. The study has shown that stem-end splitting appears to be related to an imbalance in growth rates of the fruit parts and presumably to water uptake through the stem, as water intake through the remainder of the fruit surface did not cause stem-end splitting. The entire work contained in this thesis provides the first detailed study and analysis of the problem, and therefore highlights some of the critical issues. It is hoped that the results and discussion presented will contribute to the understanding of the phenomenon of stem-end splitting in apples so that plant breeders and growers will be able to minimize the impact of this problem in the apple growing industry.

## LIST OF REFERENCES

- Altisent, M.A. 1991. Damage mechanisms in handling of fruits. In *Progress in Agricultural Physics and Engineering* (Matthew, J. (ed.)). pp: 231-257.
- Anon. 1961a. Report of East Malling Research Station for 1960, page 9.
- Anon. 1961b. Horticulture. Research Progress at the Illinois Agricultural Experiment Station : Report for 1958-1960, pp. 112-120.
- Anon. 1961c. Viticulture. Ann. Rpt. Agric. Tech. Services for the period 1st July, 1960, to 30th June, 1961, Republic of South Africa, pp. 22-24.
- Anon. 1962a. Report of East Malling Research Station for 1961, pp. 9-10.
- Anon. 1962b. Horticulture. Results of Research in 1961, being 74th Ann. Rept., Kentucky Agric. Expt. Sta., pp. 52-61.
- Armstrong, R.J. and Thompson, A.E. 1967. A diallel analysis of tomato fruit cracking. *Proc. Amer. Soc. Hort. Sci.* 91: 505-513.
- Armstrong, R.J. and Thompson, A.E. 1969. A rapid and accurate system for scoring tomato fruit cracking. *HortScience* 4: 288-290.
- Arthur, J.M. 1936. Radiation and anthocyanin pigments. In **B**iological effects of radiation, Dugger, B.M. ed. Vol. II: 1109-1118. McGraw Hill, New York.
- Askew, H.O. 1935. Changes in the chemical composition of developing apples. *J. Pomol.* 13: 232-246.
- Asquith, D. 1957. Some results on the control of the red-banded leaf roller and the two-spotted mite. *State Hort. Assoc. News*, 36: 39, 41-45.
- Assaf, R., Levin, I. and **B**ravdo, B. 1975. Effects of irrigation regimes on trunk and fruit growth rates, quality and yield of apple trees. *J. Hort. Sci.* 50: 481-493.
- Atkins, A.G. and Mai, Y.-W. 1985. *Elastic and plastic fracture*. Ellis Horwood Ltd., NY.
- Bain, J.M. and Robertson, R.N. 1951. The physiology of growth in apple fruit. I. Cell size, cell number and fruit development. *Aust. J. Sci. Res.* B4: 75-91.
- Bangerth, F. 1976. A role of auxin transport inhibitors on the Calcium content of artificially induced parthenocarpic fruits. *Physiol. Plant.* 37: 191-194.
- Bangerth, F. 1979. Calcium-related physiological disorders of plants. *Ann. Rev. Phytopathol.* 17: 97-122.
- Banks, N.H. 1993. Personal communication. Department of Plant Science, Massey University,

Palmerston North, New Zealand.

- Barden, J.A. 1992. Crop load and limb girdling affect apple fruit size, color, and quality. *HortScience* 27: 137.
- Bartlett, M.S. 1947. The use of transformation. *Biometrics* 3: 39-52.
- Batal, K.M., Weigle, J.L. and Lersten, N.R. 1972. Exogenous growth-regulator effect on tomato fruit cracking and pericarp morphology. *J. Amer. Soc. Hort. Sci.* 97: 529-531.
- Batal, K.M., Weigle, J.L. and Foley, D.C. 1970. Relation of strain-stress properties of tomato skin to cracking of tomato fruit. *HortScience* 5: 223-224.
- Bauvineau, C., Laroche, M., Heil, F., Dumont, J.-P., Cardinal, M., Cornet, J., Vallet, J.-P., Fauconneau, B. and Faure, A. 1993. Incidence de la vitesse de croissance sur les caractéristiques de la chair de la truite fario (*Salmo Trutta*) élevée en mer. Effect of growth rate on flesh characteristics of brown trout (*Salmo Trutta*) reared in sea water. *Sciences des Aliments*, 13: 201-211.
- Beadle, C.L. 1993. Growth analysis. In Hall, D.O., Scurlock, J.M.O., Bolhar-Nordenkamp, H.R., Leegood, R.C. and Long, S.P. (eds.). *Photosynthesis and production in a changing environment: a field and laboratory manual*. Chapman and Hall, London. pp. 36-46.
- Beattie, B.B., McGlasson, W.B. and Wade N.L. 1989. *Postharvest diseases of horticultural produce*. Vol. 1. Temperate Fruit. NSW Agric. and Fisheries. CSIRO, Australia.
- Bernstein, Z. and Lustig, I. 1985. Hydrostatic methods and measurement of firmness and turgor pressure of grape berries (*Vitis vinifera* L.). *Scientia Hort.* 25: 129-136.
- Bijl, van der P.A. 1914. "Apple cracking" and "apple branch blister". Caused by the fungus *Coniothecium Chomatosporum*, Corda. *Agric. J. Union of S. Africa*. Vol. 8: 64-69.
- Blanpied, G.D. and Wilde, M.H. 1968. A study of the cells in the outer flesh of developing McIntosh apple fruits. *Bot. Gaz.* 129: 173-183.
- Bohlmann, T.E. 1962. Why does fruit crack? *Fmg. S. Africa*. Vol. 38: 12-13.
- Bourne, M.C. 1983. Physical properties and structure of horticultural crops. In Peleg, M. and E.B. Bagley, eds. *Physical properties of foods*. AVI Publ. Coy, Westport. pp. 207-228.
- Broek, D. 1989. *The practical use of fracture mechanics*. Kluwer Academic Publishers, 522 pp.
- Brookfield, P.L., Hughes, J.G. and Watkins, C.B. 1993. Fruit maturity and quality of selectively picked 'Royal Gala' apples. *N.Z. J. Crop and Hort. Sci.* 21: 183-187.

- Brookfield, P.L., Ferguson, I.B., Watkins, C.B. and Bowen, J.H. 1993. Relationships between seed number, calcium content and disorders in 'Braeburn' apple fruit. Abstract of paper presented at AGRI-TECH '93 held at the Auckland College of Education, 23-26 August.
- Brooks, C. and Fisher, D.F. 1926. Some high-temperature effects in apples : Contrasts in the two sides of an apple. *J. Agric. Res.*, Vol. XXXII: 1-16.
- Brooks, W.M. 1961. Modified pruning. *Amer. Veg. Gr.* 9: 48.
- Brown, H.D. and Price, C.V. 1934. Effect of irrigation, degree of maturity, and shading upon the yield and degree of cracking of tomatoes. *Pro. Amer. Soc. Hort. Sci.* 32 : 524-528.
- Buch, M.L., Satori, K.G. and Hills, C.H. 1961. The effect of bruising and aging on the texture and pectic constituents of canned red tart cherries. *Food Technol.* 15: 526-531.
- Bullock, R.M. 1952. A study of some inorganic compounds and growth promoting chemicals in relation to fruit cracking of Bing cherries at maturity. *Proc. Amer. Soc. Hort. Sci.* 59: 243-253.
- Bullock, R.M. and Benson, N.R. 1948. Boron deficiency in apricots. *Proc. Amer. Soc. Hort. Sci.* 51: 199-204.
- Byers, R.E., Carbaugh, D.H. and Presley, C.N. 1990. 'Stayman' fruit cracking as affected by surfactants, plant growth regulators, and other chemicals. *J. Amer. Soc. Hort. Sci.* Vol. 115: 405-411.
- Byers, M.A. 1977. A scarfskin-like disorder of apples. *HortScience* 12: 226-227.
- Callan, N.W. 1986. Calcium hydroxide reduces splitting of 'Lambert' sweet cherry. *J. Amer. Soc. Hort. Sci.*, Vol. 111: 173-175.
- Callow, J.A. (ed.). 1990. *Advances in botanical research*, volume 17. Academic Press, London.
- Campbell, J.A. 1928. Cracking of Dunn's and Cox's Orange apples. *Investigations in Nelson District. N.Z. J. Agric.* pp. 85-86.
- Campbell, J.A. 1959. Tomato study seeks best Vine ripened variety. *Miss. Fm. Research* 22: 1, 8.
- Carne, W.M. 1925. Cracking and russetting of Dunn's and other apples. *J. Dept. W. Aust.* 2nd. Ser. 2, 214.
- Cation, D. 1959. Some fungicide trials on tree fruit in 1958. *Quart. Bull. Mich. Agric. Expt. Sta.* 41: 685-698.

- Causton D.R. and Venus, J.C. 1981. The biometry of plant growth. Edward Arnold London.
- Chadha, K.L. and Singh, K.K. 1963. Effect of NAA, 2,4-D and 2,4,5-T on fruit drop, size and quality of Langra Mango. *Ind. J. Hort.* 20: 30-33.
- Chalmers, D.J. 1989. A physiological examination of regulated deficit irrigation. *New Zealand Agric. Sci.* 23: 44-48.
- Chandler, W.H. 1925. Fruit growing. Boston, New York. 770 pages.
- Chazdon, R.L. 1986. The cost of leaf support in understory palms: economy versus safety. *The American Naturalist*, 127: 9-30.
- Christensen, J.V. 1970a. Numerisk undersøgelse af morfologiske kendetegn hos sødkirsebaer. Bestemmelsesnøgle til 34 sorter. (Numerical studies of morphological distinction marks in sweet cherry cultivars. Identification key for 34 cultivars.) *Tidsskr. Planteavl* 74: 44-74.
- Christensen, J.V. 1970b. Sortsforsøg med sødkirsebaer. (Cultivar trial with sweet cherries.) *Tidsskr. Planteavl* 74: 301-312.
- Christensen, J.V. 1972a. Revner i kirsebær I. Rytme og hastighed af frugternes vandoptagelse i relation til revnetilbojelighed. (Cracking in cherries. I. Fluctuation and rate of water absorption in relation to cracking susceptibility.) *Tidsskr. Planteavl* 76: 1-5.
- Christensen, J.V. 1972b. Revner i kirsebær II. Klimaets indflydelse på revnetilbojelighed. (Cracking in cherries II. The influence of climatic conditions on cracking susceptibility). *Tidsskr. Planteavl* 76: 191-195.
- Christensen, J.V. 1972c. Cracking in cherries III. Determination of cracking susceptibility. *Acta Agric. Scand.* 22: 128-136.
- Christensen, J.V. 1972d. Cracking in cherries IV. Physiological studies of the mechanism of cracking. *Acta Agric. Scand.* 22: 153-162.
- Christensen, J.V. 1973. Cracking in cherries VI. Cracking susceptibility in relation to the rhythm of the fruit. *Acta Agric. Scand.* 23: 52-54.
- Christensen, J.V. 1975. Cracking in cherries VII. Cracking susceptibility in relation to fruit size and firmness. *Acta Agric. Scand.* 25: 11-13.
- Christensen, J.V. 1976. Revnedannelse i kirsebær. (Crack formation in cherries). *Tidsskr. Planteavl* 80: 289-324.
- Clarkson, D.T. and Hanson, J.B. 1980. The mineral nutrition of higher plants. *Ann. Rev.* 

- Physiol. 31: 239-298.
- Claypool, L.L., Uriu, K. and Lasker, P.F. 1972. Split-pit of 'Dixon' cling peaches in relation to cultural factors. *J. Amer. Soc. Hort. Sci.* 97: 181-185.
- Cline, R.A. and Tehrani, G. 1973. Effects of boron and calcium sprays and mulch on cracking of Italian prune. *Can. J. Plant Sci.* 53: 827-831.
- Cochran, W.G. and Cox, G.M. 1957. *Experimental designs*. Second edition. John Wiley & Sons, Inc., NY. 611 pages.
- Cody, P.C. and Smith, J.K. 1987. *Applied statistics and the SAS programming language*. Second edition. North-Holland, NY. 280 pages.
- Coit, J.E. 1917. *Citrus fruits, an account of the citrus fruit industry, with special reference to California requirements and practices and similar conditions*. New York. 520 pages.
- Considine, J.A. and Kriedman, P.E. 1972. Fruit splitting in grapes : determination of the critical turgor pressure. *Aus. J. Agr. Res.* 23: 17-24.
- Considine, J.A., Williams, J.F. and Brown, K.C. 1974. A model of studies on stress in dermal tissues of mature fruit of *Vitis vinifera* : criteria for producing fruit resistant to cracking. In Bieleski, R.L. et al.(eds). 1974. *Mechanisms of regulation of plant growth*. Bulletin 12. The Royal Society of New Zealand, Wellington. pp. 611-617.
- Considine, J.A. 1979. *Biophysics and Histochemistry of fruit growth and development*. PhD thesis, University of Melbourne, Australia. 201 pages.
- Considine, J.A. and K. Brown. 1981. Physical aspects of fruit growth : Theoretical analysis of distribution of surface growth forces in fruit in relation to cracking and splitting. *Plant Physiol.* 68: 371-376.
- Considine, J.A. 1982. Physical aspects of fruit growth : Cuticular fracture and fracture patterns in relation to fruit structure in *Vitis vinifera*. *J. Hort. Sci.* 57: 79-91.
- Cook, J.R., DeBaerdemaeker, J.G., Rand, R.H. and Mang, H.A. 1976. A finite element analysis of guard cell deformation. *Trans. ASAE* 19: 1107-1121.
- Coombe, B.G. 1976. The development of fleshy fruits. *Ann. Rev. Plant Physiol.* 27: 207-228.
- Cortes, C., Ayuso, M.C., Palomares, G., Cuartero, J., and Nuez, F. 1983. Relationship between radial and concentric cracking of tomato fruit. *Scientia Hort.* 21: 323-328.
- Costa, G., Giulivo, C. and Ramina, A. 1983. Influence of growth regulators on apple fruit cracking (cv "Stayman Red"). *Acta Horticulturae* 137: 366-369.
- Cotner, S.D., Burns, E.E and Leeper, P.W. 1969. Pericarp anatomy of crack-resistant and



- susceptible tomato fruits. *J. Amer. Soc. Hort. Sci.* 94: 136-137.
- Cotter, D.J. and Seay, R.T. 1961. The effect of circulating air on the environment and tomato growth in a plastic greenhouse. *Proc. Amer. Soc. Hort. Sci.* 77: 643-646.
- Crafts, A.S., Currier, H.B. and Stocking, C.R. 1949. *Water in the physiology of plants.* Chronica Botanica, Waltham, Mass.
- Crauford, A. 1992. Personal communication. Crauford orchard, Havelock North, New Zealand.
- Cropley, R. 1963. Apple star crack. In Posnette, A.F. (ed). *Virus diseases of apples and pears.* Tech. Comm. 30. Commonwealth Bureaux of Hort. and Plantation Crops.
- Cropley, R. 1968. Varietal reactions to viruses causing star crack and russet rings on apple fruits. *Jour. Hort. Sci.* 43: 157-165.
- Cunningham, G.H. 1925. Fungous diseases of fruit trees (Blister-Disease, *Coniothecum Chomatosporum* Corda). Auckland, New Zealand. pp. 137-143.
- Currier, H.B. 1957. Callose substance in palnt cells. *Amer. J. Bot.* 44: 478-488.
- Davenport, D.C., Uriu, K. and Hagan, R.M. 1972. Antitranspirant film : Curtailing intake of external water by cherry fruit to reduce cracking. *HortScience* 7: 507-508.
- Davis, L.D. 1933. Size and growth relations of fruit splitting of peach pits. *Proc. Amer. Soc. Hort. Sci.* 30: 195-202.
- Davis, L.D. 1941. Split-pit of peaches: Estimation of time when splitting occurs. *Proc. Am. Soc. Hort. Sci.* 39: 183-189.
- DeEll, J. R. and Prange, R.K. 1993. Postharvest physiological disorders, diseases and ~~nit~~ concentrations of organically and conventionally grown McIntosh and Cortland ~~app~~ *Can. J. Plant Sci.* 73: 223-230.
- Dekazos, E.D. and Worley, J. F. 1967. Induction of callose formation by bruising and aging of red tart cherries. *J. Food Sci.* 32: 287-289.
- Denne, M.P. 1960. The growth of apple fruitlets, and the effect of early thinning on fruit development. *Annals of Botany.* Vol. 24: 397-406.
- Denne, M.P. 1963. A comparison between fruits of Cox's orange pippin from Kent, England, and Auckland, New Zealand. *N.Z. J. Bot.* 1: 295-300.
- Dickinson, D.B., Jr. 1963. Cellulase and polygalaturonase in tomato fruits and the effect of calcium on fruit cracking. *Diss. Abstr.* 23 : 4052, being Order No. 63-3230 of 76 pp.
- Dickinson, D.B. and McCollum, J.P. 1964. The effect of calcium on cracking on tomato

- fruits. Proc. Amer. Soc. Hort. Sci. 84: 485-490.
- Dodge, J.C. and Snyder, J.C. 1958. Horticulture. Tree Fruits. Wash. Sta. Res. Progr., No.9, 6-7.
- Dube, S.D., Tewari, J.D. and Ram, C.B. 1969. Boron deficiency in Rymer apple. Progressive Hort. Vol.1: 33-36.
- Dube, S.D. and Ram, C.B. 1970. Control of fruit-cracking in pear. Current Sci. 39: 446-447.
- Duncan, D.B. 1955. Multiple range and multiple F-tests. Biometrics 11: 1-42.
- Duncan, P. 1992. Personal Communication. Fresh fruits laboratory, NZAPMB, Hastings.
- Duran, G. 1990. Effects of RDI on apple tree (cv Royal Gala) growth, yield and fruit quality in a humid environment. PhD thesis, Massey University, Palmerston North, New Zealand.
- Eccher, T. 1986. Russeting and shape of Golden Delicious apples as related to endogenous GA content of fruitlets. Acta Horticulturae 179: 767-769.
- Edwards, R., Trought, M. and Lang, A. 1992. Cherry drupes and water loss. Is there no end to Penman-Monteith? Extended Abstracts, NZ Soc. Plant Physiol. Inc. Annual meeting in conjunction with the NZ Inst. Agr. Sci. Inc., Lincoln University, Canterbury, 24-28 August. pp. 60-62.
- El-kattan, A.A. and Stark, F.C. 1964. Tissue activity and structural differences in the storage roots of Maryland Golden and Jersey Orange sweet potatoes as related to cracking. Proc. Amer. Soc. Hort. Sci. 53: 378-388.
- Evans, I.B.P. 1907. Notes on plant diseases. I. An apple disease (*Coniothecum chomatosporum*, Corda). Transvaal Agric. J. Vol. V. no. 19: 680-681.
- Evert, D.R., Gaines, T.P. and Mullinix, G.P. Jr. 1988. Effects of split-pit on elemental concentrations of peach fruit during pit hardening. Scientia Horticulturae 34: 55-65.
- Farmer, A., Hawkins, J.E. and Roberts, G.E. 1958. 2,4,5-T hastens maturity of Oullins and Moorpark apricots. Orchard N.Z. 31: 275-9.
- Faust, M. and Shear, C.B. 1968. Corking disorders of apples : a physiological and biochemical review. Botanical Review 34: 441-469.
- Faust, M., Shear, C.B. and Williams, M.W. 1969. Disorders of carbohydrate metabolism of apples. Botanical Review 35: 168-194.
- Faust, M. and Shear, C.B. 1972. Russeting of apples, an interpretative review. HortScience 7: 233-235.

- Fawcett, H.S. and Lee, H.A. 1926. Citrus diseases and their control. New York. 582 pages.
- Fernandez, G.C.J. 1992. Residual analysis and data transformations: Important tools in statistical analysis. *HortScience* 27: 297-300.
- Finney, E.E. 1967. Dynamic elastic properties of some fruits during growth and development. *J. Agric. Engng Res.* 12: 249-256.
- Finney, E.E. Jr., and Massie, D.R. 1975. Instrumentation for testing the response of fruits to mechanical impact. *Trans. ASAE* 18: 1184-1187.
- Fischer, H. 1955. Unusual russeting and cracking in Boskoop, Glockenapfel and other apple varieties, a virus disease ? *Schweiz. Z. Obst-u. Weinb.*, 64:125-131. English Abstr. in *Hort. Abstr.*, Vol. 25, Item no. 2609.
- Fisher, D.F. 1937a. York skin crack, hydrochloric acid injury and heat cracking. *Amer. Fruit Grower*, 57: 11,16.
- Fisher, D.F. 1937b. Present equipment and methods for effective and safe washing of eastern apples. *Proc. Md. Sta. Hort. Soc.* 31: 8-14.
- Fletcher, L.A. 1929. A preliminary study of the factors affecting red color of apples. *Proc. Amer. Soc. Hort. Sci.* 26: 111.
- Fogg, G.E. 1963. The growth of plants. Penguin Books. 288 pages.
- Fogle, H.W. and Faust, M. 1975. Ultrastructure of nectarine fruit surfaces. *J. Amer. Soc. Hort. Sci.* 100: 74-77.
- Fogle, H.W. and Faust, M. 1976. Fruit growth and cracking in nectarines. *J. Amer. Soc. Hort. Sci.* 101: 434-435.
- Ford, E.M. 1979. The distribution of calcium in mature apple fruits having bitter pit disorder. *J. Hort. Sci.* 54: 91-92.
- Foster, B.R., Hodgson, R.M., Browne, R.F. and Studman, C.J. 1991. Stem end split detection in apples. Presented at the 6th NZ Image Processing Workshop, August 1991. 7 pages.
- Foster, W.R. 1937. Cracking of cherries. *Scientific Agric.*, Vol.XVII: 50.
- Frazier, W.A. 1934. A study of some factors associated with the occurrence of cracks in the tomato fruit. *Proc. Amer. Soc. Hort. Sci.* 32: 519-523.
- Frazier, W.A. 1935. Further studies on the occurrence of cracks in tomato fruits. *Proc. Amer. Soc. Hort. Sci.* 33: 536-541.
- Frazier, W.A. 1936. Type and severity of fruit cracking in tomato varieties. *Proc. Amer. Soc. Hort. Sci.* 34: 536.

- Frazier, W.A. 1938. Varietal, climatic, and age influences on daily cracking indices of tomato fruits. *Proc. Amer. Soc. Hort. Sci.* 36: 746.
- Frazier, W.A. 1947. A final report on studies of tomato fruit cracking in Maryland. *Proc. Amer. Soc. Hort. Sci.* 49: 241-255.
- Frazier, W.A. 1951. A stock with wide calyx base and resistant to cracking. TGC Report No.1, page 5.
- Frazier, W.A. 1958. Resistance to cracking. TGC Report No.8, page 15.
- Frazier, W.A. 1959. Resistance to cracking. TGC Report No.9, pp. 32-33.
- Frazier, W.A. and Bowers, J.L. 1947. A final report on studies of tomato fruit cracking in Mary Land. *Proc. Am. Soc. Hort. Sci.* 49: 241-255.
- Furmidge, C.G.L. 1959a. Physico-chemical studies on agricultural sprays. II. -The phytotoxicity of surface-active agents on leaves of apple and plum trees. *J. Sci. Food Agric.* 10: 274-282.
- Furmidge, C.G.L. 1959b. Physico-chemical studies on agricultural sprays. II. -Variation of phytotoxicity with the chemical structure of surface-active agents. *J. Sci. Food Agric.* 10: 419-425.
- Gardner, V.R., Bradford, F.C. and Hooker, H.D. 1922. *The fundamentals of fruit production.* New York. 686 pages.
- Gardner, V.R. and E.G. Christ. 1953. Studies on cracking in the Stayman apple. *Hort. News* 34: 2701, 2710-12.
- Gerhardt, F., English, H. and Smith, E. 1945. Cracking and decay of Bing cherries as ~~and~~ to the presence of moisture on the surface of the fruit. *Proc. Amer. Soc. Hort. Sci.*, 46: 191-198.
- Gerritsen, C.J. 1959. Cracking of cherries. *Hort. Abstr.* Vol.29, Item No.2267.
- Gilbert, J.C. 1959. Susceptibility to concentric cracking associated with the Mi locus on chromosome 6. TGC Report No.9, pp. 34-36.
- Gilmer, R.M. and Einset, J. 1959. Some bud mutations of apple with virus-like symptoms. *Plant Dis. Repr.* 43: 264-269.
- Gjaerum, H.B. 1958. Fruit cracking in sweet cherries. *Yrkesfruktdyrk*, No.3, page 2. Cited in *Hort. Abstr.* Vol. 29, Item No.
- Glenn, G.M. and Poovaiah, B.W. 1989. Cuticular properties and postharvest calcium applications influence cracking of sweet cherries. *J. Amer. Soc. Hort. Sci.* 114: 781-

788.

- Glenn, G.M., Rom, C.R., Rasmussen, H.P. and Poovaiah, B.W. 1990. Influence of cuticular structure on the appearance of artificially waxed 'Delicious' apple fruit. *Scientia Horticulturae* 42: 289-297.
- Goldschmidt, E. 1962. The anatomical-morphological causes of cracking in apples. (Swedish.) *Sver. pomol. Foren Arsskr*, 63:67-72. English abstr. in *Hort.Abstr.* Vol. 33, Item no. 4523.
- Gomez, K.A. and Gomez, A.A. 1984. *Statistical procedures for agricultural research*. 2nd ed. Wiley, NY.
- Goode, J.E. and Ingram, J. 1971. The effect of irrigation on the growth, cropping and nutrition of Cox's Orange Pippin apple trees. *J. Hort. Sci.* 46: 195-208.
- Goode, J.E., Fuller, M.M and Hyrycz, K.J. 1975. Skin-cracking of Cox's Orange Pippin apples in relation to water stress. *J. Hort. Sci.* 50: 265-269.
- Goodwin, B.G. 1929. Blister disease or cracking of apples. Successful remedial measures in Nelson District. *N.Z. Jour. Agric.* pp: 305-307.
- Gourley, J.H. and Howlett, F.S. 1941. *Modern Fruit Production*. The MacMillan Coy, N.Y., pp. 443-444.
- Graebner, P. 1920. *Lehrbuch der nichtparasitären pflanzenkrankheiten*. Berlin. 333 pages. Cited in : Verner, L. 1935. A physiological study of cracking in Stayman Winesap apples. *J. Agric. Res.* 51: 191-222.
- Green, P.B. 1976. Growth and cell pattern formation on an axis: critique of concepts, terminology and mode of study. *Bot. Gaz.* 137: 187-202.
- Greenham, D.W.P. 1965. A log-term manurial trial on desert apple trees. *J. Hort. Sci.* 40: 213-235.
- Greene, D.W. and Autio, W.R. 1993. Evaluation of red coloring strains of Gala apple. *Fruit Notes*, Winter, pp. 15-19.
- Gustafon, F.G. 1926. Growth studies on fruits. *Plant Physiol.* 1: 265-272.
- Haas, A.R.C. 1936. Growth and water relations of the Avocado fruit. *Plant Physiol.* 11: 383-399.
- Haas, A.R.C. and Bliss, D.E. 1935. Growth and composition of deglet noor dates in relation to water injury. *Hilgardia* 9: 295-344.
- Haller, M.H. 1942. Days from bloom as an index of maturity for apples. *Proc. Amer. Soc.*

- Hort. Sci. 40: 142-145.
- Haman, D.Z. and Burgess, G.J. 1986. Theoretical development for measuring the elastic properties of spherical cuticular membranes. *Trans. ASAE* 29: 1470-1476.
- Hamson, A.R. 1952. Measuring firmness of tomatoes in a breeding program. *Proc. Amer. Soc. Hort. Sci.* 60: 425-433.
- Hankinson, B. and Rao, V.N.M. 1979. Histological and physical behaviour of tomato skins susceptible to cracking. *J. Amer. Soc. Hort. Sci.* 104: 577-581.
- Harker, F.R. and Hallett, I.C. 1992. Physiological changes associated with development of mealiness in apple fruit during storage. *HortScience* 27: 1291-1294.
- Harley, C.P. and Masure, M.P. 1938. Relation of atmospheric conditions to enlargement rate and periodicity of Winesap apples. *J. Agric. Res.* 57: 109-124.
- Harrington, W.O., Hills, C.H., Jones, S.B., Stafford, A.E. and Tennes, B.R. 1978. Ethyl Oleate sprays to reduce cracking of sweet cherries. *HortScience* 13: 279-280.
- Hartman, H. and Bullis, D.E. 1929. Investigations relating to the handling of sweet cherries with special reference to chemical and physiological activities during ripening. *Oreg. Agr. Expt. Sta. Bull.* 247, 88 pages.
- Hartman, H. 1924. Studies relating to the harvesting and storage of apples and pears. *Oregon Agr. Expt. Sta. Bull.* 206, 32 pages.
- Hatfield, S.G.S., and Knee, M. 1988. Effects of water loss on apple in storage. *Int. Jour. Food Sci. and Tech.* 23: 575-583.
- Hayman, G. 1987. The hair-like cracking of last season. *Grower*, 107: 3, 5.
- Hayslip, N.C. and Forsee, W.T. Jr. 1953. A preliminary report on the use of nutritional sprays containing N, P and K in tomato production. *Proc. Fla. Sta. Hort. Soc. for 1953*, pp.92-97.
- Heald, F.D. 1926. *Manual of plant diseases*. McGraw-Hill Book Coy. 891 pages.
- Hepler, R.W. 1961. The measurement and inheritance of resistance to fruit cracking in the tomato. *Diss. Abstr.* 21 : 3580-1, being L.C. Card No. Mic. 61-1622 of 88 pp.
- Heinicke, A.J. 1921. The seed content and the position of the fruit as factors influencing stippen in apples. *Proc. Amer. Soc. Hort. Sci.* 17: 225-232.
- Heinicke, D.R. 1963. Note on the estimation of leaf area and leaf distribution in fruit trees. *Can. J. Plant Sci.* 43: 597-598.
- Heinicke, D.R. 1966. Characteristics of McIntosh and Red Delicious apples as influenced by

- exposure to sunlight during the growing season. *Proc. Amer. Soc. Hort. Sci.* 89: 10-13.
- Herbert, D.A. 1922. Bitter pit in apples. The crushed cell theory. *Phytopath.* 12: 489-491.
- Hills, C.H., Whittenberger, R.T., Robertson, W.F. and Case, W.H. 1953. Studies on the processing of red cherries. II. Some effects of bruising on the yield and quality of canned Montmorency cherries. *Food Technol.* 7: 32-35.
- Hockey, J.F. 1941. False sting - A virus disease of apples. *Scientific Agric.* 5: 242-243.
- Hockey, K. 1945. Cracking of cherries before harvesting. *NZ J. Agric.* 71: 639.
- Hodson, A. 1990. Personal Communication. Hawke's Bay Agricultural Research Centre, New Zealand.
- Hodson, A. 1991a. Personal Communication. Hawke's Bay Agricultural Research Centre, New Zealand.
- Hodson, A. 1991b. Stem end splitting in Gala and Fuji apples. Results of a two year study investigating the cause of stem end splitting. Unpublished. Hawke's Bay Agricultural Research Centre.
- Holt, J.E. and Schoorl, D. 1983a. Cracking and energy dissipation in cabbages. *J. Text. Std.* 14: 99-111.
- Holt, J.E. and Schoorl, D. 1983b. Fracture in potatoes and apples. *J. Mat. Sci.* 18: 2017-2028.
- Holt, J.E. and Schoorl, D. 1983c. Cracking in potatoes. *J. Text. Std.* 14: 61-70.
- Holt, J.E. and Schoorl, D. 1984. Mechanical properties and texture in stored apples. *J. Text. Std.* 15: 377-94.
- Hopfinger, J.A. and Poovaiah, B.W. 1978. Calcium and Magnesium gradients in apples with bitter pit. *Communications in Soil Science and Plant Analysis* 9: 10.
- Hough, G., Chirife, J. and Marini, C. 1993. A simple model for osmotic dehydration of apples. *Lebensm.-Wiss. u.-Technol.* 26: 151-156.
- Hudson, L. 1955. Inheritance of resistance cracking. TGC Report No.5, page 16.
- Hulme, A.C. (ed.) 1971. *The Biochemistry of fruits and their products.* Vol. 2. Academic Press, London. 788 pages.
- Hunt, R. 1982. *Plant growth curves. The functional approach to plant growth analysis.* Edward Arnold London. 248 pages.
- Huxley, J.S. 1972. *Problems of relative growth.* Dover Publications, Inc., NY.
- Ingle, M. and D'Souza, M. 1989. Physiology and control of superficial scald: a review.

HortScience 24: 28-31.

Irving, D.E., and Drost, J.H. 1987. Effects of water deficit on vegetative growth, fruit growth and fruit quality in Cox's Orange Pippin apples. *J. Hort. Sci.* 62: 427-432.

Iverson, V.E. 1938. Fruit cracking of tomatoes as influenced by applying potassium permanganate to soils in which the transplants are grown. *Montana State Coll. Agr. Expt. Sta. Bull.* 362. 15 pages.

Jackson, J.E., Palmer, J.W., Perring, M.A. and Sharples, R.O. 1977. Effects of shade on the growth and cropping of apple trees. III Effects on fruit growth, chemical composition and quality at harvest and after storage. *J. Hort. Sci.* 52 :267-282.

Japan Gibberellin Research Association, Japan. 111 pages. Cited in *Hort. Abstr.* Vol. 33, Item No. 2041.

Jenkins, J.E. and Storey, I.F. 1955. star cracking of apples in East Anglia. *Plant Pathology* 4: 50-53.

Johannessen, G.A. 1949. Skin puncture studies on red-ripe tomatoes. *Proc. Amer. Soc. Hort. Sci.* 54: 272-276.

Johannessen, G.A. 1950. Tomato fruit cracking studies. PhD Thesis (unpublished). Cornell University. Cited in Reynard, G.B. 1960. *Proc. Plant Science Seminar, Camden, New Jersey.* pp. 93-112.

John, P.W.M. 1971. *Statistical design and analysis of experiments.* The Macmillan Coy., NY. 356 pages.

Jones, K.M., Bound, S.A., Koen, T.B. and Oakford, M.J. 1992. Effect of timing of hand thinning on the cropping potential of Red Fuji apple trees. *Aust. J. Expt. Agric.* 32: 417-420.

Kamimura, S., Yoshikawa, H. and Ito, I. 1972. Studies of fruit cracking in tomatoes. (Japanese, with English summary). *Bull. Hort. Res. Sta., Series C (Morioko), No.7:* 73-138.

Kanninen, M.F. and Popelar, C.H. 1985. *Advanced fracture mechanics.* Oxford University Press, N.Y., 563 pages.

Kemp, W.S. 1959. Yellow leaf spot, fruit pimpling and cracking of nectarine and peach. *Orchard N.Z.* 32: 215-17.

Kertesz, Z.I. and Nebel, B.R. 1935. Observations on the cracking of cherries. *Plant Physiol.* 10: 763-771.



- Kessler, J.R. and Armitage, A.M. 1992. Effects of shading on growth rate, flower initiation and flower development of *Begonia x semperflorens-cultorum*. *J. Hort. Sci.* 67: 849-854.
- Khan, A.A. and Vincent, J.F.V. 1990. Anisotropy of apple parenchyma. *J. Sci Food Agric.* 52: 455-466.
- Kim, W., Kim, J., Kim, M., Shin, K. and Kim, S. 1991. Studies on the causal factors and control of calyx and necrosis in 'Sekaiicki' apples (*Malus domestica* Borkausen). Research Rept. RDA(H) 33: 16-26.
- Kirby, E.A. and Pilbeam, D.J. 1984. Calcium as a plant nutrient. *Plant Cell and Environ.* 7: 397-405.
- Kirk, T.W. 1907. Diseases of fruit crops : *Coniothecium Chomatosporum*. New Zealand Dept. Agric. 15th Rept. p.164.
- Knee, M. 1975. Changes in structural polysaccharides of apples ripening during storage. In *Facteurs et regulation de la maturation des fruits. Collques Internationaux du Centre National de la Recherche Scientifique, Paris.* pp. 341-345.
- Knoche, M. and Bukovac, M.J. 1992. Surfactants influence foliar absorption of gibberellic acid by sour cherry leaves. *J. Amer. Soc. Hort. Sci.* 117: 80-84.
- Knuth, D. and Stosser, R. 1987. Comparison of the sun-exposed and shaded side of apple fruit. I. Cuticle, epidermal cell size and surface waxes. *Hort. Abstr.* vol. 57 No. 8 Item 6223.
- Koske, T.J., Pallas, J.E. Jr., Jones, J.B. Jr. 1980. Influence of ground bed heating and cultivar on tomato fruit cracking. *HortScience* 15: 760-762.
- Kuiper, P.J.C. 1972. Water transport across membranes. *Ann. Rev. Plant Physiol.* 23: 157-172.
- Kuster, E. 1958. *Plasmoptyse. Protoplasmatologia, II C 7b.* Vienna, Springer-Verlag.
- LaBelle, R.L. and Moyer, J.C. 1960. Factors affecting the drained weight and firmness of red tart cherries. *Food Technol.* 14: 347-352.
- LaBelle, R.L., Woodams, E.E. and Bourne, M.C. 1964. Recovery of Montmorency cherries from repeated bruising. *J. Amer. Soc. Hort. Sci.* 84: 103-109.
- Lague, C. and Jenkins, B.M. 1991a. Modeling pre-harvest stress-cracking of rice kernels. Part I: Development of a finite element model. *Trans. ASAE* 34: 1797-1811.
- Lague, C. and Jenkins, B.M. 1991b. Modeling pre-harvest stress-cracking of rice kernels. Part II: Implementation and use of the model. *Trans. ASAE* 34: 1812-1823.

- Lee, S.K. and Young, R.E. 1983. Growth measurement as an indication of avocado maturity. *J. Amer. Soc. Hort. Sci.* 108: 395-397.
- Levin, J.H., Hall, C.W. and Deshmukh, A.P. 1959. Physical treatment and cracking of sweet cherries. *Mich. St. Univ. Agr. Expt. Sta. Qrtly. Bull.* Vol. 42: 133-141.
- Lewis, T.L. and Martin, D. 1969. Changes in rate of leakage of potassium from excised disks of apple fruits held at 20 C after harvest. *Austr. J. Biol. Sci* 22: 1577-1580.
- Lidster, P.D. and Tung, M.A. 1979. Identification of deformation parameters and fruit response to mechanical damage in sweet cherry. *J. Amer. Soc. Hort. Sci.* 104: 808-811.
- Lilleland, O. 1932. Growth study of the peach fruit. *Proc. Amer. Soc. Hort. Sci.* 29: 8-22.
- Lin, T.T. and Pitt R.E. 1986. Rheology of apple and potato tissue as affected by cell turgor pressure. *J. Texture Stds* 17: 291-313.
- Little, T.M. and Hills, F.J. 1978. *Agricultural experimentations - design and analysis.* Wiley, NY. 345 pages.
- Little, T.M. 1985. Analysis of percentage and rating scale data. *HortScience* 20: 642-644.
- Lord, W.J. and F.W. Southwick. 1964. The susceptibility of two Delicious strains to some pre- and post-harvest physiological disorders. *Proc. Amer. Soc. Hort. Sci.* 84: 65-71.
- Lott, R.V. 1933. Further studies of peach fruit growth. *Proc. Amer. Soc. Hort. Sci.* 30: 201-218.
- Lotter, J. de V., Beukes, J. and Weber, H.W. 1985. Growth and quality of apples as affected by different irrigation treatments. *J. Hort. Sci.* 60: 181-192.
- Louw, A.J. 1948. Investigations on the cracking of Henimuri apples. *Fmg S. Afr.* 23: 596-602.
- Lownds, N. and Bukovac, M. 1988. Studies on octylphenoxy surfactants: V. toxicity to cowpea leaves and effects of spray application parameters. *J. Amer. Soc. Hort. Sci.* 113: 205-210.
- Luckwill, L.C. 1948. The hormone content of the seed in relation to endosperm development and fruit drop in the apple. *J. Hort. Sci.* 24: 32-44.
- Luckwill, L.C. 1953a. Studies of fruit development in relation to plant hormones. I. Hormone production by the developing apple seed in relation to fruit drop. *J. Hort. Sci.* 28: 14-24.
- Luckwill, L.C. 1953b. Studies of fruit development in relation to plant hormones. II. The effect

- of naphthalene acetic acid on fruit set and fruit development in apples. *J. Hort. Sci.* 28: 26-40.
- Lustig, I. and Bernstein, Z. 1985. Determination of the mechanical properties of the grape berry skin by hydrostatic measurements. *Scientia Hort.* 25: 279-285.
- Lutz, J.M., Deonier, M.T. and Walters, B. 1949. Cracking and keeping quality of Porto Rico Sweet potatoes as influenced by rate of fertilizer, nitrogen ratio, lime, and borax. *Proc. Amer. Soc. Hort. Sci.* 54: 407-412.
- McAlpine, D. 1921. Bitter pit in apples and pears: the latest results in preventive measures. *Phytopath.* 11: 366-370.
- McArtney, S., Palmer, J.W. and Gibbs, H.M. 1993. Crop loading studies with 'Royal Gala' apples. Abstract of paper presented at AGRI-TECH '93 held at the Auckland College of Education, August 23-36.
- McCliskie, M.J. 1991. Report of the Board. 43<sup>rd</sup> Annual report of the New Zealand Apple and Pear Marketing Board, NZAPMB, Wellington. pp. 6-9
- McCutchan, H. and Shackel, K.A. 1992. Stem water potential as a sensitive indicator of water stress in prune trees (*Prunus domestica* L. cv. French). Private communication.
- McKee, H.S. and Urbach, G.E. 1953. The physiology of growth in apple fruits v. soluble nitrogen constituents. *Aust. J. Biol. Sci.* 6: 367-377.
- McLeod, S. 1992. Personal Communication. New Zealand Apple and Pear Marketing Board, Hastings.
- McGary, A. 1993. Influence of water status on carrot (*Daucus carota* L.) fracture properties. *J. Hort. Sci.* 68: 431-437.
- Magein, H. 1989. Growth and abscission dynamics of 'Cox's Orange Pippin' and 'Golden Delicious' apple fruits. *J. Hort. Sci.* 64: 265-273.
- Magness, J.R. 1928. Observations on color development in apples. *Proc. Amer. Soc. Hort. Sci.* 25: 289-292.
- Magness, J.R. and H.C. Diehl. 1924. Physical studies on apples in storage. *J. Agric. Res.* 27: 1-38.
- Mai, Y.-W. and Atkins, A.G. 1980. Crack stability in fracture toughness testing. *J. Strain Anal.* 15:63-74.
- Marcotte, M. and Le Maguer, M. 1991. Repartition of water in plant tissues subjected to osmotic processes. *J. Food Process Engng* 13: 297-320.

- Marios, J.J., Bledsoe, A.M., Bostock, R.M. and Gubler, W.D. 1987. Effects of spray adjuvants on development of *Botrytis cinerea* on *Vitis vinifera* berries. *Phytopathology* 77: 1148-1152.
- Martin, D. and Lewis, T.L. 1952. Physiology of growth in apple fruits. III. Cell characteristics and respiratory activity of light crop and heavy crop trees. *Aust. J. Sci. Res.* 5: 315-327.
- Martin, D. and Lewis, T.L. and Cerny, J. 1954. The physiology of growth of apple fruits. VIII. Between tree variation in cell physiology in relation to disorder incidence. *Aust. J. Sci. Res.* 7: 211-220.
- Masden, H.F. and Bailey, J.B. 1959. Parathion Resistant Mites. *Calif. Agric.* 13: 12.
- Mead, R. and Curnow, R.N. 1983. Statistical methods in agriculture and experimental biology. Chapman and Hall. London. 335 pages.
- Meyer, A. 1944. A study of the skin structure of Golden Delicious apples. *Proc. Amer. Soc. Hort. Sci.* 45: 105-110.
- Meynhardt, J.T. 1957. Does spray irrigation cause berry cracking in grapes? *Fmg S. Afr.* 32: 6-9.
- Meynhardt, J.T. 1964a. A histological study of berry-splitting in some grape cultivars. *S. Afr. J. Agric. Sci.* 7: 707-716.
- Meynhardt, J.T. 1964b. Some studies on berry-splitting of Queen of the Vineyard grapes. *S. Afr. J. Agric. Sci.* 7: 179-186.
- Mezzetti, A. 1959. Considerazioni sul meccanismo ch generale spaccature delle mele senescenti. (Observations on the causal mechanism of cracking in over-ripe apples.) *Frutticoltura*, 21:631-3. English Abstr. in *Hort. Abstr.* Vol. 30, Item no. 1770.
- Miki, T. 1932. Studies on the development of peach fruits with special reference to the causes of their split-pit. *Bull. Chiba Coll. Hort.* 1: 114-118.
- Milad, R.E. and Shackel, K.A. 1992. Water relations of fruit end cracking in French prune (*Prunus domestica* L.cv. French). *J. Amer. Soc. Hort. Sci.* 117: 824-828.
- Miles, J.A., Friedley, R.B. and Lorenzo, C. 1969. Strength characteristics of tomatoes subjected to quasi-static loading. *Trans. ASAE* 12: 627-630.
- Mills, T., Behboudian, M.H. and Clothier, B. 1993. Irrigation management and fruit quality in 'Braeburn' apples. Abstract of paper presented at AGRI-TECH '93, Auckland College of Education, 23-26 August.

- Mohsenin, N.N. 1970. Physical properties of plant and animal materials. Gordon and Breach, Inc., NY.
- Mohsenin, N.N. 1972. Mechanical properties of fruits and vegetables: review of a decade of research applications and needs. Trans. ASAE 15: 1064-1070.
- Mohsenin, N.N. 1977. Characterization and failure of solid foods with particular reference to fruits and vegetables. J. Text. Std. 8: 169-193.
- Mohsenin, N.N. and Gohlich, H. 1962. Techniques for determination of mechanical properties of fruits and vegetables as related to design and development of harvesting and processing machinery. J. Agr. Engng. Res. 7: 300-315.
- Mohsenin, N.N., Cooper, H.E., Hammerle, J.R., Fletcher, S.W. and Tukey, L.D. 1965. "Readiness for harvest" of apples as affected by physical and mechanical properties of the fruit. Bull. 721. Agric. Expt. Sta., The University of Pennsylvania.
- Molenaar, A. and Vincent, C.L. 1951. Studies in sprinkler irrigation with Stokesdale tomatoes. Proc. Amer Soc. Hort. Sci. 57: 259-265.
- Monsanto. 1988. Pulse penetrant. A technical newsletter. 3 pages. Monsanto Australia Ltd, Melbourne.
- Montgomery, H.B.S. 1959. Russetting and cracking of Cox's Orange Pippin apples. Report of East Mall. Res. Sta. for 1958, pp. 163-164.
- Moorby, J. and Besford, R.T. 1983. Mineral nutrition and growth. In A. Lauchi and R.L. Bielecki, Inorganic plant nutrition. Springer-Verlag, Berlin. pp. 481-527
- Moore, M.H. 1931. Investigations on Coniothecum. A progress report. In Annual Report for 1928, 1929, and 1930 II supplement. East Mall. Res. Sta. pp. 150-156.
- Mrozek, R.F. and Burkhardt, T.H. 1973. Factors causing prune side cracking. Trans. ASAE : 686-692.
- Nauriyal, J.P. 1955. A study of pre-mature fruit drop in citrus. Ind. J. Hort. 12: 39-52.
- Nii, N. 1979. Fruit development in relation to vascular anatomy of the fruit stalk in peach. Std. Inst. Hort. Kyoto Univ., 9: 13-18.
- Nii, N. 1980a. The growth of citrus fruits, satsuma mandarins and Hassaku, in relation to the development of tissue systems in the leaf and fruit stalk. J. Jap. Soc. Hort. Sci. 49: 23-53.
- Nii, N. 1980b. Seasonal changes in fruit growth in Japanese persimon, *Diospyros kaki* cv Fuyu in relation to vascular tissue development in the fruit stalk. J. Jap. Soc. Hort. Sci.

49.

- Nii, N. 1980c. Seasonal changes in growth and enlargement of the Japanese pear fruit, *Pyrus serotina* cv Shinsheiki, in relation to vascular bundle developmet in the pedicel and flesh. *J. Hort. Sci.* 55: 385-396.
- Niiuchi, K., Honda, F. and Ota, S. 1960. Studies on cracking in tomato fruit. I. Mechanisms of fruit cracking. *J. Hort. Assoc., Japan*, 29: 287-293. (*Hort. Abstr.* Vol.31, Item No.6464).
- Nikitina, K.V. 1959. The keeping quality of apples (Russian). *Sadi i Ogorod*, No.9, pp.56-9. *Hort. Abstr.* Vol. 30, Item No.1769.
- Nilsson, F. and Fernqvist, I. 1956. Sprickbildning hos Ingrid Marie. (Fruit cracking in Ingrid Marie.) *Sver. pomol. Foren. Arsskr. English Abstr.* in *Hort. Abstr.* Vol. 27, Item no. 2251.
- Nilsson, F. and Bjurman, B. 1958. Sprickor pa Ingrid Marie. (Fruit cracking in Ingrid Marie.) *Sver. pomol. Foren. Arsskr. English Abstr.* in *Hort. Abstr.* Vol. 29, Item no. 2266.
- Noga, G.J. and Bukovac, M.J. 1986. Impact of surfactants an fruit quality of 'Schatten Morelle' sour cherries and 'Golden Delicious' apples. *Acta Hort.* 179: 771-777.
- Noga, G. and Wolter, M. 1990. Surfactants as a cause of russetting in apples. *Gartenbau wissenschaft* 55(1):20-26. *Abstr.* in *Hort. Abstr.* Vol. 60 no. Item 9586.
- NZAPMB. 1989. Pest, disease and cosmetic defect identification. New Zealand Apple and Pear Marketing Board, Wellington.
- Opara, L.U., Studman, C.J. and Banks, N.H. 1992. Measurement of fruit growth, growth stress, and chronological development of stem-end splitting in 'Gala' apples. Paper presented at the Joint Annual Conference, New Zealand Institute of Agricultural Science and New Zealand Society for Horticultural Science (NZIAS/NZSHS), Lincoln University, Aug. 25-28.
- Opara, L.U., Studman, C.J. and White, A.G. 1993a. A study of the mechanical properties of mutation breeds of Royal Gala. Unpublished. Department of Agricultural Engineering, Massey University, New Zealand.
- Opara, L.U., Studman, C.J. and Banks, N.H. 1993b. Water uptake, fruit cracking and other quality attributes of Gala apples submerged in surfactant water solutions. Poster presentation at AGRI-TECH '93. Annual Convention of the NZIAS/NZSHS held at the Auckland College of Education, New Zealand. August 23-26.

- Opara, L.U., Studman, C.J. and Banks, N.H. 1993c. Mechanical and Physico-chemical properties of Gala apples as affected by orchard management practices. Oral paper presented at the 1993 Australasian postharvest conference at the University of Queensland, Gatton College, Australia. September 19-24.
- Opara, L.U., Studman, C.J. and Smith, T. 1993d. Finite element analysis of pre-harvest stem-end splitting in apples: Preliminary studies. Department of Agricultural Engineering, Massey University, New Zealand.
- Pallas J.E. Jr. and Kays, S.J. 1982. Inhibition of photosynthesis by ethylene - a stomatal effect. *Plant Physiol.* 70: 598-601.
- Pearce, G.W. and Streeter L.R. 1931. A report on the effect of light on pigment formation in apples. *Biol. Chem.* 92: 743-749.
- Pearce, B.D., Grange, R.I. and Hardwick, K. 1993. The growth of young tomato fruit. I. Effects of temperature and irradiance on fruit grown in controlled environments. *J. Hort. Sci.* 68: 1-11.
- Pearson, J.A. and Robertson, R.N. 1954. The physiology of growth in apple fruits. vi. the control of respiration rate and synthesis. *Aust. J. Biol. Sci.* 7: 1-17.
- Peet, M.M. and Willits, D.H. 1991. Tomato fruit cracking : Cultural, environmental, developmental and genetic pieces of the puzzle. *HortScience* 26: 163.
- Perring, M.A. and Wilkinson, B.G. 1965. The mineral composition of apples. IV. The radial distribution of chemical constituents in apples, and its significance in sampling for analysis. *J. Sci. Food and Agric.* 16: 535-541.
- Perring, M.A. and Cljisters, H. 1974. The chemical composition and storage characteristics of apples grown in black cloth bags. *Qualitas Plantarum* 23: 379-393.
- Perring, M.A. and Plocharski, W. 1975. Differences in the mineral composition of sound and disordered apple fruits and of sound and pitted tissue. *J. Sci. Food and Agric.* 26: 1819-1823.
- Pilgaard, A. 1957. Revner omkring blomsterpartiet hos Ingrid Marie. (Skin cracking in the calyx region of Ingrid Marie apples.) *Erhvervsfrugtavl.*, 23:110-12. English Abstr. in *Hort. Abstr.* Vol. 27, Item no. 2250.
- Pitt, R.E. and Chen, H.L. 1983. Time-dependent aspects of the strength of rheology of vegetative tissue. *Trans. ASAE* 26: 1275-84.
- Posnette, A.F.(Ed.) 1963. Virus diseases of apples and pears. *Tech. Comm.* 30.

Commonwealth Bureaux of Horticulture and Plantation Crops.

- Posnette, A.F. and R. Cropley. 1963. Genetical disorders of apple with virus-like effects. In Posnette, A.F. (ed). Virus diseases of apples and pears. Tech. Comm. 30. Commonwealth Bureaux of Hort. and Plantation Crops. Page 85.
- Powers, W.L. and Bollen, W.B. 1947. Control of cracking of fruit by rain. *Science* 105: 334-335.
- Prasad, A. and Jauhari, O.S. 1963. Effect of 2,4,5-trichlorophenoxyacetic and alpha naphthalene acetic acids on "drop stop" and size of litchi fruits. *Madras Agric. J.* 50 : 28-9.
- Prashar, D.P. 1960. Inheritance of fruit cracking in tomatoes. *Diss. Abstr.* 21 : 4.
- Prashar, D.P. and Lambeth, V.N. 1960. Inheritance of radial fruit cracking in tomatoes. *Proc. Amer. Soc. Hort. Sci.* 76: 530-537.
- Pratt, C. 1988. Apple flower and fruit: morphology and anatomy. *Hort. Rev.* 10: 273-308.
- Probine, M.C. and Preston, R.D. 1962. Cell growth and the structure and mechanical properties of the wall in internodal cells of *Nitella opaca*. II. mechanical properties of the walls. *J. Expt. Biol.* 13: 111-127.
- Proctor, J.T.A. and Lougheed, E.C. 1980. Cracking of Golden Russet apples. *Can. Plant Dis. Surv.* 60: 4, 55-58.
- Pugmire, C. 1992. GLE. A general purpose graphics package, Version 3.2. DSIR Physical Sciences, Information Technology Group, Lower Hutt. New Zealand.
- Puri, V.M. and Anantheswaran, R.C. 1993. The finite-element method in food processing: a review. *J. Food Engng* 19: 247-274.
- Rabe, E., van Rensburg, P., van der Walt, H. and Bower, J. 1990. Factors influencing preharvest fruit splitting in Ellendale (*C. reticulata*). *HortScience* 25: 135.
- Radford, P.J. 1967. Growth analysis formulae - their use and abuse. *Crop Sci.* 7: 171-175.
- Raese, J.T. 1989. Physiological disorders and maladies of pear fruit. In Janick, J. (ed)., *Hort Reviews* 11: 359-407.
- Ragland, C.H. 1934. The development of the peach fruit, with special reference to split-pit and gumming. *Proc. Amer. Soc. Hort. Sci.* 31: 1-21. Supplementary Volume.
- Randhawa, G.S., Singh, J.P. and Malik, R.S. 1958. Fruit cracking in some tree fruits with special reference to lemon (*Citrus Limon*). *Ind. J. Hort.* 15: 6-9.
- Randhawa, G.S., and Singh, J.P. 1963. Nature of fruit drop in Mandarins (*Citrus Reticulata*



- Blanco). *Ind. J. Hort.* 20: 191-199.
- Reed, H.S. and Crabill, C.H. 1915. Notes on plant diseases in Virginia observed in 1913 and 1914. *Ann. Rpt. Va. Agr. Exp. Sta. Tech Bul.* 2: 37-38.
- Reeve, R.M. 1953. Histological investigations of texture in apples. II. structure and intercellular spaces. *Food Res.* 18: 604-617.
- Reger, M.W. 1944. Thiocyanate induced chlorosis predisposes development of anthocyanin by exposing apple skin tissue to more blue violet light. *Proc. Am. Soc. Hort. Sci.* 45: 111-112.
- Reynard, G.B. 1951. Inherited resistance to radial cracks in tomato fruits. *Proc. Amer. Soc. Hort. Sci.* 58: 231-244.
- Reynard, G.B. 1960. Breeding tomatoes for resistance to fruit cracking. *Proc. Plant Science Seminar, Campbell Soup Coy., USA.* pp. 93-112.
- Rixford, G.P. 1918. Smyrna fig culture. U.S. Dept. Agri. Bull. 732, 43 pages.
- Robertson, R.N. and Turner, J.F. 1951. The physiology of growth of apple fruits. II. Respiratory and other metabolic activities as functions of cell number and cell size in fruit development. *Aust. J. Sci. Res.* 4: 92-107.
- Rohm and Haas Company. 1984. CS-31. 7 pages. Pennsylvania 19105.
- Rootsi, N. 1960. Ripening and skin cracking in plums. (German summary.) *Sver. pomol. Foren. Arsskr.* 60:117-27. English Abstr. in *Hort. Abstr.*, Vol.30, Item No.3351.
- Rootsi, N. 1962. The physiological causes of cracking in apples. (Swedish, with German summary). *Sver. pomol. Foren. Arsskr.* 63:73-81. English abstr. in *Hort. Abstr.* Vol. 33, Item no. 4522.
- Rosenbaum, J. and Sanda, C.E. 1920. Correlation between size of the fruit and the resistance to puncture and its relation to infection with *Macrosporium Tomato Cooke*. *Amer. J. Bot.* 7: 78-82.
- Ryder, Wm.S., Jr. 1954. Studies on the resistance to radial cracking of tomato fruits. PhD. Thesis (unpublished). Cornell University, USA. Cited in Reynard, G.B. 1960. *Plant Science Seminar, Campbell Soup Coy., Camden, N.J.*, pp. 93-112.
- Sacher, J.A. 1973. Senescence and postharvest physiology. *Ann. Rev. Plant Physiol.* 24: 197-224.
- Sakurai, N. and Nevins, D.J. 1992. Evaluation of stress-relaxation in fruit tissue. *HortTechnology* 2: 398-402.

- Salter, P.J. and Goode, J.E. 1967. Fruit and other tree and bush crops - disorders and diseases. In Crop responses to water at different stages of growth. Research Review. Commonwealth Bureaux of Hort. and Plantation Crops. pp. 150-151.
- SAS Institute, Inc. 1988. SAS/STATS user's guide, release 6.03. SAS Institute, Inc. Cary, NC.
- Sawada, E. 1931. Mizakura miware no kenkyu. (Studies on the cracking of cherries.) Agr. and Hort. 6:865-892. (In Japanese, with English summary.)
- Sawada, E. 1932. Butsurigaku-teki ni kansatsu shita Mizakura-miware no Kiko. (On the mechanism of the cracking of cherries studied from physical point of view.) Proc. Jap. Assoc. Adv. Sci. Vol. 7:412-422. (In Japanese).
- Sawada, E. 1934. A physical consideration of the mechanism of the cracking of sweet cherries. Trans. Sapporo Nat. Hist. Soc., Vol. XIII, Pt. 3: 365-376.
- Schilberszky, K. 1918. Hipertrofios paraszomolesok almagyumolosokon. (Hypertrophe lentizellen auf apfelfruchten). Bot. Kozleenyek 17 :93. (Reviewed by Matouschek in Ztschr. Pflanzenkrank. 29 :249. 1919). Cited in : Verner, L. 1935. A physiological study of cracking in Stayman Winesap apples. J. Agric. Res. 5: 191-222.
- Schmid, G. 1960. Russetting and cracking caused by a virus. Schweiz. Z. Obst-u. Weinb., 69:54-60. English Abstr. In Hort. Abstr. Vol. 30, Item no. 1916.
- Schmid, G. 1961. Further observations on virus russetting and cracking of apples. Schweiz. Z. Obst-u. Weinb., 70:32-35. English Abstr. in Hort. Abstr. Vol. 31, Item no. 2187.
- Schoorl, D. and Holt, J.E. 1983. Cracking in potatoes. J. Text. Std. 14: 61-70.
- Schrader, A.L. and Marth, C.P. 1931. Light intensity as a factor in the development of apple color and size. Proc. Amer. Soc. Hort. Sci. 28: 552-555.
- Schrader, A.L. and Haut, I.C. 1938. Skin-cracking of York apples as related to spray injury. Proc. Amer. Soc. Hort. Sci. Vol. 35: 180-183.
- Schroeder, C.A. and Wieland, P.A. 1956. Diurnal fluctuation in size in various parts of the Avocado tree and fruit. Proc. Amer. Soc. Hort. Sci. 68: 253-258.
- Selby, H. and White, A. 1992. The segregation for fruit shape, texture and colour in a cross between the pear cultivars Max's Red Bartlett and Nijjisseiki. Abstract of paper presented at the 1992 Convention of the NZIAS/NZSHS, Lincoln University, 25-28 August.
- Shaw, J.K. 1914. A study of variation in apples. Massachusetts Agric. Expt. Sta., Bull. No. 149. pp. 21-36.

- Shear, C.B. 1971. Symptoms of Calcium deficiency on leaves and fruit of 'York Imperial' apple. *J. Amer. Soc. Hort. Sci.* 96: 415-417.
- Shear, C.B. 1975. Calcium-related disorders of fruit and vegetables. *HortScience* 10: 361-365.
- Shutak, V. and A.L. Schrader. 1948. Factors associated with skin-cracking of York Imperial apples. *Proc. Amer. Soc. Hort. Sci.* 51: 245-257.
- Siegelman, H.W. and Hendricks, S.B. 1957. Photocontrol of anthocyanin synthesis in apple skin. *Plant Physiol.* 33: 185-190.
- Simon, E.W. 1974. Phospholipids and plant membrane permeability. *New Phytologist* 73: 377-420.
- Simon, E.W. 1977a. Membranes in ripening and senescence. *Ann. Appl. Biol.* 85: 417-465.
- Simon, E.W. 1977b. Leakage from fruit cells in water. *J. Expt. Bot.* 28: 1147-1152.
- Simon, E.W. 1978. The symptoms of Calcium deficiency in plants. *New Phytologist* 80: 1-15.
- Simons, R.K. and Aubertin, M.P. 1959. Development of epidermal, hypodermal and cortical tissues in the Golden Delicious apple as influenced by induced mechanical injury. *Proc. Am. Soc. Hort. Sci.* 74: 1-9.
- Singh, K. 1964. Physiological studies related to tomato fruit cracking. *Diss. Abstr.* 25: 1475, being Order No. 64-8887 of 78 pp.
- Skene, D.S. 1963. The fine structure of apple, pear, and plum fruit surfaces, their changes during ripening, and their response to polishing. *Ann. Bot.* 27: 581-592.
- Skene, D.S. 1965. Cracking and russeting in apple fruits. *Ann. Rept. East Mall. Res. Sta. for 1964.* pp: 99-101.
- Skene, D.S. 1966. The distribution of growth and cell division in the fruit of Cox's Orange Pippin. *Ann. Bot.* 30: 493-512.
- Skene, D.S. 1980. Growth stress during fruit development in Cox's Orange Pippin apples. *J. Hort. Sci.* 55: 27-32.
- Skene, D.S. 1981a. Growth of individual apple fruits. *Ann. Rept. East Mall. Res. Sta. for 1980.* pp. 29.
- Skene, D.S. 1981b. Stalk-end cracking in Cox. *Ann. Rept. East Mall. Res. Sta. for 1980.* pp. 28.
- Skene, D.S. 1981C. Wound healing in apple fruits : the anatomical response of Cox's Orange Pippin at different stages of development. *J. Hort. Sci.* 56: 145-153.
- Skene, D.S. 1982a. The development of russet, rough russet and cracks on the fruit of the

- apple Cox's Orange Pippin during the course of the season. *J. Hort. Sci.* 57: 165-174.
- Skene, D.S. 1982b. Cause and control of russeting and cracking. *Grower*, 97: 23-24.
- Smith, W.H. 1940. The histological structure of the flesh of the apple in relation to growth and senescence. *J. Pomol. Hort. Sci.* 8: 153-172.
- Smith, W.H. 1950. Cell-multiplication and cell-enlargement in the development of the flesh of the apple fruit. *Ann. Bot.* 53: 23-38.
- Smock, R.M. 1953. Some effects of climate during the growing season on keeping quality of apples. *Proc. Am. Soc. Hort. Sci.* 62: 272-278.
- Sorauer, P. 1922. *Manual of plant diseases*. Transl. by F. Dorrance. 3rd Ed, v.1. Wilkes-Barre, Pa. Cited in Verner, L. 1938. *J. Agric. Res.* 57: 813-824.
- Srinivas, T., Bhashyam, M.K., Mahadevappa, M. and Desikachar, H.S.R. 1977. Varietal differences in crack formation due to weathering and wetting stress in rice. *Indian J. Agric. Sci.* 47: 27-31.
- Srinivas, T., Bhashyam, M.K., Gowda, M.K.M. and Desikachar, H.S.R. 1978. Factors affecting crack formation in rice varieties during wetting and field stress. *Indian J. Agric. Sci.* 48: 424-432.
- Stanley, C.M. 1990. Personal communication. New Zealand Apple and Pear Marketing Board, Wellington.
- Steel, R.G.D. and Torrie, J.H. 1980. *Principles and procedures of statistics, a biometrical approach*. McGraw-Hill Book Coy., NY. 633 pages.
- Stevenson, E.C., Tomes, M.L. and Johnson, K.W. 1960. New tomato varieties. Report, Purdue University 3: 11.
- Stewart, W.S. and Klotz, L.J. 1947. Some effects of 2,4-Dichlorophenoxyacetic acid on fruit-drop and morphology of oranges. *Bot. Gaz.* 109: 150-162.
- Stiles, W.C., Childers, N.F., Prusik, M.J. and T.N. Kom. 1959. Effects of urea sprays and pesticides on russeting and cracking of Stayman apple. *Proc. Amer. Soc. Hort. Sci.* 74: 25-29.
- Streeter, L.R. and Pearce, G.W. 1931. Light and pigment development in apples. *Proc. Amer. Soc. Hort. Sci.* 28: 49-52.
- Studman, C.J. 1991a. Improvements relating to material testing. N. Zealand Pat. Application No. 238677.
- Studman, C.J. 1991b. A Rapid tensile tester. Personal communication. Department of

Agricultural Engineering, Massey University, New Zealand.

- Studman, C.J., Hodgson, R.M., Browne, R.F and Foster, B.R. 1991. Detection of stem end splits in apples. Project Report: July 1991. New Zealand Apple & Pear Marketing Board.
- Studman, C.J. and Yuwana. 1992. Twist test for measuring fruit firmness. *J. Text. Stud.* 23: 215-227.
- Sullivan, D.T. and Widmoyer, F.B. 1970. The effect of alar on fruit cracking of Stayman winesap apple. *Fruit Var. and Hort Dig.* 24-17-18.
- Taylor, O.C., Cahoon, G.A. and Stolzy, L.H. 1957. Why do Navel Oranges split ? *Calif. Citrogr.* 43: 32-4.
- Taylor, O.C., Cahoon, G.A. and Stolzy, L.H. 1958. Splitting of Navel Oranges. *Calif. Agric.* 12: 6,10.
- Taylor, D.R. and Knight, J.N. 1986. Russeting and cracking of apple fruit and their control with plant growth regulators. *Acta Horticulturae* 179: 819-820.
- Teaotia, S.S., and Singh, R.D. 1970. Fruit cracking - a review. *Progressive Hort.* 2: 21-32.
- Tennes, B.R. 1973. Physical properties of fruit related to cracking. Phd thesis. Michigan State University, Ann Arbor, Michigan, USA. 117 pages.
- Tetley, U. 1930. A study of the anatomical development of the apple and some observations on the "pectic constituents" of the cell-walls. *J. Pomol. and Hort. Sci.* 8: 153-171.
- Tetley, U. 1931. The morphology and cytology of apple fruit with special reference to Bramley Seedling variety. *J. Pomol. Hort. Sci.* 9: 278-280.
- Thomas, N.F. 1949. Studies of cracking of tomato fruits with emphasis on method of selecting resistant plants from segregating progenies. PhD Thesis (unpublished). Cornell University, USA. Cited in Reynard, G.B. 1960. Plant Science Seminar, Campbell Soup Coy., Camden, N.J., pp. 93-112.
- Thompson, A.E. 1965. Breeding tomato varieties with increased resistance to fruit cracking. *Ill. Res.* 7: 12-13.
- Thompson, A.E., R.W. Hepler, R.L. Lower, and J.P. McCollum. 1962. Characterisation of tomato varieties and strains for constituents of fruit quality. *Univ Illinois Agr. Expt. Sta. Bull.* 685. 32 pages.
- Tomana, T. 1961. Histological and physical studies on the Jonathan spot in apples. II. Nitrogen fertilization and harvest time in relation to spot development. (Japanese, with

- English summary). *J. Jap. Soc. Hort. Sci.* 30: 117-124.
- Trought, M.C.T. 1991. Personal communication. Marlborough Research Centre, Ministry of Agric. and Fisheries, Blenheim, New Zealand.
- Trought, M.C.T. and Lang, A. 1991. The role of water in cherry splitting. Extended Abstracts. Annual Meeting, New Zealand Society of Plant Physiologists, Great Bay of Plenty Convention, Tauranga, August 21-23. 4 pages.
- Trought, M., R. Edwards and A. Lang. 1992. Water balance and fruit splitting of sweet cherries. Extended Abstracts, NZ Soc. Plant Physiol. Inc. Annual meeting in conjunction with the NZ Inst. Agr. Sci. Inc., Lincoln University, Canterbury, 24-28 August. pp: 63-66.
- Tucker, L.R. 1934. A varietal study of the susceptibility of sweet cherries to cracking. *Univ. Idaho Agric. Expt. Sta. Bull.* 211: 1-15.
- Tukey, R.B. 1983. Calcium sprays for sweet cherries. *Proc. Wash. Sta. Hort. Assoc.* 79: 194-198.
- Tukey, L.D. 1959a. Observations on the russeting of apples growing in plastic bags. *Proc. Amer. Soc. Hort. Sci.* 74: 30-39.
- Tukey, L.D. 1959b. Periodicity in the growth of fruits of apples, peaches and sour cherries with some factors influencing this development. *Pennsylvania Agr. Expt. Bul.* 661, 21 pages.
- Tukey, L.D. 1960. Atmospheric moisture causes russeted apples. *Science for the Farmer* 7:6.
- Tukey, H.B. 1942. Time interval between full bloom and fruit maturity for several varieties of apples, pears, peaches and cherries. *Proc. Amer. Soc. Hort. Sci.* 40: 133-140.
- Tukey, H.B. and Young, J.O. 1942. Gross morphology and histology of developing fruit of the apple. *Proc. Amer. Soc. Hort. Sci.* 41: 104-104.
- Turner, N.C. 1981. Techniques and experimental approaches for the measurement of plant water status. *Plant & Soil* 58: 339-366.
- Uhlinger, R.D. 1963. Some relationships among softness, cracking, and blossom-end rot of tomato fruits. *Diss. Abstr.*, 23 : 3063-3064, being Order No. 63-728 of 177 pp.
- Union Carbide. Undated. Surface active copolymers.
- Unrath, C.R. 1991. The influence of concentrations, spray interval and number of applications of GA<sub>4+7</sub> (provide) on suppression of Stayman fruit cracking. *Abstr. HortScience* 26: 72.

- Uriu, K., Hansen, C.J. and Smith, J.J. 1962. The cracking of prunes in relation to irrigation. Proc. Amer. Soc. Hort. Sci. 80: 211-219.
- USDA. 1967. Tomato diseases and their control. Agriculture Handbook 203. Page 63.
- Verner, L. 1935. A physiological study of cracking in Stayman Winesap apples. J. Agric. Res. 51: 191-222.
- Verner, L. 1937. Study of growth rate in Stayman Winesap apples. Proc. Amer. Soc. Hort. Sci. 35: 128-131.
- Verner, L. 1938. Histology of apple fruit in relation to cracking. J. Agric. Res. 5: 813-824.
- Verner, L. 1939. Reduction of cracking in sweet cherries following the use of calcium sprays. Proc. Amer. Soc. Hort. Sci. 35: 271-274.
- Verner, L. 1957. Procedure for determining resistance of sweet cherry varieties to fruit cracking. Fruit Var. & Hort. Digest 12: 3-4.
- Verner, L. and Blodgett, E.C. 1931. Physiological studies of the cracking of sweet cherries. A preliminary report. Idaho Agr. Expt. Sta. Bull. 184, 15 pages.
- Vincent, J.F.V. 1989. The relation between density and stiffness of apple flesh. J. Sci. Food Agric. 47: 443-462.
- Vincent, J.F.V. 1990. Fracture properties of plants. Adv. Bot. Res. 17: 235-287.
- Vincent, J.F.V., Jeronimids, G., Khan, A.A. and Luyten, H. 1991. The wedge fracture test. A new method for measurement of food texture. J. Text. Std. 22: 45-57.
- Visai, C., Failla, O. and Eccher, T. 1989. Effects of promalin and paclobutrazol on cracking and quality of Neipling stayman apples. Acta Horticulturae 239: 451-453.
- Visai, C. and Marro, M. 1986. Fenomeni di spaccatura e cicatrizzazione nel melo "Stayman Winesap". (The phenomenon of cracking and wound tissue formation in Stayman Winesap apple.) Notiziario di Ortoflorofruitticoltura, 12(2):47-53. Università di Milano, Italy. English Abstr. in Hort. Abstr. Vol. 57(4), Item no. 2363.
- Voisey, P.W. and MacDonald, D.C. 1964. An instrument for measuring the puncture resistance of fruits and vegetables. Proc. Amer. Soc. Hort. Sci. 84: 557-563.
- Voisey, P.W., Kloek, M. and MacDonald, D.C. 1964. A rapid method of determining the mechanical properties of fruits and vegetables. Proc. Amer. Soc. Hort. Sci. 85: 547-553.
- Voisey, P.W. and Lyall, L.H. 1965a. Methods of determining the strength of tomato skins in relation to fruit cracking. Proc. Amer. Soc. Hort. Sci. 86: 597-609.
- Voisey, P.W. and Lyall, L.H. 1965b. Puncture resistance in relation to tomato fruit cracking.

- Can. J. Plant Sci. 45: 602-603.
- Voisey, P.W. and MacDonald, D.C. 1966. A puncture device for estimating the physical properties of fruits and vegetables. *Can. J. Plant Sci.* 46: 698-701.
- Voisey, P.W., Lyall, L.H. and Kloek, M. 1970. Tomato skin strength - Its measurement and relation to cracking. *J. Amer. Soc. Hort. Sci.* 95: 485-488.
- Volz, R.K. 1991. Fruit quality and productivity on apple replacement branches. Phd thesis, Department of Horticultural Science, Massey University, New Zealand.
- Wade, N.L. 1988. Effect of metabolic inhibitors on cracking of sweet cherry fruit. *Scientia Hort.* 34: 239-248.
- Waller, W. 1980. Use of apple analysis. In D. Atkinson, J. Jackson, R. Sharples, and W. Waller, (eds.) *Mineral nutrition of fruit trees*. Butterworth and Co. (Publ.) Ltd, London. pp. 383-394.
- Walsh, C., Statler, B., Solomos, T. and Thompson, A. 1991. Determining Gala maturity for different storage regimes. *Good fruit grower*. March, pp. 6-10.
- Walter, T.E. 1967. Russetting and cracking in apples : a review of world literature. Rept. East Mall. Res. Sta. for 1966, pp. 83-95.
- Wang, S.Y. and Faust, M. 1992. Variation in lipid composition of apples in relation to watercore. *J. Amer. Soc. Hort. Sci.* 117: 829-833.
- Watanabe, M., Yamaya, H., Yukita, K., Ishiyama, M. and Seito, M. 1987. Splitting of Mutsu apple fruit during the 1983 growing season in Aomori. *Bulletin of the Aomori Apple Expt. Sta.*, 24:83-104. In *Hort. Abstr.* Vol. 59(4), Item no. 2707.
- Watkins, C.B., Bowen, J.H. and Walker, V.J. 1989. Assessment of ethylene production by apple cultivars in relation to commercial harvest dates. *N.Z. J. Crop and Hort. Sci.* 17: 327-331.
- Way, R.D. 1967. Cherry varieties for New York. *Cornell Expt. Sta. Bull.* 1197. Ithaca, N.Y.
- Webster, D. and Lidster, P. 1986. Effects of phosphate sprays on McIntosh apple fruit and leaf composition, flesh firmness and susceptibility to low-temperature disorders. *Can. J. Plant Sci.* 66: 617-626.
- Wedding. J.N., Kattan, A.A. and Fleming, A.W. 1958. Effect of supplemental irrigation, spacing and fertility on yield and quality of processing tomatoes. *Proc. Amer. Soc. Hort. Sci.* 71: 356-368.
- Weiser, R.L. 1990. Stayman fruit cracking as related to CW composition. *Abstr.*



HortScience 25: 1093-1094.

- Weissenborn, K. and Gottwald, A. 1965. Gibt es auch glattschalige Holsteiner Cox ? (Is there also a smooth-skinned Holstein Cox ?) Mitt. ObstbVersuchsringses, jork, 20: 9-11. English abstr. in Hort. Abstr. Vol. 35, Item no. 5119.
- Weller, C.L., Paulsen, M.R. and Steinberg, M.P. 1990. Stress cracking and breakage susceptibility as affected by moisture content at harvest for four yellow dent corn hybrids. Trans. ASAE. 33: 863-869.
- Wertheim, S.J. 1982. Fruit russeting in apple as affected by various gibberellins. J. Hort. Sci. 57: 283-288.
- Westwood, M.N. 1962. Seasonal changes in specific gravity and shape of apple, pear, and peach fruits. Proc. Amer. Soc. Hort. Sci. 80: 90-96.
- Westwood, M.N. 1978. Temperate-zone pomology. W.H. Freeman and Coy., San Francisco.
- Westwood, M.N. and Batjer, L.P. 1960. Effects of environmental and chemical additives on absorption of naphthaleneacetic acid by apple leaves. Proc. Amer. Soc. Hort. Sci. 76 : 16-29.
- Westwood, M.N. and Blaney, L.T. 1963. Non-climatic factors affecting the shape of apple fruits. Nature 200: 802-803.
- Westwood, M.N. and Burkhart, D.J. 1968. Climate influences shape of Delicious. Amer. Fruit Grower 88: 26.
- Westwood, M.N. and Bjonstard, L.P. 1970. Some factors affecting rain cracking of sweet cherries. Proc. Oregon Hort. Soc. 61: 70-75.
- Westwood, M.N., Batjer, L.P. and Billingsley, H.D. 1967. Cell size, cell number, and fruit density of apples as related to fruit size, position in cluster and thinning method. Proc. Am. Soc. Hort. Sci. 91: 51-62.
- Whatley, B.T. 1957. Studies on tomato fruit cracking. Diss. Abstr., 17 : 2373, being Publ. 22,560 of 66 pp.
- White, D.G. 1955. The size of apples in relation to their location on the tree. Proc. Amer. Soc. Hort. Sci. 65: 132-134.
- White, D.G. and Whatley, B.T. 1955. A method to measure cracked apples and tomatoes. Proc. Amer. Soc. Hort. Sci. 65: 289-290.
- White, A.G., Selby, H.I. and Alspatch, R.A. 1992. Some results from a study of fruit colour and size in a mutation breeding programme on 'Royal Gala'. Abstract of paper

- presented at the 1992 Convention of the NZIAS/NZSHS, Lincoln University, 25-28 August.
- Whittenberger, R.T. and Hill, C.H. 1953. Studies on the processing of red cherries. I. Changes in fresh red cherries caused by bruising, cooling, and soaking. *Food Technol.* 7: 29-31.
- Wiersum, L.K. 1979. Effects of environment and cultural practices on Calcium nutrition. *Communications in Soil Sci. and Plant Analysis* 10: 259-278.
- Wilkinson, B.G. 1965. Some effects of storage under different conditions of humidity on the physical properties of apples. *Jour. Hort. Sci.* 40: 58-65.
- Wilkinson, B.G. and M.A. Perring. 1964. Further investigations of chemical concentration gradients in apples. *J. Sci. Food and Agr.* 15: 378-384.
- Williams, M.W. 1966. Relationship of sugars and sorbitol to watercore in apples. *Proc. Amer. Soc. Hort. Sci.* 88: 67-75.
- Wilson, I.S. 1970. Growth cracks in tomatoes. *Qld. Agric. J.* 83: 371-374.
- Wilson, B.F. and R.R. Archer. 1979. Tree design: Some biological solutions to mechanical problems. *BioScience* 29: 293-298.
- Wittwer, S.H. and Honma, S. 1969. Greenhouse tomatoes. Guidelines for successful production. *Mich. St. Univ. Press.* pp. 47.
- Woodbridge, C.G. 1968. Bitter pit. *Proc. Wash. State Hort. Assoc.* 64: 59-66.
- Woodbridge, C.G. 1971. Calcium levels of pear tissues affected with cork and black end. *HortScience* 5: 451-453.
- Woodbridge, C.G. 1978. Split-pit in peaches and nutrient levels. *J. Amer. Soc. Hort. Sci.* 103: 278-280.
- Young, H.W. 1957. 1957. Inheritance of fruit cracking in a *Lycopersicon esculentum* cross. Unpubl. PhD thesis, Ohio State University. Cited in Young, H.W. 1959.
- Young, H.W. 1958. Inheritance of fruit cracking. TGC Report No.8, pp. 38-39.
- Young, H.W. 1959. Inheritance of radial fruit cracking in a tomato cross. *Proc. Fla. St. Hort. Soc.* 72: 207-210.
- Young, H.W. 1960. Inherited fruit cracking resistance in the tomato. *Proc. Fla. St. Hort. Soc.* 73: 148-153.
- Young, P.A. 1947. Cuticle cracks in tomato fruits. *Phytopathology*, 37 : 143-145.
- Young, P.A. 1961. Yield ability of crack-resistant tomatoes. *Progr. Rep. Tex. Agric. Expt.*

- Stat., 2218, pp.3.
- Young, P.A. 1962. Yield and resistance of tomato varieties to physiological abnormalities. Progr. Rep. Tex. Agric. Stat. 2261. pp. 5.
- Young, P.A. 1963a. Symptoms and control of tomato fruit cracking. Plant Dis. Repr. 47: 523-527.
- Young, P.A. 1963b. Tomatoes. Crack resistant. Amer. Veg. Grower 11: 24
- Yuwana. 1991. Alternative tests for fruit mechanical properties. M. Agr. Sci. Thesis, Department of Agricultural Engineering, Massey University, N. Zealand.
- Zielinski, Q.B. 1964. Resistance of sweet cherry varieties to fruit cracking in relation to fruit and pit size and fruit color. Proc. Amer. Soc. Hort. Sci. 84: 98-102.

## **ERRATA**

- Jacyna, T. and Z. Soczek. 1980. Effect of different degree of shading the apple hedgerow on the light penetration inside of tree crowns, and on the size and quality of crop. III. Effect on the fruit quality. Fruit Sci. Rpts. 7: 75-86.

## APPENDIX

# APPENDIX I

# SPRAY DIARY COPY FOR LIONEL

Angus + Noeline

VARIETY

GALA

BLOCK NAMES

A	B
C	D

REGISTERED NO  
CRAUFORD ORCHARD

P.O. BOX 8033

REGISTERED OWNER  
HAYLOCK NORTH

2232

DI596

No further applications have been made since those listed in the main (yellow) diary

All Pesticides	Dates Rate/100L	11.11	20.11	30.11	9.12	19.12	24.12	27.12	2.1.92	9.1	17.1	29.1
Variety and Block Information												
POLYRAM	150g		✓	✓								
PAWTOP	50g		✓									
DODINE	80 ml	✓			✓				✓			
CHLORPYRIFOS	100 ml	✓										
RUBIGAN	25 ml			✓								
LORSBAN	75g											
ORIGLOID	150 ml						✓	✓		✓	✓	✓
PRINIPROS	350 ml									✓		✓
Herbicides												
Water Rate	Litres/ha	2500	2500	2500	2500		2500	2500	2500	2500	2500	2500
Calcium & Misc.												
OPTIONAL CHLORIDE	360g/100						✓	✓	✓	✓	✓	✓
COMMENTS WEATHER TEMPERATURES	FINE 6. 10.15	GOOD 10.15	FAIR 10.18	FAIR	EXCELLEN	PERKING	EVENING 3.25PM COLD	EARLY MORNING COLD	VG	VG	C/C HUMID	C/C HUMID

USED TOWER SPRAYER WATER AT 500 L/HA  
 LORSBAN AT 24g HA ORTHOCLID 3 L/HA  
 (FOR CONTROL OF MITE AND RUST)

BY DECLARE THAT THE INFORMATION RECORDED ABOVE

472 211 2021