

POLLEN MORPHOLOGY OF THE
EUPHORBIACEAE WITH SPECIAL REFERENCE
TO TAXONOMY

W. PUNT

(*Botanical Museum and Herbarium, Utrecht*)

(*received December 28th, 1961*)

CONTENTS

CHAPTER I	GENERAL INTRODUCTION	2
	a. Introduction	2
	b. Acknowledgements	2
CHAPTER II	HISTORY	2
	a. Pollen morphology	2
	b. Euphorbiaceae	4
CHAPTER III	MATERIAL	5
CHAPTER IV	METHODS	6
	a. Flowers	6
	b. Pollen preparations	7
	c. Preservation of pollen grains	7
	d. Microscopes	8
	e. Punched cards	8
	f. Drawings	9
CHAPTER V	SOME NOMENCLATRURAL REMARKS	9
CHAPTER VI	POLLEN MORPHOLOGY	10
CHAPTER VII	GLOSSARY	15
CHAPTER VIII	Results	18
	A. Pollen grains of the Euphorbiaceae	18
	B. Discussion of the results	20
	a. Phyllanthoideae	20
	Antidesma configuration	20
	Amanoa configuration	32
	Phyllanthus nutans configuration	37
	Breynia configuration	38
	Aristogeitonia configuration	40
	b. Crotonoideae	47
	Croton configuration	47
	Cnesmosa configuration	57
	Dysopsis configuration	60
	Plukenetia configuration	60
	Chiropetalum configuration	65
	Cephalomappa configuration	68
	Sumbavia configuration	69
	Bernardia configuration	73
	Mallotus configuration	77
	Claoxylon configuration	90
	Cladogynos configuration	93
	Hippomane configuration	95
SUMMARY		106
REFERENCES		107
INDEX		110

CHAPTER I

GENERAL INTRODUCTION

a. INTRODUCTION

Many investigators have stated (e.g. LINDAU 1895, WODEHOUSE 1935, ERDTMAN 1952), that pollen morphology can be of great importance for plant taxonomy, while it was also known that in *Euphorbiaceae* several types of pollen grains exist (e.g. ERDTMAN 1952). On the suggestion of Professor Lanjouw, who himself has worked on the *Euphorbiaceae* of Surinam, the author has investigated the pollen grains of this family of that area. From the result it was apparent that in the Surinam *Euphorbiaceae* many different pollen types could be distinguished. In the present work the study was therefore extended to all the genera in the *Euphorbiaceae*, from which one or more species have been examined. Besides a description of the pollen grains examined a drawing of most of the pollen types is given. The pollen morphologic groupings found have been compared with the systems of several authors (BENTHAM and HOOKER 1880, PAX and K. HOFFMANN 1931, etc.). The taxonomic conclusions, however, can only have a provisional character. Future investigators of the *Euphorbiaceae* will have to check the taxonomic notes and comments.

b. ACKNOWLEDGEMENTS

The investigations have been carried out at the "Botanisch Museum en Herbarium", Utrecht. The writer is greatly indebted to the director, Professor Dr. J. Lanjouw, for giving him the opportunity to carry out the investigations at his institute and for his help and guidance in preparing this paper. The author is very much indebted to Professor Dr. F. P. Jonker who advised him in the special problems of pollen morphology. He very gratefully acknowledges the "Ministerie van Onderwijs, Kunsten en Wetenschappen" for sponsoring the present study. The author wishes to express his sincere thanks to the directors of the herbaria at Brussels, Leiden, Kew and Paris for the hospitality and help during his residence in these places. He is also very grateful to the "Miquelfonds" which covered the expenses of his stay in London, Paris and Brussels where so much valuable material could be examined.

CHAPTER II

HISTORY

a. POLLEN MORPHOLOGY

The study of pollen morphology started in 1675, when MALPIGHI observed, that various types of pollen grains are to be found in different plants. He especially saw variations of colour and shape. GREW (1682) was already aware of a difference in structure, too. He distinguished

smooth and spiny pollen grains. In the next two centuries quite a number of botanists enriched our knowledge of pollen morphology. In 1834 a synopsis of the literature on the subject was published by v. MOHL, which greatly contributed to a better understanding of pollen morphology. He studied representatives of most of the plant families and gave a descriptive classification of their forms. v. MOHL recognized that the apertures of the pollen grains are the most important morphological features. Some years later FRITZSCHE published his principal work on pollen grains (Ueber den Pollen, 1837). From the descriptions it is clear that, besides a careful study of the shape and apertures of a pollen grain, the structure was accurately analysed. His drawing and description of *Jatropha panduræefolia* gives an excellent idea of the pollen grain. The description even very accurately reproduces the construction of the croton-pattern (see Pl. I, E4 and Pl. VIII, 1).

In the period after v. MOHL and FRITZSCHE we come across publications with drawings of pollen grains as additions to analytic drawings of plants (e.g. in MARTIUS, Flora Brasiliensis). Most botanists, however, added but little to pollen morphology. C. A. H. FISCHER was the first scientist to give, in 1890, a comprehensive comparative study of the data then available. From the study of 2200 species in 158 families he was able to draw, e.g. the following conclusions:

- 1: Pollen grains of related species are generally similar.
- 2: Some families have more than a single basic form.
- 3: Sometimes unrelated plants have similar pollen grains.

In 1883 RADLKOEFER made use of pollen morphology to obtain a better classification of the *Acanthaceae*. It was done more profoundly by LINDAU (1895) in "Die natürlichen Pflanzenfamilien" by ENGLER and PRANTL when he stated: "Es ist deshalb nur consequent, wenn auf die Pollenbeschaffenheit die Einteilung der Acanthaceae gegründet wird, wie dies bereits von Radlkofer angedeutet wurde und im folgenden ganz streng durchgeführt werden soll". It is obvious that, with regard to some families, pollen morphology had become a wellknown and indispensable part of taxonomy at the end of the 19th century.

In fact, a renewed general interest in pollen morphology emerged, not from the side of botany, but from the side of geology. It was the geologist v. POST who, in 1919, for the first time published a modern pollen analytic diagram: the primitive pollen analysis had resulted in a refined method in quaternary geology. However, the composition of a pollen diagram requires a sound knowledge of the morphology of pollen grains. Originally a primary acquaintance of the pollen grains of trees and anemophilous plants was considered to be sufficient, but more and more the necessity of a wider knowledge of pollen types became evident. Consequently the number of investigators who made researches into the pollen morphology of special taxonomic groups increased.

POTONIE in 1934 and WODEHOUSE in 1935 published works on pollen morphology that formed the basis of our modern terminology.

POTONIÉ as well as WODEHOUSE needed a system of well defined terms for the description of pollen grains. The construction and details of a pollen grain were, however, not well enough known to be arranged in a convenient system. Nevertheless, many terms of these investigators are still in use, although sometimes the circumscription of the terms is more or less altered.

In 1950 FAEGRI and IVERSEN, and IVERSEN and TROELS-SMITH published a system on the morphology of pollen grains. Their terminology excelled in exactitude and simplicity. The well-defined terms made it quite possible to determine pollen grains which occur in their determination-key of European pollen types.

At the same time ERDTMAN also worked at a system of pollen terminology. He published several papers on this subject, but his main work (Pollen morphology and plant taxonomy, Angiosperms) appeared in 1952. In this book ERDTMAN proposed an extended system of pollen terminology. In many respects, however, the terminology seems too complicated to be of practical use. Only pollen morphologists with a large experience are able to identify all the terms mentioned in the glossary. Moreover, the descriptions of terms are not always as exact as they should be. What, for instance, is the exact boundary between brevicolpate and brevissimicolpate or foramen and foraminoid? Nevertheless, his book is a source of valuable data providing primary information of the pollen types of all the families in the Angiosperms.

b. EUPHORBIACEAE

This family is one of the largest in the Angiosperms. It is a difficult one on account of the many different species, so that it is not surprising, that only a few botanists possessed a general knowledge of the whole family.

Since the present report is mainly a pollen morphologic work, the following lines will only briefly comment on the principal authors on Euphorbiaceae.

In the 19th century A. DE JUSSIEU, J. MUELLER OF ARGAU and H. BAILLON published important papers on the *Euphorbiaceae*. In the Journal of the Linnean Society (Botany) of 1880 BENTHAM reviewed the work of BAILLON and MUELLER ARG. In the same paper BENTHAM gave extensive notes on his own system.

From 1910–1924 PAX (partly assisted by KÄTHE HOFFMANN) monographed most of the genera in *Euphorbiaceae* in Engler's "Das Pflanzenreich". In the second edition of ENGLER and PRANTL, Die Natürlichen Pflanzenfamilien, Band 19c (1931), a revised synopsis of the *Euphorbiaceae* is given. In the present paper this synopsis of 1931 has been used as the basic classification of the family.

After PAX and K. HOFFMANN only incidental remarks have been made on the system of the *Euphorbiaceae*. Most of them were given in papers concerning floras of certain areas (e.g. LÉANDRI, Flora of Madagascar; GAGNEPAIN, Flora of Indo-Chine; LÉONARD, Flora of Congo). Important improvements have been made by CROIZAT on

several genera. SCHULTES amply discussed the genus *Hevea* and its allies. A very important work is WEBSTER's publication on *Phyllanthus*. In his monographic study "The West Indian species of *Phyllanthus*" he used pollen morphology as one of the main characters to divide the genus *Phyllanthus* into subgenera and sections.

CHAPTER III

MATERIAL

Herbarium material obtained from the following herbaria was used in the study:

London (BM):	British Museum (Natural History).
Bruxelles (BR):	Jardin Botanique de l'Etat.
Bruxelles (BRLU):	Herbier d'Afrique de l'Université de Bruxelles.
Kew (K):	The Herbarium, Royal Botanic Gardens.
Leiden (L):	Rijksherbarium.
Paris (P):	Muséum National d'Histoire Naturelle Laboratoire de Phanérogamie.
Utrecht (U):	Botanical Museum and Herbarium.
Wageningen (WAG):	Laboratory for Plant Taxonomy and Plant Geography.

Generally the use of type-material has been avoided. Only in those cases, where no other specimens were available while flowers were present, type-material has been used for pollen investigation.

The classification of the *Euphorbiaceae* as given by PAX and K. HOFFMANN in ENGLER and PRANTL, *Die natürlichen Pflanzenfamilien* ed. 2, Band 19c (1931), was the principal system used for the choice of genera. Besides this system attention has been paid to the new genera published after 1931 and listed in the *Index Kewensis*. As far as possible all known genera of the *Euphorbiaceae* were examined. In a number of genera it was, for various reasons, impossible to study the pollen grains. They fall in the following groups:

1. Male flowers unknown.

<i>Croizatia</i>	STEYERMARK
<i>Lasiochlamys</i>	PAX et K. HOFFMANN
<i>Paradrypetes</i>	KUHLMAN
<i>Phyllanoa</i>	CROIZAT

2. The material studied did not contain male flowers, or only a few, or unripe ones.

<i>Claoxylopsis</i>	LÉANDRI
<i>Calicopeplus</i>	PLANCHON
<i>Cometia</i>	THOUARS ex BAILLON
<i>Corythea</i>	WATSON
<i>Ditta</i>	GRISEBACH
<i>Keyodendron</i>	LÉANDRI
<i>Mettenia</i>	GRISEBACH
<i>Monadenium</i>	PAX

<i>Neomphalea</i>	PAX et K. HOFFMANN
<i>Neotriгонostemon</i>	PAX et K. HOFFMANN
<i>Ramelia</i>	BAILLON
<i>Riseleya</i>	HEMSLEY
<i>Syndyophyllum</i>	SCHUMACHER et LAUTERBACH
<i>Sphyranthera</i>	HOOKEr, J. D.
<i>Thelypetalum</i>	GAGNEPAIN

3. Genera of which no material has been seen.

<i>Acalyphopsis</i>	PAX et K. HOFFMANN
<i>Annesijoa</i>	PAX et K. HOFFMANN
<i>Chlamydojatropa</i>	PAX et K. HOFFMANN
<i>Clarorivinia</i>	PAX et K. HOFFMANN
<i>Gitaria</i>	PAX et K. HOFFMANN
<i>Senefelderoopsis</i>	STEYERMARK

On account of the large number of genera and species the author has found it impossible to be always sure of the accuracy (both taxonomic and nomenclatural) of the names used in the present paper. Future monographic studies will perhaps prove some names to be incorrect. With all the descriptions of pollen grains, however, the collector's name and number and the herbarium, where the specimen is preserved, are given. In those cases when the name has to be corrected the description of the pollen grain can thus always be placed under the right name.

In the Rijksherbarium at Leiden a large collection of plants of D'Alleizette is present. These plants, however, have not been collected by D'Alleizette himself. In the herbarium at Paris D'Alleizette obtained duplicates from several collectors. These duplicates were sent to the Rijksherbarium without mention of the names and collection numbers of the original collectors. As it lies beyond the scope of this work to search for the names of the original collectors, the name of D'Alleizette has been maintained in the present work.

CHAPTER IV

METHODS

a. FLOWERS

From each genus at least one species and when possible two species were examined. From those genera that can be divided into two or more sections, species were chosen from different sections.

Usually the male inflorescences of the *Euphorbiaceae* have many flowers, so that, generally speaking, no important loss occurs if one or two flowers are dissected.

Only those flowers of the *Euphorbiaceae* are useful that have just opened. When the flowers are younger the pollen has not yet ripened, so that it is impossible to give an accurate description of shape and structure of the pollen grains. It is far better to use old, outpollinated anthers than young and undoubtedly unripe ones. In the corners of their thecas the old anthers always have some pollen grains which, by a special micro-method described below, can be isolated.

b. POLLEN PREPARATIONS

For the study of the morphology of pollen grains it is desirable that cytoplasm and intine are dissolved. The microscopic image becomes obscure and the important exine remains indistinct if intine and cytoplasm are not dissolved. For that reason Wodehouse's methylene-green method, the lactic-acid method and any other method, which does not completely dissolve intine and cytoplasm are considered less suitable.

The treatment of the pollen grains with the acetolysis-method of ERDTMAN (1943) produces the best results. Everything inside the exine is dissolved, while, moreover, a colouring of the exine takes place. This method, described by ERDTMAN in 1943 and 1952 for herbarium material, has, in its original form, a great disadvantage. Too much material is required to obtain a usable preparation. In order to reduce this disadvantage a micro-method (see below) has been applied, which leaves the method as such untouched, but requires less material. If necessary even only one anther is sufficient.

MICRO-METHOD

The micro-method is a perfection of the method described by WILLRATH in a publication of POTONIÉ (1934).

A flower is boiled in water till it is free of air. Under a preparing-microscope one anther (or more if the material allows) is dissected and laid in the pit of a hollow slide. Some drops of acetolysis mixture (9 parts anhydric acetic acid : 1 part H_2SO_4 conc.) are dropped on the anther till the pit has been filled with the mixture. Now the slide is placed on a heating-apparatus as shown in Fig. 1. The end of the heating-apparatus is heated by a Bunsenburner. The flame should not be too high,

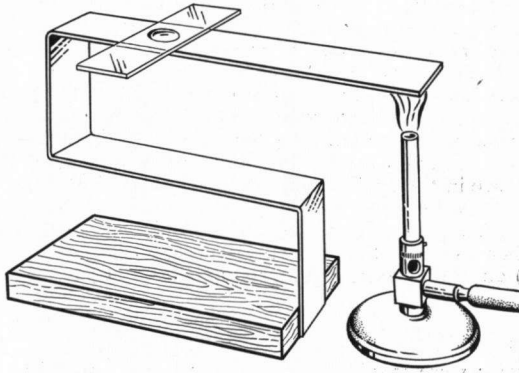

Fig. 1

but not too low either. The slide furthermore has to be removed so far from the flame that the mixture cannot take fire. A part of the mixture will evaporate. When the slide has become almost dry some more drops are added. This is repeated 3 or 4 times till the remaining mixture is turning dark brown. When the preparation once more is nearly "dry", it is quickly cooled down by placing the slide on a stone or iron surface. Under the dissecting microscope the pollen grains are to be seen as brown globules. With anthers which have a solid skin, that cannot easily be dissolved, it is desirable, while heating, to prick this skin in places with a needle to make the acetolysis mixture penetrate deeply enough into the anther.

c. PRESERVATION OF POLLEN GRAINS

For the preservation of grains the paraffin-comprising method has been used. A small drop of glycerin (diam. 1 mm.) is laid on a slide. With a brush moistened in glycerin the pollen grains are wiped off the slide or fished out of the liquid. In

the drop of glycerin the pollen grains come off the brush more or less easily. This is repeated till at least 10 grains are present in the glycerin drop.

Now a little piece of glycerin-gelatin is added. The gelatin is melted and the grains are mixed with it. To prevent the pollen grains from expanding abnormally the whole should not be heated too much. It is of the utmost importance that the grains can be studied from all sides, so that care should be taken that the cover-glass does not flatten the grains. Therefore a granule of clay (no synthetic material) is laid next to the glycerin drop. The cover-glass is now supported by the clay when placed on the preparation and the pollen grains cannot be compressed. By lightly pressing the cover-glass the thickness of the preparation can be regulated. By running melted paraffin under the cover-glass the grains are isolated from the air.

WEBSTER (1956) rejects the method of sealing up by paraffin on the ground of the preparations not durable. In Utrecht, however, preparations ten years old are still in excellent condition. It is, however, essential that the layer of paraffin should not be too thin and the drop of glycerin should not approach the edge of the cover-glass (ERDTMAN and PRAGLOWSKI 1959).

Preparations made by the micro-method have the disadvantage that some acid will enter with the pollen grains. This may cause the colour to fade after some time. After three years, however, form and structure were still unchanged. For that reason the macro-method of Erdtman is always preferable to the micro-method, but the latter has the advantage that very little material is sufficient, so that any rigorous sacrifice of herbarium-material may be prevented. In the case of flowers with large anthers it is even possible that part of a stamen suffices (*Campanula*, *Lilium*).

In describing pollen grains it is of great importance that the method used for preparation should be indicated, since the size of the pollen grain varies with it. Though the expansion of a certain pollen grain is constant in either method, only relative value can be attached to the indication of the size of that particular pollen grain. Only with regard to pollen grains that have been treated in precisely the same way the grain measures retain their value. Moreover, the size is influenced by the grade of ripeness of the pollen. When a pollen grain is on the verge of maturing, form and structure may already be fully developed, while the size has not yet reached its maximum. It is, therefore, again emphasized that *all* absolute numbers which are mentioned in the descriptions have a relative value. For this reason any accurate calculation of average sizes has been relinquished. The figures give an impression of the size in these special circumstances and allow a mutual comparison of the examined pollen grains.

The proportionate numbers, however, are more dependable. Proportions remain the same in either method. Some proportionate numbers are, e.g., Polar Area Index (= P.A.I.) and Polar axis: Equatorial axis (= P:E) (see Pollen Morphology p. 12).

d. MICROSCOPES

The pollen grains were studied with a Bausch and Lomb binocular (objective 97 \times , ocular 10 \times), and an Olympus phase contrast microscope was used. The employment of this microscope was found very useful in detecting the configuration of structure elements. Most of the structure patterns are also visible with the ordinary light-microscope, but, especially in the case of small structure elements, not without difficulty. The phase contrast microscope immediately gives a clear image of the structure.

e. PUNCHED CARDS

The study of large quantities of material requires special methods of compiling the knowledge obtained. A simple card-index is inadequate when there are many genera to be mutually compared; the great number of characters hampers any efficient arrangement. A solution of this problem was found in the use of punched cards. Punched card systems were made for the pollenmorphologic as well as for the taxonomic characters. Thus any particular botanical object could be classified in two independent systems. The groups of genera within those systems are now mutually comparable so that it became possible to recognize correlations

of characters, which, without the punched cards, would have been found at the cost of much time and labour or not at all.

A further advantage is that the investigator is compelled to look over the same characters continually. Even the absence of a special character may be of importance and finds expression in this system.

A disadvantage may be that too much reliance is placed upon the characters noted. Often characters that are indicated in the same way are not mutually comparable. If e.g. stamens are connate, this coalescence can take various forms.

There may be investigators, who are inclined to distrust this system. Nevertheless the use of punched cards and other mechanic systems should undoubtedly be taken into consideration, especially when studying larger taxa. Surveying and working up the continually increasing numbers of characters in a reasonable time is becoming more and more difficult. Loss of time, chance of errors and the risk of being incomplete are apt to compel the taxonomist to utilize some form of mechanic taxonomy. Who would, at present, venture to revise the whole genus *Solanum* or *Euphorbia*? Only through a perfection and especially through an acceleration of our methods the larger taxa will as yet have a chance of being monographically worked on.

f. DRAWINGS

The pollen grains have been drawn in such a manner that in one drawing as many characters as possible are to be seen at the same time. Each drawing therefore is midway between a scheme and a photographic reproduction. The pollen grains have been drawn without a camera lucida or other drawing instruments.

Drawing has the advantage that the most important characters can be indicated distinctly, so that the grains are easier to distinguish from others. A disadvantage is the subjective image which the drawing is apt to give.

The other possibility of reproduction is making use of photography. For the following reasons this method has not been applied:

1. In most cases at least 4 photographs of perfect quality are required to obtain a distinct picture of the grain.
2. In a photograph the structures of the pollen grains can never be pursued distinctly, because the photographic image will only be sharp for a certain optical section.
3. Deeper lying layers debase the photographic image and cause an insufficient sharpness of the essential characters.

The plates have been drawn to scale. Each picture is 1000 × enlarged, except some of the large pollen grains (e.g. *Manihot* and *Croton matourensis*), which are less enlarged. In those cases where the enlargement is not 1500 × the scale is given in the text to the plates.

CHAPTER V

SOME NOMENCLATURAL REMARKS

Bischofia BLUME

Although BLUME dedicated this genus to Bischoff he spelled, in his "Bijdragen" (1826), the name with a single f. Obviously he latinised Bischoff to Bischofius. For this reason the name of the genus should be written in the original spelling.

Briedelia WILLDENOW

In his "Species Plantarum" (4:978. 1805) WILLDENOW deliberately spelled the genus with *i e*. He commented as follows on the choice of the name: "Genus hoc a Cluytia et Rhamno abunde diversum in honorem Clariss. S. E. Briedel nominavi." Although the name of the botanist in question is spelled Bridel it is not clearly demonstrated that the author made an unintentional error. Under the rules of the international code the genus should be written in the original spelling.

Cnesmosa BLUME

In his "Bijdragen" (1825) BLUME spelled this genus as *Cnesmosa*. In the Flora van Java, Praefatio in adnotation, he changed the name, probably for grammatical reasons, in *Cenesmon*. This is not allowed under the rules of nomenclature. The original spelling should be maintained.

Koilodepas HASSKARL

Koilodepas was first published in 1855 in the Greek version (Versl. Med. Akad. Wetenschappen Amsterdam 4: 139). Two years later the name was altered in *Coelodepas* (Flora 40: 531. 1857). As CROIZAT (1942b) and AIRY-SHAW (1960) have stated, the validity of the spelling *Koilodepas* is unquestionable.

Omalanthus A. DE JUSSIEU

The first spelling of this genus appeared in A. DE JUSSIEU's "De Euphorbiacearum" in 1824. In his "Conspectus" (1828) H. G. L. REICHENBACH altered the name in *Homalanthus*. Of course the first spelling has to be maintained. *Carumbium* is a synonym of *Omalanthus*. REINWARDT published this name as a nomen nudum in OKEN's Isis 1823. So *Omalanthus* is the name first published and therefore valid.

Romanoa TREVISAN

In 1824 A. DE JUSSIEU published the genus *Anabaena*. DE BORY, however, had given the name *Anabaina* to a new algae genus (Cyanophyta) in 1821, so that the name of A. DE JUSSIEU is a homonym. In 1918 PAX et K. HOFFMANN gave the substitute name *Anabaenella* to this taxon. They did not know, however, that an older name was available. In 1848 TREVISAN had substituted *Anabaena* A. DE JUSSIEU by *Romanoa* (Alge Coccotale p. 99). If the genus is held separate from *Plukenetia*, *Romanoa* is the first correct name for *Anabaena* A. DE JUSSIEU.

CHAPTER VI

POLLEN MORPHOLOGY

In describing pollen grains the number of terms employed should be as small as possible. This was the starting point of FAEGRI and IVERSEN in 1950. One of the arguments they advanced was the difficulty of giving an analytic description of a pollen grain in exact terms. The system, however, that resulted from their attempt at

PLATE I.

- A. 1. pori; 2. colpi; 3. prolate pollen grain; 4. oblate pollen grain; P = Polar axis; E = Equatorial axis.
- B. polar view; 1. triangular; 2. three lobed; 3. circular; 4. convex triangular; S = smallest distance between two colpi ends; G = greatest breadth; S:G = Polar Area Index.
- C. 1. porus and colpus nudate; 2. p. and c. with a membrana granulata; 3. p. and c. with an operculum; 4. p. and c. with a margo (thickening a or thinning b of the ekt.); 4c. costae pori and costae colpi; 5a. porus with a vestibulum; 5b and c. composite aperture with an atrium.
- D. 1. colpus transversalis; 2. circular colp. transv.; 3. equatorial colp. transv.; m = meridional axis of the cop. transv.; e. equatorial axis of the colp. transv.; o = os; 4. costa transversalis; 5. costa circularis; 6. costa equatorialis.
- E. 1. tectum; 2. tectum perforatum; 3. reticulum; 4. croton-pattern.
- F. 1. psilate; 2. scabrate; 3. verrucate; 4. gemmate; 5. clavate; 6. baculate; 7. echinate; 8. pila.

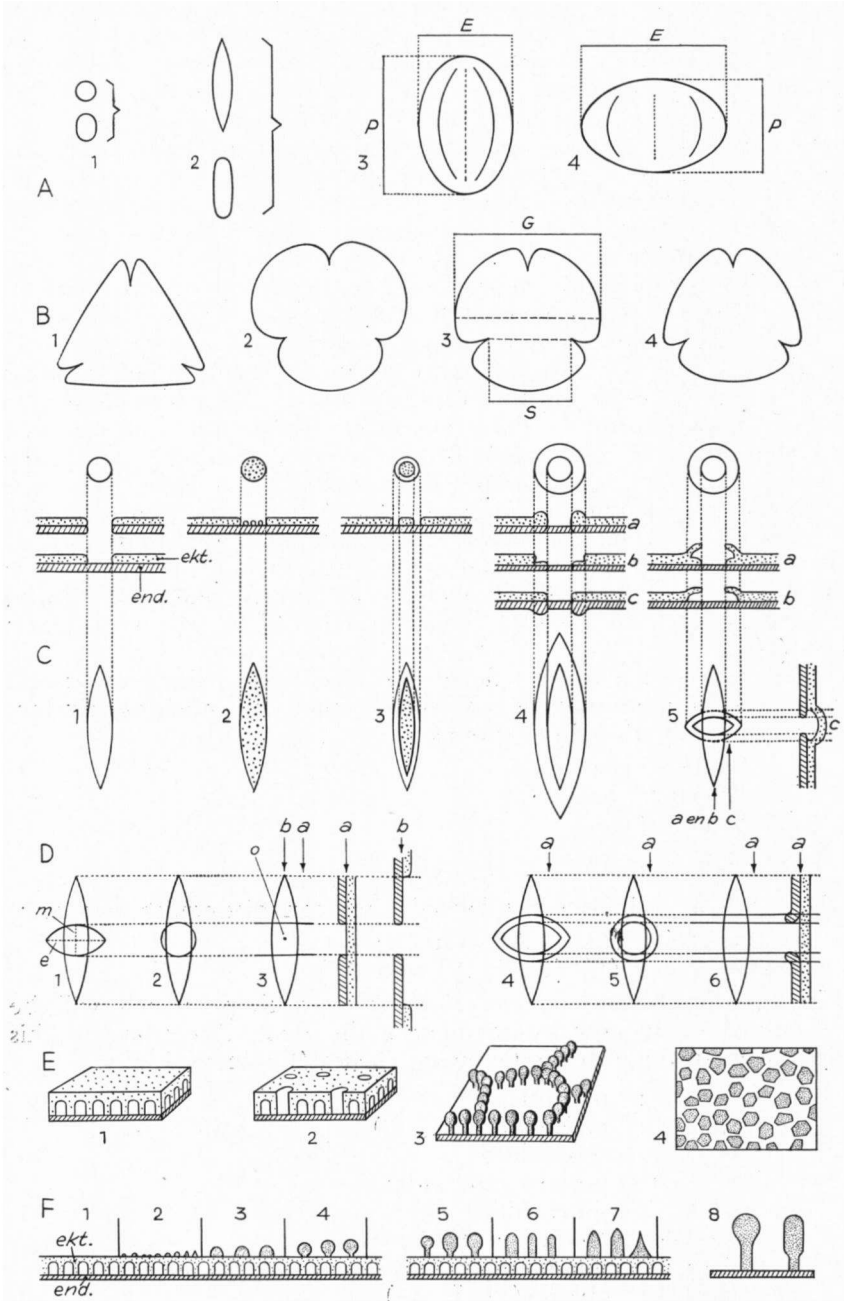

PLATE I.

simplicity was inadequate, and amplification was necessary. Especially when the amount of material to be described is considerable many difficulties are liable to arise. The number of characters of a pollen grain is comparatively small and they often appear in many transitional forms. Yet a precise and exact definition of characters is desirable.

ERDTMAN, who, in his study of the Angiosperms (1952), met with these difficulties, therefore enlarged the terminology considerably. He tried to nominate every transitional form, each nuance, which could be achieved only at the cost of exactitude and convenient arrangement. Nevertheless many pollen morphologists will feel highly attracted towards his method.

For the use of pollen morphology as an additional character in taxonomy this system is too complicated. The more obvious characters will suffice. For that reason a compromise seems to be the right course for the description of diverse pollen grains. Without going as far as ERDTMAN the present author has attempted to use a terminology as simple as was possible without loss of exactitude and completeness.

Pollen grains are composed of three layers. The central part is the cytoplasm. The middle layer is the *intine*; the outer layer the *exine*. The exine of pollen grains consists of a particularly resistant substance of a lipoid character: *sporopollenin*. Sporopollenin is even more resistant to the attack by micro-organisms than cutin. The exine substance is also highly resistant to all sorts of chemicals; it can not, or only slowly, be attacked by fluid KOH, concentrated H₂SO₄ or even fluoric acid (HF).

The exine which can be divided in two layers, the *endexine* and the *ektexine*, supplies most of the data necessary for pollen description. These data fall into three groups:

1. Shape
2. Apertures
3. Structure

1. *Shape*

If a pollen grain is not spheroidal we can distinguish two axis:

- a. *Polar axis* (P) (Pl. I, A3 and A4)
- b. *Equatorial axis* (E) (Pl. I, A3 and A4)

In equatorial view pollen grains show a shape which will be determined easily now by calculating the *P: E*. According to this relation we distinguish the following classes (ERDTMAN 1952):

P: E > 2	:	perprolate
1,33-2	:	prolate (Pl. I, A3)
1,14-1,33:		subprolate
1 -1,14:		prolate spheroidal
1	:	spheroidal
1 -0,88:		oblate spheroidal
0,88-0,75:		suboblate
0,75-0,50:		oblate (Pl. I, A4)
< 0,50:		peroblate

In polar view the circumference of a pollen grain can be:

1. triangular (Pl. I, B1)
2. convex triangular (Pl. I, B4)
3. circular (Pl. I, B3)
4. three lobed (Pl. I, B2)

2. Apertures

In the system of IVERSEN and TROELS-SMITH the principal classification is made according to the occurrence of apertures: *pori* (Pl. I, A1), *colpi* (Pl. I, A2) and *colpi transversales* (Pl. I, D1, 2, 3) (in composite apertures only).

Real *pori* and real *colpi* are formed by thinnings in the *ektexine*. A *colpus transversalis*, on the other hand, by a thinning in the *endexine*. For that reason apertures of the endexine and the *ektexine* have to be described independently of each other.

Pori can be distinguished from *colpi* by calculating the length: breadth. If length: breadth < 2 the aperture is a porus although the shape is not necessarily a pure circle. If length: breadth > 2 the aperture is a colpus. The endexine below the edges of *colpi* or *pori* may be thickened. These thickenings are called *costae colpi* and *costae pori* (Pl. I, C4c).

The *colpus transversalis* (Pl. I, D) is an easily recognisable character. It is a thinning of the *endexine*. Yet this aperture has been inaccurately described by many investigators. FAEGRI and IVERSEN (1950) confuse this aperture with a real porus when the colpus transversalis has the shape of a circle. Consequently, when using their key for the determination of European pollen types, it is sometimes difficult to decide if a "porus longitudinal elongated" or a "transversal furrow" is present. ERDTMAN calls *colpi* + *colpi transversales* "composite apertures". For the term colpus transversalis he introduced the new term *os* (pl. *ora*). If this term is used in that sense the name will have to be rejected as being a synonym. It may, however, be maintained for that part of the colpus transversalis that crosses the *colpus* (Pl. I, D3). *Colpi transversales* stand perpendicular on the *colpi*. Usually they are boat-shaped. Sometimes they fuse together into one single aperture along the equator of the pollen grain (*colpus transversalis equatorialis*), but it is also possible that the colpus transversalis becomes isodiametric (*colpus transversalis circularis* Pl. I, D2). The medial dimension of the colpus transversalis is rarely larger than the equatorial one (*Pleiostemon* type, p. 30). Edges of *colpi transversales* can also have thickenings; according to the shape of the colpus transversalis they are called: *costae circulares*, *costae transversales* and *costae equatoriales* (Pl. I, D4, 5, 6). To express the proportions of the colpus transversalis in exact figures, the quotient $m:e$ is added to the description of this character. In this formula m is the meridional axis and e the equatorial axis of the colpus transversalis (Pl. I, D1).

IVERSEN and TROELS-SMITH (1950) introduced the term *Polar Area Index* (*P.A.I.*). The *P.A.I.* is the ratio between the greatest distance of the ends of two *colpi* and the greatest breadth of the pollen grain

usually the Equatorial axis. This character is of great value for the description of pollen grains.

3. Structure

The *ektexine* furnishes characters of great diagnostic importance. The description of these characters meets, however, with considerable difficulties, so that it is necessary to use a system as simple as possible and highly desirable to avoid confusing terms (e.g. *sculpture*, see below).

The *ektexine* is composed of *structure elements*. Different forms and arrangements of these elements cause several structure types to occur. The most common structure elements occurring on the endexine are *pila* (Pl. I, F8). Each *pilum* consists of a swollen apex (*caput*) and a cylindrical basal part (*collum*; homologous *columella*). Pila are strictly found on the endexine. They may occur *ordinate* or *inordinate*. Ordinate arranged pila can form regular figures (e.g. *reticulum* Pl. I, E3) or stand in rows (e.g. *striae*). Frequently *capita* of *pila* are connate or fused. If the fusion is only laterally, and less of the surface is covered by the capita, we speak of *tegillate* pollen grains. Pollen grains are *tectate* when the fused capita cover 80 % or more of the surface (Pl. I, E1). In that case the pila form a second membrane outside the endexine. If the tectum is not completely closed (fusion of the capita more than 80 % and less than 100 %) the perforate membrane is a *tectum perforatum* (Pl. I, E2).

On the top of the *tectum* we distinguish *structure elements* of different shape. According to FAEGRI and IVERSEN they are called: *baculae*, *clavae*, *echinae*, *gemmae*, *scabrae* and *verrucae* (Pl. I, F2 t/m 7) (for descriptions see glossary). *Psilate* pollen grains have no structure elements on the tectum (Pl. I, F1).

Structure elements on the top of the tectum may also be arranged in different structure types (*reticulum*, *striae*). If a tectum is present, corresponding structure types of the *columellae* are called *intra-reticulum*, *intra-striae*. Sometimes *columellae* can give an impression of a *reticulum*. This is, however, a "*pseudo-reticulum*" in which each *columella* represents a "*lumen*" and the space between the *columellae*, the "*muri*". A real *reticulum* is always formed by several structure elements.

In the present study no difference is made between *structure* and *sculpture*. According to POTONIÉ (1934), all elements outside the tectum form the *sculpture* of a pollen grain. POTONIÉ tried to give sharp definitions of these terms, but admitted at the same time, that *structure* and *sculpture* pass into each other. FAEGRI and IVERSEN (1950) also stated, that *structure* and *sculpture* are easy to confuse. For that reason it seems better to speak of *structure elements* and *structure* only.

CHAPTER VII

GLOSSARY

- Annulus* (IVERSEN and TROELS-SMITH 1950) (Pl. I; C 4a en b)
Area which surrounds a porus and is distinguished by a thickening or a thinning of the ektexine; thus forming a prominent or depressed margin of the latter.
- Aperture* (FAEGRI and IVERSEN 1950)
Any weak perforated part of the ektexine or endexine of a pollen grain (e.g. colpus, colpus transversalis).
- Atrium* (Pl. I; 5a, b en c)
A cavity inside a composite aperture caused by a separation between two layers of the exine.
- Bacula* - pl. *Baculae* (IVERSEN and TROELS-SMITH 1950) (Pl. I; F 6)
Structure elements with at least one dimension 1μ or larger in the shape of rods. Occur on the tectum only.
- Baculate* (IVERSEN and TROELS-SMITH 1950)
Pollen grains provided with baculae.
- Caput* - pl. *Capita* (ERDTMAN 1952)
Upper part of a pilum.
- Clava* - pl. *Clavae* (IVERSEN and TROELS-SMITH 1950) (Pl. I; F 5)
Structure elements with at least one dimension 1μ or larger in the shape of clubs. Occur on the tectum only.
- Clavate* (IVERSEN and TROELS-SMITH 1950)
Pollen grains provided with clavae.
- Collum* (ERDTMAN 1952)
Lower part of a pilum; homologous with columella.
- Columella* - pl. *Columellae* (IVERSEN and TROELS-SMITH 1950)
Lower part of a pilum. Columellae bear the tectum. In 1956 FAEGRI used the term as a synonym for pilum.
- Colporate* (ERDTMAN 1945)
Pollen grains with composite apertures.
- Colpus* - pl. *Colpi* (ERDTMAN 1943) (Pl. I; A2 and C1)
Longitudinal apertures of the ektexine. Length : breadth > 2 .
- Colpus transversalis* (ERDTMAN 1943) (Pl. I; D 1, 2, 3)
Aperture of the endexine perpendicular to the colpus. Appears in composite apertures only.
- Composite aperture* (ERDTMAN 1952) (Pl. I; D 1, 2, 3)
Ektexine aperture combined with an endexine aperture (apertures not congruent).
- Costa* - pl. *Costae* (FAEGRI and IVERSEN 1950) (Pl. I; C 4 and D 4, 5, 6)
Thickenings of the endexine.
Costae circulares (D5): Thickened edges of circular colpi transversales.

- Costae colpi* (C4c): Thickened endexine below the edge of colpi.
Costae equatoriales (D6): Thickened edges of colpi transversales extended along the equator.
Costae pori (C4c): Thickened endexine below the edge of pori.
Costae transversales (D5): Thickened edges of colpi transversales.
- Croton-pattern* (ERDTMAN 1952) (Pl. I; E4)
 Structure elements in rings of 5 or 6 around a circular area.
- Echina* – *pl. Echinae* (WODEHOUSE 1928) (Pl. I; F7)
 Structure elements with at least one dimension 1 μ or larger in the shape of spines. Occur on the tectum only.
- Echinate* (WODEHOUSE 1928)
 Pollen grains provided with echinae.
- Ellipsoid*
 Inaperturate pollen grains with a long and a short axis.
- Endexine* (ERDTMAN 1943)
 Inner part of the exine.
- Ektexine* (ERDTMAN 1943)
 Outer part of the exine.
- Equatorial axis* (VAN ZINDEREN BAKKER 1953) (Pl. I; 3E and 4E)
 The line perpendicular to the Polar axis in the equatorial plane.
- Exine* (FRITZSCHE 1837)
 The outer, usually resistant, layer of the wall of a pollen grain.
- Gemma* – *pl. Gemmae* (IVERSEN and TROELS-SMITH 1950) (Pl. I; F4)
 Structure elements with at least one dimension 1 μ or larger of which the lower parts are constricted. Occur on the tectum only.
- Gemmate* (IVERSEN and TROELS-SMITH 1950)
 Pollen grains provided with gemmae.
- Inaperturate* (IVERSEN and TROELS-SMITH 1950)
 Pollen grains without apertures.
- Intectate* (IVERSEN and TROELS-SMITH 1950)
 Capita of the pila covering less than 80 % of the surface.
- Intra-reticulate* (FAEGRI and IVERSEN 1950)
 Columellae inside the tectum form a network.
- Intra-striate* (FAEGRI and IVERSEN 1950)
 Columellae inside the tectum stand in rows.
- Lumen* – *pl. Lumina* (POTONIÉ 1934)
 Spaces between the muri of a reticulum.
- Margo* (IVERSEN and TROELS-SMITH 1950)
 Area which surrounds a colpus and is distinguished by a thickening or thinning of the ektexine; thus forming a prominent or depressed margin of the latter.
- Membrana granulata* (ERDTMAN 1952) (Pl. I; C2)
 Colpus or porus membrane (= endexine) with some scattered structure elements.

Murus - *pl. Muri* (POTONIÉ 1934)

Ridges separating the lumina of a reticulum.

Operculum (WODEHOUSE 1928; FAEGRI and IVERSEN 1950) (Pl. I; C3)

Isolated part of the ektexine which is separated from the edges of a colpus or porus by a narrow zone in which the ektexine is missing or greatly reduced.

Os - *pl. Ora* (Pl. I; D3, o)

That part of a composite aperture which is formed by the crossing of the colpus and the colpus transversalis.

Periporate (IVERSEN and TROELS-SMITH 1950)

Pori \pm uniformly distributed over the surface of a pollen grain.

Pilum - *pl. Pila* (ERDTMAN 1952) (Pl. I; F8)

Structure elements consisting of a swollen apex (caput) and a cylindrical basal part (collum, columella). Occur on the endexine only.

Polar Area Index = *P.A.I.* (IVERSEN and TROELS-SMITH 1950) (Pl. I; B3)

The proportion of the greatest distance between the ends of two furrows and the greatest breadth of the pollen grain (usually the Equatorial axis).

Polar axis (ERDTMAN 1943) (Pl. I; A3p and A4p)

The perpendicular line connecting the poles of a pollen grain.

Porus - *pl. Pori* (ERDTMAN 1943) (Pl. I; A1 and C1)

Circular apertures of the ektexine. Length : breadth < 2 .

Psilate (WODEHOUSE 1928) (Pl. I; F1)

Surface of tectum smooth.

Reticulum (POTONIÉ 1934) (Pl. I; E3)

Structural pattern in the form of a network in which columellae represent the muri of the reticulum.

Scabra - *pl. scabrae* (IVERSEN and TROELS-SMITH 1950) (Pl. I; F2)

Structure elements visible but smaller than 1μ . Occur on the tectum only.

Scabrate (IVERSEN and TROELS-SMITH 1950)

Pollen grains provided with scabrae.

Sculpture (POTONIÉ 1934)

A term proposed by Potonié for the joint structure elements outside the tectum (p. 14).

Stephanocolpate (IVERSEN and TROELS-SMITH 1950)

Pollen grains with more than three colpi perpendicular to the equatorial plane.

Stephanocolporate (IVERSEN and TROELS-SMITH 1950)

Pollen grains with more than three composite apertures.

Stephanoporate (IVERSEN and TROELS-SMITH 1950)

Pollen grains with more than three apertures in the equatorial plane.

Stria - *pl. Striae* (IVERSEN and TROELS-SMITH 1950)

Structure elements standing in rows forming narrow grooves (\pm parallel).

Striate (IVERSEN and TROELS-SMITH 1950)

Pollen grains with striae.

Structure

Form and arrangement of the structure elements.

Structure elements

Individual elements either on the endexine or on the tectum.

Syncolpate (IVERSEN and TROELS-SMITH 1950)

Colpi anastomosing at the poles.

Tectate (IVERSEN and TROELS-SMITH 1950) (Pl. I; E1)

The capita of pila are fused and cover together 80 % or more of the surface of a pollen grain.

Tectum (IVERSEN and TROELS-SMITH 1950) (Pl. I; E1)

The membrane outside the endexine formed by fused capita of pila.

Tectum perforatum (IVERSEN and TROELS-SMITH 1950) (Pl. I; E2)

The tectum is not completely closed. Small holes are present.

Tegillate (ERDTMAN 1952)

The capita of the pila are laterally united or fused and cover less than 80 % of the surface of a pollen grain.

Tricolpate (IVERSEN and TROELS-SMITH 1950)

Pollen grains with three colpi perpendicular to the equatorial plane.

Tricolporate (IVERSEN and TROELS-SMITH 1950)

Pollen grains with three composite apertures.

Triporate (IVERSEN and TROELS-SMITH 1950)

Pollen grains with three pori in the equatorial plane.

Verruca - pl. *Verrucae* (IVERSEN and TROELS-SMITH 1950) (Pl. I; F3)

Structure elements with at least one dimension 1μ or larger in the shape of warts. Occur on the tectum only.

Verrucate (IVERSEN and TROELS-SMITH 1950)

Pollen grains provided with verrucae.

Vestibulum (IVERSEN and TROELS-SMITH 1950) (Pl. I; C5a, b)

Cavity inside a porus, caused by a separation between two layers of the exine.

CHAPTER VIII

RESULTS

A. POLLEN GRAINS OF THE EUPHORBIACEAE

Pollen grains of the *Euphorbiaceae* show a number of types, which can be distinguished more or less clearly. Generally pollen grains of species inside one genus belong to the same pollen type. The dimensions and proportions may differ, but in principle the pollen grains are identical. In some larger genera different pollen types occur in one genus (*Tragia*, *Phyllanthus*). More often we find that different genera possess the same pollen type. Consequently it is not possible, as it is

with the *Acanthaceae*, to place a plant instantly in a genus by means of its pollen grains.

For the greater part the pollen types within the subfamilies *Phyllanthoideae* and *Crotonoideae* can be distinguished clearly from each other. Some types, however, show some affinities; e.g. *Clutia* type (p. 77) with *Phyllanthus pentaphyllus* subtype (p. 24), and *Amanoa* type (p. 33) with *Sumbavia* type (p. 69).

According to the system of IVERSEN and TROELS-SMITH (1950) the following principal types occur:

inaperturate, periporate, triporate, stephanoporate,
tricolpate, stephanocolpate, tricolporate, stephanocolporate.

Pollen grains with composite apertures occur most frequently. Especially the number of tricolporate pollen grains is large.

The shape varies from perprolate ($P:E > 2,00$) to oblate ($P:E = 0,50-0,75$). In polar view the pollen grains are mostly convex triangular. In some cases the circumference is triangular (*Clutia* type), circular (*Moultonianthus* type) or three lobed (*Omalanthus nutans* subtype).

The colpi are usually narrow, but sometimes broad (*Amanoa* type, *Plukenetia* type). In many types the colpi are accompanied by costae colpi (*Antidesma* type, *Mallotus* type).

The P.A.I. diverge from large ($> 0,7$) to syncolpate. Syncolpate pollen grains are, however, rarely found in the *Euphorbiaceae* (*Amperea* type).

Colpi transversales, if present, can be of great diagnostic value. Shape and size are characteristic for several pollen types (*Securinea* type, *Hippomane* type).

Pollen grains of *Euphorbiaceae* are often tectate. Sometimes the columellae supporting the tectum are so small that they are barely visible (*Alchornea* type, *Ricinus* type). If the pollen grains are intectate, they generally possess a reticulum. In a few cases only the pollen grains are intectate, pilate (some *Phyllanthus* species, *Tragia fallax* type). On the tectum structure elements of different shape may be found; e.g. clavae, baculae, echinae, etc.

The croton-pattern is a structure type which we meet in many genera of the *Crotonoideae*. Outside the *Euphorbiaceae* this structure type is found in *Buxaceae* and *Thymelaeaceae* (ERDTMAN 1952).

In the following treatment of the investigated material the pollen grains are first divided into the two subfamilies:

- a. *Phyllanthoideae*
- b. *Crotonoideae*

Inside these subfamilies the pollen grains are discussed according to their similarity in type.

Different pollen grains are placed in different *pollen types*. So the type unit has been chosen as the base of the classification. Descriptions of a type are therefore as extensive as possible. If the differences are

of minor importance, the pollen grains are placed in *subtypes*. Several types can have some characters in common. To express the correspondences, these types are assembled in *configurations*. After the diagnoses of the pollen groups comment is given on the pollen morphologic characters, mostly in their relation to other pollen groupings. Besides this comment in many cases a taxonomic discussion is added, in which the value of pollen morphology in taxonomic problems is discussed.

B. DISCUSSION OF THE RESULTS

a. PHYLLANTHOIDEAE

ANTIDESMA CONFIGURATION

Tricolporate or stephanolcolporate (4). Pollen grains with a Polar axis larger than the Equatorial axis. P. rarely shorter than the E. (e.g. *Phyllanthus acidus* subtype).

Colpus transversalis usually with costae.

Pollen grains reticulate or not reticulate; never echinate.

The *Antidesma* configuration is characterised by its prolate shape of the pollen grains. The Polar axis is usually larger than the Equatorial axis. In the *Phyllanthus acidus* subtype (p. 26) only the pollen grains are spheroidal or slightly oblate spheroidal. However, the pollen grains resemble so much the *Securinega* subtype, that it seems better to place them in the same type.

The three main types of the configuration are the *Antidesma* type, the *Securinega* type and the *Dicoelia* type. The three types are closely related and have several characters in common e.g. shape, costae colpi and costae transversales. The other types resemble the main types but lack one of the important characters e.g. costae (*Heywoodia* type, p. 30) or have special characters (verrucae in the *Zimmermannia* type, p. 29).

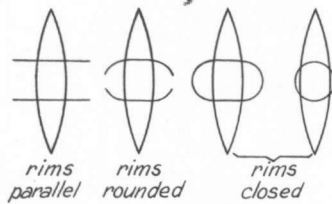

Fig. 2

The differences between the subtypes are rather faint and difficult to define and separate. The most reliable character for determination and separation is found in the colpus transversalis. These apertures are bordered by costae which make them distinctly visible. In some subtypes (e.g. *Antidesma* subtype) the rims of the costae transversales run parallel and the outer ends of the colpus transversalis are diffuse. Most *Phyllanthus* species have costae transversales with rounded ends. The outer ends of the colpus transversalis are in that case distinct and frequently even closed.

Antidesma type

Tricolporate; perprolate to prolate spheroidal.
 Colpus transversalis small or narrow elongated; costae.
 Colpi narrow; costae colpi.
 Tectate; psilate. Mostly not reticulate; rarely indistinct reticulate.

The *Antidesma* type differs from the *Dicoelia* type (p. 28) by the shape and dimensions of the colpus transversalis. In other characters the two types cannot be differentiated.

From the *Securinega* type the *Antidesma* type differs not only by the shape of the colpus transversalis but also by the structure of the exine.

Taxonomic discussion

The plants in the *Antidesma* type can be divided into two groups. The first group combines the *Antidesma* subtype with the *Baccaurea* subtype and the second group includes the two *Phyllanthus* subtypes.

The first group comprises most of the genera which PAX and K. HOFFMANN (1922, 1931) united in the subtribe *Antidesminae*. The *Antidesminae* are chiefly characterised by the inflorescence which is catkin-like or in slender spikes. The following characters are of importance too:

1. The male flowers have only few (six or less; usually five) stamens round an ovarium rudiment (in *Aporosa* the ovarium rudiment is small or absent).
2. Usually a disc is present.
3. In the female flowers a disc may be present; the styles are usually bifid.
4. The plants are nearly almost dioecious. All the genera are found in the Old World except *Hyeronima*, which is the American representative of *Antidesma* (BENTHAM, 1880).

Chonocentrum was first recognised by MUELLER as a species of *Drypetes*. PAX and K. HOFFMANN (1922, 1931) separated the plant from this genus and placed it in the vicinity of *Discocarpus*. Pollen grains of the latter genus are however quite different. *Chonocentrum* differs from *Discocarpus* by the following characters:

1. Petals are never present.
2. The stamens are not connate but free.

Some genera included in the *Antidesminae* by PAX and K. HOFFMANN possess pollen grains without an *Antidesma* type. As for the genera *Dicoelia*, *Richeria* and *Richeriella* they belong to related types. *Martretia* and *Hymenocardia* have totally different pollen grains.

The second group of the *Antidesma* type includes many species of *Phyllanthus*. Also pollen grains of *Reverchonnia* possess the *Phyllanthus pentaphyllus* subtype. In many respects the genus is related to *Phyllanthus*. The branching of the plants, however, is not phyllanthoid. The male disc, always present in *Phyllanthus*, is rather indistinct. The two stamens are inserted on a thick disc-like tissue. As in *Phyllanthus* there is no ovarium rudiment, while in the female flowers a disc is present.

Antidesma subtype

Pollen grains tricolporate; perprolate – prolate.

Colpus transversalis long; outer ends indistinct and diffuse. Edges of the costae transversales parallel.

The pollen grains are strongly elongated and have narrow elongated colpi transversales.

Though always referred to the genus *Securinega*, *Securinega congesta* has pollen grains largely different from the other pollen grains in the genus. The large P:E and narrow elongated colpus transversalis place the pollen grains straight into the *Antidesma* subtype.

Antidesma bunius (LINN.) SPRENG.
Java [U] Pl. II, 2

Antidesma subtype; perprolate.
P = 37,5 μ E = 18,5 μ P:E = 2,04.
m:e < 0,5 P.A.I. = 0,25.

Antidesma venosum TUL.
Stolz 476 [U]

Antidesma subtype; prolate.
P = 19 μ E = 13 μ P:E = 1,50.

Antidesma agusanense ELMER
Elmer 15881 [U]

Antidesma subtype.
Idem *Antidesma venosum*.

Antidesma diandrum (ROXB.) ROTH
Hohenacker 167 [U]

Antidesma subtype.
Idem *Antidesma venosum*.

Antidesma edule MERR.
Ramos 1083 [U]

Antidesma subtype.
Idem *Antidesma venosum*.

Antidesma ghesaembilla GAERTN.
Hort. Calcutta 1897 [U]

Antidesma subtype.
Idem *Antidesma venosum*.

Antidesma membranaceum MUELL. ARG.
Bels 126 [U]

Antidesma subtype.
Idem *Antidesma venosum*.

Antidesma obovatum J. J. SMITH
Versteeg 1789 [U]

Antidesma subtype.
Idem *Antidesma venosum*.

Hyeronima alchorneoides ALLEM.
Krukoff 6110 [U]

Antidesma subtype.
P = 28,5 μ E = 12 μ P:E = 2,20.

Hyeronima laxiflora (TUL.) MUELL. ARG.
Sandwith 544 [U] Pl. II, 1

Antidesma subtype.

Thecacoris leptobotrya (MUELL. ARG.)
BRENNON

Antidesma subtype.

Zenker 23 [U]
Cyathogyne spathulifolia PAX
Schlieben [P]

P = 36 μ E = 17,5 μ P:E = 2,04.
Antidesma subtype.

P = 40 μ E = 20,5 μ P:E = 1,94.
m:e \pm 0,5.

Cyathogyne viridis MUELL ARG.
F.H.I. 3936 [K]

Antidesma subtype.
Too young for measurements.

Apodiscus chevalieri HUTCH.
Pobéquin 1909 [P]

Antidesma subtype.
P = 30 μ E = 19 μ P:E = 1,58.

Protomegabaria macrophylla HUTCH.
Andoh 5474 [K] Pl. II, 3

Antidesma subtype.
P = 27,5 μ E = 19 μ P:E = 1,45.

Spondianthus preussii ENGL.
Versuchsanst. 164 [U]

Antidesma subtype.
P = 26 μ E = 18,5 μ P:E = 1,40.

Maesobotrya floribunda BENTH.
Lebrun 1039 [U]

Antidesma subtype.
P = 21 μ E = 15 μ P:E = 1,40.

Maesobotrya dusenii (PAX) HUTCH.
Zenker 221 [U]

Antidesma subtype.

Securinega congesta MUELL. ARG.
Black 2432 [U]

Antidesma subtype.
P = 45 μ E = 26 μ P:E = 1,73.
m:e < 0,5.

Baccaurea subtype

Pollen grains tricolporate; subprolate – prolate sphaeroidal.

Colpus transversalis small. Outer ends indistinct and diffuse. Edges of the costae transversales parallel.

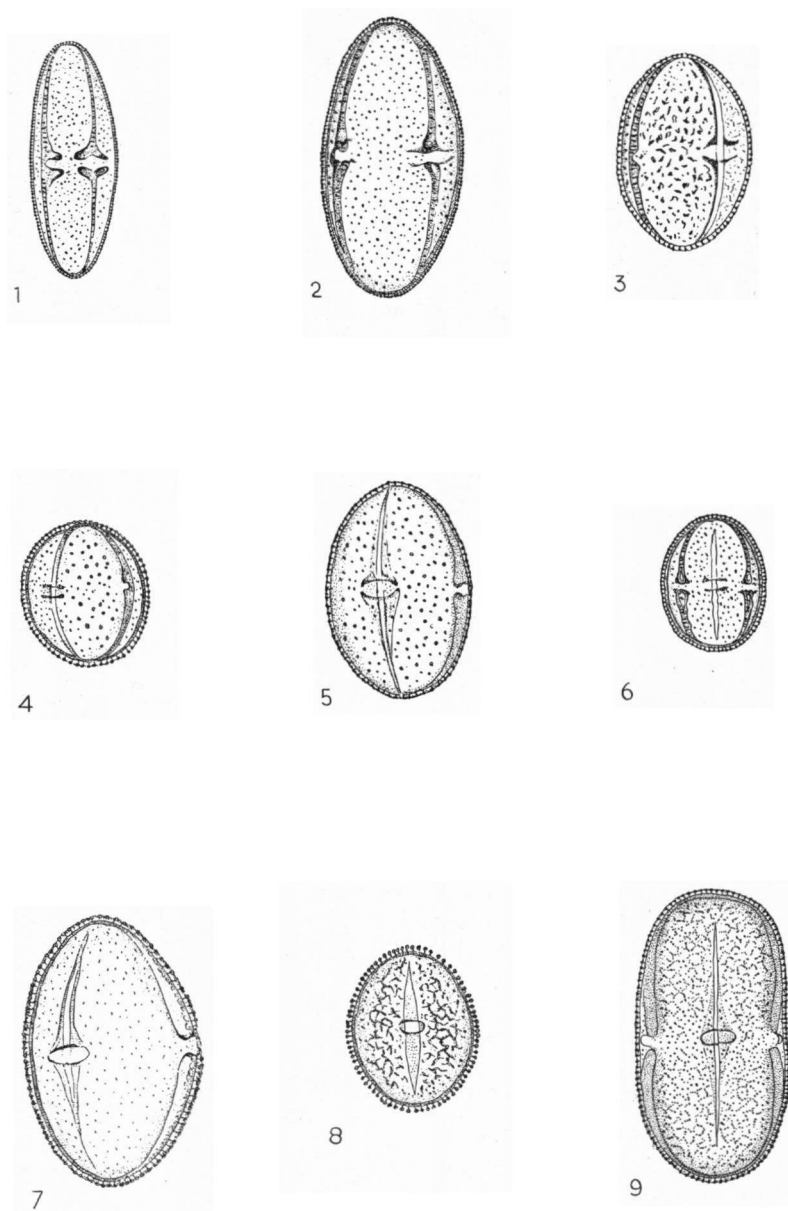

PLATE II. 1. *Hyeronima laxiflora*; 2. *Antidesma bunius*; 3. *Protomegalaria macrophylla*; 4. *Aporosa lindleyana*; 5. *Phyllanthus pentaphyllus*; 6. *Baccaurea sumatrana*; 7. *Reverchonia arenaria*; 8. *Margaritaria nobilis*; 9. *Phyllanthus niruri*.

In its exine structure this subtype is related to the *Antidesma* subtype. The pollen grains, however, are less elongated and the colpus transversalis is smaller.

Baccaurea sumatrana (MIQ.) MUELL. ARG.
Hort. Bog. VI C. 185 A [U] Pl. II, 6

Baccaurea javanica (BLUME) MUELL. ARG.
Hort. Bog. 344 [U]

Baccaurea racemosa (REINW. ex BLUME)
MUELL. ARG.

Hort. Bog. 553 [U]

Baccaurea oxycarpa GAGNEP.
(= *Gatnaia annamica* GAGNEP.)

Eberhardt 3042 [P]

Aporosa lindleyana (WIGHT) BAILL.
Hohenacker 352 [U] Pl. II, 4

Aporosa dioica (ROXB.) MUELL. ARG.
King 298 [U]

Aporosa frutescens BLUME
Herb. Utrecht 022876
Collector unknown.

Baccaurea subtype; subprolate.

P = 19 μ E = 15 μ P:E = 1,33.
P.A.I. = 0,35 — 0,3.

Baccaurea subtype.

Idem *Baccaurea sumatrana*.

Baccaurea subtype.

Idem *Baccaurea sumatrana*.

Baccaurea subtype.

P = 21 μ E = 16 μ P:E = 1,31.

Baccaurea subtype.

P = 19 μ E = 17,5 μ P:E = 1,10.
P.A.I. = 0,2 — 0,25

Baccaurea subtype.

Idem *Aporosa lindleyana*.

Baccaurea subtype.

Idem *Aporosa lindleyana*.

Phyllanthus pentaphyllus subtype

Pollen grains tricolporate; prolate — subprolate.
Colpus transversalis small; outer ends almost distinct.
Edges of the costae transversales rounded at the end.

The difference with the *Antidesma* subtype and *Baccaurea* subtype is found in the colpus transversalis.

There is also a relation with the *Phyllanthus niruri* subtype. The latter subtype, however, is 4 — colporate.

Phyllanthus pentaphyllus WRIGHT ex
GRISEBACH

Boldingh 7378 [U] Pl. II, 5

Phyllanthus sublanatus SCHUM. et THONN.
de Wit 1010 [WAG]

Phyllanthus stipulatis (RAF.) WEBSTER
Geyskes 13 [U]

Phyllanthus amarus SCHUM.

B. W. 10 [U]
de Wit 474 [WAG]

Reverchonia arenaria A. GRAY
Warnock 10723 [U] Pl. II, 7

Savia erythroxyloides GRISEB.
Wright 1434 [BM]

Phyllanthus pentaphyllus subtype; prolate.

P = 32 μ E = 22,5 μ P:E = 1,43.

m:e = 0,5 P.A.I. = 0,3.

Phyllanthus pentaphyllus subtype.

P = 45 μ E = 30 μ P:E = 1,50.

P.A.I. = 0,45.

Phyllanthus pentaphyllus subtype.

P = 24 μ E = 17,5 μ P:E = 1,37.

Phyllanthus pentaphyllus subtype.

P = 35,5 μ E = 27 μ P:E = 1,32.

Phyllanthus pentaphyllus subtype.

P = 37 μ E = 30 μ P:E = 1,60.

m:e = ca. 0,4.

Phyllanthus pentaphyllus subtype.

P = 32 μ E = 26 μ P:E = 1,24.

m:e < 0,5 P.A.I. = 0,25.

Phyllanthus niruri subtype

Pollen grains stephanocolporate (4); prolate.
Colpi transversales; costae transversales. Edges of the colpus transversalis rounded at the end.

Except for the number of colpi the *Phyllanthus niruri* type is in all its characters identical with the *Phyllanthus pentaphyllus* subtype.

As in the *Phyllanthus pentaphyllus* subtype the columellae are sometimes fairly coarse. The surface pattern seems to form a reticulum. This is however a "pseudo-reticulum" (p. 14). Only in *Phyllanthus niruri* a real reticulum formed by a regular arrangement of several columellae was seen. This reticulum was only to be seen with a phase-contrast microscope and then very indistinctly.

Phyllanthus niruri LINN.
Fuertes 89 [U] Pl. II, 9

Phyllanthus niruri subtype.
P = 39 μ E = 21 μ P:E = 1,86.
P.A.I. > 0,5. Indistinct intra-reticulate.

Phyllanthus guianensis KLOTZ.
B.W. 4599 [U]
Phyllanthus hyssopifolioides H.B.K.
Focke 1278 [U]

Phyllanthus niruri subtype.
P = 36 μ .
Phyllanthus niruri subtype.
P = 30 μ E = 18 μ P:E = 1,67.

Phyllanthus urinaria LINN.
Lanjouw 246 [U]

Phyllanthus niruri subtype.
Too young.

Chonocentrum cyathoforum (MUELL. ARG.)
PIERRE ex PAX et K. HOFFMANN
Spruce 3781 [P]

Antidesma type; tricolporate.
Colpus transversalis with costae.
P:E > 1.
Too young to give it a definite place
in the *Antidesma* type.

Securinega type

Tricolporate or stephanocolporate (4); subprolate – sphaeroidal (rarely oblate sphaeroidal).
Colpus transversalis small, circular or broad elliptic; costae.
Colpi narrow; costae colpi usually developed.
Intectate: distinctly reticulate; lumina 1–2 μ .
Pollen grains small (smaller 30 μ , usually 15–25 μ).

This type has small pollen grains with circular or broad elliptic colpi transversales. The reticulum is distinct and usually fairly coarse in comparison with the small pollen grains.

Taxonomic discussion

The *Securinega* type comprises, besides the genus *Securinega* (and *Flueggia*), many species of *Phyllanthus* and the small genera *Margaritaria* and *Astrocasia*. These genera are all closely related (WEBSTER, 1956).

The genus *Aporosella*, in PAX's system placed close to *Aporosa*, should be reduced to a section of *Phyllanthus* according to WEBSTER (1956). One of the principal reasons which led him to this conclusion is the close relation to *Phyllanthus acidus*. In fact, the pollen grains of *Phyllanthus elsiae*, belonging to the section *Aporosella*, are closely related to those of *Phyllanthus acidus* (p. 26).

Securinega subtype

Pollen grains subprolate – prolate sphaeroidal.
Colpus transversalis circular or broad elliptic.

Pollen grains of the *Securinega* subtype have always a P : E > 1. The shape of the colpus transversalis is circular to broad elliptic.

Securinega suffruticosa (PALLAS) REHDER
Cantonspark (Baarn)

Securinega subtype.
P = 22,5 μ E = 21 μ P:E = 1,08.
P.A.I. = 0,25 — 0,3. Lumina 1–2 μ .

- Securinega ramiflora* (AITON) MUELL. ARG. *Securinega* subtype.
Linsley Gressitt 229 [U] P = 23,5 μ E = 20 μ P:E = 1,17.
- Securinega neopeltandra* (GRISEB.) URBAN *Securinega* subtype.
ex Pax et K. Hoffmann P:E = 1,18 Lumina < 1 μ .
Shafer 12080 [U]
- Securinega virosa* (ROXB. ex WILLD.) BAILL. *Securinega* subtype.
Reichs-Kolon. 506 [U] Pl. III, 2
- Margaritaria nobilis* LINN. F. *Securinega* subtype.
Soeprata 2D [U] Pl. II, 8 P = 22,5 μ E = 19,5 μ P:E = 1,15.
m:e > 0,5 P.A.I. = ca. 0,25.
Lumina ca. 1 μ .
- Astrocasia tremula* (GRISEB.) WEBSTER *Securinega* subtype.
Gaumer et Sens 1261 [K] P = 29 μ E = 25,5 μ P:E = 1,14.
m:e ca. 1 P.A.I. = 0,3.
Lumina 1-2 μ .
- Phyllanthus reticulatus* POIR. *Securinega* subtype.
de Wit 128 [WAG] P = 18 μ E = 16,5 μ P:E = 1,09.
Bakhuizen v. d. Brink 3540 [U] P.A.I. = 0,25. Lumina ca. 1 μ .
- Phyllanthus discoideus* MUELL. ARG. *Securinega* subtype.
Leeuwenberg 2789 [U] P = 22,5 μ E = 18 μ P:E = 1,25.
Costae colpi. P.A.I. = 0,3.
Lumina 1-2 μ .
- Phyllanthus capillaris* SCHUM. et THONN. *Securinega* subtype.
De Wit 229 [WAG] Pl. III, 1 Stephanocolporate (4) or tricolporate.
P = 21,5 μ E = 20,5 μ P:E = 1,05.
P.A.I. = 0,5.
- Phyllanthus acuminatissima* C. B. ROBB. *Securinega* subtype.
Elmer 15662 [U] P = 22,5 μ E = 18 μ P:E = 1,25.
P.A.I. = 0,25. Lumina ca. 1 μ .
- Richierella gracilis* (MERR.) PAX et *Securinega* subtype?
K. HOFFMANN Too young for reliable measurements,
Hyting 65438 [K] but colpus transversalis distinctly circular.

Phyllanthus acidus subtype

Pollen grains tricolporate; sphaeroidal - oblate sphaeroidal.
Colpus transversalis circular.

Unlike the *Securinega* subtype the pollen grains of the *Phyllanthus acidus* subtype are spheroidal or sometimes slightly oblate spheroidal. The colpus transversalis is always circular. The exine structure is in all respects the same as in the *Securinega* subtype.

- Phyllanthus acidus* (LINN.) Skeels *Phyllanthus acidus* subtype.
Versteeg 566 [U] P = E = 17,5 μ P:E = ca. 1.
P.A.I. = 0,2 - 0,3.
- Phyllanthus muellerianus* (O. KUNTZE) *Phyllanthus acidus* subtype.
EXELL Colpi very short. Too young.
Zenker 253 [U]
- Phyllanthus elsiae* URBAN *Phyllanthus acidus* subtype.
Krug and Urban 4789 [L] Pl. III, 3 P = E = 20 μ . P.A.I. > 0,5.

Richeria type

Tricolporate; subprolate.
Colpus transversalis narrow; costae.
Colpi narrow.
Tectate (?); intra-reticulate. Lumina ca. 1 μ .

The *Richeria* type is an intermediate type between the *Antidesma* type and the *Securinega* type. The narrow elongated colpus transversalis

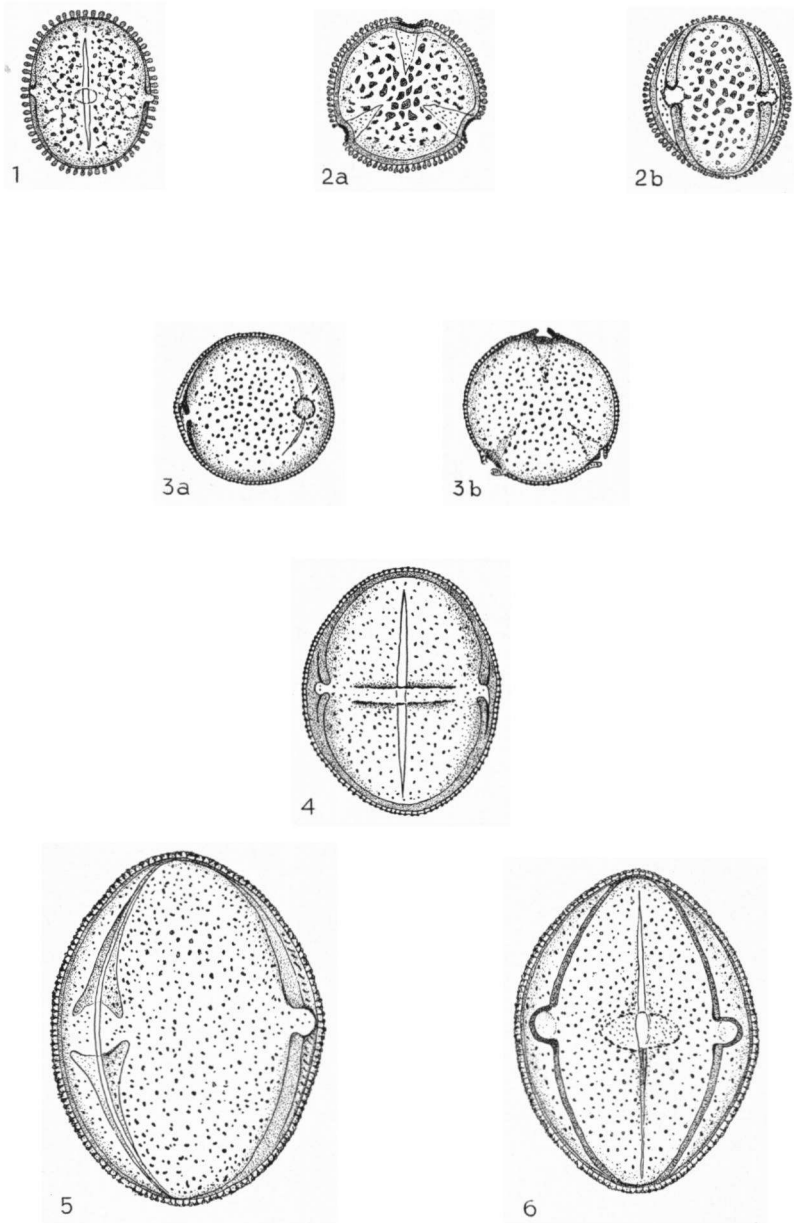

PLATE III. 1. *Phyllanthus capillaris*; 2. *Securinega virosa*; 3. *Phyllanthus elsiae*; 4. *Drypetes glauca*; 5. *Actephila excelsa*; 6. *Andrachne phyllanthoides*.

is typical of the *Antidesma* type, but the distinct, rather coarse reticulum is characteristic of the *Securinega* type.

Taxonomic discussion

PAX and K. HOFFMANN (1931) as well as BENTHAM (1880) placed this genus in the *Antidesminae*. It occurs in the New World.

Richeria laurifolia BAILL. ex MUELL. ARG. *Richeria* type; prolate.
Krukoff 8776 [U] P = 29 μ E = 24 μ P:E = 1,21.
Lumina ca. 1 μ .

Dicoelia type

Tricolporate; prolate – subprolate.
Colpus transversalis broad and elongated to broadly elliptic; costae.
Colpi narrow; costae colpi.
Tectate, psilate; sometimes intra-reticulate.
Pollen grains of medium size (ca. 25 μ – 50 μ).

The *Dicoelia* type possesses elements of the *Antidesma* type as well as of the *Securinega* type. The pollen grains have always a Polar axis of at least 25 μ ; usually between 30 μ and 55 μ . The colpus transversalis is large; broad and elongated or broadly elliptic, but never circular.

Taxonomic discussion

PAX and K. HOFFMANN (1922, 1931) included the genus *Dicoelia* in the *Antidesminae* for its elongated inflorescences. However, the loose, often androgynous clusters along the rachis of the racemes is different from any inflorescence in the *Phyllanthoideae* (BENTHAM 1880).

Dicoelia subtype

Colpus transversalis broad and elongated; m:e < 0,4.
Usually not intra-reticulate.

Dicoelia affinis J. J. SMITH
Hallier 1255 [U]

Dicoelia subtype.
P = 44 μ E = 32 μ P:E = 1,37.
m:e < 0,4 P.A.I. = 0,3.
Indistinct reticulate.

Drypetes glauca VAHL
Sintenis 5111 [U] Pl. III, 4

Dicoelia subtype.
P = 34 μ E = 27 μ P:E = 1,26.
m:e < 0,25 P.A.I. = 0,25.

Drypetes macrophylla (BLUME) PAX et
K. HOFFMANN
Bogor VIII F. 48 [U]

Dicoelia subtype.
P = 45 μ E = 40 μ P:E = 1,16.
m:e < 0,4 P.A.I. = 0,35.
Intra-reticulate.

Drypetes laterifolia (SWARTZ) KRUG et
URBAN
Fuertes 824 [U]

Dicoelia subtype.

Drypetes variabilis UITT.
B.W. 6481 [U]

Dicoelia subtype.

Andrachne subtype

Colpus transversalis broadly elliptic; m:e = ca. 0,5 or larger.
Usually intra-reticulate.

- Andrachne phyllanthoides* (NUTT.) MUELL. ARG.
Bush 14843 [U] Pl. III, 6
- Andrachne telephioides* LINN.
Dalmatië 1937, 50 [U]
- Andrachne colchica* FISCH. et MEYER
Cult. Hort. Canton (Baarn) 4884 [U]
- Andrachne aspera* SPRENG.
Pappi 4892 [U]
- Actephila excelsa* (DALZ.) MUELL. ARG.
Hort. Bog. VII B. 271 [L] Pl. III, 5
- Poranthera corymbosa* BRONG.
Constable 30096 [U]
- Poranthera microphylla* BRONG.
Hastings [U]
- Andrachne* subtype.
P = 45 μ E = 35,5 μ P:E = 1,27.
m:e = 0,5 P.A.I. = 0,2. Indistinct
costae colpi.
- Andrachne* subtype.
Intra-reticulate.
- Andrachne* subtype.
- Andrachne* subtype.
P = 43 μ E = 31 μ P:E = 1,40.
m:e > 0,5. P.A.I. = 0,3.
Longitudinal striation.
- Andrachne* subtype.
P = 48 μ E = 37 μ P:E = 1,36.
P.A.I. = 0,3. Costae colpi.
- Andrachne* subtype.
P = 34 μ E = 29,5 μ P:E = 1,15.
m:e ca. 0,5 P.A.I. = 0,25.
Tectum perforatum; lumina of the
intra-reticulum 2-3 μ .
- Andrachne* subtype.
P = 24 μ E = 19,5 μ P:E = 1,23.
Tectate; intra-reticulate; lumina ca.
1 μ .

Zimmermannia type

Tricolporate; prolate spheroidal.
Colpus transversalis small; costae.
Colpi narrow.
Tectate; verrucate.

The *Zimmermannia* type is the only type in the Phyllanthoideae with verrucae. Except for this remarkable character the pollen grains belong without doubt in the *Antidesma* configuration.

Zimmermannia capillepes PAX
Fl. Usambarica 5862 [BM] Pl. IV, 1

Zimmermannia type.
P = 58 μ E = 51 μ P:E = 1,12.
m:e > 0,5 P.A.I. = 0,25.

Leptonema type

Tricolporate; subprolate.
Colpus transversalis broad and large; costae narrow.
Colpi narrow; costae colpi absent.
Tectate; psilate. The columellae are so small, that they are hardly visible.

The *Leptonema* type has some relation with the *Dicoelia* type (p. 28). The type misses, however, the costae colpi. It differs from the *Antidesma* type (p. 21) by the broad and elongated colpus transversalis.

Taxonomic discussion

PAX and K. HOFFMANN (1922, 1931) placed in the subtribe Glochiidiinae *Leptonema* together with *Glochidion* and *Breyenia*. It seems better to keep *Leptonema* in the vicinity of *Phyllanthus* and its allied genera, as stated by BENTHAM (1880).

Leptonema venosa (POIR.) A. DE JUSS.
D'Alleizette 6405 Mad.
Nov. 1905 [L] Pl. IV, 2

Leptonema type.
P = 27 μ E = 22,5 μ P:E = 1,21.
m:e < 0,5 P.A.I. = 0,5.

PleioSTEMON type

Tricolporate; prolate spheroidal.

Colpus transversalis; costae; $m:e$ larger 1; $m = 6-8 \mu$.

Colpi narrow; costae colpi. P.A.I. small. Pollen grains sometimes syncolpate. Tectate; psilate.

The *PleioSTEMON* type belongs undoubtedly to the *Antidesma* configuration. The colpus transversalis however differs from all other types by its meridional elongation. The $m:e$ is larger than 1. Moreover, the colpi are very long. Sometimes the pollen grains are even syncolpate (colpi anastomosing at the poles).

Taxonomic discussion

The genera belonging to this type are without doubt related to *Phyllanthus* and its allied genera. MUELLER (1866) reduced the genus *PleioSTEMON* to a section of *Phyllanthus* and BENTHAM (1880) referred it to *Securinega*. In the system of PAX and K. HOFFMANN (1931) *PleioSTEMON* is maintained as a genus close to *Phyllanthus*. On the other hand, *Lingelsheimia* is found in the subtribe Drypetinae in their system. Corresponding characters are:

1. In the male flowers an extrastaminal disc present and an ovarium rudiment wanting.
2. In the female flowers an annular disc and bifid styles present.
3. Calyx is 6-partite (in *PleioSTEMON* the male flower is sometimes 4-5-partite. Petals are absent.
4. Plants monoecious and only found in Africa and Madagascar (*Dangyodrypetes*).

PleioSTEMON verrucosus SONDER
Cooper 312 [BM] Pl. IV, 3

PleioSTEMON type.
 $P = 20 \mu$ $E = 19,5 \mu$ $P:E = 1,03$
 $m:e > 1$ P.A.I. $< 0,2$.

Lingelsheimia frutescens PAX
Lebrun 3855 [K] Pl. IV, 4

PleioSTEMON type.
 $P = 22,5 \mu$ $E = 21 \mu$ $P:E = 1,07$.
P.A.I. = 0,1.

Dangyodrypetes ambigua LÉANDRI
Serv. Eaux et Forests 7675 [P]

PleioSTEMON type.
 $P = 24 \mu$ $E = 22,5 \mu$ $P:E = 1,07$.
P.A.I. almost syncolpate-syncolpate.

Heywoodia type

Tricolporate; prolate spheroidal.

Colpus transversalis broad; costae absent; $m:e$ ca 1.

Colpi narrow; costae colpi absent.

Tectate; psilate. Columellae distinct.

As the Polar axis is larger than the Equatorial axis the type is placed in the *Antidesma* configuration. There is, however, a possibility that *Heywoodia* is wrongly placed in this configuration because of the absence of costae.

Heywoodia lucens SIM
Bally 5133 [K] Pl. IV, 5

Heywoodia type.
 $P = 27,5 \mu$ $E = 25,5 \mu$ $P:E = 1,08$.
 $m:e$ ca. 1 P.A.I. = 0,3.

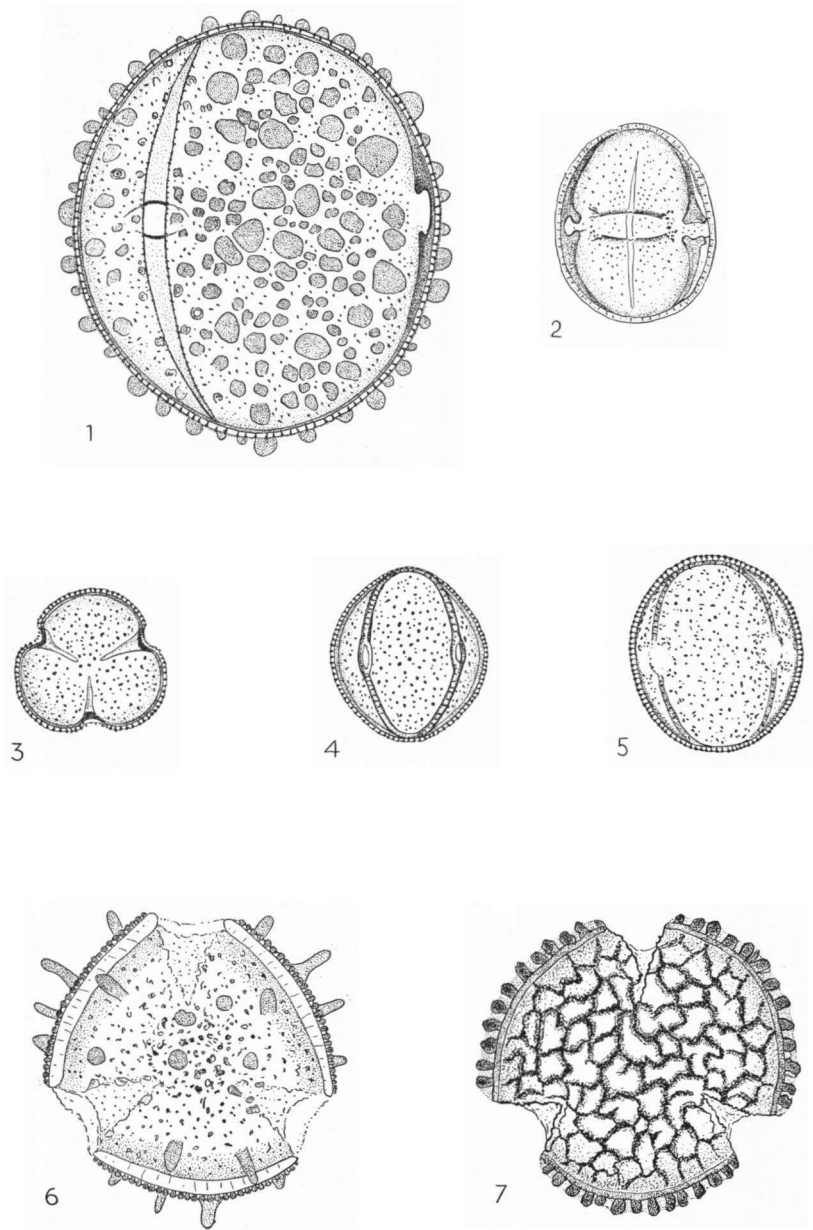

PLATE IV. 1. *Zimmermannia capillepes*; 2. *Leptonema venosa*; 3. *PleioSTEMON verrucosus*; 4. *Lingelsheimia fruticosa*; 5. *Heywoodia lucens*; 6. *Amanoa guianensis*; 7. *Pseudolachnostylis glauca*.

AMANOVA CONFIGURATION

Tricolporate-stephanocolporate (4-5). Pollen grains usually with a P. shorter than the E.

Colpus transversalis usually with costae.

Pollen grains reticulate. Rarely not reticulate (some species of *Amanoa* and the *Discocarpus* type).

The *Amanoa* configuration includes pollen types with a Polar axis shorter than the Equatorial axis and lesser than six (usually 3-4) colpi. The pollen grains are reticulate except in a few species. These latter species, however, have so many characters in common with related reticulate species, that there is no doubt that they belong to the same type.

As in the *Antidesma* configuration the types are difficult to separate. Especially the *Amanoa* type and *Savia* type are closely related.

Taxonomic discussion

The genera belonging to this configuration are all closely related. The division of the pollen grains into four types is not found again in the systems of MUELLER, BENTHAM and PAX and K. HOFFMANN.

MUELLER (1866) removed *Briedelia* and *Cleistanthus* to a distinct subtribe on account of their valvate calyx (nearly all the other genera in Phyllanthoideae have an imbricate calyx). For this reason PAX and K. HOFFMANN (1931) also placed these genera in a special tribe. BENTHAM (1880) took less account of the imbricate calyx and found, in the remaining characters, much affinity with *Amanoa*. So he placed *Briedelia* and *Cleistanthus* in close proximity of *Amanoa*. The pollen grains of *Cleistanthus* cannot be separated from those of *Savia*. Except for the longitudinal striation the pollen grains of the *Briedelia* type are also very close related to those of the *Savia* type. From these results it is clear that pollen morphology supports the statement of BENTHAM.

BENTHAM (1880) discussed *Uapaca* in the group of the *Antidesminae*. PAX and K. HOFFMANN (1931) established a special subtribe for this genus. Although the pollen grains belong to the *Savia* type it seems better to keep this genus out of the subtribes with a *Savia* type. The involucre and the absence of a disc in the male flower are characters too divergent for placing *Uapaca* in the vicinity of any other genus with a *Savia* type.

In the system of PAX and K. HOFFMANN (1931) the remaining genera of the *Amanoa* configuration are divided into four subtribes. 1. *Wielandinae*. 2. *Amanoinae*. 3. *Discocarpinae*. 4. *Pseudolachnostylidinae*.

In these subtribes the following genera do not have the typical characters of the *Amanoa* configuration.

1. *Astrocasia*. According to WEBSTER (1956) the genus is related to *Securinea*. The pollen grains undoubtedly belong to the *Securinea* type.
2. *Actephila*. The genus is classified together with *Amanoa* by all authors. *Actephila excelsa*, however, possesses pollen grains of the *Dicoelia* type. Examination of the pollen grains of other species is necessary.

3. *Chonocentrum*. The pollen grains of *Chonocentrum* belongs without doubt to the *Antidesma* type (p. 21).
4. *Savia erytroxyloides*. Pollen grains of this *Savia* species belong to the *Phyllanthus pentaphyllus* subtype.

The remaining genera have the following characters in common:

1. The calyx is 5-partite.
2. Frequently petals are present.
3. Male as well as female flowers have a disc.
4. In the male flowers an ovarium rudiment is present.
5. Stamens are often connated into a column.
6. Seeds never have a caruncula.

Amanoa type

Tricolporate-stephanocolporate (4-5); suboblate-oblate spheroidal.

Colpus transversalis broad; ora large; costae usually present.

Colpi wide; no costae colpi.

Tectate or intectate; reticulate or not reticulate.

If the pollen grains are reticulate the lumina are at least 3 μ in diameter.

When the pollen grains are not reticulate the structure elements are tall and at least 4 μ .

Exine very thick, at least 4 μ .

The *Amanoa* type is characterised by a coarse reticulum and a thick exine.

The reticulum of the *Amanoa* type had to be considered as an intrareticulum since the muri are connected by a thin membrane, which covers the lumina.

Some species of *Amanoa* lack the coarse reticulum. *Amanoa guianensis* has a tectum provided with long baculae or echinae. The columellae of *Amanoa grandiflora* are, in optical section, gemma shaped and inordinate arranged. In both *Amanoa* species the exine is, however, more than 4 μ thick.

Amanoa oblongifolia MUELL. ARG.
Krukoff 7015 [U] Pl. V, 1

Amanoa type.

P = 33,5 μ . E = 43 μ P:E = 0,78.
Colpi wide. P.A.I. = 0,25. Lumina
up to 11,5 μ .

Amanoa grandiflora MUELL. ARG.
Murca Pires 835 [U]

Amanoa type.

P = 39 μ E = 45 μ P:E = 0,87.
P.A.I. = 0,5. Not reticulate. Columel-
lae gemma shaped, inordinate ar-
ranged.

Amanoa bracteosa PLANCH.
D'Alleizette 6392 [L]

Amanoa type. E = 80 μ .

Lumina up to 10 μ . P.A.I. = 0,4.

Amanoa boiviniiana BAILL.
D'Alleizette Mad. Nov. 1906 [L]

Amanoa type.

P = 37,5 μ E = 45 μ P:E = 0,83.
P.A.I. = 0,4 — 0,5.
Lumina up to 4 μ .

Amanoa guianensis AUBL.
Bafog S.F. 1192 [U]
Wood Herb. 28 [U] Pl. IV, 6

Amanoa type.

P = 46 μ E = 52 μ P:E = 0,88.
P.A.I. = 0,3. Costae transversalis. Col-
lumellae very short. Baculate-echinate;
baculae up to 7 μ . Endexine thick.

- Pentabraction reticulatum* (MUELL. ARG.) *Amanoa* type; 3-4 colporate.
 JANTZON P = 45 μ E = 48 μ P:E = 0,94.
 Zenker 2982 [L] Lumina up to 5 μ . P.A.I. = 0,4-0,5.
 Costae transversales.
- Pseudolachnostylis glauca* (HIERN) HUTCH. *Amanoa* type; 2-3 colporate.
 Lanjouw 1181 [U] Pl. IV, 7 P = 31 μ E = 34 μ P:E = 0,91.
 Lumina up to 4,5 μ .

Savia type

Tricolporate-stephanocolporate (4); subolate-prolate spheroidal.
 Colpus transversalis usually narrow; ora small. Rarely colpus transversalis broad and ora large (*Cleistanthus ferrugineus*).
 Colpi narrow; sometimes costae colpi present.
 Tectate or intectate; reticulate. Lumina of the reticulum 3 μ or smaller.
 Exine is medium thick, lesser than 4 μ but still distinct.

In many respects the *Savia* type resembles the *Amanoa* type. The lumina of the reticulum are, however, distinctly smaller. Since the pollen grains are also relatively smaller this difference is perhaps not of fundamental importance, but, besides the smaller lumina, the colpi are narrow and the ora small, so it seems better to separate the pollen grains of the *Savia* type from those of the *Amanoa* type.

Some species with a *Savia* type (*Cluytiandra madagascariensis*, *Lachnostylis hirta*) have a Polar axis larger than the Equatorial axis. By this character the pollen grains should be placed in the *Antidesma* configuration. The exine structure, however, is quite different from the *Antidesma* configuration and is, on the other hand, in full agreement with the *Savia* type.

- Savia andringitrana* LÉANDRI
 Decary 1926 [L] *Savia* type.
 P = 26 μ E = 29 μ P:E = 0,88.
 m:e < 0,5. P.A.I. = 0,4.
 Colpi narrow and short. Lumina 3 μ .
 Costae transversales.
- Sa. ia sessiliflora* (Sw.) WILLD.
 Eggers 1905 [P] *Savia* type.
 P = 24,5 μ E = 29 μ P:E = 0,85.
 P.A.I. = 0,3.
- Blotia oblongifolia* (BAILL.) LÉANDRI
 D'Alleizette [L] *Savia* type.
 Mad. 4 Mai. 1918 P = 25,5 μ E = 28,5 μ P:E = 0,89.
 P.A.I. = 0,45.
 Colpi short and narrow. Lumina 1-2 μ .
- Wielandia elegans* BAILL.
 D'Alleizette Seych. [L] *Savia* type. 3-4 colporate.
 P = 37 μ E = 41,5 μ P:E = 0,88.
 P.A.I. = 0,65. Lumina = 1-2 μ .
 Colpi narrow and short.
- Lachnostylis hirta* (LINN. F.) MUELL. ARG.
 [= *Discocarpus hirtus* (LINN. F.) PAX et
 K. HOFFMANN]
 Bolus 2396 [K] *Savia* type; prolate spheroidal.
 P = 37 μ . E = 35 μ P:E = 1,05.
 P.A.I. = 0,3. Colpus transversalis with
 costae. Lumina 1-2 μ .
- Cluytiandra madagascariensis* LÉANDRI
 D'Alleizette Mad. 6402 [L] *Savia* type; prolate spheroidal.
 P = 32 μ E = 31 μ P:E = 1,04.
 P.A.I. = 0,3. Costae transversales. Reticulum indistinct. Lumina 1-2 μ .
- Cleistanthus winkleri* JABL.
 Bogor IX C. 165 A. [U] *Savia* type. E = 32 μ .
 Costae colpi.
- Cleistanthus dichotomus* J. J. SMITH
 Gjellerup 142 [U] *Savia* type.

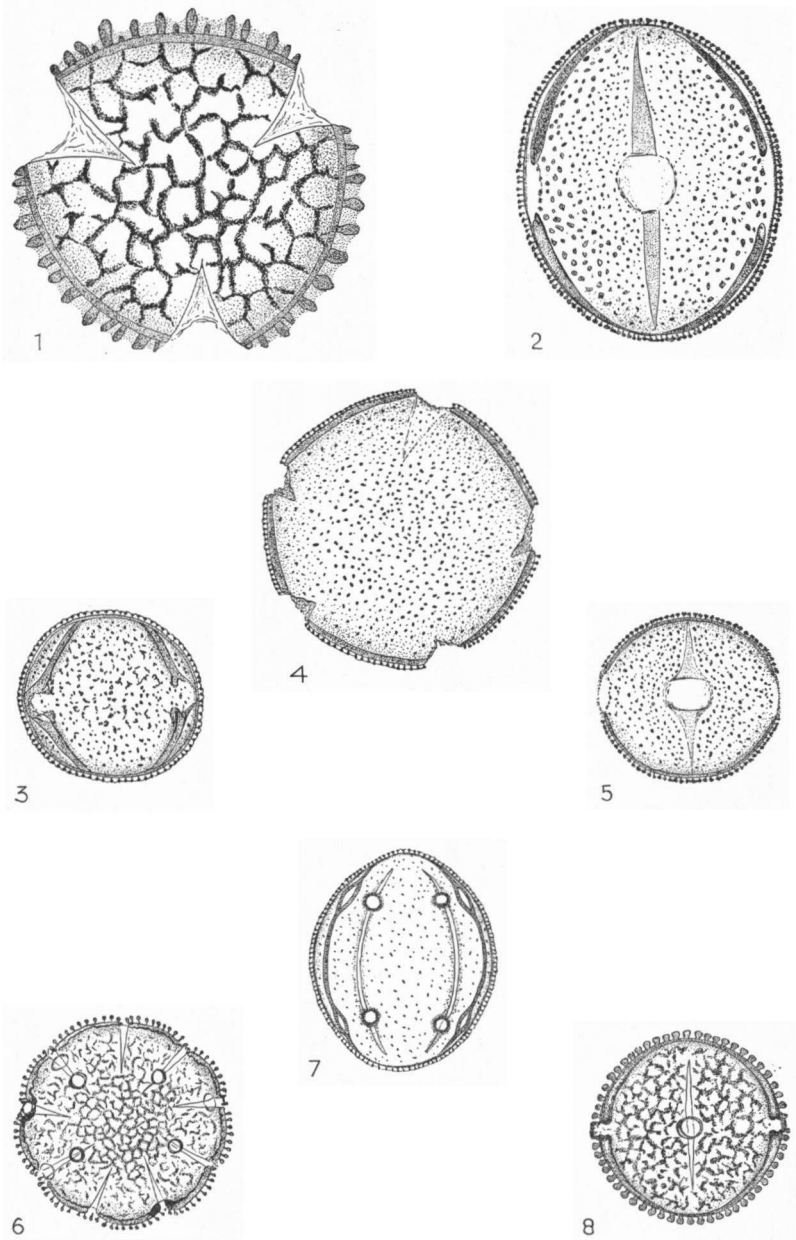

PLATE V. 1. *Amanoa oblongifolia*; 2. *Cleistanthus ferrugineus*; 3. *Uapaca heudelotii*; 4. *Discocarpus essequeboensis*; 5. *Briedelia monoica*; 6. *Breynia fruticosa*; 7. *Breyniopsis pierrei*; 8. *Glochidion sericeum*.

Cleistanthus ferrugineus MUELL. ARG.
Hort. Bogor. IX C. 43 A. [U] Pl. V, 2

Savia type; prolate.
P = 44 μ E = 33 μ P:E = 1,34.
P.A.I. = 0,4—0,5.
Colpus transversalis isodiametric; no costae; ora large. Lumina 1–2 μ .

Uapaca heudelotii BAILL.
Zenker 59 [U] Pl. V, 3

Savia type; oblate spheroidal.
P = 22 μ E = 25 μ P:E = 0,88.
m:e < 0,5. P.A.I. = 0,5. Tectate.

Uapaca kirkiana MUELL. ARG.
Stolz 622 [U]

Savia type.
P = 27 μ E = 29,5 μ P:E = 0,93.
Tectate.

Briedelia type

Tricolporate; oblate spheroidal.
Colpus transversalis broad; costae.
Colpi narrow at the ends, broadened in the equatorial part. Sometimes costae colpi present.
Intectate; reticulate. Lumina small and in chains along the colpi (pseudostriate). Muri distinct but not tall.

This type is closely related to the *Savia* type. The greatest difference is found in the longitudinal arrangement of the lumina of the reticulum. The chains of lumina give the pollen grains a striate appearance, which is, however, only a "pseudo-striation": a striation not caused by individual columellae but by the lumina of the reticulum which are, of course, composed of several columellae.

Briedelia monoica (LOUR.) MERR.
Endert E 1066 [U] Pl. V, 5

Briedelia type.
P = 24 μ E = 25,5 μ P:E = 0,94.
m:e > 0,5. P.A.I. = 0,35. Lumina < 1 μ .

Briedelia glauca BLUME
Winckel 865 B [U]

Briedelia type. E = 31 μ .

Briedelia assamica J. D. HOOK.
Herb. East Ind. Comp. 4890 [U]

Briedelia type. E = 31 μ . Lumina 1–2 μ .

Briedelia stipularis (LINN.) BLUME
v. Leeuwen-Reynvaan [U]

Briedelia type. E = 42 μ .
m:e < 0,5. P.A.I. = 0,25.

Godefroya rotundata (JABL.) GAGNEPAIN
Gourgaud [P]

Briedelia type.
P = 32 μ E = 33,5 μ P:E = 0,96.
P.A.I. = 0,25. Costae colpi.

Discocarpus type

Stephanocolporate (4–5); oblate spheroidal.
Colpus transversalis small; no costae present.
Colpi narrow. No costae colpi present.
Tectate, psilate. Not reticulate.

The *Discocarpus* type is an intermediate type between the types of the *Amanoa* configuration and the types of the *Antidesma* configuration. The small columellae and the absence of a reticulum are characters in favor of placing the type in the *Antidesma* configuration. On the other hand the oblate shape, the absence of costae and the 4–5 colpi are more in agreement with the *Amanoa* configuration. For these latter reasons it seems better to discuss the type in the *Amanoa* configuration.

Discocarpus essequeboensis KLOTZSCH
Schomburgk 659 [U] Pl. V, 4

Discocarpus type.
P = 34,5 μ E = 37 μ P:E = 0,94.
Ora small; m:e > 0,5. P.A.I. = 0,6.

PHYLLANTHUS NUTANS CONFIGURATION

Pollen grains with an areolate structure.

Taxonomic discussion

After a proposal of IVERSEN, ERDTMAN recommended the term areolatus for the structure described under *Phyllanthus nutans* type (1947). The definition given by him is: "Pollen grains with small areas separated by small grooves forming a negative reticulum". WEBSTER (1956) states that the areolate pollen grains are mostly found in the New World. Some species of *Phyllanthus* in the Old World, however, have areolate pollen grains that are superficially very similar to those of the New World.

Phyllanthus nutans type

Periporate; the surface of the pollen grains is divided into pentagons or hexagons. The pori are situated in the angular points.
Pori small.

Intectate. From each aperture two rows of pila lead to the other apertures. In the centre of the penta- and hexagons the pila form an irregular reticulum.

Phyllanthus nutans SW.
Hooker, Jamaica [U] Pl. VI, 2

Phyllanthus adianthoides KLOTZSCH
Hulk 21 [U]

Phyllanthus speciosus JACQ.
Fresh material, Greenhouse Utrecht

Phyllanthus nutans type.
Longer axis 27,5 μ . Shorter axis 25 μ .
ca. 25 pori.

Phyllanthus nutans type.
Diam. = 17 μ .

Phyllanthus nutans type.
Diam. = 20 μ . Pori ca. 15.

Dendrophyllanthus type

Tricolporate (?); oblate.
Colpus transversalis circular; costae.
Colpi very narrow; operculum consisting of one row of pila.
Intectate; not reticulate.

Without doubt the pollen grains are related to the *Phyllanthus nutans* type in their exine structure. The surface of the pollen grains is divided into three regions, separated by strings of pila, the "colpi". Each "colpus" consists of three rows of pila. If the two outer rows represent the borders of the colpus, the inner row must be taken as an operculum. However, the space between the rows is so small, that it can hardly be regarded as a weak performed part in the ektexine (see definition aperture: Glossary). For this reason it is possible to defend the opinion, that the pollen grains of *Dendrophyllanthus* are triporate. In that case the rows of pila would only be an ornamental peculiarity. Nevertheless, the rows look so much like real colpi, that in the author's opinion it is better to maintain the pollen grains in the group of the tricolporate.

Dendrophyllanthus ripicolus GUILL.
Mackee 3629 [L] Pl. VI, 3

Dendrophyllanthus type.
P = 19,5 μ E = 27 μ P:E = 0,72.
m:e = ca. 1.

BREYNIA CONFIGURATION

Stephanocolporate (colpi sometimes with two ora).
 Colpus transversalis circular rarely somewhat elliptical; costae.
 Colpi narrow and long.
 Tectate or intectate.

By its exine structure the *Breynia* configuration is related to the *Antidesma* configuration. Most pollen grains, however, have a Polar axis shorter than the Equatorial axis as in the *Amanoa* configuration. The typical character of the number of colpi with often two circular colpi transversalis per colpus seem to justify this configuration.

Breynia type

Stephanocolporate (colpi diorate); oblate - subprolate.
 Usually two circular colpi transversales per colpus, some colpi have only one colpus transversalis; costae.
 Colpi narrow; sometimes costae colpi.
 Intectate or tectate; reticulate or not reticulate; lumina small.

The *Breynia* type is easily recognised by the large number of colpi (six or more) and the double circular colpi transversales. In the species of *Breynia* one of the two colpi transversales is often reduced. The remaining endexine aperture is never situated in the equatorial plane but towards the ends of the colpus.

Taxonomic discussion

Hitherto the genera belonging to this type have never been placed in one group by any author. MUELLER (1866) recognised the relationship of *Agyneia* with *Sauropus*, which opinion was shared by BENTHAM (1880) and PAX and K. HOFFMANN (1922, 1931). *Breynia* and *Glochidion*, on the other hand, are always distinguished as genera closely related to *Phyllanthus*. *Glochidion* is even often reduced to a section of *Phyllanthus*. PAX and K. HOFFMANN keep *Glochidion*, *Breynia* and *Breyniopsis* in the subtribe *Glochidiinae*. In the author's opinion the above genera should all be placed in one group (either subtribe or other taxon). They have the following corresponding characters:

1. The number of sepals is usually six (*Glochidion* sometimes fewer).
2. In the male flowers generally three connated stamens form a column. Connectives are frequently appendiculated. Anthers extrors. There is no ovarium rudiment nor a disc. As BENTHAM states, the scale-like thickenings at the base of the sepals of *Agyneia* and *Sauropus* are not to be regarded as disc glands.
3. In the female flowers disc glands are wanting.
4. The plants are generally monoecious (Some *Glochidion* species and *Arachnodes*, however, dioecious) and only occur in the Old World.

Breynia subtype

Pollen grains oblate spheroidal - oblate.
 Intectate; reticulate; lumina 1-2 μ .

- Breynia fruticosa* (LINN.) BENTH. *Breynia* subtype; oblate.
J. and M. S. Clemens 3182 [U] P = 21 μ E = 27 μ P:E = 0,76.
Beckler 2 [U] Pl. V, 6 Colpi transversales situated almost at
the end of the colpi. Colpi not always
provided with two colpi transversales.
Colpi 8-10. Lumina 1-2 μ .
- Breynia racemosa* (BLUME) MUELL. ARG. *Breynia* subtype; oblate.
Bakhuizen v. d. Brink [U] 5-6 colpi.
- Breynia nivosa* (W. G. SMITH) SMALL *Breynia* subtype.
Collector unknown. 7-8 colpi.
- Agyneia bacciformes* (LINN.) A. DE JUSSIEU *Breynia* subtype; oblate.
v. Leeuwen-Reynvaan 1978 [U] P = 27,5 μ E = 32,5 μ P:E = 0,85.
Always two colpi transversales present.
Colpi 5-6. Costae colpi.
- Sauropus androgynis* (LINN.) MERRILL *Breynia* subtype; oblate spheroidal.
Docters v. Leeuwen, Depok 7-5-'11 P = 25,5 μ E = 28 μ P:E = 0,90.
[U] 8-9 colpi.

Breyniopsis subtype

Pollen grains subprolate.
Tectate; not reticulate.

The pollen grains of *Breyniopsis* are related to the pollen grains of *Breynia* by the number of colpi and the double circular colpi transversales. The shape and structure are, however, quite different.

- Breyniopsis pierrei* BEILLE *Breyniopsis* subtype; subprolate.
Poilane 19777 [P] Pl. V, 7 P = 32,5 μ E = 28,5 μ P:E = 1,14.
Always two colpi transversales per
colpus. 6-7 colpi. Costae colpi.

Glochidion type

Stephanocolporate (4); spheroidal - prolate spheroidal.
Colpus transversalis circular or slightly elliptical; costae.
Colpi narrow.
Intectate or tectate; reticulate; lumina 1-2 μ .

In many morphological respects the *Glochidion* type is closely related to the *Breynia* type, as ERDTMAN (1952) and WEBSTER (1956) have stated. The pollen grains lack, however, the typical double colpus transversalis. It is also possible to place the type in the *Antidesma* configuration. Its single circular, sometimes broad elliptic endexine aperture and the distinct reticulum are characters in favour of a place in the *Securinega* type (p. 25).

- Glochidion sericeum* (BLUME) J. D. HOOKER *Glochidion* type; spheroidal. P = E =
Bakhuizen v. d. Brink 1886 [U] 24 μ . Colpi narrow. P.A.I. = 0,3-0,4.
Pl. V, 8 Lumina 1-2 μ . Intectate.
- Glochidion concolor* MUELL. ARG. *Glochidion* type.
Yuncker 15648 [U]
- Glochidion littorale* BLUME *Glochidion* type.
Bakhuizen v. d. Brink 3182 [U]
- Glochidion obscurum* (WILLD.) BLUME *Glochidion* type.
Buysman 295 [U]
- Glochidion ramiflorum* J. R. et G. FORSTER *Glochidion* type.
Yuncker 15717 [U]
- Glochidion superbum* BAILLON *Glochidion* type.
Dumas 1507 [U]

Glochidion spec.

Teyssman 4411 [U]
Arachnodes chevalieri GAGNEP.
 Fleury 31755 [P] Pl. VI, 1

Glochidion type.

Glochidion type; prolate spheroidal.
 $P = 25,5 \mu$ $E = 24 \mu$ $P:E = 1,06$.
 P.A.I. $> 0,5$. Tectate; intra-reticulate. Colpus transversalis slightly elliptical.

ARISTOGEITONIA CONFIGURATION

Stephanocolpate, stephanocolporate, stephanoporate, periporate or inaperturate. The pollen grains are spheroidal or have a Polar axis shorter than the Equatorial axis.

Tectate; usually echinate, sometimes psilate.

The types of the *Aristogeitonia* configuration form a closely related group which is sharply differentiated from the other configurations in the *Phyllanthoideae*. They are easily recognised by the number of apertures and structure of the exine. Most types have echinate pollen grains and ca. six small apertures. The shape is spheroidal or oblate spheroidal to oblate.

Taxonomic discussion

The *Aristogeitonia* configuration includes a typical group of genera which are, in several respects, different from other *Phyllanthoideae*. MUELLER (1866) was acquainted with too few genera of this group to recognise it. BENTHAM (1880), however, enumerated, in the fourth group of his *Phyllanthae*, all the genera of the *Aristogeitonia* configuration then known. Only the genus *Bischofia* of Bentham's group does not belong to the configuration.

All the genera belonging to the configuration are found in one of the three groups into which PAX divides the *Phyllanthoideae* (PAX 1924). This group includes his subtribes *Drypetinae*, *Petalostigmatinae*, "*Toxicodendrinae*" (= *Hyaenanchinae*), *Dissiliarinae*, *Paivaesusinae* and the tribus *Caletieae* of the *Stenolobaeae*. Only *Drypetes*, *Lingelsheimia* and *Heywoodia* of the *Drypetinae* differ pollen-morphologically. The genera are small. The largest genus *Longetia* does not come up to more than 10 species. The male flower lacks an extra staminal disc. The flowers always are apetal, while the number of stamens is seldom constant; there are mostly more than six. In the female flower the styles are undivided, at best emarginate, but never incised. The leaves of this group are often opposite or in whorls. Some genera have, moreover, composite leaves.

Aristogeitonia type

Stephanocolpate, stephanocolporate or stephanoporate; oblate spheroidal-suboblate.

Colpi, if present, small and very short; costae colpi.

Pori, if present, with costae.

Colpus transversalis, if present, with costae.

Tectate; echinate or psilate.

In the *Aristogeitonia* type the apertures are always situated in the

equatorial plane. The apertures can have the shape of pori, colpi or composite apertures, but they are always small.

Aristogeitonia subtypе

Pollen grains echinate.

- Aristogeitonia limonifolia* PRAIN
Herb. Kew. Pl. VI, 5
- Oldfieldia africana* BENTH.
Small 621 [K]
- Paivaea dactylophylla* WELW. et OLIVER
Shabana 9 [K]
- Piranhea trifoliata* BAILL.
Glaziou 14238 [K] Pl. VI, 4
- Tetracoccus ilicifolius* COVILLE et GILMAY
Gilmay Mai. 2A. 1939 [L]
- Hyaenanche globosa* (GAERTN.) LAMB. et VAHL
Splitgerber [L] Pl. VI, 6
- Mischodon zeylanicus* THWAIT.
Hort Bogor. IX A. 125. 80883 [U]
- Paragelonium perrieri* LÉANDRI
Perrier de la Bathie 1178 [P]
- Petalostigma quadriloculare* F. v. MUELLER
Queensland [U]
- Longetia malayana* (BENTH.) PAX et K. HOFFMANN
D'Alleizette, Penang 6421 [L]
- Longetia carunculata* (BAILL.) PAX et K. HOFFMANN
Mackee 4230 [L]

Longetia buxoides subtypе

Pollen grains psilate.

- Longetia buxoides* BAILLON
D'Alleizette, Nw. Caled. 6419 [L]
Pl. VI, 7
- Dissiliaria tricornis* BENTH.
Brass 5755 [L] Pl. VI, 9

- Aristogeitonia* subtypе; stephanocolpate.
P = 30,5 μ E = 35 μ P:E = 0,86.
Colpi ca. 4,5 μ long. Echinae ca. 2,5 μ .
- Aristogeitonia* subtypе; stephanocolpate.
P = 35,5 μ E = 43 μ P:E = 0,83.
- Aristogeitonia* subtypе; stephanocolpate.
P = 43 μ E = 46,5 μ P:E = 0,92.
- Aristogeitonia* subtypе; stephanoporate.
P = 27 μ E = 32 μ P:E = 0,85.
Diam. pori 3 μ .
- Aristogeitonia* subtypе; stephanocolpate.
P = 35,5 μ E = 40 μ P:E = 0,91.
Colpi 6-7. Echinae 3,5 μ .
- Aristogeitonia* subtypе; stephanocolpate.
P = 39 μ E = 46 μ P:E = 0,85.
Colpi 6-7. Echinae 2 μ .
- Aristogeitonia* subtypе; stephanocolpate.
P = 32 μ E = 36 μ P:E = 0,89.
Colpi 5-6. Echinae 3,5 μ .
- Aristogeitonia* subtypе; stephanoporate.
P = 32 μ E = 35 μ P:E = 0,92.
Diam. pori 3 μ . Echinae 2,5-3,5 μ .
- Aristogeitonia* subtypе; stephanoporate.
P = 28,5 μ E = 32 μ P:E = 0,89.
Pori 4-6; not always exactly in the equatorial plane; diam. 3 μ . Echinae ca. 1 μ .
- Aristogeitonia* subtypе; stephanoporate.
P = 47 μ E = 52 μ P:E = 0,90.
Pori slightly elliptical diam. ca. 5 μ .
Echinae up to 6,5 μ .
- Aristogeitonia* subtypе; stephanoporate.
Pori 5(-6).

- Longetia buxoides* subtypе; stephanocolpate.
P = 22 μ E = 27 μ P:E = 0,81.
Colpi (5-) 6 (-7); small and short with thick costae.
- Longetia buxoides* subtypе; stephanoporate.
P = 19 μ E = 22,5 μ P:E = 0,85.
Pori 6; diam. 2 μ .

Stachystemon type

Periporate or inaperturate; spheroidal or ellipsoid (with a longer and a shorter axis).
Pori small; costae pori.
Tectate; echinate.

In the *Stachystemon* type the apertures are never situated in the equatorial plane, but scattered over the surface.

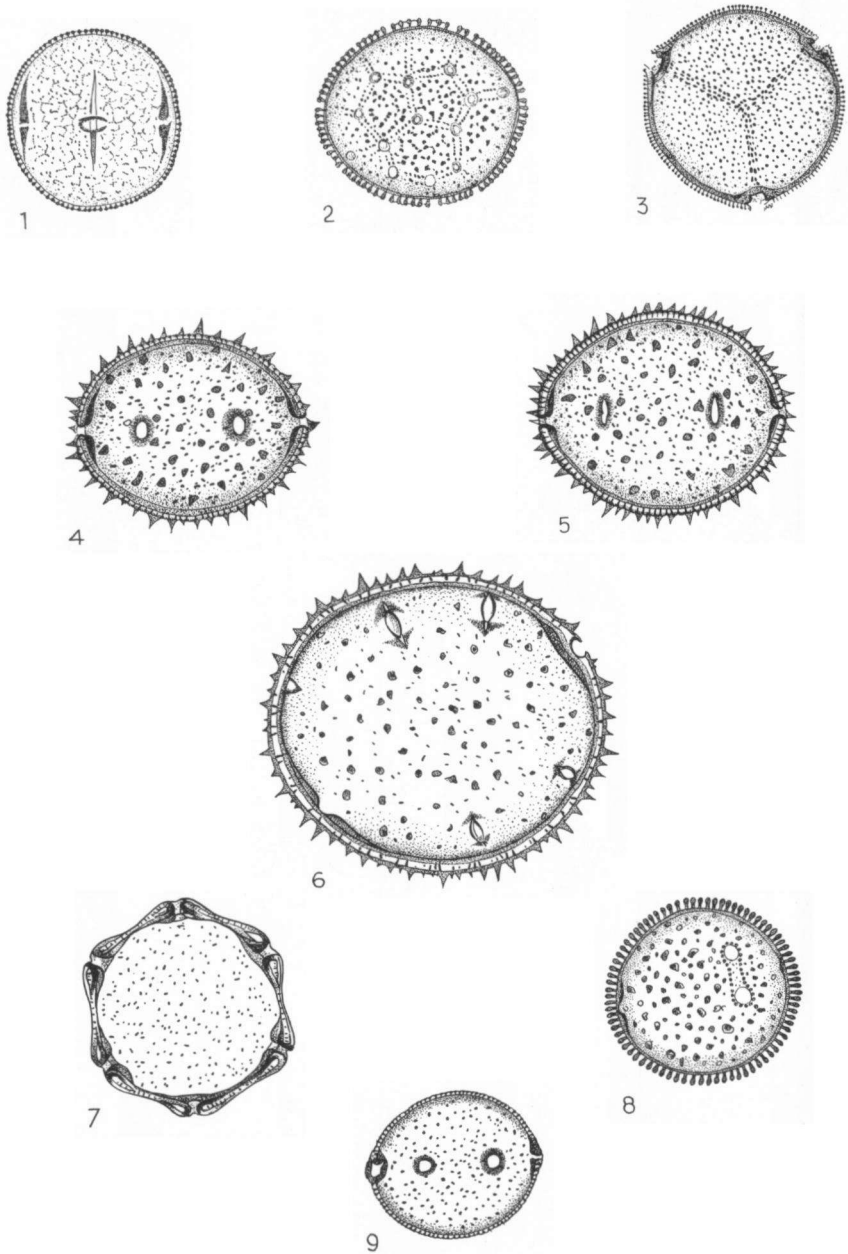

PLATE VI. 1. *Arachnodes chevalieri*; 2. *Phyllanthus nutans*; 3. *Dendrophyllanthus ripicolus*; 4. *Piranhea trifoliata*; 5. *Aristogeitonia limoniiifolia*; 6. *Hyaenanche globosa*; 7. *Longetia buxoides*; 8. *Phyllanthus acuminatus*; 9. *Dissiliaria tricornis*.

<i>Stachystemon vermicularis</i> PLANCH. Pritzel 270 [L] Pl. VII, 2	<i>Stachystemon</i> type. Diam. 36 μ . Pori ca. 12; diam. pori 2,5 μ . Echinae 1,5 μ long.
<i>Micranthem ericoides</i> . DESF. Buysman 1873; 347 [U]	<i>Stachystemon</i> type. Longer axis 45 μ . Pori ca. 25; diam. 2 μ . Echinae usually in groups of three around the pori; 3 μ long.
<i>Micranthem hexandrum</i> J. D. HOOK Tasmania [U]	<i>Stachystemon</i> type. Diam. 45 μ . Pori small; more than 40.
<i>Pseudanthus pimeleoides</i> SIEB. ex SPRENG. Buysman 1890 [U] Pl. VII, 7	<i>Stachystemon</i> type. Diam. 20 μ . Pori ca. 7; diam. 2 μ . Echinae 1 μ long.
<i>Pseudanthus nematophorus</i> F. v. MUELL. Murchinson [U]	<i>Stachystemon</i> type. Diam. 20 μ .
<i>Neoroepera banksii</i> BENTH. Banks and Solander 1770 [K]	<i>Stachystemon</i> type. Diam. 40 μ . Diam. pori 1,5 μ ; ca. 30 pori. Echinae 2 μ long.
<i>Longetia gynotricha</i> GUILL. Mackee 4191 [L]	<i>Stachystemon</i> type. Diam. 34 μ . Pori ca. 16. Echinae 2 μ .
<i>Androstachys johnsonii</i> PRAIN Pole-Evans, 3-8-1917 [K] Pl. VII, 2	<i>Stachystemon</i> type. Longer axis 46 μ . Shorter axis 40 μ . Echinae ca. 1 μ .

POLLEN TYPES NOT PLACED IN ONE OF THE ABOVE CONFIGURATIONS

Some types cannot readily be placed in one of the discussed configurations. Since most types have only one representative they are discussed separately and not put in any configuration.

Phyllanthus acuminatus type

Tricolporate (colpi diorate); spheroidal.
Colpi transversales (two in each colpus) circular; costae.
Colpi short.
Intectate; pilate. Pila ordinate arranged but not in a reticulum.

The presence of two ora in the colpi is also an important character of the *Breynia* type (p. 38). The structure of the exine, however, is quite different. Its remaining characters cannot be compared with any other configuration.

Phyllanthus acuminatus VAHL
Hostman 413 [U] Pl. VI, 8

Phyllanthus acuminatus type.
P = E = 27 μ . P.A.I. = 0,5.

Bischofia type

Tricolporate; spheroidal, P:E is 1.
Colpus transversalis small; costae. Edges of the costae transversales rounded at the ends.
Colpi narrow and long; no costae colpi.
Tectate; psilate. Columellae short.

This type should be best placed in the *Antidesma* configuration but differs from other types in this configuration by its shape (P : E = 1) and the absence of costae colpi. The columellae are moreover very short.

Taxonomic discussion

BENTHAM (1880) discussed *Bischofia* together with *Oldfieldia* and *Piranhea* because of their digitately compound leaves. PAX and K. HOFFMANN (1931) thought it better to put the genus apart in a subtribe. As the pollen grains are certainly not similar to those of *Oldfieldia* and *Piranhea* and moreover difficult to place in any other configuration, it seems right to maintain the separate subtribe.

Bischofia javanica BLUME

Hohenacker 1573 [U] Pl. VII, 5

Bischofia type.

P = E = 25 μ . P:E = ca. 1.
m:e < 0,5. P.A.I. = 0,2.

Putranjiva type

Tricolporate; spheroidal. P:E is 1.

Colpus transversalis large; costae.

Colpi narrow; costae colpi.

Tectate; psilate. Exine thick. Columellae short but endexine and tectum thick.

The *Putranjiva* type has some resemblances with the *Dicoelia* type (p. 28). There is a large colpus transversalis with costae, and also costae colpi. The type differs, however, by its shape (P:E = 1) and the remarkably thick endexine.

In a specimen of *Putranjiva* (Stocks, India), examined by ERDTMAN (1952), the pollen grains are subprolate, reticulate. The specimens Koorders 2156 β and Broadway 9249 differ considerably from that description. The typical character of the thick exine is not mentioned by Erdtman and was probably not present in his pollen grains.

Taxonomic discussion

In the system of PAX and K. HOFFMANN (1931) *Putranjiva* is found in the subtribe *Glochidiinae*. The genus is put in relationship with *Breynia* and *Glochidion*. BENTHAM (1880) gives it a place next to *Drypetes*. It must be admitted, that the pollen grains of *Putranjiva* are far more similar to those of *Drypetes* than to the *Breynia* type.

Putranjiva roxburghii WALL.

Koorders 2156 β [U]

Broadway 9249 [U] Pl. VII, 3

Putranjiva type. P = E = 40 μ .

P:E = ca. 1. m:e < 0,5.

P.A.I. = 0,3. Exine thick (4 μ).

Hymenocardia type

Triporate (-diporate); oblate.

Costae pori.

Tectate; psilate. Columellae short.

The type differs completely from all the other pollen grains in the Phyllanthoideae.

Taxonomic discussion

On account of its catkin-like male inflorescences PAX and K. HOFFMANN (1931) placed *Hymenocardia* in the Antidesminae. The most striking character of the genus is the compressed two-cocced fruit with lateral wings. *Hymenocardia* differs from the other genera in the Antidesminae in some characters:

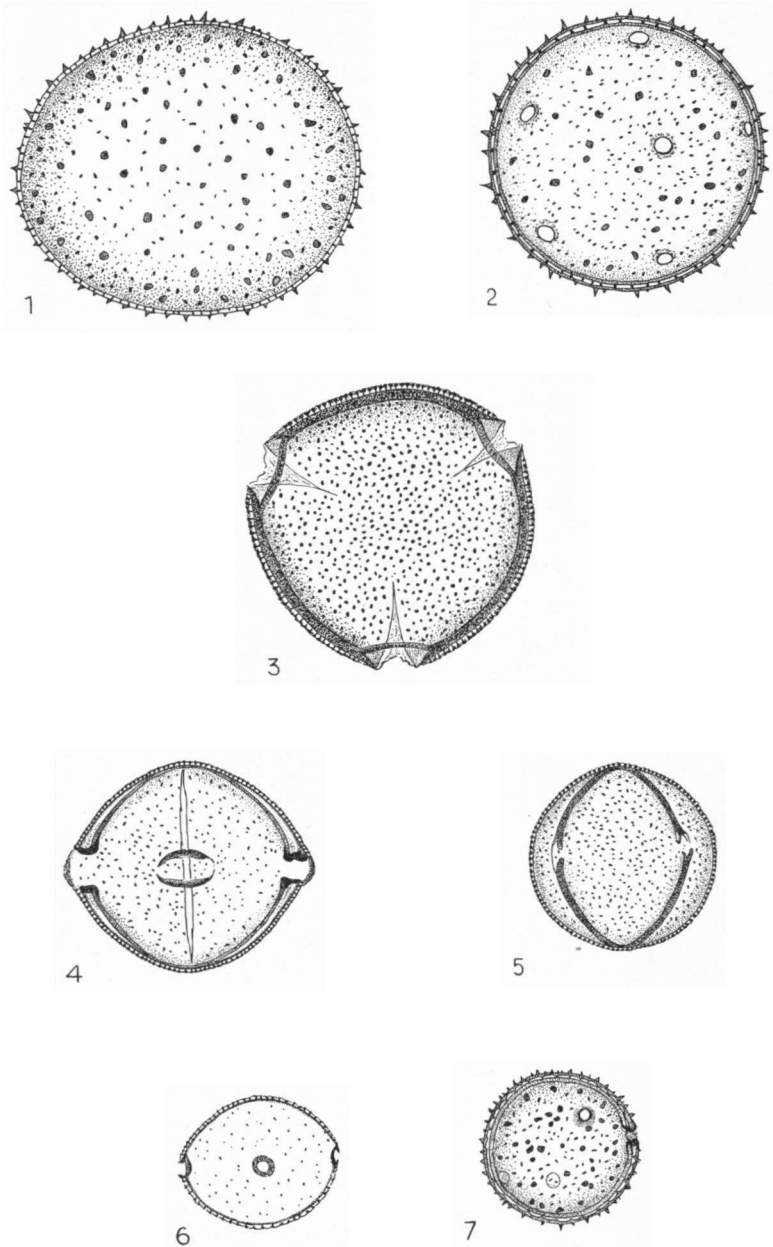

PLATE VII. 1. *Androstachys johnsonii*; 2. *Stachystemon vermicularis*; 3. *Putranjiva roxburghii*; 4. *Martretia quadricornis*; 5. *Bischofia javanica*; 6. *Hymenocardia ulmoides*; 7. *Pseudanthus pimeleoides*.

1. Disc wanting in male as well as in female flowers.
2. The styles are long and undivided.

Hymenocardia ulmoides OLIV.
Koechlin 2371 [U] Pl. VII, 6
Hymenocardia acida TUL.
Bequaert 7142 (BR)
Duvigneaud 2422 (BRLU)

Hymenocardia type.
P = 19 μ E = 22,5 μ P:E = 0,85.
Hymenocardia type.
P = 28,5 μ E = 31 μ P:E = 0,92.
Diam. pori 3 μ .

Martretia type

Tricolporate; oblate spheroidal.
Colpus transversalis; costae. Edges of the costae transversales rounded at the ends. Atrium present.
Colpi narrow; no costae colpi present.
Tectate; psilate.

The pollen grains of the *Martretia* type are oblate spheroidal but do not have any other character in common with the *Amanoa* or *Aristogeitonia* configuration. The colpus transversalis has rounded ends. This character is present in some types of the *Antidesma* configuration. The oblate shape and absence of costae colpi keeps the *Martretia* type out of the *Antidesma* configuration. A typical character is the atrium, which is not found in any other type.

Taxonomic discussion

Martretia has only one species. In many respects this species is related to the *Antidesminae* (e.g. in its inflorescence). There are, however, some differences.

1. No disc is present in the male flower nor in the female one.
2. The seeds are provided with a caruncula. No other genus in the *Antidesminae* has carunculate seeds.
3. The only genus in the whole family with a false partition in the fruits (PAX and K. HOFFMANN, 1922).

Martretia quadricornis BEILLE
Adames 251 [K] Pl. VII, 4

Martretia type.
P = 28,5 μ E = 31 μ P:E = 0,92.
m:e = 0,3 — 0,4. P.A.I. = 0,25.

TAXONOMIC COMMENT ON THE PHYLLANTHOIDEAE

The *Phyllanthoideae* can be divided into three groups of pollen types. These groups, broadly outlined, agree with the three groups PAX (1924) could already distinguish on other grounds, though without nominating them.

The first group, to which, for instance, the subtribes *Antidesmineae* and *Phyllanthinae* belong, has pollen grains which mostly have a prolate shape and distinct costae transversales (*Antidesma* configuration, p. 20). The second group has pollen grains which are mostly reticulate and generally have an oblate shape (*Amanoa* configuration, p. 32). The subtribes *Amanoinae*, *Sarropodinae*, etc., belong to this group. The third group comprises those genera that are to be found in the *Aristogeitonia* configuration (p. 40).

For the *Phyllanthoideae* (PAX and K. HOFFMANN, 1931) composed a highly differentiated system of many subtribes. This system, however, leaves much to be desired. Some subtribes (e.g. *Glochidiinae*) comprise genera which decidedly do not show any relationship with each other. On the contrary, other genera in different subtribes resemble each other so much, that it would seem desirable to unite them (*Wielandiinae* with *Amanoinae* and *Pseudolachnostylidinae*).

In the *Phyllanthoideae* pollen morphology is obviously exceedingly useful to arrive at a natural classification.

b. CROTONOIDEAE

CROTON CONFIGURATION

Croton-pattern present. Structure elements on the tectum are usually clavate but can also be echinae, baculae etc. Sometimes the structure elements are located on ridges (e.g. *Croton matourensis*, *Manihot saxicola*). Tectate.

The *Croton* configuration includes all pollen grains with a croton-pattern. In the *Euphorbiaceae* the croton-pattern is only found in the subfamily of the *Crotonoideae*. ERDTMAN (1952) states, that, outside the *Euphorbiaceae*, pollen grains with a croton-pattern have been found in the *Buxaceae* and *Thymelaeaceae*.

Most pollen grains with a croton-pattern belong to the *Croton* type. The *Manihot* type, *Klaineanthus* type and *Hevea* type occur less commonly.

Taxonomic discussion

In the subfamily of the *Crotonoideae* a great number of genera possess pollen grains with a croton-pattern.

In PAX and K. HOFFMANN's system (1931) these genera occur in the following tribes: *Crotoneae*, *Chrozophoreae*, *Joannesieae*, *Cluytieae*, *Manihoteae*, *Celonieae* and *Ricinocarpeae*. Further also *Neoboutonia* as the only genus out of the *Acalypheae*. It follows from this enumeration, that the genera possessing a croton-pattern are to be found in widely divergent groupings.

In classifying the *Crotonoideae* most authors considered the bursting open of the male calyx to be a factor of primary importance for arranging the genera. Thus MUELLER (1866) and PAX and K. HOFFMANN arrived at a classification, in which genera with an obvious relationship are kept widely apart, e.g. *Joannesia* and *Micrandra* (BALDWIN et SCHULTES 1947; SCHULTES 1955). BENTHAM (1880) already stated that within the genus *Croton* the male calyx opens both valvate and imbricate, which is why, in his system, this character plays a less important part. In Bentham's system the genera with a croton-pattern are placed close together. They are to be found in his subtribes *Jatrophineae*, *Eucrotoninae* and *Chrozophorinae*.

In comparing all the taxa that possess a croton-pattern it is seen that several characters correlate with this pollen character. With hardly an exception the male and the female flower contain a disc, while an ovarium rudiment is absent. A less constant but striking

character is the presence of petals in many genera. Genera which form an exception to these characters are:

Sagotia. The disc is wanting in both sexes. The genus, however, is related to *Dodecastigma*, *Sandwithia* and *Garcia* (CROIZAT 1948), which, on the other hand, have a disc.

Bertya. This Australian genus has no disc in both sexes either. There is, however, a distinct relation to two other Australian genera, viz. *Beyeria* and *Ricinocarpos*, which certainly have a disc.

Tritaxis has no disc in the female flower.

Adenocline and *Tetrorchidium* have no disc in the male flower.

The genera *Pantadenia* and *Oligoceras*, described by Gagnepain, were said to possess an ovarium rudiment in their male flowers. *Pantadenia* does have a little conical projection in the centre of its receptaculum, but whether this projection represents an ovarium rudiment is not certain. *Oligoceras* possesses, in its male flower, a column which, according to a drawing by GAGNEPAIN in the Flore Général de l'Indochine (1926), was said to be an ovarium rudiment. In studying the type material in Paris, however, the author concluded, that the drawing gives an erroneous picture of the reality. The column is not bottle-shaped but cylindrical. The five stamens are not placed at the foot of the column, but are grown together with it at a little distance of the base. The projections which stand at the end of the column and which, in the drawing, look like stigmas, are three staminodies. These staminodies even contain rudimentary pollen sacs. Therefore there are two whorls of stamens, the topmost of which is sterile.

A more or less distinct ovarium rudiment is found in: *Klaineanthus*, *Cladogelonium*, *Micrandra* and *Endospermum*, which all belong to the *Klaineanthus* type.

Genera not possessing a corolla are: *Neoboutonia*, *Benoistia*, *Elateriospermum*, *Baliospermum*, *Eremocarpos*, *Micrandra* (*Cunuria*), *Hevea*, *Bertya*, *Beyeria*, *Adenocline* and *Tetrorchidium*. *Suregada* mostly has no corolla (LÉONARD 1958).

The type occurring most frequently is the *Croton* type. Less common are the *Manihot* type, the *Klaineanthus* type, *Hevea* type and *Adenocline* type.

Croton type

Inaperturate; spheroidal or ellipsoid i.e. with a longer and a shorter axis.
Tectate; endexine thin. Croton-pattern.
Clavate or echinate.

The *Croton* type has no apertures and the shape is fairly uniform. There may be a longer and a shorter axis, but usually the pollen grains are spheroidal. The structure elements have more variations. The differences in these elements and the lumina enclosed by the elements, however, are slight and many transitions exist, so that it seems better to omit the formation of groups (subtypes).

The pollen grains of *Sagotia racemosa* show two shapes. The specimens Y. Mexia and Woob Herb. are echinate, while the specimen For. Dep.

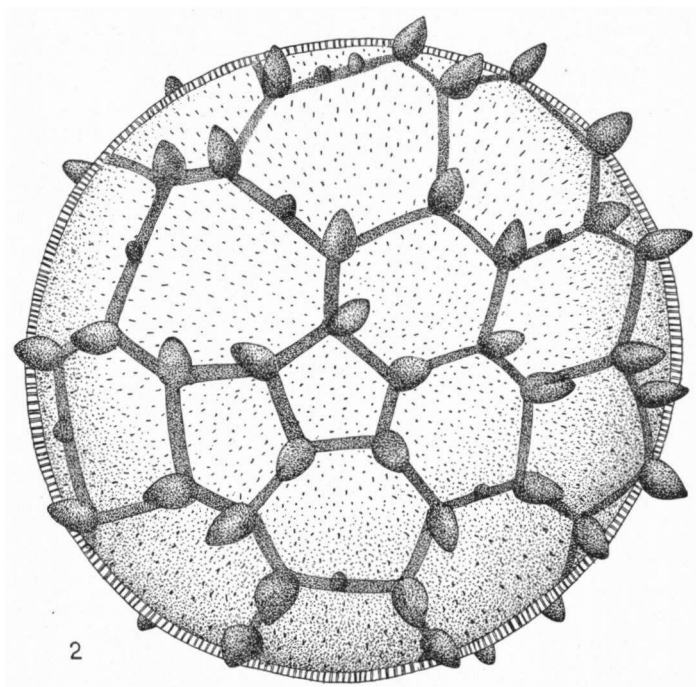
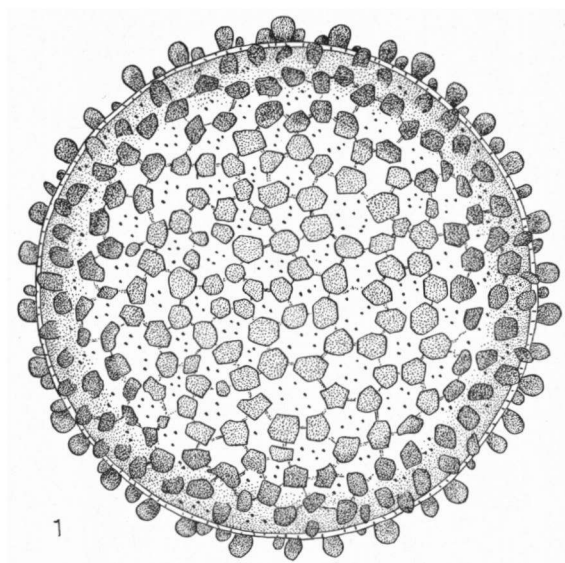

PLATE VIII. 1. *Croton cuneatus*; 2. *Croton matourensis* ($\times 800$).

is clavate. Further examination will be necessary to ascertain whether these two shapes of *Sagotia racemosa* can be distinguished by other characters besides.

According to SCHULTES (1952) *Cunuria* cannot be distinguished from *Micrandra*. The pollen grains of the *Cunuria* specimen Ducke 1087 belong to the *Croton* type, and not to the *Micrandra* type. In another *Cunuria* specimen (Ducke 24874) ERDTMAN (1952) described the pollen grains as being 5-colporate. According to SCHULTES (1952) the two Ducke specimens both belong to *Cunuria spruceana* var. *bracteosa*. *Micrandra siphonoides* and *Micrandra brownsbergensis* stand pollen-morphologically between the two specimens of *Cunuria spruceana* var. *bracteosa*.

- Croton cuneatus* KLOTZSCH
J. et P. Florschütz 1113 [U] Pl. VIII, 1
Croton bahamensis MILLSP.
Brace 4064 [U]
Croton longiradiatus LANJ.
B.W. 6711 [U]
Croton hirtus L'HERITIER
Versteeg 504 [U]
Croton matourensis AUBL.
B.W. 5050 [U] Pl. VIII, 2
Croton pullei LANJ.
Rombouts 654 [U]
Julocroton triquetus BAILLON
Hassler 6016 [U]
Julocroton argenteus (LINN.) DIDRICH
C. L. Schulz 1225 [U]
Crotonopsis elliptica WILLD.
Delzie Demaree 7066 [U]
Eremocarpus setigerus (HOOK.) BENTH.
L. S. Rose 41457 [U]
Grossera major PAX
Zenker 469 [U]
Holstia tenuifolia PAX
Drummond et Hemsley 3480 [K]
Cyrtogonone argentea (PAX) PRAIN
Zenker 561 [U]
Crotonogyne preussii PAX
Zenker 4666 [L]
Crotonogyne parvifolia PRAIN
D'Alleizette 6845 [L]
Manniophyton fulvum MUELL. ARG.
Zenker 1404 [L]
Aleurites moluccana (LINN.) WILLD.
Bunnesmeyer 8060 [U]
Deutzianthus tonkinensis GAGNEP.
Balansa 3149 [P]
Oligoceras eberhardtii GAGNEP.
Eberhardt [P]
Alphandia furfuracea BAILLON
Balansa 3439 [P]
Garcia nutans VAHL
Lundell 12248 [U]
- Croton* type.
Diam. longer axis 75 μ . Clavate; diam. clavae 3,5 μ . Clavae on ridges.
Croton type. Diam. 55 μ .
D. cl. 2,8 μ .
Croton type. Diam. 75 μ .
D. cl. 2,2 μ . Clavae distinctly on ridges.
Croton type.
Clavae acuminate; distinctly on ridges.
Diam. 115 μ . D. cl. 6,5 μ .
Croton type.
Diam. 115 μ . D. cl. 6,5 μ . Clavae distinctly on ridges.
Croton type. Diam. 120 μ .
D. cl. 3,2 μ .
Croton type. Diam. 120 μ .
D. cl. 3,2 μ .
Croton type. Diam. 60 μ .
D. cl. 1,5 μ .
Croton type. Diam. 60 μ .
D. cl. 2 μ .
Croton type. Diam. 48 μ .
D. cl. 1,8 μ .
Croton type. Diam. 45 μ .
D. cl. 2 μ .
Croton type. Diam. 60 μ .
D. cl. 3,5 μ .
Croton type. Diam. 60 μ .
D. cl. 2 μ .
Croton type. Diam. 50 μ .
D. cl. 2,8 μ .
Croton type. Diam. 60 μ .
D. cl. 3,5 μ .
Croton type. Diam. 70 μ .
D. cl. 2,0 μ .
Croton type. Diam. 65 μ .
D. cl. 2,0 μ .
Croton type. Diam. 50 μ .
D. cl. 1,8 μ .
Croton type. Diam. 40 μ .
D. cl. 2,0 μ .
Croton type. Diam. 60 μ .
D. cl. 2,0 μ .

- Joannesia princeps* VELLOSO
T. W. BROWN 35 [K]
- Neoboutonia macrocalyx* PAX
Stolz 2043 [U]
- Pantadenia adenanthera* GAGNEP.
British Museum
- Baloghia lucida* ENDLICHER
Beckler, Hastings River [U]
- Ostodes paniculata* BLUME
Griffith 4790 [U]
- Ostodes pendulus* (HASSK.) MEEUSE et
ADELBERT
Sandakan For. Dep. A. 2964 [U]
- Codiaeum variegatum* (LINN.) BLUME
Fresh material from greenhouse at
Utrecht. Pl. IX, 3
- Codiaeum stellingianum* WARB.
Docters v. Leeuwen 1567 [U]
- Fontainea pancheri* (BAILLON) HECKEL
D'Alleizette 6474 [L]
- Dimorphocalyx murina* ELMER
Elmer 12773 [U]
- Benoistia perrieri* LÉANDRI
D'Alleizette Madag. Dec. 1905 [L]
- Tritaxis gaudichaudi* BAILL.
Clemens 4351 [U]
- Strophoblachia fimbriicalyx* BOERL.
Hort. Bog. VIII F. 43 [U]
- Blachia umbellata* (WILLD.) BAILL.
D'Alleizette Austr. Nov. 1907 [L]
- Sagotia racemosa* BAILLON
For. Dep. 7443 [U]
- Mexia 6050 [U]
Wood Herb. 311 [U]
- Jatropha multifida* LINN.
Groll-Meyer, St. Eustatius [U]
- Jatropha integerrima* JACQ.
Docters v. Leeuwen 19-7-1950 [U]
- Mildbraedia paniculata* PAX
Leeuwenberg 3004 [U]
- Acidocroton adelioides* GRISEB.
Ekman 16896 [K]
- Pausandra densiflora* LANJ.
Krukoff 5464 [U]
- Pausandra morisiana* (CASAR.) RADLK.
Ducke et Kuhlmann 16594 [U]
- Givotia rottileriformis* GRIFFITH
Wight 2638 [L]
- Ricinodendron heudelotii* (BAILL.) PIERRE
ex PAX
Zenker 487 [U]
- Elateriospermum tapos* BLUME
Hort. Bog. IX. A. 129 [U]
- Baliospermum motanum* (WILLD.) MUELL.
ARG.
Bengal, J. D. Hooker [U]
- Cavacoa aurea* (CAVACO) LÉONARD
de Winter 2109b [K]
- Anomalocalyx uleanus* (PAX et K. HOFFM.)
DUCKE
Ducke 23518 [U]
- Croton* type. Diam. 70 μ .
D. cl. 3,0 μ . Clavae on ridges.
- Croton* type. Diam. 40 μ .
D. cl. 1,5 μ .
- Croton* type. Diam. 45 μ .
D. cl. 1,0 μ .
- Croton* type. Diam. 40 μ .
D. cl. 1,0 μ .
- Croton* type. Diam. 65 μ .
D. cl. 3,5 μ .
- Croton* type. Diam. 53 μ .
D. cl. 2,8 μ .
- Croton* type. Diam. 50 μ .
D. cl. 2 μ .
- Croton* type. Diam. 50 μ .
D. cl. 2,0 μ .
- Croton* type. Diam. 60 μ .
D. cl. 2,8 μ .
- Croton* type. Diam. 80 μ .
D. cl. 3,5 μ .
- Croton* type. Diam. 35 μ .
D. cl. 1,8 μ .
- Croton* type. Diam. 45 μ .
Echinate. Diam. ech. 1,8 μ .
- Croton* type. Diam. 60 μ .
D. cl. 1,8 μ .
- Croton* type. Diam. 45 μ .
D. cl. 1,8 μ .
- Croton* type. Diam. 50 μ .
D. cl. 2,0. Clavae sharp pointed.
- Echinate. Diam. 40 μ . D. ech. 1,8 μ .
- Croton* type. Diam. 95 μ .
D. cl. 4,0 μ . Clavae on ridges.
- Croton* type. Idem. *Jatropha multifida*
- Croton* type. Diam. 50 μ .
D. cl. 2,5 μ .
- Croton* type. Diam. 45 μ .
D. cl. 1,5 μ .
- Croton* type. Diam. 50 μ .
D. cl. 2,0 μ .
- Croton* type. Diam. 75 μ .
D. cl. 3,5 μ .
- Croton* type. Diam. 48 μ .
D. cl. 2,8 μ .
- Croton* type. Diam. 50 μ .
D. cl. 2,5 μ .
- Croton* type. Diam. 70 μ .
D. cl. 3,2 μ . Clavae on ridges.
- Croton* type. Diam. 43 μ .
D. cl. 1,5 μ .
- Croton* type. Diam. 75 μ .
D. cl. 2,0 μ .
- Croton* type. Diam. 55 μ .
D. cl. 3,2 μ .

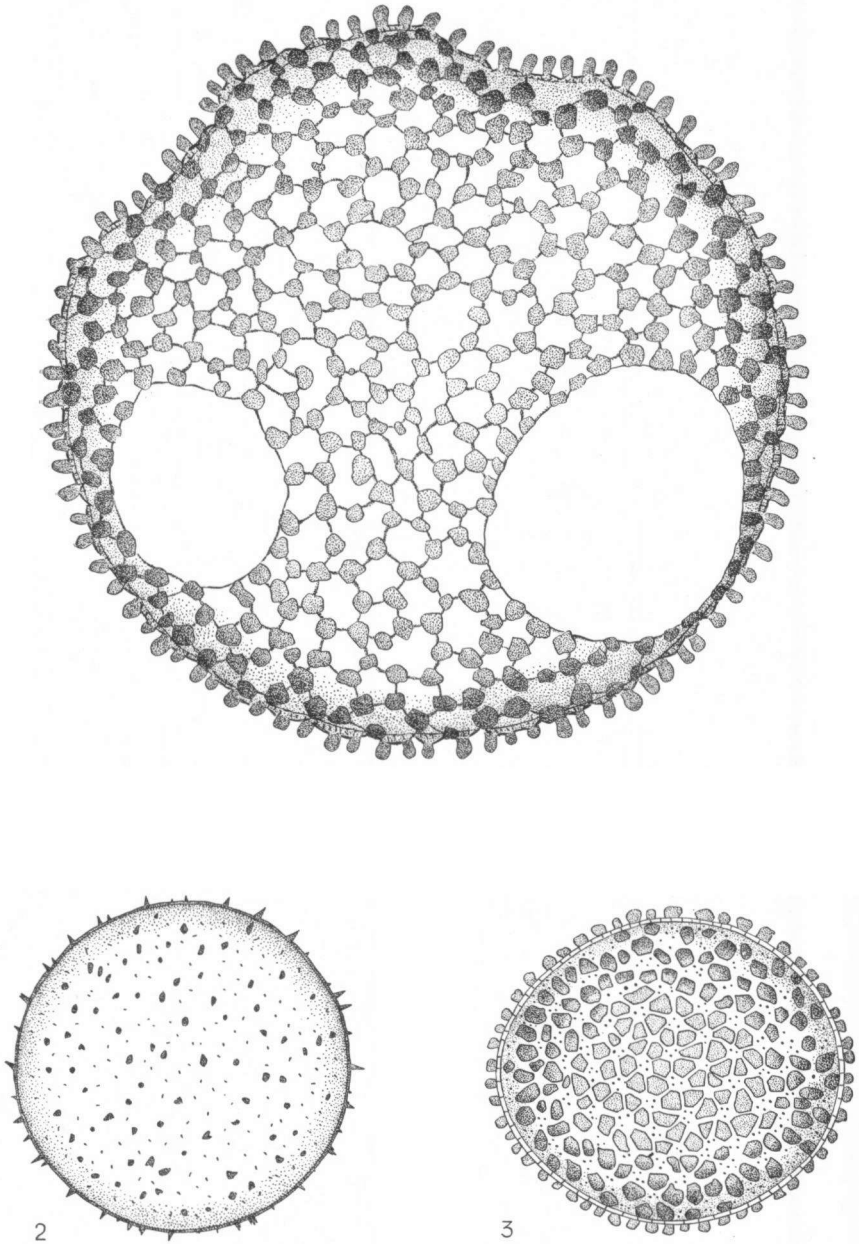

PLATE IX. 1. *Manihot saxicola* ($\times 600$); 2. *Tannodia cordifolia*; 3. *Codiaeum variegatum*.

- Sandwithia guyanensis* LANJ.
For. Dep. 2731 [U] *Croton* type. Diam. 55 μ .
D. cl. 3,5 μ .
- Dodecastigma amazonicum* DUCKE
Ducke 23543 [U] *Croton* type. Diam. 80 μ .
D. cl. 4,5 μ .
- Cunuria spruceana* BAILLON var. *bracteosa*
(DUCKE) R. E. SCHULTES
Ducke 1087 [K] *Croton* type. Diam. 50 μ .
D. cl. 1,8 μ .
- Vaupesia cataractarum* R. E. SCHULTES
Schultes 14006 [K] *Croton* type. Diam. 70 μ .
D. cl. 3,0 μ .
- Ricinocarpus pinifolius* DESF.
Austr. felix [U] *Croton* type. Diam. 60 μ .
D. cl. 1,8 μ .
- Beyeria leschenaultii* (DECAND.) BAILL.
Austr. felix [U] *Croton* type. Diam. 43 μ .
D. cl. 1,5 μ .
Clavae sharp pointed.
- Bertya gummifera* PLANCH.
Johnson et Constable 16024 [U] *Croton* type. Diam. 55 μ .
Croton-pattern indistinct.
- Domohinea perrieri* LÉANDRI
D'Alleizette 6479 Dec. 1905 [L] Pl. X, 1 *Croton* type. Diam. 50 μ .
Croton-pattern on ridges. Echinate;
diam. ech. 1,5 μ .
- Tannodia cordifolia* BAILLON
D'Alleizette, Comoren 6484 [L]
Pl. IX, 2 *Croton* type. Diam. 35 μ .
Echinate; diam. ech. 1-1,5 μ .

Manihot type

Periporate; spheroidal.
Pori large, borders indistinct.
Tectate. Croton-pattern.

The type is closely related to the *Croton* type. The pollen grains, however, have large apertures with indistinct rims. The number of pori varies in the different species.

Taxonomic discussion

According to CROIZAT (1943b) *Cnidiscolus* does not have a calyx but a corolla. This is also the case with *Manihot*. In a very definite sense *Cnidiscolus* connects *Jatropha*, sensu strictu, with *Manihot*. Both the sorts of *Cnidiscolus* examined had pollen grains of the *Manihot* type, so that at least in this respect they are closer related to *Manihot* than to *Jatropha*.

The pollen-morphological similarity between *Manihot* and *Suregada* is probably accidental and has to be considered a parallel development.

- Manihot saxicola* LANJ.
Proefst. Buitenz. 922 Boom 8 [U]
Pl. IX, 1 *Manihot* type.
Diam. 160 μ . Croton-pattern on a
distinct reticulum.
Pori ca. 25. Diam. clavae 6,8 μ .
- Manihot esculenta* CRANTZ
Rombouts 757 [U]
B.W. 2780 [U] *Manihot* type.
Idem *Manihot saxicola*.
Pori ca. 25.
- Cnidiscolus urens* (LINN.) ARTHUR
Boldingh 4829 [U] *Manihot* type. Diam. 75 μ .
D. cl. 2,5 μ . Pori 3-4.
- Cnidiscolus stimulosus* (MICHAX) GRAY
Killip 31636 [U] *Manihot* type. Pori ca. 6.
- Suregada glomerulata* (BLUME) BAILL.
Griffith 4772 [U] *Manihot* type. Diam. 40 μ .
D. cl. 2,5 μ . Pori 3-5.
- Suregada subglomerulata* (ELMER) CROIZAT
Elmer 12967 [U] *Manihot* type. Diam. 45 μ .
Pori 5-6.

Klaineanthus type

Tricolpate; oblate spheroidal to oblate.
Colpi wide or narrow; no operculum present.
Tectate; croton-pattern.

The *Klaineanthus* type, too, is closely related to the *Croton* type and the *Manihot* type. Pollen grains of this type have colpi without an operculum. The colpus membrane is frequently ruptured.

Klaineanthus subtype

Borders of colpi distinct.
Clavate.

The rims of the colpi of this subtype are distinct. The colpus membrane is frequently totally ruptured. In *Cladogelonium* the colpus membrane is not ruptured but granulate. Sometimes a rudiment of the colpus membrane remains at the outer ends of the colpi.

Klaineanthus gaboniae PIERRE ex PRAIN
Zenker 583 [U] Pl. X, 3

Klaineanthus subtype; suboblate.
P = 29,5 μ E = 37 μ P:E = 0,80.
Colpi wide. P.A.I. = 0,4.
Diam. clavae 1,8 μ .

Cladogelonium madagascariense LÉANDRI
Perrier de la Bathie 9696 [P] Pl. X, 4

Klaineanthus subtype; spheroidal.
P = 30 μ E = 30,5 μ P:E = 0,98.
Colpus membrane granulate.
P.A.I. = 0,4.

Endospermum moluccanum (THYSM. et
BINNEND.) BECCARI
Kornasse 462 [U]

Klaineanthus subtype; suboblate.
P = 33,5 μ E = 44,5 μ P:E = 0,80.
Colpus membrane absent. P.A.I. =
0,4. Diam. clavae 1,8 μ .

Glycydendron amazonicum DUCKE
Ducke 17108 [U]

Klaineanthus subtype; oblate.
P = 29 μ E = 41,5 μ P:E = 0,69.
Colpus membrane absent. P.A.I. =
0,35. Diam. clavae 1,5 μ .

Micrandra brownsbergensis LANJ.
v. Emden 9 [U]

Klaineanthus subtype.
Colpus membrane absent.

Micrandra siphonioides BENTH.
Lopez 9625 [U] Pl. X, 5

Klaineanthus subtype.
P = 41,5 μ E = 46 μ P:E = 0,92.
P.A.I. = 0,3. Croton-pattern indis-
tinct. Clavae candelabrum-shaped,
in-ordinate arranged.

Adenocline subtype

Borders of the colpi not sharply cut but irregularly ruptured.
Baculate. Baculae small and crowded.

The baculae on the tectum are small and crowded. With low magnification it is not directly obvious that the structure elements form a croton-pattern and not a reticulum.

Taxonomic discussion

The genus *Adenocline* was placed in the vicinity of *Seidelia* and *Leidesia* in the Acalyphaceae by BENTHAM (1880). PAX and K. HOFFMANN (1931) could not find the same relation and put the genus in a separate subtribe in the tribe Gelonieae. This tribe also comprises the genus *Klaineanthus*. The two genera are, however, quite different in other respects.

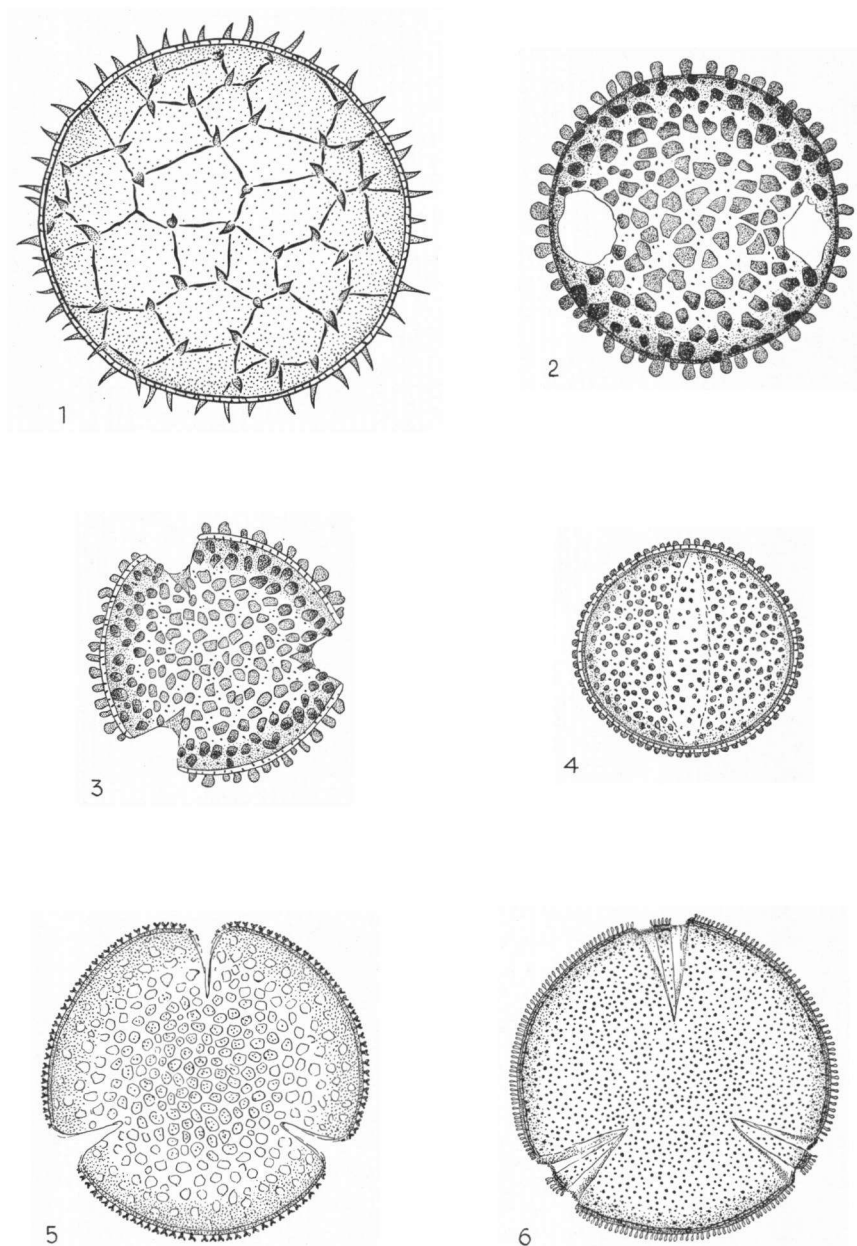

PLATE X. 1. *Domohinea perrieri*; 2. *Suregada subglomerulata*; 3. *Klaineanthus gabonias*; 4. *Cladogelonium madagascariense*; 5. *Micrandra siphonioides*; 6. *Hevea brasiliensis*.

Adenocline acuta (THUNB.) BAILL.
[= *A. mercurialis* TURCZ.]
Lanjouw 613 [U] Pl. XI, 2

Adenocline subtype; oblate spheroidal.
P = 36 μ E = 37,5 μ P:E = 0,96.
P.A.I. = 0,4.

Hevea type

Tricolpate; oblate spheroidal.
Colpi wide; operculum present.
Tectate; baculate. The baculae are so small and crowded, that the structure is hardly recognised as a croton-pattern.

As in the *Adenocline* subtype the baculae of the *Hevea* type are small in diameter and crowded. With low magnification the structure elements seems to form a reticulum, but with high magnification the arrangement of the structure elements is clearly a croton-pattern.

The operculum distinguishes this type from the *Klaineanthus* type.

Hevea brasiliensis (WILLD. ex A. JUSSIEU)
MUELL. ARG.
Schultes 8050 [U]
B.W. 752 [U] Pl. X, 6

Hevea type; oblate spheroidal.
P = 33,5 μ E = 35 μ P:E = 0,96.
P.A.I. = 0,3.

Hevea guianensis AUBLET
B.W. 41 [U]
Krukoff 5800 [U]

Hevea type.
P = 35 μ E = 38 μ P:E = 0,95.

Tetrorchidium type

Tricolporate; oblate spheroidal to prolate spheroidal.
Colpus transversalis exceptionally broad and elongated.
No costae present.
Colpi narrow; rims irregular.
Intectate; pilate. Pila coarse.

The *Tetrorchidium* type is tricolporate and differs by this character from the tricolpate *Klaineanthus* type. The extremely broad colpus transversalis is elongated to a colpus transversalis equatorialis. The tectum of this type is indistinct and the croton-pattern is not clear in all the pollen grains. In *Tetrorchidium didymostemon* the structure elements on the tectum are certainly not arranged in a croton-pattern. *Tetrorchidium rubrivenium* shows the croton-pattern more readily.

Although the most important characters of the *Croton* configuration are not always present, the structure of the pollen grains and the shape of the colpi are very much like those in the *Klaineanthus* type. The author therefore prefers to keep the *Tetrorchidium* type in the vicinity of the *Klaineanthus* type.

Taxonomic discussion

PAX and K. HOFFMANN (1931) referred *Tetrorchidium* into the subtribe Tetrorchidiinae. This subtribe was placed in the tribe Gelonieae, to which also *Klaineanthus* belongs. Although in habit and character *Adenocline* and *Tetrorchidium* differ widely, the flowers have some characters in common:

1. In the male flowers disc and ovary rudiment are absent.
2. In the female flowers the disc consists of three free glands.

<i>Tetrorchidium rubrivenium</i> POEPP. Harris and Britton 10746 [K]	<i>Tetrorchidium</i> type; oblate spheroidal. P = 36 μ E = 40 μ P:E = 0,90. P.A.I. = 0,35. Bacculate-verrucate.
<i>Tetrorchidium didymostemon</i> (BAILLON) PAX et K. HOFFMANN Zenker 4590 [L] Pl. XI, 3	<i>Tetrorchidium</i> type; prolate spheroidal. P = 28 μ E = 27 μ P:E = 1,04. P.A.I. = 0,35.

CNESMOSA CONFIGURATION

Inaperturate; no croton-pattern present.
Tectate or intectate.

Like the *Croton* type the *Cnesmosa* configuration is inaperturate, but a croton-pattern is always absent.

Cnesmosa type

Inaperturate. Pollen grains ellipsoid, i.e. with a longer and a shorter axis.
Tectate; psilate. No reticulum.

The pollen grains of this type are closely related to the *Tragia fallax* type and the *Platygyne* type. In the *Cnesmosa* type the pollen grains are tectate.

Taxonomic discussion

The genera belonging to this type are closely related and not easy to separate. CROIZAT (1941a) discussed the relationship between some genera of the *Plukenetia* and came to the following conclusions:

1. *Cnesmon* GAGNEPAIN cannot be separated from *Cnesmosa* BLUME.
2. *Megistostigma malaccense*, reduced to *Sphaerostylis* by PAX and K. HOFFMANN, is the taxonomic type of the genus *Megistostigma*, which is congeneric with *Clavistylis* J. J. SMITH.
3. *Tragiella* PAX and K. HOFFMANN should be treated as a synonym of *Sphaerostylis*, of which *S. tulasneana* is the taxonomic type (p. 63).

The pollen-morphological results are in full agreement with the statements of CROIZAT.

<i>Cnesmosa javanica</i> BLUME Elmer, Borneo 20663 [U] Java 1855 [L]	<i>Cnesmosa</i> type; ellipsoid. Longer axis 55 μ .
<i>Megistostigma beltatus</i> (J. J. SMITH) CROIZAT v. Steenis 1235 [L] Pl. XI, 6	<i>Cnesmosa</i> type; ellipsoid. Longer axis 56 μ ; shorter axis 53 μ .
<i>Megistostigma malaccense</i> J. D. HOOK. Sinclair 40242 [U] Pl. XI, 4	<i>Cnesmosa</i> type; ellipsoid. Longer axis 42 μ ; shorter axis 37 μ . Columellae in groups.
<i>Acidoton urens</i> SWARTZ Jamaica, Hooker [U]	<i>Cnesmosa</i> type; ellipsoid. Longer axis 37,5 μ ; shorter axis 35,5 μ .

Tragia fallax type

Pollen grains inaperturate; spheroidal or ellipsoid. Intectate, pilate. Pila not in a reticulum. Endexine very thin.

This type differs from the *Cnesmosa* type by its intectate structure. The pila are not arranged in a reticulum.

Taxonomic discussion

The examined species belong to the section *Bia* of *Tragia*. KLOTZSCH and BAILLON (1858) separated this section from *Tragia*. PAX and K. HOFFMANN (1919a) also stated: "Die männliche Blüte weckt den Eindruck, als ob es um eine eigene Gattung handelt". If all the species of the section *Bia* have the inaperturate pollen grains, it is perhaps better to treat this section as a distinct genus, although a great affinity with *Tragia* cannot be denied.

Tragia fallax MUELL. ARG.

Klug 4207 [U] Pl. XI, 5

Tragia sellowiana (KLOTZSCH) MUELL. ARG.

Smith 3558 [U]

Tragia fallax type.

Diam. 50 μ . Pila 1,5 μ .

Tragia fallax type.

Diam. 55 μ .

Platygyne type

Inaperturate. Pollen grains ellipsoid.

Tectate; intra-reticulate. Endexine with circular thickenings.

The *Platygyne* type is distinguished from the *Cnesmosa* type by its distinct intra-reticulum. Small circular thickenings occur on the endexine. These peculiar "costae" are distributed irregularly over the endexine and certainly not accompanied by thinnings of the ectexine.

Platygyne hexandra (JACQ.) MUELL. ARG.

Rutten-Pekelharing 346 [U] Pl. XI, 1

Platygyne type; ellipsoid.

Longer axis 40 μ . Shorter axis 36 μ .

Lumina 2-3 μ .

Trigonostemon verrucosus type

Inaperturate; spheroidal or ellipsoid.

Tectate. Gemmate.

Trigonostemon verrucosus J. J. SMITH

Cult. Hort. Bog. VIII. E-16 [U]

Pl. XII, 3

Trigonostemon fungii MERRILL

Linsley Grishitt 1089 [BM]

Trigonostemon verrucosus type; spheroidal.

Longer axis 60 μ . Diam. gemmae 2 μ .

Gemmae not in a croton-pattern.

Trigonostemon verrucosus type.

Diam. 60 μ . Diam. gemmae 1,5-2 μ .

Trigonostemon redioides type

Inaperturate; spheroidal to elliptical.

Intectate; reticulate.

Both *Trigonostemon* types are inaperturate without a croton-pattern. They belong for these reasons to the *Cnesmosa* configuration.

The *Trigonostemon verrucosa* type with the gemmate structure elements on its tectum is perhaps related to the *Croton* type (p. 48). The gemmae are, however, certainly not arranged in a croton-pattern. Except for the shape and lack of apertures the *Trigonostemon redioides* type does not have any character in common with the *Croton* configuration.

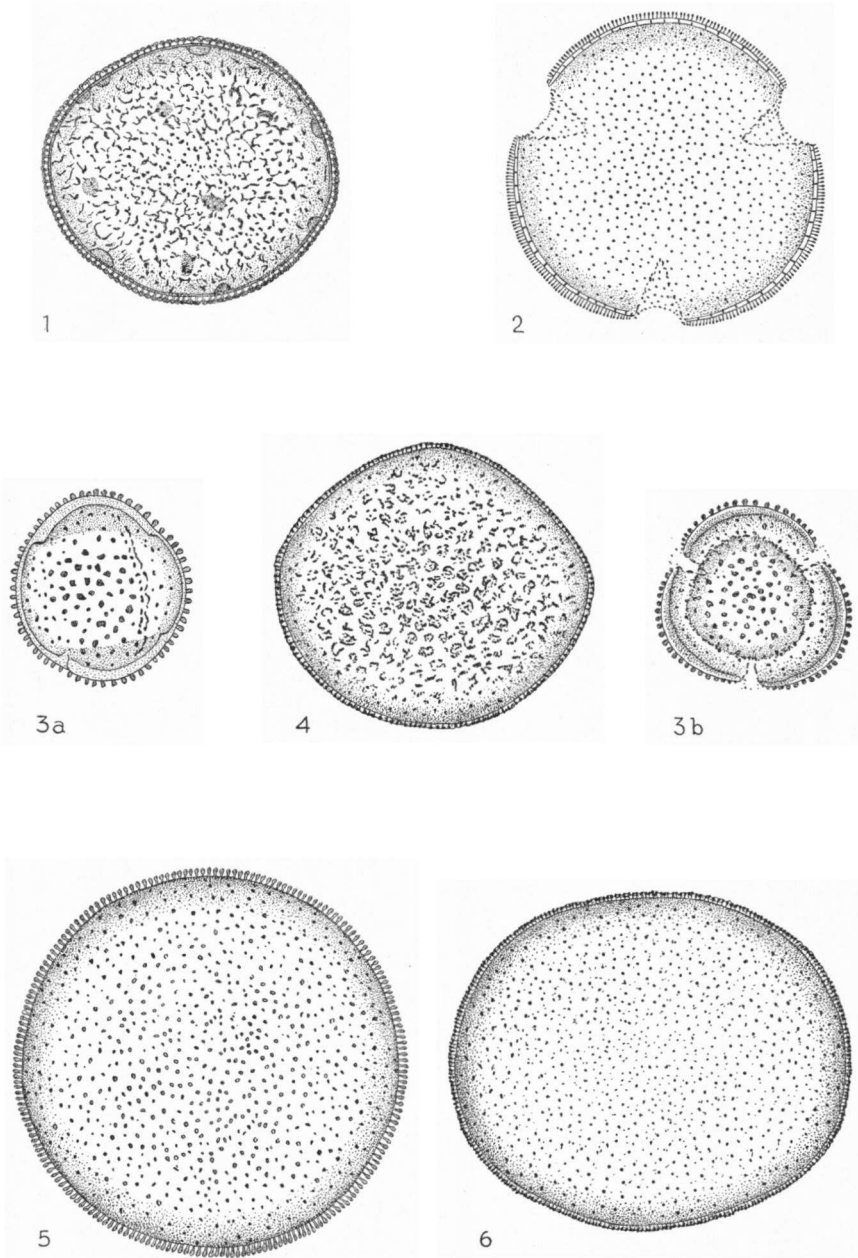

PLATE XI. 1. *Platygyne hexandra*; 2. *Adenocline mercurialis*; 3. *Tetrorchidium didymostemon*; 4. *Megistostigma malaccense*; 5. *Tragia fallax*; 6. *Megistostigma peltatus*.

Taxonomic discussion

Although the pollen grains of the *Trigonostemon* type are not provided with a croton-pattern, the genus *Trigonostemon* has great affinity with genera in the *Croton* configuration. Corresponding characters are:

1. In the male as well in the female flowers a disc is found and an ovarium rudiment is absent.
2. Sepals are present.

<i>Trigonostemon redioides</i> (KURZ) CRAIB Coudre [BM] Pl. XII, 5	<i>Trigonostemon redioides</i> type. Longer axis 34 μ . Shorter axis 30 μ . Lumina 1-2 μ .
<i>Trigonostemon longifolius</i> WALL. ex BAILLON Achmad 142 [U]	<i>Trigonostemon redioides</i> type. Diam. 55 μ . Lumina 3-5 μ .
<i>Prosartema gaudichaudii</i> GAGNEP. Poilane 10446 [K]	<i>Trigonostemon redioides</i> type. Longer axis 38 μ ; shorter axis 35 μ . Lumina ca. 2 μ .
<i>Actephilopsis malayana</i> RIDL. Ridley 2300 [K]	<i>Trigonostemon redioides</i> type. Longer axis 45 μ . Lumina small, ca. 1 μ .

DYSOPSIS CONFIGURATION

Inaperturate. Pollen grains quasi tricolpate, distinctly three-lobed.
Tectate; no croton-pattern present.

Dysopsis type

Inaperturate; quasi tricolpate; oblate spheroidal.
Tectate; psilate. Columellae fairly coarse.

The most striking character is found in the three-lobed shape of the pollen grains. The declination between the lobes is distinct, but there is not the slightest indication of any part of the exine being weakened. According to the definition (see glossary) the pollen grains are inaperturate.

Taxonomic discussion

MUELLER (1866) as well as PAX and K. HOFFMANN (1914, 1931) kept *Dysopsis* in close relationship with *Leidesia* and *Seidelia*. These latter African genera are, however, geographically far removed from the Andine genus *Dysopsis*. The three genera belong undoubtedly to the *Acalypheae*. The pollen grains of *Dysopsis* have little affinity with those of *Leidesia* and *Seidelia*. Perhaps it should be better to separate *Dysopsis* in a different subtribe.

Dysopsis glechomoides (RICH.) MUELL. ARG. *Dysopsis* type.
Lechler 956 [K] Pl. XII, 6 P = 21 μ E = 22,5 μ P:E = 0,93.

PLUKENETIA CONFIGURATION

Tricolpate or triporate. Shape of the pollen grains oblate spheroidal to oblate (rarely prolate spheroidal).
Apertures broad; costae absent.
Colpus or porus membrane ruptured.

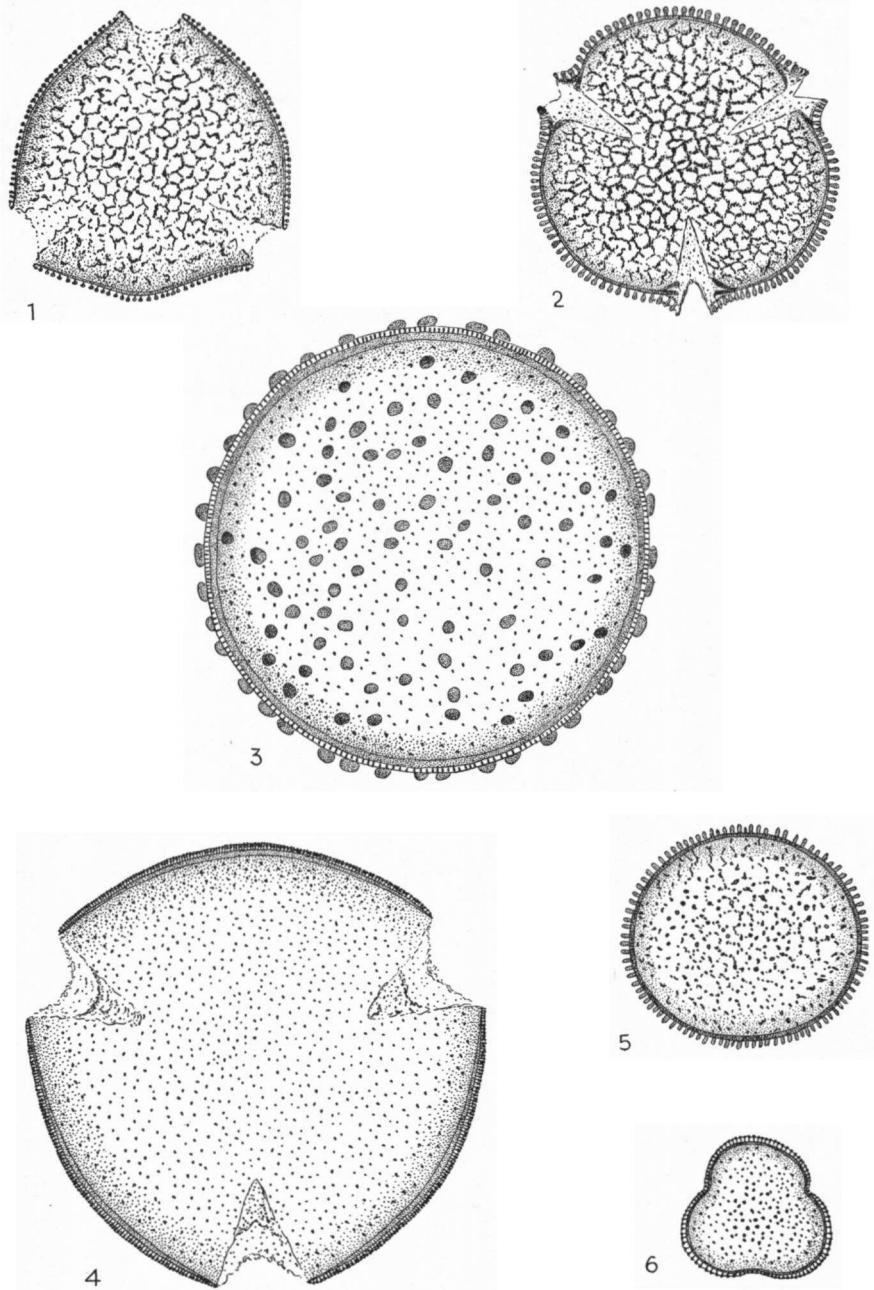

PLATE XII. 1. *Plukenetia verrucosa*; 2. *Fragarioopsis scandens*; 3. *Trigonostemon verrucosus*; 4. *Plukenetia volubilis*; 5. *Trigonostemon redioides*; 6. *Dysopsis glechomoides*.

The types of the *Plukenetia* configuration have simple apertures. In contrast with the *Chiropetalum* configuration the apertures are broad and have a ruptured colpus membrane. In some species a small piece of this membrane persists at the outer ends of the colpi.

Plukenetia type

Tricolpate; oblate spheroidal to oblate (rarely spheroidal or prolate spheroidal). Colpi broad; colpus membrane ruptured. At the outer ends of the apertures a small piece of the colpus membrane (i.e. endexine) persists.

The ruptured part is sometimes bordered by a margo.

Tectate or intectate. Reticulate or not reticulate.

Pollen grains belonging to this type can have very different exine structures. They may be intectate, tectate or tectum perforate, while the columellae are inordinate arranged or form a reticulum. The various subtypes are based on the structure patterns of the exine.

Taxonomic discussion

From the genus *Plukenetia* new genera have been separated by several authors. PAX and K. HOFFMANN (1919a) maintain this division of *Plukenetia*. BENTHAM (1880), however, has pointed out that *Fragariopsis* and *Romanoa* differ only slightly from the typical *Plukenetia* species. Other authors, too, see little difference. CROIZAT (1941a): "No characters are available to separate *Pterococcus* and *Tetracarpidium* from *Plukenetia*". MACBRIDE (1951): "*Apodandra* and *Fragariopsis* could readily be included in *Plukenetia*". Certainly the pollen grains of the above genera are not easily distinguished from those of *Plukenetia*.

In South-America three tree-shaped, non-climbing genera are to be found. SANDWICH (1950) says of them: "*Angostyles*, *Astrococcus* and *Haematostemon* are three closely allied genera of the Plukenetiinae". The pollen is indeed related. They all belong to the *Plukenetia volubilis* subtype and possess a tectum perforatum. *Astrococcus* and *Haematostemon* have moreover a margo.

On account of the imbricate calyx BENTHAM and PAX and K. HOFFMANN placed *Omphalea* outside the Plukenetiinae. CROIZAT (1942a, 1948), however, gives as his opinion that the genus shows strong affinity to the Plukenetiinae. The pollen of *Omphalea* also appears to resemble the *Plukenetia volubilis* subtype very closely.

Plukenetia volubilis subtype

Tectate; psilate. Sometimes the tectum is a tectum perforatum.

Plukenetia volubilis LINN.

Baker 153 [U] Pl. XII, 4

Plukenetia abutifolia (DUCKE) PAX et

K. HOFFM.

Ducke 20619 [U]

Eleutherostigma lehmannianum PAX et

K. HOFFM.

Lehmann 5158 [K] Pl. XIII, 1

Plukenetia volubilis subtype; oblate.

P = 36 μ E = 56 μ P:E = 0,64.

P.A.I. = 0,35.

Plukenetia volubilis subtype.

P = 50 μ E = 62 μ P:E = 0,80.

Tectum perforatum.

Plukenetia volubilis subtype.

P = 37 μ E = 47,5 μ P:E = 0,79.

P.A.I. = 0,35.

- Tetracarpidium conophorum* (MUELL. ARG.) PAX et K. HOFFM.
 [= *Plukenetia conophorum* MUELL. ARG.]
 Mann 1739 [U]
 Versuchsanst. 9 [U]
Plukenetia volubilis subtype.
 P = 30,5 μ E = 44 μ P:E = 0,69.
 P.A.I. = 0,15 — 0,2. Margo.
- Pterococcus corniculatus* (E. SMITH) PAX et K. HOFFM.
 [= *Plukenetia corniculatus* E. SMITH]
 Koorders 41720 B [U]
Plukenetia volubilis subtype.
 P = 32 μ E = 44 μ P:E = 0,66.
 P.A.I. = 0,2.
- Anabaenella tamnoides* (JUSS.) PAX et K. HOFFM.
 nom. illeg. [= *Romanoa*] TREVISAN
 [= *Plukenetia tamnoides* (JUSS.) MUELL. ARG.]
 Lutz 1086 [U]
Plukenetia volubilis subtype.
 P = 43 μ E = 49,5 μ P:E = 0,87.
 P.A.I. = 0,2. Margo.
- Angostyles longifolia* BENTH.
 Ducke 23528 [U]
Plukenetia volubilis subtype.
 P = 45 μ E = 60 μ P:E = 0,75.
 P.A.I. = 0,45. Tectum perforatum.
- Astrococcus cornutus* BENTH.
 Spruce 2050 [K] Pl. XIII, 3
Plukenetia volubilis subtype.
 P = 36,5 μ E = 50 μ P:E = 0,73.
 P.A.I. = 0,4. Margo; tectum perforatum.
- Haematostemon guianensis* SANDWICH
 Fanshawe 6016 [U]
Plukenetia volubilis subtype.
 P = 29 μ E = 40 μ P:E = 0,74.
 P.A.I. = 0,25. Margo; tectum perforatum indistinct.
- Omphalea diandra* LINN.
 Froes (Krukoff) 1893 [U] Pl. XIII, 2
 Lanjouw and Lindeman 3164 [U]
Plukenetia volubilis subtype.
 P = 21,5 μ E = 30,5 μ P:E = 0,59.
 P.A.I. = 0,3.
- Tragia capensis* THUNB.
 Hooker Herb. [K]
Plukenetia volubilis subtype; spheroidal.
 P = E = 17 μ .
- Plukenetia verrucosa* subtype
 Intectate (?); reticulate.
- Plukenetia verrucosa* SMITH
 B.W. 993 [U] Pl. XII, 1
Plukenetia verrucosa subtype; suboblate.
 P = 28 μ E = 35 μ P:E = 0,80.
 P.A.I. = 0,3. Lumina 2-3 μ .
- Apodandra buchtienii* (PAX) PAX
 [= *Plukenetia buchtienii* PAX]
 Krukoff 10753 [U]
Plukenetia verrucosa subtype.
- Fragariopsis scandens* ST.-HILL.
 D'Alleizette 6594 [L] Pl. XII, 2
Plukenetia verrucosa subtype.
 P = 33,5 μ E = 41,5 μ P:E = 0,81.
 P.A.I. = 0,45.
- Tragia stolziana* PAX et K. HOFFM.
 Stolz 1775 [U] Pl. XIII, 4
Plukenetia verrucosa subtype.
 P = 29 μ E = 32 μ P:E = 0,90.
 Reticulum consisting of separate pila,
 lumina 1-2 μ . P.A.I. = 0,6.
- Sphaerostylis natalensis* (SOND.) CROIZAT
 v. Someren 2409 [K]
Plukenetia verrucosa subtype.
 P = 38,5 μ E = 43 μ P:E = 0,89.
 P.A.I. = 0,6. Lumina 1-2 μ .
- Sphaerostylis tulasneana* BAILL.
 D'Alleizette, Nossibé. Nov. 1906 [L]
Plukenetia verrucosa subtype.
 P = 35 μ E = 44 μ P:E = 0,84.
 P.A.I. = 0,3. Lumina 1-2 μ .
- Tragia tristis* subtype
 Intectate; pilate. Pila not in a reticulum.
- Tragia tristis* MUELL. ARG.
 Hassler 6645 [BM] Pl. XIII, 5
Tragia tristis subtype.
 P = 27 μ E = 40 μ P:E = 0,68.
 P.A.I. = 0,3.

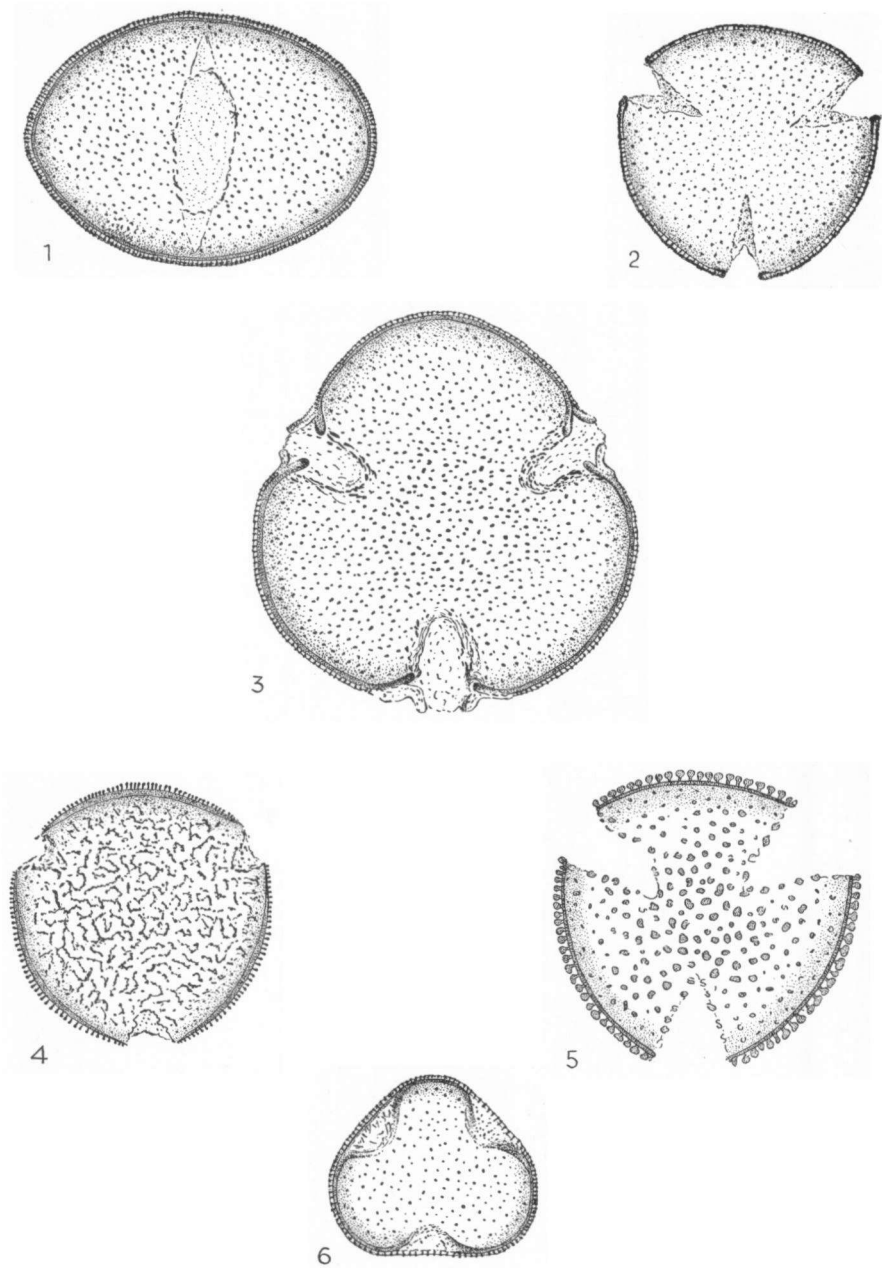

PLATE XIII. 1. *Eleutherostigma lehmannianum*; 2. *Omphalea diandra*; 3. *Astrococcus cornutus*; 4. *Tragia stolziana*; 5. *Tragia tristis*; 6. *Pachystilidium hirsutum*.

Tragia geraniifolia BAILL.
Herter 1006 A. [U]

Tragia volubilis LINN.
Focke 992 [U]

Tragia ramosa TORR.
Rogerson 4-6-1954 [U]

Tragia tristis subtype.
P = 31,5 μ E = 41,5 μ P:E = 0,76.
P.A.I. = 0,3. Pila ca. 1 μ .

Tragia tristis subtype.

Tragia tristis subtype.

Pachystylidium type

Triporate; spheroidal.

Apertures are circular in shape and sunk down. The borders are indistinct. Tectate; psilate.

The *Pachystylidium* type has circular apertures, of which the rims are indistinct. It is, however, not clear if the type belongs with certainty to the *Plukenetia* configuration. The ectexine is only very indistinctly weakened and it is therefore possible to call the type inaperturate. The endexine, however, is clearly thinned. In the author's opinion it is better to keep the type in the *Plukenetia* configuration and not in the *Cnesmosa* configuration.

Pachystylidium hirsutum (BLUME) PAX et
K. HOFFMANN
Elbert 3340 [L] Pl. XIII, 6

Pachystylidium type.
P = E = 29 μ . P.A.I. = 0,6-0,7.

CHIROPETALUM CONFIGURATION

Tricolpate or stephanocolpate (4); shape variable.

Colpi long. No costae colpi. Colpus membrane (endexine) persistent.

[Rarely tricolporate, but then pollen grains prolate in shape and an operculum present.]

This configuration is distinguished from the *Plukenetia* configuration by the colpus membrane, which is never ruptured.

Taxonomic discussion

The genera of the *Chiropetalum* type, *Ditaxis* type and *Argythamnia* type are closely related. MUELLER (1866) and BENTHAM united them in one taxon, the genus *Argythamnia* (except *Leucocroton*). PAX and K. HOFFMANN (1912c, 1931) kept the genera separated, and according to pollen morphology this seems the right opinion.

Chiropetalum type

Tricolpate (or rarely tricolporate); spheroidal to prolate spheroidal.

Colpi wide; operculum present; costae colpi absent.

Tectate or intectate; finely reticulate.

[Rarely colpus transversalis present.]

The *Chiropetalum* type and the *Lasiocroton* type are related by the presence of an operculum. *Chiropetalum* and its allies, however, are finely reticulate.

From the Ekman 16425a sheet ERDTMAN (1952) described *Leucocroton flavicans* as colpate. The Ekman sheet 12343 as examined by the

author from the Kew herbarium has tricolporate pollen grains. These pollen grains should be placed in a different configuration, although other characters (e.g. the operculum and fine reticulum) are consistent with the *Chiropetalum* type. Notwithstanding the colpus transversalis the author prefers to place the pollen grains of *Leucocroton flavicans* in the *Chiropetalum* type.

Chiropetalum lanceolatum A. JUSSIEU
Wedermann 34 [U] Pl. XIV, 2

Chiropetalum type; spheroidal.
P = E = 37,5 μ P:E ca. 1.
P.A.I. = 0,3. Lumina ca. 1 μ .
Intectate.

Chiropetalum canescens PHIL.
Wedermann 773 [U]

Chiropetalum type; prolate spheroidal.
Lumina 1-2 μ . Intectate.

Aonikena patagonica SPEGG.
[= *Chiropetalum patagonica* (SPEGG.)
O'DONN. et LOURTEIG]
Eyerden, Beetle and Grond 24370 [K]
Pl. XIV, 4

Chiropetalum type; prolate spheroidal.
P = 34,5 μ E = 30,5 μ P:E = 1,12.
P.A.I. = 0,3. Lumina 1-2 μ .

Leucocroton flavicans MUELL. ARG.
Ekman 13243 [K] Pl. XIV, 5

Chiropetalum type; subprolate.
P = 30,5 μ E = 25,5 μ P:E = 1,19.
Colpus transversalis without costae.
P.A.I. = 0,4. Lumina ca. 1 μ .

Ditaxis type

Tricolpate; oblate to suboblate. The pollen grains are bi-laterally symmetric. One lobe of the three-lobed pollen grain is smaller than the other two. Colpi long and not very narrow. Tectate; psilate; not reticulate.

This type has bi-symmetric pollen grains. Of the three lobes one is smaller than the other two. This curious shape was observed in six species of *Ditaxis*. *Argythamnia candicans* does not possess these bi-symmetric pollen grains.

Taxonomic discussion

It could not be investigated whether other species of *Argythamnia* perhaps do show the *Ditaxis* type.

CROIZAT (1945) did not see any reason to separate *Ditaxis* and *Argythamnia*. The difference in pollen type, however, supports the opinion of PAX and K. HOFFMANN (1931), who maintain *Ditaxis* next to *Argythamnia*.

Ditaxis fendleri (MUELL. ARG.) PAX et
K. HOFFM.

Ditaxis type; oblate.
P = 30,5 μ E = 51 μ P:E = 0,60.
P.A.I. = 0,15.

Stoffers 1703 [U] Pl. XIV, 1
Ditaxis catamarcensis (GRISEB.) PAX
Brizuela 759 [U]

Ditaxis type.
P = 33 μ E = 42 μ P:E = 0,79.

Ditaxis diversiflora CLOKEY
Clokey 7576 [U]

Ditaxis type.
Some pollen grains 4-colpate.

Ditaxis fasciculata VAHL ex A. DE JUSS.
Boldingh 2733 A [U]

Ditaxis type.
P = 43 μ E = 50 μ P:E = 0,86.
P.A.I. = 0,2 — 0,25.

Ditaxis lancifolia SCHLECHTEND.
Broadway 9257 [U]

Ditaxis type.
P.A.I. = 0,2 — 0,25.

Ditaxis salina PAX et K. HOFFM.
Pedersen 2638 [U]

Ditaxis type.

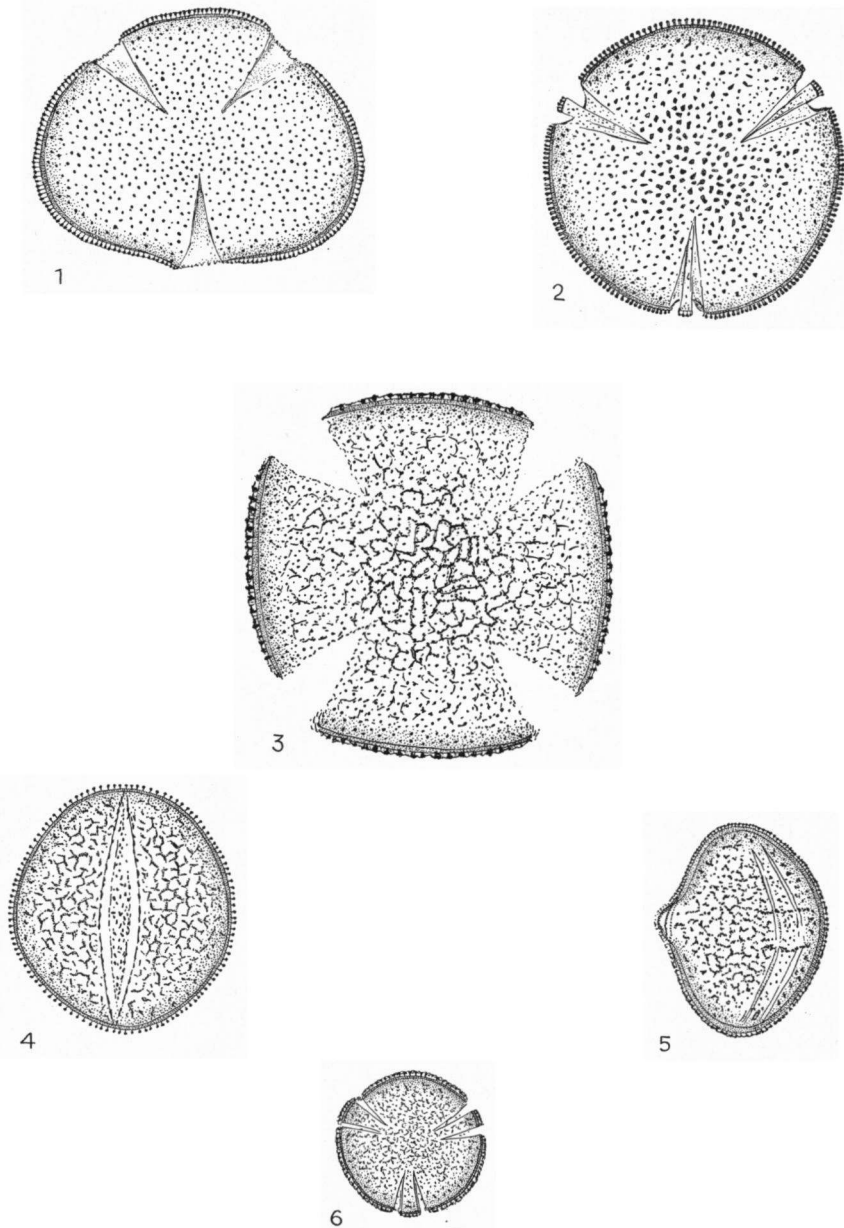

PLATE XIV. 1. *Ditaxis fendleri*; 2. *Chiropetalum lanceolatum*; 3. *Argythamnia candicans*;
 4. *Aonikena patagonica*; 5. *Leucocroton flavicans*; 6. *Lasiocroton macrophyllus*.

Argythamnia type

Stephanocolpate; oblate spheroidal.

Colpi long, not very narrow.

Tectate; on the top of the tectum a reticulum is superimposed.

Although there are some similarities with the *Ditaxis* type, shape as well as structure differ too much for the pollen grains to be placed in the same type.

Argythamnia candicans Sw.

Boldingh 3401 B. [U] Pl. XIV, 3

Argythamnia type; 4 (-3)-colpate.

P = 42 μ E = 45 μ P:E = 0,93.

P.A.I. = 0,5.

Lasiocroton type

Tricolpate or stephanocolpate; spheroidal to oblate spheroidal.

Colpi wide; operculum present; no costae present.

Tectate; psilate; no reticulum present.

The difference between the *Chiroptetalum* type and *Argythamnia* type is found in the absence of a reticulum.

According to ERDTMAN (1952) the pollen grains of *Lasiocroton macrophyllus* are reticulate. With the aid of a phase contrast microscope it was possible to conclude, that the pollen grains of the Harris 11868 specimen are certainly not reticulate.

Taxonomic discussion

Lasiocroton and *Adelia*, together with *Leucocroton* (p. 66), formed the series *Adeliiformes* (PAX and K. HOFFMANN 1914, 1931) in the subtribe *Mercurialinae*. These three genera are certainly related by the following characters:

1. Disc present in the male as well as in the female flowers. This disc is usually annular.
2. Ovarium rudiment in the male flower absent.
3. Petals absent. Number of sepals usually 5.
4. Plants usually dioecious and only growing in the New World.

Lasiocroton macrophyllus (SWARTZ) GRISEB.

Harris 11868 [K] Pl. XIV, 6

Lasiocroton type; oblate spheroidal.

P = 18,5 μ E = 19,5 μ P:E = 0,95.

P.A.I. = 0,3.

Adelia ricinella LINN.

Rutten-Pekelharing [U]

Fuertes 833 [U]

Lasiocroton type; spheroidal.

(3-) 4-colpate. P = E = 33 μ .

Operculum narrow. P.A.I. = 0,4-0,5.

CEPHALOMAPPA CONFIGURATION

Tricolpate.

Colpi very short; costae colpi present.

Cephalomappa type

Tricolpate; oblate spheroidal.

Colpi very short; costae colpi present.

Tectate; intra-reticulum coarse.

The *Cephalomappa* type differs completely from all other types in

the *Crotonoideae*. Besides the very coarse reticulum the colpi are short and bordered by distinct costae colpi.

Taxonomic discussion

The genus *Cephalomappa* is certainly related to those in the *Cladogynos* type (p. 93).

Cephalomappa mallotica J. J. SMITH
Herb. Lugd. Batav. 924.536. 117 [L]
Pl. XV, 5

Cephalomappa type.

P = 30,5 μ E = 32,5 μ P:E = 0,94.
Colpi length ca. 4 μ . Lumina 2-3 μ .

SUMBAVIA CONFIGURATION

Tricolporate – stephanocolporate; usually Polar axis shorter than Equatorial axis.

Colpi wide or narrow.

Tectate or intectate; reticulate. Reticulum coarse.

The most important character of this configuration is the coarse reticulum. Some species in the *Cladogynos* configuration (p. 93) also have a fairly coarse reticulum but in that case they have a Polar axis larger than the Equatorial axis. In the *Sumbavia* configuration the pollen grains usually have a Polar axis shorter than the Equatorial axis.

Taxonomic discussion

Most genera in this configuration belong to the *Chrozophoreae* (BENTHAM, 1880; PAX and K. HOFFMANN 1912c, 1931). These authors split up this tribe in groups. BENTHAM's third group is comparable with the subtribe *Regulares* of PAX and K. HOFFMANN, in which *Sumbavia*, *Chrozophora* and *Caperonia* are found.

Sumbavia type

Tricolporate; oblate spheroidal to oblate.

Colpus transversalis large; broad or long and narrow.

Colpi long; costae colpi present or absent.

Intectate; reticulate. Reticulum coarse.

The pollen grains of the *Sumbavia* type are always tricolporate and have a distinct reticulum. They differ from the *Chrozophora* type and *Caperonia* subtype by the number of colpi and from the *Philyra* subtype by the coarse reticulum and elongated colpus transversalis.

In 1952 ERDTMAN described pollen grains of *Monotaxis grandiflora* which are subprolate and have a membrana granulata. This description is not in accordance with the data found by the author. The pollen grains examined were suboblate and had no membrana granulata. The exine structure, however, is quite the same.

Taxonomic discussion

In the system of PAX and K. HOFFMANN (1931) *Thyrsanthera* and *Sumbaviopsis* are placed next to *Sumbavia*. This is in agreement with the close relationship of the pollen grains.

Monotaxis differs from the other genera in the *Sumbavia* type by the absence of stellate hairs and the presence of a disc and an ovarium rudiment in the male flowers. The flowers have, however, also five petals as in most genera of the *Sumbavia* type.

In many respects *Melanolepis* resembles *Sumbavia* and *Sumbaviopsis*. As with these genera there is no disc or ovarium rudiment in the male flower. On the other hand the female flower possesses a disc. The plants have stellate hairs, they are monoecious and show similarity in the form of the leaves. *Melanolepis*, however, has no petals. BAILLON (1858) therefore calls *Melanolepis* a *Sumbavia* without petals. MUELLER (1866), BENTHAM (1880) and PAX and K. HOFFMANN see *Mallotus* as nearest relation of *Melanolepis*. An accurate comparison of the corresponding characters will have to decide whether *Melanolepis* is closer related to *Mallotus* than to *Sumbavia* and *Sumbaviopsis*.

Sumbavia rottleroides BAILL.

Merrill Sp. Blancoanae 993 [L]
Pl. XV, 2

Sumbavia type; oblate spheroidal.

P = 43 μ E = 46 μ P:E = 0,93.
m:e = 0,6. P.A.I. = 0,35.

Costae colpi absent. Lumina 3-4 μ .

Sumbaviopsis albicans J. J. SMITH

Backer 19016 [L]

Sumbavia type; suboblate.

P = 32 μ E = 38,5 μ P:E = 0,80.
P.A.I. = 0,3. Lumina 1-2 μ .

Costae colpi.

Thyrsanthera suborbicularis PIERRE ex

GAGNEPAIN

Pierre 512 [K] Pl. XV, 3

Sumbavia type; suboblate.

P = 43,5 μ E = 52 μ P:E = 0,84.
P.A.I. = 0,3. Lumina 1-2 μ .

Costae colpi absent.

Melanolepis multiglandulosa (REINW. ex

BLUME) REICH.F. et ZOLLINGER
Hort. Bogor. 2127 [U] Pl. XV, 1

Sumbavia type; suboblate.

P = 32 μ E = 38,5 μ P:E = 0,82.
P.A.I. = 0,3 — 0,35. Lumina 1-3 μ .

Costae transversales.

Monotaxis grandiflora ENDL.

Pritzel XI, 1900 [U] Pl. XV, 4

Sumbavia type; oblate.

P = 30,5 μ E = 36 μ P:E = 0,84.
m:e < 0,5. P.A.I. = 0,15.

Colpus transversalis long and narrow.
Lumina 1-2 μ .

Chrozophora type

Stephanocolporate; suboblate — oblate.

Colpus transversalis broad, isodiametric; costae.

Colpi short; costae colpi.

Intectate (?); reticulate. Reticulum coarse.

The lumina of the reticulum are much larger in the *Chrozophora* type than in any other type of the *Sumbavia* configuration. Besides this character the colpi are short and the number of colpi is large (at least six). In the subfamily of the Crotonoideae pollen grains with more than three or four colpi are rather rare. Only the related *Caperonia* type has also six colpi.

Chrozophora plicata (VAHL) A. DE JUSS.

Feinbrun etc. 49169 A. [U] Pl. XV, 6

Chrozophora type; (7-) 8 (-9)-colporate;
suboblate — oblate.

P = 60 μ E = 80 μ P:E = 0,75.
m:e = ca. 1. P.A.I. > 0,5. Lumina
4-6 μ .

Chrozophora tinctoria (LINN.) A. DE JUSS.

Faure 31126 A. [U]

Chrozophora type. 6-colporate.

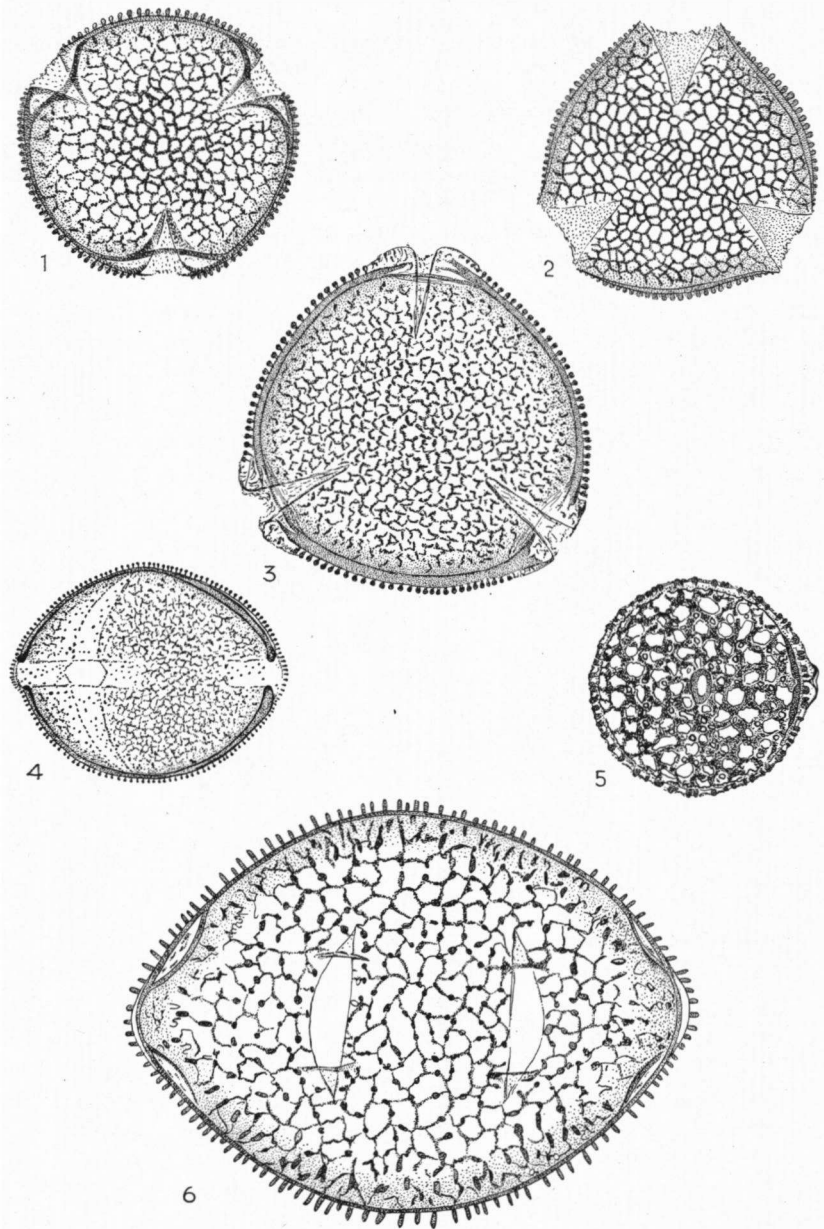

PLATE XV. 1. *Melanolepis multiglandulosa*; 2. *Sumbavia rottleroides*; 3. *Thyrsanthera suborbiculatus*; 4. *Monotaxis grandiflora*; 5. *Cephalomappa malloticarpa*; 6. *Chrozophora plicata*.

Caperonia type

Stephanocolporate or tricolporate; oblate spheroidal – prolate spheroidal.
Colpus transversalis broad, circular – broad elliptic.
Colpi long and narrow; costae colpi absent.
Intectate; reticulate. Lumina fairly small. Columellae elongated.

This type resembles the *Chrozophora* type in its number of colpi (usually six). The colpi are, however, longer, and the lumina of the reticulum much smaller. The *Philyra* subtype differs from the *Sumbavia* type by its large circular colpus transversalis.

Taxonomic discussion

MUELLER (1866) and BENTHAM (1880) included *Philyra* in the genus *Argythamnia*. PAX and K. HOFFMANN (1912c, 1931) separated *Philyra* from this genus and referred it close to *Caperonia*. Pollen-morphologically the genus is more related to *Caperonia* than to *Argythamnia* and its allies.

Caperonia subtype

Pollen grains stephanocolporate.

Caperonia palustris (LINN.) ST. HILL.
Lanjouw 1044 [U] Pl. XVI, 4

Caperonia subtype; oblate spheroidal.
P = 32 μ E = 33 μ P:E = 0,94.
m:e ca. 1. P.A.I. = 0,3. Lumina
ca. 1 μ .

Caperonia serrata PRESL
de Wit 429 [WAG]

Caperonia subtype; spheroidal.
P = E = 39 μ . P.A.I. = 0,5.

Caperonia corchoroides MUELL. ARG.
Rombouts 358 [U]

Caperonia subtype.

Philyra subtype

Pollen grains tricolporate.

Philyra brasiliensis KLOTZSCH
Hassler 12323 [K] Pl. XVI, 2

Philyra subtype; prolate spheroidal.
P = 38,5 μ E = 35 μ P:E = 1,10.
m:e = 0,7. P.A.I. = 0,4. Lumina
1–2 μ .

Caryodendron type

Tricolporate; oblate spheroidal – suboblate.
In polar view pollen grains convex triangular.
Colpus transversalis broad; no costae present.
Colpi narrow; no costae colpi.
Tectate, tectum perforatum; psilate. Intra-reticulum coarse, but lumina small.

The *Caryodendron* type is closely related to the *Sumbavia* type. The pollen grains are, however, tectate and the lumina of the intra-reticulum are fairly small. The tectum, moreover, is perforate. The holes in the tectum are very small and only visible with high magnification.

Taxonomic discussion

Caryodendron is not closely related to the genera in the *Sumbavia* type. It lacks a stellate indument and petals. BENTHAM (1880) as well as PAX and K. HOFFMANN (1914, 1931) thought of a relationship

with *Alchornea*. *Caryodendron* possesses, however, an annular disc in the female flower, a character never to be found in the genera of the *Alchornea* type, but always present in the genera of the *Sumbavia* type. This character is also present in genera of the *Bernardia* type and *Speranskia* type. On the other hand the authors cited above stated, that in their opinion *Adenophaedra* is closely related to *Caryodendron*. *Adenophaedra* belongs pollen-morphologically to the *Bernardia* type (p. 75). The pollen grains of *Caryodendron* show indeed some resemblance with this type, but the differences are too many for a combination of *Adenophaedra* and *Caryodendron* in the same type.

Caryodendron orinocense KARST.
Krukoff 5553 [U] Pl. XVI, 3

Caryodendron type; suboblate.
P = 29 μ E = 34,5 μ P:E = 0,84.
m:e = 0,4. P.A.I. = 0,3.
Lumina ca. 1 μ ; muri thick.

Caryodendron grandifolius MUELL. ARG.
Kuhlmann et Ducke 16598 [U]

Caryodendron type; oblate spheroidal.
P = 31,5 μ E = 33 μ P:E = 0,95.
P.A.I. = 0,2.

Nealchornea type

Tricolporate; oblate spheroidal. In polar view the pollen grains circular.
Colpus transversalis broad; ora large.
Colpi short and wide.
Intectate; reticulate. Reticulum coarse.

The pollen grains have a Polar axis shorter than the Equatorial axis and there is also a reticulum with large lumina. For these reasons the type is placed in the *Sumbavia* configuration. It differs from the other types by the three short colpi.

Taxonomic discussion

Nealchornea is not related to any genus discussed in other types of the *Sumbavia* configuration. Its nearest allies are perhaps *Hamilcoa*, *Plagiostyles* and *Pimeleodendron* (p. 103). Striking corresponding characters with these genera are the very short to sessile anthers and thickened pedicels.

PAX and K. HOFFMANN (1931) put the genus in the subtribe Cluytiinae with e.g. *Trigonostemon*, *Moultonianthus* and *Trigonopleura*. The latter three genera are all placed in different pollen types and even in different configurations.

Nealchornea yapurensis HUBER
Krukoff 4967 [U] Pl. XVI, 1

Nealchornea type.
P = 27 μ E = 30 μ P:E = 0,90.
m:e = ca. 1. Lumina 3-4 μ .

BERNARDIA CONFIGURATION

Tricolporate or stephanolcoporate (except *Erismanthus* type). Usually Polar axis larger than Equatorial axis.
Colpi narrow; costae colpi.
Tectate or intectate; reticulate. Reticulum fine; lumina < 2 μ (*Cyttaranthus* without reticulum).

The types of the *Bernardia* configuration are finely reticulate and have usually a Polar axis larger than the Equatorial axis. *Cyttaranthus*

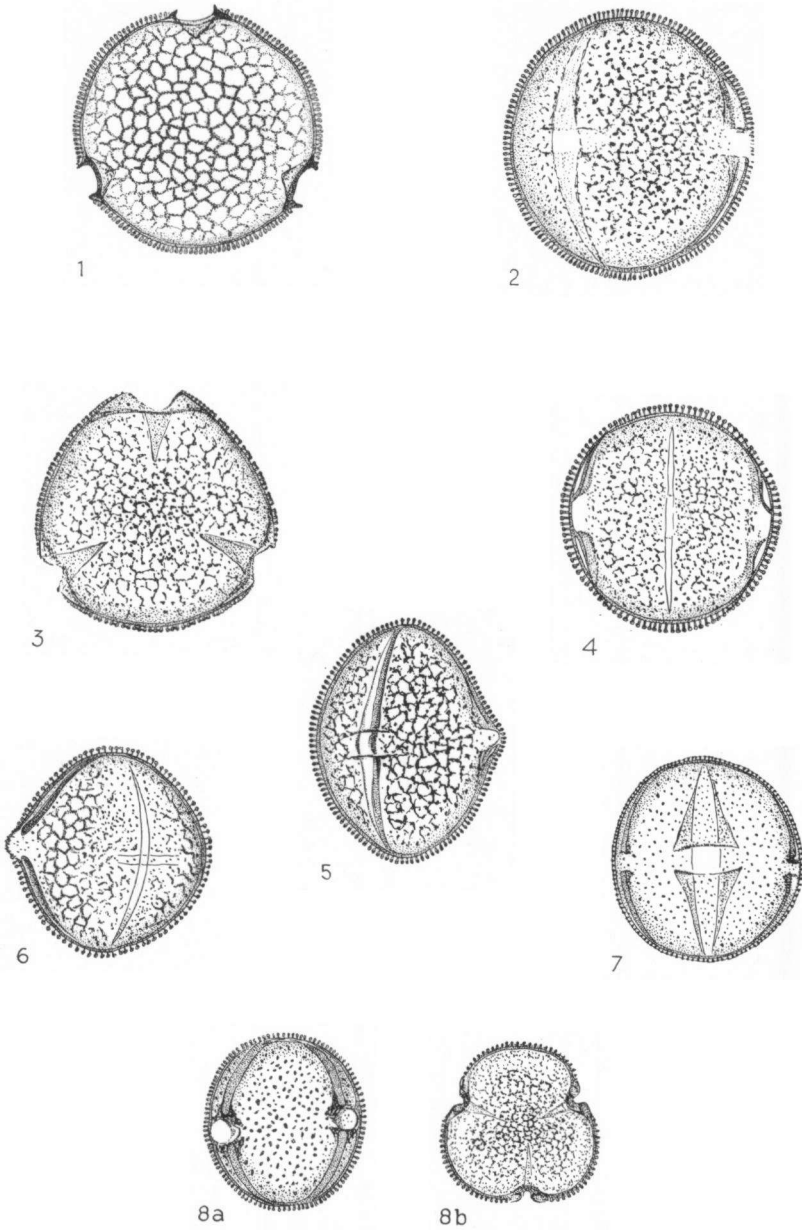

PLATE XVI. 1. *Nealchornea yapurensis*; 2. *Philyra brasiliensis*; 3. *Caryodendron orinocensis*; 4. *Caperonia palustris*; 5. *Pseudagrostistachys africana*; 6. *Heterocalyx laoticus*; 7. *Cyttaranthus congolensis*; 8. *Bernardia pulchella*.

only is not reticulate, but in other respects the pollen grains of this genus closely resemble the *Speranskia* type. Although placed in this configuration by their fine reticulum and prolate shape, the *Moultonianthus* type and the *Clutia* type differ largely from the *Bernardia* type and the *Speranskia* type.

Bernardia type

Tricolporate; spheroidal prolate – subprolate. Pollen grains in polar view distinctly three-lobed.

Colpus transversalis small; costae.

Colpi narrow; costae colpi. P.A.I. small < 0,25.

Intectate; finely reticulate; lumina ca. 1 μ .

The *Bernardia* type differs from the *Speranskia* type by its distinctly three-lobed pollen grains.

Taxonomic discussion

MUELLER originally described *Adenophaedra* as a section of *Bernardia*. In later publications he raised it to a separate genus. BENTHAM (1880) and PAX and K. HOFFMANN (1931) maintained the two genera and even placed them in a far-away group to which *Alchornea* belongs. Pollen-morphological study of the two genera showed a close relation, so it seems better to maintain *Adenophaedra* in the vicinity of *Bernardia*. Both genera are restricted to the New World.

Bernardia pulchella (BAILLON) MUELL.

Tessman 6078 [U] Pl. XVI, 8

Bernardia lorentzii MUELL. ARG.

Schulz 1554 [U]

Bernardia corensis (JACQ.) MUELL. ARG.

Boldingh 665 B. [U]

Adenophaedra minor DUCKE

Herb. Rio 10386 [U]

Bernardia type; prolate spheroidal.

P = 25,5 μ E = 24 μ P:E = 1,07.
m:e = ca. 0,5. P.A.I. = 0,15.

Bernardia type.

P = 29 μ E = 25 μ P:E = 1,17.
P.A.I. = 0,2.

Bernardia type.

P = 31 μ E = 25 μ P:E = 1,24.
P.A.I. = 0,2.

Bernardia type.

P = 28 μ E = 27 μ P:E = 1,04.
Colpus transversalis narrow;
m:e < 0,5. P.A.I. = 0,1-0,15.

Speranskia type

Tricolporate; spheroidal – prolate spheroidal. Pollen grains in polar view convex triangular.

Colpus transversalis large; costae present or absent.

Colpi narrow; costae colpi. Sometimes costae indistinct.

Tectate; intra-reticulum present or rarely absent (*Cyttaranthus*).

This type looks somewhat like the *Bernardia* type but differs by its polar view and the shape of the colpus transversalis. *Cyttaranthus* belongs undoubtedly to this type but lacks the fine reticulum.

Taxonomic discussion

Genera with a *Speranskia* type are only found in the Old World. They have several characters in common.

1. In the female flowers always a disc present.
2. Anthers usually pendulous; connectives frequently appendiculated.

3. In the male flowers an ovarium rudiment is wanting except in some *Agrostistachys* species.
4. The Asiatic genera have petals and an extrastaminal disc. The African representatives frequently lacks petals, while glands are always present on the receptaculum.
5. Stellate hairs never present.

<i>Speranskia pekinensis</i> PAX et K. HOFFMANN Bullock 10 Mai. 1888 [K] Pl. XVII, 8	<i>Speranskia</i> type; subprolate. P = 28,5 μ E = 24 μ P:E = 1,16. m:e = 0,5-1. P.A.I. = 0,10. Lumina < 1 μ .
<i>Pseudagrostistachys africana</i> (MUELL. ARG.) PAX et K. HOFFM. Moller and Quintus 16 [U] Pl. XVI, 5	<i>Speranskia</i> type; subprolate. P = 33 μ E = 26,5 μ P:E = 1,24. m:e < 0,5. P.A.I. = 0,3. Lumina ca. 1 μ .
<i>Cyttaranthus congolensis</i> LÉONARD Collens 3541 [K] Pl. XVI, 7	<i>Speranskia</i> type; prolate spheroidal. P = 30 μ E = 28,5 μ P:E = 1,05. P.A.I. = 0,35. Not reticulate!
<i>Agrostistachys indica</i> DALZ. Stocks [U]	<i>Speranskia</i> type; oblate spheroidal. P = 31,5 μ E = 33,5 μ P:E = 0,94. m:e < 0,5. P.A.I. = 0,25. Lumina 1-2 μ . Margo (thinning of the ektexine).
<i>Agrostistachys sessilifolia</i> (KURZ) PAX et K. HOFFMANN East Ind. Comp. 4739 [U]	<i>Speranskia</i> type; subprolate. P = 26,5 μ E = 23,5 μ P:E = 1,12. P.A.I. = 0,2-0,25. Costae transversales. Margo (thinning of the ektexine).
<i>Heterocalyx loiticus</i> GAGNEP. Kerr 20895 [K] Pl. XVI, 6	<i>Speranskia</i> type; spheroidal. P = E = 30 μ . P.A.I. = 0,25. Lumina 1-2 μ . Margo (thinning of the ektexine).
<i>Argomuelleria macrophylla</i> PAX de Wit 32 [WAG] Pl. XVII, 3 Swynnerton 119 A [BM]	<i>Speranskia</i> type; spheroidal. P = 25,5 μ E = 25 μ P:E = 1,02. m:e = 0,7-0,8. P.A.I. = 0,4. Lumina ca. 1 μ . Costae transversales absent. P = 30 μ E = 28,5 μ P:E = 1,08. In other characters as above.
<i>Discoglyprena caloneura</i> (PAX) PRAIN Zenker 2643 [L]	<i>Speranskia</i> type; prolate spheroidal. P = 27 μ E = 25 μ P:E = 1,09. P.A.I. = 0,25-0,3. Lumina ca. 1 μ .

Moultonianthus type

Tricolporate; spheroidal. In polar view the pollen grains circular.
Colpus transversalis narrow and small; costae.
Colpi narrow and long; costae colpi.
Intectate; reticulum fine.

The pollen grains of the *Moultonianthus* type are finely but distinctly reticulate and are therefore placed in the *Bernardia* configuration. The shape, polar view and colpus transversalis of this type differs greatly from the other types in this configuration.

Taxonomic discussion

According to v. STEENIS (1948) *Moultonianthus* is related to *Erismanthus* in several characters. Unfortunately pollen grains of *Erismanthus indochinensis* do not agree with those of *Moultonianthus leem-*

bruggianus. Perhaps other species of *Erismanthus* will show more relationship in their pollen-morphology.

<i>Moultonianthus leembruggianus</i> (BOERL. et KOORD.) v. STEENIS Serawak 464 [L] Pl. XVII, 1	<i>Moultonianthus</i> type. P = E = 23,5 μ . m:e < 0,5. P.A.I. = 0,4. Lumina 1-2 μ .
---	--

Erismanthus type

Tricolpate; oblate spheroidal. In polar view pollen grains circular. Colpi narrow. Rim of the colpi irregularly ruptured. Tectate; psilate. Columellae short.

Pollen grains of *Erismanthus indochinensis* distinctly differ from the *Moultonianthus*-type. There are no composite apertures and the grains are tectate. ERDTMAN (1952) examined *Erismanthus oblique* and on the contrary did find composite apertures in this specimen.

<i>Erismanthus indochinensis</i> GAGNEP. D'Alleizette 942, 20-4-1908 [L] Pl. XVII, 4	<i>Erismanthus</i> type. P = 24 μ E = 25,5 μ P:E = 0,93. P.A.I. = 0,4.
--	--

Clutia type

Tricolporate; subprolate. In polar view the pollen grains triangular. Colpus transversalis small; costae. Colpi narrow; costae colpi. Margo present (thinning of the ectexine). Tectate; intra-reticulum indistinct.

The *Clutia* type strongly recalls the *Phyllanthus pentaphyllus* subtype in the subfamily of the Phyllanthoideae. The type differs, however, by the shape of the colpus transversalis. The *Clutia* type differs from the *Bernardia* type by its polar view. The *Bernardia* type is three-lobed, the *Clutia* type triangular.

Taxonomical discussion

This African genus stands alone in the *Euphorbiaceae*. The inflorescence and habit are those of *Phyllanthus*; but the essential characters are those of the Chrozophorae (BENTHAM, 1880).

<i>Clutia paxii</i> KNAUF Crookewit 198 [WAG] Pl. XVII, 2	<i>Clutia</i> type. P = 35 μ E = 27 μ P:E = 1,30. m:e < 0,5.
<i>Clutia natalensis</i> BERNH. Wylie Jan. 1935 [U]	<i>Clutia</i> type. P = 43 μ E = 33 μ P:E = 1,30. Reticulum indistinct.
<i>Clutia abyssinica</i> JAUB. et SPACH Stolz 1876 [U]	<i>Clutia</i> type. P = 52 μ E = 40 μ P:E = 1,30. Reticulum indistinct.
<i>Clutia rubricaulis</i> ECKL. ex SOND. [= <i>C. alaternoides</i> LINN.] Lanjouw 165 [U]	<i>Clutia</i> type. P = 54 μ E = 41 μ P:E = 1,30. Reticulum indistinct.

MALLOTUS CONFIGURATION

Tricolporate - stephanocolporate (4). Polar axis usually shorter than Equatorial axis.
Colpi narrow.
Tectate (tectum perforate in *Blumeodendron* type); usually not reticulate; columellae short, capita indistinct.

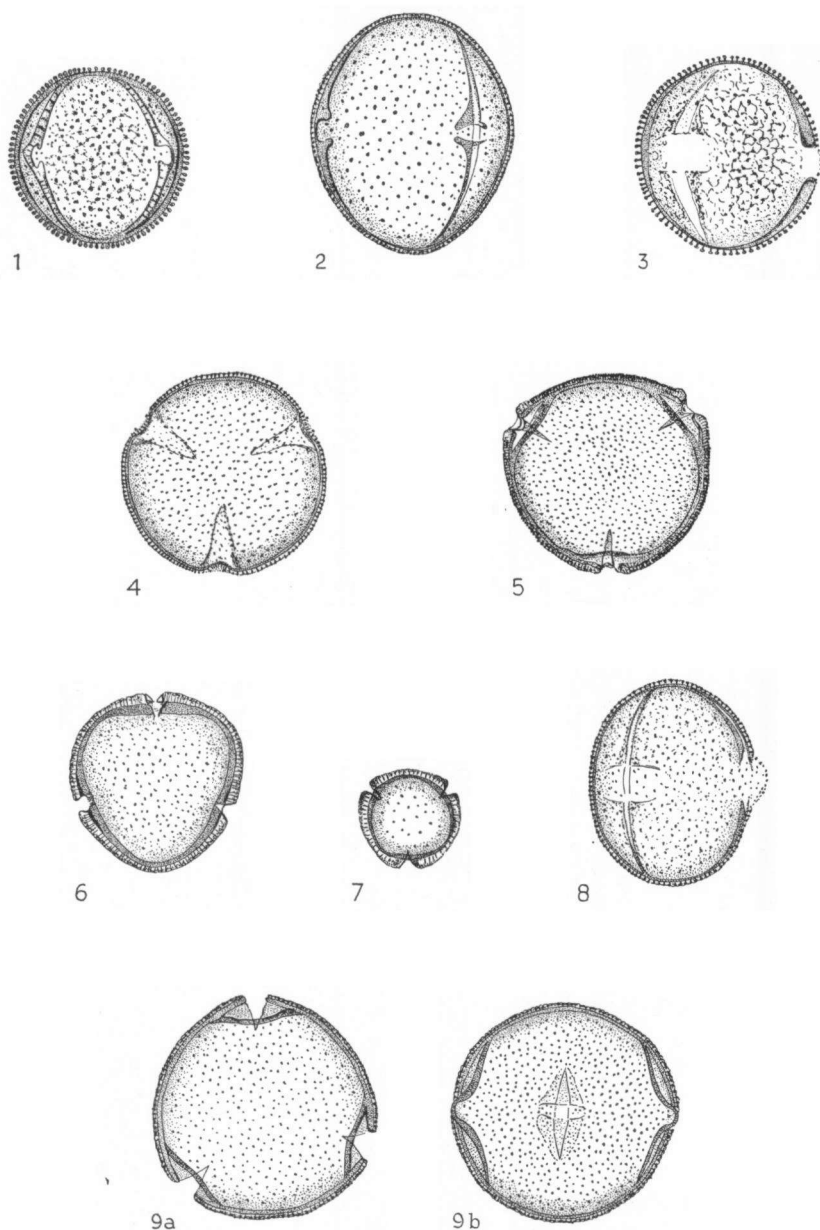

PLATE XVII. 1. *Moultonianthus leembruggianus*; 2. *Clutia paxii*; 3. *Argomuelleria macrophylla*; 4. *Erismanthus indochinensis*; 5. *Mallotus albus*; 6. *Cleidion javanicum*; 7. *Macaranga spinosa*; 8. *Speranskia pekinensis*; 9. *Trewia nudiflora*.

The most important characters of the *Mallotus* configuration are the short columellae and the indistinct capita. Besides these important characters the pollen grains are usually not reticulate.

The *Mallotus* type, *Blumeodendron* type, *Acalypha* type, *Alchornea* type, *Discocleidion* type and *Mareya* type are closely related and differ only in minor points.

The *Ricinus* type and *Pera* type are connected by the very narrow colpi and nearly visible columellae. They certainly belong to the *Mallotus* configuration although the shape of the pollen grains is often prolate.

The *Seidelia* type and *Leidesia* type are related to each other, especially in their exine structure and polar view.

The *Microdesmis* type and *Cheilosa* type are placed in the *Mallotus* configuration because of their shape and short columellae. The differences with the other types in this configuration, however, are considerable.

Mallotus type

Tricolporate – stephanocolporate (4); oblate spheroidal – suboblate. Sometimes spheroidal.

Colpus transversalis usually small; costae.

Colpi narrow; costae colpi.

Tectate; psilate or scabrate. Rarely intra-reticulate (*Adriana*).

The pollen grains are easily distinguished from the other types. The colpi, are short (P.A.I. is at least 0,4) and the shape is usually oblate spheroidal. The columellae are so short, that only with difficulty the tectum can be distinguished from the endexine. Costae colpi distinct.

Taxonomic discussion

In the system of MUELLER (1866) genera of the *Mallotus* type are all found in his subtribe *Euacalypheae*. BENTHAM (1880) placed them in the subtribe *Acalypheae* and PAX and K. HOFFMANN (1914, 1931) in the subtribe *Mercurialinae* of the tribe *Acalypheae*. In all three systems the genera are mixed up with those, closely allied to them in the *Acalypha* type, *Alchornea* type, *Blumeodendron* type, *Discocleidion* type and *Mareya* type. Corresponding characters are:

1. A disc is wanting in the male as well as in the female flowers.
2. An ovarium rudiment is wanting.
3. Usually numerous stamens are inserted on a convex receptaculum (*Macaranga* with few stamens has no receptaculum). Most times the receptaculum is glabrous. Sometimes it is provided with glands (some species of *Mallotus* and *Pycnocomia*) or hairs (*Wetria*).
4. The majority of the genera grows in the Old World; only *Avelanita* is from Chile.

Mallotus subtype

Pollen grains psilate.

- Mallotus albus* (ROXB.) MUELL. ARG.
Thomson [U] Pl. XVII, 5
Mallotus claoxyloides (F. v. MUELLER)
MUELL. ARG.
Buysman 1874 [U]
Mallotus miquelianus (SCHEFF.) PAX et
K. HOFFM.
Rutten-Kooistra 27 [U]
Mallotus repandus (WILLD.) MUELL. ARG.
Griffith 4760 [U]
Coelodiscus lanceolatus GAGNEP.
D'Alleizette Jan. 1909 [L]
Trewia nudiflora LINN.
Hohenacker 453 [U] Pl. XVII, 9
Avellanita bustillosii PHILIPPI
Philippi [BM]
Cordemoya integrifolia (WILLD.) BAILLON
Gover. Pires to Kew Nov. 1908 [K]
Coccoceras borneense J. J. SMITH
F. H. Endert 2078 [L]
Deuteromallotus acuminatus (BAILLON)
PAX et K. HOFFM.
D'Alleizette Mad. Nov. 1908 [L]
Wetria macrophylla (BLUME) J. J. SMITH
Cult. Hort. Bog. IXA. 124 [U]
Adriana quadripartita (LABILL.) GAUDICH.
F. v. Mueller, Freemantle 1861 [U]
Cleidion javanicum BLUME
Cult. Hort. Bog. IX A. 38 [U]
Pl. XVII, 6
Cleidion angustifolium PAX et K. HOFFM.
Le Rat 468 [P]
Macaranga spinosa MUELL. ARG.
Steiner 1292 [U] Pl. XVII, 7
Macaranga harveyana (MUELL. ARG.)
MUELL. ARG.
Yuncker 15980 [U]
Macaranga densiflora WARB.
Gjellerup 236 [U]
Mallotus subtype; oblate spheroidal.
P = 30 μ E = 30,5 μ P:E = 0,98.
m:e < 0,5. P.A.I. = 0,4.
Mallotus subtype.
P = 30 μ E = 32,5 μ P:E = 0,95.
P.A.I. = 0,4.
Mallotus subtype.
P = 20 μ E = 21 μ P:E = 0,95.
P.A.I. = 0,4.
Mallotus subtype. Too young.
Mallotus subtype.
P = 25,5 μ E = 27 μ P:E = 0,94.
P.A.I. = 0,4.
Mallotus subtype.
P = 27 μ E = 30,5 μ P:E = 0,89.
Colpi very short. P.A.I. > 0,75.
Mallotus subtype.
P = 25,5 μ E = 26 μ P:E = 0,98.
Costae colpi indistinct. P.A.I. = 0,45.
Mallotus subtype.
P = 20 μ E = 21,5 μ P:E = 0,93.
P.A.I. = 0,7.
Mallotus subtype; 3-4 colporate.
P = 37,5 μ E = 39 μ P:E = 0,96.
Colpi very short. P.A.I. = 0,7.
Mallotus subtype.
P = 20 μ E = 22,5 μ P:E = 0,88.
Colpi very short. P.A.I. > 0,7.
Mallotus subtype; 4- (3) colporate.
P = E = 40 μ P.A.I. = 0,5.
Mallotus subtype.
P = 33,5 μ E = 35 μ P:E = 0,96.
P.A.I. > 0,5. Intra-reticulate.
Mallotus subtype.
P = 25,5 μ E = 27 μ P:E = 0,95.
P.A.I. > 0,7.
Mallotus subtype.
P = 19 μ E = 18 μ P:E = 0,95.
P.A.I. > 0,7.
Mallotus subtype.
P = E = 14,5 μ P:E = ca. 1.
P.A.I. > 0,5.
Mallotus type.
P = 17 μ E = 17 μ P:E = ca. 1.
Mallotus subtype; P = E = 17 μ .

Pycnocoma subtype

Pollen grains scabrate.

This subtype differs from the *Mallotus* subtype by the scabrae on the tectum. In *Pycnocoma cornuta* the colpi are longer than those in other pollen grains of the *Mallotus* type. The colpi of *Pycnocoma macrophylla*, however, are as short as the others.

Pycnocoma cornuta MUELL. ARG.
Leeuwenberg 3003 [U] Pl. XVIII, 1

Pycnocoma subtype.
P = 33,5 μ E = 35,5 μ P:E = 0,94.
m:e = 0,4. P.A.I. = 0,3.

Pycnocoma macrophylla BENTHAM
Zenker 1251 [L]

Pycnocoma subtype.
P = 30,5 μ E = 32 μ P:E = 0,95.
P.A.I. > 0,5.

Blumeodendron type

Tricolporate; oblate spheroidal.
Colpus transversalis small and narrow; costae.
Colpi very short and narrow; costae colpi.
Tectum perforatum that may be regarded as a coarse reticulum.

This type is closely related with the *Mallotus* type. The tectum, however, is perforated. The holes are rather wide and it is perhaps better to speak of a coarse reticulum. The muri of the reticulum are thick and consist of many small columellae.

Taxonomic discussion

The affinities of *Blumeodendron* with *Botryophora* are extensively explained by AIRY-SHAW (1960).

Without doubt *Ptychopyxis* has several characters in common with *Blumeodendron* and *Botryophora*.

1. In the male flowers a disc and an ovarium rudiment are absent. Many stamens inserted on a receptaculum.
2. In the female flowers a disc is present. (AIRY-SHAW 1960, states, that in *Ptychopyxis* at least some species certainly have a disc.)

Blumeodendron tokbrai (BLUME) KURZ
Achmad 216 [L] Pl. XVIII, 6

Blumeodendron type.
P = 21 μ E = 23 μ P:E = 0,91.

Ptychopyxis costata MIQUEL
Kings collector 6740 [L]

Blumeodendron type.
P = 18,5 μ E = 21 μ P:E = 0,88.

Ptychopyxis kingii RIDLEY
de Haviland et Hose 3673K [K]

Blumeodendron type.
P = 19,5 μ E = 21 μ P:E = 0,83.

Botryophora geniculata (MIQ.) BEUMÉE ex
AIRY-SHAW

Blumeodendron type.
P = 22 μ E = 23,5 μ P:E = 0,93.

Docters v. Leeuwen 7707 [L]

P.A.I. = 0,5-0,6. Colpi somewhat longer.

Acalypha type

Tricolporate or stephanocolporate; oblate spheroidal to suboblate. The pollen grains are quasi porate. With high magnification the apertures are undoubtedly composite apertures.

Colpus transversalis and colpus of the same size; costae. Tectate; psilate.

The *Acalypha* type is undoubtedly related to the *Mallotus* type. The dimensions of the colpi and the colpi transversales, however, are so small that the composite apertures resemble pori.

Acalypha indica LINN.
Dewan, 12-9-1957 [U] Pl. XVIII, 4

Acalypha type.
P = 14,5 μ E = 16 μ P:E = 0,90.

Acalypha aronioides PAX et K. HOFFM.
Ellenberg 1064 [U]

Acalypha type; 4-5 (col)-porate.
P = 14 μ E = 16,5 μ P:E = 0,85.

Acalypha racemosa WALLICH ex BAILLON
Versuchsanst. 410 [U]

Acalypha type; 3 (col)-porate.
P = 12 μ E = 13,5 μ P:E = 0,89.

Acalypha platyphylla MUELL. ARG.
Killip et Garcia 33764 [U]

Acalypha type; 3 (col)-porate.
P = 13,5 μ E = 14,5 μ P:E = 0,93.

Acalypha scandens BENTHAM
Y. Mexia 6386 [U] Pl. XVIII, 5

Acalypha type; 4-5 (col)-porate.
P = 17,5 μ E = 19,5 μ P:E = 0,90.

Acalypha diversifolia JACQ.
Versteeg 466 [U]

Acalypha type. Too young.

Alchornea type

Tricolporate; spheroidal to suboblate.
 Colpus transversalis with costae.
 Colpi narrow; costae colpi. Operculum present.
 Tectate; psilate.

In shape and structure the *Alchornea* type is related to the *Mallotus* type. The pollen grains differ from the latter type by the presence of an operculum.

Taxonomic discussion

Genera of this type have much resemblance with those of the *Mallotus* type. In the systems of MUELLER (1866), BENTHAM (1880) and PAX and K. HOFFMANN (1931) they are mixed up with them.

Indeed the characters of this group correspond well with those described in the *Mallotus* type (p. 79). There are only a few indistinct differences.

1. Number of stamens is often less than 20. *Neotrewia*, *Gavarretia* and *Polyandra* have up to 60 stamens (In the *Mallotus* type up to several hundreds).
2. Receptaculum usually flat and peltate (not in species with many stamens). As in the *Mallotus* type glands are absent or scarce (*Alchornea* and *Neotrewia*).

Coelebogyne and *Lepidoturus* are genera, which nowadays are considered as belonging to *Alchornea*.

Originally CROIZAT placed *Adenophaedra prealtum* (CROIZAT) CROIZAT in the genus *Cleidion* (1943c). This genus has its widest spread in Asia and was said to have some representatives in America. Afterwards Croizat's opinion was that all American *Cleidion* species belong to *Adenophaedra* (1946a). Pollen-morphological investigation shows, that pollen grains of the species *Adenophaedra prealtum* on no account resemble those of *Adenophaedra minor* Ducke. The diagnosis of *Adenophaedra prealtum*, however, completely fits into the new genus *Polyandra* described by Léal (1951). Léal moreover published a photograph of the pollen grains of this genus, from which it is clear that the pollen grains belong to the *Alchornea* type like those of *Adenophaedra prealtum*.

- | | |
|---|--|
| <i>Alchornea villosa</i> (BENTH.) MUELL. ARG.
Bosch Proefst. F. 1152 [U] Pl. XVIII, 2 | <i>Alchornea</i> type; oblate spheroidal.
P = 25 μ E = 26,5 μ P:E = 0,94.
m:e = 0,6. P.A.I. = 0,4. |
| <i>Alchornea rugosa</i> (LOUR.) MUELL. ARG.
Elmer 14353 [U] | <i>Alchornea</i> type.
P = 24 μ E = 26,5 μ P:E = 0,92.
P.A.I. > 0,5. |
| <i>Alchornea schomburgkii</i> KLOTZSCH
Hilleris-Lambers 1922 | <i>Alchornea</i> type.
P = 24,5 μ E = 24,5 μ P:E = 1. |
| <i>Alchornea triplinervia</i> (SPRENG.) MUELL.
ARG.
Regnell III. 1066 a [U] | <i>Alchornea</i> type. P = E = 27 μ . |
| <i>Lepidoturus laxiflorus</i> BENTH.
[= <i>Alchornea laxiflora</i> (BENTH.) PAX
et K. HOFFMANN]
Faulkner 531 [K] | <i>Alchornea</i> type.
P = 20,5 μ E = 22 μ P:E = 0,93.
P.A.I. = 0,35-0,4. |

- Coelebogyne ilicifolia* J. SMITH [= *Alchornea* *ilicifolia* (J. SMITH) MUELL. ARG.]
F. v. Muell., Rockhampton 1873
[K.] Pl. XVIII, 7
- Neotrewia cumingii* (MUELL. ARG.) PAX
et K. HOFFM.
Elmer 15623 [U]
- Gavarretia terminalis* BAILL.
Ducke 23511 [U]
- Conceveiba simulata* STEYERMARK
Krukoff 6643 [U]
- Conceveibastrum martianum* (BAILL.) PAX
et K. HOFFM.
I.B.V. 23529 [U]
- Veconcibea latifolia* (BENTH.) PAX et
K. HOFFM.
[= *Conceveiba latifolia* BENTHAM]
Spruce 2826 [BM]
- Aparisthium cordatum* (JUSS.) BAILL.
Y. Mexia 6273 [U] Pl. XVIII, 3
- Lautenbergia multispicata* BAILL.
D'Alleizette Madag. Nov. 1906 [L]
- Lautenbergia coriacea* (BAILL.) PAX
D'Alleizette Madag. Oct. 1906 [L]
- Bocquillonina sessiliflora* BAILL.
Balansa 274 [L]
- Adenophaedra prealtum* (CROIZAT) CROIZAT
[= *Polyandra* LÉAL?]
Krukoff 6602 [U]
- Alchornea* type.
P = 20 μ E = 23 μ P:E = 0,88.
P.A.I. = 0,4-0,45.
- Alchornea* type.
P = 21 μ E = 22,5 μ P:E = 0,93.
P.A.I. = 0,4. Operculum consists of
only one row of pila.
- Alchornea* type.
P = 27,5 μ E = 30,5 μ P:E = 0,91.
P.A.I. = 0,3.
- Alchornea* type.
P = 19,5 μ E = 22,5 μ P:E = 0,88.
P.A.I. = 0,4. Scabrate.
- Alchornea* type.
P = 21,5 μ E = 22,5 μ P:E = 0,93.
P.A.I. = 0,4-0,45.
- Alchornea* type.
P = 25 μ E = 27 μ P:E = 0,92.
P.A.I. = 0,4.
- Alchornea* type.
P = 24 μ E = 30 μ P:E = 0,80.
P.A.I. = 0,4.
- Alchornea* type.
P = 21,5 μ E = 25 μ P:E = 0,86.
P.A.I. = 0,35.
- Alchornea* type; sometimes 4-colporate.
- Alchornea* type.
P = 21,5 μ E = 24,5 μ P:E = 0,88.
P.A.I. = 0,35.
- Alchornea* type.
P = 25,5 μ E = 29 μ P:E = 0,88.
P.A.I. = 0,45.

Discocleidion type

Tricolporate; spheroidal to suboblate.

Colpus transversalis; costae as broad as the colpi.

Colpi narrow; broad margo present (thickening of the ectexine). P.A.I. small, smaller than 0,2.

Tectate; from psilate to coarsely warted. The ornamentation differs strongly.

The pollen type shows some resemblance to the *Mareya* type as well as to the *Alchornea* type. It differs from both types by its curious ornamentation. This ornamentation varies in the individual pollen grains. It is not certain whether other specimens of *Discocleidion rufescens* will show the same variation of ornamentation.

The type differs from the *Mareya* type by the presence of costae and from the *Alchornea* type by the absence of an operculum.

Taxonomic discussion

Discocleidion differs from the genera in the *Alchornea* type by the presence of a disc in the female flowers and many glands inserted on the receptaculum of the male flowers. These characters place the genus next to the genera of the *Mareya* type.

MUELLER first described *Discocleidion* as a section of *Cleidion*. PAX

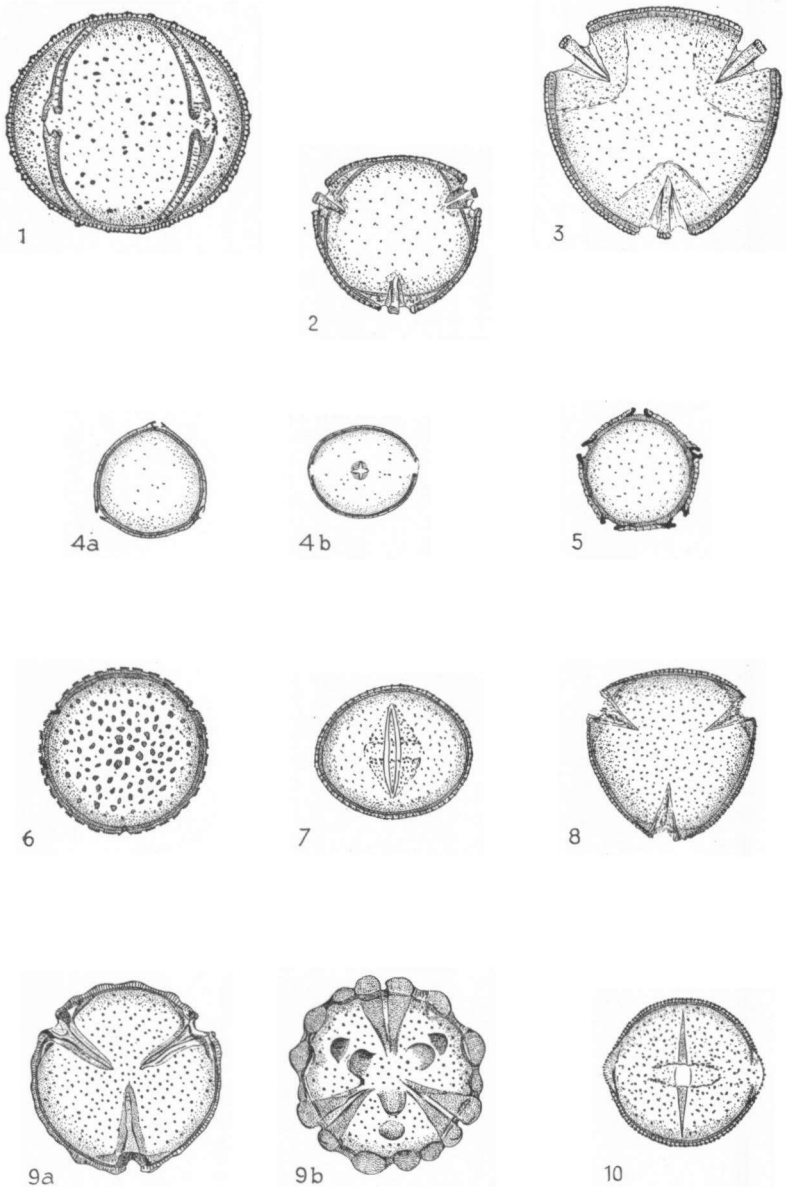

PLATE XVIII. 1. *Pycnocomma cornuta*; 2. *Alchornea villosa*; 3. *Aparisthium cordatum*; 4. *Acalypha indica*; 5. *Acalypha scandens*; 6. *Blumeodendron tokbrai*; 7. *Coelebogyne ilicifolia*; 8. *Mareya brevipes*; 9. *Discocleidion rufescens*; 10. *Kunstlerodendron sublanceolatum*.

and K. HOFFMANN (1931) thought it better to raise the section to genus level which they place in the Bernardiiformes close to *Bernardia* and *Mareya* with their allies. HURUSAWA (1954) at last reduced the genus again to a section, this time of *Alchornea*.

Discocleidion rufescens (FRANCH.) PAX et
K. HOFFMANN
D'Alleizette China Mai. 1908 [L]
Pl. XVIII, 9

Discocleidion type.
P = 24 μ E = 27 μ P:E = 0,89.
m:e = 0,7. P.A.I. = 0,1-0,15.

Mareya type

Tricolporate; oblate spheroidal to prolate spheroidal. In polar view pollen grains convex triangular.
Colpus transversalis elongated; no costae.
Colpi narrow; no costae colpi present.
Tectate; psilate.

The pollen grains are small. The largest axis is smaller than 30 μ . The *Mareya* type is distinguished from the *Mallotus* type by the absence of costae.

Taxonomic discussion

In PAX and K. HOFFMANN's system (1914, 1931) genera of this type belong to the Bernardiiformes. By the following characters the genera differ from those in the *Mallotus* type and *Alchornea* type:

1. In the female flowers a disc is present.
2. The male flowers have a receptaculum often set with glands. A disc and an ovarium rudiment are wanting. (*Mareyopsis* is anomalous by the presence of extra-staminal disc glands and the absence of glands in the receptaculum.)
3. Anthers often have appendiculate connectives.
4. Plants usually grow in the Old World. (*Alchorneopsis* in the New World.)

The American genus *Alchorneopsis* differs from the above characters by having an ovarium rudiment and the presence of hairs on the receptaculum instead of glands.

Mareya berripes PAX
Zenker 1794 [L] Pl. XVIII, 8

Mareya type; oblate spheroidal.
P = 21 μ E = 23 μ P:E = 0,91.
m:e < 0,5. P.A.I. = 0,3.
Colpus membrane granulate.

Crotonogynopsis usambarica PAX
Egging 3826 [K]

Mareya type. Too young to give reliable measures.

Chondrostylis bancana BOERL.
Cult. Hort. Bogor. II. I 8. [L]

Mareya type; spheroidal.
P = E = 25 μ . P.A.I. = 0,3.

Kunsterodendron sublanceolatum RIDL.
Sinclair 39882 [L] Pl. XVIII, 10

Mareya type; oblate spheroidal.
P = 20,5 μ E = 21 μ P:E = 0,98.
P.A.I. = 0,3.

Mareyopsis longifolia (PAX) PAX et
K. HOFFMANN
Zenker 4228 [K]

Mareya type; oblate spheroidal.
P = 18 μ E = 19 μ P:E = 0,96.
P.A.I. = 0,2.

Neopalissy castaneifolia (BAILL.) PAX
Pervillé 387 [P]

Mareya type; prolate spheroidal.
P = 22 μ E = 21 μ P:E = 1,05.
P.A.I. = 0,25-0,3.

- Necepsia afzelii* PRAIN
Leeuwenberg 2211 [U]
Mareya type; prolate spheroidal.
P = 21,5 μ E = 21 μ P:E = 1,02.
P.A.I. = 0,3.
- Amyrea humberti* LÉANDRI
D'Alleizette Dec. 1905 [L]
Mareya type; prolate spheroidal.
P = 24 μ E = 21,5 μ P:E = 1,13.
P.A.I. = 0,3.
- Alchorneopsis floribunda* (BENTH.) MUELL.
ARG.
For. Dept. 2889 [U]
Mareya type; oblate spheroidal.
P = 18 μ E = 19 μ P:E = 0,95.
P.A.I. = 0,2.
- Alchorneopsis trimera* LANJ.
Lanjouw 1926; 49 [U]
Mareya type; oblate spheroidal.
P = 21 μ E = 22 μ P:E = 0,96.
P.A.I. = 0,25.

Ricinus type

Tricolporate; shape differs from suboblate to subprolate.
Colpus transversalis narrow; no costae.
Colpi very narrow; no costae colpi present.
Tectate; psilate. Columellae very short, nearly visible in some species.

The pollen grains resemble the *Pera* type, but the *Ricinus* type misses costae as in the *Mareya* type. It differs from the latter type by narrow colpi and nearly visible columellae.

Taxonomic discussion

The genera in this type fall apart in two groups. The first group includes *Ricinus*, *Homonoia* and *Lasiococca*. These genera are remarkable for the large number of anthers crowded on repeatedly branched filaments.

The second group comprises *Koilodepas* only, which genus occupies an isolated position in the family (AIRY-SHAW, 1960). CROIZAT (1942b) as well as AIRY-SHAW reduced *Nephrostylus* GAGNEPAIN and *Calpigyne* BLUME to *Koilodepas*. According to CROIZAT, *Calpigyne hainanense* and *Nephrostylus poilanei* are synonyms. In the opinion of AIRY-SHAW, *Nephrostylus poilanei* belongs to the species *Koilodepas longifolium*. Pollen grains of both species are practically identical and show great structural resemblance with *Koilodepas bantamense*.

- Ricinus communis* LINN.
v. Heerdt 531 [U]
Versteeg 243 [U] Pl. XIX, 3
Ricinus type; spheroidal.
P = 32 μ E = 32 μ P:E ca. 1.
m: e < 0,5. P.A.I. = 0,2.
- Lasiococca symphyllifolia* (KURZ)
J. D. Hook.
Hort. Bogor. Cult. 6-4-1887 [L]
Ricinus type; spheroidal.
P = E = 23 μ . P.A.I. = 0,45.
- Homonoia javensis* (BLUME) MUELL. ARG.
Hort. Bogor. IX A. 60 [U] Pl. XIX, 2
Ricinus type; prolate spheroidal.
P = 22,5 μ E = 21 μ P:E = 1,08.
P.A.I. = 0,5. Costae transversales?
- Homonoia riparia* LOUR.
Helfer 4746 [U]
Ricinus type; oblate spheroidal-suboblate.
P = 25 μ E = 29 μ P:E = 0,88.
- Koilodepas bantamense* HASSK.
Hort. Bogor. IX C. 36 [U] Pl. XIX, 4
Ricinus type; spheroidal-suboblate.
P = 20 μ E = 24 μ P:E = 0,84.
m:e < 0,5. P.A.I. = 0,3.
- Koilodepas hainanense* (MERR.) CROIZAT
[= *Calpigyne hainanense* MERR.]
S. K. Lau 3542 [P]
[? = *Nephrostylus poilanei* GAGNEP.
D'Alleizette, Annam 11-4-1907 [L]
Ricinus type; subprolate.
P = 21 μ E = 17,5 μ P:E = 1,18.
P.A.I. = 0,3.
P = 20,5 μ E = 17,5 μ P:E = 1,17.
P.A.I. = 0,3.

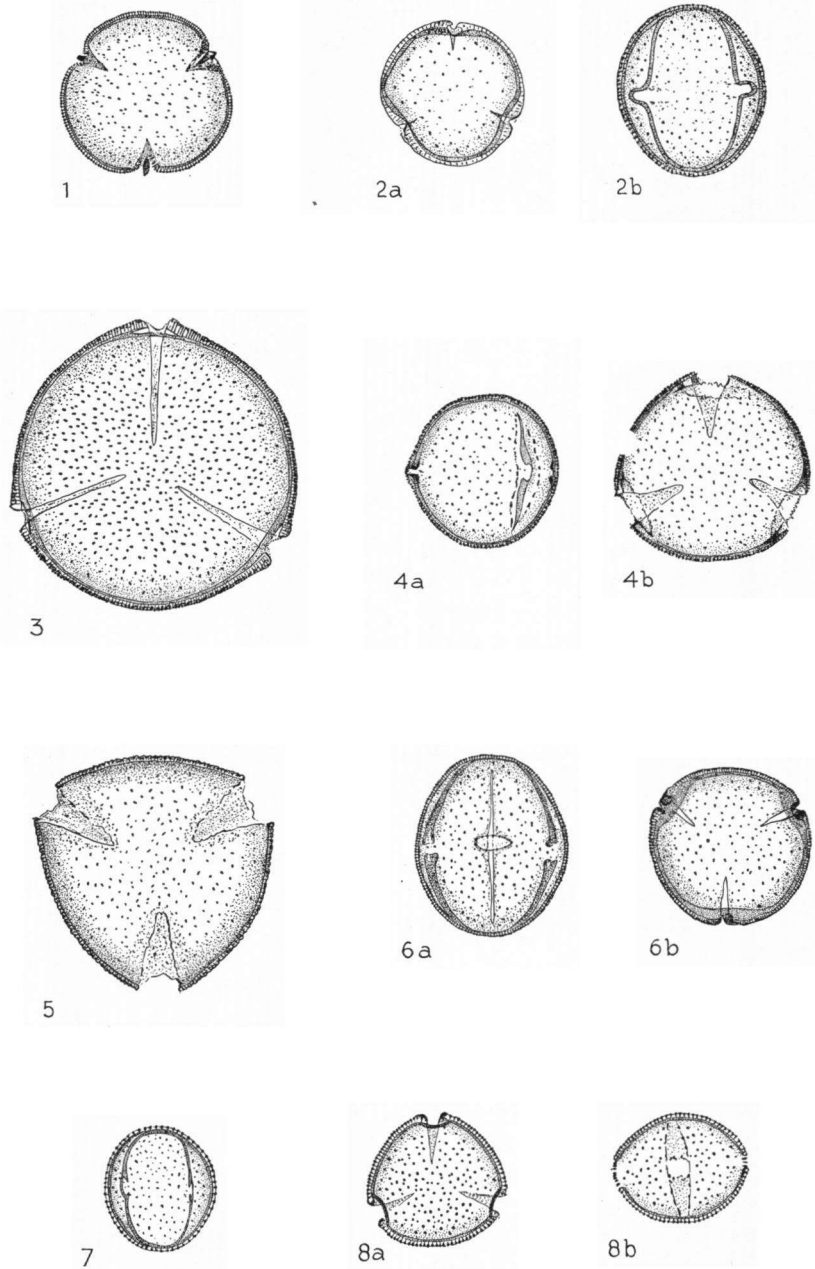

PLATE XIX. 1. *Leidesia procumbens*; 2. *Homonoia javensis*; 3. *Ricinus communis*; 4. *Koilodepas bantamense*; 5. *Chaetocarpus castanocarpus*; 6. *Pera bicolor*; 7. *Seidelia triandra*; 8. *Microdesmis casearifolia*.

Pera type

Tricolporate; prolate spheroidal.
 Colpus transversalis small; costae.
 Colpi narrow; costae colpi narrow but distinct.
 Tectate; psilate. Columellae very short.

The *Pera* type has the same very narrow colpi and nearly visible columellae as the *Ricinus* type, but there are distinct costae colpi and costae transversales present.

Pera bicolor (KLOTZSCH) MUELL. ARG.
 Ule 8409 [U] Pl. XIX, 6

Pera type.
 $P = 25,5 \mu$ $E = 24 \mu$ $P:E = 1,07$.
 $m:e < 0,5$. P.A.I. = 0,3.

Pera glabrata (SCHOTT) BAILL.
 Reitz 4548 [U]

Pera type.
 $P = 19 \mu$ $E = 18 \mu$ $P:E = 1,06$.
 P.A.I. = 0,5.

Seidelia type

Tricolporate; prolate spheroidal. In polar view the pollen grains distinctly three-lobed.
 Colpus transversalis small; costae.
 Colpi narrow; no costae colpi.
 Tectate; psilate. Columellae short.

The pollen grains of this type are distinctly three-lobed and have costae transversales.

Seidelia triandra (E. MEYER) PAX
 Mac Gregor Mus. 1254 [K] Pl. XIX, 7

Seidelia type.
 $P = 17,5 \mu$ $E = 16,5 \mu$ $P:E = 1,06$.
 $m:e = 0,6$. P.A.I. = 0,25.

Leidesia type

Tricolporate; oblate spheroidal. In polar view the pollen grains distinctly three-lobed.
 Colpus transversalis narrow and long; no costae.
 Colpi narrow; no costae colpi. Narrow operculum.
 Tectate; psilate. Columellae short.

The *Leidesia* type resembles the *Seidelia* type in its polar view and exine structure. It differs, however, by the absence of costae and the addition of a narrow operculum.

Taxonomic discussion

Leidesia and *Seidelia* are *Mercurialis*-like plants which BENTHAM (1880) as well as PAX and K. HOFFMANN (1914, 1931) enumerated close together with *Mercurialis*. This relationship, however, is not confirmed by pollen-morphological results.

Leidesia procumbens (LINN.) PRAIN
 Splitgerber [L] Pl. XIX, 1

Leidesia type.
 $P = 19 \mu$ $E = 20,5 \mu$ $P:E = 0,92$.
 $m:e < 0,5$. P.A.I. = 0,3.

Microdesmis type

Tricolporate; spheroidal to oblate spheroidal. In polar view pollen grains convex triangular.
 Colpus transversalis isodiametric; $m:e = 1$; ora large.
 Colpi narrow; costae colpi broad and indistinct or absent.
 Tectate; psilate. Columellae short.

The *Microdesmis* type is characterised by the isodiametric colpus transversalis and the large ora.

Taxonomic discussion

BENTHAM (1880) discussed the genera of this type in two tribes, *Galearieae* and *Gelonieae*. *Microdesmis*, *Galearia* and *Pogonophora* occurring in the *Galearieae* have characters both of the *Phyllanthoideae* and *Crotonoideae*. Pollen grains of these genera are, however, not at all comparable with those in the *Phyllanthoideae*.

PIERRE's description being unknown to PAX (1899), he described *Centroplacus glaucinus* PIERRE in *Microdesmis* as *Microdesmis paniculata*. PAX, however, did not have female flowers at his disposal. PIERRE (1899) and GILG (1908), on the other hand, studied female material and found 2 ovules per locule, for which reason the plant had to be placed in the subfamily of the *Phyllanthoideae*. The structure of the male flowers, however, resembles that of *Microdesmis* to such an extent, that it is by no means strange that PAX reckoned this species to *Microdesmis*. Since it is evident that the pollen grains of *Centroplacus* cannot be distinguished from those of *Microdesmis*, the correctness of placing the genus in the subtribe *Antidesminae* (PAX 1931) seems questionable. Two conclusions are possible:

1. *Centroplacus* forms a link between the sub-family *Phyllanthoideae* and *Crotonoideae*. On one side we find the characters that suggest a close relationship to *Microdesmis*, while the *Phyllanthoideae*-character of the two ovula per locule in the ovary stands on the other side.
2. *Centroplacus* has been described on the basis of material belonging to two species. The plant is dioecious, so that the possibility of an erroneous combination of plants should not be overlooked.

A renewed accurate examination of the known material, will possibly remove the doubt.

Microdesmis subtype

Pollen grains small. Smaller than 20 μ .
Costae colpi absent.

Microdesmis casearifolia PLANCH.
Thorenaar T. 50 [U] Pl. XIX, 8

Microdesmis subtype; oblate spheroidal.
P = 15,5 μ E = 17,5 μ P:E = 0,89.
P.A.I. = 0,3.

Microdesmis zenkeri PAX
de Wit 4 [WAG]

Microdesmis subtype.
P = 18 μ E = 19 μ P:E = 0,95.
P.A.I. = 0,5.

Centroplacus glaucinus PIERRE
Tester 1922 [K]

Microdesmis subtype.
P = 14 μ E = 15,5 μ P:E = 0,90.
P.A.I. = 0,3.

Galearia dognaiensis PIERRE ex GAGNEP.
Clemens 3528 [U]

Microdesmis subtype; suboblate.
P = 14,5 μ E = 17,5 μ P:E = 0,83.
P.A.I. = 0,35.

Galearia filiformis (BLUME) PAX
Blume, Java [U]

Microdesmis subtype.
P = 16,5 μ E = 19 μ P:E = 0,89.
P.A.I. = 0,3.

Chaetocarpus subtype

Pollen grains large. Larger than 30 μ .
Costae colpi broad but indistinct.

Chaetocarpus castanocarpus (ROXB.)

THWAITES

Elmer, Borneo 21064 [U] Pl. XIX, 5

Chaetocarpus schomburgkianus (O. KUNTZE)

PAX et K. HOFFM.

For. Dept. 2519 [U]

Trigonopleura malayana J. D. HOOK.

Bosch Proefst. 83 E. 1P. 1031 [L]

Pl. XX, 1

Pogonophora schomburgkiana MIERS

B. W. 6015 [U]

Krukoff 8645 [U]

Chaetocarpus subtype; spheroidal.

P = E = 29 μ m:e ca. 1.

P.A.I. = 0,3.

Chaetocarpus subtype.

Chaetocarpus subtype; oblate spheroidal.

P = 35 μ E = 38 μ P:E = 0,92.

P.A.I. = 0,2.

Chaetocarpus subtype; oblate spheroidal.

P = 42 μ E = 45 μ P:E = 0,93.

P.A.I. = 0,4-0,45. Tectum perforatum.

Cheilosa type

Tricolporate; suboblate to oblate spheroidal. In polar view pollen grains convex triangular.

Colpus transversalis; costae.

Colpi narrow; indistinct costae colpi.

Tectate; echinate or micro-echinate. Columellae short.

The *Cheilosa* type possesses the most important characters of the *Mallotus* configuration and is therefore placed in this configuration.

The type differs, however, distinctly by the spines on the tectum.

In *Cheilosa* these spines are larger than 1 μ (echinate); in *Neoscortechinia* smaller than 1 μ . According to the nomenclature of FAEGRI and

IVERSEN the pollen grains of *Neoscortechinia* are scabrate. The author would like to call the small spines microechinate according to ERDTMAN (1952). Echinate pollen grains are rarely found in the subfamily of the *Crotonoideae*, only in the *Croton* configuration.

Taxonomic discussion

BENTHAM (1880) discussed *Cheilosa* in the *Acalyphae*, although the male calyx is divided into slightly imbricate lobes. In the system of PAX and K. HOFFMANN (1931) the genus is found in the tribe *Gelonieae*, to which also *Neoscortechinia* belongs. The pollen grains of both genera are undoubtedly related. Unfortunately this is not confirmed by other characters.

Cheilosa montana BLUME

Korthals, Java [L] Pl. XX, 9

Cheilosa type; suboblate.

P = 22,5 μ E = 29 μ P:E = 0,78.

m:e = 0,5. P.A.I. = 0,5-0,6.

Echinate; echinae 1-2 μ .

Neoscortechinia arborea (ELMER) PAX et

K. HOFFM.

Hort. Bogor. IX A. 6a. [U] Pl. XX, 8

Cheilosa type; oblate spheroidal.

P = 21 μ E = 22,5 μ P:E = 0,93.

P.A.I. = 0,3. Scabrate (micro-echinate).

CLAOXYLON CONFIGURATION

Tricolporate or stephanocolporate (4, rarely 5).

Colpi narrow.

Tectate; capita of the columellae distinct.

Pollen grains not reticulate.

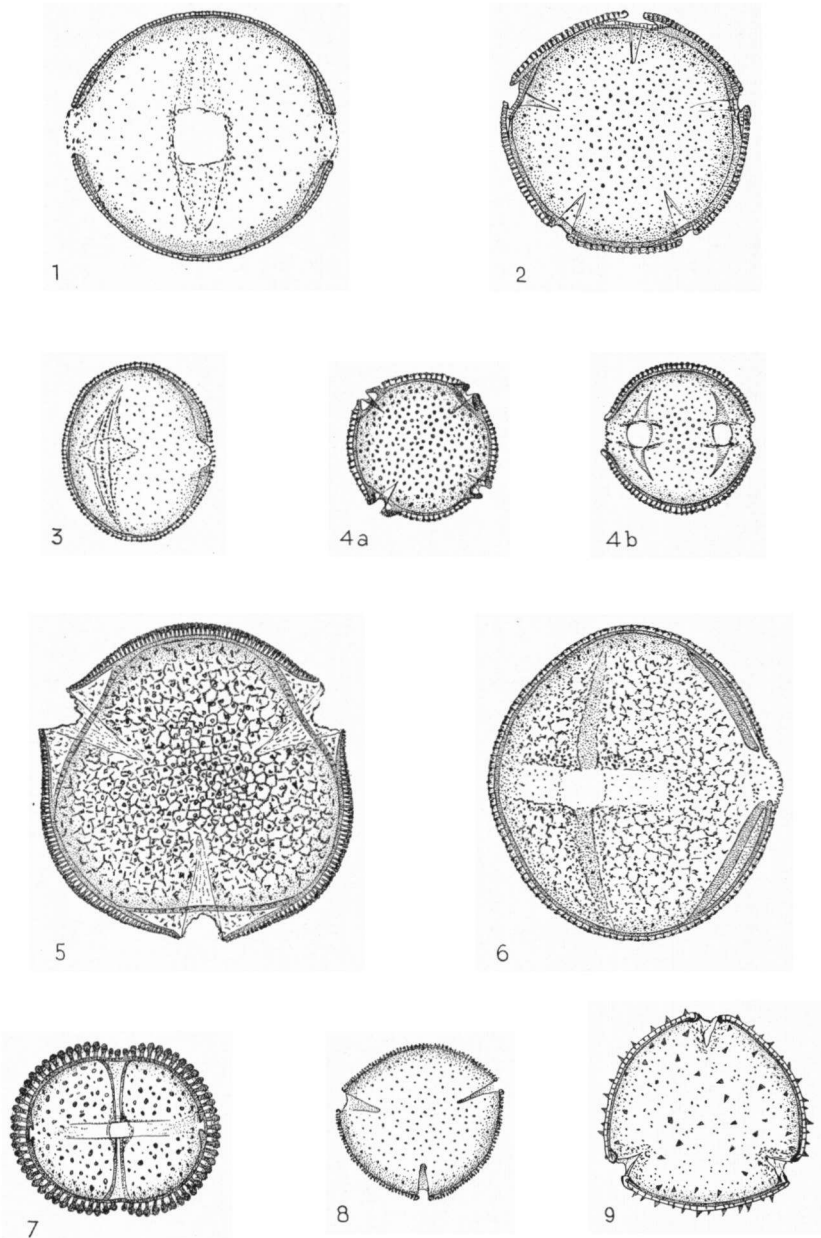

PLATE XX. 1. *Trigonopleura malayana*; 2. *Athroandra manni*; 3. *Mercurialis annua*; 4. *Claoxylon cuneatum*; 5. *Cladogynos orientalis*; 6. *Cephalocrotonopsis socotrana*; 7. *Amperea xiphoclada*; 8. *Neoscortechinia arborea*; 9. *Cheilosa montana*.

The *Claoxylon* configuration is related to the *Mallotus* configuration. The capita of the columellae, however, are distinctly visible.

Claoxylon type

Tricolporate or stephanocolporate; oblate spheroidal-prolate spheroidal.
Colpus transversalis small; costae present but sometimes indistinct.
Colpi narrow; costae colpi absent or indistinct.
Tectate; psilate or scabrate. Columellae coarse, capita distinct.

This type is in some characters comparable with types of the *Mallotus* configuration. The small spheroidal pollen grains resemble, in their shape, those of the *Mareya* type (p. 85). As in the *Mallotus* type (p. 79) more than three composite apertures can be present. Placing the type in the *Bernardia* configuration (p. 77) is out of question as a reticulum is always absent.

The *Claoxylon* type is distinguished by the distinct capita of the columellae, which form a coarse and inordinate pattern.

Taxonomic discussion

Genera belonging to this type are all readily recognised by the shape and attachment of the anthers. Other corresponding characters are:

1. A disc present in the female flowers.
2. In the male flowers an ovarium rudiment is always absent. Usually an extrastaminal disc is also absent, but glands are inserted on the receptaculum. In *Discoclaoxylon* receptaculum glands fails, but in this genus an extrastaminal disc is present.
3. Plants are usually dioecious and grow only in the Old World.

<i>Erythrocoeca stolziana</i> PAX et K. HOFFM. Stolz 1556 [U]	<i>Claoxylon</i> type; spheroidal. P = E = 22 μ . m:e < 0,5. P.A.I. > 0,5.
<i>Athroandra mannii</i> (J. D. HOOK.) PAX et K. HOFFMANN [= <i>Erythrocoeca mannii</i> (J. D. HOOK.) PRAIN] Mann 260 [U] Pl. XX, 2	<i>Claoxylon</i> type; oblate spheroidal-sub- oblate. 5 (-4) colporate. P = 30 μ E = 33,5 μ P:E = 0,89.
<i>Athroandra africana</i> (BAILL.) PAX et K. HOFFMANN [= <i>Erythrocoeca africana</i> (BAILL.) PRAIN] Zenker 453 [U]	<i>Claoxylon</i> type; prolate spheroidal. P = 22,5 μ E = 21 μ P:E = 1,07.
<i>Claoxylon cuneatum</i> J. J. SMITH Versteeg 1752 [U] Pl. XX, 4	<i>Claoxylon</i> type; spheroidal. P = E = 21 μ .
<i>Claoxylon tumidum</i> J. J. SMITH Versteeg 1708 [U]	<i>Claoxylon</i> type; spheroidal. 3- (4) colporate. P = E = 19 μ . P.A.I. = 0,4. Psilate to scabrate.
<i>Microcoeca mercurialis</i> (LINN.) BENTH. D'Alleizette Mad. 1906 [L]	<i>Claoxylon</i> type; prolate spheroidal. 3- (4) colporate. P = 27 μ E = 25 μ P:E = 1,08. P.A.I. = 0,3.
<i>Discoclaoxylon hexandrum</i> (MUELL. ARG.) PAX et K. HOFFM. Zenker 35 [U]	<i>Claoxylon</i> type; spheroidal. P = E = 21 μ . P.A.I. = 0,3.

Mercurialis type

Tricolporate; subprolate to prolate.

Colpus transversalis small; costae as long as the costae colpi.

Colpi narrow; costae colpi. Operculum present but very narrow, consisting of only one row of columellae. Tectate; psilate. Columellae distinct.

There is a certain relation between the *Mercurialis* type and the *Claoxylon* type. The two types have distinct capita; both are not reticulate and possess small colpi transversales. The *Mercurialis* type differs by the presence of an operculum, which is narrow and indistinct, and by the distinctly prolate shape of the pollen grains.

Taxonomic discussion

Shape and attachment of the anthers show much similarity with the genera of the *Claoxylon* group. For that reason BENTHAM (1880) placed *Mercurialis* in the immediate vicinity of *Claoxylon*, *Erythrococca*, etc. Although the *Mercurialis* type differs somewhat from the *Cloxyton* type, there is enough affinity for the author to share the opinion of BENTHAM.

Mercurialis annua LINN.

Fresh material, Z.-Limb. Pl. XX, 3

Mercurialis type; subprolate.

P = 25,5 μ E = 22,5 μ P:E = 1,16.

m:e < 0,5. P.A.I. = 0,4. Operculum indistinct, consisting of some scattered pila on the endexine (membrana granulata).

Mercurialis reverchonii ROUY

Faure 18-6-1931 [U]

Mercurialis type.

P = 28,5 μ E = 22 μ P:E = 1,30.

Mercurialis tomentosa LINN.

Leeuwenberg 1317 [U]

Mercurialis type.

P = 40 μ E = 28,8 μ P:E = 1,40.

CLADOGYNOS CONFIGURATION

Tricolporate.

Colpi narrow; costae colpi.

Tectate; columellae distinct. Exine thick.

The *Cladogynos* configuration includes those pollen grains with distinct columellae that bear always a tectum or tectum perforatum. These columellae can be arranged in a reticulum but more frequently they do not form a regular pattern. The pollen grains are usually large; the largest axis is at least 25 μ and often up to 50 μ .

Cladogynos type

Tricolporate; spheroidal prolate (*Epiprinus* oblate spheroidal).

Colpus transversalis; costae.

Colpi narrow; costae colpi.

Tectate or tectum perforatum. Columellae distinct.

Exine thick. Some species intra-reticulate.

The most striking character of this type is the distinct, sometimes even tall, columellae. The pollen grains are large and generally they have a P : E larger than 1.

Taxonomic discussion

By PAX and K. HOFFMANN (1914, 1931) most genera of this type are placed in the series *Cladogyniformes* of their subtribe Mercurialinae, to which also *Mallotus* and *Alchornea* belong. The group can be distinguished as follows:

1. An ovarium rudiment present in the male flowers while a disc is absent. The few stamens are not inserted on a receptacle.
2. Male flowers usually in a capitule.
3. Anthers pendulous.
4. Stellate hairs always present.
5. Plants are monoecious and grow in the Old World.

<i>Cladogynos orientalis</i> ZIPP ex SPANOGHE Pierre 6213 [L] Pl. XX, 5	<i>Cladogynos</i> type; prolate spheroidal. P = 42 μ E = 40 μ P:E = 1,05. Colpus transversalis narrow. Tectum perforatum. P.A.I. = 0,3. Intra-reticulate; lumina 1-2 μ .
<i>Cephalocroton cordofanus</i> HOCHST. D'Alleizette Nubié, Aug. 1909 [L]	<i>Cladogynos</i> type; subprolate. P = 49 μ E = 42 μ P:E = 1,17. Colpus transversalis broad; m:e > 0,5. P.A.I. = 0,3. Intra-reticulate.
<i>Cephalocrotonopsis socotrana</i> (BALF. F.) PAX Schweinfurth 594 [K] Pl. XX, 6	<i>Cladogynos</i> type; prolate spheroidal. P = 46 μ E = 42,5 μ P:E = 1,09. P.A.I. = 0,25. Intra-reticulate.
<i>Symphyllia siletiana</i> BAILL. Hort. Bog. Cult. [L]	<i>Cladogynos</i> type; prolate spheroidal. P = 27 μ E = 25 μ P:E = 1,07. P.A.I. = 0,25-0,3. Not reticulate.
<i>Adenochlaena leucocephala</i> BAILL. Hildebrandt 3258b [L]	<i>Cladogynos</i> type; prolate spheroidal. P = 53 μ E = 48 μ P:E = 1,10. m:e = 0,4. P.A.I. = 0,3. Not reticulate.
<i>Epiprinus poilanei</i> GAGNEP. Clemens 3058 [U]	<i>Cladogynos</i> type; oblate spheroidal. P = 32 μ E = 35 μ P:E = 0,91. P.A.I. = 0,2-0,25. Not reticulate.

Amperea type

Dicolporate or tricolporate. Shape differs with the number of colpi from oblate spheroidal (dicolporate) to prolate spheroidal (tricolporate). Colpus transversalis narrow; costae. Colpi narrow and long; costae colpi. P.A.I. small to 0. Tectate; psilate. Exine thick. Intrareticulate or not reticulate.

The *Amperea*-type shows much similarity with the *Cladogynos* type. Especially the thick exine and the tall columellae are striking. The P.A.I., however, is much smaller. Some pollen grains are even syncolpate.

Taxonomic discussion

Amperea belongs to those Australian genera, that were kept separate on account of their narrow cotyles (*Stenolobae*). Should this group as such be abolished, then, according to the statement of PAX (1924), this genus has to be placed in the Mercurialinae. This group also comprises the genera of the *Cladogynos* type.

- Amperea xiphoclada* (SIEB. et SPRENG.) *Amperea* type.
 DRUCE
 Constable 26475 [U] Pl. XX, 7
 2-colporate: P:E = 0,90.
 3-colporate: P:E = 1,02.
 P = 27-29 μ E = 28-30 μ .
 P.A.I. = 0,15-0. m:e < 0,5.
 Not reticulate.
- Amperea spartioides* BRONGN. *Amperea* type; spheroidal.
 Tasmania [U] P = E = 26 μ . Intra-reticulate.

Pseudocroton type

Tricolporate; prolate spheroidal to subprolate.
 Colpus transversalis; costae?
 Colpi narrow; costae colpi?
 Tectate; psilate. Not reticulate.

The pollen grains of the sheet examined were not mature, so it is difficult to put them in the proper type. There is some resemblance with the *Speranskia* type (p. 75). A reticulum, however, is absent. As distinct columellae are present, it seems best to place this type in the *Cladogynos* configuration.

Taxonomic discussion

BENTHAM (1880) as well as PAX et K. HOFFMANN (1931) discuss *Pseudocroton* in the *Chrozophoreae*. They accept relationship with *Argythamnia* and its allies. The pollen grains have some affinity with the *Speranskia* type. Although the genera of this type belong to the *Chrozophoreae*, they are only found in the Old World, while *Pseudocroton* grows in Central America. Affinities with genera of the *Cladogynos* configuration are few.

- Pseudocroton tinctorius* MUELL. ARG. *Pseudocroton* type.
 O. Kuntze 1808 [K] Too young to give reliable measures.

HIPPOMANE CONFIGURATION

Tricolporate; pollen grains in polar view circular or three-lobed.
 Never convex triangular or triangular.
 Colpus transversalis frequently short; sometimes narrow elongated.
 Colpi narrow; usually long. A margo is nearly always present.
 Intectate or more often tectate. Columellae distinct, frequently large.

It is not possible to define this configuration with one or two exceptionless characters. The pollen grains are, however, easily recognised by a combination of several typical characters. The most important ones are: three-lobed polar view; margo; distinct, sometimes large, columellae and short colpi transversales. If one of these striking characters is absent the combination of the others still places the pollen grains immediately in this configuration.

Taxonomic discussion

The genera of this configuration can be divided into two groups. The first group comprises genera of the tribe *Hippomaneae* of PAX and K. HOFFMANN (1912b, 1931). In 1880, BENTHAM stated of his subtribe

Hippomaneae: "This is one of the most natural subtribes of *Crotoneae*". Indeed there is not any doubt of a close relationship between the genera.

Pachystroma is added to the first group. Evidently on technical grounds BENTHAM added *Pachystroma* to the group of the *Adrianeae* with *Manihot*, *Adriana* and *Cephalocroton*, three genera now placed in three different groups of plants. PAX and K. HOFFMANN (1919d, 1931) separated the monotypic genus into the tribe *Pachystromateae*, although they were aware of some affinity with the *Hippomaneae*. The well-developed calyx of the male flower, which is never present in the *Hippomaneae*, led them to the decision to separate the genus. There are, however, more characters in favour of a fusion than of a separation. Pollen morphology is one of the data in favour of fusing.

The second group includes all the genera of the *Euphorbieae* with the addition of *Hura*. It is remarkable that the typical *Euphorbieae*, so well characterised by their cyathium, possess pollen grains which can hardly separated from those of the *Hippomaneae*. PAX (1924) when discussing the phylogenetic relations of the *Euphorbiaceae*, pointed already to this relationship. He noticed, e.g., the unbranched laticiferous vessels which both taxa possess. Pollen morphology is another character to support the opinion of PAX.

Hippomane type

Tricolporate; shape differs from subprolate to suboblate. Pollen grains in polar view circular or three-lobed.

Colpus transversalis small (rarely elongated); costae.

Colpi narrow and long; costae colpi. Usually margo present.

P.A.I. is small (smaller 0,3) except in some species of *Mabea*.

Tectate; psilate. Columellae sometimes tall.

The *Hippomane* type differs from the *Euphorbia hirta* type by its narrower margo. Usually the margo is narrower than the colpus transversalis. In other respects both types can hardly be separated.

Pollen grains of the *Omalanthus nutans* subtype can be separated from the *Hippomane* subtype by the deeply three-lobed pollen grains.

Some species in the *Hippomane* type have an intra-reticulum. They do not belong altogether to the *Dichostema* type (p. 100) as the upper part of the columellae is fused in all directions, thus forming a tectum.

Hippomane subtype

Pollen grains in polar view circular or slightly three-lobed.

Hippomane manciella LINN.

Buysman 1856 [U] Pl. XXI, 3

Hippomane subtype; prolate spheroidal.

P = 32,5 μ E = 30,5 μ P:E = 1,06.
m:e < 0,5. P.A.I. = 0,25.

Omalanthus populneus (GEISEL) PAX

Docters v. Leeuwen 1716 [U]

Hippomane subtype.

P = 40 μ E = 34 μ P:E = 1,17.
P.A.I. = 0,15-0,20.

Mabea piriri AUBL.

B. W. 6296 [U]

Hippomane subtype.

P = 50 μ E = 44 μ P:E = 1,14.
P.A.I. = 0,20-0,25. Not reticulate.

Mabea taquari AUBL.

Pulle 67 [U]

Hippomane subtype.

P = 43,5 μ E = 41 μ P:E = 1,05.
P.A.I. = 0,4. Intra-reticulate.

- Mabea caudata* PAX et K. HOFFM.
v. Emden 18-9-1931 [U] *Hippomane* subtype.
P = E = 70 μ . P.A.I. = 0,4-0,3.
Not reticulate.
- Mabea fistulifera* MART.
Y. Mexia 4473 [U] *Hippomane* subtype.
P = E = 70 μ . P.A.I. = 0,3.
Indistinct intra-reticulate.
Tectum perforatum.
- Actinostemon lanceolatus* SALDANHA
Y. Mexia 4987 [U] *Hippomane* subtype; oblate spheroidal.
P = 33,5 μ E = 35 μ P:E = 0,94.
P.A.I. = 0,25. Margo absent. Costae
indistinct.
- Gymnanthes lucida* SWARTZ
Jamaica, Hohnle [U] *Hippomane* subtype; oblate spheroidal.
P = 25 μ E = 26 μ P:E = 0,96.
P.A.I. = 0,25. Margo absent. Columellae short.
- Glyphostylus laoticus* GAGNEP.
Lakshnaka 1352 [K] *Hippomane* subtype.
P = 36,5 μ E = 34,5 μ P:E = 1,06.
P.A.I. = 0,25. Colpus transversalis
elongated. Columellae tall.
- Spirostachys venenifera* (PAX) PAX
[= *Excoecaria venenifera* PAX]
Graham 1464 [K] Pl. XXIII, 3
Excoecaria bicolor HASSK.
Hort. Bogor. IX C. 77 [U] Pl. XXII, 4
Hippomane subtype.
P = 22 μ E = 23 μ P:E = 0,96.
P.A.I. = 0,25. Margo absent.
- Stillingia gymnogyna* PAX et K. HOFFM.
Wiggins 1351 [U] *Hippomane* subtype.
P = 38 μ E = 36 μ P:E = 1,05.
P.A.I. = 0,25.
- Sapium longifolium* (MUELL. ARG.) HUBER
Pedersen 72 [U] *Hippomane* subtype.
P = 35,5 μ E = 33 μ P:E = 1,08.
P.A.I. = 0,2.
- Colliguaya integerrima* GILL. et HOOK.
Donat 167 [U] *Hippomane* subtype.
P = 55 μ E = 43 μ P:E = 1,26.
P.A.I. = 0,25. Colpus transversalis
elongated. Costae equatoriales or
almost equatorial.
- Colliguaya integerrima* GILL. et HOOK.
Donat 167 [U] *Hippomane* subtype.
P = 35,5 μ E = 34 μ P:E = 1,04.
P.A.I. = 0,2. Margo indistinct;
narrow.

Omalanthus nutans subtype

Pollen grains in polar view distinctly three-lobed.

- Omalanthus nutans* (FORST.) PAX
Yuncker 15356 [U] Pl. XXI, 8 *Omalanthus nutans* subtype.
P = 35 μ E = 31,5 μ P:E = 1,11.
P.A.I. = 0,15.
- Mabea indorum* SP. MOORE
Krukoff 1084 [U] *Omalanthus nutans* subtype.
P = 45 μ E = 36,5 μ P:E = 1,22.
P.A.I. = 0,2-0,25.
- Actinostemon concolor* (SPRENG.) MUELL.
Bornmueller 536 [U] Pl. XXII, 3
Gymnanthes jamaicensis (BRITTEN) URBAN
Harris 10936 [U] *Omalanthus nutans* subtype.
P = 30 μ E = 34 μ P:E = 0,88.
Columellae short.
- Sebastiania chamaelea* (LINN.) MUELL. ARG.
Hohenacker 830 [U] *Omalanthus nutans* subtype.
P = E = 22 μ . Margo absent.
- Sebastiania corniculata* (VAHL) MUELL. ARG.
Froes 11761 [U]
Macquire and Stahel 22758 [U] *Omalanthus nutans* subtype.
P = 33 μ E = 29 μ P:E = 1,14.
P.A.I. = 0,2.
- Sebastiania scottiana* MUELL. ARG.
Bertoni 1714 [U] *Omalanthus nutans* subtype.
P = E = 40 μ . P.A.I. = 0,15-0,2.
- Sebastiania scottiana* MUELL. ARG.
Bertoni 1714 [U] *Omalanthus nutans* subtype.
P = E = 27 μ . P.A.I. = 0,2.

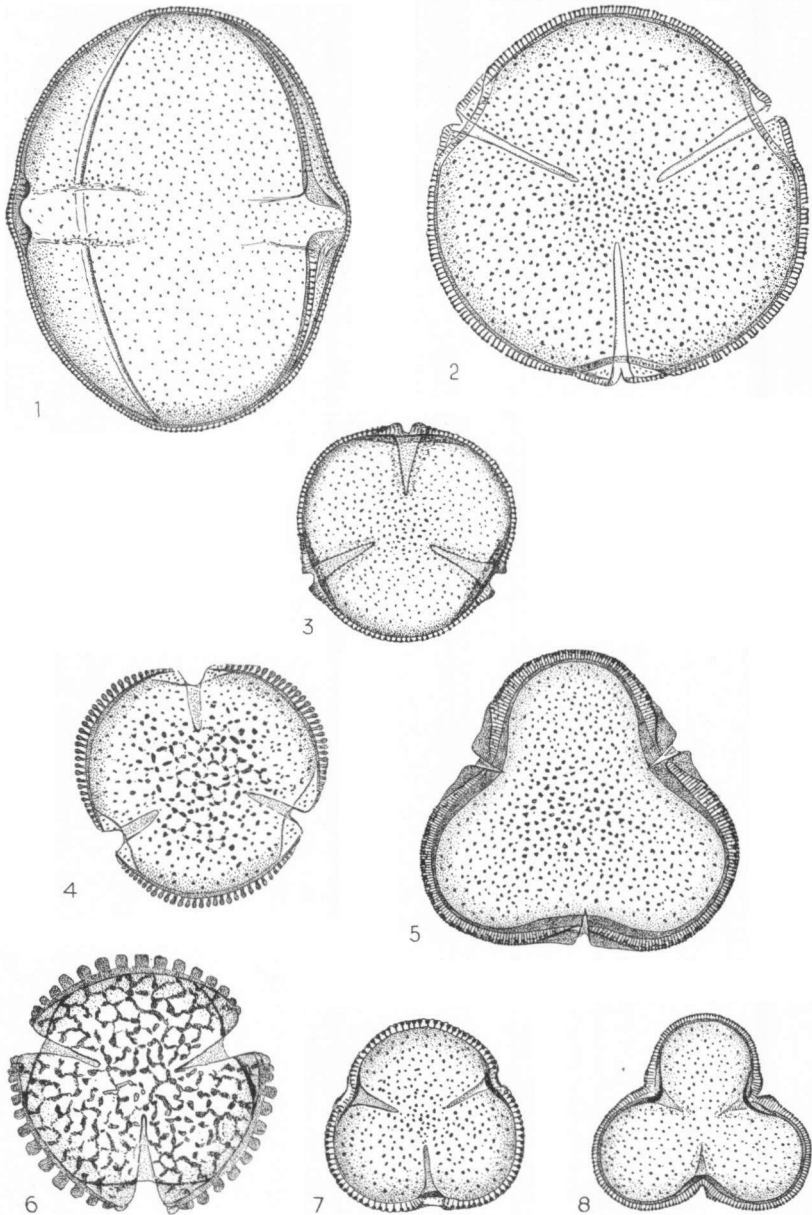

PLATE XXI. 1. *Stenadenium spinescens*; 2. *Elaeophorbia drupifera*; 3. *Hippomane mancinella*; 4. *Dichostema glaucescens*; 5. *Pachystroma longifolium*; 6. *Senefeldera macrophylla*; 7. *Tetraplandra gibbosa*; 8. *Omаланthus nutans*.

- Dwigneaudia inopinata* (PRAIN) LÉONARD
Zenker 217 [U] *Omalanthus nutans* subtype.
P = 23 μ E = 20 μ P:E = 1,16.
P.A.I. = 0,2.
- Maprounea brasiliensis* ST.-HILL.
Williamson-Assis 8047 [U] *Omalanthus nutans* subtype.
P = 33,5 μ E = 30,5 μ P:E = 1,11.
P.A.I. = 0,2.
- Maprounea guyanensis* AUBL.
B. W. 5393 [U] *Omalanthus nutans* subtype.
P = 24 μ E = 20 μ P:E = 1,20.
P.A.I. = 0,2.
- Excoecaria philippinensis* MERRILL
Elmer, Palawan 13124 [U] *Omalanthus nutans* subtype.
P = 32 μ E = 32 μ P.A.I. = 0,2-0,25.
- Sapium ellipticum* (HOCHST.) PAX
Croockewit 728 [WAG] *Omalanthus nutans* subtype.
P = E = 30 μ P.A.I. = 0,2.
P = 40 μ E = 34 μ P:E = 1,18.
- Sapium sebiferum* (LINN.) ROXB.
Lilnee, Japan [U] *Omalanthus nutans* subtype.
P = 46 μ .
- Sapium aubletianum* (MUELL. ARG.) HUBER
B. W. 2141 [U] *Omalanthus nutans* subtype.
P = 46 μ .
- Sapium montanum* LANJ.
B. W. 5889 [U] *Omalanthus nutans* subtype.
P = 52 μ .
- Sapium klotzschianum* (MUELL. ARG.)
HUBER *Omalanthus nutans* subtype.
P = 54 μ .
- Stahel, Oct. 1944 [U]
- Grimmeodendron eglandulosum* (A. RICH.)
URBAN *Omalanthus nutans* subtype.
P = 28 μ E = 26 μ P:E = 1,08.
P.A.I. = 0,2. Colpus transversalis
narrow elongated.
- Curtiss 190 [K]
- Bonania cubana* A. RICH.
Howard 5774 [U] *Omalanthus nutans* subtype (?).
P = 27 μ E = 25,5 μ P:E = 1,06.
P.A.I. = 0,2.
- Bonania domingensis* (URB.) URB.
Fuertes 813 [U] *Omalanthus nutans* subtype.
P = 22 μ E = 22 μ P.A.I. = 0,25.
Columellae small.
- Adenopeltis colliguaya* BERT. ex JUSS.
Andreas 834 [U] *Omalanthus nutans* subtype.
P = 34,5 μ E = 33,5 μ P:E = 1,03.
P.A.I. = 0,15. Intra-reticulate.
- Dalembertia populifolia* BAILL.
Hinton 4353 [K] *Omalanthus nutans* subtype.
P = 41 μ E = 36 μ P:E = 1,12.
P.A.I. = 0,15-0,2. Intra-reticulate.
- Tetraplandra gibbosa* PAX et K. HOFFM.
Glaziou 5613 [K] Pl. XXI, 7 *Omalanthus nutans* subtype.
P = 30 μ E = 27 μ P:E = 1,11.
P.A.I. = 0,15.
- Ophthalmoblaston macrophyllum* F. ALLEM.
Glaziou 17752 [K] *Omalanthus nutans* subtype.
P = 42 μ E = 39 μ P:E = 1,08.
P.A.I. = 0,2.
- Algernonia brasiliensis* BAILL.
H. F. Hance 1887 [K] *Omalanthus nutans* subtype.
Young.

Pachystroma type

Tricolporate; spheroidal. Pollen grains slightly three-lobed.
Colpus transversalis broad elliptic; costae thick.
Colpi narrow and short; costae colpi. No margo present.
Tectate; psilate.

Pollen grains of this type are strongly related to those of the *Hippomane* type. The colpus transversalis, however, is broadly elliptic and the P.A.I. is much larger.

Pachystroma longifolium (NEES)

I. M. JOHNSTON

Krug and Urban 1367 [L] Pl. XXI, 5

Pachystroma type.P = 41 μ E = 41 μ P:E ca. 1.

Length of colpi differs; mostly short, sometimes long. Costae thick.

Euphorbia hirta type

Tricolporate; subprolate to oblate spheroidal. Pollen grains in polar view three-lobed.

Colpus transversalis; costae.

Colpi narrow; margo broad. Sometimes an operculum is present.

Tectate; psilate. Columellae distinct.

The pollen grains belonging to this type can hardly be separated from the *Hippomane* type. The margo is broader; mostly as broad as the colpus transversalis. The colpi are narrow. If in the future more *Euphorbiaceae* species are examined pollen-morphologically, it will perhaps be necessary to combine the two types.

Euphorbia hirta subtype

Pollen grains without an operculum.

Euphorbia hirta LINN.

Soeprata 20 H [U]

Euphorbia hirta subtype; subprolate.P = 30 μ E = 23 μ P:E = 1,30.

P.A.I. = 0,10.

Euphorbia pepus LINN.

Fresh material, Utrecht.

Euphorbia hirta subtype. Oblate spheroidal.P = 26,5 μ E = 28,5 μ P:E = 0,93.

P.A.I. = 0,25.

Euphorbia palustris LINN.

Fresh material, Hortus Utrecht.

Euphorbia hirta subtype. Prolate spheroidal.P = 50 μ E = 45 μ P:E = 1,10.

P.A.I. = 0,3.

Diplocyathium capitata (REICHB.)

H. SCHMIDT

Baldacci, Aug. 1891 [BR]

Euphorbia hirta subtype; oblate spheroidal.P = 31,5 μ E = 34,5 μ P:E = 0,91.

P.A.I. = 0,2.

Euphorbia esula subtype

Pollen grains with an operculum.

This subtype differs from the other pollen grains in the *Euphorbia hirta* type by its operculum.

Euphorbia esula LINN.

Fresh material, Utrecht.

Euphorbia esula subtype. Oblate spheroidal.P = 43 μ E = 40 μ P:E = 0,93.

P.A.I. = 0,2.

Dichostema type

Tricolporate; oblate spheroidal. Pollen grains in polar view circular to three-lobed.

Colpus transversalis; costae.

Colpi narrow; margo small or absent.

Intectate; reticulate. Columellae large. Exine thick.

The *Dichostema* type is differentiated from the other types by its distinct reticulum and narrow margo. The columellae are fused laterally in their upper part and form a tigillate reticulum. The pollen grains have a thick exine.

Dichostema glaucescens PIERRE

Klaine 1129 [L] Pl. XXI, 4

Dichostema type; oblate spheroidal-suboblate.P = 31 μ E = 36 μ P:E = 0,87.m:e=0,5. P.A.I.=0,3. Lumina 1-3 μ .

- Anthostema aubryanum* A. DE JUSS.
Spuitebanto 1074 [U] *Dichostema* type; oblate spheroidal.
P = 29 μ E = 31,5 μ P:E = 0,92.
Lumina 1-2 μ .
- Senefeldera macrophylla* DUCKE
For. Dept. 7549 [U] Pl. XXI, 6 *Dichostema* type; spheroidal.
P = E = 36 μ . P.A.I. = 0,2-0,25.
Lumina 2-3 μ .
- Euphorbia cotinoides* MIQUEL
Ellenberg 1635 [U] *Dichostema* type; prolate spheroidal.
Stahel and Gongryp 816 [U] P = 28 μ E = 26 μ P:E = 1,08.
m:e = 0,5. P.A.I. = 0,25. Margo absent; Lumina 2-3 μ .

Stenadenium type

Tricolporate; subprolate. Pollen grains large.
Colpus transversalis broad and elongated; costae.
Colpi narrow and long; costae colpi indistinct. Margo absent.
Tectate; psilate; not reticulate. Columellae distinct but small in diameter.
Exine relatively thin.

Pollen grains of this type are large (larger than 40 μ) and have a relatively thin exine. The columellae are slender; their diameter is small. In polar view the pollen grains are not distinctly three-lobed. A margo is absent.

The pollen grains of *Hura crepitans* have a colpus transversalis shorter than those of *Stenadenium* and *Synadenium*. The shape and structure, however, are similar.

- Stenadenium spinescens* PAX
Goetze 1099 [BM] Pl. XXI, 1 *Stenadenium* type; subprolate.
P = 59 μ E = 47 μ P:E = 1,26.
- Elaeophorbium drupifera* (THONN.) STAPP
Leeuwenberg 2314 [U] Pl. XXI, 2 *Stenadenium* type.
P = 58 μ E = 50 μ P:E = 1,16.
P.A.I. = 0,2. Tectum perforatum.
- Hura crepitans* LINN.
B. W. 694 [U] *Stenadenium* type.
P = 75 μ E = 63 μ P:E = 1,20.
B.B.S. 502 [U] Pl. XXII, 2 P.A.I. = 0,4.
- Synadenium arborescens* BOISS.
D'Alleizette, Medley 8492 [L] *Stenadenium* type.
Young.

Pedilanthus type

Tricolpate; oblate spheroidal to suboblate. Pollen grains slightly three-lobed.
Colpi broad. Margo narrow. Membrana granulata.
Intectate (tectum perforatum?); psilate. Columellae tall.

Pedilanthus differs from other types in the *Hippomane* configuration by the absence of a colpus transversalis. Also the P.A.I. is somewhat larger.

- Pedilanthus palmeri* MILLSP.
Hinton 15793 [U] Pl. XXII, 1 *Pedilanthus* type.
P = 72 μ E = 83 μ P:E = 0,87.
P.A.I. = 0,3.

POLLEN GRAINS NOT PLACED IN ONE OF THE CROTONOIDEAE CONFIGURATIONS

Dalechampia type

Tricolporate; Pollen grains large, usually prolate to prolate spheroidal.
Colpus transversalis elongated. Sometimes costae quatoriales.
Colpi short and narrow. No costae colpi present.
Tectate; intra-reticulate. Reticulum very coarse. Between the muri of the reticulum a membrane is present, covering the lumina.

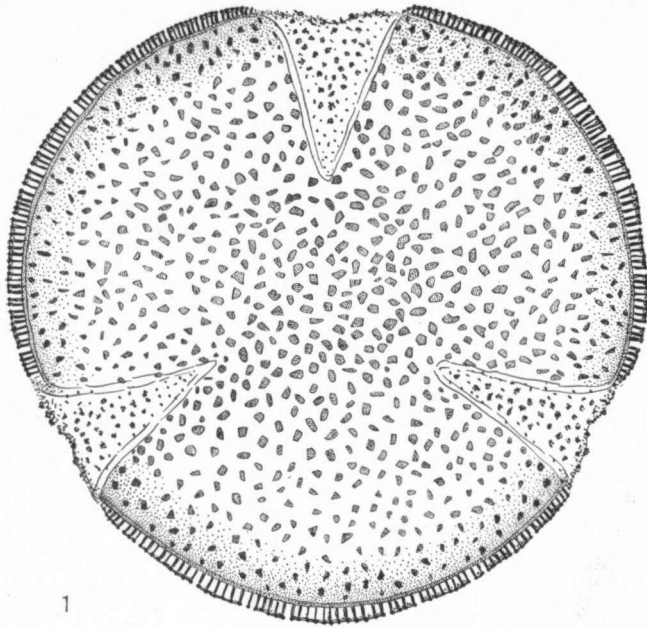

1

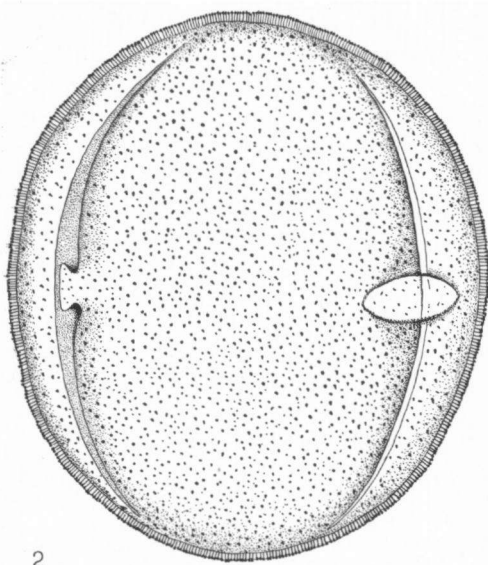

2

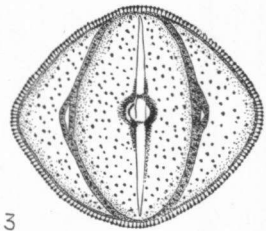

3

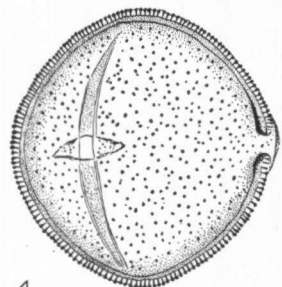

4

PLATE XXII. 1. *Pedilanthus palmeri*; 2. *Hura crepitans*; 3. *Actinostemon concolor*; 4. *Excoecaria bicolor*.

The type is characterised by its large pollen grains and wide lumened reticulum. The pollen grains are so typical, that no other type can be compared with them.

Taxonomic discussion

Dalechampia is easily distinguished from other genera by its typical involucre. For this reason MUELLER (1866) placed it in the vicinity of the *Euphorbieae*. BENTHAM (1880) pointed to the similar characters in the *Plukenetieae*: e.g. climbing growth, stinging hairs and thickened style in the female flowers. PAX and K. HOFFMANN (1919) thought it better to separate the genus into an apart tribe. CROIZAT (1940a) and HURUSAWA (1954) once again placed the genus near *Euphorbia* and its allies.

Pollen grains show a typical structure and are neither comparable with the types in the *Plukenetinae* nor with those in the *Euphorbieae*. PAX and K. HOFFMANN's classification maintaining the genus in a separate tribus not too far from the *Plukenetinae* seems the best opinion.

Dalechampia dioscoreifolia POEPP. et
ENDLICH.
G. Klug 4186 [U] Pl. XXIII, 6

Dalechampia affinis MUELL. ARG.
B. W. 2183 [U]

Dalechampia brasiliensis LAM.
Y. Mexia 5270 [U]

Dalechampia scandens LINN.
Serv. Forest. 4328 [U]

Dalechampia spathulata (SCHEIDW.) BAILL.
Fresh material, Hort. Utrecht.
Pl. XXIII, 5

Dalechampia type; prolate.

P = 105 μ E = 70 μ P:E = 1,50.
Lumina up to 12 μ . Costae equatoriales.

Dalechampia type; prolate spheroidal.

P = 105 μ E = 97 μ P:E = 1,08.
Costae equatoriales.

Dalechampia type; prolate spheroidal.

P = 57 μ E = 55 μ P:E = 1,04.
Costae equatoriales.

Dalechampia type; oblate spheroidal.

P = 105 μ E = 75 μ P:E = 1,40.
Costae equatoriales.

Dalechampia type; oblate spheroidal.

P = 63 μ E = 65 μ P:E = 0,97.
Costae transversales; m:e = 0,5.

Hamilcoa type

Tricolporate; suboblate. In polar view the pollen grains circular to slightly convex triangular.

Colpus transversalis narrow.

Colpi narrow and short; indistinct costae colpi.

Tectate (?); intra-reticulum fine or not reticulate; columellae distinct but small.

The *Hamilcoa* type cannot be placed in one of the discussed configurations. The pollen grains have columellae with small but distinct capita and are for that reason excepted from the *Mallotus* configuration (p. 77). The structure of *Hamilcoa* would be in better agreement with the *Claoxylon* configuration, (p. 90), but the related pollen grains of *Plagiostyles* and *Pimeleodendron* are reticulate; moreover, the polar view differs. Perhaps the *Moultonianthus* type in the *Bernardia* configuration (p. 73) is most related to the *Hamilcoa* type because of its circular polar view and fine reticulum present in some species.

As the position of this type is still uncertain the author prefers to keep it apart from all other configurations.

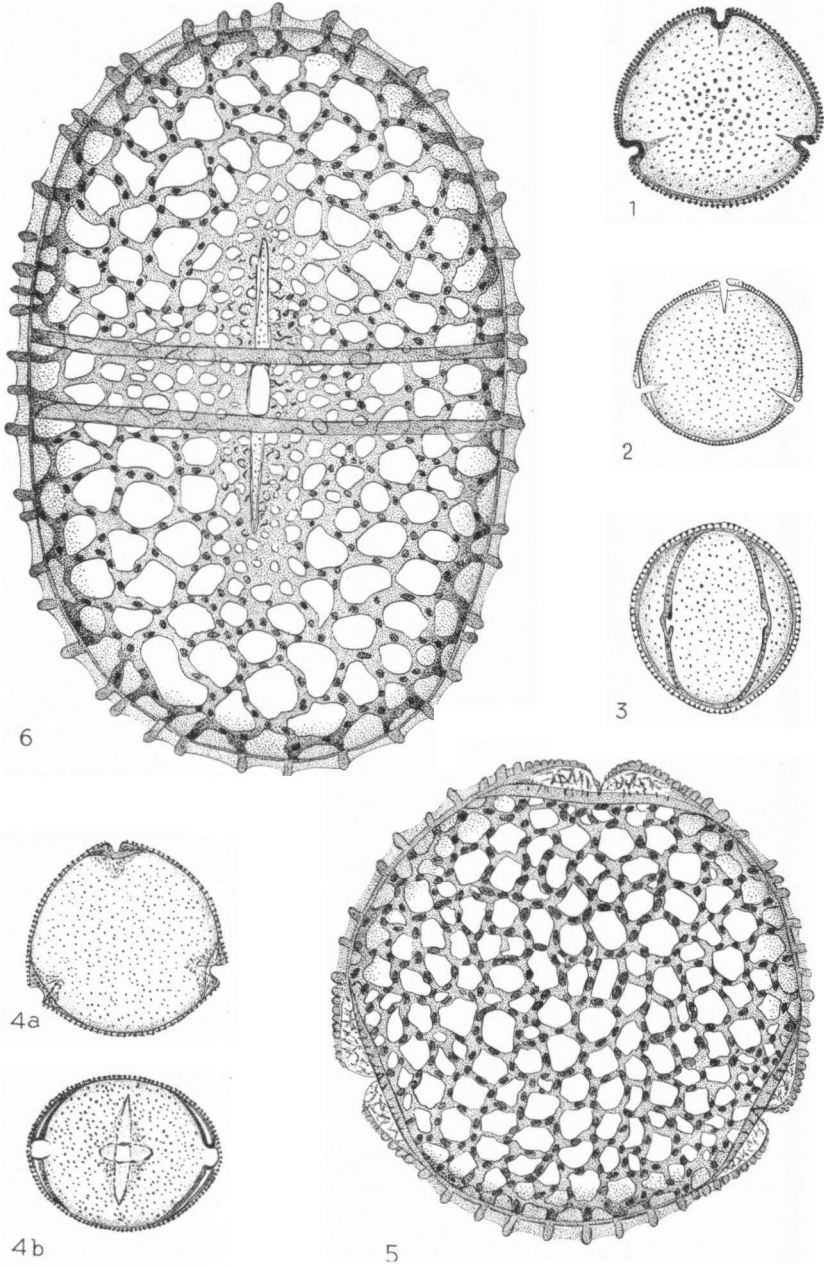

PLATE XXIII. 1. *Plagiostyles africana*; 2. *Pimeleodendron zoanthogyne*; 3. *Spirostachys venenifera*; 4. *Hamilcoa zenkeri*; 5. *Dalechampia spathulata*; 6. *Dalechampia dioscoreifolia*.

Taxonomic discussion

PRAIN (1913) thought *Hamilcoa* was nearest related to *Plagiostyles* PIERRE and *Pimeleodendron* HASSKARL. PAX and K. HOFFMANN (1912b, 1931) agreed with the relationship of *Plagiostyles* and *Pimeleodendron*, which they placed both in the Hippomaneae. *Hamilcoa*, however, was transferred to the Gelonieae. In doing so they rejected the affinity between *Hamilcoa* and *Plagiostyles*.

The three genera have several characters in common:

1. Disc absent in male as well as in female flowers.
2. In male flowers an ovarium rudiment is absent. Filaments are very short or wanting.
3. Pedicels are thickened.
4. Styles are undivided.
5. Plants dioecious (In *Hippomaneae* usually monoecious).

Perhaps *Nealchornea*, in the present paper placed in the *Sumbavia* configuration (p. 69), is also related to *Hamilcoa* and its allies.

Hamilcoa zenkeri (PAX) PRAIN
Zenker 4765 [L] Pl. XXIII, 4

Hamilcoa type; suboblate to oblate spheroidal.

P = 23,5 μ E = 27 μ P:E = 0,87.
m:e < 0,5. P.A.I. > 0,5. Lumina ca. 1 μ .

Pimeleodendron zoanthogyne J. J. SMITH
Hallier 152a [U] Pl. XXIII, 2

Hamilcoa type; spheroidal.

P = E = 24 μ . m:e ca. 1. P.A.I. = 0,5-0,6. Not reticulate.

Plagiostyles africana (MUELL. ARG.) PRAIN
Zenker 94 [U] Pl. XXIII, 1

Hamilcoa type; oblate spheroidal.

P = 27 μ E = 29 μ P:E = 0,90.
m:e ca. 1. P.A.I. = 0,4. Costae colpi.

TAXONOMIC COMMENT ON THE CROTONOIDEAE

The subfamily of the *Crotonoideae* includes a large number of pollen types.

The types with a croton-pattern attract most attention. When in the future a revision of the *Crotonoideae* will be undertaken, the placing of all genera with a croton-pattern into one group will be advisable. This will benefit a natural classification of the subfamily. The relationship of, e.g., *Joannesia* with *Cunuria* and *Garcia* with *Sagotia* will, in this way, show to better advantage than it does at present in PAX and K. HOFFMANN's system.

Two other groups of well-distinguished pollen grains, the *Cnesmosa* configuration and the *Plukenetia* configuration, are found in the subtribe *Plukenetiinae*. *Omphalea* is added to the *Plukenetia* configuration, which agrees with the opinion of CROIZAT (p. 62).

MUELLER ARG., BENTHAM and PAX and K. HOFFMANN include the tribe *Chrozophoreae* in their systems. This tribe falls into two groups of pollen types. The first group with e.g. *Crotonogyne*, *Aleurites*, etc. possesses pollen grains with a croton-pattern. As stated previously these genera should be separated from the other ones and transferred to the group of which *Croton* is the principal genus. The second group with, e.g., *Sumbavia*, *Chrozophora*, *Agrostistachys*, has aperturate pollen

grains, which belong to several pollen types. The present author would like to retain this second group as the subtribe *Chrozophorinae*.

The tribe *Acalypheae* of PAX and K. HOFFMANN includes most genera of the *Crotonoideae*. There are, however, comparatively few types which are, moreover, closely related (*Mallotus* configuration, *Bernardia* configuration, etc.).

The tribes *Gelonieae* and *Cluytieae*, too, include genera of which the pollen grains are provided with a croton-pattern mixed up with genera of which the pollen grains lack this structure. These latter genera are divisible into several types. A reclassification of these tribes is badly needed.

Although *Hippomaneae* and *Euphorbieae* are both homogeneous taxa which are taxonomically well-defined, the morphology of the pollen grains shows but little difference between the two groups. PAX (1924) already pointed out the relationship of these groups on other grounds. Since the *Hippomaneae* are treated by all authors as a tribe of the *Crotonoideae*, the *Euphorbieae* should also be treated as a tribe of the *Crotonoideae* close to the *Hippomaneae*.

SUMMARY

In the present study pollen morphology of the *Euphorbeaceae* is treated as an additional character in taxonomy.

Besides the greater part of the genera occurring in the system of PAX and K. HOFFMANN (1931), most of the genera published after 1931 are studied.

The pollen grains have been described with the aid of a terminology as simple as possible. In principle the terminology of IVERSEN and TROELS-SMITH has been followed, although in addition, many improvements of ERDTMAN have been used. One of the simplifications is the rejection of POTONIÉ's term sculpture. All elements occurring on the endexine are called structure elements; all structure elements together form the structure of a pollen grain. For the sake of consequence endexine apertures and extexine apertures are discussed separately.

Different pollen grains are placed in different pollen types. If the differences are of minor importance, the pollen grains are placed in subtypes. Several types can have some characters in common. To express the correspondences, these types are assembled in configurations.

As the pollen types in *Phyllanthoideae* and *Crotonoideae* differ distinctly, the division of the *Euphorbiaceae* in these subfamilies is maintained in the discussion of the results.

The *Phyllanthoideae* can be separated in three large groups of pollen types (*Antidesma* configuration, *Amanoa* configuration and *Aristogeiton* configuration), which agrees with the grouping of PAX in 1924. The remaining small configurations belong in taxonomic respect to the genera of the *Antidesma* configuration.

In the *Crotonoideae* many genera possess pollen grains with a croton-pattern. These genera should be treated as a single group.

Besides this natural group, the *Plukenetinae* possess pollen grains which are clearly distinguished from other genera in the *Crotonoideae*. Pollen grains of *Omphalea* are similar to those in the *Plukenetia* configuration. This pollen-morphological result agrees with the opinion of CROIZAT.

The remaining pollen grains in the *Crotonoideae* are less easy to differentiate in groups. One of the largest configurations is the *Mallotus* configuration, which includes most genera of the *Acalyphaeae* and several genera or other tribes. The *Hippomane* configuration is another large one. This configuration comprises the tribes *Hippomaneae* and *Euphorbieae*. The pollen grains of both tribes are very similar. The genus *Pachystroma* is pollen-morphologically as well as taxonomically related to the tribe *Hippomaneae*.

Pera, treated as a separate tribe by PAX and K. HOFFMANN, is related by its pollen grains to some genera in the *Acalyphaeae*.

Dalechampia is habitually related to the genera in the *Plukenetiinae*. Pollen-morphological data, however, do not support this relation. The pollen grains of *Dalechampia* are not similar to any other pollen type.

The morphology of the pollen grains of the *Stenolobeae* is in agreement with the opinion of PAX, that any separation of these Australian genera is an artificial one.

REFERENCES

- AIRY-SHAW, H. K. 1949. Note on the Euphorbiaceous genus *Botryophora*. Kew Bull. **3**: 484.
 ———. 1960. Notes on Malaysian Euphorbiaceae. Kew Bull. **14**: 353-397, 469-475.
 BAILLON, H. 1858. Etude générale du groupe des Euphorbiacées. Paris. 684 pp.
 ———. 1874. Histoires des Plantes **5**: 105-256.
 BALDWIN, J. T. and R. E. SCHULTES. 1947. A conspectus of the genus *Cunuria*. Bot. Mus. Leaf. Harv. Univ. **12**: 325-349.
 BENTHAM, G. 1880. Notes on Euphorbiaceae. Journ. Linn. Soc. Bot. **17**: 185-267.
 ——— and J. D. HOOKER. 1880. Genera Plantarum **3**: 239-340.
 BLUME, C. L. 1825-1826. Bijdragen tot de flora van Ned. Ind. Batavia. 1169 pp.
 CAMPO-DUPLAN, M. v. and N. HALLÉ. 1959. Bull. de l'Inst. Franc. d'Afrique Noire **21 ser. A**: 808-818.
 CROIZAT, L. 1940a. Novelties in Chinese *Phyllanthus*. Lignan Sc. Journ. **20**: 1.
 ———. 1940b. Thirty-five new species of American *Croton*. Journ. Arnold Arb. **21**: 76-107.
 ———. 1940c. New and critical Euphorbiaceae from Eastern Tropical Asia. Journ. Arnold Arb. **21**: 490-510.
 ———. 1941a. The tribe *Plukenetiinae* of the Euphorbiaceae in Eastern Tropical Asia. Journ. Arnold Arb. **22**: 417-431.
 ———. 1941b. Notes on the Euphorbiaceae 2. Bull. Bot. Gard. Buitenzorg ser. 3. **17**: 204-208.
 ———. 1942a. Notes on the Euphorbiaceae 3. Bull. Bot. Gard. Buitenzorg ser. 3. **17**: 209-219.
 ———. 1942b. On certain Euphorbiaceae from the Tropical Far East. Journ. Arnold Arb. **23**: 29-54.
 ———. 1942c. A study of *Manihot* in North-America. Journ. Arnold Arb. **23**: 216-225.
 ———. 1943a. Notes on American Euphorbiaceae. Journ. Wash. Acad. Sci. **33**: 11-20.
 ———. 1943b. New and critical Euphorbiaceae of Brazil. Tropical Woods **76**: 11-14.
 ———. 1943c. Novelties in American Euphorbiaceae. Journ. Arnold Arb. **24**: 165-189.
 ———. 1945. New or critical Euphorbiaceae of the Americas. Journ. Arnold Arb. **26**: 181-196.
 ———. 1946a. Nomenclatorial transfers and corrections in the Euphorbiaceae. Tropical Woods **88**: 30-32.
 ———. 1946b. Novelties in American Euphorbiaceae. Journ. Arnold Arb. **27**: 289-291.

- . 1948. Plant Explorations in 1944, chiefly to the Tafelberg and the Kaietur Plateau; Euphorbiaceae: 400–408.
- ERDTMAN, G. 1934. Ueber die Verwendung von Essigsäureanhydrid bei Pollenuntersuchungen. *Svensk Bot. Tidskr.* **28**: 345–358.
- . 1943. An introduction to Pollen Analysis. Waltham, Mass. 239 pp.
- . 1945. Pollen morphology and plant taxonomy. *Svensk Bot. Tidskr.* **39**: 187–192.
- . 1947. Classification of pollen grains and spores. *Svensk Bot. Tidskr.* **41**: 104–114.
- . 1952. Pollen morphology and Plant Taxonomy, Angiosperms. Uppsala. 539 pp.
- and J. R. PRAGLOWSKI. 1959. On the swelling of pollen grains in glycerine jelly. *Bot. Notiser* **112**: 175–176.
- FAEGRI, K. 1956. Recent trends in Palynology. *Bot. Review* **22**: 639–664.
- and J. IVERSEN. 1950. Text-book of modern Pollen Analysis. Copenhagen. 168 pp.
- FISCHER, H. 1890. Beiträge zur vergleichende Morphologie der Pollenkörner. Berlin. 72 pp.
- FRITZSCHE, J. 1837. Ueber den Pollen. *Mém. Acad. Sci. St.-Pétersbourg (Sav. Étrang.)* **3**.
- GAGNEPAIN, F. and L. BEILLE. 1925–1927. In Lecomte, Flore Générale de l'Indochine. **5**: 229–673.
- GILG, E. 1908. Beiträge zur Flora von Africa, Centroplacus. *Bot. Jahrb.* **40**: 516–518.
- GREW, N. 1692. The Anatomy of Plants. London. 304 pp.
- GRUENING, G. 1913. In Engler, das Pflanzenreich **IV. 147**. Euphorbiaceae; Porantheroideae and Ricinocarpaceae. 97 pp.
- HASSKARL, K. 1855. Brief van den Heer Hasskarl. *Versl. en Meded. Kon. Akad. Wet. (Natuurk.) Amsterdam* **4**: 135–141.
- HURUSAWA, I. 1954. Eine nochmalige Durchsicht des herkömmlichen Systems der Euphorbiaceae in weiteren Sinne. *Journ. Fac. Sci. Univ. Tokyo Bot.* **6**: 209–242.
- HUTCHINSON, J. and J. M. DALZIEL. 1958. Ed. 2. Revised by R. W. J. Keay. London. Euphorbiaceae; 363–423.
- IVERSEN, J. and J. TROELS-SMITH. 1950. Pollenmorphologischen Definitionen und Typen. *Danm. Geol. Unders. ser. 4.* **3 (8)**: 54 pp.
- JABLONSKY, É. 1951. In Engler, Das Pflanzenreich **IV. 147 (8)**: Euphorbiaceae-Phyllanthoideae-Brideliaceae. 98 pp.
- JUSSIEU, ADR. DE. 1824. De Euphorbiacearum Generibus Medisque Earundum Viribus Tentamen. Paris. 118 pp.
- LANJOUW, J. 1931. The Euphorbiaceae of Surinam. Thesis. Utrecht. 195 pp.
- LÉAL, C. 1951. Contribucao a estudo du familia Euphorbiaceae. *Arq. Jard. Bot. Rio de Janeiro* **11**: 63–69.
- LÉANDRI, J. 1958. Flore de Madagascar, Euphorbiacées **1**: 1–199.
- LÉONARD, J. 1955. Euphorbiaceae Africanae Novae. *Bull. Jard. Bot. de l'Etat Bruxelles* **25**: 281–301.
- . 1958. Notes sur les genres Suregada Roxb. ex Rottl. et Gelonium Roxb. ex Willd. *Bull. Jard. Bot. de l'Etat Bruxelles* **28**: 443–450.
- . 1959. Notes sur les espèces africaines continentales des genres Sapium P. Browne et Excoecaria Linn. *Bull. Jard. Bot. de l'Etat Bruxelles* **29**: 133–146.
- LINDAU, G. 1895. Acanthaceae in Engler and Prantl, Die Natuerlichen Pflanzenfamilien **4 (3b)**: 274–354.
- MACBRIDE, J. F. 1951. Flora of Peru, Euphorbiaceae. *Field Mus. Nat. Hist. Bot.* **13 (3a.1)**: 3–200.
- MALPIGHI, M. 1675. Anatomie Plantarum. Londini. p. 49, t. 188.
- MOHL, H. v. 1835. Sur la structure et les formes des graines de pollen. *Ann. Sci. Nat. ser. 2.* **3**: 148–180, 220–236, 304–346.
- MUELLER, J. (Arg.). 1866. Nachschrift zu meiner systematischen Arbeit über die Euphorbiaceae. *Bot. Ztg.* **24**: 333–345.
- . 1875. Replik auf Dr. Baillon's "Nouvelles observations sur les Euphorbiées." *Bot. Ztg.* **33**: 223–239, 254–256.

- and E. BOISSIER. 1866. Euphorbiaceae in Decandolle, *Prodromus* **15** (2): 1286 pp.
- O'DONNELL, C. A. and A. LOURTEIG. 1942. *Chrozophorae Argentinae*. *Lilloa* **8**: 37–81.
- PAX, F. 1899. Euphorbiaceae Africanae 5, *Microdesmis paniculata*. *Bot. Jahrb.* **28**: 25.
- . 1910a. In Engler, *Das Pflanzenreich* **IV. 147** (1): Euphorbiaceae–Jatrophaeae. 148 pp.
- . 1910b. In Engler, *Das Pflanzenreich* **IV. 147** (2): Euphorbiaceae–Adrianeae. 110 pp.
- . 1924. Die Phylogenie der Euphorbiaceae. *Bot. Jahrb.* **59**: 129–183.
- and K. HOFFMANN. 1911. In Engler, *Das Pflanzenreich* **IV. 147** (3): Euphorbiaceae–Cluytieae. 124 pp.
- and ————. 1912a. In Engler, *Das Pflanzenreich* **IV. 147** (4): Euphorbiaceae–Gelonieae. 41 pp.
- and ————. 1912b. In Engler, *Das Pflanzenreich* **IV. 147** (5): Euphorbiaceae–Hippomaneae. 319 pp.
- and ————. 1912c. In Engler, *Das Pflanzenreich* **IV. 147** (6): Euphorbiaceae–Acalypheae–Chrozophorinae. 142 pp.
- and ————. 1914. In Engler, *Das Pflanzenreich* **IV. 147** (7): Euphorbiaceae–Acalypheae–Mercurialinae. 473 pp.
- and ————. 1919a. In Engler, *Das Pflanzenreich* **IV. 147** (9–11): Euphorbiaceae–Acalypheae–Plukenetinae, Epiprininae, Ricineae. 134 pp.
- and ————. 1919b. In Engler, *Das Pflanzenreich* **IV. 147** (12): Euphorbiaceae–Dalechampieae. 59 pp.
- and ————. 1919c. In Engler, *Das Pflanzenreich* **IV. 147** (13): Euphorbiaceae–Pereae. 13 pp.
- and ————. 1919d. In Engler, *Das Pflanzenreich* **IV. 147** (14): Euphorbiaceae–Additamentum. 231 pp.
- and ————. 1922. In Engler, *Das Pflanzenreich* **IV. 147** (15): Euphorbiaceae–Phyllanthoideae–Phyllanthae. 349 pp.
- and ————. 1924. In Engler, *Das Pflanzenreich* **IV. 147** (16): Euphorbiaceae–Crotonoideae–Acalypheae–Acalyphinae. 231 pp.
- and ————. In Engler and Harms, *Die Natürlichen Pflanzenfamilien*. ed. 2. **19c**: 11–233.
- PHILLIPS, E. 1943. Some changes in nomenclature. *Journ. S. Afr. Bot.* **9**: 137–140.
- PIERRE, L. 1899. *Centroplacus glaucinus*. *Bull. Soc. Linn. Paris ser. 2*: 114.
- POST, L. v. 1918. Skogsträdspollen i sydsvenska torfmosselagerföldjer. *Forhandl. 16*. Skand. Naturforskermøte 1916.
- POTONIE, R. 1934. Zur Morphologie der fossilen Pollen und Sporen. *Arb. Inst. Palaeobot. und Petrogr. Brennsteine* **4**: 5–25, 109.
- SANDWICH, N. Y. 1950. On two Euphorbiaceae of British Guiana. *Kew Bull.* **1950**: 133–136.
- SCHULTES, R. E. 1952. Studies in the genus *Micrandra* I. *Bot. Mus. Leafl. Harv. Univ.* **15**: 201–224.
- . 1955. A new generic concept in the Euphorbiaceae. *Bot. Mus. Leafl. Harv. Univ.* **17**: 27–36.
- SMITH, J. J. 1910. In S. H. Koorders en Th. Valetton, *Boomsorten van Java* **12**: 9–638.
- STEENIS, C. G. G. J. v. 1948. Note on the genus *Moultonianthus* Merr. (Euph.). *Bull. Bot. Gard. Buitenzorg ser. 3.* **17**: 404–405.
- TREVISAN, V. B. A. 1848. *Alge Cocotale*. Padova. p. 99.
- WEBSTER, G. L. 1956–1958. A monographic study of the West Indian species of *Phyllanthus*. *Journ. Arnold Arb.* **37**, **38** and **39**.
- WODEHOUSE, R. P. 1928. The phylogenetic value of pollen-grain characters. *Ann. Bot.* **42**: 891–934.
- . 1935. *Pollen grains*. New York. 574 pp.
- ZINDEREN BAKKER, E. M. VAN. 1953. *South African pollen grains and spores I*. Amsterdam (Cape Town) 88 pp.

INDEX

(Asterisks indicate illustrations)

- Acalypha* type, 79, 81
Acalypha aronioides, 81
diversifolia, 81
 * *indica*, 81
racemosa, 81
platyphylla, 81
 * *scandens*, 81
Acalyphopsis, 6
Acidocroton adelioides, 51
Acidoton urens, 57
 * *Acephila excelsa*, 29, 32
Actephilopsis malayana, 60
 * *Actinostemon concolor*, 97
lanceolatus, 97
Adelia ricinella, 68
Adenochlaena leucocephala, 94
Adenocline subtype, 48, 54
Adonocline, 48, 54
acuta, 56
 * *mercurialis*, 56
Adenopeltis colliguaya, 99
Adenophaedra, 73
minor, 75, 82
prealtum, 82
Adriana, 96
quadripartita, 80
Agrostistachys, 105
indica, 76
sessilifolia, 76
Agymeia bacciformis, 39
Alchornea type, 19, 73, 79, 82, 83, 85
Alchornea, 73, 75, 85, 94
ilicifolia, 83
laxiflora, 82
rugosa, 82
schomburgkii, 82
triplinervia, 82
 * *villosa*, 82
Alchorneopsis, 85
floribunda, 86
trimera, 86
Aleurites, 105
moluccana, 50
Algernonia brasiliensis, 99
Alphardia furfuracea, 50
Amanoa configuration, 32, 36, 38, 46
Amanoa type, 32, 33, 34
Amanoa, 19, 32, 33
boiviniana, 33
bracteosa, 33
grandiflora, 33
 * *guianensis*, 33
 * *oblongifolia*, 33
Amperea type, 19, 94
Amperea spartioides, 95
 * *xiphoclada*, 95
Amyrea humberti, 86
Anabaena, 10
Anabaenella, 10
tamnoides, 63
Anabaina, 10
Andrachne subtype, 28
Andrachne aspera, 29
colchica, 29
 * *phyllanthoides*, 29
telephioides, 29
 * *Androstachys johnsonii*, 43
Angostyles longifolia, 63
Annesjooa, 6
Anomalocalyx uleanus, 51
Anthostema aubryanum, 101
Antidesma configuration, 20, 30, 32, 34, 39, 36, 43, 46
Antidesma type, 19, 20, 21, 26, 28
Antidesma subtype, 20, 21, 22, 24
Antidesma agusanense, 22
 * *bunius*, 22
diandrum, 22
edule, 22
ghesaembilla, 22
membranaceum, 22
obovatum, 22
venosum, 22
 * *Aonikena patagonica*, 66
 * *Aparisthium cordatum*, 83
Apodandra, 62
buchtienii, 63
Apodiscus chevalieri, 22
Aporosa, 25
dioica, 24
frutescens, 24
 * *lindleyana*, 24
Aporosella, 25
 * *Arachnodes*, 38
chevalieri, 40
Argythamnia type, 68
Argythamnia, 66
 * *candicans*, 266, 68
 * *Argomuelleria macrophylla*, 76
Aristogeitonia configuration, 40, 46
Aristogeitonia type, 40
Aristogeitonia subtype, 41
 * *Aristogeitonia limoniifolia*, 41
Astrocasia, 25, 32
tremula, 26
Astrocooccus, 62
 * *cornutus*, 63
 * *Athroandra africana*, 92
 * *mannii*, 92
Avellanita bustillosii, 80

- Baccaurea* subtype, 21, 22, 24
Baccaurea javanica, 24
 oxyarpa, 24
 racemosa, 24
 * *sumatrana*, 24
Baliospermum, 48
 montanum, 51
Baloghia lucida, 51
Benoistia, 48
 perrieri, 51
Bernardia configuration, 73, 92, 103, 106
Bernardia type, 73, 75, 76, 77
Bernardia, 85
 corensis, 75
 lorentzii, 75
 * *pulchella*, 75
Bertya, 48
 gummifera, 53
Beyeria, 48
 leschenaultii, 53
Bischofia type, 43
Bischofia, 9, 40, 44
 * *javanica*, 44
Blachia umbellata, 51
Blotia oblongifolia, 34
Blumeodendron type, 79, 81
 * *Blumeodendron tokbrai*, 81
Bocquillonia sessiliflora, 83
Bonania cubana, 99
 domingensis, 99
Botryophora geniculata, 81
Breynia configuration, 38
Breynia type, 38, 39
Breynia subtype, 38
Breynia, 29, 38, 39, 44
 * *fruticosa*, 39
 nivosa, 39
 racemosa, 39
Breyniopsis subtype, 39
 * *Breyniopsis Pierrei*, 39
Briedelia type, 32, 36
Briedelia, 9, 32
 assamica, 36
 glauca, 36
 * *monoica*, 36
 stipularis, 36

Calpigyne hainanense, 86
Calicopeplus, 5
Caperonia type, 72
Caperonia subtype, 72
Caperonia, 69
 corchoroides, 72
 * *palustris*, 72
 serrata, 72
Carumbium, 10
Caryodendron type, 72
Caryodendron grandifolius, 73
 * *orinocense*, 73
Cavacoa aurea, 51

Cenesmon, 10, 57
Centroplacus glaucinus, 89
Cephalocroton, 96
 cordofanus, 94
 * *Cephalocrotonopsis socotrana*, 94
Cephalomappa configuration, 68
Cephalomappa type, 68
 * *Cephalomappa malloiticarpa*, 69
Chaetocarpus subtype, 90
 * *Chaetocarpus castanocarpus*, 90
 schomburgkianus, 90
Cheilosa type, 79, 90
 * *Cheilosa montana*, 90
Chiroptetalum configuration, 62, 65
Chiroptetalum type, 65, 66, 68
Chiroptetalum canescens, 66
 * *lanceolatum*, 66
 patagonica, 66
Chlamydojatropa, 6
Chondrostylis bancana, 85
Chonocentrum, 21, 33
 cyathoform, 25
Chrozophora type, 69, 70, 72
Chrozophora, 105
 * *plicata*, 70
 tinctoria, 70
Cladogelonium, 48, 54
 * *madagascariense*, 54
Cladogynos configuration, 69, 93
Cladogynos type, 69, 93, 94
Cladogynos
 * *orientalis*, 94
Claoxylon configuration, 90, 103
Claoxylon type, 92, 93
 * *Claoxylon cuneatum*, 92
 tumidum, 92
Claoxyloopsis, 5
Clarorivinia, 6
Cleidion, 82, 83
 angustifolium, 80
 javanicum, 80
Cleistanthus, 32
 dichotomus, 34
 * *ferrugineus*, 36
 winkleri, 34
Clutia type, 19, 75, 77
Clutia abyssinica, 77
 alaternoides, 77
 natalensis, 77
 * *paxii*, 77
 rubricaulis, 77
Cluytiandra madagascariensis, 34
Cnesmosa configuration, 57, 58, 105
Cnesmosa type, 57, 58
Cnesmosa, 10
 javanica, 57
Cnidiscolus stimulosus, 53
 urens, 53
Coccoceras borneense, 80
 * *Codiaeum variegatum*, 51
 stelligianum, 51

- * *Coelebogyne ilicifolia*, 83
- Coelodepas*, 10
- Coelodiscus lanceolatus*, 80
- Colliguaya integerrima*, 97
- Cometia*, 5
- Conveiba latifolia*, 83
- simulata*, 83
- Conceveibastrum martianum*, 83
- Cordemoya integrifolia*, 80
- Corythea*, 5
- Croizatia*, 5
- Crotonoideae, 47
- Croton configuration, 47, 58, 90
- Croton type, 48, 53, 54, 57, 58
- Croton bahamensis*, 50
- * *cuneatus*, 50
- hirtus*, 50
- lingiradiatus*, 50
- * *matourensis*, 47, 50
- pullei*, 50
- Crotonogyne*, 105
- parvifolia*, 50
- preussii*, 50
- Crotonognopsis usambarica*, 85
- Crotonopsis elliptica*, 50
- Cunuria*, 49
- spruceana* var. *bracteosa*, 50, 53
- Cyathogyne spathulifolia*, 22
- viridis*, 22
- Cyrtogonone argentea*, 50
- * *Cyrtaranthus congolensis*, 75, 76
- Dalechampia* type, 101
- Dalechampia affinis*, 103
- brasiliensis*, 103
- * *dioscoriifolia*, 103
- scandens*, 103
- * *spathulata*, 103
- Dalembertia populifolia*, 99
- Danguyodrypetes ambigua*, 30
- Dendrophyllanthus* type, 37
- * *Dendrophyllanthus ripicolus*, 37
- Deuteromallotus acuminatus*, 80
- Deutzianthus tonkinensis*, 50
- Dichostema* type, 96, 100
- * *Dichostema glaucescens*, 100
- Dicoelia* type, 20, 21, 28, 29, 32, 44
- Dicoelia* subtype, 28
- Dicoelia affinis*, 28
- Dimorphocalyx murina*, 51
- Diplocyathium capitata*, 100
- Discocarpus* type, 32, 36
- Discocarpus*, 21
- * *essequiboensis*, 36
- hirtus*, 34
- Discoelaoxylon hexandrum*, 92
- Discocleidion* type, 79, 83
- * *Discocleidion rufescens*, 85
- Discoglyprena caloneura*, 76
- * *Dissiliaria tricornis*, 41
- Ditaxis* type, 65, 66, 68
- Ditaxis catamarcensis*, 66
- diversiflora*, 66
- fasciculata*, 66
- * *fendleri*, 66
- lanceifolia*, 66
- salina*, 66
- Ditta*, 5
- Dodecastigma*, 48
- amazonicum*, 53
- * *Domohinea perrieri*, 53
- Drypetes*, 21, 44
- * *glauca*, 28
- laterifolia*, 28
- macrophylla*, 28
- variabilis*, 28
- Dwigneaudia inopinata*, 99
- Dysopsis* configuration, 60
- Dysopsis* type, 60
- * *Dysopsis glechomoides*, 60
- * *Elaeophorbia drupifera*, 101
- Elateriospermum*, 48
- tapos*, 51
- * *Eleuterostigma lehmannianum*, 62
- Endospermum*, 48
- moluccanum*, 54
- Epiprinus poilanei*, 94
- Eremocarpus*, 48
- setigerus*, 50
- Erismanthus* type, 77
- * *Erismanthus indochinensis*, 77
- oblique*, 77
- Erythrocoeca africana*, 92
- mannii*, 92
- stolziana*, 92
- Euphorbia hirta* type, 96, 100
- Euphorbia esula* subtype, 100
- Euphorbia hirta* subtype, 100
- Euphorbia*, 9, 103
- cotinoides*, 101
- esula*, 100
- hirta*, 100
- palustris*, 100
- peplus*, 100
- * *Excoecaria bicolor*, 97
- philippinensis*, 99
- venenifera*, 97
- Flueggia*, 25
- Fontainea pancheri*, 51
- Fragariopsis*, 62
- * *scandens*, 63
- Galearia dognaiensis*, 89
- filiformis*, 89
- Garcia*, 48, 105
- nutans*, 50
- Gatnaia annamica*, 24
- Gavarretia terminalis*, 83
- Gitaria*, 6
- Givotia rottleriformis*, 51

- Glochidion type, 39
Glochidion, 29, 38, 44
 concolor, 39
 littorale, 39
 obscurum, 39
 ramiflorum, 39
 * *sericeum*, 39
 superbum, 39
Glycydendron amazonicum, 54
Glyphostylus laoticus, 97
Godefroya rotundata, 36
Grimmeodendron eglandulosum, 99
Grossera major, 50
Gymnanthes lucida, 97
 jamaicensis, 97

Haematostemon guianensis, 63
Hamilcoa type, 103
 * *Hamilcoa zenkeri*, 105
 * *Heterocalyx laoticus*, 76
Hevea type, 48, 56
 * *Hevea brasiliensis*, 56
 guianensis, 56
Heywoodia type, 20, 30
 * *Heywoodia lucens*, 30
Hippomane configuration, 95
Hippomane type, 19, 96, 100
Hippomane subtype, 96
 * *Hippomane mancinella*, 96
Holstia tenuifolia, 50
Homalanthus, 10
 * *Homonoia javensis*, 86
 riparia, 86
Hura, 96
 crepitans, 101
 * *Hymenocardia* type, 44
Hymenocardia, 21, 44
 acida, 46
 ulmoides, 46
 * *Hyaenanche globosa*, 41
Hyeronima, 21
 alchorneoides, 22
 * *laxiflora*, 22

Jatropha, 53
 integerrima, 51
 multifida, 51
 panduraefolia, 3
Joannesia, 48, 105
 princeps, 51
Julocroton argenteus, 50
 triqueter, 50

Keyodendron, 5
Klaineanthus type, 47, 48, 54, 56
Klaineanthus subtype, 54
Klaineanthus, 48, 54, 56
 * *gaboniae*, 54
Koulodepas, 10
 * *bantamense*, 86
 hainanense, 86
 longifolium, 86
 * *Kunstlerodendron sublanceolatum*, 85

Lachnostylis hirta, 34
Lasioclamys, 5
Lasiococca symphylliaefolia, 86
Lasiocroton type, 65, 68
 * *Lasiocroton macrophyllus*, 68
Lautenbergia coriacea, 83
 multispicata, 83
Leidesia type, 79, 88
Leidesia, 54, 60
 * *procumbens*, 88
Lepidoturus laxiflorus, 82
Leptonema type, 29
 * *Leptonema venosa*, 29
 * *Leucocroton flavicans*, 66
 * *Lingelsheimia frutescens*, 30
Longetia buxoides subtype, 41
 * *Longetia buxoides*, 41
 carunculata, 41
 gynotricha, 43
 malayana, 41

Mabea caudata, 97
 fistulifera, 97
 indorum, 97
 piriri, 96
 taquari, 96
Macaranga densiflora, 80
 harveyana, 80
 * *spinosa*, 80
Maesobotrya dusenii, 22
 floribunda, 22
Mallotus configuration, 77, 90, 92,
 103, 106
Mallotus type, 19, 79, 81, 82, 85, 92
Mallotus subtype, 79, 80
Mallotus, 70, 79, 94
 * *albus*, 80
 claoxyloides, 80
 miquelianus, 80
 repandus, 80
Manihot type, 47, 48, 53, 54
Manihot, 53, 96
 esculenta, 53
 saxicola, 47, 53
 * *Manniophyton fulvum*, 50
Maprounea brasiliensis, 99
 guyanensis, 99
Mareya type, 79, 83, 86, 92
 * *Mareya brevipes*, 85
 Mareyopsis longifolia, 85
 * *Margaritaria nobilis*, 26
Martretia type, 46
 * *Martretia quadricornis*, 46
 * *Megistostigma pellatus*, 57
 * *malaccense*, 57
 * *Melanolepis multiglandulosa*, 70
Mercurialis type, 93
Mercurialis, 88

- * *annua*, 93
- reverchonii*, 93
- tomentosa*, 93
- Mettienia*, 5
- Micrandra*, 47, 48, 50
- brownsbergensis*, 50, 54
- * *siphonioides*, 50, 54
- Micrantheum ericoides*, 43
- hexandrum*, 43
- Micrococca mercurialis*, 92
- Microdesmis* type, 79, 88
- Microdesmis* subtype, 89
- * *Microdesmis caseariaefolia*, 89
- paniculata*, 89
- zenkeri*, 89
- Mildbraedia paniculata*, 51
- Mischodon zeylanicus*, 41
- Monadenium*, 5
- * *Monotaxis grandiflora*, 70
- Moultonianthus* type, 19, 76, 103
- Moultonianthus*, 73, 75, 76
- * *leembruggianus*, 77
- Nealchornea* type, 73
- Nealchornea*, 105
- * *yapurensis*, 73
- Necepsia afzelii*, 86
- Neoboutonia*, 47, 48
- macrocalyx*, 51
- Neomphalea*, 6
- Neopalissya castaneifolia*, 85
- Neoroepera banksii*, 43
- * *Neoscortechinia arborea*, 90
- Neotrewia cumingii*, 83
- Neotrigonostemon*, 6
- Nephrostylus poilanei*, 86
- Oldfieldia*, 44
- africana*, 41
- Oligoceras*, 48
- eberhardtii*, 50
- Omalanthus nutans* subtype, 19, 96, 97
- Omalanthus*, 10
- * *nutans*, 97
- populneus*, 96
- Omphalea*, 62, 105
- * *diandra*, 63
- Ophthalmoblapton macrophyllum*, 99
- Ostodes paniculata*, 51
- pendulus*, 51
- Pachystroma* type, 99
- Pachystroma*, 96
- * *longifolium*, 100
- Pachystilidium* type, 65
- * *Pachystylidium hirsutum*, 65
- Paivausa dactylophylla*, 41
- Pantadenia*, 48
- adenanthera*, 51
- Paradrypetes*, 5
- Paragelonium perrieri*, 41
- Pausandra densiflora*, 51
- morisiana*, 51
- Pedilanthus* type, 101
- * *Pedilanthus palmeri*, 101
- Pentabrachion reticulatum*, 34
- Pera* type, 79, 86, 88
- * *Pera bicolor*, 88
- glabrata*, 88
- Petalostigma quadriloculare*, 41
- Philyra* subtype, 69, 72
- * *Philyra brasiliensis*, 72
- Phyllansea*, 5
- Phyllanthoideae*, 20
- Phyllanthus nutans* configuration, 37
- Phyllanthus acuminatus* type, 43
- Phyllanthus nutans* type, 37
- Phyllanthus acidus* subtype, 20, 26
- Phyllanthus niruri* subtype, 24
- Phyllanthus pentaphyllus* subtype, 21, 24, 33, 77
- Phyllanthus*, 18, 20, 21, 25, 29, 38, 77
- acidus*, 25, 26
- * *acuminatus*, 43
- acuminatissima*, 26
- adanthoides*, 37
- amarus*, 24
- * *capillaris*, 26
- discoideus*, 26
- * *elsiae*, 25, 26
- guianensis*, 25
- hyssopifolioides*, 25
- muellerianus*, 26
- * *niruri*, 25
- * *nutans*, 37
- * *pentaphyllus*, 24
- reticulatus*, 26
- stipulatus*, 24
- sublanatus*, 24
- speciosus*, 37
- urinaria*, 25
- * *Pimeleodendron zoanthogyne*, 105
- Piranhea*, 44
- * *trifoliata*, 41
- * *Plagiostyles africana*, 105
- Platygyne* type, 57, 58
- * *Platygyne hexandra*, 58
- Pleiosstemon* type, 30
- * *Pleiosstemon verrucosus*, 30
- Plukenetia* configuration, 60, 65, 105
- Plukenetia* type, 19, 62
- Plukenetia verrucosa* subtype, 63
- Plukenetia volubilis* subtype, 62
- Plukenetia*, 62
- abutifolia*, 62
- buchtienii*, 63
- conophorum*, 63
- corniculatus*, 63
- tamnooides*, 63
- * *verrucosa*, 63
- * *volubilis*, 62

- Pogonophora schomburgkiana*, 90
Polyandra, 82, 83
Poranthera corymbosa, 29
 microphylla, 29
Prosartema gaudichaudii, 60
* *Protomegabaria macrophylla*, 22
* *Pseudagrostistachys africana*, 76
Pseudanthus nematophorus, 43
* *pimeleoides*, 43
Pseudocroton type, 95
Pseudocroton tinctorius, 95
* *Pseudolachnostylus glauca*, 34
Pterococcus corniculatus, 63
Ptychopyxis costata, 81
 kingii, 81
Putranjiva type, 44
* *Putranjiva roxburghii*, 44
Pycnocomma subtype, 80
* *Pycnocomma cornuta*, 80
 macrophylla, 81

Ramelia, 6
Reverchonia, 21
* *arenaria*, 24
Richeria type, 26
Richeria laurifolia, 28
Richeriella, 21
Richeriella gracilis, 26
Ricinocarpus, 48
 pinifolius, 53
Ricinodendron heudelotii, 51
Ricinus type, 19, 79, 86, 88
* *Ricinus communis*, 86
Riseleya, 6
Romanoa, 10, 62, 63

Sagotia, 48, 105
 racemosa, 48, 51
Sandwithia guyanensis, 53
Sapium aubletianum, 99
 ellipticum, 99
 klotzschianum, 99
 longifolium, 97
 montanum, 99
 sebiferum, 99
Sauropus androgynis, 39
Savia type, 32, 34, 36
Savia andringitrana, 34
 erythroxyloides, 24, 33
 sessiliflora, 34
Sebastiania chamaelea, 97
 corniculata, 97
 schottiana, 97
Securinega type, 19, 20, 21, 25, 26,
 32, 39
Securinega subtype, 25, 26
Securinega, 25, 30, 32
 congesta, 22
 neopeltandra, 26
 ramiflora, 26
 suffruticosa, 25

* *virosa*, 26
Seidelia type, 79, 88
Seidelia, 54, 60
 triandra, 88
* *Senefeldera macrophylla*, 105
Senefelderopsis, 6
Speranskia type, 73, 75, 95
* *Speranskia pekinensis*, 76
Sphaerostylis, 57
 natalensis, 63
 tulasneana, 57, 63
Sphyranthera, 6
* *Spirostachys venenifera*, 97
Spondianthus preussii, 22
Stachystemon type, 41
* *Stachystemon vermicularis*, 43
Stenadenium type, 101
* *Stenadenium spinescens*, 101
Stillingia gymnogyna, 97
Strophoblachia fimbriocalyx, 51
Sumbavia configuration, 69, 73, 105
Sumbavia type, 19, 69, 70, 72
Sumbavia, 105
* *rotteroides*, 70
Sumbaviopsis albicans, 70
Suregada, 48, 53
 glomerulata, 53
* *subglomerulata*, 53
Symphyllia siletiana, 94
Synadenium arborescens, 101
Syndyophyllum, 6

* *Tannodia cordifolia*, 53
Tetracarpidium conophorum, 63
Tetracoccus ilicifolius, 41
* *Tetraplandra gibbosa*, 99
Thecacoris leptobotrya, 22
Tetrorchidium type, 56
Tetrorchidium, 48, 56
* *didymostemon*, 57
 rubrivenium, 57
Thelypetalum, 6
Thymelaeaceae, 19
* *Thyrsanthera suborbicularis*, 70
Tragia fallax type, 19, 57
Tragia tristis subtype, 63
Tragia, 18, 58
 capensis, 63
* *fallax*, 58
 geraniifolia, 65
 ramosa, 65
 sellowiana, 58
* *stolziana*, 63
* *tristis*, 63
 volubilis, 65
Tragiella, 57
* *Trewia nudiflora*, 80
Trigonopleura, 73
* *malayana*, 90
Trigonostemon redioides type, 58
Trigonostemon verrucosus type, 58

- Trigonostemon*, 73
fungii, 58
longifolius, 60
 * *rediodes*, 60
 * *verrucosus*, 58
Tritaxis, 48
gaudichaudii, 51
Uapaca, 32
 * *heudelotii*, 36

- kirkiana*, 36
Vaupesia cataractarum, 53
Veconcitea latifolia, 83
Wetria macrophylla, 80
Wielandia elegans, 34
Zimmermannia type, 20, 29
 * *Zimmermannia capillepes*, 29